

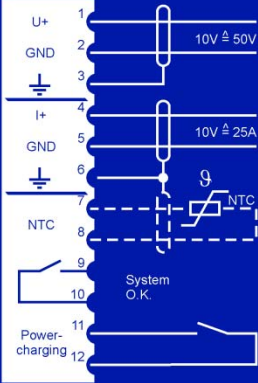

Pb	adj.	nominal	
Pb	adj.	Powercharging	
<hr/>			
NiCd	adj.	nominal	
NiCd	adj.	Powercharging	
<hr/>			
	$I_{max.}$		
	Powercharging		
	System O.K.		
<hr/>			
	12V		
	Battery voltage		
<hr/>			
	24V		
	Pb		
	Battery type		
	NiCd		
<hr/>			
Ausgang Output			



Measuring outputs



Netz / Mains
340 - 530V_{Ac}
50 / 60Hz



Batterieladegerät
Battery Charger
BL20 - 400





Vor dem Öffnen des Gerätes
Entladung der Elkos abwarten
(ca. 5 min.) Betriebsanweisung
beachten !

Before opening the cover wait
about 5 min. to ensure the
discharge of the capacitors. Pay
attention to operation
instructions !

BL20-400 – Power Supply and Battery Charging Unit

Manual BL20-400 (Revision Rev. A)

Woodward Governor Company reserves the right to update any portion of this publication at any time. Information provided by Woodward Governor Company is believed to be correct and reliable. However, no responsibility is assumed by Woodward Governor Company unless otherwise expressly undertaken.

© Woodward 1994-2008

Content

1.	Application	4
2.	Characteristics and Features	5
3.	Functions and Settings	6
3.1	LED Indications	7
3.2	Internal System Signal	7
3.3	Mounting and Connection	8
3.4	Application as stabilized Power Supply Unit	10
3.5	Application as battery charger.....	11
3.5.1	Charging according IU-Characteristics	11
3.6	Temperature Compensation of the Charging Voltage	12
3.7	Parallel Connection of Several Units	12
3.8	Thermal Overload Protection	12
4.	Technical Data.....	13
4.1	Tests and Regulations	15

1. Application

The BL20 is a widely applicable DC - supply unit which is used as battery charger or also as stabilized power supply.

As charging unit it is used for charging, as well as for maintaining the fully charged condition of 12 V or 24 V Pb- or NiCd-batteries. Simultaneous supply of DC-consumers (parallel operation) is possible. Operated in parallel with a battery or other consumer, the BL20 guarantees the supply of the consumers up to the rated output of the charging unit even after disconnection of the battery, for example during maintenance or for ex-change.

The BL20 is short-circuit proof so that it is not necessary to shut down the charging unit during operations which could cause nearly a short-circuit (for instance start of a diesel engine).

As stabilized power supply unit, the BL20 supplies connected consumers with a stabilized d.c. voltage which is adjustable in the range of 11.5 ~ 15.5 V DC (Pos. 12 V) or 23 V DC to 31 V DC (Pos. 24 V).

2. Characteristics and Features

- Supply voltage 3 x 340 ~ 530 V AC
50 Hz / 60 Hz
- Safety according to VDE 0805/EN 60950
- High stability of output voltage
- Low residual ripple
- High efficiency
- Screw type and plug-in connectors
- Interference immunity acc. EN55011 class B
- Suppression of radio interferences acc. to EN 50081-1 und EN50082-2
- Short-circuit and no-load proof
- Parallel connection of several units possible
- Compact housing
- Low weight 3.8 kg
- Clip-on rail fastening or hole fastening
- Various operational LED indications
- Internal system signals
- Complies with PFC Standard acc. to EN 61000-3-2
- Pre-adjusted, switchable charging voltage values
- I /U characteristic acc. to DIN 41772/DIN41773

3. Functions and Settings

The following adjusting and indicating elements are located at the front of the BL20:

Potentiometer: »Pb adj. nominal«
 »Pb adj. Power charging«
 »NiCd adj. nominal«
 »NiCd adj. Power charging«

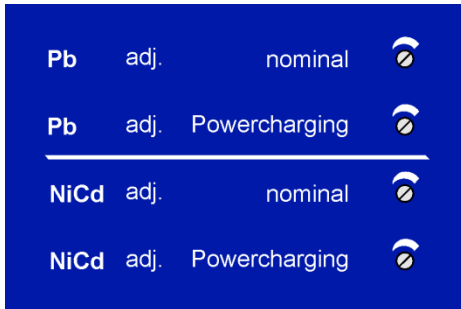

Figure 3.1: Adjusting potentiometer

The charging voltages in the respective operational modes, i.e. »12 V«/»24 V« and »Pb«/»NiCd« are adjusted by the potentiometers. Adjustments are done during no-load operation. For measuring the charging voltage or output voltage of the BL20 a suitable measuring instrument (cl.1 %) has to be used. When turning clockwise, the output voltage rises. The four adjustments given above work independently of each other. The setting range is 23 ~ 31 V DC in pos. »24 V« and 11.5 ~ 15.5 V DC in pos. »12 V«.

Slide switch: »Battery voltage« (12 V/24 V)
 »Battery type« (Pb/NiCd)

The rated voltage of the battery is selected by »Battery voltage«. When switching over, the output voltage of the BL20 is doubled (from 12 V to 24 V) or divided in half (from 24 V to 12 V).

The Pb- or NiCd charging voltage is selected by »Battery type«. When switching over it is changed between the set charging voltages of the two potentiometer pairs Pb and NiCd. Switching over from »Nominal« to »Power charging« is realized by an external potential free NO contact (terminal 11/12) at the 12 pol. signal terminal strip.

By using a small screwdriver, the slide switches are to be put into the appropriate switching position (acc. to the required operational mode).

3.1 LED Indications

»I _{max} « (yellow)	The LED lights up when the current control is in operation. The BL20 operates for instance as power source during I-charging operation when the battery is discharged. For constant power supply in partial mains operation the output voltage is reduced when this LED lights up due to overloading.
»Powercharging« (yellow)	The LED lights up when operational mode »Power charging« is selected.
»System o.k.«	The LED lights up when the BL20 is ready to operate.-
»12 V« (green)	The LED lights up when the rated battery voltage »12 V« was selected.
»24 V« (green)	The LED lights up when the rated battery voltage »24 V« was selected.
»Pb« (green)	The LED lights up when battery type »Pb« was selected.
»NiCd« (green)	The LED lights up when battery type »NiCd« was selected.

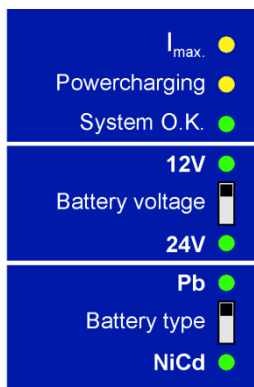

Figure 3.2: LED Indication

3.2 Internal System Signal

As soon as the minimal output values are reached, a potential free NO contact signals „System o.k.“. For this the output voltage has to be $>1A$ or the internal nominal value must have exceeded $0.97 \times U_{\text{soll}}$.

3.3 Mounting and Connection

In order to ensure optimal cooling, it is absolutely necessary to install the unit in the right position, i. e. input terminals (L1/L2/L3/PE or L1/N/PE)) must be on top and output terminals (\pm) at the bottom.

A free space of at least 100 mm must be left above and below the BL20, and of at least 30 mm at both sides.

Please ensure that the temperature of the incoming air does not exceed the admissible value of the ambient temperature indicated in the technical data.

Connection of the three-phase input voltage is to be made according to the instructions printed on the housing of the unit. For this no specific phase sequence has to be observed. The primary side of the unit should be protected with a three-pole L-miniature circuit-breaker or a three-pole motor protection switch (setting 2.5 A). During failure of one phase, operation of the unit is not permitted. The protected earth (PE) of the BL20 must be connected with the protected earth of the switch-board.

Installation must be done acc. to VDE 0100 and VDE 0160.



Figure 3.3: Mains connection

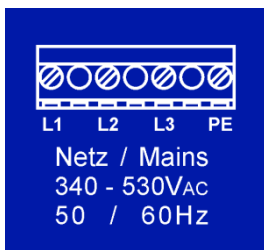

Figure 3.4: Mains connection

Signal terminal strip

Next to the output terminal strip there is a 12-pole signal terminal strip which is used as follows:

- »KI 1, 2, 3« U+/GND/Shield
normalized measuring signal of the charging or output voltage 10V - 50V normalization.
- »KI. 4, 5, 6« I+/GND/Shield
normalized measuring signal of the charging or output current 10A - 25A normalisation.
- »KI. 7, 8« Temperature compensation of the charging or output voltage above 25°C, via NTC room temperature sensors.
- »KI. 9, 10« Contact output »System o.k.«
Contact is closed when the BL20 is ready to operate.
- »KI. 11, 12« Contact input »Power charging«
With an energized external NO contact (potential free!) Power Charging is actuated

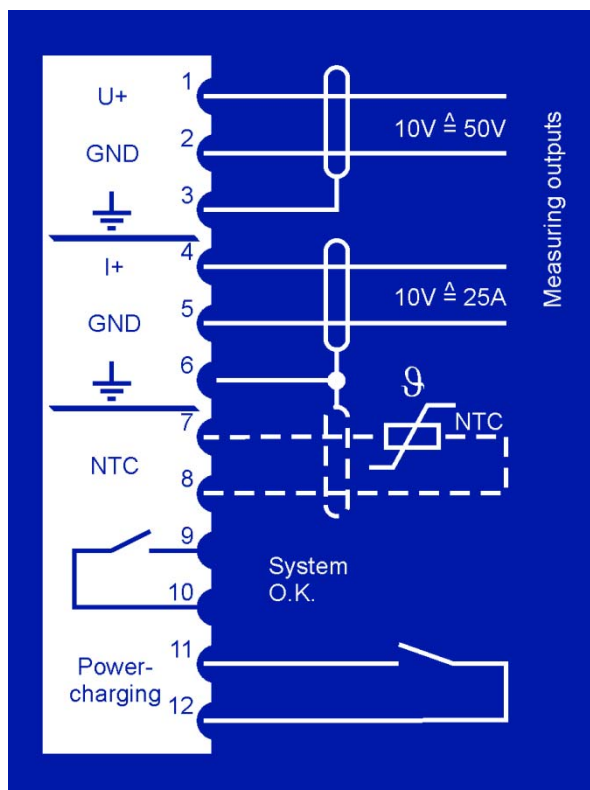

Figure 3.5: Output Terminal Strip

Attention!

The existing safety rules at site must be observed during all installation and service jobs!

There are two output voltage terminals for each pole. For drawing the total current always both connections have to be used.

3.4 Application as stabilized Power Supply Unit

Used as stabilized power supply unit, the BL20 supplies consumers with a constant output voltage between 11.5 ~ 15.5 V DC (operat. mode 12 V) or 23 ~ 31 V DC (operat. mode 24 V).

The output voltage is stabilized up to the rated current (20 A) at the output voltage terminals (!) of the BL20. The output voltage is reduced by :

- a load causing currents > 20 A ,
- thermal overload protection, (temperature derating),
- external temperature sensors,
- a too low supply voltage.

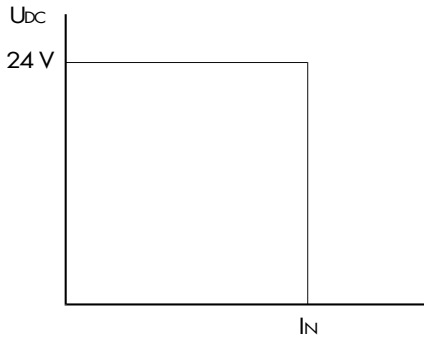

Figure 3.6: Limitation of current

3.5 Application as battery charger

For charging at normal temperatures up to 30° C, most battery manufacturers recommend for lead acid batteries a trickle charging voltage of 2.25 V per cell. From this results a trickle charging voltage of 27 V for a 24 V lead acid battery. In case of higher ambient temperatures, the charging voltages must be reduced following the instructions of the battery manufacturers, whereas in case of external voltage losses they must be increased accordingly.

The default setting of the BL20 is for the following charging voltages and dependent on the operational mode these are as listed below:

Pb/12 V/Nominal:	13.5 V DC
Pb/12 V/Powercharging:	14.4 V DC
Pb/24 V/Nominal:	27.0 V DC
Pb/24 V/Powercharging:	28.8 V DC
NiCd/12 V/Nominal:	14.0 V DC
NiCd/12 V/Powercharging:	15.5 V DC
NiCd/24V Nominal:	28.0 V DC
Ni Cd/24 V/Powercharging:	31.0 V DC

3.5.1 Charging according IU-Characteristics

Charging is done acc. to a IU-characteristic (see Figure 3.7). When batteries are discharged, a high current of approx. 20 - 22 A flows in the first stage (I-charge). It is limited by the BL20. As soon as the charging voltage reaches the set value (equalizing charging), transition for charging at constant voltage takes place (U charge). The charging current decreases until the unit supplies a trickle charging current, in addition to the current necessary for connected consumers. The advantage of this charging procedure, compared to the charging at constant current, is shown here. By reduction of the current upon reaching the trickle charging voltage, overcharge of the battery is prevented. Therefore, an inadmissibly high water loss by gassing is avoided, which would occur, if a continued high charging current flows, after the battery has been fully charged.

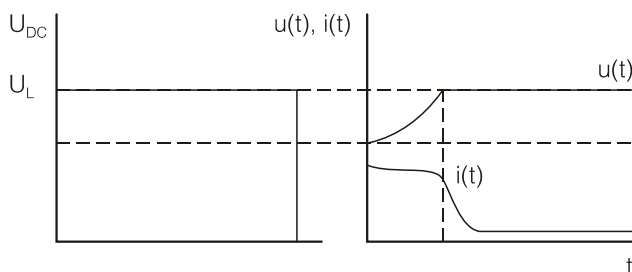

Figure 3.7: Charging acc. To IU characteristic

3.6 Temperature Compensation of the Charging Voltage

For reducing the charging voltage at an ambient temperature of $> 25^{\circ}\text{C}$ a NTC temperature sensor (NTC 4k7 BC-Components 2322 640 63472) can be connected.

The compensation value comes to:

In the 12 V range: -0.0303 V/K

In the 24 V range: -0.0606 V/K

Example: «Pb/12 V/Nominal» at 60°C :

$-0.0303 \text{ V} \times 35 \text{ K} = 1.9695 \text{ V}$ compensation value

For the respective compensation value a tolerance of $\pm 10\%$ applies.

The compensation function is inactive if there is no NTC sensor connected to terminals 7 and 8.

3.7 Parallel Connection of Several Units

If constant currents are required which exceed the rated current of one unit, any number of BL20 units can be connected in parallel. To achieve an optimal distribution of the load it is important that all units are led to the bus bar via equally long connection lines of identical cross sections. During no-load operation each of the output voltages of the units have to be adjusted accurately to the first decimal point by means of a digital multimeter.

NOTE:

Series connection of several BL20 units is not possible!

3.8 Thermal Overload Protection

In order to prevent defects due to excessive ambient temperatures, the BL20 unit is provided with a controlled temperature derating device. If the limiting temperature is exceeded at the power semi conductors, the output power is reduced.

Reduction of the output power becomes evident by reduced charging current. Power derating begins at $> 50^{\circ}\text{C}$ with about $-1.7 \% / \text{K}$.

4. Technical Data

General Data

Type:	BL20-400
Permissible operating time:	continuous operation
Connection terminals:	max. 2.5mm ² (wire connection)
Type of cooling:	convection cooling
Maintenance:	none
Short circuit:	sustained short circuit proof
Battery types:	12 V or 24 V, Pb or NiCd batteries

Input circuit

Supply voltage

Voltage range:	3 x 340 VAC to 530 VAC
max. supply current:	3 x 1.8 A (24 V operation at 3x 340 VAC supply)
Frequency range:	47 - 63 Hz
Inrush current:	<50 A
Power factor cosφ:	0.71 capacitive
Fuse:	three-pool motor protection switch 2.5~4 A, Setting 3 A or 3 x 6A C- miniature C.B
Max. earth stray current:	< 3.5 mAAC
Booster charge/Control contact:	NO contact, potential free, with small-signal ability load 5V / <10 mA
Temp. compensation of the charging voltage:	NTC / 4.7 kΩ 500 mW +/- 5% BC-Components 2322-640-63472

Output circuits

Setting ranges of charging voltages

12V- operation:	11.5 VDC up to 15.5 VDC (for all settings)
24V- operation:	23 VDC up to 31 VDC (for all settings)

Factory setting

12V-Pb- Nominal:	13.5	VDC
12V-Pb- Power charging:	14.4	VDC
24V Pb- Nominal:	27.0	VDC
24V Pb- Power charging:	28.8	VDC
12V-NiCd- Nominal:	14.0	VDC
12V-NiCd- Power charging:	15.5	VDC
24V NiCd- Nominal:	28.0	VDC
24V NiCd- Power charging:	31.0	VDC
Rated current range:	20 ADC to 22 ADC	
Rated current tolerance:	±2 %	
Continuous output power:	620 W at 25 °C 350 W at 70 °C (controlled thermal derating)	
Efficiency:	0.87 (at ratings UV=400V, UA=31V, IA=20A)	
Max. power loss:	90 W	
Max. residual ripple of voltage:	<200 mVpp	
Max. residual ripple of current:	<200 mA _{pp}	

Charging voltage regulation (at 25°C)

static load deviation	0 auf 100 %:	< 2% deviation
	10 auf 90 %:	< 1% deviation
dynamic regulation deviation	10 auf 90 %:	< 1V, < 2ms
	90 auf 10 %:	< 1V, < 10 ms

Temp. drift of the output volt.:	<0.05%/K
----------------------------------	----------

Normalized output values

Charging voltage:	50V equivalent to 10V normalized output value
Charging current:	25A equivalent to 10V normalized output value
Load impedance:	=/ > 2 k Ω
Signal System o.k.	
NO contact	
Max. switching voltage:	250VAC, 220 VDC
Max. switching current:	3 A
Switching load:	50VA / 60 W
Min. load:	10mVDC / 0.1 mA

Operational data**Temperature ranges**

- during operation:	-25 up to +70°C, with free convection
- during storage:	-25 up to +85°C
Autom. derating of the output power:	-1.7%/K (ab > 50°C bei Pab=520W)

Housing

Dimensions (W x H x D):	264 mm x 175 mm x 130 mm (BxHxT)
Space for convection:	above and below the unit 100 mm, lateral 30 mm
Weight:	approx. 3.8 kg
Mounting:	DIN-rail mounting acc. to DIN EN 50022, 35x15 mm

4.1 Tests and Regulations

General Regulations: EN50178

IU-charge:	Characteristic acc. to: DIN 41772 DIN 41773
Special basic standards:	EN50081-1, EN50082-2
High-voltage test:	EN50178, GL Pri./Sec.: 3000 Vdc, Pri./PE: 3000 Vdc, Sec./PE: 800 Vdc, Pri./Contact: 3000 Vdc, Sec./Contact: 2200 Vdc, PE/Contact: 2200 Vdc
Interference immunity/BURST:	EN61000-4-4, class 4 Mains inputs ± 4 kV/2,5 kHz Other in- and outputs ± 2 kV/5kHz
Interference immunity/SURGE:	EN61000-4-5, class 4 Mains inputs, symmetric/asymmetric ± 4 kV
Interference immunity/HF- FELD:	EN61000-4-3, class 3 Position x, y, z with 10 V/m
Interference immunity/ESD:	EN 61000-4-2, class 3 Air discharge 8 kV Contact discharge 6 kV
Interference immunity.: energy M-FELD	EN61000-4-8, class 5 Position x, y, z 100 A/m für 1 Min., 1000 A/m for 3 sec.
Radio interference voltage:	EN55011, limiting value cl. B
Radio interference radiation:	EN55011, limiting value cl. A
Vibration test :	EN60255-21-1, class 1 Vibration test for functionality 0.035mm/0.5 g, per cycle in x, y, z Continuous vibration test 1 g, per 20 cycles in x, y, z
Dry heat:	DNV [5/95] GL [10/97] Temp.: +55°C / +70°C, rel. humidity: 10%, cycles:1, 16 + 2h
Cold:	DNV [5/95] GL [10/97] Temp.: -25°C, cycles: 1, 2h
Humid heat:	DNV [5/95] GL [10/97] LR [1996] IEC 60068-2-30 Temp.: +55°C, rel. humidity: 95 %, cycles: 2, 12 + 12h
Degree of protection:	IP20

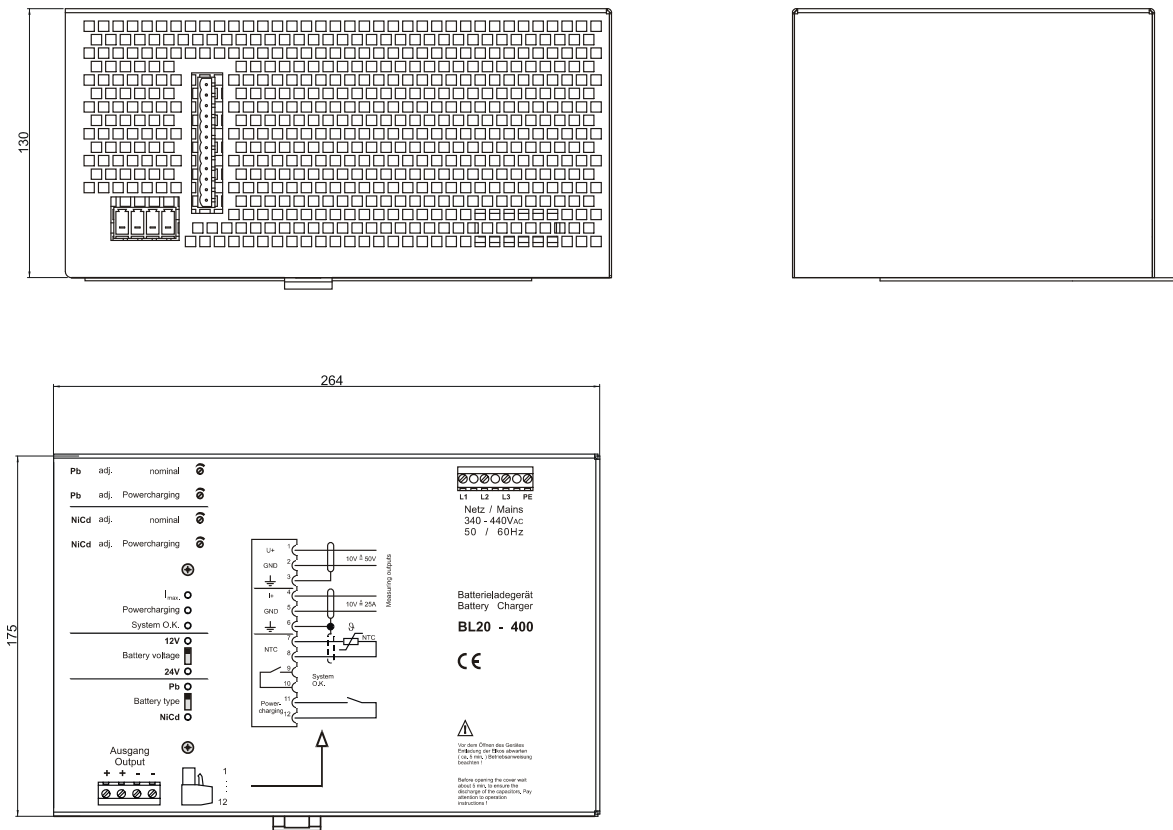

Figure 4.1: Housing dimensions

All dimensions in mm!

Mounting: Din-rail EN50022, 35 x 15 mm

A free space of at least 100 mm must be left above and below the BL20, and of at least 30 mm at both sides. (refer chapter 3.3).

**Woodward Kempen GmbH**

Krefelder Weg 47 · D – 47906 Kempen (Germany)
Postfach 10 07 55 (P.O.Box) · D – 47884 Kempen (Germany)
Phone: +49 (0) 21 52 145 1

Internet

www.woodward.com

Sales

Phone: +49 (0) 21 52 145 216 or 342 · Telefax: +49 (0) 21 52 145 354
e-mail: salesEMEA_PG@woodward.com

Service

Phone: +49 (0) 21 52 145 614 · Telefax: +49 (0) 21 52 145 455
e-mail: SupportEMEA_PG@woodward.com