

MANUAL

Smart view | PARAMETER SETTING AND EVALUATION SOFTWARE

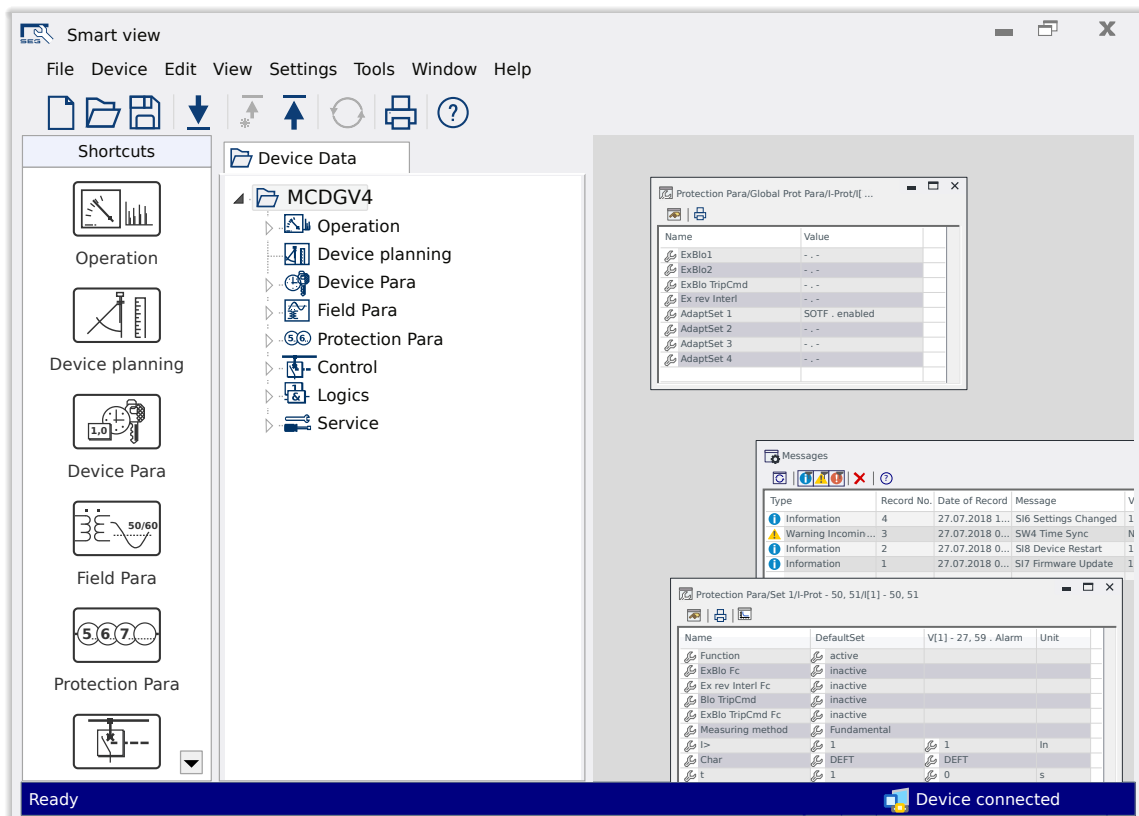

PARAMETER SETTING AND EVALUATION SOFTWARE

Version: 4.90

Original document

English

Manual (original)

SEG Electronics GmbH

Krefelder Weg 47 • D-47906 Kempen (Germany)

Telephone: +49 (0) 21 52 145 1

Internet: www.SEGelectronics.de

Sales

Telephone: +49 (0) 21 52 145 331

Fax: +49 (0) 21 52 145 354

E-mail: sales@SEGelectronics.de

Service

Telephone: +49 (0) 21 52 145 614

Fax: +49 (0) 21 52 145 354

E-mail: support@SEGelectronics.de

© 2020 SEG Electronics GmbH. All rights reserved.

Table of Contents

1	Important Definitions	5
2	Introduction to Smart view	9
2.1	Installation of Smart view	9
2.2	Silent Installation	10
2.3	Uninstall Smart view	11
2.4	Optional Accessories	11
2.5	Program Exit	12
3	Setting up the Connection between PC and Device	13
3.1	Connect a HighPROTEC Device via a USB Cable	14
3.2	Connect a HighPROTEC Device via TCP/IP (Ethernet)	16
3.3	Connect a HighPROTEC Device via a Serial RS232 Interface	17
3.4	Connect a High Tech Line 3 Device	19
3.5	Troubleshooting during Setting up the Connection	21
3.5.1	Persistent Connection Problems (*)	21
4	Command-Line Parameters and Exit Codes	23
5	Smart view Keyboard Commands	30
6	Operating a HighPROTEC Protection Device	31
6.1	Loading of Device Data when using Smart view	31
6.2	Transfer Device Data from Smart view to the Device	32
6.3	Backup and Documentation when using Smart view	34
6.4	Offline Device Planning via Smart view	36
6.5	Measuring Values	37
6.6	Acknowledgments and Resets	38
6.7	Status Display via Smart view	39
6.8	Recorders	40
6.8.1	Disturbance Recorder	40
6.8.2	Fault Recorder	41
6.8.3	Trend Recorder	41

6.8.4	Event Recorder	42
6.8.5	Motor Start Recorder	44
6.8.6	Statistic Recorder	47
6.8.7	Internal Messages (Self-Supervision Recorder)	47
6.9	Passwords	48
6.10	Device Planning	49
6.11	Parameters	50
6.11.1	Parameter Files	53
6.12	Digital Inputs	56
6.13	Synchronize Date and Time via Smart view	58
6.14	Display Version Information	59
6.15	Display of ANSI-Codes	60
6.16	Graphical Display of Tripping Characteristics	61
6.17	Single-Line Diagrams	63
6.18	Programmable Logic via Smart view	65
6.19	Communication (SCADA)	66
6.19.1	IEC 61850(*)	67
6.19.2	Configurable Communication Protocols(*)	68
6.19.2.1	Data-Point Mapping Using the SCADApter	69
6.19.3	Remote Configuration for Line Differential Protection Devices(*)	71
7	Operating a High Tech Line 3 Device	72
7.1	Loading of Device Data when using Smart view	72
7.2	Transfer Device Data from Smart view to the Device	73
7.3	Backup and Documentation when using Smart view	74
7.4	Offline Device Planning via Smart view	75
7.5	Measuring Values	76
7.6	Status Display via Smart view	77
7.7	Recorders	78
7.8	Parameters	80
7.9	Synchronize Date and Time via Smart view	82
7.10	Version via Smart view	83
8	Index	84

1 Important Definitions

The types of messages shown below serve the safety of life and limb as well as for the appropriate operating life of the device.

DANGER!



DANGER indicates an immediately dangerous situation that will result in death or serious injury if it is not avoided.

WARNING!



WARNING indicates a hazardous situation that can result in death or serious injury if it is not avoided.

CAUTION!



CAUTION indicates a possibly hazardous situation that can result in minor or moderate injuries if it is not avoided.

NOTICE!



NOTICE is used to address practices not related to personal injury.



This symbol indicates useful tips and recommendations as well as information for efficient and trouble-free operation.

Proper Use of the Device and of This Manual

WARNING!



FOLLOW INSTRUCTIONS

Read this entire manual and all other publications pertaining to the work to be performed before installing, operating, or servicing this equipment. Practice all plant and safety instructions and precautions. Failure to follow instructions can cause personal injury and/or property damage.

WARNING!**PROPER USE**

Any unauthorized modifications to or use of this equipment outside its specified mechanical, electrical, or other operating limits may cause personal injury and/or property damage, including damage to the equipment. Any such unauthorized modifications: (1) constitute “misuse” and/or “negligence” within the meaning of the product warranty thereby excluding warranty coverage for any resulting damage, and (2) invalidate product certifications or listings.

The programmable devices subject to this manual are designed for protection and also control of power installations and operational devices that are fed by voltage sources with a fixed frequency, i.e. fixed at 50 or 60 Hertz. They are not intended for use with Variable Frequency Drives. The devices are further designed for installation in low-voltage (LV) compartments of medium voltage (MV) switchgear panels or in decentralized protection panels. The programming and parameterization has to meet all requirements of the protection concept (of the equipment that is to be protected). You must ensure that the device will properly recognize and manage (e. g. switch off the circuit breaker) on the basis of your programming and parameterization all operational conditions (failures). The proper use requires a backup protection by an additional protective device. Before starting any operation and after any modification of the programming (parameterization) test make a documentary proof that your programming and parameterization meets the requirements of your protection concept.

The Self-Supervision Contact (Life-Contact) has to be wired with the substation automation system in order to supervise and monitor the state of health of the programmable protective device. It is very important that an alarm annunciation is driven from the programmable protective device self-supervision contact (Life-Contact) that requires immediate attention when tripped. The alarm indicates that the protective device is no longer protecting the circuit and the system should be serviced.

Typical applications for this product family/device line are for instance:

- Feeder protection
- Mains protection
- Machine protection
- Transformer Protection
- Generator Protection

Any usage beyond these applications the devices are not designed for. This applies also to the use as a partly completed machinery. The manufacturer cannot be held liable for any resulting damage, the user alone bears the risk for this. As to the appropriate use of the device: The technical data and tolerances specified by *SEG* have to be met.

***Out-of-date documentation?***

This publication may have been revised or updated since this copy was produced. To verify that you have the latest revision, please visit the download section of our website.

Please check the web site of SEG for the latest revision of this Technical Manual and if there is an Errata Sheet with updated information.

- Visit the company website and search for the documents you are interested in. (The ID of every document is printed on its cover page.)
- Alternatively, every Prot_WIN_SW device has a QR code printed on it. Scan this code, and you are taken to an online directory that contains all relevant documents in the most recent version.

Important Information**WARNING!**

In line with the customer's requirement the devices are combined in a modular way (in compliance with the order code). The terminal assignment of the device can be found on the top of the device (wiring diagram).

CAUTION!



Electrostatic Discharge Awareness

All electronic equipment is electro static-sensitive, some components more than others. To protect these components from electro static damage, you must take special precautions to minimize or eliminate electrostatic discharges. Follow these precautions when working with or near the control.

1. Before doing maintenance on the electronic control, discharge the static electricity on your body to ground by touching and holding a grounded metal object (pipes, cabinets, equipment, etc.).
2. Avoid the build-up of static electricity on your body by not wearing clothing made of synthetic materials. Wear cotton or cotton-blend materials as much as possible because these do not store static electric charges as much as synthetics.
3. Keep plastic, vinyl, and Styrofoam materials (such as plastic or Styrofoam cups, cup holders, cigarette packages, cellophane wrappers, vinyl books or folders, plastic bottles, and plastic ash trays) away from the control, the modules, and the work area as much as possible.
4. Do not remove any printed circuit board (PCB) from the control cabinet unless absolutely necessary. If you must remove the PCB from the control cabinet, follow these precautions:
 - Verify the safe isolation from supply. All connectors have to be unplugged.
 - Do not touch any part of the PCB except the edges.
 - Do not touch the electrical conductors, the connectors, or the components with conductive devices or with your hands.
 - When replacing a PCB, keep the new PCB in the plastic antistatic protective bag it comes in until you are ready to install it. Immediately after removing the old PCB from the control cabinet, place it in the antistatic protective bag.

SEG reserves the right to update any portion of this publication at any time. Information provided by *SEG* is believed to be correct and reliable. However, no responsibility is assumed by *SEG* unless otherwise expressly undertaken.

© 2020 SEG. All Rights Reserved.

2 Introduction to Smart view

Smart view is a parameter setting and evaluation software.

It is primarily intended to be connected with devices from the *HighPROTEC* family of protection devices, and therefore this is the main focus of this manual, especially because the devices from this series offer the most complexity and feature-richness. However, there are also a lot of protection devices from the *High Tech Line 3*, the *Professional Line* and the *WI Line* series supported. SEG will continue to add support for more and more devices (plus – of course – further enhancements in general); therefore it is worthwhile making sure to always have the latest *Smart view* version installed.

However, please be aware that for devices from the *High Tech Line 3*, the *Professional Line* and the *WI Line* series, not all functionality described in this manual is available; only those features can be used that are actually supported by the connected device.

The full feature set, as available with *HighPROTEC* devices, comprises:

- Menu-controlled parameter setting incl. validity checks
- Offline configuration of all relay types
- Reading and evaluating of statistical data and measuring values
- Setting into operation assistance
- Display of the device status
- Fault analysis via event- and fault recorder

NOTICE!



Smart view 3.0 or higher supports reading parameter files generated by older versions of *Smart view*. Parameter files generated by *Smart view* 3.0 and higher cannot be read by older versions of *Smart view*.

2.1 Installation of Smart view

NOTICE!



The TCP/IP ports in the range 52152 ... 52163 must not be blocked by a firewall, and none of these ports must be used by any other (non-SEG) application.

(This requirement persists regardless of the connection type that will be actually used, i. e. also for [USB connections](#).)

NOTICE!



If the Windows User Access Control pops up while installing *Smart view*, please “Allow” all installation requirements concerning *Smart view*.

System Requirements

Windows 7, Windows 8.x or Windows 10 (upgraded to the latest officially available status)

Setup

The *Smart view* setup file is available on the product DVD, that is part of the delivery of the protective device. The setup program “Smartview_SE_Install.exe” is contained in the “*Smart view SE*” folder of the product DVD.

In addition, the *Smart view* setup can also be retrieved from the SEG download area: [⇒ docs.SEGelectronics.de/smart_view](https://docs.SEGelectronics.de/smart_view)

To install *Smart view*:

- Double-click on the installation file with the left mouse button.
- Select a language for the installation procedure.
- Confirm by pressing the »Continue« button in the INFO frame.
- Select an installation path or confirm the standard installation path by mouse click on the »Continue« button.
- Confirm the entry for the suggested installation folder by mouse click on the »Continue« button.
- By mouse click on the »Install« button, the installation routine is started.
- Close the installation procedure by mouse click on the »Complete« button.

Now you can launch the program via [Start / Programs / SEG / Smart view].

If DLLs should be Missing

If *Smart view* should refuse to start because of missing DLLs then your Windows PC needs to have the “*Visual C++ 2017 Redistributable (x86)*” package installed.

You can get this package either from our download area at [⇒ docs.SEGelectronics.de/vc_redist_x86](https://docs.SEGelectronics.de/vc_redist_x86), or directly from Microsoft.

Switching the Language of the Graphical User Interface

Within the menu [Settings / Language], you can change the language of the graphical user interface.

2.2 Silent Installation

In some cases it is required to perform an unattended (“silent”) installation. For example, an IT department might want to remotely install or upgrade *Smart view* without the PC user being distracted by dialog windows.

The setup program features a special “silent” mode for this purpose, which is entered if command-line options are given as follows:

- Smartview_SE_Install.exe /SILENT

This command performs a “silent” installation of all *Smart view*-related applications including USB driver, and there is no user interaction needed for the installation

process. However, the Installation Progress window is visible during the installation process.

- `Smartview_SE_Install.exe /VERYSILENT`

This command performs a “very silent” installation of all *Smart view*-related applications including USB driver: There is no user interaction needed for the installation process, and no dialog or window is visible.

The SILENT and VERYSILENT options may be used with another option, UNINSTOLD.

- `Smartview_SE_Install.exe /SILENT /UNINSTOLD`

`Smartview_SE_Install.exe /VERYSILENT /UNINSTOLD`

In addition to the “silent” and “very silent” installation described above, it is checked whether there are any previous (“old”) versions of *Smart view* installed, and if this is the case then the previous version(s) are uninstalled (also in a “silent” manner, without any user interaction).

NOTICE!



Note that additional preparations might be necessary to let the installation process run seamlessly; in particular, the “UAC” (User Access Control) dialog of the Windows operating system has to be managed via the “Microsoft System Center” and the “Microsoft Group Policy”.

2.3 Uninstall Smart view

Via the usual Software Control Panel - [Start / System Control / Software] - the *Smart view* can be removed from your computer.

2.4 Optional Accessories

The type of cable required for the connection is dependent on the type of protective device. The cables are not part of the product delivery, but can be ordered separately from SEG.

		
<p><i>USB cable</i>, for protective devices with USB front connector.</p> <p>SEG article: 5450-1946</p>	<p><i>Null Modem cable</i>, for protective devices with RS232 front connector.</p> <p>SEG article: COMRS232Nullm</p>	<p><i>USB/Serial adaptor</i>, for protective devices with RS232 front connector and PC without RS232 connector.</p> <p>SEG article: USB2RS232ADAP</p>

2.5 Program Exit

You quit *Smart view* by clicking the menu item [File / Exit] or, alternatively, clicking the »Exit« icon (“☒”) top right of the window, as usual with Windows applications.

If any modifications have been made in a currently loaded parameter setting file, you are asked to save these changes.

If a device is still connected, this connection will be closed.

3 Setting up the Connection between PC and Device

The menu item [Settings / Device Connection] allows for selecting the type of connection that is used for connecting *Smart view* with a protection device. There are various options:

- Serial connection, see [↪ “3.3 Connect a HighPROTEC Device via a Serial RS232 Interface”](#)
- USB connection, see [↪ “3.1 Connect a HighPROTEC Device via a USB Cable”](#)
- Ethernet connection, see [↪ “3.2 Connect a HighPROTEC Device via TCP/IP \(Ethernet\)”](#)
- HTL3/PL/WIP device connection, which is used for connecting with a protection device from the *High Tech Line 3*, the *Professional Line* or *WI Line* series; see [↪ “3.4 Connect a High Tech Line 3 Device”](#)

NOTICE!



If a firewall is installed on your computer, make sure that no TCP/IP port in the range 52152 ... 52163 is blocked. (This is required for all connection types listed here.)

Secured Communication

Only for HighPROTEC devices as of Release 3.4: For security reasons, it is possible to restrict or disable the connection between *Smart view* and the HighPROTEC device. Of course, the following descriptions assume that the access has **not** been blocked.

Only for HighPROTEC devices as of Release 3.6: Moreover, a connection is established only after a connection password has been entered. Finally, the connection is fully encrypted, and certificates guarantee the correct identity of the communication parties. The user, however, need not take care of the encryption, this is established automatically in the background. (See the “Security” chapter of the device manual for details.)

3.1 Connect a HighPROTEC Device via a USB Cable

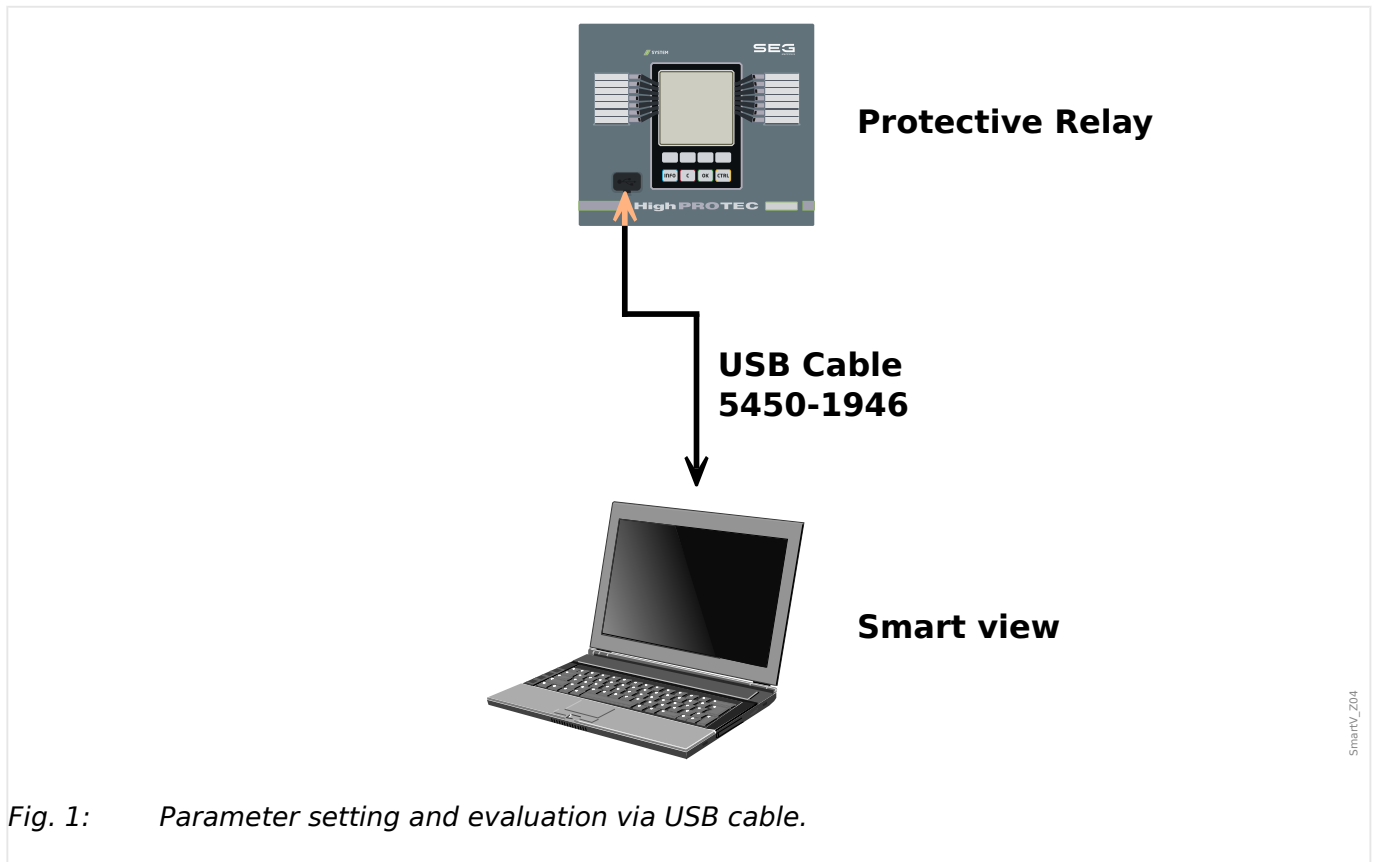

SmartV_Z04

NOTICE!

! For HighPROTEC devices as of Release 3.4 it is possible for security reasons to disable this connection type (though the factory default is that it is set active). Of course, the following description assumes that the access has been activated.

- ⚙
- 1. ▷ Please install *Smart view* in case that it has not yet been installed on your PC.
- 2. ▷ Connect your PC/notebook via a USB cable with a powered/running device.
- 3. ▷ Start *Smart view*.
- 4. ▷ Select the menu point »Device Connection« in menu »Settings«.
- 5. ▷ Within this menu select the communication option USB connection.
- 6. ▷ Within the Drop-Down-Menu select the connected USB device.
 - ▶ If the interface is chosen for the first time, a pop-up window will appear “The selected connection is currently not installed. Should this connection be used for device communication?”.
- 7. ▷ Confirm this by pressing the “Yes” button.

Only for HighPROTEC devices as of Release 3.6: Remember that later, while establishing a connection, *Smart view* might ask for a connection password (“USB connection”, unless this has been set empty). See [↳ “Secured Communication”,](#) [↳](#)

[“Change Passwords via Smart view”](#) and the [“Security”](#) chapter in the Technical Manual of the relay.

3.2 Connect a HighPROTEC Device via TCP/IP (Ethernet)

WARNING!



Mixing up IP-Addresses (In case that there is more than one protective device within the TCP/IP network). Establishing an unintentional wrong connection to a protective device based on a wrong entered IP-Address. Transferring parameters into a wrong protective device might lead to death, personal injury or damage of electrical equipment.

In order to prevent faulty connections the user has to document and maintain a list with the IP addresses of any switchboard/protective device.

The user has to doublecheck the IP addresses of the connection that is to be established. That means, the user must first read out the IP address at the HMI of the device (within menu [Device Para / TCP/IP / TCP/IP config]), then compare the IP address with the list. If the addresses are identical, establish the connection. Otherwise do **not** connect.

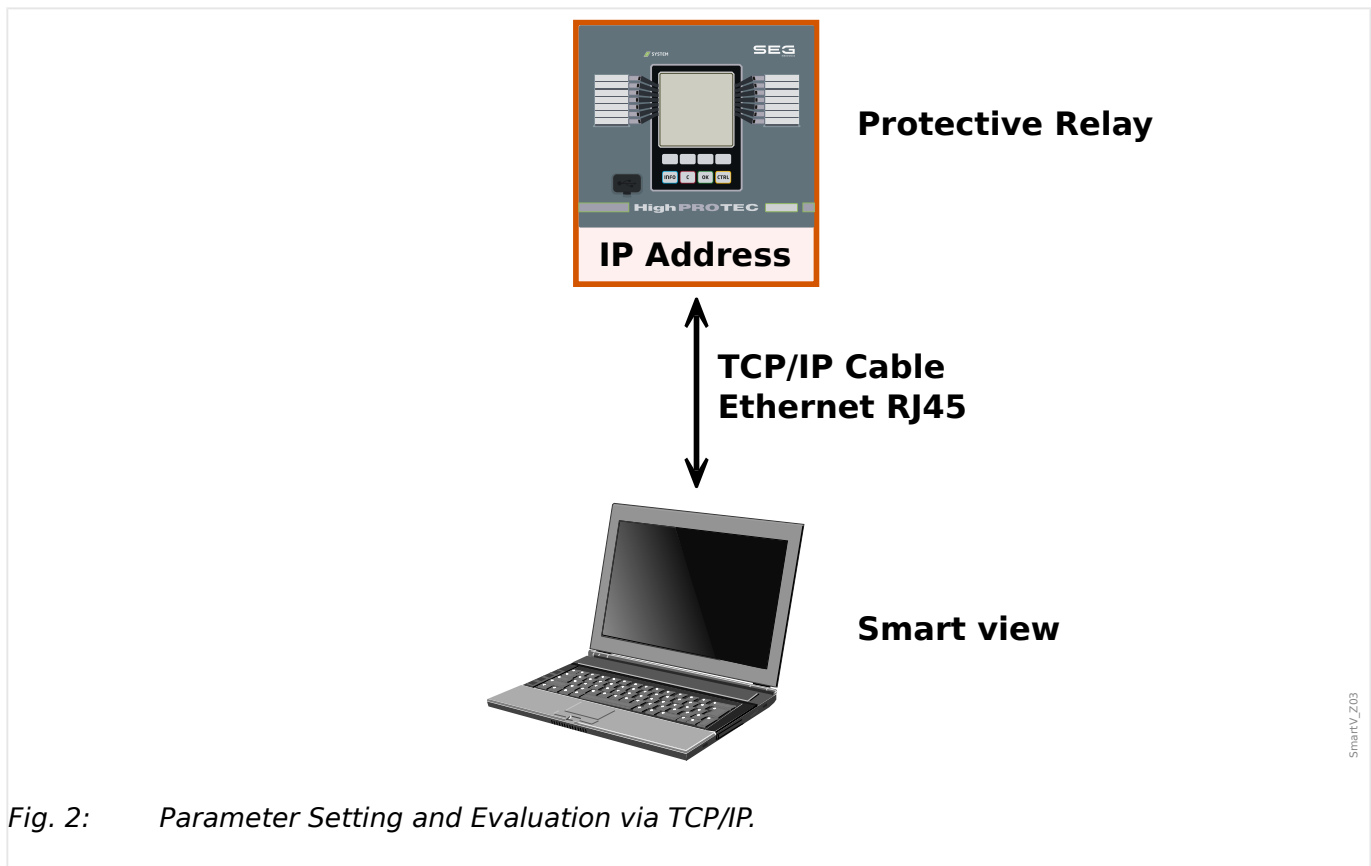



Fig. 2: Parameter Setting and Evaluation via TCP/IP.

NOTICE!



Establishing a connection via TCP/IP to the device is only possible if your device is equipped with an Ethernet interface.

Contact your IT administrator in order to establish the network connection.

For HighPROTEC devices as of Release 3.4 it is possible for security reasons to disable this connection type. Of course, the following description assumes that the access is permitted.

Part 1: Set the TCP/IP Parameters at the panel (Device).

Enter the menu branch [Device Para / TCP/IP / TCP/IP config] at the HMI (panel) and set the following parameters:

- TCP/IP address
- Subnet mask
- Gateway

Part 2: Setting the IP address within Smart view



1. ▷ Enter the menu [Settings / Device Connection] within *Smart view*.
2. ▷ Select the button »Ethernet-Connection«.
3. ▷ Enter the IP-Address of the device that should be connected.

Only for HighPROTEC devices as of Release 3.6: Remember that later, while establishing a connection, *Smart view* might ask for a connection password (“Remote network connection”, unless this has been set empty). See [↩️ “Secured Communication”](#), [↩️ “Change Passwords via Smart view”](#) and the “Security” chapter in the Technical Manual of the relay.

3.3 Connect a HighPROTEC Device via a Serial RS232 Interface

NOTICE!



The serial connection described here is applicable only for older HighPROTEC protection devices (until Release 2.5).

As of Release 3.0, all HighPROTEC protection devices have a USB interface, instead of RS232. (Therefore the description in [↩️ “3.1 Connect a HighPROTEC Device via a USB Cable”](#) is applicable for these.)



Null Modem cable

SEG article:

COMRS232Nullm



After installation of the *Smart view*, the »Connection PC/Notebook to the Device« has to be configured once so that you are able to read device data or re-write them into the device by means of *Smart view*.

NOTICE!



For connection of your PCs/notebooks with the device, you need the following equipment:

- a **zero-modem cable** (SEG article "COMRS232Nullm", no serial cable)!
Please refer to chapter »Zero Modem Cable« within the device manual.
- If your PC/notebook does not have a serial interface, you need a special »**USB-to-serial-adapter**« (SEG article "USB2RS232ADAP").

Only if the »USB-to-serial-adapter« is correctly installed - aided by the provided CD - the communication with the device can be established. (See [↔](#) "Setting up/Configuring the Connection".)



Null Modem cable

SEG article:

COMRS232Nullm



USB/Serial adaptor

SEG article:

USB2RS232ADAP



Setting up/Configuring the Connection



1. ▷ Connect your PC/notebook with the device via a zero-modem cable. Start the software *Smart view*.
2. ▷ Select the menu point »Device Connection« in menu »Settings«.
3. ▷ Click on »Serial Connection«.
4. ▷ Select the serial interface (COM-Port) where the device shall be connected to.
5. ▷ Confirm the adjustments by clicking the »OK« button.
 - ▶ If the interface is chosen for the first time, a popup window will appear "The selected connection is currently not installed. Should this connection be used for device communication? "
6. ▷ Confirm this by pressing the "Yes" button.

Establishing the Connection via a USB-/RS232-Adapter

If your PC/notebook is not provided with a serial interface, this can be compensated by a special USB-/RS232-Adapter+Zero Modem-Cable.

NOTICE!

Only an adapter accepted by SEG is to be used (USB2RS232ADAP). First install the adapter (with the related driver that you can find on the CD) and then establish the connection (*Smart view* => Device). The adapters must support very high speed.

3.4 Connect a High Tech Line 3 Device

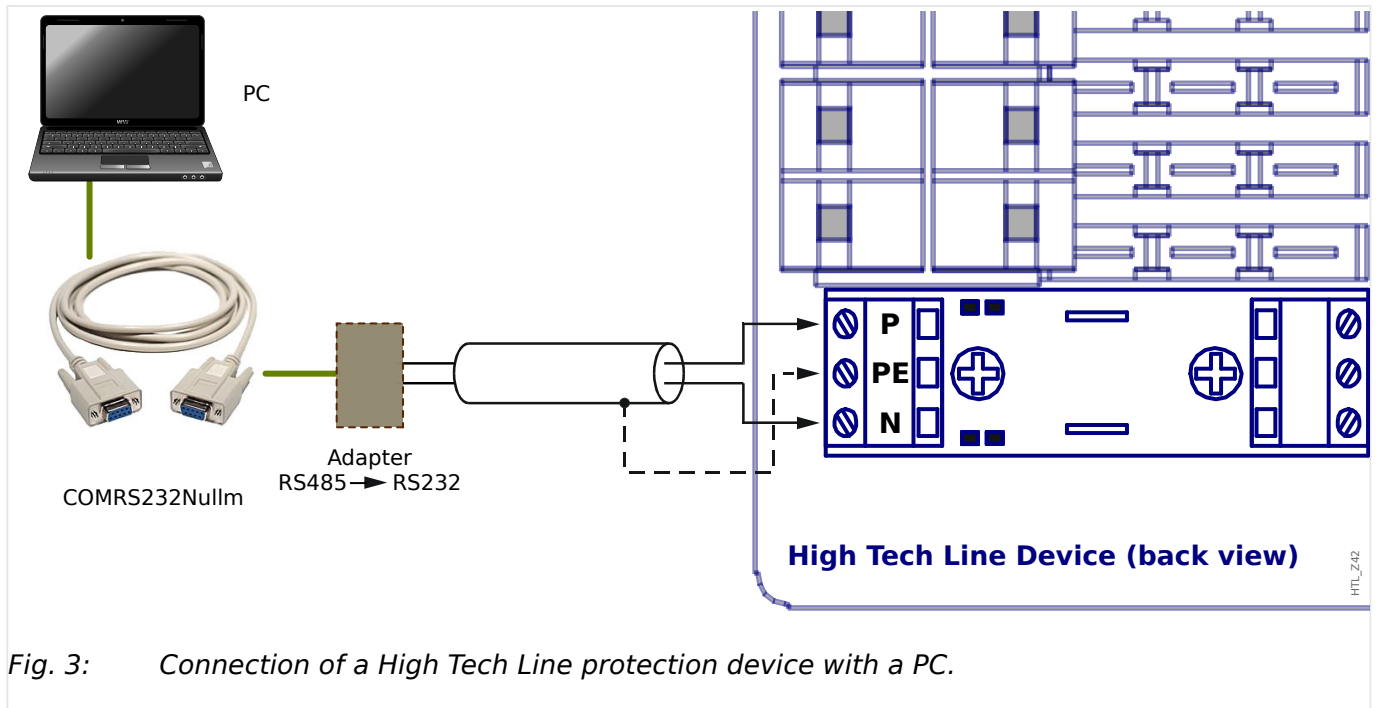

Fig. 3: Connection of a High Tech Line protection device with a PC.

NOTICE!

For connection of your PCs/notebooks with the device, you need the following equipment:

- an »RS485 to RS232 adapter« (any supplier), and
- a zero-modem cable (SEG article "COMRS232Nullm", no serial cable)!

NOTICE!

If your PC/notebook does not have a serial interface, you also need a special »USB-to-serial-adapter« (SEG article "USB2RS232ADAP").

Setting up/Configuring the Connection



1. ▷ Connect your PC/notebook with the device via a zero-modem cable and »RS485 to RS232 adapter« (see diagram above).

3 Setting up the Connection between PC and Device

3.4 Connect a High Tech Line 3 Device

Start the software *Smart view*.

2. ▷ Select the menu point »Device Connection« in menu »Settings«.
3. ▷ Click on »HTL3 / PL / WIP Device Connection«.
4. ▷ Select the serial interface (COM-Port) where the device shall be connected to.

3.5 Troubleshooting during Setting up the Connection

General

- If your problem is not covered by the general aspects listed below then it might also be worth checking the “*HighPROTEC Troubleshooting Guide*” (separate document).
- If a firewall is installed on your computer, make sure that no TCP/IP port in the range 52152 ... 52163 is blocked.

Ethernet Connections

- Make sure that all TCP/IP data has been configured correctly (including the configuration of the protection device).
- Check that the IP address of the protection device has been correctly entered in Smart view.
- Note that currently only IPv4 addresses are supported.

Serial Connections (RS232) and USB Connections

- Make sure whether the Windows service “Telephony” is started. If you press the Windows start button and navigate to [Start / System Control / Administration / Services] the service “Telephony” must be visible and must have also been started. If not, the service has to be started.
- For establishing the connection, you need to have sufficient rights (administration rights).
- If your computer is not provided with a serial interface, you need a USB-to-serial-adaptor (SEG article “USB2RS232ADAP”). This adaptor has to be properly installed.
- Ensure that a zero-modem cable is used (a standard serial cable without control wires does not enable communication).

3.5.1 Persistent Connection Problems (*)

(*) *applies only to serial connections (RS232) and USB connections*

In case of persistent connection problems you should remove all connection settings and establish them again afterwards. In order to remove all connection settings please proceed as follows:

1. Remove the settings for the Dial-up Network



1. ▷ Close *Smart view*
2. ▷ Launch the »Control Panel«.
3. ▷ Choose »Network & Internet«.
4. ▷ On the left side, click on »Manage Network Connections«.
5. ▷ Click on *HighPROTEC Direct Connection* with the right-hand mouse key.
6. ▷ Choose »Delete« from the shortcut menu.

7. ▷ Click on the »OK« button.

2. Remove the virtual modem



1. ▷ Launch the »Control Panel«.
2. ▷ Choose »Hardware & Sound«.
3. ▷ Choose »Phone & Modem Options«.
4. ▷ Go to Tab »Modem«.
5. ▷ Click on the correct (in case there is more than one) entry »Connection cable between two computers«.
6. ▷ Click on the »Remove« button.

4 Command-Line Parameters and Exit Codes

Command-Line Parameters

It is possible to start the *Smart view* application with additional command-line options.

All the options listed below are **not** case-sensitive. All these options may also start with a slash character “/”, instead of a dash “-”.

Option	Description
-noLogo	This option suppresses the display of the sign-on banner (“splash screen”) during the start-up phase of the application.
-file:<filename>	<filename> must be an existing parameter file. <i>Smart view</i> then directly opens this file during the start-up phase.
-checkParameter	A plausibility check (see ↪ “Plausibility check”) is performed for the currently loaded parameter data.
-minimize	This options starts <i>Smart view</i> with a minimized main window.
-deviceModelFolder:<directory>	<directory> must be an existing directory. <i>Smart view</i> then uses this directory as standard repository for device model files.
-exportCSV:<filename>	<i>Smart view</i> creates a file in CSV-format from the currently loaded setting data. Example: Smartview.exe -file:MySettings.HptPara -exportCSV:MyData.csv
-iec61850CreateSCD:<filename>	<i>Smart view</i> creates an IEC 61850 SCD file (<i>Substation Configuration Description</i>) from the currently loaded setting data. Example: Smartview.exe -file:MySettings.HptPara -iec61850CreateSCD:MyDev.scd
-iec61850SendConfig:<filename>	<filename> must be an existing and valid IEC 61850 SCD file. <i>Smart view</i> sends the SCD file to the connected protection device. Example: Smartview.exe -file:MySettings.HptPara -iec61850SendConfig:MyDev.scd -password:1234 This example command starts <i>Smart view</i> and makes it load the existing parameter file MySettings.HptPara, connects to a device (with the current connection settings). Then it creates the IEC 61850 configuration from the SCD file MyDev.scd and sends this configuration data to the device.

Option	Description
<p>-language: <Language-ID></p>	<p>Sets the language of the graphical user interface.</p> <p><Language-ID> must specify any of the supported languages:</p> <ul style="list-style-type: none"> • ENG (English) • DEU (German) • ESP (Spanish) • FRA (French) • PLK (Polish) • PTB (Portuguese [Brazil]) • RUS (Russian) • ROM (Romanian)
<p>-newFile: <param-filename></p> <p>-deviceModel: <dm-filename></p>	<p><param-filename> must be an non-existing parameter file.</p> <p><dm-filename> must be an existing device model file. (If no path is specified then the standard device model path is used.)</p> <p><i>Smart view</i> writes a new parameter file from the specified device model file. The result can be checked from the application exit code.</p> <p>Example:</p> <pre>Smartview.exe -newFile:MySettings.HptPara - deviceModel:MRA4_V3.4.a.dm_c</pre>
<p>-paraKey: <param-key></p> <p>-paraValue: <param-value></p> <p>-paraSetnumber: <parameter-set></p> <p>-paraAdaptiveSet: <adaptive-set></p>	<p><param-key> is the case-sensitive internal description of the parameter to be modified.</p> <p><param-value> is the new value of the parameter.</p> <p><parameter-set> is optional and valid only for Setting Group Parameters. It can be the number of the parameter set to be used. (Possible values: 0 [default], 1, 2, 3.)</p> <p><adaptive-set> is optional and valid only for Adaptive Parameters. It can be the number of the adaptive set to be used. (Possible values: 0 [default], 1, 2, 3.)</p> <p><i>Smart view</i> writes a specific parameter setting value into the currently loaded parameter file.</p> <p>Example 1:</p> <pre>Smartview.exe -newFile:MySettings.HptPara -deviceModel:MRA4_V3.4.a.dm_c -paraKey:"/root/MDMs/CT_1_1/SingleSet/Current/CTprim" -paraValue:1234 -quit</pre>

Option	Description
	<p>This example command starts <i>Smart view</i> and makes it create a new parameter file <code>MySettings.HptPara</code>, then it assigns a new value 1234 of a particular parameter, and finally exits.</p> <p>This example parameter belongs to the setting »CT pri« of the nominal current of the primary side of the current transformers. (In the graphical user interface of <i>Smart view</i>, this setting can be found in the menu branch [Field Para / CT]. If <i>Smart view</i> has been launched with the <code>-serviceInfo</code> option (see below), then it shows the internal <code><param-value></code> for every parameter.)</p> <p>Example 2:</p> <pre>Smartview.exe -file:MySettings.HptPara -paraKey:"/root/MDMs/I1/MultiSet/Fct/Char" -paraValue:NINV -paraSetnumber:2 -checkParameter -saveParameter</pre> <p>This example command starts <i>Smart view</i> and opens an existing parameter file <code>MySettings.HptPara</code>, then it assigns a new value NINV of a particular Setting Group Parameter within the specified parameter set. Then it checks all settings for plausibility and finally saves the parameter file.</p>
<p><code>-paraListFile:<txt-filename></code></p>	<p><code><txt-filename></code> must be an existing text file that specifies parameter setting values.</p> <p><i>Smart view</i> reads these settings and writes them into the currently loaded parameter file.</p> <p>The text file must contain one setting per line, and each line must have the following format:</p> <pre><param-key> <param-value> <parameter-set></pre> <p>The specifications within each line must be separated one from another by a blank character. For example:</p> <pre>/root/MDMs/CT_1_1/SingleSet/Current/CTprim 1234 0 /root/MDMs/I1/MultiSet/Fct/Char NINV 2</pre> <p>In addition, comment lines are allowed: Every line that starts with either <code>"#"</code>, <code>","</code> or <code>"//"</code> is ignored.</p> <p>Command-Line Example:</p> <pre>Smartview.exe</pre>

Option	Description
	<p>-file:MySettings.HptPara</p> <p>-paraListFile:"MyParameterValues.txt"</p> <p>-checkParameter</p> <p>-saveParameter</p> <p>This example command starts <i>Smart view</i> and opens an existing parameter file <i>MySettings.HptPara</i>, then it reads the settings from the file <i>MyParameterValues.txt</i>. Then it checks all settings for plausibility and finally saves the parameter file.</p>
-password: <password>	<p><password> is a valid access level password for the connected device.</p> <p>This password is necessary to change settings on the device. For devices which support different access levels with different passwords, always the password of the highest required access level must be given.</p>
-connectionPassword: <password>	<p><password> is the connection password for the protection device.</p> <p>Depending on how the protection device is connected this is either the "USB connection" password or the "Remote network connection" password.</p> <p>A password for establishing a <i>Smart view</i> connection is supported by HighPROTEC devices as of Release 3.6.</p> <p>(See ↩ Chapter 6.9.)</p>
-quit	<p>This option makes <i>Smart view</i> exit immediately after it has finished all its tasks.</p> <p>Example:</p> <pre>Smartview.exe -newFile:MySettings.HptPara -deviceModel:MRA4_V3.4.a.dm_c -quit</pre> <p>This example command starts <i>Smart view</i> and makes it create a new parameter file <i>MySettings.HptPara</i>, then exits.</p>
-rasConnection -rasConnection: <network-connection>	<p>Specify that the communication with the device shall be done with a (e. g. serial PPP) network connection.</p> <p>If an optional <network-connection> is available, then this connection is used for the communication.</p> <p>Example:</p> <pre>Smartview -rasConnection:"HighPROTEC Direct Connection"</pre>

Option	Description
-Ht13PIConnection: <COM-Port>	<p>Specify that the communication shall be done with a with a device from the <i>High Tech Line 3</i>, the <i>Professional Line</i> or the <i>WI Line</i> series.</p> <p><COM-Port> is the number of the serial COM port to which the device is connected.</p> <p>Example:</p> <pre>Smartview -Ht13PIConnection:1</pre>
-receiveParameter	<p>This option makes <i>Smart view</i> connect to a device and receive all parameters from it.</p> <p>Example:</p> <pre>Smartview -receiveParameter -saveParameter:MySettings.HptPara -quit</pre> <p>This example command starts <i>Smart view</i> and makes it receive all parameters from the connected device, then saves these to the parameter file <i>MySettings.HptPara</i>, finally exits.</p>
-saveParameter -saveParameter: <filename>	<p>The currently loaded parameter data is saved with the current filename.</p> <p>If a <filename> has been specified then the parameter data is saved to the specified file.</p>
-sendParameter -sendParameter: modified	<p>All the currently loaded parameter data are transferred to the connected device, or – if in case of “modified” – only the modified parameters are transferred.</p> <p>Example 1:</p> <pre>Smartview.exe -file:MySettings.HptPara -sendParameter -password:1234 -silent -quit</pre> <p>This example command starts <i>Smart view</i> and opens the parameter file <i>MySettings.HptPara</i>, then all parameters contained in this file are transferred to the connected device. Finally <i>Smart view</i> exits.</p> <p>Example 2:</p>

Option	Description
	<p>Smartview.exe</p> <ul style="list-style-type: none"> -file:MySettings.HptPara -paraListFile:"MyParameterValues.txt" -checkParameter -sendParameter:modified -password:1234 -quit <p>This example command starts <i>Smart view</i> and opens an existing parameter file MySettings.HptPara, then it reads the settings from the file MyParameterValues.txt. Then it checks all settings for plausibility, it transfers the modified parameters to the connected device. Finally <i>Smart view</i> exits.</p>
-serviceInfo	<p>This option makes <i>Smart view</i> additional service information. In general, this kind of information is needed only for service and testing purposes.</p>
-silent	<p>This option makes <i>Smart view</i> avoid user interactions while executing some its tasks. This can be helpful if particular operations shall be executed via command-line.</p>
<p>-TcpIp</p> <p>-TcpIp:<TCP/IP-address></p>	<p>Specify that the communication with the device shall be done with a TCP/IP connection.</p> <p>If an optional <TCP/IP-address> is available, then this address is used for the communication.</p> <p>Example:</p> <pre>Smartview -TcpIp:192.168.0.8</pre>
-typecode:<typecode>	<p><typecode> is a valid typecode string for the currently loaded parameter data.</p> <p>Example:</p> <pre>Smartview -newFile:MySettings.HptPara -deviceModel:MRA4_V3.4.a.dm_c -typecode:MRA4-2A0AAA -saveParameter -quit</pre> <p>This example command starts <i>Smart view</i>, it creates a new parameter file from the existing device model based on the specified</p>

Option	Description
	typecode values. Then it saves this parameter modification in the parameter file, and <i>Smart view</i> finally exits.

Exit Codes

After one has called *Smart view* via command-line options it can be interesting to check the exit code (also called return code).

The exit code gives information about whether the *Smart view* execution has been successful or some error has occurred.

Exit Code	Description
0	<i>Smart view</i> has successfully exited. No error.
1	File already exists.
2	Error in device template file.
3	Implausible parameter file.
4	Unknown error.
5	Error during writing parameter file.
6	No parameter data available.
7	Error during sending parameter data to a connected device.
8	Single parameter value could not be written with specific command-line option.
9	Cannot read device template file.
10	Cannot read text file with list of parameter values.
11	Invalid typecode.

5 Smart view Keyboard Commands

You can control *Smart view* alternatively by means of keyboard commands (instead of the mouse)

Key	Description
↑	Moving up within the navigation tree or parameter list.
↓	Moving down within the navigation tree or parameter list.
←	Collapse the tree item or select a folder on a higher level.
→	Expands the tree item or selects a subfolder.
Numpad +	Expands the tree item.
Numpad –	Collapses the tree item.
POS1	Moves to the top of the active window.
ENDE	Moves to the bottom of the active window.
STRG+O	Opens the file opening dialog. Browsing through the file system for an existing device file.
STRG+N	Creates a new parameter file file by means of a template.
STRG+S	Saves actual loaded parameter file.
F1	Displays the <i>Smart view</i> help information.
F2	Load Device Data
F5	Reloads the displayed data of a device.
STRG+F5	Enables automatic refresh.
STRG+Umschalt+T	Back to the navigation window.
Home	Walks through the tabular forms (detail windows).
Page ↑	Previous value (parameter setting).
Page ↓	Next value (parameter setting).
Ctrl+Shift+Alt+S	Switches on/off the service info mode, which displays additional service information.

6 Operating a HighPROTEC Protection Device

6.1 Loading of Device Data when using Smart view



1. ▷ Start *Smart view*.
2. ▷ Make sure the connection has been established properly. (See [↪ “3 Setting up the Connection between PC and Device”](#).)
3. ▷ Connect your PC with the device.
4. ▷ Select »Receive Data from Device« in menu [Device].

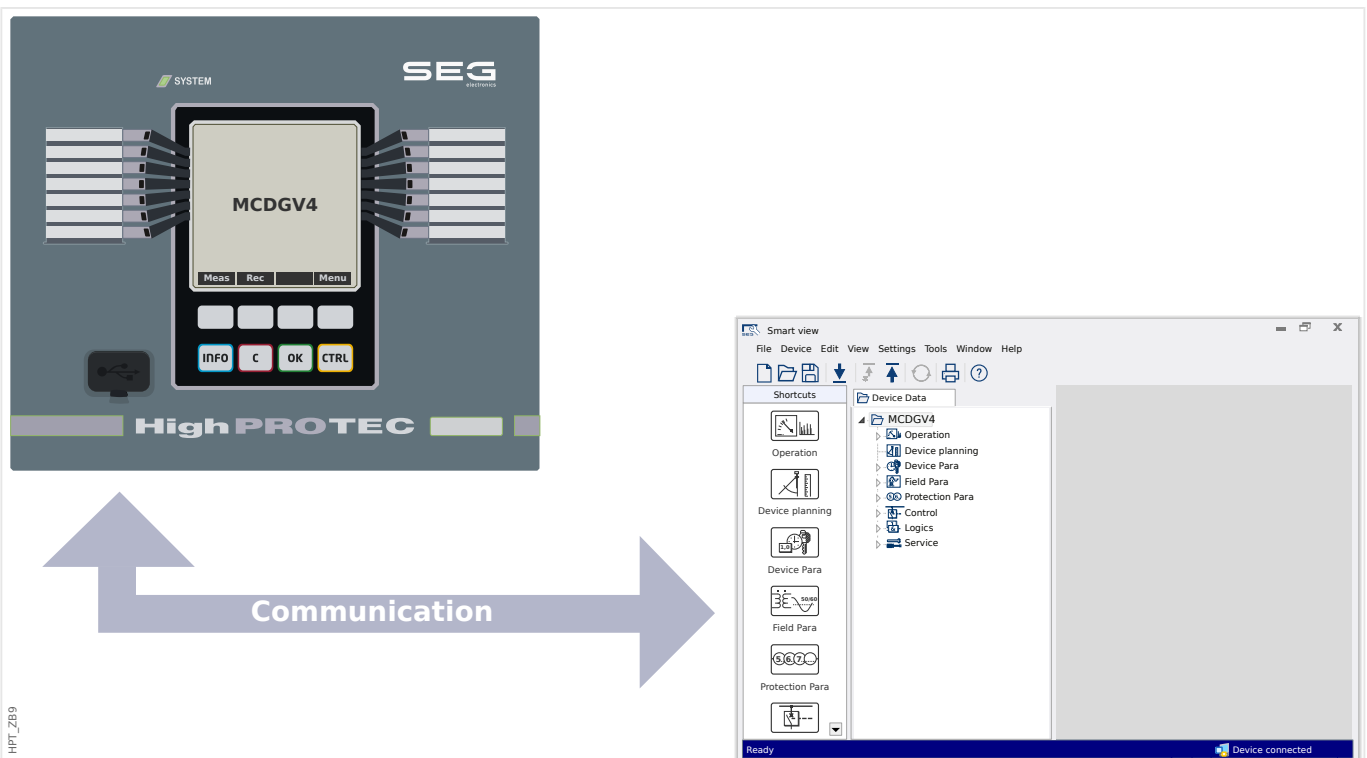

Fig. 4: After you have selected “Receive Data from Device”, Smart view presents the full menu tree of the connected device.

6.2 Transfer Device Data from Smart view to the Device

WARNING!



Via the button »Transfer only modified parameters into the device« only modified parameters are transmitted into the device.

Parameter modifications are indicated by a red “star symbol” in front of the parameter.

The star symbol (in the device tree window) indicates that parameters in the opened file (within *Smart view*) differ from parameters stored on your local hard disk.

Via the button »Transfer only modified parameters into the device«, you can transmit all parameters that are marked by this symbol.

If a parameter file is saved on your local hard drive, these parameters are no longer classified to be modified and cannot be transmitted via the button »Transfer only modified parameters into the device«.

In case that you have loaded and modified a parameter file from the device and saved it to your local hard drive without transferring the parameters into the device beforehand, you cannot use the button »Transfer only modified parameters into the device«. In a case like that, use »Transfer all parameters into the device«.

NOTICE!



The button »Transfer only modified parameters into the device« only works if modified parameters are available in the *Smart view*.

In contrast to that, all parameters of the device are transferred when the button »Transfer all parameters into the device« is pressed (unless there are invalid or implausible device parameters, see [↩️ “Change a Parameter via Smart view - Example”](#)).



1. ▷ In order to (re-)transfer parameters into the device, please select either »Transfer all parameters into the device« or »Transfer only modified parameters into the device« in menu [Device].
2. ▷ Confirm the safety inquiry »Shall the parameters be overwritten into the device?«.
3. ▷ Enter the password for setting parameters in the popup window.
 - ▶ Thereafter the changed data is transferred to the device and adopted.
4. ▷ Confirm the inquiry »Parameters successfully updated. It is recommended to save the parameters into a local file on your hard drive. Shall The Data Be Saved Locally? « with »Yes« (recommended). Select a suitable folder on your hard disk.
5. ▷ Confirm the chosen folder by clicking »Save«.
 - ▶ The changed parameter data is now saved in the folder chosen by you.

Error Message: Invalid Device Type

NOTICE!



In order to be able to transmit a parameter file into the device the following data must be equal:

- Type Code (written on the top of the device/type label) and
- Version of the device model (can be found at [Device Para / Version] »*DM-Version*«).

In case of a non-matching device type the error message “Invalid Device Type” is issued.

6.3 Backup and Documentation when using Smart view

How to Save Device Data on a PC



1. ▷ Click on »Save as ...« in menu [File].
2. ▷ Specify a name and choose a folder on your hard disk.
3. ▷ Save the device data accordingly.

Printing of Device Data when using Smart view (Setting List)

The »Printing menu« offers the following options:

- Printer setting
- Page preview
- Printing
- Export the selected printing range into a txt-file.

The printing menu of the *Smart view* software offers contextual different types of printing ranges.

- *Printing of the complete parameter tree:*All values and parameters of the present parameter file are printed.
- *Printing of the displayed working window:*
Only the data shown on the relevant working window are printed, i. e. this applies, if at least one window is opened.
- *Printing of all opened working windows:*
The data shown on all windows are printed, i. e. this applies only if more than one window is opened.
- *Printing of the device parameter tree as from a shown position on:*
All data and parameters of the device parameter tree are printed as from the position/markings in the navigation window. Below this selection the complete name of the marking is additionally displayed.

Saving Data as a txt-file via Smart view

Within the print menu [File / Print] you can choose »Export into File« in order to export the device data into a text-file.

NOTICE!



Only the actual selected printing range will be exported into a text-file. That means: If you have chosen the “Complete device parameter tree” then the “Complete device parameter tree” will be exported. But, if you have chosen “Actual working window”, only this window will be exported.

You can print out operating data but not export them.

If you export a txt-file, the content of this file is encoded as Unicode (UTF-8). Therefore the application that you want to use to open the file must support this encoding. (This, however, should be the case with all modern PC applications.)

6.4 Offline Device Planning via Smart view

NOTICE!



In order to be able to transmit a parameter file (e. g. offline created) into the device the following data must be equal:

- Type Code (written on the top of the device/type label) and
- Version of the device model (can be found at [Device Para / Version] »DM-Version«).

The *Smart view* software enables also to parameterize offline. The advantage is: By using device models you can do planning jobs for a device and set parameters in advance.

You can also read the parameter file out of the device, further process it offline (e.g. from your office) and finally re-transfer it to the device.

You can either:

- load an existing parameter file from a device (see [↪](#) “6.1 Loading of Device Data when using Smart view”).
- create a new parameter file (see below),
- open a locally saved parameter file (backup).

In order to create a new device/parameter file by way of a device template offline:



1. ▷ In order to create a new offline parameter file please choose within the menu [File] the entry »Create new parameter file«.
2. ▷ A dialog window pops up. Please make sure that you select the right device type with the correct version and configuration.
3. ▷ Finally click on »Apply«.
4. ▷ In order to save the device configuration select »Save« out of the [File] menu.
5. ▷ Within the menu [Edit / Modify Device Configuration (Typecode)] you can modify the device configuration or simply find out the type code of your current selection.

For the transfer of the parameter file into a device, see [↪](#) “6.2 Transfer Device Data from Smart view to the Device”.

6.5 Measuring Values

Read out of Measured Values via Smart view



1. ▷ In case *Smart view* is not running – please start it.
 2. ▷ If the device data were not yet loaded – select »Receive Data from Device« from menu [Device].
 3. ▷ Double click on icon »Operation« in the navigation tree.
 4. ▷ Double click on icon »Measured Values« within the navigation tree [Operation].
 5. ▷ Within the »Measured Values«, double click the category of measured values that you are interested in.
- ▶ The measured and calculated values are shown now in tabular form on the window.

NOTICE!



To have the measuring data read in a cyclic manner, select »Auto refresh« in menu [View]. The measured values are read out about every two seconds.

6.6 Acknowledgments and Resets

Manual Acknowledgment via Smart view



1. ▷ In case *Smart view* is not running – please start it.
2. ▷ If the device data were not yet loaded – select »Receive Data from Device« from menu [Device].
3. ▷ Double click on icon »Operation« in the navigation tree.
4. ▷ Double click on icon »Acknowledgement« within the operation menu.
5. ▷ Double click the entry within the popup that is to be acknowledged.
6. ▷ Press the button »Execute immediately«.
7. ▷ Confirm the question if the changes should be executed by »Yes«.
8. ▷ Enter your password.

External Acknowledge via Smart view



1. ▷ In case *Smart view* is not running – please start it.
2. ▷ If the device data were not yet loaded – select »Receive Data from Device« from menu [Device].
3. ▷ Double click on icon »Device Para« in the navigation tree.
4. ▷ Double click on icon »Ex Acknowledge« within the operation menu.
5. ▷ In the dialog window, you can assign now each one signal that resets all acknowledgeable LEDs, a signal that resets all binary outputs, a signal that resets the SCADA-signals respectively a signal that acknowledges a pending trip command.

Manual Resets via Smart view



1. ▷ In case *Smart view* is not running – please start it.
2. ▷ If the device data were not yet loaded – select »Receive Data from Device« from menu [Device].
3. ▷ Double click the »Operation« icon in the navigation tree.
4. ▷ Double click the icon »Reset« within the menu [Operation].
5. ▷ Double click the entry within the popup that is to be reset or deleted.

6.7 Status Display via Smart view



1. ▷ In case *Smart view* is not running – please start it.
2. ▷ If the device data were not yet loaded – select »Receive Data from Device« from menu [Device].
3. ▷ Double click the »Operation« icon in the navigation tree.
4. ▷ Double click the icon »Status Display« within the menu [Operation].
5. ▷ Double-click on any of the subordinated modules. If, for example, you want to see the states of general alarms, double-click on the entry »Prot«.

NOTICE!



To have the data read in a cyclic manner, select »Auto refresh« in menu [View]. The measured values are read out about every two seconds.

Signal State / Module Input	Display within <i>Smart view</i>
false / »0«	0
true / »1«	1
No connection to the device or busy.	?

6.8 Recorders

6.8.1 Disturbance Recorder

Disturbance records / DataVisualizer

With the tool *DataVisualizer* it is possible to visualize the disturbance records of the device. The *DataVisualizer* is always installed along with *Smart view*.

- Disturbance records can be downloaded (read out) by means of the parameter setting and evaluation software *Smart view*.
- The disturbance records can be viewed and analyzed within *DataVisualizer*.
- Disturbance records can be converted into the COMTRADE file format by means of *DataVisualizer*.

A disturbance record contains measuring values inclusively some (configured) pre-trigger-time. By means of *Smart view / DataVisualizer* the oscillographic curves of the analog (current, voltage) and digital channels/traces can be shown and evaluated in a graphical form. The disturbance recorder has a storage capacity of 120 s. The disturbance recorder is able to record up to 15 s (adjustable) per record. The amount of records depends on the size of each record.

Check Disturbance Records via Smart view

	
1. ▷	In case <i>Smart view</i> is not running – please start it.
2. ▷	If the device data were not yet loaded – select »Receive Data from Device« from menu [Device].
3. ▷	Double click the »Operation« icon in the navigation tree.
4. ▷	Navigate to the menu branch [Operation / Recorders] and double-click on »Disturb rec«.
▶	In the window the disturbance records are shown in tabular form.
5. ▷	Double-click any disturbance record and choose a folder where it is to be saved to.
6. ▷	You can analyze the disturbance records using the software <i>DataVisualizer</i> after clicking on »Yes« when you are asked “Shall the received disturbance record be opened by the <i>DataVisualizer</i> ?”

Delete Disturbance Records via Smart view

	
1. ▷	In case <i>Smart view</i> is not running – please start it.
2. ▷	If the device data were not yet loaded – select »Receive Data from Device« from menu [Device].
3. ▷	Double click the »Operation« icon in the navigation tree.
4. ▷	Navigate to the menu branch [Operation / Recorders] and double-click on »Disturb rec«.
▶	In the window the disturbance records are shown in tabular form.

5. ▷ In order to delete a disturbance record double-click on: »X« (the red x) in front of the disturbance record and confirm.

6.8.2 Fault Recorder

Check Fault Records via Smart view



1. ▷ In case *Smart view* is not running – please start it.
2. ▷ If the device data were not yet loaded – select »Receive Data from Device« from menu [Device].
3. ▷ Double click the »Operation« icon in the navigation tree.
4. ▷ Navigate to the menu branch [Operation / Recorders] and double-click on »Fault rec«.
▶ In the window the fault records are shown in tabular form.
5. ▷ In order to see more detailed information on a fault, double-click the item in the list.

Via the print menu you can export the data into a file. Please proceed as follows:



1. ▷ Open the data as described above.
2. ▷ Press the button »Print«.
3. ▷ Press the button »Export to File«.
4. ▷ Enter a file name.
5. ▷ Choose a location where to save the file.
6. ▷ Press the button »Save«.

6.8.3 Trend Recorder

Trend Recorder

The Trend Data are data points stored by the Trend Recorder on the relay device over fixed intervals of time, and can be downloaded from the device using *Smart view*. A Trend Record is viewable using the Data Visualizer software by selecting files saved by *Smart view* with a file extension of “. HptTr”.

The list of available trend recorder data is viewable by selecting [Operation / Recorders / Trend rec].

When viewed within the *DataVisualizer*, the trend record will show the observed values (up to 10) that the user has specified. The values available in the Trend Recorder depend on the type of the connected device and the configuration of the Trend Recorder.

Managing Trend Records

To download information from the Trend Recorder, select [Operation / Recorders / Trend rec] from the menu tree. The user will find three options within the Trend Recorder window that will allow to:

- Receive Trend Records,
- Refresh the Trend Recorder, and
- Delete Trend Records.

Selecting the »Receive Trend Record« button will download data from the relay to the user's PC. By selecting the »Refresh Trend Recorder«, *Smart view* updates the list of Trend Records. The »Delete Trend Records« button removes all trend data from the relay. Trend Recorder data previously stored on the user's PC remains untouched.

After having received trend data from the device, the user can view the data in the *DataVisualizer* by double-clicking on the received ".HptTr" file stored on the PC. Once the ".HptTr" file is open, the user will see the "Analog Channels" that are monitored by the Trend Recorder. By clicking on the "Analog Channels", all monitored parameters are listed. To view a channel, the user must click on the left mouse key, then drag and drop the channel onto the right-hand side of the *DataVisualizer* screen. The channel is then listed under the »Displayed Channels«.

To remove a channel from view, the user must select the Trend Data to be removed in the »Displayed Channels« menu tree, then click on the right mouse button to bring up the menu options. Here, the user finds the »Remove« menu option that, when selected, removes the trend data.

6.8.4 Event Recorder

Check Event Records via Smart view



1. ▷ In case *Smart view* is not running - please start it.
 2. ▷ If the device data were not yet loaded - select »Receive Data from Device« from menu [Device].
 3. ▷ Double click the »Operation« icon in the navigation tree.
 4. ▷ Navigate to the menu branch [Operation / Recorders] and double-click on »Event rec«.
- ▶ In the window the event records are shown in tabular form.

NOTICE!



To have the event data read in a cyclic manner, select »Auto refresh« in menu [View].
Smart view is able to record more events than the device itself, if the window of the event recorder is opened and »Automatic Up-Date« is set to active.

Via the print menu you can export the data into a file. Please proceed as follows:



1. ▷ Open the data as described above.
2. ▷ Select the menu [File / Print].
3. ▷ Choose »Print Actual Working Window« within the popup.
4. ▷ Press the button »Print«.
5. ▷ Press the »Export to File« button.
6. ▷ Enter a file name.
7. ▷ Choose a location where to save the file.
8. ▷ Press the button »Save«.

6.8.5 Motor Start Recorder

Manage Motor Start Records

The Motor Start Recorder logs information during a motor start-up. These records are stored in a fail-safe manner and the capacity allows for recording up to 5 start-ups. After 5 start-ups, every following start-up overwrites the recording of the oldest one (“First in First out” principle).

Every recording consists of a summary of information and recorded analog trends. However, the exact set of data is dependent on the ordered device variant. The summary data can be accessed using *Smart view* or via the front panel interface. This feature provides information recorded at the time of each start of the motor such as:

- Date of the motor start event
- Record number
- *IL1 max RMS, IL2 max RMS, IL3 max RMS, IG max RMS* – Maximum RMS phase current of the respective phase
- *Unbalance max* – Maximum current unbalance during the motor start-up
- *I avg* – Average current of all three phases at the time of the start-to-run transition
- *Speed* – The motor nominal speed (1 or 2)
- Time (duration) values:
 - *tS-tI* – The time that elapses from the start until the current value drops below the set start-up threshold
 - *tS-tR* – The time that elapses from the start until the motor is running, or – in case of an incomplete start sequence – until the trip command
- *I2T used* – Thermal capacity used, specified as percentage of the maximum thermal capacity
- *Start success* – This is set to 1 if the motor start has been successful (and equals 0 otherwise).

Smart view allows for storing the summary information as text files, or have them printed out.

The analog trends can be viewed using the *DataVisualizer* software. Examples for recorded analog trends are:







- Phase current values
- Current unbalance
- Thermal capacity
- Temperatures (in case an RTD box is fitted)

Read Motor Start Records via *Smart view*:

The start recorder data can be downloaded by means of *Smart view* from the device.

- Start *Smart view* if this has not been done already.

- If the data has not been downloaded from the device yet, select the menu item "Receive Start Recorder" in the "Device" menu.
- Within the navigation tree, go to the [Operation / Recorders] menu. Here the user will find the »Start rec« menu item.
- When »Start rec« is selected the Start Recorder Window appears.

	To access data that has been stored in the device using <i>Smart view</i> , the user must select the "Receive Start Recorder" button in the upper left hand corner of the "Start Rec" window. When clicked, the <i>Smart view</i> software will retrieve the highlighted record from the device.
	After selecting one of the max. 5 recordings a summary of the Start Recorder data can be retrieved (for the selected recording) by clicking the "Receive Summary Data" button in the upper left hand corner of the "Start Rec" window.
	A list of all currently available Start Records is viewable by selecting the "Refresh Start Recorder" button on the start recorder.
	It is possible to delete individual records that are stored on the protective device. First, select "Receive Start Recorder", and then select the record to be deleted by clicking on the record number, followed by the selection of the "Delete Start Record" button in the upper left hand corner of the "Start Rec" window.
	To permanently remove all start records within a device's start recorder, select the "Delete All Start Records" button also located in the upper left hand corner of the "Start Rec" window. This removes all previously stored start records within the device to which the user is presently connected.
	Open a Start Record file from a local storage device. Please note that it is possible to compare an archived Start Record against archived Parameter settings that are also stored on a local device. Read the "Caution" information below (page ↩ ➤ ↩).

When using *Smart view* to view the Start Recorder data, the Start Recorder features can also be found by right clicking anywhere within the "Start Rec" window.

NOTICE!



The "Print" button takes the user to the printing dialogue, where it is possible to export the summary into a text file. This is done the following way:

- Retrieve the data in the "Start Rec" window, as described above.
- Click on the button "Receive Summary Data".
- Click on the "Print" button.
- Click on the button "Export to file".
- Enter a valid file name.
- Select the file path.
- Click on the "Save" button.

Display Start Records:

When a Start Record is called up, a window with the following options pops up.

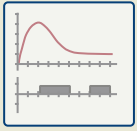

View motor start data graphically in the *DataVisualizer* software. In the *DataVisualizer* software the user can view the RMS value of the phase currents, thermal capacity used, and temperatures measured by the URTD module if a URTD is installed and attached to the relay.

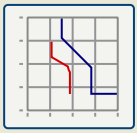

View motor start data overlayed with the Motor Protection Curves (Starting Profile Plot versus Protection limits). The user can view the average current recorded during the motor start versus protection elements such as 50P, or the Thermal Model. The user has the option to alter the displayed setting groups.

Please note: Protective elements that are not projected within the device planning are not visible.

The Starting Profile Plot offers two user scenarios:

- Adapt the protection settings to the recorded start curve: The user then sees the impact of parameter changes in the Profile Plot. By means of this the user can decide if the relay settings match the protection requirements.
- Analyze a Start Record: Since a Start Record does not include the relay settings, the user has to ensure that backups of the relay settings are available that were valid at the time of recording.

CAUTION!



Please note that the Starting Profile Plot shows the recorded average current versus the current relay settings. The relay settings itself are not part of a Start Record.

Adaptive parameters and their impacts wont be visible within the Starting Profile.

Blockings wont be visible within the Starting Profile.

Please make sure to save the setting files together with this record to guarantee the graph represents the conditions of when this event occurred.

6.8.6 Statistic Recorder

The Statistic Recorder shows motor specific statistical data on a monthly base. The Statistic Recorder can record up to 24 monthly reports. The reports are power fail safe stored.

In order to view information from the Statistic Recorder, the user has to select [Operation / Recorders / Statistic rec] from the menu tree.

When using Smart view, a double-click on the »Date of Record« shows detailed statistical information such as the number of starts, the number of successful starts, the average start time, the »average I2T« value during any start, and the average of all maximum currents value seen during each start.

6.8.7 Internal Messages (Self-Supervision Recorder)

Check Self-Supervision Messages via Smart view

NOTICE!



This feature is available only when connecting with a recent HighPROTEC protection device (as of version 3.4).

The protection device supervises its own functionality by constantly performing various self-tests. If it detects any serious problem, or any event that has a serious impact on the operation of the device then this event is recorded.

HighPROTEC protection devices as of version 3.6 use this recorder also for security-related messages, for example to report a problem with the encrypted communication or if a wrong password has been entered.

The menu [Operation / Self-Supervision / Messages] gives access to this list of internal messages. The following data is part of each entry:

- *Record Number* - a counter without special meaning
- *Date of Record* - timestamp of the event
- *Message* - a message ID with a (short, heavily abbreviated) message text
- *Value* - additional data specific to the event

All messages that can potentially appear here are described in detail in a separate document, the "HighPROTEC Troubleshooting Guide" (HPT-4.90-EN-TSG).

6.9 Passwords

In general, there are *access level passwords*, that permit to change the setting values of related parameters, and *connection passwords*, that permit to establish a connection of the Smart view with the operating software *Smart view*.

Note, however, that *connection passwords* are always prompted for by *Smart view*, i. e. they are always entered via PC keyboard. (See the “Security” chapter of the Technical Manual of your HighPROTEC device for a detailed description.)



Entering *wrong* passwords (regardless whether connection password or access level password, and regardless whether via HMI or *Smart view*) triggers a “time penalty” stage: The Smart view blocks any further password entry for an increasing amount of time, until a correct password has been entered. A dedicated message informs the user

about this blocking. This timer affects only the password entry (i. e. the Softkey  on the HMI), so that it does not prevent the user from doing some other, “password-free” activities during this blocking time.

Change Passwords via Smart view

Download the parameter file from the device.



1. ▷ Passwords can be changed by a double-click within the menu [Device Para / Security / Password] on the corresponding password.
2. ▷ Enter the old password and the new password twice.
3. ▷ Confirm the changes by a click on »OK«.

6.10 Device Planning

“Device Planning” means to change the functional range to a degree that suits the protection task to be fulfilled (i. e.: the device deactivates all functions that are not needed, and shows only the active ones).

There is a top-level menu item [Device planning] that is dedicated to this; it collects a setting parameter for each function which can be set to “-” or to “use”. (In some cases there are additional setting options, for example with devices featuring direction determination).

If the user, for example, activates the voltage protection function, all menu branches related to this function appear in the menu tree. All corresponding events, signals, etc., are activated as well.

WARNING!



It **MUST** be taken into account that Device Planning changes the functionality of the device.

If, for example, the user cancels the directional feature of the overcurrent protections, the device will no longer trip in a directional way but merely in a non-directional way. If the user deactivates a protection function, the device will no longer trip according to the criteria related to this protection function.

The manufacturer does not accept liability for any personal or material damage as a result of incorrect planning.

Contact your SEG Customer Service representative for more information.

WARNING!



Beware of the inadvertent deactivating of protective functions/modules, because all the settings of a deactivated module get lost (i. e. are set back to their respective default values)!

This means: If the user is activating any of these modules again at some later time, all parameters of the re-activated modules need to be reconfigured.

6.11 Parameters

Parameter Setting via Smart view

Smart view shows within the windows, where parameters are edited also the required access level for the parameters and settings. The required access authorizations will be verified when the parameter file should be transferred into the protective device. For the transmission, two options are available.

- The transfer of *all Parameters*. This always requires the Supervisor (administrator) password.
- The transfer of the *modified Parameters* only. *Smart view* checks the set of access levels that are required by the parameter to be modified, and it prompts for the highest required passwords (access authorizations).



Example 1:

A »Prot-Lv1« parameter and a »Prot-Lv2« parameter have been edited and are about to be transferred. The user is being prompted for the password »Prot-Lv2«.



Example 2:

A »Prot-Lv1« parameter, a »Prot-Lv2« parameter and a device planning parameter have been edited and are about to be transferred. The user is being prompted for the administrator password »Supervisor-Lv3«.



Example 3:

A »Prot-Lv1« parameter, a »Prot-Lv2« parameter and a »Control-Lv1« parameter have been edited and are about to be transferred. The user is being prompted for the two passwords »Prot-Lv2« and »Control-Lv1«.

Change a Parameter via Smart view - Example

Example: Changing of a protective parameter. (We want to alter the characteristic for the overcurrent protection function »I[1]« in parameter set 1).



1. ▷ In case *Smart view* is not running – please start it.
2. ▷ If the device data were not yet loaded – select »Receive Data from Device« from menu [Device].
3. ▷ Double-click the icon »Protection Para« in the navigation tree.
4. ▷ Within the [Protection Para] menu, double-click the icon »Set 1«.
5. ▷ Within the parameter set 1, double-click »I-Prot«.
6. ▷ Double-click »I«[1].
- ▶ In the dialog window a tabulated overview appears, showing the parameters assigned to this protective function.
7. ▷ In this table double-click the value/parameter you want to change (here: »Char«).
8. ▷ An editing dialog window is opened where you can select the required characteristic.

9. ▷ Close this window by clicking the »OK« button.
10. ▷ Additional parameters can be changed if required.
11. ▷ There are two options available within the menu [device]: Transfer all parameters to the device, or only the modified ones. See [↩▷ “6.2 Transfer Device Data from Smart view to the Device”](#).
12. ▷ Confirm the safety inquiry »Shall The Parameters Be Overwritten?«.
13. ▷ Enter all the passwords that you are prompted for.
 - ▶ Afterwards the parameters are transferred to the protection device.
14. ▷ We recommend to confirm the inquiry »Shall The Data Be Saved Locally?« with »Yes«. Select a suitable storing location on your hard disk. Confirm the chosen storing location by clicking »Save«.
 - ▶ The changed parameter data is saved now in the data file chosen by you. Thereafter the changed data is transferred to the device and adopted.

NOTICE!



A star (asterisk) symbol in front of the changed parameters indicates that the alterations have not yet been stored in a parameter file. This is independent of whether the parameters have been transferred to the device in the meantime.

In order to make things easier to follow, especially where complex parameter changes are involved, the menu tree indicates the parameter change by the star symbol on every superior/higher menu level, too (“star trace”). This makes it possible to control or follow up from the main menu level at any time where parameter changes have been made but not been saved yet.

The “star trace” is cleared only if the parameter changes are saved in a parameter file, or if all device data is reloaded from the device.

NOTICE!



Once you have entered a password, *Smart view* remembers it for ca. 10 minutes so that you are not asked again during this time. This time interval is re-started whenever parameters are transmitted into the device. If no parameters are transmitted into the device for a duration of more than 10 minutes, *Smart view* clears its password memory so that you are asked again when you are trying to transmit parameters into the device.

Plausibility check

NOTICE!



In order to prevent obvious wrong settings the software monitors constantly all temporary saved parameter changes. If it detects an implausibility, this is indicated by a question mark in front of the respective parameter.

In order to make things easier to follow up, especially where complex parameter changes are involved, on every superior/higher menu level above of the temporary saved parameters, an implausibility is indicated by a question mark (plausibility trace). This makes it possible to control or follow from the main menu level at any time where implausibilities exist.

So it is possible to see from each point of the menu tree that implausibilities have been detected by the software.

A star/parameter change indication is always overwritten by the question mark/implausibility symbol.

If the software detects an implausibility it rejects saving and adopting of the parameters.

Switch Setting Groups (Parameter Sets) via Smart view



1. ▷ In case *Smart view* is not running – please start it.
2. ▷ If the device data were not yet loaded – select »Receive Data from Device« from menu [Device].
3. ▷ Double-click the icon »Protection Para« in the navigation tree.
4. ▷ Within the [Protection Para] menu, double-click the icon »PSet-Switch«.
5. ▷ Configure the Setting Group Switch respectively choose an active set manually.

Copying Setting Groups (Parameter Sets) via Smart view

NOTICE!



Setting groups can only be copied if there are no implausibilities (no red question mark, see the Notice at the end of [↳ "Change a Parameter via Smart view - Example"](#)).

It is not necessary to set up two setting groups that only differ in a few parameters.

With the help of *Smart view* you can copy simply an existing setting group to another one(not yet configured) . You only need to change those parameters where the two setting groups are different.

To establish efficiently a second parameter set where only a few parameters are different, proceed as follows:



1. ▷ In case *Smart view* is not running – please start it.
2. ▷ Open an (offline) parameter file of a device or load data of a connected device.
3. ▷ By way of precaution, save (the relevant) device parameters: [File / Save as]
4. ▷ Select »Copy Parameter Sets« out of the menu [Edit].
5. ▷ Define the source and destination parameter set for copying (source = »copy from«; destination: »copy to«).
6. ▷ Click on »OK« to start copy procedure.
 - ▶ The copied parameter set is cached now, but not yet saved.
7. ▷ Then modify the copied parameter set(s) as required.
8. ▷ Assign a new file name to the revised device parameter file and save it on your hard disk (backup copy).
9. ▷ Transfer the modified parameters back to the device (see [↩» “6.2 Transfer Device Data from Smart view to the Device”.](#))

Compare Setting Groups via Smart view



1. ▷ In case *Smart view* is not running – please start it.
2. ▷ Open an (offline) parameter file of a device or load data of a connected device.
3. ▷ Click on menu item [Edit] and select »Compare Parameter Sets«.
4. ▷ Select the two parameter sets from the (two) drop down menus you would like to have compared with each other.
5. ▷ Press the button »Compare«.
- ▶ The values that are different from the set parameters are listed in tabular form.

6.11.1 Parameter Files

Parameter files have the extension *.HptPara and store all settings of a protection device.

An HptPara file is always related to a device model (see the *HighPROTEC Quick Start Guide*, HPT-4.90-EN-QSG or the device documentation).

Therefore you have two alternative principles for the creation of a new configuration file:

- Creating a *.HptPara offline, i. e. without being connected to a protection device. In this case *Smart view* opens selection dialogs, asking you to specify the exact device and typecode for which the configuration shall be made. (The “typecode” defines the particular device variant, including housing and communication options.)

In the typecode dialog, it is possible to double-click every specification line (or highlight it and click the »Edit« button) and adapt the entry to your particular device. Alternatively, you can also click the “pencil” button and directly type in the letters and digits of your device's typecode.

You can find the typecode printed as “CAT No.” on the adhesive label that is glued to the housing of the protection device. Moreover, as of HighPROTEC Release 3.4, you can also check the value of [Device Para / Version] »CAT No.«.

And finally, you can use the *Smart view* menu »[File → Properties]« to open a window that displays various information, including the typecode.

- Creating a *.HptPara while being connected to a particular device. In this case *Smart view* defines all settings for this particular device, and immediately after having retrieved the data from the device *Smart view* asks you whether you want to save them into a new HptPara file. (Of course it is possible to re-use the HptPara file later for another protection device, provided the variant and firmware version (release) are identical.)

Open a Parameter File

The menu item [File / Open Existing Parameter File] opens an existing parameter setting file. If another parameter file is already open, this file and all related open dialog windows is automatically closed.

Save a Parameter File

The menu item [File / Save] saves the currently opened parameter setting file.

Save a Parameter File as a New File

The menu item [File / Save As] saves the currently opened parameter setting file at a different location or with a different filename.

View Properties of a Parameter File

The menu item [File / Properties] shows the properties of the currently opened parameters/menu tree in a new window.

This is, for example:

- the filename (if loaded from file)
- the origin of the parameter data (loaded from file or received from device)
- version information (device type, typecode, version)
- various internal locations and paths (e. g. folder and filename of the used device model)

Compare Parameter Files via Smart view

With the help of *Smart view* you can simply compare/diff the currently open parameter/device file against a file on your hard disk. The precondition is that the versions and type of devices match. Please proceed as follows:



1. ▷ Click on »Compare with a Parameter File« within the menu [Device].
 2. ▷ Click on the folder icon in order to select a file on your hard disk.
- ▶ The differences are shown in tabular form.



Converting Parameter Files via Smart view

Parameter files of the same type can be converted. As many parameters as possible will be taken over.

- Parameters that are added are set to the default value.
- Parameters that are not part of the target file version are deleted.

In order to convert a parameter file please proceed as follows:

⚙	
1.	▷ In case <i>Smart view</i> is not running – please start it.
2.	▷ Open a parameter file or load the parameters from a device that should be converted.
3.	▷ Make a backup of this file at a fail safe place.
4.	▷ Choose »Save as« from the menu [File].
5.	▷ Enter a new file name (in order to prevent overwriting the original file)
6.	▷ Choose the new file type from the drop-down menu »File Type«.
7.	▷ Confirm the security check by clicking on »yes« if and only you are sure that the file conversion should be executed.
▶	In the tabular form the new and deleted parameters are shown as follows.

New parameter:	
Deleted parameter:	

Close a Parameter File

The menu item [File / Close] closes the currently opened parameter setting file and all related open dialog windows. If the parameter setting file has been modified or an unnamed file has not been saved yet, *Smart view* reminds you to save this parameter setting file.

6.12 Digital Inputs

Assignment of Digital Inputs

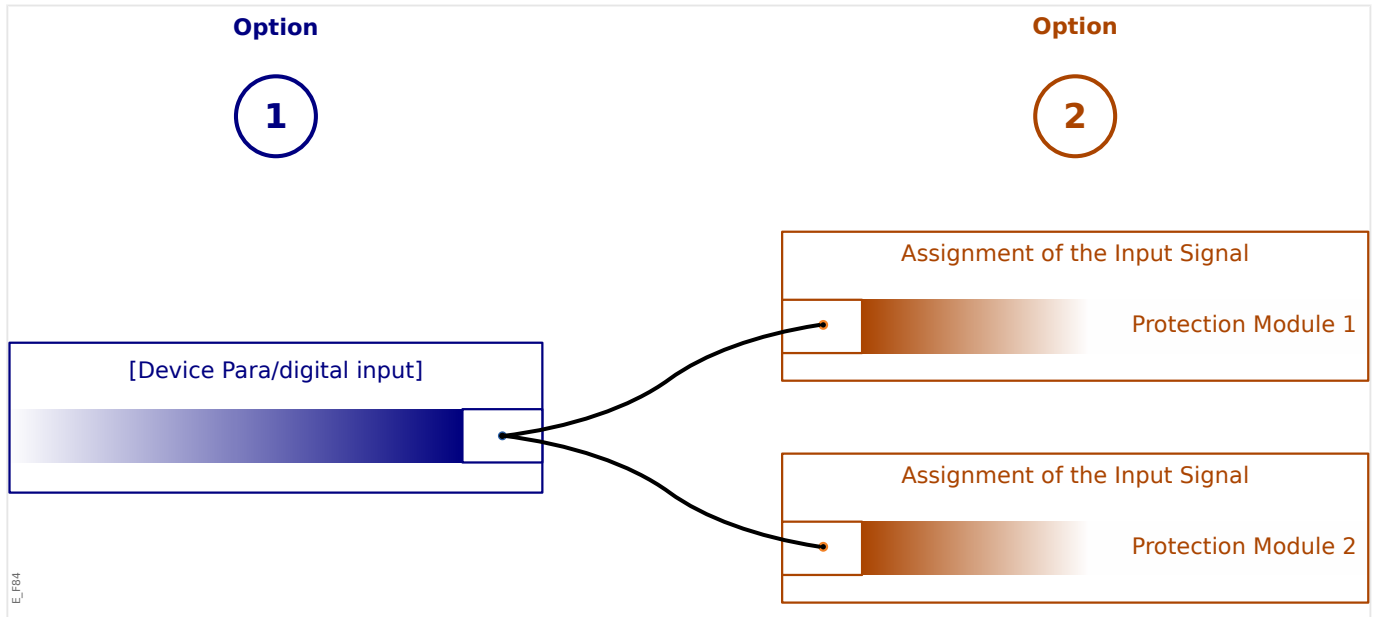

There are two options available in order to determine where a Digital Input should be assigned to.

Option 1: Assigning a Digital Input onto one or multiple modules.

Adding an assignment via Smart view:

Within menu [Device Para / Digital Inputs], Digital Inputs can be assigned onto one or multiple targets.

Select the Digital Input (double-click on the DI entry) and select the assignment that has to be added.

By means of clicking on »Add« the assignment is shifted from the list of available to the list of used assignments.

Deleting an assignment via Smart view:

Select the assignments (double-click on the DI entry) and select the assignment that is to be deleted. The assignment is deleted from the list of used assignments by means of clicking on »Remove«.

Option 2: Connecting a Module Input with a Digital Input

Navigate to a module. Within this module assign a Digital Input onto a module input.

Example: A protection module should be blocked depending on the state of a Digital Input. For this enter the [Global Prot Para] and assign the required Digital Input to the blocking input (e. g. »ExBlo1«) .

Check the Assignments of a Digital Input

In order to check the targets that a Digital Input is assigned to please proceed as follows:



1. ▷ Enter the menu [Device Para / Digital Inputs].
2. ▷ Navigate to the Digital Input that you want to check.
3. ▷ All targets of a Digital Input will be shown, listed and separated by a semicolon behind a Digital Input.
Please note that the window might be too small and thus hide some targets.
4. ▷ All assignments can be seen by means of a double click onto a Digital Input. Within this window also further assignments can be done.

6.13 Synchronize Date and Time via Smart view



1. ▷ In case *Smart view* is not running – please start it.
2. ▷ If the device data were not yet loaded – select »Receive Data from Device« from menu [Device].
3. ▷ Within the navigation tree, enter »Date and Time«, which is in the menu branch [Device Para / Time]. Double-click this entry.
 - ▶ A dialog opens that shows the current date and time of both PC and HighPROTEC device. (A checkbox allows to toggle the timezone between local and UTC; however, see also the note below.)
4. ▷ Click on the button »Synchronize«. You are then asked for the password of access level »Supervisor-Lv3«.
 - ▶ The HighPROTEC device receives and takes over date and time from the PC.

NOTICE!



Smart view as of version 4.50 in connection with a HighPROTEC device as of version 3.4 is able to consider that the timezone settings might be different on PC and HighPROTEC device.

This is not possible in case of a connection with an older HighPROTEC device, so that there is the risk of ending up with a wrong time setting. Therefore it is recommended in case of an older HighPROTEC device to first set the device to the same timezone as the PC and only afterwards synchronize date and time.

If you are unsure whether your connection supports this timezone check: If the checkbox for toggling between UTC and local timezone is visible in the dialog mentioned above then the timezone check is supported.

6.14 Display Version Information

Within the menu [File / Properties] you can obtain detailed information on the currently opened file like e. g. software and hardware version.

NOTICE!



In order to be able to transmit a parameter file (e. g. offline created) into the device the following data must be equal:

- Type Code (written on the top of the device/type label) and
- Version of the device model (can be found at [Device Para / Version] »*DM-Version*«).

6.15 Display of ANSI-Codes

It is possible to make *Smart view* display ANSI codes:



1. ▷ In case *Smart view* is not running – please start it.
2. ▷ Within the menu [Settings], tick the checkbox »Display ANSI device numbers«.

6.16 Graphical Display of Tripping Characteristics

Smart view supports the graphical display of tripping characteristics. Depending on the device type and the device configuration various tripping characteristics and related characteristics can be displayed.

- Overcurrent Tripping Characteristics (ANSI, IEC,...)
- LVRT/FRT Profiles (Low Voltage Ride Through)
- Tripping areas of the underexcitation protection
- Switchgear-Wear-Curves



Example - Graphical Visualization of the Overcurrent Tripping Characteristic »I[1]«

1. ▷ If the device data/parameters are not loaded yet, please load them from the device or open a file.
2. ▷ Within the navigation tree, enter the menu branch [Protection Para / Set 1 / I-Prot / I[1]].
3. ▷ Double-click on the protective element »I[1]«.
4. ▷ A dialog window is opened that shows all the parameters in tabular form that are tied to this protective element and that define the tripping characteristic.
5. ▷ Click on the icon »View Characteristic« within the toolbar of this window: 
6. ▷ A new window now shows the graphical visualization of the selected tripping characteristic.

Adding and Removing Tripping Characteristics to the Visualization

Additional tripping characteristics of further protective elements and protection sets can be added to the visualization.



Example: Adding Additional Curves to the Visualization of the Tripping Characteristic »I[1]«

1. ▷ Open, as described in the example above, the window for the visualization of the tripping characteristic of the protective element »I[1]«.
2. ▷ Click within the toolbar of this diagram window on the icon »Add/Remove Curves...«: 
3. ▷ A selection window pops up. There you can select:
 - Which protective elements should be displayed additionally. (Only available, if more than one protective element of the same type is projected.)
 - Which parameter sets should be shown additionally in this visualization. (Only available, if this protective element is available in multiple parameter sets.)
4. ▷ Select those curves, that you want to add to the current visualization.
5. ▷ Close the selection window by a click on »Apply«.
- ▶ The graphical visualization is updated, so that the additionally selected curves are shown.

Selection of related curves

Related curves (e. g. reset curves, voltage restrained overcurrent curves, ...) can be displayed, the availability is depending on the device and configuration.

If such curves are available they can be selected by a drop-down menu in the toolbar of the diagram window.



Example: Visualization of the Reset Curve for Overcurrent Element »I[1]«

1. ▷ Open as described in the example above, the working window for the visualization of the tripping characteristic of the overcurrent element »I[1]«.
2. ▷ There is a drop-down menu within the the upper menu bar of this working window. This can be used in order to select related curves as:
 - Tripping characteristics
 - Reset curves
 - Voltage restrained overcurrent protection curves
3. ▷ Select within the drop down menu »Reset curve«
 - ▶ The diagram window gets updated. Now the »Reset Curve« is shown instead of the »Tripping Curve«.

6.17 Single-Line Diagrams

The single-line diagram is displayed after the »CTRL« has been pressed on the HMI of a HighPROTEC device. It can be replaced by another one, so that you are able to adapt it to your application. The following is important to know in this context:



When *Smart view* saves the current configuration to a “*.HptPara”-file the currently active single-line diagram is always included. Vice versa, if you load an HptPara file and transfer it to the protection device the single line diagram contained therein gets displayed.

But it is important to note that the other way round is **not** possible: There is no way to retrieve the currently active single-line diagram (in editable form) from the protection device, nor is it possible to export it from the HptPara file. As a consequence, it is strongly recommended to archive all the files that you have come across, not only the original file from which you started, but also all files that you created as individually modified single-line diagrams. There is a dedicated “*.HptPage” file format that keeps a single-line diagram – the so-called “page” – for later re-use.

Remark: The default single-line that the protection device displays after a factory reset can be found as an HptPage file on the product CD that has been part of the delivery. Alternatively, it can be downloaded from the web-address that is printed as a QR-code on a sticker fastened on the device. In most cases you can use it as a template and adapt it to your individual needs.

The software to be used for editing an HptPage file is named *Page Editor*. It is a stand-alone application which is installed along with the *Smart view* installation. It is possible to launch it the usual way, (for example) via the Windows Start button. But if you have *Smart view* already running it is probably more convenient to use the menu item [*Tools* → *Page Editor*].

Please refer to the *Page Editor Manual* for a description of what can be done within the *Page Editor*. The *Page Editor Manual* can be simply opened by calling the *Page Editor* menu item [*Help* → *Help*] (or pressing the »F1« key).

After you have saved your own HptPage file you transfer it to the protection device as follows:



1. ▷ In *Smart view*, open the menu item [Device planning].
2. ▷ A double-click on the entry »Ctrl . Single Line«, “①” in the diagram below, opens the editing dialog.
 - ▶ The following information is displayed along with the preview of the single-line diagram:
 - Single-line Name — The name of the currently used Single-line, e. g. “BusbarFeeder”
 - Switchgear Properties — a list with the switchgears that are used in the single-line. For each switchgear, a running number is shown (e. g. “SG 1”), the short designation (as it appears in the single-line, e. g. “QA1”) and the switchgear type (e. g. “Controlled Make Break SG”).
 - »Single-line Diagram« — Clicking this button allows for replacing the single-line by some other, which is stored in an HptPage.
3. ▷ Click on the button »Single-line Diagram« (“②” in the diagram below).

- ▶ This opens a file-select dialog.
- 4. ▷ Select your HptPage file.
- ▶ The editing dialog displays the selected file (filename without “HptPage” extension, plus preview. If you have successfully passed the “Compatibility Check” of the *Page Editor* your new single-line should be o.k. so that the field »Single-line Error Messages« is blank.
- 5. ▷ Click »Apply« to close the editing dialog (“③” in the diagram below).
- ▶ The parameter »Ctrl . Single Line« is now marked as “modified” (see [“Change a Parameter via Smart view - Example”](#) and, in particular, the Notice about the “red star” token therein).
- 6. ▷ Just as with any parameter change, the final step is to transfer the modifications to the protection device (keys »F7« or »Ctrl«+»F7«, or menu items [Device → Transfer ALL Parameters into the Device], [Device → Transfer only modified Parameters into the Device], see [“6.2 Transfer Device Data from Smart view to the Device”](#)).

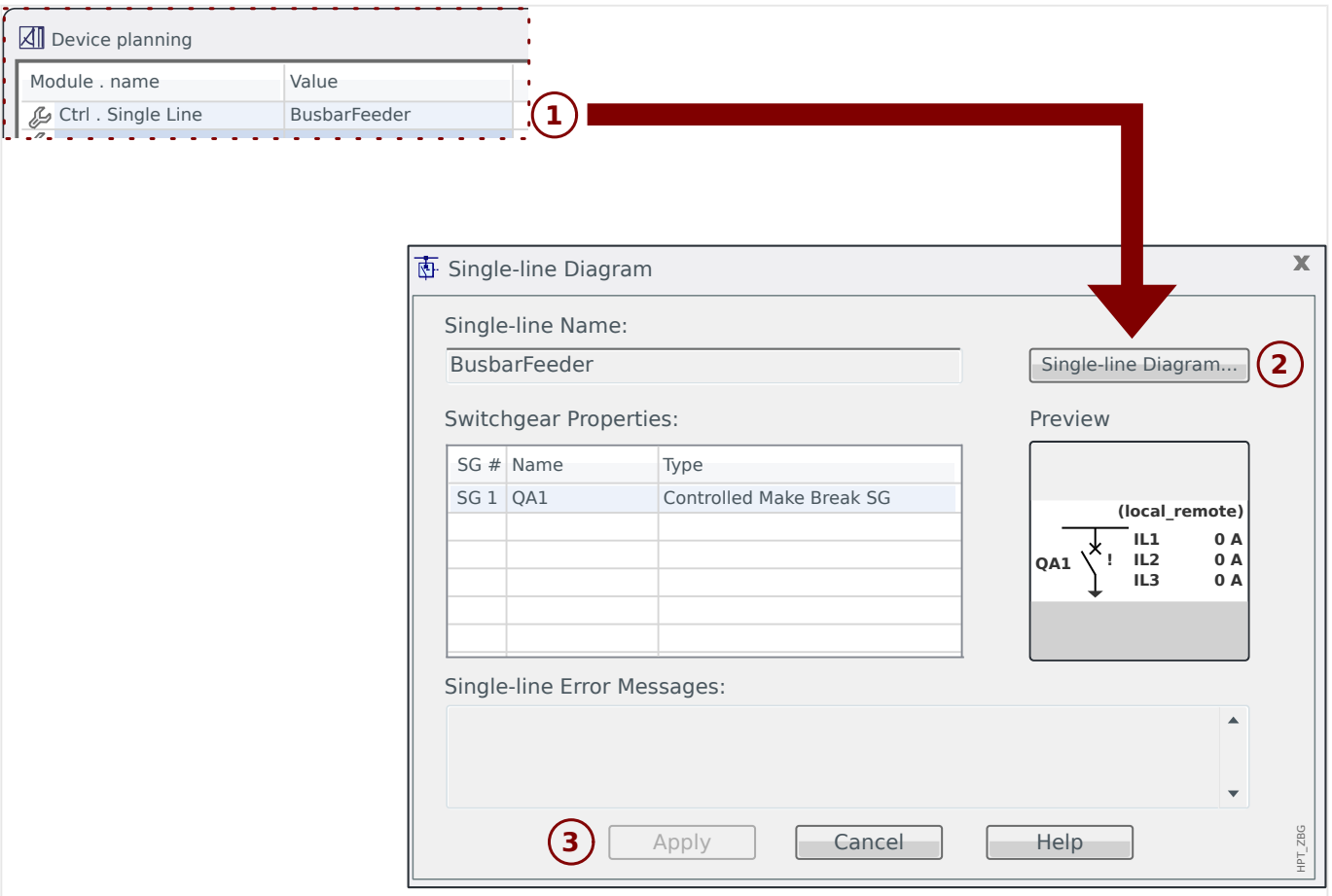

6.18 Programmable Logic via Smart view

WARNING!



Improper use of Logic Equations might result in personal injury or damage the electrical equipment.

Do not use Logic Equations unless that you can ensure the safe functionality.

NOTICE!



It is recommended to configure the logic via *Smart view* (instead of the HMI of the device).



Configuration of a Logic Equation

1. ▷ Enter the menu [Logics / LE x].
2. ▷ Launch the Logic Editor.
3. ▷ Set the Input Signals (where necessary, invert them).
4. ▷ If required, configure the timers (»*LEx.t-On Delay*« and »*LEx.t-Off Delay*«).
5. ▷ If the latched output signal is used assign a reset signal to the reset input »*LEx.Reset Latched*«.

In case that Logic Equations should be cascaded the user has to be aware of timing delays (cycles) in case of descending sequences (Please refer to section: Cascading Logical Outputs).

Within the [Operation / Status Display / Logics], the user can check the status of the logical inputs and outputs of the Logic Equation.

6.19 Communication (SCADA)

Select the SCADA (Communication) Protocol

The set of available SCADA protocols depends on the ordered hardware variant (see the Technical Manual of the HighPROTEC device). Note that (besides IRIG-B) always only one protocol can be active at a time.

Therefore you have to define which one of the available SCADA protocols the HighPROTEC device shall use. This is done by setting [Device planning] »*Protocol*« to the required communication protocol.

After this, you have to make some more settings related to the selected protocol (see the Technical Manual and/or Reference Manual of the HighPROTEC device).

6.19.1 IEC 61850(*)

(*) = only available in devices that feature this protocol.

Generation/Export of a Device-Specific ICD File

Each device of the HighPROTEC line includes a description of its own functionality and communications skills in form of an ICD file (*IED Capability Description*). This file can be exported as follows and be used for the configuration of the substation.

NOTICE!



A change of the devices parameters has an influence on the content of the ICD file.



1. ▷ Connect the device with your PC/Notebook and start *Smart view*.
2. ▷ Select »Receive data from Device« from the [Device] menu.
3. ▷ Navigate to the menu branch [Device Para / IEC 61850].
4. ▷ Click on the ICD icon in the IEC 61850 window.
5. ▷ Select a drive and file name for the ICD file and click »Save«.
6. ▷ Repeat the steps 1 to 5 for all connected devices in this IEC 61850 environment.

Generation/Export of an SCD File

Each device of the HighPROTEC can create an export its own functionality and communications skills as an SCD file.



1. ▷ Connect the device with your PC/Notebook and start *Smart view*.
2. ▷ Select »Receive data from Device« from the [Device] menu.
3. ▷ Navigate to the menu branch [Device Para / IEC 61850].
4. ▷ Click on the SCD icon in the IEC 61850 window.
5. ▷ Select a drive and file name for the SCD file and click »Save«.
6. ▷ Repeat the steps 1 to 5 for all connected devices in this IEC 61850 environment.

Import the SCD File into the Device

When the substation configuration is completed, the SCD file has to be transmitted to all connected devices. This is has to be done as follows:



1. ▷ Connect the device with your PC/Notebook and start *Smart view*.

2. ▷ Select »Receive data from Device« from the [Device] menu.
3. ▷ Navigate to the menu branch [Device Para / IEC 61850].
4. ▷ Switch off the IEC 61850 communication ([Device Para / IEC 61850] »Function« = "inactive") and submit the changed parameter into the device.
5. ▷ Click on the IEC icon in the IEC 61850 window.
6. ▷ Select the folder, where the SCD file is stored. Select the SCD file and click »Open«.
- ▶ The file is then read and checked.
7. ▷ The configuration can be transmitted into the device if no internal fault is detected. Press the button »Send Config.«.
8. ▷ As usual, you might be prompted for a password.
9. ▷ Switch on again the IEC 61850 communication ([Device Para / IEC 61850] »Function« = "active") and submit the changed parameter into the device.
10. ▷ Repeat the steps 1 to 9 for all connected devices in this IEC 61850 environment.
- ▶ If no error message occurs, the configuration has been completed successfully.

WARNING!

When changing the substation configuration, usually a new .SCD file has to be generated. This .SCD file has to be mandatory transmitted to all devices by means of *Smart view*. For the case, that this step will be forgotten, IEC 61850 malfunctions will be the result

Provided that parameters of the devices are changed after the substation configuration completion, changes in the corresponding ICD file may result – this in turn may make an update of the SCD file necessary.

6.19.2 Configurable Communication Protocols(*)

(*) = only available in devices that feature the protocols listed below and only for Release 3.6 and later.

Some of the SCADA protocols have an option to adapt the mapping of data objects to the protocol-internal addresses to one's own needs. This can be done using a separate PC software tool, *SCADApter*.

The protocols supporting such a re-mapping are currently as follows:

- IEC 60870-5-104 (as of **HighPROTEC Release 3.6**)
- Modbus (as of **HighPROTEC Release 3.6**)
- Profibus (as of **HighPROTEC Release 3.7**)
- IEC 60870-5-103 (as of **HighPROTEC Release 3.7**)

For detailed information, see the *SCADApter* documentation, and the respective protocol-specific chapters in the Technical Manual of the HighPROTEC device.

6.19.2.1 Data-Point Mapping Using the SCADApter

Software Tools

The setup procedure for a user-defined data-point mapping always works the same way for all SCADA protocols that support user-defined mappings. A mapping of data objects is always based on a separate file of file-type (extension) *.HptSMap. This file is edited with a separate PC tool, *SCADApter*, and *Smart view* is used to download the currently active user mapping from the protection device (for further editing), or to upload and activate the edited new *.HptSMap mapping file.

NOTICE!



The factory default mapping cannot be downloaded for further editing.

Specify the Data-Point Mapping

The setting parameter [Device Para / protocol-name / Config. Data Obj.] »*Type of SCADA mapping*« can be set to either “Standard” or to “User-defined”.

- “Standard” means that the protection device uses the factory-default as data-point mapping (even if a user-defined mapping has already been uploaded to the Smart view).
- “User-defined” means that the protection device uses the user-defined data-point mapping. (If no valid mapping file has been uploaded then the device reports this by setting the output value [Device Para / protocol-name / Advanced] »Update time« = “Error 1/2”.)

Transfer the Data-Point Mapping

If there is already a user-defined data-point mapping on the protection device, it is possible to download it and use it for further editing. (The factory default cannot be downloaded.)

Depending on the value of »*Type of SCADA mapping*«, the active mapping is either the factory default or a previously uploaded valid mapping file.

Both the download of a mapping file or a (later) upload of an edited mapping file has to be done via *Smart view*, to which the protection device has to be connected.

After the *Smart view* connection has been established and all device data has been retrieved, double-click the menu item [Device Para / protocol-name / Config. Data Obj.].

A dialog window is opened that features a »SCADA Configuration Transfer« button. (See **(1)** in the example figure below.)

Clicking on this button opens another dialog, »SCADA Point Mapping Configuration«. There are two buttons there, **(2)** and **(a)** in the figure below.

Button **(a)** performs the download: The protection devices sends its user-defined SCADA protocol mapping to the »SCADA Point Mapping Configuration«, then a »Save as« file-dialog appears, that allows the user to create a new *.HptSMap file from these protocol definitions. (This download is not possible for the (factory default) standard mapping.)

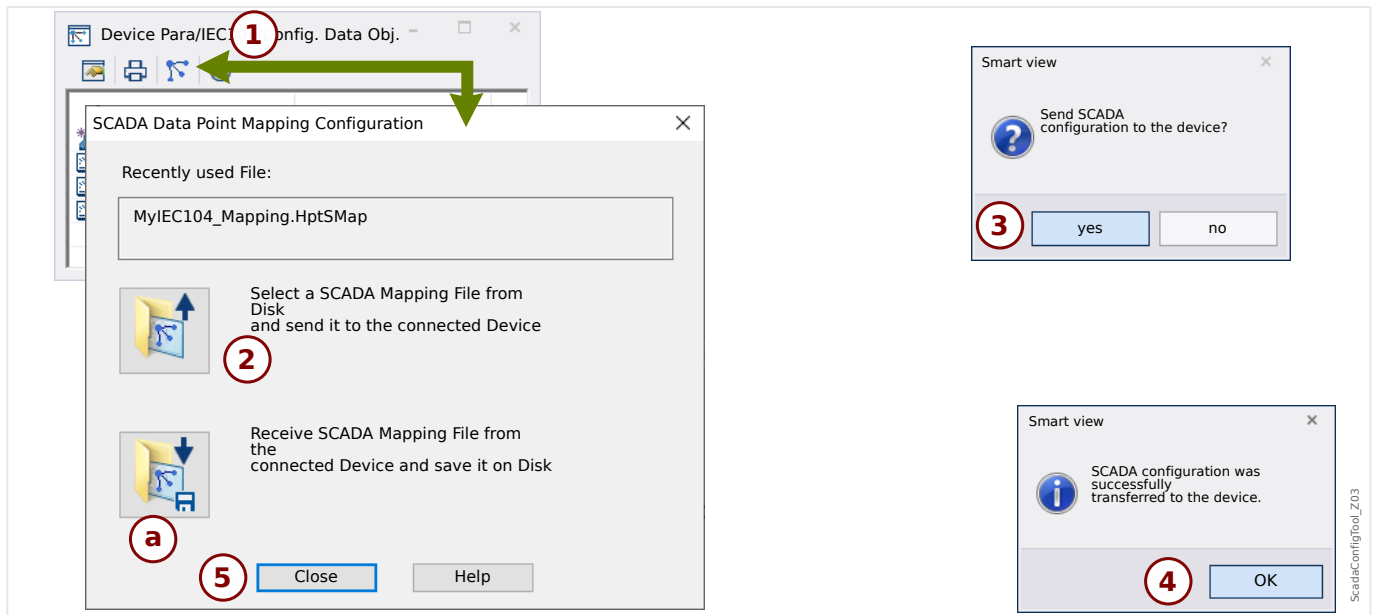

Fig. 5: Example of using Smart view to transfer the *.HptSMap to the protection device.

Button **(2)**, »Select a SCADA Mapping File from Disk and send it to the connected Device.«, starts the upload of an edited mapping file. After clicking this button a file-select dialog opens.

Then navigate to the *.HptSMap file that keeps the required SCADA definitions and click »Open«.

Smart view opens and checks the *.HptSMap file. If it is compatible with the connected protection device a dialog asks the user whether the protocol definitions shall be transferred to the protection device [**(3)** in the diagram].

After clicking »yes« (and entering the password for the access level »Supervisor-Lv3«) the data is transferred, and the user is informed about the success **(4)**.

The user may now click »Close« **(5)** in the »SCADA Point Mapping Configuration« dialog, to return to the Smart view main window.

Finally the user-specific mapping must be activated by the setting [Device Para / protocol-name / Config. Data Obj.] »Type of SCADA mapping« = "User-defined".

Do not forget to transfer all (or all changed) settings (from Smart view) to the protection device. Moreover, it is recommended to have the "Automatic Refresh" active within Smart view, so that all entries within the [Config. Data Obj.] dialog get updated properly.

6.19.3 Remote Configuration for Line Differential Protection Devices(*)

(*) = only available in HighPROTEC devices with Line Differential Protection.

In case of two interconnected Line Differential Protection devices, *Smart view* also allows the configuration of the remote device.

NOTICE!



The “remote access” feature of the local Line Differential Protection device has to be set to active.

NOTICE!



The TCP/IP ports in the range 52152 ... 52163 must not be blocked by a firewall, and none of these ports must be used by any other (non-SEG) application.



1. ▷ Connect the local device with your PC/Notebook and start *Smart view*.
 2. ▷ Select »Receive data from Device« from the [Device] menu.
 3. ▷ After the connection is established a selection window for the local or remote device appears.
 4. ▷ In this selection dialog, choose »Remote Device«.
- ▶ The data of the remote device will be loaded.
The device data tree in *Smart view* is marked with a yellow frame whenever data of the remote device is displayed.

7 Operating a High Tech Line 3 Device

7.1 Loading of Device Data when using Smart view



1. ▷ Start *Smart view*.
2. ▷ Make sure the connection has been established properly. (See [3.4 Connect a High Tech Line 3 Device](#).)
3. ▷ Connect your PC with the device.
4. ▷ Select »Receive Data from Device« in menu [Device].

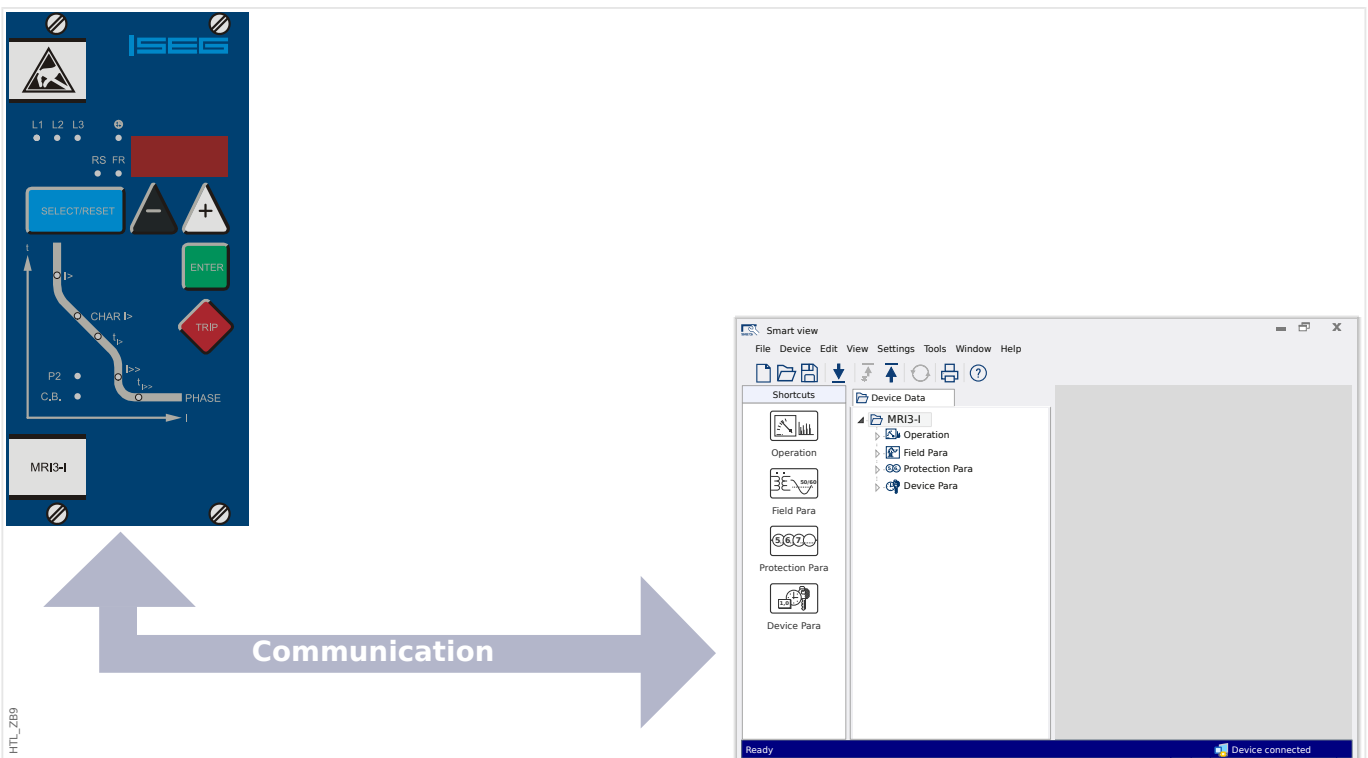

Fig. 6: After you have selected "Receive Data from Device", Smart view presents the available settings of the connected device.

7.2 Transfer Device Data from Smart view to the Device

WARNING!



Via the button »Transfer only modified parameters into the device« only modified parameters are transmitted into the device.

Parameter modifications are indicated by a red “star symbol” in front of the parameter.

The star symbol (in the device tree window) indicates that parameters in the opened file (within *Smart view*) differ from parameters stored on your local hard disk.

Via the button »Transfer only modified parameters into the device«, you can transmit all parameters that are marked by this symbol.

If a parameter file is saved on your local hard drive, these parameters are no longer classified to be modified and cannot be transmitted via the button »Transfer only modified parameters into the device«.

In case that you have loaded and modified a parameter file from the device and saved it to your local hard drive without transferring the parameters into the device beforehand, you cannot use the button »Transfer only modified parameters into the device«. In a case like that, use »Transfer all parameters into the device«.

NOTICE!



The button »Transfer only modified parameters into the device« only works if modified parameters are available in the *Smart view*.

In contrast to that, all parameters of the device are transferred when the button »Transfer all parameters into the device« is pressed (unless there are invalid or implausible device parameters, see [↔ “Change a Parameter via Smart view - Example”](#)).



1. ▷ In order to (re-)transfer changed parameters into the device, please select »Transfer all parameters into the device« in menu [Device].
2. ▷ Confirm the safety inquiry »Shall the parameters be overwritten into the device?«.
3. ▷ Enter the password for setting parameters in the popup window.
 - ▶ Thereafter the changed data is transferred to the device and adopted.
4. ▷ Confirm the inquiry »Parameters successfully updated. It is recommended to save the parameters into a local file on your hard drive. Shall The Data Be Saved Locally? « with »Yes« (recommended). Select a suitable folder on your hard disk.
5. ▷ Confirm the chosen folder by clicking »Save«.
 - ▶ The changed parameter data is now saved in the folder chosen by you.

7.3 Backup and Documentation when using Smart view

How to Save Device Data on a PC



1. ▷ Click on »Save as ...« in menu [File].
2. ▷ Specify a name and choose a folder on your hard disk.
3. ▷ Save the device data accordingly.

Printing of Device Data when using Smart view (Setting List)

The printing menu of the *Smart view* software offers contextual different types of printing ranges.

- *Printing of the complete parameter tree:*All values and parameters of the present parameter file are printed.

- *Printing of the displayed working window:*

Only the data shown on the relevant working window are printed, i. e. this applies, if at least one window is opened.

- *Printing of all opened working windows:*

The data shown on all windows are printed, i. e. this applies only if more than one window is opened.

- *Printing of the device parameter tree as from a shown position on:*

All data and parameters of the device parameter tree are printed as from the position/markings in the navigation window. Below this selection the complete name of the marking is additionally displayed.

7.4 Offline Device Planning via Smart view

The *Smart view* software enables also to parameterize offline. The advantage is: By using device models you can do planning jobs for a device and set parameters in advance.

You can also read the parameter file out of the device, further process it offline (e.g. from your office) and finally re-transfer it to the device.

You can either:

- load an existing parameter file from a device (see [↩➤ “7.1 Loading of Device Data when using Smart view”](#)).
- create a new parameter file (see below),
- open a locally saved parameter file (backup).

In order to create a new device/parameter file by way of a device template offline:



1. ▷ In order to create a new offline parameter file please choose within the menu [File] the entry »Create new parameter file«.
2. ▷ A dialog window pops up. Please make sure that you select the right device type and version.
3. ▷ In order to save the device configuration select »Save« out of the [File] menu.

For the transfer of the parameter file into a device, see [↩➤ “7.2 Transfer Device Data from Smart view to the Device”](#).

7.5 Measuring Values

Read out of Measured Values via Smart view



1. ▷ In case *Smart view* is not running – please start it.
 2. ▷ If the device data were not yet loaded – select »Receive Data from Device« from menu [Device].
 3. ▷ Double click on icon »Operation« in the navigation tree.
 4. ▷ Double click on icon »Measured Values« within the navigation tree [Operation].
 5. ▷ Within the »Measured Values«, double click the category of measured values that you are interested in.
- ▶ The measured and calculated values are shown now in tabular form on the window.

NOTICE!



To have the measuring data read in a cyclic manner, select »Auto refresh« in menu [View]. The measured values are read out about every two seconds.

7.6 Status Display via Smart view



1. ▷ In case *Smart view* is not running – please start it.
2. ▷ If the device data were not yet loaded – select »Receive Data from Device« from menu [Device].
3. ▷ Double click the »Operation« icon in the navigation tree.
4. ▷ Double click the icon »STATUS« within the menu [Operation].

NOTICE!



To have the data read in a cyclic manner, select »Auto refresh« in menu [View]. The measured values are read out about every two seconds.

Signal State / Module Input	Display within <i>Smart view</i>
false / »0«	0
true / »1«	1
No connection to the device or busy.	?

7.7 Recorders

Check Disturbance Records via Smart view

	
1. ▷	In case <i>Smart view</i> is not running – please start it.
2. ▷	If the device data were not yet loaded – select »Receive Data from Device« from menu [Device].
3. ▷	Double click the »Operation« icon in the navigation tree.
4. ▷	Navigate to the menu branch [Operation / Recorders] and double-click on »Disturb rec«.
▶	In the window the disturbance records are shown in tabular form.
5. ▷	Double-click any disturbance record and choose a folder where it is to be saved to.
6. ▷	You can analyze the disturbance records using the software <i>DataVisualizer</i> after clicking on »Yes« when you are asked “Shall the received disturbance record be opened by the <i>DataVisualizer</i> ?”

Delete Disturbance Records via Smart view

	
1. ▷	In case <i>Smart view</i> is not running – please start it.
2. ▷	If the device data were not yet loaded – select »Receive Data from Device« from menu [Device].
3. ▷	Double click the »Operation« icon in the navigation tree.
4. ▷	Navigate to the menu branch [Operation / Recorders] and double-click on »Disturb rec«.
▶	In the window the disturbance records are shown in tabular form.
5. ▷	In order to delete a disturbance record double-click on: »X« (the red x) in front of the disturbance record and confirm.

Check Fault Records via Smart view

	
1. ▷	In case <i>Smart view</i> is not running – please start it.
2. ▷	If the device data were not yet loaded – select »Receive Data from Device« from menu [Device].
3. ▷	Double click the »Operation« icon in the navigation tree.
4. ▷	Navigate to the menu branch [Operation / Recorders] and double-click on »Fault rec«.
▶	In the window the fault records are shown in tabular form.

Via the print menu you can export the data into a file. Please proceed as follows:



1. ▷ Open the data as described above.
2. ▷ Press the button »Print«.
3. ▷ Press the button »Export to File«.
4. ▷ Enter a file name.
5. ▷ Choose a location where to save the file.
6. ▷ Press the button »Save«.

7.8 Parameters

Change a Parameter via Smart view - Example

Example: Changing of a protective parameter. (We want to alter the characteristic for the overcurrent protection in parameter set 1).



1. ▷ In case *Smart view* is not running - please start it.
2. ▷ If the device data were not yet loaded - select »Receive Data from Device« from menu [Device].
3. ▷ Double-click the icon »PROTECTION SETTINGS« in the navigation tree.
4. ▷ Within the [PROTECTION SETTINGS] menu, double-click the icon »Set 1«.
5. ▷ In this table double-click the value/parameter you want to change (here: »CHAR I> Characteristics«).
6. ▷ An editing dialog window is opened where you can select the required characteristic.
7. ▷ Close this window by clicking the »OK« button.
8. ▷ Additional parameters can be changed if required.
9. ▷ There are two options available within the menu [device]: Transfer all parameters to the device, or only the modified ones. See [↔ “7.2 Transfer Device Data from Smart view to the Device”](#).
10. ▷ Confirm the safety inquiry »Shall The Parameters Be Overwritten?«.

NOTICE!



A star (asterisk) symbol in front of the changed parameters indicates that the alterations have not yet been stored in a parameter file. This is independent of whether the parameters have been transferred to the device in the meantime.

In order to make things easier to follow, especially where complex parameter changes are involved, the menu tree indicates the parameter change by the star symbol on every superior/higher menu level, too (“star trace”). This makes it possible to control or follow up from the main menu level at any time where parameter changes have been made but not been saved yet.

The “star trace” is cleared only if the parameter changes are saved in a parameter file, or if all device data is reloaded from the device.

Switch Setting Groups (Parameter Sets) via Smart view



1. ▷ In case *Smart view* is not running - please start it.
2. ▷ If the device data were not yet loaded - select »Receive Data from Device« from menu [Device].
3. ▷ Double-click the icon »Protection Para« in the navigation tree.
4. ▷ Within the [Protection Para] menu, double-click the icon »PS«.

5. ▷ Configure the Setting Group Switch respectively choose an active set manually.

7.9 Synchronize Date and Time via Smart view



1. ▷ In case *Smart view* is not running – please start it.
2. ▷ If the device data were not yet loaded – select »Receive Data from Device« from menu [Device].
3. ▷ Within the navigation tree, enter »Date and Time«, which is in the menu branch [Device Para / Time]. Double-click this entry.
 - ▶ A dialog opens that shows the current date and time of both PC and device.
4. ▷ Click on the button »Synchronize«.
 - ▶ The device receives and takes over date and time from the PC.

7.10 Version via Smart view

Within the menu [File / Properties] you can obtain detailed information on the currently opened file like e. g. software and hardware version.

Index

A

ANSI-Codes	60
access level password	48
accessories	11

C

Configurable SCADA Protocols	68
command-line parameters	23
connection password	48

D

DM version	33
Date + Time	58
Digital Inputs	56
Disturbance Recorder	40
device connection	
Ethernet connection	13, 16
USB connection	13, 14
secured communication	13
serial connection	13, 17

E

Event Recorder	42
exit codes	29

F

Fault Recorder	41
----------------------	----

H

HptPage file	63
HptPara file	63

I

ICD file	67
IEC 60870-5-104	68
IEC 61850	67
Invalid Device Type	32
installation	9

K

keyboard shortcuts	30
--------------------------	----

L

Logic	65
-------------	----

M

MODBUS	68
Measured Values	37

N

Null Modem cable	11, 17
------------------------	--------

P

Page Editor	63
Parameter Sets	52
compare	53
copy	52
Parameter files	53
compare	54
convert	54
properties	54
Programmable Logic	65
parameter setting	50
plausibility check	52

R

Receive Data from Device	31
Recorder	
Disturbance Recorder	40
Event Recorder	42
Fault Recorder	41
Motor Statistics	47
Motor start records	44
Self-Supervision Recorder	47
Trend Recorder	41
Remote Configuration	71
Reset (=acknowledge) LED, output relays, trip commands	38, 38
Reset counters	38
return codes	29

S

SCADA	
IEC 60870-5-104	68
IEC 61850	67
MODBUS	68
protocol selection	66
SCADApter	68
SCD file	
export	67
import	67
Self-Supervision Recorder	47
Setting Groups	52
compare	53
copy	52
Smart view	9
Status Display	39
silent installation	10

single-line	63
switchgear	63
T	
TXT file	34
Transfer device data	
Transfer all parameters into the device	32
Transfer only modified parameters into the device	32
Trend Recorder	41
Tripping curves	61
typecode	32
U	
USB cable	11, 14
USB/Serial adaptor	11, 18, 18
uninstall Smart view	11
V	
Version	59

Smart view SE

docs.SEGelectronics.de/smart_view

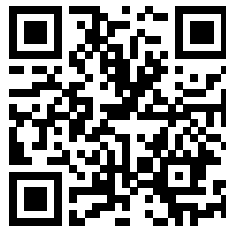

SEG Electronics GmbH reserves the right to update any portion of this publication at any time. Information provided by SEG Electronics GmbH is believed to be correct and reliable. However, SEG Electronics GmbH assumes no responsibility unless otherwise expressly undertaken.



SEG Electronics GmbH
Krefelder Weg 47 • D-47906 Kempen (Germany)
Telephone: +49 (0) 21 52 145 1

Internet: www.SEGelectronics.de

Sales
Telephone: +49 (0) 21 52 145 331
Fax: +49 (0) 21 52 145 354

Service
Telephone: +49 (0) 21 52 145 614
Fax: +49 (0) 21 52 145 354

Complete address / phone / fax / email information for all locations is available on our website.