



**MCA4**

Software-Version: 2.1.i

DOK-HB-MCA4E

Revision: B

English

# MCA4 Functional Overview

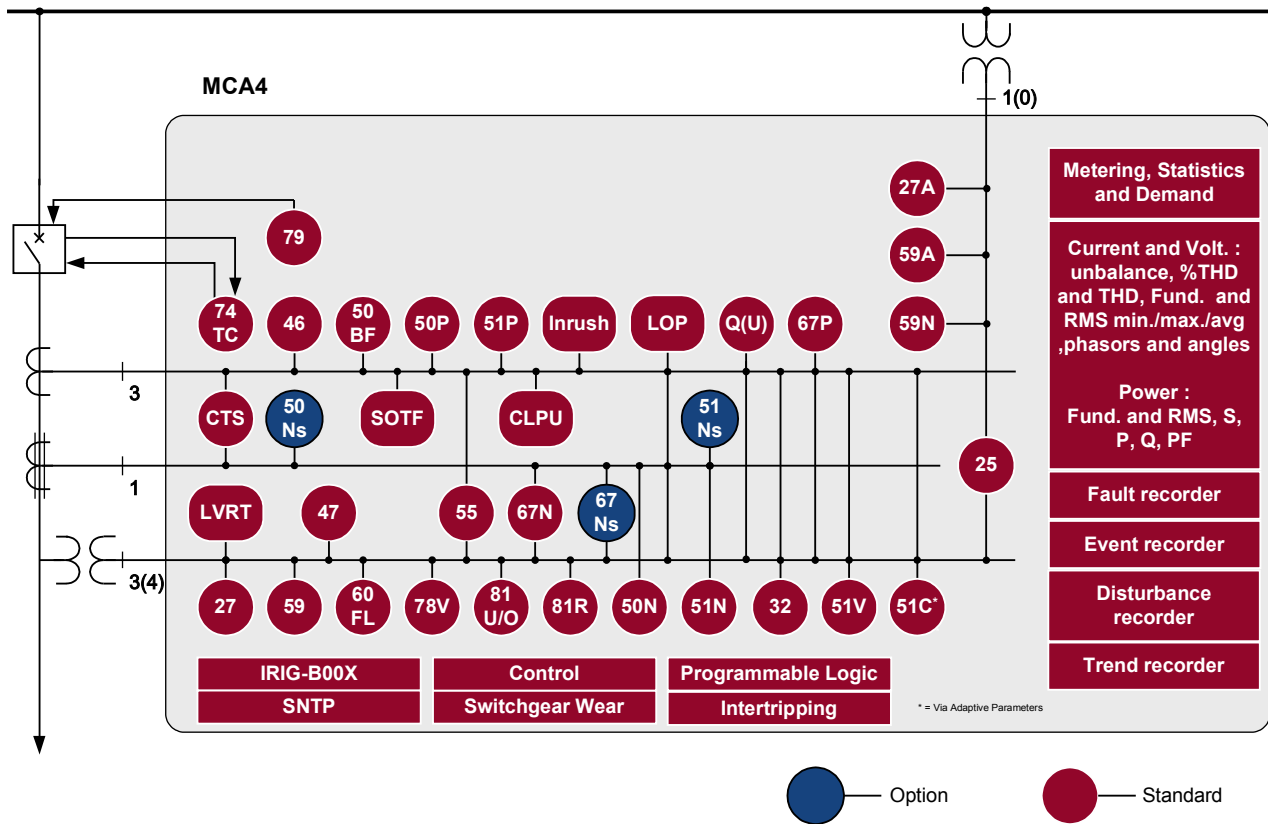

**Order Code**

Directional Feeder Protection				MCA4-				
Digital Inputs	Binary output relays	Housing	Large display					
8	7	B2	X					<b>A</b>
16	7	B2	X					<b>B</b>
16	13	B2	X					<b>D</b>
<b>Hardware variant 2</b>								
Phase Current 5A/1A, Ground Current 5A/1A								<b>0</b>
Phase Current 5A/1A, Sensitive Ground Current 5A/1A								<b>1</b>
<b>Housing and mounting</b>								
Door mounting								<b>A</b>
Door mounting 19" (flush mounting)								<b>B</b>
<b>Communication protocol</b>								
Protocol/without protocol								<b>A</b>
Modbus RTU, IEC60870-5-103, RS485/terminals								<b>B</b>
Modbus TCP, IEC61850 prepared, Ethernet 100 MB/RJ45 connector								<b>C</b>
Profibus-DP, optic fibre								<b>D</b>
Profibus-DP, RS485/D-SUB								<b>E</b>
Modbus RTU, IEC60870-5-103, optic fiber								<b>F</b>
Modbus RTU, IEC60870-5-103, RS485/D-SUB								<b>G</b>
IEC61850, Ethernet 100MB/ RJ45								<b>H</b>
<b>Pre-setting from available menu languages</b>								
Standard English/German/Russian/Polish/Portuguese/French								

The parameterizing- and disturbance analyzing software is included in delivery of HighPROTEC devices.

ANSI: 50, 51, 67, 51C, 51V, 25, 50N, 51N, 67N, 50Ns, 51Ns, 67Ns, 46, 49, 27, 59, 59N, 51Q, 81U/O, 60FL, 79, 86, 50BF, 74TC, 81R, 78, 47, 60FL, 60L, 32F, 37F, 32Q, 37Q, 37QR, 32S, 37S, 37R, 55, 51C, LVRT

With control functions for up to 6 switchgears and logic up to 80 equations.

<b>Comments on the Manual</b> .....	<b>9</b>
Information Concerning Liability and Warranty .....	9
<b>IMPORTANT DEFINITIONS</b> .....	<b>10</b>
Scope of Delivery .....	14
Storage.....	14
Important Information .....	14
Symbols.....	15
General Conventions.....	21
Load Reference Arrow System.....	22
<b>Device</b> .....	<b>23</b>
Device Planning.....	23
Device Planning Parameters of the Device.....	24
<b>Installation and Connection</b> .....	<b>25</b>
Three-Side-View - 19".....	25
Three-Side-View - 7-Pushbutton Version.....	26
Three-Side-View - 8-Pushbutton Version.....	27
Installation Diagram 7-Pushbutton Version.....	28
Installation Diagram 8-Pushbutton Version.....	30
Assembly Groups.....	31
Grounding.....	31
Legend for Wiring Diagrams.....	32
Slot X1: Power Supply Card with Digital Inputs.....	34
Slot X2: Relay Output Card.....	38
Slot X3: Current Transformer Measuring Inputs.....	41
Slot X4: Voltage Transformer Measuring Inputs.....	53
Slot X5: Relay Output Card.....	63
Slot X6: Digital Inputs.....	64
Digital Inputs.....	65
Slot X100: Ethernet Interface.....	67
Slot X103: Data Communication.....	69
Slot X104: IRIG-B00X and Supervision Contact.....	78
<b>Input, Output and LED Settings</b> .....	<b>82</b>
Configuration of the Digital Inputs.....	82
DI-8P X.....	83
DI-8 X.....	87
Output Relays Settings.....	90
OR-5 X.....	94
LED configuration.....	117
<b>Navigation - Operation</b> .....	<b>137</b>
Basic Menu Control .....	143
Smart view Keyboard Commands.....	144
<b>Smart View</b> .....	<b>145</b>
Installation of Smart View.....	145
Deinstalling Smart view.....	146
Switching the Language of the Graphical User Interface.....	146
Setting up the Connection PC - Device.....	147
Loading of Device Data when using Smart view .....	155
Restoring of Device Data when using Smart view.....	156
Backup and Documentation when using Smart view.....	157
Offline Device Planning via Smart view.....	159
<b>Wide Frequency Range</b> .....	<b>160</b>
<b>Measuring Values</b> .....	<b>161</b>
Read out Measured Values.....	161



Current - Measured Values.....	163
Voltage - Measured Values.....	166
Power - Measured Values.....	170
<b>Energy Counter.....</b>	<b>172</b>
Global Parameters of the Energy Counter Module.....	172
Direct Commands of the Energy Counter Module .....	172
Signals of the Energy Counter Module (States of the Outputs).....	172
<b>Statistics.....</b>	<b>174</b>
Configuration of the Minimum and Maximum Values.....	174
Configuration of the Average Value Calculation.....	175
Direct Commands.....	176
Global Protection Parameters of the Statistics Module.....	177
States of the Inputs of the Statistics Module.....	181
Signals of the Statistics Module.....	181
Counters of the Module Statistics.....	182
<b>System Alarms.....</b>	<b>193</b>
Demand Management.....	193
Peak Values.....	196
Min. and Max. Values.....	196
THD Protection.....	197
Device Planning Parameters of the Demand Management.....	197
Signals of the Demand Management (States of the Outputs).....	197
Global Protection Parameter of the Demand Management.....	198
States of the Inputs of the Demand Management.....	201
<b>Acknowledgments.....</b>	<b>202</b>
Manual Acknowledgment.....	204
Manual Acknowledgment via Smart view.....	204
External Acknowledgments.....	205
External Acknowledge via Smart view.....	205
Manual Resets .....	206
Manual Resets via Smart view.....	206
Reset to Factory Defaults.....	206
<b>Status Display .....</b>	<b>207</b>
Status Display via Smart View.....	207
<b>Operating Panel (HMI).....</b>	<b>208</b>
Special Parameters of the Panel.....	208
Direct Commands of the Panel.....	208
Global Protection Parameters of the Panel.....	208
<b>Recorders.....</b>	<b>209</b>
Disturbance Recorder .....	209
Fault Recorder .....	219
Trend Recorder.....	224
Event Recorder .....	230
<b>Communication Protocols.....</b>	<b>233</b>
SCADA Interface.....	233
Modbus®.....	234
Profibus.....	241
IEC60870-5-103.....	255
IEC61850.....	260
<b>Time Synchronisation.....</b>	<b>270</b>
SNTP.....	277
IRIG-B00X.....	284
<b>Parameters.....</b>	<b>288</b>

Parameter Definitions.....	288
Access Authorizations (access areas).....	305
Passwords – Areas.....	305
How to find out what access areas/levels are unlocked?.....	309
Unlocking Access Areas.....	310
Changing Passwords.....	310
Changing Passwords via Smart view.....	311
Password Entry at the Panel.....	312
Password Forgotten .....	312
Parameter Setting at the HMI.....	313
Parameter Setting via Smart view.....	317
Setting Groups.....	320
Comparing Parameter Files via Smart view.....	332
Converting Parameter Files via Smart view.....	332
Setting Lock.....	333
<b>Device Parameters.....</b>	<b>334</b>
Date and Time.....	334
Synchronize Date and Time via Smart View.....	334
Version.....	334
Version via Smart view.....	334
TCP/IP Settings.....	335
Direct Commands of the System Module.....	336
Global Protection Parameters of the System.....	337
System Module Input States.....	339
System Module Signals.....	340
Special Values of the System Module.....	341
<b>Field Parameters .....</b>	<b>342</b>
General Field Parameters.....	342
Field Parameters – Current Related.....	343
Field Parameters – Voltage Related.....	345
<b>Blockings.....</b>	<b>348</b>
Permanent Blocking.....	348
Temporary Blocking.....	348
To Activate or Deactivate the Tripping Command of a Protection Module.....	350
Activate, Deactivate Respectively Block Temporarily Protection Functions.....	351
<b>Module: Protection (Prot).....</b>	<b>355</b>
Direct Commands of the Protection Module.....	362
Global Protection Parameters of the Protection Module .....	362
Protection Module Input States.....	363
Protection Module Signals (Output States).....	363
Protection Module Values.....	364
<b>Switchgear/Breaker – Manager.....</b>	<b>365</b>
Single Line Diagram.....	366
Import of a Single Line Diagram.....	366
Transfer of the Single Line Diagram into the device.....	366
Export of a Single Line Diagram.....	366
Notes on Special Switchgears.....	368
Switchgear Configuration.....	370
Switchgear Wear.....	381
Control - Example: Switching of a Circuit Breaker.....	388
Control Parameters.....	392
Controlled Circuit Breaker.....	403
Monitored Circuit Breaker.....	417

Controlled Disconnecter.....	431
Monitored Disconnecter.....	445
<b>Protective Elements.....</b>	<b>459</b>
I - Overcurrent Protection [50, 51,51Q, 51V, 67].....	460
Directional Features for Measured Ground Fault Elements 50N/51N.....	493
Directional Features for Calculated (IG calc) Ground Fault 50N/51N.....	494
IG - Ground Fault [50N/G, 51N/G, 67N/G].....	498
ThR-Protection Module: Thermal Replica [49].....	523
I2 and %I2/I1> - Unbalanced Load [46].....	532
IH2 - Inrush.....	541
SOTF - Switch Onto Fault.....	547
CLPU - Cold Load Pickup.....	554
V - Voltage Protection [27/59].....	563
VG, VX - Voltage Supervision [59N].....	575
Sync - Synchrocheck [25].....	583
V 012 – Voltage Asymmetry [47].....	608
PQS - Power [32, 37].....	615
PF - Power Factor [55].....	633
Q->&V< Reactive-Power/Undervoltage Protection.....	641
LVRT – Low Voltage Ride Through.....	658
Intertripping (Remote).....	671
f - Frequency [81O/U, 78, 81R].....	677
AR - Automatic Reclosure [79].....	701
ExP - External Protection.....	742
<b>Supervision.....</b>	<b>748</b>
CBF- Circuit Breaker Failure [50BF].....	748
TCS - Trip Circuit Supervision [74TC].....	768
CTS - Current Transformer Supervision [60L].....	776
LOP - Loss of Potential.....	782
Self Supervision.....	792
<b>Programmable Logic.....</b>	<b>794</b>
General Description.....	794
Programmable Logic at the Panel.....	798
Programmable Logic via Smart view.....	798
<b>Commissioning .....</b>	<b>803</b>
Commissioning/Protection Test .....	804
Putting out of Operation – Plug out the Relay.....	805
Service and Commissioning Support.....	806
Forcing RTDs*.....	810
Forcing Analog Outputs*.....	811
Forcing Analog Inputs*.....	812
Failure Simulator (Sequencer)*.....	813
<b>Technical Data .....</b>	<b>828</b>
Climatic Environmental Conditions.....	828
Degree of Protection EN 60529.....	828
Routine Test.....	828
Housing.....	829
Current and Earth Current Measurement.....	830
Voltage and Residual Voltage Measurement.....	831
Frequency Measurement .....	831
Voltage Supply.....	832
Power Consumption.....	832
Display.....	833

---

Front Interface RS232.....	833
Real Time Clock.....	833
Digital Inputs.....	834
Binary Output Relays.....	835
Supervision Contact (SC).....	835
Time Synchronization IRIG.....	835
RS485*.....	836
Fibre Optic*.....	836
URTD-Interface*.....	836
Boot phase.....	836
<b>Standards.....</b>	<b>837</b>
Approvals.....	837
Design Standards.....	837
High Voltage Tests (IEC 60255-6).....	837
EMC Immunity Tests.....	838
EMC Emission Tests.....	838
Environmental Tests.....	839
Mechanical Tests.....	840
<b>Specifications.....</b>	<b>841</b>
Specifications of the Real Time Clock.....	841
Time Synchronisation Tolerances.....	841
Specifications of the Measured Value Acquisition.....	842
Protection Elements Accuracy.....	844
<b>Assignment List .....</b>	<b>851</b>
List of the Digital Inputs.....	910
Signals of the Digital Inputs and Logic.....	911

This manual applies to devices (version):

Version 2.1.i

Build: 18165

## Comments on the Manual

This manual explains in general the tasks of device planning, parameter setting, installation, commissioning, operation and maintenance of the HighPROTEC devices.

The manual serves as working basis for:

- Engineers in the protection field,
- commissioning engineers,
- people dealing with setting, testing and maintenance of protection and control devices,
- as well as trained personnel for electrical installations and power stations.

All functions concerning the type code will be defined. Should there be a description of any functions, parameters or inputs/outputs which do not apply to the device in use, please ignore that information.

All details and references are explained to the best of our knowledge and are based on our experience and observations.

This manual describes the (optionally) full featured versions of the devices.

All technical information and data included in this manual reflect their state at the time this document was issued. We reserve the right to carry out technical modifications in line with further development without changing this manual and without previous notice. Hence no claim can be brought based on the information and descriptions this manual includes.

Text, graphic and formulae do not always apply to the actual delivery scope. The drawings and graphics are not true to scale. We do not accept any liability for damage and operational failures caused by operating errors or disregarding the directions of this manual.

No part of this manual is allowed to be reproduced or passed on to others in any form, unless *Woodward Kempen GmbH* have approved in writing.

This user manual is part of the delivery scope when purchasing the device. In case the device is passed on (sold) to a third party, the manual has to be handed over as well.

Any repair work carried out on the device requires skilled and competent personnel who need to be well aware especially of the local safety regulations and have the necessary experience for working on electronic protection devices and power installations (provided by evidence).

## Information Concerning Liability and Warranty

*Woodward* does not accept any liability for damage resulting from conversions or changes carried out on the device or planning (projecting) work, parameter setting or adjustment changes done by the customer.

The warranty expires after a device has been opened by others than *Woodward* specialists.

Warranty and liability conditions stated in *Woodward* General Terms and Conditions are not supplemented by the above mentioned explanations.

## IMPORTANT DEFINITIONS

The signal definitions shown below serve the safety of life and limb as well as for the appropriate operating life of the device.

 **DANGER** indicates a hazardous situation which, if not avoided, will result in death or serious injury.

 **WARNING** indicates a hazardous situation which, if not avoided, could result in death or serious injury.

 **CAUTION**, used with the safety alert symbol, indicates a hazardous situation which, if not avoided, could result in minor or moderate injury.

 **NOTICE** is used to address practices not related to personal injury.

 **CAUTION**, without the safety alert symbol, is used to address practices not related to personal injury.



**FOLLOW INSTRUCTIONS**

Read this entire manual and all other publications pertaining to the work to be performed before installing, operating, or servicing this equipment. Practice all plant and safety instructions and precautions. Failure to follow instructions can cause personal injury and/or property damage.



**PROPER USE**

Any unauthorized modifications to or use of this equipment outside its specified mechanical, electrical, or other operating limits may cause personal injury and/or property damage, including damage to the equipment. Any such unauthorized modifications: (1) constitute "misuse" and/or "negligence" within the meaning of the product warranty thereby excluding warranty coverage for any resulting damage, and (2) invalidate product certifications or listings.

The programmable devices subject to this manual are designed for protection and also control of power installations and operational devices that are fed by voltage sources with a fixed frequency, i.e. fixed at 50 or 60 Hertz. They are not intended for use with Variable Frequency Drives. The devices are further designed for installation in low-voltage (LV) compartments of medium voltage (MV) switchgear panels or in decentralized protection panels. The programming and parameterization has to meet all requirements of the protection concept (of the equipment that is to be protected). You must ensure that the device will properly recognize and manage (e.g. switch off the circuit breaker) on the basis of your programming and parameterization all operational conditions (failures). The proper use requires a backup protection by an additional protective device. Before starting any operation and after any modification of the programming (parameterization) test make a documentary proof that your programming and parameterization meets the requirements of your protection concept.

Typical applications for this product family/device line are for instance:

- Feeder protection
- Mains protection
- Machine protection
- Transformer Differential Protection

Any usage beyond these applications the devices are not designed for. This applies also to the use as a partly completed machinery. The manufacturer cannot be held liable for any resulting damage, the user alone bears the risk for this. As to the appropriate use of the device: The technical data and tolerances specified by *Woodward* have to be met.



**OUT-OF-DATE PUBLICATION**

This publication may have been revised or updated since this copy was produced. To verify that you have the latest revision, please visit the download section of our website:

[www.woodward.com](http://www.woodward.com)

If your publication is not there, please contact your customer service representative to get the latest copy.



**CAUTION**

**Electrostatic Discharge Awareness**

All electronic equipment is electro static-sensitive, some components more than others. To protect these components from electro static damage, you must take special precautions to minimize or eliminate electrostatic discharges.

Follow these precautions when working with or near the control.

1. Before doing maintenance on the electronic control, discharge the static electricity on your body to ground by touching and holding a grounded metal object (pipes, cabinets, equipment, etc.).
2. Avoid the build-up of static electricity on your body by not wearing clothing made of synthetic materials. Wear cotton or cotton-blend materials as much as possible because these do not store static electric charges as much as synthetics.
3. Keep plastic, vinyl, and Styrofoam materials (such as plastic or Styrofoam cups, cup holders, cigarette packages, cellophane wrappers, vinyl books or folders, plastic bottles, and plastic ash trays) away from the control, the modules, and the work area as much as possible.
4. Do not remove any printed circuit board (PCB) from the control cabinet unless absolutely necessary. If you must remove the PCB from the control cabinet, follow these precautions:
  - Verify the safe isolation from supply. All connectors have to be unplugged.
  - Do not touch any part of the PCB except the edges.
  - Do not touch the electrical conductors, the connectors, or the components with conductive devices or with your hands.
  - When replacing a PCB, keep the new PCB in the plastic antistatic protective bag it comes in until you are ready to install it. Immediately after removing the old PCB from the control cabinet, place it in the antistatic protective bag.

To prevent damage to electronic components caused by improper handling, read and observe the precautions in Woodward manual 82715, Guide for Handling and Protection of Electronic Controls, Printed Circuit Boards, and Modules.

Woodward reserves the right to update any portion of this publication at any time. Information provided by Woodward is believed to be correct and reliable. However, no responsibility is assumed by Woodward unless otherwise expressly undertaken.

### Scope of Delivery

The delivery scope does not include the fastening material, but includes all connection terminals, except communication connectors. Please check the consignment for completeness on arrival (delivery note).

Please ascertain whether the type plate, connection diagram, type code and description of the device tally. If you have any doubts please contact our Service Department (contact address to be found on the reverse of the manual).

### Storage

The devices must not be stored outdoors. The storing facilities have to be sufficiently ventilated and must be dry (see Technical Data).

### Important Information



In line with the customer's requirement the devices are combined in a modular way (in compliance with the order code). The terminal assignment of the device can be found on the top of the device (wiring diagram).

# Symbols

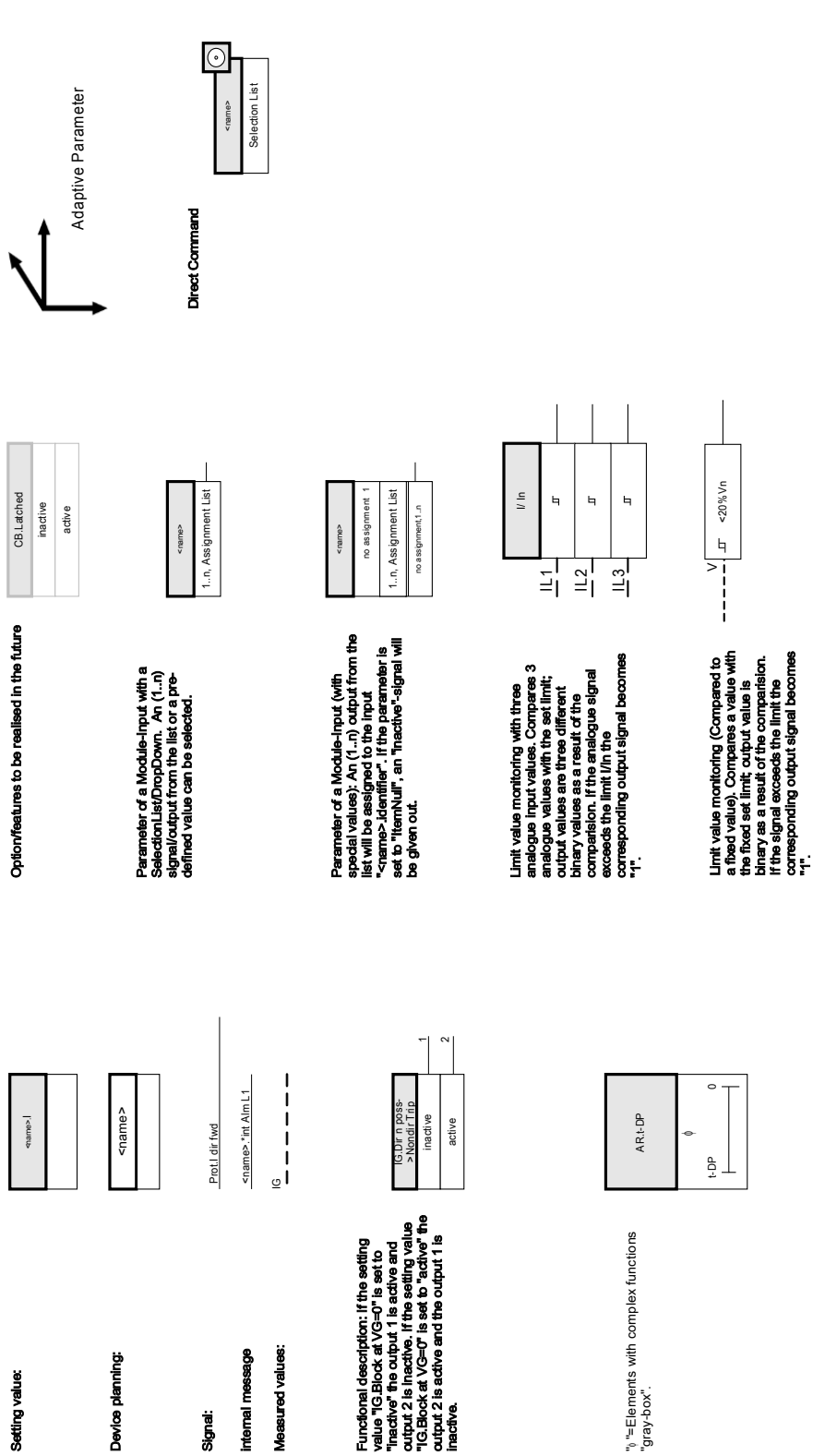

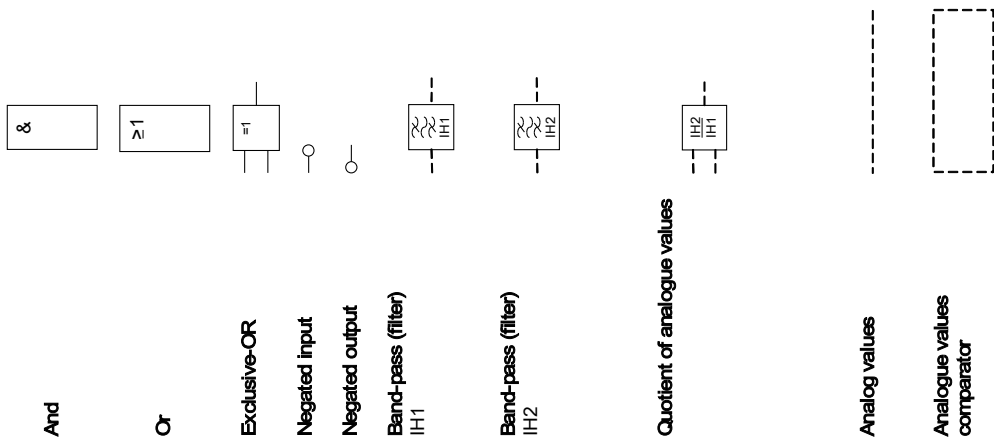

**RS flip-flop**



a b c d  
 0 0 Unchanged  
 0 1 0 1  
 1 0 1 0  
 1 1 0 1

**Time stage:** A "1" at the input starts the stage. If the time <name>.t is expired the output becomes "1" too. The time stage will be reset by "0" at the input. Thus the output will be set to "0" at the same time.

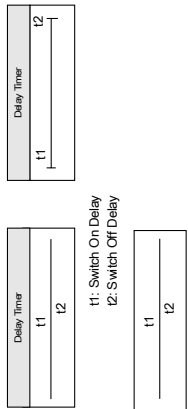

**Edge triggered counter**  
 + increment  
 R Reset

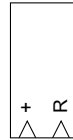

Counter increments with every rising edge. Output will be set as long as  $n < N$ .

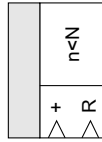

**Quotient of analogue values**

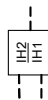

**Time stage minimum pulse width:** The pulse width <name>.t will be started if a "1" is feed to the input. By starting <name>.t the output becomes "1". If the time is expired, the output becomes "0" independent from the input signal.

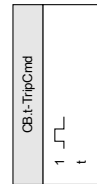

**Analog values**



**Analogue values comparator**

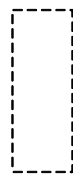

# IMPORTANT DEFINITIONS

<p>2 — Input Signal</p> <p>2</p> <p>Output Signal</p> <p>2</p>	<p>16</p> <p>Each trip of an active, trip authorized protection module will lead to a general trip.</p> <p>name.Trip L1</p> <p>16a</p> <p>Each trip of an active, trip authorized protection module will lead to a general trip.</p> <p>name.Trip L1</p> <p>16b</p> <p>Each trip of an active, trip authorized protection module will lead to a general trip.</p> <p>name.Trip L1</p> <p>17</p> <p>Each trip of an active, trip authorized protection module will lead to a general trip.</p> <p>name.Trip L2</p> <p>17a</p> <p>Each trip of an active, trip authorized protection module will lead to a general trip.</p> <p>name.Trip L2</p> <p>17b</p> <p>Each trip of an active, trip authorized protection module will lead to a general trip.</p> <p>name.Trip L2</p> <p>18</p> <p>Each trip of an active, trip authorized protection module will lead to a general trip.</p> <p>name.Trip L3</p> <p>18a</p> <p>Each trip of an active, trip authorized protection module will lead to a general trip.</p> <p>name.Trip L3</p> <p>18b</p> <p>Each trip of an active, trip authorized protection module will lead to a general trip.</p> <p>name.Trip L3</p> <p>19</p> <p>Each trip of an active, trip authorized protection module will lead to a general trip.</p> <p>name.TripCmd</p> <p>19a</p> <p>Each trip of an active, trip authorized protection module will lead to a general trip.</p> <p>name.TripCmd</p> <p>19b</p> <p>Each trip of an active, trip authorized protection module will lead to a general trip.</p> <p>name.TripCmd</p> <p>19c</p> <p>Each trip of an active, trip authorized protection module will lead to a general trip.</p> <p>name.TripCmd</p> <p>19d</p> <p>Each trip of an active, trip authorized protection module will lead to a general trip.</p> <p>name.TripCmd</p>
<p>1</p> <p>Please Refer To Diagram: Ptd</p> <p>2</p> <p>Please Refer To Diagram: Blockings</p> <p>3</p> <p>Please Refer To Diagram: Trip blockings</p> <p>4</p> <p>Please Refer To Diagram: Blockings**</p> <p>5</p> <p>Please Refer To Diagram: IH2</p> <p>6</p> <p>Please Refer To Diagram: IH2</p> <p>7</p> <p>Please Refer To Diagram: IH2</p> <p>8</p> <p>Please Refer To Diagram: IH2</p> <p>9</p> <p>Please Refer To Diagram: direction decision phase overcurrent</p> <p>10</p> <p>Please Refer To Diagram: direction decision Earth fault</p> <p>11</p> <p>Please Refer To Diagram: CB</p> <p>12a</p> <p>Please Refer To Diagram: VTS</p> <p>12b</p> <p>Please Refer To Diagram: VTS</p> <p>12c</p> <p>Please Refer To Diagram: VTS</p> <p>Each alarm of a module (except from supervision modules but including CBF) will lead to a general alarm (collective alarm).</p> <p>14</p> <p>name.Alarm</p> <p>15</p> <p>Each trip of an active, trip authorized protection module will lead to a general trip.</p> <p>name.TripCmd</p>	<p>Prot.available</p> <p>name.active</p> <p>name.Blo TripCmd</p> <p>name.active</p> <p>IH2.Blo L1</p> <p>IH2.Blo L2</p> <p>IH2.Blo L3</p> <p>IH2.Blo IG</p> <p>name.Fault in projected direction</p> <p>name.Fault in projected direction</p> <p>CB.Trip CB</p> <p>VTS.Alarm</p> <p>VTS.VTS.Ex FF VT</p> <p>VTS.VTS.Ex FF EVT</p>

## IMPORTANT DEFINITIONS

- Each trip of an active, trip authorized protection module will lead to a general trip.
- 20** name.Trip L1
- Each trip of an active, trip authorized protection module will lead to a general trip.
- 21** name.Trip L2
- Each trip of an active, trip authorized protection module will lead to a general trip.
- 22** name.Trip L3
- Each trip of an active, trip authorized protection module will lead to a general trip.
- 23** name.Trip
- Each phase selective alarm of a module (I, IG, V, VX depending on the device type) will lead to a phase selective general alarm (collective alarm).
- 24** name.Alarm L1
- Each phase selective alarm of a module (I, IG, V, VX depending on the device type) will lead to a phase selective general alarm (collective alarm).
- 24a** name.Alarm L1
- Each phase selective alarm of a module (I, IG, V, VX depending on the device type) will lead to a phase selective general alarm (collective alarm).
- 24b** name.Alarm L1
- Each phase selective alarm of a module (I, IG, V, VX depending on the device type) will lead to a phase selective general alarm (collective alarm).
- 25** name.Alarm L2
- Each phase selective alarm of a module (I, IG, V, VX depending on the device type) will lead to a phase selective general alarm (collective alarm).
- 25a** name.Alarm L2
- Each phase selective alarm of a module (I, IG, V, VX depending on the device type) will lead to a phase selective general alarm (collective alarm).
- 25b** name.Alarm L2
- Each phase selective alarm of a module (I, IG, V, VX depending on the device type) will lead to a phase selective general alarm (collective alarm).
- 26** name.Alarm L3
- Each phase selective alarm of a module (I, IG, V, VX depending on the device type) will lead to a phase selective general alarm (collective alarm).
- 26a** name.Alarm L3
- Each phase selective alarm of a module (I, IG, V, VX depending on the device type) will lead to a phase selective general alarm (collective alarm).
- 26b** name.Alarm L3
- Each phase selective alarm of a module (I, IG, V, VX depending on the device type) will lead to a phase selective general alarm (collective alarm).
- 27** name.Alarm
- Each phase selective alarm of a module (I, IG, V, VX depending on the device type) will lead to a phase selective general alarm (collective alarm).
- 27a** name.Alarm
- Each phase selective alarm of a module (I, IG, V, VX depending on the device type) will lead to a phase selective general alarm (collective alarm).
- 27b** name.Alarm
- Each phase selective alarm of a module (I, IG, V, VX depending on the device type) will lead to a phase selective general alarm (collective alarm).
- 27c** name.Alarm
- Each phase selective alarm of a module (I, IG, V, VX depending on the device type) will lead to a phase selective general alarm (collective alarm).
- 27d** name.Alarm
- Each phase selective alarm of a module (I, IG, V, VX depending on the device type) will lead to a phase selective general alarm (collective alarm).
- 28** name.Alarm L1
- Each phase selective alarm of a module (I, IG, V, VX depending on the device type) will lead to a phase selective general alarm (collective alarm).
- 29** name.Alarm L2
- Each phase selective alarm of a module (I, IG, V, VX depending on the device type) will lead to a phase selective general alarm (collective alarm).
- 30** name.Alarm L3
- Each phase selective alarm of a module (I, IG, V, VX depending on the device type) will lead to a phase selective general alarm (collective alarm).
- 31** name.Alarm
- Prot.Blo TripCmd
- CB.Pos
- Please Refer To Diagram: CB.CB Manager
- 33** CB.Pos
- Please Refer To Diagram: CB.CB Manager
- 34** CB.Pos ON
- Please Refer To Diagram: CB.CB Manager
- 35** CB.Pos OFF
- Please Refer To Diagram: CB.CB Manager
- 36** CB.Pos Indeterm
- Please Refer To Diagram: CB.CB Manager
- 37** CB.Pos Disturb
- Please Refer To Diagram: CB.CB Manager
- 38a** LOP.LOP Blo
- Please Refer To Diagram: LOP.LOP Blo
- 38b** LOP.Ex FF VT
- Please Refer To Diagram: LOP.Ex FF VT
- 38c** LOP.Ex FF EVT
- Please Refer To Diagram: LOP.Ex FF EVT

- Q-> &V< Decoupling Energy Resource 39  
Please Refer To Diagram: Q->&V<:Decoupling Energy Resource
- CTS.Alarm 40  
Please Refer To Diagram: CTS.Alarm
- 41  
Please Refer To Diagram: SG.Prot ON
- SG.ON Cmd 42  
Please Refer To Diagram: SG.ON Cmd
- AnIn[1].Value 43  
Please Refer To Diagram: Analog values
- AnIn[2].Value 44  
Please Refer To Diagram: Analog values
- AnIn[n].Value 45  
Please Refer To Diagram: Analog values

**Access Level**

*(Please refer to chapter [Parameter\Access Level])*

Read Only-Lv0

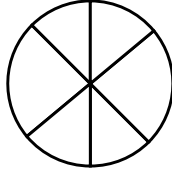

Parameters can only be read within this level.

Prot-Lv1

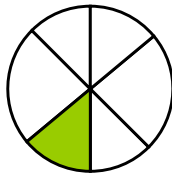

This level enables to execute Resets and Acknowledgements

Prot-Lv2



This level enables to modify protection settings

Control-Lv1

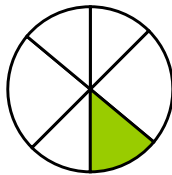

This level enables to control switchgears

Control-Lv2

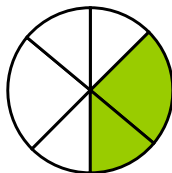

This level enables to modify the settings of switchgears

Supervisor-Lv3

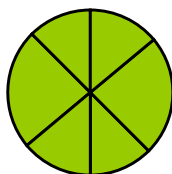

This level provides full access (not limited) to all settings



## General Conventions

»Parameters are indicated by right and left double arrow heads and written in *italic*

»SIGNALS are indicated by right and left double arrow heads and small caps

[Paths are indicated by brackets.]

*Software and Device names are written in italic*

*Module and Instance (Element) names are displayed italic and underlined.*

»Pushbuttons, Modes and Menu entries are indicated by right and left double arrow heads .«



Image References (Squares)

## Load Reference Arrow System

Within the HighPROTEC the “Load Reference Arrow System” is used in principal. Generator protection relays are working based on the “Generator Reference System”.

## Device

MCA4

### Device Planning

Planning of a device means to reduce the functional range to a degree that suits the protection task to be fulfilled, i.e. the device shows only those functions you really need. If you, for example, deactivate the voltage protection function, all parameter branches related to this function do not appear in the parameter tree any more. All corresponding events, signals etc. will be deactivated too. By this the parameter trees become very transparent. Planning also involves adjustment of all basic system data (frequency etc.).



**WARNING**

But it has to be taken into account that by deactivating, for instance, protective functions, you also change the functionality of the device. If you cancel the directional feature of the overcurrent protections then the device no longer trips in a directional way but merely in a non-directional way.

The manufacturer does not accept liability for any personal or material damage as a result of wrong planning.

A planning service is also offered by *Woodward Kempen GmbH*.







**WARNING**

**Beware of inadvertent deactivating protective functions/modules**

If you are deactivating modules within the device planning all parameters of those modules will be set on default.

If you are activating one of these modules again all parameters of those reactivated modules will be set on default.

## Device Planning Parameters of the Device

Parameter	Description	Options	Default	Menu path
Hardware Variant 1 	Optional Hardware Extension	»A« 8 digital inputs   7 binary output relays, »B« 16 digital inputs   6 binary output relays, »D« 16 digital inputs   13 binary output relays	16 digital inputs   13 binary output relays	[MCA4]
Hardware Variant 2 	Optional Hardware Extension	»0« Phase Current 5A/1A, Ground Current 5A/1A, »1« Phase Current 5A/1A, Sensitive Ground Current 5A/1A	Phase Current 5A/1A, Ground Current 5A/1A	[MCA4]
Housing 	Mounting form	»A« Flush mounting, »B« 19 inch mounting (semi-flush), »H« Customized Version 1	Flush mounting	[MCA4]
Communication 	Communication	»A« Without, »B« RS 485: Modbus RTU   IEC 60870-5-103, »C« Ethernet: Modbus TCP, »D« Fiber Optics: Profibus-DP, »E« D-SUB: Profibus-DP, »F« Fiber Optics: Modbus RTU   IEC 60870-5-103, »G« RS 485/D-SUB: Modbus RTU   IEC 60870-5-103, »H« Ethernet: IEC61850	Ethernet: IEC61850	[MCA4]

# Installation and Connection

## Three-Side-View - 19"

**NOTICE** Dependent on the connection method of the SCADA system used the needed space (depth) differs. If, for instance, a D-Sub-Plug is used, it has to be added to the depth dimension.

**NOTICE** The three-side-view shown in this section is exclusively valid for 19" devices.

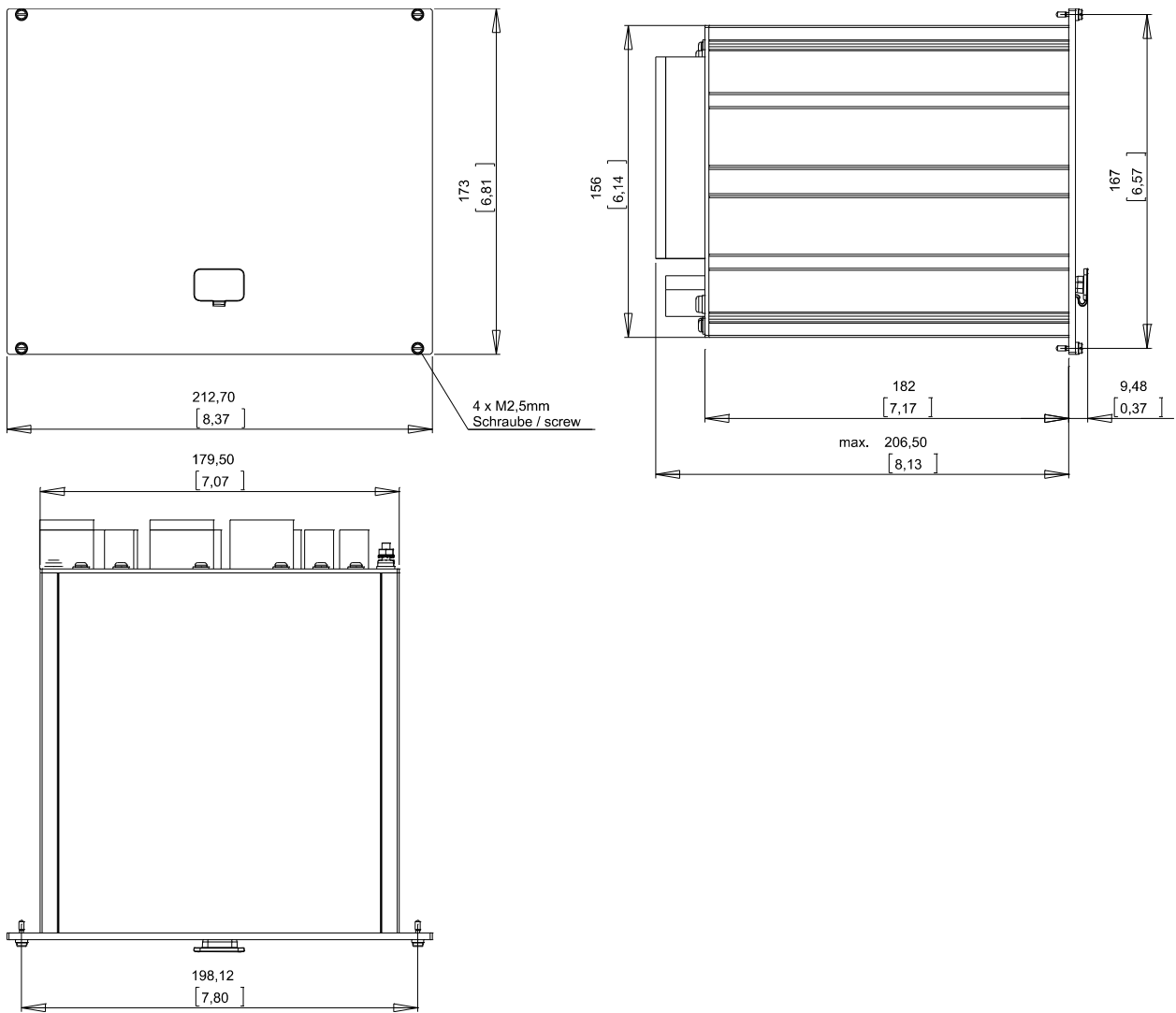

### 3-Side-View B2 Housing (19" Devices)

**WARNING** The housing must be carefully earthed. Connect a ground cable (4 to 6 mm<sup>2</sup> / AWG 12-10) / 1,7 Nm [15 lb-in]) to the housing, using the screw, which is marked with the ground symbol (at the rear side of the device).

The power supply card needs a separate ground connection (2.5 mm<sup>2</sup> / AWG 14) at terminal X1 (0.56-0.79 Nm [5-7 lb-in]).

### Three-Side-View - 7-Pushbutton Version

**NOTICE** Dependent on the connection method of the SCADA system used the needed space (depth) differs. If, for instance, a D-Sub-Plug is used, it has to be added to the depth dimension.

**NOTICE** The installation diagram shown in this section is exclusively valid for devices with 7 pushbuttons at the front side of the HMI. (INFO-, C-, OK-Pushbutton and 4 Softkeys (Pushbuttons)).

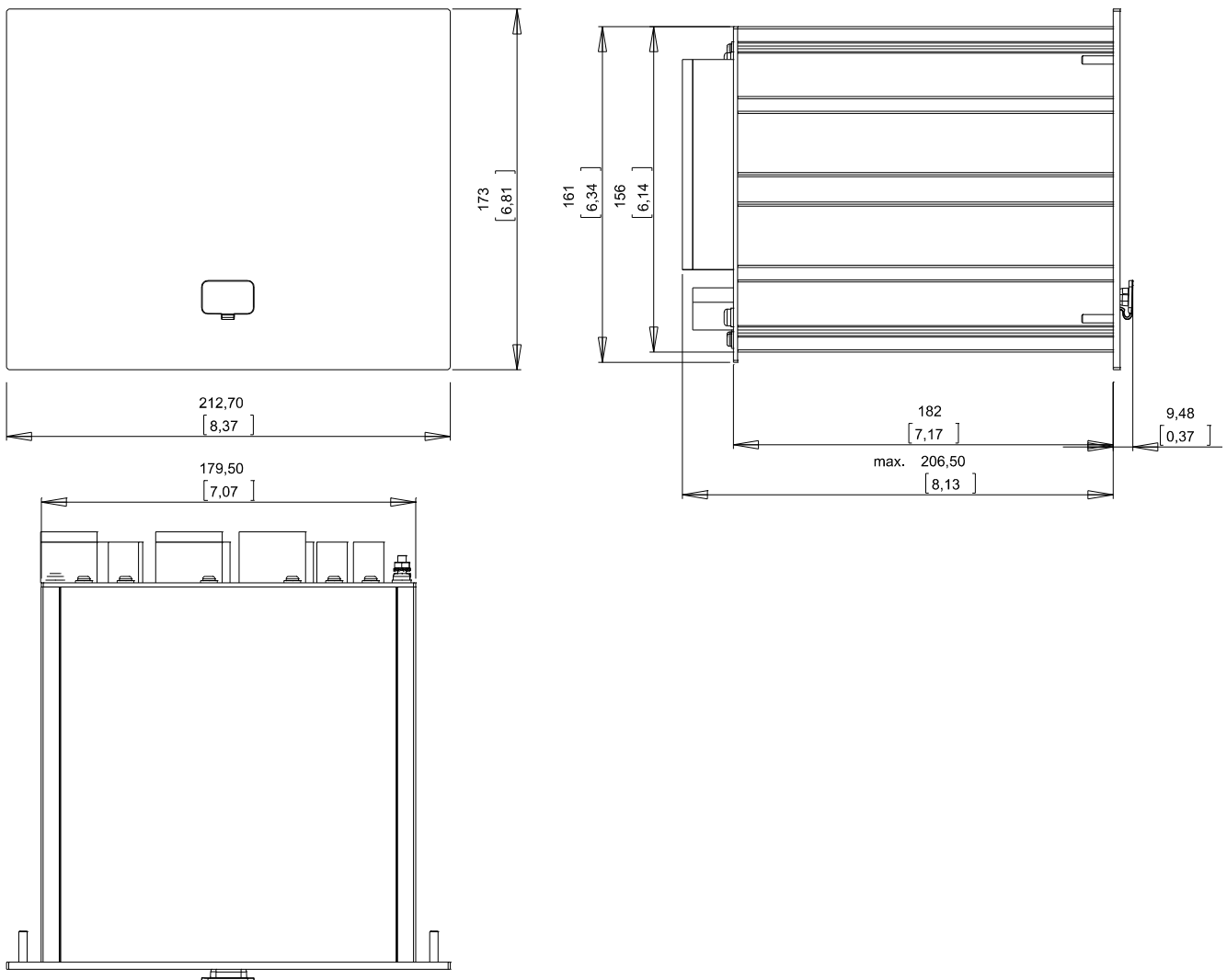

3-Side-View B2 Housing (Devices with 7 Softkeys)

**WARNING** The housing must be carefully earthed. Connect a ground cable (4 to 6 mm<sup>2</sup> / AWG 12-10) / 1,7 Nm [15 lb-in]) to the housing, using the screw, which is marked with the ground symbol (at the rear side of the device).

The power supply card needs a separate ground connection (2.5 mm<sup>2</sup> / AWG 14) at terminal X1 (0.56-0.79 Nm [5-7 lb-in]).

### Three-Side-View - 8-Pushbutton Version

**NOTICE** Dependent on the connection method of the SCADA system used the needed space (depth) differs. If, for instance, a D-Sub-Plug is used, it has to be added to the depth dimension.

**NOTICE** The installation diagram shown in this section is exclusively valid for devices with 8 pushbuttons at the front side of the HMI. (INFO-, C-, OK-, CTRL-Pushbutton and 4 Softkeys (Pushbuttons)).

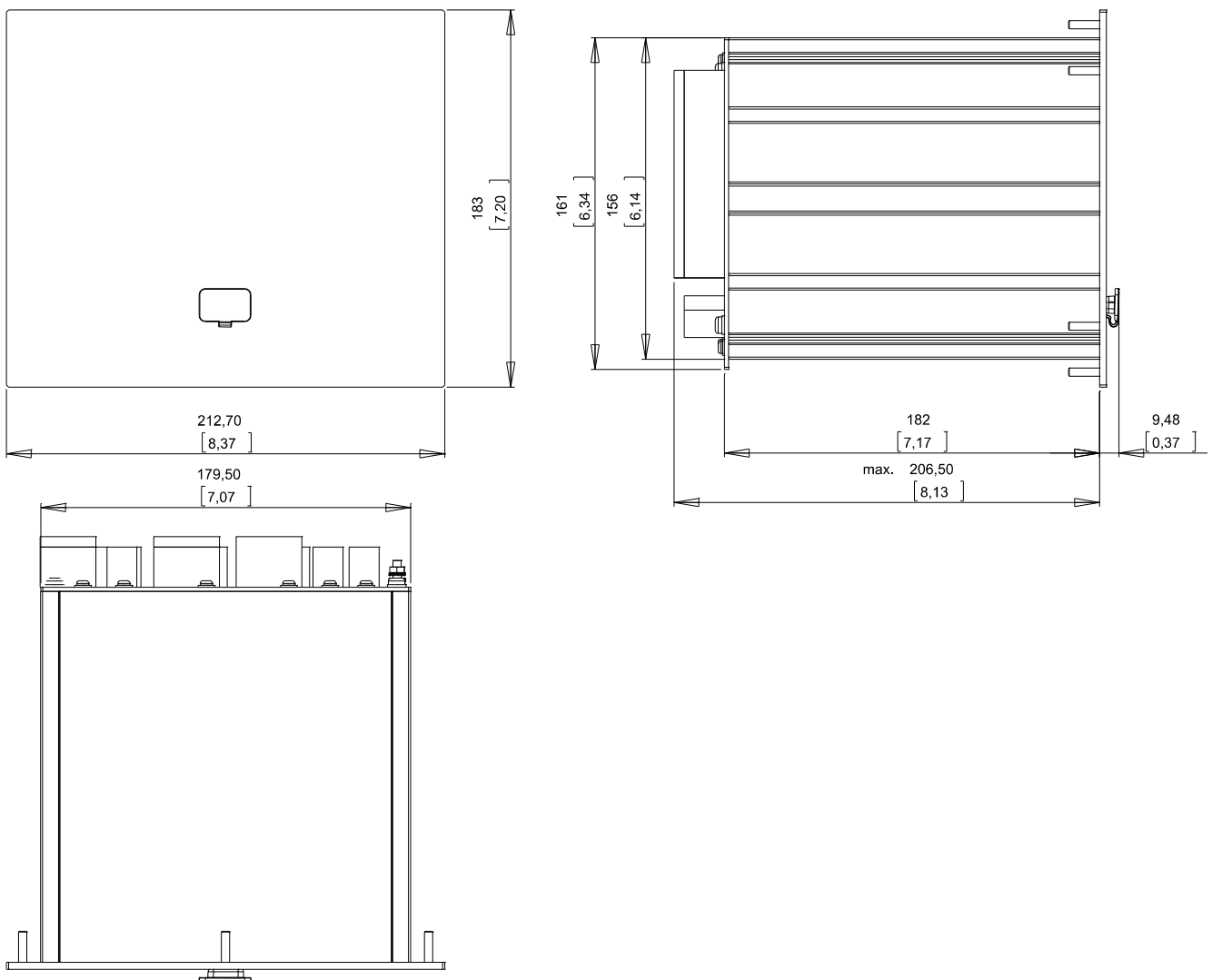

3-Side-View B2 Housing (Devices with 8 Softkeys)

**WARNING** The housing must be carefully earthed. Connect a ground cable (4 to 6 mm<sup>2</sup> / AWG 12-10) / 1,7 Nm [15 lb-in]) to the housing, using the screw, which is marked with the ground symbol (at the rear side of the device).

The power supply card needs a separate ground connection (2.5 mm<sup>2</sup> / AWG 14) at terminal X1 (0.56-0.79 Nm [5-7 lb-in]).

### Installation Diagram 7-Pushbutton Version



**WARNING**

Even when the auxiliary voltage is switched-off, unsafe voltages might remain at the device connections.

**NOTICE**

The installation diagram shown in this section is exclusively valid for devices with 7 pushbuttons at the front side of the HMI.  
(INFO-, C-, OK-Pushbutton and 4 Softkeys (Pushbuttons)).

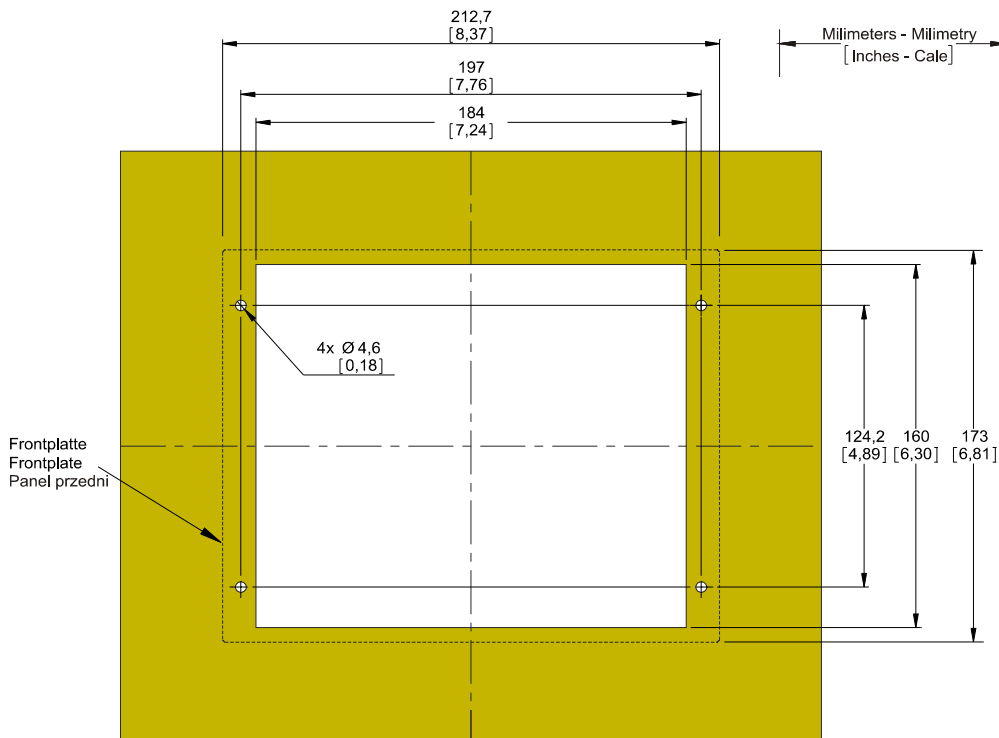

### B2 Housing Door Cut-out (7-Pushbutton Version)



**WARNING**

The housing must be carefully earthed. Connect a ground cable (4 to 6 mm<sup>2</sup> / AWG 12-10) / 1,7 Nm [15 lb-in]) to the housing, using the screw, which is marked with the ground symbol (at the rear side of the device).

The power supply card needs a separate ground connection (2.5 mm<sup>2</sup> / AWG 14) at terminal X1 (0.56-0.79 Nm [5-7 lb-in]).



**CAUTION**

Be careful. Do not overtighten the mountings nuts of the relay (M4 metric 4 mm). Check the torque by means of a torque wrench (1,7 Nm [15 lb-in]). Overtightening the mounting nuts could due to personal injury or damage the relay.





## Installation Diagram 8-Pushbutton Version

**WARNING** Even when the auxiliary voltage is switched-off, unsafe voltages might remain at the device connections.

**NOTICE** The installation diagram shown in this section is exclusively valid for devices with 8 pushbuttons at the front side of the HMI.  
(INFO-, C-, OK-, CTRL-Pushbutton and 4 Softkeys (Pushbuttons)).

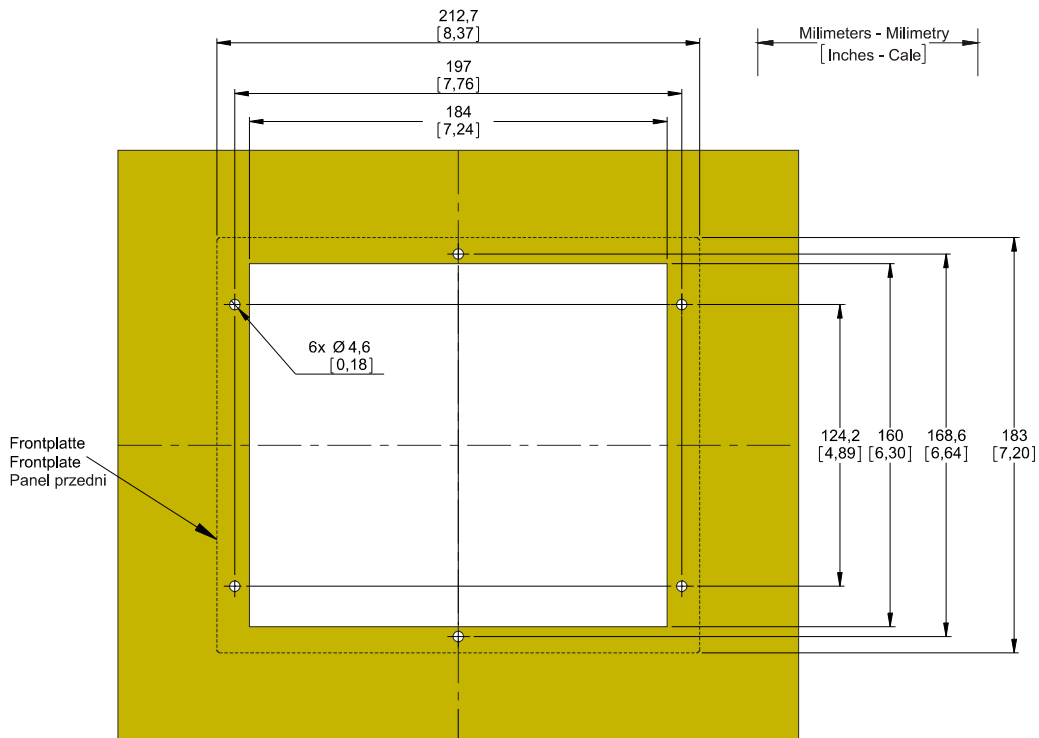

### B2 Housing Door Cut-out (8-Pushbutton Version)

**WARNING** The housing must be carefully earthed. Connect a ground cable (4 to 6 mm<sup>2</sup> / AWG 12-10) / 1,7 Nm [15 lb-in]) to the housing, using the screw, which is marked with the ground symbol (at the rear side of the device).

The power supply card needs a separate ground connection (2.5 mm<sup>2</sup> / AWG 14) at terminal X1 (0.56-0.79 Nm [5-7 lb-in]).

**CAUTION** Be careful. Do not overtighten the mountings nuts of the relay (M4 metric 4 mm). Check the torque by means of a torque wrench (1,7 Nm [15 lb-in]). Overtightening the mounting nuts could due to personal injury or damage the relay.

## Assembly Groups



**WARNING**

In line with the customer's requirement the devices are combined in a modular way (in compliance with the order code). In each of the slots an assembly-group may be integrated. In the following the terminal assignment of the individual assembly-groups are shown. The exact installation place of the individual modules can be learned from the connection diagram fixed at the top of your device.

### Middle Housing B2

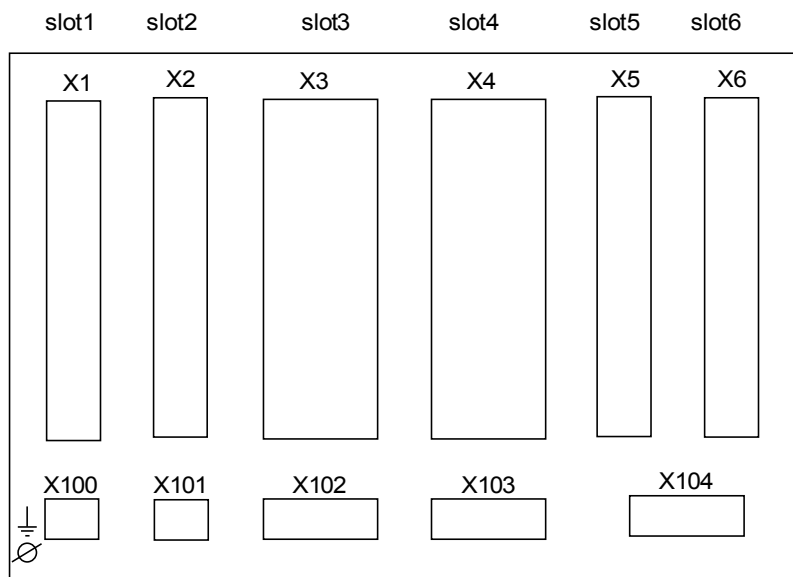

Rear view of B2 housing

## Grounding



**WARNING**

The housing must be carefully grounded. Connect a ground cable (4 to 6 mm<sup>2</sup> / AWG 12-10) / 1,7 Nm [15 lb-in]) to the housing, using the screw, which is marked with the ground symbol (at the rear side of the device).

The power supply card needs a separate ground connection (2.5 mm<sup>2</sup> / AWG 14) at terminal X1 (0.56-0.79 Nm [5-7 lb-in]).

**CAUTION**

The devices are very sensitive to electro-static discharges.

## Legend for Wiring Diagrams

In this legend designations of various device types are listed, e. g. transformer protection, motor protection, generator protection, etc. Therefore it can occur that you will not find each designation on the wiring diagram of your device.

Designation	Meaning
FE	Connection of functional earth
Power Supply	Connection for auxiliary power supply
I L1	Phase current input L1
I L2	Phase current input L2
I L3	Phase current input L3
IG	Earth current input IG
I L1 W1	Phase current input L1, winding side 1
I L2 W1	Phase current input L2, winding side 1
I L3 W1	Phase current input L3, winding side 1
I G W1	Earth current input IG, winding side 1
I L1 W2	Phase current input L1, winding side 2
I L2 W2	Phase current input L2, winding side 2
I L3 W2	Phase current input L3, winding side 2
I G W2	Earth current input IG, winding side 2
V L1	Phase voltage L1
V L2	Phase voltage L2
V L3	Phase voltage L3
V 12	Phase to phase voltage V 12
V 23	Phase to phase voltage V 23
V 31	Phase to phase voltage V 31
V X	Forth voltage measuring input for measuring residual voltage or for Synchro-check
BO	Contact output, change over contact
NO	Contact output, normally open
DI	Digital input
COM	Common connection of digital inputs
Out+	Analog output + (0/4...20 mA or 0...10 V)
IN-	Analog input + (0/4...20 mA or 0...10 V)
N.C.	Not connected
DO NOT USE	Do not use
SC	Self supervision contact
GND	Ground

HF SHIELD	Connection cable shield
Fibre Connection	Fibre optic connection
Only for use with external galvanic decoupled CTs. See chapter Current Transformers of the manual.	Only for use with external galvanic decoupled CTs. See chapter Current Transformers of the manual.
Caution Sensitive Current Inputs	Caution Sensitive Current Inputs
Connection Diagram see specification	Connection Diagram see specification

### Slot X1: Power Supply Card with Digital Inputs

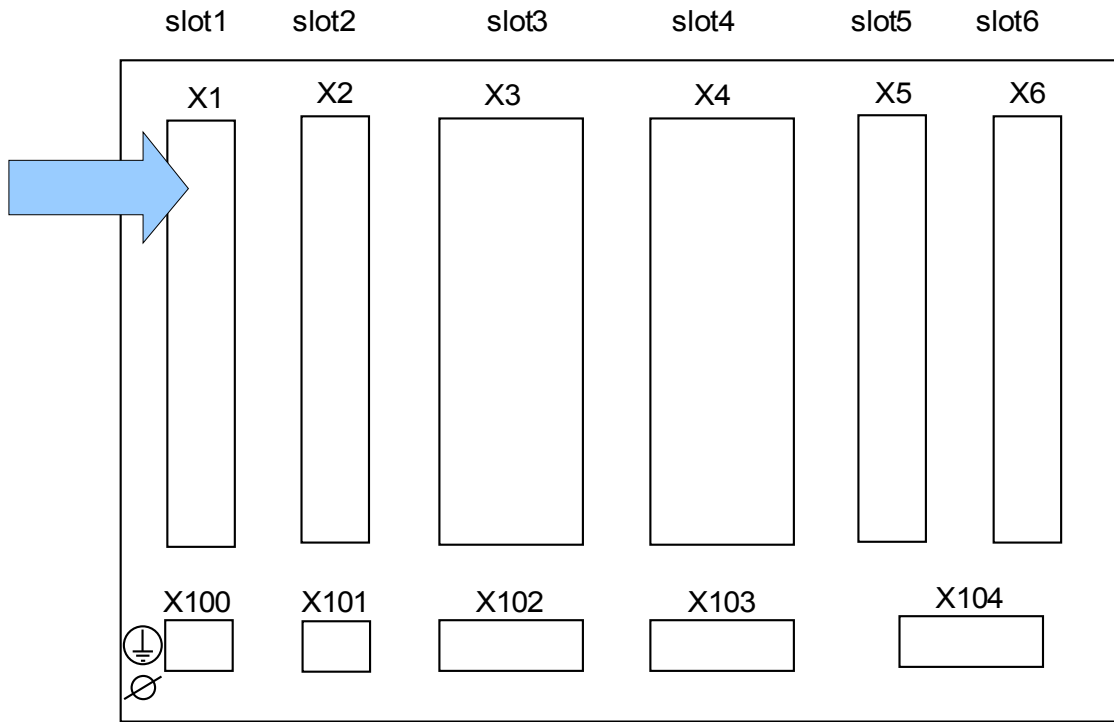

Rear side of the device (Slots)

The type of power supply card and the number of digital inputs on it used in this slot is dependent on the ordered device type. The different variants have a different scope of functions.

*Available assembly groups in this slot:*

- **(DI8-X1):** This assembly group comprises a wide-range power supply unit; and two non-grouped digital inputs and six (6) digital inputs (grouped).

**NOTICE** The available combinations can be gathered from the ordering code.

## DI8-X Power Supply and Digital Inputs

**⚠ WARNING** Ensure the correct tightening torques.

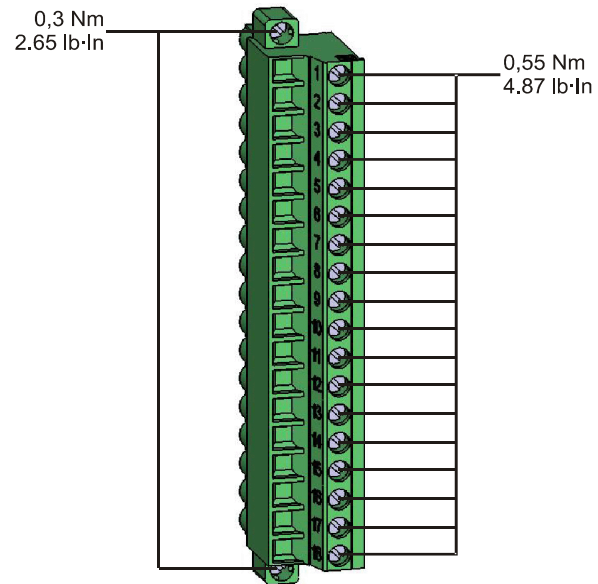

This assembly group comprises:

- a wide-range power supply unit
- 6 digital inputs, grouped
- 2 digital inputs, non-grouped
- 24V DC (for options with *Woodward Devices* only)

### *Auxiliary voltage supply*

- The aux. voltage inputs (wide-range power supply unit) are non-polarized. The device could be provided with AC or DC voltage.

### *Digital inputs*

#### **CAUTION**

For each digital input group the related voltage input range has to be parameterized. Wrong switching thresholds can result in malfunctions/wrong signal transfer times.

The digital inputs are provided with different switching thresholds (can be parameterized) (two AC and five DC input ranges). For the six grouped (connected to common potential) inputs and the two non-grouped inputs the following switching levels can be defined:

- 24V DC
- 48V DC / 60V DC
- 110 V AC/DC
- 230 V AC/DC

If a voltage >80% of the set switching threshold is applied at the digital input, the state change is recognized (physically "1"). If the voltage is below 40% of the set switching threshold, the device detects physically "0".

#### **CAUTION**

The ground terminal has to be connected to the »-pole« when using DC supply.

#### **CAUTION**

Use of the 24 V DC Output is prohibited. This output is exclusively for factory testing and commissioning.



**Terminals**

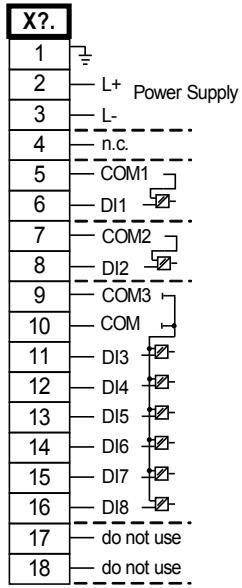

*Electro-mechanical assignment*

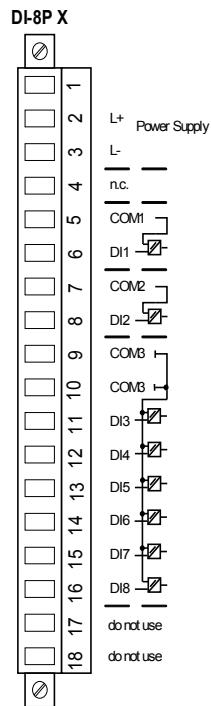

### Slot X2: Relay Output Card

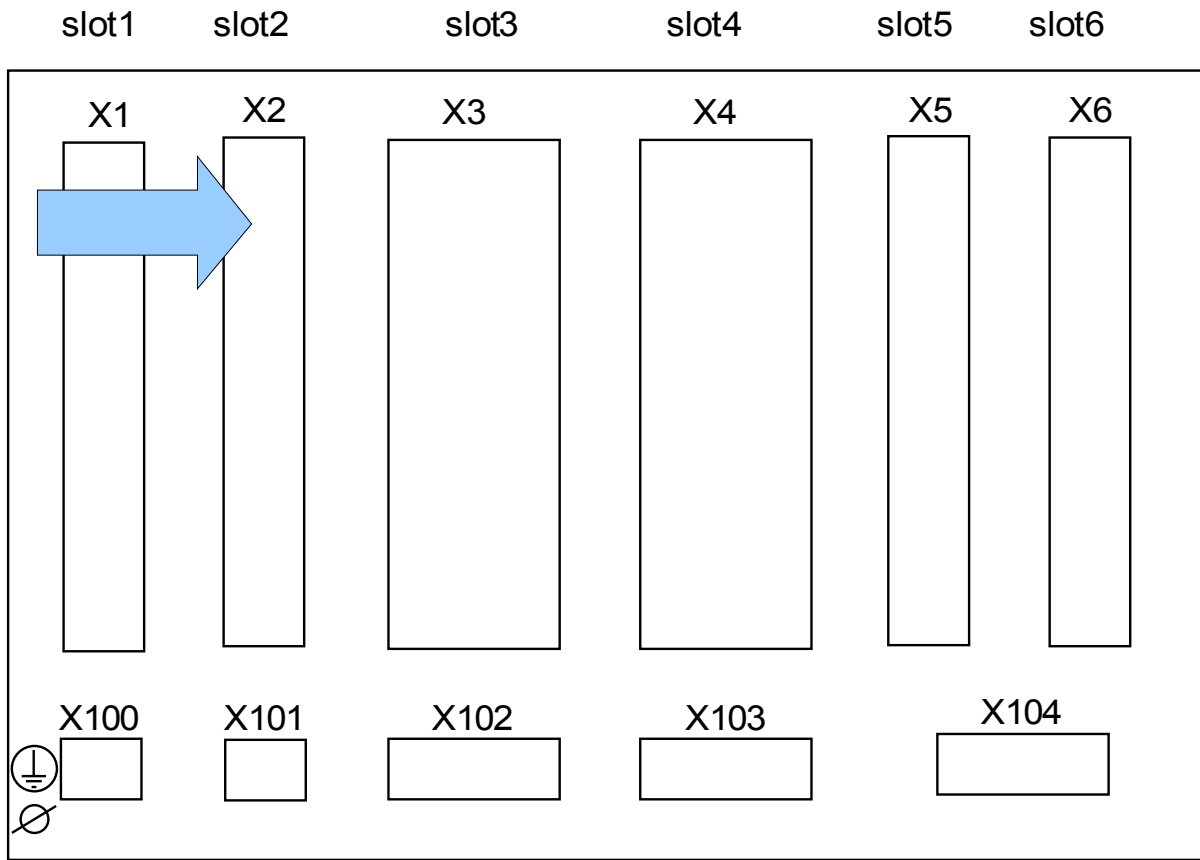

Rear side of the device (Slots)

The type of card in this slot is dependent on the ordered device type. The different variants have a different scope of functions.

*Available assembly groups in this slot:*

- **(RO-6 X2):** Assembly Group with 6 Relay Outputs.

### NOTICE

The available combinations can be gathered from the ordering code.

## Binary Output Relays

The number of the binary output relay contacts is related to the type of the device or type code. The binary output relays are potential-free change-over contacts. In chapter [Assignment/binary outputs] the assignment of the binary output relays is specified. The changeable signals are listed in the »assignment list« which can be found in the appendix.



**WARNING**

Ensure the correct tightening torques.

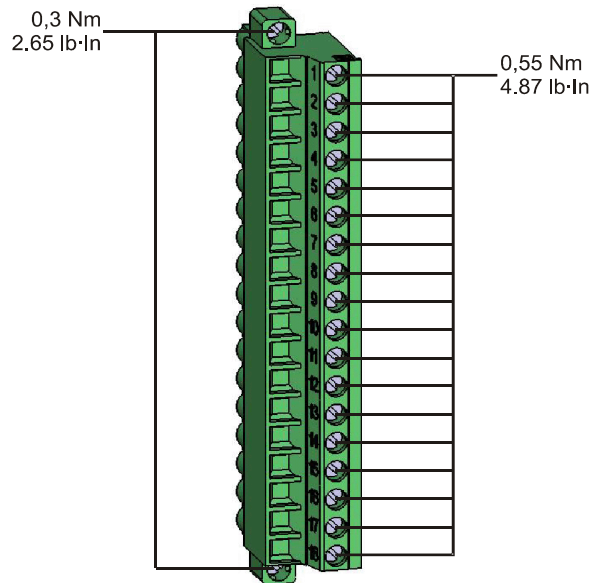

**CAUTION**

Please duly consider the current carrying capacity of the binary output relays.  
Please refer to the Technical Data.

**Terminals**

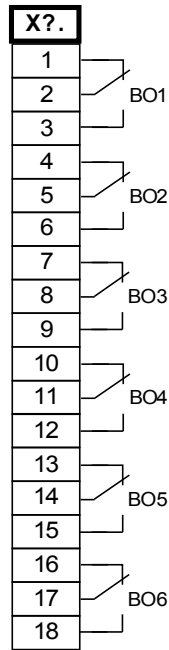

*Electro-mechanical assignment*

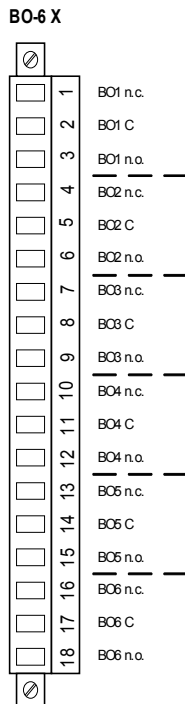

### Slot X3: Current Transformer Measuring Inputs

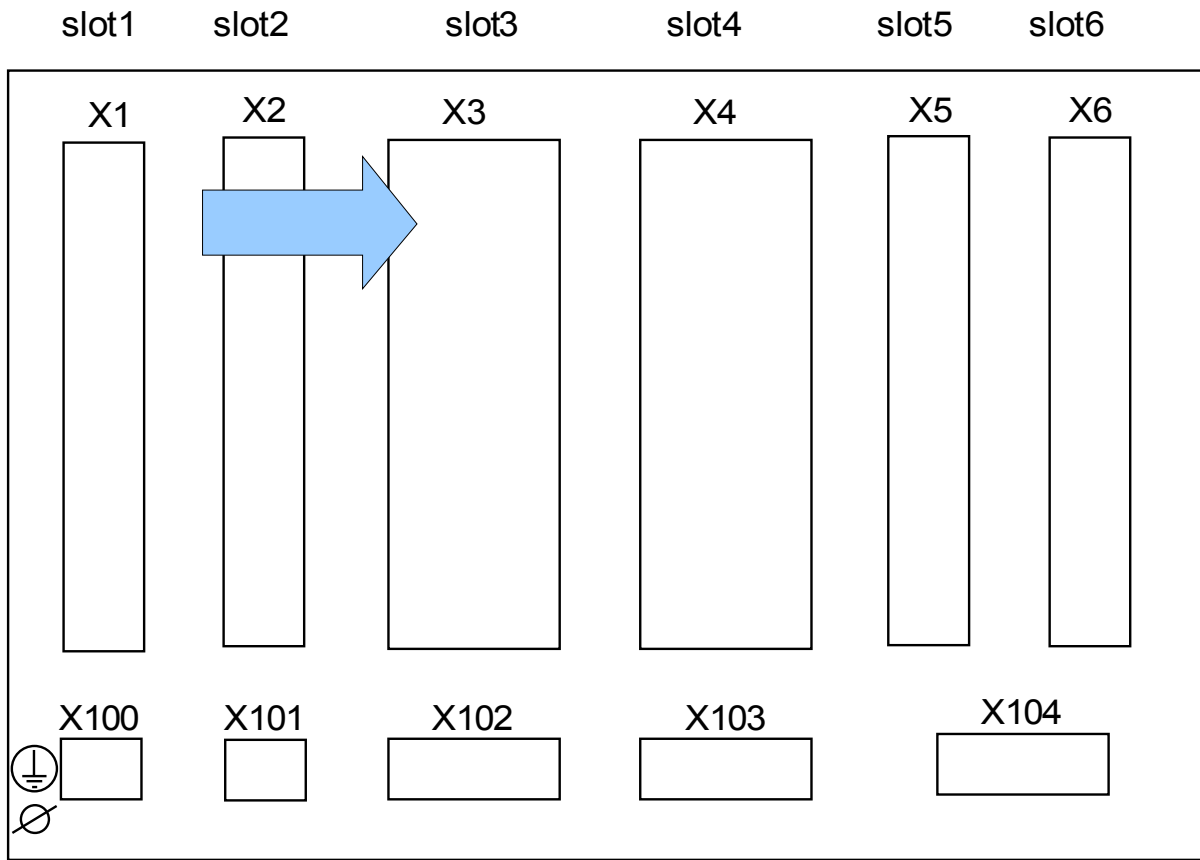

Rear side of the device (Slots)

This slot contains the current transformer measuring inputs. Depending on the order code, this might be a standard current measuring card or a sensitive ground current measuring card.

*Available assembly groups in this slot:*

- **(TI-4 X3):** Standard ground current measuring card.
- **(TIS-4 X3):** Sensitive Ground current measuring card. The Technical data of the sensitive ground measuring input deviate are different to the Technical Data of the phase current measuring inputs. Please refer to the Technical Data.

## TI X- Standard Phase and Ground Current Measuring Input Card

The device is provided with 4 current measuring inputs: three for measuring the phase currents and one for measuring of the earth current. Each of the current measuring inputs has a measuring input for 1 A and 5 A.

The input for earth current measuring either can be connected to a cable-type current transformer or alternatively it is possible to connect the summation current path of the phase current transformer to this input (Holmgreen connection).



**Current transformers have to be earthed on their secondary side.**



**Interrupting the secondary circuits of current transformers causes hazardous voltages.**

**The secondary side of the current transformers have to be short circuited before the current circuit to the device is opened.**



**The current measuring inputs may exclusively be connected to current measuring transformers (with galvanic separation).**



- Do not interchange the inputs (1 A/5 A)
- Make sure the transformation ratios and the power of the CTs are correctly rated. If the rating of the CTs is not right (overrated), then the normal operational conditions may not be recognized. The pickup value of the measuring unit amounts approx. 3% of the rated current of the device. Also the CTs need a current greater than approx 3% of the rated current to ensure sufficient accuracy. Example: For a 600 A CT (primary current) any currents below 18 A cannot be detected any more.
- Overloading can result in destruction of the measuring inputs or faulty signals. Overloading means that in case of a short-circuit the current-carrying capacity of the measuring inputs could be exceeded.



**WARNING** Ensure the correct tightening torques.

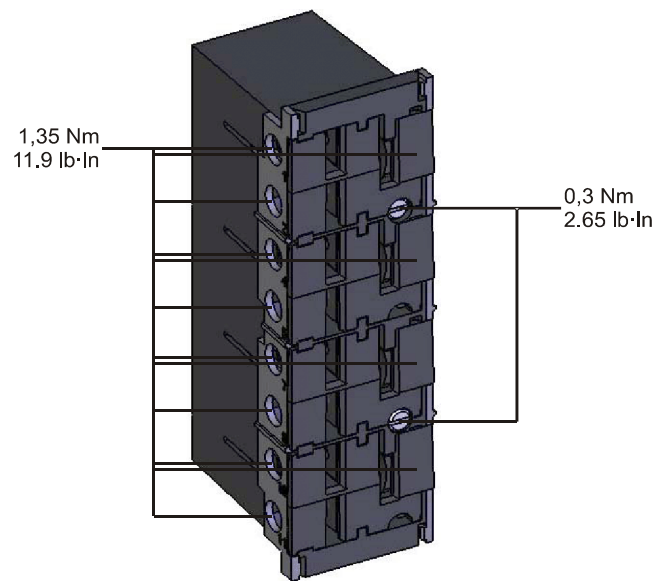

**Terminals**

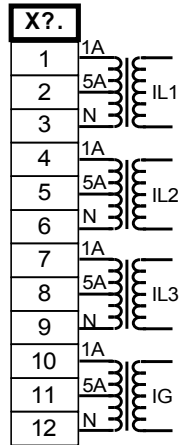

*Electro-mechanical assignment*

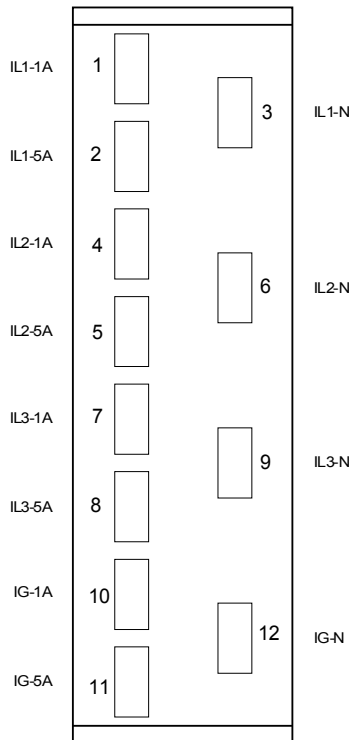



## Current Transformers (CT)

Check the installation direction.



**DANGER** It is imperative that the secondary sides of measuring transformers be grounded.



**DANGER** The current measuring inputs may exclusively be connected to current measuring transformers (with galvanic separation).



**WARNING** CT secondary circuits must always to be low burdened or short-circuited during operation.

### NOTICE

For current and voltage sensing function external wired and appropriate current and voltage transformer shall be used, based on the required input measurement ratings. Those devices provide the necessary insulation functionality.

All current measuring inputs can be provided with 1 A or 5 A nominal. Make sure that the wiring is correct.

## Sensitive Ground Current Measurement

The proper use of sensitive current measuring inputs is the measurement of small currents like they could occur in isolated and high resistance grounded networks.

Due to the sensitiveness of these measuring inputs don't use them for the measurement of ground short circuit currents like they occur in solidly earthed networks.

If a sensitive measuring input should be used for the measurement of ground short circuit currents, it has to be ensured, that the measuring currents are transformed by a matching transformer according to the technical data of the protective device.

### Current Transformer Connection Examples

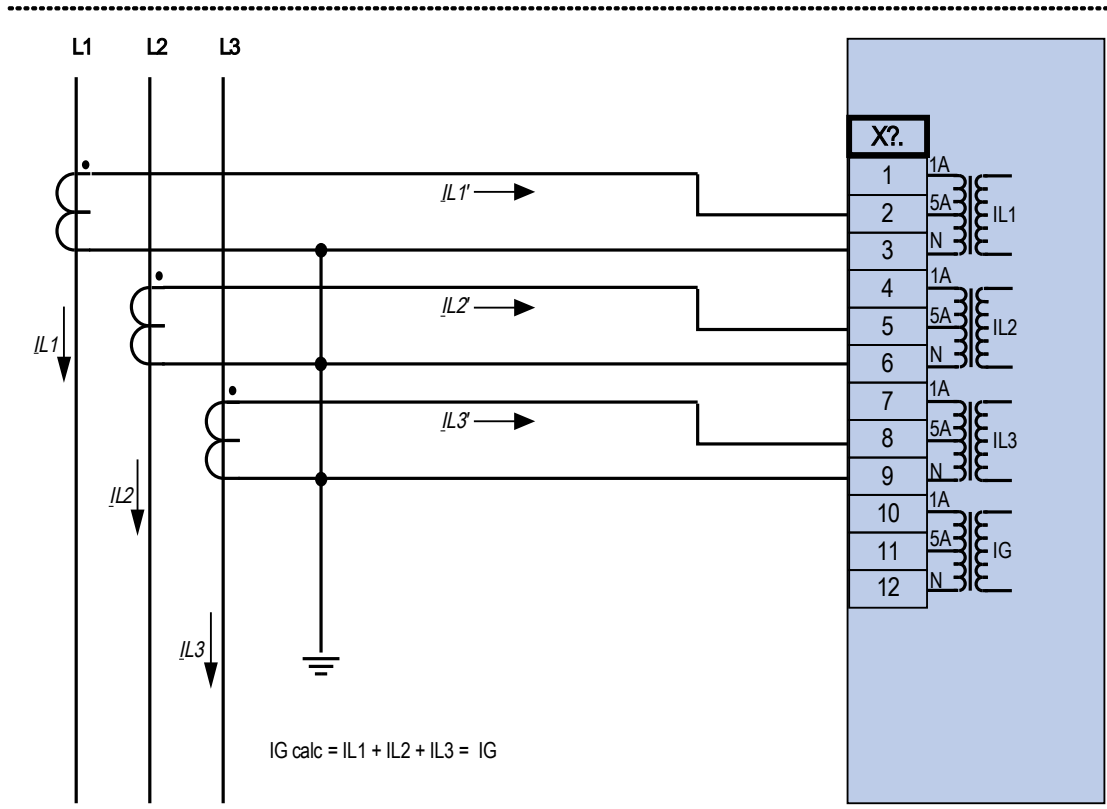

Three phase current measurement; In secondary = 5 A.

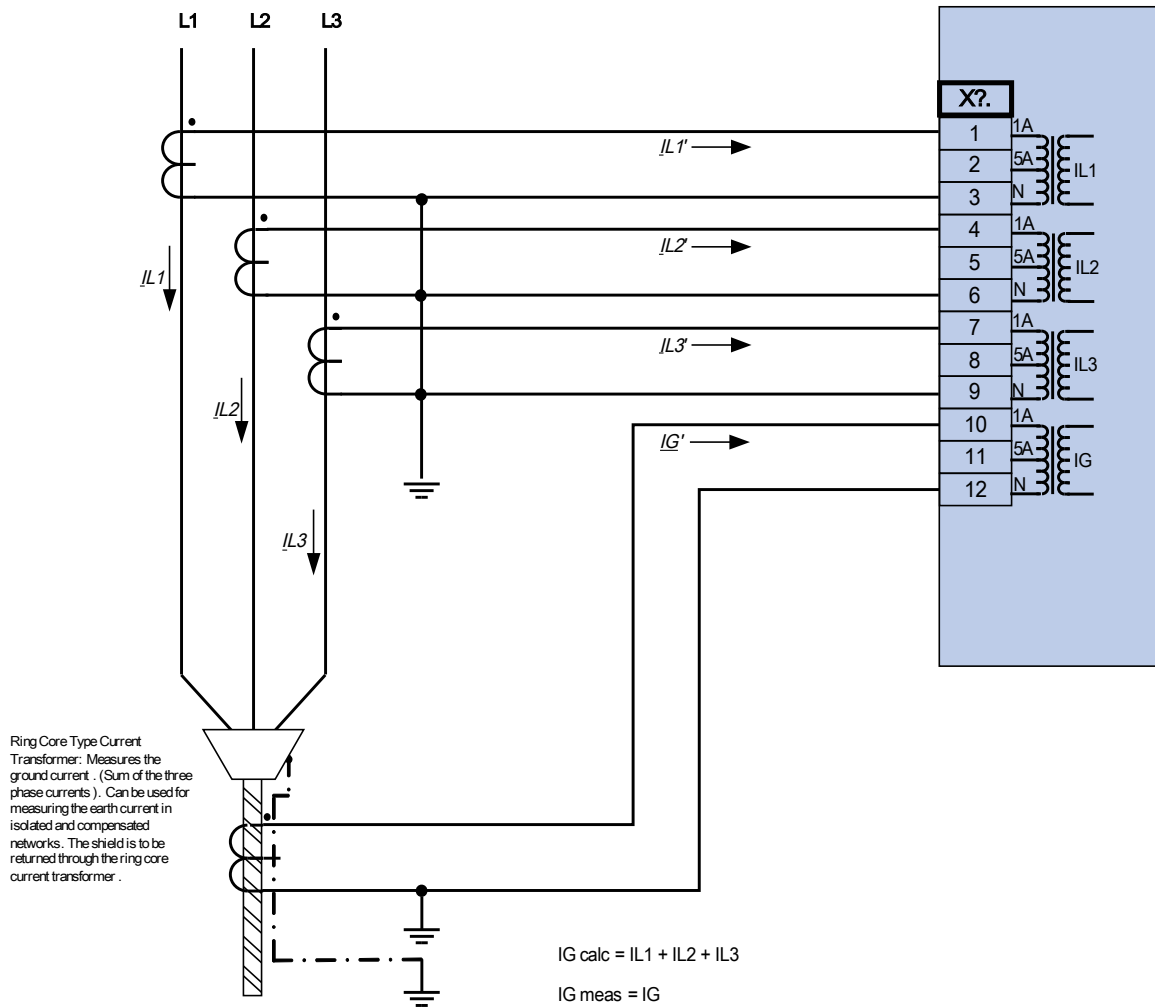

Three phase current measurement ; In secondary = 1 A.  
 Earth-current measuring via cable-type current transformer ; IGnom secondary = 1 A.



**Warning!**  
 The shielding at the dismantled end of the line has to be put through the cable -type current transformer and has to be grounded at the cable side .

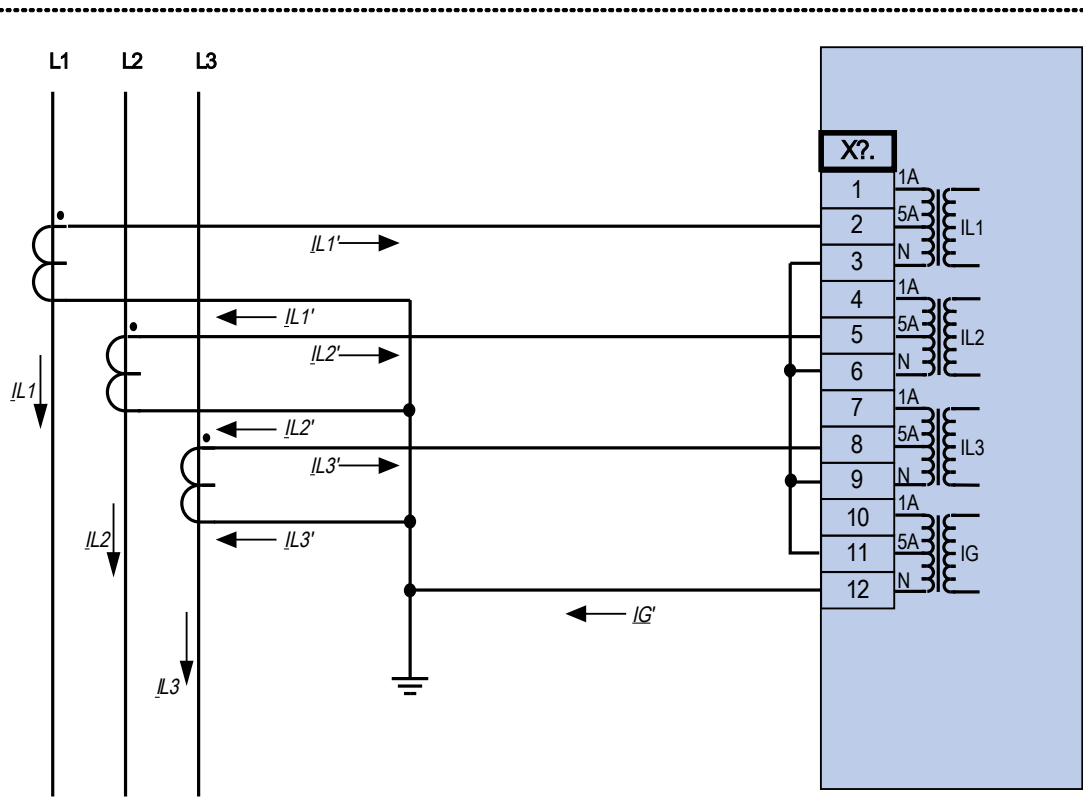

Three phase current measurement;  $I_n$  secondary = 5 A.

Earth-current measuring via Holmgreen-connection;  $I_{Gnom}$  secondary = 5 A.

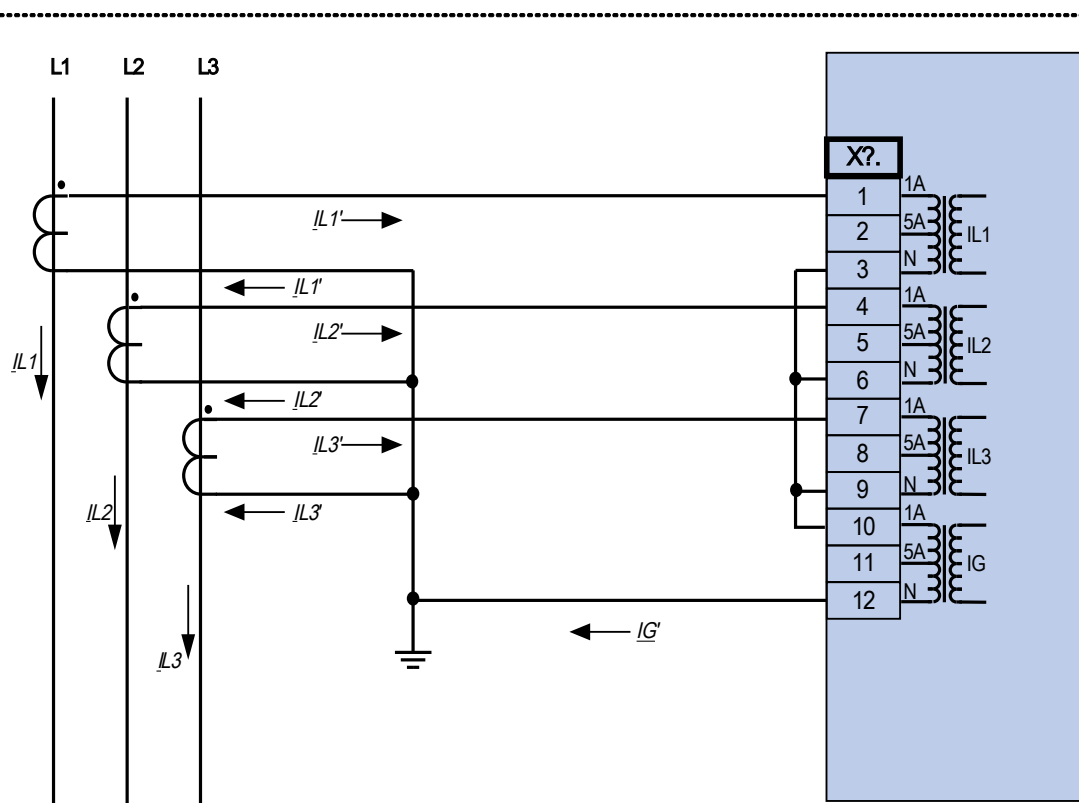

Three phase current measurement;  $I_n$  secondary = 1 A.

Earth-current measuring via Holmgreen-connection;  $I_{Gnom}$  secondary = 1 A.

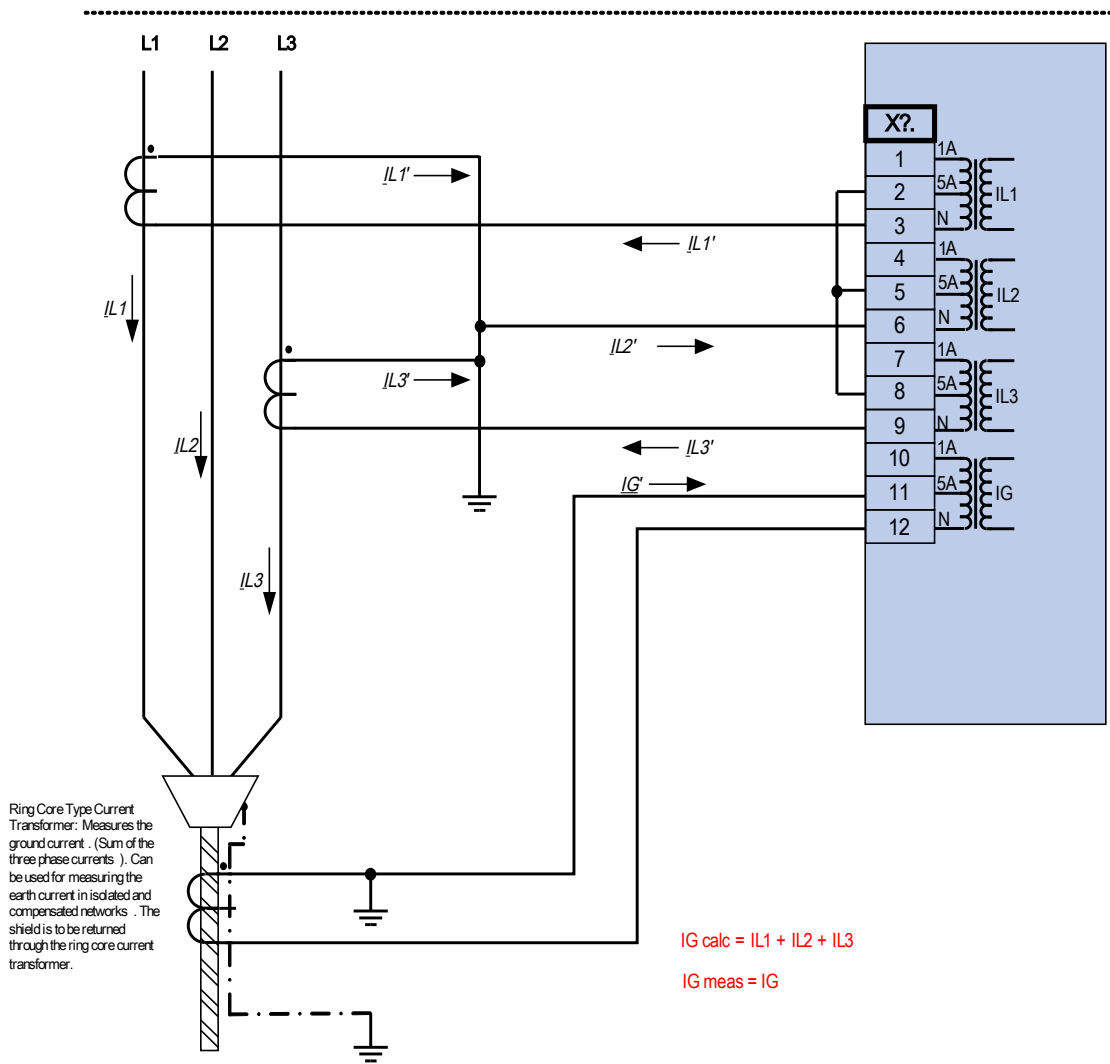

Two phase current measurement (Open Delta); In secondary = 5 A.  
 Earth-current measuring via cable-type current transformer ; IGnom secondary = 5 A.



**Warning!**

The shielding at the dismantled end of the line has to be put through the cable -type current transformer and has to be grounded at the cable side .

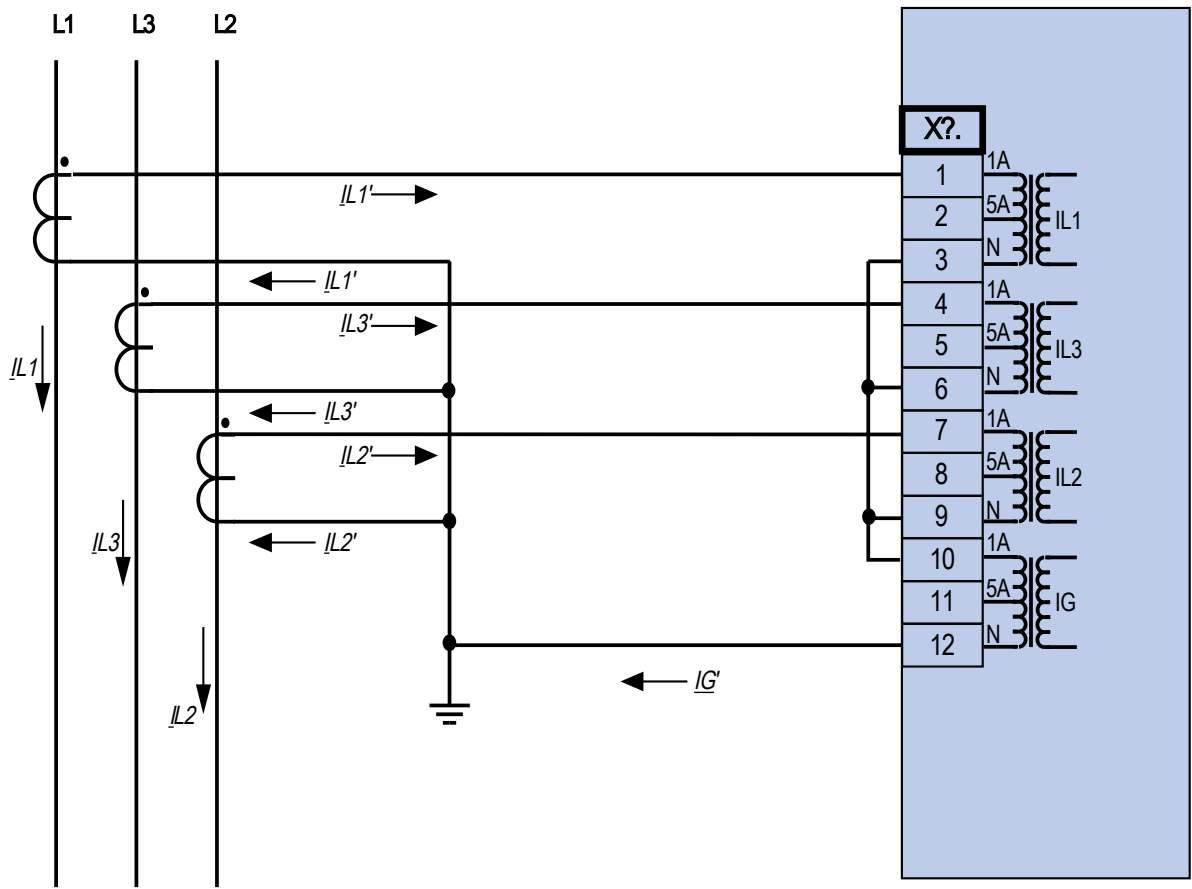

Three phase current measurement; In secondary = 1 A.

Earth-current measuring via Holmgreen-connection; IGnom secondary = 1 A.

Differential Protection Variant for Electrical Machinery (Availability depends on ordered device)

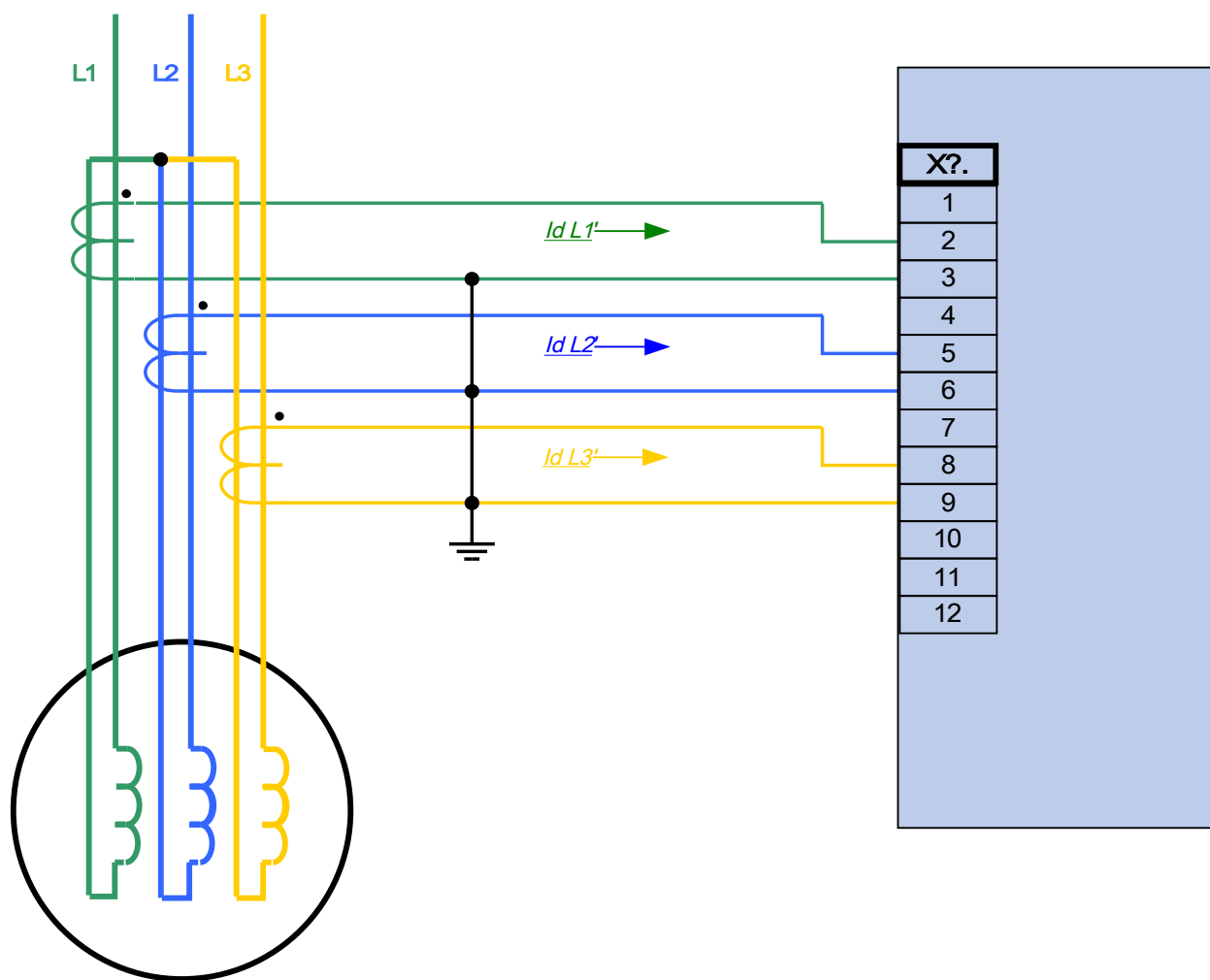



### Slot X4: Voltage Transformer Measuring Inputs

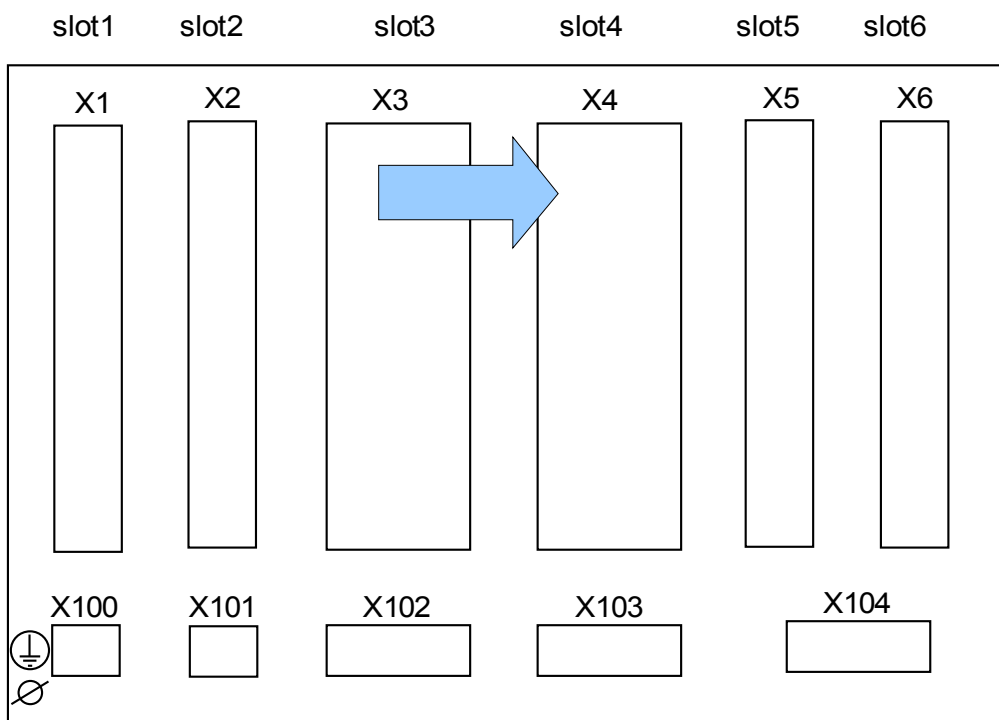

Rear side of the device (Slots)

This slot contains the voltage transformer measuring inputs.

## Voltage Measuring Inputs

The device is provided with 4 voltage measuring inputs: three for measuring the phase-to-phase voltages («V12«, «V23«, «V31») or phase-to-neutral voltages («VL1«, «VL2«, «VL3») and one for the measuring of the residual voltage «VE». With the field parameters the correct connection of the voltage measuring inputs has to be set:

- phase-to-neutral (star)
- phase-to-phase (Open Delta respectively V-Connection)

**WARNING** Ensure the correct tightening torques.

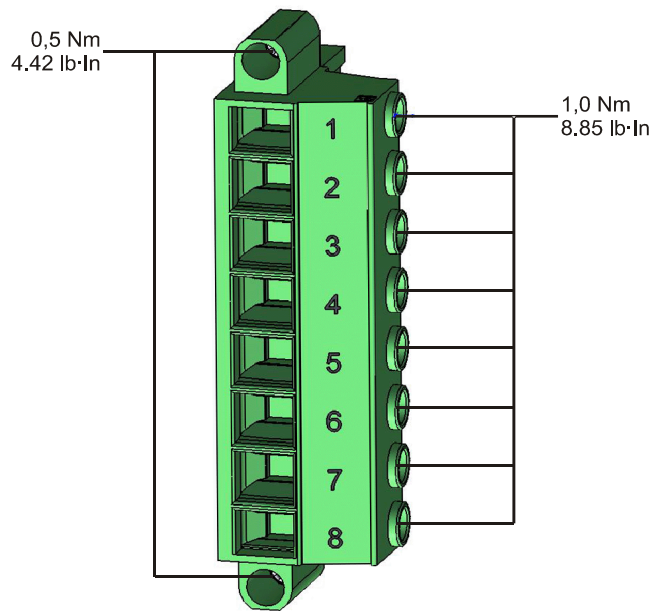

**CAUTION** The rotating field of your power supply system has to be taken in to account. Make sure that the transformer is wired correctly.

For the V-connection the parameter «VT con» has to be set to «phase-to-phase».

Please refer to the Technical Data.

**Terminals**

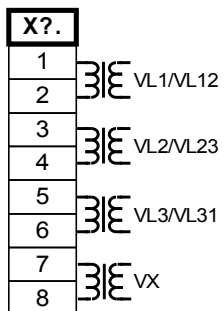

*Electro-mechanical assignment*

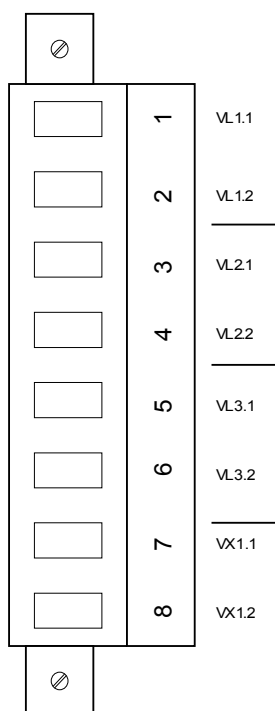

## Voltage Transformers

Check the installation direction of the VTs.

### **⚠ DANGER**

It is imperative that the secondary sides of measuring transformers be grounded.

### **NOTICE**

For current and voltage sensing function external wired and appropriate current and voltage transformer shall be used, based on the required input measurement ratings. Those devices provide the necessary insulation functionality.

## Check of the Voltage Measuring Values

Connect a three-phase measuring voltage equal to the rated voltage to the relay.

### **NOTICE**

Take connection of the measuring transformers (star connection/open delta connection) duly into account.

Now adjust voltage values in the nominal voltage range with the corresponding nominal frequency which are not likely to cause overvoltage- or undervoltage trips.

Compare the values shown in the device display with the readings of the measuring instruments. The deviation must be according to the technical data.

### **NOTICE**

When r.m.s. value measuring instruments are used, higher deviations can arise if the fed voltage has a very high harmonic content. Since the device is provided with a filter for the harmonics, only the fundamental oscillation is evaluated (exception: thermal protection functions). If, however, a r.m.s. value forming measuring instrument is used, the harmonics are also measured.

## Wiring Examples of the Voltage Transformers

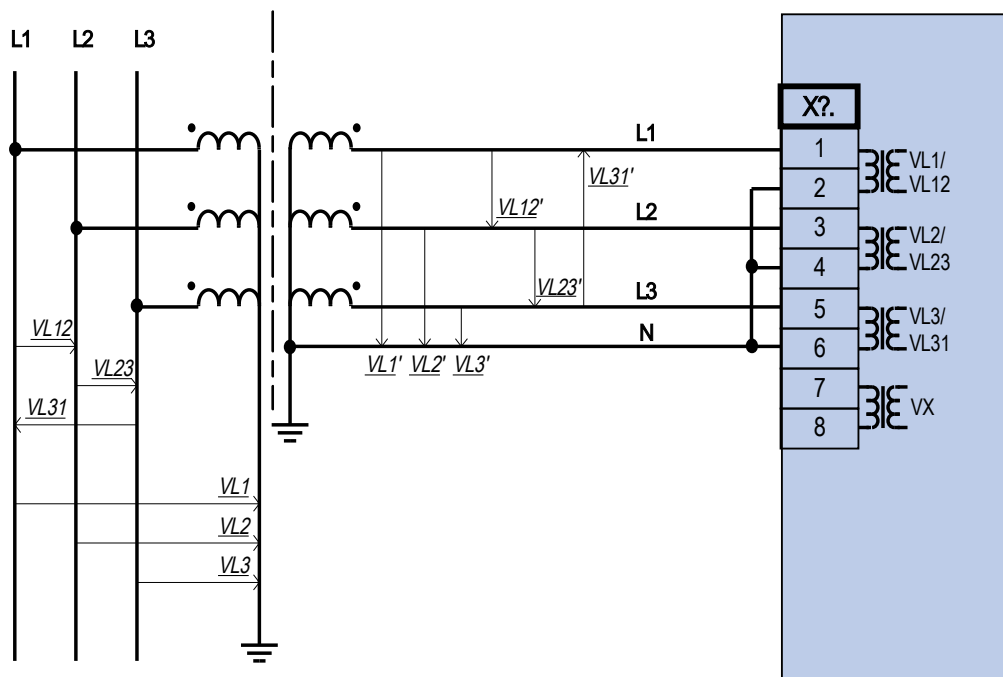

Three-phase voltage measurement - wiring of the measurement inputs : "star-connection"

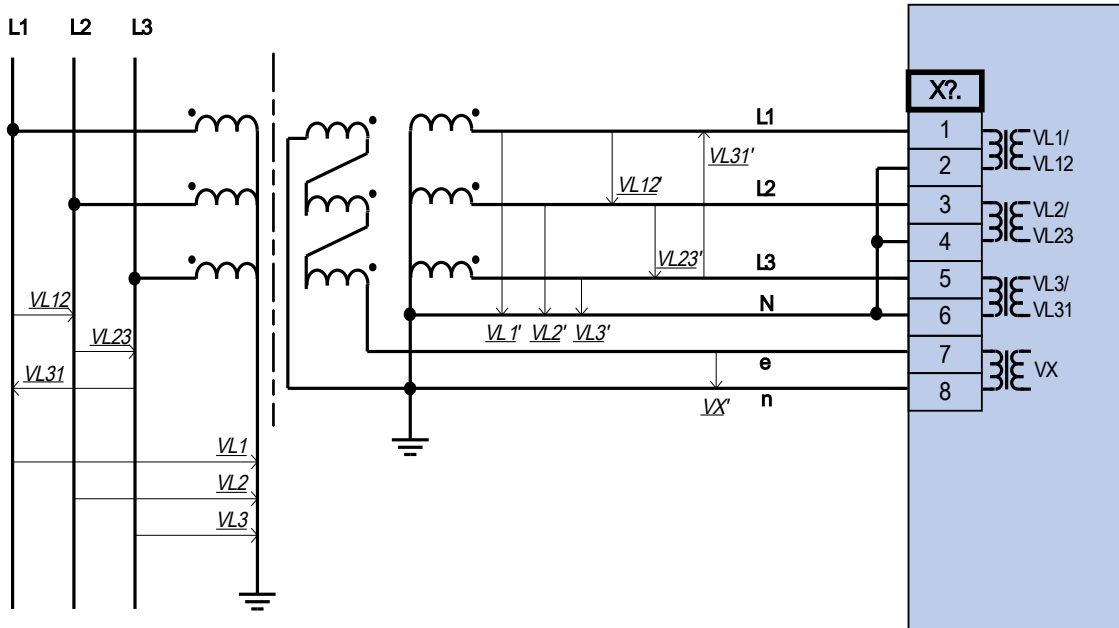

Three-phase voltage measurement - wiring of the measurement inputs: "star-connection"  
 Measurement of the residual voltage VG via auxilliary windings (e-n) "broken delta"

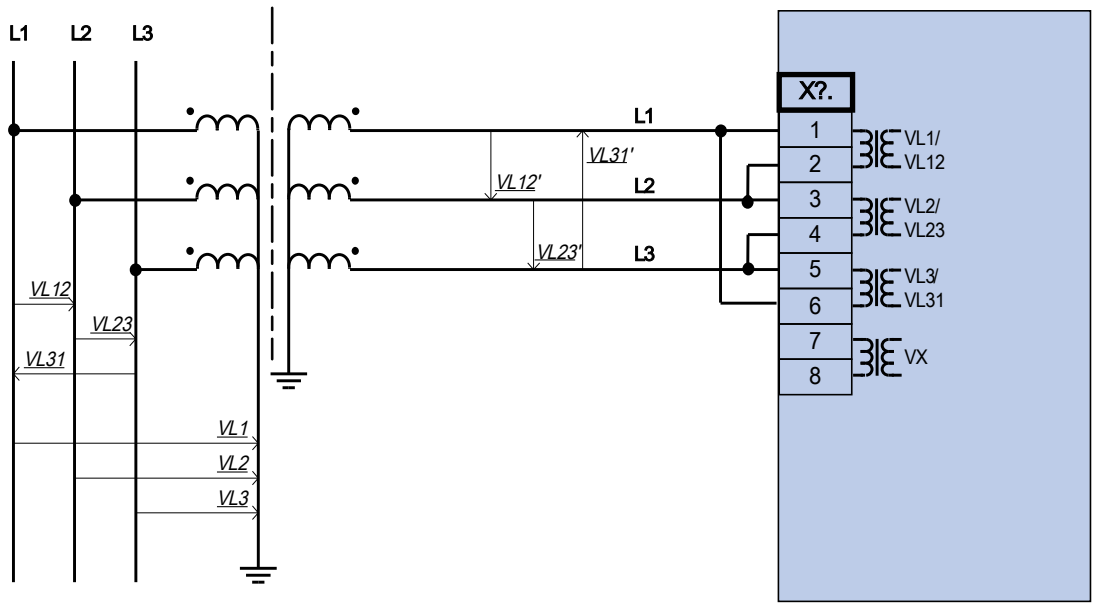

Three-phase voltage measurement - wiring of the measurement inputs : "open delta"



Notice!  
Calculation of the residual voltage VG is not possible

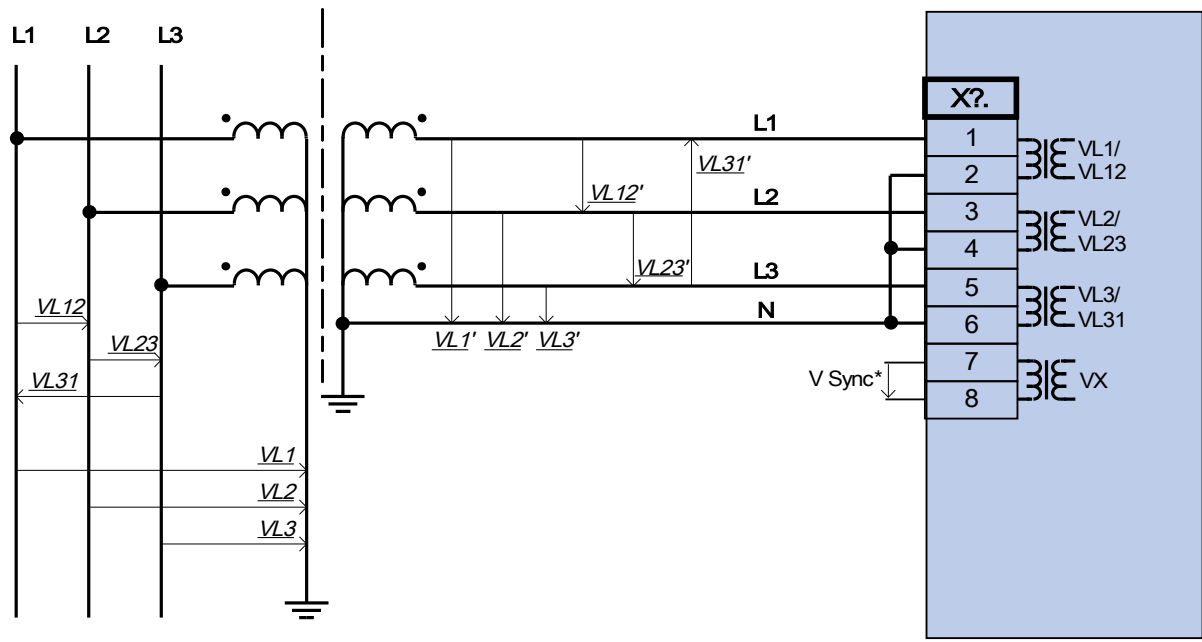

\*=\* Availability dependent on device type

Three-phase voltage measurement - wiring of the measurement inputs : "star-connection".  
 Fourth measuring input for measuring a synchronisation voltage .



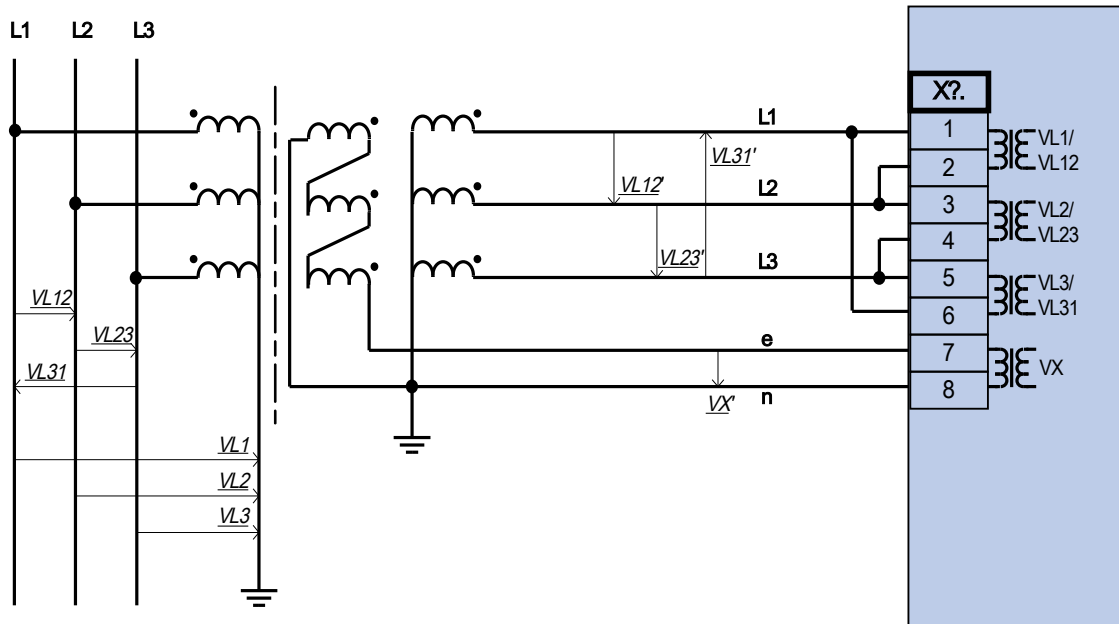

Three-phase voltage measurement - wiring of the measurement inputs : "open delta"  
 Measurement of the residual voltage VG via auxilliary windings (e-n) "broken delta"



### Slot X5: Relay Output Card

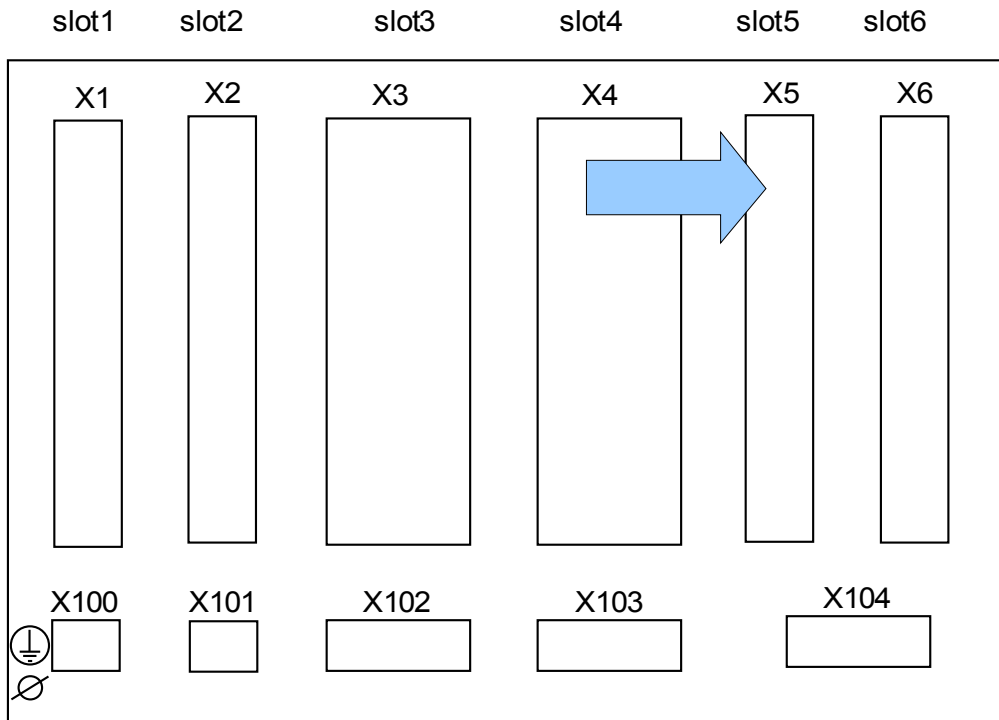

Rear side of the device (Slots)

The type of card in this slot is dependent on the ordered device type. The different variants have a different scope of functions.

*Available assembly groups in this slot:*

- **(RO-6 X5):** Assembly Group with 6 Relay Outputs. The Relay Output Card is identical with the one on Slot X2.

**NOTICE** The available combinations can be gathered from the ordering code.

### Slot X6: Digital Inputs

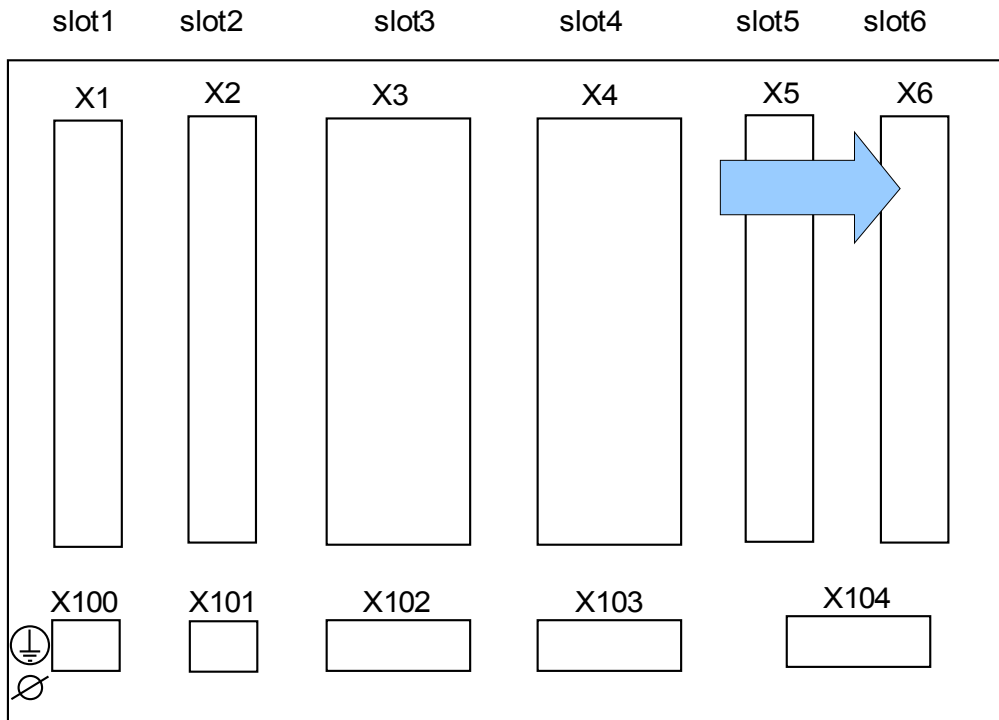

Rear side of the device (Slots)

The type of card in this slot is dependent on the ordered device type. The different variants have a different scope of functions.

*Available assembly groups in this slot:*

- **(DI-8 X5):** Assembly Group with 8 Digital Inputs.

**NOTICE** The available combinations can be gathered from the ordering code.

## Digital Inputs

This module is provided with 8 grouped digital inputs.

In chapter [Device parameter/Digital Inputs] the assignment of the digital inputs is specified.

**WARNING** Ensure the correct tightening torques.

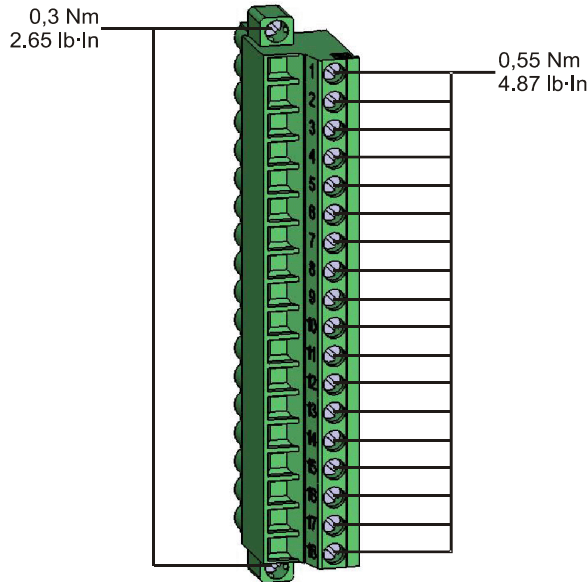

**CAUTION** The ground terminal has to be connected to the »-pole« when using DC supply.

**CAUTION** For each digital input group the related voltage input range has to be parameterized. Wrong switching thresholds can result in malfunctions/wrong signal transfer times.

**NOTICE** Via the »assignment list« the states of the digital inputs are assigned to the module inputs (e.g. I[1]).

The digital inputs are provided with different switching thresholds (can be parameterized) (two AC and five DC input ranges). For each group the following switching thresholds can be defined:

- 24V DC
- 48V DC / 60V DC
- 110 V AC/DC
- 230 V AC/DC

If a voltage >80% of the set switching threshold is applied at the digital input, the state change is recognized (physically "1"). If the voltage is below 40% of the set switching threshold, the device detects physically "0".

**Terminal Marking**

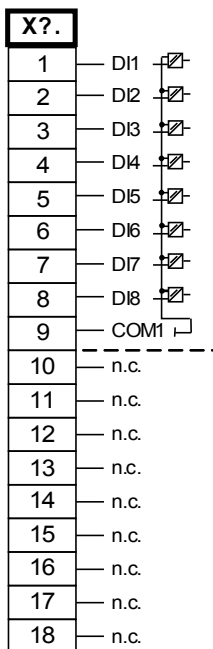

*Electro-mechanical assignment*

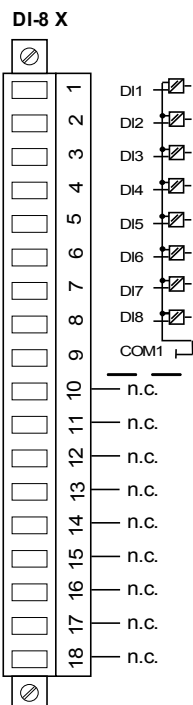

### Slot X100: Ethernet Interface

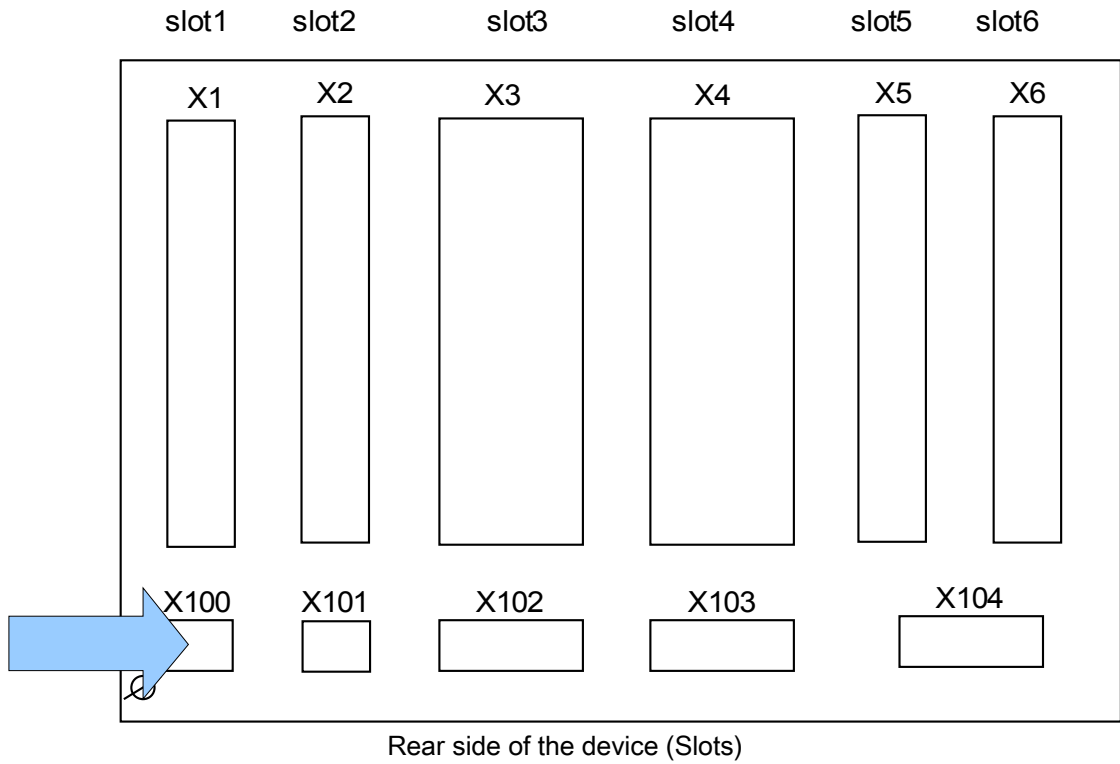

An Ethernet interface may be available depending on the device type ordered.

**NOTICE**

The available combinations can be gathered from the ordering code.

# Ethernet - RJ45

## Terminals

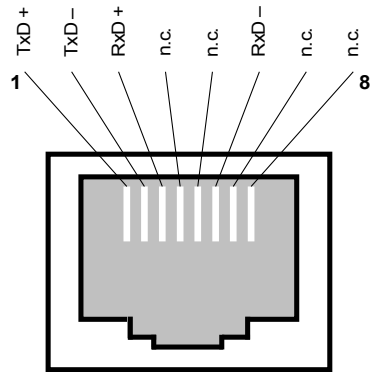



### Slot X103: Data Communication

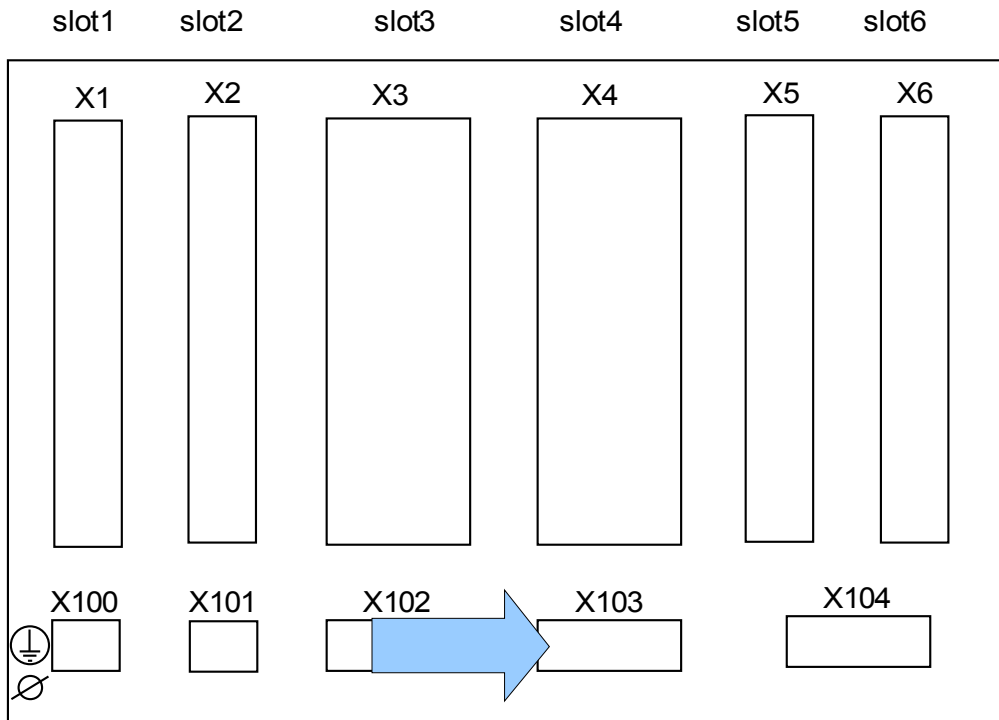

Rear side of the device (Slots)

The data communication interface in the **X103** slot is dependent on the ordered device type. The scope of functions is dependent on the type of data communication interface.

*Available assembly groups in this slot:*

- RS485 Terminals for Modbus and IEC
- LWL Interface for Modbus, IEC and Profibus
- D-SUB Interface for Modbus and IEC
- D-SUB Interface for Profibus

**NOTICE** The available combinations can be gathered from the ordering code.

Modbus® RTU / IEC 60870-5-103 via RS485

**WARNING** There are two different versions of the RS485 interface. By means of the wiring diagram on the top of your device, you have to find out which version is built in your device (Type1 or Type2).

**WARNING** Ensure the correct tightening torques.

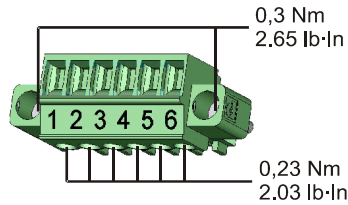

RS485 – Type 1 (see wiring diagram)

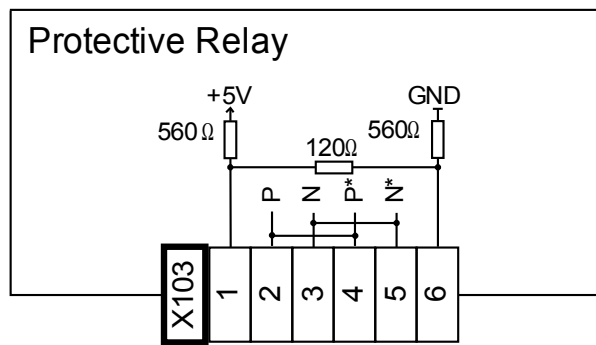

Electro-mechanical assignment Type 1 (see wiring diagram)

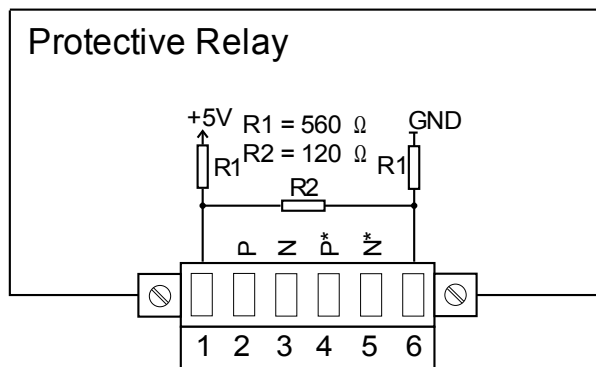

**NOTICE** The Modbus® / IEC 60870-5-103 connection cable must be shielded. The shielding has to be fixed at the screw which is marked with the ground symbol at the rear side of the device. The communication is Halfduplex.

Type 1 Wiring example, Device in the Middle of the BUS

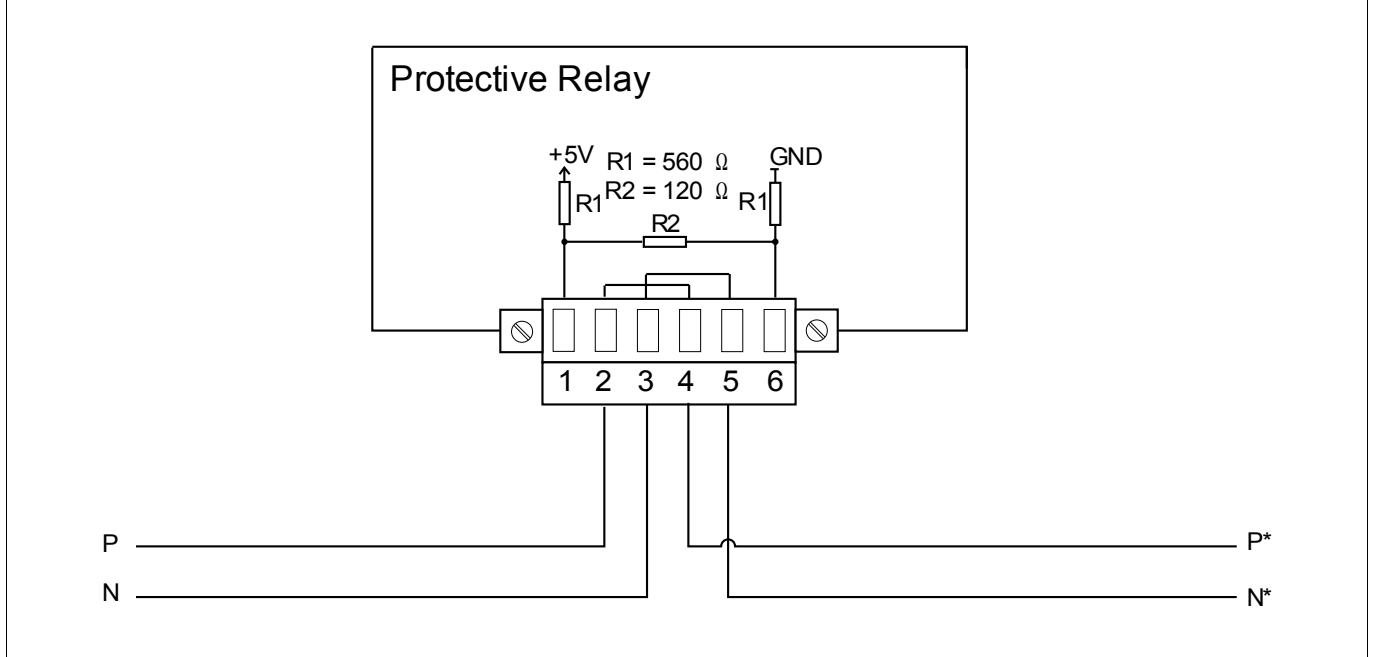

Type 1 Wiring example, Device at the End of the BUS (using the integrated Terminal Resistor)

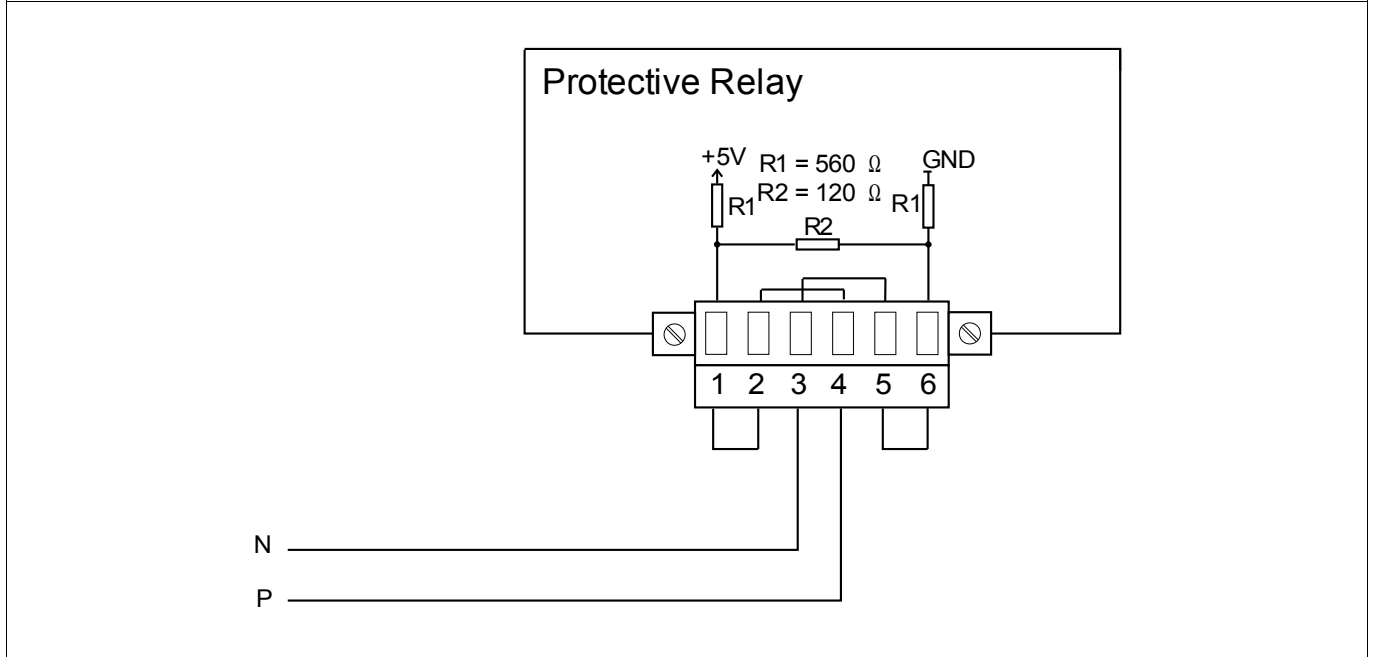



**WARNING**

There are two different versions of the RS485 interface. By means of the wiring diagram on the top of your device, you have to find out which version is built in your device (Type1 or Type2).



**WARNING**

Ensure the correct tightening torques.

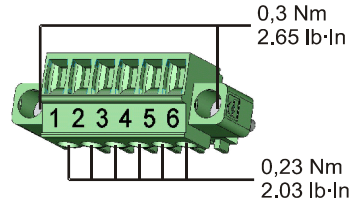

**RS485 – Type 2 (see wiring diagram)**

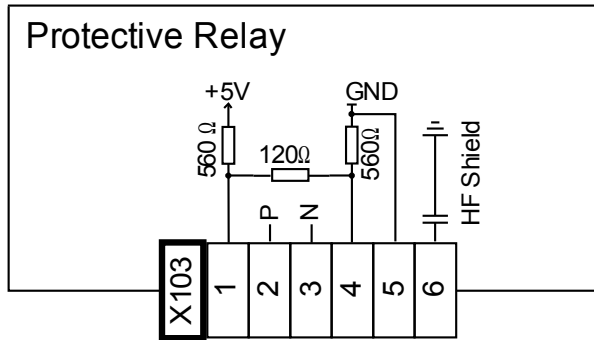

*Electro-mechanical assignment Type 2 (see wiring diagram)*

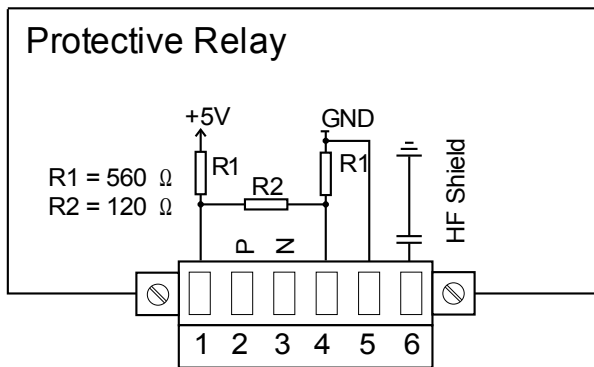

**NOTICE**

The Modbus® / IEC 60870-5-103 connection cable must be shielded. The shielding has to be fixed at the screw which is marked with the ground symbol at the rear side of the device.

The communication is Halfduplex.

Type 2 Wiring example, Device in the Middle of the BUS

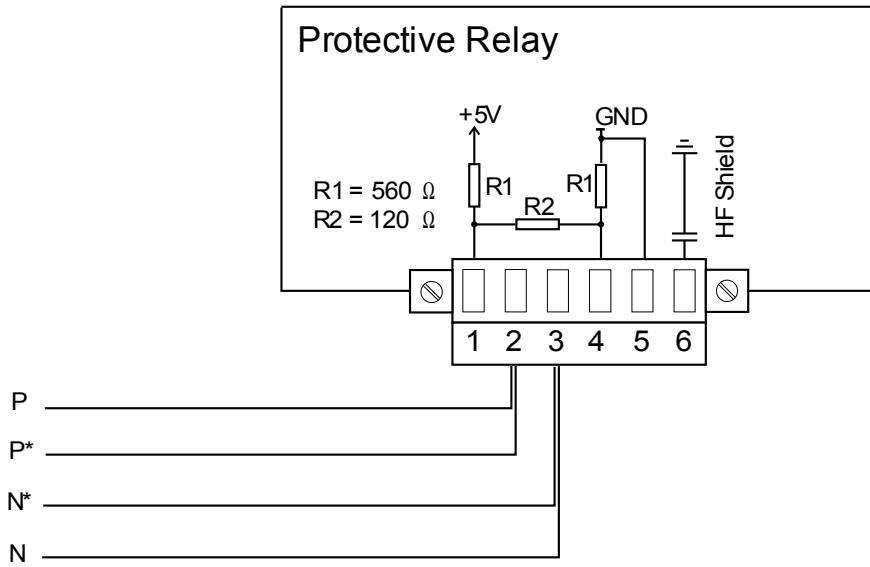

Type 2 Wiring example, Device at the End of the BUS (using the integrated Terminal Resistor)

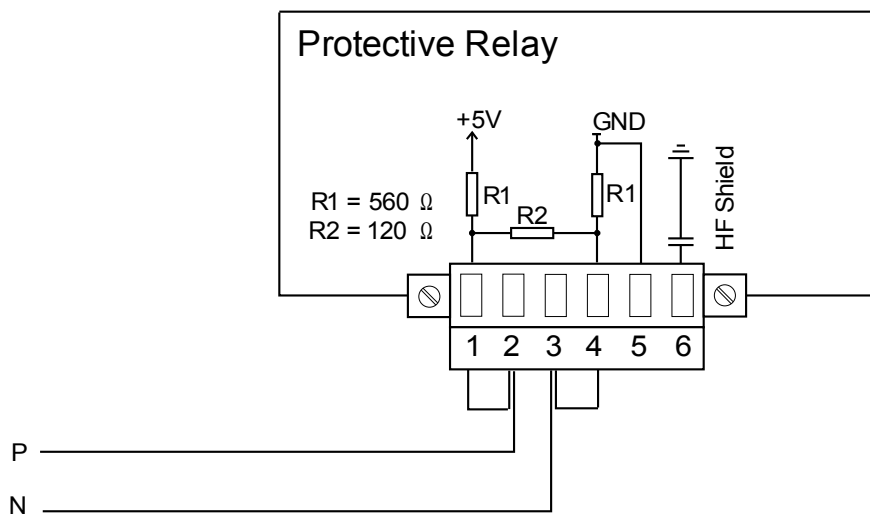

Type 2 Shielding Options (2-wire + Shield)

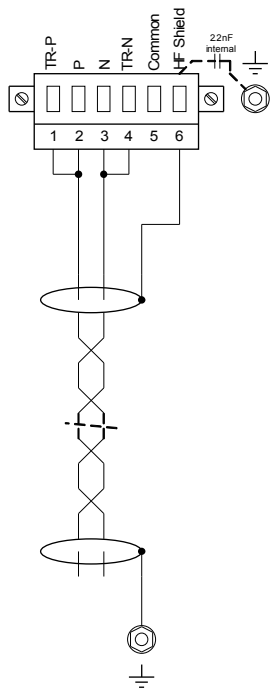

Shield at bus master side connected to earth termination resistors used

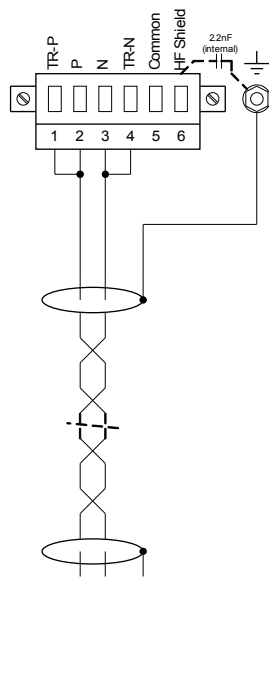

Shield at bus device side connected to earth termination resistors used

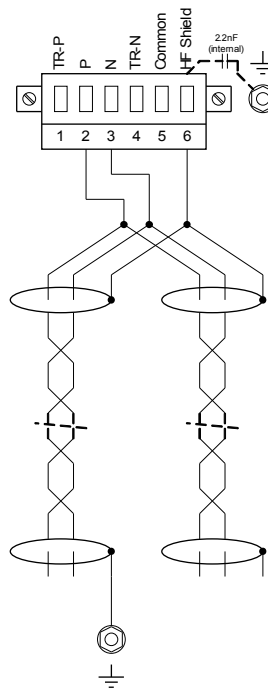

Shield at bus master side connected to earth termination resistors not used

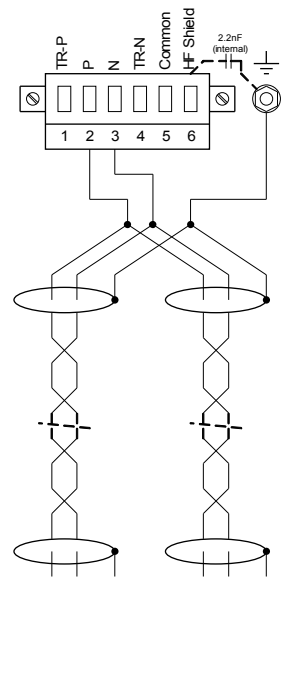

Shield at bus device side connected to earth termination resistors not used

Type 2 Shielding Options (3-wire + Shield)

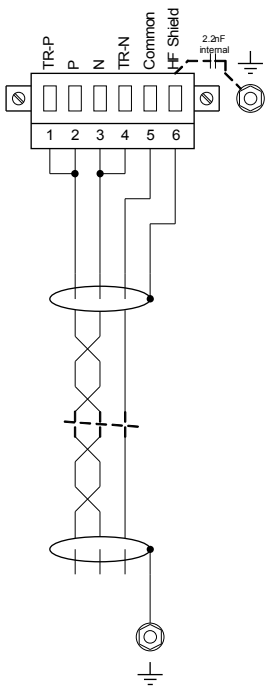

Shield at bus master side connected to earth termination resistors used

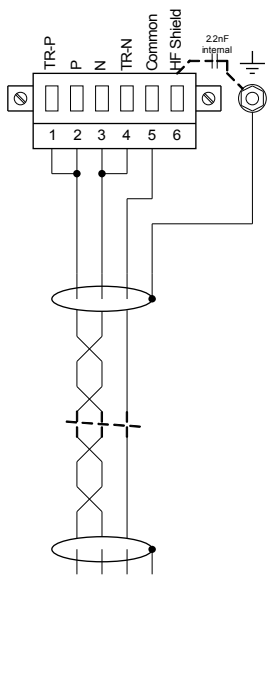

Shield at bus device side connected to earth termination resistors used

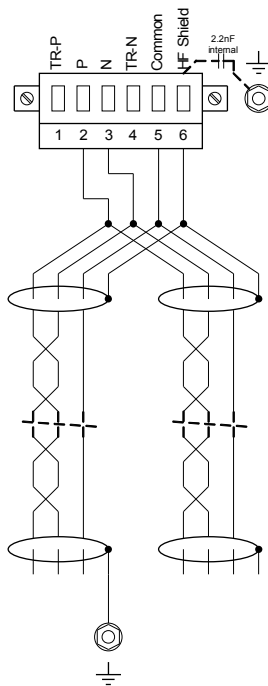

Shield at bus master side connected to earth termination resistors not used

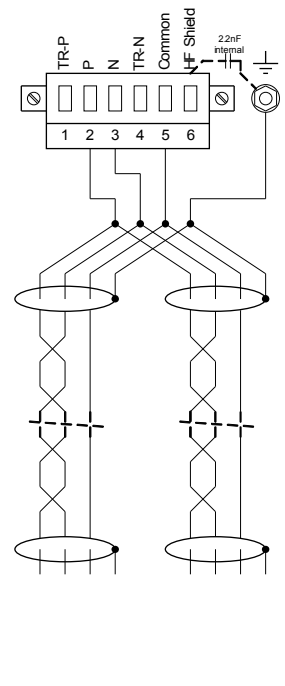

Shield at bus device side connected to earth termination resistors not used

## Profibus DP/ Modbus<sup>®</sup> RTU / IEC 60870-5-103 via fibre optic

### Fibre Optic

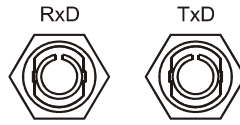

## Modbus® RTU / IEC 60870-5-103 via D-SUB

### D-SUB

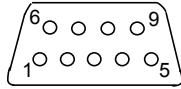

### *Electro-mechanical assignment*

D-SUB assignment - bushing  
1 Earthing/shielding  
3 RxD TxD - P: High-Level  
4 RTS-signal  
5 DGND: Ground, neg. Potential of aux voltage supply  
6 VP: pos. Potential of the aux voltage supply  
8 RxD TxD - N: Low-Level

## **NOTICE**

The connection cable must be shielded. The shielding has to be fixed at the screw which is marked with the ground symbol at the back side of the device.



## Profibus DP via D-SUB

### D-SUB

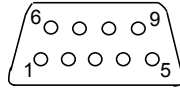

### *Electro-mechanical assignment*

D-SUB assignment - bushing  
1 Earthing/shielding  
3 RxD TxD - P: High-Level  
4 RTS-signal  
5 DGND: Ground, neg. Potential of aux voltage supply  
6 VP: pos. Potential of the aux voltage supply  
8 RxD TxD - N: Low-Level

### **NOTICE**

The connection cable must be shielded. The shielding has to be fixed at the screw which is marked with the ground symbol at the back side of the device.

### Slot X104: IRIG-B00X and Supervision Contact

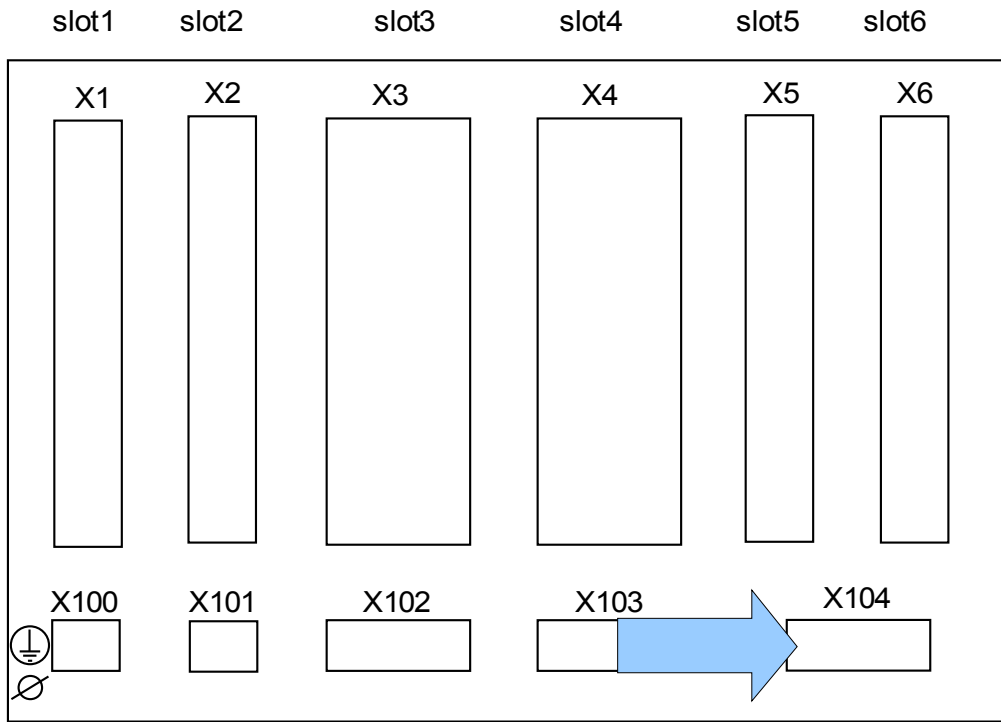

Rear side of the device (Slots)

This comprises the IRIG-B00X and the System contact (Supervision Contact).

## System Contact and IRIG-B00X



**Ensure the correct tightening torques.**

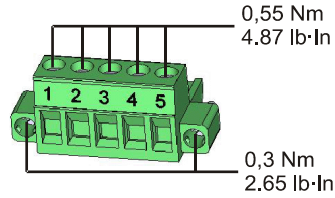

### Terminal

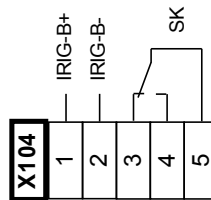

### Electro-mechanical assignment

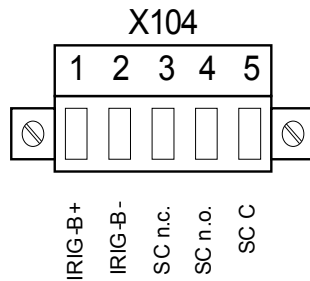

The *System-OK contact (SC relay)* cannot be configured. The system contact is a changeover contact that picks up when the device is free from internal faults. While the device is booting up, the *System OK relay (SC)* remains dropped-off (unenergized). As soon as the system is properly started (and protection is active), the System Contact picks up and the assigned LED is activated accordingly (please refer to the Self Supervision chapter).

## PC Interface - X120

9-pole D-Sub at all device fronts

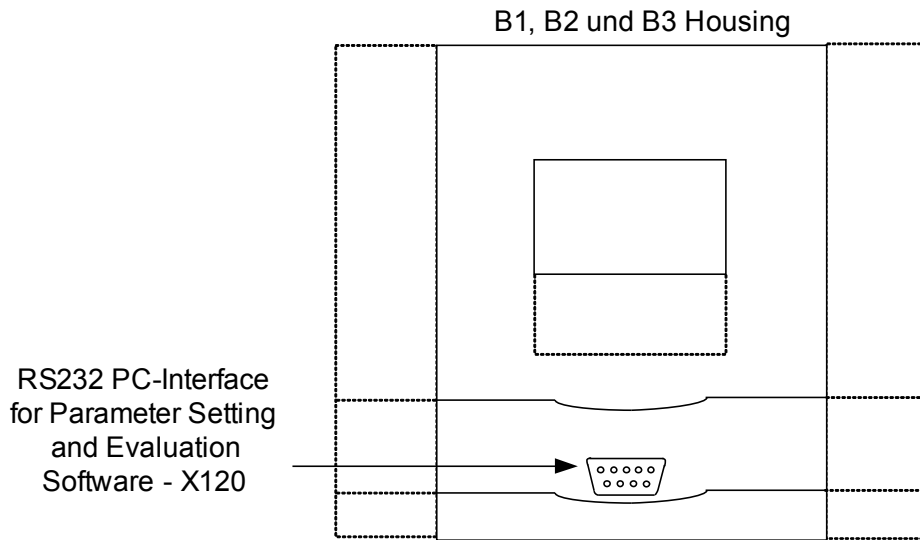

### *Electro-mechanical assignment for all device types*

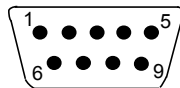

- 1 DCD
- 2 RxD
- 3 TxD
- 4 DTR
- 5 GND
- 6 DSR
- 7 RTS
- 8 CTS
- 9 RI
- housing shielded

## Assignment of the Zero Modem Cable

*Assignment of the fully wired zero modem cable*

<i>Dsub -9 (female)</i>	<i>Signal</i>	<i>Dsub -9 (female)</i>	<i>Signal</i>
2	RxD	3	TxD
3	TxD	2	RxD
4	DTR	6,1	DSR, DCD
6,1	DSR, DCD	4	DTR
7	RTS	8	CTS
8	CTS	7	RTS
5	GND (Ground)	5	GND (Ground)
9	Ring signal	9	Ring signal

### **NOTICE**

The connection cable must be shielded.

# Input, Output and LED Settings

## Configuration of the Digital Inputs

**CAUTION** Based on the »assignment list«, the states of digital inputs are allocated to the module inputs.

Set the following parameters for each of the digital inputs:

- »Nominal voltage«
- »Debouncing time«: A state change will only be adopted by the digital input after the debouncing time has expired.
- »Inverting« (where necessary)

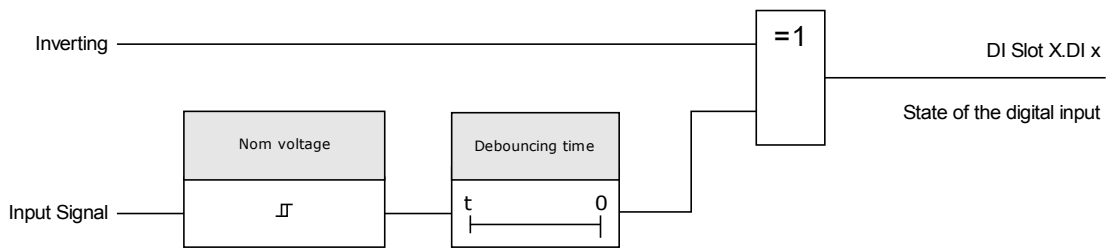







**CAUTION** The debouncing time will be started each time the state of the input signal alternates.



**CAUTION** In addition to the debouncing time that can be set via software, there is always a hardware debouncing time (approx 12 ms) that cannot be turned of.

## DI-8P X





### DI Slot X1

#### Device Parameters of the Digital Inputs on DI-8P X

Parameter	Description	Setting range	Default	Menu path
 Nom voltage	Nominal voltage of the digital inputs	24 V DC, 48 V DC, 60 V DC, 110 V DC, 230 V DC, 110 V AC, 230 V AC	24 V DC	[Device Para /Digital Inputs /DI Slot X1 /Group 1]
 Inverting 1	Inverting the input signals.	inactive, active	inactive	[Device Para /Digital Inputs /DI Slot X1 /Group 1]
 Debouncing time 1	A change of the state of a digital input will only be recognized after the debouncing time has expired (become effective). Thus, transient signals will not be misinterpreted.	no debouncing time, 20 ms, 50 ms, 100 ms	no debouncing time	[Device Para /Digital Inputs /DI Slot X1 /Group 1]
 Nom voltage	Nominal voltage of the digital inputs	24 V DC, 48 V DC, 60 V DC, 110 V DC, 230 V DC, 110 V AC, 230 V AC	24 V DC	[Device Para /Digital Inputs /DI Slot X1 /Group 2]
 Inverting 2	Inverting the input signals.	inactive, active	inactive	[Device Para /Digital Inputs /DI Slot X1 /Group 2]
 Debouncing time 2	A change of the state of a digital input will only be recognized after the debouncing time has expired (become effective). Thus, transient signals will not be misinterpreted.	no debouncing time, 20 ms, 50 ms, 100 ms	no debouncing time	[Device Para /Digital Inputs /DI Slot X1 /Group 2]

<i>Parameter</i>	<i>Description</i>	<i>Setting range</i>	<i>Default</i>	<i>Menu path</i>
Nom voltage 	Nominal voltage of the digital inputs	24 V DC, 48 V DC, 60 V DC, 110 V DC, 230 V DC, 110 V AC, 230 V AC	24 V DC	[Device Para /Digital Inputs /DI Slot X1 /Group 3]
Inverting 3 	Inverting the input signals.	inactive, active	inactive	[Device Para /Digital Inputs /DI Slot X1 /Group 3]
Debouncing time 3 	A change of the state of a digital input will only be recognized after the debouncing time has expired (become effective). Thus, transient signals will not be misinterpreted.	no debouncing time, 20 ms, 50 ms, 100 ms	no debouncing time	[Device Para /Digital Inputs /DI Slot X1 /Group 3]
Inverting 4 	Inverting the input signals.	inactive, active	inactive	[Device Para /Digital Inputs /DI Slot X1 /Group 3]
Debouncing time 4 	A change of the state of a digital input will only be recognized after the debouncing time has expired (become effective). Thus, transient signals will not be misinterpreted.	no debouncing time, 20 ms, 50 ms, 100 ms	no debouncing time	[Device Para /Digital Inputs /DI Slot X1 /Group 3]
Inverting 5 	Inverting the input signals.	inactive, active	inactive	[Device Para /Digital Inputs /DI Slot X1 /Group 3]
Debouncing time 5 	A change of the state of a digital input will only be recognized after the debouncing time has expired (become effective). Thus, transient signals will not be misinterpreted.	no debouncing time, 20 ms, 50 ms, 100 ms	no debouncing time	[Device Para /Digital Inputs /DI Slot X1 /Group 3]
Inverting 6 	Inverting the input signals.	inactive, active	inactive	[Device Para /Digital Inputs /DI Slot X1 /Group 3]



<i>Parameter</i>	<i>Description</i>	<i>Setting range</i>	<i>Default</i>	<i>Menu path</i>
 Debouncing time 6	A change of the state of a digital input will only be recognized after the debouncing time has expired (become effective). Thus, transient signals will not be misinterpreted.	no debouncing time, 20 ms, 50 ms, 100 ms	no debouncing time	[Device Para /Digital Inputs /DI Slot X1 /Group 3]
 Inverting 7	Inverting the input signals.	inactive, active	inactive	[Device Para /Digital Inputs /DI Slot X1 /Group 3]
 Debouncing time 7	A change of the state of a digital input will only be recognized after the debouncing time has expired (become effective). Thus, transient signals will not be misinterpreted.	no debouncing time, 20 ms, 50 ms, 100 ms	no debouncing time	[Device Para /Digital Inputs /DI Slot X1 /Group 3]
 Inverting 8	Inverting the input signals.	inactive, active	inactive	[Device Para /Digital Inputs /DI Slot X1 /Group 3]
 Debouncing time 8	A change of the state of a digital input will only be recognized after the debouncing time has expired (become effective). Thus, transient signals will not be misinterpreted. 8	no debouncing time, 20 ms, 50 ms, 100 ms	no debouncing time	[Device Para /Digital Inputs /DI Slot X1 /Group 3]







## Signals of the Digital Inputs on DI-8P X

<i>Signal</i>	<i>Description</i>
DI 1	Signal: Digital Input
DI 2	Signal: Digital Input
DI 3	Signal: Digital Input
DI 4	Signal: Digital Input
DI 5	Signal: Digital Input
DI 6	Signal: Digital Input
DI 7	Signal: Digital Input
DI 8	Signal: Digital Input

## DI-8 X

### DI Slot X6

#### Device Parameters of the Digital Inputs on DI-8 X

Parameter	Description	Setting range	Default	Menu path
 Nom voltage	Nominal voltage of the digital inputs	24 V DC, 48 V DC, 60 V DC, 110 V DC, 230 V DC, 110 V AC, 230 V AC	24 V DC	[Device Para /Digital Inputs /DI Slot X6 /Group 1]
 Inverting 1	Inverting the input signals.	inactive, active	inactive	[Device Para /Digital Inputs /DI Slot X6 /Group 1]
 Debouncing time 1	A change of the state of a digital input will only be recognized after the debouncing time has expired (become effective). Thus, transient signals will not be misinterpreted.	no debouncing time, 20 ms, 50 ms, 100 ms	no debouncing time	[Device Para /Digital Inputs /DI Slot X6 /Group 1]
 Inverting 2	Inverting the input signals.	inactive, active	inactive	[Device Para /Digital Inputs /DI Slot X6 /Group 1]
 Debouncing time 2	A change of the state of a digital input will only be recognized after the debouncing time has expired (become effective). Thus, transient signals will not be misinterpreted.	no debouncing time, 20 ms, 50 ms, 100 ms	no debouncing time	[Device Para /Digital Inputs /DI Slot X6 /Group 1]
 Inverting 3	Inverting the input signals.	inactive, active	inactive	[Device Para /Digital Inputs /DI Slot X6 /Group 1]
 Debouncing time 3	A change of the state of a digital input will only be recognized after the debouncing time has expired (become effective). Thus, transient signals will not be misinterpreted.	no debouncing time, 20 ms, 50 ms, 100 ms	no debouncing time	[Device Para /Digital Inputs /DI Slot X6 /Group 1]

Parameter	Description	Setting range	Default	Menu path
Inverting 4 	Inverting the input signals.	inactive, active	inactive	[Device Para /Digital Inputs /DI Slot X6 /Group 1]
Debouncing time 4 	A change of the state of a digital input will only be recognized after the debouncing time has expired (become effective). Thus, transient signals will not be misinterpreted.	no debouncing time, 20 ms, 50 ms, 100 ms	no debouncing time	[Device Para /Digital Inputs /DI Slot X6 /Group 1]
Inverting 5 	Inverting the input signals.	inactive, active	inactive	[Device Para /Digital Inputs /DI Slot X6 /Group 1]
Debouncing time 5 	A change of the state of a digital input will only be recognized after the debouncing time has expired (become effective). Thus, transient signals will not be misinterpreted.	no debouncing time, 20 ms, 50 ms, 100 ms	no debouncing time	[Device Para /Digital Inputs /DI Slot X6 /Group 1]
Inverting 6 	Inverting the input signals.	inactive, active	inactive	[Device Para /Digital Inputs /DI Slot X6 /Group 1]
Debouncing time 6 	A change of the state of a digital input will only be recognized after the debouncing time has expired (become effective). Thus, transient signals will not be misinterpreted.	no debouncing time, 20 ms, 50 ms, 100 ms	no debouncing time	[Device Para /Digital Inputs /DI Slot X6 /Group 1]
Inverting 7 	Inverting the input signals.	inactive, active	inactive	[Device Para /Digital Inputs /DI Slot X6 /Group 1]
Debouncing time 7 	A change of the state of a digital input will only be recognized after the debouncing time has expired (become effective). Thus, transient signals will not be misinterpreted.	no debouncing time, 20 ms, 50 ms, 100 ms	no debouncing time	[Device Para /Digital Inputs /DI Slot X6 /Group 1]
Inverting 8 	Inverting the input signals.	inactive, active	inactive	[Device Para /Digital Inputs /DI Slot X6 /Group 1]

<i>Parameter</i>	<i>Description</i>	<i>Setting range</i>	<i>Default</i>	<i>Menu path</i>
Debouncing time 8 	A change of the state of a digital input will only be recognized after the debouncing time has expired (become effective). Thus, transient signals will not be misinterpreted. 8	no debouncing time, 20 ms, 50 ms, 100 ms	no debouncing time	[Device Para /Digital Inputs /DI Slot X6 /Group 1]

### Signals of the Digital Inputs on DI-8 X

<i>Signal</i>	<i>Description</i>
DI 1	Signal: Digital Input
DI 2	Signal: Digital Input
DI 3	Signal: Digital Input
DI 4	Signal: Digital Input
DI 5	Signal: Digital Input
DI 6	Signal: Digital Input
DI 7	Signal: Digital Input
DI 8	Signal: Digital Input

## Output Relays Settings

### BO Slot X2 ,BO Slot X5

The conditions of module outputs and signals/protective functions (such as reverse interlocking) can be passed by means of alarm relays. The alarm relays are potential-free contacts (which can be used as opening or closing contact). Each alarm relay can be assigned up to 7 functions out of the »assignment list«.

Set the following parameters for each of the binary output relays:

- Up to 7 signals from the »assignment list« (OR-connected)
- Each of the assigned signals can be inverted.
- The (collective) state of the binary output relay can be inverted (open or closed circuit current principle)
- By the Operating Mode it can be determined whether the relay output works in working current or closed-circuit principle.
- »Latched« active or inactive
  - »Latched = inactive«:  
If the latching function is »inactive«, the alarm relay respectively the alarm contact will adopt the state of those alarms that were assigned.
  - »Latched = active«  
If the »latching function« is »active«, the state of the alarm relay respectively alarm contact that was set by the alarms will be stored.

The alarm relay can only be acknowledged after reset of those signals that had initiated setting of the relay and after expiry of the minimum retention time.

- »Hold time«: At signal changes, the minimal latching time ensures that the relay will be maintained picked-up or released for at least this period.

## CAUTION

If binary outputs are parameterized »Latched=*active*«, they will keep (return into) their position even if there is a break within the power supply.

If binary output relays are parameterized »Latched=*active*«, The binary output will also retain, if the binary output is reprogrammed in another way. This applies also if »Latched is set to *inactive*«. Resetting a binary output that has latched a signal will always require an acknowledgement.

## NOTICE

The »*System OK Relay*« (watchdog) cannot be configured.

### *Acknowledgment options*

Binary output relays can be acknowledged:

- Via the push-button »C« at the operating panel.
- Each binary output relay can be acknowledged by a signal of the »assignment list« (If »*Latched is active*«).
- Via the module »Ex Acknowledge« all binary output relays can be acknowledged at once, if the signal for external acknowledgement that was selected from the »assignment list« becomes true. (e.g the state of a digital input).
- Via SCADA, all output relays can be acknowledged at once.

## WARNING

Relay output contacts can be set by force or disarmed (for commissioning support, please refer to the „Service/Disarming the Output Relay Contacts“ and „Service/Forcing the Output Relay Contacts“ sections).

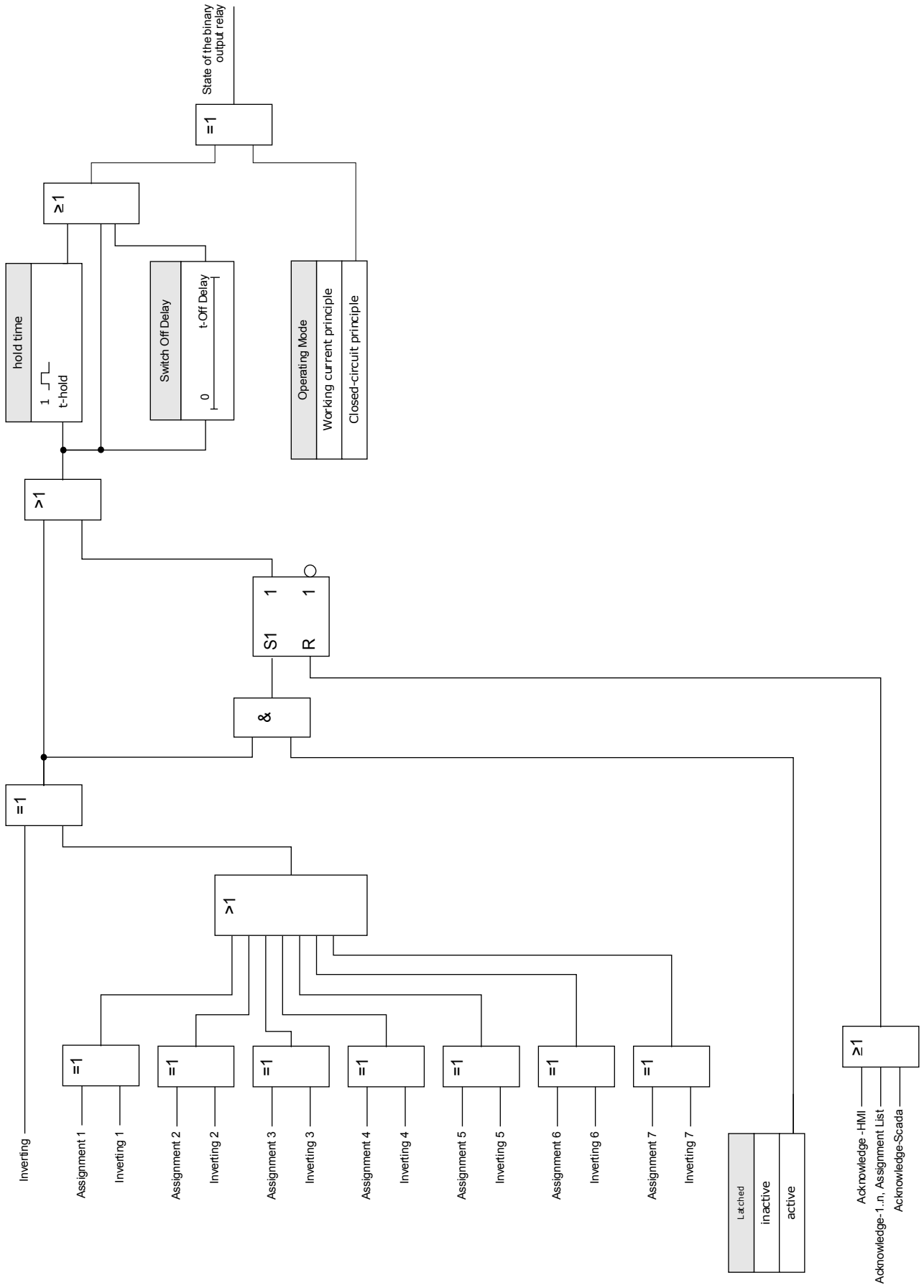









## System Contact



The *System OK alarm relay (SC)* is the devices »LIFE CONTACT«. Its installation location depends on the housing type. Please refer to the wiring diagram of the device (WDC-contact).

The *System-OK relay (SC)* cannot be parameterized. The system contact is an operating current contact that picks-up, when the device is free from internal faults. While the device is booting up, the *System OK relay (SC)* remains dropped-off. As soon as the system was duly started up, the relay picks up and the assigned LED is activated accordingly (please refer to chapter Self Supervision).







## OR-5 X

### Direct Commands of OR-5 X









Parameter	Description	Setting range	Default	Menu path
 DISARMED	<p>This is the second step, after the "DISARMED Ctrl" has been activated, that is required to DISARM the relay outputs. This will DISARM those output relays that are currently not latched and that are not on "hold" by a pending minimum hold time. CAUTION! RELAYS DISARMED in order to safely perform maintenance while eliminating the risk of taking an entire process off-line. (Note: Zone Interlocking and Supervision Contact cannot be disarmed). YOU MUST ENSURE that the relays are ARMED AGAIN after maintenance.</p> <p>Only available if: DISARMED Ctrl = active</p>	inactive, active	inactive	[Service /Test (Prot inhibit) /DISARMED /BO Slot X2]
 Force all Outs	By means of this function the normal Output Relay State can be overwritten (forced). The relay can be set from normal operation (relay works according to the assigned signals) to "force energized" or "force de-energized" state. Forcing all outputs relays of an entire assembly group is superior to forcing a single output relay.	Normal, De-Energized, Energized	Normal	[Service /Test (Prot inhibit) /Force OR /BO Slot X2]
 Force OR1	By means of this function the normal Output Relay State can be overwritten (forced). The relay can be set from normal operation (relay works according to the assigned signals) to "force energized" or "force de-energized" state.	Normal, De-Energized, Energized	Normal	[Service /Test (Prot inhibit) /Force OR /BO Slot X2]
 Force OR2	By means of this function the normal Output Relay State can be overwritten (forced). The relay can be set from normal operation (relay works according to the assigned signals) to "force energized" or "force de-energized" state.	Normal, De-Energized, Energized	Normal	[Service /Test (Prot inhibit) /Force OR /BO Slot X2]
 Force OR3	By means of this function the normal Output Relay State can be overwritten (forced). The relay can be set from normal operation (relay works according to the assigned signals) to "force energized" or "force de-energized" state.	Normal, De-Energized, Energized	Normal	[Service /Test (Prot inhibit) /Force OR /BO Slot X2]
 Force OR4	By means of this function the normal Output Relay State can be overwritten (forced). The relay can be set from normal operation (relay works according to the assigned signals) to "force energized" or "force de-energized" state.	Normal, De-Energized, Energized	Normal	[Service /Test (Prot inhibit) /Force OR /BO Slot X2]

Parameter	Description	Setting range	Default	Menu path
Force OR5 	By means of this function the normal Output Relay State can be overwritten (forced). The relay can be set from normal operation (relay works according to the assigned signals) to "force energized" or "force de-energized" state.	Normal, De-Energized, Energized	Normal	[Service /Test (Prot inhibit) /Force OR /BO Slot X2]
Force OR6 	By means of this function the normal Output Relay State can be overwritten (forced). The relay can be set from normal operation (relay works according to the assigned signals) to "force energized" or "force de-energized" state.	Normal, De-Energized, Energized	Normal	[Service /Test (Prot inhibit) /Force OR /BO Slot X2]







### Device Parameters of the Binary Output Relays on OR-5 X









Parameter	Description	Setting range	Default	Menu path
Operating Mode 	Operating Mode	Working current principle, Closed-circuit principle	Working current principle	[Device Para /Binary Outputs /BO Slot X2 /BO 1]
t-hold 	To clearly identify the state transition of a binary output relay, the "new state" is being hold, at least for the duration of the hold time.	0.00 - 300.00s	0.00s	[Device Para /Binary Outputs /BO Slot X2 /BO 1]
t-Off Delay 	Switch Off Delay	0.00 - 300.00s	0.00s	[Device Para /Binary Outputs /BO Slot X2 /BO 1]
Latched 	Defines whether the Relay Output will be latched when it picks up.	inactive, active	BO Slot X2: active BO Slot X5: inactive	[Device Para /Binary Outputs /BO Slot X2 /BO 1]
Acknowledgement 	Acknowledgement Signal - An acknowledgement signal (that acknowledges the corresponding binary output relay) can be assigned to each output relay. The acknowledgement-signal is only effective if the parameter "Latched" is set to active.  Only available if: Latched = active	1..n, Assignment List	--	[Device Para /Binary Outputs /BO Slot X2 /BO 1]
Inverting 	Inverting of the Binary Output Relay.	inactive, active	inactive	[Device Para /Binary Outputs /BO Slot X2 /BO 1]

Parameter	Description	Setting range	Default	Menu path
Assignment 1 	Assignment	1..n, Assignment List	BO Slot X2: SG[1].TripCmd BO Slot X5: --	[Device Para /Binary Outputs /BO Slot X2 /BO 1]
Inverting 1 	Inverting of the state of the assigned signal.	inactive, active	inactive	[Device Para /Binary Outputs /BO Slot X2 /BO 1]
Assignment 2 	Assignment	1..n, Assignment List	--	[Device Para /Binary Outputs /BO Slot X2 /BO 1]
Inverting 2 	Inverting of the state of the assigned signal.	inactive, active	inactive	[Device Para /Binary Outputs /BO Slot X2 /BO 1]
Assignment 3 	Assignment	1..n, Assignment List	--	[Device Para /Binary Outputs /BO Slot X2 /BO 1]
Inverting 3 	Inverting of the state of the assigned signal.	inactive, active	inactive	[Device Para /Binary Outputs /BO Slot X2 /BO 1]
Assignment 4 	Assignment	1..n, Assignment List	--	[Device Para /Binary Outputs /BO Slot X2 /BO 1]
Inverting 4 	Inverting of the state of the assigned signal.	inactive, active	inactive	[Device Para /Binary Outputs /BO Slot X2 /BO 1]
Assignment 5 	Assignment	1..n, Assignment List	--	[Device Para /Binary Outputs /BO Slot X2 /BO 1]



<i>Parameter</i>	<i>Description</i>	<i>Setting range</i>	<i>Default</i>	<i>Menu path</i>
Inverting 5 	Inverting of the state of the assigned signal.	inactive, active	inactive	[Device Para /Binary Outputs /BO Slot X2 /BO 1]
Assignment 6 	Assignment	1..n, Assignment List	--	[Device Para /Binary Outputs /BO Slot X2 /BO 1]
Inverting 6 	Inverting of the state of the assigned signal.	inactive, active	inactive	[Device Para /Binary Outputs /BO Slot X2 /BO 1]
Assignment 7 	Assignment	1..n, Assignment List	--	[Device Para /Binary Outputs /BO Slot X2 /BO 1]
Inverting 7 	Inverting of the state of the assigned signal.	inactive, active	inactive	[Device Para /Binary Outputs /BO Slot X2 /BO 1]
Operating Mode 	Operating Mode	Working current principle, Closed-circuit prin- ciple	Working current principle	[Device Para /Binary Outputs /BO Slot X2 /BO 2]
t-hold 	To clearly identify the state transition of a binary output relay, the "new state" is being hold, at least for the duration of the hold time.	0.00 - 300.00s	0.00s	[Device Para /Binary Outputs /BO Slot X2 /BO 2]
t-Off Delay 	Switch Off Delay	0.00 - 300.00s	0.00s	[Device Para /Binary Outputs /BO Slot X2 /BO 2]
Latched 	Defines whether the Relay Output will be latched when it picks up.	inactive, active	inactive	[Device Para /Binary Outputs /BO Slot X2 /BO 2]

Parameter	Description	Setting range	Default	Menu path
 Acknowledgement	Acknowledgement Signal - An acknowledgement signal (that acknowledges the corresponding binary output relay) can be assigned to each output relay. The acknowledgement-signal is only effective if the parameter "Latched" is set to active.  Only available if: Latched = active	1..n, Assignment List	-.-	[Device Para /Binary Outputs /BO Slot X2 /BO 2]
 Inverting	Inverting of the Binary Output Relay.	inactive, active	inactive	[Device Para /Binary Outputs /BO Slot X2 /BO 2]
 Assignment 1	Assignment	1..n, Assignment List	BO Slot X2: Prot.Alarm BO Slot X5: -.-	[Device Para /Binary Outputs /BO Slot X2 /BO 2]
 Inverting 1	Inverting of the state of the assigned signal.	inactive, active	inactive	[Device Para /Binary Outputs /BO Slot X2 /BO 2]
 Assignment 2	Assignment	1..n, Assignment List	-.-	[Device Para /Binary Outputs /BO Slot X2 /BO 2]
 Inverting 2	Inverting of the state of the assigned signal.	inactive, active	inactive	[Device Para /Binary Outputs /BO Slot X2 /BO 2]
 Assignment 3	Assignment	1..n, Assignment List	-.-	[Device Para /Binary Outputs /BO Slot X2 /BO 2]
 Inverting 3	Inverting of the state of the assigned signal.	inactive, active	inactive	[Device Para /Binary Outputs /BO Slot X2 /BO 2]
 Assignment 4	Assignment	1..n, Assignment List	-.-	[Device Para /Binary Outputs /BO Slot X2 /BO 2]









<i>Parameter</i>	<i>Description</i>	<i>Setting range</i>	<i>Default</i>	<i>Menu path</i>
Inverting 4 	Inverting of the state of the assigned signal.	inactive, active	inactive	[Device Para /Binary Outputs /BO Slot X2 /BO 2]
Assignment 5 	Assignment	1..n, Assignment List	-.-	[Device Para /Binary Outputs /BO Slot X2 /BO 2]
Inverting 5 	Inverting of the state of the assigned signal.	inactive, active	inactive	[Device Para /Binary Outputs /BO Slot X2 /BO 2]
Assignment 6 	Assignment	1..n, Assignment List	-.-	[Device Para /Binary Outputs /BO Slot X2 /BO 2]
Inverting 6 	Inverting of the state of the assigned signal.	inactive, active	inactive	[Device Para /Binary Outputs /BO Slot X2 /BO 2]
Assignment 7 	Assignment	1..n, Assignment List	-.-	[Device Para /Binary Outputs /BO Slot X2 /BO 2]
Inverting 7 	Inverting of the state of the assigned signal.	inactive, active	inactive	[Device Para /Binary Outputs /BO Slot X2 /BO 2]
Operating Mode 	Operating Mode	Working current principle, Closed-circuit prin- ciple	Working current principle	[Device Para /Binary Outputs /BO Slot X2 /BO 3]
t-hold 	To clearly identify the state transition of a binary output relay, the "new state" is being hold, at least for the duration of the hold time.	0.00 - 300.00s	0.00s	[Device Para /Binary Outputs /BO Slot X2 /BO 3]

Parameter	Description	Setting range	Default	Menu path
t-Off Delay 	Switch Off Delay	0.00 - 300.00s	0.00s	[Device Para /Binary Outputs /BO Slot X2 /BO 3]
Latched 	Defines whether the Relay Output will be latched when it picks up.	inactive, active	inactive	[Device Para /Binary Outputs /BO Slot X2 /BO 3]
Acknowledgement 	Acknowledgement Signal - An acknowledgement signal (that acknowledges the corresponding binary output relay) can be assigned to each output relay. The acknowledgement-signal is only effective if the parameter "Latched" is set to active.  Only available if: Latched = active	1..n, Assignment List	--	[Device Para /Binary Outputs /BO Slot X2 /BO 3]
Inverting 	Inverting of the Binary Output Relay.	inactive, active	inactive	[Device Para /Binary Outputs /BO Slot X2 /BO 3]
Assignment 1 	Assignment	1..n, Assignment List	BO Slot X2: SG[1].ON Cmd BO Slot X5: --	[Device Para /Binary Outputs /BO Slot X2 /BO 3]
Inverting 1 	Inverting of the state of the assigned signal.	inactive, active	inactive	[Device Para /Binary Outputs /BO Slot X2 /BO 3]
Assignment 2 	Assignment	1..n, Assignment List	--	[Device Para /Binary Outputs /BO Slot X2 /BO 3]
Inverting 2 	Inverting of the state of the assigned signal.	inactive, active	inactive	[Device Para /Binary Outputs /BO Slot X2 /BO 3]
Assignment 3 	Assignment	1..n, Assignment List	--	[Device Para /Binary Outputs /BO Slot X2 /BO 3]







<i>Parameter</i>	<i>Description</i>	<i>Setting range</i>	<i>Default</i>	<i>Menu path</i>
Inverting 3 	Inverting of the state of the assigned signal.	inactive, active	inactive	[Device Para /Binary Outputs /BO Slot X2 /BO 3]
Assignment 4 	Assignment	1..n, Assignment List	-.-	[Device Para /Binary Outputs /BO Slot X2 /BO 3]
Inverting 4 	Inverting of the state of the assigned signal.	inactive, active	inactive	[Device Para /Binary Outputs /BO Slot X2 /BO 3]
Assignment 5 	Assignment	1..n, Assignment List	-.-	[Device Para /Binary Outputs /BO Slot X2 /BO 3]
Inverting 5 	Inverting of the state of the assigned signal.	inactive, active	inactive	[Device Para /Binary Outputs /BO Slot X2 /BO 3]
Assignment 6 	Assignment	1..n, Assignment List	-.-	[Device Para /Binary Outputs /BO Slot X2 /BO 3]
Inverting 6 	Inverting of the state of the assigned signal.	inactive, active	inactive	[Device Para /Binary Outputs /BO Slot X2 /BO 3]
Assignment 7 	Assignment	1..n, Assignment List	-.-	[Device Para /Binary Outputs /BO Slot X2 /BO 3]
Inverting 7 	Inverting of the state of the assigned signal.	inactive, active	inactive	[Device Para /Binary Outputs /BO Slot X2 /BO 3]









Parameter	Description	Setting range	Default	Menu path
 Operating Mode	Operating Mode	Working current principle, Closed-circuit principle	Working current principle	[Device Para /Binary Outputs /BO Slot X2 /BO 4]
 t-hold	To clearly identify the state transition of a binary output relay, the "new state" is being hold, at least for the duration of the hold time.	0.00 - 300.00s	0.00s	[Device Para /Binary Outputs /BO Slot X2 /BO 4]
 t-Off Delay	Switch Off Delay	0.00 - 300.00s	0.00s	[Device Para /Binary Outputs /BO Slot X2 /BO 4]
 Latched	Defines whether the Relay Output will be latched when it picks up.	inactive, active	inactive	[Device Para /Binary Outputs /BO Slot X2 /BO 4]
 Acknowledgement	Acknowledgement Signal - An acknowledgement signal (that acknowledges the corresponding binary output relay) can be assigned to each output relay. The acknowledgement-signal is only effective if the parameter "Latched" is set to active.  Only available if: Latched = active	1..n, Assignment List	--	[Device Para /Binary Outputs /BO Slot X2 /BO 4]
 Inverting	Inverting of the Binary Output Relay.	inactive, active	inactive	[Device Para /Binary Outputs /BO Slot X2 /BO 4]
 Assignment 1	Assignment	1..n, Assignment List	BO Slot X2: SG[1].OFF Cmd BO Slot X5: --	[Device Para /Binary Outputs /BO Slot X2 /BO 4]
 Inverting 1	Inverting of the state of the assigned signal.	inactive, active	inactive	[Device Para /Binary Outputs /BO Slot X2 /BO 4]
 Assignment 2	Assignment	1..n, Assignment List	--	[Device Para /Binary Outputs /BO Slot X2 /BO 4]







<i>Parameter</i>	<i>Description</i>	<i>Setting range</i>	<i>Default</i>	<i>Menu path</i>
Inverting 2 	Inverting of the state of the assigned signal.	inactive, active	inactive	[Device Para /Binary Outputs /BO Slot X2 /BO 4]
Assignment 3 	Assignment	1..n, Assignment List	--	[Device Para /Binary Outputs /BO Slot X2 /BO 4]
Inverting 3 	Inverting of the state of the assigned signal.	inactive, active	inactive	[Device Para /Binary Outputs /BO Slot X2 /BO 4]
Assignment 4 	Assignment	1..n, Assignment List	--	[Device Para /Binary Outputs /BO Slot X2 /BO 4]
Inverting 4 	Inverting of the state of the assigned signal.	inactive, active	inactive	[Device Para /Binary Outputs /BO Slot X2 /BO 4]
Assignment 5 	Assignment	1..n, Assignment List	--	[Device Para /Binary Outputs /BO Slot X2 /BO 4]
Inverting 5 	Inverting of the state of the assigned signal.	inactive, active	inactive	[Device Para /Binary Outputs /BO Slot X2 /BO 4]
Assignment 6 	Assignment	1..n, Assignment List	--	[Device Para /Binary Outputs /BO Slot X2 /BO 4]
Inverting 6 	Inverting of the state of the assigned signal.	inactive, active	inactive	[Device Para /Binary Outputs /BO Slot X2 /BO 4]

Parameter	Description	Setting range	Default	Menu path
Assignment 7 	Assignment	1..n, Assignment List	.-	[Device Para /Binary Outputs /BO Slot X2 /BO 4]
Inverting 7 	Inverting of the state of the assigned signal.	inactive, active	inactive	[Device Para /Binary Outputs /BO Slot X2 /BO 4]
Operating Mode 	Operating Mode	Working current principle, Closed-circuit principle	Working current principle	[Device Para /Binary Outputs /BO Slot X2 /BO 5]
t-hold 	To clearly identify the state transition of a binary output relay, the "new state" is being hold, at least for the duration of the hold time.	0.00 - 300.00s	0.00s	[Device Para /Binary Outputs /BO Slot X2 /BO 5]
t-Off Delay 	Switch Off Delay	0.00 - 300.00s	0.00s	[Device Para /Binary Outputs /BO Slot X2 /BO 5]
Latched 	Defines whether the Relay Output will be latched when it picks up.	inactive, active	inactive	[Device Para /Binary Outputs /BO Slot X2 /BO 5]
Acknowledgement 	Acknowledgement Signal - An acknowledgement signal (that acknowledges the corresponding binary output relay) can be assigned to each output relay. The acknowledgement-signal is only effective if the parameter "Latched" is set to active.  Only available if: Latched = active	1..n, Assignment List	.-	[Device Para /Binary Outputs /BO Slot X2 /BO 5]
Inverting 	Inverting of the Binary Output Relay.	inactive, active	inactive	[Device Para /Binary Outputs /BO Slot X2 /BO 5]
Assignment 1 	Assignment	1..n, Assignment List	BO Slot X2: SG[4].ON Cmd BO Slot X5: .-	[Device Para /Binary Outputs /BO Slot X2 /BO 5]



<i>Parameter</i>	<i>Description</i>	<i>Setting range</i>	<i>Default</i>	<i>Menu path</i>
Inverting 1 	Inverting of the state of the assigned signal.	inactive, active	inactive	[Device Para /Binary Outputs /BO Slot X2 /BO 5]
Assignment 2 	Assignment	1..n, Assignment List	-.-	[Device Para /Binary Outputs /BO Slot X2 /BO 5]
Inverting 2 	Inverting of the state of the assigned signal.	inactive, active	inactive	[Device Para /Binary Outputs /BO Slot X2 /BO 5]
Assignment 3 	Assignment	1..n, Assignment List	-.-	[Device Para /Binary Outputs /BO Slot X2 /BO 5]
Inverting 3 	Inverting of the state of the assigned signal.	inactive, active	inactive	[Device Para /Binary Outputs /BO Slot X2 /BO 5]
Assignment 4 	Assignment	1..n, Assignment List	-.-	[Device Para /Binary Outputs /BO Slot X2 /BO 5]
Inverting 4 	Inverting of the state of the assigned signal.	inactive, active	inactive	[Device Para /Binary Outputs /BO Slot X2 /BO 5]
Assignment 5 	Assignment	1..n, Assignment List	-.-	[Device Para /Binary Outputs /BO Slot X2 /BO 5]
Inverting 5 	Inverting of the state of the assigned signal.	inactive, active	inactive	[Device Para /Binary Outputs /BO Slot X2 /BO 5]

Parameter	Description	Setting range	Default	Menu path
 Assignment 6	Assignment	1..n, Assignment List	.-	[Device Para /Binary Outputs /BO Slot X2 /BO 5]
 Inverting 6	Inverting of the state of the assigned signal.	inactive, active	inactive	[Device Para /Binary Outputs /BO Slot X2 /BO 5]
 Assignment 7	Assignment	1..n, Assignment List	.-	[Device Para /Binary Outputs /BO Slot X2 /BO 5]
 Inverting 7	Inverting of the state of the assigned signal.	inactive, active	inactive	[Device Para /Binary Outputs /BO Slot X2 /BO 5]
 Operating Mode	Operating Mode	Working current principle, Closed-circuit principle	Working current principle	[Device Para /Binary Outputs /BO Slot X2 /BO 6]
 t-hold	To clearly identify the state transition of a binary output relay, the "new state" is being hold, at least for the duration of the hold time.	0.00 - 300.00s	0.00s	[Device Para /Binary Outputs /BO Slot X2 /BO 6]
 t-Off Delay	Switch Off Delay	0.00 - 300.00s	0.00s	[Device Para /Binary Outputs /BO Slot X2 /BO 6]
 Latched	Defines whether the Relay Output will be latched when it picks up.	inactive, active	inactive	[Device Para /Binary Outputs /BO Slot X2 /BO 6]
 Acknowledgement	<p>Acknowledgement Signal - An acknowledgement signal (that acknowledges the corresponding binary output relay) can be assigned to each output relay. The acknowledgement-signal is only effective if the parameter "Latched" is set to active.</p> <p>Only available if: Latched = active</p>	1..n, Assignment List	.-	[Device Para /Binary Outputs /BO Slot X2 /BO 6]

<i>Parameter</i>	<i>Description</i>	<i>Setting range</i>	<i>Default</i>	<i>Menu path</i>
Inverting 	Inverting of the Binary Output Relay.	inactive, active	inactive	[Device Para /Binary Outputs /BO Slot X2 /BO 6]
Assignment 1 	Assignment	1..n, Assignment List	BO Slot X2: SG[4].OFF Cmd BO Slot X5: -.-	[Device Para /Binary Outputs /BO Slot X2 /BO 6]
Inverting 1 	Inverting of the state of the assigned signal.	inactive, active	inactive	[Device Para /Binary Outputs /BO Slot X2 /BO 6]
Assignment 2 	Assignment	1..n, Assignment List	-.-	[Device Para /Binary Outputs /BO Slot X2 /BO 6]
Inverting 2 	Inverting of the state of the assigned signal.	inactive, active	inactive	[Device Para /Binary Outputs /BO Slot X2 /BO 6]
Assignment 3 	Assignment	1..n, Assignment List	-.-	[Device Para /Binary Outputs /BO Slot X2 /BO 6]
Inverting 3 	Inverting of the state of the assigned signal.	inactive, active	inactive	[Device Para /Binary Outputs /BO Slot X2 /BO 6]
Assignment 4 	Assignment	1..n, Assignment List	-.-	[Device Para /Binary Outputs /BO Slot X2 /BO 6]
Inverting 4 	Inverting of the state of the assigned signal.	inactive, active	inactive	[Device Para /Binary Outputs /BO Slot X2 /BO 6]

Parameter	Description	Setting range	Default	Menu path
 Assignment 5	Assignment	1..n, Assignment List	.-	[Device Para /Binary Outputs /BO Slot X2 /BO 6]
 Inverting 5	Inverting of the state of the assigned signal.	inactive, active	inactive	[Device Para /Binary Outputs /BO Slot X2 /BO 6]
 Assignment 6	Assignment	1..n, Assignment List	.-	[Device Para /Binary Outputs /BO Slot X2 /BO 6]
 Inverting 6	Inverting of the state of the assigned signal.	inactive, active	inactive	[Device Para /Binary Outputs /BO Slot X2 /BO 6]
 Assignment 7	Assignment	1..n, Assignment List	.-	[Device Para /Binary Outputs /BO Slot X2 /BO 6]
 Inverting 7	Inverting of the state of the assigned signal.	inactive, active	inactive	[Device Para /Binary Outputs /BO Slot X2 /BO 6]
 DISARMED Ctrl	Enables and disables the disarming of the relay outputs. This is the first step of a two step process, to inhibit the operation or the relay outputs. Please refer to "DISARMED" for the second step.	inactive, active	inactive	[Service /Test (Prot inhibit) /DISARMED /BO Slot X2]
 Disarm Mode	CAUTION!RELAYS DISARMED in order to safely perform maintenance while eliminating the risk of taking an entire process off-line. (Note: The Supervision Contact cannot be disarmed). YOU MUST ENSURE that the relays are ARMED AGAIN after maintenance.	permanent, timeout	permanent	[Service /Test (Prot inhibit) /DISARMED /BO Slot X2]
 t-Timeout DISARM	The relays will be armed again after expiring of this time.  Only available if: Mode = Timeout DISARM	0.00 - 300.00s	0.03s	[Service /Test (Prot inhibit) /DISARMED /BO Slot X2]



<i>Parameter</i>	<i>Description</i>	<i>Setting range</i>	<i>Default</i>	<i>Menu path</i>
Force Mode 	By means of this function the normal Output Relay States can be overwritten (forced) in case that the Relay is not in a disarmed state. The relays can be set from normal operation (relay works according to the assigned signals) to "force energized" or "force de-energized" state.	permanent, timeout	permanent	[Service /Test (Prot inhibit) /Force OR /BO Slot X2]
t-Timeout Force 	The Output State will be set by force for the duration of this time. That means for the duration of this time the Output Relay does not show the state of the signals that are assigned on it.  Only available if: Mode = Timeout DISARM	0.00 - 300.00s	0.03s	[Service /Test (Prot inhibit) /Force OR /BO Slot X2]

## Input States of the Binary Output Relays on OR-5 X

<i>Name</i>	<i>Description</i>	<i>Assignment via</i>
BO1.1	Module input state: Assignment	[Device Para /Binary Outputs /BO Slot X2 /BO 1]
BO1.2	Module input state: Assignment	[Device Para /Binary Outputs /BO Slot X2 /BO 1]
BO1.3	Module input state: Assignment	[Device Para /Binary Outputs /BO Slot X2 /BO 1]
BO1.4	Module input state: Assignment	[Device Para /Binary Outputs /BO Slot X2 /BO 1]
BO1.5	Module input state: Assignment	[Device Para /Binary Outputs /BO Slot X2 /BO 1]
BO1.6	Module input state: Assignment	[Device Para /Binary Outputs /BO Slot X2 /BO 1]
BO1.7	Module input state: Assignment	[Device Para /Binary Outputs /BO Slot X2 /BO 1]
Ack signal BO 1	Module input state: Acknowledgement signal for the binary output relay. If latching is set to active, the binary output relay can only be acknowledged if those signals that initiated the setting are fallen back and the hold time is expired.	[Device Para /Binary Outputs /BO Slot X2 /BO 1]
BO2.1	Module input state: Assignment	[Device Para /Binary Outputs /BO Slot X2 /BO 2]

<i>Name</i>	<i>Description</i>	<i>Assignment via</i>
BO2.2	Module input state: Assignment	[Device Para /Binary Outputs /BO Slot X2 /BO 2]
BO2.3	Module input state: Assignment	[Device Para /Binary Outputs /BO Slot X2 /BO 2]
BO2.4	Module input state: Assignment	[Device Para /Binary Outputs /BO Slot X2 /BO 2]
BO2.5	Module input state: Assignment	[Device Para /Binary Outputs /BO Slot X2 /BO 2]
BO2.6	Module input state: Assignment	[Device Para /Binary Outputs /BO Slot X2 /BO 2]
BO2.7	Module input state: Assignment	[Device Para /Binary Outputs /BO Slot X2 /BO 2]
Ack signal BO 2	Module input state: Acknowledgement signal for the binary output relay. If latching is set to active, the binary output relay can only be acknowledged if those signals that initiated the setting are fallen back and the hold time is expired.	[Device Para /Binary Outputs /BO Slot X2 /BO 2]
BO3.1	Module input state: Assignment	[Device Para /Binary Outputs /BO Slot X2 /BO 3]
BO3.2	Module input state: Assignment	[Device Para /Binary Outputs /BO Slot X2 /BO 3]

Name	Description	Assignment via
BO3.3	Module input state: Assignment	[Device Para /Binary Outputs /BO Slot X2 /BO 3]
BO3.4	Module input state: Assignment	[Device Para /Binary Outputs /BO Slot X2 /BO 3]
BO3.5	Module input state: Assignment	[Device Para /Binary Outputs /BO Slot X2 /BO 3]
BO3.6	Module input state: Assignment	[Device Para /Binary Outputs /BO Slot X2 /BO 3]
BO3.7	Module input state: Assignment	[Device Para /Binary Outputs /BO Slot X2 /BO 3]
Ack signal BO 3	Module input state: Acknowledgement signal for the binary output relay. If latching is set to active, the binary output relay can only be acknowledged if those signals that initiated the setting are fallen back and the hold time is expired.	[Device Para /Binary Outputs /BO Slot X2 /BO 3]
BO4.1	Module input state: Assignment	[Device Para /Binary Outputs /BO Slot X2 /BO 4]
BO4.2	Module input state: Assignment	[Device Para /Binary Outputs /BO Slot X2 /BO 4]
BO4.3	Module input state: Assignment	[Device Para /Binary Outputs /BO Slot X2 /BO 4]

<i>Name</i>	<i>Description</i>	<i>Assignment via</i>
BO4.4	Module input state: Assignment	[Device Para /Binary Outputs /BO Slot X2 /BO 4]
BO4.5	Module input state: Assignment	[Device Para /Binary Outputs /BO Slot X2 /BO 4]
BO4.6	Module input state: Assignment	[Device Para /Binary Outputs /BO Slot X2 /BO 4]
BO4.7	Module input state: Assignment	[Device Para /Binary Outputs /BO Slot X2 /BO 4]
Ack signal BO 4	Module input state: Acknowledgement signal for the binary output relay. If latching is set to active, the binary output relay can only be acknowledged if those signals that initiated the setting are fallen back and the hold time is expired.	[Device Para /Binary Outputs /BO Slot X2 /BO 4]
BO5.1	Module input state: Assignment	[Device Para /Binary Outputs /BO Slot X2 /BO 5]
BO5.2	Module input state: Assignment	[Device Para /Binary Outputs /BO Slot X2 /BO 5]
BO5.3	Module input state: Assignment	[Device Para /Binary Outputs /BO Slot X2 /BO 5]
BO5.4	Module input state: Assignment	[Device Para /Binary Outputs /BO Slot X2 /BO 5]

<i>Name</i>	<i>Description</i>	<i>Assignment via</i>
BO5.5	Module input state: Assignment	[Device Para /Binary Outputs /BO Slot X2 /BO 5]
BO5.6	Module input state: Assignment	[Device Para /Binary Outputs /BO Slot X2 /BO 5]
BO5.7	Module input state: Assignment	[Device Para /Binary Outputs /BO Slot X2 /BO 5]
Ack signal BO 5	Module input state: Acknowledgement signal for the binary output relay. If latching is set to active, the binary output relay can only be acknowledged if those signals that initiated the setting are fallen back and the hold time is expired.	[Device Para /Binary Outputs /BO Slot X2 /BO 5]
BO6.1	Module input state: Assignment	[Device Para /Binary Outputs /BO Slot X2 /BO 6]
BO6.2	Module input state: Assignment	[Device Para /Binary Outputs /BO Slot X2 /BO 6]
BO6.3	Module input state: Assignment	[Device Para /Binary Outputs /BO Slot X2 /BO 6]
BO6.4	Module input state: Assignment	[Device Para /Binary Outputs /BO Slot X2 /BO 6]
BO6.5	Module input state: Assignment	[Device Para /Binary Outputs /BO Slot X2 /BO 6]

## Input, Output and LED Settings

---

<i>Name</i>	<i>Description</i>	<i>Assignment via</i>
BO6.6	Module input state: Assignment	[Device Para /Binary Outputs /BO Slot X2 /BO 6]
BO6.7	Module input state: Assignment	[Device Para /Binary Outputs /BO Slot X2 /BO 6]
Ack signal BO 6	Module input state: Acknowledgement signal for the binary output relay. If latching is set to active, the binary output relay can only be acknowledged if those signals that initiated the setting are fallen back and the hold time is expired.	[Device Para /Binary Outputs /BO Slot X2 /BO 6]

## Signals of the Binary Output Relays on OR-5 X

<i>Signal</i>	<i>Description</i>
BO 1	Signal: Binary Output Relay
BO 2	Signal: Binary Output Relay
BO 3	Signal: Binary Output Relay
BO 4	Signal: Binary Output Relay
BO 5	Signal: Binary Output Relay
BO 6	Signal: Binary Output Relay
DISARMED!	Signal: CAUTION! RELAYS DISARMED in order to safely perform maintenance while eliminating the risk of taking an entire process off-line. (Note: The Self Supervision Contact cannot be disarmed). YOU MUST ENSURE that the relays are ARMED AGAIN after maintenance
Outs forced	Signal: The State of at least one Relay Output has been set by force. That means that the state of at least one Relay is forced and hence does not show the state of the assigned signals.



## LED configuration

The LEDs can be configured within menu:

[Device Para/LEDs/Group X]

### CAUTION

Attention must be paid that there are no overlapping functions due to double or multiple LED assignment of colors and flashing codes.

### CAUTION

If LEDs are parameterized »Latched=*active*«, they will keep (return into) their blink code/color even if there is a break within the power supply.

If LEDs are parameterized »Latched=*active*«, The LED blink code will also retain, if the LED is reprogrammed in another way. This applies also if »Latched is set to *inactive*«. Resetting a LED that has latched a signal will always require an acknowledgement.

### NOTICE

This chapter contains information on the LEDs that are placed on the left hand of the display (group A).

If your device is also equipped with LEDs on the right hand of the display (group B), the information in this chapter is valid analog. The only difference is "group A" and "group B" within the menu paths.

Via push button »INFO« it is always possible to display the current alarms/alarm texts that are assigned to an LED. Please refer to chapter *Navigation* (description of the »INFO-key«).

Set the following parameters for each LED:

- »Latching/self holding function«: If »Latching« is set to »*active*«, the state that is set by the alarms will be stored. If latching »Latching« is set to »*inactive*«, the LED always adopts the state of those alarms that were assigned.
- »Acknowledgment« (signal from the »assignment list«)
- »LED active color«, LED lights up in this color in case that at least one of the allocated functions is valid (red, red flashing, green, green flashing, off).
- »LED inactive color«, LED lights up in this color in case that none of the allocated functions is valid (red, red flashing, green, green flashing, off).
- Apart from the *LED for System OK*, each LED can be assigned up to five functions/alarms out of the »assignment list«.
- »Inverting« (of the signals), if necessary.

### *Acknowledgment options*

LEDs can be acknowledged by:

- Via the push-button »C« at the operating panel.
- Each LED can be acknowledged by a signal of the »assignment list« (If »*Latched = active*«).
- Via the module »Ex Acknowledge« all LEDs can be acknowledged at once, if the signal for external acknowledgment that was selected from the »assignment list« becomes true (e.g. the state of a digital input).
- Via SCADA, all LEDs can be acknowledged at once.

### **NOTICE**

The Product-CD that is delivered with the device contains a PDF-Template in order to create and print out self adhesive films for LED assignment texts (front foil) by means of a laser printer. Recommendation: (AVERY Zweckform Art.Nr.3482)

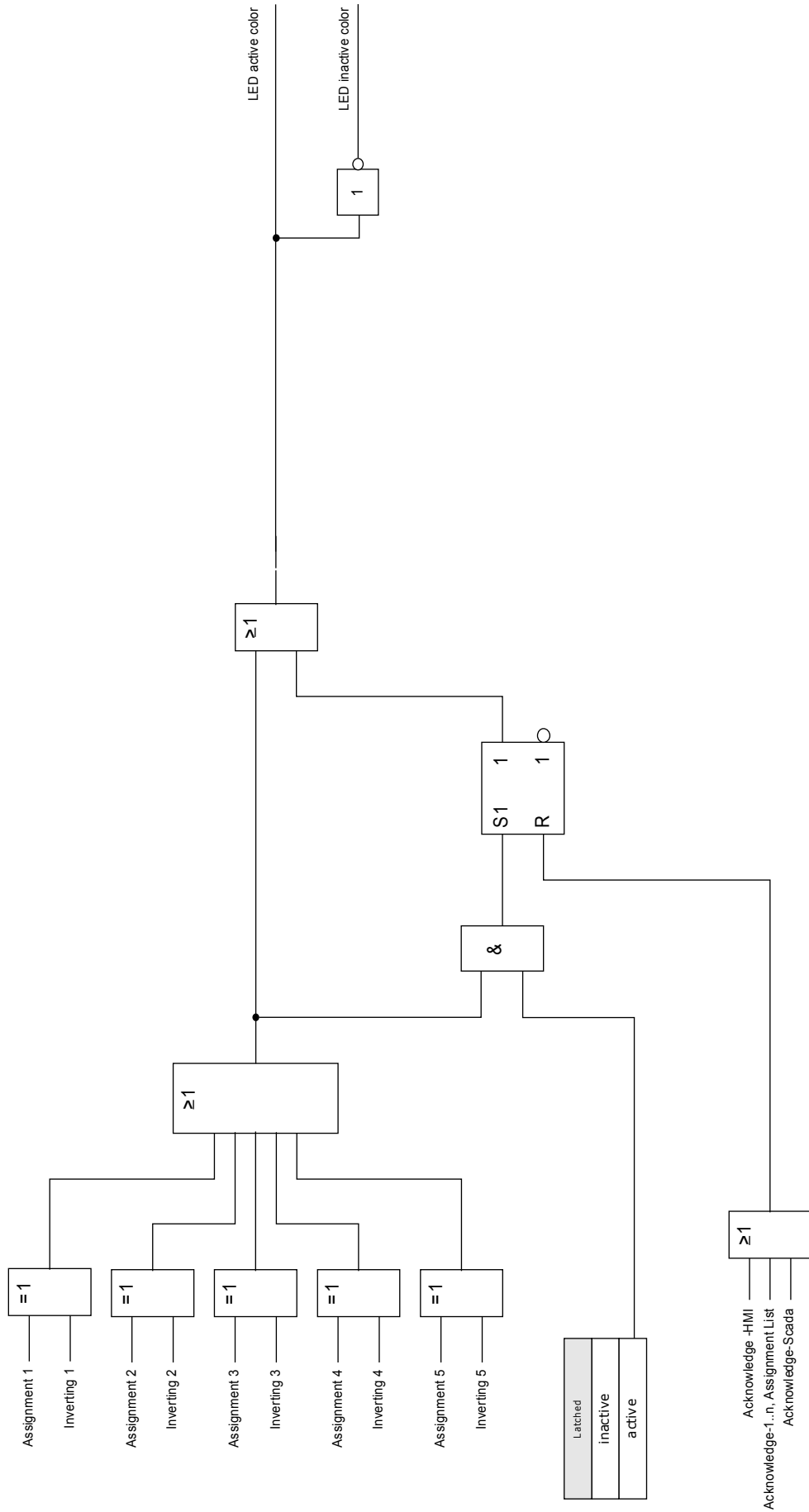









## The »System OK« LED









This LED flashes green while the device is booting. After completed booting, the LED for *System OK* lights up in green thus signaling that the *protection* (function) is »activated«. If, however, in spite of successful booting, or after the third unsuccessful reboot caused by the module self supervision the *System OK – LED* flashes in red or is red illuminated, please contact the *Woodward Kempen GmbH – Service Dept* (See also chapter Self Supervision).









*LED System OK* cannot be parameterized.









## Global Protection Parameters of the LED Module

### LEDs group A ,LEDs group B









Parameter	Description	Setting range	Default	Menu path
Latched 	Defines whether the LED will be latched when it picks up.	inactive, active	inactive	[Device Para /LEDs /LEDs group A /LED 1]
Ack signal 	Acknowledgement signal for the LED. If latching is set to active the LED can only be acknowledged if those signals that initiated the setting are no longer present.  Dependency Only available if: Latched = active	1..n, Assignment List	-.-	[Device Para /LEDs /LEDs group A /LED 1]
LED active color 	The LED lights up in this color if the state of the OR-assignment of the signals is true.	green, red, red flash, green flash, -	LEDs group A: green LEDs group B: red	[Device Para /LEDs /LEDs group A /LED 1]
LED inactive color 	The LED lights up in this color if the state of the OR-assignment of the signals is untrue.	green, red, red flash, green flash, -	-	[Device Para /LEDs /LEDs group A /LED 1]
Assignment 1 	Assignment	1..n, Assignment List	LEDs group A: Prot.active LEDs group B: -.-	[Device Para /LEDs /LEDs group A /LED 1]
Inverting 1 	Inverting of the state of the assigned signal.	inactive, active	inactive	[Device Para /LEDs /LEDs group A /LED 1]
Assignment 2 	Assignment	1..n, Assignment List	-.-	[Device Para /LEDs /LEDs group A /LED 1]
Inverting 2 	Inverting of the state of the assigned signal.	inactive, active	inactive	[Device Para /LEDs /LEDs group A /LED 1]









Parameter	Description	Setting range	Default	Menu path
Assignment 3 	Assignment	1..n, Assignment List	--	[Device Para /LEDs /LEDs group A /LED 1]
Inverting 3 	Inverting of the state of the assigned signal.	inactive, active	inactive	[Device Para /LEDs /LEDs group A /LED 1]
Assignment 4 	Assignment	1..n, Assignment List	--	[Device Para /LEDs /LEDs group A /LED 1]
Inverting 4 	Inverting of the state of the assigned signal.	inactive, active	inactive	[Device Para /LEDs /LEDs group A /LED 1]
Assignment 5 	Assignment	1..n, Assignment List	--	[Device Para /LEDs /LEDs group A /LED 1]
Inverting 5 	Inverting of the state of the assigned signal.	inactive, active	inactive	[Device Para /LEDs /LEDs group A /LED 1]
Latched 	Defines whether the LED will be latched when it picks up.	inactive, active	LEDs group A: active LEDs group B: inactive	[Device Para /LEDs /LEDs group A /LED 2]
Ack signal 	Acknowledgement signal for the LED. If latching is set to active the LED can only be acknowledged if those signals that initiated the setting are no longer present.  Only available if: Latched = active	1..n, Assignment List	--	[Device Para /LEDs /LEDs group A /LED 2]
LED active color 	The LED lights up in this color if the state of the OR-assignment of the signals is true.	green, red, red flash, green flash, -	red	[Device Para /LEDs /LEDs group A /LED 2]









Parameter	Description	Setting range	Default	Menu path
LED inactive color 	The LED lights up in this color if the state of the OR-assignment of the signals is untrue.	green, red, red flash, green flash, -	-	[Device Para /LEDs /LEDs group A /LED 2]
Assignment 1 	Assignment	1..n, Assignment List	LEDs group A: SG[1].TripCmd LEDs group B: -.-	[Device Para /LEDs /LEDs group A /LED 2]
Inverting 1 	Inverting of the state of the assigned signal.	inactive, active	inactive	[Device Para /LEDs /LEDs group A /LED 2]
Assignment 2 	Assignment	1..n, Assignment List	-.-	[Device Para /LEDs /LEDs group A /LED 2]
Inverting 2 	Inverting of the state of the assigned signal.	inactive, active	inactive	[Device Para /LEDs /LEDs group A /LED 2]
Assignment 3 	Assignment	1..n, Assignment List	-.-	[Device Para /LEDs /LEDs group A /LED 2]
Inverting 3 	Inverting of the state of the assigned signal.	inactive, active	inactive	[Device Para /LEDs /LEDs group A /LED 2]
Assignment 4 	Assignment	1..n, Assignment List	-.-	[Device Para /LEDs /LEDs group A /LED 2]
Inverting 4 	Inverting of the state of the assigned signal.	inactive, active	inactive	[Device Para /LEDs /LEDs group A /LED 2]









Parameter	Description	Setting range	Default	Menu path
Assignment 5 	Assignment	1..n, Assignment List	--	[Device Para /LEDs /LEDs group A /LED 2]
Inverting 5 	Inverting of the state of the assigned signal.	inactive, active	inactive	[Device Para /LEDs /LEDs group A /LED 2]
Latched 	Defines whether the LED will be latched when it picks up.	inactive, active	inactive	[Device Para /LEDs /LEDs group A /LED 3]
Ack signal 	Acknowledgement signal for the LED. If latching is set to active the LED can only be acknowledged if those signals that initiated the setting are no longer present.  Only available if: Latched = active	1..n, Assignment List	--	[Device Para /LEDs /LEDs group A /LED 3]
LED active color 	The LED lights up in this color if the state of the OR-assignment of the signals is true.	green, red, red flash, green flash, -	LEDs group A: red flash  LEDs group B: red	[Device Para /LEDs /LEDs group A /LED 3]
LED inactive color 	The LED lights up in this color if the state of the OR-assignment of the signals is untrue.	green, red, red flash, green flash, -	-	[Device Para /LEDs /LEDs group A /LED 3]
Assignment 1 	Assignment	1..n, Assignment List	LEDs group A: Prot.Alarm  LEDs group B: --	[Device Para /LEDs /LEDs group A /LED 3]
Inverting 1 	Inverting of the state of the assigned signal.	inactive, active	inactive	[Device Para /LEDs /LEDs group A /LED 3]
Assignment 2 	Assignment	1..n, Assignment List	--	[Device Para /LEDs /LEDs group A /LED 3]





















Parameter	Description	Setting range	Default	Menu path
Inverting 2 	Inverting of the state of the assigned signal.	inactive, active	inactive	[Device Para /LEDs /LEDs group A /LED 3]
Assignment 3 	Assignment	1..n, Assignment List	-.-	[Device Para /LEDs /LEDs group A /LED 3]
Inverting 3 	Inverting of the state of the assigned signal.	inactive, active	inactive	[Device Para /LEDs /LEDs group A /LED 3]
Assignment 4 	Assignment	1..n, Assignment List	-.-	[Device Para /LEDs /LEDs group A /LED 3]
Inverting 4 	Inverting of the state of the assigned signal.	inactive, active	inactive	[Device Para /LEDs /LEDs group A /LED 3]
Assignment 5 	Assignment	1..n, Assignment List	-.-	[Device Para /LEDs /LEDs group A /LED 3]
Inverting 5 	Inverting of the state of the assigned signal.	inactive, active	inactive	[Device Para /LEDs /LEDs group A /LED 3]
Latched 	Defines whether the LED will be latched when it picks up.	inactive, active	inactive	[Device Para /LEDs /LEDs group A /LED 4]
Ack signal 	Acknowledgement signal for the LED. If latching is set to active the LED can only be acknowledged if those signals that initiated the setting are no longer present.  Only available if: Latched = active	1..n, Assignment List	-.-	[Device Para /LEDs /LEDs group A /LED 4]









Parameter	Description	Setting range	Default	Menu path
LED active color 	The LED lights up in this color if the state of the OR-assignment of the signals is true.	green, red, red flash, green flash, -	red	[Device Para /LEDs /LEDs group A /LED 4]
LED inactive color 	The LED lights up in this color if the state of the OR-assignment of the signals is untrue.	green, red, red flash, green flash, -	-	[Device Para /LEDs /LEDs group A /LED 4]
Assignment 1 	Assignment	1..n, Assignment List	.-	[Device Para /LEDs /LEDs group A /LED 4]
Inverting 1 	Inverting of the state of the assigned signal.	inactive, active	inactive	[Device Para /LEDs /LEDs group A /LED 4]
Assignment 2 	Assignment	1..n, Assignment List	.-	[Device Para /LEDs /LEDs group A /LED 4]
Inverting 2 	Inverting of the state of the assigned signal.	inactive, active	inactive	[Device Para /LEDs /LEDs group A /LED 4]
Assignment 3 	Assignment	1..n, Assignment List	.-	[Device Para /LEDs /LEDs group A /LED 4]
Inverting 3 	Inverting of the state of the assigned signal.	inactive, active	inactive	[Device Para /LEDs /LEDs group A /LED 4]
Assignment 4 	Assignment	1..n, Assignment List	.-	[Device Para /LEDs /LEDs group A /LED 4]

Parameter	Description	Setting range	Default	Menu path
Inverting 4 	Inverting of the state of the assigned signal.	inactive, active	inactive	[Device Para /LEDs /LEDs group A /LED 4]
Assignment 5 	Assignment	1..n, Assignment List	--	[Device Para /LEDs /LEDs group A /LED 4]
Inverting 5 	Inverting of the state of the assigned signal.	inactive, active	inactive	[Device Para /LEDs /LEDs group A /LED 4]
Latched 	Defines whether the LED will be latched when it picks up.	inactive, active	inactive	[Device Para /LEDs /LEDs group A /LED 5]
Ack signal 	Acknowledgement signal for the LED. If latching is set to active the LED can only be acknowledged if those signals that initiated the setting are no longer present.  Only available if: Latched = active	1..n, Assignment List	--	[Device Para /LEDs /LEDs group A /LED 5]
LED active color 	The LED lights up in this color if the state of the OR-assignment of the signals is true.	green, red, red flash, green flash, -	red	[Device Para /LEDs /LEDs group A /LED 5]
LED inactive color 	The LED lights up in this color if the state of the OR-assignment of the signals is untrue.	green, red, red flash, green flash, -	-	[Device Para /LEDs /LEDs group A /LED 5]
Assignment 1 	Assignment	1..n, Assignment List	--	[Device Para /LEDs /LEDs group A /LED 5]
Inverting 1 	Inverting of the state of the assigned signal.	inactive, active	inactive	[Device Para /LEDs /LEDs group A /LED 5]

<i>Parameter</i>	<i>Description</i>	<i>Setting range</i>	<i>Default</i>	<i>Menu path</i>
Assignment 2 	Assignment	1..n, Assignment List	.-	[Device Para /LEDs /LEDs group A /LED 5]
Inverting 2 	Inverting of the state of the assigned signal.	inactive, active	inactive	[Device Para /LEDs /LEDs group A /LED 5]
Assignment 3 	Assignment	1..n, Assignment List	.-	[Device Para /LEDs /LEDs group A /LED 5]
Inverting 3 	Inverting of the state of the assigned signal.	inactive, active	inactive	[Device Para /LEDs /LEDs group A /LED 5]
Assignment 4 	Assignment	1..n, Assignment List	.-	[Device Para /LEDs /LEDs group A /LED 5]
Inverting 4 	Inverting of the state of the assigned signal.	inactive, active	inactive	[Device Para /LEDs /LEDs group A /LED 5]
Assignment 5 	Assignment	1..n, Assignment List	.-	[Device Para /LEDs /LEDs group A /LED 5]
Inverting 5 	Inverting of the state of the assigned signal.	inactive, active	inactive	[Device Para /LEDs /LEDs group A /LED 5]
Latched 	Defines whether the LED will be latched when it picks up.	inactive, active	inactive	[Device Para /LEDs /LEDs group A /LED 6]

Parameter	Description	Setting range	Default	Menu path
Ack signal 	Acknowledgement signal for the LED. If latching is set to active the LED can only be acknowledged if those signals that initiated the setting are no longer present.  Only available if: Latched = active	1..n, Assignment List	.-	[Device Para /LEDs /LEDs group A /LED 6]
LED active color 	The LED lights up in this color if the state of the OR-assignment of the signals is true.	green, red, red flash, green flash, -	red	[Device Para /LEDs /LEDs group A /LED 6]
LED inactive color 	The LED lights up in this color if the state of the OR-assignment of the signals is untrue.	green, red, red flash, green flash, -	-	[Device Para /LEDs /LEDs group A /LED 6]
Assignment 1 	Assignment	1..n, Assignment List	.-	[Device Para /LEDs /LEDs group A /LED 6]
Inverting 1 	Inverting of the state of the assigned signal.	inactive, active	inactive	[Device Para /LEDs /LEDs group A /LED 6]
Assignment 2 	Assignment	1..n, Assignment List	.-	[Device Para /LEDs /LEDs group A /LED 6]
Inverting 2 	Inverting of the state of the assigned signal.	inactive, active	inactive	[Device Para /LEDs /LEDs group A /LED 6]
Assignment 3 	Assignment	1..n, Assignment List	.-	[Device Para /LEDs /LEDs group A /LED 6]
Inverting 3 	Inverting of the state of the assigned signal.	inactive, active	inactive	[Device Para /LEDs /LEDs group A /LED 6]

Parameter	Description	Setting range	Default	Menu path
Assignment 4 	Assignment	1..n, Assignment List	.-	[Device Para /LEDs /LEDs group A /LED 6]
Inverting 4 	Inverting of the state of the assigned signal.	inactive, active	inactive	[Device Para /LEDs /LEDs group A /LED 6]
Assignment 5 	Assignment	1..n, Assignment List	.-	[Device Para /LEDs /LEDs group A /LED 6]
Inverting 5 	Inverting of the state of the assigned signal.	inactive, active	inactive	[Device Para /LEDs /LEDs group A /LED 6]
Latched 	Defines whether the LED will be latched when it picks up.	inactive, active	inactive	[Device Para /LEDs /LEDs group A /LED 7]
Ack signal 	Acknowledgement signal for the LED. If latching is set to active the LED can only be acknowledged if those signals that initiated the setting are no longer present.  Only available if: Latched = active	1..n, Assignment List	.-	[Device Para /LEDs /LEDs group A /LED 7]
LED active color 	The LED lights up in this color if the state of the OR-assignment of the signals is true.	green, red, red flash, green flash, -	red	[Device Para /LEDs /LEDs group A /LED 7]
LED inactive color 	The LED lights up in this color if the state of the OR-assignment of the signals is untrue.	green, red, red flash, green flash, -	-	[Device Para /LEDs /LEDs group A /LED 7]
Assignment 1 	Assignment	1..n, Assignment List	.-	[Device Para /LEDs /LEDs group A /LED 7]

<i>Parameter</i>	<i>Description</i>	<i>Setting range</i>	<i>Default</i>	<i>Menu path</i>
Inverting 1 	Inverting of the state of the assigned signal.	inactive, active	inactive	[Device Para /LEDs /LEDs group A /LED 7]
Assignment 2 	Assignment	1..n, Assignment List	-.-	[Device Para /LEDs /LEDs group A /LED 7]
Inverting 2 	Inverting of the state of the assigned signal.	inactive, active	inactive	[Device Para /LEDs /LEDs group A /LED 7]
Assignment 3 	Assignment	1..n, Assignment List	-.-	[Device Para /LEDs /LEDs group A /LED 7]
Inverting 3 	Inverting of the state of the assigned signal.	inactive, active	inactive	[Device Para /LEDs /LEDs group A /LED 7]
Assignment 4 	Assignment	1..n, Assignment List	-.-	[Device Para /LEDs /LEDs group A /LED 7]
Inverting 4 	Inverting of the state of the assigned signal.	inactive, active	inactive	[Device Para /LEDs /LEDs group A /LED 7]
Assignment 5 	Assignment	1..n, Assignment List	-.-	[Device Para /LEDs /LEDs group A /LED 7]
Inverting 5 	Inverting of the state of the assigned signal.	inactive, active	inactive	[Device Para /LEDs /LEDs group A /LED 7]

## LED Module Input States

<i>Name</i>	<i>Description</i>	<i>Assignment via</i>
LED1.1	Module input state: LED	[Device Para /LEDs /LEDs group A /LED 1]
LED1.2	Module input state: LED	[Device Para /LEDs /LEDs group A /LED 1]
LED1.3	Module input state: LED	[Device Para /LEDs /LEDs group A /LED 1]
LED1.4	Module input state: LED	[Device Para /LEDs /LEDs group A /LED 1]
LED1.5	Module input state: LED	[Device Para /LEDs /LEDs group A /LED 1]
Acknow Sig 1	Module input state: Acknowledgement Signal (only for automatic acknowledgement)	[Device Para /LEDs /LEDs group A /LED 1]
LED2.1	Module input state: LED	[Device Para /LEDs /LEDs group A /LED 2]
LED2.2	Module input state: LED	[Device Para /LEDs /LEDs group A /LED 2]
LED2.3	Module input state: LED	[Device Para /LEDs /LEDs group A /LED 2]



Input, Output and LED Settings

Name	Description	Assignment via
LED2.4	Module input state: LED	[Device Para /LEDs /LEDs group A /LED 2]
LED2.5	Module input state: LED	[Device Para /LEDs /LEDs group A /LED 2]
Acknow Sig 2	Module input state: Acknowledgement Signal (only for automatic acknowledgement)	[Device Para /LEDs /LEDs group A /LED 2]
LED3.1	Module input state: LED	[Device Para /LEDs /LEDs group A /LED 3]
LED3.2	Module input state: LED	[Device Para /LEDs /LEDs group A /LED 3]
LED3.3	Module input state: LED	[Device Para /LEDs /LEDs group A /LED 3]
LED3.4	Module input state: LED	[Device Para /LEDs /LEDs group A /LED 3]
LED3.5	Module input state: LED	[Device Para /LEDs /LEDs group A /LED 3]
Acknow Sig 3	Module input state: Acknowledgement Signal (only for automatic acknowledgement)	[Device Para /LEDs /LEDs group A /LED 3]

Input, Output and LED Settings

Name	Description	Assignment via
LED4.1	Module input state: LED	[Device Para /LEDs /LEDs group A /LED 4]
LED4.2	Module input state: LED	[Device Para /LEDs /LEDs group A /LED 4]
LED4.3	Module input state: LED	[Device Para /LEDs /LEDs group A /LED 4]
LED4.4	Module input state: LED	[Device Para /LEDs /LEDs group A /LED 4]
LED4.5	Module input state: LED	[Device Para /LEDs /LEDs group A /LED 4]
Acknow Sig 4	Module input state: Acknowledgement Signal (only for automatic acknowledgement)	[Device Para /LEDs /LEDs group A /LED 4]
LED5.1	Module input state: LED	[Device Para /LEDs /LEDs group A /LED 5]
LED5.2	Module input state: LED	[Device Para /LEDs /LEDs group A /LED 5]
LED5.3	Module input state: LED	[Device Para /LEDs /LEDs group A /LED 5]

Input, Output and LED Settings

Name	Description	Assignment via
LED5.4	Module input state: LED	[Device Para /LEDs /LEDs group A /LED 5]
LED5.5	Module input state: LED	[Device Para /LEDs /LEDs group A /LED 5]
Acknow Sig 5	Module input state: Acknowledgement Signal (only for automatic acknowledgement)	[Device Para /LEDs /LEDs group A /LED 5]
LED6.1	Module input state: LED	[Device Para /LEDs /LEDs group A /LED 6]
LED6.2	Module input state: LED	[Device Para /LEDs /LEDs group A /LED 6]
LED6.3	Module input state: LED	[Device Para /LEDs /LEDs group A /LED 6]
LED6.4	Module input state: LED	[Device Para /LEDs /LEDs group A /LED 6]
LED6.5	Module input state: LED	[Device Para /LEDs /LEDs group A /LED 6]
Acknow Sig 6	Module input state: Acknowledgement Signal (only for automatic acknowledgement)	[Device Para /LEDs /LEDs group A /LED 6]

<i>Name</i>	<i>Description</i>	<i>Assignment via</i>
LED7.1	Module input state: LED	[Device Para /LEDs /LEDs group A /LED 7]
LED7.2	Module input state: LED	[Device Para /LEDs /LEDs group A /LED 7]
LED7.3	Module input state: LED	[Device Para /LEDs /LEDs group A /LED 7]
LED7.4	Module input state: LED	[Device Para /LEDs /LEDs group A /LED 7]
LED7.5	Module input state: LED	[Device Para /LEDs /LEDs group A /LED 7]
Acknow Sig 7	Module input state: Acknowledgement Signal (only for automatic acknowledgement)	[Device Para /LEDs /LEDs group A /LED 7]

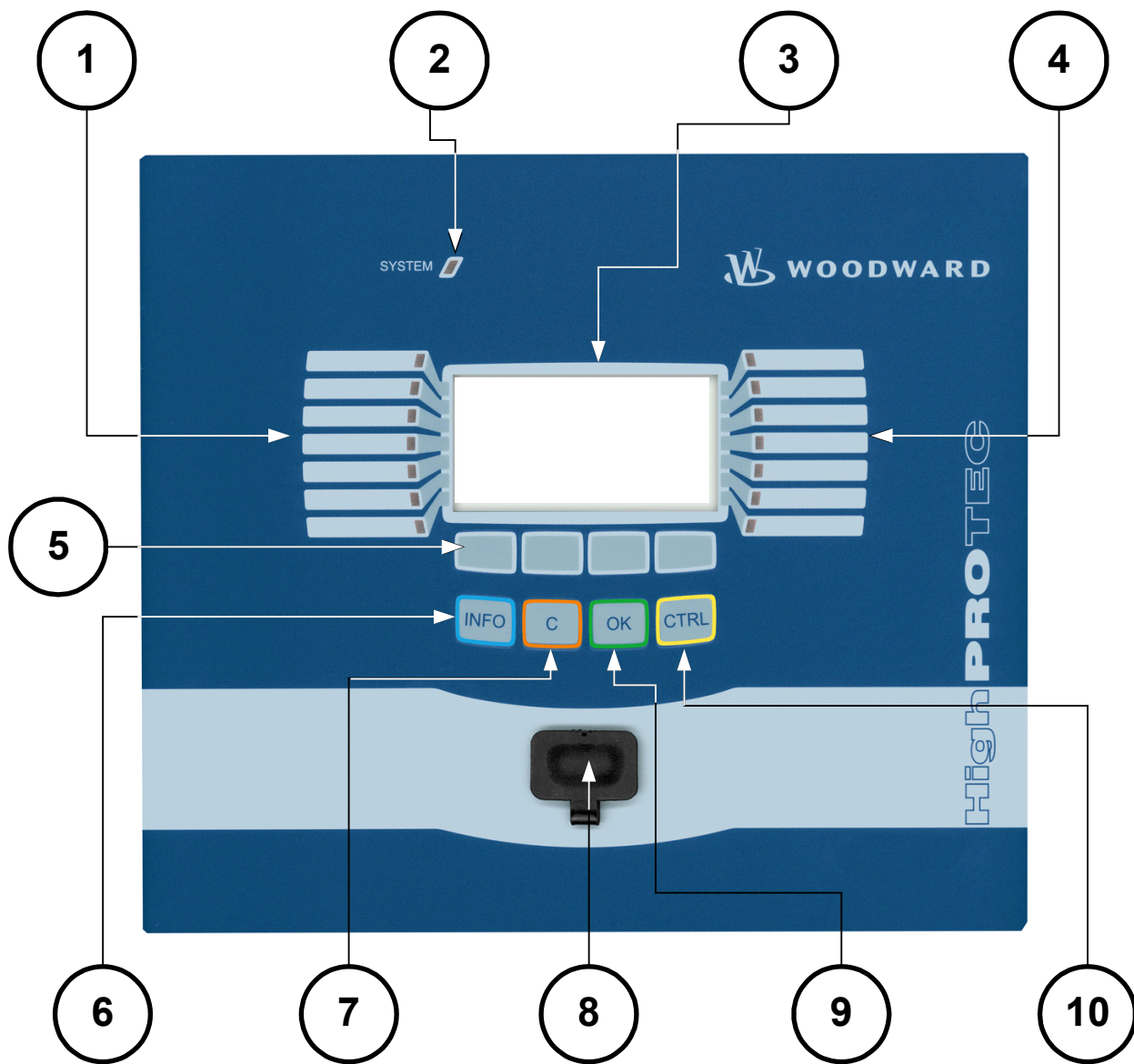

## Navigation - Operation

The following illustration applies to protective devices with a small display:

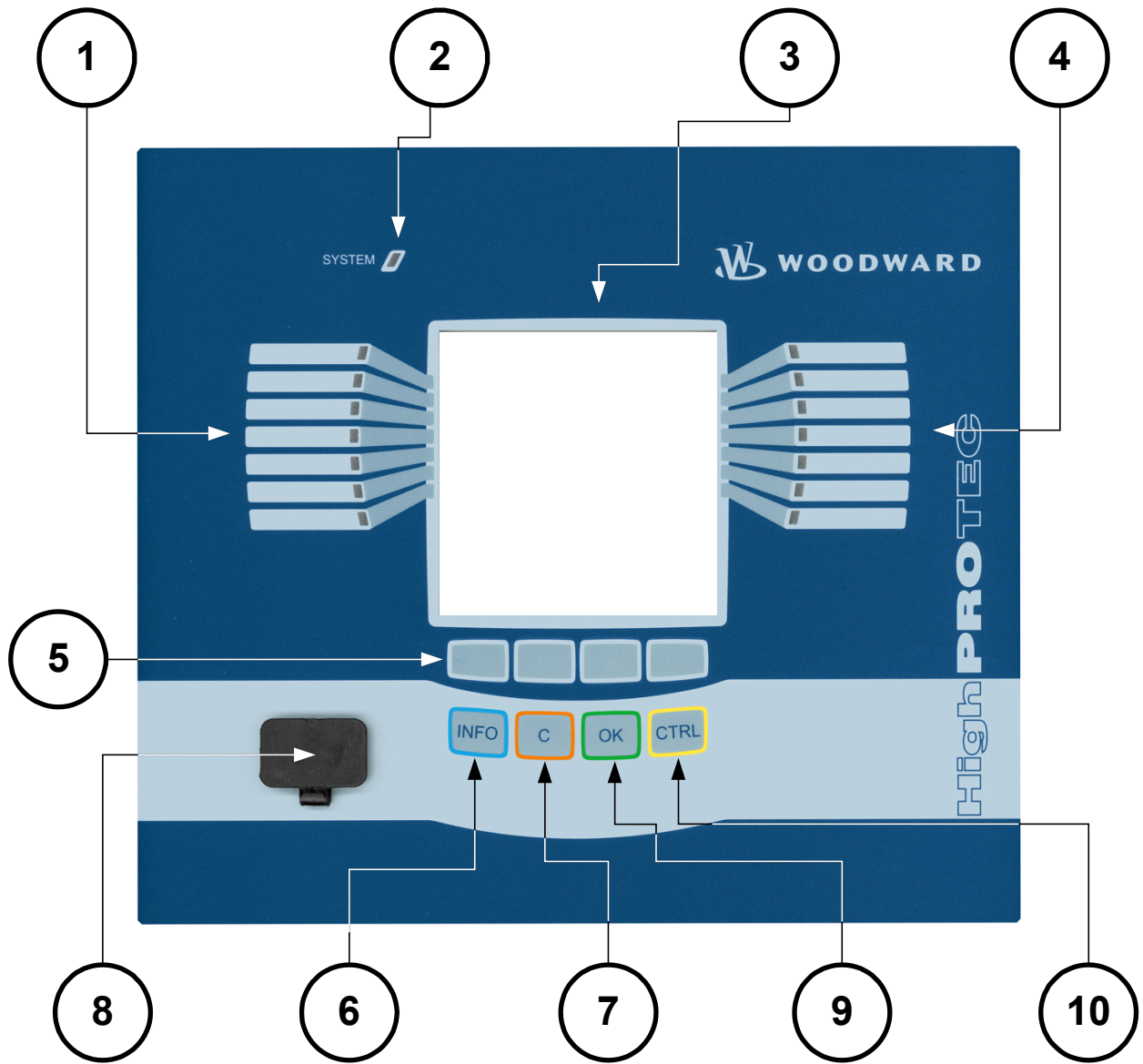

The following illustration applies to protective devices with a large display:

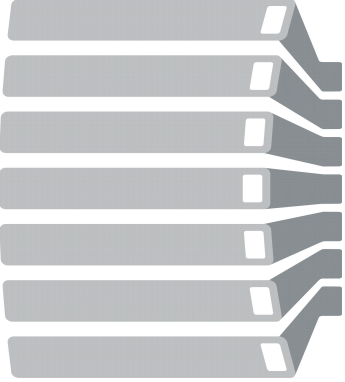

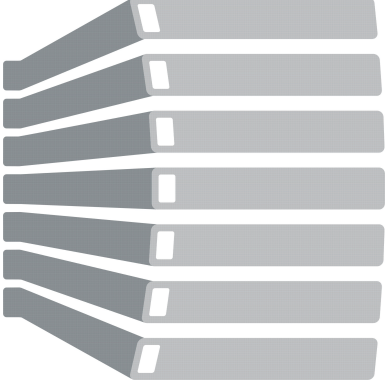



1		LEDs group A (left)	<p>Messages inform you about operational conditions, system data or other device particulars. They additionally provide you with information regarding failures and functioning of the device as well as other states of the device and the equipment.</p> <p>Alarm signals can be freely allocated to LEDs out of the »assignment list«.</p> <p>An overview about all alarm signals available in the device can be obtained from the »ASSIGNMENT LIST« which can be found in the appendix.</p>
	SYSTEM 	LED »System OK«	Should LED »System OK« flash red during operation, contact the Service Dept. immediately.
3		Display	Via the display you can read-out operational data and edit parameters.
4		LEDs group B (right)	<p>Messages inform you about operational conditions, system data or other device particulars. They additionally provide you with information regarding failures and functioning of the device as well as other states of the device and the equipment.</p> <p>Alarm signals can be freely allocated to LEDs out of the »assignment list« .</p> <p>An overview about all alarm signals available in the device can be obtained from the »assignment list« which can be found in the appendix.</p>

5		Softkeys	<p>The function of the »SOFTKEYS« are contextual. On the bottom line of the display the present function is displayed/symbolized.</p> <p>Possible functions are:</p> <ul style="list-style-type: none"><li>■ Navigation</li><li>■ Parameter decrement/increment.</li><li>■ Scrolling up/down a menu page</li><li>■ Moving to a digit</li><li>■ Change into the parameter setting mode »wrench symbol«.</li></ul>
---	---	----------	--

















<p>6</p>		<p>INFO Key (Signals/Messages)</p>	<p>Looking through the present LED assignment. The direct select key can be actuated at any time.</p> <p>If the INFO key is actuated once, the »LEFT LED SIGNALS« are inserted, if the INFO key is actuated again, the »RIGHT LED SIGNALS« are inserted. If the INFO key is actuated again you will leave the LED menu.</p> <p>Here only the first assignments of the LEDs will be shown. Every three seconds the »SOFTKEYS« will be shown (flashing).</p> <p><i>Displaying the multiple Assignments</i></p> <p>If the INFO-Button is pressed only the first assignments of any LED is shown. Every three seconds the »SOFTKEYS« will be shown (flashing).</p> <p>If there is more than one signal assigned to a LED (indicated by three dots) you can check the state of the multiple assignments if you proceed as follows.</p> <p>In order to show all (multiple) assignments select a LED by means of the »SOFTKEYS« »up« and »down«</p> <p>Via the »Softkey« »right« call up a Submenu of this LED that gives you detailed information on the state of all signals assigned to this LED. An arrow symbol points to the LED whose assignments are currently displayed.</p> <p>Via the »SOFTKEYS« »up« and »down« you can call up the next / previous LED.</p> <p>In order to leave the LED menu press the »SOFTKEY« »left« multiple times.</p>
----------	---	------------------------------------	--

7		»C Key«	<p>To abort changes and to acknowledge messages.</p> <p>In order to reset please press the Softkey »wrench« and enter the password.</p> <p>The reset menu can be left by pressing the Softkey »Arrow-left«</p>
8		RS232 Interface ( <i>Smart view</i> Connection)	Connection to software <i>Smart view</i> is done via the RS232 interface.
9		»OK Key«	When using the »OK« key parameter changes are temporarily stored. If the »OK« key is pressed again, those changes are stored definitely.
10		»CTRL Key«*	Direct Access to the Control Menu.

\*=Not for all devices available.

## Basic Menu Control

The graphic user interface is equivalent to a hierarchical structured menu tree. For access to the individual submenus the »SOFTKEYS«/Navigation Keys are used. The function of the »SOFTKEYS« can be found as symbol in the footer of the display.

<i>Softkey</i>	<i>Description</i>
	■ Via »SOFTKEY« »up« you will come to the prior menu point/one parameter up by scrolling upwards.
	■ Via »SOFTKEY« »left« you will go one step back.
	■ Via »SOFTKEY« »down« you will change to the next menu point/one parameter down by scrolling downwards.
	■ Via »SOFTKEY« »right« you will come to a submenu.
	■ Via »SOFTKEY« »Top of list« you will jump directly to the top of a list.
	■ Via »SOFTKEY« »Bottom of list« you will jump directly to the end of a list.
	■ Via »SOFTKEY« »+«the related digit will be incremented. (Continuous pressure -> fast).
	■ Via »SOFTKEY« »-«the related digit will be decremented. (Continuous pressure -> fast)
	■ Via »SOFTKEY« »left« you will go one digit to the left.
	■ Via »SOFTKEY« »right« you will go one digit to the right.
	■ Via »SOFTKEY« »Parameter setting« you will call up the parameter setting mode.
	■ Via »SOFTKEY« »Parameter setting« you will call up the parameter setting mode. Password authorization required.
	■ Via »SOFTKEY« »delete« data will be deleted.
	■ Fast forward scrolling is possible via »SOFTKEY« »Fast forward«
	■ Fast backward scrolling is possible via »SOFTKEY« »Fast backward«

In order to return to the main menu, just keep pressing the Softkey »Arrow-Left« until you arrive at the »main menu«.

## Smart view Keyboard Commands

You can control *Smart view* alternatively by means of keyboard commands (instead of the mouse)

<b>Key</b>	<b>Description</b>
↑	Moving up within the navigation tree or parameter list.
↓	Moving down within the navigation tree or parameter list.
←	Collapse the tree item or select a folder on a higher level.
→	Expands the tree item or selects a subfolder.
Numpad +	Expands the tree item.
Numpad -	Collapses the tree item.
Home	Moves to the top of the active window.
End	Moves to the bottom of the active window.
Ctrl+O	Opens the file opening dialog. Browsing through the file system for an existing device file.
Ctrl+N	Creates a new parameter file file by means of a template.
Ctrl+S	Saves actual loaded parameter file.
F1	Displays the online help information.
F2	Load Device Data
F5	Reloads the displayed data of a device.
Ctrl+F5	Enables automatic refresh.
Ctrl+Shift+T	Back to the navigation window.
Ctrl+F6	Walks through the tabular forms (detail windows).
Page ↑	Previous value (parameter setting).
Page ↓	Next value (parameter setting).

## Smart View

*Smart view* is a parameter setting and evaluation software.

- Menu-controlled parameter setting incl. validity checks
- Offline configuration of all relay types
- Reading and evaluating of statistical data and measuring values
- Setting into operation assistance
- Display of the device status
- Fault analysis via event- and fault recorder

### NOTICE

Smart view 3.0 or higher supports reading parameter files generated by older versions of Smart view. Parameter files generated by Smart view 3.0 and higher cannot be read by older versions of Smart view.

## Installation of Smart View

### NOTICE

Port 52152 must not be blocked by a Firewall

### NOTICE

If the Windows Vista User Access Control pops up while installing Smart view, please "Allow" all installation requirements concerning Smart view.

### *System requirements:*

Windows XP, Windows Vista or Windows 7

- Double-click on the installation file with the left mouse button.
- Select a language for the installation procedure.
- Confirm by pressing the »Continue« button in the INFO frame.
- Select an installation path or confirm the standard installation path by mouse click on the »Continue« button.
- Confirm the entry for the suggested installation folder by mouse click on the »Continue« button.
- By mouse click on the »Install« button, the installation routine is started.
- Close the installation procedure by mouse click on the »Complete« button.

Now you can call up the program via [Start>Programs>Woodward>HighPROTEC>Smart view].

## Deinstalling Smart view

Via the menu [Start>System Control >Software] the Smart view can be removed from your computer.

## Switching the Language of the Graphical User Interface

Within the menu Settings/Language, you can change the language of the graphical user interface.

## Setting up the Connection PC - Device

### Set-up a Connection via Ethernet - TCP/IP

#### **NOTICE**

Establishing a connection via TCP/IP to the device is only possible if your device is equipped with an Ethernet Interface (RJ45).

Contact your IT administrator in order to establish the network connection.

#### *Part 1: Set the TCP/IP Parameters at the panel (Device)*

Call up the menu »Device parameter/TCP/IP« at the HMI (panel) and set the following parameters:

- TCP/IP address
- Subnetmask
- Gateway

#### *Part 2: Setting the IP address within Smart view*

- Call up the menu Settings/Device Connection within Smart view.
- Set radio button Network Connection.
- Enter the IP-Address of the device that should be connected.

## Set up a Connection via Serial Interface under Windows XP

After installation of the software, the »Connection PC/Notebook to the Device« has to be configured once so that you are able to read device data or re-write them into the device by means of the software *Smart view*.

### NOTICE

For connection of your PCs/notebooks with the device, you need a zero-modem cable (no serial cable!/please refer to chapter »Zero Modem Cable«).

### NOTICE

If your PC/notebook does not have a serial interface, you need a special »USB-to-serial-adapter«. Only if the »USB-to-serial-adapter« is correctly installed - aided by the provided CD – the communication with the device can be established. (see next chapter).

### NOTICE

The connection Notebook/PC to the device must not be protected/encrypted via a smartcard.

If the network connection wizard asks you, to encrypt the connection via a smartcard or not, please choose »Do not use the smartcard«.

### Setting up/Configuring the connection

- Connect your PC/notebook with the device via a zero-modem cable.
- Start the software *Smart view*.
- Select the menu point »Device Connection« in menu »Settings«.
- Click on »Serial Connection«.
- Click button »Settings«.
- When initially setting up the connection, a dialogue window appears with the information that, so far, a direct connection with your protection device has not been established. Click on »Yes«.
- If, so far, a location has not been set up on your PC, your location information has to be put in. Confirm the following pop-up window »Telephone and Modem Options« with »OK«.
- The Windows network connection assistant appears after the location information is set up. Select the connection type »Establish direct connection to another computer«.
- Select the serial interface (COM-Port) where the device shall be connected to.
- Select »To be used for all users« in window »Availability of the connection«.
- Do not change the connection name appearing in window »Name of the connection« and click the button »Complete«.
- Finally you arrive again in window »Device Installation« from where you started establishing the connection. Confirm the adjustments by clicking the »OK« button.



## Set up a Connection via Serial Interface under Windows Vista or Windows 7

Establishing the connection between *Smart view* and the device is a three step procedure.

1. Installing *Smart view* (the application itself)
2. Installing a (virtual) modem (that is a precondition for TCP/IP communication via a zero-modem cable)/  
(to be done within the Windows Phone and Modem dialog).
3. Establishing a network connection between *Smart view* and the device  
(to be done within Smart view).

### 1. Installation of *Smart view* (the application itself).

Please see above.

### 2. Installation of the (virtual) modem

- Open the Windows Start menu and type "Phone and Modem" and RETURN. This opens the "Phone and Modem" Dialog
- Go to Tab »Modem«
- Click on the »Add« button
- The Hardware Wizard window Install New Modem pops up
- Set the check box Don't detect my modem; I will select it from a list
- Click on the »Next« button
- Select Communications cable between two computers
- Click on the »Next« button
- Choose the correct COM-Port
- Click on the »Next« button
- Click on the »Finish« button
- Select the new added modem and click on the »Properties« button
- Go to Tab »General«
- Click on the »Change settings« button

- Go to Tab »Modem«
- Set within the Drop-Down Menu the correct baud rate = 115200
- Close this dialog with the »OK« button
- Close the Phone and Modem dialog with the »OK« button
- **You have to reboot your computer now!**

### *3. Establishing a network connection between Smart view and the device*

- Connect the device to the PC/notebook via a **correct Zero-Modem-Cable**.
- Run *Smart view*.
- Call up »Device Connection« within the menu »Device Connection«.
- Click on the »Settings« button.
- A connection wizard will pop up asking you **How do you want to connect**.
- Choose »Dial-up«.
- The Telephone number must not be empty. **Please enter any number** (e.g. 1).
- **Don't care about the username and password**.
- Click on the »OK« button.

## Connected to the Device and Calling up Websites at the same Time

In principle, it is possible to call up websites *while* there is an active connection to the device.

If your computer has no direct connection to the internet, that means, that it is placed behind a proxy server, the device connection has to be modified in certain circumstances. The device connection has to be provided with the proxy settings.

### *Internet Explorer*

For each connection the proxy settings have to be set manually. Please proceed as follows:

- Start your *Internet Explorer*.
- Call up the »Tools« menu.
- Call up the menu »Internet options«.
- Call up the tab »Connections«.
- Click with the left hand mouse key on the button »Settings« on the right of the »HighPROTEC-Device-Connection«.
- Set the check box »Use Proxy Server for this connection.
- Enter the proxy settings that are available by your network administrator.
- Confirm the settings by pressing »OK«.

### *Firefox*

The proxy settings are centrally managed, so there is no need to modify any settings.

## Establishing the Connection via a USB-/RS232-Adapter

If your PC/notebook is not provided with a serial interface, this can be compensated by a special *USB-/RS232-Adapter+Zero Modem-Cable*.

### **NOTICE**

Only an adapter accepted by *Woodward Kempen GmbH* may be used. First install the adapter (with the related driver that you can find on the CD) and then establish the connection (*Smart view => Device*). The adapters must support very high speed.

## Set-up a Connection via Ethernet - TCP/IP



### WARNING

Warning: Mixing up IP-Addresses (In case that there is more than one protective device within the TCP/IP network). Establishing an unintentional wrong connection to a protective device based on a wrong entered IP-Address. Transferring parameters into a wrong protective device might lead to death, personal injury or damage of electrical equipment.

In order to prevent faulty connections the user has to document and maintain a list with the IP addresses of any switchboard/protective device.

The user has to doublecheck the IP addresses of the connection that is to be established. That means, the user must first read out the IP address at the HMI of the device (within menu [Device para/TCP IP] then compare the IP address with the list. If the addresses are identical, establish the connection. If not, DO not connect.

### NOTICE

Establishing a connection via TCP/IP to the device is only possible if your device is equipped with an Ethernet Interface (RJ45).

Contact your IT administrator in order to establish the network connection.

#### *Part 1: Set the TCP/IP Parameters at the panel (Device)*

Call up the menu »Device parameter/TCP/IP« at the HMI (panel) and set the following parameters:

- TCP/IP address
- Subnet mask
- Gateway

#### *Part 2: Setting the IP address within Smart view*

- Call up the menu Settings/Device Connection within Smart view.
- Set radio button Network Connection.
- Enter the IP-Address of the device that should be connected.

## Smart view Troubleshooting during Setting up the Connection

- Make sure whether the Windows service *Telephony* is started. In [Start>System Control >Administration >Services] the service »Telephony« must be visible and must have also been started. If not, the service has to be started.
- For establishing the connection, you need to have sufficient rights (administration rights).
- If a firewall is installed on your computer, TCP/IP port 52152 must have been released.
- If your computer is not provided with a serial interface, you need a *USB-to-serial-adapter*, accepted by *Woodward Kempen GmbH*. This adapter has to be properly installed.
- Ensure that a zero-modem cable is used (a standard serial cable without control wires does not enable communication).

### NOTICE

If the message »Warning, invalid connection settings« appears during establishing the connection, this indicates that the connection adjustments you have chosen are not correct.

On this warning you can react as follows:

»Yes«: (to set up the connection completely new).

By this, all adjustments are cancelled and the connection assistant is opened again for renewed adjustment of the connection to the device.

This procedure is advisable in case basic adjustments cannot be modified via the characteristics dialogue (e.g. if a new additional serial interface has been installed on the system).

»No«: (to modify the existing dial-up network entry).

Opens the dialogue for characteristics of the connection settings. During the dialogue it is possible to correct invalid settings (e.g. the recommended baud rate).

»Cancel«:

The warning is ignored and the connection adjustments remain as they are. This procedure is accepted for a limited time, but in such a case, the user is obliged to establish a correct connection later on.

## Smart view persistent connection problems

In case of persistent connection problems you should remove all connection settings and establish them again afterwards. In order to remove all connection settings please proceed as follows:

### 1. Remove the settings for the Dial-up Network

- Close Smart view
  
- Call up the »Control Panel«
  
- Choose »Network & Internet«
  
- On the left side click on »Manage Network Connections«
- 
- Click on HighPROTEC Direct Connection with the right hand mouse key
- 
- Choose Delete from the shortcut menu
  
- Click on the OK button

### 2. Remove the virtual modem

- Call up the »Control Panel«
  
- Choose »Hardware & Sound«
  
- Choose »Phone & Modem Options«
  
- Go to Tab Modem
  
- Click on the correct (in case there is more than one) entry Connection cable between two computers
  
- Click on the Remove button

## Loading of Device Data when using Smart view

- Starting of the *Smart view*.
- Make sure the connection has been established properly.
- Connect your PC with the device via a *zero-modem cable*.
- Select »Receiving Data From The Device« in menu »Device«.

## Restoring of Device Data when using Smart view



Via the button »Transfer only modified parameters into the device« only modified parameters are transmitted into the device.

Parameter modifications are indicated by a red “star symbol” in front of the parameter.

The star symbol (in the device tree window) indicates that parameters in the opened file (within smart view) differ from parameters stored on your local hard disk.

Via the button »Transfer only modified parameters into the device«, you can transmit all parameters that are marked by this symbol.

If a parameter file is saved on your local hard drive, these parameters are no longer classified to be modified and cannot be transmitted via the button »Transfer only modified parameters into the device«.

In case that you have loaded and modified a parameter file from the device and saved it to your local hard drive without transferring the parameters into the device beforehand, you cannot use the button »Transfer only modified parameters into the device«. In a case like that, use »Transfer all parameters into the device«.

### NOTICE

The button »Transfer only modified parameters into the device« only works if modified parameters are available in the *Smart view*.

In contrast to that, all parameters of the device are transferred when the button »Transfer all parameters into the device« is pressed (provided all device parameters are valid).

- In order to (re-)transfer changed parameters into the device, please select »Transfer all parameters into the device« in menu »Device«.
- Confirm the safety inquiry »Shall the parameters be overwritten into the device?“«.
- Enter the password for setting parameters in the popup window.
- Thereafter the changed data is transferred to the device and adopted.
- Confirm the inquiry »Parameters successfully updated. It is recommended to save the parameters into a local file on your hard drive. Shall The Data Be Saved Locally?“« with »Yes« (recommended). Select a suitable folder on your hard disk.
- Confirm the chosen folder by clicking »Save«.
- The changed parameter data is now saved in the folder chosen by you.



## Backup and Documentation when using Smart view

*How to save device data on a PC:*

Click on »Save as ...« in menu »File«. Specify a name, choose a folder on your hard disk and save the device data accordingly.

## Printing of Device Data When using Smart view (Setting List)

The »Printing menu« offers the following options:

- Printer setting
- Page preview
- Printing
- Export the selected printing range into a txt-file.

The printing menu of the *Smart view* software offers contextual different types of printing ranges.

- *Printing of the complete parameter tree:*  
All values and parameters of the present parameter file are printed.
- *Printing of the displayed working window:*  
Only the data shown on the relevant working window are printed, i.e. this applies, if at least one window is opened.
- *Printing of all opened working windows:*  
The data shown on all windows are printed, i.e. this applies only if more than one window is opened.
- *Printing of the device parameter tree as from a shown position on:*  
All data and parameters of the device parameter tree are printed as from the position/marking in the navigation window. Below this selection the complete name of the marking is additionally displayed.

## Saving Data as a txt-file via Smart view

Within the print menu [File>Print] you can choose »Export into File« in order to export the device data into a text-file.

### NOTICE

Only the actual selected printing range will be exported into a text-file. That means: If you have chosen the "Complete device parameter tree" then the "Complete device parameter tree" will be exported. But, if you have chosen "Actual working window", only this window will be exported.

You can print out operating data but not export them.

### NOTICE

If you export a txt-file, the content of this file is encoded as Unicode. That means that, if you want to edit this file, your application must support Unicode encoded files (e.g. Microsoft Office 2003 or higher).

## Offline Device Planning via Smart view

### **NOTICE**

In order to be able to transmit a parameter file (e.g. offline created) into the device the following issues must comply:

- **Type Code (written on the top of the device/type label) and**
- **Version of the device model (can be found in menu [Device Parameters\Version]).**

The *Smart view* software enables also to parameterize offline. The advantage is: By using device models you can do planning jobs for a device and set parameters in advance.

You can also read the parameter file out of the device, further process it offline (e.g. from your office) and finally re-transfer it to the device.

You can either:

- load an existing parameter file from a device (please refer to chapter [Loading device data when using Smart view]).
- create a new parameter file (see below),
- open a locally saved parameter file (backup).

In order to create a new device/parameter file by way of a device template offline:

- In order to create a new offline parameter file please choose within the »file-menu« »create new parameter file«.
- A working window pops up. Please make sure, that you select the right device type with the correct version and configuration.
- Finally click on »Apply«
- In order to save the device configuration select »Save« out of the »File-Menu«.
- Within the menu »Modify Device Configuration (Typecode)« you can modify the device configuration or simply find out the type code of your current selection.

If you want to transfer the parameter file into a device, please refer to chapter "Restoring of device data when using Smart view".

## Wide Frequency Range

The frequency will be calculated based on the three phase voltages as well as the fourth voltage measuring input.

Some protective elements are using Discrete Fourier Transformation (DFT) in order to extract the fundamentals and phase angles from the measured values. Other protective elements are using True RMS values. For some protective elements, the User can specify if they should work based on DFT or True RMS values.

The calculation of measuring quantities via DFT is very fast. The values are calculated several times per cycle. For some technical reasons, the calculation of DFT values is only possible if the frequency is close to the nominal frequency (+/- 5 Hz). If the frequency is out of the nominal frequency range, the DFT values are no longer precise. That is why protective elements (and directional features), that work based on DFT values, will be blocked either because they are set fixed to DFT or they are set by the User to DFT, as soon as the frequency leaves the nominal range (+/- 5 Hz).

Protective elements, that are working based on True RMS values are able to work in a wide frequency range (5-70 Hz). For technical reasons, the True RMS based calculation of measured values will be done once per cycle. The lower the frequency, the longer the cycle, the slower the calculation will become. That means that the True RMS based calculations will have longer settling times (<2 cycles). This especially applies the lower the frequency is.

The duration of a cycle will be calculated based on the voltage measuring channels. The duration of a cycle for True RMS is possible if the voltage magnitudes exceeds 10 V. In case the cycle duration cannot be determined, the rated frequency will be assumed for DFT and True RMS calculations. As soon as a sufficient magnitude is fed to the relay, the wide frequency range will be activated a few cycles later (after the settling time) if the frequency is out of the nominal range.

$ (f - fN)  < 5 \text{ Hz}$	$ (f - fN)  > 5 \text{ Hz}$
<b>DFT available:</b> The measured values are calculated several times per cycle.	<b>DFT imprecise:</b> Protective elements will be blocked.
<b>True RMS available:</b> The measured values are calculated several times per cycle.	<b>True RMS available 5-70 Hz:</b> Measured values are updated after each cycle.

The dropout ratio is 1 Hz below 5 Hz.

## Measuring Values

### Read out Measured Values

In menu »Operation/Measured Values« both measured and calculated values can be viewed. The measured values are ordered by »Standard values« and »special values« (depending on the type of device).

### Read out of Measured Values via Smart view

- In case *Smart view* is not running – please start it.
- If the device data were not yet loaded – select »Receive Data From The Device« from menu »Device«.
- Double click on icon »Operation« in the navigation tree.
- Double click on icon »Measured Values« within the navigation tree »Operation«.
- Double click the »Standard Values« or special values within the »Measured values«.
- The measured and calculated values are shown now in tabular form on the window.

#### **NOTICE**

To have the measuring data read in a cyclic manner, select »Auto refresh« in menu »View«. The measured values are read out about every two seconds.

### Measurement Display

Menu [Device Para\Measurem Display] offers options to change the display of measured values within the HMI and Smart view.

#### *Scaling of Measured values*

By means of the parameter »Scaling« the user can determine how measured values are to be displayed within the HMI and *Smart view*.

- Primary quantities
- Secondary quantities
- Per Unit quantities

#### *Power Units (applies only for devices with power measurement)*

By means of the parameter »Power Units« the User can determine how measured values are to be displayed within the HMI and *Smart view*.

- Power Auto Scaling
- kW, kVAr or kVA
- MW, MVar or MVA
- GW, GVar or GVA

### *Energy Units (applies only for devices with energy measurement)*

By means of the parameter »*Energy Units*« the User can determine how measured values are to be displayed within the HMI and *Smart view*.

- Energy Auto Scaling
- kWh, kVAh or kVAh
- MWh, MVAh or MVAh
- GWh, GVAh or GVAh

### *Temperature Unit (applies only for devices with temperature measurement)*

By means of the parameter »*Temperatur Unit*« the User can determine how measured values are to be displayed within the HMI and *Smart view*.

- ° Celsius
- ° Fahrenheit

### *Cutoff level*

In order to suppress noise within measured values that are close to zero the user has the option to set cutoff levels. By means of the cutoff levels, measuring quantities that are close to zero will be displayed as zero. These parameters have no impact on recorded values.

## Current - Measured Values

### Current

If the device is not equipped with an voltage measuring card the first measuring input on the first current measuring card (slot with the lowest number) will be used as the reference angle (»IL1«).

<i>Value</i>	<i>Description</i>	<i>Menu path</i>
IL1	Measured value: Phase current (fundamental)	[Operation /Measured values /Current ]
IL2	Measured value: Phase current (fundamental)	[Operation /Measured values /Current ]
IL3	Measured value: Phase current (fundamental)	[Operation /Measured values /Current ]
IG meas	Measured value (measured): IG (fundamental)	[Operation /Measured values /Current ]
IG calc	Measured value (calculated): IG (fundamental)	[Operation /Measured values /Current ]
I0	Measured value (calculated): Zero current (fundamental)	[Operation /Measured values /Current ]
I1	Measured value (calculated): Positive phase sequence current (fundamental)	[Operation /Measured values /Current ]
I2	Measured value (calculated): Unbalanced load current (fundamental)	[Operation /Measured values /Current ]
IL1 H2	Measured value: 2nd harmonic/1st harmonic of IL1	[Operation /Measured values /Current ]
IL2 H2	Measured value: 2nd harmonic/1st harmonic of IL2	[Operation /Measured values /Current ]
IL3 H2	Measured value: 2nd harmonic/1st harmonic of IL3	[Operation /Measured values /Current ]

## Measuring Values

<i>Value</i>	<i>Description</i>	<i>Menu path</i>
IG H2 meas	Measured value: 2nd harmonic/1st harmonic of IG (measured)	[Operation /Measured values /Current ]
IG H2 calc	Measured value (calculated): 2nd harmonic/1st harmonic of IG (calculated)	[Operation /Measured values /Current ]
phi IL1	Measured value (calculated): Angle of Phasor IL1	[Operation /Measured values /Current ]
phi IL2	Measured value (calculated): Angle of Phasor IL2	[Operation /Measured values /Current ]
phi IL3	Measured value (calculated): Angle of Phasor IL3	[Operation /Measured values /Current ]
phi IG meas	Measured value (calculated): Angle of Phasor IG meas	[Operation /Measured values /Current ]
phi IG calc	Measured value (calculated): Angle of Phasor IG calc	[Operation /Measured values /Current ]
phi I0	Measured value (calculated): Angle Zero Sequence System	[Operation /Measured values /Current ]
phi I1	Measured value (calculated): Angle of Positive Sequence System	[Operation /Measured values /Current ]
phi I2	Measured Value (calculated): Angle of Negative Sequence System	[Operation /Measured values /Current ]
IL1 RMS	Measured value: Phase current (RMS)	[Operation /Measured values /Current RMS]
IL2 RMS	Measured value: Phase current (RMS)	[Operation /Measured values /Current RMS]
IL3 RMS	Measured value: Phase current (RMS)	[Operation /Measured values /Current RMS]



## Measuring Values

<i>Value</i>	<i>Description</i>	<i>Menu path</i>
IG meas RMS	Measured value (measured): IG (RMS)	[Operation /Measured values /Current RMS]
IG calc RMS	Measured value (calculated): IG (RMS)	[Operation /Measured values /Current RMS]
%IL1 THD	Measured value (calculated): IL1 Total Harmonic Distortion	[Operation /Measured values /Current RMS]
%IL2 THD	Measured value (calculated): IL2 Total Harmonic Distortion	[Operation /Measured values /Current RMS]
%IL3 THD	Measured value (calculated): IL3 Total Harmonic Distortion	[Operation /Measured values /Current RMS]
IL1 THD	Measured value (calculated): IL1 Total Harmonic Current	[Operation /Measured values /Current RMS]
IL2 THD	Measured value (calculated): IL2 Total Harmonic Current	[Operation /Measured values /Current RMS]
IL3 THD	Measured value (calculated): IL3 Total Harmonic Current	[Operation /Measured values /Current RMS]
%(I2/I1)	Measured value (calculated): I2/I1, phase sequence will be taken into account automatically.	[Operation /Measured values /Current ]

## Voltage - Measured Values

### Voltage

The first measuring input on the first measuring card (slot with the lowest number) is used as the reference angle.  
E.g. » VL 1« respectively » VL 12«.

<i>Value</i>	<i>Description</i>	<i>Menu path</i>
f	Measured value: Frequency	[Operation /Measured values /Voltage ]
VL12	Measured value: Phase-to-phase voltage (fundamental)	[Operation /Measured values /Voltage ]
VL23	Measured value: Phase-to-phase voltage (fundamental)	[Operation /Measured values /Voltage ]
VL31	Measured value: Phase-to-phase voltage (fundamental)	[Operation /Measured values /Voltage ]
VL1	Measured value: Phase-to-neutral voltage (fundamental)	[Operation /Measured values /Voltage ]
VL2	Measured value: Phase-to-neutral voltage (fundamental)	[Operation /Measured values /Voltage ]
VL3	Measured value: Phase-to-neutral voltage (fundamental)	[Operation /Measured values /Voltage ]
VX meas	Measured value (measured): VX measured (fundamental)	[Operation /Measured values /Voltage ]
VG calc	Measured value (calculated): VG (fundamental)	[Operation /Measured values /Voltage ]
V0	Measured value (calculated): Symmetrical components Zero voltage(fundamental)	[Operation /Measured values /Voltage ]
V1	Measured value (calculated): Symmetrical components positive phase sequence voltage(fundamental)	[Operation /Measured values /Voltage ]

## Measuring Values

<i>Value</i>	<i>Description</i>	<i>Menu path</i>
V2	Measured value (calculated): Symmetrical components negative phase sequence voltage(fundamental)	[Operation /Measured values /Voltage ]
VL12 RMS	Measured value: Phase-to-phase voltage (RMS)	[Operation /Measured values /Voltage RMS]
VL23 RMS	Measured value: Phase-to-phase voltage (RMS)	[Operation /Measured values /Voltage RMS]
VL31 RMS	Measured value: Phase-to-phase voltage (RMS)	[Operation /Measured values /Voltage RMS]
VL1 RMS	Measured value: Phase-to-neutral voltage (RMS)	[Operation /Measured values /Voltage RMS]
VL2 RMS	Measured value: Phase-to-neutral voltage (RMS)	[Operation /Measured values /Voltage RMS]
VL3 RMS	Measured value: Phase-to-neutral voltage (RMS)	[Operation /Measured values /Voltage RMS]
VX meas RMS	Measured value (measured): VX measured (RMS)	[Operation /Measured values /Voltage RMS]
VG calc RMS	Measured value (calculated): VG (RMS)	[Operation /Measured values /Voltage RMS]
phi VL12	Measured value (calculated): Angle of Phasor VL12	[Operation /Measured values /Voltage ]
phi VL23	Measured value (calculated): Angle of Phasor VL23	[Operation /Measured values /Voltage ]
phi VL31	Measured value (calculated): Angle of Phasor VL31	[Operation /Measured values /Voltage ]
phi VL1	Measured value (calculated): Angle of Phasor VL1	[Operation /Measured values /Voltage ]

## Measuring Values

Value	Description	Menu path
phi VL2	Measured value (calculated): Angle of Phasor VL2	[Operation /Measured values /Voltage ]
phi VL3	Measured value (calculated): Angle of Phasor VL3	[Operation /Measured values /Voltage ]
phi VX meas	Measured value: Angle of Phasor VX meas	[Operation /Measured values /Voltage ]
phi VG calc	Measured value (calculated): Angle of Phasor VG calc	[Operation /Measured values /Voltage ]
phi V0	Measured value (calculated): Angle Zero Sequence System	[Operation /Measured values /Voltage ]
phi V1	Measured value (calculated): Angle of Positive Sequence System	[Operation /Measured values /Voltage ]
phi V2	Measured Value (calculated): Angle of Negative Sequence System	[Operation /Measured values /Voltage ]
%(V2/V1)	Measured value (calculated): V2/V1, phase sequence will be taken into account automatically.	[Operation /Measured values /Voltage ]
%VL12 THD	Measured value (calculated): V12 Total Harmonic Distortion / Ground wave	[Operation /Measured values /Voltage RMS]
%VL23 THD	Measured value (calculated): V23 Total Harmonic Distortion / Ground wave	[Operation /Measured values /Voltage RMS]
%VL31 THD	Measured value (calculated): V31 Total Harmonic Distortion / Ground wave	[Operation /Measured values /Voltage RMS]
%VL1 THD	Measured value (calculated): VL1 Total Harmonic Distortion / Ground wave	[Operation /Measured values /Voltage RMS]

## Measuring Values

<i>Value</i>	<i>Description</i>	<i>Menu path</i>
%VL2 THD	Measured value (calculated): VL2 Total Harmonic Distortion / Ground wave	[Operation /Measured values /Voltage RMS]
%VL3 THD	Measured value (calculated): VL3 Total Harmonic Distortion / Ground wave	[Operation /Measured values /Voltage RMS]
VL12 THD	Measured value (calculated): V12 Total Harmonic Distortion	[Operation /Measured values /Voltage RMS]
VL23 THD	Measured value (calculated): V23 Total Harmonic Distortion	[Operation /Measured values /Voltage RMS]
VL31 THD	Measured value (calculated): V31 Total Harmonic Distortion	[Operation /Measured values /Voltage RMS]
VL1 THD	Measured value (calculated): VL1 Total Harmonic Distortion	[Operation /Measured values /Voltage RMS]
VL2 THD	Measured value (calculated): VL2 Total Harmonic Distortion	[Operation /Measured values /Voltage RMS]
VL3 THD	Measured value (calculated): VL3 Total Harmonic Distortion	[Operation /Measured values /Voltage RMS]

## Power - Measured Values

<i>Value</i>	<i>Description</i>	<i>Menu path</i>
S	Measured Value (Calculated): Apparent power (fundamental)	[Operation /Measured values /Power]
P	Measured value (calculated): Active power (P- = Fed Active Power, P+ = Consumted Active Power) (fundamental)	[Operation /Measured values /Power]
Q	Measured value (calculated): Reactive power (Q- = Fed Reactive Power, Q+ = Consumted Reactive Power) (fundamental)	[Operation /Measured values /Power]
cos phi	Measured value (calculated): Power factor	[Operation /Measured values /Power]
Wp+	Positive Active Power is consumed active energy	[Operation /Measured values /Energy]
Wp-	Negative Active Power (Fed Energy)	[Operation /Measured values /Energy]
Wq+	Positive Reactive Power is consumed Reactive Energy	[Operation /Measured values /Energy]
Wq-	Negative Reactive Power (Fed Energy)	[Operation /Measured values /Energy]
Ws Net	Absolute Apparent Power Hours	[Operation /Measured values /Energy]
Wp Net	Absolute Active Power Hours	[Operation /Measured values /Energy]
Wq Net	Absolute Reactive Power Hours	[Operation /Measured values /Energy]
Start Date/Time	Energy counters run since... (Date and time of last reset)	[Operation /Measured values /Energy]

## Measuring Values

---

<i>Value</i>	<i>Description</i>	<i>Menu path</i>
S RMS	Measured Value (Calculated): Apparent power (RMS)	[Operation /Measured values /Power RMS]
P RMS	Measured value (calculated): Active power (P- = Fed Active Power, P+ = Consumted Active Power) (RMS)	[Operation /Measured values /Power RMS]
cos phi RMS	Measured value (calculated): Power factor	[Operation /Measured values /Power RMS]
P 1	Measured value (calculated): Active power in positive sequence system (P- = Fed Active Power, P+ = Consumted Active Power)	[Operation /Measured values /Power]
Q 1	Measured value (calculated): Reactive power in positive sequence system (Q- = Fed Reactive Power, Q+ = Consumted Reactive Power)	[Operation /Measured values /Power]

# Energy Counter

PQSCr

## Global Parameters of the Energy Counter Module

Parameter	Description	Setting range	Default	Menu path
 S, P, Q Cutoff Level	The Active/Reactive/Apparent Power shown in the Display or within the PC Software will be displayed as zero, if the absolute value of the corresponding Power falls below this Cutoff Level. This parameter has no impact on recorders.	0.0 - 0.100Sn	0.005Sn	[Device Para /Measurem Display]

## Direct Commands of the Energy Counter Module

Parameter	Description	Setting range	Default	Menu path
 Res all Energy Cr	Reset of all Energy Counters	inactive, active	inactive	[Operation /Reset]

## Signals of the Energy Counter Module (States of the Outputs)

Signal	Description
Cr OfIw Ws Net	Signal: Counter Overflow Ws Net
Cr OfIw Wp Net	Signal: Counter Overflow Wp Net
Cr OfIw Wp+	Signal: Counter Overflow Wp+
Cr OfIw Wp-	Signal: Counter Overflow Wp-
Cr OfIw Wq Net	Signal: Counter Overflow Wq Net
Cr OfIw Wq+	Signal: Counter Overflow Wq+
Cr OfIw Wq-	Signal: Counter Overflow Wq-
Ws Net Res Cr	Signal: Ws Net Reset Counter
Wp Net Res Cr	Signal: Wp Net Reset Counter
Wp+ Res Cr	Signal: Wp+ Reset Counter
Wp- Res Cr	Signal: Wp- Reset Counter
Wq Net Res Cr	Signal: Wq Net Reset Counter
Wq+ Res Cr	Signal: Wq+ Reset Counter
Wq- Res Cr	Signal: Wq- Reset Counter
Res all Energy Cr	Signal: Reset of all Energy Counters
Cr OfIwW Ws Net	Signal: Counter Ws Net will overflow soon



## Energy Counter

---

<i>Signal</i>	<i>Description</i>
Cr OfWw Wp Net	Signal: Counter Wp Net will overflow soon
Cr OfWw Wp+	Signal: Counter Wp+ will overflow soon
Cr OfWw Wp-	Signal: Counter Wp- will overflow soon
Cr OfWw Wq Net	Signal: Counter Wq Net will overflow soon
Cr OfWw Wq+	Signal: Counter Wq+ will overflow soon
Cr OfWw Wq-	Signal: Counter Wq- will overflow soon

# Statistics

## Statistics

In menu »*Operation/Statistics*« the min., max. and mean values of the measured and calculated measured quantities can be found.

## Configuration of the Minimum and Maximum Values

The calculation of the minimum and maximum values will be started:

- When a Reset signal becomes active (Min-/Max)
- When the device is restarted
- After configuration

<i>Minimum and Maximum Values (Peak Values/Pointers)</i>		
	<b>Time interval for the calculation of the minimum and maximum values</b>	<b>Reset</b>
<i>Configuration Options</i>  Where to configure? Within menu [Device Para\ Statistics\ Min/Max]	The minimum and maximum values will be resetted with the rising edge of the corresponding reset signal.	Res Min  Res Max  (e.g. via digital Inputs). These signals will reset the minimum and maximum pointers.
<i>Display of Minimum Values</i>	Where? Within menu [Operation\Statistics\Min]	
<i>Display of Maximum Values</i>	Where? Within menu [Operation\Statistics\Max]	

## Configuration of the Average Value Calculation

### Configuration of the Current Based Average Value Calculation\*

\*=Availability depends on the ordered device code.

<b>Current based Average Values and Peak Values</b>			
	<b>Time period for the calculation of the average and peak values</b>	<b>Start options</b>	<b>Reset of the average and peak values</b>
<b>Configuration Options</b> Where to configure? In [Device Para\ Statistics\ Demand\ Current Demand]	sliding: (sliding: average calculation based on sliding period)  fixed: (fixed: Average calculation is resetted by the end of the period, that means with the next starting period)	duration: (fixed or sliding period)  Start Fct: (The average values are calculated based on the time period between two rising edges of this signal)	Res Fc  (e.g. via Digital Input in order to reset the average values in advance (before the next rising edge of the start signal). This applies to option „Start FC“ only.
<i>Trip (command) option to limit the average current demand: Yes</i>	Please refer to chapter „System Alarms“		
<i>View average values and peak values</i>	Where? Within menu [Operation\Statistics\Demand]		

### Configuration of the Voltage Based Average Value Calculation\*

\*=Availability depends on the ordered device code.





<b>Voltage based Average Values</b>			
	<b>Time period for the calculation of the average values</b>	<b>Start options</b>	<b>Reset of the average and peak values</b>
<b>Configuration Options</b> Where to configure? In [Device Para\ Statistics\ Umit]	sliding: (sliding: average calculation based on sliding period)  fixed: (fixed: Average calculation is resetted by the end of the period, that means with the next starting period)	duration: (fixed or sliding period)  Start Fct: (The average values are calculated based on the time period between two rising edges of this signal)	Res Fc  (e.g. via Digital Input in order to reset the average values in advance (before the next rising edge of the start signal). This applies to option „Start FC“ only.
<i>View average values</i>	Where? Within menu [Operation\Statistics\Vavg]		



## Configuration of the Power Based Average Value Calculation\*

\*=Availability depends on the ordered device code.







<i>Power based Average Values (Demand) and Peak Values</i>			
	<b>Time period for the calculation of the average and peak values</b>	<b>Start options</b>	<b>Reset of the average and peak values</b>
<b>Configuration Options</b> Where to configure? In [Device Para\ Statistics\ Bezugsmanagm\ Power Demand]	sliding: (sliding: average calculation based on sliding period)  fixed: (fixed: Average calculation is resetted by the end of the period, that means with the next starting period)	duration: (fixed or sliding period)  Start Fct: (The average values are calculated based on the time period between two rising edges of this signal)	Res Fc (e.g. via Digital Input in order to reset the average values in advance (before the next rising edge of the start signal). This applies to option „Start FC“ only.
<i>Trip (command) option to limit the average power demand: Yes</i>	Please refer to chapter „System Alarms“		
<i>View average values and peak values</i>	Where? Within menu [Operation\Statistics\Demand]		





## Direct Commands





Parameter	Description	Setting range	Default	Menu path
ResFc all 	Resetting of all Statistic values (Current Demand, Power Demand, Min, Max)	inactive, active	inactive	[Operation /Reset]
ResFc Vavg 	Resetting of the sliding average calculation.	inactive, active	inactive	[Operation /Reset]
ResFc I Demand 	Resetting of Statistics - Current Demand (avg, peak avg)	inactive, active	inactive	[Operation /Reset]
ResFc P Demand 	Resetting of Statistics - Power Demand (avg, peak avg)	inactive, active	inactive	[Operation /Reset]



Parameter	Description	Setting range	Default	Menu path
ResFc Min 	Resetting of all Minimum values	inactive, active	inactive	[Operation /Reset]
ResFc Max 	Resetting of all Maximum values	inactive, active	inactive	[Operation /Reset]

### Global Protection Parameters of the Statistics Module

Parameter	Description	Setting range	Default	Menu path
ResFc Max 	Resetting of all Maximum values	1..n, Assignment List	-.-	[Device Para /Statistics /Min / Max]
ResFc Min 	Resetting of all Minimum values	1..n, Assignment List	-.-	[Device Para /Statistics /Min / Max]
Min Max Definition 	Definition of the time base that is used for calculating the minimum and maximum values.	Sliding window, Peak values	Sliding window	[Device Para /Statistics /Min / Max]
Start Vavg via: 	Start sliding average supervision by:	Duration, StartFct	Duration	[Device Para /Statistics /Vavg]
Start Vavg Fc 	Start of the calculation, if the assigned signal becomes true.  Only available if: Start P Demand via: = StartFct	1..n, Assignment List	-.-	[Device Para /Statistics /Vavg]
ResFc Vavg 	Resetting of the sliding average calculation.	1..n, Assignment List	-.-	[Device Para /Statistics /Vavg]

Parameter	Description	Setting range	Default	Menu path
 Duration Vavg	Recording time	2 s, 5 s, 10 s, 15 s, 30 s, 1 min, 5 min, 10 min, 15 min, 30 min, 1 h, 2 h, 6 h, 12 h, 1 d, 2 d, 5 d, 7 d, 10 d, 30 d	10 min	[Device Para /Statistics /Vavg]
 Window Vavg	Window configuration	sliding, fixed	sliding	[Device Para /Statistics /Vavg]
 Start I Demand via:	Start Current demand by:	Duration, StartFct	Duration	[Device Para /Statistics /Demand /Current Demand]
 Start I Demand Fc	Start of the calculation, if the assigned signal becomes true.  Only available if: Start I Demand via: = StartFct	1..n, Assignment List	--	[Device Para /Statistics /Demand /Current Demand]
 ResFc I Demand	Resetting of Statistics - Current Demand (avg, peak avg)	1..n, Assignment List	--	[Device Para /Statistics /Demand /Current Demand]

Parameter	Description	Setting range	Default	Menu path
 Duration I Demand	Recording time  Only available if: Start I Demand via: = Duration	2 s, 5 s, 10 s, 15 s, 30 s, 1 min, 5 min, 10 min, 15 min, 30 min, 1 h, 2 h, 6 h, 12 h, 1 d, 2 d, 5 d, 7 d, 10 d, 30 d	15 s	[Device Para /Statistics /Demand /Current Demand]
 Window I Demand	Window configuration	sliding, fixed	sliding	[Device Para /Statistics /Demand /Current Demand]
 Start P Demand via:	Start Active Power demand by:	Duration, StartFct	Duration	[Device Para /Statistics /Demand /Power Demand]
 Start P Demand Fc	Start of the calculation, if the assigned signal becomes true.  Only available if: Start P Demand via: = StartFct	1..n, Assignment List	--	[Device Para /Statistics /Demand /Power Demand]
 ResFc P Demand	Resetting of Statistics - Power Demand (avg, peak avg)	1..n, Assignment List	--	[Device Para /Statistics /Demand /Power Demand]

<i>Parameter</i>	<i>Description</i>	<i>Setting range</i>	<i>Default</i>	<i>Menu path</i>
 Duration P Demand	Recording time  Only available if: Start P Demand via: = Duration	2 s, 5 s, 10 s, 15 s, 30 s, 1 min, 5 min, 10 min, 15 min, 30 min, 1 h, 2 h, 6 h, 12 h, 1 d, 2 d, 5 d, 7 d, 10 d, 30 d	15 s	[Device Para /Statistics /Demand /Power Demand]
 Window P Demand	Window configuration	sliding, fixed	sliding	[Device Para /Statistics /Demand /Power Demand]



## States of the Inputs of the Statistics Module

<i>Name</i>	<i>Description</i>	<i>Assignment via</i>
StartFc 3-l	State of the module input: (StartFunc3_h)	[Device Para /Statistics /Vavg]
StartFc 1-l	State of the module input: Start of Statistics 1	[Device Para /Statistics /Demand /Current Demand]
StartFc 2-l	State of the module input: Start of Statistics 2	[Device Para /Statistics /Demand /Power Demand]
ResFc Vavg-l	State of the module input: Resetting of the sliding average calculation.	[Device Para /Statistics /Vavg]
ResFc I Demand-l	State of the module input: Resetting of Statistics - Current Demand (avg, peak avg)	[Device Para /Statistics /Demand /Current Demand]
ResFc P Demand-l	State of the module input: Resetting of Statistics - Power Demand (avg, peak avg)	[Device Para /Statistics /Demand /Power Demand]
ResFc Max-l	State of the module input: Resetting of all Maximum values	[Device Para /Statistics /Min / Max]
ResFc Min-l	State of the module input: Resetting of all Minimum values	[Device Para /Statistics /Min / Max]

## Signals of the Statistics Module

<i>Signal</i>	<i>Description</i>
ResFc all	Signal: Resetting of all Statistic values (Current Demand, Power Demand, Min, Max)
ResFc Vavg	Signal: Resetting of the sliding average calculation.
ResFc I Demand	Signal: Resetting of Statistics - Current Demand (avg, peak avg)
ResFc P Demand	Signal: Resetting of Statistics - Power Demand (avg, peak avg)
ResFc Max	Signal: Resetting of all Maximum values

<i>Signal</i>	<i>Description</i>
ResFc Min	Signal: Resetting of all Minimum values

### Counters of the Module Statistics

<i>Value</i>	<i>Description</i>	<i>Menu path</i>
Res Cr Vavg	Number of resets since last booting. The timestamp shows date and time of the last reset.	[Operation /Statistics /Vavg]
Res Cr I Demand	Number of resets since last booting. The timestamp shows date and time of the last reset.	[Operation /Statistics /Demand /Current Demand]
Res Cr P Demand	Number of resets since last booting. The timestamp shows date and time of the last reset.	[Operation /Statistics /Demand /Power Demand]
Res Cr Min values	Number of resets since last booting. The timestamp shows date and time of the last reset.	[Operation /Statistics /Min /Power]
Res Cr Max values	Number of resets since last booting. The timestamp shows date and time of the last reset.	[Operation /Statistics /Max /Power]

**Current - Statistic Values**

<i>Value</i>	<i>Description</i>	<i>Menu path</i>
I1 max	Maximum value positive phase sequence current (fundamental)	[Operation /Statistics /Max /Current]
I1 min	Minimum value positive phase sequence current (fundamental)	[Operation /Statistics /Min /Current]
I2 max	Maximum value unbalanced load (fundamental)	[Operation /Statistics /Max /Current]
I2 min	Minimum value unbalanced load current (fundamental)	[Operation /Statistics /Min /Current]
IL1 H2 max	Maximum ratio of 2nd harmonic over fundamental of IL1	[Operation /Statistics /Max /Current]
IL1 H2 min	Minimum ratio of 2nd harmonic over fundamental of IL1	[Operation /Statistics /Min /Current]
IL2 H2 max	Maximum ratio of 2nd harmonic over fundamental of IL2	[Operation /Statistics /Max /Current]
IL2 H2 min	Minimum ratio of 2nd harmonic over fundamental of IL2	[Operation /Statistics /Min /Current]
IL3 H2 max	Maximum ratio of 2nd harmonic over fundamental of IL3	[Operation /Statistics /Max /Current]

<i>Value</i>	<i>Description</i>	<i>Menu path</i>
IL3 H2 min	Minimum ratio of 2nd harmonic/1st harmonic minimum value of IL3	[Operation /Statistics /Min /Current]
IG H2 meas max	Measured value: Maximum ratio of 2nd harmonic over fundamental of IG (measured)	[Operation /Statistics /Max /Current]
IG H2 meas min	Measured value: Minimum ratio of 2nd harmonic over fundamental of IG (measured)	[Operation /Statistics /Min /Current]
IG H2 calc max	Measured value (calculated): Maximum ratio of 2nd harmonic over fundamental of IG (calculated)	[Operation /Statistics /Max /Current]
IG H2 calc min	IG H2 calc min	[Operation /Statistics /Min /Current]
IL1 max RMS	IL1 maximum value (RMS)	[Operation /Statistics /Max /Current]
IL1 avg RMS	IL1 average value (RMS)	[Operation /Statistics /Demand /Current Demand]
IL1 min RMS	IL1 minimum value (RMS)	[Operation /Statistics /Min /Current]
IL2 max RMS	IL2 maximum value (RMS)	[Operation /Statistics /Max /Current]

<i>Value</i>	<i>Description</i>	<i>Menu path</i>
IL2 avg RMS	IL2 average value (RMS)	[Operation /Statistics /Demand /Current Demand]
IL2 min RMS	IL2 minimum value (RMS)	[Operation /Statistics /Min /Current]
IL3 max RMS	IL3 maximum value (RMS)	[Operation /Statistics /Max /Current]
IL3 avg RMS	IL3 average value (RMS)	[Operation /Statistics /Demand /Current Demand]
IL3 min RMS	IL3 minimum value (RMS)	[Operation /Statistics /Min /Current]
IG meas max RMS	Measured value: IG maximum value (RMS)	[Operation /Statistics /Max /Current]
IG meas min RMS	Measured value: IG minimum value (RMS)	[Operation /Statistics /Min /Current]
IG calc max RMS	Measured value (calculated):IG maximum value (RMS)	[Operation /Statistics /Max /Current]
IG calc min RMS	Measured value (calculated):IG minimum value (RMS)	[Operation /Statistics /Min /Current]

<i>Value</i>	<i>Description</i>	<i>Menu path</i>
%(I2/I1) max	Measured value (calculated): I2/I1 maximum value, phase sequence will be taken into account automatically	[Operation /Statistics /Max /Current]
%(I2/I1) min	Measured value (calculated): I2/I1 minimum value, phase sequence will be taken into account automatically	[Operation /Statistics /Min /Current]
IL1 Peak demand	IL1 Peak value, RMS value	[Operation /Statistics /Demand /Current Demand]
IL2 Peak demand	IL2 Peak value, RMS value	[Operation /Statistics /Demand /Current Demand]
IL3 Peak demand	IL3 Peak value, RMS value	[Operation /Statistics /Demand /Current Demand]

**Voltage - Statistic Values**

<i>Value</i>	<i>Description</i>	<i>Menu path</i>
f max	Max. frequency value	[Operation /Statistics /Max /Voltage]
f min	Min. frequency value	[Operation /Statistics /Min /Voltage]
V1 max	Maximum value: Symmetrical components positive phase sequence voltage(fundamental)	[Operation /Statistics /Max /Voltage]
V1 min	Minimum value: Symmetrical components positive phase sequence voltage(fundamental)	[Operation /Statistics /Min /Voltage]
V2 max	Maximum value: Symmetrical components negative phase sequence voltage(fundamental)	[Operation /Statistics /Max /Voltage]
V2 min	Minimum value: Symmetrical components negative phase sequence voltage(fundamental)	[Operation /Statistics /Min /Voltage]
VL12 max RMS	VL12 maximum value (RMS)	[Operation /Statistics /Max /Voltage]
VL12 avg RMS	VL12 average value (RMS)	[Operation /Statistics /Avg]
VL12 min RMS	VL12 minimum value (RMS)	[Operation /Statistics /Min /Voltage]

<i>Value</i>	<i>Description</i>	<i>Menu path</i>
VL23 max RMS	VL23 maximum value (RMS)	[Operation /Statistics /Max /Voltage]
VL23 avg RMS	VL23 average value (RMS)	[Operation /Statistics /Avg]
VL23 min RMS	VL23 minimum value (RMS)	[Operation /Statistics /Min /Voltage]
VL31 max RMS	VL31 maximum value (RMS)	[Operation /Statistics /Max /Voltage]
VL31 avg RMS	VL31 average value (RMS)	[Operation /Statistics /Avg]
VL31 min RMS	VL31 minimum value (RMS)	[Operation /Statistics /Min /Voltage]
VL1 max RMS	VL1 maximum value (RMS)	[Operation /Statistics /Max /Voltage]
VL1 avg RMS	VL1 average value (RMS)	[Operation /Statistics /Avg]
VL1 min RMS	VL1 minimum value (RMS)	[Operation /Statistics /Min /Voltage]
VL2 max RMS	VL2 maximum value (RMS)	[Operation /Statistics /Max /Voltage]



<i>Value</i>	<i>Description</i>	<i>Menu path</i>
VL2 avg RMS	VL2 average value (RMS)	[Operation /Statistics /Vavg]
VL2 min RMS	VL2 minimum value (RMS)	[Operation /Statistics /Min /Voltage]
VL3 max RMS	VL3 maximum value (RMS)	[Operation /Statistics /Max /Voltage]
VL3 avg RMS	VL3 average value (RMS)	[Operation /Statistics /Vavg]
VL3 min RMS	VL3 minimum value (RMS)	[Operation /Statistics /Min /Voltage]
VX meas max RMS	Measured value: VX maximum value (RMS)	[Operation /Statistics /Max /Voltage]
VX meas min RMS	Measured value: VX minimum value (RMS)	[Operation /Statistics /Min /Voltage]
VG calc max RMS	Measured value (calculated):VX maximum value (RMS)	[Operation /Statistics /Max /Voltage]
VG calc min RMS	Measured value (calculated):VX minimum value (RMS)	[Operation /Statistics /Min /Voltage]
%(V2/V1) max	Measured value (calculated):V2/V1 maximum value, phase sequence will be taken into account automatically	[Operation /Statistics /Max /Voltage]

## Statistics

---

<i>Value</i>	<i>Description</i>	<i>Menu path</i>
%(V2/V1) min	Measured value (calculated):V2/V1 minimum value , phase sequence will be taken into account automatically	[Operation /Statistics /Min /Voltage]

**Power - Statistic Values**

<i>Value</i>	<i>Description</i>	<i>Menu path</i>
cos phi max	Maximum value of the power factor	[Operation /Statistics /Max /Power]
cos phi min	Minimum value of the power factor	[Operation /Statistics /Min /Power]
S max	Maximum value of the apparent power	[Operation /Statistics /Max /Power]
S avg	Average of the apparent power	[Operation /Statistics /Demand /Power Demand]
S min	Minimum value of the apparent power	[Operation /Statistics /Min /Power]
P max	Maximum value of the active power	[Operation /Statistics /Max /Power]
P avg	Average of the active power	[Operation /Statistics /Demand /Power Demand]
P min	Minimum value of the active power	[Operation /Statistics /Min /Power]
Q max	Maximum value of the reactive power	[Operation /Statistics /Max /Power]

<i>Value</i>	<i>Description</i>	<i>Menu path</i>
Q avg	Average of the reactive power	[Operation /Statistics /Demand /Power Demand]
Q min	Minimum value of the reactive power	[Operation /Statistics /Min /Power]
cos phi max RMS	Maximum value of the power factor	[Operation /Statistics /Max /Power]
cos phi min RMS	Minimum value of the power factor	[Operation /Statistics /Min /Power]
VA Peak demand	VA Peak value, RMS value	[Operation /Statistics /Demand /Power Demand]
Watt Peak demand	WATTS Peak value, RMS value	[Operation /Statistics /Demand /Power Demand]
VAr Peak demand	VARs Peak value, RMS value	[Operation /Statistics /Demand /Power Demand]

## System Alarms

Available Elements:

SysA

Within the System Alarms menu [SysA] the User can configure:

- General Settings (activate/inactivate the Demand Management, optional assign a signal, that will block the Demand Management);
- Power Protection (Peak values);
- Demand Management (Power and Current); and
- THD Protection.

Please note, that all thresholds are to be set as primary values.

### Demand Management

Demand is the average of system current or power over a time interval (window). Demand management supports the User to keep energy demand below target values bound by contract (with the energy supplier). If the contractual target values are exceeded, extra charges are to be paid to the energy supplier.

Therefore, demand management helps the User detect and avoid averaged peak loads that are taken into account for the billing. In order to reduce the demand charge respective to demand rate, peak loads, if possible, should be diversified. That means, if possible, avoiding large loads at the same time. In order to assist the User in analyzing the demand, demand management might inform the User by an alarm. The User might also use demand alarms and assign them on relays in order to perform load shedding (where applicable).

Demand management comprises:

- Power Demand
  - Watt Demand (Active Power);
  - VAr Demand (Reactive Power);
  - VA Demand (Apparent Power); and
- Current Demand.

### Configuring the Demand

Configuring the demand is a two step procedure. Proceed as follows.

Step1: Configure the general settings within the [Device Para/Statistics/Demand] menu:

- Set the trigger source to »Duration«.
- Select a time base for the »window«.
- Determine if the window is »fixed« or »sliding«.
- If applicable assign a reset signal.

The interval time (window) can be set to fixed or sliding.

**Example for a fixed window:** If the range is set for 15 minutes, the protective device calculates the average current or power over the past 15 minutes and updates the value every 15 minutes.

**Example for a sliding window:** If the sliding window is selected and the interval is set to 15 minutes, the protective device calculates and updates the average current or power continuously, for the past 15 minutes (the newest measuring value replaces the oldest measuring value continuously).

**Window configuration = sliding**

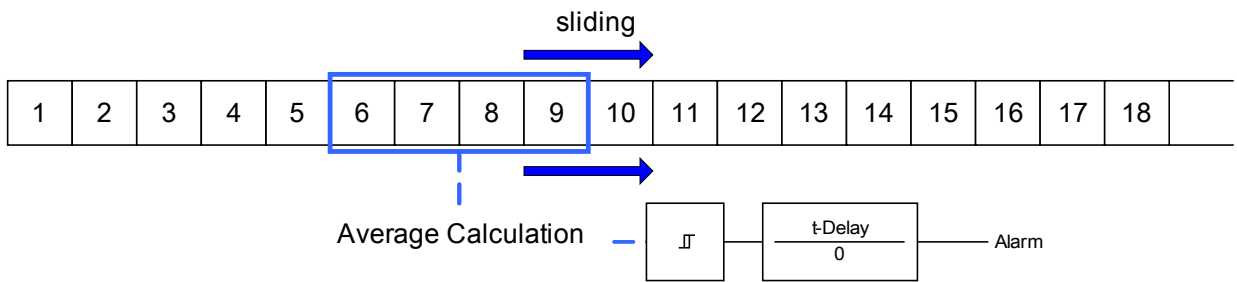
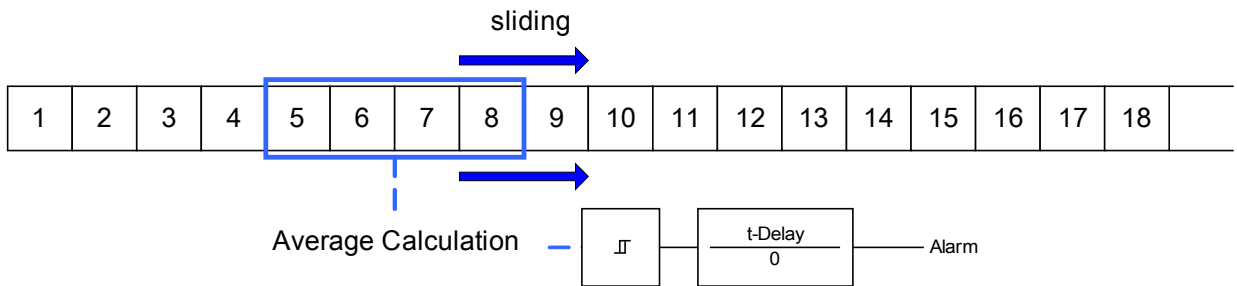
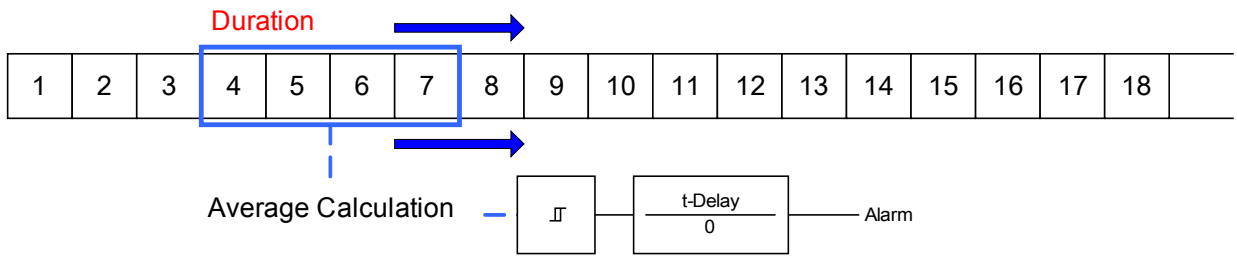

**Window configuration = fixed**

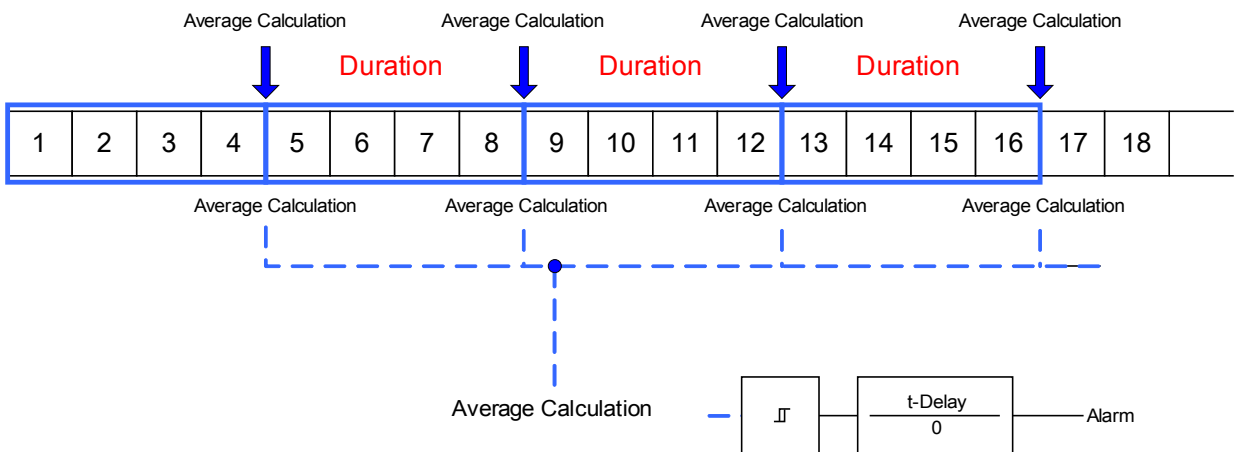

Step 2:

- In addition, the Demand specific settings have to be configured in the [SysA/Demand] menu.
- Determine if the demand should generate an alarm or if it should run in the silent mode. (Alarm active/inactive).
- Set the threshold.
- Where applicable, set a delay time for the alarm.

## Peak Values

The protective device also saves the peak demand values for current and power. The quantities represent the largest demand value since the demand values were last reset. Peak demands for current and system power are date and time stamped.

Within the [Operation/Statistics] menu, the current Demand and Peak demand values can be seen.

## Configuring the Peak Value Supervision

The supervision for the peak values can be configured within menu [SysA/Power] in order to monitor:

- Active Power (Watt),
- Reactive Power (VAr)
- Apparent Power (VA)

The specific settings are to be set within menu [SysA/Power].

- Determine if the peak value supervision should generate an alarm or if it should run in the silent mode. (Alarm active/inactive).
- Set the threshold.
- Where applicable, set a delay time for the alarm.

## Min. and Max. Values.

Within [Operation/Statistics] menu the minimum (min.) and maximum (max.) values can be seen.

**Minimum values since last reset:** The minimum values are continuously compared to the last minimum value for that measuring value. If the new value is less than the last minimum, the value is updated. Within the [Device Para/Statistics/"Min / Max"] menu, a reset signal can be assigned.

**Maximum values since last reset:** The maximum values are continuously compared to the last maximum value for that measuring value. If the new value is greater than the last maximum, the value is updated. Within the [Device Para/Statistics/"Min / Max"] menu, a reset signal can be assigned.



## THD Protection

In order to supervise power quality, the protective device can monitor the voltage (phase-to-phase) and current THDs.

Within the [SysA/THD] menu:

- Determine if an alarm is to be issued or not (Alarm active/inactive);
- Set the threshold; and
- Where applicable, set a delay time for the alarm.

## Device Planning Parameters of the Demand Management

Parameter	Description	Options	Default	Menu path
Mode 	Mode	do not use, use	do not use	[Device planning]

## Signals of the Demand Management (States of the Outputs)

Signal	Description
active	Signal: active
ExBlo	Signal: External Blocking
Alarm Watt Power	Signal: Alarm permitted Active Power exceeded
Alarm VAr Power	Signal: Alarm permitted Reactive Power exceeded
Alarm VA Power	Signal: Alarm permitted Apparent Power exceeded
Alarm Watt Demand	Signal: Alarm averaged Active Power exceeded
Alarm VAr Demand	Signal: Alarm averaged Reactive Power exceeded
Alarm VA Demand	Signal: Alarm averaged Apparent Power exceeded
Alm Current Demd	Signal: Alarm averaged demand current
Alarm I THD	Signal: Alarm Total Harmonic Distortion Current
Alarm V THD	Signal: Alarm Total Harmonic Distortion Voltage
Trip Watt Power	Signal: Trip permitted Active Power exceeded
Trip VAr Power	Signal: Trip permitted Reactive Power exceeded
Trip VA Power	Signal: Trip permitted Apparent Power exceeded
Trip Watt Demand	Signal: Trip averaged Active Power exceeded
Trip VAr Demand	Signal: Trip averaged Reactive Power exceeded
Trip VA Demand	Signal: Trip averaged Apparent Power exceeded
Trip Current Demand	Signal: Trip averaged demand current
Trip I THD	Signal: Trip Total Harmonic Distortion Current
Trip V THD	Signal: Trip Total Harmonic Distortion Voltage











## Global Protection Parameter of the Demand Management

Parameter	Description	Setting range	Default	Menu path
 Function	Permanent activation or deactivation of module/stage.	inactive, active	inactive	[SysA /General settings]
 ExBlo Fc	Activate (allow) or inactivate (disallow) blocking of the module/stage. This parameter is only effective if a signal is assigned to the corresponding global protection parameter. If the signal becomes true, those modules/stages are blocked that are parameterized "ExBlo Fc=active".	1..n, Assignment List	--	[SysA /General settings]
 Alarm	Alarm	inactive, active	inactive	[SysA /Power /Watt]
 Threshold	Threshold (to be entered as primary value)	1 - 40000000kW	10000kW	[SysA /Power /Watt]
 t-Delay	Tripping Delay	0 - 60min	0min	[SysA /Power /Watt]
 Alarm	Alarm	inactive, active	inactive	[SysA /Power /VAr]
 Threshold	Threshold (to be entered as primary value)	1 - 40000000kVAr	10000kVAr	[SysA /Power /VAr]
 t-Delay	Tripping Delay	0 - 60min	0min	[SysA /Power /VAr]
 Alarm	Alarm	inactive, active	inactive	[SysA /Power /VA]

## System Alarms

Parameter	Description	Setting range	Default	Menu path
Threshold 	Threshold (to be entered as primary value)	1 - 40000000kVA	10000kVA	[SysA /Power /VA]
t-Delay 	Tripping Delay	0 - 60min	0min	[SysA /Power /VA]
Alarm 	Alarm	inactive, active	inactive	[SysA /Demand /Power Demand /Watt Demand]
Threshold 	Threshold (to be entered as primary value)	1 - 40000000kW	10000kW	[SysA /Demand /Power Demand /Watt Demand]
t-Delay 	Tripping Delay	0 - 60min	0min	[SysA /Demand /Power Demand /Watt Demand]
Alarm 	Alarm	inactive, active	inactive	[SysA /Demand /Power Demand /VAr Demand]
Threshold 	Threshold (to be entered as primary value)	1 - 40000000kVAr	20000kVAr	[SysA /Demand /Power Demand /VAr Demand]
t-Delay 	Tripping Delay	0 - 60min	0min	[SysA /Demand /Power Demand /VAr Demand]
Alarm 	Alarm	inactive, active	inactive	[SysA /Demand /Power Demand /VA Demand]
Threshold 	Threshold (to be entered as primary value)	1 - 40000000kVA	20000kVA	[SysA /Demand /Power Demand /VA Demand]

## System Alarms

Parameter	Description	Setting range	Default	Menu path
t-Delay 	Tripping Delay	0 - 60min	0min	[SysA /Demand /Power Demand /VA Demand]
Alarm 	Alarm	inactive, active	inactive	[SysA /Demand /Current Demand]
Threshold 	Threshold (to be entered as primary value)	10 - 500000A	500A	[SysA /Demand /Current Demand]
t-Delay 	Tripping Delay	0 - 60min	0min	[SysA /Demand /Current Demand]
Alarm 	Alarm	inactive, active	inactive	[SysA /THD /I THD]
Threshold 	Threshold (to be entered as primary value)	1 - 500000A	500A	[SysA /THD /I THD]
t-Delay 	Tripping Delay	0 - 3600s	0s	[SysA /THD /I THD]
Alarm 	Alarm	inactive, active	inactive	[SysA /THD /V THD]
Threshold 	Threshold (to be entered as primary value)	1 - 500000V	10000V	[SysA /THD /V THD]
t-Delay 	Tripping Delay	0 - 3600s	0s	[SysA /THD /V THD]

## States of the Inputs of the Demand Management

<i>Name</i>	<i>Description</i>	<i>Assignment via</i>
ExBlo-I	Module input state: External blocking	[SysA /General settings]

# Acknowledgments

Collective Acknowledgments for latched signals:

<b>Collective Acknowledgments</b>					
	<i>LEDs</i>	<i>Binary Output Relays</i>	<i>SCADA</i>	<i>Pending Trip Command</i>	<i>LEDs+ Binary Output Relays+ SCADA+ Pending Trip Command</i>
<p>Via <b>Smart view</b> or at the <b>panel all...</b> can be acknowledged.</p> <p>At the panel, the menu [Operation\ Acknowledge] can directly be accessed via the <b>»C«</b> key</p>	<p>All LEDs at once: Where? [Operation\ Acknowledge]</p>	<p>All Binary Output Relays at once: Where? [Operation\ Acknowledge]</p>	<p>All SCADA signals at once: Where? [Operation\ Acknowledge]</p>	<p>All pending trip commands at once: Where? [Operation\ Acknowledge]</p>	<p>All at once: Where? [Operation\ Acknowledge]</p>
<p><b>External Acknowledgment</b> *: Via a signal from the assignment list (e.g. a digital Input) <b>all...</b> can be acknowledged.</p>	<p>All LEDs at once: Where? Within the menu <u>Ex Acknowledge</u></p>	<p>All Binary Output Relays at once: <u>Where? Within the menu Ex Acknowledge</u></p>	<p>All SCADA signals at once: <u>Where? Within the menu Ex Acknowledge</u></p>	<p>All pending trip commands at once: <u>Where? Within the menu Ex Acknowledge</u></p>	

\*The External Acknowledgement might be disabled if parameter **»Ex Ack** «is set to **»inactive«** within menu [Device Para/Ex Acknowledge]. This blocks also the acknowledgement via Communication (e.g. Modbus).

Options for individual acknowledgments for latched signals:

<b>Individual Acknowledgment</b>			
	<i>LEDs</i>	<i>Binary Output Relays</i>	<i>Pending Trip Command</i>
Via a signal from the assignment list (e.g.: a digital Input) a <b>single...</b> can be acknowledged.	<p>Single LED:</p> <p>Where?</p> <p>Within the configuration menu of this single LED.</p>	<p>Binary Output Relay:</p> <p>Where?</p> <p>Within the configuration menu of this single Binary Output Relay.</p>	<p>Pending Trip Command.</p> <p>Where?</p> <p>Within the module <u><i>TripControl</i></u></p>

**NOTICE** As long as you are within the parameter setting mode, you cannot acknowledge.

**NOTICE** In case of a fault during parameter setting via the operating panel, you must first leave the parameter mode by pressing either push-button »C« or »OK« before you may access to menu »Acknowledgments« via push-button.

## Manual Acknowledgment

- Press the C-Button at the panel.
- Select the item to be acknowledged via the Softkeys:
  - Binary output relays,
  - LEDs,
  - SCADA,
  - a pending trip command or
  - all (above) mentioned items at once.
- Press the Softkey with the »Wrench-Symbol«.
- Enter your password.

## Manual Acknowledgment via Smart view

- In case *Smart view* is not running – please start it
- If the device data were not yet loaded – select »Receive Data From The Device« from menu »Device«
- Double click on icon »Operation« in the navigation tree.
- Double click on icon »Acknowledgment« within the operation menu.
- Double click the entry within the popup that is to be acknowledged.
- Press the button »Execute immediately«.
- Enter your password.



## External Acknowledgments

Within the menu [Ex Acknowledge] you can assign a signal (e.g. the state of a digital input) from the assignment list that:

- acknowledges all (acknowledgeable) LEDs at once;
- acknowledges all (acknowledgeable) binary outputs at once:
- acknowledges all (acknowledgeable) SCADA-signals at once.

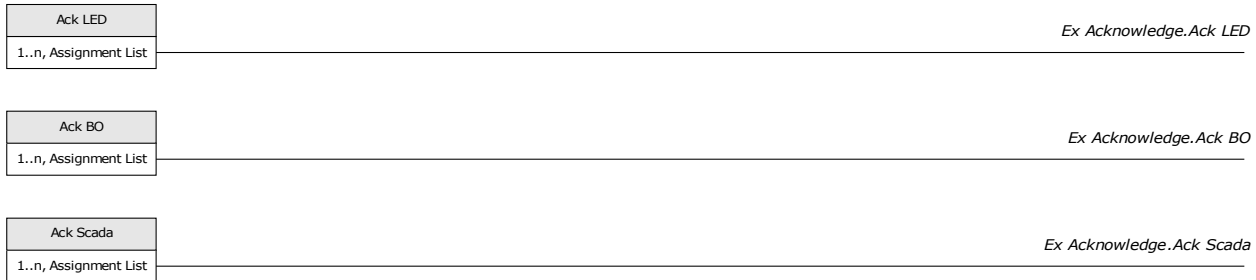

Within the menu [Protection Para\Global Prot Para\TripControl] you can assign a signal that:

- acknowledges a pending trip command.

For details, please refer to chapter » *TripControl*«.

## External Acknowledge via Smart view

In case *Smart view* is not running – please start it.

- If the device data were not yet loaded – select »Receive Data From The Device« from menu »Device«
- Double click on icon »Device Parameter« in the navigation tree
- Double click on icon »Ex Acknowledge« within the operation menu
- In the working window you can assign now each one signal that resets all acknowledgeable LEDs, a signal that resets all binary outputs, a signal that resets the SCADA-signals respectively a signal that acknowledges a pending trip command.

## Manual Resets

In menu »Operation/Reset« you can:

- reset counters,
- delete records (e.g. disturbance records) and
- reset special things (like statistics, thermal replica...).

### NOTICE

The description of the reset commands can be found within the corresponding modules.

## Manual Resets via Smart view

- In case *Smart view* is not running – please start it
- If device data has not been loaded yet – click »Receive Data From The Device« in menu »Device«
- Double click the »Operation« icon in the navigation tree
- Double click the »Reset icon« within the operation menu
- Double click the entry within the popup that is to be reset or deleted.

### NOTICE

The description of the reset commands can be found within the corresponding modules.

## Reset to Factory Defaults

### ⚠ WARNING



This Function will reset the device to the factory defaults.  
All records will be deleted and the measured values and counters will be reset. The operation hours counter will be kept.

This Function is available at the HMI only.

- Press the »C-key« during a cold start, in order to access the »Reset« menu.
- Select »Reset to factory default«.
- Confirm »Reset device to factory defaults and reboot« with »Yes« in order to execute the reset to factory defaults.«

## Status Display

In the status display within the »Operation« menu, the present state of all signals can be viewed. This means the User is able to see if the individual signals are active or inactive at that moment. The User can see all signals sorted by protective elements/modules.

State of the module input/signal is...	Is shown at the panel as...
false / »0«	
true / »1«	

### Status Display via Smart View

- In case *Smart view* is not running – please start it.
- If the device data were not yet loaded – select »Receive Data From The Device« from menu »Device«.
- Double click on icon »Operation« in the navigation tree
- Double click on icon »Status Display« within the operational data
- Double click on a subfolder (e.g. *Prof*) in order to see e.g. the states of the general alarms.

### NOTICE

To have the status display updated in a cyclic manner select »Automatic Up-Date« in menu »VIEW«.

State of the module input/signal is...	Is shown in Smart view as...
false / »0«	0
true / »1«	1
No connection to the device	?

## Operating Panel (HMI)

### HMI



### Special Parameters of the Panel

This menu »Device Parameter/HMI« is used to define the contrast of the display, the maximum admissible edit time and the menu language (after expiry of which, all unsaved parameter changes will be rejected).

### Direct Commands of the Panel

<i>Parameter</i>	<i>Description</i>	<i>Setting range</i>	<i>Default</i>	<i>Menu path</i>
Contrast 	Contrast	30 - 60	50	[Device Para /HMI]

### Global Protection Parameters of the Panel

<i>Parameter</i>	<i>Description</i>	<i>Setting range</i>	<i>Default</i>	<i>Menu path</i>
t-max Edit 	If no other key(s) is pressed at the panel, after expiration of this time, all cached (changed) parameters are canceled.	20 - 3600s	180s	[Device Para /HMI]
Menu language 	Selection of the language	English, German, Russian, Polish, French, Portuguese	English	[Device Para /HMI]

## Recorders

### Disturbance Recorder

Available elements:

Disturb rec

The disturbance recorder works with 32 samples per cycle. The disturbance recorder can be started by one of eight start events (selection from the »assignment list«/OR-Logic). The disturbance record contains the measuring values inclusively pre-trigger-time. By means of *Smart view/Datavisualizer* (option) the oscillographic curves of the analogue (current, voltage) and digital channels/traces can be shown and evaluated in a graphical form. The disturbance recorder has a storage capacity of 120s. The disturbance recorder is able to record up to 10s (adjustable) per record. The amount of records depends on the file size of each record.

The disturbance recorder can be parameterized in the menu »*Device Parameter/Recorder/Disturb rec*«.

Determine the max. recording time to register a disturbance event. The max. total length of a recording is 10s (inclusive pre-trigger and post-trigger time).

To trigger the disturbance recorder, up to 8 signals can be selected from the »assignment list«. The trigger events are OR-linked. If a disturbance record is written, a new disturbance record cannot be triggered until all trigger signals, which have triggered the previous disturbance record, are gone. Recording is only done for the time the assigned event exists (event controlled), plus the time for the pre- and post-trigger, but not longer than 10s. The time for forward run and tracking of the disturbance recorder is shown in percent of the total recording length.

#### **NOTICE**

The post-trigger time will be up to "Post-trigger time" depending on the duration of the trigger signal. The post-trigger will be the remaining time of the "Max file size" but at maximum "Post-trigger time"

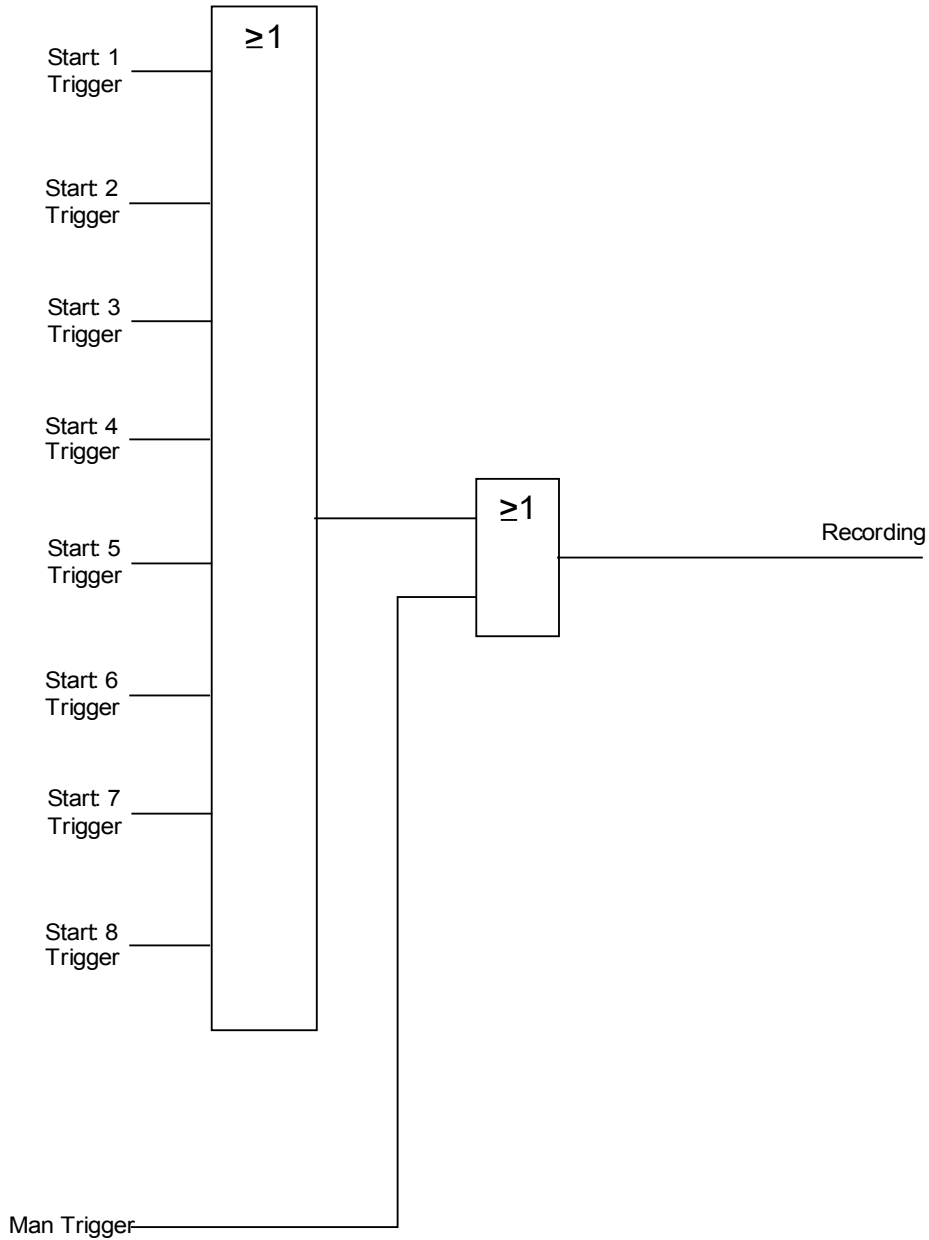

**Example**

The disturbance recorder is started by the general activation facility. After the fault has been cancelled (+ follow-up time), the recording process is stopped (but after 10s at the latest).

The parameter »Auto Delete« defines how the device shall react if there is no saving place available. In case »Auto Delete« is »active«, the first recorded disturbance will be overwritten according to the FIFO principle. If the parameter is set to »inactive«, recording of the disturbance events will be stopped until the storage location is released manually.

Example Disturbance Recorder Timing Chart I

- Start 1 = Prot. Trip
- Start 2 = -.-
- Start 3 = -.-
- Start 4 = -.-
- Start 5 = -.-
- Start 6 = -.-
- Start 7 = -.-
- Start 8 = -.-
- Auto overwriting = active
- Post-trigger time = 25%
- Pre-trigger time = 15%
- Max file size = 2s

**t-rec < Max file size**

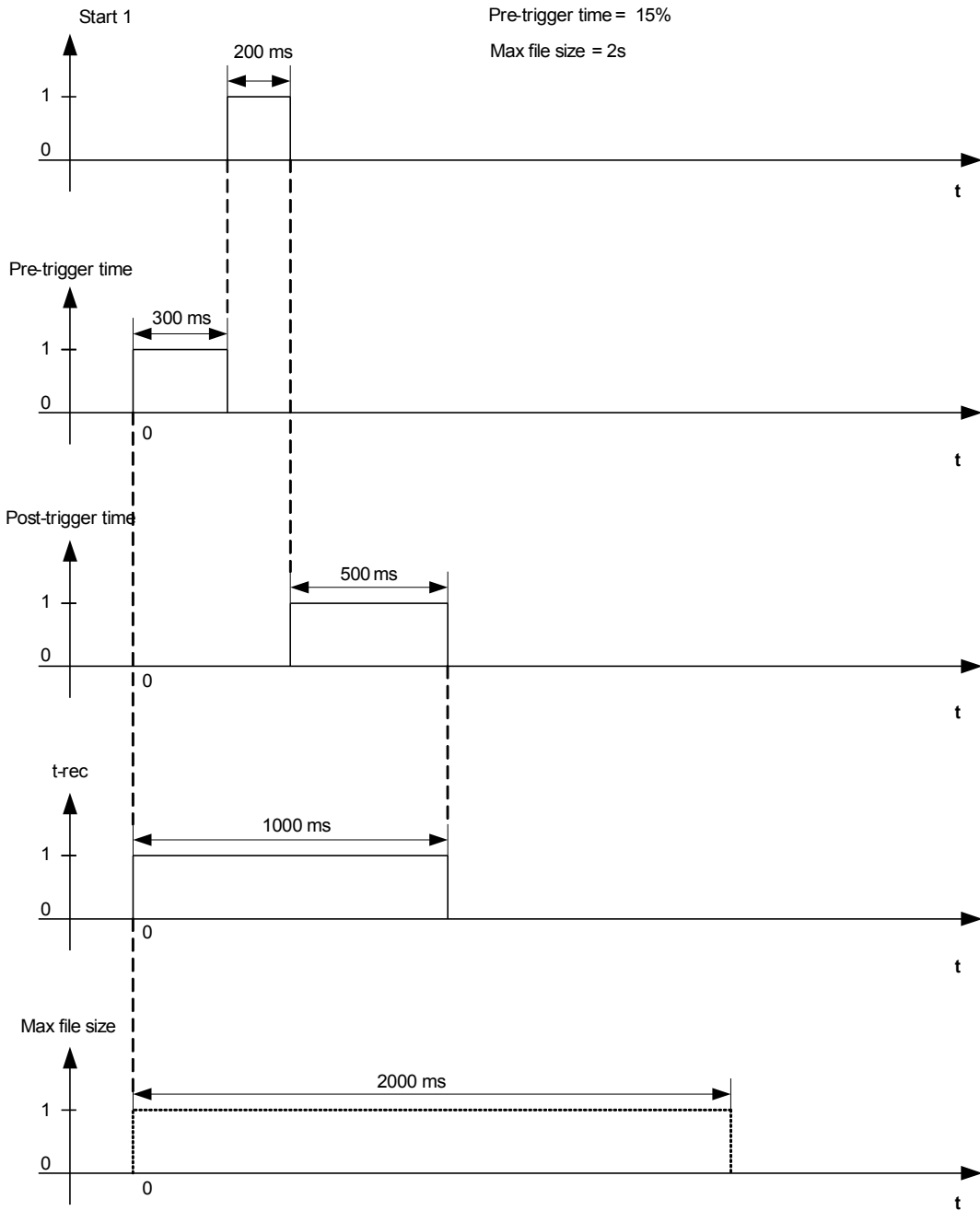

Example Disturbance Recorder Timing Chart II

- Start 1 = Prot.Alarm
- Start 2 = -.-
- Start 3 = -.-
- Start 4 = -.-
- Start 5 = -.-
- Start 6 = -.-
- Start 7 = -.-
- Start 8 = -.-
- Auto overwriting = active
- Post-trigger time = 25%
- Pre-trigger time = 15%
- Max file size = 2s

**t-rec = Max file size**

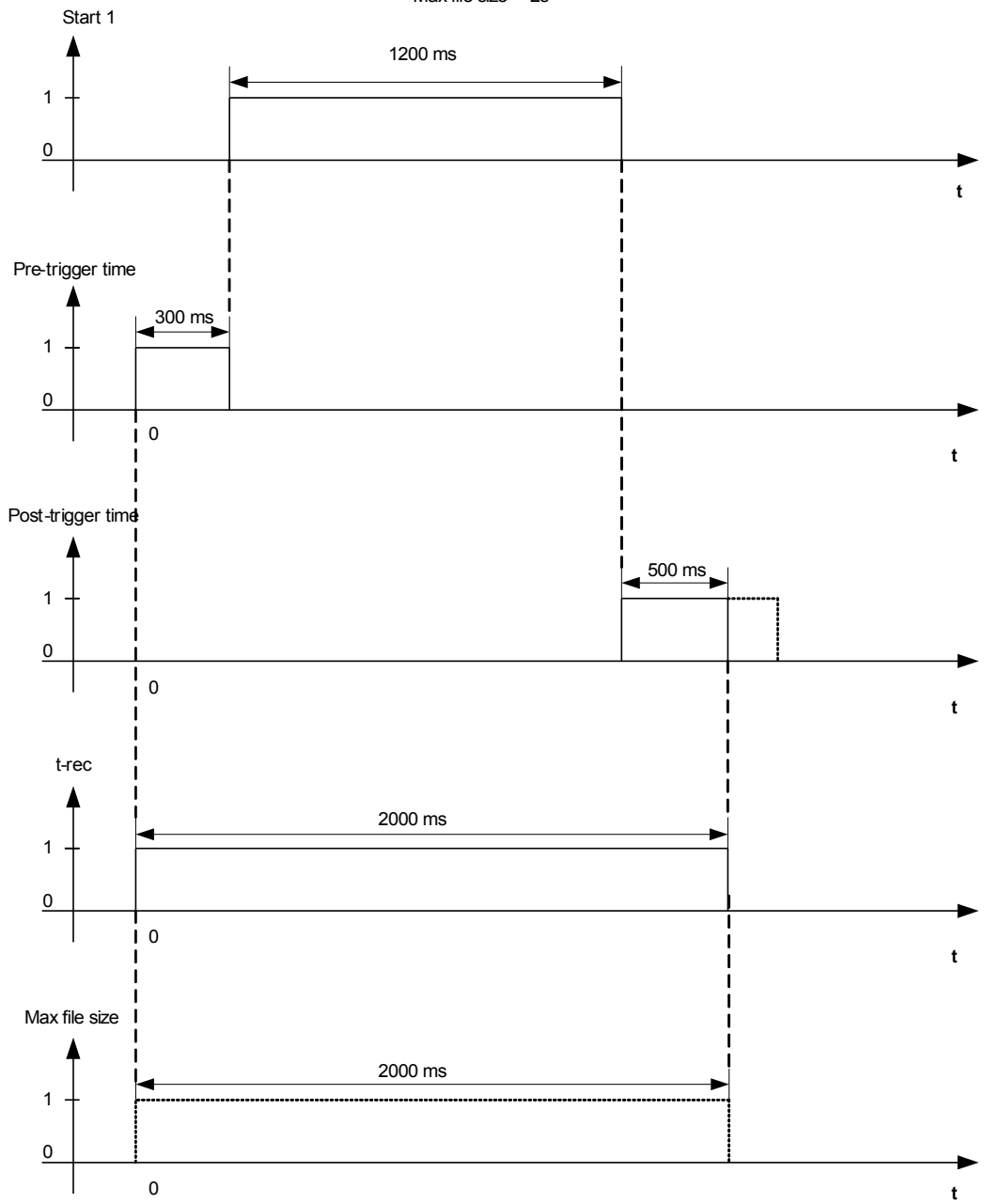



## Read Out Disturbance Records

Within the Menu Operation/Disturb rec you can

- Detect accumulated Disturbance Records.

### **NOTICE**

Within the Menu »Operation/Recorders/Man Trigger« you can trigger the disturbance recorder manually.

## Disturbance Recorder to be Read Out by Smart view

- In case *Smart view* is not running – please start it.
- If device data has not been loaded yet – click »Receive Data From The Device« in menu »Device«.
- Double click the »Operation« icon in the navigation tree.
- Double click the »Recorders« icon in the navigation tree.
- Double click the »Disturb rec-Icon«.
- In the window the disturbance records are shown in tabular form.
- A popup will be appear by a double click onto a disturbance record. Choose a folder where the disturbance record is to be saved to.
- You can analyze the disturbance records by means of the optionally available *Data Visualizer* by clicking on Yes when you are asked "Shall the received disturbance record be opened by the *Data Visualizer*?"

## Deleting Disturbance Records

Within the Menu Operation/Disturb rec you can

- Delete Disturbance Records.
- Choose via »SOFTKEY« »up« and »SOFTKEY« »down« the disturbance record that is to be deleted.
- Call up the detailed view of the disturbance record via »SOFTKEY« »right«.
- Confirm by pressing »SOFTKEY« »delete«
- Enter your password followed by pressing the key »OK«
- Choose whether only the current or whether all disturbance records should be deleted.
- Confirm by pressing »SOFTKEY« »OK«



## Deleting Disturbance Records via Smart view

- In case *Smart view* is not running – please start it.
- If device data has not been loaded yet – click »Receive Data From The Device« in menu »Device«.
- Double click the »Operation« icon in the navigation tree.
- Double click the »Recorders« icon in the navigation tree.
- Double click the »Disturb rec-Icon«.
- In the window the disturbance records are shown in tabular form.
- In order to delete a disturbance record double click on:









(the red x) in front of the disturbance record and confirm.





### Direct Commands of the Disturbance Recorder

Parameter	Description	Setting range	Default	Menu path
Man Trigger 	Manual Trigger	False, True	False	[Operation /Recorders /Man Trigger]
Res all rec 	Reset all records	inactive, active	inactive	[Operation /Reset]

### Global Protection Parameters of the Disturbance Recorder

Parameter	Description	Setting range	Default	Menu path
Start: 1 	Start recording if the assigned signal is true.	1..n, Assignment List	Prot.Alarm	[Device Para /Recorders /Disturb rec]
Start: 2 	Start recording if the assigned signal is true.	1..n, Assignment List	--	[Device Para /Recorders /Disturb rec]
Start: 3 	Start recording if the assigned signal is true.	1..n, Assignment List	--	[Device Para /Recorders /Disturb rec]
Start: 4 	Start recording if the assigned signal is true.	1..n, Assignment List	--	[Device Para /Recorders /Disturb rec]
Start: 5 	Start recording if the assigned signal is true.	1..n, Assignment List	--	[Device Para /Recorders /Disturb rec]
Start: 6 	Start recording if the assigned signal is true.	1..n, Assignment List	--	[Device Para /Recorders /Disturb rec]
Start: 7 	Start recording if the assigned signal is true.	1..n, Assignment List	--	[Device Para /Recorders /Disturb rec]

## Recorders

<i>Parameter</i>	<i>Description</i>	<i>Setting range</i>	<i>Default</i>	<i>Menu path</i>
Start: 8 	Start recording if the assigned signal is true.	1..n, Assignment List	.-	[Device Para /Recorders /Disturb rec]
Auto overwriting 	If there is no more free memory capacity left, the oldest file will be overwritten.	inactive, active	active	[Device Para /Recorders /Disturb rec]
Post-trigger time 	The post trigger time is settable up to a maximum of 50% of the Maximum file size setting. The post-trigger will be the remaining time of the "Max file size" but at maximum "Post-trigger time"	0 - 50%	20%	[Device Para /Recorders /Disturb rec]
Pre-trigger time 	The pre trigger time is settable up to a maximum of 50% of the Maximum file size setting.	0 - 50%	20%	[Device Para /Recorders /Disturb rec]
Max file size 	The maximum storage capacity per record is 10 seconds, including pre-trigger and post-trigger time. The disturbance recorder has a total storage capacity of 120 seconds.	0.1 - 10.0s	2s	[Device Para /Recorders /Disturb rec]

### Disturbance Recorder Input States

<i>Name</i>	<i>Description</i>	<i>Assignment via</i>
Start1-l	State of the module input:: Trigger event / start recording if:	[Device Para /Recorders /Disturb rec]
Start2-l	State of the module input:: Trigger event / start recording if:	[Device Para /Recorders /Disturb rec]
Start3-l	State of the module input:: Trigger event / start recording if:	[Device Para /Recorders /Disturb rec]
Start4-l	State of the module input:: Trigger event / start recording if:	[Device Para /Recorders /Disturb rec]
Start5-l	State of the module input:: Trigger event / start recording if:	[Device Para /Recorders /Disturb rec]
Start6-l	State of the module input:: Trigger event / start recording if:	[Device Para /Recorders /Disturb rec]
Start7-l	State of the module input:: Trigger event / start recording if:	[Device Para /Recorders /Disturb rec]
Start8-l	State of the module input:: Trigger event / start recording if:	[Device Para /Recorders /Disturb rec]

### Disturbance Recorder Signals

<i>Signal</i>	<i>Description</i>
recording	Signal: Recording
memory full	Signal: Memory full
Clear fail	Signal: Clear failure in memory
Res all records	Signal: All records deleted
Res rec	Signal: Delete record
Man Trigger	Signal: Manual Trigger

**Special Parameters of the Disturbance Recorder**

<i>Value</i>	<i>Description</i>	<i>Default</i>	<i>Size</i>	<i>Menu path</i>
Rec state	Recording state	Ready	Ready, Recording, Writing file, Trigger Blo	[Operation /Status display /Recorders /Disturb rec]
Error code	Error code	OK	OK, Write err, Clear fail, Calculation err, File not found, Auto overwriting off	[Operation /Status display /Recorders /Disturb rec]

## Fault Recorder

### Fault rec

The fault recorder can be started by one of eight start events (selection from the »assignment list«/OR-Logic). The fault recorder can register up to 20 faults. The last of the recorded faults is stored in a fail-safe manner.

If one of the assigned trigger events becomes true, the fault recorder will be started. Each fault is saved inclusive module and name, fault number, mains fault number and record number at that time one of the trigger events becomes true. To each of the faults the measuring values (at the time when the trigger event became true) can be viewed.

Up to 8 signals to trigger the fault recorder can be selected from following list. The trigger events are OR-linked.

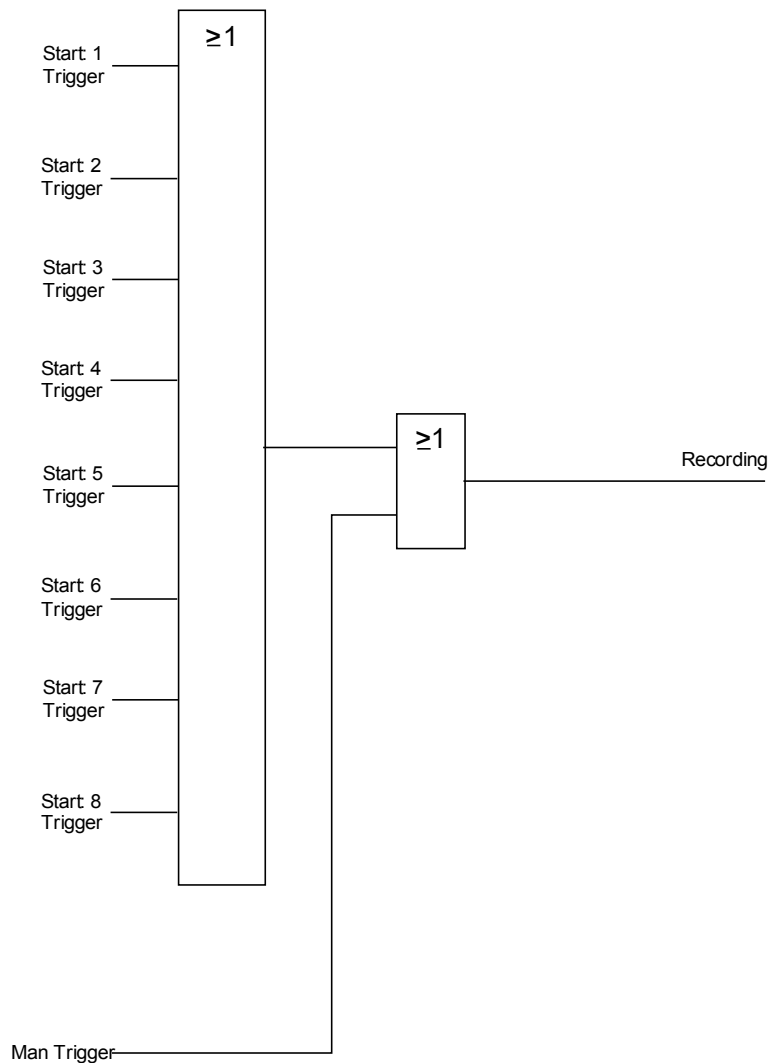

The parameter »Auto Delete« defines how the device shall react if there is no saving place available. In case »Auto Delete« is »active«, the first recorded fault will be overwritten according to the FIFO principle. If the parameter is set to »inactive«, recording of the fault events will be stopped until the storage location is released manually.

## Read Out the Fault Recorder

The measured values at the time of tripping are saved (failure safe) within the fault recorder. If there is no more memory free, the oldest record will be overwritten (FIFO).

In order to read out a failure record:

- call up the main menu,
- call up the submenu Operation/Recorders/Fault rec.,
- select a fault record,
- analyze the corresponding measured values.

## Read Out the Fault Recorder via Smart View

- In case *Smart view* is not running – please start it.
- If device data has not been loaded yet – click »Receive Data From The Device« in menu »Device«.
- Double click the »Operation« icon in the navigation tree.
- Double click the »Fault Rec« icon within the tree »Operation/Recorders«.
- In the window the fault recordings are shown in tabular form.
- In order to receive more detailed information on a fault double click the selected item in the list.



### **NOTICE**

Via the print menu you can export the data into a file. Please proceed as follows:







- Call up the data as described above.
- Call up the menu [File/Print].
- Choose »Print Actual Working Window« within the popup.
- Press the »Print« button.
- Press the »Export to File« button.
- Enter a file name.
- Choose a location where to save the file.
- Confirm the »Save« button.



### Direct Commands of the Fault Recorder



Parameter	Description	Setting range	Default	Menu path
Res all rec 	Reset all records	inactive, active	inactive	[Operation /Reset]
Man Trigger 	Manual Trigger	False, True	False	[Operation /Recorders /Man Trigger]

### Global Protection Parameters of the Fault Recorder

Parameter	Description	Setting range	Default	Menu path
Start: 1 	Start recording if the assigned signal is true.	1..n, Assignment List	Prot.Trip	[Device Para /Recorders /Fault rec]
Start: 2 	Start recording if the assigned signal is true.	1..n, Assignment List	--	[Device Para /Recorders /Fault rec]
Start: 3 	Start recording if the assigned signal is true.	1..n, Assignment List	--	[Device Para /Recorders /Fault rec]
Start: 4 	Start recording if the assigned signal is true.	1..n, Assignment List	--	[Device Para /Recorders /Fault rec]
Start: 5 	Start recording if the assigned signal is true.	1..n, Assignment List	--	[Device Para /Recorders /Fault rec]
Start: 6 	Start recording if the assigned signal is true.	1..n, Assignment List	--	[Device Para /Recorders /Fault rec]
Start: 7 	Start recording if the assigned signal is true.	1..n, Assignment List	--	[Device Para /Recorders /Fault rec]

## Recorders

---

<i>Parameter</i>	<i>Description</i>	<i>Setting range</i>	<i>Default</i>	<i>Menu path</i>
Start: 8 	Start recording if the assigned signal is true.	1..n, Assignment List	.-.	[Device Para /Recorders /Fault rec]
Auto overwriting 	If there is no more free memory capacity left, the oldest file will be overwritten.	inactive, active	active	[Device Para /Recorders /Fault rec]

### Fault Recorder Input States

<i>Name</i>	<i>Description</i>	<i>Assignment via</i>
Start1-l	State of the module input:: Trigger event / start recording if:	[Device Para /Recorders /Fault rec]
Start2-l	State of the module input:: Trigger event / start recording if:	[Device Para /Recorders /Fault rec]
Start3-l	State of the module input:: Trigger event / start recording if:	[Device Para /Recorders /Fault rec]
Start4-l	State of the module input:: Trigger event / start recording if:	[Device Para /Recorders /Fault rec]
Start5-l	State of the module input:: Trigger event / start recording if:	[Device Para /Recorders /Fault rec]
Start6-l	State of the module input:: Trigger event / start recording if:	[Device Para /Recorders /Fault rec]
Start7-l	State of the module input:: Trigger event / start recording if:	[Device Para /Recorders /Fault rec]
Start8-l	State of the module input:: Trigger event / start recording if:	[Device Para /Recorders /Fault rec]

### Fault Recorder Signals

<i>Signal</i>	<i>Description</i>
Res rec	Signal: Delete record
Man Trigger	Signal: Manual Trigger

## Trend Recorder

Available Elements:

Trend rec

### Functional Description

The Trend Data are data points stored by the Trend Recorder on the relay device over fixed intervals of time, and can be downloaded from the device using *Smart view*. A Trend Record is viewable using the *Data Visualizer* software by selecting files saved by *Smart view* with a file extension of “.ErTr”. The list of available trend recorder data is viewable by selecting [Operation/Recorders/Trend Recorder].

When viewed within the *Data Visualizer*, the trend record will show the observed values (up to 10) that the User has specified. The values available in the Trend Recorder depend on the type of the connected device and the configuration of the Trend Recorder.

### Managing Trend Records

To download information from the Trend Recorder, select [Operation/Recorder/Trend Rec] from the menu tree. The User will find three options within the Trend Recorder window that will allow the User to:

- Receive Trend Records,
- Refresh the Trend Recorder, and
- Delete Trend Records.

Selecting the »Receive Trend Record« button will download data from the relay to the User's PC. By selecting the »Refresh Trend Recorder«, *Smart view* updates the list of the Trend Recorder. The »Delete Trend Records« function will clear all trend data from the relay. Trend Recorder data previously stored on the User's PC remains untouched.

After having received trend data from the device, the User can view the data in the *Data Visualizer* by double-clicking on the received “.ErTr” file stored on the PC. Once the “.ErTr” file is open, the User will see the “Analog Channels” that are monitored by the Trend Recorder. By clicking on the “Analog Channels”, all monitored parameters are listed. To view a channel, the User must click on the left mouse key, then drag and drop the channel onto the right side of the *Data Visualizer* screen. The channel is then listed under the »Displayed Channels«.

To remove a channel from view, the User must select the Trend Data to be removed in the »Displayed Channels« menu tree, then click on the right mouse button to bring up the menu options. Here, the User will find the »Remove« menu option that, when selected, will remove the trend data.

### Configuring the Trend Recorder







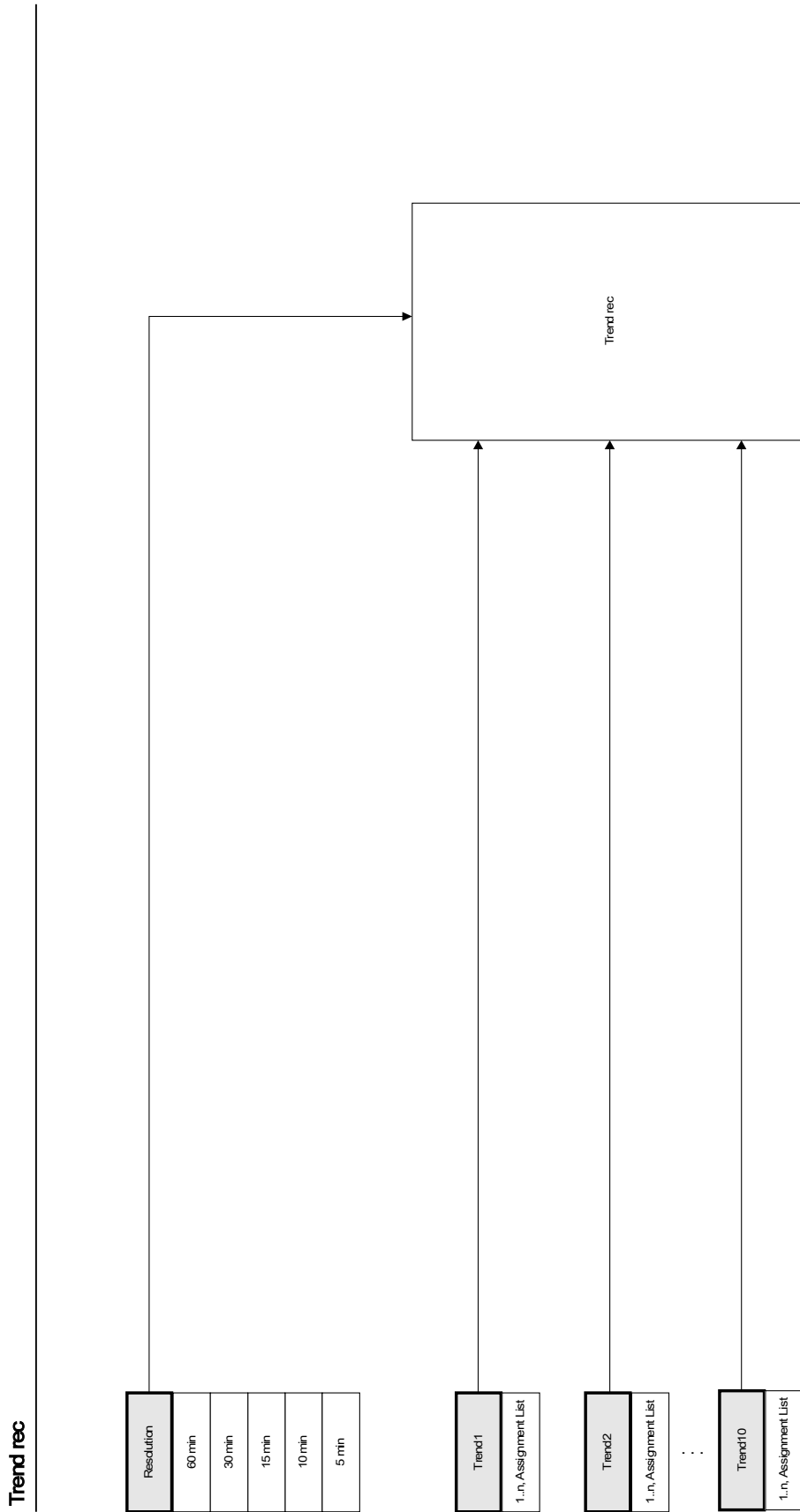

The Trend Recorder is to be configured within [Device Para/Recorders/Trend Recorder] menu.

The User has to set the time interval. This defines the distance between two measuring points.

The User can select up to ten values that will be recorded.



**Global Protection Parameters of the Trend Recorder**

<i>Parameter</i>	<i>Description</i>	<i>Setting range</i>	<i>Default</i>	<i>Menu path</i>
Resolution 	Resolution (recording frequency)	60 min, 30 min, 15 min, 10 min, 5 min	15 min	[Device Para /Recorders /Trend rec]
Trend1 	Observed Value1	1..n, TrendRecList	IL1 RMS	[Device Para /Recorders /Trend rec]
Trend2 	Observed Value2	1..n, TrendRecList	IL2 RMS	[Device Para /Recorders /Trend rec]
Trend3 	Observed Value3	1..n, TrendRecList	IL3 RMS	[Device Para /Recorders /Trend rec]
Trend4 	Observed Value4	1..n, TrendRecList	IG meas RMS	[Device Para /Recorders /Trend rec]
Trend5 	Observed Value5	1..n, TrendRecList	VL1 RMS	[Device Para /Recorders /Trend rec]
Trend6 	Observed Value6	1..n, TrendRecList	VL2 RMS	[Device Para /Recorders /Trend rec]
Trend7 	Observed Value7	1..n, TrendRecList	VL3 RMS	[Device Para /Recorders /Trend rec]
Trend8 	Observed Value8	1..n, TrendRecList	VX meas RMS	[Device Para /Recorders /Trend rec]
Trend9 	Observed Value9	1..n, TrendRecList	-	[Device Para /Recorders /Trend rec]

## Recorders

---

<i>Parameter</i>	<i>Description</i>	<i>Setting range</i>	<i>Default</i>	<i>Menu path</i>
Trend10 	Observed Value10	1..n, TrendReclst	-	[Device Para /Recorders /Trend rec]

## Trend Recorder Signals (Output States)

<i>Signal</i>	<i>Description</i>
Hand Reset	Hand Reset

### Direct Commands of the Trend Recorder

Parameter	Description	Setting range	Default	Menu path
Reset 	Delete all entries	inactive, active	inactive	[Operation /Reset]

### Assignable Values of the Trend Recorder

Name	Description
-	No assignment
IL1	Measured value: Phase current (fundamental)
IL2	Measured value: Phase current (fundamental)
IL3	Measured value: Phase current (fundamental)
IG meas	Measured value (measured): IG (fundamental)
IG calc	Measured value (calculated): IG (fundamental)
IL1 RMS	Measured value: Phase current (RMS)
IL2 RMS	Measured value: Phase current (RMS)
IL3 RMS	Measured value: Phase current (RMS)
IG meas RMS	Measured value (measured): IG (RMS)
IG calc RMS	Measured value (calculated): IG (RMS)
I0	Measured value (calculated): Zero current (fundamental)
I1	Measured value (calculated): Positive phase sequence current (fundamental)
I2	Measured value (calculated): Unbalanced load current (fundamental)
VL1	Measured value: Phase-to-neutral voltage (fundamental)
VL2	Measured value: Phase-to-neutral voltage (fundamental)
VL3	Measured value: Phase-to-neutral voltage (fundamental)
VX meas	Measured value (measured): VX measured (fundamental)
VG calc	Measured value (calculated): VG (fundamental)
VL12	Measured value: Phase-to-phase voltage (fundamental)
VL23	Measured value: Phase-to-phase voltage (fundamental)
VL31	Measured value: Phase-to-phase voltage (fundamental)
VL1 RMS	Measured value: Phase-to-neutral voltage (RMS)
VL2 RMS	Measured value: Phase-to-neutral voltage (RMS)
VL3 RMS	Measured value: Phase-to-neutral voltage (RMS)
VX meas RMS	Measured value (measured): VX measured (RMS)
VG calc RMS	Measured value (calculated): VG (RMS)
VL12 RMS	Measured value: Phase-to-phase voltage (RMS)
VL23 RMS	Measured value: Phase-to-phase voltage (RMS)
VL31 RMS	Measured value: Phase-to-phase voltage (RMS)



Recorders

Name	Description
V0	Measured value (calculated): Symmetrical components Zero voltage(fundamental)
V1	Measured value (calculated): Symmetrical components positive phase sequence voltage(fundamental)
V2	Measured value (calculated): Symmetrical components negative phase sequence voltage(fundamental)
IL1 avg RMS	IL1 average value (RMS)
IL2 avg RMS	IL2 average value (RMS)
IL3 avg RMS	IL3 average value (RMS)
VL1 avg RMS	VL1 average value (RMS)
VL2 avg RMS	VL2 average value (RMS)
VL3 avg RMS	VL3 average value (RMS)
VL12 avg RMS	VL12 average value (RMS)
VL23 avg RMS	VL23 average value (RMS)
VL31 avg RMS	VL31 average value (RMS)
f	Measured value: Frequency
cos phi	Measured value (calculated): Power factor
cos phi RMS	Measured value (calculated): Power factor
IL1 THD	Measured value (calculated): IL1 Total Harmonic Current
IL2 THD	Measured value (calculated): IL2 Total Harmonic Current
IL3 THD	Measured value (calculated): IL3 Total Harmonic Current
VL1 THD	Measured value (calculated): VL1 Total Harmonic Distortion
VL2 THD	Measured value (calculated): VL2 Total Harmonic Distortion
VL3 THD	Measured value (calculated): VL3 Total Harmonic Distortion
VL12 THD	Measured value (calculated): V12 Total Harmonic Distortion
VL23 THD	Measured value (calculated): V23 Total Harmonic Distortion
VL31 THD	Measured value (calculated): V31 Total Harmonic Distortion

General Values of the Trend Recorder

Value	Description	Default	Size	Menu path
Max avail Entries	Maximum available entries in the current configuration	0	0 - 999999999	[Operation /Count and RevData /Trend rec]

## Event Recorder

### Event rec

The event recorder can register up to 300 events and the last (minimum) 50 saved events are recorded fail-safe. The following information is provided for any of the events:

*Events are logged as follows:*

<i>Record No.</i>	<i>Fault No.</i>	<i>No of grid faults</i>	<i>Date of Record</i>	<i>Module.Name</i>	<i>State</i>
Sequential Number	Number of the ongoing fault  This counter will be incremented by each General Alarm (Prot.Alarm).	A grid fault No. can have several Fault No.  This counter will be incremented by each General Alarm.  (Exception AR: this applies only to devices that offer auto reclosing).	Time stamp	What has changed?	Changed Value

*There are three different classes of events:*

- **Alternation of binary states are shown as:**
  - 0->1 if the signal changes physically from »0« to »1«.
  - 1->0 if the signal changes physically from »1« to »0«.
  
- **Counters increment is shown as:**
  - Old Counter state -> New Counter state (e.g. 3->4)
  
- **Alternation of multiple states are shown as:**
  - Old state -> New state (e.g. 0->2)

## Read Out the Event Recorder

- Call up the »*main menu*«.
- Call up the submenu »*Operation/Recorders/Event rec*«.
- Select an event.

## Read Out the Event Recorder via Smart View

- In case *Smart view* is not running – please start it.
- If device data has not been loaded yet – click »Receive Data From The Device« in menu »Device«.
- Double click the »Operation« icon in the navigation tree.
- Double click the »Event Rec« icon within the »OPERATION/RECORDERS« menu.
- In the window the events are shown in tabular form.

### **NOTICE**

To have the event recorder up-dated in a cyclic manner, select »Automatic Up-Date« in menu *View*.

Smart view is able to record more events than the device itself, if the window of the event recorder is opened and »Automatic Up-Date« is set to active.

### **NOTICE**

Via the print menu you can export the data into a file. Please proceed as follows:

- Call up the data as described above.
- Call up the menu [File/Print].
- Choose »Print Actual Working Window« within the popup.
- Press the »Print« button.
- Press the »Export to File« button.
- Enter a file name.
- Choose a location where to save the file.
- Confirm the »Save« button.

### Direct Commands of the Event Recorder

<i>Parameter</i>	<i>Description</i>	<i>Setting range</i>	<i>Default</i>	<i>Menu path</i>
Res all rec 	Reset all records	inactive, active	inactive	[Operation /Reset]

### Event Recorder Signals

<i>Signal</i>	<i>Description</i>
Res all records	Signal: All records deleted

## Communication Protocols

### SCADA Interface

X103

#### Device Planning Parameters of the Serial Scada Interface

<i>Parameter</i>	<i>Description</i>	<i>Options</i>	<i>Default</i>	<i>Menu path</i>
Protocol 	Caution! Changing the protocol will cause a restart of the device	-, Modbus, IEC60870-5-103, Profibus	Modbus	[Device planning]

#### Global Protection Parameters of the Serial Scada Interface

<i>Parameter</i>	<i>Description</i>	<i>Setting range</i>	<i>Default</i>	<i>Menu path</i>
Optical rest position 	Optical rest position	Light off, Light on	Light on	[Device Para /X103]

## Modbus®

### Modbus

## Modbus® Protocol Configuration

The time-controlled Modbus® protocol is based on the Master-Slave working principle. This means that the substation control and protection system sends an enquiry or instruction to a certain device (slave address) which will then be answered or carried out accordingly. If the enquiry/instruction cannot be answered/carried out (e.g. because of an invalid slave address), a failure message is returned to the master.

The Master (substation control and protection system) can query information from the device, such as:

- Type of unit version
- Measuring values/Statistical measured values
- Switch operating position (in preparation)
- State of device
- Time and date
- State of the device's digital inputs
- Protection-/State alarms

The Master (control system) can give commands/instructions to the device, such as:

- Control of switchgear (where applicable, i.e. each acc. to the applied device version)
- Change-over of parameter set
- Reset and acknowledgement of alarms/signals
- Adjustment of date and time
- Control of alarm relays

For detailed information on data point lists and error handling, please refer to the Modbus® documentation.

To allow configuration of the devices for Modbus® connection, some default values of the control system must be available.

## Modbus RTU

### *Part 1: Configuration of the Devices*

Call up »*Device parameter/Modbus*« and set the following communication parameters there:

- Slave-address, to allow clear identification of the device.
- Baud-Rate

Also, select below indicated RS485 interface-related parameters from there, such as:

- Number of data bits
- One of the following supported communication variants: Number of data bits, even, odd, parity or no parity, number of stop bits.
- »*t-timeout*«: communication errors are only identified after expiry of a supervision time »*t-timeout*«.
- Response time (defining the period within which an enquiry from the master has to be answered).

### *Part 2: Hardware Connection*

- For hardware connection to the control system, there is an RS485 interface at the rear side of the device (RS485, fiber optic or terminals).
- Connect bus and device (wiring).

### *Error Handling - Hardware Errors*

Information on physical communication errors, such as:

- Baudrate Error
- Parity Error ...

can be obtained from the event recorder.

### *Error Handling – Errors on protocol level*

If, for example, an invalid memory address is enquired, error codes will be returned by the device that need to be interpreted.

## Modbus TCP

### NOTICE

Establishing a connection via TCP/IP to the device is only possible if your device is equipped with an Ethernet Interface (RJ45).

Contact your IT administrator in order to establish the network connection.

### *Part 1: Setting the TCP/IP Parameters*

Call up »Device parameter/TCP/IP« at the HMI (panel) and set the following parameters:

- TCP/IP address
- Subnetmask
- Gateway

### *Part 2: Configuration of the Devices*

Call up »Device parameter/Modbus« and set the following communication parameters:

- Setting a Unit Identifier is only necessary if a TCP network should be coupled to a RTU network.
- If a different port than the default port 502 should be used please proceed as follows:
  - Choose "Private" within the TCP-Port-Configuration.
  - Set the port-number.
- Set the maximum accepted time of "no communication". If this time has expired – without any communication, the device concludes a failure within the master system.
- Allow or disallow the blocking of SCADA commands.

### *Part 3: Hardware Connection*







- There is a RJ45 interface at the rear side of the device for the hardware connection to the control system.
- Establish the connection to the device by means of a proper Ethernet cable.



### Direct Commands of the Modbus®

Parameter	Description	Setting range	Default	Menu path
 Res Diagn Cr	All Modbus Diagnosis Counters will be reset.	inactive, active	inactive	[Operation /Reset]

### Global Protection Parameters of the Modbus®

Parameter	Description	Setting range	Default	Menu path
 Slave ID	Device address (Slave ID) within the bus system. Each device address has to be unique within a bus system.  Only available if:Device planning = RTU	1 - 247	1	[Device Para /Modbus]
 Unit ID	The Unit Identifier is used for routing. This parameter is to be set, if a Modbus RTU and a Modbus TCP network should be coupled.  Only available if:Device planning = TCP	1 - 255	255	[Device Para /Modbus]
 TCP Port Config	TCP Port Configuration. This parameter is to be set only if the default Modbus TCP Port should not be used.  Only available if:Device planning = TCP	Default, Private	Default	[Device Para /Modbus]
 Port	Port number  Only available if:Device planning = TCP And Only available if: TCP Port Config = Private	502 - 65535	502	[Device Para /Modbus]
 t-timeout	Within this time the answer has to be received by the SCADA system, otherwise the request will be disregarded. In that case the Scada system detects a communication failure and the Scada System has to send a new request.  Only available if:Device planning = RTU	0.01 - 10.00s	1s	[Device Para /Modbus]
 Baud rate	Baud rate  Only available if:Device planning = RTU	1200, 2400, 4800, 9600, 19200, 38400	19200	[Device Para /Modbus]

Parameter	Description	Setting range	Default	Menu path
Physical Settings 	Digit 1: Number of bits. Digit 2: E=even parity, O=odd parity, N=no parity. Digit 3: Number of stop bits. More information on the parity: It is possible that the last data bit is followed by a parity bit which is used for recognition of communication errors. The parity bit ensures that with even parity ("EVEN") always an even number of bits with valence "1" or with odd parity ("ODD") an odd number of "1" valence bits are transmitted. But it is also possible to transmit no parity bits (here the setting is "Parity = None"). More information on the stop-bits: The end of a data byte is terminated by the stop-bits.  Only available if:Device planning = RTU	8E1, 8O1, 8N1, 8N2	8E1	[Device Para /Modbus]
t-call 	If there is no request telegram sent from Scada to the device after expiry of this time - the device concludes a communication failure within the Scada system.	1 - 3600s	10s	[Device Para /Modbus]
Scada CmdBlo 	Activating (allowing)/ Deactivating (disallowing) the blocking of the Scada Commands	inactive, active	inactive	[Device Para /Modbus]
Disable Latching 	Disable Latching: If this parameter is active (true), none of the Modbus states will be latched. That means that trip signals wont be latched by Modbus.	inactive, active	inactive	[Device Para /Modbus]
AllowGap 	If this parameter is active (True), the user can request a set of modbus register without getting an exception, because of invalid address in the requested array. The invalid addresses have a special value 0xFAFA, but the user is responsible for ignoring invalid addresses. Attention: This special value can be valid, if address is valid.	inactive, active	inactive	[Device Para /Modbus]

## Modbus® Signals (Output States)

**NOTICE** Some signals (that are for a short time active only) have to be acknowledged separately (e.g. Trip signals) by the Communication System.

<i>Signal</i>	<i>Description</i>
Transmission	Signal: SCADA active
Scada Cmd 1	Scada Command
Scada Cmd 2	Scada Command
Scada Cmd 3	Scada Command
Scada Cmd 4	Scada Command
Scada Cmd 5	Scada Command
Scada Cmd 6	Scada Command
Scada Cmd 7	Scada Command
Scada Cmd 8	Scada Command
Scada Cmd 9	Scada Command
Scada Cmd 10	Scada Command
Scada Cmd 11	Scada Command
Scada Cmd 12	Scada Command
Scada Cmd 13	Scada Command
Scada Cmd 14	Scada Command
Scada Cmd 15	Scada Command
Scada Cmd 16	Scada Command

## Modbus® Values

Value	Description	Default	Size	Menu path
NoOfRequestsTotal	Total number of requests. Includes requests for other slaves.	0	0 - 9999999999	[Operation /Count and RevData /Modbus]
NoOfRequestsForMe	Total Number of requests for this slave.	0	0 - 9999999999	[Operation /Count and RevData /Modbus]
NoOfResponse	Total number of requests having been responded.  Only available if:Device planning = TCP	0	0 - 9999999999	[Operation /Count and RevData /Modbus]
NoOfResponseTimeOverruns	Total number of requests with exceeded response time. Physically corrupted Frame.  Only available if:Device planning = RTU	0	0 - 9999999999	[Operation /Count and RevData /Modbus]
NoOfOverrunErrors	Total Number of Overrun Failures. Physically corrupted Frame.  Only available if:Device planning = RTU	0	0 - 9999999999	[Operation /Count and RevData /Modbus]
NoOfParityErrors	Total number of parity errors. Physically corrupted Frame.  Only available if:Device planning = RTU	0	0 - 9999999999	[Operation /Count and RevData /Modbus]
NoOfFrameErrors	Total Number of Frame Errors. Physically corrupted Frame.  Only available if:Device planning = RTU	0	0 - 9999999999	[Operation /Count and RevData /Modbus]
NoOfBreaks	Number of detected communication aborts  Only available if:Device planning = RTU	0	0 - 9999999999	[Operation /Count and RevData /Modbus]
NoOfQueryInvalid	Total number of Request errors. Request could not be interpreted	0	0 - 9999999999	[Operation /Count and RevData /Modbus]
NoOfInternalError	Total Number of Internal errors while interpreting the request.	0	0 - 9999999999	[Operation /Count and RevData /Modbus]

## Profibus

### Profibus

#### *Part 1: Configuration of the Devices*

Call up »*Device parameter/Profibus*« and set the following communication parameter:

- Slave-address, to allow clear identification of the device.

In addition to that the Master has to be provided with the GSD-file. The GSD-file can be taken from the Product-CD.

#### *Part 2: Hardware Connection*

- For hardware connection to the control system, there is optional an D-SUB interface at the rear side of the device.
- Connect bus and device (wiring).
- Up to 123 slaves can be connected.
- Terminate the Bus by means of an Terminate Resistor.

#### *Error Handling*

Information on physical communication errors, such as:

- Baudrate Error

can be obtained from the event recorder or the status display.

#### *Error Handling – Status LED at the rear side*









The Profibus D-SUB interface at the rear side of the device is equipped with an status LED.











- Baud Search -> red flashing
- Baud Found -> green flashing
- Data Exchange -> green
- No Profibus/Unplugged, not connected -> red











### Direct Commands of the Profibus

Parameter	Description	Setting range	Default	Menu path
Reset Comds 	All Profibus Commands will be reset.	inactive, active	inactive	[Operation /Reset]

### Global Protection Parameters of the Profibus





Parameter	Description	Setting range	Default	Menu path
Assignment 1 	Assignment	1..n, Assignment List	--	[Device Para /Profibus /Assignment 1-16]
Latched 1 	Defines whether the Input is latched. Only available if: Latched = active	inactive, active	inactive	[Device Para /Profibus /Assignment 1-16]
Assignment 2 	Assignment	1..n, Assignment List	--	[Device Para /Profibus /Assignment 1-16]
Latched 2 	Defines whether the Input is latched. Only available if: Latched = active	inactive, active	inactive	[Device Para /Profibus /Assignment 1-16]
Assignment 3 	Assignment	1..n, Assignment List	--	[Device Para /Profibus /Assignment 1-16]
Latched 3 	Defines whether the Input is latched. Only available if: Latched = active	inactive, active	inactive	[Device Para /Profibus /Assignment 1-16]
Assignment 4 	Assignment	1..n, Assignment List	--	[Device Para /Profibus /Assignment 1-16]
Latched 4 	Defines whether the Input is latched. Only available if: Latched = active	inactive, active	inactive	[Device Para /Profibus /Assignment 1-16]







Parameter	Description	Setting range	Default	Menu path
Assignment 5 	Assignment	1..n, Assignment List	.-.	[Device Para /Profibus /Assignment 1-16]
Latched 5 	Defines whether the Input is latched. Only available if: Latched = active	inactive, active	inactive	[Device Para /Profibus /Assignment 1-16]
Assignment 6 	Assignment	1..n, Assignment List	.-.	[Device Para /Profibus /Assignment 1-16]
Latched 6 	Defines whether the Input is latched. Only available if: Latched = active	inactive, active	inactive	[Device Para /Profibus /Assignment 1-16]
Assignment 7 	Assignment	1..n, Assignment List	.-.	[Device Para /Profibus /Assignment 1-16]
Latched 7 	Defines whether the Input is latched. Only available if: Latched = active	inactive, active	inactive	[Device Para /Profibus /Assignment 1-16]
Assignment 8 	Assignment	1..n, Assignment List	.-.	[Device Para /Profibus /Assignment 1-16]
Latched 8 	Defines whether the Input is latched. Only available if: Latched = active	inactive, active	inactive	[Device Para /Profibus /Assignment 1-16]
Assignment 9 	Assignment	1..n, Assignment List	.-.	[Device Para /Profibus /Assignment 1-16]
Latched 9 	Defines whether the Input is latched. Only available if: Latched = active	inactive, active	inactive	[Device Para /Profibus /Assignment 1-16]







Parameter	Description	Setting range	Default	Menu path
Assignment 10 	Assignment	1..n, Assignment List	.-.	[Device Para /Profibus /Assignment 1-16]
Latched 10 	Defines whether the Input is latched. Only available if: Latched = active	inactive, active	inactive	[Device Para /Profibus /Assignment 1-16]
Assignment 11 	Assignment	1..n, Assignment List	.-.	[Device Para /Profibus /Assignment 1-16]
Latched 11 	Defines whether the Input is latched. Only available if: Latched = active	inactive, active	inactive	[Device Para /Profibus /Assignment 1-16]
Assignment 12 	Assignment	1..n, Assignment List	.-.	[Device Para /Profibus /Assignment 1-16]
Latched 12 	Defines whether the Input is latched. Only available if: Latched = active	inactive, active	inactive	[Device Para /Profibus /Assignment 1-16]
Assignment 13 	Assignment	1..n, Assignment List	.-.	[Device Para /Profibus /Assignment 1-16]
Latched 13 	Defines whether the Input is latched. Only available if: Latched = active	inactive, active	inactive	[Device Para /Profibus /Assignment 1-16]
Assignment 14 	Assignment	1..n, Assignment List	.-.	[Device Para /Profibus /Assignment 1-16]
Latched 14 	Defines whether the Input is latched. Only available if: Latched = active	inactive, active	inactive	[Device Para /Profibus /Assignment 1-16]



<i>Parameter</i>	<i>Description</i>	<i>Setting range</i>	<i>Default</i>	<i>Menu path</i>
Assignment 15 	Assignment	1..n, Assignment List	.-.	[Device Para /Profibus /Assignment 1-16]
Latched 15 	Defines whether the Input is latched.  Only available if: Latched = active	inactive, active	inactive	[Device Para /Profibus /Assignment 1-16]
Assignment 16 	Assignment	1..n, Assignment List	.-.	[Device Para /Profibus /Assignment 1-16]
Latched 16 	Defines whether the Input is latched.  Only available if: Latched = active	inactive, active	inactive	[Device Para /Profibus /Assignment 1-16]
Assignment 17 	Assignment	1..n, Assignment List	.-.	[Device Para /Profibus /Assignment 17-32]
Latched 17 	Defines whether the Input is latched.  Only available if: Latched = active	inactive, active	inactive	[Device Para /Profibus /Assignment 17-32]
Assignment 18 	Assignment	1..n, Assignment List	.-.	[Device Para /Profibus /Assignment 17-32]
Latched 18 	Defines whether the Input is latched.  Only available if: Latched = active	inactive, active	inactive	[Device Para /Profibus /Assignment 17-32]
Assignment 19 	Assignment	1..n, Assignment List	.-.	[Device Para /Profibus /Assignment 17-32]
Latched 19 	Defines whether the Input is latched.  Only available if: Latched = active	inactive, active	inactive	[Device Para /Profibus /Assignment 17-32]

<i>Parameter</i>	<i>Description</i>	<i>Setting range</i>	<i>Default</i>	<i>Menu path</i>
Assignment 20 	Assignment	1..n, Assignment List	.-.	[Device Para /Profibus /Assignment 17-32]
Latched 20 	Defines whether the Input is latched.  Only available if: Latched = active	inactive, active	inactive	[Device Para /Profibus /Assignment 17-32]
Assignment 21 	Assignment	1..n, Assignment List	.-.	[Device Para /Profibus /Assignment 17-32]
Latched 21 	Defines whether the Input is latched.  Only available if: Latched = active	inactive, active	inactive	[Device Para /Profibus /Assignment 17-32]
Assignment 22 	Assignment	1..n, Assignment List	.-.	[Device Para /Profibus /Assignment 17-32]
Latched 22 	Defines whether the Input is latched.  Only available if: Latched = active	inactive, active	inactive	[Device Para /Profibus /Assignment 17-32]
Assignment 23 	Assignment	1..n, Assignment List	.-.	[Device Para /Profibus /Assignment 17-32]
Latched 23 	Defines whether the Input is latched.  Only available if: Latched = active	inactive, active	inactive	[Device Para /Profibus /Assignment 17-32]
Assignment 24 	Assignment	1..n, Assignment List	.-.	[Device Para /Profibus /Assignment 17-32]
Latched 24 	Defines whether the Input is latched.  Only available if: Latched = active	inactive, active	inactive	[Device Para /Profibus /Assignment 17-32]

Parameter	Description	Setting range	Default	Menu path
Assignment 25 	Assignment	1..n, Assignment List	.-.	[Device Para /Profibus /Assignment 17-32]
Latched 25 	Defines whether the Input is latched. Only available if: Latched = active	inactive, active	inactive	[Device Para /Profibus /Assignment 17-32]
Assignment 26 	Assignment	1..n, Assignment List	.-.	[Device Para /Profibus /Assignment 17-32]
Latched 26 	Defines whether the Input is latched. Only available if: Latched = active	inactive, active	inactive	[Device Para /Profibus /Assignment 17-32]
Assignment 27 	Assignment	1..n, Assignment List	.-.	[Device Para /Profibus /Assignment 17-32]
Latched 27 	Defines whether the Input is latched. Only available if: Latched = active	inactive, active	inactive	[Device Para /Profibus /Assignment 17-32]
Assignment 28 	Assignment	1..n, Assignment List	.-.	[Device Para /Profibus /Assignment 17-32]
Latched 28 	Defines whether the Input is latched. Only available if: Latched = active	inactive, active	inactive	[Device Para /Profibus /Assignment 17-32]
Assignment 29 	Assignment	1..n, Assignment List	.-.	[Device Para /Profibus /Assignment 17-32]
Latched 29 	Defines whether the Input is latched. Only available if: Latched = active	inactive, active	inactive	[Device Para /Profibus /Assignment 17-32]

<i>Parameter</i>	<i>Description</i>	<i>Setting range</i>	<i>Default</i>	<i>Menu path</i>
Assignment 30 	Assignment	1..n, Assignment List	.-	[Device Para /Profibus /Assignment 17-32]
Latched 30 	Defines whether the Input is latched.  Only available if: Latched = active	inactive, active	inactive	[Device Para /Profibus /Assignment 17-32]
Assignment 31 	Assignment	1..n, Assignment List	.-	[Device Para /Profibus /Assignment 17-32]
Latched 31 	Defines whether the Input is latched.  Only available if: Latched = active	inactive, active	inactive	[Device Para /Profibus /Assignment 17-32]
Assignment 32 	Assignment	1..n, Assignment List	.-	[Device Para /Profibus /Assignment 17-32]
Latched 32 	Defines whether the Input is latched.  Only available if: Latched = active	inactive, active	inactive	[Device Para /Profibus /Assignment 17-32]
Slave ID 	Device address (Slave ID) within the bus system. Each device address has to be unique within a bus system.	2 - 125	2	[Device Para /Profibus /Bus parameters]

### Inputs of the Profibus

<i>Name</i>	<i>Description</i>	<i>Assignment via</i>
Assignment 1-I	Module input state: Scada Assignment	[Device Para /Profibus /Assignment 1-16]
Assignment 2-I	Module input state: Scada Assignment	[Device Para /Profibus /Assignment 1-16]
Assignment 3-I	Module input state: Scada Assignment	[Device Para /Profibus /Assignment 1-16]
Assignment 4-I	Module input state: Scada Assignment	[Device Para /Profibus /Assignment 1-16]
Assignment 5-I	Module input state: Scada Assignment	[Device Para /Profibus /Assignment 1-16]
Assignment 6-I	Module input state: Scada Assignment	[Device Para /Profibus /Assignment 1-16]
Assignment 7-I	Module input state: Scada Assignment	[Device Para /Profibus /Assignment 1-16]
Assignment 8-I	Module input state: Scada Assignment	[Device Para /Profibus /Assignment 1-16]
Assignment 9-I	Module input state: Scada Assignment	[Device Para /Profibus /Assignment 1-16]
Assignment 10-I	Module input state: Scada Assignment	[Device Para /Profibus /Assignment 1-16]
Assignment 11-I	Module input state: Scada Assignment	[Device Para /Profibus /Assignment 1-16]
Assignment 12-I	Module input state: Scada Assignment	[Device Para /Profibus /Assignment 1-16]

<i>Name</i>	<i>Description</i>	<i>Assignment via</i>
Assignment 13-I	Module input state: Scada Assignment	[Device Para /Profibus /Assignment 1-16]
Assignment 14-I	Module input state: Scada Assignment	[Device Para /Profibus /Assignment 1-16]
Assignment 15-I	Module input state: Scada Assignment	[Device Para /Profibus /Assignment 1-16]
Assignment 16-I	Module input state: Scada Assignment	[Device Para /Profibus /Assignment 1-16]
Assignment 17-I	Module input state: Scada Assignment	[Device Para /Profibus /Assignment 17-32]
Assignment 18-I	Module input state: Scada Assignment	[Device Para /Profibus /Assignment 17-32]
Assignment 19-I	Module input state: Scada Assignment	[Device Para /Profibus /Assignment 17-32]
Assignment 20-I	Module input state: Scada Assignment	[Device Para /Profibus /Assignment 17-32]
Assignment 21-I	Module input state: Scada Assignment	[Device Para /Profibus /Assignment 17-32]
Assignment 22-I	Module input state: Scada Assignment	[Device Para /Profibus /Assignment 17-32]
Assignment 23-I	Module input state: Scada Assignment	[Device Para /Profibus /Assignment 17-32]
Assignment 24-I	Module input state: Scada Assignment	[Device Para /Profibus /Assignment 17-32]
Assignment 25-I	Module input state: Scada Assignment	[Device Para /Profibus /Assignment 17-32]

<i>Name</i>	<i>Description</i>	<i>Assignment via</i>
Assignment 26-I	Module input state: Scada Assignment	[Device Para /Profibus /Assignment 17-32]
Assignment 27-I	Module input state: Scada Assignment	[Device Para /Profibus /Assignment 17-32]
Assignment 28-I	Module input state: Scada Assignment	[Device Para /Profibus /Assignment 17-32]
Assignment 29-I	Module input state: Scada Assignment	[Device Para /Profibus /Assignment 17-32]
Assignment 30-I	Module input state: Scada Assignment	[Device Para /Profibus /Assignment 17-32]
Assignment 31-I	Module input state: Scada Assignment	[Device Para /Profibus /Assignment 17-32]
Assignment 32-I	Module input state: Scada Assignment	[Device Para /Profibus /Assignment 17-32]

**Profibus Signals (Output States)**

<i>Signal</i>	<i>Description</i>
Data OK	Data within the Input field are OK (Yes=1)
SubModul Err	Assignable Signal, Failure in Sub-Module, Communication Failure.
Connection active	Connection active
Scada Cmd 1	Scada Command
Scada Cmd 2	Scada Command
Scada Cmd 3	Scada Command
Scada Cmd 4	Scada Command
Scada Cmd 5	Scada Command
Scada Cmd 6	Scada Command
Scada Cmd 7	Scada Command
Scada Cmd 8	Scada Command
Scada Cmd 9	Scada Command
Scada Cmd 10	Scada Command
Scada Cmd 11	Scada Command
Scada Cmd 12	Scada Command
Scada Cmd 13	Scada Command
Scada Cmd 14	Scada Command
Scada Cmd 15	Scada Command
Scada Cmd 16	Scada Command



**Profibus Values**

<i>Value</i>	<i>Description</i>	<i>Default</i>	<i>Size</i>	<i>Menu path</i>
Fr Sync Err	Frames, that were sent from the Master to the Slave are faulty.	1	1 - 99999999	[Operation /Count and RevData /Profibus]
crcErrors	Number of CRC errors that the ss manager has recognized in received response frames from ss (each error caused a subsystem reset)	1	1 - 99999999	[Operation /Count and RevData /Profibus]
frLossErrors	Number of frame loss errors that the ss manager recognized in received response frames from ss (each error caused a subsystem reset)	1	1 - 99999999	[Operation /Count and RevData /Profibus]
ssCrcErrors	Number of CRC errors that the subsystem has recognized in received trigger frames from host	1	1 - 99999999	[Operation /Count and RevData /Profibus]
ssResets	Number of subsystem resets/restarts from ss manager	1	1 - 99999999	[Operation /Count and RevData /Profibus]
Master ID	Device address (Master ID) within the bus system. Each device address has to be unique within a bus system.	1	1 - 125	[Operation /Status display /Profibus /State]
HO Id PSub	Handoff Id of PbSub	0	0 - 9999999999	[Operation /Status display /Profibus /State]
t-WatchDog	The Profibus Chip detects a communication issue if this timer is expired without any communication (Parameterising telegram).	0	0 - 9999999999	[Operation /Status display /Profibus /State]

<i>Value</i>	<i>Description</i>	<i>Default</i>	<i>Size</i>	<i>Menu path</i>
Slave State	Communication State between Slave and Master.	Baud Search	Baud Search, Baud Found, PRM OK, PRM REQ, PRM Fault, CFG Fault, Clear Data, Data exchange	[Operation /Status display /Profibus /State]
Baud rate	The baud rate that has been detected lastly, will still be shown after a connection issue.	--	12 Mb/s, 6 Mb/s, 3 Mb/s, 1.5 Mb/s, 0.5 Mb/s, 187500 baud, 93750 baud, 45450 baud, 19200 baud, 9600 baud, --	[Operation /Status display /Profibus /State]
PNO Id	PNO Identification Number. GSD Identification Number.	0C50h	0C50h	[Operation /Status display /Profibus /State]

## IEC60870-5-103

### IEC 103

#### IEC60870-5-103 Protocol Configuration

In order to use the IEC60870-5-103 protocol it has to be assigned to the X103 Interface within the Device Planning. The device will reboot after setting this parameter.

#### **NOTICE**

The parameter X103 is only available if the device is at the rear side equipped with an interface like RS485 or Fiber Optic.

#### **NOTICE**

If the device is equipped with an Fiber Optic Interface, the Optical Rest Position has to be set within the Device Parameters .

The time-controlled IEC60870-5-103 protocol is based on the Master-Slave working principle. This means that the substation control and protection system sends an enquiry or instruction to a certain device (slave address) which will then be answered or carried out accordingly.

The device meets the compatibility mode 2. Compatibility mode 3 is not supported.

The following IEC60870-5-103-functions will be supported:

- Initialization (Reset)
- Time Synchronization
- Reading out of time stamped, instantaneous signals
- General Queries
- Cyclic Signals
- General Commands
- Transmission of Disturbance Data

#### *Initialization*

The communication has to be reset by a Reset Command each time that the device is turned on or that communication parameters have been changed. The “Reset CU” Command resets. The relay acts on both Reset Commands (Reset CU or Reset FCB).

The relay acts on the reset command by an identification signal ASDU 5 (Application Service Data Unit), as a reason (Cause Of Transmission, COT) for the transmission of the answer either a “Reset CU” or a “Reset FCB” will be sent depending on the type of the reset command. This information can be part of the data section of the ASDU-signal.

#### *Name of the Manufacturer*

The section for the identification of the software contains three digits of the device code for the identification of the device type. Beside the upper mentioned identification number the device generates a communication start event.

#### *Time Synchronization*

Time and date of the relay can be set by means of the time synchronization function of the IEC60870-5-103 protocol. If the time synchronization signal is send out with a confirmation request, the device will answer with a confirmation signal.

### *Spontaneous Events*

The events that are generated by the device will be forwarded to the master with numbers for standard function types / standard information. The data point list comprises all events that can be generated by the device.

### *Cyclic Measurement*

The device generates on a cyclic base measured values by means of ASDU 9. They can be read out via a class 2 query. Please take into account that the measured values will be send out as multiples (1.2 or 2.4 times the rated value). How to set 1.2 or 2.4 as multiplier for a value can be taken from the data point list.

The parameter "Transm priv meas val" defines if additional measurement values should be transmitted in the private part. Public and private measured values are transmitted by ASDU9. That means that either a "private" or a "public" ASDU9 will be transmitted. If this parameter is set, the ASDU9 will contain additional measured values that are an enhancement of the standard. The "private" ASDU9 is send with a fixed function type and information number that does not depend the type of device. Please refer to the data point list.

### *Commands*

The data point list comprises a list of the supported commands. Any command will be responded by the device with a positive or negative confirmation. If the command is executable, the execution with the corresponding reason for the transmission (COT) will be lead in at first, and subsequently the execution will be confirmed with COT1 within a ASDU9.

### *Disturbance Recording*

The disturbances recorded by the device can be read out by means described in standard IEC60870-5-103. The device is in compliance with the VDEW-Control System by transmission of an ASDU 23 without disturbance records at the beginning of an GI-Cycle.





A disturbance record contains the following information:

- Analog Measured Values, IL1, IL2, IL3, IN, Voltages VL1, VL2, VL3, VEN;
- Binary States, transmitted as marks, e.g. Alarms and Trips.
- The Transmission ratio will not be supported. The transmission ratio is included in the "Multiplier".

### *Blocking the Transmission Direction*

The relay does not support functions to block the transmission in a certain direction (supervision direction).

**Global Protection Parameters of the IEC60870-5-103**

Parameter	Description	Setting range	Default	Menu path
Slave ID 	Device address (Slave ID) within the bus system. Each device address has to be unique within a bus system.	1 - 247	1	[Device Para /IEC 103]
t-call 	If there is no request telegram sent from Scada to the device after expiry of this time - the device concludes a communication failure within the Scada system.	1 - 3600s	60s	[Device Para /IEC 103]
Transm priv meas val 	Transmit additional (private) measuring values	inactive, active	inactive	[Device Para /IEC 103]
Baud rate 	Baud rate	1200, 2400, 4800, 9600, 19200, 38400, 57600	19200	[Device Para /IEC 103]
Physical Settings 	Digit 1: Number of bits. Digit 2: E=even parity, O=odd parity, N=no parity. Digit 3: Number of stop bits. More information on the parity: It is possible that the last data bit is followed by a parity bit which is used for recognition of communication errors. The parity bit ensures that with even parity ("EVEN") always an even number of bits with valence "1" or with odd parity ("ODD") an odd number of "1" valence bits are transmitted. But it is also possible to transmit no parity bits (here the setting is "Parity = None"). More information on the stop-bits: The end of a data byte is terminated by the stop-bits.	8E1, 8O1, 8N1, 8N2	8E1	[Device Para /IEC 103]

**IEC60870-5-103 Signals (Output States)**

<i>Signal</i>	<i>Description</i>
Scada Cmd 1	Scada Command
Scada Cmd 2	Scada Command
Scada Cmd 3	Scada Command
Scada Cmd 4	Scada Command
Scada Cmd 5	Scada Command
Scada Cmd 6	Scada Command
Scada Cmd 7	Scada Command
Scada Cmd 8	Scada Command
Scada Cmd 9	Scada Command
Scada Cmd 10	Scada Command
Transmission	Signal: SCADA active
Fail phy Interf	Failure in the physical interface
Failure Event lost	Failure event lost

**IEC60870-5-103 Values**

<i>Value</i>	<i>Description</i>	<i>Default</i>	<i>Size</i>	<i>Menu path</i>
Internal errors	Internal errors	0	0 - 9999999999	[Operation /Count and RevData /IEC 103]
NReceived	Total Number of received Messages	0	0 - 9999999999	[Operation /Count and RevData /IEC 103]
NSent	Total Number of sent Messages	0	0 - 9999999999	[Operation /Count and RevData /IEC 103]
NBadFramings	Number of bad Messages	0	0 - 9999999999	[Operation /Count and RevData /IEC 103]
NBadParities	Number of Parity Errors	0	0 - 9999999999	[Operation /Count and RevData /IEC 103]
NBreakSignals	Number of Communication Interrupts	0	0 - 9999999999	[Operation /Count and RevData /IEC 103]
NInternalError	Number of Internal Errors	0	0 - 9999999999	[Operation /Count and RevData /IEC 103]
NBadCharChecksum	Number of Checksum Errors	0	0 - 9999999999	[Operation /Count and RevData /IEC 103]

# IEC61850

## IEC61850

### Introduction

To understand the functioning and mode of operation of a substation in an IEC61850 automation environment, it is useful to compare the commissioning steps with those of a conventional substation in a Modbus TCP environment.

In a conventional substation the individual IEDs (Intelligent Electronic Devices) communicate in vertically direction with the higher level control center via SCADA. The horizontal communication is exclusively realized by wiring output relays (OR) and digital inputs (DI) among each other.

In an IEC61850 environment communication between the IEDs takes place digitally (via Ethernet) by a service called GOOSE (Generic Object Oriented Substation Event). By means of this service information about events is submitted between each IED. Therefore each IED has to know about the functional capability of all other connected IEDs.

Each IEC61850 capable device includes a description of it's own functionality and communications skills (IED Capability Description, \*.ICD).

By means of a Substation Configuration Tool to describe the structure of the substation, assignment of the devices to the primary technique, etc. a virtual wiring of the IEDs among each other and with other switch gear of the substation can be done. A description of the substation configuration will be generated in form of a \*.SCD file. At last this file has to be submitted to each device. Now the IEDs are able to communicate closed among each other, react to interlockings and operate switch gear.

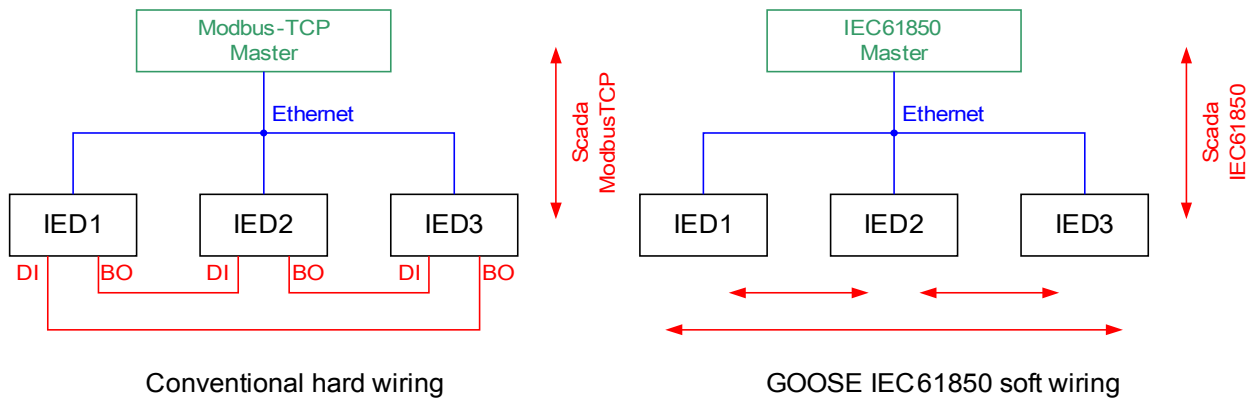

#### Commissioning steps for a conventional substation with modbus TCP environment:

- Parameter setting of the IEDs
- Ethernet installation
- TCP/IP settings for the IEDs
- Wiring according to wiring scheme

#### Commissioning steps for a substation with IEC61850 environment:

1. Parameter setting of the IEDs  
Ethernet installation  
TCP/IP settings for the IEDs
2. IEC61850 configuration (software wiring)
  - a) Exporting an ICD file from each device
  - b) Configuration of the substation (generating a SCD file)
  - c) Transmit SCD file to each device



## Generation/Export of a device specific ICD file

Each device of the HighPROTEC line includes a description of it's own functionality and communications skills in form of an \*.ICD file (IED Capability Description). This file can be exported as follows and be used for the configuration of the substation.

### NOTICE

- A change of the devices parameters has an influence on the content of the ICD file.

1. Connect the device with your PC/Notebook.
2. Start Smart view.
3. Click on »*Receive data from Device*« in the menu »*Device*«.
4. Click on »*IEC61850*« in the menu »*Device Para*«.
5. Click on the ICD icon in the IEC61850 window.
6. Select a drive and file name for the ICD file and click "save".
7. Repeat the steps 1 to 6 for all connected devices in this IEC61850 environment.

## Generation/Export of a SCD file

Each device of the HighPROTEC can create an export it's own functionality and communications skills in form of a \*.SCD file.

1. Connect the device with your PC/Notebook.
2. Start Smart view.
3. Click on »*Receive data from Device*« in the menu »*Device*«.
4. Click on »*IEC61850*« in the menu »*Device Para*«.
5. Click on the SCD icon in the IEC61850 window.
6. Select a drive and file name for the SCD file and click "save".
7. Repeat the steps 1 to 6 for all connected devices in this IEC61850 environment.

## Substation configuration, Generation of .SCD file (Station Configuration Description)

The substation configuration, i. e. connection of all logical nodes of protection and control devices, as well as switch gear usually is done with a „Substation Configuration Tool“. Therefore the ICD files of all connected IEDs in the IEC61850 environment have to be available. The result of the station wide “software wiring” can be exported in the form of a SCD file (Station Configuration Description).

Suitable Substation Configuration Tools (SCT) are available by the following Companies:

H&S, Hard- & Software Technologie GmbH & Co. KG, Dortmund (Germany) ([www.hstech.de](http://www.hstech.de)).

Applied Systems Engineering Inc. ([www.ase-systems.com](http://www.ase-systems.com))

Kalki Communication Technologies Limited ([www.kalkitech.com](http://www.kalkitech.com))

## Import of the .SCD file into the device

When the substation configuration is completed, the .SCD file has to be transmitted to all connected devices. This is has to be done as follows:

1. Connect the device with your PC/Notebook.
2. Start Smart view.
3. Click on »*Receive data from Device*« in the menu »*Device*«.
4. Click on »*IEC61850*« in the menu »*Device Para*«.
5. Switch the parameter »*IEC61850 Communication*« to »*OFF*« and submit the changed parameter set into the device.
6. Click on the IEC icon in the IEC61850 window.
7. Select the folder, where the .SCD file is stored. Select the .SCD file and click "open".
8. Now a password is requested. Enter the same password, which you use for parameter setting of the device (4 digits).
9. Acc. to step 5 switch on again the IEC Communication and submit the changed parameter set into the device.
10. Repeat the steps 1 to 9 for all devices connected to this IEC61850 environment.
11. If no error message occurs, the configuration has been completed successfully.



- **When changing the substation configuration, usually a new .SCD file has to be generated. This .SCD file has to be mandatory transmitted to all devices by means of Smart view. For the case, that this step will be forgotten, IEC61850 malfunctions will be the result**
- **Provided that parameters of the devices are changed after the substation configuration completion, changes in the corresponding .ICD file may result – this in turn may make an update of the .SCD file necessary.**

## IEC 61850 Virtual Outputs

Additionally to the standardized logical node status information up to 16 free configurable status information can be assigned to 16 Virtual Outputs. This can be done in the menu [Device Para/IEC61850].

### Device Planning Parameters of the IEC 61850

<i>Parameter</i>	<i>Description</i>	<i>Options</i>	<i>Default</i>	<i>Menu path</i>
Mode 	Mode	do not use, use	use	[Device planning]

### Direct Commands of the IEC 61850

Parameter	Description	Setting range	Default	Menu path
 ResetStatistic	Reset of all IEC61850 diagnostic counters	inactive, active	inactive	[Operation /Reset]

### Global Parameters of the IEC 61850

Parameter	Description	Setting range	Default	Menu path
 Function	Permanent activation or deactivation of module/stage.	inactive, active	inactive	[Device Para /IEC61850]
 VirtualOutput1	Virtual Output. This signal can be assigned or visualized via the SCD file to other devices within the IEC61850 substation.	1..n, Assignment List	--	[Device Para /IEC61850]
 VirtualOutput2	Virtual Output. This signal can be assigned or visualized via the SCD file to other devices within the IEC61850 substation.	1..n, Assignment List	--	[Device Para /IEC61850]
 VirtualOutput3	Virtual Output. This signal can be assigned or visualized via the SCD file to other devices within the IEC61850 substation.	1..n, Assignment List	--	[Device Para /IEC61850]
 VirtualOutput4	Virtual Output. This signal can be assigned or visualized via the SCD file to other devices within the IEC61850 substation.	1..n, Assignment List	--	[Device Para /IEC61850]
 VirtualOutput5	Virtual Output. This signal can be assigned or visualized via the SCD file to other devices within the IEC61850 substation.	1..n, Assignment List	--	[Device Para /IEC61850]
 VirtualOutput6	Virtual Output. This signal can be assigned or visualized via the SCD file to other devices within the IEC61850 substation.	1..n, Assignment List	--	[Device Para /IEC61850]
 VirtualOutput7	Virtual Output. This signal can be assigned or visualized via the SCD file to other devices within the IEC61850 substation.	1..n, Assignment List	--	[Device Para /IEC61850]

Parameter	Description	Setting range	Default	Menu path
VirtualOutput8 	Virtual Output. This signal can be assigned or visualized via the SCD file to other devices within the IEC61850 substation.	1..n, Assignment List	--	[Device Para /IEC61850]
VirtualOutput9 	Virtual Output. This signal can be assigned or visualized via the SCD file to other devices within the IEC61850 substation.	1..n, Assignment List	--	[Device Para /IEC61850]
VirtualOutput10 	Virtual Output. This signal can be assigned or visualized via the SCD file to other devices within the IEC61850 substation.	1..n, Assignment List	--	[Device Para /IEC61850]
VirtualOutput11 	Virtual Output. This signal can be assigned or visualized via the SCD file to other devices within the IEC61850 substation.	1..n, Assignment List	--	[Device Para /IEC61850]
VirtualOutput12 	Virtual Output. This signal can be assigned or visualized via the SCD file to other devices within the IEC61850 substation.	1..n, Assignment List	--	[Device Para /IEC61850]
VirtualOutput13 	Virtual Output. This signal can be assigned or visualized via the SCD file to other devices within the IEC61850 substation.	1..n, Assignment List	--	[Device Para /IEC61850]
VirtualOutput14 	Virtual Output. This signal can be assigned or visualized via the SCD file to other devices within the IEC61850 substation.	1..n, Assignment List	--	[Device Para /IEC61850]
VirtualOutput15 	Virtual Output. This signal can be assigned or visualized via the SCD file to other devices within the IEC61850 substation.	1..n, Assignment List	--	[Device Para /IEC61850]
VirtualOutput16 	Virtual Output. This signal can be assigned or visualized via the SCD file to other devices within the IEC61850 substation.	1..n, Assignment List	--	[Device Para /IEC61850]

**States of the Inputs of the IEC 61850**

<i>Name</i>	<i>Description</i>	<i>Assignment via</i>
VirtOut1-I	Module input state: Binary state of the Virtual Output (GGIO)	[Device Para /IEC61850]
VirtOut2-I	Module input state: Binary state of the Virtual Output (GGIO)	[Device Para /IEC61850]
VirtOut3-I	Module input state: Binary state of the Virtual Output (GGIO)	[Device Para /IEC61850]
VirtOut4-I	Module input state: Binary state of the Virtual Output (GGIO)	[Device Para /IEC61850]
VirtOut5-I	Module input state: Binary state of the Virtual Output (GGIO)	[Device Para /IEC61850]
VirtOut6-I	Module input state: Binary state of the Virtual Output (GGIO)	[Device Para /IEC61850]
VirtOut7-I	Module input state: Binary state of the Virtual Output (GGIO)	[Device Para /IEC61850]
VirtOut8-I	Module input state: Binary state of the Virtual Output (GGIO)	[Device Para /IEC61850]
VirtOut9-I	Module input state: Binary state of the Virtual Output (GGIO)	[Device Para /IEC61850]
VirtOut10-I	Module input state: Binary state of the Virtual Output (GGIO)	[Device Para /IEC61850]
VirtOut11-I	Module input state: Binary state of the Virtual Output (GGIO)	[Device Para /IEC61850]
VirtOut12-I	Module input state: Binary state of the Virtual Output (GGIO)	[Device Para /IEC61850]
VirtOut13-I	Module input state: Binary state of the Virtual Output (GGIO)	[Device Para /IEC61850]
VirtOut14-I	Module input state: Binary state of the Virtual Output (GGIO)	[Device Para /IEC61850]
VirtOut15-I	Module input state: Binary state of the Virtual Output (GGIO)	[Device Para /IEC61850]
VirtOut16-I	Module input state: Binary state of the Virtual Output (GGIO)	[Device Para /IEC61850]

**IEC 61850 Module Signals (Output States)**

<i>Signal</i>	<i>Description</i>
VirtInp1	Signal: Virtual Input (IEC61850 GGIO Ind)
VirtInp2	Signal: Virtual Input (IEC61850 GGIO Ind)
VirtInp3	Signal: Virtual Input (IEC61850 GGIO Ind)
VirtInp4	Signal: Virtual Input (IEC61850 GGIO Ind)
VirtInp5	Signal: Virtual Input (IEC61850 GGIO Ind)
VirtInp6	Signal: Virtual Input (IEC61850 GGIO Ind)
VirtInp7	Signal: Virtual Input (IEC61850 GGIO Ind)
VirtInp8	Signal: Virtual Input (IEC61850 GGIO Ind)
VirtInp9	Signal: Virtual Input (IEC61850 GGIO Ind)
VirtInp10	Signal: Virtual Input (IEC61850 GGIO Ind)
VirtInp11	Signal: Virtual Input (IEC61850 GGIO Ind)
VirtInp12	Signal: Virtual Input (IEC61850 GGIO Ind)
VirtInp13	Signal: Virtual Input (IEC61850 GGIO Ind)
VirtInp14	Signal: Virtual Input (IEC61850 GGIO Ind)
VirtInp15	Signal: Virtual Input (IEC61850 GGIO Ind)
VirtInp16	Signal: Virtual Input (IEC61850 GGIO Ind)

### IEC 61850 Module Values

<i>Value</i>	<i>Description</i>	<i>Default</i>	<i>Size</i>	<i>Menu path</i>
NoOfGooseRxAll	Total number of received GOOSE messages including messages for other devices (subscribed and not subscribed messages).	0	0 - 9999999999	[Operation /Count and RevData /IEC61850]
NoOfGooseRxSubscribed	Total Number of subscribed GOOSE messages including messages with incorrect content.	0	0 - 9999999999	[Operation /Count and RevData /IEC61850]
NoOfGooseRxCorrect	Total Number of subscribed and correctly received GOOSE messages.	0	0 - 9999999999	[Operation /Count and RevData /IEC61850]
NoOfGooseRxNew	Number of subscribed and correctly received GOOSE messages with new content.	0	0 - 9999999999	[Operation /Count and RevData /IEC61850]
NoOfGooseTxAll	Total Number of GOOSE messages that have been published by this device.	0	0 - 9999999999	[Operation /Count and RevData /IEC61850]
NoOfGooseTxNew	Total Number of new GOOSE messages (modified content) that have been published by this device.	0	0 - 9999999999	[Operation /Count and RevData /IEC61850]
NoOfServerRequestsAll	Total number of MMS Server requests including incorrect requests.	0	0 - 9999999999	[Operation /Count and RevData /IEC61850]
NoOfDataReadAll	Total Number of values read from this device including incorrect requests.	0	0 - 9999999999	[Operation /Count and RevData /IEC61850]
NoOfDataReadCorrect	Total Number of correctly read values from this device.	0	0 - 9999999999	[Operation /Count and RevData /IEC61850]
NoOfDataWrittenAll	Total Number of values written by this device including incorrect ones.	0	0 - 9999999999	[Operation /Count and RevData /IEC61850]



<i>Value</i>	<i>Description</i>	<i>Default</i>	<i>Size</i>	<i>Menu path</i>
NoOfDataWrittenCorrect	Total Number of correctly written values by this device.	0	0 - 999999999	[Operation /Count and RevData /IEC61850]
NoOfDataChangeNotification	Number of detected changes within the datasets that are published with GOOSE messages.	0	0 - 999999999	[Operation /Count and RevData /IEC61850]

### Values of the IEC 61850

<i>Value</i>	<i>Description</i>	<i>Default</i>	<i>Size</i>	<i>Menu path</i>
GoosePublisherState	State of the GOOSE Publisher (on or off)	Off	Off, On, Error	[Operation /Status display /IEC61850]
GooseSubscriberState	State of the GOOSE Subscriber (on or off)	Off	Off, On, Error	[Operation /Status display /IEC61850]
MmsServerState	State of MMS Server (on or off)	Off	Off, On, Error	[Operation /Status display /IEC61850]

# Time Synchronisation

## TimeZones

The user has the possibility to synchronise the device with a central time generator. This offers the following advantages:

- The time does not drift off from the reference time. A continuously accumulating deviation from the reference time thereby will be balanced. Also refer to the chapter Specifications (Tolerances Real Time Clock).
- All time synchronised devices operate with the same time. Thus logged events of the individual devices can be compared exactly and be evaluated in conjunction (single events of the event recorder, disturbance records).

The device's time can be synchronised via the following protocols:

- IRIG-B
- SNTP
- Communications-Protocol Modbus (RTU or TCP)
- Communications-Protocol IEC60870-5-103

The provided protocols use different hardware interfaces and differ also in their achieved time accuracy. Further information can be found in the chapter Specifications.

<i>Used Protocol</i>	<i>Hardware-Interface</i>	<i>Recommended Application</i>
Without time synchronisation	---	Not recommended
IRIG-B	IRIG-B Terminal	Recommended, if interface available
SNTP	RJ45 (Ethernet)	Recommended alternative to IRIG-B, especially when using IEC 61850 or Modbus TCP
Modbus RTU	RS485, D-SUB or Fibre Optic	Recommended when using Modbus RTU communication protocol and when no IRIG-B code generator is available
Modbus TCP	RJ45 (Ethernet)	Limited recommendation when Modbus TCP communication protocol is used and no IRIG-B code generator or SNTP-Server is available
IEC 60870-5-103	RS485, D-SUB or Fibre Optic	Recommended when using IEC 10870-5-103 communication protocol and no IRIG-B code generator is available

## Accuracy of Time Synchronisation

The accuracy of the device's synchronised system time depends on several factors:

- accuracy of the connected time generator
- used synchronisation protocol
- when using Modbus TCP or SNTP: Network load and data package transmission times

## NOTICE

Please consider the accuracy of the used time generator. Fluctuations of the time generator's time will cause the same fluctuations of the protection relay's system time.

### Selection of Timezone and Synchronisation Protocol

The protection relay masters both UTC and local time. This means that the device can be synchronised with UTC time while using local time for user display.

#### Time Synchronisation with UTC time (recommended):

Time synchronisation is usually done using UTC time. This means for example that an IRIG-B time generator is sending UTC time information to the protection relay. This is the recommended use case, since here a continuous time synchronisation can be ensured. There are no "leaps in time" through change of summer- and wintertime.

To achieve that the device shows the current local time, the timezone and the change between summer- and wintertime can be configured.

Please carry out the following parameterization steps under [Device Para/ Time]:

1. Select your local timezone in the timezone menu.
2. There also configure the switching of daylight saving time.
3. Select the used time synchronisation protocol in the TimeSync menu (e.g. "IRIG-B").
4. Set the parameters of the synchronisation protocol (refer to the according chapter).

#### Time Synchronisation with local time:

Should the time synchronisation however be done using local time, then please leave the timezone to »UTC+0 London« and do not use switching of daylight saving time.

## NOTICE

The synchronisation of the relay's system time is exclusively done by the synchronisation protocol selected in the menu [Device Para/ Time/ TimeSync/ Used Protocol].

#### Without Time Synchronisation:







To achieve that the device shows the current local time, the timezone and the change between summer- and wintertime can be configured.







Please carry out the following parameterization steps under [Device Para/ Time]:

5. Select your local timezone in the timezone menu.
6. There also configure the switching of daylight saving time.
7. Select »manual« as your used protocol in the TimeSync menu.
8. Set date and time.

### Global Protection Parameters of the Time Synchronization

## Time Synchronisation

<i>Parameter</i>	<i>Description</i>	<i>Setting range</i>	<i>Default</i>	<i>Menu path</i>
DST offset 	Difference to wintertime	-180 - 180min	60min	[Device Para /Time /Timezone]
DST manual 	Manual setting of the Daylight Saving Time	inactive, active	active	[Device Para /Time /Timezone]
Summertime 	Daylight Saving Time  Only available if: DST manual = active	inactive, active	inactive	[Device Para /Time /Timezone]
Summertime m 	Month of clock change summertime  Only available if: DST manual = active	January, February, March, April, May, June, July, August, September, October, November, December	March	[Device Para /Time /Timezone]
Summertime d 	Day of clock change summertime  Only available if: DST manual = active	Sunday, Monday, Tuesday, Wednesday, Thursday, Friday, Saturday, General day	Saturday	[Device Para /Time /Timezone]
Summertime w 	Place of selected day in month (for clock change summertime)  Only available if: DST manual = active	First, Second, Third, Fourth, Last	Last	[Device Para /Time /Timezone]

<i>Parameter</i>	<i>Description</i>	<i>Setting range</i>	<i>Default</i>	<i>Menu path</i>
Summertime h 	Hour of clock change summertime Only available if: DST manual = active	0 - 23h	2h	[Device Para /Time /Timezone]
Summertime min 	Minute of clock change summertime Only available if: DST manual = active	0 - 59min	0min	[Device Para /Time /Timezone]
Wintertime m 	Month of clock change wintertime Only available if: DST manual = active	January, February, March, April, May, June, July, August, September, October, November, December	October	[Device Para /Time /Timezone]
Wintertime d 	Day of clock change wintertime Only available if: DST manual = active	Sunday, Monday, Tuesday, Wednesday, Thursday, Friday, Saturday, General day	Saturday	[Device Para /Time /Timezone]
Wintertime w 	Place of selected day in month (for clock change wintertime) Only available if: DST manual = active	First, Second, Third, Fourth, Last	Last	[Device Para /Time /Timezone]
Wintertime h 	Hour of clock change wintertime Only available if: DST manual = active	0 - 23h	3h	[Device Para /Time /Timezone]

## Time Synchronisation

---

<i>Parameter</i>	<i>Description</i>	<i>Setting range</i>	<i>Default</i>	<i>Menu path</i>
Wintertime min 	Minute of clock change wintertime  Only available if: DST manual = active	0 - 59min	0min	[Device Para /Time /Timezone]

<i>Parameter</i>	<i>Description</i>	<i>Setting range</i>	<i>Default</i>	<i>Menu path</i>
Time Zones 	Time Zones	UTC+14 Kiritimati, UTC+13 Rawaki, UTC+12.75 Chat- ham Island, UTC+12 Welling- ton, UTC+11.5 Kings- ton, UTC+11 Port Vila, UTC+10.5 Lord Howe Island, UTC+10 Sydney, UTC+9.5 Adelaide, UTC+9 Tokyo, UTC+8 Hong Kong, UTC+7 Bangkok, UTC+6.5 Rangoon, UTC+6 Colombo, UTC+5.75 Kath- mandu, UTC+5.5 New Del- hi, UTC+5 Islamabad, UTC+4.5 Kabul, UTC+4 Abu Dhabi, UTC+3.5 Tehran, UTC+3 Moscow, UTC+2 Athens, UTC+1 Berlin, UTC+0 London, UTC-1 Azores, UTC-2 Fern. d. No- ronha, UTC-3 Buenos Ai- res, UTC-3.5 St. John's, UTC-4 Santiago, UTC-5 New York, UTC-6 Chicago, UTC-7 Salt Lake City, UTC-8 Los Ange- les,	UTC+0 London	[Device Para /Time /Timezone]

## Time Synchronisation

---

<i>Parameter</i>	<i>Description</i>	<i>Setting range</i>	<i>Default</i>	<i>Menu path</i>
TimeSync 	Time synchronisation	-, IRIG-B, SNTP, Modbus, IEC60870-5-103	-	[Device Para /Time /TimeSync /TimeSync]



## SNTP

### SNTP

#### **NOTICE**

**Important pre-condition: The protective relay needs to have access to a SNTP server via the connected network. This server preferably should be installed locally.**

### Principle – General Use

SNTP is a standard protocol for time synchronisation via a network. For this at least one SNTP server has to be available within the network. The device can be configured for one or two SNTP servers.

The protection relay's system time will be synchronised with the connected SNTP server 1-4 times per minute. In turn the SNTP server synchronises its time via NTP with other NTP servers. This is the normal case. Alternatively it can synchronise its time via GPS, radio controlled clock or the like.

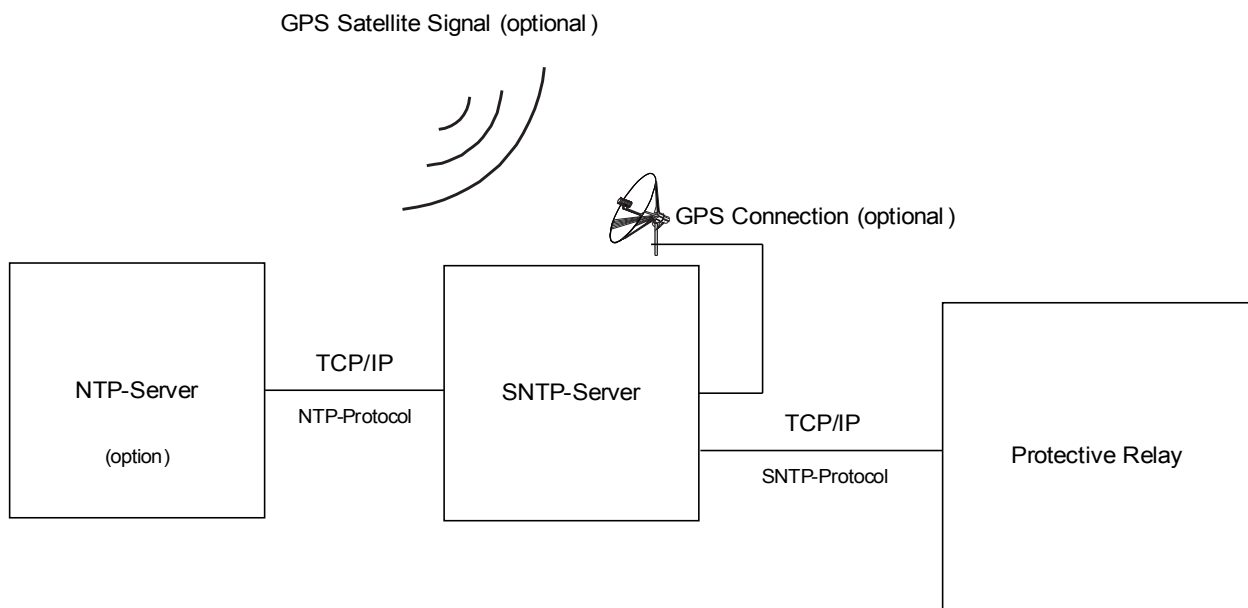

### Accuracy

The accuracy of the used SNTP server and the excellence of its reference clock influences the accuracy of the protection relay's clock.

For further information about accuracy refer to chapter Specifications.

With each transmitted time information, the SNTP server also sends information about its accuracy:

- **Stratum:** The stratum indicates over how many interacting NTP-Servers the used SNTP server is connected to an atomic or radio controlled clock.
- **Precision:** This indicates the accuracy of the system time provided by the SNTP server.

Additionally the performance of the connected network (traffic and data package transmission times) has an influence on the accuracy of the time synchronisation.

Recommended is a locally installed SNTP server with an accuracy of  $\leq 200$   $\mu$ sec. If this cannot be realised, the connected server's excellence can be checked in the menu [Operation/Status Display/TimeSync]:

- The server quality gives information about the accuracy of the used server. The quality should be GOOD or SUFFICIENT. A server with BAD quality should not be used, because this could cause fluctuations in time synchronisation.
- The network quality gives information about the network's load and data package transmission time. The quality should be GOOD or SUFFICIENT. A network with BAD quality should not be used, because this could cause fluctuations in time synchronisation.

### Using two SNTP Servers

When configuring two SNTP servers, the device selects the server with the lower stratum value, because this generally provides a more precise time synchronisation. If the servers have the same stratum value, the device selects the server with the better precision. It does not matter, which of the servers is configured as server 1 or server 2.

When the last used server fails, the device automatically switches to the other server. Should the first server recover after some time, the device switches back to this (better) server automatically.

### SNTP Commissioning

Activate the SNTP time synchronisation by means of the menu [Device Para/ Time/ TimeSync]:

- Select »SNTP« in the time synchronisation menu.
- Set the IP address of the first server in the SNTP menu.
- Set the IP address of the second server, if available.
- Set all configured servers to "active".

## Fault Analysis

If there is no SNTP signal for more than 120 sec, the SNTP status changes from “active” to “inactive” and an entry in the Event Recorder will be created.

The SNTP functionality can be checked in the menu [Operation/Status Display/TimeSync/Sntp]:  
If the SNTP status is not indicated as being “active”, please proceed as follows:

- Check if the wiring is correct (Ethernet-cable connected).
- Check if a valid IP address is set in the device (Device Para/TCP/IP).
- Check if the Ethernet connection is active (Device Para/TCP/IP/Link = Up?).
- Check if both the SNTP server and the protection device answer to a Ping.
- Check if the SNTP server is up and working.





## Device Planning Parameters of the SNTP

Parameter	Description	Options	Default	Menu path
Mode 	Mode	do not use, use	do not use	[Device planning]





## Direct Commands of the SNTP

Parameter	Description	Setting range	Default	Menu path
Res Counter 	Reset all Counters.	inactive, active	inactive	[Operation /Reset]

## Global Protection Parameters of the SNTP

Parameter	Description	Setting range	Default	Menu path
Server1 	Server 1	inactive, active	inactive	[Device Para /Time /TimeSync /SNTP]
IP Byte1 	IP1.IP2.IP3.IP4	0 - 255	0	[Device Para /Time /TimeSync /SNTP]
IP Byte2 	IP1.IP2.IP3.IP4	0 - 255	0	[Device Para /Time /TimeSync /SNTP]
IP Byte3 	IP1.IP2.IP3.IP4	0 - 255	0	[Device Para /Time /TimeSync /SNTP]
IP Byte4 	IP1.IP2.IP3.IP4	0 - 255	0	[Device Para /Time /TimeSync /SNTP]

## Time Synchronisation

<i>Parameter</i>	<i>Description</i>	<i>Setting range</i>	<i>Default</i>	<i>Menu path</i>
Server2 	Server 2	inactive, active	inactive	[Device Para /Time /TimeSync /SNTP]
IP Byte1 	IP1.IP2.IP3.IP4	0 - 255	0	[Device Para /Time /TimeSync /SNTP]
IP Byte2 	IP1.IP2.IP3.IP4	0 - 255	0	[Device Para /Time /TimeSync /SNTP]
IP Byte3 	IP1.IP2.IP3.IP4	0 - 255	0	[Device Para /Time /TimeSync /SNTP]
IP Byte4 	IP1.IP2.IP3.IP4	0 - 255	0	[Device Para /Time /TimeSync /SNTP]

## Signals of the SNTP

<i>Signal</i>	<i>Description</i>
SNTP active	Signal: If there is no valid SNTP signal for 120 sec, SNTP is regarded as inactive.

## SNTP Counters

<i>Value</i>	<i>Description</i>	<i>Default</i>	<i>Size</i>	<i>Menu path</i>
NoOfSynchs	Total Number of Synchronizations.	0	0 - 9999999999	[Operation /Count and RevData /TimeSync /SNTP]
NoOfConnectLost	Total Number of lost SNTP Connections (no sync for 120 sec).	0	0 - 9999999999	[Operation /Count and RevData /TimeSync /SNTP]
NoOfSmallSynchs	Service counter: Total Number of very small Time Corrections.	0	0 - 9999999999	[Operation /Count and RevData /TimeSync /SNTP]
NoOfNormSynchs	Service counter: Total Number of normal Time Corrections	0	0 - 9999999999	[Operation /Count and RevData /TimeSync /SNTP]
NoOfBigSynchs	Service counter: Total Number of big Time Corrections	0	0 - 9999999999	[Operation /Count and RevData /TimeSync /SNTP]
NoOfFiltSynchs	Service counter: Total Number of filtered Time Corrections	0	0 - 9999999999	[Operation /Count and RevData /TimeSync /SNTP]
NoOfSlowTrans	Service counter: Total Number of slow Transfers.	0	0 - 9999999999	[Operation /Count and RevData /TimeSync /SNTP]
NoOfHighOffs	Service counter: Total Number of high Offsets.	0	0 - 9999999999	[Operation /Count and RevData /TimeSync /SNTP]

## Time Synchronisation

<i>Value</i>	<i>Description</i>	<i>Default</i>	<i>Size</i>	<i>Menu path</i>
NoOfIntTimeouts	Service counter: Total Number of internal timeouts.	0	0 - 999999999	[Operation /Count and RevData /TimeSync /SNTP]
StratumServer1	Stratum of Server 1	0	0 - 999999999	[Operation /Status display /TimeSync /SNTP]
StratumServer2	Stratum of Server 2	0	0 - 999999999	[Operation /Status display /TimeSync /SNTP]

## SNTP Values

<i>Value</i>	<i>Description</i>	<i>Default</i>	<i>Size</i>	<i>Menu path</i>
Used Server	Which Server is used for SNTP synchronization.	None	Server1, Server2, None	[Operation /Status display /TimeSync /SNTP]
PrecServer1	Precision of Server 1	0ms	0 - 1000.00000ms	[Operation /Status display /TimeSync /SNTP]
PrecServer2	Precision of Server 2	0ms	0 - 1000.00000ms	[Operation /Status display /TimeSync /SNTP]
ServerQty	Quality of Server used for Synchronization (GOOD, SUFFICIENT, BAD)	-	GOOD, SUFFICIENT, BAD, -	[Operation /Status display /TimeSync /SNTP]
NetConn	Quality of Network Connection (GOOD, SUFFICIENT, BAD).	-	GOOD, SUFFICIENT, BAD, -	[Operation /Status display /TimeSync /SNTP]

## IRIG-B00X

### IRIG-B

**NOTICE** Requirement: An IRIG-B00X time code generator is needed. IRIG-B004 and higher will support/transmit the “year information”.

If you are using an IRIG time code that does not support the “year information” (IRIG-B000, IRIG-B001, IRIG-B002, IRIG-B003), you have to set the “year” manually within the device. In these cases the correct year information is a precondition for a properly working IRIG-B.

### Principle - General Use

The IRIG-B standard is the most used standard to synchronize the time of protection devices in medium voltage applications.

The protection device supports IRIG-B according to the IRIG STANDARD 200-04. This means that all time synchronization formats IRIG-B00X (IRIG-B000 / B001 / B002 / B003 / B004 / B005 / B006 / B007) are supported. It is recommended to use IRIG-B004 and higher which also transmits the “year information”.

The system time of the protection device is being synchronized with the connected IRIG-B code generator once a second. The accuracy of the used IRIG-B code generator can be increased by connecting a GPS-receiver to it.

GPS Satellite Signal (optional)

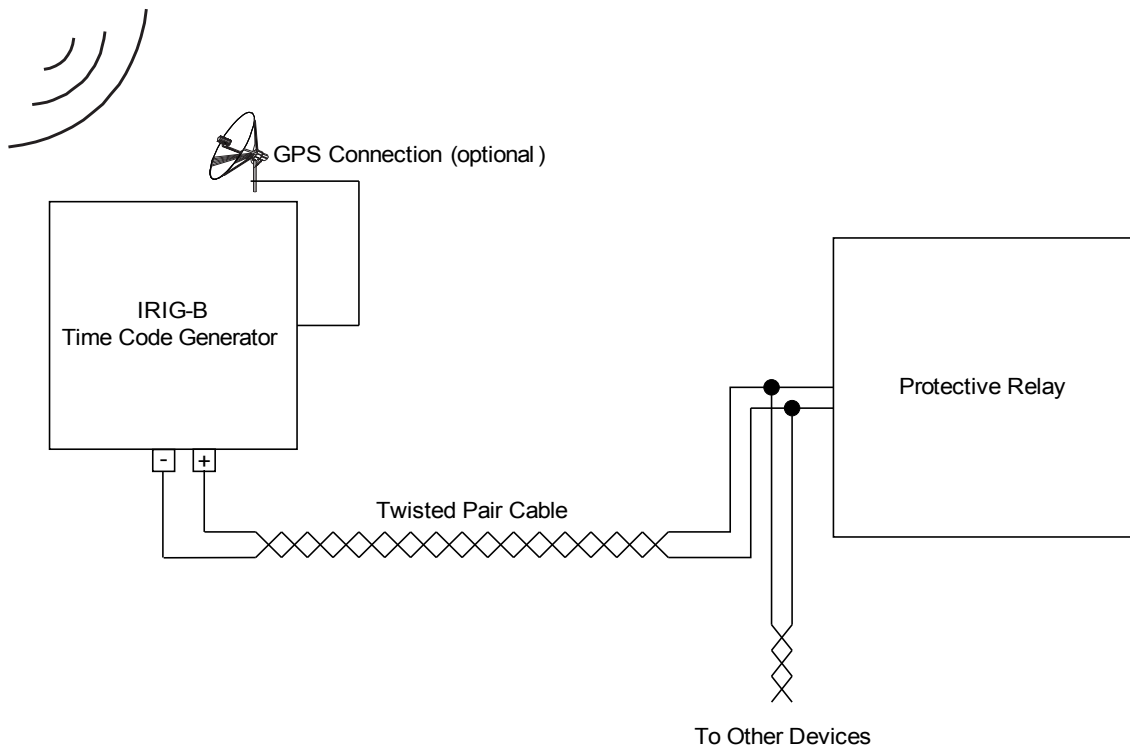

The location of the IRIG-B interface depends to the device type. Please refer to the wiring diagram supplied with the protective device.



## IRIG-B Commissioning

Activate the IRIG-B synchronization within menu [Device Para/ Time/ TimeSync]:

- Select »IRIG-B« in the time synchronisation menu.
- Set the time synchronization in the IRIG-B menu to »Active«.
- Select the IRIG-B type (choose B000 through B007).

## Fault Analysis

If the device does not receive any IRIG-B time code for more than 60 s, the IRIG-B status switches from »active« to »inactive« and there is created an entry within the Event Recorder.

Check the IRIG-B functionality through the menu [Operation/ Status display/ TimeSync/ IRIG-B]:  
Should the IRIG-B status not be reported as being »active«, please proceed as follows:

- To begin with check the IRIG-B wiring.
- Check, if the correct IRIG-B00X type is configured.

## IRIG-B Control Commands

In addition to the date and time information, the IRIG-B code offers the option to transmit up to 18 control commands that can be processed by the protective device. They have to be set and issued by the IRIG-B code generator.

The protective device offers up to 18 IRIG-B assignment options for those control commands in order to carry out the assigned action. If there is a control command assigned to an action, this action is being triggered as soon as the control command is transmitted as being true. As an example there can be triggered the start of statistics or the street lighting can be switched on through a relay.



### Device Planning Parameters of the IRIG-B00X

<i>Parameter</i>	<i>Description</i>	<i>Options</i>	<i>Default</i>	<i>Menu path</i>
Mode 	Mode	do not use, use	do not use	[Device planning]

### Direct Commands of the IRIG-B00X

<i>Parameter</i>	<i>Description</i>	<i>Setting range</i>	<i>Default</i>	<i>Menu path</i>
Res IRIG-B Cr 	Resetting of the Diagnosis Counters: IRIG-B	inactive, active	inactive	[Operation /Reset]

### Global Protection Parameters of the IRIG-B00X

<i>Parameter</i>	<i>Description</i>	<i>Setting range</i>	<i>Default</i>	<i>Menu path</i>
Function 	Permanent activation or deactivation of module/stage.	inactive, active	inactive	[Device Para /Time /TimeSync /IRIG-B]
IRIG-B00X 	Determination of the Type: IRIG-B00X. IRIG-B types differ in types of included "Coded Expressions" (year, control-functions, straight-binary-seconds).	IRIGB-000, IRIGB-001, IRIGB-002, IRIGB-003, IRIGB-004, IRIGB-005, IRIGB-006, IRIGB-007	IRIGB-000	[Device Para /Time /TimeSync /IRIG-B]

### Signals of the IRIG-B00X (Output States)

<i>Signal</i>	<i>Description</i>
active	Signal: active
inverted	Signal: IRIG-B inverted
Control Signal1	Signal: IRIG-B Control Signal
Control Signal2	Signal: IRIG-B Control Signal
Control Signal4	Signal: IRIG-B Control Signal
Control Signal5	Signal: IRIG-B Control Signal
Control Signal6	Signal: IRIG-B Control Signal
Control Signal7	Signal: IRIG-B Control Signal
Control Signal8	Signal: IRIG-B Control Signal
Control Signal9	Signal: IRIG-B Control Signal
Control Signal10	Signal: IRIG-B Control Signal
Control Signal11	Signal: IRIG-B Control Signal
Control Signal12	Signal: IRIG-B Control Signal
Control Signal13	Signal: IRIG-B Control Signal
Control Signal14	Signal: IRIG-B Control Signal
Control Signal15	Signal: IRIG-B Control Signal
Control Signal16	Signal: IRIG-B Control Signal
Control Signal17	Signal: IRIG-B Control Signal
Control Signal18	Signal: IRIG-B Control Signal

### IRIG-B00X Values

<i>Value</i>	<i>Description</i>	<i>Default</i>	<i>Size</i>	<i>Menu path</i>
NoOffFramesOK	Total Number valid Frames.	0	0 - 65535	[Operation /Count and RevData /TimeSync /IRIG-B]
NoOffFrameErrors	Total Number of Frame Errors. Physically corrupted Frame.	0	0 - 65535	[Operation /Count and RevData /TimeSync /IRIG-B]
Edges	Edges	0	0 - 65535	[Operation /Count and RevData /TimeSync /IRIG-B]

## Parameters

Parameter setting and planning can be done:

- directly at the device or
- by way of the *Smart view* software.

## Parameter Definitions

### Device Parameters

**Device Parameters** are part of the Device Parameter Tree. By means of them you can (depending on the type of device):

- Set cutoff levels,
- Configure Digital Inputs,
- Configure Output Relays,
- Assign LEDs,
- Assign Acknowledgment Signals,
- Configure Statistics,
- Configure Protocol Parameters,
- Adapt HMI Settings,
- Configure Recorders (reports),
- Set Date and Time,
- Change Passwords,
- Check the version (build) of the device.

### Field Parameters

**Field Parameters** are part of the Device Parameter Tree. Field Parameters comprise the essential, basic settings of your switchboard such as rated frequency, transformer ratios.

### Protection Parameters

**Protection Parameters** are part of the Device Parameter Tree. This tree comprises:

- **Global Protection Parameters are part of the Protection Parameters:** All settings and assignments that are done within the Global Parameter Tree are valid independent of the Setting Groups. They have to be set once only. In addition to that they comprise the CB Management.
- **The Parameter Setting Switch is part of the Protection Parameters:** You can either direct switch onto a certain parameter setting group or you can determine the conditions for switching onto another parameter setting group.
- **Setting Group Parameters are part of the Protection Parameters:** By means of the Parameter Setting Group Parameters you can individually adapt your protective device to the current conditions or grid conditions. They can be individually set in each Setting group.

## Device Planning Parameters

*Device Planning Parameters* are part of the Device Parameter Tree.

- **Improving the Usability (clearness):** All protection modules that are currently not needed can be de-protected (switched to invisible) by means of Device Planning. In Menu Device Planning you can adapt the scope of functionality of the protective device exactly to your needs. You can improve the usability by de-projecting all modules that are currently not needed.
- **Adapting the device to your application:** For those modules that you need, determine how they should work (e.g. directional, non-directional, <, >...).

## Direct Commands

*Direct Commands* are part of the Device Parameter Tree but they are **NOT** part of the parameter file. They will be executed directly (e.g. Resetting of a Counter).

## State of the Module Inputs

*Module Inputs* are part of the Device Parameter Tree. The State of the Module Input is context-dependent.

By means of the Module Inputs influence can be taken on the Modules. You can assign Signals onto **Module Inputs**. The state of the signals that are assigned to an input can be taken from the Status Display. Module Inputs can be identified by an „-I“ at the end of the name.

## Signals

*Signals* are part of the Device Parameter Tree. The state of the signal is context-dependent.

- **Signals** represent the state of your installation/equipment (e.g. Position Indicators of the Circuit Breaker).
- **Signals** are assessments of the state of the grid and the equipment (System OK, Transformer failure detected...).
- **Signals** represent decisions that are taken by the device (e.g. Trip command) based on your parameter settings.

# Adaptive Parameter Sets

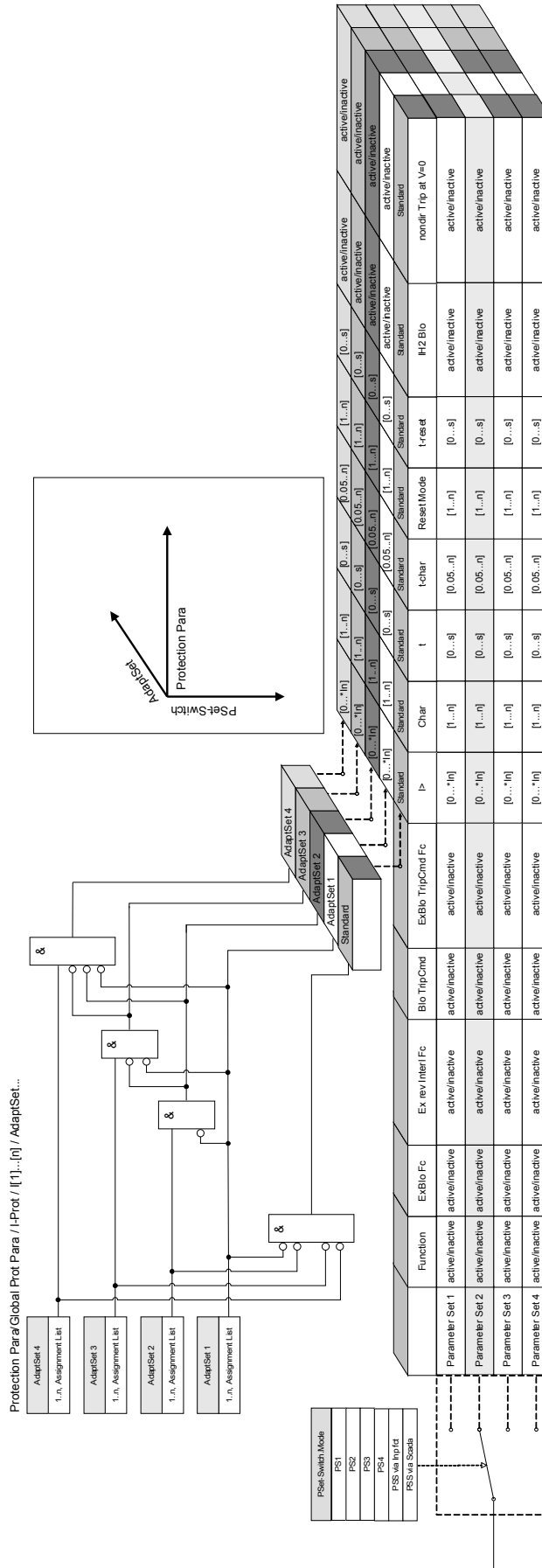

**Adaptive Parameter Sets** are part of the Device Parameter Tree.

By means of **Adaptive Parameter Sets** you can modify temporarily single parameters within the parameter setting groups.

**NOTICE**

Adaptive Parameters fall back automatically, if the acknowledged signal, that has activated them, has fallen back. Please take into account that Adaptive Set 1 is dominant to Adaptive Set 2. Adaptive Set 2 is dominant to Adaptive Set 3. Adaptive Set 3 is dominant to Adaptive Set 4.

**NOTICE**

In order to increase the usability (clearness) Adaptive Parameter Sets become visible if an corresponding activation signals has been assigned (Smart view 2.0 and higher).

**Example: In order to use Adaptive Parameters within Protective Element I[1] please proceed as follows:**

- Assign within the Global Parameter tree within Protective Element I[1] an activation signal for AdaptiveParameterSet 1.
- AdaptiveParameterSet 1 becomes now visible within the Protection Parameter Sets for element I[1].

**By means of additional activation signals further Adaptive Parameter Sets can be used.**

The functionality of the IED (relay) can be enhanced / adapted by means of **Adaptive Parameters** in order to meet the requirements of modified states of the grid or the power supply system respectively to manage unpredictable events.

Moreover, the adaptive parameter can also be used to realize various special protective functions or to expand the existing function modules in a simple way without to redesign the existing hardware or software platform costly.

The **Adaptive Parameter** feature allows, besides a standard parameter set, one of the four parameter sets labeled from 1 to 4, to be used for example in a time overcurrent element under the control of the configurable Set Control Logics. The dynamical switch-over of the adaptive parameter set is only active for a particular element when its adaptive set control logic is configured and only as long as the activation signal is true.

For some protection elements such as time overcurrent and instantaneous overcurrent ( 50P, 51P, 50G, 51G...), besides the "default" setting there exist another 4 "alternative" settings for pickup value, curve type, time dial, reset mode set values which can be switched-over dynamically by means of the configurable adaptive setting control logics in the single set parameter.

If the **Adaptive Parameter** feature is not used, the adaptive set control logics will not be selected (assigned). The protective elements work in this case just like a normal protection using the "Default" settings. If one of the **Adaptive Set Control logics** is assigned to a logic function, the protective element will be "switched-over" to the corresponding adaptive settings if the assigned logic function is asserted and will fall back to the "Default" Setting if the assigned signal that has been activated the **Adaptive Set** has fallen back.

### *Application Example*

During a Switch-OnTo-Fault condition, it is usually requested to make the embedded protective function tripping the faulted line faster, instantaneously or sometimes non-directionally.

Such a Switch-OnTo-Fault application can easily be realized using the **Adaptive Parameter** features above mentioned: The standard time overcurrent protection element (e.g. 51P) normally works with an inverse curve type (e.g. ANSI Type A), while in case of SOTF condition, it should trip instantaneously. If the SOTF logic function »SOTF\_ENABLED« is detecting a manual circuit breaker close condition the relay switches to **AdaptiveSet1** if the signal »SOTF\_ENABLED« is assigned to **AdaptiveSet1**. The corresponding **AdaptiveSet1** will become active and that means e.g. »curve type = DEFT« and »t = 0« sec.



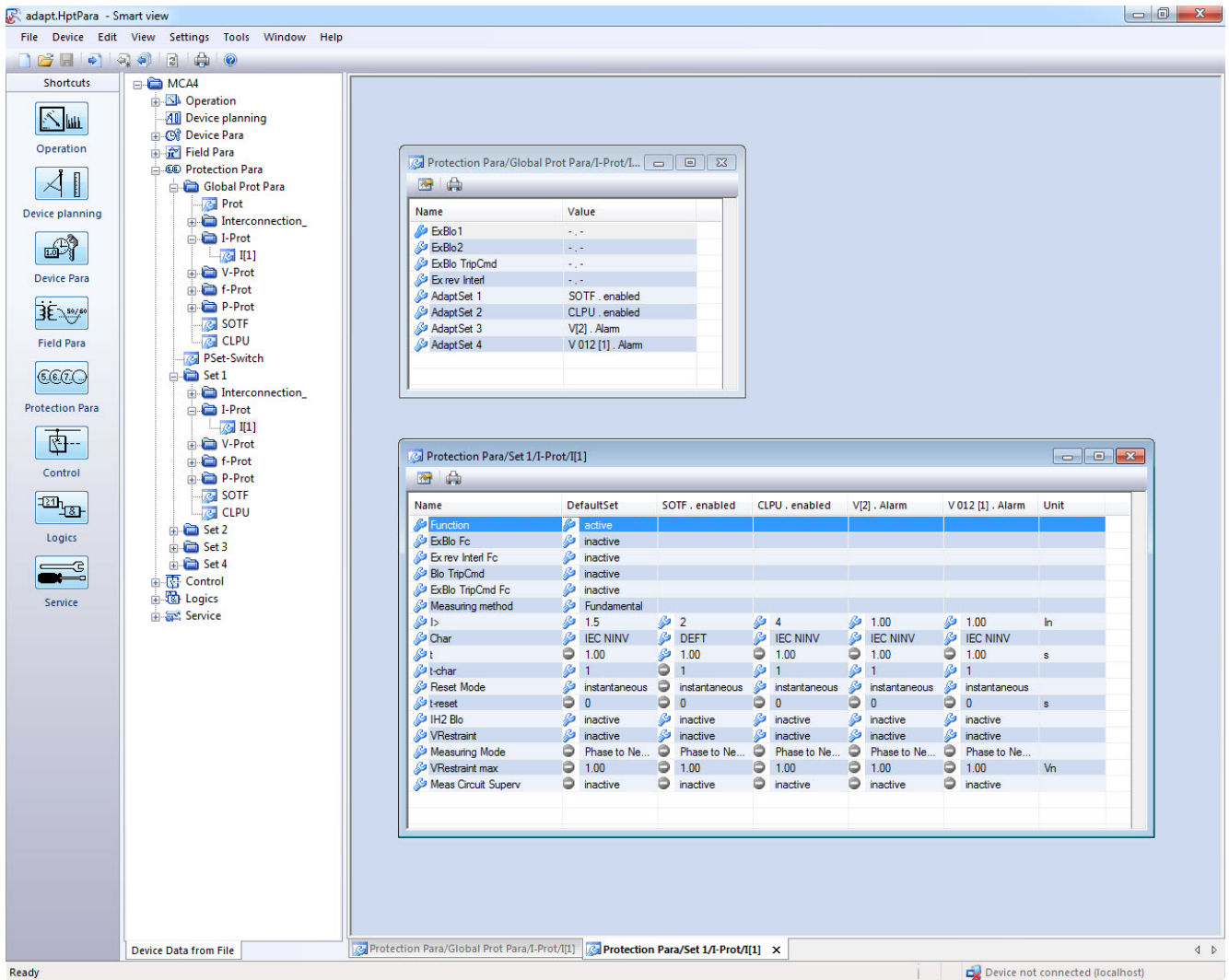

The screenshot above shows the adaptive setting configurations following applications based on only one simple overcurrent protection element:

1. Standard Set: Default settings
2. Adaptive Set 1: *SOTF* application (Switch-Onto-Fault)
3. Adaptive Set 2: *CLPU* application (Cold Load Pickup)
4. Adaptive Set 3: Voltage-Controlled time overcurrent protection (ANSI 51V)
5. Adaptive Set 4: Negative- Phase- Sequence- Voltage-Controlled time overcurrent protection

### *Application Examples*

- The output signal of the Switch Onto Fault module can be used to activate an **Adaptive Parameter Set** that sensibilizes the overcurrent protection.
- The output signal of the Cold Load Pickup module can be used to activate an **Adaptive Parameter Set** that desensitizes the overcurrent protection.
- By means of **Adaptive Parameter Sets** an Adaptive Auto Reclosure can be realized. After a reclosure attempt the tripping thresholds or tripping curves of the overcurrent protection can be adapted.
- Depending on undervoltage the overcurrent protection can be modified (Voltage Controlled).
- The earth overcurrent protection can be modified by the residual voltage.
- Matching the ground current protective settings dynamically and automatically according to the single-phase load diversity (Adaptive relay Setting – Normal Setting/Alternative Setting)

### **NOTICE**

**Adaptive Parameter Sets are only available for devices with current protection modules.**

## Adaptive Parameter Set Activation Signals

<i>Name</i>	<i>Description</i>
--	No assignment
IH2.Blo L1	Signal: Blocked L1
IH2.Blo L2	Signal: Blocked L2
IH2.Blo L3	Signal: Blocked L3
IH2.Blo IG meas	Signal: Blocking of the ground (earth) protection module (measured ground current)
IH2.Blo IG calc	Signal: Blocking of the ground (earth) protection module (calculated ground current)
IH2.3-ph Blo	Signal: Inrush was detected in at least one phase - trip command blocked.
V[1].Alarm	Signal: Alarm voltage stage
V[2].Alarm	Signal: Alarm voltage stage
V[3].Alarm	Signal: Alarm voltage stage
V[4].Alarm	Signal: Alarm voltage stage
V[5].Alarm	Signal: Alarm voltage stage
V[6].Alarm	Signal: Alarm voltage stage
Intertripping.Alarm	Signal: Alarm
LVRT.Alarm	Signal: Alarm voltage stage
LVRT.t-LVRT is running	Signal: t-LVRT is running
VG[1].Alarm	Signal: Alarm Residual Voltage Supervision-stage
VG[2].Alarm	Signal: Alarm Residual Voltage Supervision-stage
V012[1].Alarm	Signal: Alarm voltage asymmetry
V012[2].Alarm	Signal: Alarm voltage asymmetry
V012[3].Alarm	Signal: Alarm voltage asymmetry
V012[4].Alarm	Signal: Alarm voltage asymmetry
V012[5].Alarm	Signal: Alarm voltage asymmetry
V012[6].Alarm	Signal: Alarm voltage asymmetry
AR.running	Signal: Auto Reclosing running
AR.Pre Shot	Pre Shot Control
AR.Shot 1	Shot Control
AR.Shot 2	Shot Control
AR.Shot 3	Shot Control
AR.Shot 4	Shot Control
AR.Shot 5	Shot Control
AR.Shot 6	Shot Control
ExP[1].Alarm	Signal: Alarm
ExP[2].Alarm	Signal: Alarm
ExP[3].Alarm	Signal: Alarm
ExP[4].Alarm	Signal: Alarm
SOTF.enabled	Signal: Switch Onto Fault enabled. This Signal can be used to modify Overcurrent Protection Settings.
CLPU.enabled	Signal: Cold Load enabled

## Parameters

<i>Name</i>	<i>Description</i>
DI Slot X1.DI 1	Signal: Digital Input
DI Slot X1.DI 2	Signal: Digital Input
DI Slot X1.DI 3	Signal: Digital Input
DI Slot X1.DI 4	Signal: Digital Input
DI Slot X1.DI 5	Signal: Digital Input
DI Slot X1.DI 6	Signal: Digital Input
DI Slot X1.DI 7	Signal: Digital Input
DI Slot X1.DI 8	Signal: Digital Input
DI Slot X6.DI 1	Signal: Digital Input
DI Slot X6.DI 2	Signal: Digital Input
DI Slot X6.DI 3	Signal: Digital Input
DI Slot X6.DI 4	Signal: Digital Input
DI Slot X6.DI 5	Signal: Digital Input
DI Slot X6.DI 6	Signal: Digital Input
DI Slot X6.DI 7	Signal: Digital Input
DI Slot X6.DI 8	Signal: Digital Input
Logics.LE1.Gate Out	Signal: Output of the logic gate
Logics.LE1.Timer Out	Signal: Timer Output
Logics.LE1.Out	Signal: Latched Output (Q)
Logics.LE1.Out inverted	Signal: Negated Latched Output (Q NOT)
Logics.LE2.Gate Out	Signal: Output of the logic gate
Logics.LE2.Timer Out	Signal: Timer Output
Logics.LE2.Out	Signal: Latched Output (Q)
Logics.LE2.Out inverted	Signal: Negated Latched Output (Q NOT)
Logics.LE3.Gate Out	Signal: Output of the logic gate
Logics.LE3.Timer Out	Signal: Timer Output
Logics.LE3.Out	Signal: Latched Output (Q)
Logics.LE3.Out inverted	Signal: Negated Latched Output (Q NOT)
Logics.LE4.Gate Out	Signal: Output of the logic gate
Logics.LE4.Timer Out	Signal: Timer Output
Logics.LE4.Out	Signal: Latched Output (Q)
Logics.LE4.Out inverted	Signal: Negated Latched Output (Q NOT)
Logics.LE5.Gate Out	Signal: Output of the logic gate
Logics.LE5.Timer Out	Signal: Timer Output
Logics.LE5.Out	Signal: Latched Output (Q)
Logics.LE5.Out inverted	Signal: Negated Latched Output (Q NOT)
Logics.LE6.Gate Out	Signal: Output of the logic gate
Logics.LE6.Timer Out	Signal: Timer Output
Logics.LE6.Out	Signal: Latched Output (Q)
Logics.LE6.Out inverted	Signal: Negated Latched Output (Q NOT)

## Parameters

<i>Name</i>	<i>Description</i>
Logics.LE7.Gate Out	Signal: Output of the logic gate
Logics.LE7.Timer Out	Signal: Timer Output
Logics.LE7.Out	Signal: Latched Output (Q)
Logics.LE7.Out inverted	Signal: Negated Latched Output (Q NOT)
Logics.LE8.Gate Out	Signal: Output of the logic gate
Logics.LE8.Timer Out	Signal: Timer Output
Logics.LE8.Out	Signal: Latched Output (Q)
Logics.LE8.Out inverted	Signal: Negated Latched Output (Q NOT)
Logics.LE9.Gate Out	Signal: Output of the logic gate
Logics.LE9.Timer Out	Signal: Timer Output
Logics.LE9.Out	Signal: Latched Output (Q)
Logics.LE9.Out inverted	Signal: Negated Latched Output (Q NOT)
Logics.LE10.Gate Out	Signal: Output of the logic gate
Logics.LE10.Timer Out	Signal: Timer Output
Logics.LE10.Out	Signal: Latched Output (Q)
Logics.LE10.Out inverted	Signal: Negated Latched Output (Q NOT)
Logics.LE11.Gate Out	Signal: Output of the logic gate
Logics.LE11.Timer Out	Signal: Timer Output
Logics.LE11.Out	Signal: Latched Output (Q)
Logics.LE11.Out inverted	Signal: Negated Latched Output (Q NOT)
Logics.LE12.Gate Out	Signal: Output of the logic gate
Logics.LE12.Timer Out	Signal: Timer Output
Logics.LE12.Out	Signal: Latched Output (Q)
Logics.LE12.Out inverted	Signal: Negated Latched Output (Q NOT)
Logics.LE13.Gate Out	Signal: Output of the logic gate
Logics.LE13.Timer Out	Signal: Timer Output
Logics.LE13.Out	Signal: Latched Output (Q)
Logics.LE13.Out inverted	Signal: Negated Latched Output (Q NOT)
Logics.LE14.Gate Out	Signal: Output of the logic gate
Logics.LE14.Timer Out	Signal: Timer Output
Logics.LE14.Out	Signal: Latched Output (Q)
Logics.LE14.Out inverted	Signal: Negated Latched Output (Q NOT)
Logics.LE15.Gate Out	Signal: Output of the logic gate
Logics.LE15.Timer Out	Signal: Timer Output
Logics.LE15.Out	Signal: Latched Output (Q)
Logics.LE15.Out inverted	Signal: Negated Latched Output (Q NOT)
Logics.LE16.Gate Out	Signal: Output of the logic gate
Logics.LE16.Timer Out	Signal: Timer Output
Logics.LE16.Out	Signal: Latched Output (Q)
Logics.LE16.Out inverted	Signal: Negated Latched Output (Q NOT)

## Parameters

<i>Name</i>	<i>Description</i>
Logics.LE17.Gate Out	Signal: Output of the logic gate
Logics.LE17.Timer Out	Signal: Timer Output
Logics.LE17.Out	Signal: Latched Output (Q)
Logics.LE17.Out inverted	Signal: Negated Latched Output (Q NOT)
Logics.LE18.Gate Out	Signal: Output of the logic gate
Logics.LE18.Timer Out	Signal: Timer Output
Logics.LE18.Out	Signal: Latched Output (Q)
Logics.LE18.Out inverted	Signal: Negated Latched Output (Q NOT)
Logics.LE19.Gate Out	Signal: Output of the logic gate
Logics.LE19.Timer Out	Signal: Timer Output
Logics.LE19.Out	Signal: Latched Output (Q)
Logics.LE19.Out inverted	Signal: Negated Latched Output (Q NOT)
Logics.LE20.Gate Out	Signal: Output of the logic gate
Logics.LE20.Timer Out	Signal: Timer Output
Logics.LE20.Out	Signal: Latched Output (Q)
Logics.LE20.Out inverted	Signal: Negated Latched Output (Q NOT)
Logics.LE21.Gate Out	Signal: Output of the logic gate
Logics.LE21.Timer Out	Signal: Timer Output
Logics.LE21.Out	Signal: Latched Output (Q)
Logics.LE21.Out inverted	Signal: Negated Latched Output (Q NOT)
Logics.LE22.Gate Out	Signal: Output of the logic gate
Logics.LE22.Timer Out	Signal: Timer Output
Logics.LE22.Out	Signal: Latched Output (Q)
Logics.LE22.Out inverted	Signal: Negated Latched Output (Q NOT)
Logics.LE23.Gate Out	Signal: Output of the logic gate
Logics.LE23.Timer Out	Signal: Timer Output
Logics.LE23.Out	Signal: Latched Output (Q)
Logics.LE23.Out inverted	Signal: Negated Latched Output (Q NOT)
Logics.LE24.Gate Out	Signal: Output of the logic gate
Logics.LE24.Timer Out	Signal: Timer Output
Logics.LE24.Out	Signal: Latched Output (Q)
Logics.LE24.Out inverted	Signal: Negated Latched Output (Q NOT)
Logics.LE25.Gate Out	Signal: Output of the logic gate
Logics.LE25.Timer Out	Signal: Timer Output
Logics.LE25.Out	Signal: Latched Output (Q)
Logics.LE25.Out inverted	Signal: Negated Latched Output (Q NOT)
Logics.LE26.Gate Out	Signal: Output of the logic gate
Logics.LE26.Timer Out	Signal: Timer Output
Logics.LE26.Out	Signal: Latched Output (Q)
Logics.LE26.Out inverted	Signal: Negated Latched Output (Q NOT)

## Parameters

<i>Name</i>	<i>Description</i>
Logics.LE27.Gate Out	Signal: Output of the logic gate
Logics.LE27.Timer Out	Signal: Timer Output
Logics.LE27.Out	Signal: Latched Output (Q)
Logics.LE27.Out inverted	Signal: Negated Latched Output (Q NOT)
Logics.LE28.Gate Out	Signal: Output of the logic gate
Logics.LE28.Timer Out	Signal: Timer Output
Logics.LE28.Out	Signal: Latched Output (Q)
Logics.LE28.Out inverted	Signal: Negated Latched Output (Q NOT)
Logics.LE29.Gate Out	Signal: Output of the logic gate
Logics.LE29.Timer Out	Signal: Timer Output
Logics.LE29.Out	Signal: Latched Output (Q)
Logics.LE29.Out inverted	Signal: Negated Latched Output (Q NOT)
Logics.LE30.Gate Out	Signal: Output of the logic gate
Logics.LE30.Timer Out	Signal: Timer Output
Logics.LE30.Out	Signal: Latched Output (Q)
Logics.LE30.Out inverted	Signal: Negated Latched Output (Q NOT)
Logics.LE31.Gate Out	Signal: Output of the logic gate
Logics.LE31.Timer Out	Signal: Timer Output
Logics.LE31.Out	Signal: Latched Output (Q)
Logics.LE31.Out inverted	Signal: Negated Latched Output (Q NOT)
Logics.LE32.Gate Out	Signal: Output of the logic gate
Logics.LE32.Timer Out	Signal: Timer Output
Logics.LE32.Out	Signal: Latched Output (Q)
Logics.LE32.Out inverted	Signal: Negated Latched Output (Q NOT)
Logics.LE33.Gate Out	Signal: Output of the logic gate
Logics.LE33.Timer Out	Signal: Timer Output
Logics.LE33.Out	Signal: Latched Output (Q)
Logics.LE33.Out inverted	Signal: Negated Latched Output (Q NOT)
Logics.LE34.Gate Out	Signal: Output of the logic gate
Logics.LE34.Timer Out	Signal: Timer Output
Logics.LE34.Out	Signal: Latched Output (Q)
Logics.LE34.Out inverted	Signal: Negated Latched Output (Q NOT)
Logics.LE35.Gate Out	Signal: Output of the logic gate
Logics.LE35.Timer Out	Signal: Timer Output
Logics.LE35.Out	Signal: Latched Output (Q)
Logics.LE35.Out inverted	Signal: Negated Latched Output (Q NOT)
Logics.LE36.Gate Out	Signal: Output of the logic gate
Logics.LE36.Timer Out	Signal: Timer Output
Logics.LE36.Out	Signal: Latched Output (Q)
Logics.LE36.Out inverted	Signal: Negated Latched Output (Q NOT)

## Parameters

<i>Name</i>	<i>Description</i>
Logics.LE37.Gate Out	Signal: Output of the logic gate
Logics.LE37.Timer Out	Signal: Timer Output
Logics.LE37.Out	Signal: Latched Output (Q)
Logics.LE37.Out inverted	Signal: Negated Latched Output (Q NOT)
Logics.LE38.Gate Out	Signal: Output of the logic gate
Logics.LE38.Timer Out	Signal: Timer Output
Logics.LE38.Out	Signal: Latched Output (Q)
Logics.LE38.Out inverted	Signal: Negated Latched Output (Q NOT)
Logics.LE39.Gate Out	Signal: Output of the logic gate
Logics.LE39.Timer Out	Signal: Timer Output
Logics.LE39.Out	Signal: Latched Output (Q)
Logics.LE39.Out inverted	Signal: Negated Latched Output (Q NOT)
Logics.LE40.Gate Out	Signal: Output of the logic gate
Logics.LE40.Timer Out	Signal: Timer Output
Logics.LE40.Out	Signal: Latched Output (Q)
Logics.LE40.Out inverted	Signal: Negated Latched Output (Q NOT)
Logics.LE41.Gate Out	Signal: Output of the logic gate
Logics.LE41.Timer Out	Signal: Timer Output
Logics.LE41.Out	Signal: Latched Output (Q)
Logics.LE41.Out inverted	Signal: Negated Latched Output (Q NOT)
Logics.LE42.Gate Out	Signal: Output of the logic gate
Logics.LE42.Timer Out	Signal: Timer Output
Logics.LE42.Out	Signal: Latched Output (Q)
Logics.LE42.Out inverted	Signal: Negated Latched Output (Q NOT)
Logics.LE43.Gate Out	Signal: Output of the logic gate
Logics.LE43.Timer Out	Signal: Timer Output
Logics.LE43.Out	Signal: Latched Output (Q)
Logics.LE43.Out inverted	Signal: Negated Latched Output (Q NOT)
Logics.LE44.Gate Out	Signal: Output of the logic gate
Logics.LE44.Timer Out	Signal: Timer Output
Logics.LE44.Out	Signal: Latched Output (Q)
Logics.LE44.Out inverted	Signal: Negated Latched Output (Q NOT)
Logics.LE45.Gate Out	Signal: Output of the logic gate
Logics.LE45.Timer Out	Signal: Timer Output
Logics.LE45.Out	Signal: Latched Output (Q)
Logics.LE45.Out inverted	Signal: Negated Latched Output (Q NOT)
Logics.LE46.Gate Out	Signal: Output of the logic gate
Logics.LE46.Timer Out	Signal: Timer Output
Logics.LE46.Out	Signal: Latched Output (Q)
Logics.LE46.Out inverted	Signal: Negated Latched Output (Q NOT)



## Parameters

<i>Name</i>	<i>Description</i>
Logics.LE47.Gate Out	Signal: Output of the logic gate
Logics.LE47.Timer Out	Signal: Timer Output
Logics.LE47.Out	Signal: Latched Output (Q)
Logics.LE47.Out inverted	Signal: Negated Latched Output (Q NOT)
Logics.LE48.Gate Out	Signal: Output of the logic gate
Logics.LE48.Timer Out	Signal: Timer Output
Logics.LE48.Out	Signal: Latched Output (Q)
Logics.LE48.Out inverted	Signal: Negated Latched Output (Q NOT)
Logics.LE49.Gate Out	Signal: Output of the logic gate
Logics.LE49.Timer Out	Signal: Timer Output
Logics.LE49.Out	Signal: Latched Output (Q)
Logics.LE49.Out inverted	Signal: Negated Latched Output (Q NOT)
Logics.LE50.Gate Out	Signal: Output of the logic gate
Logics.LE50.Timer Out	Signal: Timer Output
Logics.LE50.Out	Signal: Latched Output (Q)
Logics.LE50.Out inverted	Signal: Negated Latched Output (Q NOT)
Logics.LE51.Gate Out	Signal: Output of the logic gate
Logics.LE51.Timer Out	Signal: Timer Output
Logics.LE51.Out	Signal: Latched Output (Q)
Logics.LE51.Out inverted	Signal: Negated Latched Output (Q NOT)
Logics.LE52.Gate Out	Signal: Output of the logic gate
Logics.LE52.Timer Out	Signal: Timer Output
Logics.LE52.Out	Signal: Latched Output (Q)
Logics.LE52.Out inverted	Signal: Negated Latched Output (Q NOT)
Logics.LE53.Gate Out	Signal: Output of the logic gate
Logics.LE53.Timer Out	Signal: Timer Output
Logics.LE53.Out	Signal: Latched Output (Q)
Logics.LE53.Out inverted	Signal: Negated Latched Output (Q NOT)
Logics.LE54.Gate Out	Signal: Output of the logic gate
Logics.LE54.Timer Out	Signal: Timer Output
Logics.LE54.Out	Signal: Latched Output (Q)
Logics.LE54.Out inverted	Signal: Negated Latched Output (Q NOT)
Logics.LE55.Gate Out	Signal: Output of the logic gate
Logics.LE55.Timer Out	Signal: Timer Output
Logics.LE55.Out	Signal: Latched Output (Q)
Logics.LE55.Out inverted	Signal: Negated Latched Output (Q NOT)
Logics.LE56.Gate Out	Signal: Output of the logic gate
Logics.LE56.Timer Out	Signal: Timer Output
Logics.LE56.Out	Signal: Latched Output (Q)
Logics.LE56.Out inverted	Signal: Negated Latched Output (Q NOT)

## Parameters

<i>Name</i>	<i>Description</i>
Logics.LE57.Gate Out	Signal: Output of the logic gate
Logics.LE57.Timer Out	Signal: Timer Output
Logics.LE57.Out	Signal: Latched Output (Q)
Logics.LE57.Out inverted	Signal: Negated Latched Output (Q NOT)
Logics.LE58.Gate Out	Signal: Output of the logic gate
Logics.LE58.Timer Out	Signal: Timer Output
Logics.LE58.Out	Signal: Latched Output (Q)
Logics.LE58.Out inverted	Signal: Negated Latched Output (Q NOT)
Logics.LE59.Gate Out	Signal: Output of the logic gate
Logics.LE59.Timer Out	Signal: Timer Output
Logics.LE59.Out	Signal: Latched Output (Q)
Logics.LE59.Out inverted	Signal: Negated Latched Output (Q NOT)
Logics.LE60.Gate Out	Signal: Output of the logic gate
Logics.LE60.Timer Out	Signal: Timer Output
Logics.LE60.Out	Signal: Latched Output (Q)
Logics.LE60.Out inverted	Signal: Negated Latched Output (Q NOT)
Logics.LE61.Gate Out	Signal: Output of the logic gate
Logics.LE61.Timer Out	Signal: Timer Output
Logics.LE61.Out	Signal: Latched Output (Q)
Logics.LE61.Out inverted	Signal: Negated Latched Output (Q NOT)
Logics.LE62.Gate Out	Signal: Output of the logic gate
Logics.LE62.Timer Out	Signal: Timer Output
Logics.LE62.Out	Signal: Latched Output (Q)
Logics.LE62.Out inverted	Signal: Negated Latched Output (Q NOT)
Logics.LE63.Gate Out	Signal: Output of the logic gate
Logics.LE63.Timer Out	Signal: Timer Output
Logics.LE63.Out	Signal: Latched Output (Q)
Logics.LE63.Out inverted	Signal: Negated Latched Output (Q NOT)
Logics.LE64.Gate Out	Signal: Output of the logic gate
Logics.LE64.Timer Out	Signal: Timer Output
Logics.LE64.Out	Signal: Latched Output (Q)
Logics.LE64.Out inverted	Signal: Negated Latched Output (Q NOT)
Logics.LE65.Gate Out	Signal: Output of the logic gate
Logics.LE65.Timer Out	Signal: Timer Output
Logics.LE65.Out	Signal: Latched Output (Q)
Logics.LE65.Out inverted	Signal: Negated Latched Output (Q NOT)
Logics.LE66.Gate Out	Signal: Output of the logic gate
Logics.LE66.Timer Out	Signal: Timer Output
Logics.LE66.Out	Signal: Latched Output (Q)
Logics.LE66.Out inverted	Signal: Negated Latched Output (Q NOT)

## Parameters

<i>Name</i>	<i>Description</i>
Logics.LE67.Gate Out	Signal: Output of the logic gate
Logics.LE67.Timer Out	Signal: Timer Output
Logics.LE67.Out	Signal: Latched Output (Q)
Logics.LE67.Out inverted	Signal: Negated Latched Output (Q NOT)
Logics.LE68.Gate Out	Signal: Output of the logic gate
Logics.LE68.Timer Out	Signal: Timer Output
Logics.LE68.Out	Signal: Latched Output (Q)
Logics.LE68.Out inverted	Signal: Negated Latched Output (Q NOT)
Logics.LE69.Gate Out	Signal: Output of the logic gate
Logics.LE69.Timer Out	Signal: Timer Output
Logics.LE69.Out	Signal: Latched Output (Q)
Logics.LE69.Out inverted	Signal: Negated Latched Output (Q NOT)
Logics.LE70.Gate Out	Signal: Output of the logic gate
Logics.LE70.Timer Out	Signal: Timer Output
Logics.LE70.Out	Signal: Latched Output (Q)
Logics.LE70.Out inverted	Signal: Negated Latched Output (Q NOT)
Logics.LE71.Gate Out	Signal: Output of the logic gate
Logics.LE71.Timer Out	Signal: Timer Output
Logics.LE71.Out	Signal: Latched Output (Q)
Logics.LE71.Out inverted	Signal: Negated Latched Output (Q NOT)
Logics.LE72.Gate Out	Signal: Output of the logic gate
Logics.LE72.Timer Out	Signal: Timer Output
Logics.LE72.Out	Signal: Latched Output (Q)
Logics.LE72.Out inverted	Signal: Negated Latched Output (Q NOT)
Logics.LE73.Gate Out	Signal: Output of the logic gate
Logics.LE73.Timer Out	Signal: Timer Output
Logics.LE73.Out	Signal: Latched Output (Q)
Logics.LE73.Out inverted	Signal: Negated Latched Output (Q NOT)
Logics.LE74.Gate Out	Signal: Output of the logic gate
Logics.LE74.Timer Out	Signal: Timer Output
Logics.LE74.Out	Signal: Latched Output (Q)
Logics.LE74.Out inverted	Signal: Negated Latched Output (Q NOT)
Logics.LE75.Gate Out	Signal: Output of the logic gate
Logics.LE75.Timer Out	Signal: Timer Output
Logics.LE75.Out	Signal: Latched Output (Q)
Logics.LE75.Out inverted	Signal: Negated Latched Output (Q NOT)
Logics.LE76.Gate Out	Signal: Output of the logic gate
Logics.LE76.Timer Out	Signal: Timer Output
Logics.LE76.Out	Signal: Latched Output (Q)
Logics.LE76.Out inverted	Signal: Negated Latched Output (Q NOT)

## Parameters











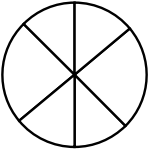

---

<i>Name</i>	<i>Description</i>
Logics.LE77.Gate Out	Signal: Output of the logic gate
Logics.LE77.Timer Out	Signal: Timer Output
Logics.LE77.Out	Signal: Latched Output (Q)
Logics.LE77.Out inverted	Signal: Negated Latched Output (Q NOT)
Logics.LE78.Gate Out	Signal: Output of the logic gate
Logics.LE78.Timer Out	Signal: Timer Output
Logics.LE78.Out	Signal: Latched Output (Q)
Logics.LE78.Out inverted	Signal: Negated Latched Output (Q NOT)
Logics.LE79.Gate Out	Signal: Output of the logic gate
Logics.LE79.Timer Out	Signal: Timer Output
Logics.LE79.Out	Signal: Latched Output (Q)
Logics.LE79.Out inverted	Signal: Negated Latched Output (Q NOT)
Logics.LE80.Gate Out	Signal: Output of the logic gate
Logics.LE80.Timer Out	Signal: Timer Output
Logics.LE80.Out	Signal: Latched Output (Q)
Logics.LE80.Out inverted	Signal: Negated Latched Output (Q NOT)

## Access Authorizations (access areas)

### Passwords – Areas

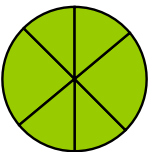
The following table shows the access areas and the authorization passwords that they require in order to access them.

<i>Area Symbol</i>	<i>Authorization Password</i>	<i>Access to:</i>
	 Read Only-Lv0	Level 0 provides Read Only access to all settings and parameters of the device. The device will fall back into this level automatically after a longer period or inactivity
	 Prot-Lv1	This password provides access to the reset- and acknowledge options. In addition to that, it permits the execution of manual trigger signals.
	 Prot-Lv2	This password provides access to the reset and acknowledge options. In addition to that it permits changing of protection settings and the configuration of the trip manager.
	 Control-Lv1	This password grants permission for switching operations (switching switchgears)
	 Control-Lv2	This password grants permission for switching operations (switching switchgears). In addition to that it gives access to the switchgear settings (switching authority, interlockings, general settings of switchgears, Breaker wear...).
	 Supervisor-Lv3	This password grants non-restricted access to all parameters and settings of the device (device configuration). This includes also the devices planning, device parameters (e.g. Date and Time), Field Parameters, Service Parameters and Logic Parameters.

**NOTICE**

If the device was not active within the parameter setting mode for a longer time (can be set between 20 – 3600 seconds) it changes into »Read Only-Lv0« mode automatically. This parameter (t-max-Edit) can be modified within menu [Device Para\HMI].

Access Areas (Password Level):

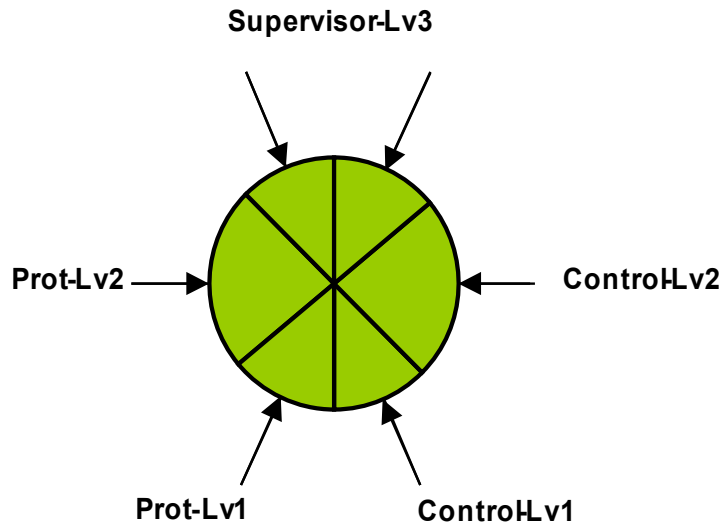

**NOTICE**

You have to ensure, that the access authorizations are protected by secure passwords. These passwords have to be kept as a secret and to be known only by the authorized persons.

**NOTICE**

A lock symbol indicates in the upper right corner of the display if there are any access authorizations active at the moment . That means, within the mode "Read Only Lv0" a closed (locked) lock symbol will be shown in the upper right corner of the display. As soon as there are any access authorizations active (above the "Read Only-Lv0" level), the upper right corner of the display will show an unlocked (open) lock symbol.

**NOTICE**

During setting parameters the C-Button will be used for the cancelling of parameter changes. Because of that it is not possible, to acknowledge (LEDs, Output Relays...) as long as there are non saved (cached only) parameters.

Acknowledgement can only be executed, when the upper right corner of the display shows this symbol:



**NOTICE**

The passwords are part of the device (fixed assignments). That means, passwords will not be overwritten, if a parameter file is transmitted into a device.



Existing passwords are persistent (assigned to a device). If an offline created parameter file is transmitted into a device, or if a parameter file is transmitted from one device to another, this will have no impact on existing passwords within the device.

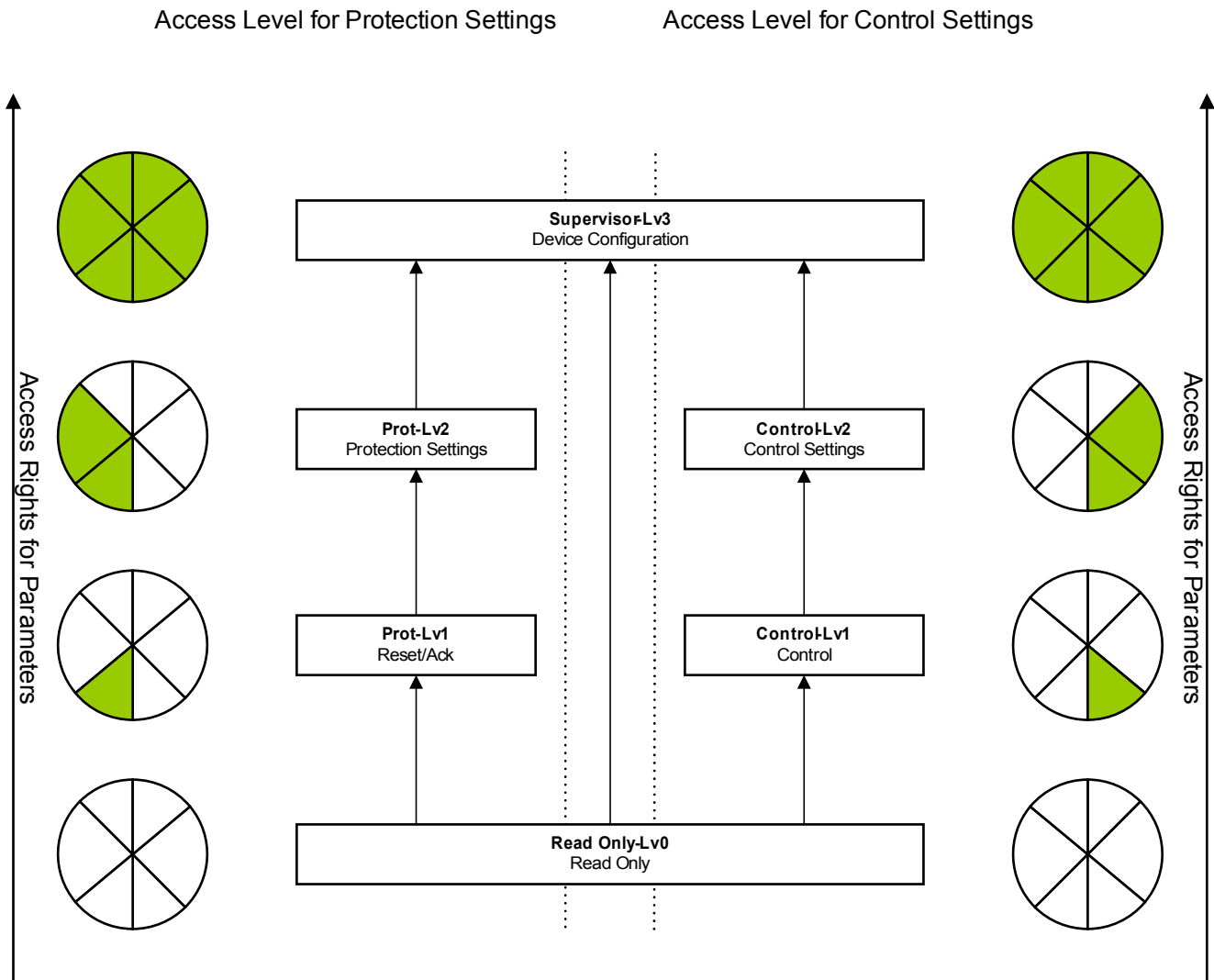

*Available Levels/Access Authorizations*

The access authorizations are designed in form of two hierachic strings.  
 The supervisor (administrator) password provides access to all parameters and settings.



- Legend : Lv = Level
-  Parameters are read only
  -  Parameters can be modified

**How to find out what access areas/levels are unlocked?**

The menu [Device para\Access levels] provides the information, which access areas (authorizations) are currently unlocked.

As soon as there is an unlocked access area (authorization) above »Read Only-Lv0«, this will be indicated by an unlocked lock symbol within the upper right corner of the device display.

## Unlocking Access Areas

Within the menu [Device Para\Access level] access areas can be unlocked or locked (at the HMI).

## Changing Passwords

Passwords can be changed at the device in menu [Device Para/Passwords] or by means of the *Smart view* software.

### **NOTICE**

A password must be a user-defined combination of the numerics 1, 2, 3 and 4.

All other characters and keys won't be accepted.

When you want to change a password, the existing one has to be entered firstly. The new password (up to 8 digits) is then to be confirmed twice. Please proceed as follows:

- In order to change the password please enter your old password by means of the Softkeys followed by pressing the »OK«-key.
- Enter the new password by means of the Softkeys and press the »OK«-key.
- Afterwards enter the new password once again by means of the Softkeys and press the »OK«-key.

## Deactivating Passwords during Commissioning

It is possible optionally to deactivate passwords during commissioning. It is not allowed to use this feature for other purposes than commissioning. In order to deactivate the password protection replace the existing password with an empty one for the corresponding access areas. All access authorizations (access areas) that are protected by an empty password are unlocked permanent. That means, that all parameters and settings within those areas can be modified without any further access authorization. It is no longer possible to change into the »*Read Only-Lv0*« level (the protective device will also not fall back into this mode if the maximum edit time is expired (t-max-Edit)).

### **⚠ WARNING**

You have to ensure that all passwords are activated again after the commissioning. That means, that all access areas have to be protected by a password that consists of 4 digits as minimum.

Woodward will not overtake any liability for any personal injuries or damages that are caused by deactivated password protection.

## Changing Passwords via Smart view

Download the parameter file from the device.

- Passwords can be changed by a double-click within menu [Device Para\Password\Change Password] on the corresponding password.
- Enter the old password and the new password twice
- Confirm the changes by a click on »OK«.

## Password Entry at the Panel

Passwords can be entered by way of the Softkeys.

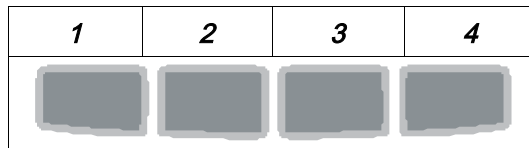

Example: For password (3244) press successively:

- Softkey 3
- Softkey 2
- Softkey 4
- Softkey 4

## Password Forgotten

By pressing the »C« key during cold booting a reset menu will be called up. By selecting »Reset All Passwords?« and confirming with »Yes« all passwords will be reset to the defaults »1234«.

## Parameter Setting at the HMI

Every parameter belongs to an access area. Editing and changing of a parameter requires a sufficient access authorization.

The User can obtain the required access authorizations by unlocking access areas in advance of parameter changes or context-dependent. In the following sections both options will be explained.

### Option 1: Direct Authorization for an Access Area

Call up menu [Device Para\Access level].

Select the required access level respectively navigate to the required access authorization (level). Enter the required password. If the correct password has been entered, the required access authorization will be obtained. In order to do the parameter changes please proceed as follows:

- Move to the parameter you want to change by using the Softkeys. If the parameter is selected, the lower right corner of the display should show a »Wrench« symbol.



This symbol indicates, that the parameter is unlocked and can be edited, because the required access authorization is available. Confirm the Softkey »Wrench«, in order to edit the parameter. Change the parameter.

Now you can:

- save the change you made and have them adopted by the system or:
- change additional parameters and save finally all the altered parameters and have them adopted by the system.

*To save parameter changes immediately,*

- press the »OK« key for saving changed parameters directly and to have them adopted by the device. Confirm the parameter changes by pressing the »Yes« Softkey or dismiss by pressing »No«.

*To change additional parameters and save afterwards,*

- move to other parameters and change them

### NOTICE

A star symbol in front of the changed parameters indicates that the modifications have only been saved temporarily, they are not yet finally stored and adopted by the device.

In order to make things easier to follow, especially where complex parameter changes are involved, on every superior/higher-ranking menu level the intended change of the parameter is indicated by the star symbol (star trace). This makes it possible to control or follow up from the main menu level at any time where parameter changes have been made and have not been saved finally.

In addition to the star trace to the temporary saved parameter changes, a general parameter changing symbol is faded-in at the left corner of the display, and so it is possible from each point of the menu tree to see that there are parameter changes still not adopted by the device.

Press the »OK« key to initiate the final storage of all parameter changes. Confirm the parameter changes by pressing the »Yes« softkey or dismiss by pressing Softkey »No«.

### HINWEIS

If the display shows a Key Symbol instead of a Wrench-Symbol, this will indicate, that the required access authorization is not available.



In order to edit this parameter, a password is required, that provides the required authorization.

### NOTICE

**Plausibility check:** In order to prevent obvious wrong settings the device monitors constantly all temporary saved parameter changes. If the device detects an implausibility, this is indicated by a question mark in front of the respective parameter.

In order to make things easier to follow up, especially where complex parameter changes are involved, on every superior/higher-ranking menu level, above the temporarily saved parameters an invalidity is indicated by the question mark (plausibility trace). This makes it possible to control or follow from the main menu level at any time where implausibilities are intended to be saved.

In addition to the question mark trace to the temporary saved implausible parameter changes a general implausibility symbol/question mark is faded-in at the left corner of the display, and so it is possible to see from each point of the menu tree that implausibilities have been detected by the device.

A star/parameter change indication is always overwritten by the question mark/implausibility symbol.

If a device detects an implausibility, it rejects saving and adopting of the parameters.

## Option 2: Context-dependent Access Authorization

Navigate to the parameter, that is to be changed. If the parameter is selected, the lower right corner of the display shows a »Key«-Symbol.



This symbol indicates, that the device is still within the »Read Only Lv0«-Level, or that the current level does not provide sufficient access rights to allow editing of this parameter.

Press this Softkey and enter the password<sup>1)</sup> that provides access to this parameter.  
Please change the parameter settings.

<sup>1)</sup> This page provides also information, which password/access authorization is required to do changes on this parameter.

Now you can:

- save the change you made and have them adopted by the system or:
- change additional parameters and save finally all the altered parameters and have them adopted by the system.

*To save parameter changes immediately,*

- press the »OK« key for saving changed parameters directly and to have them adopted by the device.  
Confirm the parameter changes by pressing the »Yes« Softkey or dismiss by pressing »No«.

*To change additional parameters and save afterwards,*

- move to other parameters and change them

### NOTICE

A star symbol in front of the changed parameters indicates that the modifications have only been saved temporary, they are not yet finally stored and adopted by the device.

In order to make things easier to follow up, especially where complex parameter changes are involved, on every superior/higher-ranking menu level the intended change of the parameter is indicated by the star symbol (star trace). This makes it possible to control or follow from the main menu level at any time where parameter changes have been made and have not been saved finally.

In addition to the star trace to the temporary saved parameter changes, a general parameter changing symbol is faded-in at the left corner of the display, and so it is possible from each point of the menu tree to see that there are parameter changes still not adopted by the device.

Press the »OK« key to initiate the final storage of all parameter changes. Confirm the parameter changes by pressing the »Yes« Softkey or dismiss by pressing Softkey »No«.

**NOTICE**

**Plausibility check:** In order to prevent obvious wrong settings the device monitors constantly all temporary saved parameter changes. If the device detects an implausibility, this is indicated by a question mark in front of the respective parameter.

In order to make things easier to follow up, especially where complex parameter changes are involved, on every superior/higher-ranking menu level, above the temporary saved parameters an invalidity is indicated by the question mark (plausibility trace). This makes it possible to control or follow from the main menu level at any time where implausibilities are intended to be saved.

In addition to the question mark trace to the temporary saved implausible parameter changes a general implausibility symbol/question mark is faded-in at the left corner of the display, and so it is possible to see from each point of the menu tree that implausibilities have been detected by the device.

A star/parameter change indication is always overwritten by the question mark/implausibility symbol.

If a device detects an implausibility, it rejects saving and adopting of the parameters.



## Parameter Setting via Smart view

Smart view shows within the windows, where parameters are edited also the required access level for the parameters and settings. The required access authorizations will be verified when the parameter file should be transferred into the protective device. For the transmission, two options are available.

1. The transfer of *all Parameters*. This always requires the Supervisor (administrator) password.
2. The transfer of the *modified Parameters* only. It has to be taken into account, the passwords that are required by this are determined by those parameters, that require the highest passwords (access authorizations).

*Example1:*

A »Prot-Lv1«-parameter and a »Prot-Lv2« parameter have been edited and should be transferred. The User will be asked for the »Prot-Lv2« password.

*Example2:*

A »Prot-Lv1« parameter and a »Prot-Lv2« parameter and a device planning parameter have been changed and should be transferred. The User will be asked for the »Supervisor-Lv3« password.

*Example3:*

A »Prot-Lv1« parameter and a »Prot-Lv2« parameter as well as a »Ctrl-Lv2« parameter have been changed and should be transferred. The User will be asked for the »Prot-Lv2« and the »Ctrl-Lv2« password.

## Changing of Parameters when using the Smart View - Example

Example: Changing of a protective parameter (to alter the characteristic for the overcurrent protection function I[1] in parameter set 1).

- In case *Smart view* is not in operation – start this software.
- In case the device data has not been loaded – select »Data To Be Received From The Device« in menu »Device«.
- Double-click the »Protection Para Icon« in the navigation tree.
- Double-click the »Protection Para Set Icon« in the navigation tree.
- Double-click the »Set 1 Icon« in the navigation tree.
- Double-click the »protection stage I[1]« in the navigation tree.
- In the working window a tabulated overview appears, showing the parameters assigned to this protective function.
- In this table double-click the value/parameter you want to change (here: »Char«).
- Another window (popup) is opened where you can select the required characteristic.
- Close this window by clicking the »OK« key.

**NOTICE**

A star symbol in front of the changed parameters indicates that the alterations have only been saved temporarily. They are not yet finally stored and adopted by the software/device.

In order to make things easier to follow, especially where complex parameter changes are involved, on every superior/higher menu level, the intended change of the parameter is indicated by the star symbol (star trace). This makes it possible to control or follow up from the main menu level at any time where parameter changes have been made and have not been saved finally.

**NOTICE**

**Plausibility check:** In order to prevent obvious wrong settings the software monitors constantly all temporary saved parameter changes. If it detects an implausibility, this is indicated by a question mark in front of the respective parameter.

In order to make things easier to follow up, especially where complex parameter changes are involved, on every superior/higher menu level above of the temporary saved parameters, an implausibility is indicated by a question mark (plausibility trace). This makes it possible to control or follow from the main menu level at any time where implausibilities exist.

So it is possible to see from each point of the menu tree that implausibilities have been detected by the software.

A star/parameter change indication is always overwritten by the question mark/implausibility symbol.

If the software detects an implausibility it rejects saving and adopting of the parameters.

- Additional parameters can be changed if required.
- There are two options available to transfer changed parameters into the device within menu »Device«.
  1. »Transfer all Parameters into the Device«. This always requires the Supervisor (administrator) password.
  2. »Transfer only modified parameters into the Device«. For this parameter transfer the User needs passwords that provide sufficient access authorization for all parameters that are to be transferred.
- Confirm the safety inquiry »Shall The Parameters Be Overwritten?«.
- Enter the password for setting parameters in the popup window.
- Confirm the inquiry »Shall The Data Be Saved Locally?« with »Yes« (recommended). Select a suitable storing location on your hard disk.
- Confirm the chosen storing location by clicking »Save«.
- The changed parameter data is saved now in the data file chosen by you. Thereafter the changed data is transferred to the device and adopted. .

**NOTICE**

Once you have entered the parameter setting password, Smart view wont ask you again for the password for 10 minutes at least. This time interval will start again, each time parameters are transmitted into the device. If for more than 10 minutes no parameters are transmitted into the device, Smart view will ask you again for the password, when you are trying to transmit parameters into the device.

Protection Parameters

**! WARNING**

It has to be taken into account that by deactivating, for instance, protective functions, you also change the functionality of the device.

The manufacturer does not accept liability for any personal or material damage as a result of wrong planning.

A planning/parameter setting service is also offered by *Woodward Kempen GmbH*.

The protection parameters include the following protection parameter trees:

- Global Protection Parameters: »*Global Prot Para*«: Here you can find all protection parameters that are valid universally, that means that they are valid independent of the protection parameter sets.
- Setting Group Parameters: »*Set1..4*«: The protection parameters that you set within a parameter set are only valid, if the parameter set where you set them is switched to active.

## Setting Groups

### Setting Group Switch

Within the menu »Protection Para/P-Set Switch« you have the following possibilities:

- To set one of the four setting groups active manually.
- To assign a signal to each setting group that sets this group to active.
- Scada switches the setting groups.

<b>Option</b>	<b>Setting Group Switch</b>
<i>Manual Selection</i>	Switch over, if another setting group is chosen manually within the menu »Protection Para/P-Set Switch«
<i>Via Input Function (e.g. Digital Input)</i>	<p>Switch over not until the request is clear.</p> <p>That means, if there is more or less than one request signal active, no switch over will be executed.</p> <p>Example::</p> <p>DI3 is assigned onto Parameter set 1. DI3 is active „1“.</p> <p>DI4 is assigned onto Parameter set 2. DI4 is inactive „0“.</p> <p>Now the device should switch from parameter set 1 to parameter set 2. Therefore at first DI3 has to become inactive “0”. Than DI4 has to be active “1”.</p> <p>If DI4 becomes again inactive „0“, parameter set 2 will remain active “1” as long as there is no clear request (e.g. DI3 becomes active “1”, all the other assignments are inactive “0”)</p>
<i>Via Scada</i>	<p>Switch over if there is a clear SCADA request.</p> <p>Otherwise no switch over will be executed.</p>

### **NOTICE**

The description of the parameters can be found within chapter System Parameters.

## Signals that can be used for PSS

<i>Name</i>	<i>Description</i>
--	No assignment
Prot.DFT Invalid	DFT values of fundamental and harmonics (except VX) are not valid. They depend on period time of frequency and measured channels 1-3 (VL1,VL2,VL3).
Prot.DFT Valid	DFT values of fundamental and harmonics (except VX) are valid. They depend on period time of frequency and measured channels 1-3 (VL1,VL2,VL3).
Prot.DFT Invalid (VX)	DFT values of fundamental and harmonics of VX (only) are not valid.
Prot.DFT Valid (VX)	DFT values of fundamental and harmonics of VX (only) are valid.
DI Slot X1.DI 1	Signal: Digital Input
DI Slot X1.DI 2	Signal: Digital Input
DI Slot X1.DI 3	Signal: Digital Input
DI Slot X1.DI 4	Signal: Digital Input
DI Slot X1.DI 5	Signal: Digital Input
DI Slot X1.DI 6	Signal: Digital Input
DI Slot X1.DI 7	Signal: Digital Input
DI Slot X1.DI 8	Signal: Digital Input
DI Slot X6.DI 1	Signal: Digital Input
DI Slot X6.DI 2	Signal: Digital Input
DI Slot X6.DI 3	Signal: Digital Input
DI Slot X6.DI 4	Signal: Digital Input
DI Slot X6.DI 5	Signal: Digital Input
DI Slot X6.DI 6	Signal: Digital Input
DI Slot X6.DI 7	Signal: Digital Input
DI Slot X6.DI 8	Signal: Digital Input
Logics.LE1.Gate Out	Signal: Output of the logic gate
Logics.LE1.Timer Out	Signal: Timer Output
Logics.LE1.Out	Signal: Latched Output (Q)
Logics.LE1.Out inverted	Signal: Negated Latched Output (Q NOT)
Logics.LE2.Gate Out	Signal: Output of the logic gate
Logics.LE2.Timer Out	Signal: Timer Output
Logics.LE2.Out	Signal: Latched Output (Q)
Logics.LE2.Out inverted	Signal: Negated Latched Output (Q NOT)
Logics.LE3.Gate Out	Signal: Output of the logic gate
Logics.LE3.Timer Out	Signal: Timer Output
Logics.LE3.Out	Signal: Latched Output (Q)
Logics.LE3.Out inverted	Signal: Negated Latched Output (Q NOT)
Logics.LE4.Gate Out	Signal: Output of the logic gate
Logics.LE4.Timer Out	Signal: Timer Output
Logics.LE4.Out	Signal: Latched Output (Q)
Logics.LE4.Out inverted	Signal: Negated Latched Output (Q NOT)

## Parameters

<i>Name</i>	<i>Description</i>
Logics.LE5.Gate Out	Signal: Output of the logic gate
Logics.LE5.Timer Out	Signal: Timer Output
Logics.LE5.Out	Signal: Latched Output (Q)
Logics.LE5.Out inverted	Signal: Negated Latched Output (Q NOT)
Logics.LE6.Gate Out	Signal: Output of the logic gate
Logics.LE6.Timer Out	Signal: Timer Output
Logics.LE6.Out	Signal: Latched Output (Q)
Logics.LE6.Out inverted	Signal: Negated Latched Output (Q NOT)
Logics.LE7.Gate Out	Signal: Output of the logic gate
Logics.LE7.Timer Out	Signal: Timer Output
Logics.LE7.Out	Signal: Latched Output (Q)
Logics.LE7.Out inverted	Signal: Negated Latched Output (Q NOT)
Logics.LE8.Gate Out	Signal: Output of the logic gate
Logics.LE8.Timer Out	Signal: Timer Output
Logics.LE8.Out	Signal: Latched Output (Q)
Logics.LE8.Out inverted	Signal: Negated Latched Output (Q NOT)
Logics.LE9.Gate Out	Signal: Output of the logic gate
Logics.LE9.Timer Out	Signal: Timer Output
Logics.LE9.Out	Signal: Latched Output (Q)
Logics.LE9.Out inverted	Signal: Negated Latched Output (Q NOT)
Logics.LE10.Gate Out	Signal: Output of the logic gate
Logics.LE10.Timer Out	Signal: Timer Output
Logics.LE10.Out	Signal: Latched Output (Q)
Logics.LE10.Out inverted	Signal: Negated Latched Output (Q NOT)
Logics.LE11.Gate Out	Signal: Output of the logic gate
Logics.LE11.Timer Out	Signal: Timer Output
Logics.LE11.Out	Signal: Latched Output (Q)
Logics.LE11.Out inverted	Signal: Negated Latched Output (Q NOT)
Logics.LE12.Gate Out	Signal: Output of the logic gate
Logics.LE12.Timer Out	Signal: Timer Output
Logics.LE12.Out	Signal: Latched Output (Q)
Logics.LE12.Out inverted	Signal: Negated Latched Output (Q NOT)
Logics.LE13.Gate Out	Signal: Output of the logic gate
Logics.LE13.Timer Out	Signal: Timer Output
Logics.LE13.Out	Signal: Latched Output (Q)
Logics.LE13.Out inverted	Signal: Negated Latched Output (Q NOT)
Logics.LE14.Gate Out	Signal: Output of the logic gate
Logics.LE14.Timer Out	Signal: Timer Output
Logics.LE14.Out	Signal: Latched Output (Q)
Logics.LE14.Out inverted	Signal: Negated Latched Output (Q NOT)

## Parameters

<i>Name</i>	<i>Description</i>
Logics.LE15.Gate Out	Signal: Output of the logic gate
Logics.LE15.Timer Out	Signal: Timer Output
Logics.LE15.Out	Signal: Latched Output (Q)
Logics.LE15.Out inverted	Signal: Negated Latched Output (Q NOT)
Logics.LE16.Gate Out	Signal: Output of the logic gate
Logics.LE16.Timer Out	Signal: Timer Output
Logics.LE16.Out	Signal: Latched Output (Q)
Logics.LE16.Out inverted	Signal: Negated Latched Output (Q NOT)
Logics.LE17.Gate Out	Signal: Output of the logic gate
Logics.LE17.Timer Out	Signal: Timer Output
Logics.LE17.Out	Signal: Latched Output (Q)
Logics.LE17.Out inverted	Signal: Negated Latched Output (Q NOT)
Logics.LE18.Gate Out	Signal: Output of the logic gate
Logics.LE18.Timer Out	Signal: Timer Output
Logics.LE18.Out	Signal: Latched Output (Q)
Logics.LE18.Out inverted	Signal: Negated Latched Output (Q NOT)
Logics.LE19.Gate Out	Signal: Output of the logic gate
Logics.LE19.Timer Out	Signal: Timer Output
Logics.LE19.Out	Signal: Latched Output (Q)
Logics.LE19.Out inverted	Signal: Negated Latched Output (Q NOT)
Logics.LE20.Gate Out	Signal: Output of the logic gate
Logics.LE20.Timer Out	Signal: Timer Output
Logics.LE20.Out	Signal: Latched Output (Q)
Logics.LE20.Out inverted	Signal: Negated Latched Output (Q NOT)
Logics.LE21.Gate Out	Signal: Output of the logic gate
Logics.LE21.Timer Out	Signal: Timer Output
Logics.LE21.Out	Signal: Latched Output (Q)
Logics.LE21.Out inverted	Signal: Negated Latched Output (Q NOT)
Logics.LE22.Gate Out	Signal: Output of the logic gate
Logics.LE22.Timer Out	Signal: Timer Output
Logics.LE22.Out	Signal: Latched Output (Q)
Logics.LE22.Out inverted	Signal: Negated Latched Output (Q NOT)
Logics.LE23.Gate Out	Signal: Output of the logic gate
Logics.LE23.Timer Out	Signal: Timer Output
Logics.LE23.Out	Signal: Latched Output (Q)
Logics.LE23.Out inverted	Signal: Negated Latched Output (Q NOT)
Logics.LE24.Gate Out	Signal: Output of the logic gate
Logics.LE24.Timer Out	Signal: Timer Output
Logics.LE24.Out	Signal: Latched Output (Q)
Logics.LE24.Out inverted	Signal: Negated Latched Output (Q NOT)

## Parameters

<i>Name</i>	<i>Description</i>
Logics.LE25.Gate Out	Signal: Output of the logic gate
Logics.LE25.Timer Out	Signal: Timer Output
Logics.LE25.Out	Signal: Latched Output (Q)
Logics.LE25.Out inverted	Signal: Negated Latched Output (Q NOT)
Logics.LE26.Gate Out	Signal: Output of the logic gate
Logics.LE26.Timer Out	Signal: Timer Output
Logics.LE26.Out	Signal: Latched Output (Q)
Logics.LE26.Out inverted	Signal: Negated Latched Output (Q NOT)
Logics.LE27.Gate Out	Signal: Output of the logic gate
Logics.LE27.Timer Out	Signal: Timer Output
Logics.LE27.Out	Signal: Latched Output (Q)
Logics.LE27.Out inverted	Signal: Negated Latched Output (Q NOT)
Logics.LE28.Gate Out	Signal: Output of the logic gate
Logics.LE28.Timer Out	Signal: Timer Output
Logics.LE28.Out	Signal: Latched Output (Q)
Logics.LE28.Out inverted	Signal: Negated Latched Output (Q NOT)
Logics.LE29.Gate Out	Signal: Output of the logic gate
Logics.LE29.Timer Out	Signal: Timer Output
Logics.LE29.Out	Signal: Latched Output (Q)
Logics.LE29.Out inverted	Signal: Negated Latched Output (Q NOT)
Logics.LE30.Gate Out	Signal: Output of the logic gate
Logics.LE30.Timer Out	Signal: Timer Output
Logics.LE30.Out	Signal: Latched Output (Q)
Logics.LE30.Out inverted	Signal: Negated Latched Output (Q NOT)
Logics.LE31.Gate Out	Signal: Output of the logic gate
Logics.LE31.Timer Out	Signal: Timer Output
Logics.LE31.Out	Signal: Latched Output (Q)
Logics.LE31.Out inverted	Signal: Negated Latched Output (Q NOT)
Logics.LE32.Gate Out	Signal: Output of the logic gate
Logics.LE32.Timer Out	Signal: Timer Output
Logics.LE32.Out	Signal: Latched Output (Q)
Logics.LE32.Out inverted	Signal: Negated Latched Output (Q NOT)
Logics.LE33.Gate Out	Signal: Output of the logic gate
Logics.LE33.Timer Out	Signal: Timer Output
Logics.LE33.Out	Signal: Latched Output (Q)
Logics.LE33.Out inverted	Signal: Negated Latched Output (Q NOT)
Logics.LE34.Gate Out	Signal: Output of the logic gate
Logics.LE34.Timer Out	Signal: Timer Output
Logics.LE34.Out	Signal: Latched Output (Q)
Logics.LE34.Out inverted	Signal: Negated Latched Output (Q NOT)



## Parameters

<i>Name</i>	<i>Description</i>
Logics.LE35.Gate Out	Signal: Output of the logic gate
Logics.LE35.Timer Out	Signal: Timer Output
Logics.LE35.Out	Signal: Latched Output (Q)
Logics.LE35.Out inverted	Signal: Negated Latched Output (Q NOT)
Logics.LE36.Gate Out	Signal: Output of the logic gate
Logics.LE36.Timer Out	Signal: Timer Output
Logics.LE36.Out	Signal: Latched Output (Q)
Logics.LE36.Out inverted	Signal: Negated Latched Output (Q NOT)
Logics.LE37.Gate Out	Signal: Output of the logic gate
Logics.LE37.Timer Out	Signal: Timer Output
Logics.LE37.Out	Signal: Latched Output (Q)
Logics.LE37.Out inverted	Signal: Negated Latched Output (Q NOT)
Logics.LE38.Gate Out	Signal: Output of the logic gate
Logics.LE38.Timer Out	Signal: Timer Output
Logics.LE38.Out	Signal: Latched Output (Q)
Logics.LE38.Out inverted	Signal: Negated Latched Output (Q NOT)
Logics.LE39.Gate Out	Signal: Output of the logic gate
Logics.LE39.Timer Out	Signal: Timer Output
Logics.LE39.Out	Signal: Latched Output (Q)
Logics.LE39.Out inverted	Signal: Negated Latched Output (Q NOT)
Logics.LE40.Gate Out	Signal: Output of the logic gate
Logics.LE40.Timer Out	Signal: Timer Output
Logics.LE40.Out	Signal: Latched Output (Q)
Logics.LE40.Out inverted	Signal: Negated Latched Output (Q NOT)
Logics.LE41.Gate Out	Signal: Output of the logic gate
Logics.LE41.Timer Out	Signal: Timer Output
Logics.LE41.Out	Signal: Latched Output (Q)
Logics.LE41.Out inverted	Signal: Negated Latched Output (Q NOT)
Logics.LE42.Gate Out	Signal: Output of the logic gate
Logics.LE42.Timer Out	Signal: Timer Output
Logics.LE42.Out	Signal: Latched Output (Q)
Logics.LE42.Out inverted	Signal: Negated Latched Output (Q NOT)
Logics.LE43.Gate Out	Signal: Output of the logic gate
Logics.LE43.Timer Out	Signal: Timer Output
Logics.LE43.Out	Signal: Latched Output (Q)
Logics.LE43.Out inverted	Signal: Negated Latched Output (Q NOT)
Logics.LE44.Gate Out	Signal: Output of the logic gate
Logics.LE44.Timer Out	Signal: Timer Output
Logics.LE44.Out	Signal: Latched Output (Q)
Logics.LE44.Out inverted	Signal: Negated Latched Output (Q NOT)

## Parameters

<i>Name</i>	<i>Description</i>
Logics.LE45.Gate Out	Signal: Output of the logic gate
Logics.LE45.Timer Out	Signal: Timer Output
Logics.LE45.Out	Signal: Latched Output (Q)
Logics.LE45.Out inverted	Signal: Negated Latched Output (Q NOT)
Logics.LE46.Gate Out	Signal: Output of the logic gate
Logics.LE46.Timer Out	Signal: Timer Output
Logics.LE46.Out	Signal: Latched Output (Q)
Logics.LE46.Out inverted	Signal: Negated Latched Output (Q NOT)
Logics.LE47.Gate Out	Signal: Output of the logic gate
Logics.LE47.Timer Out	Signal: Timer Output
Logics.LE47.Out	Signal: Latched Output (Q)
Logics.LE47.Out inverted	Signal: Negated Latched Output (Q NOT)
Logics.LE48.Gate Out	Signal: Output of the logic gate
Logics.LE48.Timer Out	Signal: Timer Output
Logics.LE48.Out	Signal: Latched Output (Q)
Logics.LE48.Out inverted	Signal: Negated Latched Output (Q NOT)
Logics.LE49.Gate Out	Signal: Output of the logic gate
Logics.LE49.Timer Out	Signal: Timer Output
Logics.LE49.Out	Signal: Latched Output (Q)
Logics.LE49.Out inverted	Signal: Negated Latched Output (Q NOT)
Logics.LE50.Gate Out	Signal: Output of the logic gate
Logics.LE50.Timer Out	Signal: Timer Output
Logics.LE50.Out	Signal: Latched Output (Q)
Logics.LE50.Out inverted	Signal: Negated Latched Output (Q NOT)
Logics.LE51.Gate Out	Signal: Output of the logic gate
Logics.LE51.Timer Out	Signal: Timer Output
Logics.LE51.Out	Signal: Latched Output (Q)
Logics.LE51.Out inverted	Signal: Negated Latched Output (Q NOT)
Logics.LE52.Gate Out	Signal: Output of the logic gate
Logics.LE52.Timer Out	Signal: Timer Output
Logics.LE52.Out	Signal: Latched Output (Q)
Logics.LE52.Out inverted	Signal: Negated Latched Output (Q NOT)
Logics.LE53.Gate Out	Signal: Output of the logic gate
Logics.LE53.Timer Out	Signal: Timer Output
Logics.LE53.Out	Signal: Latched Output (Q)
Logics.LE53.Out inverted	Signal: Negated Latched Output (Q NOT)
Logics.LE54.Gate Out	Signal: Output of the logic gate
Logics.LE54.Timer Out	Signal: Timer Output
Logics.LE54.Out	Signal: Latched Output (Q)
Logics.LE54.Out inverted	Signal: Negated Latched Output (Q NOT)

## Parameters

<i>Name</i>	<i>Description</i>
Logics.LE55.Gate Out	Signal: Output of the logic gate
Logics.LE55.Timer Out	Signal: Timer Output
Logics.LE55.Out	Signal: Latched Output (Q)
Logics.LE55.Out inverted	Signal: Negated Latched Output (Q NOT)
Logics.LE56.Gate Out	Signal: Output of the logic gate
Logics.LE56.Timer Out	Signal: Timer Output
Logics.LE56.Out	Signal: Latched Output (Q)
Logics.LE56.Out inverted	Signal: Negated Latched Output (Q NOT)
Logics.LE57.Gate Out	Signal: Output of the logic gate
Logics.LE57.Timer Out	Signal: Timer Output
Logics.LE57.Out	Signal: Latched Output (Q)
Logics.LE57.Out inverted	Signal: Negated Latched Output (Q NOT)
Logics.LE58.Gate Out	Signal: Output of the logic gate
Logics.LE58.Timer Out	Signal: Timer Output
Logics.LE58.Out	Signal: Latched Output (Q)
Logics.LE58.Out inverted	Signal: Negated Latched Output (Q NOT)
Logics.LE59.Gate Out	Signal: Output of the logic gate
Logics.LE59.Timer Out	Signal: Timer Output
Logics.LE59.Out	Signal: Latched Output (Q)
Logics.LE59.Out inverted	Signal: Negated Latched Output (Q NOT)
Logics.LE60.Gate Out	Signal: Output of the logic gate
Logics.LE60.Timer Out	Signal: Timer Output
Logics.LE60.Out	Signal: Latched Output (Q)
Logics.LE60.Out inverted	Signal: Negated Latched Output (Q NOT)
Logics.LE61.Gate Out	Signal: Output of the logic gate
Logics.LE61.Timer Out	Signal: Timer Output
Logics.LE61.Out	Signal: Latched Output (Q)
Logics.LE61.Out inverted	Signal: Negated Latched Output (Q NOT)
Logics.LE62.Gate Out	Signal: Output of the logic gate
Logics.LE62.Timer Out	Signal: Timer Output
Logics.LE62.Out	Signal: Latched Output (Q)
Logics.LE62.Out inverted	Signal: Negated Latched Output (Q NOT)
Logics.LE63.Gate Out	Signal: Output of the logic gate
Logics.LE63.Timer Out	Signal: Timer Output
Logics.LE63.Out	Signal: Latched Output (Q)
Logics.LE63.Out inverted	Signal: Negated Latched Output (Q NOT)
Logics.LE64.Gate Out	Signal: Output of the logic gate
Logics.LE64.Timer Out	Signal: Timer Output
Logics.LE64.Out	Signal: Latched Output (Q)
Logics.LE64.Out inverted	Signal: Negated Latched Output (Q NOT)

## Parameters

<i>Name</i>	<i>Description</i>
Logics.LE65.Gate Out	Signal: Output of the logic gate
Logics.LE65.Timer Out	Signal: Timer Output
Logics.LE65.Out	Signal: Latched Output (Q)
Logics.LE65.Out inverted	Signal: Negated Latched Output (Q NOT)
Logics.LE66.Gate Out	Signal: Output of the logic gate
Logics.LE66.Timer Out	Signal: Timer Output
Logics.LE66.Out	Signal: Latched Output (Q)
Logics.LE66.Out inverted	Signal: Negated Latched Output (Q NOT)
Logics.LE67.Gate Out	Signal: Output of the logic gate
Logics.LE67.Timer Out	Signal: Timer Output
Logics.LE67.Out	Signal: Latched Output (Q)
Logics.LE67.Out inverted	Signal: Negated Latched Output (Q NOT)
Logics.LE68.Gate Out	Signal: Output of the logic gate
Logics.LE68.Timer Out	Signal: Timer Output
Logics.LE68.Out	Signal: Latched Output (Q)
Logics.LE68.Out inverted	Signal: Negated Latched Output (Q NOT)
Logics.LE69.Gate Out	Signal: Output of the logic gate
Logics.LE69.Timer Out	Signal: Timer Output
Logics.LE69.Out	Signal: Latched Output (Q)
Logics.LE69.Out inverted	Signal: Negated Latched Output (Q NOT)
Logics.LE70.Gate Out	Signal: Output of the logic gate
Logics.LE70.Timer Out	Signal: Timer Output
Logics.LE70.Out	Signal: Latched Output (Q)
Logics.LE70.Out inverted	Signal: Negated Latched Output (Q NOT)
Logics.LE71.Gate Out	Signal: Output of the logic gate
Logics.LE71.Timer Out	Signal: Timer Output
Logics.LE71.Out	Signal: Latched Output (Q)
Logics.LE71.Out inverted	Signal: Negated Latched Output (Q NOT)
Logics.LE72.Gate Out	Signal: Output of the logic gate
Logics.LE72.Timer Out	Signal: Timer Output
Logics.LE72.Out	Signal: Latched Output (Q)
Logics.LE72.Out inverted	Signal: Negated Latched Output (Q NOT)
Logics.LE73.Gate Out	Signal: Output of the logic gate
Logics.LE73.Timer Out	Signal: Timer Output
Logics.LE73.Out	Signal: Latched Output (Q)
Logics.LE73.Out inverted	Signal: Negated Latched Output (Q NOT)
Logics.LE74.Gate Out	Signal: Output of the logic gate
Logics.LE74.Timer Out	Signal: Timer Output
Logics.LE74.Out	Signal: Latched Output (Q)
Logics.LE74.Out inverted	Signal: Negated Latched Output (Q NOT)

## Parameters

---

<i>Name</i>	<i>Description</i>
Logics.LE75.Gate Out	Signal: Output of the logic gate
Logics.LE75.Timer Out	Signal: Timer Output
Logics.LE75.Out	Signal: Latched Output (Q)
Logics.LE75.Out inverted	Signal: Negated Latched Output (Q NOT)
Logics.LE76.Gate Out	Signal: Output of the logic gate
Logics.LE76.Timer Out	Signal: Timer Output
Logics.LE76.Out	Signal: Latched Output (Q)
Logics.LE76.Out inverted	Signal: Negated Latched Output (Q NOT)
Logics.LE77.Gate Out	Signal: Output of the logic gate
Logics.LE77.Timer Out	Signal: Timer Output
Logics.LE77.Out	Signal: Latched Output (Q)
Logics.LE77.Out inverted	Signal: Negated Latched Output (Q NOT)
Logics.LE78.Gate Out	Signal: Output of the logic gate
Logics.LE78.Timer Out	Signal: Timer Output
Logics.LE78.Out	Signal: Latched Output (Q)
Logics.LE78.Out inverted	Signal: Negated Latched Output (Q NOT)
Logics.LE79.Gate Out	Signal: Output of the logic gate
Logics.LE79.Timer Out	Signal: Timer Output
Logics.LE79.Out	Signal: Latched Output (Q)
Logics.LE79.Out inverted	Signal: Negated Latched Output (Q NOT)
Logics.LE80.Gate Out	Signal: Output of the logic gate
Logics.LE80.Timer Out	Signal: Timer Output
Logics.LE80.Out	Signal: Latched Output (Q)
Logics.LE80.Out inverted	Signal: Negated Latched Output (Q NOT)

## Setting Group Switch via Smart view

- In case *Smart view* is not running – please start it.
- If device data has not been loaded yet – click »Receive Data From The Device« in menu »Device«.
- Double click the »Protection Para« icon in the navigation tree.
- Double click the »P-Set Switch« within the protection parameters.
- Configure the Setting Group Switch respectively choose an active set manually.

### **NOTICE**

The description of the parameters can be found within chapter System Parameters.

## Copying Setting Groups (Parameter Sets) via Smart view

### NOTICE

Setting groups can only be copied if there are no implausibilities (no red question mark).

It is not necessary to set up two setting groups that only differ in a few parameters.

With the help of „Smart view“ you can copy simply an existing setting group to another one(not yet configured) . You only need to change those parameters where the two setting groups are different.

To establish efficiently a second parameter set where only a few parameters are different, proceed as follows:

- In case *Smart view* is not running – please start it.
- Open an (offline) parameter file of a device or load data of a connected device.
- By way of precaution, save (the relevant) device parameters [File\Save as].
- Select »Copy Parameter Sets« out of the menu “Edit”.
- Then define both, source and destination of the parameter set that should be copied (source = copy from; destination: copy to ).
- Mouse click on »OK« to start copy procedure.
- The copied parameter set is cached now (not yet saved!).
- Then, modify the copied parameter set(s), if applicable.
- Assign a new file name to the revised device parameter file and save it on your hard disk (backup copy).
- To transfer the modified parameters back to the device, click on menu item »Device« and select »Transfer All Parameters into the Device«.

## Comparing Setting Groups via Smart View

- In case *Smart view* is not running – please start it.
- Click on menu item »Edit« and select »Compare Parameter Sets«.
- Select the two parameter sets from the (two) drop down menus you would like to have compared with each other.
- Press the pushbutton »compare«.
- The values that are different from the set parameters will be listed in tabular form.

## Comparing Parameter Files via Smart view

With the help of „Smart view“ you can simply compare/diff the currently open parameter/device file against a file on your hard disk. The precondition is that the versions and type of devices match. Please proceed as follows:

- Click on »Compare with a Parameter File« within the menu »Device«.
- Click on the Folder icon in order to select a file on your hard disk.
- The differences will be shown in tabular form.



## Converting Parameter Files via Smart view

Parameter files of the same type can be up- or downgraded (converted). As many parameters as possible will be taken over.

- Parameters, that are added newly will be set to default.
- Parameters, that are not included in the target file version will be deleted.

In order to convert a parameter file please proceed as follows:

- In case *Smart view* is not in operation – start this software.
- Open a parameter file or load the parameters from a device that should be converted.
- Make a backup of this file at a fail safe place.
- Choose »Save as« from menu »File«
- Enter a new file name (in order to prevent overwriting the original file)
- Choose the new file type from drop down menu »File Type«.
- Confirm the security check by clicking on »yes« if and only you are sure that the file conversion should be executed.
- In tabular form the modifications will be shown as follows.

Added parameter:	
Deleted parameter:	



## Setting Lock

By means of the Setting Lock, parameter settings can be locked against any changes as long as the assigned signal is true (active). The Setting Lock can be activated within menu [Field Para/General Settings/Lock Settings].

## Bypass of the Setting Lock

The setting lock can be overwritten (temporarily) in case that the status of the signal that activates the setting lock cannot be modified or should not be modified (spare key).

The Setting Lock can be bypassed by means of the Direct Control Parameter »*Setting Lock Bypass*« [Field Para/General Settings/Setting Lock Bypass]. The protective device will fall back into the Setting Lock either:

- Directly after a parameter change has been saved, else
  
- 10 minutes after the bypass has been activated.

## Device Parameters

Sys

### Date and Time

In menu »*Device parameters/Date/Time*« you can set date and time.

### Synchronize Date and Time via Smart View

- In case *Smart view* is not running – please start it.
- If device data has not been loaded yet – click »Receive Data From The Device« in menu »Device«
- Double click the »Device parameters« icon in the navigation tree.
- Double click the »Date/time-icon« within the operational data.
- Out of the working window you can now synchronize date and time of the device with your PC i.e. That means, that the device takes over date and time from your PC.

### Version

Within this menu »*Device parameters/Version*« you can obtain information on the soft- and hardware version.

### Version via Smart view

Within this menu »*File/Properties*« you can obtain detailed information on the currently opened file like e.g. soft- and hardware version....

#### **NOTICE**

In order to be able to transmit a parameter file (e.g. offline created) into the device the following issues must comply:

- Type Code (written on the top of the device/type label) and
- Version of the device model (can be found in menu [Device Parameters\Version]).

## TCP/IP Settings

Within menu »*Device Para / TCP/IP*« the TCP/IP settings have to be set.

The first-time setting of the TCP/IP Parameters can be done at the panel (HMI) only.

### **NOTICE**

Establishing a connection via TCP/IP to the device is only possible if your device is equipped with an Ethernet Interface (RJ45).







Contact your IT administrator in order to establish the network connection.

Set the TCP/IP Parameters

Call up »*Device parameter/TCP/IP*« at the HMI (panel) and set the following parameters:







- TCP/IP address
- Subnetmask
- Gateway

## Direct Commands of the System Module





Parameter	Description	Setting range	Default	Menu path
Ack LED 	All acknowledgeable LEDs will be acknowledged.	inactive, active	inactive	[Operation /Acknowledge]
Ack BO 	All acknowledgeable binary output relays will be acknowledged.	inactive, active	inactive	[Operation /Acknowledge]
Ack Scada 	SCADA will be acknowledged.	inactive, active	inactive	[Operation /Acknowledge]
Ack BO LED Scd TCmd 	Reset the binary output relays, LEDs, SCADA and the Trip Command.	inactive, active	inactive	[Operation /Acknowledge]
Reboot 	Rebooting the device.	no, yes	no	[Service /General]
Setting Lock Bypass 	Short-period unlock of the Setting Lock	inactive, active	inactive	[Field Para /General settings]

**CAUTION** CAUTION, rebooting the device manually will release the Supervision Contact.

## Global Protection Parameters of the System

Parameter	Description	Setting range	Default	Menu path
 PSet-Switch	Switching Parameter Set	PS1, PS2, PS3, PS4, PSS via Inp fct, PSS via Scada	PS1	[Protection Para /PSet-Switch]
 PS1: activated by	<p>This Setting Group will be the active one if: The Parameter Setting Group Switch is set to "Switch via Input" and the other three input functions are inactive at the same time. In case that there is more than one input function active, no Parameter Setting Group Switch will be executed. In case all input functions are inactive, the device will keep working with the Setting Group that was activated lastly.</p> <p>Only available if: PSet-Switch = PSS via Inp fct</p>	1..n, PSS	--	[Protection Para /PSet-Switch]
 PS2: activated by	<p>This Setting Group will be the active one if: The Parameter Setting Group Switch is set to "Switch via Input" and the other three input functions are inactive at the same time. In case that there is more than one input function active, no Parameter Setting Group Switch will be executed. In case all input functions are inactive, the device will keep working with the Setting Group that was activated lastly.</p> <p>Only available if: PSet-Switch = PSS via Inp fct</p>	1..n, PSS	--	[Protection Para /PSet-Switch]
 PS3: activated by	<p>This Setting Group will be the active one if: The Parameter Setting Group Switch is set to "Switch via Input" and the other three input functions are inactive at the same time. In case that there is more than one input function active, no Parameter Setting Group Switch will be executed. In case all input functions are inactive, the device will keep working with the Setting Group that was activated lastly.</p> <p>Only available if: PSet-Switch = PSS via Inp fct</p>	1..n, PSS	--	[Protection Para /PSet-Switch]
 PS4: activated by	<p>This Setting Group will be the active one if: The Parameter Setting Group Switch is set to "Switch via Input" and the other three input functions are inactive at the same time. In case that there is more than one input function active, no Parameter Setting Group Switch will be executed. In case all input functions are inactive, the device will keep working with the Setting Group that was activated lastly.</p> <p>Only available if: PSet-Switch = PSS via Inp fct</p>	1..n, PSS	--	[Protection Para /PSet-Switch]
 Ack LED	All acknowledgeable LEDs will be acknowledged if the state of the assigned signal becomes true.	1..n, Assignment List	--	[Device Para /Ex Acknowledge]

Device Parameters

<i>Parameter</i>	<i>Description</i>	<i>Setting range</i>	<i>Default</i>	<i>Menu path</i>
Ack BO 	All acknowledgeable binary output relays will be acknowledged if the state of the assigned signal becomes true.	1..n, Assignment List	-.-	[Device Para /Ex Acknowledge]
Ack Scada 	SCADA will be acknowledged if the state of the assigned signal becomes true.	1..n, Assignment List	-.-	[Device Para /Ex Acknowledge]
Scaling 	Display of the measured values as primary, secondary or per unit values	Per unit values, Primary values, Secondary values	Per unit values	[Device Para /Measurem Display]
Lock Settings 	No parameters can be changed as long as this input is true. The parameter settings are locked.	1..n, Assignment List	-.-	[Field Para /General settings]

## System Module Input States

<i>Name</i>	<i>Description</i>	<i>Assignment via</i>
Ack LED-I	Module input state: LEDs acknowledgement by digital input	[Device Para /Ex Acknowledge]
Ack BO-I	Module input state: Acknowledgement of the binary Output Relays	[Device Para /Ex Acknowledge]
Ack Scada-I	Module input state: Acknowledge Scada via digital input. The replica that SCADA has got from the device is to be reset.	[Device Para /Ex Acknowledge]
PS1-I	State of the module input respectively of the signal, that should activate this Parameter Setting Group.	[Protection Para /PSet-Switch]
PS2-I	State of the module input respectively of the signal, that should activate this Parameter Setting Group.	[Protection Para /PSet-Switch]
PS3-I	State of the module input respectively of the signal, that should activate this Parameter Setting Group.	[Protection Para /PSet-Switch]
PS4-I	State of the module input respectively of the signal, that should activate this Parameter Setting Group.	[Protection Para /PSet-Switch]

## System Module Signals

<i>Signal</i>	<i>Description</i>
Reboot	Signal: Rebooting the device: 1=Restart initiated by power supply; 2=Restart initiated by the user; 3=Set on defaults (Super Reset); 4=Restart by the debugger; 5=Restart because of configuration change; 6=General failure; 7=Restart initiated by System Abort (host side); 8=Restart initiated by watchdog timeout (host side); 9=Restart initiated by System Abort (dspside); 10=Restart initiated by watchdog timeout (dspside); 11=Power supply failure (short term interruption) or power supply voltage too low; 12=illegal memory access.
Act Set	Signal: Active Parameter Set
PS 1	Signal: Parameter Set 1
PS 2	Signal: Parameter Set 2
PS 3	Signal: Parameter Set 3
PS 4	Signal: Parameter Set 4
PSS manual	Signal: Manual Switch over of a Parameter Set
PSS via Scada	Signal: Parameter Set Switch via Scada
PSS via Inp fct	Signal: Parameter Set Switch via input function
min 1 param changed	Signal: At least one parameter has been changed
Setting Lock Bypass	Signal: Short-period unlock of the Setting Lock
Param to be saved	Number of parameters to be saved. 0 means that all parameter changes are overtaken.
Ack LED	Signal: LEDs acknowledgement
Ack BO	Signal: Acknowledgement of the Binary Outputs
Ack Counter	Signal: Reset of all Counters
Ack Scada	Signal: Acknowledge Scada
Ack TripCmd	Signal: Reset Trip Command
Ack LED-HMI	Signal: LEDs acknowledgement :HMI
Ack BO-HMI	Signal: Acknowledgement of the Binary Outputs :HMI
Ack Counter-HMI	Signal: Reset of all Counters :HMI
Ack Scada-HMI	Signal: Acknowledge Scada :HMI
Ack TripCmd-HMI	Signal: Reset Trip Command :HMI
Ack LED-Sca	Signal: LEDs acknowledgement :SCADA
Ack BO-Sca	Signal: Acknowledgement of the Binary Outputs :SCADA
Ack Counter-Sca	Signal: Reset of all Counters :SCADA
Ack Scada-Sca	Signal: Acknowledge Scada :SCADA
Ack TripCmd-Sca	Signal: Reset Trip Command :SCADA
Res OperationsCr	Signal:: Res OperationsCr
Res AlarmCr	Signal:: Res AlarmCr
Res TripCmdCr	Signal:: Res TripCmdCr
Res TotalCr	Signal:: Res TotalCr



## Special Values of the System Module



<i>Value</i>	<i>Description</i>	<i>Menu path</i>
Build	Build	[Device Para /Version]
Version	Version	[Device Para /Version]
Operating hours Cr	Operating hours counter of the protective device	[Operation /Count and RevData /Sys]

## Field Parameters







### Field Para

Within the field parameters you can set all parameters, that are relevant for the primary side and the mains operational method like frequency, primary and secondary values and the star point treatment.



### General Field Parameters

<i>Parameter</i>	<i>Description</i>	<i>Setting range</i>	<i>Default</i>	<i>Menu path</i>
Phase Sequence 	Phase Sequence direction	ABC, ACB	ABC	[Field Para /General settings]
f 	Nominal frequency	50Hz, 60Hz	50Hz	[Field Para /General settings]









## Field Parameters – Current Related

Parameter	Description	Setting range	Default	Menu path
CT pri 	Nominal current of the primary side of the current transformers.	1 - 50000A	1000A	[Field Para /Current transf]
CT sec 	Nominal current of the secondary side of the current transformers.	1A, 5A	1A	[Field Para /Current transf]
CT dir 	Protection functions with directional feature can only work properly if the connection of the current transformers is free of wiring errors. If all current transformers are connected to the device with an incorrect polarity, the wiring error can be compensated by this parameter. This parameter turns the current vectors by 180 degrees.	0°, 180°	0°	[Field Para /Current transf]
ECT pri 	This parameter defines the primary nominal current of the connected earth current transformer. If the earth current is measured via the Holmgreen connection, the primary value of the phase current transformer must be entered here.	1 - 50000A	1000A	[Field Para /Current transf]
ECT sec 	This parameter defines the secondary nominal current of the connected earth current transformer. If the earth current is done via the Holmgreen connection, the primary value of the phase current transformer must be entered here.	1A, 5A	1A	[Field Para /Current transf]
ECT dir 	Earth fault protection with directional feature depends also on the correct wiring of the earth current transformer. An incorrect polarity/wiring can be corrected by means of the settings "0°" or "180°". The operator has the possibility of turning the current vector by 180 degrees (change of sign) without modification of the wiring. This means, that – in terms of figures - the determined current indicator was turned by 180° by the device.	0°, 180°	0°	[Field Para /Current transf]
IL1, IL2, IL3 Cutoff Level 	The Current shown in the Display or within the PC Software will be displayed as zero, if the Current falls below this Cutoff Level. This parameter has no impact on recorders.	0.0 - 0.100In	0.005In	[Device Para /Measurem Display]







## Field Parameters

<i>Parameter</i>	<i>Description</i>	<i>Setting range</i>	<i>Default</i>	<i>Menu path</i>
IG meas Cutoff Level 	The measured Earth Current shown in the Display or within the PC Software will be displayed as zero, if the measured Earth Current falls below this Cutoff Level. This parameter has no impact on recorders.	0.0 - 0.100In	0.005In	[Device Para /Measurem Display]
IG calc Cutoff Level 	The calculated Earth Current shown in the Display or within the PC Software will be displayed as zero, if the calculated Earth Current falls below this Cutoff Level. This parameter has no impact on recorders.	0.0 - 0.100In	0.005In	[Device Para /Measurem Display]
I012 Cutoff Level 	The Symmetrical Component shown in the Display or within the PC Software will be displayed as zero, if the Symmetrical Component falls below this Cutoff Level. This parameter has no impact on recorders.	0.0 - 0.100In	0.005In	[Device Para /Measurem Display]

## Field Parameters – Voltage Related



Parameter	Description	Setting range	Default	Menu path
VT pri 	Nominal voltage of the Voltage Transformers at the primary side. The phase to phase voltage is to be entered even if the load is in delta connection.	60 - 500000V	10000V	[Field Para /Voltage transf]
VT sec 	Nominal voltage of the Voltage Transformers at the secondary side. The phase to phase voltage is to be entered even if the load is in delta connection.	60.00 - 520.00V	100V	[Field Para /Voltage transf]
VT con 	This parameter has to be set in order to ensure the correct assignment of the voltage measurement channels in the device.	Phase to Phase, Phase to Ground	Phase to Ground	[Field Para /Voltage transf]
EVT pri 	Primary nominal voltage of the e-n winding of the voltage transformers, which is only taken into account in the direct measurement of the residual voltage (GVT con=measured/broken delta).	60 - 500000V	10000V	[Field Para /Voltage transf]
EVT sec 	Secondary nominal voltage of the e-n winding of the voltage transformers, which is only taken into account in the direct measurement of the residual voltage.	35.00 - 520.00V	100V	[Field Para /Voltage transf]
V Block f 	Threshold for the release of the frequency stages	0.15 - 1.00Vn	0.5Vn	[Field Para /General settings]
V Sync 	The fourth measuring input of the voltage measuring card measures the voltage that is to be synchronized.	L1, L2, L3, L12, L23, L31	L12	[Field Para /Voltage transf]
delta phi - Mode 	delta phi - Mode	one phase, two phases, three phases	two phases	[Field Para /Voltage transf]
Phase MTA 	Maximum Torque Angle: Angle between phase current and reference voltage in case of a short circuit. This angle is needed to determine the fault direction in case of short circuits.	0 - 360°	45°	[Field Para /Direction]

## Field Parameters

Parameter	Description	Setting range	Default	Menu path
 IG calc dir ctrl	Options for direction detection. IGcalc is used as operating quantity.	IG calc 3V0, IG calc IPol (IG meas), Dual, I2,V2	IG calc 3V0	[Field Para /Direction]
 IG meas dir ctrl	Options for direction detection. IGmeas is used as operating quantity.	IG meas 3V0, I2,V2, Dual	IG meas 3V0	[Field Para /Direction]
 3V0 Source	Earth overcurrent protection elements take into account this parameter for direction decisions. You have to ensure, that this parameter is set to "Measured" only if the residual voltage is fed to the fourth measuring input of the voltage measuring card.	measured, calculated	measured	[Field Para /Direction]
 Ground MTA	Ground Maximum Torque Angle: Angle between chosen operating quantity and chosen reference quantity in case of a ground fault. This angle is needed to determine the ground fault direction in case of a short circuit. Depending on the selected ground direction option, different MTA values are used: IGcalc 3V0, IGmeas 3V0 : Ground MTA; IGcalc Neg, IGmeas Neg : $90^\circ + \text{Phase MTA}$ ; IGcalc IPol : $0^\circ$ ; IGcalc Dual : $0^\circ$ (if I2 and V2 available) or Ground MTA; IGmeas Dual : $90^\circ + \text{Phase MTA}$ (if I2 and V2 available) or Ground MTA.	0 - $360^\circ$	$110^\circ$	[Field Para /Direction]
 ECT Angle Cor	Fine adjustment of the measuring angle of the earth current transformers. By means of the Angle Correction, faults of the earth voltage transformers can be taken into account.	$-45 - 45^\circ$	$0^\circ$	[Field Para /Direction]
 V Cutoff Level	The Phase Voltage shown in the Display or within the PC Software will be displayed as zero, if the Phase Voltage falls below this Cutoff Level. This parameter has no impact on recorders. This parameter is related to the voltage that is connected to the device (phase-to-phase or phase-to-earth).	0.0 - 0.100Vn	0.005Vn	[Device Para /Measurem Display]
 VG meas Cutoff Level	The measured Residual Voltage shown in the Display or within the PC Software will be displayed as zero, if the measured Residual Voltage falls below this Cutoff Level. This parameter has no impact on recorders.	0.0 - 0.100Vn	0.005Vn	[Device Para /Measurem Display]

## Field Parameters

---

<i>Parameter</i>	<i>Description</i>	<i>Setting range</i>	<i>Default</i>	<i>Menu path</i>
VG calc Cutoff Level 	The calculated Residual Voltage shown in the Display or within the PC Software will be displayed as zero, if the calculated Residual Voltage falls below this Cutoff Level. This parameter has no impact on recorders.	0.0 - 0.100Vn	0.005Vn	[Device Para /Measurem Display]
V012 Comp Cutoff Level 	The Symmetrical Component shown in the Display or within the PC Software will be displayed as zero, if the Symmetrical Component falls below this Cutoff Level. This parameter has no impact on recorders.	0.0 - 0.100Vn	0.005Vn	[Device Para /Measurem Display]

## Blockings

The device provides a function for temporary and permanent blocking of the complete protection functionality or of single protection stages.



**WARNING** Make absolutely sure that no illogical or even life-threatening blockings are allocated.

Make sure that you do not carelessly deactivate protection functions which have to be available according to the protection concept.

### Permanent Blocking

*Switching ON or OFF the complete protection functionality*

In module »*Protection*« the complete protection of the device can be switched on or off. Set the parameter *Function* to »*active*« or »*inactive*« in module »*Prot*«.



**WARNING** Only if in module »*Prot*« the parameter »*Function*« is = »*active*«, the protection is activated; i.e. with »*Function*« = »*inactive*«, no protection function is operating. Then the device cannot protect any components.

*Switching modules ON or OFF*

Each of the modules can be switched on or off (permanently). This is achieved when the parameter »*Function*« is set to »*active*« or »*inactive*« in the respective module.

*Activating or deactivating the tripping command of a protection stage permanently*

In each of the protection stages the tripping command to the CB can be permanently blocked. For this purpose the parameter »*TripCmd Blo*« has to be set to »*active*«.

### Temporary Blocking

*To block the complete protection of the device temporarily by a signal*

In module »*Prot*« the complete protection of the device can be blocked temporarily by a signal. On condition that a module-external blocking is permitted »*ExBlo Fc=active*«. In addition to this, a related blocking signal from the »assignment list« must have been assigned. For the time the allocated blocking signal is active, the module is blocked.



**WARNING** If the module »*Prot*« is blocked, the complete protection function does not work. As long as the blocking signal is active, the device cannot protect any components.

*To block a complete protection module temporarily by an active assignment*

- In order to establish a temporary blockage of a protection module, the parameter »*ExBlo Fc*« of the module



has to be set to »*active*«. This gives the permission: »This module can be blocked«.

- Within the general protection parameters a signal has to be additionally chosen from the »ASSIGNMENT LIST«. The blocking only becomes active when the assigned signal is active.

*To block the tripping command of a protection stage temporarily by an active assignment.*

The tripping command of any of the protection modules can be blocked from external. In this case, external does not only mean from outside the device, but also from outside the module. Not only real external signals are permitted to be used as blocking signals, as for example, the state of a digital input, but you can also choose any other signal from the »assignment list«.

- In order to establish a temporary blockage of a protection stage, the parameter »*ExBlo TripCmd Fc*« of the module has to be set to »*active*«. This gives the permission: »The tripping command of this stage can be blocked«.
- Within the general protection parameters, a signal has to be chosen additionally and assigned to the parameter »*ExBlo*« from the »assignment list«. If the selected signal is activated, the temporary blockage becomes effective.

## To Activate or Deactivate the Tripping Command of a Protection Module

**Trip blockings**

**name** = all modules that are blockable

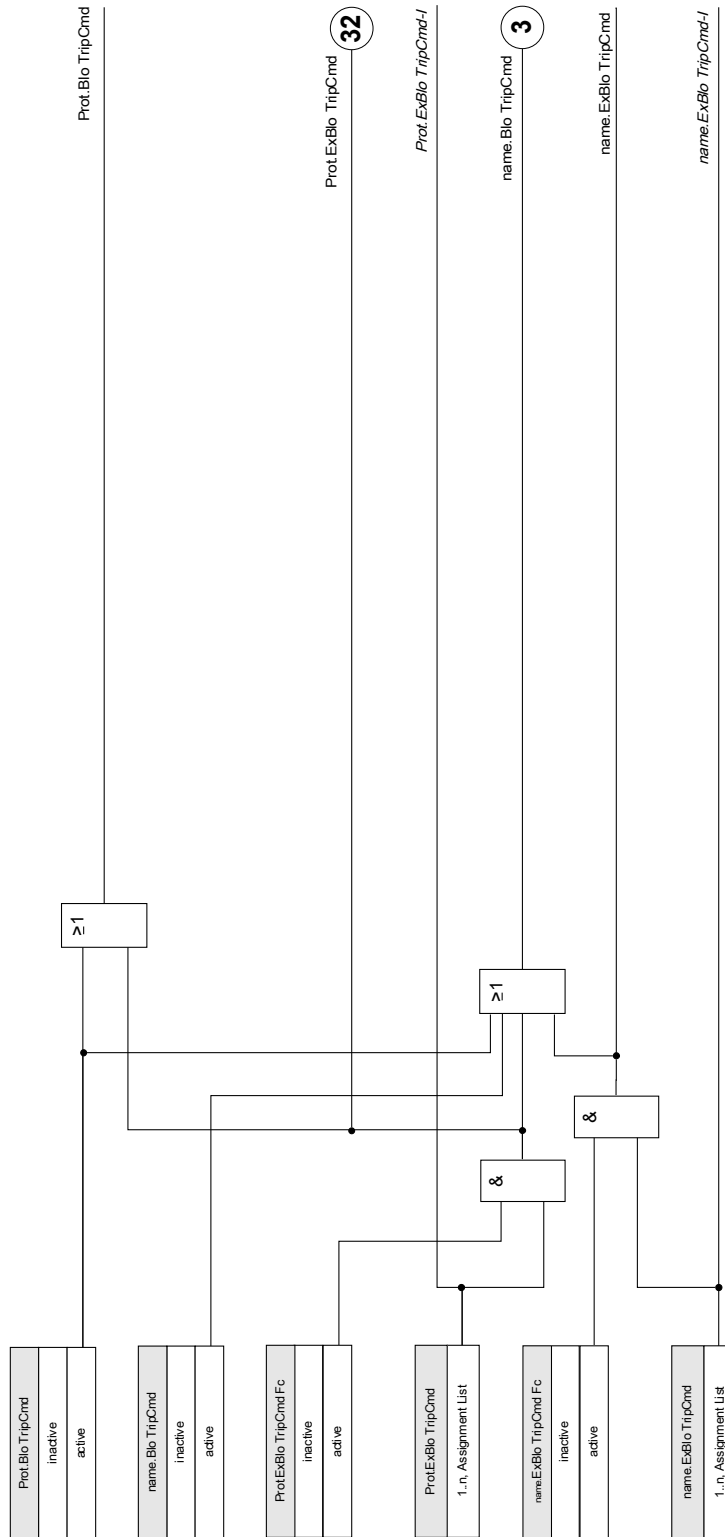

## Activate, Deactivate Respectively Block Temporarily Protection Functions

The following diagram applies to all protective elements except: Phase current, Earth current and Q->&V< protection elements.

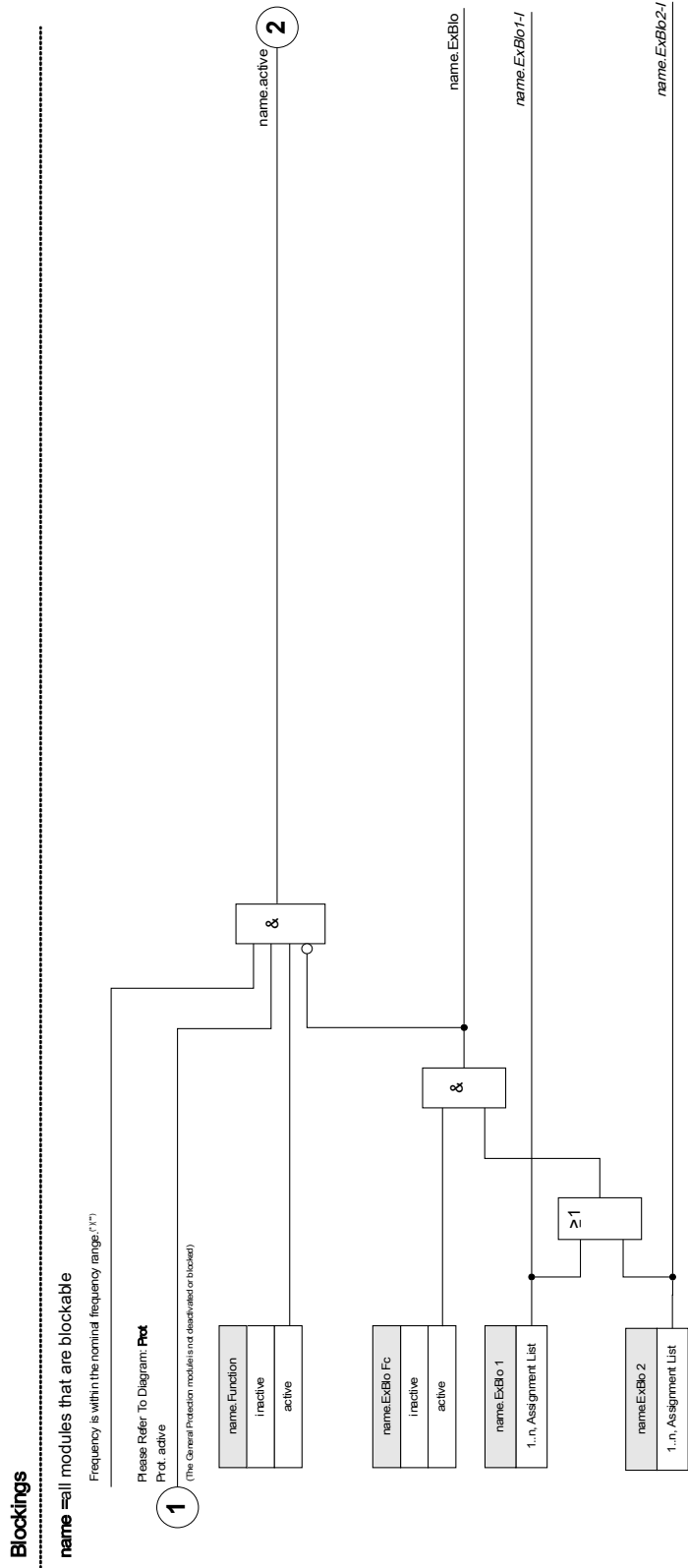

The following diagram is applies to the Q->&V< Protection:

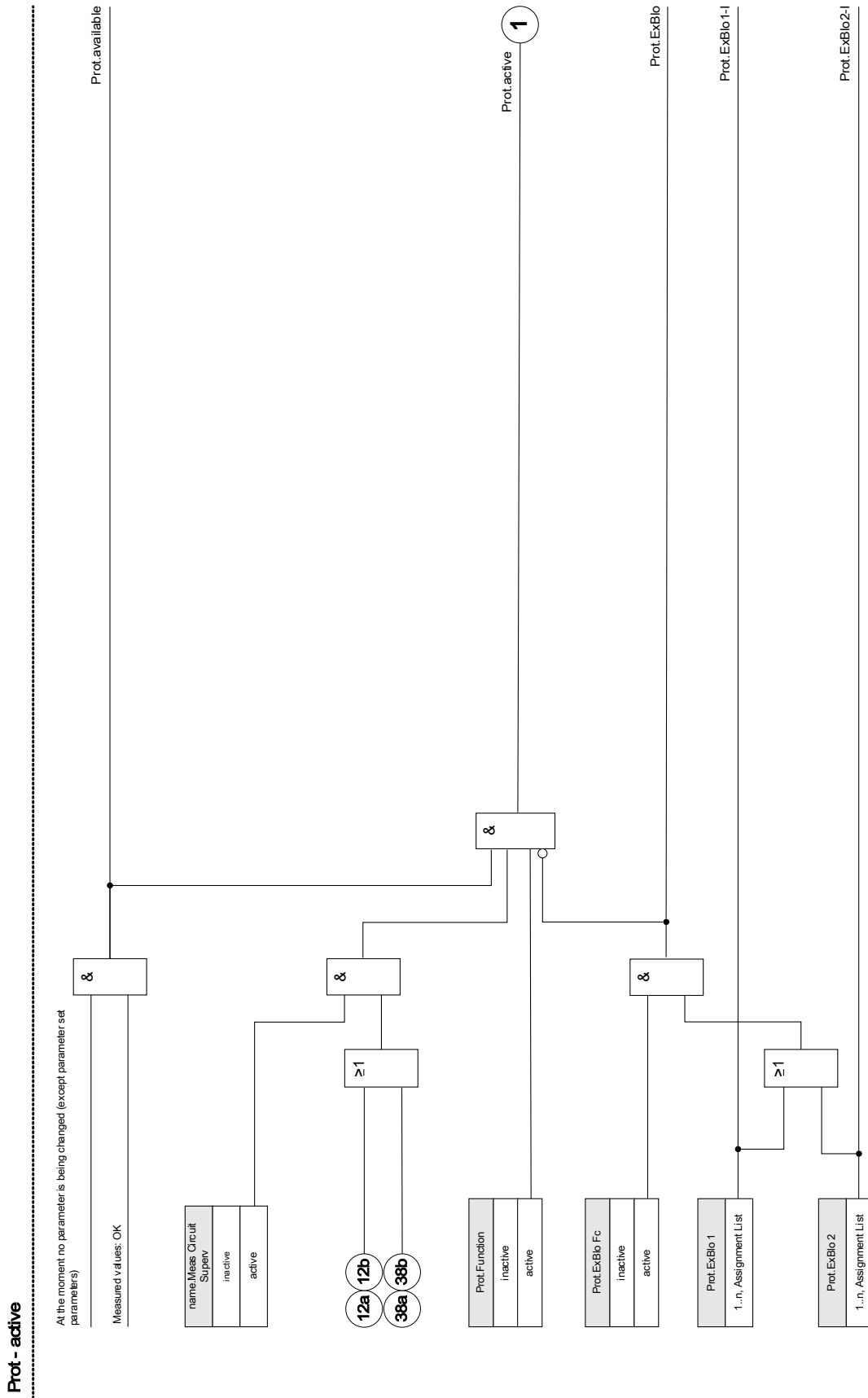

Current protective functions cannot only be blocked permanently («function = inactive») or temporarily by any blocking signal from the »assignment list«, but also by »reverse Interlocking«.

The following diagram applies phase current elements:

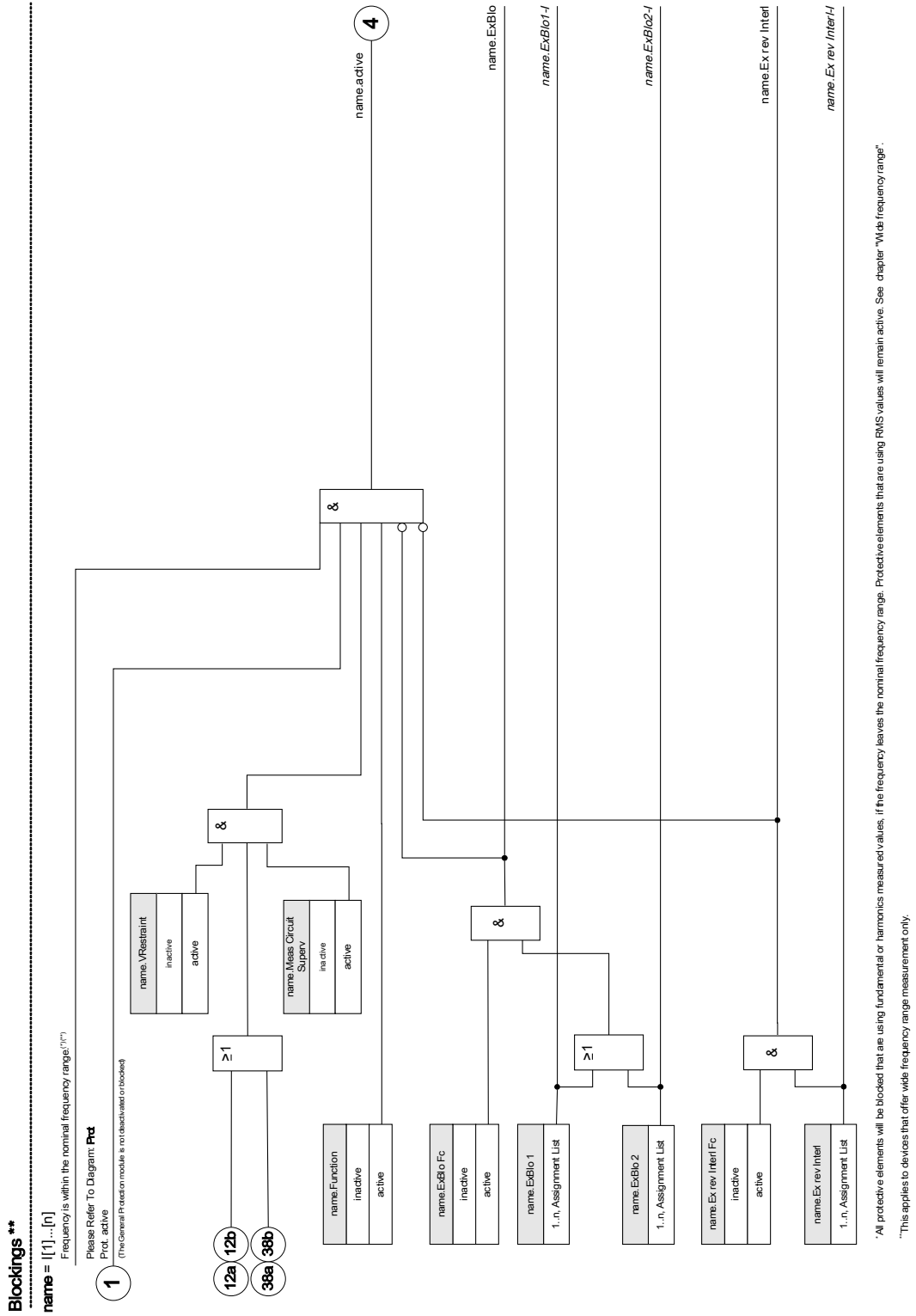

Earth current protective functions cannot only be blocked permanently (»function = inactive«) or temporarily by any blocking signal from the »assignment list«, but also by »reverse Interlocking«.

The following diagram applies to earth current elements:

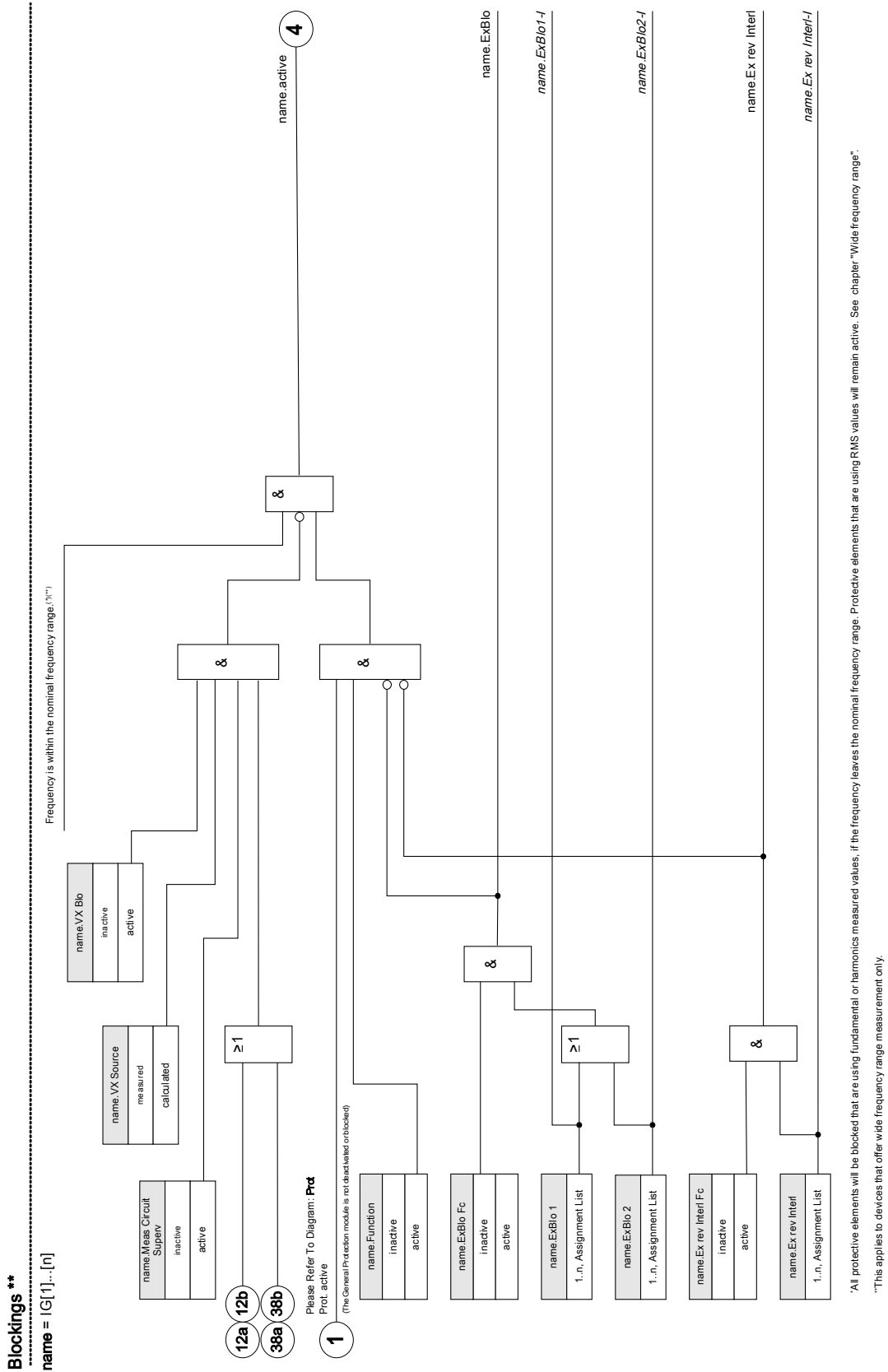

## Module: Protection (Prot)

### Prot

The module *»Protection«* serves as outer frame for all other protection modules, i.e. they are all enclosed by the module *»Protection«*. All alarms and tripping commands are combined in module *»Protection«* by an OR-logic.



If in module *»Protection«* the parameter *»Function«* is set on *»inactive«* or in case the module is blocked, then the complete protective function of the device does not work anymore.

### *Protection inactive*

If the master module *»Protection«* was permanently deactivated or if a temporary blockage of this module has occurred and the allocated blocking signal is still active, then the complete functionality (protection) of the device is zero. In such a case the protective function is *»inactive«*.

### *Protection active*

If the master module *»Protection«* was activated and a blockade for this module was not activated respectively the assigned blocking signal is inactive at that moment, then the *»Protection«* is *»active«*.

Prot - active

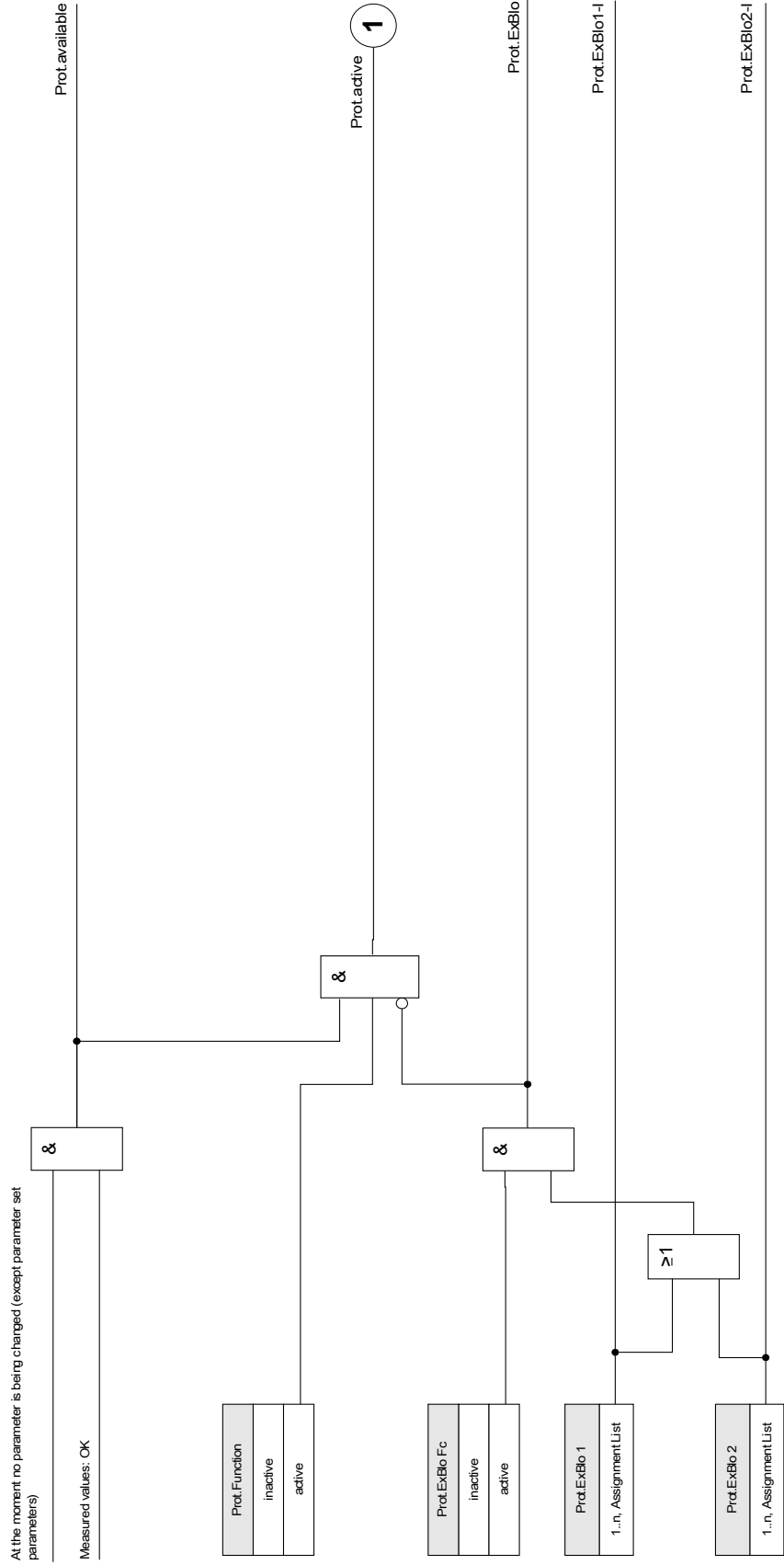



Each protection stage can decide automatically about a trip. The trip decision is passed on to module »Prot« and The tripping commands of all protection stages are combined in module »Prot« by an OR logic (Collective signals, direction decisions, information about phases). The tripping commands are executed by the module » TripControl«.



The tripping commands are executed by the module »TripControl«

If a protection module is activated respectively issues a trip command to the CB two alarm signals will be created:

1. The module or the protection stage issues an alarm e.g. »I[1].ALARM« or »I[1].TRIP«.
2. The master module »Prot« collects/summarizes the signals and issues an alarm or a trip signal »PROT.ALARM« »PROT.TRIP«.

**Prot.Trip**

name = Each trip of an active, trip authorized protection module will lead to a general trip.

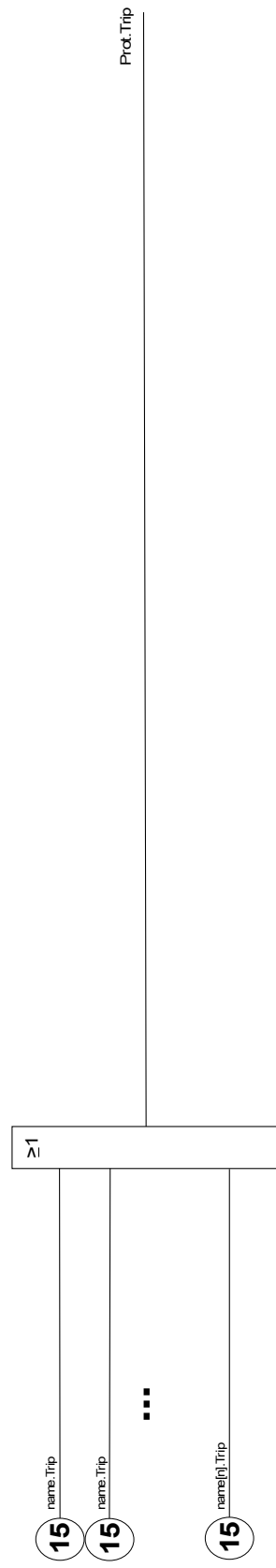

**Prot.Alarm**

name = Each alarm of a module (except from supervision modules but including CBF) will lead to a general alarm (collective alarm).

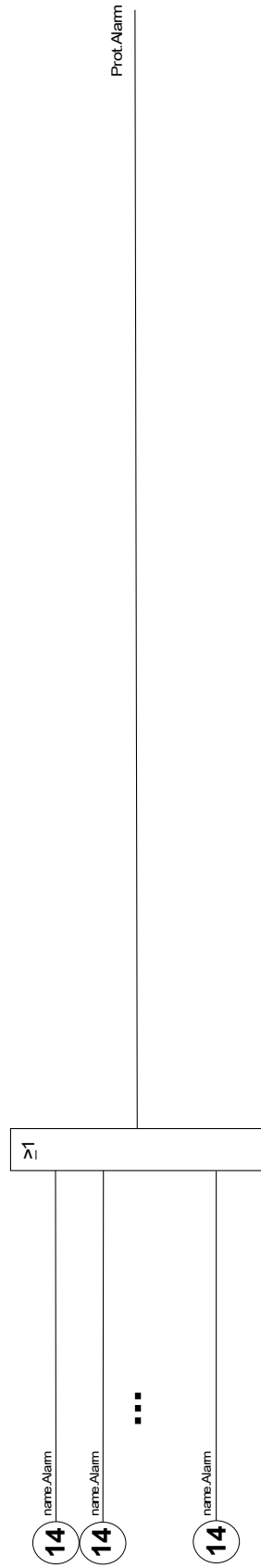

**Prot. Trip**

Each phase selective trip of a trip authorized module (I, IG, V, VX depending on the device type) will lead to a phase selective general trip.

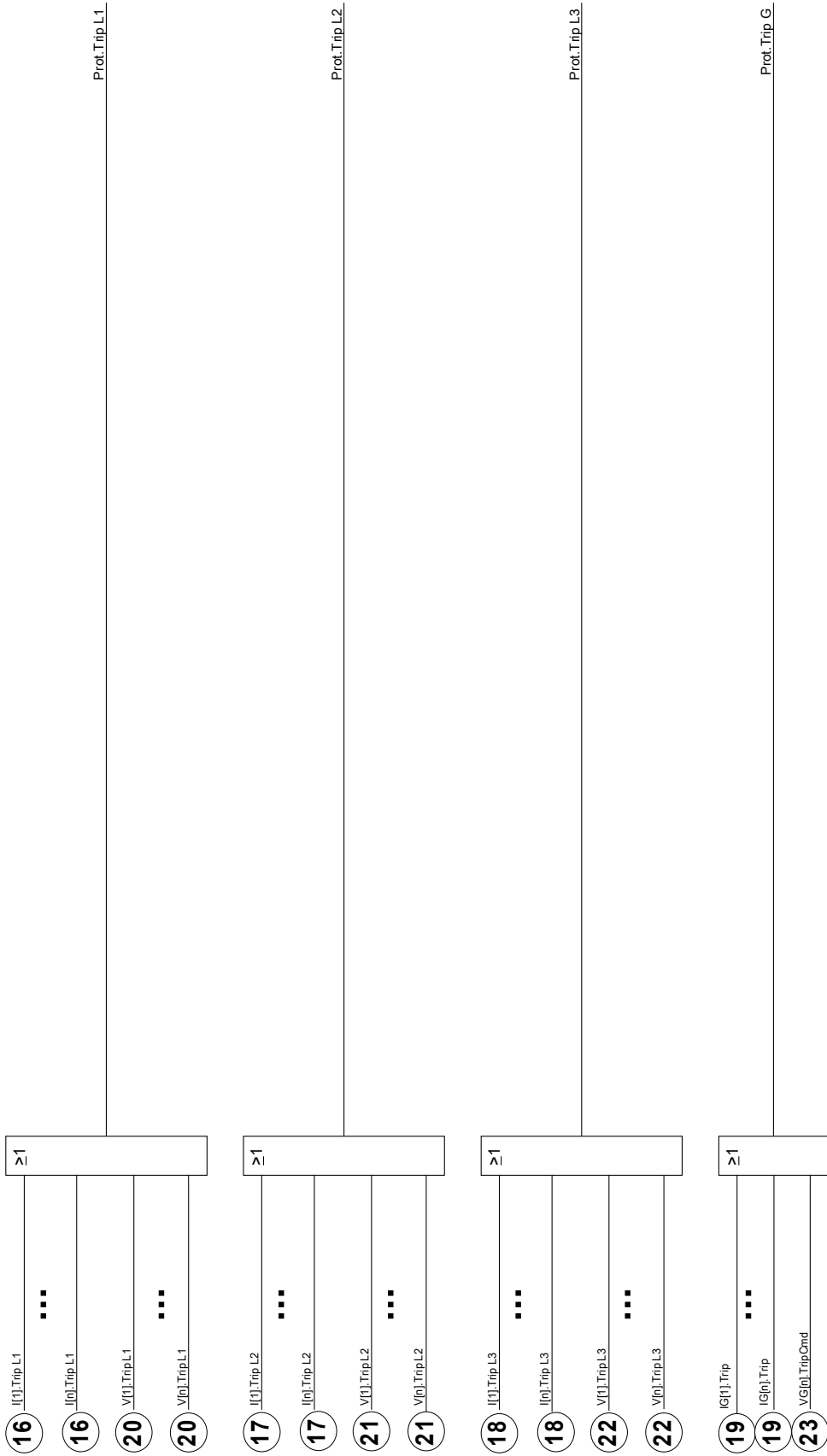

**Prot Alarm**

Each phase selective alarm of a module (I, IG, V, VX depending on the device type) will lead to a phase selective general alarm (collective alarm).

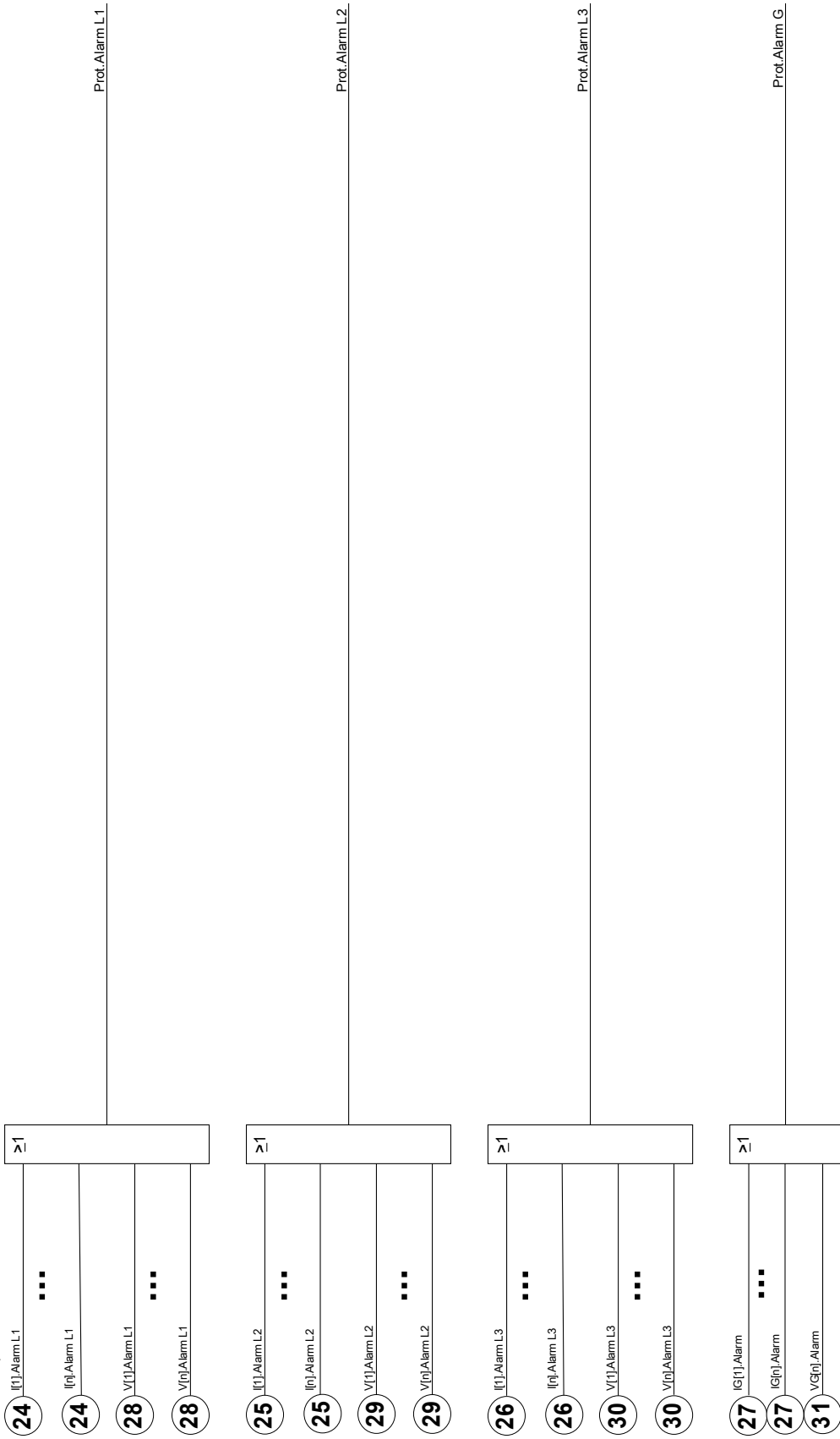

## Direct Commands of the Protection Module

Parameter	Description	Setting range	Default	Menu path
Res Fault a Mains No 	Resetting of fault number and number of grid faults.	inactive, active	inactive	[Operation /Reset]

## Global Protection Parameters of the Protection Module

Parameter	Description	Setting range	Default	Menu path
Function 	Permanent activation or deactivation of module/stage.	inactive, active	active	[Protection Para /Global Prot Para /Prot]
ExBlo Fc 	Activate (allow) the external blocking of the global protection functionality of the device.	inactive, active	inactive	[Protection Para /Global Prot Para /Prot]
ExBlo1 	If external blocking of this module is activated (allowed), the global protection functionality of the device will be blocked if the state of the assigned signal becomes true.	1..n, Assignment List	..-	[Protection Para /Global Prot Para /Prot]
ExBlo2 	If external blocking of this module is activated (allowed), the global protection functionality of the device will be blocked if the state of the assigned signal becomes true.	1..n, Assignment List	..-	[Protection Para /Global Prot Para /Prot]
Blo TripCmd 	Permanent blocking of the Trip Command of the entire Protection.	inactive, active	inactive	[Protection Para /Global Prot Para /Prot]
ExBlo TripCmd Fc 	Activate (allow) the external blocking of the trip command of the entire device.	inactive, active	inactive	[Protection Para /Global Prot Para /Prot]
ExBlo TripCmd 	If external blocking of the tripping command is activated (allowed), the tripping command of the entire device will be blocked if the state of the assigned signal becomes true.	1..n, Assignment List	..-	[Protection Para /Global Prot Para /Prot]

## Protection Module Input States

<i>Name</i>	<i>Description</i>	<i>Assignment via</i>
ExBlo1-I	Module input state: External blocking1	[Protection Para /Global Prot Para /Prot]
ExBlo2-I	Module input state: External blocking2	[Protection Para /Global Prot Para /Prot]
ExBlo TripCmd-I	Module input state: External Blocking of the Trip Command	[Protection Para /Global Prot Para /Prot]

## Protection Module Signals (Output States)

<i>Signal</i>	<i>Description</i>
available	Signal: Protection is available
active	Signal: active
ExBlo	Signal: External Blocking
Blo TripCmd	Signal: Trip Command blocked
ExBlo TripCmd	Signal: External Blocking of the Trip Command
Alarm L1	Signal: General-Alarm L1
Alarm L2	Signal: General-Alarm L2
Alarm L3	Signal: General-Alarm L3
Alarm G	Signal: General-Alarm - Earth fault
Alarm	Signal: General Alarm
Trip L1	Signal: General Trip L1
Trip L2	Signal: General Trip L2
Trip L3	Signal: General Trip L3
Trip G	Signal: General Trip Ground fault
Trip	Signal: General Trip
Res Fault a Mains No	Signal: Resetting of fault number and number of grid faults.
I dir fwd	Signal: Phase current failure forward direction
I dir rev	Signal: Phase current failure reverse direction
I dir n poss	Signal: Phase fault - missing reference voltage
IG calc dir fwd	Signal: Ground fault (calculated) forward
IG calc rev dir	Signal: Ground fault (calculated) reverse direction
IG calc dir n poss	Signal: Ground fault (calculated) direction detection not possible
IG meas dir fwd	Signal: Ground fault (measured) forward
IG meas rev dir	Signal: Ground fault (measured) reverse direction

<i>Signal</i>	<i>Description</i>
IG meas dir n poss	Signal: Ground fault (measured) direction detection not possible
f(VL123)<10Hz	Frequency of the measuring channels 1-3 (VL1,VL2,VL3) is lower than 10Hz.
f(VL123)>10Hz	Frequency of the measuring channels 1-3 (VL1,VL2,VL3) is greater than 10Hz.
f(VL123)<70Hz	Frequency of the measuring channels 1-3 (VL1,VL2,VL3) is lower than 70Hz.
f(VL123)>70Hz	Frequency of the measuring channels 1-3 (VL1,VL2,VL3) is greater than 70Hz.
DFT Invalid	DFT values of fundamental and harmonics (except VX) are not valid. They depend on period time of frequency and measured channels 1-3 (VL1,VL2,VL3).
DFT Valid	DFT values of fundamental and harmonics (except VX) are valid. They depend on period time of frequency and measured channels 1-3 (VL1,VL2,VL3).
f(VX)<10Hz	Frequency of the measuring channel 4 (VX) is lower than 10Hz.
f(VX)>10Hz	Frequency of the measuring channel 4 (VX) is greater than 10Hz.
f(VX)<70Hz	Frequency of the measuring channel 4 (VX) is lower than 70Hz.
f(VX)>70Hz	Frequency of the measuring channel 4 (VX) is greater than 70Hz.
DFT Invalid (VX)	DFT values of fundamental and harmonics of VX (only) are not valid.
DFT Valid (VX)	DFT values of fundamental and harmonics of VX (only) are valid.

## Protection Module Values

<i>Parameter</i>	<i>Description</i>
FaultNo	Disturbance No
No of grid faults	Number of grid faults: A grid fault, e.g. a short circuit, might cause several faults with trip and autoreclosing, each fault being identified by an increased fault number. In this case, the grid fault number remains the same.



## Switchgear/Breaker – Manager



**WARNING** Misconfiguration of switchgear could result in death or serious injury. This e. g. is the case when opening a disconnecter under load or when switching a ground connector to live parts of a system.

Beside protection functions, protective relays more and more will take care about controlling switchgear, like circuit breakers, load break switches, disconnectors and ground connectors.

A correct configuration of all switchgear is an indispensable precondition for the proper functioning of the protective device. This also is the case, when the switchgear are not controlled, but supervised only.

## Single Line Diagram

For construction of a single line diagram, please address to our technical support.

The single line diagram includes the graphical description of the switchgear and their designations (names) as well as their features (short circuit proof or not ...). For displaying in the devices software, the switchgear designations (e. g. QA1, QA2, instead of SG[x]) will be taken from the single line diagram.

Beside switching properties a configuration file also includes a single line diagram. Switching properties and single line diagram are coupled via the the configuration file. Since the single line diagram is independent of the device type, a new/other single line diagram can be imported into the configuration file.

### **NOTICE**

Whenever a configuration file is loaded into a protection device, a single line diagram will be always loaded at the same time.

This means, whenever a configuration file is transferred from one to another device, a suitable single line diagram has to be loaded by means of the Device Planning menu.

## Import of a Single Line Diagram

To import a single line diagram into a device, proceed as follows:

- Load the configuration file of the device via Smart view.
- Change into the Device Planning menu.
- Assign the right single line diagram to the configuration file.
- Save the configuration file to a volume. The single line diagram now is saved together with the \*.HptPara file.

## Transfer of the Single Line Diagram into the device

If in the Smart view menu »Device« »Transfer All Parameters into the Device« has been selected, beside all parameters also the single line diagram and the switchgear properties will be transferred into the device.

## Export of a Single Line Diagram

To export a single line diagram, go into the Device Planning menu [Device Planning/Control]. Click onto »Control.{Name}«. Afterwards click onto the field "Export current File to Disk".

After the single line diagram has been loaded, each individual switchgear has to be configured. The following table shows the required configurations dependent on the type of switchgear.

To be configured at:	Type of switchgear							
[Control\SG\Designation of switchgear]	Circuit Breaker (controlled)	Circuit Breaker (supervised)	Switch Disconnector (controlled)	Switch Disconnector (supervised)	Ground Connector (controlled)	Ground Connector (supervised)	Disconnector (controlled)	Disconnector (supervised)
Assignment of position indications (Digital inputs)	x	x	x	x	x	x	x	x
Assignment of commands (Output relays)	x	-	x	-	x	-	x	-
Setting of supervision timers	x	x	x	x	x	x	x	x
Interlockings	x	-	x	-	x	-	x	-
Trip Manager (Assignment of trip commands)	x	x	-	-	-	-	-	-
Optional: Synchronous switching	x	-	-	-	-	-	-	-
Optional: Ex ON/OFF Cmd	x	-	x	-	x	-	x	-
Optional: SGW	x	x	x	x	x	x	x	x

## Notes on Special Switchgears

### Combination of a Disconnecter and an Earthing Switch

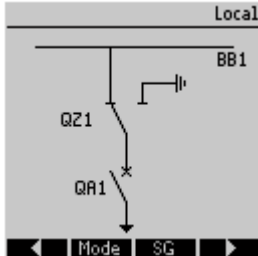

This switchgear is a combination of a disconnecter and an earthing switch. This Switch switches between the »ON-Position« (e.g. Busbar) and the »Earthing-Position«.

### NOTICE

The Earthing position of a „Diconnecter and Earthing“-Switchgear combination is shown as „CB POS OFF“ within the SCADA documentation (register maps).

### Three Position Disconnecter

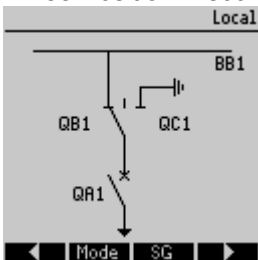

The “Three Position Disconnecter” covers functional two switchgears. One switchgear corresponds to the disconnecter of the “Three Positon Disconnecter”, and the second switchgear corresponds to the earthing switch. The Single Line shows the current position of the “Three Positon Disconnecter”. The separation into two switchgears prevent unintentional direct switching from the »ON«-position via the »OFF«-position into the »EARTH«-position. From security aspects there are two clear switch positions »Isolating« and »EARTH«. Thanks to this separation, individual supervision and switching timers for the earthing and isolating part can be set. In addition to that individual interlockings and device names (designations) can be set for the earthing and the isolating part.

### NOTICE

The Command Execution Supervision will issue the following message in case of a switching attempt from the earthing position (directly) into the isolator position and vice versa:  
„CES SwitchDir“

### NOTICE

The “Earth” position of a „Diconnecter and Earthing“-switchgear combination is shown as „CB POS OFF“ within the SCADA documentation (register maps).

*Withdrawable Circuit Breaker (Draw Out Circuit Breaker)*

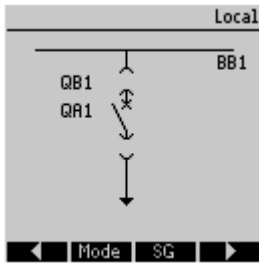

The truck of a withdrawable circuit breaker has to be managed as an individual switchgear. There is no fixed connection between the circuit breaker and the truck. An interlocking has to be set by the User because it is not allowed to withdraw the breaker as long as it is in the closed position. The circuit breaker can be switched in the withdrawn and in the non-withdrawn position.

The signals of the control circuit (low voltage) plug have to be wired and configured with(-in) the protective device. The control (supervision) will be set to »Removed« when the control circuit plug is removed (pulled). The circuit breaker will be set into the »CB OFF«-position as long as the »Removed«-signal is active.

**NOTICE** It's not possible to manipulate the Position Signals of a withdrawn (removed) circuit breaker.

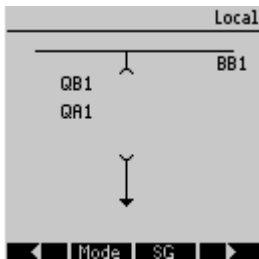

## Switchgear Configuration

### Wiring

At first the switchgear positioning indicators have to be connected to the digital inputs of the protection device. One of the position indicators (either the »Aux ON« or the »Aux OFF«) contact has to be connected necessarily. It is recommended also to connect the »Aux OFF« contact.

Thereafter the command outputs (relay outputs) have to be connected with the switchgear.

#### **NOTICE**

Please observe the following option: In the general settings of a circuit breaker, the ON/OFF commands of a protection element can be issued to the same output relays, where the other control commands are issued. If the commands are issued to different relays output relays the amount of wiring increases.

### Assignment of Position Indications

The position indication is needed by the device to get (evaluate) the information about the current status /position of the breaker. The switchgear position indications are shown in the devices display. Each position change of a switchgear results in a change of the corresponding switchgear symbol.

#### **NOTICE**

For the detection of a switchgear's position always two separate Aux contacts are recommended! If only one Aux contact is used, no intermediate or disturbed positions can be detected. A (reduced) transition supervision (time between issue of the command and position feedback indication of the switchgear) is also possible by one Aux contact.

In the menu [Control/SG/SG [x] ] the assignments for the position indications have to be set.

#### *Detection of switchgear position with two Aux contacts – Aux ON and Aux OFF (recommended!)*

For detection of their positions switchgear are provided with Aux contacts (Aux ON and Aux OFF). It is recommended to use both contacts to detect intermediate and disturbed positions too.

The protection device continuously supervises the status of the inputs »Aux ON-I« and »Aux OFF-I«. These signals are validated based on the supervision timers »t-Move ON« and »t-Move OFF« validation functions. As a result, the switchgear position will be detected by the following signals:

- Pos ON
- Pos OFF
- Pos Indeterm
- Pos Disturb.
- Pos (State=0,1,.2 or 3)

*Supervision of the ON command*

When an ON command is initiated, the »*t-Move ON*« timer will be started. While the timer is running, the »POS INDETERM« State will become true. If the command is executed and properly fed back from the switchgear before the timer has run down, »POS ON« will become true. Otherwise, if the timer has expired »POS DISTURB« will become true.

*Supervision of the OFF command*

When an OFF command is initiated, the »*t-Move OFF*« timer will be started. While the timer is running, the »POS INDETERM« State will become true. If the command is executed and properly fed back before the timer has run down, »POS OFF« will become true. Otherwise, if the timer has expired »POS DISTURB« will become true.

The following table shows how switchgear positions are validated:

States of the Digital Inputs		Validated Breaker Positions				
Aux ON-I	Aux OFF-I	POS ON	POS OFF	POS Indeterm	POS Disturb	POS State
0	0	0	0	1 (while a Moving timer is running)	0 (while a Moving timer is running)	0 Intermediate
1	1	0	0	1 (while a Moving timer is running)	0 (while a Moving timer is running)	0 Intermediate
0	1	0	1	0	0	1 OFF
1	0	1	0	0	0	2 ON
0	0	0	0	0 (Moving timer elapsed)	1 (Moving timer elapsed)	3 Disturbed
1	1	0	0	0 (Moving timer elapsed)	1 (Moving timer elapsed)	3 Disturbed

*Single Position Indication Aux ON or Aux OFF*

If the single pole indication is used, the »SI SINGLECONTACTIND« will become true.

The moving time supervision works only in one direction. If the Aux OFF signal is connected to the device, only the “OFF command” can be supervised and if the Aux ON signal is connected to the device, only the “ON command” can be supervised.

*Single Position Indication – Aux ON*

If only the Aux ON signal is used for the Status Indication of an “ON command”, the switch command will also start the moving time, the position indication indicates an INTERMEDIATE position during this time interval. When the switchgear reaches the end position indicated by the signals Pos ON and CES succesf before the moving time has elapsed the signal Pos Indeterm disappears.

If the moving time elapsed before the switchgear has reached the end position, the switching operation was not successful and the Position Indication will change to POS Disturb and the signal Pos Indeterm disappears. After the moving time has elapsed, the Dwell time will be started (if set). During this time interval the Position Indication will also indicate an INTERMEDIATE state. When the Dwell time elapses the Position Indication will change to Pos ON.

*The following table shows how breaker positions are validated based on Aux ON:*

<b>States of the Digital Input</b>		<b>Validated Breaker Positions</b>				
<i>Aux ON-I</i>	<i>Aux OFF-I</i>	<i>POS ON</i>	<i>POS OFF</i>	<i>POS Indeterm</i>	<i>POS Disturb</i>	<i>POS State</i>
0	Not wired	0	0	1 (while t-Move ON is running)	0 (while t-Move ON is running)	0 Intermediate
0	Not wired	0	1	0	0	1 OFF
1	Not wired	1	0	0	0	2 ON

If there is no digital input assigned to the »Aux On« contact, the position indication will have the value 3 (disturbed).



*Single Position Indication – Aux OFF*

If only the Aux OFF signal is used for the monitoring of the “OFF command”, the switch command will start the moving timer. The Position Indication will indicate an INTERMEDIATE position. When the switchgear reaches its end position before the moving timer elapses, »CES succesf« will be indicated. At the same time the signal »Pos Indeterm« disappears.

If the moving time elapsed before the switchgear has reached the OFF position, the switching operation was not successful and the Position Indication will change to »Pos Disturb« and the signal »Pos Indeterm« disappears. When the moving timer has elapsed, the dwell timer will be started (if configured). During this timer elapses »Pos Disturb« will be indicated. When the dwell time has elapsed, the OFF position of the switchgear will be indicated by the »Pos OFF« signal.

The following table shows how breaker positions are validated based on **Aux OFF**:

States of the Digital Input		Validated Breaker Positions				
Aux ON-I	Aux OFF-I	POS ON	POS OFF	POS Indeterm	POS Disturb	POS State
Not wired	0	0	0	1 (while t-Move OFF is running)	0 (while t-Move OFF is running)	0 Intermediate
Not wired	0	0	1	0	0	1 OFF
Not wired	1	1	0	0	0	2 ON

If there is no digital input assigned to the »Aux OFF« contact, the position indication will have the value 3 (disturbed).

**Setting of Supervision Times**

In the menu [Control/SG/SG[x]/General Settings] the supervision times of the individual switchgear have to be set. Dependent on the type of switchgear it can be necessary to set further parameters, like dwell time.

**Interlockings**

To avoid faulty operations, interlockings have to be provided. This can be realised mechanically or electrically.

For a controllable switchgear up to three interlockings can be assigned in both switching directions (ON/OFF). These interlockings prevent switching in the corresponding direction.

The protection OFF command and the reclosing command of the AR module are always executed without interlockings. For the case, that a protection OFF command must not be issued, this must be blocked separately.

Further interlockings can be realised by means of the Logic module.

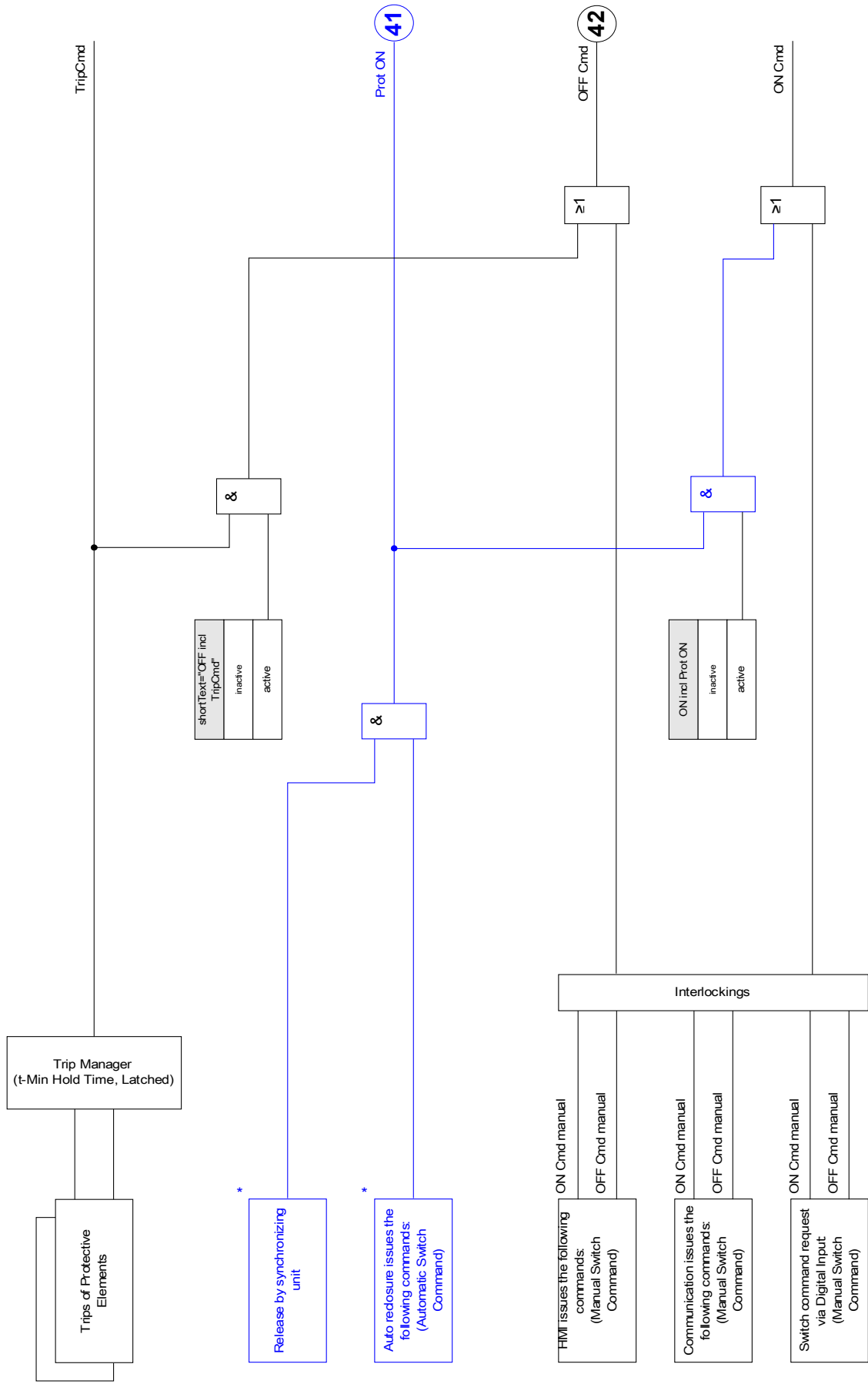

\* Availability dependent on device type

### Trip Manager – Assignment of commands

The trip commands of the protection elements have to be assigned to those switchgear, that are make/break capable (Circuit Breaker). For every make/break capable switchgear a Trip Manager is provided. In the Trip Manger all tripping commands are combined by an “OR” logic. The actual tripping command to the switchgear is exclusively given by the Trip Manager. This means, that only tripping commands which are assigned in the Trip Manager lead to an operation of the switchgear. In addition to that, the User can set the minimum hold time of the tripping command within this module and define whether the tripping command is latched or not.

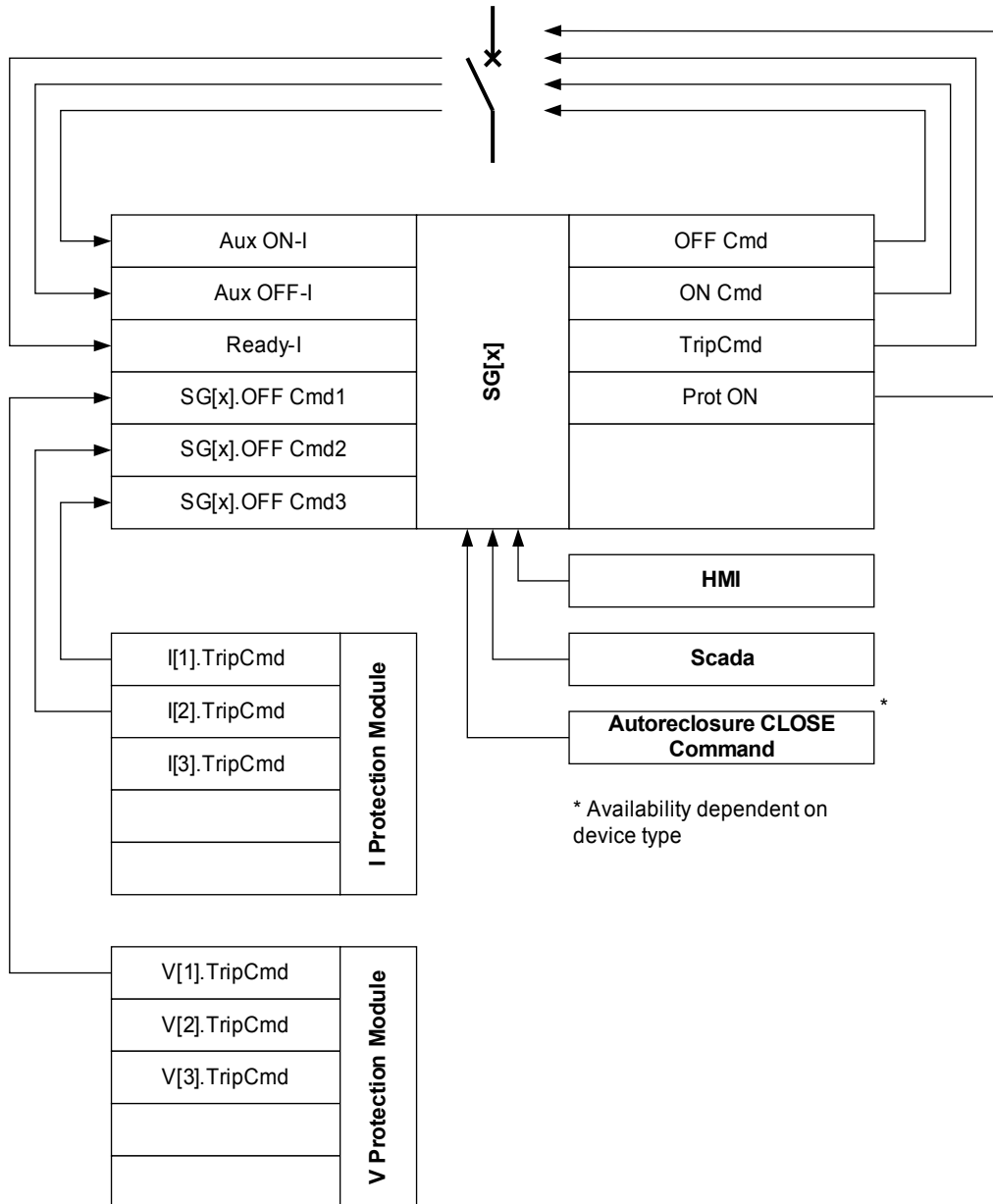

The exact name of the Switchgear is defined in the Single Line file.

**SGxj.Trip.CB**

name =Module name of the assigned trip command

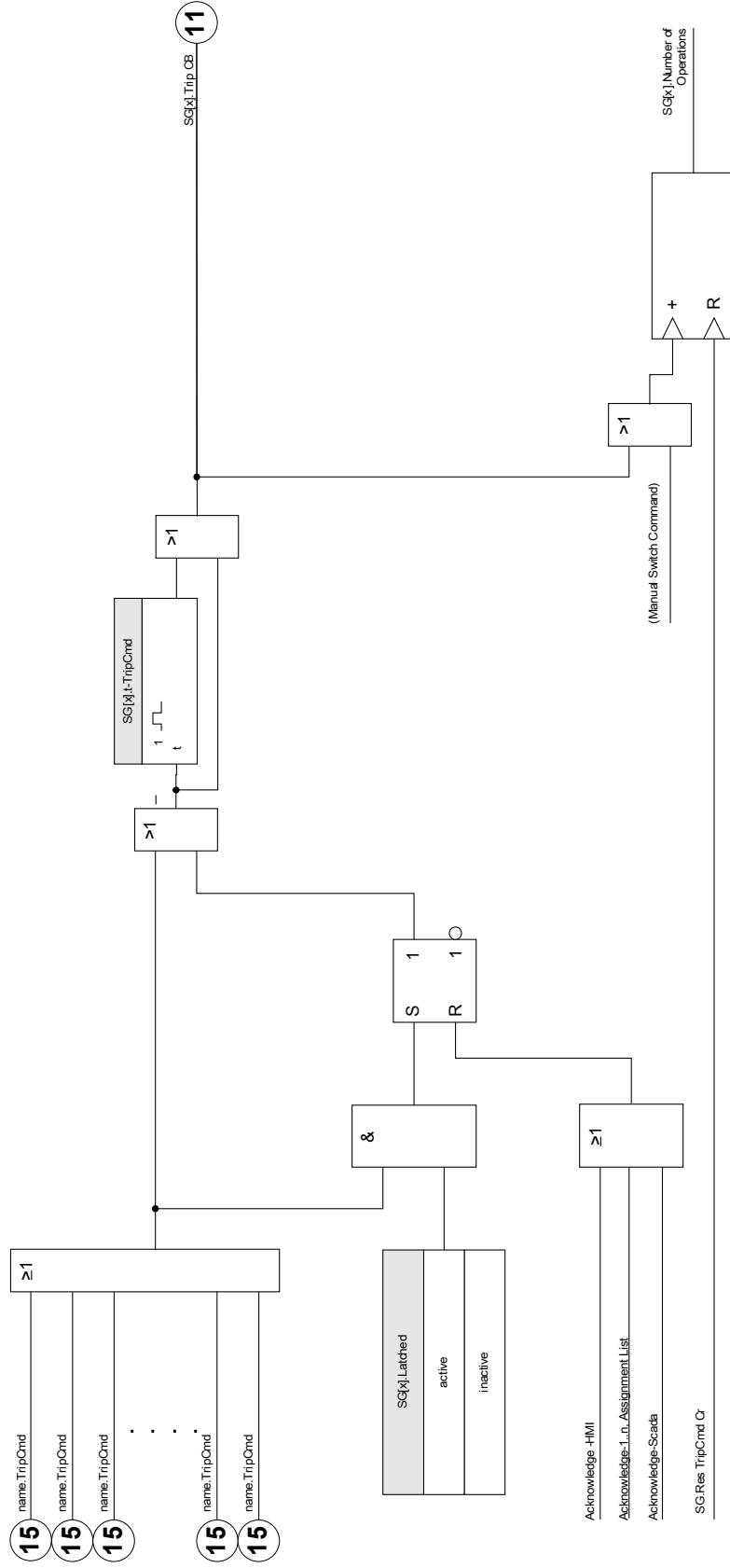

## Ex ON/OFF

If the switchgear should be opened or closed by an external signal, the User can assign one signal that will trigger the ON and one signal that will trigger the OFF command (e.g. digital inputs or output signals of the Logics). An OFF command has priority. ON commands are slope oriented, OFF commands are level oriented.

## Synchronised Switching\*

\*=availability depends on ordered device type

Before a switchgear may connect two mains sections, synchronism of these sections must be assured. In the menu [Synchronous Switching] the parameter »Synchronism« defines which signal indicates synchronism.

If the synchronism condition shall be evaluated by the internal Synch-Check module the signal »*Sync. Ready to Close*« (release by synch-check module) has to be assigned. Alternatively a digital input or a logic output can be assigned.

In the synchronisation mode “Generator-to-System” additionally the synchronism request has to be assigned in the menu [Protection Para\Global Prot Para\Sync].

If a synchronism signal is assigned, the switching command will only be executed, when the synchronism signal will become true within the maximum supervision time »*t-MaxSyncSuperv*«. This supervision time will be started with the issued ON command. If no synchronism signal has been assigned, the synchronism release is permanently.

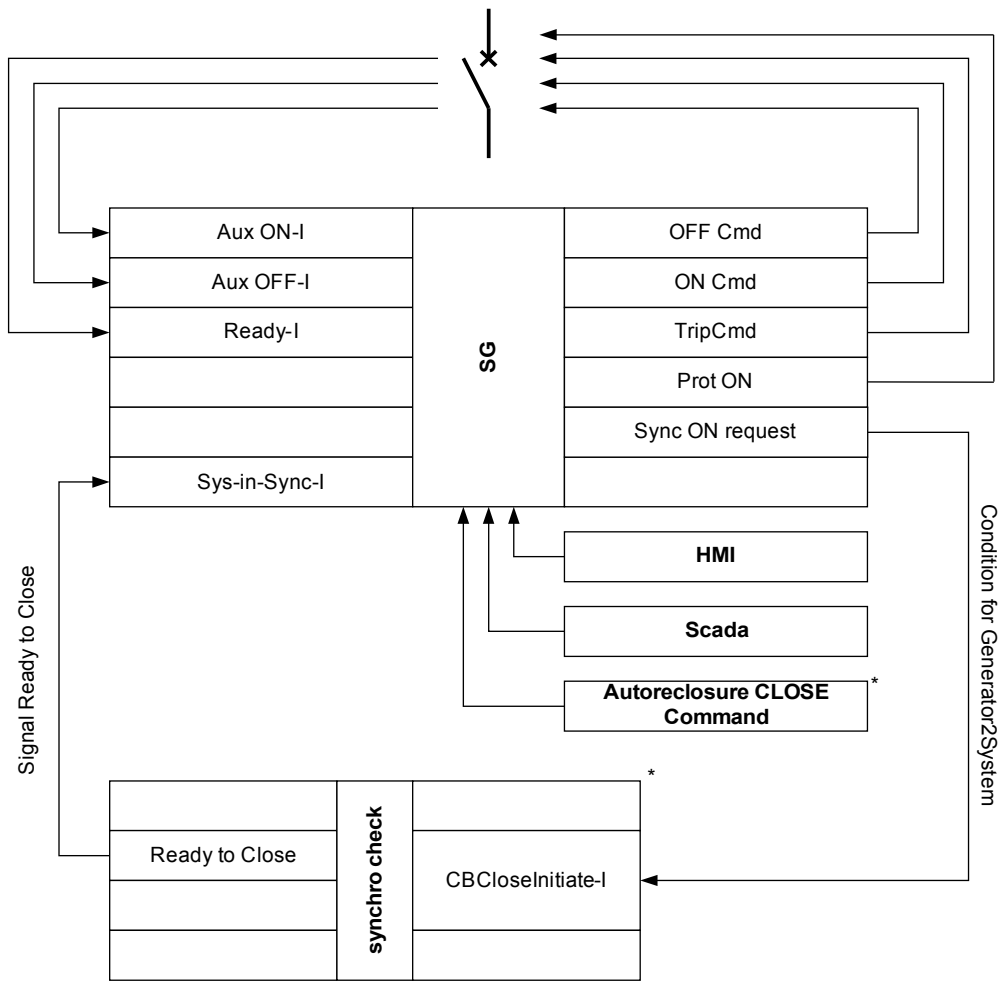

\* Availability dependent on device type

### Switching Authority

For the Switching Authority [Control\General Settings], the following general settings are possible:

- NONE: No control function;
- LOCAL: Control only via push buttons at the panel;
- REMOTE: Control only via SCADA, digital inputs, or internal signals; and
- LOCAL&REMOTE: Control via push buttons, SCADA, digital inputs, or internal signals.

## Non interlocked Switching

For test purposes, during commissioning and temporarily operations, interlockings can be disabled.



**WARNING: Non interlocked Switching can lead to serious injuries or death!**

For non interlocked switching the menü [Control\General Settings] provides the following options:

- Non interlocked switching for one single command
- Permanent
- Non interlocked switching for a certain time
- Non interlocked switching, activated by an assigned signal

The set time for non interlocked switching applies also for the „single Operation“ mode.

## Manual Manipulation of the Switchgear Position

In case of faulty position indication contacts (Aux contacts) or broken wires, the position indication resulted from the assigned signals can be manipulated (overwritten) manually, to keep the ability to switch the affected switchgear. A manipulated switchgear position will be indicated on the display by an exclamation mark “!” beside the switchgear symbol.



**WARNING: Manipulation of the Switchgear Position can lead to serious injuries or death!**

## Double Operation Locking

All control commands to any switchgear in a bay have to be processed sequentially. During a running control command no other command will be handled.



## Switch Direction Control

Switching commands are validated before execution. When the switchgear is already in the desired position, the switch command will not be issued again. An opened circuit breaker cannot be opened again. This also applies for switching command at the HMI or via SCADA.

## Anti Pumping

By pressing the ON command softkey only a single switching ON impulse will be issued independent, how low the softkey is actuated. The switchgear will close only once per close command.

## Direct commands of the Switching Authority

<i>Parameter</i>	<i>Description</i>	<i>Setting range</i>	<i>Default</i>	<i>Menu path</i>
Switching Authority 	Switching Authority	None, Local, Remote, Local and Remote	Local	[Control /General settings]
NonInterl 	DC for Non-Interlocking	inactive, active	inactive	[Control /General settings]

## Signals of the Switching Authority

<i>Signal</i>	<i>Description</i>
Local	Switching Authority: Local
Remote	Switching Authority: Remote
NonInterl	Non-Interlocking is active
SG Indeterm	Minimum one Switchgear is moving (Position cannot be determined).
SG Disturb	Minimum one Switchgear is disturbed.

## Counters of the Command Execution Supervision

<i>Parameter</i>	<i>Description</i>
CES SAAuthority	Command Execution Supervision: Switching Command not executed. No switching authority.
CES DoubleOperating	Command Execution Supervision: A second switch command is in conflict with a pending one.
No. of rej. Com	No. of rej. Com because Locked by ParaSystem



## Switchgear Wear

### Switchgear Wear Features

The sum of the accumulated interrupted currents.

A »SGwear Slow Switchgear« might indicate malfunction at an early stage.

The protective relay will calculate the »SG OPEN Capacity« continuously. 100% means, that switchgear maintenance is mandatory now.

The protective relay will make a alarm decision based on the curve that the user provides.

The relay will monitor the frequency of ON/OFF cycles. The User can set thresholds for the maximum allowed sum of interrupt currents and the maximum allowed sum of interrupt currents per hour. By means of this alarm, excessive switchgear operations can be detected at an early stage.

### Slow Switchgear Alarm

An increase of the close or opening time of the switchgear is an indication for the maintenance need. If the measured time exceeds the time »*t-Move OFF*« or »*t-Move ON*«, the signal »SGwear Slow Switchgear« will be activated.

### Switchgear Wear Curve

In order to keep the switchgear in good working condition, the switchgear needs to be monitored. The switchgear health (operation life) depends above all on:







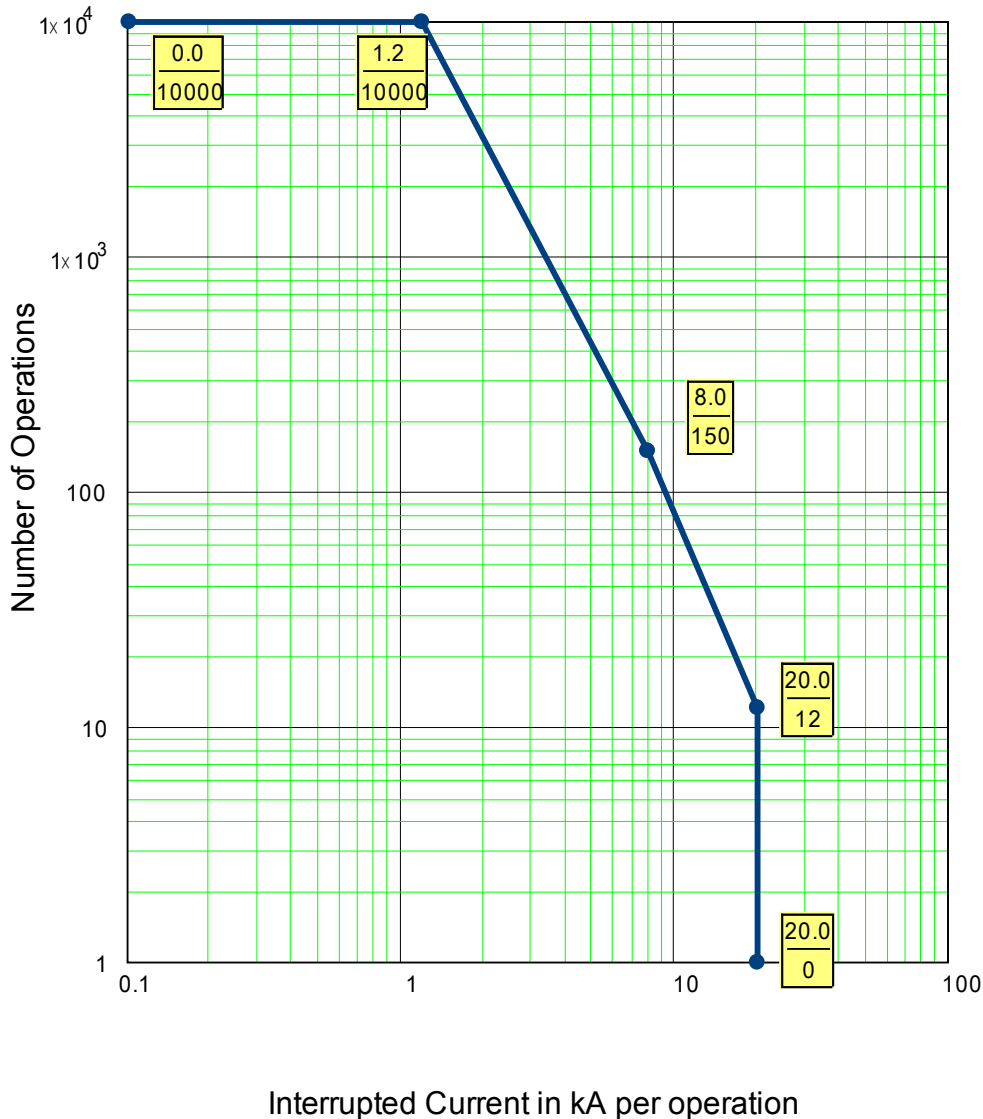

- The number of CLOSE/OPEN cycles.
- The amplitudes of the interrupting currents.
- The frequency that the switchgear operates (Operations per hour).

The User has to maintain the switchgear accordingly to the maintenance schedule that is to be provided by the manufacturer (switchgear operation statistics). By means of up to ten points that the user can replicate the switchgear wear curve within menu [Control/SG/SG[x]/SGW] . Each point has two settings: the interrupt current in kilo amperes and the allowed operation counts. No matter how many points are used, the operation counts the last point as zero. The protective relay will interpolate the allowed operations based on the switchgear wear curve. When the interrupted current is greater than the interrupt current at the last point, the protective relay will assume zero operation counts.

Breaker Maintenance Curve for a typical 25kV Circuit Breaker



## Global Protection Parameters of the Breaker Wear Module

Parameter	Description	Setting range	Default	Menu path
Operations Alarm 	Service Alarm, too many Operations	1 - 100000	9999	[Control /SG /SG[1] /SG Wear]
Isum Intr Alarm 	Alarm, the Sum (Limit) of interrupting currents has been exceeded.	0.00 - 2000.00kA	100.00kA	[Control /SG /SG[1] /SG Wear]
Isum Intr ph Alm 	Alarm, the per hour Sum (Limit) of interrupting currents has been exceeded.	0.00 - 2000.00kA	100.00kA	[Control /SG /SG[1] /SG Wear]
SGwear Curve Fc 	The Circuit Breaker (load-break switch) Wear Curve defines the maximum allowed CLOSE/OPEN cycles depending on the brake currents. If the circuit breaker maintenance curve is exceeded, an alarm will be issued. The breaker maintenance curve is to be taken from the technical data sheet of the breaker manufacturer. By means of the available points this curve is to be replicated.	inactive, active	inactive	[Control /SG /SG[1] /SG Wear]
WearLevel Alarm 	Threshold for the Alarm  Only available if:SGwear Curve Fc = active	0.00 - 100.00%	80.00%	[Control /SG /SG[1] /SG Wear]
WearLevel Lockout 	Threshold for the Lockout Level  Only available if:SGwear Curve Fc = active	0.00 - 100.00%	95.00%	[Control /SG /SG[1] /SG Wear]
Current1 	Interrupted Current Level #1  Only available if:SGwear Curve Fc = active	0.00 - 2000.00kA	0.00kA	[Control /SG /SG[1] /SG Wear]
Count1 	Open Counts Allowed #1  Only available if:SGwear Curve Fc = active	1 - 32000	10000	[Control /SG /SG[1] /SG Wear]

Parameter	Description	Setting range	Default	Menu path
 Current2	Interrupted Current Level #2 Only available if:SGwear Curve Fc = active	0.00 - 2000.00kA	1.20kA	[Control /SG /SG[1] /SG Wear]
 Count2	Open Counts Allowed #2 Only available if:SGwear Curve Fc = active	1 - 32000	10000	[Control /SG /SG[1] /SG Wear]
 Current3	Interrupted Current Level #3 Only available if:SGwear Curve Fc = active	0.00 - 2000.00kA	8.00kA	[Control /SG /SG[1] /SG Wear]
 Count3	Open Counts Allowed #3 Only available if:SGwear Curve Fc = active	1 - 32000	150	[Control /SG /SG[1] /SG Wear]
 Current4	Interrupted Current Level #4 Only available if:SGwear Curve Fc = active	0.00 - 2000.00kA	20.00kA	[Control /SG /SG[1] /SG Wear]
 Count4	Open Counts Allowed #4 Only available if:SGwear Curve Fc = active	1 - 32000	12	[Control /SG /SG[1] /SG Wear]
 Current5	Interrupted Current Level #5 Only available if:SGwear Curve Fc = active	0.00 - 2000.00kA	20.00kA	[Control /SG /SG[1] /SG Wear]
 Count5	Open Counts Allowed #5 Only available if:SGwear Curve Fc = active	1 - 32000	1	[Control /SG /SG[1] /SG Wear]
 Current6	Interrupted Current Level #6 Only available if:SGwear Curve Fc = active	0.00 - 2000.00kA	20.00kA	[Control /SG /SG[1] /SG Wear]

<i>Parameter</i>	<i>Description</i>	<i>Setting range</i>	<i>Default</i>	<i>Menu path</i>
Count6 	Open Counts Allowed #6 Only available if:SGwear Curve Fc = active	1 - 32000	1	[Control /SG /SG[1] /SG Wear]
Current7 	Interrupted Current Level #7 Only available if:SGwear Curve Fc = active	0.00 - 2000.00kA	20.00kA	[Control /SG /SG[1] /SG Wear]
Count7 	Open Counts Allowed #7 Only available if:SGwear Curve Fc = active	1 - 32000	1	[Control /SG /SG[1] /SG Wear]
Current8 	Interrupted Current Level #8 Only available if:SGwear Curve Fc = active	0.00 - 2000.00kA	20.00kA	[Control /SG /SG[1] /SG Wear]
Count8 	Open Counts Allowed #8 Only available if:SGwear Curve Fc = active	1 - 32000	1	[Control /SG /SG[1] /SG Wear]
Current9 	Interrupted Current Level #9 Only available if:SGwear Curve Fc = active	0.00 - 2000.00kA	20.00kA	[Control /SG /SG[1] /SG Wear]
Count9 	Open Counts Allowed #9 Only available if:SGwear Curve Fc = active	1 - 32000	1	[Control /SG /SG[1] /SG Wear]
Current10 	Interrupted Current Level #10 Only available if:SGwear Curve Fc = active	0.00 - 2000.00kA	20.00kA	[Control /SG /SG[1] /SG Wear]
Count10 	Open Counts Allowed #10 Only available if:SGwear Curve Fc = active	1 - 32000	1	[Control /SG /SG[1] /SG Wear]

### Breaker Wear Signals (Output States)

<i>Signal</i>	<i>Description</i>
Operations Alarm	Signal: Service Alarm, too many Operations
Isum Intr trip: IL1	Signal: Maximum permissible Summation of the interrupting (tripping) currents exceeded: IL1
Isum Intr trip: IL2	Signal: Maximum permissible Summation of the interrupting (tripping) currents exceeded: IL2
Isum Intr trip: IL3	Signal: Maximum permissible Summation of the interrupting (tripping) currents exceeded: IL3
Isum Intr trip	Signal: Maximum permissible Summation of the interrupting (tripping) currents exceeded in at least one phase.
Res TripCmd Cr	Signal: Resetting of the Counter: total number of trip commands
Res Sum trip	Signal: Reset summation of the tripping currents
WearLevel Alarm	Signal: Threshold for the Alarm
WearLevel Lockout	Signal: Threshold for the Lockout Level
Res SGwear Curve	Signal: Reset of the Circuit Breaker (load-break switch) Wear maintenance curve.
Isum Intr ph Alm	Signal: Alarm, the per hour Sum (Limit) of interrupting currents has been exceeded.
Res Isum Intr ph Alm	Signal: Reset of the Alarm, "the per hour Sum (Limit) of interrupting currents has been exceeded".

### Breaker Wear Counter Values





<i>Value</i>	<i>Description</i>	<i>Default</i>	<i>Size</i>	<i>Menu path</i>
TripCmd Cr	Counter: Total number of trips of the switchgear (circuit breaker, load break switch...). Resettable with Total or All.	0	0 - 200000	[Operation /Count and RevData /Ctrl /SG[1]]

### Breaker Wear Values

<i>Value</i>	<i>Description</i>	<i>Default</i>	<i>Size</i>	<i>Menu path</i>
Sum trip IL1	Summation of the tripping currents phase	0.00A	0.00 - 1000.00A	[Operation /Count and RevData /Ctrl /SG[1]]
Sum trip IL2	Summation of the tripping currents phase	0.00A	0.00 - 1000.00A	[Operation /Count and RevData /Ctrl /SG[1]]

<i>Value</i>	<i>Description</i>	<i>Default</i>	<i>Size</i>	<i>Menu path</i>
Sum trip IL3	Summation of the tripping currents phase	0.00A	0.00 - 1000.00A	[Operation /Count and RevData /Ctrl /SG[1]]
Isum Intr per hour	Sum per hour of interrupting currents.	0.00kA	0.00 - 1000.00kA	[Operation /Count and RevData /Ctrl /SG[1]]
SG OPEN capacity	Used capacity. 100% means, that the switchgear is to be maintained.	0.0%	0.0 - 100.0%	[Operation /Count and RevData /Ctrl /SG[1]]





### Direct Commands of the Breaker Wear Module

<i>Parameter</i>	<i>Description</i>	<i>Setting range</i>	<i>Default</i>	<i>Menu path</i>
Res TripCmd Cr 	Resetting of the Counter: total number of trip commands	inactive, active	inactive	[Operation /Reset]
Res Sum trip 	Reset summation of the tripping currents	inactive, active	inactive	[Operation /Reset]
Res Isum Intr per hour 	Reset of the Sum per hour of interrupting currents.	inactive, active	inactive	[Operation /Reset]
Res CB OPEN capacity 	Resetting of the CB OPEN capacity. 100% means, that the circuit breaker is to be maintained.	inactive, active	inactive	[Operation /Reset]

## Control - Example: Switching of a Circuit Breaker

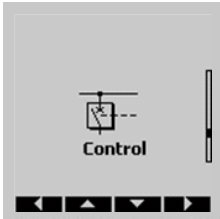
Ctrl

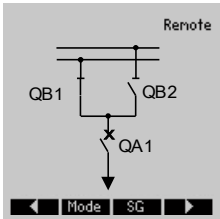
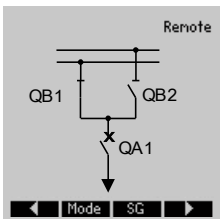
The following example shows how to switch a circuit breaker via the HMI at the device.

	<p>Change into the menu »Control« or alternatively push the »CTRL« button at the device front.</p>
	<p>Change to the control page by pushing the »right arrow« softkey.</p>
	<p><b>Information only:</b> On the control page a single line diagram with the current switchgear positions is displayed. By means of the softkey »Mode« it can be switched to the menu »General Settings«. In this menu switching authority and interlockings can be set.</p> <p>By means of the softkey »SG« it can be switched to the menu »SG«. In this menu specific settings for the switch gear can be done.</p>
	<p>To execute a switching operation, change into the switching menu by pushing the right arrow softkey button.</p>
	<p>Executing a switching command via the devices HMI is only possible when the switching authority is set to »Local«. If no switching authority is given, this has to be set first to »Local« or »Local and Remote«.</p> <p>With the softkey »OK« it can be switched back to the single line diagram page.</p>



	<p>Pushing the softkey »Mode« leads to the menu »General Settings«.</p>
--	---

	<p>In this menu the switching authority can be changed.</p>
--	---

	<p>Select between »Local« or »Local and Remote«.</p>
--	--

	<p>Now it is possible to execute switching commands at the HMI.</p>
--	---

	<p>Push the »right arrow« softkey to get to the control page.</p>
--	---

	<p>To select a switchgear press the softkey »Select« as long as the desired switchgear is selected. The current selection is displayed by the edges of a rectangle. In this example the circuit breaker is selected. Switchgears that are supervised only, cannot be selected.</p>
--	--

	<p>The circuit breaker is opened, therefore it can be closed only. After pushing the softkey »ON« a confirmation window appears.</p>
--	--

	<p>When you are sure to proceed with the switching operation, press the softkey »YES«.</p>
--	--

	<p>The switching command will be given to the circuit breaker. The display shows the intermediate position of the switchgear.</p>
--	---



	<p>It will be shown on the display when the switchgear reaches the new end position. Further possible switching operations (OPEN) will be displayed by softkeys.</p>
--	--



Notice: For the case, the switchgear does not reach the new end position within the set supervision time the following Warning appears on the display.

## Control Parameters

### Global Protection Parameters of the Control Module

Parameter	Description	Setting range	Default	Menu path
Res NonIL 	Resetmode Non-Interlocking	single Operation, timeout, permanent	single Operation	[Control /General settings]
Timeout NonIL 	Timeout Non-Interlocking  Only available if: Res NonIL = permanent	2 - 3600s	60s	[Control /General settings]
NonIL Assign 	Assignment Non-Interlocking	1..n, Assignment List	--	[Control /General settings]

### Control Moduel Input States

Name	Description	Assignment via
NonInter-l	Non-Interlocking	[Control /General settings]

### Synchronization inputs

Name	Description
--	No assignment
Sync.Ready to Close	Signal: Ready to Close
DI Slot X1.DI 1	Signal: Digital Input
DI Slot X1.DI 2	Signal: Digital Input
DI Slot X1.DI 3	Signal: Digital Input
DI Slot X1.DI 4	Signal: Digital Input
DI Slot X1.DI 5	Signal: Digital Input
DI Slot X1.DI 6	Signal: Digital Input
DI Slot X1.DI 7	Signal: Digital Input
DI Slot X1.DI 8	Signal: Digital Input
DI Slot X6.DI 1	Signal: Digital Input
DI Slot X6.DI 2	Signal: Digital Input
DI Slot X6.DI 3	Signal: Digital Input
DI Slot X6.DI 4	Signal: Digital Input

<i>Name</i>	<i>Description</i>
DI Slot X6.DI 5	Signal: Digital Input
DI Slot X6.DI 6	Signal: Digital Input
DI Slot X6.DI 7	Signal: Digital Input
DI Slot X6.DI 8	Signal: Digital Input
Logics.LE1.Gate Out	Signal: Output of the logic gate
Logics.LE1.Timer Out	Signal: Timer Output
Logics.LE1.Out	Signal: Latched Output (Q)
Logics.LE1.Out inverted	Signal: Negated Latched Output (Q NOT)
Logics.LE2.Gate Out	Signal: Output of the logic gate
Logics.LE2.Timer Out	Signal: Timer Output
Logics.LE2.Out	Signal: Latched Output (Q)
Logics.LE2.Out inverted	Signal: Negated Latched Output (Q NOT)
Logics.LE3.Gate Out	Signal: Output of the logic gate
Logics.LE3.Timer Out	Signal: Timer Output
Logics.LE3.Out	Signal: Latched Output (Q)
Logics.LE3.Out inverted	Signal: Negated Latched Output (Q NOT)
Logics.LE4.Gate Out	Signal: Output of the logic gate
Logics.LE4.Timer Out	Signal: Timer Output
Logics.LE4.Out	Signal: Latched Output (Q)
Logics.LE4.Out inverted	Signal: Negated Latched Output (Q NOT)
Logics.LE5.Gate Out	Signal: Output of the logic gate
Logics.LE5.Timer Out	Signal: Timer Output
Logics.LE5.Out	Signal: Latched Output (Q)
Logics.LE5.Out inverted	Signal: Negated Latched Output (Q NOT)
Logics.LE6.Gate Out	Signal: Output of the logic gate
Logics.LE6.Timer Out	Signal: Timer Output
Logics.LE6.Out	Signal: Latched Output (Q)
Logics.LE6.Out inverted	Signal: Negated Latched Output (Q NOT)
Logics.LE7.Gate Out	Signal: Output of the logic gate
Logics.LE7.Timer Out	Signal: Timer Output
Logics.LE7.Out	Signal: Latched Output (Q)
Logics.LE7.Out inverted	Signal: Negated Latched Output (Q NOT)
Logics.LE8.Gate Out	Signal: Output of the logic gate
Logics.LE8.Timer Out	Signal: Timer Output
Logics.LE8.Out	Signal: Latched Output (Q)
Logics.LE8.Out inverted	Signal: Negated Latched Output (Q NOT)
Logics.LE9.Gate Out	Signal: Output of the logic gate
Logics.LE9.Timer Out	Signal: Timer Output
Logics.LE9.Out	Signal: Latched Output (Q)
Logics.LE9.Out inverted	Signal: Negated Latched Output (Q NOT)

<i>Name</i>	<i>Description</i>
Logics.LE10.Gate Out	Signal: Output of the logic gate
Logics.LE10.Timer Out	Signal: Timer Output
Logics.LE10.Out	Signal: Latched Output (Q)
Logics.LE10.Out inverted	Signal: Negated Latched Output (Q NOT)
Logics.LE11.Gate Out	Signal: Output of the logic gate
Logics.LE11.Timer Out	Signal: Timer Output
Logics.LE11.Out	Signal: Latched Output (Q)
Logics.LE11.Out inverted	Signal: Negated Latched Output (Q NOT)
Logics.LE12.Gate Out	Signal: Output of the logic gate
Logics.LE12.Timer Out	Signal: Timer Output
Logics.LE12.Out	Signal: Latched Output (Q)
Logics.LE12.Out inverted	Signal: Negated Latched Output (Q NOT)
Logics.LE13.Gate Out	Signal: Output of the logic gate
Logics.LE13.Timer Out	Signal: Timer Output
Logics.LE13.Out	Signal: Latched Output (Q)
Logics.LE13.Out inverted	Signal: Negated Latched Output (Q NOT)
Logics.LE14.Gate Out	Signal: Output of the logic gate
Logics.LE14.Timer Out	Signal: Timer Output
Logics.LE14.Out	Signal: Latched Output (Q)
Logics.LE14.Out inverted	Signal: Negated Latched Output (Q NOT)
Logics.LE15.Gate Out	Signal: Output of the logic gate
Logics.LE15.Timer Out	Signal: Timer Output
Logics.LE15.Out	Signal: Latched Output (Q)
Logics.LE15.Out inverted	Signal: Negated Latched Output (Q NOT)
Logics.LE16.Gate Out	Signal: Output of the logic gate
Logics.LE16.Timer Out	Signal: Timer Output
Logics.LE16.Out	Signal: Latched Output (Q)
Logics.LE16.Out inverted	Signal: Negated Latched Output (Q NOT)
Logics.LE17.Gate Out	Signal: Output of the logic gate
Logics.LE17.Timer Out	Signal: Timer Output
Logics.LE17.Out	Signal: Latched Output (Q)
Logics.LE17.Out inverted	Signal: Negated Latched Output (Q NOT)
Logics.LE18.Gate Out	Signal: Output of the logic gate
Logics.LE18.Timer Out	Signal: Timer Output
Logics.LE18.Out	Signal: Latched Output (Q)
Logics.LE18.Out inverted	Signal: Negated Latched Output (Q NOT)
Logics.LE19.Gate Out	Signal: Output of the logic gate
Logics.LE19.Timer Out	Signal: Timer Output
Logics.LE19.Out	Signal: Latched Output (Q)
Logics.LE19.Out inverted	Signal: Negated Latched Output (Q NOT)

<i>Name</i>	<i>Description</i>
Logics.LE20.Gate Out	Signal: Output of the logic gate
Logics.LE20.Timer Out	Signal: Timer Output
Logics.LE20.Out	Signal: Latched Output (Q)
Logics.LE20.Out inverted	Signal: Negated Latched Output (Q NOT)
Logics.LE21.Gate Out	Signal: Output of the logic gate
Logics.LE21.Timer Out	Signal: Timer Output
Logics.LE21.Out	Signal: Latched Output (Q)
Logics.LE21.Out inverted	Signal: Negated Latched Output (Q NOT)
Logics.LE22.Gate Out	Signal: Output of the logic gate
Logics.LE22.Timer Out	Signal: Timer Output
Logics.LE22.Out	Signal: Latched Output (Q)
Logics.LE22.Out inverted	Signal: Negated Latched Output (Q NOT)
Logics.LE23.Gate Out	Signal: Output of the logic gate
Logics.LE23.Timer Out	Signal: Timer Output
Logics.LE23.Out	Signal: Latched Output (Q)
Logics.LE23.Out inverted	Signal: Negated Latched Output (Q NOT)
Logics.LE24.Gate Out	Signal: Output of the logic gate
Logics.LE24.Timer Out	Signal: Timer Output
Logics.LE24.Out	Signal: Latched Output (Q)
Logics.LE24.Out inverted	Signal: Negated Latched Output (Q NOT)
Logics.LE25.Gate Out	Signal: Output of the logic gate
Logics.LE25.Timer Out	Signal: Timer Output
Logics.LE25.Out	Signal: Latched Output (Q)
Logics.LE25.Out inverted	Signal: Negated Latched Output (Q NOT)
Logics.LE26.Gate Out	Signal: Output of the logic gate
Logics.LE26.Timer Out	Signal: Timer Output
Logics.LE26.Out	Signal: Latched Output (Q)
Logics.LE26.Out inverted	Signal: Negated Latched Output (Q NOT)
Logics.LE27.Gate Out	Signal: Output of the logic gate
Logics.LE27.Timer Out	Signal: Timer Output
Logics.LE27.Out	Signal: Latched Output (Q)
Logics.LE27.Out inverted	Signal: Negated Latched Output (Q NOT)
Logics.LE28.Gate Out	Signal: Output of the logic gate
Logics.LE28.Timer Out	Signal: Timer Output
Logics.LE28.Out	Signal: Latched Output (Q)
Logics.LE28.Out inverted	Signal: Negated Latched Output (Q NOT)
Logics.LE29.Gate Out	Signal: Output of the logic gate
Logics.LE29.Timer Out	Signal: Timer Output
Logics.LE29.Out	Signal: Latched Output (Q)
Logics.LE29.Out inverted	Signal: Negated Latched Output (Q NOT)

<i>Name</i>	<i>Description</i>
Logics.LE30.Gate Out	Signal: Output of the logic gate
Logics.LE30.Timer Out	Signal: Timer Output
Logics.LE30.Out	Signal: Latched Output (Q)
Logics.LE30.Out inverted	Signal: Negated Latched Output (Q NOT)
Logics.LE31.Gate Out	Signal: Output of the logic gate
Logics.LE31.Timer Out	Signal: Timer Output
Logics.LE31.Out	Signal: Latched Output (Q)
Logics.LE31.Out inverted	Signal: Negated Latched Output (Q NOT)
Logics.LE32.Gate Out	Signal: Output of the logic gate
Logics.LE32.Timer Out	Signal: Timer Output
Logics.LE32.Out	Signal: Latched Output (Q)
Logics.LE32.Out inverted	Signal: Negated Latched Output (Q NOT)
Logics.LE33.Gate Out	Signal: Output of the logic gate
Logics.LE33.Timer Out	Signal: Timer Output
Logics.LE33.Out	Signal: Latched Output (Q)
Logics.LE33.Out inverted	Signal: Negated Latched Output (Q NOT)
Logics.LE34.Gate Out	Signal: Output of the logic gate
Logics.LE34.Timer Out	Signal: Timer Output
Logics.LE34.Out	Signal: Latched Output (Q)
Logics.LE34.Out inverted	Signal: Negated Latched Output (Q NOT)
Logics.LE35.Gate Out	Signal: Output of the logic gate
Logics.LE35.Timer Out	Signal: Timer Output
Logics.LE35.Out	Signal: Latched Output (Q)
Logics.LE35.Out inverted	Signal: Negated Latched Output (Q NOT)
Logics.LE36.Gate Out	Signal: Output of the logic gate
Logics.LE36.Timer Out	Signal: Timer Output
Logics.LE36.Out	Signal: Latched Output (Q)
Logics.LE36.Out inverted	Signal: Negated Latched Output (Q NOT)
Logics.LE37.Gate Out	Signal: Output of the logic gate
Logics.LE37.Timer Out	Signal: Timer Output
Logics.LE37.Out	Signal: Latched Output (Q)
Logics.LE37.Out inverted	Signal: Negated Latched Output (Q NOT)
Logics.LE38.Gate Out	Signal: Output of the logic gate
Logics.LE38.Timer Out	Signal: Timer Output
Logics.LE38.Out	Signal: Latched Output (Q)
Logics.LE38.Out inverted	Signal: Negated Latched Output (Q NOT)
Logics.LE39.Gate Out	Signal: Output of the logic gate
Logics.LE39.Timer Out	Signal: Timer Output
Logics.LE39.Out	Signal: Latched Output (Q)
Logics.LE39.Out inverted	Signal: Negated Latched Output (Q NOT)



<i>Name</i>	<i>Description</i>
Logics.LE40.Gate Out	Signal: Output of the logic gate
Logics.LE40.Timer Out	Signal: Timer Output
Logics.LE40.Out	Signal: Latched Output (Q)
Logics.LE40.Out inverted	Signal: Negated Latched Output (Q NOT)
Logics.LE41.Gate Out	Signal: Output of the logic gate
Logics.LE41.Timer Out	Signal: Timer Output
Logics.LE41.Out	Signal: Latched Output (Q)
Logics.LE41.Out inverted	Signal: Negated Latched Output (Q NOT)
Logics.LE42.Gate Out	Signal: Output of the logic gate
Logics.LE42.Timer Out	Signal: Timer Output
Logics.LE42.Out	Signal: Latched Output (Q)
Logics.LE42.Out inverted	Signal: Negated Latched Output (Q NOT)
Logics.LE43.Gate Out	Signal: Output of the logic gate
Logics.LE43.Timer Out	Signal: Timer Output
Logics.LE43.Out	Signal: Latched Output (Q)
Logics.LE43.Out inverted	Signal: Negated Latched Output (Q NOT)
Logics.LE44.Gate Out	Signal: Output of the logic gate
Logics.LE44.Timer Out	Signal: Timer Output
Logics.LE44.Out	Signal: Latched Output (Q)
Logics.LE44.Out inverted	Signal: Negated Latched Output (Q NOT)
Logics.LE45.Gate Out	Signal: Output of the logic gate
Logics.LE45.Timer Out	Signal: Timer Output
Logics.LE45.Out	Signal: Latched Output (Q)
Logics.LE45.Out inverted	Signal: Negated Latched Output (Q NOT)
Logics.LE46.Gate Out	Signal: Output of the logic gate
Logics.LE46.Timer Out	Signal: Timer Output
Logics.LE46.Out	Signal: Latched Output (Q)
Logics.LE46.Out inverted	Signal: Negated Latched Output (Q NOT)
Logics.LE47.Gate Out	Signal: Output of the logic gate
Logics.LE47.Timer Out	Signal: Timer Output
Logics.LE47.Out	Signal: Latched Output (Q)
Logics.LE47.Out inverted	Signal: Negated Latched Output (Q NOT)
Logics.LE48.Gate Out	Signal: Output of the logic gate
Logics.LE48.Timer Out	Signal: Timer Output
Logics.LE48.Out	Signal: Latched Output (Q)
Logics.LE48.Out inverted	Signal: Negated Latched Output (Q NOT)
Logics.LE49.Gate Out	Signal: Output of the logic gate
Logics.LE49.Timer Out	Signal: Timer Output
Logics.LE49.Out	Signal: Latched Output (Q)
Logics.LE49.Out inverted	Signal: Negated Latched Output (Q NOT)

<i>Name</i>	<i>Description</i>
Logics.LE50.Gate Out	Signal: Output of the logic gate
Logics.LE50.Timer Out	Signal: Timer Output
Logics.LE50.Out	Signal: Latched Output (Q)
Logics.LE50.Out inverted	Signal: Negated Latched Output (Q NOT)
Logics.LE51.Gate Out	Signal: Output of the logic gate
Logics.LE51.Timer Out	Signal: Timer Output
Logics.LE51.Out	Signal: Latched Output (Q)
Logics.LE51.Out inverted	Signal: Negated Latched Output (Q NOT)
Logics.LE52.Gate Out	Signal: Output of the logic gate
Logics.LE52.Timer Out	Signal: Timer Output
Logics.LE52.Out	Signal: Latched Output (Q)
Logics.LE52.Out inverted	Signal: Negated Latched Output (Q NOT)
Logics.LE53.Gate Out	Signal: Output of the logic gate
Logics.LE53.Timer Out	Signal: Timer Output
Logics.LE53.Out	Signal: Latched Output (Q)
Logics.LE53.Out inverted	Signal: Negated Latched Output (Q NOT)
Logics.LE54.Gate Out	Signal: Output of the logic gate
Logics.LE54.Timer Out	Signal: Timer Output
Logics.LE54.Out	Signal: Latched Output (Q)
Logics.LE54.Out inverted	Signal: Negated Latched Output (Q NOT)
Logics.LE55.Gate Out	Signal: Output of the logic gate
Logics.LE55.Timer Out	Signal: Timer Output
Logics.LE55.Out	Signal: Latched Output (Q)
Logics.LE55.Out inverted	Signal: Negated Latched Output (Q NOT)
Logics.LE56.Gate Out	Signal: Output of the logic gate
Logics.LE56.Timer Out	Signal: Timer Output
Logics.LE56.Out	Signal: Latched Output (Q)
Logics.LE56.Out inverted	Signal: Negated Latched Output (Q NOT)
Logics.LE57.Gate Out	Signal: Output of the logic gate
Logics.LE57.Timer Out	Signal: Timer Output
Logics.LE57.Out	Signal: Latched Output (Q)
Logics.LE57.Out inverted	Signal: Negated Latched Output (Q NOT)
Logics.LE58.Gate Out	Signal: Output of the logic gate
Logics.LE58.Timer Out	Signal: Timer Output
Logics.LE58.Out	Signal: Latched Output (Q)
Logics.LE58.Out inverted	Signal: Negated Latched Output (Q NOT)
Logics.LE59.Gate Out	Signal: Output of the logic gate
Logics.LE59.Timer Out	Signal: Timer Output
Logics.LE59.Out	Signal: Latched Output (Q)
Logics.LE59.Out inverted	Signal: Negated Latched Output (Q NOT)

<i>Name</i>	<i>Description</i>
Logics.LE60.Gate Out	Signal: Output of the logic gate
Logics.LE60.Timer Out	Signal: Timer Output
Logics.LE60.Out	Signal: Latched Output (Q)
Logics.LE60.Out inverted	Signal: Negated Latched Output (Q NOT)
Logics.LE61.Gate Out	Signal: Output of the logic gate
Logics.LE61.Timer Out	Signal: Timer Output
Logics.LE61.Out	Signal: Latched Output (Q)
Logics.LE61.Out inverted	Signal: Negated Latched Output (Q NOT)
Logics.LE62.Gate Out	Signal: Output of the logic gate
Logics.LE62.Timer Out	Signal: Timer Output
Logics.LE62.Out	Signal: Latched Output (Q)
Logics.LE62.Out inverted	Signal: Negated Latched Output (Q NOT)
Logics.LE63.Gate Out	Signal: Output of the logic gate
Logics.LE63.Timer Out	Signal: Timer Output
Logics.LE63.Out	Signal: Latched Output (Q)
Logics.LE63.Out inverted	Signal: Negated Latched Output (Q NOT)
Logics.LE64.Gate Out	Signal: Output of the logic gate
Logics.LE64.Timer Out	Signal: Timer Output
Logics.LE64.Out	Signal: Latched Output (Q)
Logics.LE64.Out inverted	Signal: Negated Latched Output (Q NOT)
Logics.LE65.Gate Out	Signal: Output of the logic gate
Logics.LE65.Timer Out	Signal: Timer Output
Logics.LE65.Out	Signal: Latched Output (Q)
Logics.LE65.Out inverted	Signal: Negated Latched Output (Q NOT)
Logics.LE66.Gate Out	Signal: Output of the logic gate
Logics.LE66.Timer Out	Signal: Timer Output
Logics.LE66.Out	Signal: Latched Output (Q)
Logics.LE66.Out inverted	Signal: Negated Latched Output (Q NOT)
Logics.LE67.Gate Out	Signal: Output of the logic gate
Logics.LE67.Timer Out	Signal: Timer Output
Logics.LE67.Out	Signal: Latched Output (Q)
Logics.LE67.Out inverted	Signal: Negated Latched Output (Q NOT)
Logics.LE68.Gate Out	Signal: Output of the logic gate
Logics.LE68.Timer Out	Signal: Timer Output
Logics.LE68.Out	Signal: Latched Output (Q)
Logics.LE68.Out inverted	Signal: Negated Latched Output (Q NOT)
Logics.LE69.Gate Out	Signal: Output of the logic gate
Logics.LE69.Timer Out	Signal: Timer Output
Logics.LE69.Out	Signal: Latched Output (Q)
Logics.LE69.Out inverted	Signal: Negated Latched Output (Q NOT)

<i>Name</i>	<i>Description</i>
Logics.LE70.Gate Out	Signal: Output of the logic gate
Logics.LE70.Timer Out	Signal: Timer Output
Logics.LE70.Out	Signal: Latched Output (Q)
Logics.LE70.Out inverted	Signal: Negated Latched Output (Q NOT)
Logics.LE71.Gate Out	Signal: Output of the logic gate
Logics.LE71.Timer Out	Signal: Timer Output
Logics.LE71.Out	Signal: Latched Output (Q)
Logics.LE71.Out inverted	Signal: Negated Latched Output (Q NOT)
Logics.LE72.Gate Out	Signal: Output of the logic gate
Logics.LE72.Timer Out	Signal: Timer Output
Logics.LE72.Out	Signal: Latched Output (Q)
Logics.LE72.Out inverted	Signal: Negated Latched Output (Q NOT)
Logics.LE73.Gate Out	Signal: Output of the logic gate
Logics.LE73.Timer Out	Signal: Timer Output
Logics.LE73.Out	Signal: Latched Output (Q)
Logics.LE73.Out inverted	Signal: Negated Latched Output (Q NOT)
Logics.LE74.Gate Out	Signal: Output of the logic gate
Logics.LE74.Timer Out	Signal: Timer Output
Logics.LE74.Out	Signal: Latched Output (Q)
Logics.LE74.Out inverted	Signal: Negated Latched Output (Q NOT)
Logics.LE75.Gate Out	Signal: Output of the logic gate
Logics.LE75.Timer Out	Signal: Timer Output
Logics.LE75.Out	Signal: Latched Output (Q)
Logics.LE75.Out inverted	Signal: Negated Latched Output (Q NOT)
Logics.LE76.Gate Out	Signal: Output of the logic gate
Logics.LE76.Timer Out	Signal: Timer Output
Logics.LE76.Out	Signal: Latched Output (Q)
Logics.LE76.Out inverted	Signal: Negated Latched Output (Q NOT)
Logics.LE77.Gate Out	Signal: Output of the logic gate
Logics.LE77.Timer Out	Signal: Timer Output
Logics.LE77.Out	Signal: Latched Output (Q)
Logics.LE77.Out inverted	Signal: Negated Latched Output (Q NOT)
Logics.LE78.Gate Out	Signal: Output of the logic gate
Logics.LE78.Timer Out	Signal: Timer Output
Logics.LE78.Out	Signal: Latched Output (Q)
Logics.LE78.Out inverted	Signal: Negated Latched Output (Q NOT)
Logics.LE79.Gate Out	Signal: Output of the logic gate
Logics.LE79.Timer Out	Signal: Timer Output
Logics.LE79.Out	Signal: Latched Output (Q)
Logics.LE79.Out inverted	Signal: Negated Latched Output (Q NOT)

<i>Name</i>	<i>Description</i>
Logics.LE80.Gate Out	Signal: Output of the logic gate
Logics.LE80.Timer Out	Signal: Timer Output
Logics.LE80.Out	Signal: Latched Output (Q)
Logics.LE80.Out inverted	Signal: Negated Latched Output (Q NOT)

### Assignable Trip Commands (Trip Manager)



<i>Name</i>	<i>Description</i>
-.-	No assignment
I[1].TripCmd	Signal: Trip Command
I[2].TripCmd	Signal: Trip Command
I[3].TripCmd	Signal: Trip Command
I[4].TripCmd	Signal: Trip Command
I[5].TripCmd	Signal: Trip Command
I[6].TripCmd	Signal: Trip Command
IG[1].TripCmd	Signal: Trip Command
IG[2].TripCmd	Signal: Trip Command
IG[3].TripCmd	Signal: Trip Command
IG[4].TripCmd	Signal: Trip Command
ThR.TripCmd	Signal: Trip Command
I2>[1].TripCmd	Signal: Trip Command
I2>[2].TripCmd	Signal: Trip Command
V[1].TripCmd	Signal: Trip Command
V[2].TripCmd	Signal: Trip Command
V[3].TripCmd	Signal: Trip Command
V[4].TripCmd	Signal: Trip Command
V[5].TripCmd	Signal: Trip Command
V[6].TripCmd	Signal: Trip Command
df/dt.TripCmd	Signal: Trip Command
delta phi.TripCmd	Signal: Trip Command
Intertripping.TripCmd	Signal: Trip Command
P.TripCmd	Signal: Trip Command
Q.TripCmd	Signal: Trip Command
LVRT.TripCmd	Signal: Trip Command
VG[1].TripCmd	Signal: Trip Command
VG[2].TripCmd	Signal: Trip Command
V012[1].TripCmd	Signal: Trip Command
V012[2].TripCmd	Signal: Trip Command
V012[3].TripCmd	Signal: Trip Command
V012[4].TripCmd	Signal: Trip Command

<i>Name</i>	<i>Description</i>
V012[5].TripCmd	Signal: Trip Command
V012[6].TripCmd	Signal: Trip Command
f[1].TripCmd	Signal: Trip Command
f[2].TripCmd	Signal: Trip Command
f[3].TripCmd	Signal: Trip Command
f[4].TripCmd	Signal: Trip Command
f[5].TripCmd	Signal: Trip Command
f[6].TripCmd	Signal: Trip Command
PQS[1].TripCmd	Signal: Trip Command
PQS[2].TripCmd	Signal: Trip Command
PQS[3].TripCmd	Signal: Trip Command
PQS[4].TripCmd	Signal: Trip Command
PQS[5].TripCmd	Signal: Trip Command
PQS[6].TripCmd	Signal: Trip Command
PF[1].TripCmd	Signal: Trip Command
PF[2].TripCmd	Signal: Trip Command
ExP[1].TripCmd	Signal: Trip Command
ExP[2].TripCmd	Signal: Trip Command
ExP[3].TripCmd	Signal: Trip Command
ExP[4].TripCmd	Signal: Trip Command



## Controlled Circuit Breaker

SG[1]

### Direct Commands of a Controlled Circuit Breaker

Parameter	Description	Setting range	Default	Menu path
Manipulate Position 	WARNING! Fake Position - Manual Position Manipulation	inactive, Pos OFF, Pos ON	inactive	[Control /SG /SG[1] /General settings]
Res SGwear SI SG 	Resetting the slow Switchgear Alarm	inactive, active	inactive	[Operation /Reset]
Ack TripCmd 	Acknowledge Trip Command	inactive, active	inactive	[Operation /Acknowledge]

### Global Protection Parameters of a Controlled Circuit Breaker

Parameter	Description	Setting range	Default	Menu path
Aux ON 	The CB is in ON-position if the state of the assigned signal is true (52a).	1..n, DI-LogicList	DI Slot X1.DI 1	[Control /SG /SG[1] /Pos Indicatr Wirng]
Aux OFF 	The CB is in OFF-position if the state of the assigned signal is true (52b).	1..n, DI-LogicList	DI Slot X1.DI 2	[Control /SG /SG[1] /Pos Indicatr Wirng]
Ready 	Circuit breaker is ready for operation if the state of the assigned signal is true. This digital input can be used by some protective elements (if they are available within the device) like Auto Reclosure (AR), e.g. as a trigger signal.	1..n, DI-LogicList	---	[Control /SG /SG[1] /Pos Indicatr Wirng]

Parameter	Description	Setting range	Default	Menu path
Removed 	The withdrawable circuit breaker is Removed	1..n, DI-LogicList	--	[Control /SG /SG[1] /Pos Indicatrs Wiring]
Interl ON1 	Interlocking of the ON command	1..n, Assignment List	--	[Control /SG /SG[1] /Interlockings]
Interl ON2 	Interlocking of the ON command	1..n, Assignment List	--	[Control /SG /SG[1] /Interlockings]
Interl ON3 	Interlocking of the ON command	1..n, Assignment List	--	[Control /SG /SG[1] /Interlockings]
Interl OFF1 	Interlocking of the OFF command	1..n, Assignment List	--	[Control /SG /SG[1] /Interlockings]
Interl OFF2 	Interlocking of the OFF command	1..n, Assignment List	--	[Control /SG /SG[1] /Interlockings]
Interl OFF3 	Interlocking of the OFF command	1..n, Assignment List	--	[Control /SG /SG[1] /Interlockings]
SCmd ON 	Switching ON Command, e.g. the state of the Logics or the state of the digital input	1..n, DI-LogicList	--	[Control /SG /SG[1] /Ex ON/OFF Cmd]
SCmd OFF 	Switching OFF Command, e.g. the state of the Logics or the state of the digital input	1..n, DI-LogicList	--	[Control /SG /SG[1] /Ex ON/OFF Cmd]



Parameter	Description	Setting range	Default	Menu path
t-TripCmd 	Minimum hold time of the OFF-command (circuit breaker, load break switch)	0 - 300.00s	0.2s	[Control /SG /SG[1] /Trip Manager]
Latched 	Defines whether the Binary Output Relay will be Latched when it picks up.	inactive, active	inactive	[Control /SG /SG[1] /Trip Manager]
Ack TripCmd 	Ack TripCmd	1..n, Assignment List	--	[Control /SG /SG[1] /Trip Manager]
Off Cmd1 	Off Command to the Circuit Breaker if the state of the assigned signal becomes true.	1..n, Trip Cmds	I[1].TripCmd	[Control /SG /SG[1] /Trip Manager]
Off Cmd2 	Off Command to the Circuit Breaker if the state of the assigned signal becomes true.	1..n, Trip Cmds	V[1].TripCmd	[Control /SG /SG[1] /Trip Manager]
Off Cmd3 	Off Command to the Circuit Breaker if the state of the assigned signal becomes true.	1..n, Trip Cmds	V[2].TripCmd	[Control /SG /SG[1] /Trip Manager]
Off Cmd4 	Off Command to the Circuit Breaker if the state of the assigned signal becomes true.	1..n, Trip Cmds	f[1].TripCmd	[Control /SG /SG[1] /Trip Manager]
Off Cmd5 	Off Command to the Circuit Breaker if the state of the assigned signal becomes true.	1..n, Trip Cmds	f[2].TripCmd	[Control /SG /SG[1] /Trip Manager]
Off Cmd6 	Off Command to the Circuit Breaker if the state of the assigned signal becomes true.	1..n, Trip Cmds	PQS[1].TripCmd	[Control /SG /SG[1] /Trip Manager]

Parameter	Description	Setting range	Default	Menu path
Off Cmd7 	Off Command to the Circuit Breaker if the state of the assigned signal becomes true.	1..n, Trip Cmds	--	[Control /SG /SG[1] /Trip Manager]
Off Cmd8 	Off Command to the Circuit Breaker if the state of the assigned signal becomes true.	1..n, Trip Cmds	--	[Control /SG /SG[1] /Trip Manager]
Off Cmd9 	Off Command to the Circuit Breaker if the state of the assigned signal becomes true.	1..n, Trip Cmds	--	[Control /SG /SG[1] /Trip Manager]
Off Cmd10 	Off Command to the Circuit Breaker if the state of the assigned signal becomes true.	1..n, Trip Cmds	--	[Control /SG /SG[1] /Trip Manager]
Off Cmd11 	Off Command to the Circuit Breaker if the state of the assigned signal becomes true.	1..n, Trip Cmds	--	[Control /SG /SG[1] /Trip Manager]
Off Cmd12 	Off Command to the Circuit Breaker if the state of the assigned signal becomes true.	1..n, Trip Cmds	--	[Control /SG /SG[1] /Trip Manager]
Off Cmd13 	Off Command to the Circuit Breaker if the state of the assigned signal becomes true.	1..n, Trip Cmds	--	[Control /SG /SG[1] /Trip Manager]
Off Cmd14 	Off Command to the Circuit Breaker if the state of the assigned signal becomes true.	1..n, Trip Cmds	--	[Control /SG /SG[1] /Trip Manager]
Off Cmd15 	Off Command to the Circuit Breaker if the state of the assigned signal becomes true.	1..n, Trip Cmds	--	[Control /SG /SG[1] /Trip Manager]

Parameter	Description	Setting range	Default	Menu path
Off Cmd16 	Off Command to the Circuit Breaker if the state of the assigned signal becomes true.	1..n, Trip Cmds	--	[Control /SG /SG[1] /Trip Manager]
Off Cmd17 	Off Command to the Circuit Breaker if the state of the assigned signal becomes true.	1..n, Trip Cmds	--	[Control /SG /SG[1] /Trip Manager]
Off Cmd18 	Off Command to the Circuit Breaker if the state of the assigned signal becomes true.	1..n, Trip Cmds	--	[Control /SG /SG[1] /Trip Manager]
Off Cmd19 	Off Command to the Circuit Breaker if the state of the assigned signal becomes true.	1..n, Trip Cmds	--	[Control /SG /SG[1] /Trip Manager]
Off Cmd20 	Off Command to the Circuit Breaker if the state of the assigned signal becomes true.	1..n, Trip Cmds	--	[Control /SG /SG[1] /Trip Manager]
Off Cmd21 	Off Command to the Circuit Breaker if the state of the assigned signal becomes true.	1..n, Trip Cmds	--	[Control /SG /SG[1] /Trip Manager]
Off Cmd22 	Off Command to the Circuit Breaker if the state of the assigned signal becomes true.	1..n, Trip Cmds	--	[Control /SG /SG[1] /Trip Manager]
Off Cmd23 	Off Command to the Circuit Breaker if the state of the assigned signal becomes true.	1..n, Trip Cmds	--	[Control /SG /SG[1] /Trip Manager]
Off Cmd24 	Off Command to the Circuit Breaker if the state of the assigned signal becomes true.	1..n, Trip Cmds	--	[Control /SG /SG[1] /Trip Manager]

Parameter	Description	Setting range	Default	Menu path
Off Cmd25 	Off Command to the Circuit Breaker if the state of the assigned signal becomes true.	1..n, Trip Cmds	--	[Control /SG /SG[1] /Trip Manager]
Off Cmd26 	Off Command to the Circuit Breaker if the state of the assigned signal becomes true.	1..n, Trip Cmds	--	[Control /SG /SG[1] /Trip Manager]
Off Cmd27 	Off Command to the Circuit Breaker if the state of the assigned signal becomes true.	1..n, Trip Cmds	--	[Control /SG /SG[1] /Trip Manager]
Off Cmd28 	Off Command to the Circuit Breaker if the state of the assigned signal becomes true.	1..n, Trip Cmds	--	[Control /SG /SG[1] /Trip Manager]
Off Cmd29 	Off Command to the Circuit Breaker if the state of the assigned signal becomes true.	1..n, Trip Cmds	--	[Control /SG /SG[1] /Trip Manager]
Off Cmd30 	Off Command to the Circuit Breaker if the state of the assigned signal becomes true.	1..n, Trip Cmds	--	[Control /SG /SG[1] /Trip Manager]
Off Cmd31 	Off Command to the Circuit Breaker if the state of the assigned signal becomes true.	1..n, Trip Cmds	--	[Control /SG /SG[1] /Trip Manager]
Off Cmd32 	Off Command to the Circuit Breaker if the state of the assigned signal becomes true.	1..n, Trip Cmds	--	[Control /SG /SG[1] /Trip Manager]
Off Cmd33 	Off Command to the Circuit Breaker if the state of the assigned signal becomes true.	1..n, Trip Cmds	--	[Control /SG /SG[1] /Trip Manager]



Parameter	Description	Setting range	Default	Menu path
Off Cmd34 	Off Command to the Circuit Breaker if the state of the assigned signal becomes true.	1..n, Trip Cmds	--	[Control /SG /SG[1] /Trip Manager]
Off Cmd35 	Off Command to the Circuit Breaker if the state of the assigned signal becomes true.	1..n, Trip Cmds	--	[Control /SG /SG[1] /Trip Manager]
Off Cmd36 	Off Command to the Circuit Breaker if the state of the assigned signal becomes true.	1..n, Trip Cmds	--	[Control /SG /SG[1] /Trip Manager]
Off Cmd37 	Off Command to the Circuit Breaker if the state of the assigned signal becomes true.	1..n, Trip Cmds	--	[Control /SG /SG[1] /Trip Manager]
Off Cmd38 	Off Command to the Circuit Breaker if the state of the assigned signal becomes true.	1..n, Trip Cmds	--	[Control /SG /SG[1] /Trip Manager]
Off Cmd39 	Off Command to the Circuit Breaker if the state of the assigned signal becomes true.	1..n, Trip Cmds	--	[Control /SG /SG[1] /Trip Manager]
Off Cmd40 	Off Command to the Circuit Breaker if the state of the assigned signal becomes true.	1..n, Trip Cmds	--	[Control /SG /SG[1] /Trip Manager]
Off Cmd41 	Off Command to the Circuit Breaker if the state of the assigned signal becomes true.	1..n, Trip Cmds	--	[Control /SG /SG[1] /Trip Manager]
Off Cmd42 	Off Command to the Circuit Breaker if the state of the assigned signal becomes true.	1..n, Trip Cmds	--	[Control /SG /SG[1] /Trip Manager]

Parameter	Description	Setting range	Default	Menu path
Off Cmd43 	Off Command to the Circuit Breaker if the state of the assigned signal becomes true.	1..n, Trip Cmds	--	[Control /SG /SG[1] /Trip Manager]
Off Cmd44 	Off Command to the Circuit Breaker if the state of the assigned signal becomes true.	1..n, Trip Cmds	--	[Control /SG /SG[1] /Trip Manager]
Off Cmd45 	Off Command to the Circuit Breaker if the state of the assigned signal becomes true.	1..n, Trip Cmds	--	[Control /SG /SG[1] /Trip Manager]
Off Cmd46 	Off Command to the Circuit Breaker if the state of the assigned signal becomes true.	1..n, Trip Cmds	--	[Control /SG /SG[1] /Trip Manager]
Off Cmd47 	Off Command to the Circuit Breaker if the state of the assigned signal becomes true.	1..n, Trip Cmds	--	[Control /SG /SG[1] /Trip Manager]
Off Cmd48 	Off Command to the Circuit Breaker if the state of the assigned signal becomes true.	1..n, Trip Cmds	--	[Control /SG /SG[1] /Trip Manager]
Off Cmd49 	Off Command to the Circuit Breaker if the state of the assigned signal becomes true.	1..n, Trip Cmds	--	[Control /SG /SG[1] /Trip Manager]
Off Cmd50 	Off Command to the Circuit Breaker if the state of the assigned signal becomes true.	1..n, Trip Cmds	--	[Control /SG /SG[1] /Trip Manager]
Off Cmd51 	Off Command to the Circuit Breaker if the state of the assigned signal becomes true.	1..n, Trip Cmds	--	[Control /SG /SG[1] /Trip Manager]

<i>Parameter</i>	<i>Description</i>	<i>Setting range</i>	<i>Default</i>	<i>Menu path</i>
Off Cmd52 	Off Command to the Circuit Breaker if the state of the assigned signal becomes true.	1..n, Trip Cmds	--	[Control /SG /SG[1] /Trip Manager]
Off Cmd53 	Off Command to the Circuit Breaker if the state of the assigned signal becomes true.	1..n, Trip Cmds	--	[Control /SG /SG[1] /Trip Manager]
Off Cmd54 	Off Command to the Circuit Breaker if the state of the assigned signal becomes true.	1..n, Trip Cmds	--	[Control /SG /SG[1] /Trip Manager]
Off Cmd55 	Off Command to the Circuit Breaker if the state of the assigned signal becomes true.	1..n, Trip Cmds	--	[Control /SG /SG[1] /Trip Manager]
Off Cmd56 	Off Command to the Circuit Breaker if the state of the assigned signal becomes true.	1..n, Trip Cmds	--	[Control /SG /SG[1] /Trip Manager]
Off Cmd57 	Off Command to the Circuit Breaker if the state of the assigned signal becomes true.	1..n, Trip Cmds	--	[Control /SG /SG[1] /Trip Manager]
Off Cmd58 	Off Command to the Circuit Breaker if the state of the assigned signal becomes true.	1..n, Trip Cmds	--	[Control /SG /SG[1] /Trip Manager]
Off Cmd59 	Off Command to the Circuit Breaker if the state of the assigned signal becomes true.	1..n, Trip Cmds	--	[Control /SG /SG[1] /Trip Manager]
Off Cmd60 	Off Command to the Circuit Breaker if the state of the assigned signal becomes true.	1..n, Trip Cmds	--	[Control /SG /SG[1] /Trip Manager]

Parameter	Description	Setting range	Default	Menu path
Off Cmd61 	Off Command to the Circuit Breaker if the state of the assigned signal becomes true.	1..n, Trip Cmds	--	[Control /SG /SG[1] /Trip Manager]
Off Cmd62 	Off Command to the Circuit Breaker if the state of the assigned signal becomes true.	1..n, Trip Cmds	--	[Control /SG /SG[1] /Trip Manager]
Off Cmd63 	Off Command to the Circuit Breaker if the state of the assigned signal becomes true.	1..n, Trip Cmds	--	[Control /SG /SG[1] /Trip Manager]
Off Cmd64 	Off Command to the Circuit Breaker if the state of the assigned signal becomes true.	1..n, Trip Cmds	--	[Control /SG /SG[1] /Trip Manager]
Off Cmd65 	Off Command to the Circuit Breaker if the state of the assigned signal becomes true.	1..n, Trip Cmds	--	[Control /SG /SG[1] /Trip Manager]
Off Cmd66 	Off Command to the Circuit Breaker if the state of the assigned signal becomes true.	1..n, Trip Cmds	--	[Control /SG /SG[1] /Trip Manager]
Off Cmd67 	Off Command to the Circuit Breaker if the state of the assigned signal becomes true.	1..n, Trip Cmds	--	[Control /SG /SG[1] /Trip Manager]
Off Cmd68 	Off Command to the Circuit Breaker if the state of the assigned signal becomes true.	1..n, Trip Cmds	--	[Control /SG /SG[1] /Trip Manager]
Off Cmd69 	Off Command to the Circuit Breaker if the state of the assigned signal becomes true.	1..n, Trip Cmds	--	[Control /SG /SG[1] /Trip Manager]



Parameter	Description	Setting range	Default	Menu path
Off Cmd70 	Off Command to the Circuit Breaker if the state of the assigned signal becomes true.	1..n, Trip Cmds	--	[Control /SG /SG[1] /Trip Manager]
Synchronism 	Synchronism	1..n, In-SyncList	--	[Control /SG /SG[1] /Synchron Switchg]
t-MaxSyncSuperv 	Synchron-Run timer: Max. time allowed for synchronizing process after a close initiate. Only used for GENERATOR2SYSTEM working mode.	0 - 3000.00s	0.2s	[Control /SG /SG[1] /Synchron Switchg]
ON incl Prot ON 	The ON Command includes the ON Command issued by the Protection module.	inactive, active	active	[Control /SG /SG[1] /General settings]
OFF incl TripCmd 	The OFF Command includes the OFF Command issued by the Protection module.	inactive, active	active	[Control /SG /SG[1] /General settings]
t-Move ON 	Time to move to the ON Position	0.01 - 100.00s	0.1s	[Control /SG /SG[1] /General settings]
t-Move OFF 	Time to move to the OFF Position	0.01 - 100.00s	0.1s	[Control /SG /SG[1] /General settings]
t-Dwell 	Dwell time	0 - 100.00s	0s	[Control /SG /SG[1] /General settings]

## Controlled Circuit Breaker Input States

<i>Name</i>	<i>Description</i>	<i>Assignment via</i>
Aux ON-I	Module Input State: Position indicator/check-back signal of the CB (52a)	[Control /SG /SG[1] /Pos Indicatrs Wirng]
Aux OFF-I	Module input state: Position indicator/check-back signal of the CB (52b)	[Control /SG /SG[1] /Pos Indicatrs Wirng]
Ready-I	Module input state: CB ready	[Control /SG /SG[1] /Pos Indicatrs Wirng]
Sys-in-Sync-I	State of the module input: This signals has to become true within the synchronization time. If not, switching is unsuccessful.	[Control /SG /SG[1] /Synchron Switchg]
Removed-I	State of the module input: The withdrawable circuit breaker is Removed	[Control /SG /SG[1] /Pos Indicatrs Wirng]
Ack TripCmd-I	State of the module input: Acknowledgement Signal (only for automatic acknowledgement) Module input signal	[Control /SG /SG[1] /Trip Manager]
Interl ON1-I	State of the module input: Interlocking of the ON command	[Control /SG /SG[1] /Interlockings]
Interl ON2-I	State of the module input: Interlocking of the ON command	[Control /SG /SG[1] /Interlockings]
Interl ON3-I	State of the module input: Interlocking of the ON command	[Control /SG /SG[1] /Interlockings]

<i>Name</i>	<i>Description</i>	<i>Assignment via</i>
Interl OFF1-I	State of the module input: Interlocking of the OFF command	[Control /SG /SG[1] /Interlockings]
Interl OFF2-I	State of the module input: Interlocking of the OFF command	[Control /SG /SG[1] /Interlockings]
Interl OFF3-I	State of the module input: Interlocking of the OFF command	[Control /SG /SG[1] /Interlockings]
SCmd ON-I	State of the module input: Switching ON Command, e.g. the state of the Logics or the state of the digital input	[Control /SG /SG[1] /Ex ON/OFF Cmd]
SCmd OFF-I	State of the module input: Switching OFF Command, e.g. the state of the Logics or the state of the digital input	[Control /SG /SG[1] /Ex ON/OFF Cmd]

## Signals of a Controlled Circuit Breaker



<i>Signal</i>	<i>Description</i>
SI SingleContactInd	Signal: The Position of the Switchgear is detected by one auxiliary contact (pole) only. Thus indeterminate and disturbed Positions cannot be detected.
Pos not ON	Signal: Pos not ON
Pos ON	Signal: Circuit Breaker is in ON-Position
Pos OFF	Signal: Circuit Breaker is in OFF-Position
Pos Indeterm	Signal: Circuit Breaker is in Indeterminate Position
Pos Disturb	Signal: Circuit Breaker Disturbed - Undefined Breaker Position. The Position Indicators contradict themselves. After expiring of a supervision timer this signal becomes true.
Pos	Signal: Circuit Breaker Position (0 = Indeterminate, 1 = OFF, 2 = ON, 3 = Disturbed)
Ready	Signal: Circuit breaker is ready for operation.
t-Dwell	Signal: Dwell time
Removed	Signal: The withdrawable circuit breaker is Removed
Interl ON	Signal: One or more IL_On inputs are active.
Interl OFF	Signal: One or more IL_Off inputs are active.
CES succesf	Signal: Command Execution Supervision: Switching command executed successfully.

<i>Signal</i>	<i>Description</i>
CES Disturbed	Signal: Command Execution Supervision: Switching Command unsuccessful. Switchgear in disturbed position.
CES Fail TripCmd	Signal: Command Execution Supervision: Command execution failed because trip command is pending.
CES SwitchDir	Signal: Command Execution Supervision respectively Switching Direction Control: This signal becomes true, if a switch command is issued even though the switchgear is already in the requested position. Example: A switchgear that is already OFF should be switched OFF again (doubly). The same applies to CLOSE commands.
CES ON d OFF	Signal: Command Execution Supervision: On Command during a pending OFF Command.
CES SG not ready	Signal: Command Execution Supervision: Switchgear not ready
CES Fiel Interl	Signal: Command Execution Supervision: Switching Command not executed because of field interlocking.
CES SyncTimeout	Signal: Command Execution Supervision: Switching Command not executed. No Synchronization signal while t-sync was running.
CES SG removed	Signal: Command Execution Supervision: Switching Command unsuccessful, Switchgear removed.
Prot ON	Signal: ON Command issued by the Prot module
TripCmd	Signal: Trip Command
Ack TripCmd	Signal: Acknowledge Trip Command
ON incl Prot ON	Signal: The ON Command includes the ON Command issued by the Protection module.
OFF incl TripCmd	Signal: The OFF Command includes the OFF Command issued by the Protection module.
Position Ind manipul	Signal: Position Indicators faked
SGwear Slow SG	Signal: Alarm, the circuit breaker (load-break switch) becomes slower
Res SGwear SI SG	Signal: Resetting the slow Switchgear Alarm
ON Cmd	Signal: ON Command issued to the switchgear. Depending on the setting the signal may include the ON command of the Prot module.
OFF Cmd	Signal: OFF Command issued to the switchgear. Depending on the setting the signal may include the OFF command of the Prot module.
ON Cmd manual	Signal: ON Cmd manual
OFF Cmd manual	Signal: OFF Cmd manual
Sync ON request	Signal: Synchronous ON request



## Monitored Circuit Breaker









SG[3]

### Direct Commands of a Monitored Circuit Breaker

Parameter	Description	Setting range	Default	Menu path
 Manipulate Position WARNING! Fake Position - Manual Position Manipulation		inactive, Pos OFF, Pos ON	inactive	[Control /SG /SG[3] /General settings]
 Res SGwear SI SG	Resetting the slow Switchgear Alarm	inactive, active	inactive	[Operation /Reset]
 Ack TripCmd	Acknowledge Trip Command	inactive, active	inactive	[Operation /Acknowledge]

### Global Protection Parameters of a Monitored Circuit Breaker

Parameter	Description	Setting range	Default	Menu path
 Aux ON The CB is in ON-position if the state of the assigned signal is true (52a).		1..n, DI-LogicList	DI Slot X1.DI 3	[Control /SG /SG[3] /Pos Indicatr Wirng]
 Aux OFF The CB is in OFF-position if the state of the assigned signal is true (52b).		1..n, DI-LogicList	DI Slot X1.DI 4	[Control /SG /SG[3] /Pos Indicatr Wirng]
 Ready Circuit breaker is ready for operation if the state of the assigned signal is true. This digital input can be used by some protective elements (if they are available within the device) like Auto Reclosure (AR), e.g. as a trigger signal.		1..n, DI-LogicList	--	[Control /SG /SG[3] /Pos Indicatr Wirng]

Parameter	Description	Setting range	Default	Menu path
Removed 	The withdrawable circuit breaker is Removed	1..n, DI-LogicList	-.-	[Control /SG /SG[3] /Pos Indicatr Wirng]
Interl ON1 	Interlocking of the ON command	1..n, Assignment List	-.-	[Control /SG /SG[3] /Interlockings]
Interl ON2 	Interlocking of the ON command	1..n, Assignment List	-.-	[Control /SG /SG[3] /Interlockings]
Interl ON3 	Interlocking of the ON command	1..n, Assignment List	-.-	[Control /SG /SG[3] /Interlockings]
Interl OFF1 	Interlocking of the OFF command	1..n, Assignment List	-.-	[Control /SG /SG[3] /Interlockings]
Interl OFF2 	Interlocking of the OFF command	1..n, Assignment List	-.-	[Control /SG /SG[3] /Interlockings]
Interl OFF3 	Interlocking of the OFF command	1..n, Assignment List	-.-	[Control /SG /SG[3] /Interlockings]
SCmd ON 	Switching ON Command, e.g. the state of the Logics or the state of the digital input	1..n, DI-LogicList	-.-	[Control /SG /SG[3] /Ex ON/OFF Cmd]
SCmd OFF 	Switching OFF Command, e.g. the state of the Logics or the state of the digital input	1..n, DI-LogicList	-.-	[Control /SG /SG[3] /Ex ON/OFF Cmd]

Parameter	Description	Setting range	Default	Menu path
t-TripCmd 	Minimum hold time of the OFF-command (circuit breaker, load break switch)	0 - 300.00s	0.2s	[Control /SG /SG[3] /Trip Manager]
Latched 	Defines whether the Binary Output Relay will be Latched when it picks up.	inactive, active	inactive	[Control /SG /SG[3] /Trip Manager]
Ack TripCmd 	Ack TripCmd	1..n, Assignment List	-.-	[Control /SG /SG[3] /Trip Manager]
Off Cmd1 	Off Command to the Circuit Breaker if the state of the assigned signal becomes true.	1..n, Trip Cmds	-.-	[Control /SG /SG[3] /Trip Manager]
Off Cmd2 	Off Command to the Circuit Breaker if the state of the assigned signal becomes true.	1..n, Trip Cmds	-.-	[Control /SG /SG[3] /Trip Manager]
Off Cmd3 	Off Command to the Circuit Breaker if the state of the assigned signal becomes true.	1..n, Trip Cmds	-.-	[Control /SG /SG[3] /Trip Manager]
Off Cmd4 	Off Command to the Circuit Breaker if the state of the assigned signal becomes true.	1..n, Trip Cmds	-.-	[Control /SG /SG[3] /Trip Manager]
Off Cmd5 	Off Command to the Circuit Breaker if the state of the assigned signal becomes true.	1..n, Trip Cmds	-.-	[Control /SG /SG[3] /Trip Manager]
Off Cmd6 	Off Command to the Circuit Breaker if the state of the assigned signal becomes true.	1..n, Trip Cmds	-.-	[Control /SG /SG[3] /Trip Manager]

Parameter	Description	Setting range	Default	Menu path
Off Cmd7 	Off Command to the Circuit Breaker if the state of the assigned signal becomes true.	1..n, Trip Cmds	--	[Control /SG /SG[3] /Trip Manager]
Off Cmd8 	Off Command to the Circuit Breaker if the state of the assigned signal becomes true.	1..n, Trip Cmds	--	[Control /SG /SG[3] /Trip Manager]
Off Cmd9 	Off Command to the Circuit Breaker if the state of the assigned signal becomes true.	1..n, Trip Cmds	--	[Control /SG /SG[3] /Trip Manager]
Off Cmd10 	Off Command to the Circuit Breaker if the state of the assigned signal becomes true.	1..n, Trip Cmds	--	[Control /SG /SG[3] /Trip Manager]
Off Cmd11 	Off Command to the Circuit Breaker if the state of the assigned signal becomes true.	1..n, Trip Cmds	--	[Control /SG /SG[3] /Trip Manager]
Off Cmd12 	Off Command to the Circuit Breaker if the state of the assigned signal becomes true.	1..n, Trip Cmds	--	[Control /SG /SG[3] /Trip Manager]
Off Cmd13 	Off Command to the Circuit Breaker if the state of the assigned signal becomes true.	1..n, Trip Cmds	--	[Control /SG /SG[3] /Trip Manager]
Off Cmd14 	Off Command to the Circuit Breaker if the state of the assigned signal becomes true.	1..n, Trip Cmds	--	[Control /SG /SG[3] /Trip Manager]
Off Cmd15 	Off Command to the Circuit Breaker if the state of the assigned signal becomes true.	1..n, Trip Cmds	--	[Control /SG /SG[3] /Trip Manager]



Parameter	Description	Setting range	Default	Menu path
Off Cmd16 	Off Command to the Circuit Breaker if the state of the assigned signal becomes true.	1..n, Trip Cmds	--	[Control /SG /SG[3] /Trip Manager]
Off Cmd17 	Off Command to the Circuit Breaker if the state of the assigned signal becomes true.	1..n, Trip Cmds	--	[Control /SG /SG[3] /Trip Manager]
Off Cmd18 	Off Command to the Circuit Breaker if the state of the assigned signal becomes true.	1..n, Trip Cmds	--	[Control /SG /SG[3] /Trip Manager]
Off Cmd19 	Off Command to the Circuit Breaker if the state of the assigned signal becomes true.	1..n, Trip Cmds	--	[Control /SG /SG[3] /Trip Manager]
Off Cmd20 	Off Command to the Circuit Breaker if the state of the assigned signal becomes true.	1..n, Trip Cmds	--	[Control /SG /SG[3] /Trip Manager]
Off Cmd21 	Off Command to the Circuit Breaker if the state of the assigned signal becomes true.	1..n, Trip Cmds	--	[Control /SG /SG[3] /Trip Manager]
Off Cmd22 	Off Command to the Circuit Breaker if the state of the assigned signal becomes true.	1..n, Trip Cmds	--	[Control /SG /SG[3] /Trip Manager]
Off Cmd23 	Off Command to the Circuit Breaker if the state of the assigned signal becomes true.	1..n, Trip Cmds	--	[Control /SG /SG[3] /Trip Manager]
Off Cmd24 	Off Command to the Circuit Breaker if the state of the assigned signal becomes true.	1..n, Trip Cmds	--	[Control /SG /SG[3] /Trip Manager]

Parameter	Description	Setting range	Default	Menu path
Off Cmd25 	Off Command to the Circuit Breaker if the state of the assigned signal becomes true.	1..n, Trip Cmds	--	[Control /SG /SG[3] /Trip Manager]
Off Cmd26 	Off Command to the Circuit Breaker if the state of the assigned signal becomes true.	1..n, Trip Cmds	--	[Control /SG /SG[3] /Trip Manager]
Off Cmd27 	Off Command to the Circuit Breaker if the state of the assigned signal becomes true.	1..n, Trip Cmds	--	[Control /SG /SG[3] /Trip Manager]
Off Cmd28 	Off Command to the Circuit Breaker if the state of the assigned signal becomes true.	1..n, Trip Cmds	--	[Control /SG /SG[3] /Trip Manager]
Off Cmd29 	Off Command to the Circuit Breaker if the state of the assigned signal becomes true.	1..n, Trip Cmds	--	[Control /SG /SG[3] /Trip Manager]
Off Cmd30 	Off Command to the Circuit Breaker if the state of the assigned signal becomes true.	1..n, Trip Cmds	--	[Control /SG /SG[3] /Trip Manager]
Off Cmd31 	Off Command to the Circuit Breaker if the state of the assigned signal becomes true.	1..n, Trip Cmds	--	[Control /SG /SG[3] /Trip Manager]
Off Cmd32 	Off Command to the Circuit Breaker if the state of the assigned signal becomes true.	1..n, Trip Cmds	--	[Control /SG /SG[3] /Trip Manager]
Off Cmd33 	Off Command to the Circuit Breaker if the state of the assigned signal becomes true.	1..n, Trip Cmds	--	[Control /SG /SG[3] /Trip Manager]

Parameter	Description	Setting range	Default	Menu path
Off Cmd34 	Off Command to the Circuit Breaker if the state of the assigned signal becomes true.	1..n, Trip Cmds	--	[Control /SG /SG[3] /Trip Manager]
Off Cmd35 	Off Command to the Circuit Breaker if the state of the assigned signal becomes true.	1..n, Trip Cmds	--	[Control /SG /SG[3] /Trip Manager]
Off Cmd36 	Off Command to the Circuit Breaker if the state of the assigned signal becomes true.	1..n, Trip Cmds	--	[Control /SG /SG[3] /Trip Manager]
Off Cmd37 	Off Command to the Circuit Breaker if the state of the assigned signal becomes true.	1..n, Trip Cmds	--	[Control /SG /SG[3] /Trip Manager]
Off Cmd38 	Off Command to the Circuit Breaker if the state of the assigned signal becomes true.	1..n, Trip Cmds	--	[Control /SG /SG[3] /Trip Manager]
Off Cmd39 	Off Command to the Circuit Breaker if the state of the assigned signal becomes true.	1..n, Trip Cmds	--	[Control /SG /SG[3] /Trip Manager]
Off Cmd40 	Off Command to the Circuit Breaker if the state of the assigned signal becomes true.	1..n, Trip Cmds	--	[Control /SG /SG[3] /Trip Manager]
Off Cmd41 	Off Command to the Circuit Breaker if the state of the assigned signal becomes true.	1..n, Trip Cmds	--	[Control /SG /SG[3] /Trip Manager]
Off Cmd42 	Off Command to the Circuit Breaker if the state of the assigned signal becomes true.	1..n, Trip Cmds	--	[Control /SG /SG[3] /Trip Manager]

Parameter	Description	Setting range	Default	Menu path
Off Cmd43 	Off Command to the Circuit Breaker if the state of the assigned signal becomes true.	1..n, Trip Cmds	--	[Control /SG /SG[3] /Trip Manager]
Off Cmd44 	Off Command to the Circuit Breaker if the state of the assigned signal becomes true.	1..n, Trip Cmds	--	[Control /SG /SG[3] /Trip Manager]
Off Cmd45 	Off Command to the Circuit Breaker if the state of the assigned signal becomes true.	1..n, Trip Cmds	--	[Control /SG /SG[3] /Trip Manager]
Off Cmd46 	Off Command to the Circuit Breaker if the state of the assigned signal becomes true.	1..n, Trip Cmds	--	[Control /SG /SG[3] /Trip Manager]
Off Cmd47 	Off Command to the Circuit Breaker if the state of the assigned signal becomes true.	1..n, Trip Cmds	--	[Control /SG /SG[3] /Trip Manager]
Off Cmd48 	Off Command to the Circuit Breaker if the state of the assigned signal becomes true.	1..n, Trip Cmds	--	[Control /SG /SG[3] /Trip Manager]
Off Cmd49 	Off Command to the Circuit Breaker if the state of the assigned signal becomes true.	1..n, Trip Cmds	--	[Control /SG /SG[3] /Trip Manager]
Off Cmd50 	Off Command to the Circuit Breaker if the state of the assigned signal becomes true.	1..n, Trip Cmds	--	[Control /SG /SG[3] /Trip Manager]
Off Cmd51 	Off Command to the Circuit Breaker if the state of the assigned signal becomes true.	1..n, Trip Cmds	--	[Control /SG /SG[3] /Trip Manager]

Parameter	Description	Setting range	Default	Menu path
Off Cmd52 	Off Command to the Circuit Breaker if the state of the assigned signal becomes true.	1..n, Trip Cmds	--	[Control /SG /SG[3] /Trip Manager]
Off Cmd53 	Off Command to the Circuit Breaker if the state of the assigned signal becomes true.	1..n, Trip Cmds	--	[Control /SG /SG[3] /Trip Manager]
Off Cmd54 	Off Command to the Circuit Breaker if the state of the assigned signal becomes true.	1..n, Trip Cmds	--	[Control /SG /SG[3] /Trip Manager]
Off Cmd55 	Off Command to the Circuit Breaker if the state of the assigned signal becomes true.	1..n, Trip Cmds	--	[Control /SG /SG[3] /Trip Manager]
Off Cmd56 	Off Command to the Circuit Breaker if the state of the assigned signal becomes true.	1..n, Trip Cmds	--	[Control /SG /SG[3] /Trip Manager]
Off Cmd57 	Off Command to the Circuit Breaker if the state of the assigned signal becomes true.	1..n, Trip Cmds	--	[Control /SG /SG[3] /Trip Manager]
Off Cmd58 	Off Command to the Circuit Breaker if the state of the assigned signal becomes true.	1..n, Trip Cmds	--	[Control /SG /SG[3] /Trip Manager]
Off Cmd59 	Off Command to the Circuit Breaker if the state of the assigned signal becomes true.	1..n, Trip Cmds	--	[Control /SG /SG[3] /Trip Manager]
Off Cmd60 	Off Command to the Circuit Breaker if the state of the assigned signal becomes true.	1..n, Trip Cmds	--	[Control /SG /SG[3] /Trip Manager]

Parameter	Description	Setting range	Default	Menu path
Off Cmd61 	Off Command to the Circuit Breaker if the state of the assigned signal becomes true.	1..n, Trip Cmds	--	[Control /SG /SG[3] /Trip Manager]
Off Cmd62 	Off Command to the Circuit Breaker if the state of the assigned signal becomes true.	1..n, Trip Cmds	--	[Control /SG /SG[3] /Trip Manager]
Off Cmd63 	Off Command to the Circuit Breaker if the state of the assigned signal becomes true.	1..n, Trip Cmds	--	[Control /SG /SG[3] /Trip Manager]
Off Cmd64 	Off Command to the Circuit Breaker if the state of the assigned signal becomes true.	1..n, Trip Cmds	--	[Control /SG /SG[3] /Trip Manager]
Off Cmd65 	Off Command to the Circuit Breaker if the state of the assigned signal becomes true.	1..n, Trip Cmds	--	[Control /SG /SG[3] /Trip Manager]
Off Cmd66 	Off Command to the Circuit Breaker if the state of the assigned signal becomes true.	1..n, Trip Cmds	--	[Control /SG /SG[3] /Trip Manager]
Off Cmd67 	Off Command to the Circuit Breaker if the state of the assigned signal becomes true.	1..n, Trip Cmds	--	[Control /SG /SG[3] /Trip Manager]
Off Cmd68 	Off Command to the Circuit Breaker if the state of the assigned signal becomes true.	1..n, Trip Cmds	--	[Control /SG /SG[3] /Trip Manager]
Off Cmd69 	Off Command to the Circuit Breaker if the state of the assigned signal becomes true.	1..n, Trip Cmds	--	[Control /SG /SG[3] /Trip Manager]

<i>Parameter</i>	<i>Description</i>	<i>Setting range</i>	<i>Default</i>	<i>Menu path</i>
Off Cmd70 	Off Command to the Circuit Breaker if the state of the assigned signal becomes true.	1..n, Trip Cmds	--	[Control /SG /SG[3] /Trip Manager]
Synchronism 	Synchronism	1..n, In-SyncList	--	[Control /SG /SG[3] /Synchron Switchg]
t-MaxSyncSuperv 	Synchron-Run timer: Max. time allowed for synchronizing process after a close initiate. Only used for GENERATOR2SYSTEM working mode.	0 - 3000.00s	0.2s	[Control /SG /SG[3] /Synchron Switchg]
ON incl Prot ON 	The ON Command includes the ON Command issued by the Protection module.	inactive, active	active	[Control /SG /SG[3] /General settings]
OFF incl TripCmd 	The OFF Command includes the OFF Command issued by the Protection module.	inactive, active	active	[Control /SG /SG[3] /General settings]
t-Move ON 	Time to move to the ON Position	0.01 - 100.00s	0.1s	[Control /SG /SG[3] /General settings]
t-Move OFF 	Time to move to the OFF Position	0.01 - 100.00s	0.1s	[Control /SG /SG[3] /General settings]
t-Dwell 	Dwell time	0 - 100.00s	0s	[Control /SG /SG[3] /General settings]

## Monitored Circuit Breaker Input States

<i>Name</i>	<i>Description</i>	<i>Assignment via</i>
Aux ON-I	Module Input State: Position indicator/check-back signal of the CB (52a)	[Control /SG /SG[3] /Pos Indicatrs Wirng]
Aux OFF-I	Module input state: Position indicator/check-back signal of the CB (52b)	[Control /SG /SG[3] /Pos Indicatrs Wirng]
Ready-I	Module input state: CB ready	[Control /SG /SG[3] /Pos Indicatrs Wirng]
Sys-in-Sync-I	State of the module input: This signals has to become true within the synchronization time. If not, switching is unsuccessful.	[Control /SG /SG[3] /Synchron Switchg]
Removed-I	State of the module input: The withdrawable circuit breaker is Removed	[Control /SG /SG[3] /Pos Indicatrs Wirng]
Ack TripCmd-I	State of the module input: Acknowledgement Signal (only for automatic acknowledgement) Module input signal	[Control /SG /SG[3] /Trip Manager]
Interl ON1-I	State of the module input: Interlocking of the ON command	[Control /SG /SG[3] /Interlockings]
Interl ON2-I	State of the module input: Interlocking of the ON command	[Control /SG /SG[3] /Interlockings]
Interl ON3-I	State of the module input: Interlocking of the ON command	[Control /SG /SG[3] /Interlockings]



<i>Name</i>	<i>Description</i>	<i>Assignment via</i>
Interl OFF1-I	State of the module input: Interlocking of the OFF command	[Control /SG /SG[3] /Interlockings]
Interl OFF2-I	State of the module input: Interlocking of the OFF command	[Control /SG /SG[3] /Interlockings]
Interl OFF3-I	State of the module input: Interlocking of the OFF command	[Control /SG /SG[3] /Interlockings]
SCmd ON-I	State of the module input: Switching ON Command, e.g. the state of the Logics or the state of the digital input	[Control /SG /SG[3] /Ex ON/OFF Cmd]
SCmd OFF-I	State of the module input: Switching OFF Command, e.g. the state of the Logics or the state of the digital input	[Control /SG /SG[3] /Ex ON/OFF Cmd]

## Signals of a Monitored Circuit Breaker



<i>Signal</i>	<i>Description</i>
SI SingleContactInd	Signal: The Position of the Switchgear is detected by one auxiliary contact (pole) only. Thus indeterminate and disturbed Positions cannot be detected.
Pos not ON	Signal: Pos not ON
Pos ON	Signal: Circuit Breaker is in ON-Position
Pos OFF	Signal: Circuit Breaker is in OFF-Position
Pos Indeterm	Signal: Circuit Breaker is in Indeterminate Position
Pos Disturb	Signal: Circuit Breaker Disturbed - Undefined Breaker Position. The Position Indicators contradict themselves. After expiring of a supervision timer this signal becomes true.
Pos	Signal: Circuit Breaker Position (0 = Indeterminate, 1 = OFF, 2 = ON, 3 = Disturbed)
Ready	Signal: Circuit breaker is ready for operation.
t-Dwell	Signal: Dwell time
Removed	Signal: The withdrawable circuit breaker is Removed
Interl ON	Signal: One or more IL_On inputs are active.
Interl OFF	Signal: One or more IL_Off inputs are active.
CES succesf	Signal: Command Execution Supervision: Switching command executed successfully.

<i>Signal</i>	<i>Description</i>
CES Disturbed	Signal: Command Execution Supervision: Switching Command unsuccessful. Switchgear in disturbed position.
CES Fail TripCmd	Signal: Command Execution Supervision: Command execution failed because trip command is pending.
CES SwitchDir	Signal: Command Execution Supervision respectively Switching Direction Control: This signal becomes true, if a switch command is issued even though the switchgear is already in the requested position. Example: A switchgear that is already OFF should be switched OFF again (doubly). The same applies to CLOSE commands.
CES ON d OFF	Signal: Command Execution Supervision: On Command during a pending OFF Command.
CES SG not ready	Signal: Command Execution Supervision: Switchgear not ready
CES Fiel Interl	Signal: Command Execution Supervision: Switching Command not executed because of field interlocking.
CES SyncTimeout	Signal: Command Execution Supervision: Switching Command not executed. No Synchronization signal while t-sync was running.
CES SG removed	Signal: Command Execution Supervision: Switching Command unsuccessful, Switchgear removed.
Prot ON	Signal: ON Command issued by the Prot module
TripCmd	Signal: Trip Command
Ack TripCmd	Signal: Acknowledge Trip Command
ON incl Prot ON	Signal: The ON Command includes the ON Command issued by the Protection module.
OFF incl TripCmd	Signal: The OFF Command includes the OFF Command issued by the Protection module.
Position Ind manipul	Signal: Position Indicators faked
SGwear Slow SG	Signal: Alarm, the circuit breaker (load-break switch) becomes slower
Res SGwear SI SG	Signal: Resetting the slow Switchgear Alarm
ON Cmd	Signal: ON Command issued to the switchgear. Depending on the setting the signal may include the ON command of the Prot module.
OFF Cmd	Signal: OFF Command issued to the switchgear. Depending on the setting the signal may include the OFF command of the Prot module.
ON Cmd manual	Signal: ON Cmd manual
OFF Cmd manual	Signal: OFF Cmd manual
Sync ON request	Signal: Synchronous ON request



## Controlled Disconnecter

SG[4]

### Direct Commands of a Controlled Disconnecter

Parameter	Description	Setting range	Default	Menu path
Manipulate Position 	WARNING! Fake Position - Manual Position Manipulation	inactive, Pos OFF, Pos ON	inactive	[Control /SG /SG[4] /General settings]
Res SGwear SI SG 	Resetting the slow Switchgear Alarm	inactive, active	inactive	[Operation /Reset]
Ack TripCmd 	Acknowledge Trip Command	inactive, active	inactive	[Operation /Acknowledge]

### Global Protection Parameters of a Controlled Disconnecter

Parameter	Description	Setting range	Default	Menu path
Aux ON 	The CB is in ON-position if the state of the assigned signal is true (52a).	1..n, DI-LogicList	DI Slot X1.DI 5	[Control /SG /SG[4] /Pos Indicatr Wirng]
Aux OFF 	The CB is in OFF-position if the state of the assigned signal is true (52b).	1..n, DI-LogicList	DI Slot X1.DI 6	[Control /SG /SG[4] /Pos Indicatr Wirng]
Ready 	Circuit breaker is ready for operation if the state of the assigned signal is true. This digital input can be used by some protective elements (if they are available within the device) like Auto Reclosure (AR), e.g. as a trigger signal.	1..n, DI-LogicList	---	[Control /SG /SG[4] /Pos Indicatr Wirng]

<i>Parameter</i>	<i>Description</i>	<i>Setting range</i>	<i>Default</i>	<i>Menu path</i>
Removed 	The withdrawable circuit breaker is Removed	1..n, DI-LogicList	-.-	[Control /SG /SG[4] /Pos Indicatr Wiring]
Interl ON1 	Interlocking of the ON command	1..n, Assignment List	SG[1].Pos ON	[Control /SG /SG[4] /Interlockings]
Interl ON2 	Interlocking of the ON command	1..n, Assignment List	SG[6].Pos ON	[Control /SG /SG[4] /Interlockings]
Interl ON3 	Interlocking of the ON command	1..n, Assignment List	-.-	[Control /SG /SG[4] /Interlockings]
Interl OFF1 	Interlocking of the OFF command	1..n, Assignment List	SG[1].Pos ON	[Control /SG /SG[4] /Interlockings]
Interl OFF2 	Interlocking of the OFF command	1..n, Assignment List	-.-	[Control /SG /SG[4] /Interlockings]
Interl OFF3 	Interlocking of the OFF command	1..n, Assignment List	-.-	[Control /SG /SG[4] /Interlockings]
SCmd ON 	Switching ON Command, e.g. the state of the Logics or the state of the digital input	1..n, DI-LogicList	-.-	[Control /SG /SG[4] /Ex ON/OFF Cmd]
SCmd OFF 	Switching OFF Command, e.g. the state of the Logics or the state of the digital input	1..n, DI-LogicList	-.-	[Control /SG /SG[4] /Ex ON/OFF Cmd]

Parameter	Description	Setting range	Default	Menu path
t-TripCmd 	Minimum hold time of the OFF-command (circuit breaker, load break switch)	0 - 300.00s	0.2s	[Control /SG /SG[4] /Trip Manager]
Latched 	Defines whether the Binary Output Relay will be Latched when it picks up.	inactive, active	inactive	[Control /SG /SG[4] /Trip Manager]
Ack TripCmd 	Ack TripCmd	1..n, Assignment List	-.-	[Control /SG /SG[4] /Trip Manager]
Off Cmd1 	Off Command to the Circuit Breaker if the state of the assigned signal becomes true.	1..n, Trip Cmds	-.-	[Control /SG /SG[4] /Trip Manager]
Off Cmd2 	Off Command to the Circuit Breaker if the state of the assigned signal becomes true.	1..n, Trip Cmds	-.-	[Control /SG /SG[4] /Trip Manager]
Off Cmd3 	Off Command to the Circuit Breaker if the state of the assigned signal becomes true.	1..n, Trip Cmds	-.-	[Control /SG /SG[4] /Trip Manager]
Off Cmd4 	Off Command to the Circuit Breaker if the state of the assigned signal becomes true.	1..n, Trip Cmds	-.-	[Control /SG /SG[4] /Trip Manager]
Off Cmd5 	Off Command to the Circuit Breaker if the state of the assigned signal becomes true.	1..n, Trip Cmds	-.-	[Control /SG /SG[4] /Trip Manager]
Off Cmd6 	Off Command to the Circuit Breaker if the state of the assigned signal becomes true.	1..n, Trip Cmds	-.-	[Control /SG /SG[4] /Trip Manager]

Parameter	Description	Setting range	Default	Menu path
Off Cmd7 	Off Command to the Circuit Breaker if the state of the assigned signal becomes true.	1..n, Trip Cmds	--	[Control /SG /SG[4] /Trip Manager]
Off Cmd8 	Off Command to the Circuit Breaker if the state of the assigned signal becomes true.	1..n, Trip Cmds	--	[Control /SG /SG[4] /Trip Manager]
Off Cmd9 	Off Command to the Circuit Breaker if the state of the assigned signal becomes true.	1..n, Trip Cmds	--	[Control /SG /SG[4] /Trip Manager]
Off Cmd10 	Off Command to the Circuit Breaker if the state of the assigned signal becomes true.	1..n, Trip Cmds	--	[Control /SG /SG[4] /Trip Manager]
Off Cmd11 	Off Command to the Circuit Breaker if the state of the assigned signal becomes true.	1..n, Trip Cmds	--	[Control /SG /SG[4] /Trip Manager]
Off Cmd12 	Off Command to the Circuit Breaker if the state of the assigned signal becomes true.	1..n, Trip Cmds	--	[Control /SG /SG[4] /Trip Manager]
Off Cmd13 	Off Command to the Circuit Breaker if the state of the assigned signal becomes true.	1..n, Trip Cmds	--	[Control /SG /SG[4] /Trip Manager]
Off Cmd14 	Off Command to the Circuit Breaker if the state of the assigned signal becomes true.	1..n, Trip Cmds	--	[Control /SG /SG[4] /Trip Manager]
Off Cmd15 	Off Command to the Circuit Breaker if the state of the assigned signal becomes true.	1..n, Trip Cmds	--	[Control /SG /SG[4] /Trip Manager]

Parameter	Description	Setting range	Default	Menu path
Off Cmd16 	Off Command to the Circuit Breaker if the state of the assigned signal becomes true.	1..n, Trip Cmds	--	[Control /SG /SG[4] /Trip Manager]
Off Cmd17 	Off Command to the Circuit Breaker if the state of the assigned signal becomes true.	1..n, Trip Cmds	--	[Control /SG /SG[4] /Trip Manager]
Off Cmd18 	Off Command to the Circuit Breaker if the state of the assigned signal becomes true.	1..n, Trip Cmds	--	[Control /SG /SG[4] /Trip Manager]
Off Cmd19 	Off Command to the Circuit Breaker if the state of the assigned signal becomes true.	1..n, Trip Cmds	--	[Control /SG /SG[4] /Trip Manager]
Off Cmd20 	Off Command to the Circuit Breaker if the state of the assigned signal becomes true.	1..n, Trip Cmds	--	[Control /SG /SG[4] /Trip Manager]
Off Cmd21 	Off Command to the Circuit Breaker if the state of the assigned signal becomes true.	1..n, Trip Cmds	--	[Control /SG /SG[4] /Trip Manager]
Off Cmd22 	Off Command to the Circuit Breaker if the state of the assigned signal becomes true.	1..n, Trip Cmds	--	[Control /SG /SG[4] /Trip Manager]
Off Cmd23 	Off Command to the Circuit Breaker if the state of the assigned signal becomes true.	1..n, Trip Cmds	--	[Control /SG /SG[4] /Trip Manager]
Off Cmd24 	Off Command to the Circuit Breaker if the state of the assigned signal becomes true.	1..n, Trip Cmds	--	[Control /SG /SG[4] /Trip Manager]

Parameter	Description	Setting range	Default	Menu path
Off Cmd25 	Off Command to the Circuit Breaker if the state of the assigned signal becomes true.	1..n, Trip Cmds	--	[Control /SG /SG[4] /Trip Manager]
Off Cmd26 	Off Command to the Circuit Breaker if the state of the assigned signal becomes true.	1..n, Trip Cmds	--	[Control /SG /SG[4] /Trip Manager]
Off Cmd27 	Off Command to the Circuit Breaker if the state of the assigned signal becomes true.	1..n, Trip Cmds	--	[Control /SG /SG[4] /Trip Manager]
Off Cmd28 	Off Command to the Circuit Breaker if the state of the assigned signal becomes true.	1..n, Trip Cmds	--	[Control /SG /SG[4] /Trip Manager]
Off Cmd29 	Off Command to the Circuit Breaker if the state of the assigned signal becomes true.	1..n, Trip Cmds	--	[Control /SG /SG[4] /Trip Manager]
Off Cmd30 	Off Command to the Circuit Breaker if the state of the assigned signal becomes true.	1..n, Trip Cmds	--	[Control /SG /SG[4] /Trip Manager]
Off Cmd31 	Off Command to the Circuit Breaker if the state of the assigned signal becomes true.	1..n, Trip Cmds	--	[Control /SG /SG[4] /Trip Manager]
Off Cmd32 	Off Command to the Circuit Breaker if the state of the assigned signal becomes true.	1..n, Trip Cmds	--	[Control /SG /SG[4] /Trip Manager]
Off Cmd33 	Off Command to the Circuit Breaker if the state of the assigned signal becomes true.	1..n, Trip Cmds	--	[Control /SG /SG[4] /Trip Manager]



Parameter	Description	Setting range	Default	Menu path
Off Cmd34 	Off Command to the Circuit Breaker if the state of the assigned signal becomes true.	1..n, Trip Cmds	--	[Control /SG /SG[4] /Trip Manager]
Off Cmd35 	Off Command to the Circuit Breaker if the state of the assigned signal becomes true.	1..n, Trip Cmds	--	[Control /SG /SG[4] /Trip Manager]
Off Cmd36 	Off Command to the Circuit Breaker if the state of the assigned signal becomes true.	1..n, Trip Cmds	--	[Control /SG /SG[4] /Trip Manager]
Off Cmd37 	Off Command to the Circuit Breaker if the state of the assigned signal becomes true.	1..n, Trip Cmds	--	[Control /SG /SG[4] /Trip Manager]
Off Cmd38 	Off Command to the Circuit Breaker if the state of the assigned signal becomes true.	1..n, Trip Cmds	--	[Control /SG /SG[4] /Trip Manager]
Off Cmd39 	Off Command to the Circuit Breaker if the state of the assigned signal becomes true.	1..n, Trip Cmds	--	[Control /SG /SG[4] /Trip Manager]
Off Cmd40 	Off Command to the Circuit Breaker if the state of the assigned signal becomes true.	1..n, Trip Cmds	--	[Control /SG /SG[4] /Trip Manager]
Off Cmd41 	Off Command to the Circuit Breaker if the state of the assigned signal becomes true.	1..n, Trip Cmds	--	[Control /SG /SG[4] /Trip Manager]
Off Cmd42 	Off Command to the Circuit Breaker if the state of the assigned signal becomes true.	1..n, Trip Cmds	--	[Control /SG /SG[4] /Trip Manager]

Parameter	Description	Setting range	Default	Menu path
Off Cmd43 	Off Command to the Circuit Breaker if the state of the assigned signal becomes true.	1..n, Trip Cmds	--	[Control /SG /SG[4] /Trip Manager]
Off Cmd44 	Off Command to the Circuit Breaker if the state of the assigned signal becomes true.	1..n, Trip Cmds	--	[Control /SG /SG[4] /Trip Manager]
Off Cmd45 	Off Command to the Circuit Breaker if the state of the assigned signal becomes true.	1..n, Trip Cmds	--	[Control /SG /SG[4] /Trip Manager]
Off Cmd46 	Off Command to the Circuit Breaker if the state of the assigned signal becomes true.	1..n, Trip Cmds	--	[Control /SG /SG[4] /Trip Manager]
Off Cmd47 	Off Command to the Circuit Breaker if the state of the assigned signal becomes true.	1..n, Trip Cmds	--	[Control /SG /SG[4] /Trip Manager]
Off Cmd48 	Off Command to the Circuit Breaker if the state of the assigned signal becomes true.	1..n, Trip Cmds	--	[Control /SG /SG[4] /Trip Manager]
Off Cmd49 	Off Command to the Circuit Breaker if the state of the assigned signal becomes true.	1..n, Trip Cmds	--	[Control /SG /SG[4] /Trip Manager]
Off Cmd50 	Off Command to the Circuit Breaker if the state of the assigned signal becomes true.	1..n, Trip Cmds	--	[Control /SG /SG[4] /Trip Manager]
Off Cmd51 	Off Command to the Circuit Breaker if the state of the assigned signal becomes true.	1..n, Trip Cmds	--	[Control /SG /SG[4] /Trip Manager]

<i>Parameter</i>	<i>Description</i>	<i>Setting range</i>	<i>Default</i>	<i>Menu path</i>
Off Cmd52 	Off Command to the Circuit Breaker if the state of the assigned signal becomes true.	1..n, Trip Cmds	--	[Control /SG /SG[4] /Trip Manager]
Off Cmd53 	Off Command to the Circuit Breaker if the state of the assigned signal becomes true.	1..n, Trip Cmds	--	[Control /SG /SG[4] /Trip Manager]
Off Cmd54 	Off Command to the Circuit Breaker if the state of the assigned signal becomes true.	1..n, Trip Cmds	--	[Control /SG /SG[4] /Trip Manager]
Off Cmd55 	Off Command to the Circuit Breaker if the state of the assigned signal becomes true.	1..n, Trip Cmds	--	[Control /SG /SG[4] /Trip Manager]
Off Cmd56 	Off Command to the Circuit Breaker if the state of the assigned signal becomes true.	1..n, Trip Cmds	--	[Control /SG /SG[4] /Trip Manager]
Off Cmd57 	Off Command to the Circuit Breaker if the state of the assigned signal becomes true.	1..n, Trip Cmds	--	[Control /SG /SG[4] /Trip Manager]
Off Cmd58 	Off Command to the Circuit Breaker if the state of the assigned signal becomes true.	1..n, Trip Cmds	--	[Control /SG /SG[4] /Trip Manager]
Off Cmd59 	Off Command to the Circuit Breaker if the state of the assigned signal becomes true.	1..n, Trip Cmds	--	[Control /SG /SG[4] /Trip Manager]
Off Cmd60 	Off Command to the Circuit Breaker if the state of the assigned signal becomes true.	1..n, Trip Cmds	--	[Control /SG /SG[4] /Trip Manager]

Parameter	Description	Setting range	Default	Menu path
Off Cmd61 	Off Command to the Circuit Breaker if the state of the assigned signal becomes true.	1..n, Trip Cmds	--	[Control /SG /SG[4] /Trip Manager]
Off Cmd62 	Off Command to the Circuit Breaker if the state of the assigned signal becomes true.	1..n, Trip Cmds	--	[Control /SG /SG[4] /Trip Manager]
Off Cmd63 	Off Command to the Circuit Breaker if the state of the assigned signal becomes true.	1..n, Trip Cmds	--	[Control /SG /SG[4] /Trip Manager]
Off Cmd64 	Off Command to the Circuit Breaker if the state of the assigned signal becomes true.	1..n, Trip Cmds	--	[Control /SG /SG[4] /Trip Manager]
Off Cmd65 	Off Command to the Circuit Breaker if the state of the assigned signal becomes true.	1..n, Trip Cmds	--	[Control /SG /SG[4] /Trip Manager]
Off Cmd66 	Off Command to the Circuit Breaker if the state of the assigned signal becomes true.	1..n, Trip Cmds	--	[Control /SG /SG[4] /Trip Manager]
Off Cmd67 	Off Command to the Circuit Breaker if the state of the assigned signal becomes true.	1..n, Trip Cmds	--	[Control /SG /SG[4] /Trip Manager]
Off Cmd68 	Off Command to the Circuit Breaker if the state of the assigned signal becomes true.	1..n, Trip Cmds	--	[Control /SG /SG[4] /Trip Manager]
Off Cmd69 	Off Command to the Circuit Breaker if the state of the assigned signal becomes true.	1..n, Trip Cmds	--	[Control /SG /SG[4] /Trip Manager]

Parameter	Description	Setting range	Default	Menu path
Off Cmd70 	Off Command to the Circuit Breaker if the state of the assigned signal becomes true.	1..n, Trip Cmds	.-	[Control /SG /SG[4] /Trip Manager]
Synchronism 	Synchronism	1..n, In-SyncList	.-	[Control /SG /SG[4] /Synchron Switchg]
t-MaxSyncSuperv 	Synchron-Run timer: Max. time allowed for synchronizing process after a close initiate. Only used for GENERATOR2SYSTEM working mode.	0 - 3000.00s	0.2s	[Control /SG /SG[4] /Synchron Switchg]
ON incl Prot ON 	The ON Command includes the ON Command issued by the Protection module.	inactive, active	active	[Control /SG /SG[4] /General settings]
OFF incl TripCmd 	The OFF Command includes the OFF Command issued by the Protection module.	inactive, active	active	[Control /SG /SG[4] /General settings]
t-Move ON 	Time to move to the ON Position	0.01 - 100.00s	0.1s	[Control /SG /SG[4] /General settings]
t-Move OFF 	Time to move to the OFF Position	0.01 - 100.00s	0.1s	[Control /SG /SG[4] /General settings]
t-Dwell 	Dwell time	0 - 100.00s	0s	[Control /SG /SG[4] /General settings]

## Controlled Disconnecter Input States

<i>Name</i>	<i>Description</i>	<i>Assignment via</i>
Aux ON-I	Module Input State: Position indicator/check-back signal of the CB (52a)	[Control /SG /SG[4] /Pos Indicatrs Wirng]
Aux OFF-I	Module input state: Position indicator/check-back signal of the CB (52b)	[Control /SG /SG[4] /Pos Indicatrs Wirng]
Ready-I	Module input state: CB ready	[Control /SG /SG[4] /Pos Indicatrs Wirng]
Sys-in-Sync-I	State of the module input: This signals has to become true within the synchronization time. If not, switching is unsuccessful.	[Control /SG /SG[4] /Synchron Switchg]
Removed-I	State of the module input: The withdrawable circuit breaker is Removed	[Control /SG /SG[4] /Pos Indicatrs Wirng]
Ack TripCmd-I	State of the module input: Acknowledgement Signal (only for automatic acknowledgement) Module input signal	[Control /SG /SG[4] /Trip Manager]
Interl ON1-I	State of the module input: Interlocking of the ON command	[Control /SG /SG[4] /Interlockings]
Interl ON2-I	State of the module input: Interlocking of the ON command	[Control /SG /SG[4] /Interlockings]
Interl ON3-I	State of the module input: Interlocking of the ON command	[Control /SG /SG[4] /Interlockings]

<i>Name</i>	<i>Description</i>	<i>Assignment via</i>
Interl OFF1-I	State of the module input: Interlocking of the OFF command	[Control /SG /SG[4] /Interlockings]
Interl OFF2-I	State of the module input: Interlocking of the OFF command	[Control /SG /SG[4] /Interlockings]
Interl OFF3-I	State of the module input: Interlocking of the OFF command	[Control /SG /SG[4] /Interlockings]
SCmd ON-I	State of the module input: Switching ON Command, e.g. the state of the Logics or the state of the digital input	[Control /SG /SG[4] /Ex ON/OFF Cmd]
SCmd OFF-I	State of the module input: Switching OFF Command, e.g. the state of the Logics or the state of the digital input	[Control /SG /SG[4] /Ex ON/OFF Cmd]

## Signals of a Controlled Disconnecter

<i>Signal</i>	<i>Description</i>
SI SingleContactInd	Signal: The Position of the Switchgear is detected by one auxiliary contact (pole) only. Thus indeterminate and disturbed Positions cannot be detected.
Pos not ON	Signal: Pos not ON
Pos ON	Signal: Circuit Breaker is in ON-Position
Pos OFF	Signal: Circuit Breaker is in OFF-Position
Pos Indeterm	Signal: Circuit Breaker is in Indeterminate Position
Pos Disturb	Signal: Circuit Breaker Disturbed - Undefined Breaker Position. The Position Indicators contradict themselves. After expiring of a supervision timer this signal becomes true.
Pos	Signal: Circuit Breaker Position (0 = Indeterminate, 1 = OFF, 2 = ON, 3 = Disturbed)
Ready	Signal: Circuit breaker is ready for operation.
t-Dwell	Signal: Dwell time
Removed	Signal: The withdrawable circuit breaker is Removed
Interl ON	Signal: One or more IL_On inputs are active.
Interl OFF	Signal: One or more IL_Off inputs are active.
CES succesf	Signal: Command Execution Supervision: Switching command executed successfully.



<i>Signal</i>	<i>Description</i>
CES Disturbed	Signal: Command Execution Supervision: Switching Command unsuccessful. Switchgear in disturbed position.
CES Fail TripCmd	Signal: Command Execution Supervision: Command execution failed because trip command is pending.
CES SwitchDir	Signal: Command Execution Supervision respectively Switching Direction Control: This signal becomes true, if a switch command is issued even though the switchgear is already in the requested position. Example: A switchgear that is already OFF should be switched OFF again (doubly). The same applies to CLOSE commands.
CES ON d OFF	Signal: Command Execution Supervision: On Command during a pending OFF Command.
CES SG not ready	Signal: Command Execution Supervision: Switchgear not ready
CES Fiel Interl	Signal: Command Execution Supervision: Switching Command not executed because of field interlocking.
CES SyncTimeout	Signal: Command Execution Supervision: Switching Command not executed. No Synchronization signal while t-sync was running.
CES SG removed	Signal: Command Execution Supervision: Switching Command unsuccessful, Switchgear removed.
Prot ON	Signal: ON Command issued by the Prot module
TripCmd	Signal: Trip Command
Ack TripCmd	Signal: Acknowledge Trip Command
ON incl Prot ON	Signal: The ON Command includes the ON Command issued by the Protection module.
OFF incl TripCmd	Signal: The OFF Command includes the OFF Command issued by the Protection module.
Position Ind manipul	Signal: Position Indicators faked
SGwear Slow SG	Signal: Alarm, the circuit breaker (load-break switch) becomes slower
Res SGwear SI SG	Signal: Resetting the slow Switchgear Alarm
ON Cmd	Signal: ON Command issued to the switchgear. Depending on the setting the signal may include the ON command of the Prot module.
OFF Cmd	Signal: OFF Command issued to the switchgear. Depending on the setting the signal may include the OFF command of the Prot module.
ON Cmd manual	Signal: ON Cmd manual
OFF Cmd manual	Signal: OFF Cmd manual
Sync ON request	Signal: Synchronous ON request





## Monitored Disconnecter









SG[2] .SG[5] .SG[6]

### Direct Commands of a Monitored Disconnecter

Parameter	Description	Setting range	Default	Menu path
Manipulate Position 	WARNING! Fake Position - Manual Position Manipulation	inactive, Pos OFF, Pos ON	inactive	[Control /SG /SG[2] /General settings]
Res SGwear SI SG 	Resetting the slow Switchgear Alarm	inactive, active	inactive	[Operation /Reset]
Ack TripCmd 	Acknowledge Trip Command	inactive, active	inactive	[Operation /Acknowledge]

### Global Protection Parameters of a Monitored Disconnecter

Parameter	Description	Setting range	Default	Menu path
Aux ON 	The CB is in ON-position if the state of the assigned signal is true (52a).	1..n, DI-LogicList	SG[2]: -.- SG[5]: -.- SG[6]: DI Slot X1.DI 7	[Control /SG /SG[2] /Pos Indicatr Wirng]
Aux OFF 	The CB is in OFF-position if the state of the assigned signal is true (52b).	1..n, DI-LogicList	SG[2]: -.- SG[5]: -.- SG[6]: DI Slot X1.DI 8	[Control /SG /SG[2] /Pos Indicatr Wirng]
Ready 	Circuit breaker is ready for operation if the state of the assigned signal is true. This digital input can be used by some protective elements (if they are available within the device) like Auto Reclosure (AR), e.g. as a trigger signal.	1..n, DI-LogicList	-.-	[Control /SG /SG[2] /Pos Indicatr Wirng]

Parameter	Description	Setting range	Default	Menu path
Removed 	The withdrawable circuit breaker is Removed	1..n, DI-LogicList	-.-	[Control /SG /SG[2] /Pos Indicatrs Wiring]
Interl ON1 	Interlocking of the ON command	1..n, Assignment List	-.-	[Control /SG /SG[2] /Interlockings]
Interl ON2 	Interlocking of the ON command	1..n, Assignment List	-.-	[Control /SG /SG[2] /Interlockings]
Interl ON3 	Interlocking of the ON command	1..n, Assignment List	-.-	[Control /SG /SG[2] /Interlockings]
Interl OFF1 	Interlocking of the OFF command	1..n, Assignment List	-.-	[Control /SG /SG[2] /Interlockings]
Interl OFF2 	Interlocking of the OFF command	1..n, Assignment List	-.-	[Control /SG /SG[2] /Interlockings]
Interl OFF3 	Interlocking of the OFF command	1..n, Assignment List	-.-	[Control /SG /SG[2] /Interlockings]
SCmd ON 	Switching ON Command, e.g. the state of the Logics or the state of the digital input	1..n, DI-LogicList	-.-	[Control /SG /SG[2] /Ex ON/OFF Cmd]
SCmd OFF 	Switching OFF Command, e.g. the state of the Logics or the state of the digital input	1..n, DI-LogicList	-.-	[Control /SG /SG[2] /Ex ON/OFF Cmd]

Parameter	Description	Setting range	Default	Menu path
t-TripCmd 	Minimum hold time of the OFF-command (circuit breaker, load break switch)	0 - 300.00s	0.2s	[Control /SG /SG[2] /Trip Manager]
Latched 	Defines whether the Binary Output Relay will be Latched when it picks up.	inactive, active	inactive	[Control /SG /SG[2] /Trip Manager]
Ack TripCmd 	Ack TripCmd	1..n, Assignment List	-.-	[Control /SG /SG[2] /Trip Manager]
Off Cmd1 	Off Command to the Circuit Breaker if the state of the assigned signal becomes true.	1..n, Trip Cmds	-.-	[Control /SG /SG[2] /Trip Manager]
Off Cmd2 	Off Command to the Circuit Breaker if the state of the assigned signal becomes true.	1..n, Trip Cmds	-.-	[Control /SG /SG[2] /Trip Manager]
Off Cmd3 	Off Command to the Circuit Breaker if the state of the assigned signal becomes true.	1..n, Trip Cmds	-.-	[Control /SG /SG[2] /Trip Manager]
Off Cmd4 	Off Command to the Circuit Breaker if the state of the assigned signal becomes true.	1..n, Trip Cmds	-.-	[Control /SG /SG[2] /Trip Manager]
Off Cmd5 	Off Command to the Circuit Breaker if the state of the assigned signal becomes true.	1..n, Trip Cmds	-.-	[Control /SG /SG[2] /Trip Manager]
Off Cmd6 	Off Command to the Circuit Breaker if the state of the assigned signal becomes true.	1..n, Trip Cmds	-.-	[Control /SG /SG[2] /Trip Manager]

Parameter	Description	Setting range	Default	Menu path
Off Cmd7 	Off Command to the Circuit Breaker if the state of the assigned signal becomes true.	1..n, Trip Cmds	--	[Control /SG /SG[2] /Trip Manager]
Off Cmd8 	Off Command to the Circuit Breaker if the state of the assigned signal becomes true.	1..n, Trip Cmds	--	[Control /SG /SG[2] /Trip Manager]
Off Cmd9 	Off Command to the Circuit Breaker if the state of the assigned signal becomes true.	1..n, Trip Cmds	--	[Control /SG /SG[2] /Trip Manager]
Off Cmd10 	Off Command to the Circuit Breaker if the state of the assigned signal becomes true.	1..n, Trip Cmds	--	[Control /SG /SG[2] /Trip Manager]
Off Cmd11 	Off Command to the Circuit Breaker if the state of the assigned signal becomes true.	1..n, Trip Cmds	--	[Control /SG /SG[2] /Trip Manager]
Off Cmd12 	Off Command to the Circuit Breaker if the state of the assigned signal becomes true.	1..n, Trip Cmds	--	[Control /SG /SG[2] /Trip Manager]
Off Cmd13 	Off Command to the Circuit Breaker if the state of the assigned signal becomes true.	1..n, Trip Cmds	--	[Control /SG /SG[2] /Trip Manager]
Off Cmd14 	Off Command to the Circuit Breaker if the state of the assigned signal becomes true.	1..n, Trip Cmds	--	[Control /SG /SG[2] /Trip Manager]
Off Cmd15 	Off Command to the Circuit Breaker if the state of the assigned signal becomes true.	1..n, Trip Cmds	--	[Control /SG /SG[2] /Trip Manager]

Parameter	Description	Setting range	Default	Menu path
Off Cmd16 	Off Command to the Circuit Breaker if the state of the assigned signal becomes true.	1..n, Trip Cmds	--	[Control /SG /SG[2] /Trip Manager]
Off Cmd17 	Off Command to the Circuit Breaker if the state of the assigned signal becomes true.	1..n, Trip Cmds	--	[Control /SG /SG[2] /Trip Manager]
Off Cmd18 	Off Command to the Circuit Breaker if the state of the assigned signal becomes true.	1..n, Trip Cmds	--	[Control /SG /SG[2] /Trip Manager]
Off Cmd19 	Off Command to the Circuit Breaker if the state of the assigned signal becomes true.	1..n, Trip Cmds	--	[Control /SG /SG[2] /Trip Manager]
Off Cmd20 	Off Command to the Circuit Breaker if the state of the assigned signal becomes true.	1..n, Trip Cmds	--	[Control /SG /SG[2] /Trip Manager]
Off Cmd21 	Off Command to the Circuit Breaker if the state of the assigned signal becomes true.	1..n, Trip Cmds	--	[Control /SG /SG[2] /Trip Manager]
Off Cmd22 	Off Command to the Circuit Breaker if the state of the assigned signal becomes true.	1..n, Trip Cmds	--	[Control /SG /SG[2] /Trip Manager]
Off Cmd23 	Off Command to the Circuit Breaker if the state of the assigned signal becomes true.	1..n, Trip Cmds	--	[Control /SG /SG[2] /Trip Manager]
Off Cmd24 	Off Command to the Circuit Breaker if the state of the assigned signal becomes true.	1..n, Trip Cmds	--	[Control /SG /SG[2] /Trip Manager]

<i>Parameter</i>	<i>Description</i>	<i>Setting range</i>	<i>Default</i>	<i>Menu path</i>
Off Cmd25 	Off Command to the Circuit Breaker if the state of the assigned signal becomes true.	1..n, Trip Cmds	--	[Control /SG /SG[2] /Trip Manager]
Off Cmd26 	Off Command to the Circuit Breaker if the state of the assigned signal becomes true.	1..n, Trip Cmds	--	[Control /SG /SG[2] /Trip Manager]
Off Cmd27 	Off Command to the Circuit Breaker if the state of the assigned signal becomes true.	1..n, Trip Cmds	--	[Control /SG /SG[2] /Trip Manager]
Off Cmd28 	Off Command to the Circuit Breaker if the state of the assigned signal becomes true.	1..n, Trip Cmds	--	[Control /SG /SG[2] /Trip Manager]
Off Cmd29 	Off Command to the Circuit Breaker if the state of the assigned signal becomes true.	1..n, Trip Cmds	--	[Control /SG /SG[2] /Trip Manager]
Off Cmd30 	Off Command to the Circuit Breaker if the state of the assigned signal becomes true.	1..n, Trip Cmds	--	[Control /SG /SG[2] /Trip Manager]
Off Cmd31 	Off Command to the Circuit Breaker if the state of the assigned signal becomes true.	1..n, Trip Cmds	--	[Control /SG /SG[2] /Trip Manager]
Off Cmd32 	Off Command to the Circuit Breaker if the state of the assigned signal becomes true.	1..n, Trip Cmds	--	[Control /SG /SG[2] /Trip Manager]
Off Cmd33 	Off Command to the Circuit Breaker if the state of the assigned signal becomes true.	1..n, Trip Cmds	--	[Control /SG /SG[2] /Trip Manager]



Parameter	Description	Setting range	Default	Menu path
Off Cmd34 	Off Command to the Circuit Breaker if the state of the assigned signal becomes true.	1..n, Trip Cmds	--	[Control /SG /SG[2] /Trip Manager]
Off Cmd35 	Off Command to the Circuit Breaker if the state of the assigned signal becomes true.	1..n, Trip Cmds	--	[Control /SG /SG[2] /Trip Manager]
Off Cmd36 	Off Command to the Circuit Breaker if the state of the assigned signal becomes true.	1..n, Trip Cmds	--	[Control /SG /SG[2] /Trip Manager]
Off Cmd37 	Off Command to the Circuit Breaker if the state of the assigned signal becomes true.	1..n, Trip Cmds	--	[Control /SG /SG[2] /Trip Manager]
Off Cmd38 	Off Command to the Circuit Breaker if the state of the assigned signal becomes true.	1..n, Trip Cmds	--	[Control /SG /SG[2] /Trip Manager]
Off Cmd39 	Off Command to the Circuit Breaker if the state of the assigned signal becomes true.	1..n, Trip Cmds	--	[Control /SG /SG[2] /Trip Manager]
Off Cmd40 	Off Command to the Circuit Breaker if the state of the assigned signal becomes true.	1..n, Trip Cmds	--	[Control /SG /SG[2] /Trip Manager]
Off Cmd41 	Off Command to the Circuit Breaker if the state of the assigned signal becomes true.	1..n, Trip Cmds	--	[Control /SG /SG[2] /Trip Manager]
Off Cmd42 	Off Command to the Circuit Breaker if the state of the assigned signal becomes true.	1..n, Trip Cmds	--	[Control /SG /SG[2] /Trip Manager]

Parameter	Description	Setting range	Default	Menu path
Off Cmd43 	Off Command to the Circuit Breaker if the state of the assigned signal becomes true.	1..n, Trip Cmds	--	[Control /SG /SG[2] /Trip Manager]
Off Cmd44 	Off Command to the Circuit Breaker if the state of the assigned signal becomes true.	1..n, Trip Cmds	--	[Control /SG /SG[2] /Trip Manager]
Off Cmd45 	Off Command to the Circuit Breaker if the state of the assigned signal becomes true.	1..n, Trip Cmds	--	[Control /SG /SG[2] /Trip Manager]
Off Cmd46 	Off Command to the Circuit Breaker if the state of the assigned signal becomes true.	1..n, Trip Cmds	--	[Control /SG /SG[2] /Trip Manager]
Off Cmd47 	Off Command to the Circuit Breaker if the state of the assigned signal becomes true.	1..n, Trip Cmds	--	[Control /SG /SG[2] /Trip Manager]
Off Cmd48 	Off Command to the Circuit Breaker if the state of the assigned signal becomes true.	1..n, Trip Cmds	--	[Control /SG /SG[2] /Trip Manager]
Off Cmd49 	Off Command to the Circuit Breaker if the state of the assigned signal becomes true.	1..n, Trip Cmds	--	[Control /SG /SG[2] /Trip Manager]
Off Cmd50 	Off Command to the Circuit Breaker if the state of the assigned signal becomes true.	1..n, Trip Cmds	--	[Control /SG /SG[2] /Trip Manager]
Off Cmd51 	Off Command to the Circuit Breaker if the state of the assigned signal becomes true.	1..n, Trip Cmds	--	[Control /SG /SG[2] /Trip Manager]



Parameter	Description	Setting range	Default	Menu path
Off Cmd52 	Off Command to the Circuit Breaker if the state of the assigned signal becomes true.	1..n, Trip Cmds	--	[Control /SG /SG[2] /Trip Manager]
Off Cmd53 	Off Command to the Circuit Breaker if the state of the assigned signal becomes true.	1..n, Trip Cmds	--	[Control /SG /SG[2] /Trip Manager]
Off Cmd54 	Off Command to the Circuit Breaker if the state of the assigned signal becomes true.	1..n, Trip Cmds	--	[Control /SG /SG[2] /Trip Manager]
Off Cmd55 	Off Command to the Circuit Breaker if the state of the assigned signal becomes true.	1..n, Trip Cmds	--	[Control /SG /SG[2] /Trip Manager]
Off Cmd56 	Off Command to the Circuit Breaker if the state of the assigned signal becomes true.	1..n, Trip Cmds	--	[Control /SG /SG[2] /Trip Manager]
Off Cmd57 	Off Command to the Circuit Breaker if the state of the assigned signal becomes true.	1..n, Trip Cmds	--	[Control /SG /SG[2] /Trip Manager]
Off Cmd58 	Off Command to the Circuit Breaker if the state of the assigned signal becomes true.	1..n, Trip Cmds	--	[Control /SG /SG[2] /Trip Manager]
Off Cmd59 	Off Command to the Circuit Breaker if the state of the assigned signal becomes true.	1..n, Trip Cmds	--	[Control /SG /SG[2] /Trip Manager]
Off Cmd60 	Off Command to the Circuit Breaker if the state of the assigned signal becomes true.	1..n, Trip Cmds	--	[Control /SG /SG[2] /Trip Manager]

Parameter	Description	Setting range	Default	Menu path
Off Cmd61 	Off Command to the Circuit Breaker if the state of the assigned signal becomes true.	1..n, Trip Cmds	--	[Control /SG /SG[2] /Trip Manager]
Off Cmd62 	Off Command to the Circuit Breaker if the state of the assigned signal becomes true.	1..n, Trip Cmds	--	[Control /SG /SG[2] /Trip Manager]
Off Cmd63 	Off Command to the Circuit Breaker if the state of the assigned signal becomes true.	1..n, Trip Cmds	--	[Control /SG /SG[2] /Trip Manager]
Off Cmd64 	Off Command to the Circuit Breaker if the state of the assigned signal becomes true.	1..n, Trip Cmds	--	[Control /SG /SG[2] /Trip Manager]
Off Cmd65 	Off Command to the Circuit Breaker if the state of the assigned signal becomes true.	1..n, Trip Cmds	--	[Control /SG /SG[2] /Trip Manager]
Off Cmd66 	Off Command to the Circuit Breaker if the state of the assigned signal becomes true.	1..n, Trip Cmds	--	[Control /SG /SG[2] /Trip Manager]
Off Cmd67 	Off Command to the Circuit Breaker if the state of the assigned signal becomes true.	1..n, Trip Cmds	--	[Control /SG /SG[2] /Trip Manager]
Off Cmd68 	Off Command to the Circuit Breaker if the state of the assigned signal becomes true.	1..n, Trip Cmds	--	[Control /SG /SG[2] /Trip Manager]
Off Cmd69 	Off Command to the Circuit Breaker if the state of the assigned signal becomes true.	1..n, Trip Cmds	--	[Control /SG /SG[2] /Trip Manager]

<i>Parameter</i>	<i>Description</i>	<i>Setting range</i>	<i>Default</i>	<i>Menu path</i>
Off Cmd70 	Off Command to the Circuit Breaker if the state of the assigned signal becomes true.	1..n, Trip Cmds	--	[Control /SG /SG[2] /Trip Manager]
Synchronism 	Synchronism	1..n, In-SyncList	--	[Control /SG /SG[2] /Synchron Switchg]
t-MaxSyncSuperv 	Synchron-Run timer: Max. time allowed for synchronizing process after a close initiate. Only used for GENERATOR2SYSTEM working mode.	0 - 3000.00s	0.2s	[Control /SG /SG[2] /Synchron Switchg]
ON incl Prot ON 	The ON Command includes the ON Command issued by the Protection module.	inactive, active	active	[Control /SG /SG[2] /General settings]
OFF incl TripCmd 	The OFF Command includes the OFF Command issued by the Protection module.	inactive, active	active	[Control /SG /SG[2] /General settings]
t-Move ON 	Time to move to the ON Position	0.01 - 100.00s	0.1s	[Control /SG /SG[2] /General settings]
t-Move OFF 	Time to move to the OFF Position	0.01 - 100.00s	0.1s	[Control /SG /SG[2] /General settings]
t-Dwell 	Dwell time	0 - 100.00s	0s	[Control /SG /SG[2] /General settings]

## Monitored Disconnecter Input States

<i>Name</i>	<i>Description</i>	<i>Assignment via</i>
Aux ON-I	Module Input State: Position indicator/check-back signal of the CB (52a)	[Control /SG /SG[2] /Pos Indicatr Wirng]
Aux OFF-I	Module input state: Position indicator/check-back signal of the CB (52b)	[Control /SG /SG[2] /Pos Indicatr Wirng]
Ready-I	Module input state: CB ready	[Control /SG /SG[2] /Pos Indicatr Wirng]
Sys-in-Sync-I	State of the module input: This signals has to become true within the synchronization time. If not, switching is unsuccessful.	[Control /SG /SG[2] /Synchron Switchg]
Removed-I	State of the module input: The withdrawable circuit breaker is Removed	[Control /SG /SG[2] /Pos Indicatr Wirng]
Ack TripCmd-I	State of the module input: Acknowledgement Signal (only for automatic acknowledgement) Module input signal	[Control /SG /SG[2] /Trip Manager]
Interl ON1-I	State of the module input: Interlocking of the ON command	[Control /SG /SG[2] /Interlockings]
Interl ON2-I	State of the module input: Interlocking of the ON command	[Control /SG /SG[2] /Interlockings]
Interl ON3-I	State of the module input: Interlocking of the ON command	[Control /SG /SG[2] /Interlockings]

<i>Name</i>	<i>Description</i>	<i>Assignment via</i>
Interl OFF1-I	State of the module input: Interlocking of the OFF command	[Control /SG /SG[2] /Interlockings]
Interl OFF2-I	State of the module input: Interlocking of the OFF command	[Control /SG /SG[2] /Interlockings]
Interl OFF3-I	State of the module input: Interlocking of the OFF command	[Control /SG /SG[2] /Interlockings]
SCmd ON-I	State of the module input: Switching ON Command, e.g. the state of the Logics or the state of the digital input	[Control /SG /SG[2] /Ex ON/OFF Cmd]
SCmd OFF-I	State of the module input: Switching OFF Command, e.g. the state of the Logics or the state of the digital input	[Control /SG /SG[2] /Ex ON/OFF Cmd]

## Signals of a Monitored Disconnecter

<i>Signal</i>	<i>Description</i>
SI SingleContactInd	Signal: The Position of the Switchgear is detected by one auxiliary contact (pole) only. Thus indeterminate and disturbed Positions cannot be detected.
Pos not ON	Signal: Pos not ON
Pos ON	Signal: Circuit Breaker is in ON-Position
Pos OFF	Signal: Circuit Breaker is in OFF-Position
Pos Indeterm	Signal: Circuit Breaker is in Indeterminate Position
Pos Disturb	Signal: Circuit Breaker Disturbed - Undefined Breaker Position. The Position Indicators contradict themselves. After expiring of a supervision timer this signal becomes true.
Pos	Signal: Circuit Breaker Position (0 = Indeterminate, 1 = OFF, 2 = ON, 3 = Disturbed)
Ready	Signal: Circuit breaker is ready for operation.
t-Dwell	Signal: Dwell time
Removed	Signal: The withdrawable circuit breaker is Removed
Interl ON	Signal: One or more IL_On inputs are active.
Interl OFF	Signal: One or more IL_Off inputs are active.
CES succesf	Signal: Command Execution Supervision: Switching command executed successfully.

<i>Signal</i>	<i>Description</i>
CES Disturbed	Signal: Command Execution Supervision: Switching Command unsuccessful. Switchgear in disturbed position.
CES Fail TripCmd	Signal: Command Execution Supervision: Command execution failed because trip command is pending.
CES SwitchDir	Signal: Command Execution Supervision respectively Switching Direction Control: This signal becomes true, if a switch command is issued even though the switchgear is already in the requested position. Example: A switchgear that is already OFF should be switched OFF again (doubly). The same applies to CLOSE commands.
CES ON d OFF	Signal: Command Execution Supervision: On Command during a pending OFF Command.
CES SG not ready	Signal: Command Execution Supervision: Switchgear not ready
CES Fiel Interl	Signal: Command Execution Supervision: Switching Command not executed because of field interlocking.
CES SyncTimeout	Signal: Command Execution Supervision: Switching Command not executed. No Synchronization signal while t-sync was running.
CES SG removed	Signal: Command Execution Supervision: Switching Command unsuccessful, Switchgear removed.
Prot ON	Signal: ON Command issued by the Prot module
TripCmd	Signal: Trip Command
Ack TripCmd	Signal: Acknowledge Trip Command
ON incl Prot ON	Signal: The ON Command includes the ON Command issued by the Protection module.
OFF incl TripCmd	Signal: The OFF Command includes the OFF Command issued by the Protection module.
Position Ind manipul	Signal: Position Indicators faked
SGwear Slow SG	Signal: Alarm, the circuit breaker (load-break switch) becomes slower
Res SGwear SI SG	Signal: Resetting the slow Switchgear Alarm
ON Cmd	Signal: ON Command issued to the switchgear. Depending on the setting the signal may include the ON command of the Prot module.
OFF Cmd	Signal: OFF Command issued to the switchgear. Depending on the setting the signal may include the OFF command of the Prot module.
ON Cmd manual	Signal: ON Cmd manual
OFF Cmd manual	Signal: OFF Cmd manual
Sync ON request	Signal: Synchronous ON request

## Protective Elements

### Interconnection

Various state-of-the-art protective elements have been developed for the *HighPROTEC*. Due to the increasing role of distributed energy resources interconnection protection becomes more and more important. A new, sophisticated protection function package covers all protective elements for interconnection applications. This package can be found within menu [Interconnection].

These protective elements can be used flexible. They can be adapted easily by parameter settings to various international and local grid codes.

In the following an overview is given on this menu. Please refer for details on these protective elements to the corresponding chapters.

*The Interconnection menu comprises:*

A submenu with mains-decoupling elements. Depending on the grid codes that are to be taken into account various mains decoupling elements are mandatory (or forbidden). Within this menu, you have access to the following mains decoupling elements:

- ROCOF (df/dt) (please refer to chapter frequency protection). This element is consistent with a Frequency Protection element, that is set to „df/dt“ within the Device Planning.
- Vector shift (delta phi) (please refer to chapter frequency protection). This element is consistent with a Frequency Protection element, that is set to „delta phi“ within the Device Planning.
- Pr (please refer to chapter power protection). This element is consistent with a Power Protection element, that is set to „Pr>“ within the Device Planning.
- Qr (please refer to chapter power protection). This element is consistent with a Power Protection element, that is set to „Qr>“ within the Device Planning.
- Intertripping (please refer to chapter intertripping).

A submenu for Low Voltage Ride Through (please refer to the LVRT chapter).

A submenu for Q->&V<-Protection (please refer to the Q-Y&V< chapter).

A submenu for synchronization (please refer to the synchronization chapter).

### **NOTICE**

**The device offers also among other things for low voltage systems a voltage quality supervision based on the ten minutes sliding mean square measurement. (please refer to chapter Voltage Protection).**

## I - Overcurrent Protection [50, 51,51Q, 51V, 67]

Available stages:  
[I\[1\]](#) [I\[2\]](#) [I\[3\]](#) [I\[4\]](#) [I\[5\]](#) [I\[6\]](#)



### WARNING

If you are using inrush blockings the tripping delay of the current protection functions must be at least 30ms or more in order to prevent faulty trippings.



### CAUTION

In order to ensure correct functioning of the directional detection after single-phase short-circuits, the following reference voltage is used: For phase current *I1* it is the line-to-line voltage *U23*, for phase current *I2* the line-to-line voltage *U31* and for phase current *I3* the line-to-line voltage *U12*.

In case the fault happens to be near the measuring location and there is no reference voltage for directional recognition available any more (neither measured or from history (voltage memory)), then the module will - depending on the parameter setting - either trip non-directional or it will be blocked.



### NOTICE

All overcurrent protective elements are identically structured.



### NOTICE

This module offers Adaptive Parameter Sets. Parameters can be modified within parameter sets dynamically by means of Adaptive Parameter Sets. Please refer to chapter Parameter / Adaptive Parameter Sets.

The following table shows the application options of the Overcurrent Protection element

Applications of the I-Protection Module	Setting in	Option
ANSI 50 – Overcurrent protection, non-directional	Device Planning menu	Measuring Mode: Fundamental/TrueRMS/negative phase sequence current (I2)
ANSI 51 – Short circuit protection, non-directional	Device Planning menu	Measuring Mode: Fundamental/TrueRMS/negative phase sequence current (I2)
ANSI 67 – Overcurrent/ Short circuit protection, directional	Device Planning menu	Measuring Mode: Fundamental/TrueRMS/negative phase sequence current (I2)
ANSI 51V – Voltage restraint overcurrent protection	Parameter Set: VRestraint = active	Measuring Mode: Fundamental/TrueRMS/negative phase sequence current (I2)  Measuring Channel: Phase to Phase/Phase to Neutral
ANSI 51Q Negative Phase Sequence Overcurrent Protection	Parameter Set: Measuring Method =I2 (Negative Sequence Current)	



<p>51R Voltage controlled overcurrent protection</p> <p><b>(Please refer to the chapter Parameter/Adaptive Parameter)</b></p>	<p>Adaptive Parameters</p>	<p>Measuring Mode: Fundamental/TrueRMS/negative phase sequence current (I2)</p> <p>Measuring Channel: (in voltage protection module) Phase to Phase/Phase to Neutral</p>
---	----------------------------	--

*Measuring Mode*

For all protection elements it can be determined, whether the measurement is done on basis of the »*Fundamental*« or if »*TrueRMS*« measurement is used.

Alternatively the »*Measuring Mode*« can be set to »*I2*«. In this case the negative phase sequence current will be measured. This is to detect unbalanced faults.

*Voltage restraint overcurrent protection 51V*

When the Parameter »*VRestraint*« is set to active the overcurrent protection element works voltage restraint. That means, the overcurrent pickup threshold will be lowered during voltage drops. This results in a more sensitive overcurrent protection. For the voltage threshold »*VRestraint max*« additionally the »*Measuring Channel*« can be determined.

*Measuring Channel*

With the parameter »*Measuring Channel*« it can be determined, whether the »*Phase to Phase*« voltage or the »*Phase to Neutral*« voltage is measured.

All overcurrent protective elements can be planned as non-directional or optionally as directional elements. This means, all 6 elements can be planned user defined in forward/reverse or non directional.

For each element the following characteristics are available:

- DEFT (UMZ)
- NINV (IEC/AMZ)
- VINV (IEC/AMZ)
- LINV (IEC/AMZ)
- EINV (IEC/AMZ)
- MINV (ANSI/AMZ)
- VINV (ANSI/AMZ)
- EINV (ANSI/AMZ)
- Thermal Flat
- IT
- I2T
- I4T

Explanation:

t = Tripping delay

t-char = Time multiplier/tripping characteristic factor . The setting range depends on the selected tripping curve .

I = Fault current

I> = If the pickup value is exceeded , the module/element starts to time out to trip .

By using the projecting parameters each of the overcurrent protective elements can be defined as »*forward*«, »*reverse*« or »*non-directional*«. The forward or reverse direction is based on the characteristic angle for the phase direction specified by the field parameter »*I MTA*«. No directional information will be taken into account if the current protective element is planned as »*non-directional*«

### DEFT

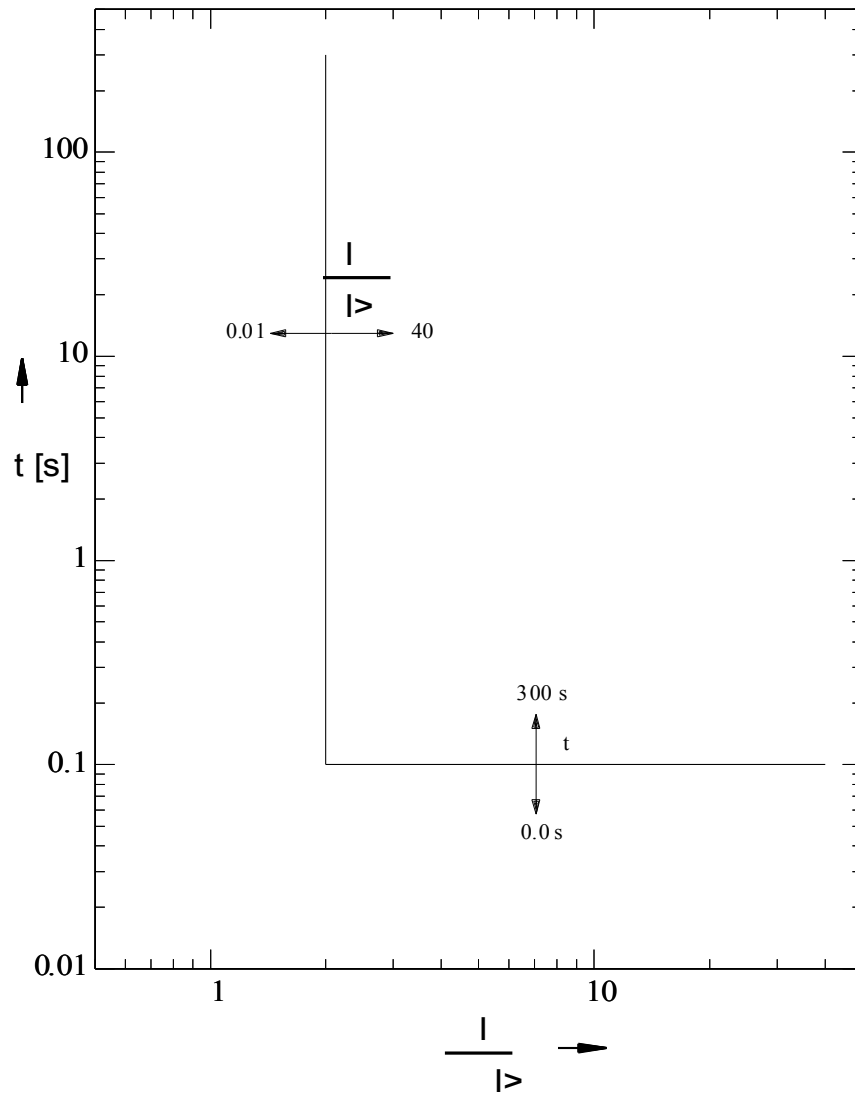

**IEC NINV**



**Notice!**

Various reset modes are available . Resetting via characteristic, delayed and instantaneous .

**Reset**

**Trip**

$$t = \left| \frac{0.14}{\left(\frac{1}{I>} \right)^2 - 1} \right| * t\text{-char [s]}$$

$$t = \frac{0.14}{\left(\frac{1}{I>} \right)^{0.02} - 1} * t\text{-char [s]}$$

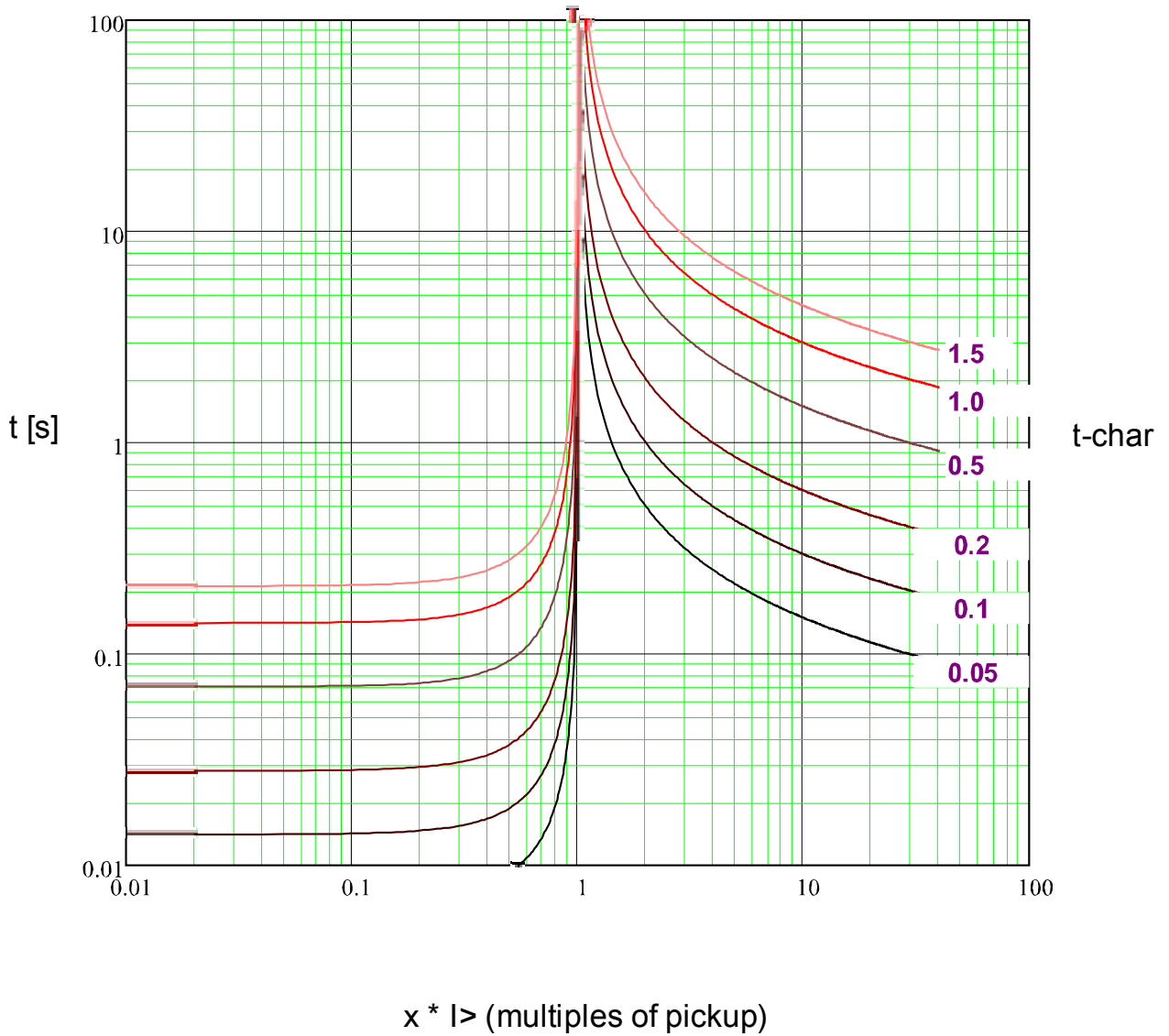

**IEC VINV**



**Notice!**

Various reset modes are available . Resetting via characteristic, delayed and instantaneous .

**Reset**

**Trip**

$$t = \left| \frac{13.5}{\left(\frac{1}{I>} \right)^2 - 1} \right| * t\text{-char [s]}$$

$$t = \frac{13.5}{\left(\frac{1}{I>} \right) - 1} * t\text{-char [s]}$$

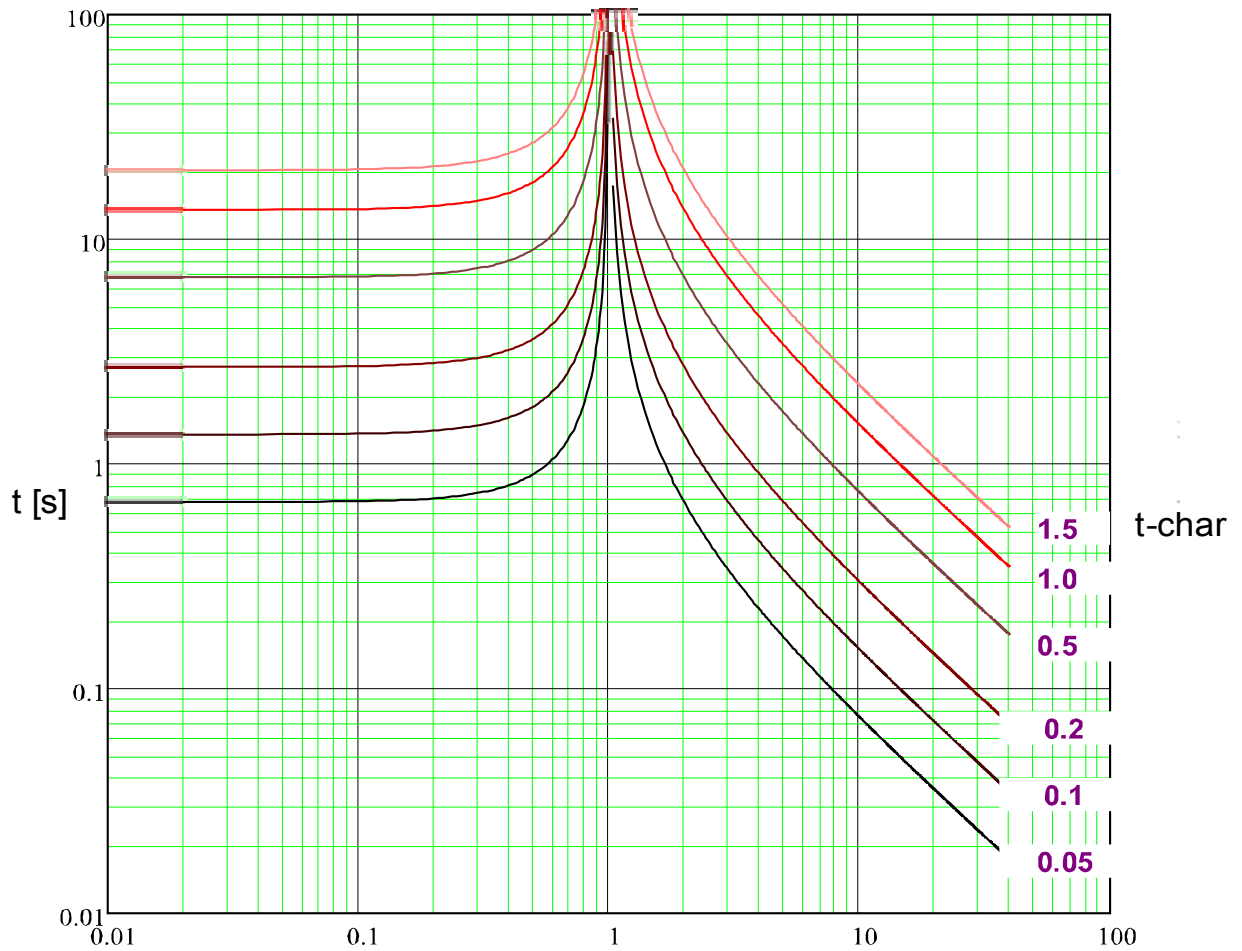

x \* I> (multiples of pickup)

**IEC LINV**



**Notice!**

Various reset modes are available . Resetting via characteristic, delayed and instantaneous .

**Reset**

**Trip**

$$t = \left| \frac{120}{\left(\frac{I}{I_p}\right)^2 - 1} \right| * t\text{-char [s]}$$

$$t = \frac{120}{\left(\frac{I}{I_p}\right) - 1} * t\text{-char [s]}$$

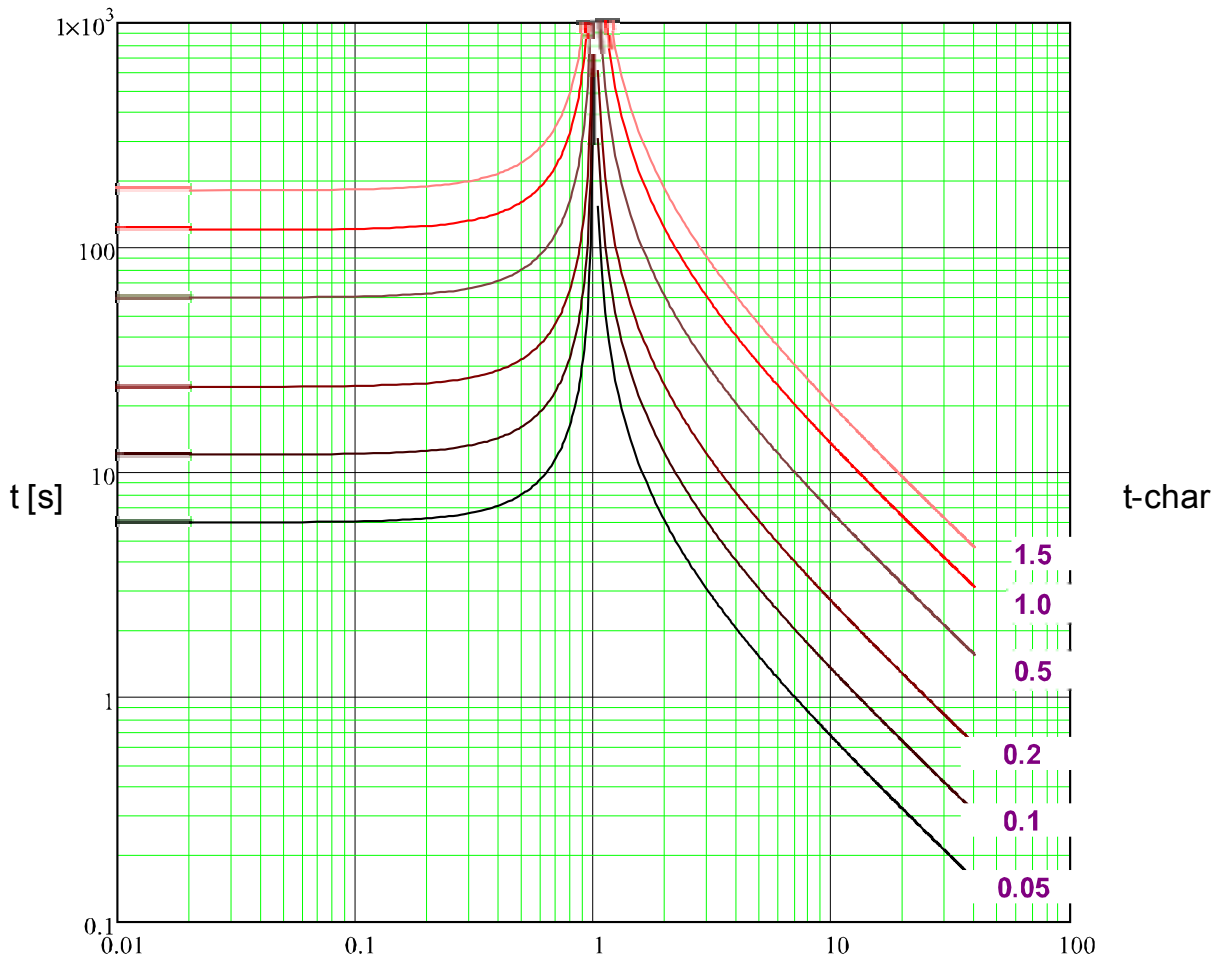

x \* I<sub>p</sub> (multiples of pickup)

**IEC EINV**



**Notice!**

Various reset modes are available . Resetting via characteristic, delayed and instantaneous .

**Reset**

**Trip**

$$t = \left| \frac{80}{\left(\frac{1}{I>} \right)^2 - 1} \right| * t\text{-char [s]}$$

$$t = \frac{80}{\left(\frac{1}{I>} \right)^2 - 1} * t\text{-char [s]}$$

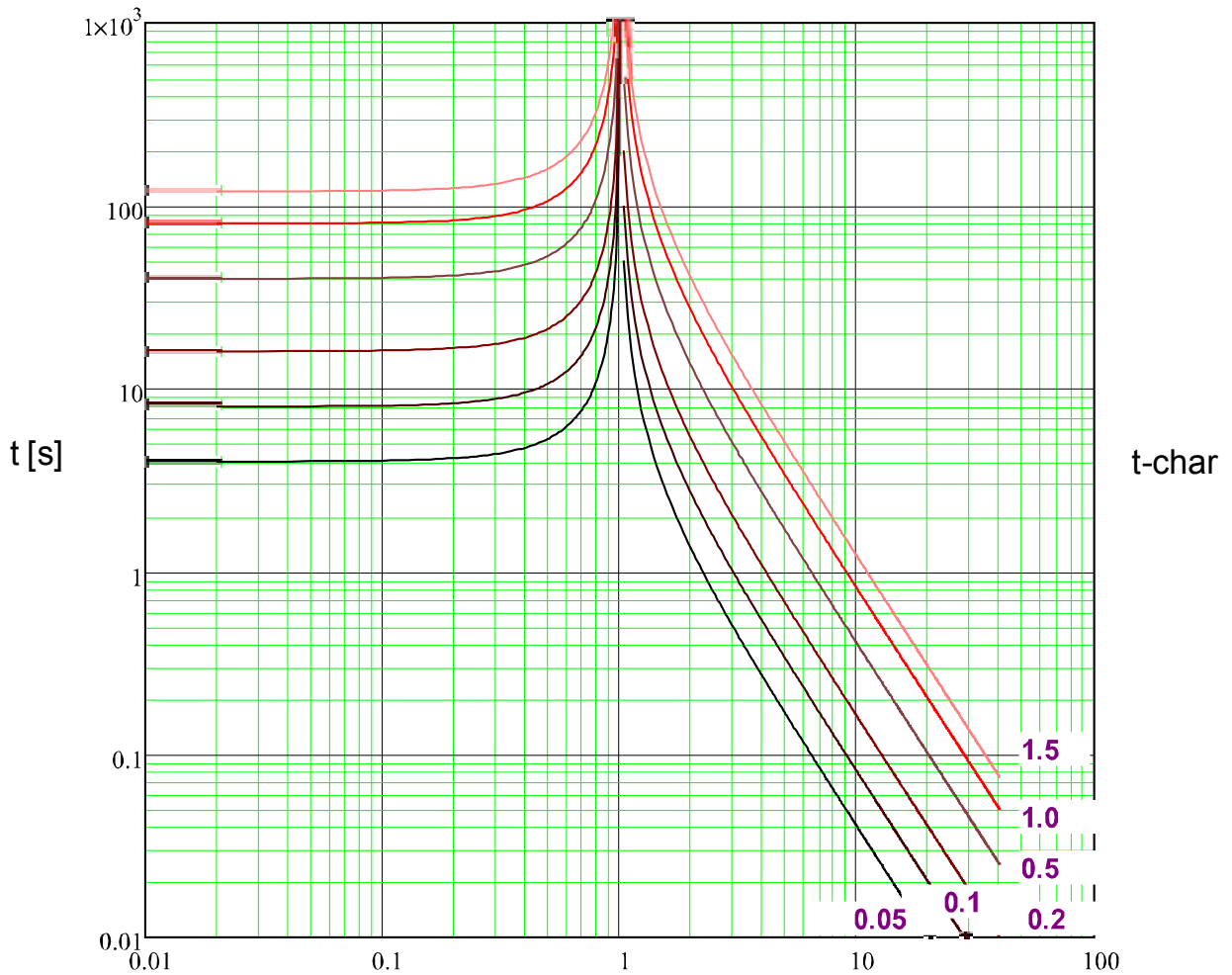

$x * I>$  (multiples of pickup)

**ANSI MINV**



**Notice!**

Various reset modes are available . Resetting via characteristic, delayed and instantaneous .

**Reset**

**Trip**

$$t = \left| \frac{4.85}{\left(\frac{1}{I>} \right)^2 - 1} \right| * t\text{-char [s]}$$

$$t = \left( \frac{0.0515}{\left(\frac{1}{I>} \right)^{0.02} + 0.1140} \right) * t\text{-char [s]}$$

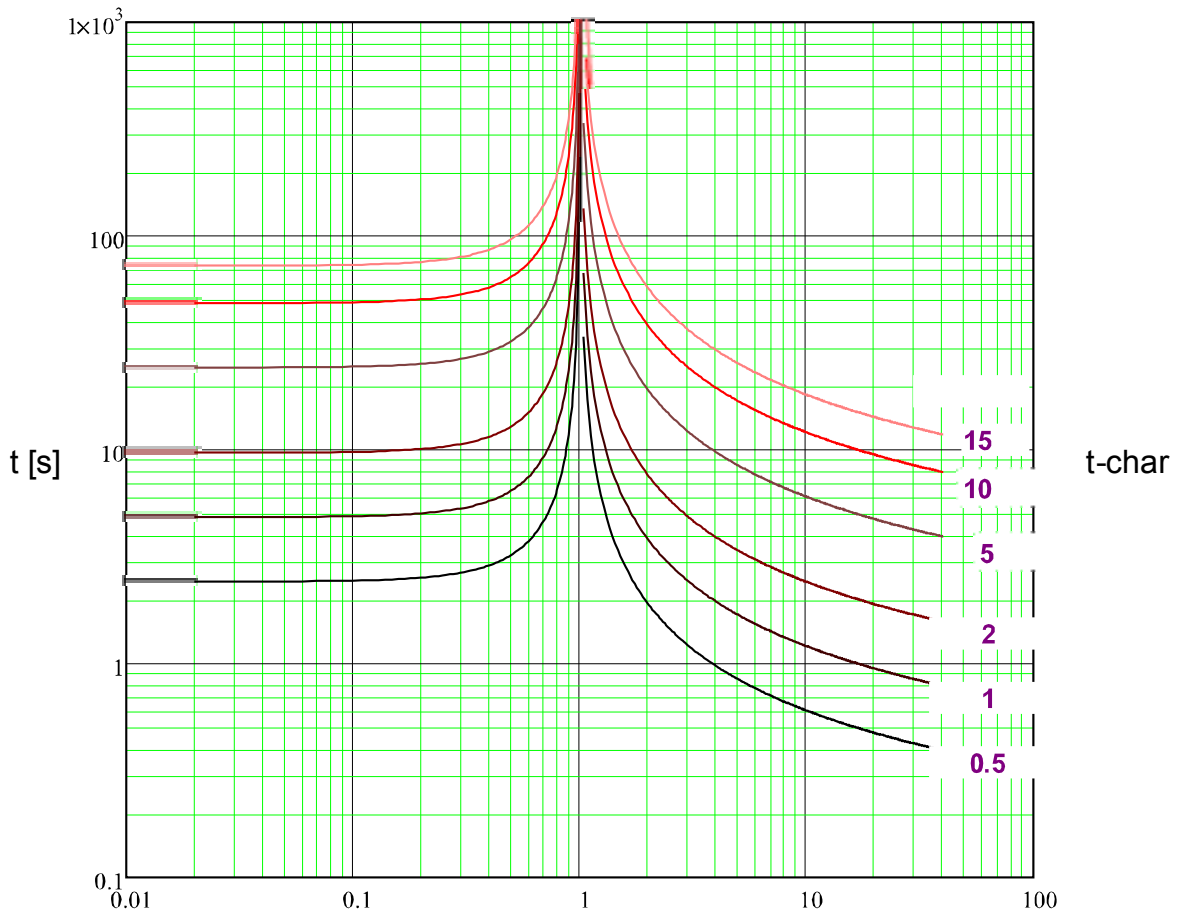

x \* I> (multiples of pickup)



**ANSI VINV**



**Notice!**

Various reset modes are available . Resetting via characteristic, delayed and instantaneous .

**Reset**

$$t = \left| \frac{21.6}{\left(\frac{1}{I>} \right)^2 - 1} \right| * t\text{-char [s]}$$

**Trip**

$$t = \left( \frac{19.61}{\left(\frac{1}{I>} \right)^2} + 0.491 \right) * t\text{-char [s]}$$

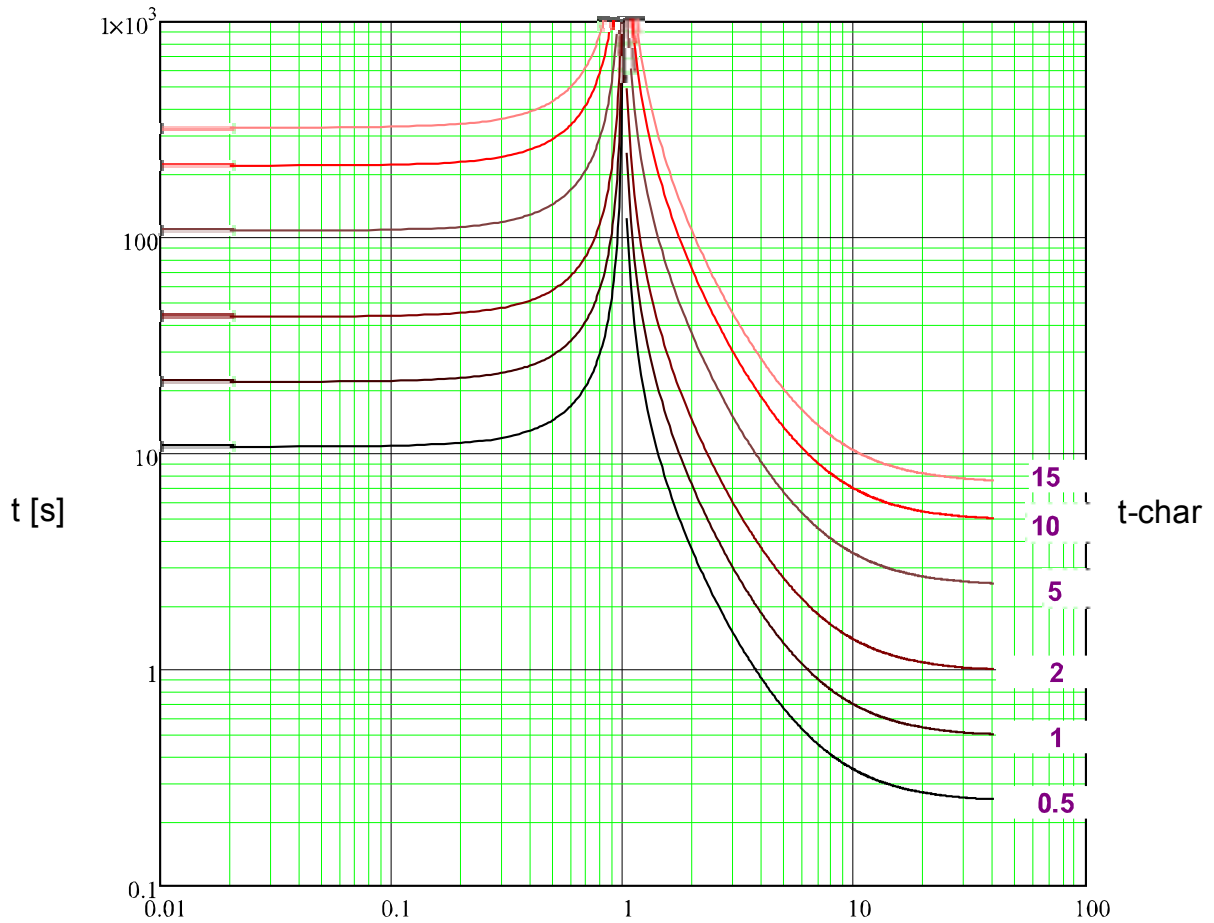

$x * I>$  (multiples of pickup)

**ANSI EINV**



**Notice!**

Various reset modes are available . Resetting via characteristic, delayed and instantaneous .

**Reset**

**Trip**

$$t = \left| \frac{29.1}{\left(\frac{1}{I>} \right)^2 - 1} \right| * t\text{-char [s]}$$

$$t = \left( \frac{28.2}{\left(\frac{1}{I>} \right)^2 - 1} + 0.1217 \right) * t\text{-char [s]}$$

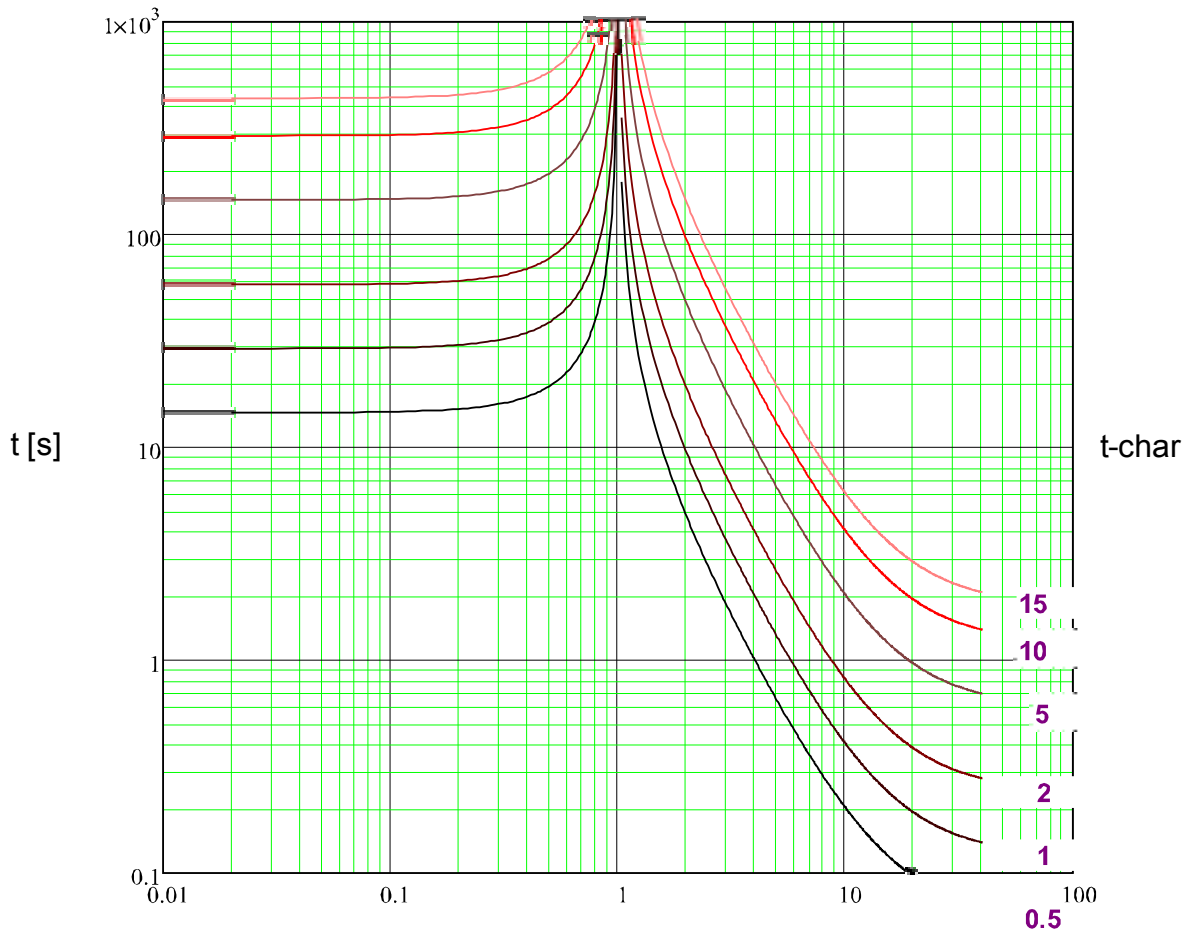

$x * I>$  (multiples of pickup)

### Therm Flat



**Notice!**

Various reset modes are available . Resetting via characteristic , delayed and instantaneous .

**Reset**

$$t = \left| \frac{5 \cdot 3^2}{\left(\frac{I}{I_n}\right)^0} \right| \cdot t_{\text{-char}} \text{ [s]}$$

**Trip**

$$t = \frac{5 \cdot 1^2}{\left(\frac{I}{I_n}\right)^0} \cdot t_{\text{-char}} \text{ [s]}$$

$$t = 45 \cdot t_{\text{-char}} \text{ [s]}$$

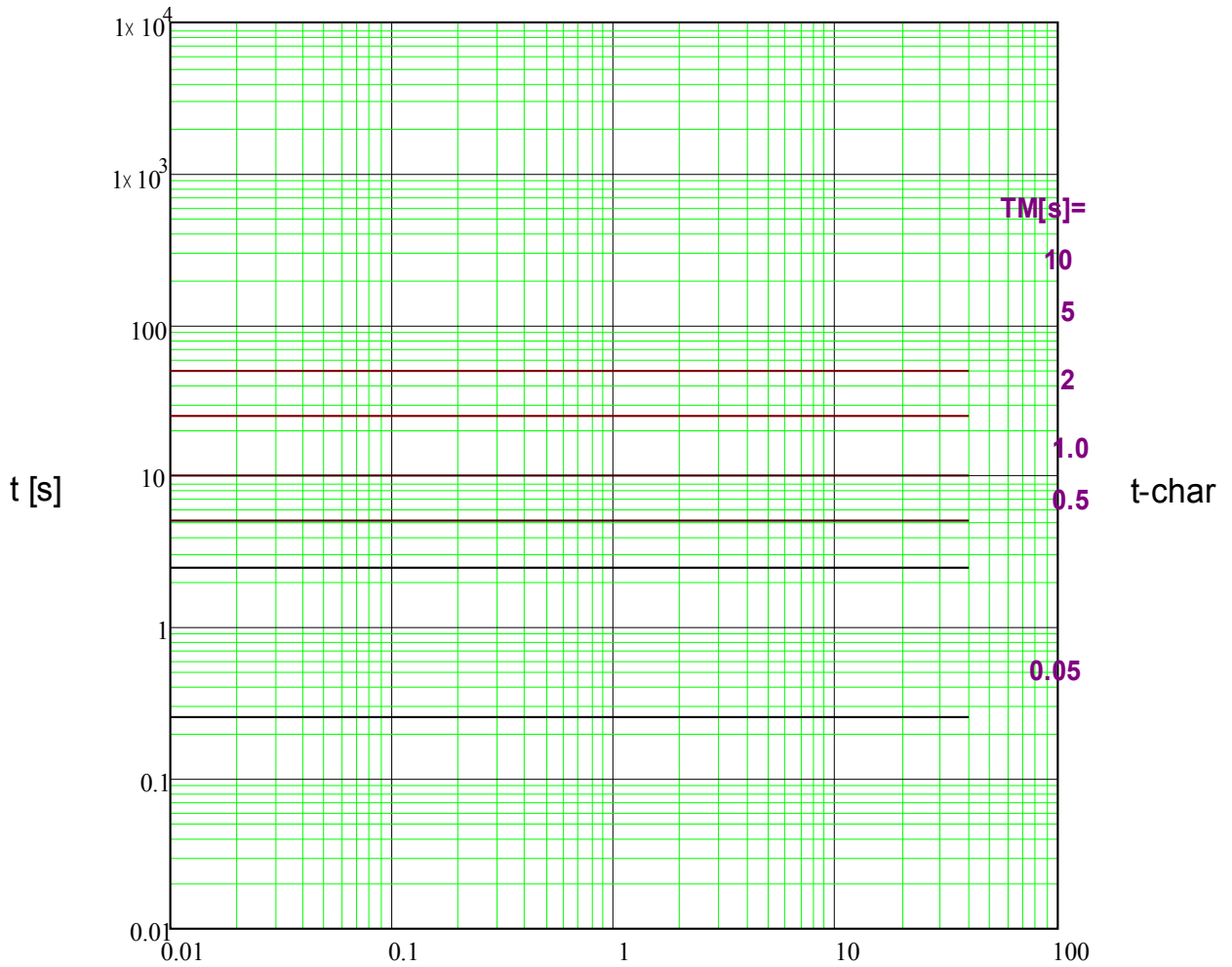

$x \cdot I_n$  (multiples of the nominal current)

IT



**Notice!**

Various reset modes are available . Resetting via characteristic, delayed and instantaneous .

**Reset**

**Trip**

$$t = \left| \frac{5 \cdot 3^2}{\left(\frac{I}{I_n}\right)^0} \right| \cdot t_{\text{-char}} \text{ [s]}$$

$$t = \frac{5 \cdot 3^1}{\left(\frac{I}{I_n}\right)^1} \cdot t_{\text{-char}} \text{ [s]}$$

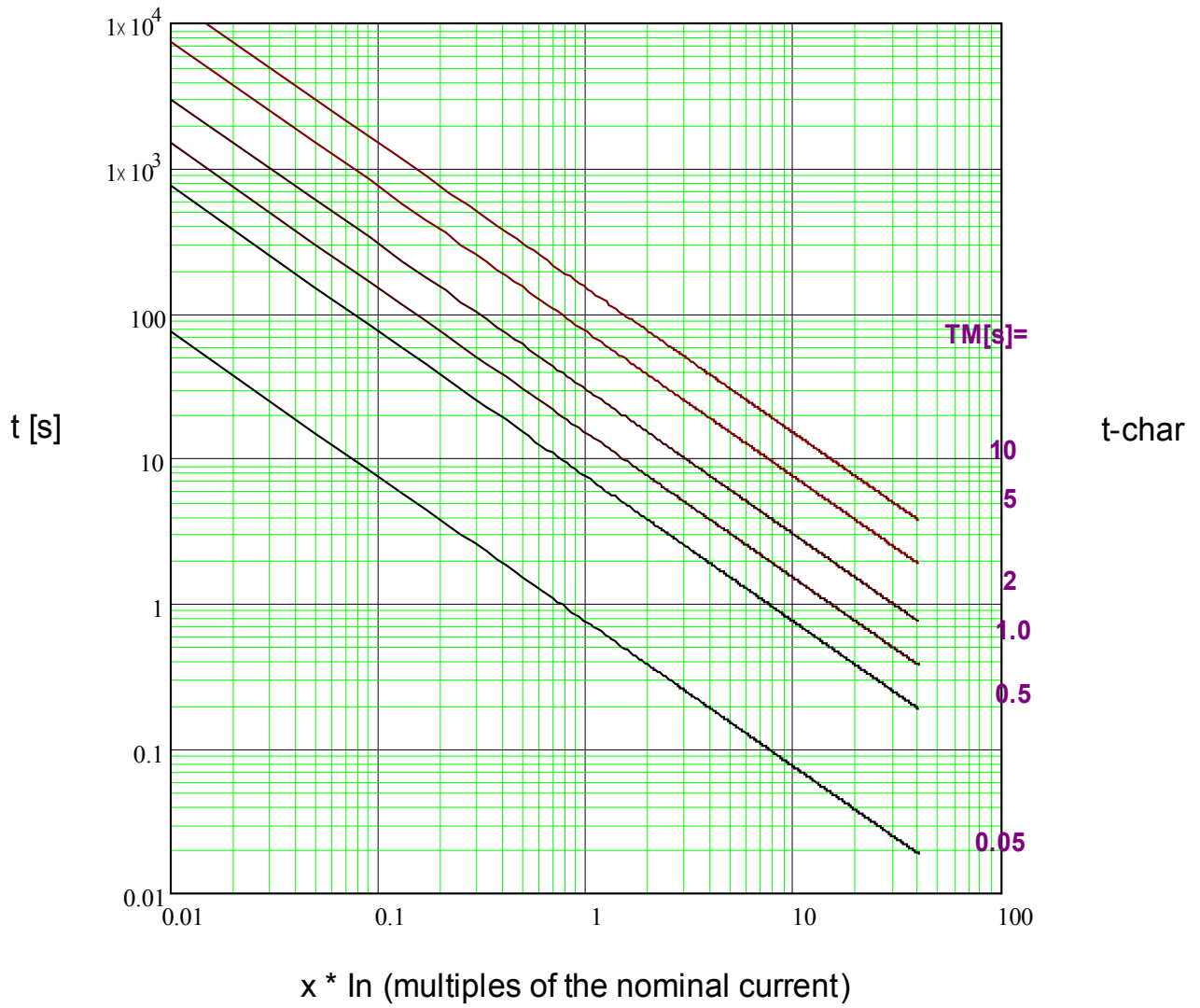

I2T



**Notice!**

Various reset modes are available . Resetting via characteristic, delayed and instantaneous .

**Reset**

**Trip**

$$t = \left| \frac{5 \cdot 3^2}{\left(\frac{I}{I_n}\right)^0} \right| \cdot t\text{-char [s]}$$

$$t = \frac{5 \cdot 3^2}{\left(\frac{I}{I_n}\right)^2} \cdot t\text{-char [s]}$$

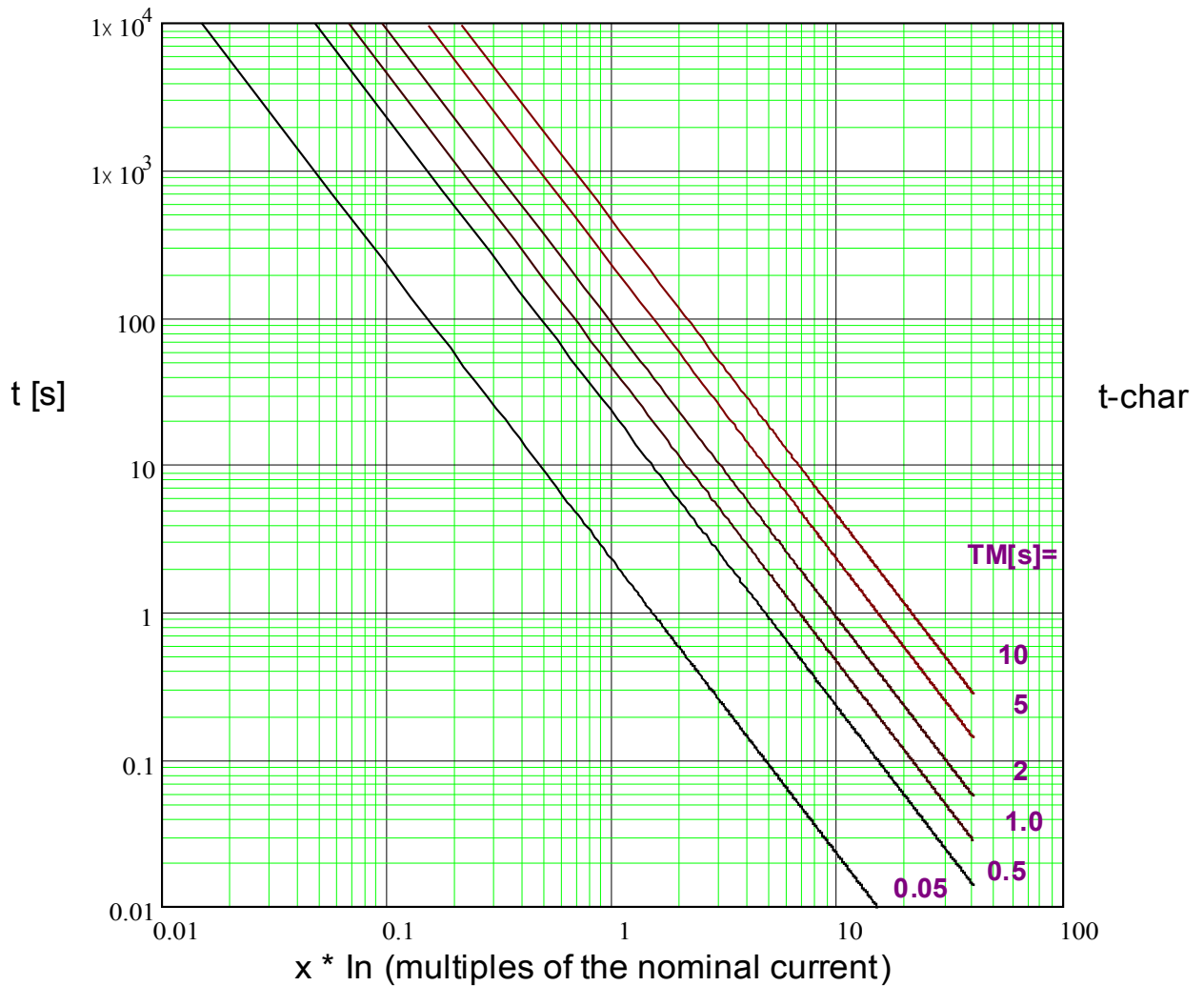

I4T



**Notice!**

Various reset modes are available . Resetting via characteristic, delayed and instantaneous .

**Reset**

**Trip**

$$t = \left| \frac{5 \cdot 3^2}{\left(\frac{I}{I_n}\right)^0} \right| \cdot t_{\text{-char}} \text{ [s]}$$

$$t = \frac{5 \cdot 3^4}{\left(\frac{I}{I_n}\right)^4} \cdot t_{\text{-char}} \text{ [s]}$$

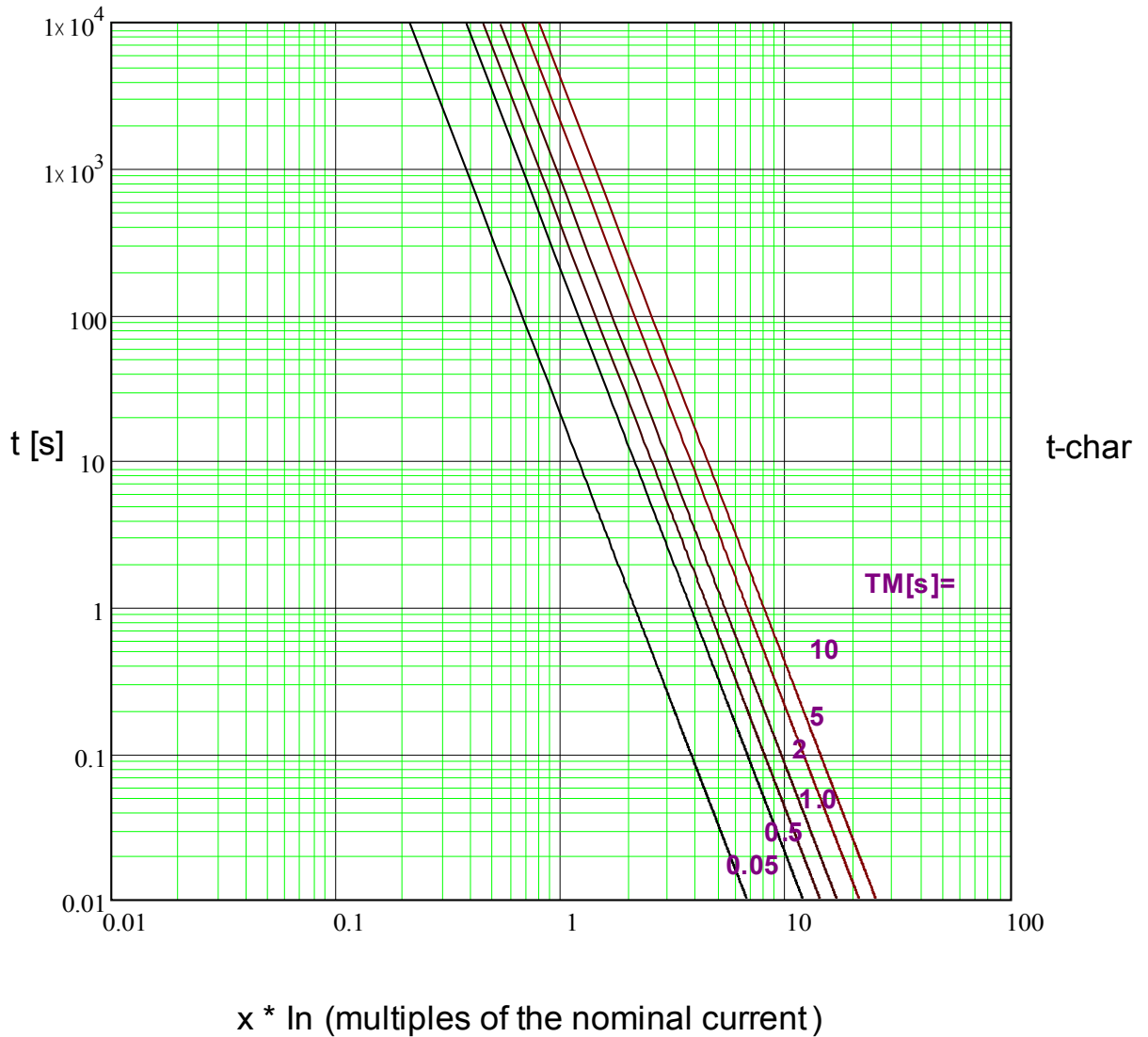

Prot - phase failure direction detection

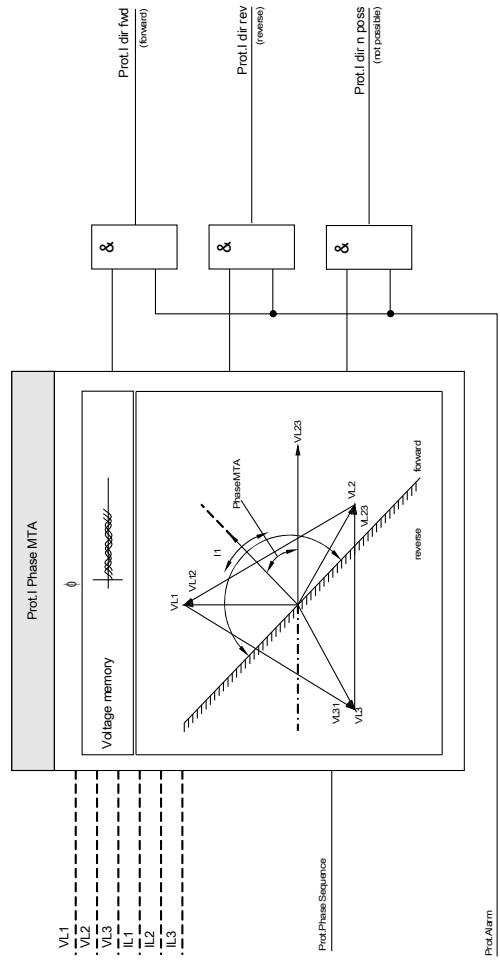

**direction decision phase overcurrent**

name = [1]...[n]

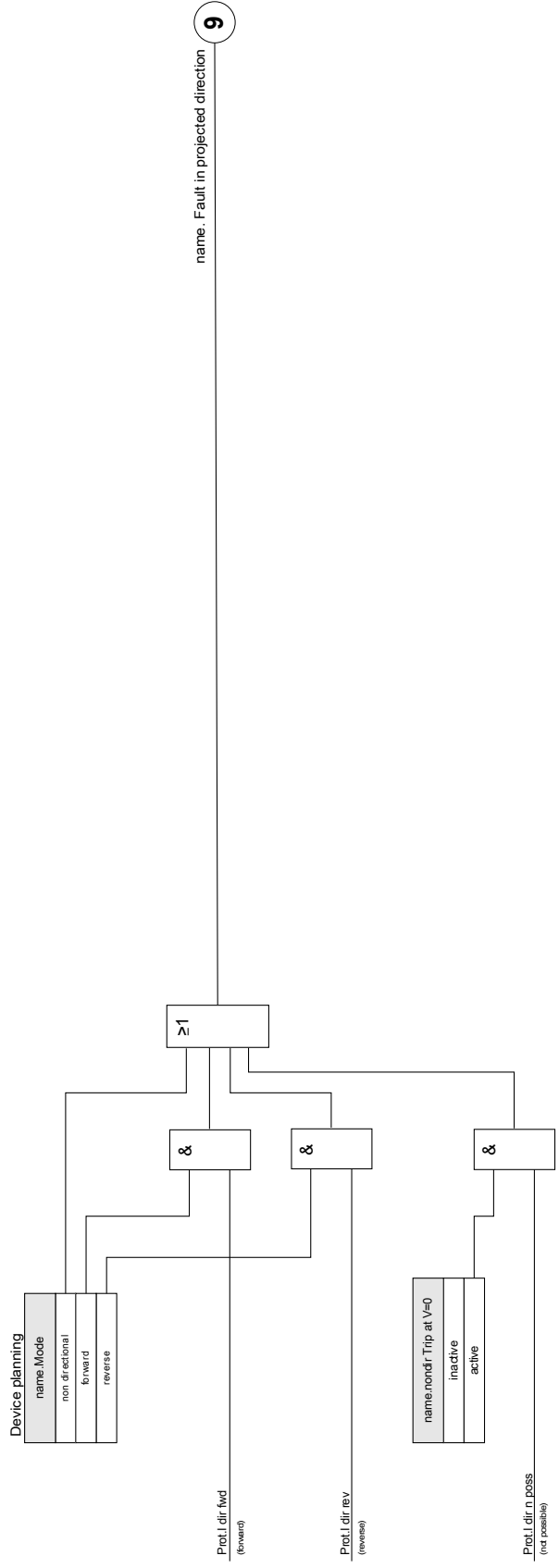



I[1]...[n]

name = I[1]...[n]

4 Please Refer To Diagram Blockings\*\*  
(Stage is not deactivated and no active blocking signals)

5 Please Refer To Diagram IH2\*  
IH2.Blo L1

6 Please Refer To Diagram IH2\*  
IH2.Blo L2

7 Please Refer To Diagram IH2\*  
IH2.Blo L3

3 Please Refer To Diagram Trip blockings  
(Tripping command deactivated or blocked...)



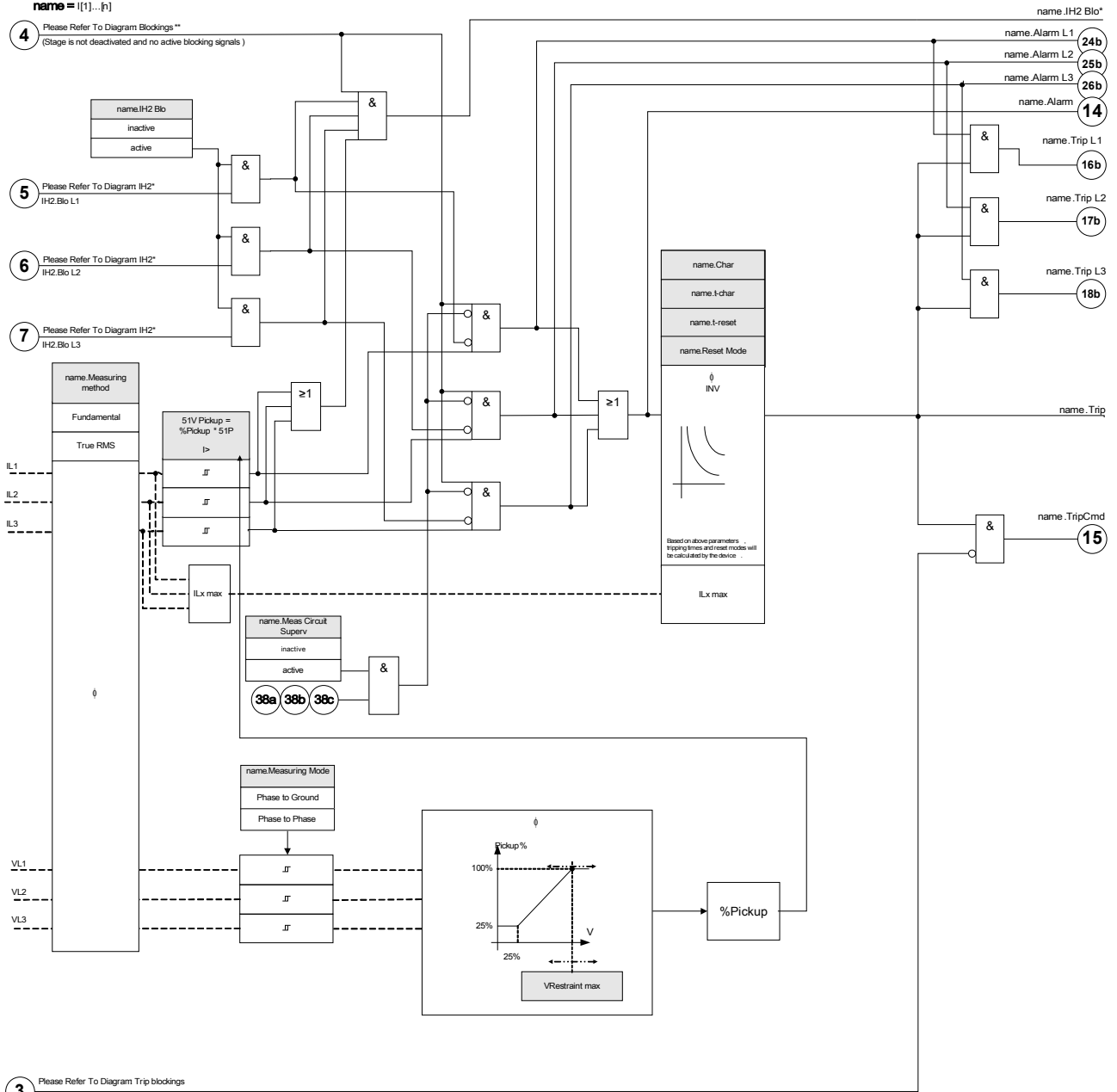

\*\*Applies only to devices that offer Inrush Protection



## Device Planning Parameters of the I Module



Parameter	Description	Options	Default	Menu path
Mode 	Mode	do not use, non directional, forward, reverse	I[1]: non directional I[2]: do not use I[3]: do not use I[4]: do not use I[5]: do not use I[6]: do not use	[Device planning]

## Global Protection Parameters of the I Module







Parameter	Description	Setting range	Default	Menu path
ExBlo1 	External blocking of the module, if blocking is activated (allowed) within a parameter set and if the state of the assigned signal is true.	1..n, Assignment List	--	[Protection Para /Global Prot Para /I-Prot /I[1]]
ExBlo2 	External blocking of the module, if blocking is activated (allowed) within a parameter set and if the state of the assigned signal is true.	1..n, Assignment List	--	[Protection Para /Global Prot Para /I-Prot /I[1]]
ExBlo TripCmd 	External blocking of the Trip Command of the module/the stage, if blocking is activated (allowed) within a parameter set and if the state of the assigned signal is true.	1..n, Assignment List	--	[Protection Para /Global Prot Para /I-Prot /I[1]]
Ex rev Interl 	External blocking of the module by external reverse interlocking, if blocking is activated (allowed) within a parameter set and if the state of the assigned signal is true.	1..n, Assignment List	--	[Protection Para /Global Prot Para /I-Prot /I[1]]
AdaptSet 1 	Assignment Adaptive Parameter 1	AdaptSet	--	[Protection Para /Global Prot Para /I-Prot /I[1]]
AdaptSet 2 	Assignment Adaptive Parameter 2	AdaptSet	--	[Protection Para /Global Prot Para /I-Prot /I[1]]

## Protective Elements

---

<i>Parameter</i>	<i>Description</i>	<i>Setting range</i>	<i>Default</i>	<i>Menu path</i>
AdaptSet 3 	Assignment Adaptive Parameter 3	AdaptSet	-.-	[Protection Para /Global Prot Para /I-Prot /[1]]
AdaptSet 4 	Assignment Adaptive Parameter 4	AdaptSet	-.-	[Protection Para /Global Prot Para /I-Prot /[1]]

### Setting Group Parameters of the I Module

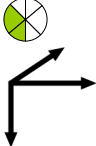
Parameter	Description	Setting range	Default	Menu path
 Function	Permanent activation or deactivation of module/stage.	inactive, active	I[1]: active I[2]: inactive I[3]: inactive I[4]: inactive I[5]: inactive I[6]: inactive	[Protection Para /<1..4> /I-Prot /I[1]]
 ExBlo Fc	Activate (allow) or inactivate (disallow) blocking of the module/stage. This parameter is only effective if a signal is assigned to the corresponding global protection parameter. If the signal becomes true, those modules/stages are blocked that are parameterized "ExBlo Fc=active".	inactive, active	inactive	[Protection Para /<1..4> /I-Prot /I[1]]
 Ex rev Interl Fc	Activate (allow) or inactivate (disallow) blocking of the module/stage. This parameter is only effective if a signal is assigned to the corresponding global protection parameter. If the signal becomes true, those modules/stages are blocked that are parameterized "Ex rev Interl Fc = active".	inactive, active	inactive	[Protection Para /<1..4> /I-Prot /I[1]]
 Blo TripCmd	Permanent blocking of the Trip Command of the module/stage.	inactive, active	inactive	[Protection Para /<1..4> /I-Prot /I[1]]
 ExBlo TripCmd Fc	Activate (allow) or inactivate (disallow) blocking of the module/stage. This parameter is only effective if a signal is assigned to the corresponding global protection parameter. If the signal becomes true, those modules/stages are blocked that are parameterized "ExBlo TripCmd Fc=active".	inactive, active	inactive	[Protection Para /<1..4> /I-Prot /I[1]]
 Measuring method	Measuring method: fundamental or rms	Fundamental, True RMS, I2	Fundamental	[Protection Para /<1..4> /I-Prot /I[1]]
 I>	If the pickup value is exceeded, the module/element starts to time out to trip.  Only available if: Characteristic = DEFT Or Characteristic = INV Minimum of the setting range If: VRestrict = active Minimum of the setting range If: VRestrict = inactive	0.02 - 40.00In	1.00In	[Protection Para /<1..4> /I-Prot /I[1]]

Protective Elements

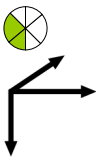
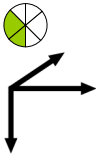
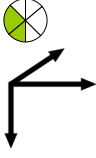
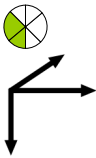
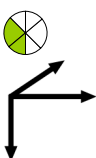
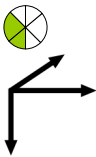
Parameter	Description	Setting range	Default	Menu path
Char 	Characteristic	DEFT, IEC NINV, IEC VINV, IEC EINV, IEC LINV, ANSI MINV, ANSI VINV, ANSI EINV, Therm Flat, IT, I2T, I4T	DEFT	[Protection Para /<1..4> /I-Prot /[1]]
t 	Tripping delay  Only available if: Characteristic = DEFT	0.00 - 300.00s	1.00s	[Protection Para /<1..4> /I-Prot /[1]]
t-char 	Time multiplier/tripping characteristic factor. The setting range depends on the selected tripping curve.  Only available if: Characteristic = INV Or Characteristic = Therm Flat Or Characteristic = IT Or Characteristic = I2T Or Characteristic = I4T	0.02 - 20.00	1	[Protection Para /<1..4> /I-Prot /[1]]
Reset Mode 	Reset Mode  Only available if: Characteristic = INV Or Characteristic = Therm Flat Or Characteristic = IT Or Characteristic = I2T Or Characteristic = I4T	instantaneous, t-delay, calculated	instantaneous	[Protection Para /<1..4> /I-Prot /[1]]
t-reset 	Reset time for intermittent phase failures (INV characteristics only)  Available if: Reset Mode = t-delay	0.00 - 60.00s	0s	[Protection Para /<1..4> /I-Prot /[1]]
IH2 Blo 	Blocking the trip command, if an inrush is detected.	inactive, active	inactive	[Protection Para /<1..4> /I-Prot /[1]]

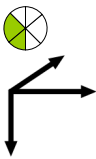
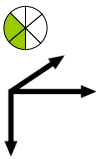
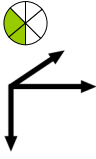
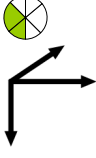
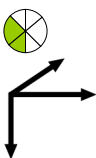
Parameter	Description	Setting range	Default	Menu path
nondir Trip at V=0 	Only relevant for current protection modules/stages with directional feature! The device will trip non directional if this parameter is set to active and no direction could be determined because no reference voltage (V=0) could be measured any more (e.g. if there is a three-phase short circuit close to the device). If this parameter is set to inactive, the protection stage will be blocked in case of V=0.  Only available if: Device planning: I.Mode = directional	inactive, active	inactive	[Protection Para /<1..4> /I-Prot /[1]]
VRestraint 	Voltage Restraint Protection	inactive, active	inactive	[Protection Para /<1..4> /I-Prot /[1]]
Measuring Mode 	Measuring Mode  Only available if: VRestraint = active	Phase to Neutral, Phase to Phase	Phase to Neutral	[Protection Para /<1..4> /I-Prot /[1]]
VRestraint max 	Maximum voltage restraint level. Definition of Vn: Vn is dependent on the System Parameter setting of "VT con". When the System Parameters "VT con" is set to "phase-to-phase" , "Vn = VT sec ". When the System Parameters "VT con" is set to "phase-to-ground", "Vn = VT sec/SQRT(3)".  Only available if: VRestraint = active	0.04 - 1.50Vn	1.00Vn	[Protection Para /<1..4> /I-Prot /[1]]
Meas Circuit Superv 	Measuring Circuit Supervision  Only available if: VRestraint = active	inactive, active	inactive	[Protection Para /<1..4> /I-Prot /[1]]

## I Module Input States

<i>Name</i>	<i>Description</i>	<i>Assignment via</i>
ExBlo1-I	Module input state: External blocking1	[Protection Para /Global Prot Para /I-Prot /[1]]
ExBlo2-I	Module input state: External blocking2	[Protection Para /Global Prot Para /I-Prot /[1]]
ExBlo TripCmd-I	Module input state: External Blocking of the Trip Command	[Protection Para /Global Prot Para /I-Prot /[1]]
Ex rev Inter-I	Module input state: External reverse interlocking	[Protection Para /Global Prot Para /I-Prot /[1]]
AdaptSet1-I	Module input state: Adaptive Parameter1	[Protection Para /Global Prot Para /I-Prot /[1]]
AdaptSet2-I	Module input state: Adaptive Parameter2	[Protection Para /Global Prot Para /I-Prot /[1]]
AdaptSet3-I	Module input state: Adaptive Parameter3	[Protection Para /Global Prot Para /I-Prot /[1]]
AdaptSet4-I	Module input state: Adaptive Parameter4	[Protection Para /Global Prot Para /I-Prot /[1]]

## I Module Signals (Output States)

<i>Signal</i>	<i>Description</i>
active	Signal: active
ExBlo	Signal: External Blocking
Ex rev Interl	Signal: External reverse Interlocking
Blo TripCmd	Signal: Trip Command blocked
ExBlo TripCmd	Signal: External Blocking of the Trip Command
IH2 Blo	Signal: Blocking the trip command by an inrush
Alarm L1	Signal: Alarm L1
Alarm L2	Signal: Alarm L2
Alarm L3	Signal: Alarm L3
Alarm	Signal: Alarm
Trip L1	Signal: General Trip Phase L1
Trip L2	Signal: General Trip Phase L2
Trip L3	Signal: General Trip Phase L3
Trip	Signal: Trip
TripCmd	Signal: Trip Command
Active AdaptSet	Active Adaptive Parameter
DefaultSet	Signal: Default Parameter Set
AdaptSet 1	Signal: Adaptive Parameter 1
AdaptSet 2	Signal: Adaptive Parameter 2
AdaptSet 3	Signal: Adaptive Parameter 3
AdaptSet 4	Signal: Adaptive Parameter 4



## Commissioning: Overcurrent Protection, non-directional [50, 51]

### *Object to be tested*

- Signals to be measured for each current protection element, the threshold values, total tripping time (recommended), or alternatively tripping delays and the fallback ratios; each time 3 x single-phase and 1 x three-phase.

### **NOTICE**

Especially in Holmgreen connections, wiring errors can easily happen, and these are then detected safely. Measuring the total tripping time can ensure that the secondary wiring is o.k. (from the terminal on, up to the trip coil of the CB).

### **NOTICE**

It is recommended to measure the total tripping time instead of the tripping delay. The tripping delay should be specified by the customer. The total tripping time is measured at the position signalling contact of the CB (not at the relay output!).

**Total tripping time = tripping delay (please refer to the tolerances of the protection stages) + CB operating time (about 50 ms)**

**Please take the CB operating times from the technical data specified in the relevant documentation provided by the CB manufacturer.**

### *Necessary means*

- Current source
- May be: ampere meters
- Timer

### *Procedure*

#### *Testing the threshold values (3 x single-phase and 1 x three-phase)*

Each time feed a current which is about 3-5% above the threshold value for activation/tripping. Then check the threshold values.

#### *Testing the total tripping delay (recommendation)*

Measure the total tripping times at the auxiliary contacts of the CB (CB tripping).

#### *Testing the tripping delay (measuring at the relay output)*

Measure the tripping times at the relay output.

#### *Testing the fallback ratio*

Reduce the current to 97% below the trip value and check the fallback ratio.

### *Successful test result*

The measured total tripping delays or individual tripping delays, threshold values and fallback ratios correspond with those values, specified in the adjustment list. Permissible deviations/tolerances can be found under Technical Data.

## Commissioning: Overcurrent Protection, directional [67]

### *Object to be tested*

For each directional overcurrent element is to be measured: the total tripping time (recommendation) or alternatively tripping delays and the fallback ratios; each time 3 x single-phase and 1 x three-phase.

### **NOTICE**

Especially in Holmgreen connections, wiring errors can happen easily and these are then detected safely. By measuring the total tripping time, it can be ensured that the secondary wiring is o.k. (from the terminal on, up to the trip coil of the CB ).

### **NOTICE**

It is recommended to measure the total tripping time instead of the tripping time. The tripping delay should be specified by the customer. The total tripping time is measured at the position signaling contacts of the CBs (not at the relay output!).

**Total tripping time: = tripping delay (please refer to the tolerances of the protection stages) + CB operating time (about 50 ms)**

**Please take the CB switching times from the technical data, specified in the relevant documentation, provided by the CB manufacturer.**

### *Necessary means*

- Synchronizable current and voltage sources
- May be: ampere meters
- Timer

### *Procedure*

Synchronize the 3-phase current and voltage sources with each other. Then simulate the tripping directions to be tested by the angle between current and voltage.

#### *Testing the threshold values (3 x single-phase and 1 x three-phase)*

Each time feed a current which is about 3-5% above the threshold value for activation/tripping. Check then the threshold values.

#### *Testing the total tripping delay (recommendation)*

Measure the total tripping times at the auxiliary contacts of the CB (CB tripping).

#### *Testing the trip delay (measured at the relay output)*

Measure the tripping times at the relay output.

#### *Testing the fallback ratio*

Reduce the current to 97% below the trip value and check the fallback ratio.

#### *Successful test result*

The measured total tripping delays or individual tripping delays, threshold values and fallback ratios correspond with those values, specified in the adjustment list. Permissible deviations/tolerances can be found under Technical Data.

## 51V - Voltage Restraint Overcurrent

For activating this function, the parameter »*VRestraint*« has to be set to *active* in the parameter set of the corresponding overcurrent element I[x].

The *51V* protection function restrains operation which reduces pickup levels. This allows the User to lower the pickup value of the *51V* protection function with the corresponding phase input voltage (phase-to-phase or phase-to-ground, depending on the setting of »*Measuring Channel*« within the current protection module). When the minimum fault phase current is close to the load current, it may make the phase time overcurrent protection coordination difficult. In this case, an undervoltage function may be used to alleviate this situation. When the voltage is low, the phase time overcurrent pickup threshold may be set low accordingly, so that the phase time overcurrent protection may achieve adequate sensitivity and better coordination. The device uses a simple linear model to determine the effective pickup by characterizing the relationship between the voltage and the phase time overcurrent pickup threshold.

Once the voltage restraint protection function is activated, the effective phase time overcurrent pickup threshold will be the calculated Pickup% times the phase time overcurrent pickup setting. The effective pickup threshold must be within the setting range allowed and, if it is less, the minimum pickup value will be used.

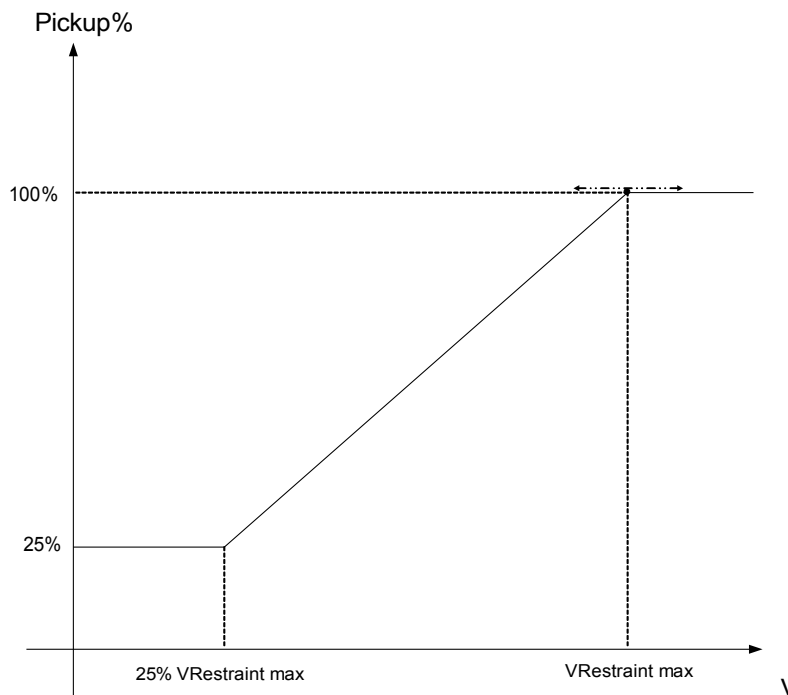

That means:

$$V_{min} = 0.25 \cdot V_{max};$$

- Pickup%<sub>min</sub> = 25%;

- Pickup% = 25%, if  $V \leq V_{min}$ ;

- $\text{Pickup\%} = \frac{1}{V_{max}} \cdot (V - V_{min}) + 25\%$ , if  $V_{min} < V < V_{max}$ ;

- Pickup% = 100%, if  $V \geq V_{max}$ ;

The tripping curves (characteristic) will not be influenced by the voltage restraint function.

If the voltage transformer supervision is activated, the voltage restraint overcurrent protection element is blocked in case of m.c.b. trip to avoid false trippings.

**NOTICE**

Definition of  $V_n$ :

$V_n$  is dependent on the »*Measuring Channel*« setting in the current protection modules.

In case that this parameter is set to "Phase to Phase":

$$V_n = \text{Main VT sec}$$

In case that this parameter is set to "Phase to Neutral":

$$V_n = \frac{\text{Main VT sec}}{\sqrt{3}}$$

If the parameter »*VT con*« within the field parameters is set to »*Phase to Phase*« the setting »*Phase to Neutral*« in the current modules is effectless.

## Commissioning: Overcurrent Protection, Non-directional [ANSI 51V]

*Object to be tested:*

Signals to be measured for Voltage Restraint protection function: the threshold values, total tripping time (recommended), or alternatively tripping delays and the dropout ratios; each time 3 x single-phase and 1 x three-phase.

### **NOTICE**

It is recommended to measure the total tripping time instead of the tripping time. The tripping delay should be specified by the customer. The total tripping time is measured at the position signaling contacts of the CBs (not at the relay output!).

**Total tripping time: = tripping delay (please refer to the tolerances of the protection stages) + CB operating time (about 50 ms)**

**Please take the CB switching times from the technical data, specified in the relevant documentation, provided by the CB manufacturer.**

*Necessary means:*

- Current source;
- Voltage Source;
- Current and Voltage meters; and
- Timer.

*Procedure:*

*Testing the threshold values (3 x single-phase and 1 x three-phase)*

Feed %Pickup voltage. For each test performed, feed a current that is about 3-5% above the threshold value for activation/tripping. Then check if the pickup values are %Pickup of the value according to the standard overcurrent protection.

*Testing the total tripping delay (recommendation)*

Measure the total tripping times at the auxiliary contacts of the breakers (breaker tripping).

*Testing the tripping delay (measuring at the relay output contact)*

Measure the tripping times at the relay output contact.

*Testing the dropout ratio*

Reduce the current to 97% below the trip value and check the dropout ratio.

*Successful test result*

The measured total tripping delays or individual tripping delays, threshold values, and dropout ratios correspond with those values specified in the adjustment list. Permissible deviations/tolerances can be found under Technical Data.

## I2> - Negative-Sequence Overcurrent [51Q]

For activating this function, the parameter »Measuring Mode« has to be set to »I2« in the parameter set of the corresponding overcurrent element I[x].

The negative-sequence overcurrent protection function (I2>) is to be seen as an equivalent to the phase overcurrent protection with the exception that it uses negative-sequence current (I2>) as measured quantities instead of the three phase currents used by phase overcurrent protection function. The negative-sequence current used by I2> is derived from the following well-known symmetrical component transformation:

$$I_2 = \frac{1}{3}(I_{L1} + a^2 I_{L2} + a I_{L3})$$

The pickup set value of a I2> protection function should be set in accordance of the negative-sequence current occurrence in the protected object.

Besides that, the negative-sequence overcurrent protection function (I2>) uses the same setting parameters as the phase overcurrent protection function, like trip and reset characteristics from both IEC/ANSI standards, time multiplier, etc.

The negative-sequence overcurrent protection function (I2>) can be used for line, generator, transformer and motor protection to protect the system from unbalanced faults. Because the I2> protection function operates on the negative-sequence current component which is normally absent during load conditions, the I2> can, therefore, be set more sensitive than the phase overcurrent protection functions. On the other hand, coordination of negative-sequence overcurrent protection function in a radial system does not mean automatically very long fault clearing time for the furthest upstream protection devices, because the tripping time of concerned negative-sequence overcurrent protection function needs only be coordinate with the next downstream device with the negative-sequence overcurrent protection function. This makes the I2> in many cases as an advantageous protection concept in addition to the phase overcurrent protection function.



**WARNING** If you are using inrush blockings, the tripping delay of the current protection functions must be at least 30 ms or more in order to prevent faulty trippings.

### NOTICE

At the moment of breaker closure, negative-sequence current might be the result of transients.

**I[1]...[n]: Measuring method = (I2>**

**name = I[1]...[n]**

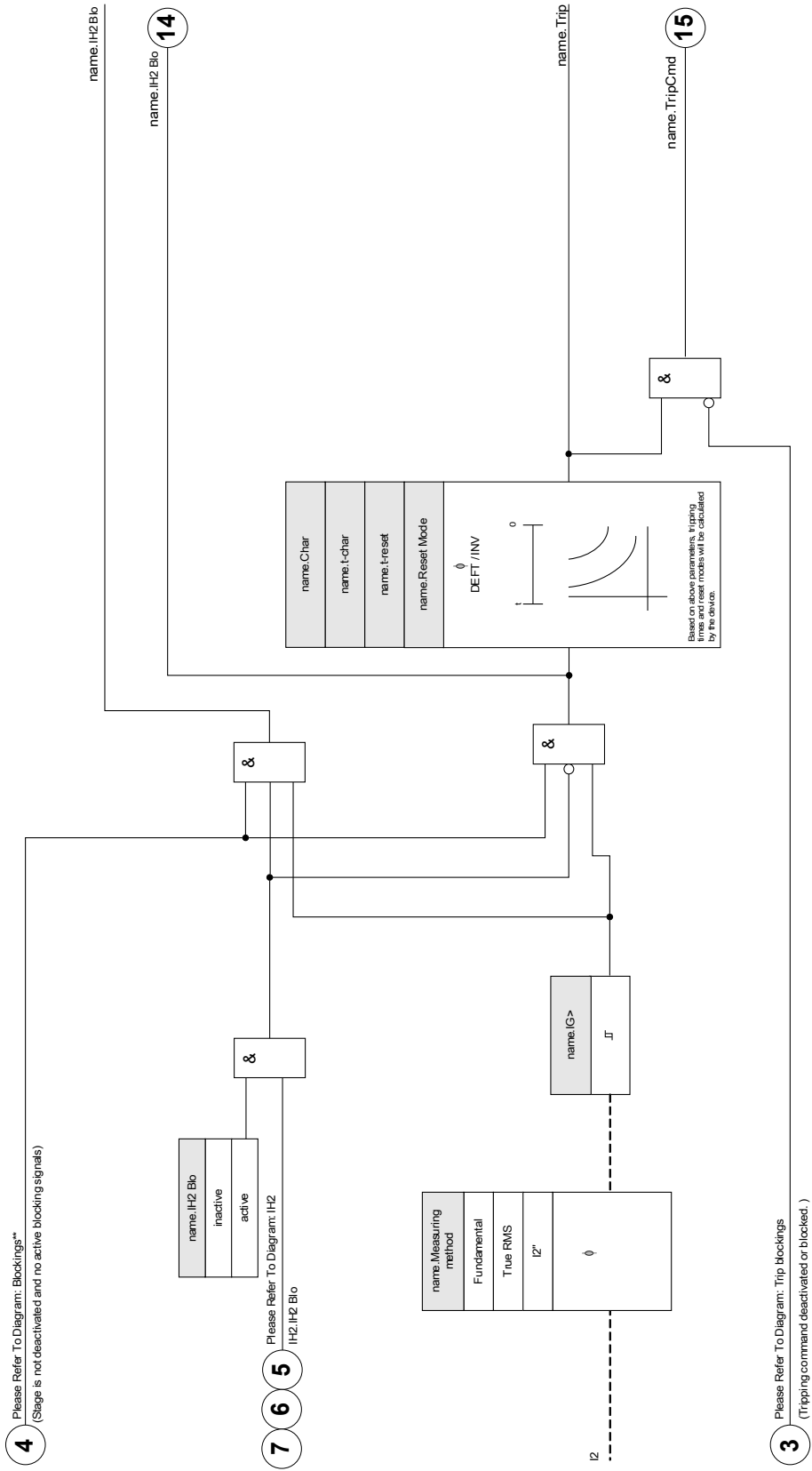

## Commissioning: Negative Sequence Overcurrent

### *Object to be tested*

Signals to be measured for each current protection function: the threshold values, total tripping time (recommended), or alternatively tripping delays and the dropout ratios.

### **NOTICE**

It is recommended to measure the total tripping time instead of the tripping time. The tripping delay should be specified by the customer. The total tripping time is measured at the position signalling contacts of the CBs (not at the relay output!).

**Total tripping time:** = tripping delay (please refer to the tolerances of the protection stages) + CB operating time (about 50 ms)

**Please take the CB switching times from the technical data, specified in the relevant documentation, provided by the CB manufacturer.**

### *Necessary means:*

- Current source
- Current meters
- Timer

### *Procedure:*

#### *Testing the threshold values*

In order to get a negative-sequence current, please change the phase sequence at the terminals of the current source (in case of ABC sequence to ACB – in case of a ACB sequence to ABC).

For each test performed, feed a current that is about 3-5% above the threshold value for activation/tripping. Then check the threshold values.

#### *Testing the total tripping delay (recommendation)*

Measure the total tripping times at the auxiliary contacts of the breakers (breaker tripping).

#### *Testing the tripping delay (measuring at the relay output contact)*

Measure the tripping times at the relay output contact.

#### *Testing the dropout ratio*

Reduce the current to 97% below the trip value and check the dropout ratio.

#### *Successful test result*

The measured total tripping delays or individual tripping delays, threshold values, and dropout ratios correspond with those values specified in the adjustment list. Permissible deviations/tolerances can be found under Technical Data.



## Directional Features for Measured Ground Fault Elements 50N/51N

All ground fault elements can be selected as »non-directional/forward/reverse« operated. This has to be done in the »Device Planning« menu.

### Important Definitions

**Polarizing Quantity:** This is the quantity that is used as a reference value. The *polarizing quantity* can be selected by the parameter »IG meas dir ctrl« in the [Field Para/Direction] menu as follows:

- »IG meas 3V0«: The neutral voltage selected by the parameter »3V0 Source« will be used as the polarizing quantity. The traditional way to polarize a ground fault element is to use neutral voltage (3V0). The neutral voltage can, however, be either »measured« or »calculated«. This can be selected by the parameter »3V0 Source« in the [Field Para/Direction] menu.
- »I2, V2«: With this selection, the negative phase sequence voltage and current (Polarizing: V2/Operating: I2) will be used to detect direction. The monitored current is still the measured residual current IG meas.
- »Dual«: For this method, the negative phase sequence voltage »V2« will be used as polarizing quantity if »V2« and »I2« are available, otherwise 3V0 will be used. The operating quantity is either I2 if »V2« and »I2« are available, else IG meas.

The following table gives the User a quick overview of all possible directional settings.

<b>50N/51N Direction Decision by Angle Between:</b>	<b>[Field Para/Direction]</b>  <b>The Following Angle Has to Be Set:</b>	<b>[Field Para/Direction]:</b>  <b>IG meas dir ctrl =</b>	<b>[Field Para/Direction]:</b>  <b>3V0 Source =</b>
Measured ground current and neutral voltage: <b>IG meas, 3V0 (measured)</b>	Ground MTA	IG meas 3V0	measured
Measured ground current and neutral voltage: <b>IG meas, 3V0 (calculated)</b>	Ground MTA	IG meas 3V0	calculated
Negative sequence voltage and current <b>I2, V2</b>	90° + Phase MTA	I2,V2	not used
Negative phase sequence current and voltage (preferred), measured ground current and neutral voltage (alternatively): <b>I2, V2 (if available)</b> or else: <b>IG meas, 3V0 (measured)</b>	If V2 and I2 are available: 90° + Phase MTA  else: Ground MTA	Dual	measured
Negative phase sequence current and voltage (preferred), measured ground current and neutral voltage (alternatively): <b>I2, V2 (if available)</b> or else: <b>IG meas, 3V0 (calculated)</b>	If V2 and I2 are available: 90° + Phase MTA  else: Ground MTA	Dual	calculated

**Prot - 50G/51G - direction detection**

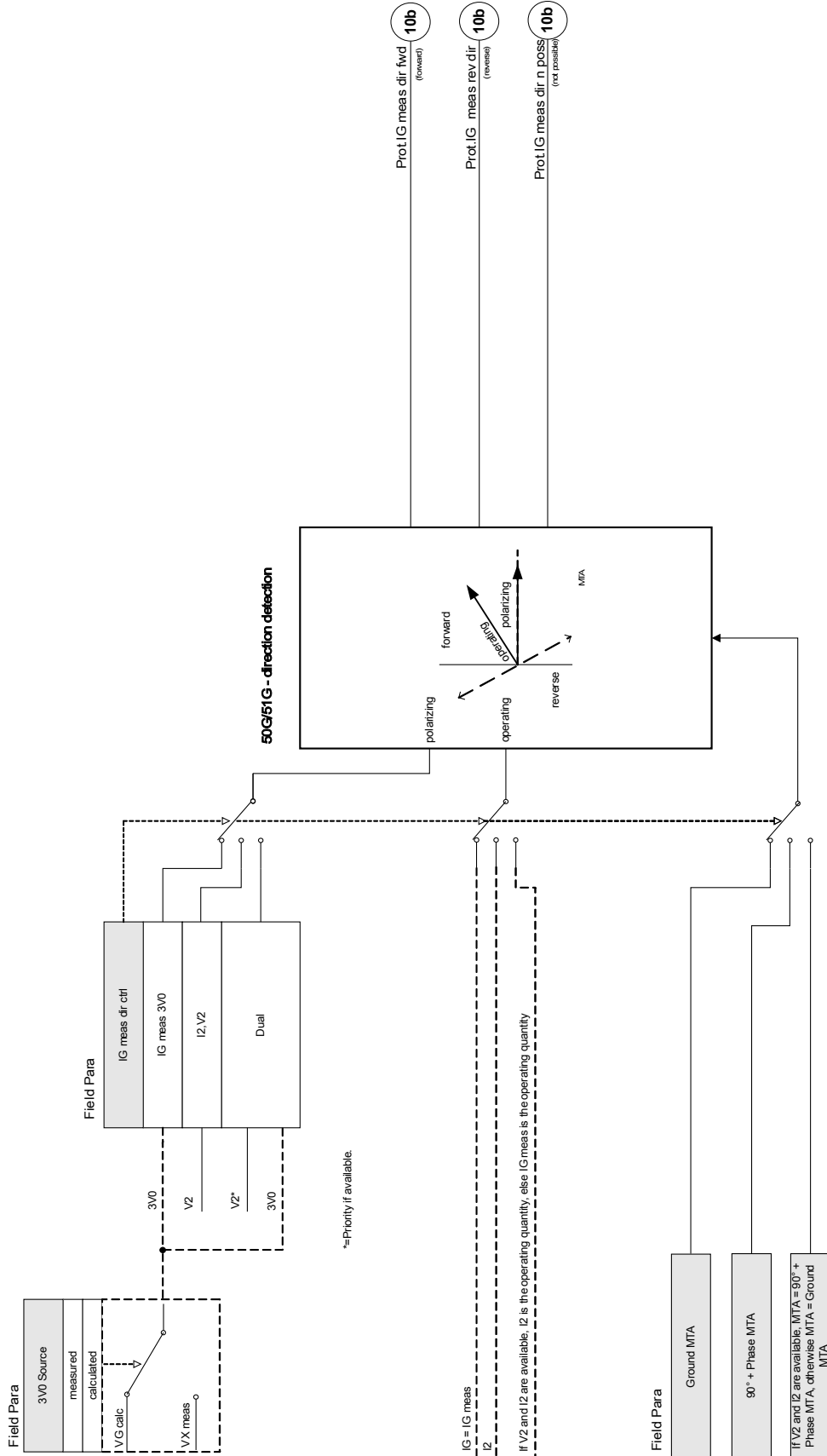

## Directional Features for Calculated (IG calc) Ground Fault 50N/51N

All ground fault elements can be selected as »non-directional/forward/reverse« operated. This has to be done in the »Device Planning« menu.

## Important Definitions

**Polarizing Quantity:** This is the quantity that is used as a reference value. The *polarizing quantity* can be selected by the parameter »IG calc dir ctrl« in the [Field Para/Direction] menu as follows:

- »IG calc 3V0«: The neutral voltage selected by the parameter »3V0 Source« will be used as the polarizing quantity. The traditional way to polarize a ground fault element is to use neutral voltage (3V0). The neutral voltage can, however, be either »measured« or »calculated«. This can be selected by the parameter »3V0 Source« in the [Field Para/Direction] menu.
- »IG calc Ipol (IG meas)«: The measured neutral current (usually = IG meas) will be used as polarizing quantity.
- »Dual«: For this method, the measured neutral current Ipol=IG meas will be used as polarizing quantity, if available, otherwise 3V0 will be used.
- »I2, V2«: With this selection, the negative phase sequence voltage and current will be used to detect the direction. The monitored current is still the calculated residual current IG calc.

**Operating Quantity:** For the directional IG calc elements, the *operating quantity* is in general the *calculated neutral current IG calc* (except from »I2, V2« mode, where »I2« is the operating quantity).

The ground maximum torque angles (MTA) can be adjusted from 0° to 360°, except, if »IG calc Ipol (IG meas)« is selected. In this case it is set to 0° (fixed).

The MTA will also be set internally to 0° in case that Ipol=IG meas is available within the Dual-Mode

The following table gives the User a quick overview of all possible directional settings.

<b>50N/51N Direction Decision by Angle Between:</b>	<b>[Field Para/ Direction]</b>	<b>[Field Para/Direction]:</b>	<b>[Field Para/Direction]:</b>
	<b>The Following Angle Has to Be Set:</b>	<b>IG calc dir ctrl =</b>	<b>3V0 Source =</b>
Residual current and neutral voltage: <b>IG calc, 3V0 (measured)</b>	Ground MTA	<i>IG calc 3V0</i>	measured
Residual current and neutral voltage: <b>IG calc, 3V0 (calculated)</b>	Ground MTA	<i>IG calc 3V0</i>	calculated
Residual current and neutral/ground current <b>IG calc, IG meas</b>	0° (fixed)	IG calc Ipol (IG meas)	not used
Residual current and neutral/ground current (preferred), residual current and neutral voltage (alternatively): <b>IG calc, IG meas (if available)</b> or else: <b>IG calc, 3V0 (measured)</b>	If Ipol (=IG meas) is available, MTA = 0° (fixed); else MTA=Ground MTA	Dual	measured
Residual current and neutral/ground current (preferred), residual current and neutral voltage (alternatively): <b>IG calc, IG meas (if available)</b> or else: <b>IG calc, 3V0 (calculated)</b>	If Ipol (=IG meas) is available, MTA = 0° (fixed); else MTA=Ground MTA	Dual	calculated
Negative sequence voltage and current <b>I2, V2</b>	90° + Phase MTA	<i>I2, V2</i>	not used

**Prot. - 50N51N - direction detection**

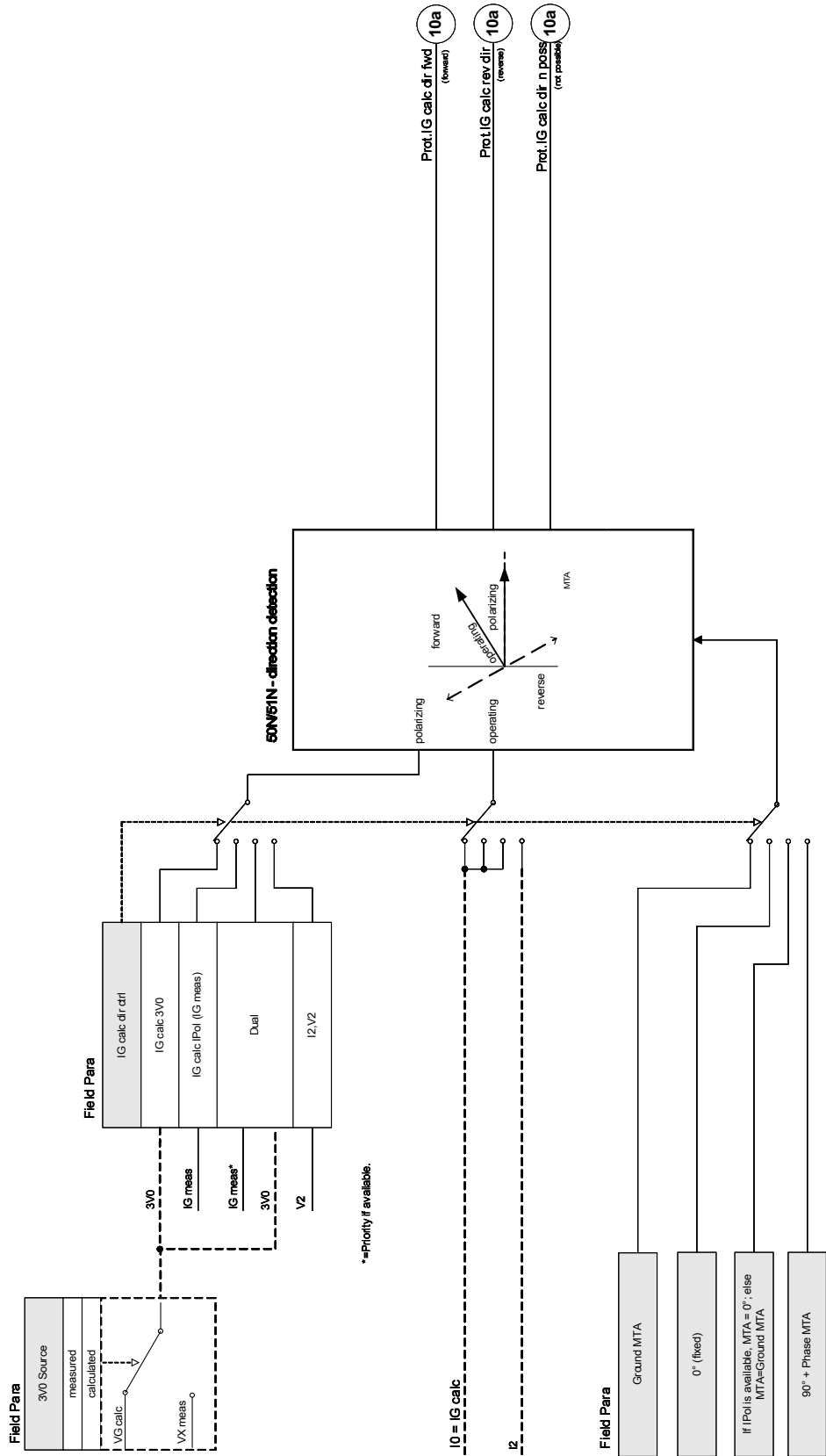

## IG - Ground Fault [50N/G, 51N/G, 67N/G]

Available elements:  
IG[1] .IG[2] .IG[3] .IG[4]



**WARNING** If you are using inrush blockings the tripping delay of the earth current protection functions must be at least 30ms or more in order to prevent faulty trippings.



**NOTICE** All earth current elements are identically structured.



**NOTICE** This module offers Adaptive Parameter Sets. Parameters can be modified within parameter sets dynamically by means of Adaptive Parameter Sets. Please refer to chapter Parameter / Adaptive Parameter Sets.

The following table shows the application options of the earth overcurrent protection element

Applications of the IE-Protection Module	Setting in	Option
ANSI 50N/G – Earth overcurrent protection, non directional	Device Planning menu Setting: non directional	Measuring Mode: Fundamental/TrueRMS
ANSI 51N/G – Earth short circuit protection, non directional	Device Planning menu Setting: non directional	Measuring Mode: Fundamental/TrueRMS
ANSI 67N/G – Earth overcurrent/Earth short circuit protection, directional	Device Planning menu Setting: directional  Field parameter menu 3V0 Source: measured/calculated  3I0 Source: measured/calculated	Measuring Mode: Fundamental/TrueRMS  IG Source: measured/calculated VG Source: measured/calculated

### Measuring Mode

For all protection elements it can be determined, whether the measurement is done on basis of the »Fundamental« or if »TrueRMS« measurement is used.

### IG Source/VG Source

Within the parameter menu, this parameter determines, whether the earth current and the residual voltage is »measured« or »calculated«.

### Direction detection (3V0 Source und 3I0 Source)

In the field parameter menu it can be determined, if the earth current directional detection should be based on measured or calculated values of currents and voltages. This setting takes effect on all earth current elements.

**NOTICE**

- Calculation of the residual voltage is only possible, when phase to neutral voltage is applied to the voltage inputs.

**At setting »measured« the quantities to be measured, i. e. Residual voltage and the measured earth current have to be applied to the corresponding 4<sup>th</sup> measuring input.**

All earth current protective elements can be planned user defined as non-directional or as directional stages. This means, for instance, all 4 elements can be projected in forward/reverse direction. For each element the following characteristics are available:

- DEFT
- NINV (IEC)
- VINV (IEC)
- LINV (IEC)
- EINV (IEC)
- MINV (ANSI)
- VINV (ANSI)
- EINV (ANSI)
- RXIDG
- Thermal Flat
- IT
- I2T
- I4T

Explanation:

t = Tripping delay

t-char = Time multiplier/tripping characteristic factor. The setting range depends on the selected tripping curve.  
IG = Fault current

IG> = If the pickup value is exceeded, the module/element starts to time out to trip .

The earth current can be measured either directly via a cable-type transformer or detected by a Holmgreen connection. The earth current can alternatively be calculated from the phase currents; but this is only possible if the phase currents are not ascertained by a V-connection.

The device can optionally be procured with a sensitive earth current measuring input.

### DEFT

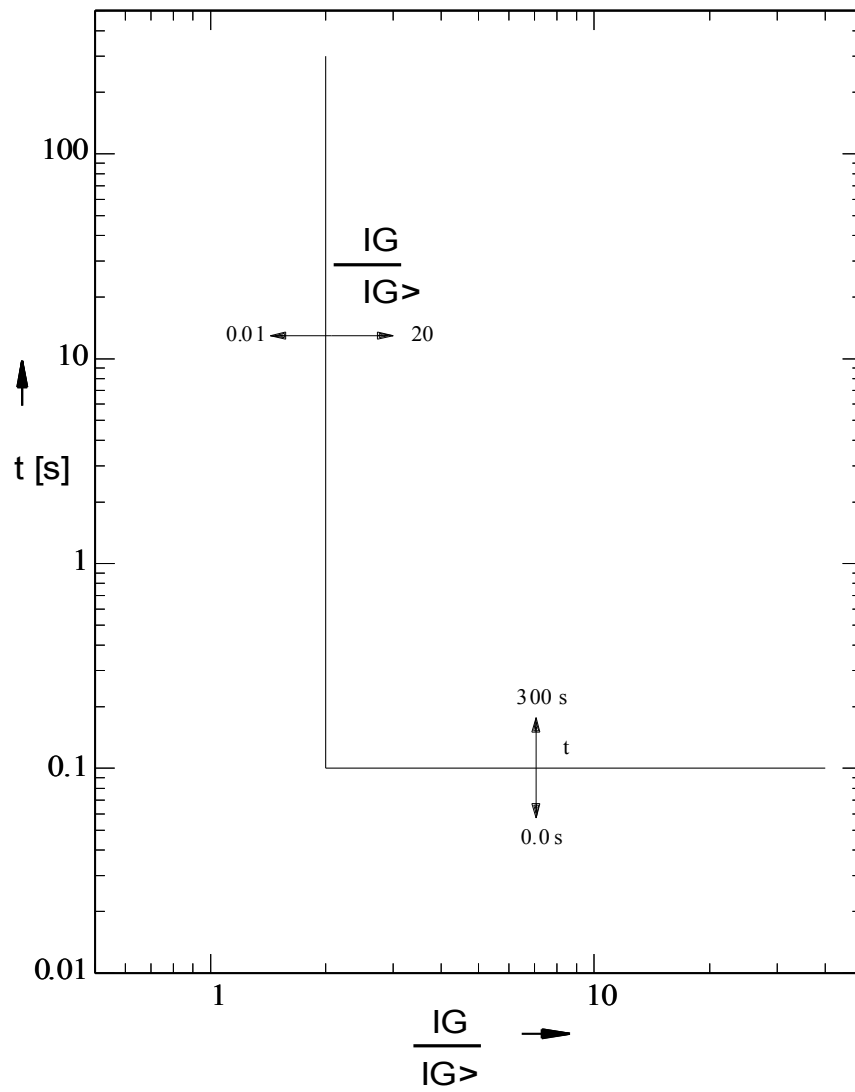



**IEC NINV**



**Notice!**

Various reset modes are available . Resetting via characteristic, delayed and instantaneous .

**Reset**

**Trip**

$$t = \left| \frac{0.14}{\left(\frac{IG}{IG>} \right)^2 - 1} \right| * t\text{-char [s]}$$

$$t = \frac{0.14}{\left(\frac{IG}{IG>} \right)^{0.02} - 1} * t\text{-char [s]}$$

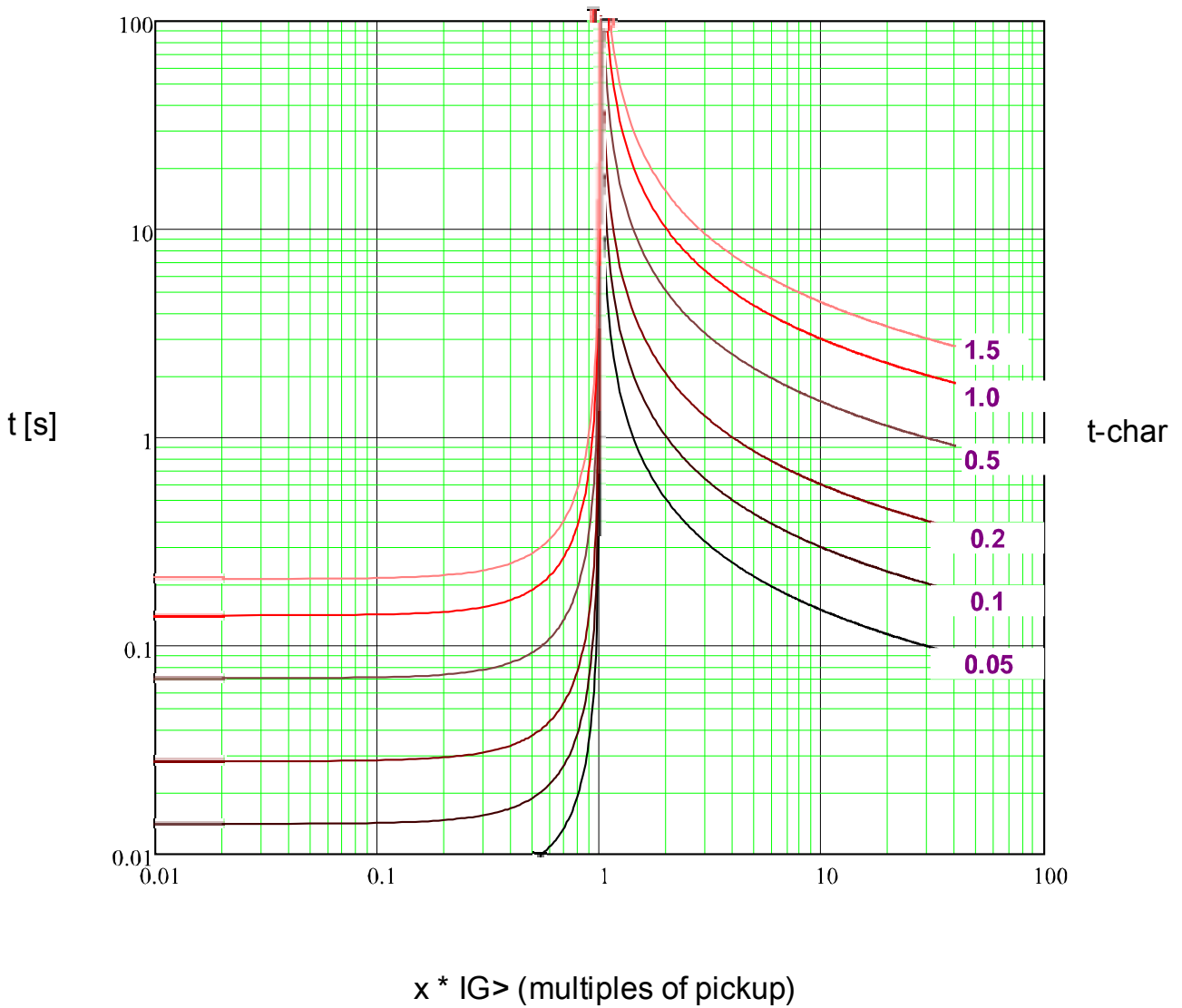

**IEC VINV**



**Notice!**

Various reset modes are available . Resetting via characteristic, delayed and instantaneous .

**Reset**

**Trip**

$$t = \left| \frac{13.5}{\left(\frac{IG}{IG>}\right)^2 - 1} \right| * t\text{-char [s]}$$

$$t = \frac{13.5}{\left(\frac{IG}{IG>}\right) - 1} * t\text{-char [s]}$$

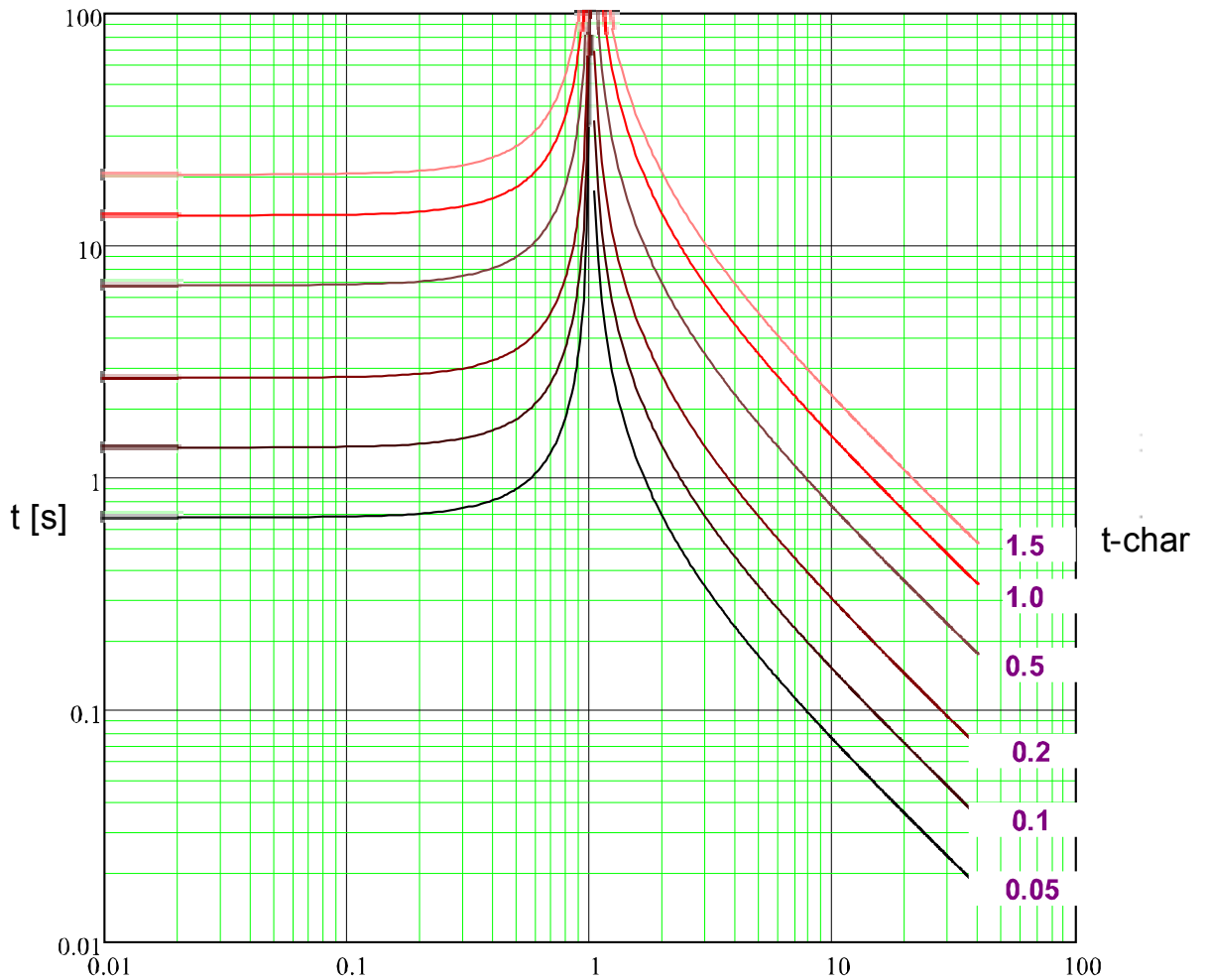

x \* IG> (multiples of pickup)

**IEC LINV**



**Notice!**

Various reset modes are available . Resetting via characteristic, delayed and instantaneous .

**Reset**

$$t = \left| \frac{120}{\left(\frac{IG}{IG>} \right)^2 - 1} \right| * t\text{-char [s]}$$

**Trip**

$$t = \frac{120}{\left(\frac{IG}{IG>} \right)^2 - 1} * t\text{-char [s]}$$

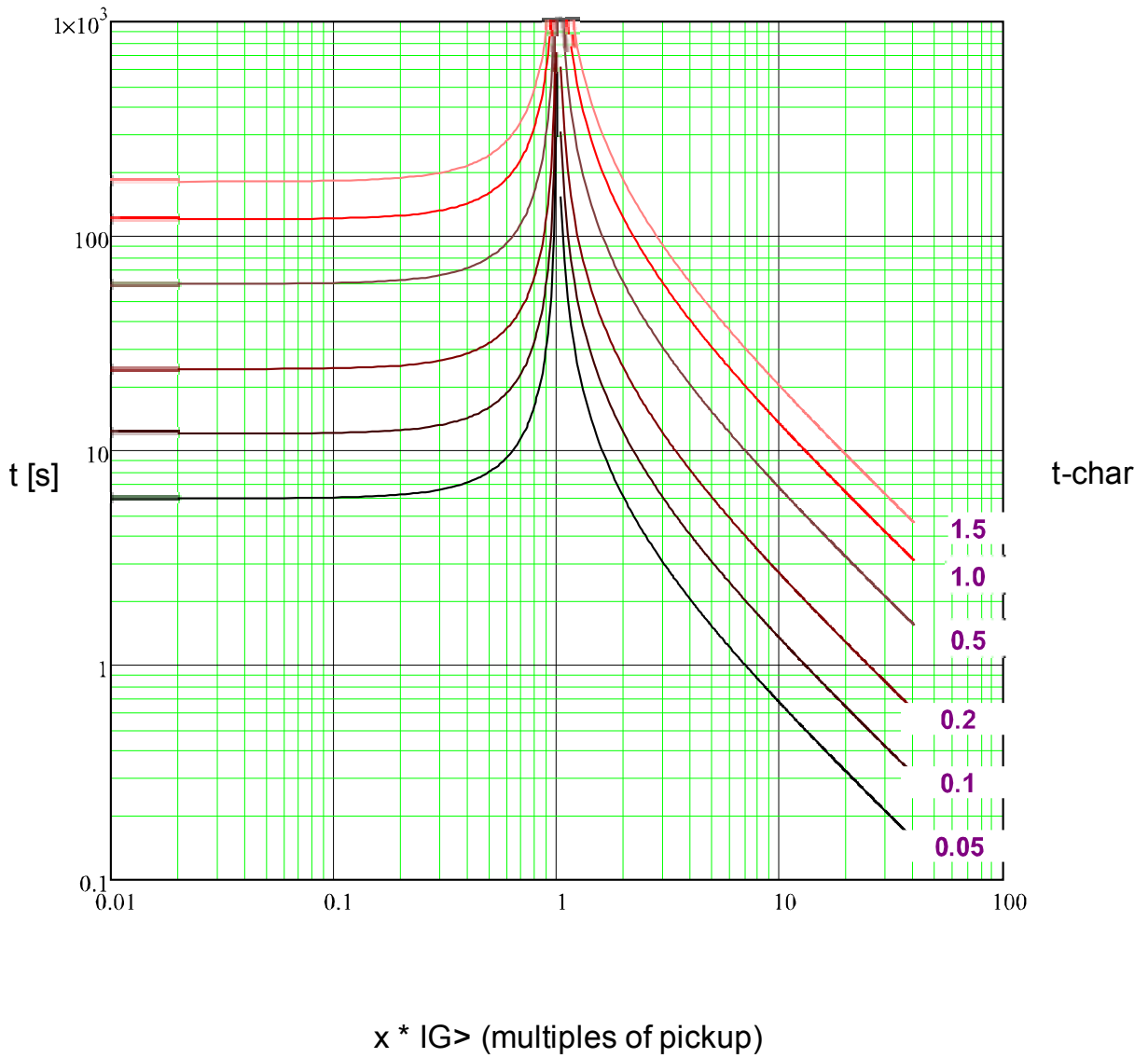

**IEC EINV**



**Notice!**

Various reset modes are available . Resetting via characteristic, delayed and instantaneous .

**Reset**

**Trip**

$$t = \left| \frac{80}{\left(\frac{IG}{IG>}\right)^2 - 1} \right| * t\text{-char [s]}$$

$$t = \frac{80}{\left(\frac{IG}{IG>}\right)^2 - 1} * t\text{-char [s]}$$

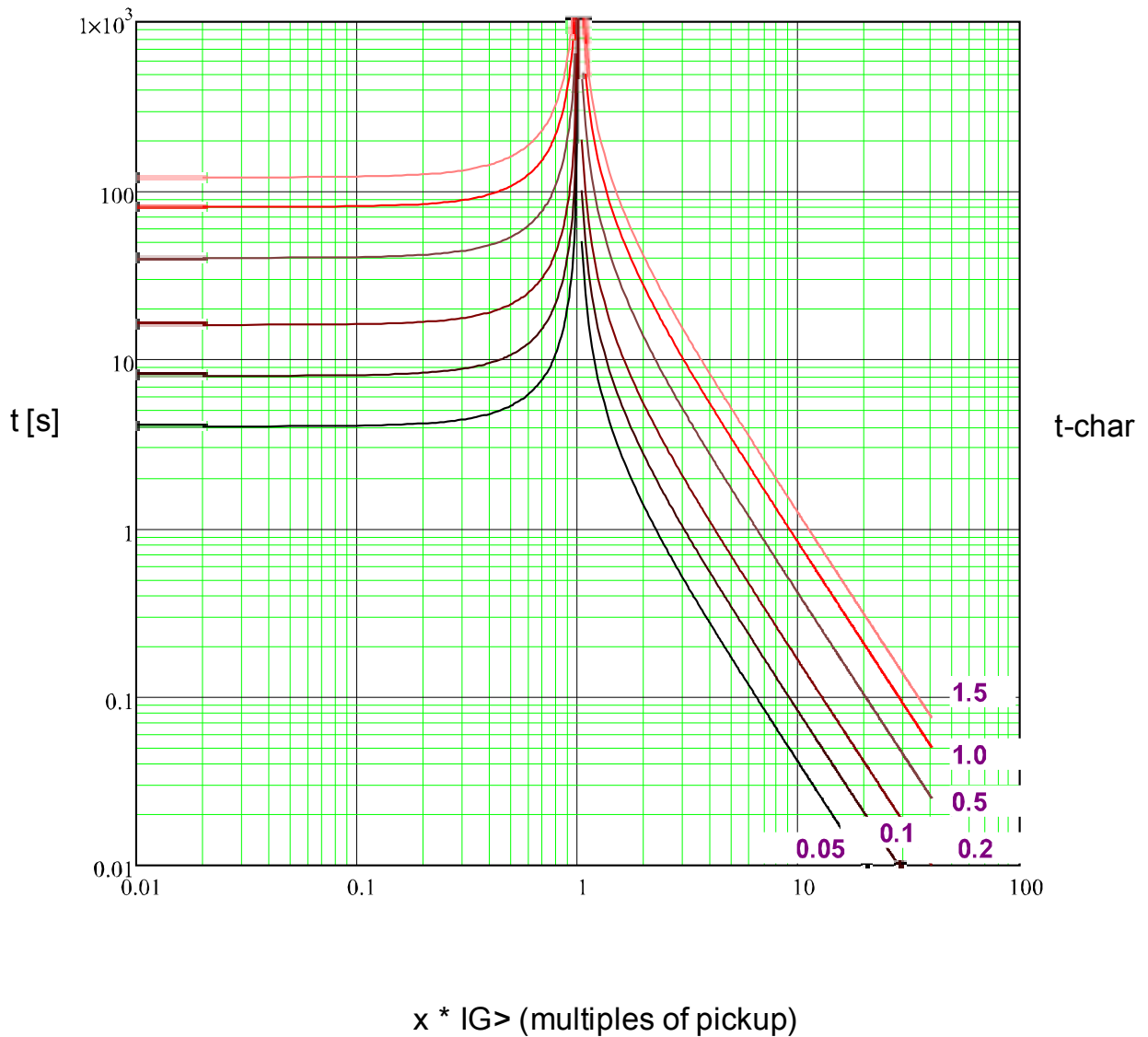

**ANSI MINV**



**Notice!**

Various reset modes are available . Resetting via characteristic, delayed and instantaneous .

**Reset**

**Trip**

$$t = \left| \frac{4.85}{\left(\frac{IG}{I>} \right)^2 - 1} \right| * t\text{-char [s]}$$

$$t = \left( \frac{0.0515}{\left(\frac{IG}{IG>} \right)^{0.02} + 0.1140} \right) * t\text{-char [s]}$$

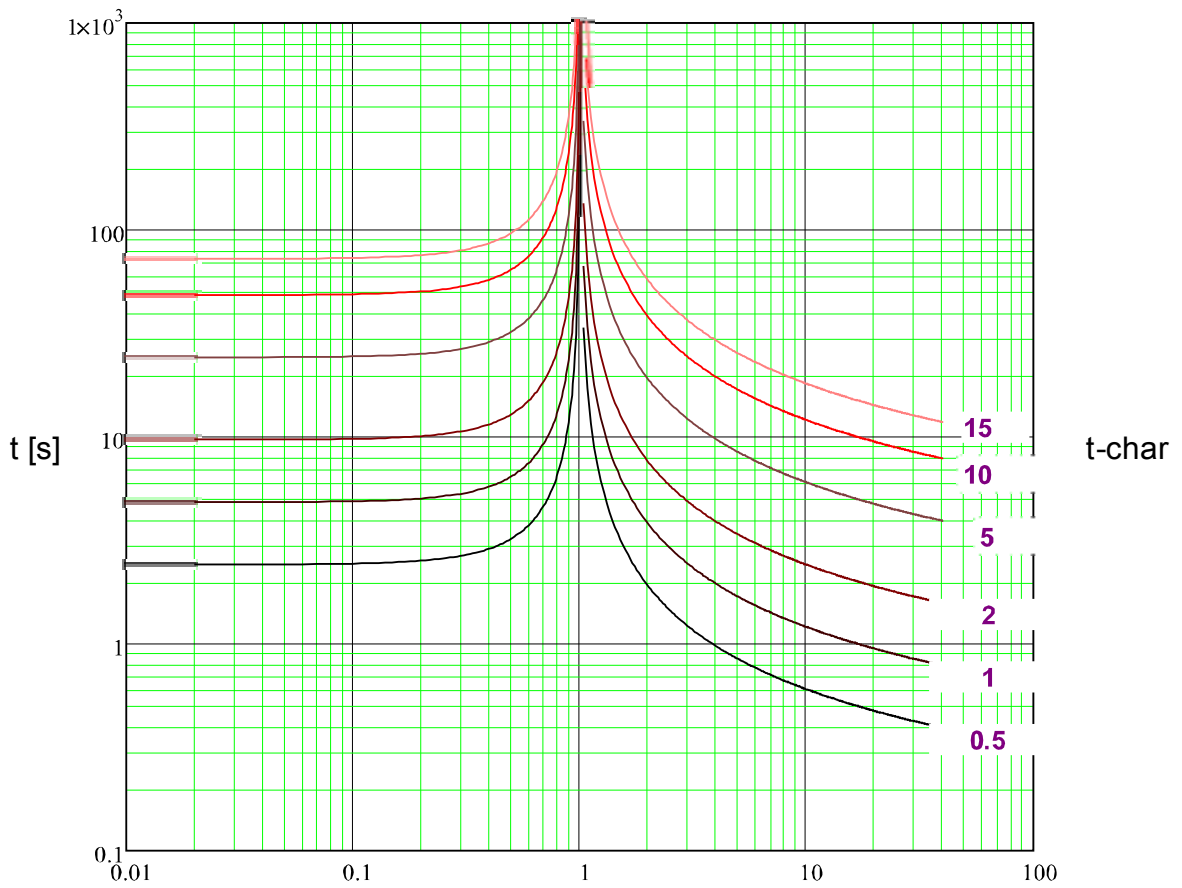

x \* IG> (multiples of pickup)

**ANSI VINV**



**Notice!**

Various reset modes are available . Resetting via characteristic, delayed and instantaneous .

**Reset**

$$t = \left| \frac{21.6}{\left(\frac{IG}{IG>} \right)^2 - 1} \right| * t\text{-char [s]}$$

**Trip**

$$t = \left( \frac{19.61}{\left(\frac{IG}{IG>} \right)^2 - 1} + 0.491 \right) * t\text{-char [s]}$$

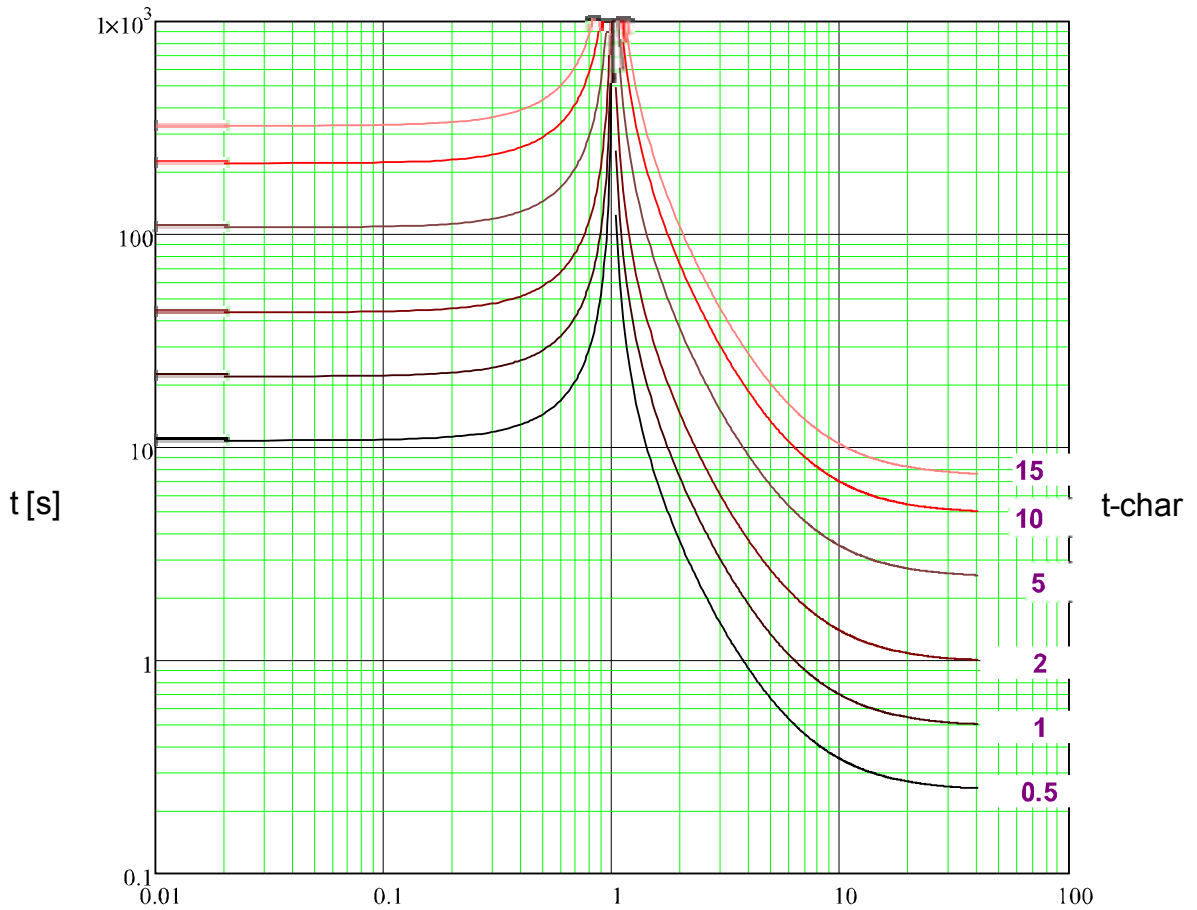

x \* IG> (multiples of pickup)

### ANSI EINV



**Notice!**

Various reset modes are available . Resetting via characteristic, delayed and instantaneous .

#### Reset

$$t = \left| \frac{29.1}{\left(\frac{IG}{IG>} \right)^2 - 1} \right| * t\text{-char [s]}$$

#### Trip

$$t = \left( \frac{28.2}{\left(\frac{IG}{IG>} \right)^2 - 1} + 0.1217 \right) * t\text{-char [s]}$$

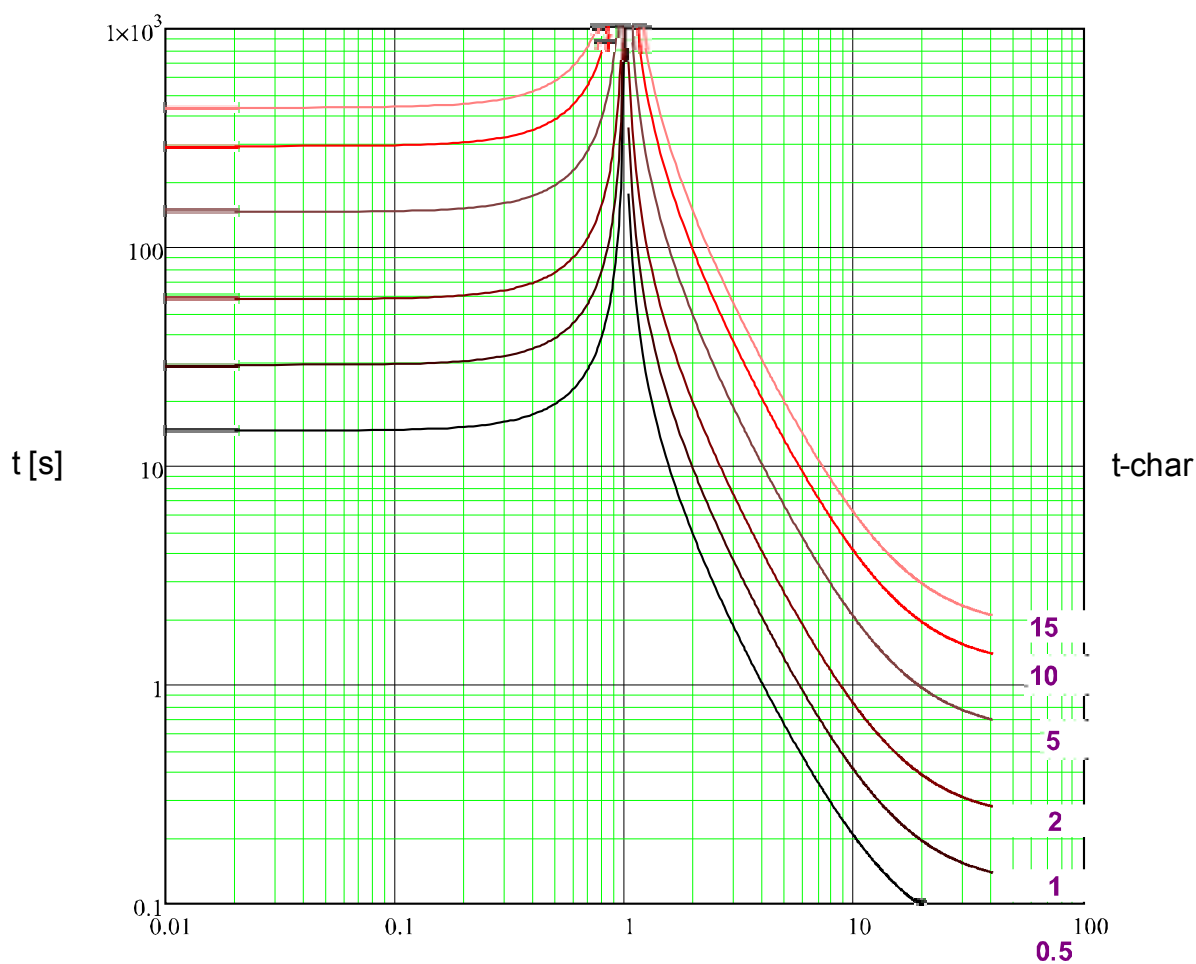

x \* IG> (multiples of pickup)

### RXIDG

### Trip

$$t = 5.8 - 1.35 * \ln \left( \frac{IG}{t\text{-char} * IG>} \right) \text{ [s]}$$

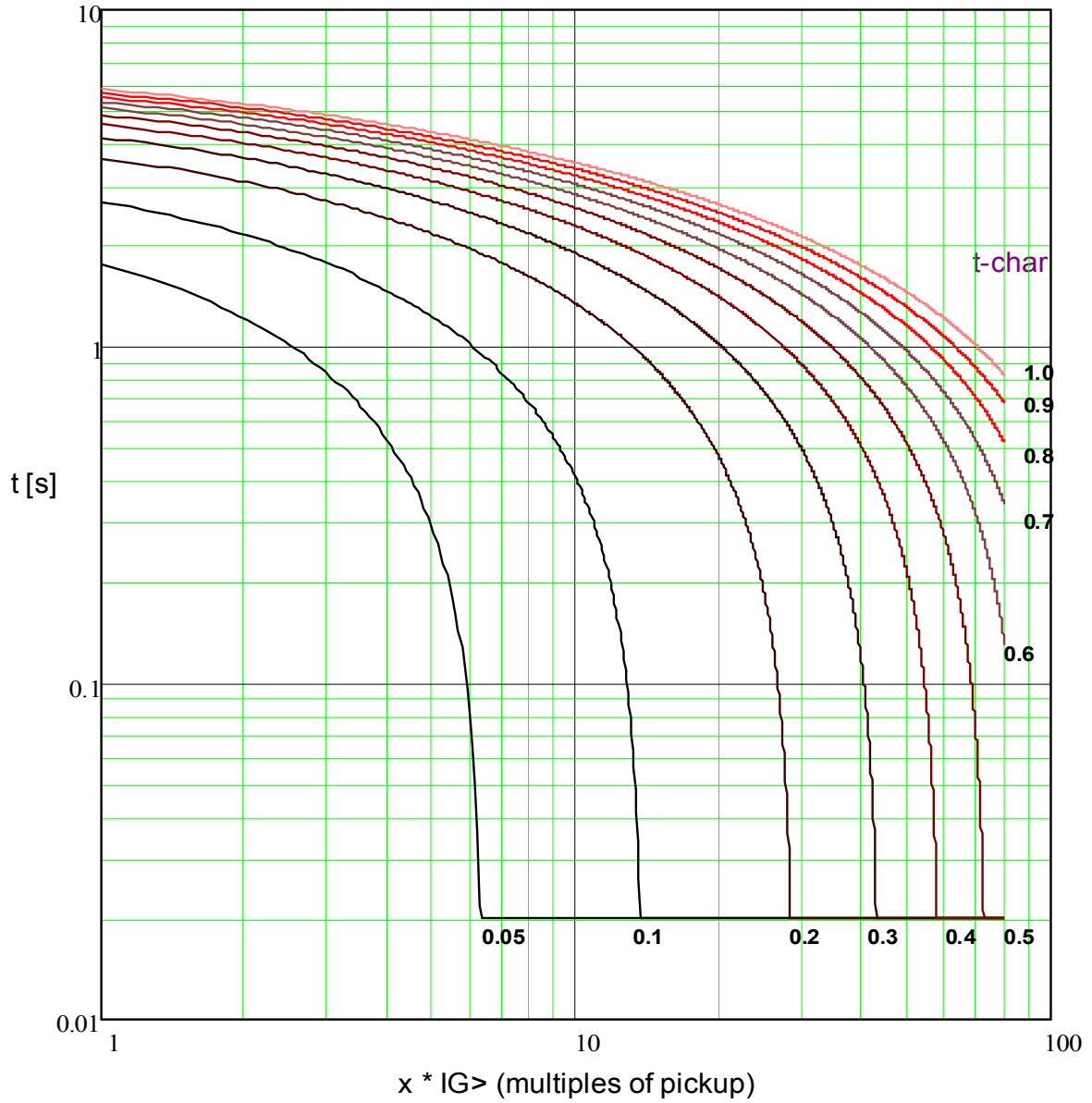



### Therm Flat



**Notice!**

Various reset modes are available . Resetting via characteristic, delayed and instantaneous .

**Reset**

$$t = \left| \frac{5 \cdot 1^2}{\left(\frac{IG}{IGnom}\right)^0} \right| \cdot t\text{-char [s]}$$

**Trip**

$$t = \frac{5}{\left(\frac{IG}{IGnom}\right)^0} \cdot t\text{-char [s]}$$

$$t = 5 \cdot t\text{-char [s]}$$

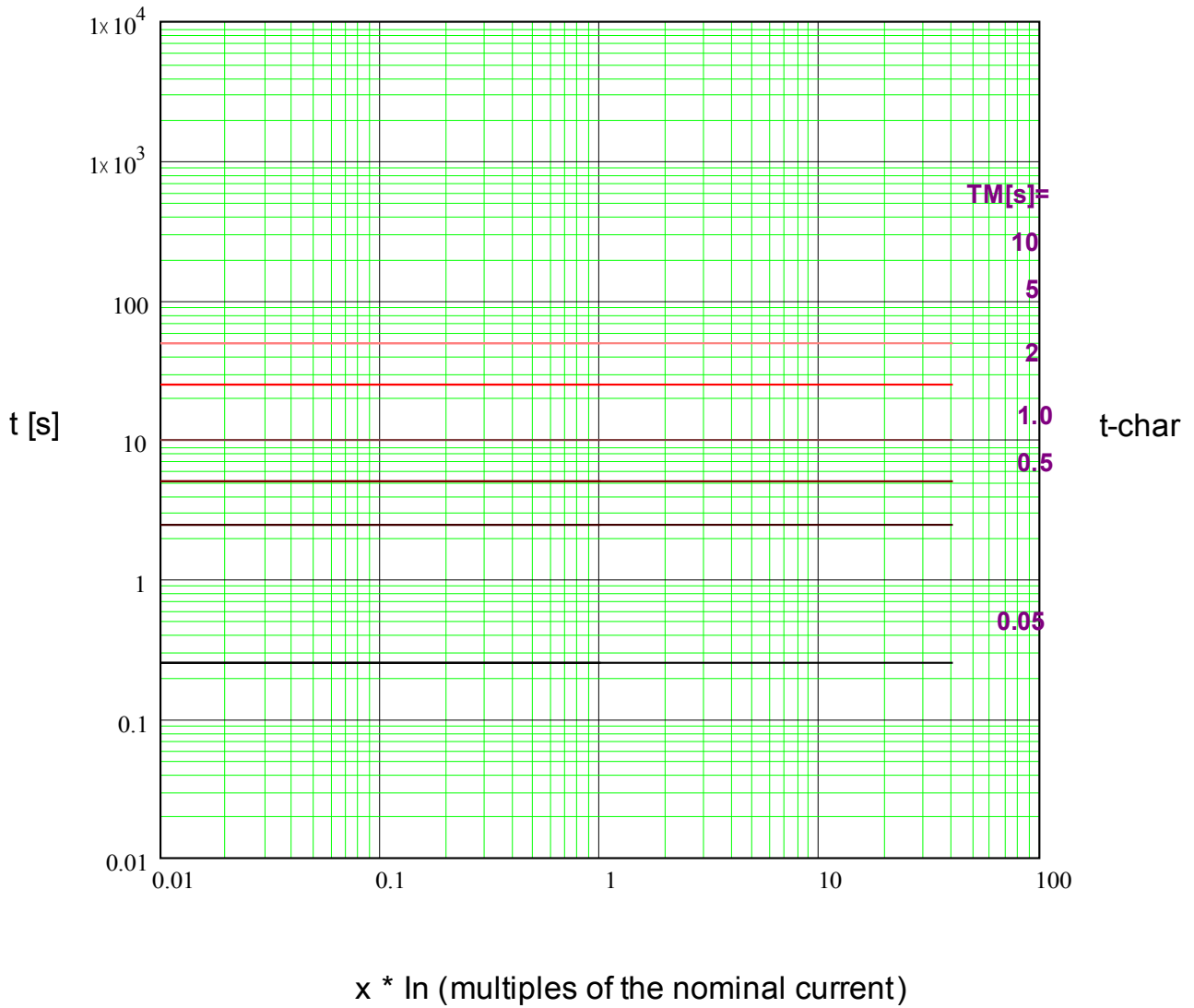

IT



**Notice!**

Various reset modes are available . Resetting via characteristic, delayed and instantaneous .

**Reset**

**Trip**

$$t = \left| \frac{5 \cdot 1^2}{\left(\frac{IG}{IGnom}\right)^0} \right| * t-char [s]$$

$$t = \frac{5 \cdot 1^1}{\left(\frac{IG}{IGnom}\right)^1} * t-char [s]$$

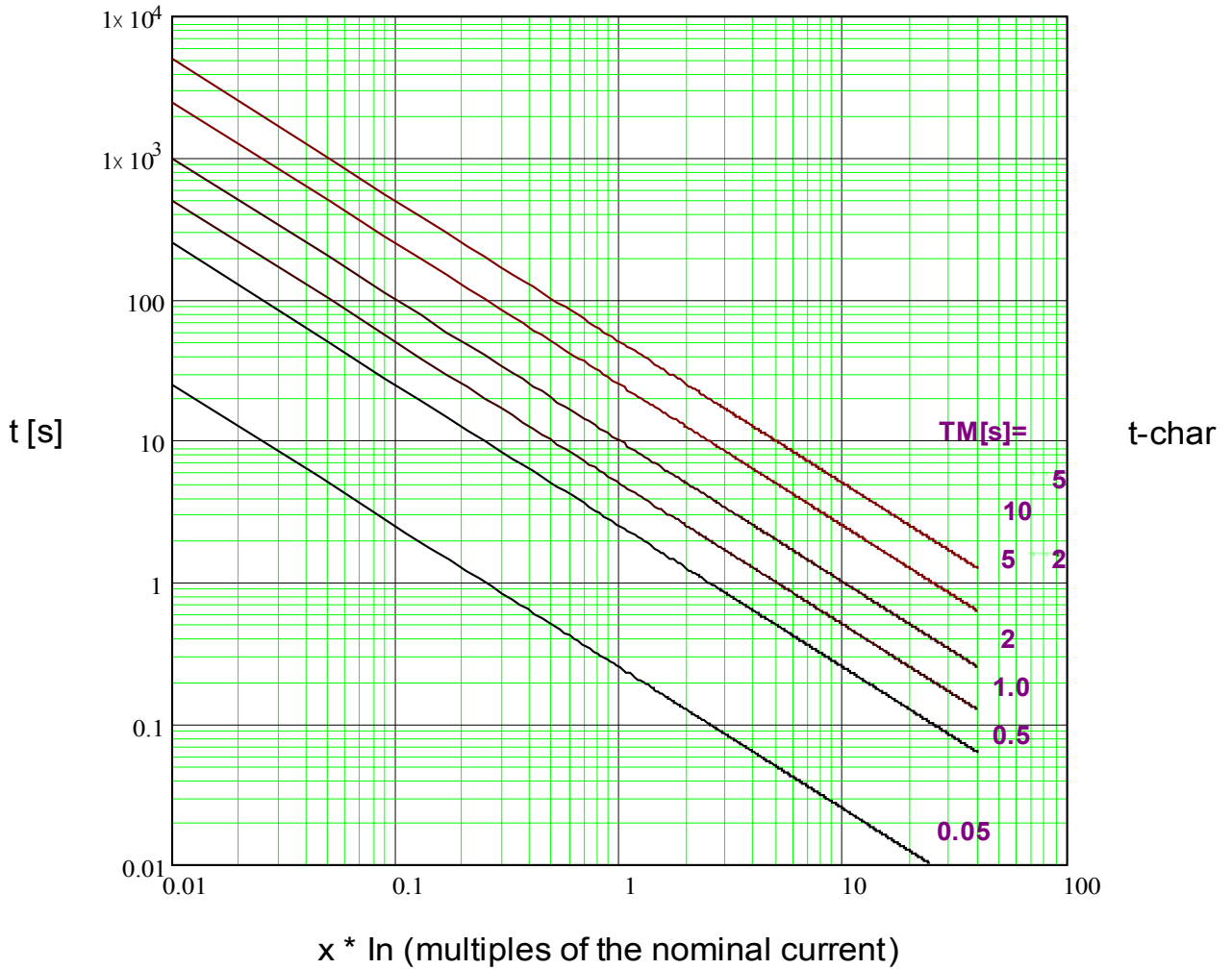

**I<sup>2</sup>T**



**Notice!**

Various reset modes are available . Resetting via characteristic, delayed and instantaneous .

**Reset**

$$t = \left| \frac{5 \cdot 1^2}{\left(\frac{IG}{IG_{nom}}\right)^0} \right| \cdot t\text{-char [s]}$$

**Trip**

$$t = \frac{5 \cdot 1^2}{\left(\frac{IG}{IG_{nom}}\right)^2} \cdot t\text{-char [s]}$$

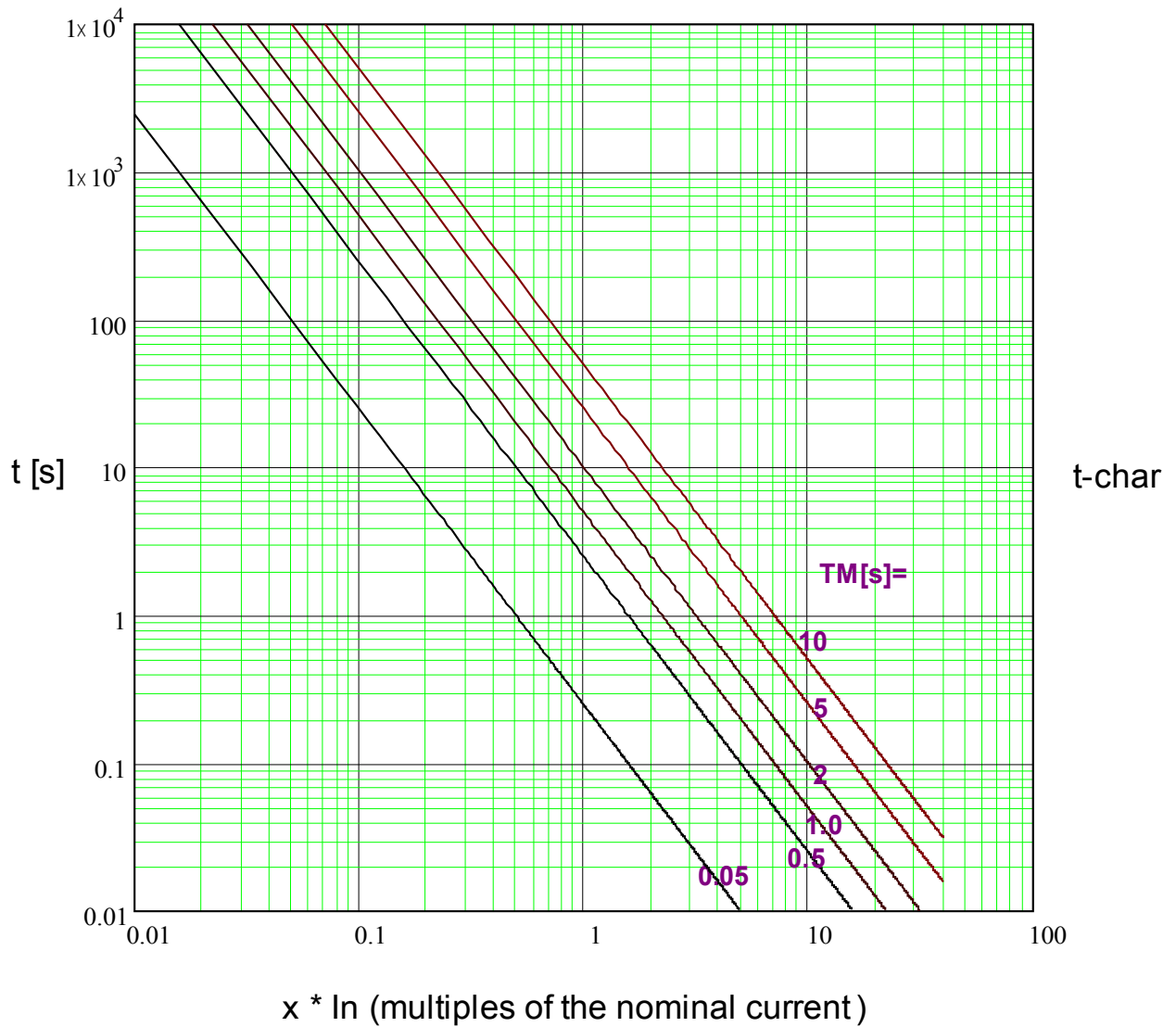

**I4T**



**Notice!**

Various reset modes are available . Resetting via characteristic, delayed and instantaneous .

**Reset**

$$t = \left| \frac{5 \cdot 1^2}{\left(\frac{IG}{IGnom}\right)^0} \right| \cdot t\text{-char [s]}$$

**Trip**

$$t = \frac{5 \cdot 1^4}{\left(\frac{IG}{IGnom}\right)^4} \cdot t\text{-char [s]}$$

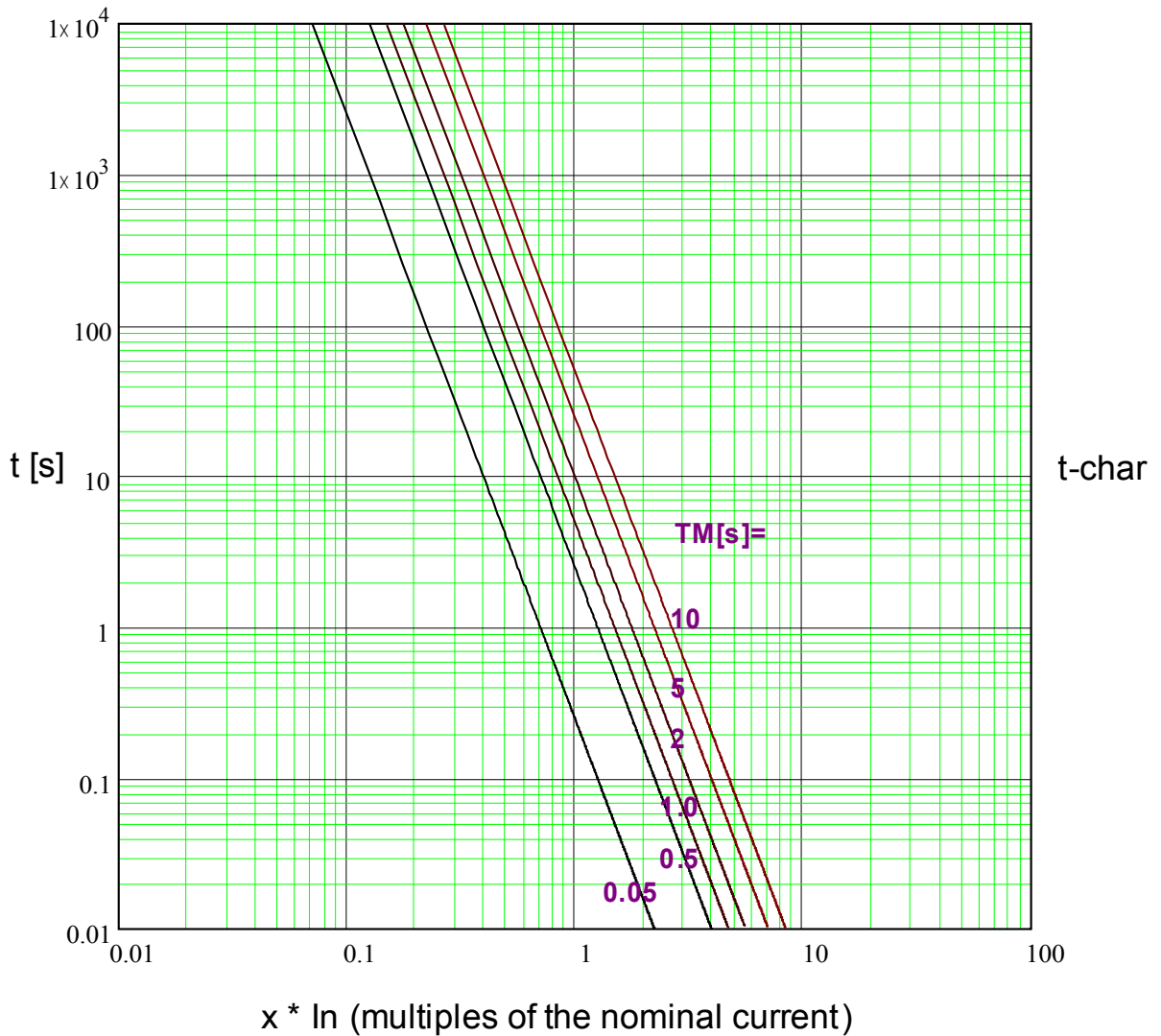

Prot - Earth fault - direction detection

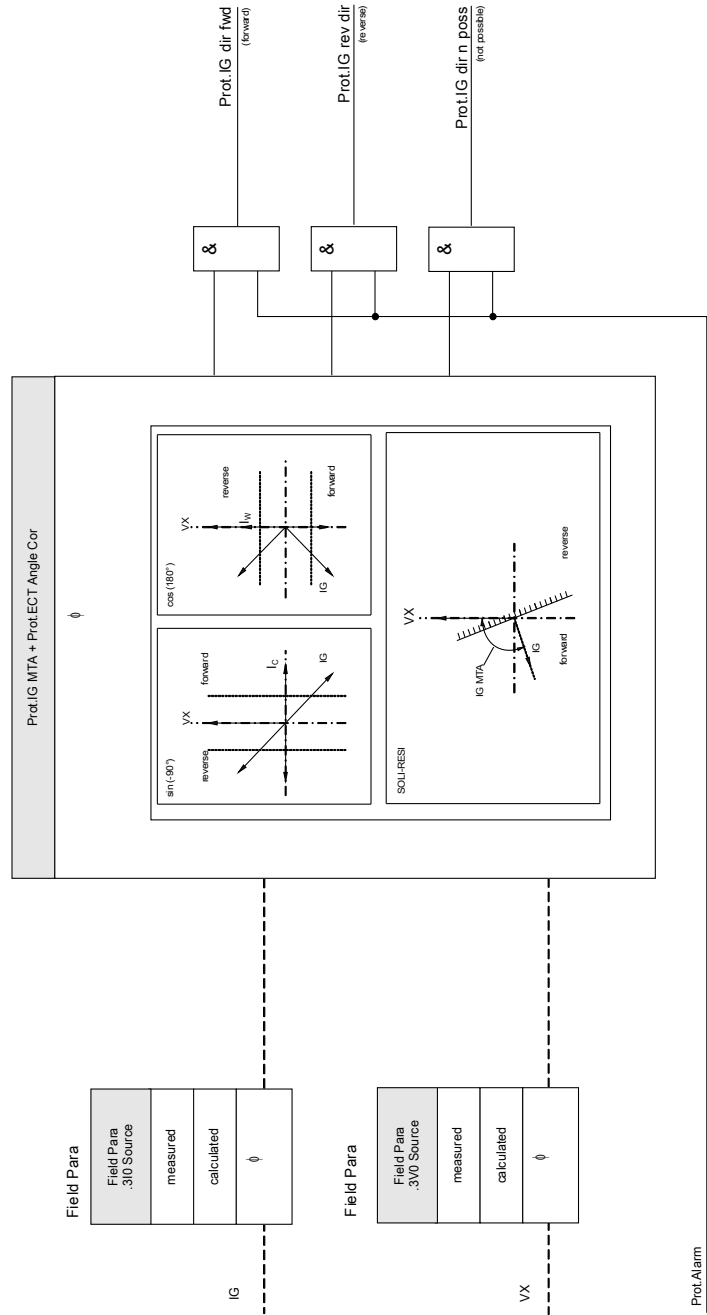

**direction decision Earth fault**

name = IG[1]...[n]

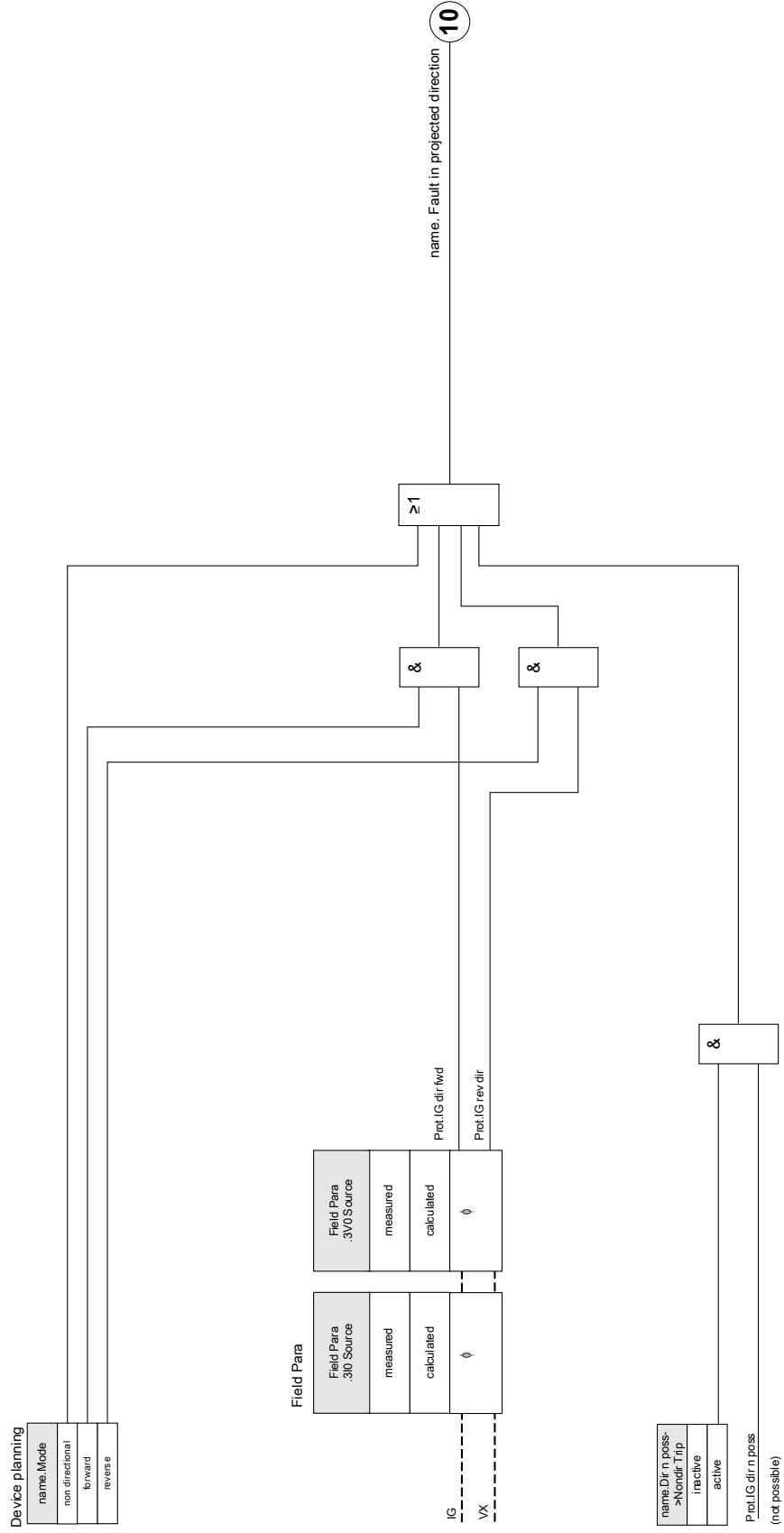

IG[1]...[n]

name = IG[1]...[n]

4 Please Refer To Diagram: Blockings\*\*  
(Stage is not deactivated and no active blocking signals)

10 Please Refer To Diagram: direction decision Earth fault  
name: \* Fault in projected direction

8 Please Refer To Diagram: IH2  
IH2: Blo IG

3 Please Refer To Diagram: Trip blockings  
(Tripping command deactivated or blocked.)

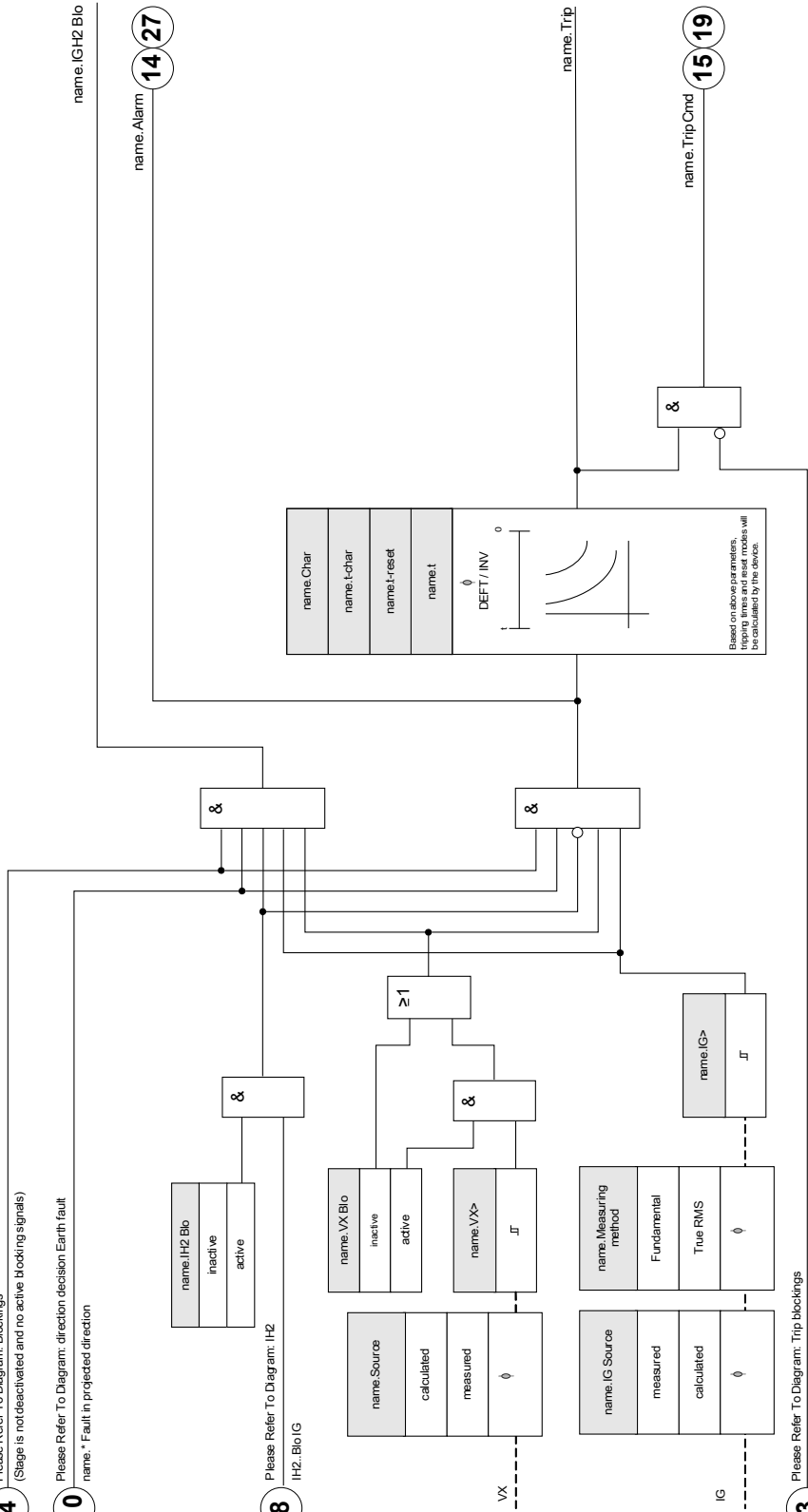

## Device Planning Parameters of the Ground Fault Protection

Parameter	Description	Options	Default	Menu path
 Mode	Mode	do not use, non directional, forward, reverse	do not use	[Device planning]

### Global Protection Parameters of the Ground Fault Protection

Parameter	Description	Setting range	Default	Menu path
 ExBlo1	External blocking of the module, if blocking is activated (allowed) within a parameter set and if the state of the assigned signal is true.	1..n, Assignment List	--	[Protection Para /Global Prot Para /I-Prot /IG[1]]
 ExBlo2	External blocking of the module, if blocking is activated (allowed) within a parameter set and if the state of the assigned signal is true.	1..n, Assignment List	--	[Protection Para /Global Prot Para /I-Prot /IG[1]]
 ExBlo TripCmd	External blocking of the Trip Command of the module/the stage, if blocking is activated (allowed) within a parameter set and if the state of the assigned signal is true.	1..n, Assignment List	--	[Protection Para /Global Prot Para /I-Prot /IG[1]]
 Ex rev Interl	External blocking of the module by external reverse interlocking, if blocking is activated (allowed) within a parameter set and if the state of the assigned signal is true.	1..n, Assignment List	--	[Protection Para /Global Prot Para /I-Prot /IG[1]]
 AdaptSet 1	Assignment Adaptive Parameter 1	AdaptSet	--	[Protection Para /Global Prot Para /I-Prot /IG[1]]
 AdaptSet 2	Assignment Adaptive Parameter 2	AdaptSet	--	[Protection Para /Global Prot Para /I-Prot /IG[1]]
 AdaptSet 3	Assignment Adaptive Parameter 3	AdaptSet	--	[Protection Para /Global Prot Para /I-Prot /IG[1]]





## Protective Elements

---

<i>Parameter</i>	<i>Description</i>	<i>Setting range</i>	<i>Default</i>	<i>Menu path</i>
AdaptSet 4 	Assignment Adaptive Parameter 4	AdaptSet	-.-	[Protection Para /Global Prot Para /I-Prot /IG[1]]

### Setting Group Parameters of the Ground Fault Protection

Parameter	Description	Setting range	Default	Menu path
 Function	Permanent activation or deactivation of module/stage.	inactive, active	inactive	[Protection Para /<1..4> /I-Prot /IG[1]]
 ExBlo Fc	Activate (allow) or inactivate (disallow) blocking of the module/stage. This parameter is only effective if a signal is assigned to the corresponding global protection parameter. If the signal becomes true, those modules/stages are blocked that are parameterized "ExBlo Fc=active".	inactive, active	inactive	[Protection Para /<1..4> /I-Prot /IG[1]]
 Ex rev Interl Fc	Activate (allow) or inactivate (disallow) blocking of the module/stage. This parameter is only effective if a signal is assigned to the corresponding global protection parameter. If the signal becomes true, those modules/stages are blocked that are parameterized "Ex rev Interl Fc = active".	inactive, active	inactive	[Protection Para /<1..4> /I-Prot /IG[1]]
 Blo TripCmd	Permanent blocking of the Trip Command of the module/stage.	inactive, active	inactive	[Protection Para /<1..4> /I-Prot /IG[1]]
 ExBlo TripCmd Fc	Activate (allow) or inactivate (disallow) blocking of the module/stage. This parameter is only effective if a signal is assigned to the corresponding global protection parameter. If the signal becomes true, those modules/stages are blocked that are parameterized "ExBlo TripCmd Fc=active".	inactive, active	inactive	[Protection Para /<1..4> /I-Prot /IG[1]]
 IG Source	Selection if measured or calculated ground current should be used.	sensitive measure- ment, measured, calculated	calculated	[Protection Para /<1..4> /I-Prot /IG[1]]
 Measuring method	Measuring method: fundamental or rms	Fundamental, True RMS	Fundamental	[Protection Para /<1..4> /I-Prot /IG[1]]
 VX Source	Selection if VG is measured or calculated (neutral voltage or residual voltage)	measured, calculated	measured	[Protection Para /<1..4> /I-Prot /IG[1]]

Protective Elements

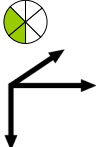
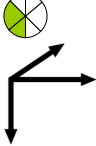
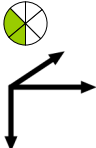
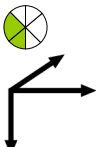
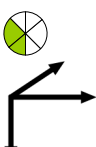
Parameter	Description	Setting range	Default	Menu path
Meas Circuit Superv 	Measuring Circuit Supervision Only available if "VX Source" ist set to "calculated".	inactive, active	inactive	[Protection Para <1..4> /I-Prot /IG[1]]
IG> 	If the pickup value is exceeded, the module/stage will be started.	0.02 - 20.00In	0.02In	[Protection Para <1..4> /I-Prot /IG[1]]
IGs> 	If the pickup value is exceeded, the module/stage will be started.	0.002 - 2.000In	0.02In	[Protection Para <1..4> /I-Prot /IG[1]]
Char 	Characteristic	DEFT, IEC NINV, IEC VINV, IEC EINV, IEC LINV, ANSI MINV, ANSI VINV, ANSI EINV, Therm Flat, IT, I2T, I4T, RXIDG	DEFT	[Protection Para <1..4> /I-Prot /IG[1]]
t 	Tripping delay Only available if: Characteristic = DEFT	0.00 - 300.00s	0.00s	[Protection Para <1..4> /I-Prot /IG[1]]
t-char 	Time multiplier/tripping characteristic factor. The setting range depends on the selected tripping curve. Only available if: Characteristic = INV Or Characteristic = Therm Flat Or Characteristic = IT Or Characteristic = I2T Or Characteristic = I4T Or Characteristic = RXIDG	0.02 - 20.00	1	[Protection Para <1..4> /I-Prot /IG[1]]

Protective Elements

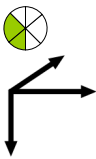
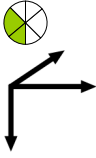
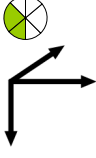
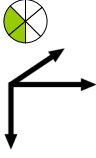
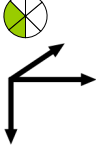
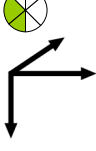
Parameter	Description	Setting range	Default	Menu path
 Reset Mode	Reset Mode  Only available if: Characteristic = INV Or Characteristic = Therm Flat Or Characteristic = IT Or Characteristic = I2T Or Characteristic = I4T Or Characteristic = RXIDG	instantaneous, t-delay, calculated	instantaneous	[Protection Para <1..4> /I-Prot /IG[1]]
 t-reset	Reset time for intermittent phase failures (INV characteristics only)  Only available if: Characteristic = INV Or Characteristic = Therm Flat Or Characteristic = IT Or Characteristic = I2T Or Characteristic = I4T Or Characteristic = RXIDG Only available if: Reset Mode = t-delay	0.00 - 60.00s	0.00s	[Protection Para <1..4> /I-Prot /IG[1]]
 IH2 Blo	Blocking the trip command, if an inrush is detected.	inactive, active	inactive	[Protection Para <1..4> /I-Prot /IG[1]]
 Dir n poss->Nondir Trip	Only relevant for current protection elements with directional feature! The device will trip non directional if this parameter is set to active and no direction could be determined. Direction detection is impossible e.g. if the required quantities for the direction detection cannot be measured or validated. Direction detection is also impossible if the frequency deviates significantly from the nominal frequency. Caution: If this parameter is set to inactive, the protective element will trip only if the direction can be detected.  Only available if: Device planning: Earth current protection - Stage.Mode = directional	inactive, active	inactive	[Protection Para <1..4> /I-Prot /IG[1]]
 VX Blo	VX Blo = active means that the IG-stage will only excite if a residual voltage higher than the pickup value is measured at the same time. VX Blo = inactive means that the excitation of the IG stage does not depend on any residual voltage stage.	inactive, active	inactive	[Protection Para <1..4> /I-Prot /IG[1]]
 VX>	If the pickup value is exceeded, the module/stage will be started.  Only available if: VX Blo = active	0.01 - 1.50Vn	1.00Vn	[Protection Para <1..4> /I-Prot /IG[1]]

## Ground Fault Protection Input States

<i>Name</i>	<i>Description</i>	<i>Assignment via</i>
ExBlo1-I	Module input state: External blocking1	[Protection Para /Global Prot Para /I-Prot /IG[1]]
ExBlo2-I	Module input state: External blocking2	[Protection Para /Global Prot Para /I-Prot /IG[1]]
ExBlo TripCmd-I	Module input state: External Blocking of the Trip Command	[Protection Para /Global Prot Para /I-Prot /IG[1]]
Ex rev Inter-I	Module input state: External reverse interlocking	[Protection Para /Global Prot Para /I-Prot /IG[1]]
AdaptSet1-I	Module input state: Adaptive Parameter1	[Protection Para /Global Prot Para /I-Prot /IG[1]]
AdaptSet2-I	Module input state: Adaptive Parameter2	[Protection Para /Global Prot Para /I-Prot /IG[1]]
AdaptSet3-I	Module input state: Adaptive Parameter3	[Protection Para /Global Prot Para /I-Prot /IG[1]]
AdaptSet4-I	Module input state: Adaptive Parameter4	[Protection Para /Global Prot Para /I-Prot /IG[1]]

## Ground Fault Protection Signals (Output States)

<i>Signal</i>	<i>Description</i>
active	Signal: active
ExBlo	Signal: External Blocking
Ex rev Interl	Signal: External reverse Interlocking
Blo TripCmd	Signal: Trip Command blocked
ExBlo TripCmd	Signal: External Blocking of the Trip Command
Alarm	Signal: Alarm IG
Trip	Signal: Trip
TripCmd	Signal: Trip Command
IGH2 Blo	Signal: blocked by an inrush
Active AdaptSet	Active Adaptive Parameter
DefaultSet	Signal: Default Parameter Set
AdaptSet 1	Signal: Adaptive Parameter 1
AdaptSet 2	Signal: Adaptive Parameter 2
AdaptSet 3	Signal: Adaptive Parameter 3
AdaptSet 4	Signal: Adaptive Parameter 4

### Commissioning: Ground Fault Protection – non-directional [50N/G, 51N/G]

Please test the non-directional earth overcurrent analog to the non-directional phase overcurrent protection.

### Commissioning: Ground Fault Protection – directional [50N/G, 51N/G, 67N/G]

Please test the directional earth overcurrent analog to the directional phase overcurrent protection.

## ThR-Protection Module: Thermal Replica [49]

### ThR

The maximal permissible thermal loading capacity, and consequently the tripping delay of a component, depends on the amount of the flowing current at a specific time, the »previously existing load (current)« as well as on a constant specified by the component.

The thermal overload protection is in compliance with IEC255-8 (VDE 435 T301). A complete thermal replica function is implemented in the device as Homogeneous-Body Replica of the equipment to be protected and by taking the previously existing load into account. The protection function is of one step design, provided with a warning limit.

For this the device calculates the thermal load of the equipment by using the existing measured values and the parameter settings. When knowing the thermal constants, the temperature of the equipment can be established (simulated).

The general tripping times of the overload protection can be gathered from the following equation according to IEC 255-8:

$$t = \tau\text{-warm} \ln\left(\frac{I^2 - I_p^2}{I^2 - (K \cdot I_b)^2}\right)$$

### Legend:

t = Tripping delay

$\tau\text{-warm}$  = Warming-up time constant

$\tau\text{-cool}$  = Cooling time constant

$I_b$  = Base current: Maximum permissible thermal continuous current.

K = Overload Factor: The maximum thermal limit is defined as  $k \cdot I_b$ , the product of the overload factor and the base current .

I = measured current (x ln)

$I_p$  = Preload Current

**ThR**

name = ThR

**2**

Please Refer To Diagram: Blockings  
(Stage is not deactivated and no active blocking signals)

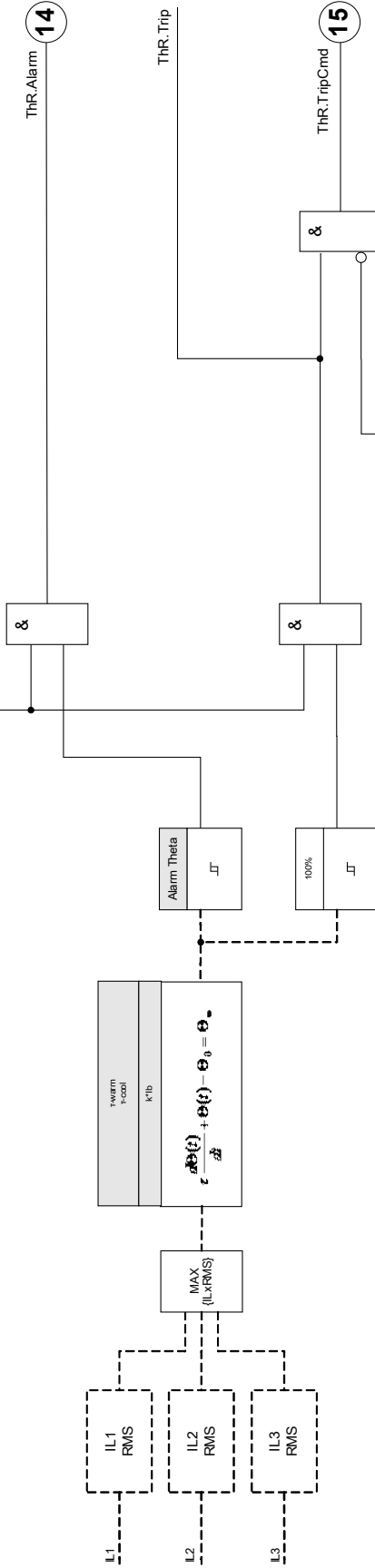

**3**

Please Refer To Diagram: Trip blockings  
(Tripping command deactivated or blocked.)





### Direct Commands of the Thermal Overload Module

<i>Parameter</i>	<i>Description</i>	<i>Setting range</i>	<i>Default</i>	<i>Menu path</i>
Reset 	Reset the Thermal Replica	inactive, active	inactive	[Operation /Reset]

### Device Planning Parameters of the Thermal Overload Module

<i>Parameter</i>	<i>Description</i>	<i>Options</i>	<i>Default</i>	<i>Menu path</i>
Mode 	Mode	do not use, use	do not use	[Device planning]

## Global Protection Parameters of the Thermal Overload Module

<i>Parameter</i>	<i>Description</i>	<i>Setting range</i>	<i>Default</i>	<i>Menu path</i>
ExBlo1 	External blocking of the module, if blocking is activated (allowed) within a parameter set and if the state of the assigned signal is true.	1..n, Assignment List	.-	[Protection Para /Global Prot Para /I-Prot /ThR]
ExBlo2 	External blocking of the module, if blocking is activated (allowed) within a parameter set and if the state of the assigned signal is true.	1..n, Assignment List	.-	[Protection Para /Global Prot Para /I-Prot /ThR]
ExBlo TripCmd 	External blocking of the Trip Command of the module/the stage, if blocking is activated (allowed) within a parameter set and if the state of the assigned signal is true.	1..n, Assignment List	.-	[Protection Para /Global Prot Para /I-Prot /ThR]

## Setting Group Parameters of the Thermal Overload Module

Parameter	Description	Setting range	Default	Menu path
Function 	Permanent activation or deactivation of module/stage.	inactive, active	inactive	[Protection Para /<1..4> /I-Prot /ThR]
ExBlo Fc 	Activate (allow) or inactivate (disallow) blocking of the module/stage. This parameter is only effective if a signal is assigned to the corresponding global protection parameter. If the signal becomes true, those modules/stages are blocked that are parameterized "ExBlo Fc=active".	inactive, active	inactive	[Protection Para /<1..4> /I-Prot /ThR]
Blo TripCmd 	Permanent blocking of the Trip Command of the module/stage.	inactive, active	inactive	[Protection Para /<1..4> /I-Prot /ThR]
ExBlo TripCmd Fc 	Activate (allow) or inactivate (disallow) blocking of the module/stage. This parameter is only effective if a signal is assigned to the corresponding global protection parameter. If the signal becomes true, those modules/stages are blocked that are parameterized "ExBlo TripCmd Fc=active".	inactive, active	inactive	[Protection Para /<1..4> /I-Prot /ThR]
Ib 	Base current: Maximum permissible thermal continuous current.	0.01 - 4.00I <sub>n</sub>	1.00I <sub>n</sub>	[Protection Para /<1..4> /I-Prot /ThR]
K 	Overload Factor: The maximum thermal limit is defined as $k \cdot I_B$ , the product of the overload factor and the base current.	0.80 - 1.20	1.00	[Protection Para /<1..4> /I-Prot /ThR]
Alarm Theta 	Pickup value	50 - 100%	80%	[Protection Para /<1..4> /I-Prot /ThR]
$\tau$ -warm 	Warming-up time constant	1 - 60000s	10s	[Protection Para /<1..4> /I-Prot /ThR]

## Protective Elements

---

<i>Parameter</i>	<i>Description</i>	<i>Setting range</i>	<i>Default</i>	<i>Menu path</i>
$\tau$ -cool 	Cooling time constant	1 - 60000s	10s	[Protection Para /<1..4> /I-Prot /ThR]

## Thermal Overload Module Input States

<i>Name</i>	<i>Description</i>	<i>Assignment via</i>
ExBlo1-I	Module input state: External blocking1	[Protection Para /Global Prot Para /I-Prot /ThR]
ExBlo2-I	Module input state: External blocking2	[Protection Para /Global Prot Para /I-Prot /ThR]
ExBlo TripCmd-I	Module input state: External Blocking of the Trip Command	[Protection Para /Global Prot Para /I-Prot /ThR]

## Signals of the Thermal Overload Signals (Output States)

<i>Signal</i>	<i>Description</i>
active	Signal: active
ExBlo	Signal: External Blocking
Blo TripCmd	Signal: Trip Command blocked
ExBlo TripCmd	Signal: External Blocking of the Trip Command
Alarm	Signal: Alarm Thermal Overload
Trip	Signal: Trip
TripCmd	Signal: Trip Command
Res Thermal Cap	Signal: Resetting Thermal Replica

### Thermal Overload Module Values

<i>Value</i>	<i>Description</i>	<i>Menu path</i>
Thermal Cap Used	Measured value: Thermal Capacity Used	[Operation /Measured values /ThR]
Time To Trip	Measured value (calculated/measured): Remaining time until the thermal overload module will trip	[Operation /Measured values /ThR]

### Thermal Overload Module Statistics

<i>Value</i>	<i>Description</i>	<i>Menu path</i>
Thermal Cap max	Thermal Capacity maximum value	[Operation /Statistics /Max /ThR]
Thermal Cap min	Thermal Capacity minimum value	[Operation /Statistics /Min /ThR]

## Commissioning: Thermal Replica

*Object to be tested*

Protective function *ThR*

*Necessary means*

- Three-phase current source
- Timer

*Procedure*

Calculate the tripping time for the current to be constantly impressed by using the formula for the thermal image.

**NOTICE** The parameter of the temperature rise of the component » $\tau_w$ « has to be known to guarantee an optimal protection.

$$t = \tau_{\text{warm}} \ln \left( \frac{I^2 - I_p^2}{I^2 - (K \cdot I_b)^2} \right)$$

Legend:

t = Tripping delay

$\tau_{\text{warm}}$  = Warming-up time constant

$\tau_{\text{cool}}$  = Cooling time constant

$I_b$  = Base current: Maximum permissible thermal continuous current.

K = Overload Factor: The maximum thermal limit is defined as  $k \cdot I_b$ , the product of the overload factor and the base current .

I = measured current (x ln)

$I_p$  = Preload Current

*Testing the threshold values*

Apply the current you have based your mathematical calculation on.

*Testing the trip delay*

**NOTICE** The thermal capacity should be zero before the test is started. See »Measuring Values«.

For testing the trip delay, a timer is to be connected to the contact of the associated trip relay.

Apply the current you have based your mathematical calculation on. The timer is started as soon as the current is applied and it is stopped when the relay trips.

*Successful test result*

The calculated tripping time and the fallback ratio comply with the measured values. For permissible deviations/tolerances, please see Technical Data.

## I2 and %I2/I1> - Unbalanced Load [46]

Elements:

I2>[1], I2>[2]

The I2> Current Unbalance element works similar to the V 012 Voltage Unbalance element. The positive and negative sequence currents are calculated from the 3-phase currents. The Threshold setting defines a minimum operating current magnitude of I2 for the 46 function to operate, which insures that the relay has a solid basis for initiating a current unbalance trip. The » % (I2/I1) « (option) setting is the unbalance trip pickup setting. It is defined by the ratio of negative sequence current to positive sequence current » % (I2/I1) «.

This function requires positive or negative sequence current magnitude above the threshold setting and the percentage current unbalance above the » % (I2/I1) « setting before allowing a current unbalance trip. Therefore, both the threshold and percent settings must be met for the specified Delay time setting before the relay initiates a trip for current unbalance.

**NOTICE** All elements are identically structured.

Rating value I2> is the permitted continuous unbalanced load current. For both steps trip characteristics are provided, namely a definite time characteristic (DEFT) and an inverse characteristic (INV).

The characteristic of the inverse curve is as follows:

$$t [s] \leq \frac{K * I_n^2}{I^2 - I_{2>}^2}$$

Legend:

I<sub>n</sub> [A] = Nominal current

t [s] = Tripping delay

K [s] = Indicates the thermal load capability of the engine while running with 100% unbalanced load current.

I2> [A] = The Threshold setting defines a minimum operating current magnitude of I2 for the 46 function to operate, which ensures that the relay has a solid basis for initiating a current unbalance trip. This is a supervisory function and not a trip level.

I2 [A] = Measured value (calculated): Unbalanced load current

In the equation shown above the heating-up process is assumed by integration of the counter system current I2. When I2> is undershoot, the built-up heat amount will be reduced in line with the adjusted cooling-down constant "tau-cool".

$$\Theta(t) = \Theta_0 * e^{-\frac{t}{\tau_{cool}}}$$



Legend:

$t$  = Tripping delay

$\tau$ -cool = Cooling time constant

$\Theta(t)$  = Momentary heat (thermal) energy

$\Theta_0$  = Heat (thermal) energy before the cooling down has started

If the heat amount is not reduced when the permitted unbalanced load current is overshoot again, the remaining heat amount will cause an earlier tripping.

46[1]...[n]

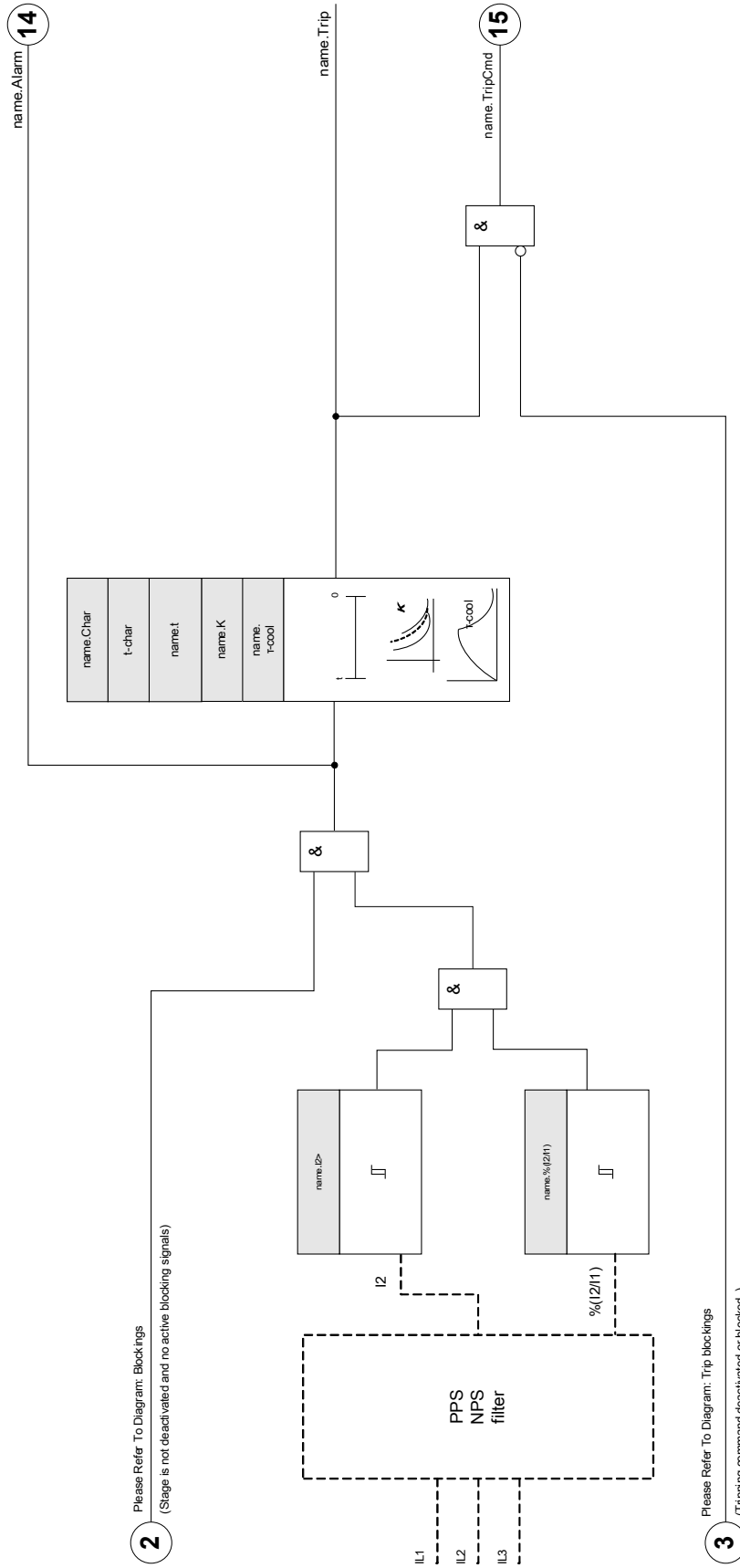

name = 46[1]...[n]











## Device Planning Parameters of the Current Unbalance Module

<i>Parameter</i>	<i>Description</i>	<i>Options</i>	<i>Default</i>	<i>Menu path</i>
Mode 	Mode	do not use, use	do not use	[Device planning]



## Global Protection Parameters of the Current Unbalance Module

<i>Parameter</i>	<i>Description</i>	<i>Setting range</i>	<i>Default</i>	<i>Menu path</i>
ExBlo1 	External blocking of the module, if blocking is activated (allowed) within a parameter set and if the state of the assigned signal is true.	1..n, Assignment List	-.-	[Protection Para /Global Prot Para /I-Prot /I2>[1]]
ExBlo2 	External blocking of the module, if blocking is activated (allowed) within a parameter set and if the state of the assigned signal is true.	1..n, Assignment List	-.-	[Protection Para /Global Prot Para /I-Prot /I2>[1]]
ExBlo TripCmd 	External blocking of the Trip Command of the module/the stage, if blocking is activated (allowed) within a parameter set and if the state of the assigned signal is true.	1..n, Assignment List	-.-	[Protection Para /Global Prot Para /I-Prot /I2>[1]]

### Setting Group Parameters of the Current Unbalance Module

Parameter	Description	Setting range	Default	Menu path
Function 	Permanent activation or deactivation of module/stage.	inactive, active	inactive	[Protection Para /<1..4> /I-Prot /I2>[1]]
ExBlo Fc 	Activate (allow) or inactivate (disallow) blocking of the module/stage. This parameter is only effective if a signal is assigned to the corresponding global protection parameter. If the signal becomes true, those modules/stages are blocked that are parameterized "ExBlo Fc=active".	inactive, active	inactive	[Protection Para /<1..4> /I-Prot /I2>[1]]
Blo TripCmd 	Permanent blocking of the Trip Command of the module/stage.	inactive, active	inactive	[Protection Para /<1..4> /I-Prot /I2>[1]]
ExBlo TripCmd Fc 	Activate (allow) or inactivate (disallow) blocking of the module/stage. This parameter is only effective if a signal is assigned to the corresponding global protection parameter. If the signal becomes true, those modules/stages are blocked that are parameterized "ExBlo TripCmd Fc=active".	inactive, active	inactive	[Protection Para /<1..4> /I-Prot /I2>[1]]
I2> 	The Threshold setting defines a minimum operating current magnitude of I2 for the 46 function to operate, which ensures that the relay has a solid basis for initiating a current unbalance trip. This is a supervisory function and not a trip level.  Only available if: Device planning: I2>.Mode = 46	0.01 - 4.00In	0.01In	[Protection Para /<1..4> /I-Prot /I2>[1]]
%(I2/I1) 	The %(I2/I1) setting is the unbalance trip pickup setting. It is defined by the ratio of negative sequence current to positive sequence current (% Unbalance=I2/I1). Phase sequence will be taken into account automatically.	inactive, active	inactive	[Protection Para /<1..4> /I-Prot /I2>[1]]
%(I2/I1) 	The %(I2/I1) setting is the unbalance trip pickup setting. It is defined by the ratio of negative sequence current to positive sequence current (% Unbalance=I2/I1). Phase sequence will be taken into account automatically.  Only available if: %(I2/I1) = use	2 - 40%	20%	[Protection Para /<1..4> /I-Prot /I2>[1]]
Char 	Characteristic	DEFT, INV	DEFT	[Protection Para /<1..4> /I-Prot /I2>[1]]

## Protective Elements

Parameter	Description	Setting range	Default	Menu path
t 	<p>Tripping delay</p> <p>Only available if: Characteristic = DEFT</p>	0.00 - 300.00s	0.00s	[Protection Para /<1..4> /I-Prot /I2>[1]]
K 	<p>This setting is the negative sequence capability constant. This value is normally provided by the generator manufacturer.</p> <p>Only available if: Characteristic = INV</p>	1.00 - 200.00s	10.0s	[Protection Para /<1..4> /I-Prot /I2>[1]]
T-cool 	<p>If the unbalanced load current falls below the pickup value, the cooling-off time is taken into account. If the unbalanced load exceeds the pickup value again, than the saved heat within the electrical equipment will lead to an accelerated trip.</p> <p>Only available if: Characteristic = INV</p>	0.0 - 60000.0s	0.0s	[Protection Para /<1..4> /I-Prot /I2>[1]]

## Current Unbalance Module Input States

<i>Name</i>	<i>Description</i>	<i>Assignment via</i>
ExBlo1-I	Module input state: External blocking1	[Protection Para /Global Prot Para /I-Prot /I2>[1]]
ExBlo2-I	Module input state: External blocking2	[Protection Para /Global Prot Para /I-Prot /I2>[1]]
ExBlo TripCmd-I	Module input state: External Blocking of the Trip Command	[Protection Para /Global Prot Para /I-Prot /I2>[1]]

## Current Unbalance Module Signals (Output States)

<i>Signal</i>	<i>Description</i>
active	Signal: active
ExBlo	Signal: External Blocking
Blo TripCmd	Signal: Trip Command blocked
ExBlo TripCmd	Signal: External Blocking of the Trip Command
Alarm	Signal: Alarm Negative Sequence
Trip	Signal: Trip
TripCmd	Signal: Trip Command

## Commissioning: Current Unbalance Module

### *Object to be tested:*

Test of the unbalanced load protection function.

### *Necessary means:*

- Three-phase current source with adjustable current unbalance; and
- Timer.

### *Procedure:*

#### *Check the phase sequence:*

- Ensure that the phase sequence is the same as that set in the field parameters.
- Feed-in a three-phase nominal current.
- Change to the »Measuring Values« menu.
- Check the measuring value for the unbalanced current »I2«. The measuring value displayed for »I2« should be zero (within the physical measuring accuracy).

### **NOTICE**

**If the displayed magnitude for I2 is the same as that for the symmetrical nominal currents fed to the relay, it implies that the phase sequence of the currents seen by the relay is reversed.**

- Now turn-off phase L1.
- Again check the measuring value of the unbalanced current »I2« in the »Measuring Values« menu. The measuring value of the asymmetrical current »I2« should now be 33%.
- Turn-on phase L1, but turn-off phase L2.
- Once again check the measuring value of the asymmetrical current I2 in the »Measuring Values« menu. The measuring value of the asymmetrical current »I2« should be again 33%.
- Turn-on phase L2, but turn-off phase L3.
- Again check the measuring value of asymmetrical current »I2« in the »Measuring Values« menu. The measuring value of the asymmetrical current »I2« should still be 33%.

#### *Testing the trip delay:*

- Apply a symmetrical three-phase current system (nominal currents).
- Switch off IL1 (the threshold value »Threshold« for »I2« must be below 33%).
- Measure the tripping time.

The present current unbalance »I2« corresponds with 1/3 of the existing phase current displayed.

#### *Testing the threshold values*

- Configure minimum »  $I_{2/1}$  « setting (2%) and an arbitrary threshold value » *Threshold* « (I2).
- For testing the threshold value, a current has to be fed to phase A which is lower than three times the adjusted threshold value » *Threshold* « (I2).
- Feeding only phase A results in »  $I_{2/1} = 100\%$ «, so the first condition »  $I_{2/1} \geq 2\%$ « is always fulfilled.
- Now increase the phase L1 current until the relay is activated.

### *Testing the dropout ratio of the threshold values*

Having tripped the relay in the previous test, now decrease the phase A current. The dropout ratio must not be higher than 0.97 times the threshold value.

### *Testing $I_{2/1}$*

- Configure minimum threshold value » *Threshold* « (I2) ( $0.01 \times I_n$ ) and set »  $I_{2/1}$  « greater or equal to 10%.
- Apply a symmetrical three-phase current system (nominal currents). The measuring value of »  $I_{2/1}$  « should be 0%.
- Now increase the phase L1 current. With this configuration, the threshold value » *Threshold* « (I2) should be reached before the value »  $I_{2/1}$  « reaches the set »  $I_{2/1}$  « ratio threshold.
- Continue increasing the phase 1 current until the relay is activated.

### *Testing the dropout ratio of $I_{2/1}$*

Having tripped the relay in the previous test, now decrease the phase L1 current. The dropout of »  $I_{2/1}$  « has to be 1% below the »  $I_{2/1}$  « setting.

### *Successful test result:*

The measured trip delays, threshold values, and dropout ratios are within the permitted deviations/tolerances, specified under Technical Data.



## IH2 - Inrush

Available elements:

IH2

The inrush module can prevent false trips caused by switching actions of saturated inductive loads. The ratio of the 2<sup>nd</sup> harmonic to the 1<sup>st</sup> harmonic is taken into account.

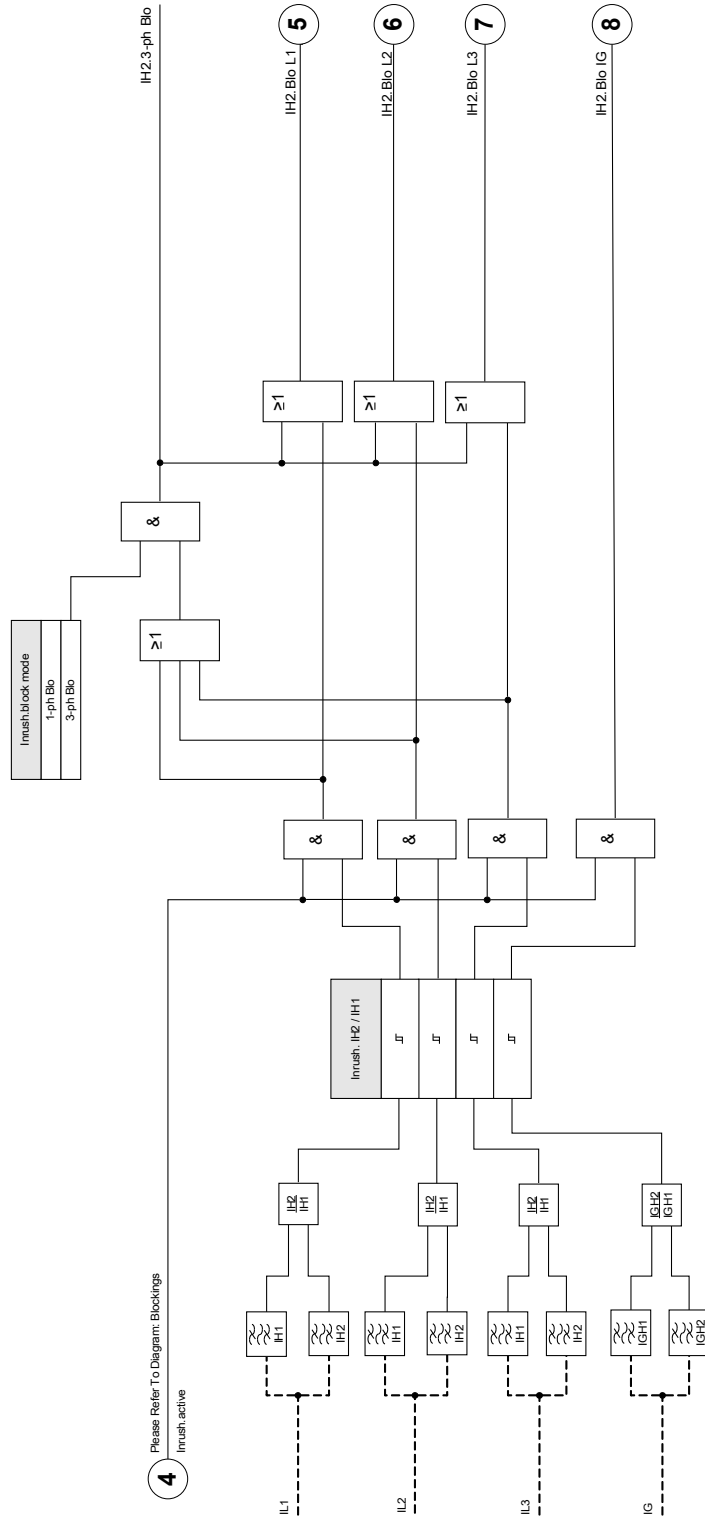

IH2







## Device Planning Parameters of the Inrush Module

<i>Parameter</i>	<i>Description</i>	<i>Options</i>	<i>Default</i>	<i>Menu path</i>
Mode 	Mode	do not use, use	do not use	[Device planning]

## Global Protection Parameters of the Inrush module

<i>Parameter</i>	<i>Description</i>	<i>Setting range</i>	<i>Default</i>	<i>Menu path</i>
ExBlo1 	External blocking of the module, if blocking is activated (allowed) within a parameter set and if the state of the assigned signal is true.	1..n, Assignment List	-.-	[Protection Para /Global Prot Para /I-Prot /IH2]
ExBlo2 	External blocking of the module, if blocking is activated (allowed) within a parameter set and if the state of the assigned signal is true.	1..n, Assignment List	-.-	[Protection Para /Global Prot Para /I-Prot /IH2]

### Setting Group Parameters of the Inrush Module

Parameter	Description	Setting range	Default	Menu path
Function 	Permanent activation or deactivation of module/stage.	inactive, active	inactive	[Protection Para /<1..4> /I-Prot /IH2]
ExBlo Fc 	Activate (allow) or inactivate (disallow) blocking of the module/stage. This parameter is only effective if a signal is assigned to the corresponding global protection parameter. If the signal becomes true, those modules/stages are blocked that are parameterized "ExBlo Fc=active".	inactive, active	inactive	[Protection Para /<1..4> /I-Prot /IH2]
IH2 / IH1 	Maximum permissible percentage of the 2nd harmonic of the 1st harmonic.	10 - 40%	15%	[Protection Para /<1..4> /I-Prot /IH2]
block mode 	1-ph Blo: If an inrush is detected in one phase, the corresponding phase of those modules will be blocked, where inrush blocking is set to active./3-ph Blo: If an inrush is detected in at least one phase, all three phases of those modules where inrush blocking is set to active will be blocked (cross blocking).	1-ph Blo, 3-ph Blo	1-ph Blo	[Protection Para /<1..4> /I-Prot /IH2]

### Inrush Module Input States

Name	Description	Assignment via
ExBlo1-I	Module input state: External blocking1	[Protection Para /Global Prot Para /I-Prot /IH2]
ExBlo2-I	Module input state: External blocking2	[Protection Para /Global Prot Para /I-Prot /IH2]

**Inrush Module Signals (Output States)**

<i>Signal</i>	<i>Description</i>
active	Signal: active
ExBlo	Signal: External Blocking
Blo L1	Signal: Blocked L1
Blo L2	Signal: Blocked L2
Blo L3	Signal: Blocked L3
Blo IG meas	Signal: Blocking of the ground (earth) protection module (measured ground current)
Blo IG calc	Signal: Blocking of the ground (earth) protection module (calculated ground current)
3-ph Blo	Signal: Inrush was detected in at least one phase - trip command blocked.

## Commissioning: Inrush

### NOTICE

Dependent on the parameterized inrush-blocking-mode («*1-ph Blo* or *3-ph Blo*»), the test procedure is different.

For mode «*1-ph-Blo*» the test has to be carried out first for each individual phase and then for all three phases together.

For mode «*3-ph-Blo*» the test is a three-phase one.

#### *Object to be tested*

Test of inrush blocking.

#### *Necessary means*

- three-phase current source with adjustable frequency
- three-phase current source (for the first harmonic)

#### *Procedure (dependent on the parameterized blocking mode)*

- Feed the current to the secondary side with nominal frequency.
- Feed abruptly current to the secondary side with double nominal frequency. The amplitude must exceed the preset ratio/threshold «*I<sub>H2</sub>/I<sub>N</sub>*».
- Ascertain that the signal «*INRUSH ALARM*» is generated now.

#### *Successful test results*

The signal «*INRUSH ALARM*» is generated and the event recorder indicates the blocking of the current protection stage.

## SOTF - Switch Onto Fault

### SOTF

In case a faulty line is energized (e.g.: when an earthing switch is in the ON-Position), an instantaneous trip is required. The SOTF module is provided to generate a permissive signal for other protection functions such as overcurrents to accelerate their trips (via adaptive parameters). The SOTF condition is recognized according to the User's operation mode that can be based on:

- The breaker state (CB Pos);
- No current flowing ( $I <$ );
- Breaker state and no current flowing( CB Pos and  $I <$ );
- Breaker switched on manually (CB manually On); and/or
- An external trigger (Ex SOTF).

This protection module can initiate a high speed trip of the overcurrent protection modules.

**CAUTION** This module issues a signal only (the module is not armed and does not issue a trip command).

In order to influence the trip settings of the overcurrent protection in case of switching onto a fault, the User has to assign the signal "SOTF.ENABLED" onto an Adaptive Parameter Set. Please refer to Parameter / Adaptive Parameter Sets sections. Within the Adaptive Parameter Set, the User has to modify the trip characteristic of the overcurrent protection according to the User's needs.

**NOTICE** This Notice applies to protective devices that offer control functionality only! This protective element requires, that a switchgear (circuit breaker) is assigned to it. It is allowed only to assign switchgears (circuit breaker) to this protective element, whose measuring transformers provide measuring data to the protective device.

**SOTF**

name = SOTF

2 Please Refer To Diagram: Blockings  
(Stage is not deactivatd and no active blocking signals)

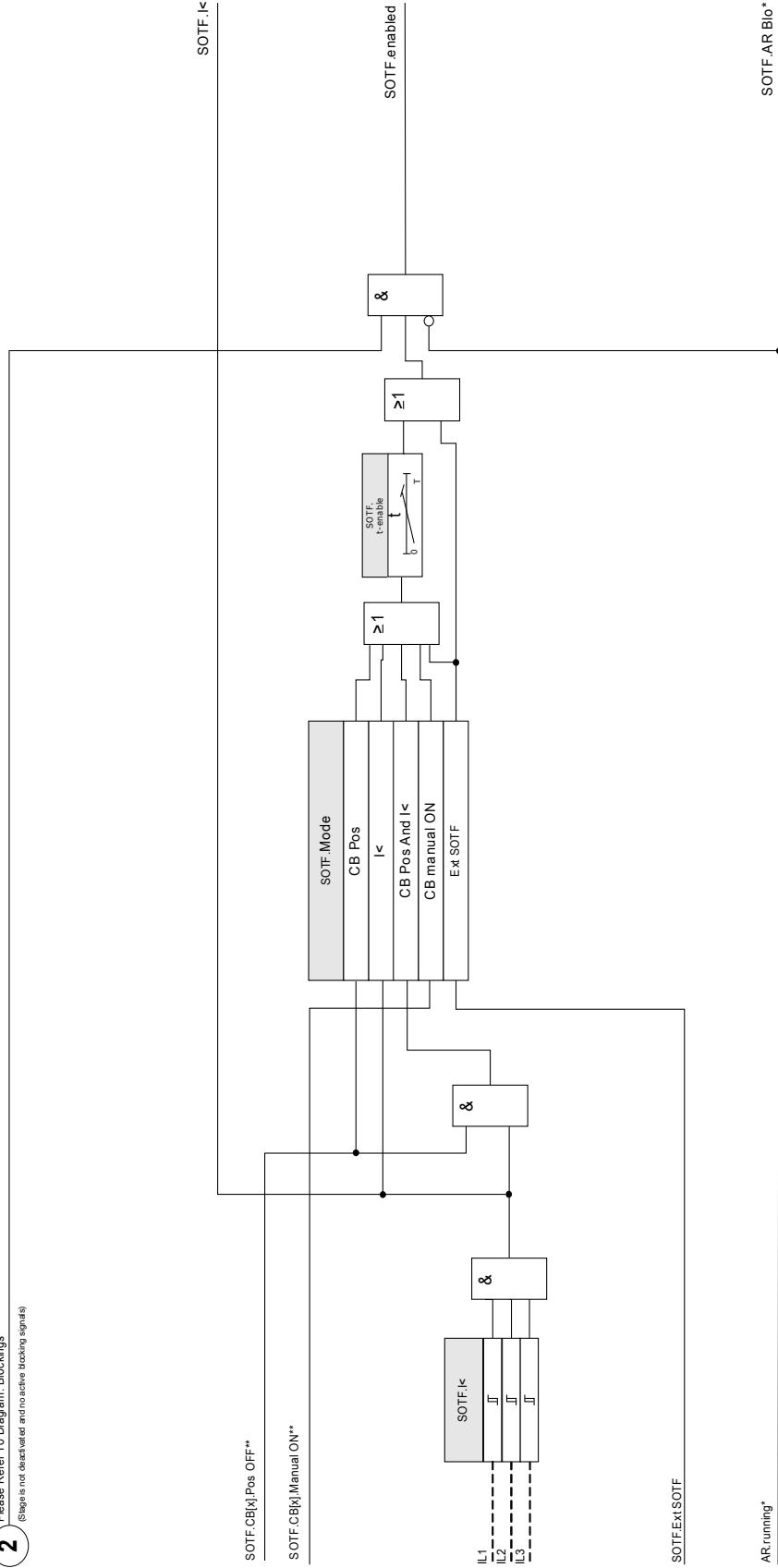

\*Applies only for devices with Auto Reclosure

\*\*This signal is the output of the switchgear that is assigned to this protective element. This applies to protective devices that offer control functionality.







### Device Planning Parameters of the Switch Onto Fault Module

<i>Parameter</i>	<i>Description</i>	<i>Options</i>	<i>Default</i>	<i>Menu path</i>
Mode 	Mode	do not use, use	do not use	[Device planning]

## Global Protection Parameters of the Switch Onto Fault Module

Parameter	Description	Setting range	Default	Menu path
Mode 	Mode	CB Pos, I<, CB Pos And I<, CB manual ON, Ext SOTF	CB Pos	[Protection Para /Global Prot Para /SOTF]
ExBlo1 	External blocking of the module, if blocking is activated (allowed) within a parameter set and if the state of the assigned signal is true.	1..n, Assignment List	--	[Protection Para /Global Prot Para /SOTF]
ExBlo2 	External blocking of the module, if blocking is activated (allowed) within a parameter set and if the state of the assigned signal is true.	1..n, Assignment List	--	[Protection Para /Global Prot Para /SOTF]
Ex rev Interl 	External blocking of the module by external reverse interlocking, if blocking is activated (allowed) within a parameter set and if the state of the assigned signal is true.	1..n, Assignment List	--	[Protection Para /Global Prot Para /SOTF]
Assigned SG 	Assigned Switchgear  Only available if: Mode = CB Pos Or CB Pos And I<	-, SG[1], SG[2], SG[3], SG[4], SG[5], SG[6]	SG[1]	[Protection Para /Global Prot Para /SOTF]
Ext SOTF 	External Switch Onto Fault  Only available if: Mode = Ext SOTF	1..n, DI-LogicList	--	[Protection Para /Global Prot Para /SOTF]

## Setting Group Parameters of the Switch Onto Fault Module

Parameter	Description	Setting range	Default	Menu path
Function 	Permanent activation or deactivation of module/stage.	inactive, active	inactive	[Protection Para /<1..4> /SOTF]
ExBlo Fc 	Activate (allow) or inactivate (disallow) blocking of the module/stage. This parameter is only effective if a signal is assigned to the corresponding global protection parameter. If the signal becomes true, those modules/stages are blocked that are parameterized "ExBlo Fc=active".	inactive, active	inactive	[Protection Para /<1..4> /SOTF]
Ex rev Interl Fc 	Activate (allow) or inactivate (disallow) blocking of the module/stage. This parameter is only effective if a signal is assigned to the corresponding global protection parameter. If the signal becomes true, those modules/stages are blocked that are parameterized "Ex rev Interl Fc = active".	inactive, active	inactive	[Protection Para /<1..4> /SOTF]
I< 	The CB is in the OFF Position, if the measured current is less than this parameter.	0.01 - 1.00In	0.01In	[Protection Para /<1..4> /SOTF]
t-enable 	While this timer is running, and while the module is not blocked, the Switch Onto Fault Module is effective (SOTF is armed).	0.10 - 10.00s	2s	[Protection Para /<1..4> /SOTF]

## Switch Onto Fault Module Input States

<i>Name</i>	<i>Description</i>	<i>Assignment via</i>
ExBlo1-I	Module input state: External blocking	[Protection Para /Global Prot Para /SOTF]
ExBlo2-I	Module input state: External blocking	[Protection Para /Global Prot Para /SOTF]
Ex rev Interl-I	Module input state: External reverse interlocking	[Protection Para /Global Prot Para /SOTF]
Ext SOTF-I	Module input state: External Switch Onto Fault Alarm	[Protection Para /Global Prot Para /SOTF]

## Signals of the Switch Onto Fault Module (Output States)

<i>Signal</i>	<i>Description</i>
active	Signal: active
ExBlo	Signal: External Blocking
Ex rev Interl	Signal: External reverse Interlocking
enabled	Signal: Switch Onto Fault enabled. This Signal can be used to modify Overcurrent Protection Settings.
AR Blo	Signal: Blocked by AR
I<	Signal: No Load Current.

## Commissioning: Switch Onto Fault

### Object to be tested

Testing the module *Switch Onto Fault* according to the parameterized operating mode:

- The breaker state (CB Pos);
- No current flowing ( $I <$ );
- Breaker state and no current flowing (CB Pos and  $I <$ );
- Breaker switched on manually (CB manually On); and/or
- An external trigger (Ex SOTF).

### Necessary means:

- Three-phase current source (If the Enable-Mode depends on current);
- Ampere meters (May be needed if the Enable-Mode depends on current); and
- Timer.

### Test Example for Mode CB manual ON

#### **NOTICE**

**Mode  $I <$ :** In order to test the effectiveness: Initially do not feed any current. Start the timer and feed with an abrupt change current that is distinctly greater than the  $I <$ -threshold to the measuring inputs of the relay.

**Mode  $I <$  and Bkr state:** Simultaneous switch on the breaker manually and feed with an abrupt change current that is distinctly greater than the  $I <$ -threshold.

**Mode Bkr state:** The breaker has to be in the OFF Position. The signal „SOTF.ENABLED“=0 is untrue. If the breaker is switched on, the signal „SOTF.ENABLED“=1 becomes true as long as the timer t-enabled is running.

- The Circuit Breaker has to be in the OFF Position. There must be no load current.
- The Status Display of the device shows the signal „SOTF.ENABLED“=1.

### Testing

- Switch the Circuit Breaker manually ON and start the timer at the same time.
- After the hold time t-enable is expired the state of the signal has to change to „SOTF.ENABLED“=0.
- Write down the measured time.

### Successful test result

The measured total tripping delays or individual tripping delays, threshold values and fallback ratios correspond with those values, specified in the adjustment list. Permissible deviations/tolerances can be found under Technical Data.

## CLPU - Cold Load Pickup

Available Elements:

CLPU

When the electric load is freshly started or restarted after a prolonged outage, the load current tends to have a temporary surge that could be several times the normal load current in magnitude due to motor starting. This phenomena is called cold load inrush. If the overcurrent pickup threshold is set according to the maximum possible load inrush, the overcurrent protection may be insensitive to some faults, thus making whole protection systems coordination difficult or even impossible. On the other hand, the overcurrent protection could trip on load inrush if it is set based on the fault current studies. The CLPU module is provided to generate a temporary blocking/desensitizing signal to prevent overcurrent protections from unwanted tripping. The cold load pickup function detects a warm-to-cold load transition according to the four selectable cold load detection modes:

- CB POS (Breaker state);
- I< (Undercurrent);
- CB POS AND I< (Breaker state and undercurrent); and
- CB POS OR I< (Breaker state OR undercurrent).

After a warm-to-cold load transition has been detected, a specified load-off timer will be started. This User-settable load-off timer is used in some cases to make sure that the load is really “cold” enough. After the load-off timer times out, the CLPU function issues an “enable” signal »CLPU.ENABLED« that can be used to block some sensitive protection elements like instantaneous overcurrent elements, current unbalance, or power protection elements at User’s choice. Using this enable signal, some time inverse overcurrent elements may also be desensitized at the User’s choice by means of activating adaptive settings of the corresponding overcurrent elements.

When a cold load condition is finished (a cold-to-warm load condition is detected) due to, for example, breaker closing or load current injection, a load inrush detector will be initiated that supervises the coming and going of the load inrush current process. A load inrush is detected if the coming load current exceeds a User-specified inrush current threshold. This load inrush is considered as finished if the load current is decreased to 90% of the inrush current threshold. After the inrush current is diminished, a settle timer starts. The cold load pickup enable signal can only be reset after the settle timer times out. Another max-Block timer, which is started parallel with the load inrush detector after a cold load condition is finished, may also terminate the CLPU enable signal if a load inrush condition is prolonged abnormally.

The cold load pickup function can be blocked manually by external or internal signal at the User’s choice. For the devices with Auto-Reclosing function, the CLPU function will be blocked automatically if auto-reclosure is initiated (AR is running).



**This module issues a signal only (it is not armed).**

**In order to influence the tripping settings of the overcurrent protection, the User has to assign the signal “CLPU.ENABLED“ to an adaptive parameter set. Please refer to the Parameter / Adaptive Parameter Sets section. Within the adaptive parameter set, the User has to modify the tripping characteristic of the overcurrent protection according to the needs.**

**NOTICE**

Please be aware of the meaning of the two delay timers.

**t load Off (Pickup Delay):** After this time expires, the load is no longer diversified.

**t Max Block (Release Delay):** After the starting condition is fulfilled (e.g.: breaker switched on manually), the “CLPU.enabled” signal will be issued for this time. That means for the duration of this time, the tripping thresholds of the overcurrent protection can be desensitized by means of adaptive parameters (please refer to the Parameters section). This timer will be stopped if the current falls below 0.9 times of the threshold of the load inrush detector and remains below 0.9 times of the threshold for the duration of the settle time.

**NOTICE**

This Notice applies to protective devices that offer control functionality only! This protective element requires, that a switchgear (circuit breaker) is assigned to it. It is allowed only to assign switchgears (circuit breaker) to this protective element, whose measuring transformers provide measuring data to the protective device.

CLPU  
name = CLPU

2 Please Refer To Diagram: Blockings  
(Stage is not deactived and no active blocking signals)

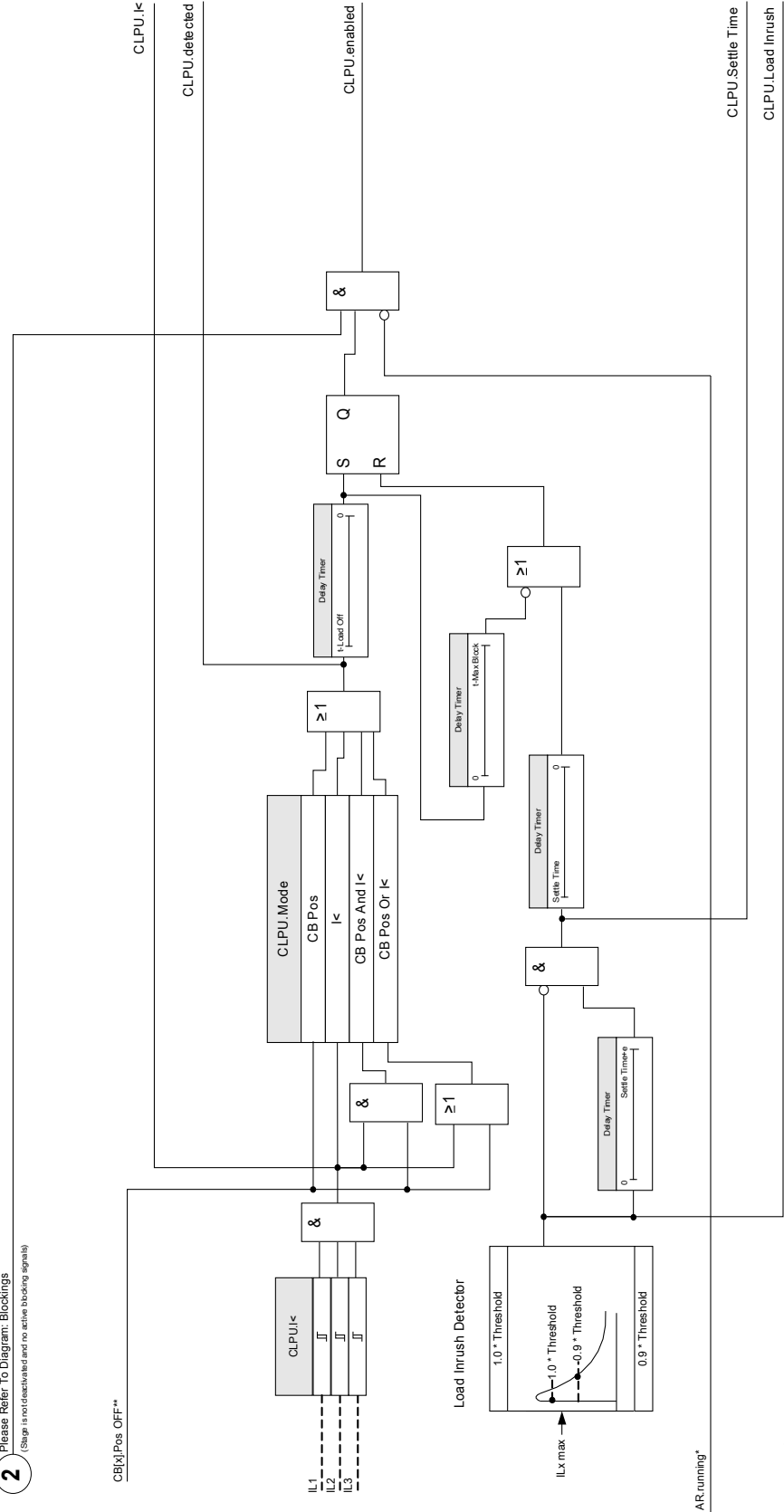

AR.running\*

\*Applies only for devices with Auto Reclosure

\*\*This signal is the output of the switchgear that is assigned to this protective element. This applies to protective devices that offer control functionality.



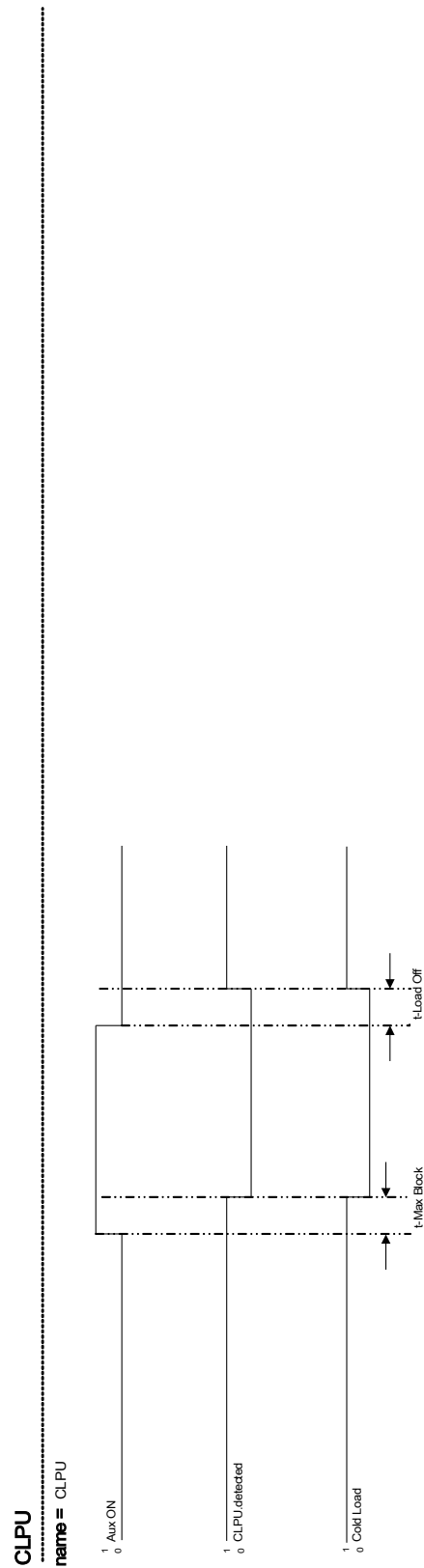













### Device Planning Parameters of the Cold Load Pickup Module

Parameter	Description	Options	Default	Menu path
 Mode	Mode	do not use, use	do not use	[Device planning]

### Global Protection Parameter of the Cold Load Pickup Module

Parameter	Description	Setting range	Default	Menu path
 Mode	Mode	CB Pos, I<, CB Pos Or I<, CB Pos And I<	CB Pos	[Protection Para /Global Prot Para /CLPU]
 ExBlo1	External blocking of the module, if blocking is activated (allowed) within a parameter set and if the state of the assigned signal is true.	1..n, Assignment List	--	[Protection Para /Global Prot Para /CLPU]
 ExBlo2	External blocking of the module, if blocking is activated (allowed) within a parameter set and if the state of the assigned signal is true.	1..n, Assignment List	--	[Protection Para /Global Prot Para /CLPU]
 Ex rev Interl	External blocking of the module by external reverse interlocking, if blocking is activated (allowed) within a parameter set and if the state of the assigned signal is true.	1..n, Assignment List	--	[Protection Para /Global Prot Para /CLPU]
 CB Pos Detect	Criterion by which the Circuit Breaker Switch Position is to be detected.  Only available if: CLPU.Mode = I<	--, SG[1].Pos, SG[2].Pos, SG[3].Pos, SG[4].Pos, SG[5].Pos, SG[6].Pos	--	[Protection Para /Global Prot Para /CLPU]

## Set Parameters of the Cold Load Pickup Module

Parameter	Description	Setting range	Default	Menu path
Function 	Permanent activation or deactivation of module/stage.	inactive, active	inactive	[Protection Para /<1..4> /CLPU]
ExBlo Fc 	Activate (allow) or inactivate (disallow) blocking of the module/stage. This parameter is only effective if a signal is assigned to the corresponding global protection parameter. If the signal becomes true, those modules/stages are blocked that are parameterized "ExBlo Fc=active".	inactive, active	inactive	[Protection Para /<1..4> /CLPU]
Ex rev Interl Fc 	Activate (allow) or inactivate (disallow) blocking of the module/stage. This parameter is only effective if a signal is assigned to the corresponding global protection parameter. If the signal becomes true, those modules/stages are blocked that are parameterized "Ex rev Interl Fc = active".	inactive, active	inactive	[Protection Para /<1..4> /CLPU]
t-Load Off 	Select the outage time required for a load to be considered cold. If the Pickup Timer (Delay) has run out, a Cold Load Signal will be issued.	0.00 - 7200.00s	1.00s	[Protection Para /<1..4> /CLPU]
t-Max Block 	Select the amount of time for the cold load inrush. If the Release Time (Delay) has run out, a Warm Load Signal will be issued.	0.00 - 300.00s	1.00s	[Protection Para /<1..4> /CLPU]
I< 	The CB is in the OFF Position, if the measured current is less than this parameter.	0.01 - 1.00In	0.01In	[Protection Para /<1..4> /CLPU]
Threshold 	Set the load current inrush threshold.	0.10 - 4.00In	1.2In	[Protection Para /<1..4> /CLPU]
Settle Time 	Select the time for the cold load inrush	0.00 - 300.00s	1.00s	[Protection Para /<1..4> /CLPU]

## States of the Inputs of the Cold Load Pickup Module

<i>Name</i>	<i>Description</i>	<i>Assignment via</i>
ExBlo1-I	Module input state: External blocking	[Protection Para /Global Prot Para /CLPU]
ExBlo2-I	Module input state: External blocking	[Protection Para /Global Prot Para /CLPU]
Ex rev Interl-I	Module input state: External reverse interlocking	[Protection Para /Global Prot Para /CLPU]
CB Pos-I	Module input state: Circuit Breaker Position by now (switching position).	[Protection Para /Global Prot Para /CLPU]

## Signals of the Cold Load Pickup Module (States of the Outputs)

<i>Signal</i>	<i>Description</i>
active	Signal: active
ExBlo	Signal: External Blocking
Ex rev Interl	Signal: External reverse Interlocking
enabled	Signal: Cold Load enabled
detected	Signal: Cold Load detected
AR Blo	Signal: Blocked by AR
I<	Signal: No Load Current.
Load Inrush	Signal: Load Inrush
Settle Time	Signal: Settle Time

## Commissioning of the Cold Load Pickup Module

*Object to be tested:*

Testing the *Cold Load Pickup* module according to the configured operating mode:

- I< (No current);
- Bkr state (Breaker position);
- I< (No Current) and Bkr state (Breaker position); and
- I< (No Current) or Bkr state (Breaker position).

*Necessary means:*

- Three-phase current source (if the Enable Mode depends on current);
- Ampere meters (may be needed if the Enable Mode depends on current); and
- Timer.

*Test Example for Mode Bkr State (Breaker Position)*

### **NOTICE**

**Mode I<:** In order to test the tripping delay, start the timer and feed with an abrupt change current that is distinctly less than the I<-threshold. Measure the tripping delay. In order to measure the drop-out ratio, feed a current with an abrupt change that is distinctly above the I<-threshold.

**Mode I< and Bkr state:** Combine the abrupt change (switching the current ON and OFF) with the manual switching ON and OFF of the breaker.

**Mode I< or Bkr state:** Initially carry out the test with an abrupt changing current that is switched ON and OFF (above and below the I<-threshold). Measure the tripping times. Finally, carry out the test by manually switching the breaker ON and OFF.

- The breaker has to be in the OFF position. There must not be any load current.
- The Status Display of the device shows the signal "CLPU.ENABLED"=1.
- The Status Display of the device shows the signal "CLPU.I<"=1.
- Testing the tripping delay and the resetting ratio:*
- Switch the breaker manually ON and simultaneously start the timer.
- After the the »t Max Block (Release Delay)« timer has expired, the signal "CPLU.Enabled"=0 has to become untrue.
- Write down the measured time.
- Manually switch the breaker OFF and simultaneously start the timer.

- After the »t load Off« timer has expired, the signal "CPLU.ENABLED"=1 has to become true.
- Write down the measured time.

Successful test result:

The measured total tripping delays or individual tripping delays, threshold values, and drop-out ratios correspond with those values specified in the adjustment list. Permissible deviations/tolerances can be found in the Technical Data section.

## V - Voltage Protection [27/59]

Available stages:  
V[1] . V[2] . V[3] . V[4] . V[5] . V[6]

**CAUTION** If the VT measurement location is not at the bus bar side but at the output side, the following has to be taken into account:

When disconnecting the line it has to be ensured that by an »*External Blocking*« undervoltage tripping of the U<-elements cannot happen. This is realized through detecting of the CB position (via digital inputs).

When the aux. voltage is switched on and the measuring voltage has not yet been applied, undervoltage tripping has to be prevented by an »*External Blocking*«

**CAUTION** In case of an fuse failure, it is important to block the »U<-stages« so that an undesired operation can be prevented.

**NOTICE** All voltage elements are identically structured and can optionally be projected as over-, undervoltage or time dependent (polygon) element.

**NOTICE** If phase voltages are applied to the measuring inputs of the device and field parameter »*VT con*« is set to »*Phase-to-neutral*«, the messages issued by the voltage protection module in case of actuation or trip should be interpreted as follows:

»V[1].ALARM L1« or »V[1].TRIP L1« => alarm or trip caused by phase voltage »VL1«.  
 »V[1].ALARM L2« or »V[1].TRIP L2« => alarm or trip caused by phase voltage »VL2«.  
 »V[1].ALARM L3« or »V[1].TRIP L3« => alarm or trip caused by phase voltage »VL3«.

If, however, line-to-line voltages are applied to the measuring inputs and field parameter »*VT con*« is set to »*Phase to Phase*«, then the messages should be interpreted as follows:

»V[1].ALARM L1« or »V[1].TRIP L1« => alarm or trip caused by line-to-line voltage »V12«.  
 »V[1].ALARM L2« or »V[1].TRIP L2« => alarm or trip caused by line-to-line voltage »V23«.  
 »V[1].ALARM L3« or »V[1].TRIP L3« => alarm or trip caused by line-to-line voltage »V31«

The following table shows the application options of the voltage protection element

Applications of the V-Protection Module	Setting in	Option
ANSI 27 Undervoltage protection	Device Planning menu Setting: V<	<i>Measuring Method:</i> Fundamental/TrueRMS  <i>Measuring Mode:</i> Phase to ground, Phase-to-Phase
10 minutes sliding average supervision V<	Device Planning menu Setting: V<	<i>Measuring Method:</i> Umit  <i>Measuring Mode:</i> Phase to ground, Phase-to-Phase
ANSI 59 Overvoltage protection	Device Planning menu Setting: V>	<i>Measuring Method:</i> Fundamental/TrueRMS  <i>Measuring Mode:</i> Phase to ground, Phase-to-Phase
Sliding average supervision V>	Device Planning menu Setting: V>	<i>Measuring Method:</i> Vavg  <i>Measuring Mode:</i> Phase to ground, Phase-to-Phase
ANSI 27(t) Voltage dependent undervoltage protection	Device Planning menu Setting: V(t)<	<i>Measuring Method:</i> Fundamental/TrueRMS  <i>Measuring Mode:</i> Phase to ground, Phase-to-Phase

*Measuring Method*

For all protection elements it can be determined, whether the measurement is done on basis of the »Fundamental« or if »TrueRMS« measurement is used. In addition to that a sliding average supervision »Vavg« can be parametrized.

**NOTICE** The required settings for the calculation of the “average value” of the “sliding average value supervision” have to be taken within menu [Device Para\Statistics\Vavg].

*Measuring Method*

If the measuring inputs of the voltage measuring card is fed with "Phase-to-Ground" voltages, the Field Parameter »VT con« has to be set to »Phase-to-Ground«. In this case, the user has the option, to set the »Measuring Mode« of each phase voltage protection element to »Phase-to-Ground« or »Phase-to-Phase«. That means, he can determine for each phase voltage protection element if » $V_n = VT_{sec} / \sqrt{3}$ « by setting »Measuring-Mode = phase-to-ground« or if » $V_n = VT_{sec}$ « by setting »Measuring-Mode = Phase-to-Phase«. CAUTION! If the measuring inputs of the voltage measuring card is fed with »Phase-to-Phase« voltages, the Field Parameter »VT con« has to be set to »Phase-to-Phase«. In this case the parameter »Measuring Mode« has to be set to »Phase-to-Ground«. In this case the device works always based on »Phase-to-Phase« voltages. In this case the parameter »Measuring mode« is internally set to »Phase-to-Phase«.

For each of the voltage protection elements it can be defined if it picks up when over- or undervoltage is detected in one of three, two of three or in all three phases. The dropout ratio is settable.



V[1]...[n]

name = V[1]...[n]

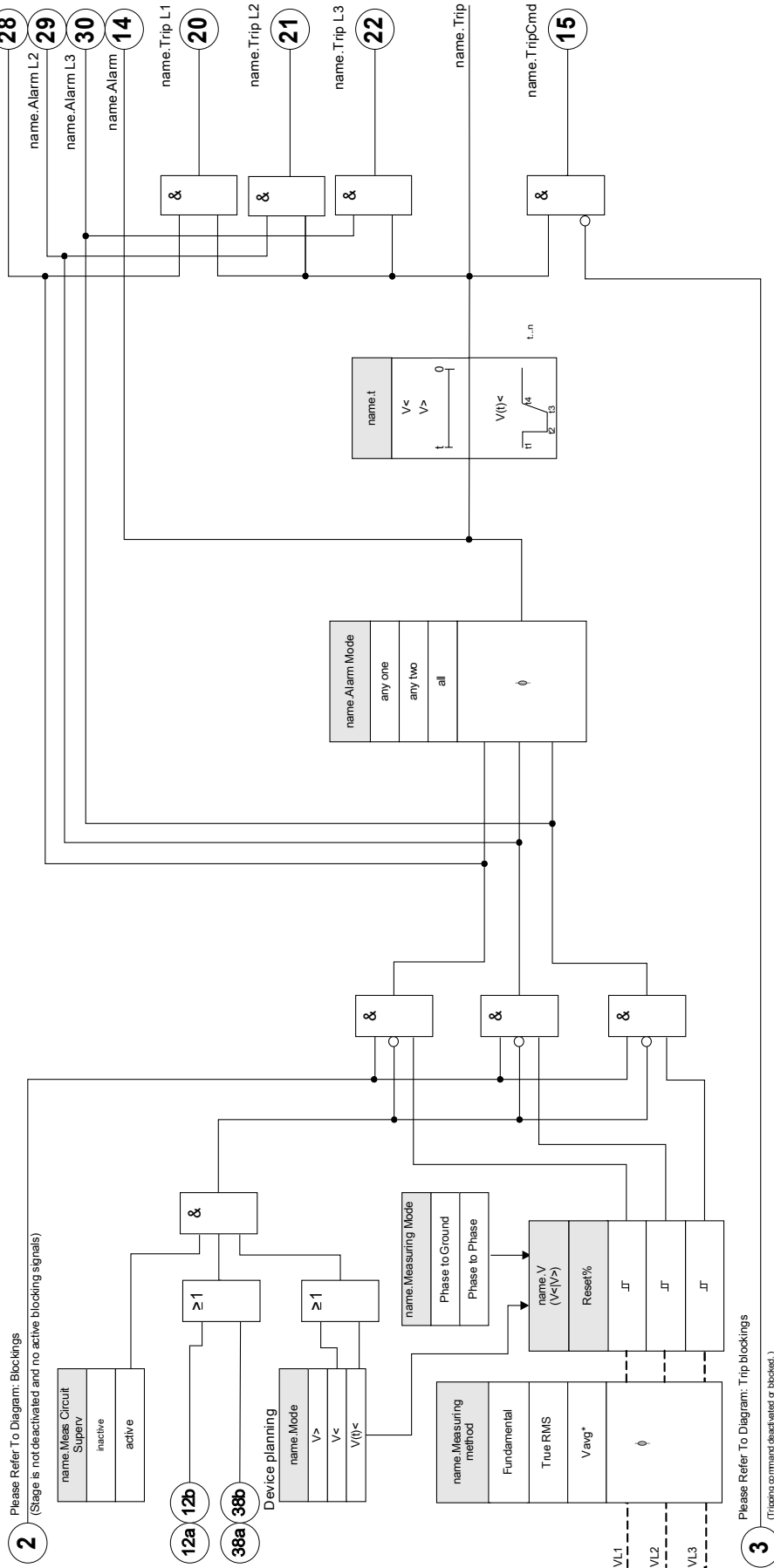

2 Please Refer To Diagram: Blockings (Stage is not deactivated and no active blocking signals)

12a 12b  
38a 38b



3 Please Refer To Diagram: Trip blockings (Tripping command deactivated or blocked)

\*Do not use this setting (Vavg) with V(t)-elements.







## Device Planning Parameters of the Voltage Protection Module





Parameter	Description	Options	Default	Menu path
Mode 	Mode	do not use, V>, V<, V(t)<	V[1]: V> V[2]: V< V[3]: do not use V[4]: do not use V[5]: do not use V[6]: do not use	[Device planning]

## Global Protection Parameters of the Voltage Protection Module

Parameter	Description	Setting range	Default	Menu path
ExBlo1 	External blocking of the module, if blocking is activated (allowed) within a parameter set and if the state of the assigned signal is true.	1..n, Assignment List	--	[Protection Para /Global Prot Para /V-Prot /V[1]]
ExBlo2 	External blocking of the module, if blocking is activated (allowed) within a parameter set and if the state of the assigned signal is true.	1..n, Assignment List	--	[Protection Para /Global Prot Para /V-Prot /V[1]]
ExBlo TripCmd 	External blocking of the Trip Command of the module/the stage, if blocking is activated (allowed) within a parameter set and if the state of the assigned signal is true.	1..n, Assignment List	--	[Protection Para /Global Prot Para /V-Prot /V[1]]

### Setting Group Parameters of the Voltage Protection Module

Parameter	Description	Setting range	Default	Menu path
 Function	Permanent activation or deactivation of module/stage.	inactive, active	V[1]: active V[2]: active V[3]: inactive V[4]: inactive V[5]: inactive V[6]: inactive	[Protection Para /<1..4> /V-Prot /N[1]]
 ExBlo Fc	Activate (allow) or inactivate (disallow) blocking of the module/stage. This parameter is only effective if a signal is assigned to the corresponding global protection parameter. If the signal becomes true, those modules/stages are blocked that are parameterized "ExBlo Fc=active".	inactive, active	inactive	[Protection Para /<1..4> /V-Prot /N[1]]
 Blo TripCmd	Permanent blocking of the Trip Command of the module/stage.	inactive, active	inactive	[Protection Para /<1..4> /V-Prot /N[1]]
 ExBlo TripCmd Fc	Activate (allow) or inactivate (disallow) blocking of the module/stage. This parameter is only effective if a signal is assigned to the corresponding global protection parameter. If the signal becomes true, those modules/stages are blocked that are parameterized "ExBlo TripCmd Fc=active".	inactive, active	inactive	[Protection Para /<1..4> /V-Prot /N[1]]
 Measuring Mode	Measuring/Supervision Mode: Determines if the phase-to-phase or phase-to-earth voltages are to be supervised	Phase to Ground, Phase to Phase	Phase to Ground	[Protection Para /<1..4> /V-Prot /N[1]]
 Measuring method	Measuring method: fundamental or rms	Fundamental, True RMS, Vavg	Fundamental	[Protection Para /<1..4> /V-Prot /N[1]]
 Alarm Mode	Alarm criterion for the voltage protection stage.	any one, any two, all	any one	[Protection Para /<1..4> /V-Prot /N[1]]

Parameter	Description	Setting range	Default	Menu path
V> 	<p>If the pickup value is exceeded, the module/element will be started. Definition of Vn: If the measuring inputs of the voltage measuring card is fed with "Phase-to-Ground" voltages, the Field Parameter "VT con" has to be set to "Phase-to-Ground". In this case, the user has the option, to set the "Measuring Mode" of each phase voltage protection element to "Phase-to-Ground" or "Phase-to-Phase". That means, he can determine for each phase voltage protection element if "Vn=VTsec/SQRT(3)" by setting "Measuring-Mode = phase-to-ground" or if "Vn=VTsec" by setting "Measuring-Mode = Phase-to-Phase". CAUTION! If the measuring inputs of the voltage measuring card is fed with "Phase-to-Phase" voltages, the Field Parameter "VT con" has to be set to "Phase-to-Phase". In this case the parameter "Measuring Mode" has to be set to "Phase-to-Ground". In this case the device works always based on "Phase-to-Phase" Voltages. In this case the parameter "Measuring mode" is internally set to "Phase-to-Phase".</p> <p>Only available if: Device planning: V.Mode = V&gt; Or V&gt;</p>	0.01 - 1.50Vn	V[1]: 1.1Vn V[2]: 1.20Vn V[3]: 1.20Vn V[4]: 1.20Vn V[5]: 1.20Vn V[6]: 1.20Vn	[Protection Para /<1..4> /V-Prot /V[1]]
V> Reset% 	<p>Adjustable Drop Out Ratio</p> <p>Only available if: Device planning: V.Mode = V&gt; Or V&gt;</p>	80 - 99%	97%	[Protection Para /<1..4> /V-Prot /V[1]]
V< 	<p>If the pickup value is exceeded, the module/element will be started. Definition of Vn: If the measuring inputs of the voltage measuring card is fed with "Phase-to-Ground" voltages, the Field Parameter "VT con" has to be set to "Phase-to-Ground". In this case, the user has the option, to set the "Measuring Mode" of each phase voltage protection element to "Phase-to-Ground" or "Phase-to-Phase". That means, he can determine for each phase voltage protection element if "Vn=VTsec/SQRT(3)" by setting "Measuring-Mode = phase-to-ground" or if "Vn=VTsec" by setting "Measuring-Mode = Phase-to-Phase". CAUTION! If the measuring inputs of the voltage measuring card is fed with "Phase-to-Phase" voltages, the Field Parameter "VT con" has to be set to "Phase-to-Phase". In this case the parameter "Measuring Mode" has to be set to "Phase-to-Ground". In this case the device works always based on "Phase-to-Phase" Voltages. In this case the parameter "Measuring mode" is internally set to "Phase-to-Phase".</p> <p>Only available if: Device planning: V.Mode = V&lt;</p>	0.01 - 1.50Vn	V[1]: 0.80Vn V[2]: 0.9Vn V[3]: 0.80Vn V[4]: 0.80Vn V[5]: 0.80Vn V[6]: 0.80Vn	[Protection Para /<1..4> /V-Prot /V[1]]
V< Reset% 	<p>Adjustable Drop Out Ratio</p> <p>Only available if: Device planning: V.Mode = V&lt;</p>	101 - 110%	103%	[Protection Para /<1..4> /V-Prot /V[1]]

Parameter	Description	Setting range	Default	Menu path
t 	Tripping delay  Only available if: Device planning: V.Mode = V> Or V> Only available if: Device planning: V.Mode = V<	0.00 - 3000.00s	V[1]: 1s V[2]: 1s V[3]: 0.00s V[4]: 0.00s V[5]: 0.00s V[6]: 0.00s	[Protection Para /<1..4> /V-Prot /V[1]]
Meas Circuit Superv 	Measuring Circuit Supervision  Only available if: Device planning: V.Mode = V< Only available if: Device planning: V.Mode = V(t)<	inactive, active	inactive	[Protection Para /<1..4> /V-Prot /V[1]]
Vstart< 	If the voltage falls below this Voltage, the Time Depending Voltage Protection will be started.  Only available if: Device planning: V.Mode = V(t)<	0.00 - 1.50Vn	0.90Vn	[Protection Para /<1..4> /V-Prot /V[1]]
Vrecover> 	A LVRT cycle will be terminated as soon as the voltage rises above this threshold  Only available if: Device planning: V.Mode = V(t)<	0.10 - 1.50Vn	0.93Vn	[Protection Para /<1..4> /V-Prot /V[1]]
V(t)<1 	Pickup value  Only available if: Device planning: V.Mode = V(t)<	0.00 - 1.50Vn	0.00Vn	[Protection Para /<1..4> /V-Prot /V[1]]
t1 	Tripping delay  Only available if: Device planning: V.Mode = V(t)<	0.00 - 20.00s	0.00s	[Protection Para /<1..4> /V-Prot /V[1]]
V(t)<2 	Pickup value  Only available if: Device planning: V.Mode = V(t)<	0.00 - 1.50Vn	0.00Vn	[Protection Para /<1..4> /V-Prot /V[1]]
t2 	Tripping delay  Only available if: Device planning: V.Mode = V(t)<	0.00 - 20.00s	0.15s	[Protection Para /<1..4> /V-Prot /V[1]]

Protective Elements

Parameter	Description	Setting range	Default	Menu path
V(t)<3 	Pickup value Only available if: Device planning: V.Mode = V(t)<	0.00 - 1.50Vn	V[1]: 0.70Vn V[2]: 0.70Vn V[3]: 0.70Vn V[4]: 0.30Vn V[5]: 0.30Vn V[6]: 0.30Vn	[Protection Para <1..4> /V-Prot /V[1]]
t3 	Tripping delay Only available if: Device planning: V.Mode = V(t)<	0.00 - 20.00s	0.15s	[Protection Para <1..4> /V-Prot /V[1]]
V(t)<4 	Pickup value Only available if: Device planning: V.Mode = V(t)<	0.00 - 1.50Vn	V[1]: 0.70Vn V[2]: 0.70Vn V[3]: 0.70Vn V[4]: 0.30Vn V[5]: 0.30Vn V[6]: 0.30Vn	[Protection Para <1..4> /V-Prot /V[1]]
t4 	Tripping delay Only available if: Device planning: V.Mode = V(t)<	0.00 - 20.00s	V[1]: 0.70s V[2]: 0.70s V[3]: 0.70s V[4]: 0.6s V[5]: 0.6s V[6]: 0.6s	[Protection Para <1..4> /V-Prot /V[1]]
V(t)<5 	Pickup value Only available if: Device planning: V.Mode = V(t)<	0.00 - 1.50Vn	0.90Vn	[Protection Para <1..4> /V-Prot /V[1]]
t5 	Tripping delay Only available if: Device planning: V.Mode = V(t)<	0.00 - 20.00s	1.50s	[Protection Para <1..4> /V-Prot /V[1]]
V(t)<6 	Pickup value Only available if: Device planning: V.Mode = V(t)<	0.00 - 1.50Vn	0.90Vn	[Protection Para <1..4> /V-Prot /V[1]]
t6 	Tripping delay Only available if: Device planning: V.Mode = V(t)<	0.00 - 20.00s	3.00s	[Protection Para <1..4> /V-Prot /V[1]]

## Protective Elements

Parameter	Description	Setting range	Default	Menu path
V(t)<7 	Pickup value Only available if: Device planning: V.Mode = V(t)<	0.00 - 1.50Vn	0.90Vn	[Protection Para <1..4> V-Prot V[1]]
t7 	Tripping delay Only available if: Device planning: V.Mode = V(t)<	0.00 - 20.00s	3.00s	[Protection Para <1..4> V-Prot V[1]]
V(t)<8 	Pickup value Only available if: Device planning: V.Mode = V(t)<	0.00 - 1.50Vn	0.90Vn	[Protection Para <1..4> V-Prot V[1]]
t8 	Tripping delay Only available if: Device planning: V.Mode = V(t)<	0.00 - 20.00s	3.00s	[Protection Para <1..4> V-Prot V[1]]
V(t)<9 	Pickup value Only available if: Device planning: V.Mode = V(t)<	0.00 - 1.50Vn	0.90Vn	[Protection Para <1..4> V-Prot V[1]]
t9 	Tripping delay Only available if: Device planning: V.Mode = V(t)<	0.00 - 20.00s	3.00s	[Protection Para <1..4> V-Prot V[1]]
V(t)<10 	Pickup value Only available if: Device planning: V.Mode = V(t)<	0.00 - 1.50Vn	0.90Vn	[Protection Para <1..4> V-Prot V[1]]
t10 	Tripping delay Only available if: Device planning: V.Mode = V(t)<	0.00 - 20.00s	3.00s	[Protection Para <1..4> V-Prot V[1]]

## Voltage Protection Module Input States

<i>Name</i>	<i>Description</i>	<i>Assignment via</i>
ExBlo1-I	Module input state: External blocking1	[Protection Para /Global Prot Para /V-Prot /V[1]]
ExBlo2-I	Module input state: External blocking2	[Protection Para /Global Prot Para /V-Prot /V[1]]
ExBlo TripCmd-I	Module input state: External Blocking of the Trip Command	[Protection Para /Global Prot Para /V-Prot /V[1]]

## Voltage Protection Module Signals (Output States)

<i>Signal</i>	<i>Description</i>
active	Signal: active
ExBlo	Signal: External Blocking
Blo TripCmd	Signal: Trip Command blocked
ExBlo TripCmd	Signal: External Blocking of the Trip Command
Alarm L1	Signal: Alarm L1
Alarm L2	Signal: Alarm L2
Alarm L3	Signal: Alarm L3
Alarm	Signal: Alarm voltage stage
Trip L1	Signal: General Trip Phase L1
Trip L2	Signal: General Trip Phase L2
Trip L3	Signal: General Trip Phase L3
Trip	Signal: Trip
TripCmd	Signal: Trip Command



## Commissioning: Overvoltage Protection [59]

### *Object to be tested*

Test of the overvoltage protection elements, 3 x single-phase and 1 x three-phase (for each element)

### **CAUTION**

Through testing the overvoltage protection stages, it can also be ensured that the wiring from the switchboard input terminals is correct. Wiring errors at the voltage measuring inputs might result in:

- False tripping of the directional current protection  
Example: Device suddenly trips in reverse direction but it does not trip in forward direction.
- Wrong or no power factor indication
- Errors with regard to power directions etc.

### *Necessary means*

- 3-phase AC voltage source
- Timer for measuring of the tripping time
- Voltmeter

*Procedure (3 x single-phase, 1 x three-phase, for each element)*

### *Testing the threshold values*

For testing the threshold values and fallback values, the test voltage has to be increased until the relay is activated. When comparing the displayed values with those of the voltmeter, the deviation must be within the permissible tolerances.

### *Testing the trip delay*

For testing the trip delay, a timer is to be connected to the contact of the associated trip relay.

The timer is started when the limiting value of the tripping voltage is exceeded and it is stopped when the relay trips.

### *Testing the fallback ratio*

Reduce the measuring quantity to less than 97% of the trip value. The relay must only fall back at 97% of the trip value at the earliest.

### *Successful test result*

The measured threshold values, trip delays and fallback ratios comply with those specified in the adjustment list. Permissible deviations/tolerances can be taken from the Technical Data.

## Commissioning: Undervoltage Protection [27]

This test can be carried out similar to the test for overvoltage protection (by using the related undervoltage values).

Please consider the following deviations:

- For testing the threshold values the test voltage has to be decreased until the relay is activated.
- For detection of the fallback value, the measuring quantity has to be increased so to achieve more than 103% of the trip value. At 103% of the trip value the relay is to fall back at the earliest.

## VG, VX - Voltage Supervision [59N]

Available elements:  
 VG[1] .VG[2]

**NOTICE** All elements of the voltage supervision of the fourth measuring input are structured identically.

This protective element can be used to (depending on device planning and setting)

- Supervision of the calculated or measured residual voltage. The residual voltage can be calculated only if the phase voltages (star connection) are connected to the measuring inputs of the device.
- Supervision of another (auxiliary) voltage against overvoltage or undervoltage.

The following table shows the application options of the voltage protection element

Applications of the VG/VX-Protection Module	Setting in	Option
ANSI 59N/G Residual voltage protection (measured or calculated)	Device Planning menu Setting: V>	Criterion: Fundamental/TrueRMS  VG Source: measured/calculated
ANSI 59A Supervision of an Auxiliary (additional) Voltage in relation to Overvoltage.	Device Planning menu Setting: V>  Within the corresponding Parameter-Set: VG Source:measured	Criterion: Fundamental/TrueRMS
ANSI 27A Supervision of an Auxiliary (additional) Voltage in relation to Undervoltage.	Device Planning menu Setting: V<  Within the corresponding Parameter-Set: VG Source:measured	Criterion: Fundamental/TrueRMS

### Measuring Mode



For all protection elements it can be determined, whether the measurement is done on basis of the »Fundamental« or if »TrueRMS« measurement is used.



## Device Planning Parameters of the Residual Voltage Supervision Module

Parameter	Description	Options	Default	Menu path
Mode 	Mode	do not use, V>, V<	do not use	[Device planning]

## Global Protection Parameters of the Residual Voltage Supervision Module



Parameter	Description	Setting range	Default	Menu path
ExBlo1 	External blocking of the module, if blocking is activated (allowed) within a parameter set and if the state of the assigned signal is true.	1..n, Assignment List	--	[Protection Para /Global Prot Para /V-Prot /VG[1]]
ExBlo2 	External blocking of the module, if blocking is activated (allowed) within a parameter set and if the state of the assigned signal is true.	1..n, Assignment List	--	[Protection Para /Global Prot Para /V-Prot /VG[1]]
ExBlo TripCmd 	External blocking of the Trip Command of the module/the stage, if blocking is activated (allowed) within a parameter set and if the state of the assigned signal is true.	1..n, Assignment List	--	[Protection Para /Global Prot Para /V-Prot /VG[1]]

### Setting Group Parameters of the Residual Voltage Supervision Module

Parameter	Description	Setting range	Default	Menu path
 Function	Permanent activation or deactivation of module/stage.	inactive, active	inactive	[Protection Para <1..4> /V-Prot /VG[1]]
 ExBlo Fc	Activate (allow) or inactivate (disallow) blocking of the module/stage. This parameter is only effective if a signal is assigned to the corresponding global protection parameter. If the signal becomes true, those modules/stages are blocked that are parameterized "ExBlo Fc=active".	inactive, active	inactive	[Protection Para <1..4> /V-Prot /VG[1]]
 Blo TripCmd	Permanent blocking of the Trip Command of the module/stage.	inactive, active	inactive	[Protection Para <1..4> /V-Prot /VG[1]]
 ExBlo TripCmd Fc	Activate (allow) or inactivate (disallow) blocking of the module/stage. This parameter is only effective if a signal is assigned to the corresponding global protection parameter. If the signal becomes true, those modules/stages are blocked that are parameterized "ExBlo TripCmd Fc=active".	inactive, active	inactive	[Protection Para <1..4> /V-Prot /VG[1]]
 VX Source	Selection if VG is measured or calculated (neutral voltage or residual voltage)	measured, calculated	measured	[Protection Para <1..4> /V-Prot /VG[1]]
 Measuring method	Measuring method: fundamental or rms	Fundamental, True RMS	Fundamental	[Protection Para <1..4> /V-Prot /VG[1]]
 VX>	If the pickup value is exceeded, the module/stage will be started.  Only available if: Device planning: VG.Mode = V>	0.01 - 1.50Vn	1Vn	[Protection Para <1..4> /V-Prot /VG[1]]
 VG<	Undervoltage Threshold  Only available if: Device planning: VG.Mode = V<	0.01 - 1.50Vn	0.8Vn	[Protection Para <1..4> /V-Prot /VG[1]]

## Protective Elements

---

<i>Parameter</i>	<i>Description</i>	<i>Setting range</i>	<i>Default</i>	<i>Menu path</i>
t 	Tripping delay	0.00 - 300.00s	0.00s	[Protection Para /<1..4> /V-Prot /VG[1]]
Meas Circuit Superv 	Measuring Circuit Supervision	inactive, active	inactive	[Protection Para /<1..4> /V-Prot /VG[1]]

## Residual Voltage Supervision Module Input States

<i>Name</i>	<i>Description</i>	<i>Assignment via</i>
ExBlo1-I	Module input state: External blocking1	[Protection Para /Global Prot Para /V-Prot /VG[1]]
ExBlo2-I	Module input state: External blocking2	[Protection Para /Global Prot Para /V-Prot /VG[1]]
ExBlo TripCmd-I	Module input state: External Blocking of the Trip Command	[Protection Para /Global Prot Para /V-Prot /VG[1]]

## Residual Voltage Supervision Module Signals (Output States)

<i>Signal</i>	<i>Description</i>
active	Signal: active
ExBlo	Signal: External Blocking
Blo TripCmd	Signal: Trip Command blocked
ExBlo TripCmd	Signal: External Blocking of the Trip Command
Alarm	Signal: Alarm Residual Voltage Supervision-stage
Trip	Signal: Trip
TripCmd	Signal: Trip Command



## Commissioning: Residual Voltage Protection - Measured [59N]

### *Object to be tested*

Residual voltage protection stages.

### *Necessary components*

- 1-phase AC voltage source
- Timer for measuring of the tripping time
- Voltmeter

### *Procedure (for each element)*

#### *Testing the threshold values*

For testing the threshold and fallback values, the test voltage at the measuring input for the residual voltage has to be increased until the relay is activated. When comparing the displayed values with those of the voltmeter, the deviation must be within the permissible tolerances.

#### *Testing the trip delay*

For testing the trip delay a timer is to be connected to the contact of the associated trip relay.

The timer is started when the limiting value of the tripping voltage is exceeded and it is stopped when the relay trips.

#### *Testing the fallback ratio*

Reduce the measuring quantity to less than 97% of the trip value. The relay must only fall back at 97% of the trip value at the latest.

#### *Successful test result*

The measured threshold values, trip delays and fallback ratios comply with those specified in the adjustment list. Permissible deviations/tolerances can be taken from the Technical Data.

## Commissioning: Residual Voltage Protection - Calculated [59N]

### *Object to be tested*

Test of the residual voltage protection elements

### *Necessary means*

- 3-phase voltage source

### **NOTICE**

Calculation of the residual voltage is only possible if phase voltages (star) were applied to the voltage measuring inputs and if »VX Source=calculated« is set within the corresponding parameter set.

### *Procedure*

- Feed a three-phase, symmetrical voltage system ( $V_n$ ) into the voltage measuring inputs of the relay.
- Set the limiting value of VX[x] to 90%  $V_n$ .
- Disconnect the phase voltage at two measuring inputs (symmetrical feeding at the secondary side has to be maintained).
- Now the »VX calc« measuring value has to be about 100% of the value  $V_n$ .
- Ascertain that the signal »VX.ALARM« or »VX.TRIP« is generated now.

### *Successful test result*

The signal »VX.ALARM« or »VX.TRIP« is generated.

## Sync - Synchrocheck [25]

Available Elements:  
Sync



### WARNING

The synchrocheck function can be bypassed by external sources. In this case, synchronization has to be secured by other synchronizing systems before breaker closing!

### NOTICE

The bus voltages are to be measured by the first three measuring inputs of the voltage measuring card (VL1/VL1-L2, VL2/VL2-L3, VL3/VL3-L1). The line voltage is to be measured by the fourth measuring input of the voltage measuring card (VX). In the menu [Field Para/Voltage transf/V Sync] the User has to define to which phase the fourth measuring input is compared.

### Synchrocheck

The synchrocheck function is provided for the applications where a line has two-ended power sources. The synchrocheck function has the abilities to check voltage magnitude, angle differences, and frequency difference (slip frequency) between the bus and the line. If enabled, the synchrocheck may supervise the closing operation manually, automatically, or both. This function can be overridden by certain bus-line operation conditions and can be bypassed with an external source.

### Voltage Difference $\Delta V$

The first condition for paralleling two electrical systems is that their voltage phasors have the same magnitude. This can be controlled by the generator's AVR.

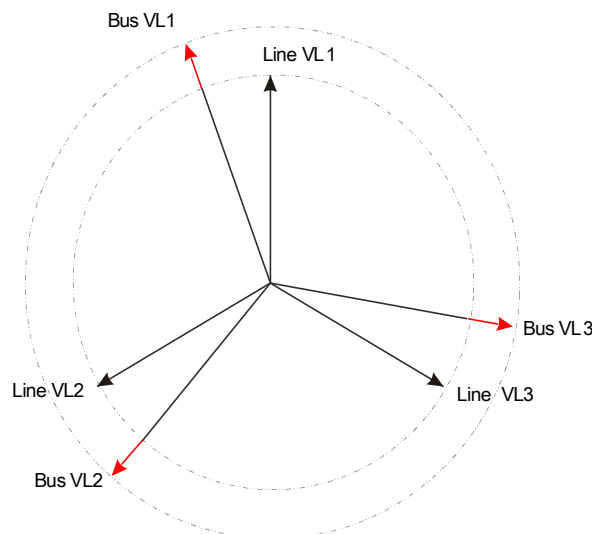

### Frequency Difference (Slip Frequency) $\Delta F$

The second condition for paralleling two electrical systems is that their frequencies are nearly equal. This can be controlled by the generator's speed governor.

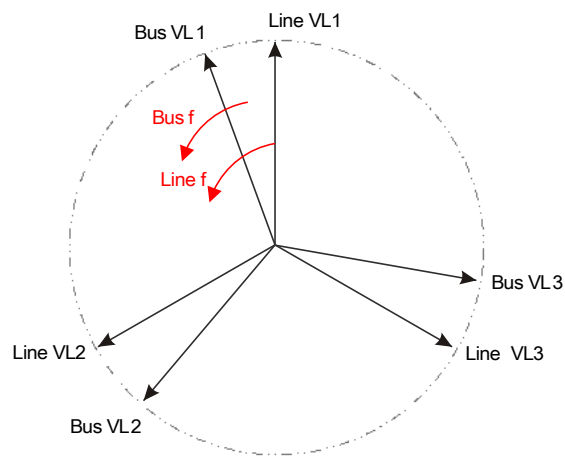

If the generator frequency  $f_{\text{Bus}}$  is not equal to the mains frequency  $f_{\text{Line}}$ , it results in a slip frequency  $\Delta F = |f_{\text{Bus}} - f_{\text{Line}}|$  between the two system frequencies.

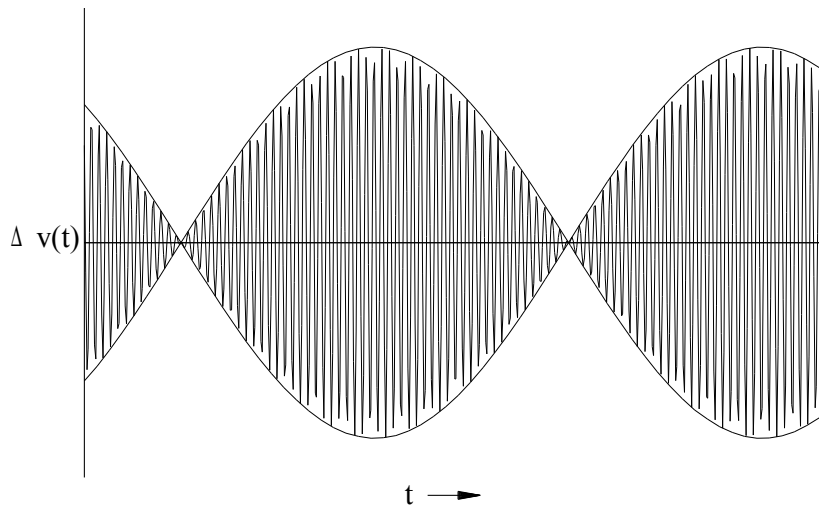

*Voltage Curve with Enlarged Resolution.*

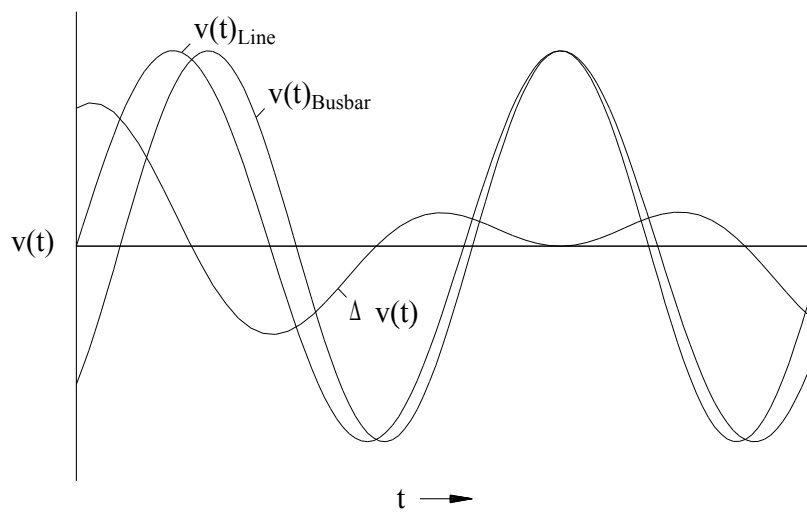

Angular or Phase Difference.

Even if the frequency of both systems is exactly identical, usually an angular difference of the voltage phasors is the case.

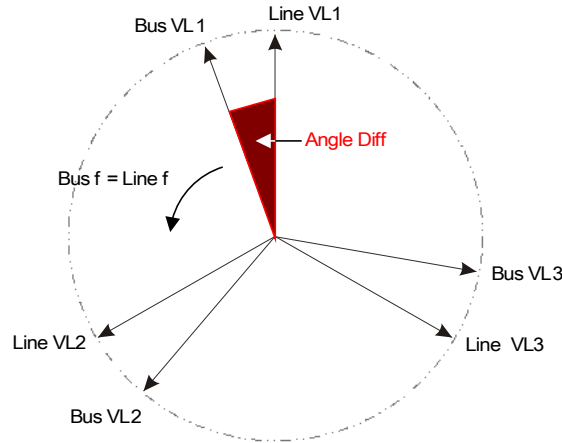

At the instant of synchronization, the angular difference of the two systems should be nearly zero because, otherwise, unwanted load inrushes occur. Theoretically, the angular difference can be regulated to zero by giving short pulses to the speed governors. When paralleling generators with the grid, in practice, synchronization is requested as quick as possible and so usually a slight frequency difference is accepted. In such cases, the angular difference is not constant but changes with the slip frequency  $\Delta F$ .

By taking the breaker closing time into consideration, a lead of the closing release impulse can be calculated in a way that breaker closing takes place at exactly the time when both systems are in angular conformity.

Basically the following applies:

Where large rotating masses are concerned, the frequency difference (slip frequency) of the two systems should possibly be nearly zero, because of the very high load inrushes at the instant of breaker closing. For smaller rotating masses, the frequency difference of the systems can be higher.

## Synchronization Modes

The synchrocheck module is able to check the synchronization of two electrical systems (system-to-system) or between a generator and an electrical system (generator-to-system). For paralleling two electrical systems, the station frequency, voltage and phase angle should be exactly the same as the utility grid. Whereas the synchronization of a generator to a system can be done with a certain slip-frequency, depending on the size of the generator used. Therefore the maximum breaker closing time has to be taken into consideration. With the set breaker closing time, the synchrocheck module is able to calculate the moment of synchronization and gives the paralleling release.



**WARNING** When paralleling two systems, it has to be verified that the system-to-system mode is selected. Paralleling two systems in generator-to-system mode can cause severe damage!

### Working Principle Synchrocheck (Generator-to-System)

(Please refer to the block diagram on next page.)

The synchrocheck element measures the three phase-to-neutral voltages »VL1«, »VL2«, and »VL3« or the three phase-to-phase voltages »VL1-L2«, »VL2-L3«, and »VL3-L1« of the generator busbar. The line voltage  $V_x$  is measured by the fourth voltage input. If all synchronous conditions are fulfilled (i. e.:  $\Delta V$  [VoltageDiff],  $\Delta F$  [SlipFrequency], and  $\Delta\phi$  [AngleDiff]) are within the limits, a signal will be issued that both systems are synchronous. An advanced Close Angle Evaluator function takes the breaker closing time into consideration.

2 Sync=: SyncMode= Generator2System

Please Refer To Diagram: Blockings  
 (Stage is not deactivated and no active blocking signals)

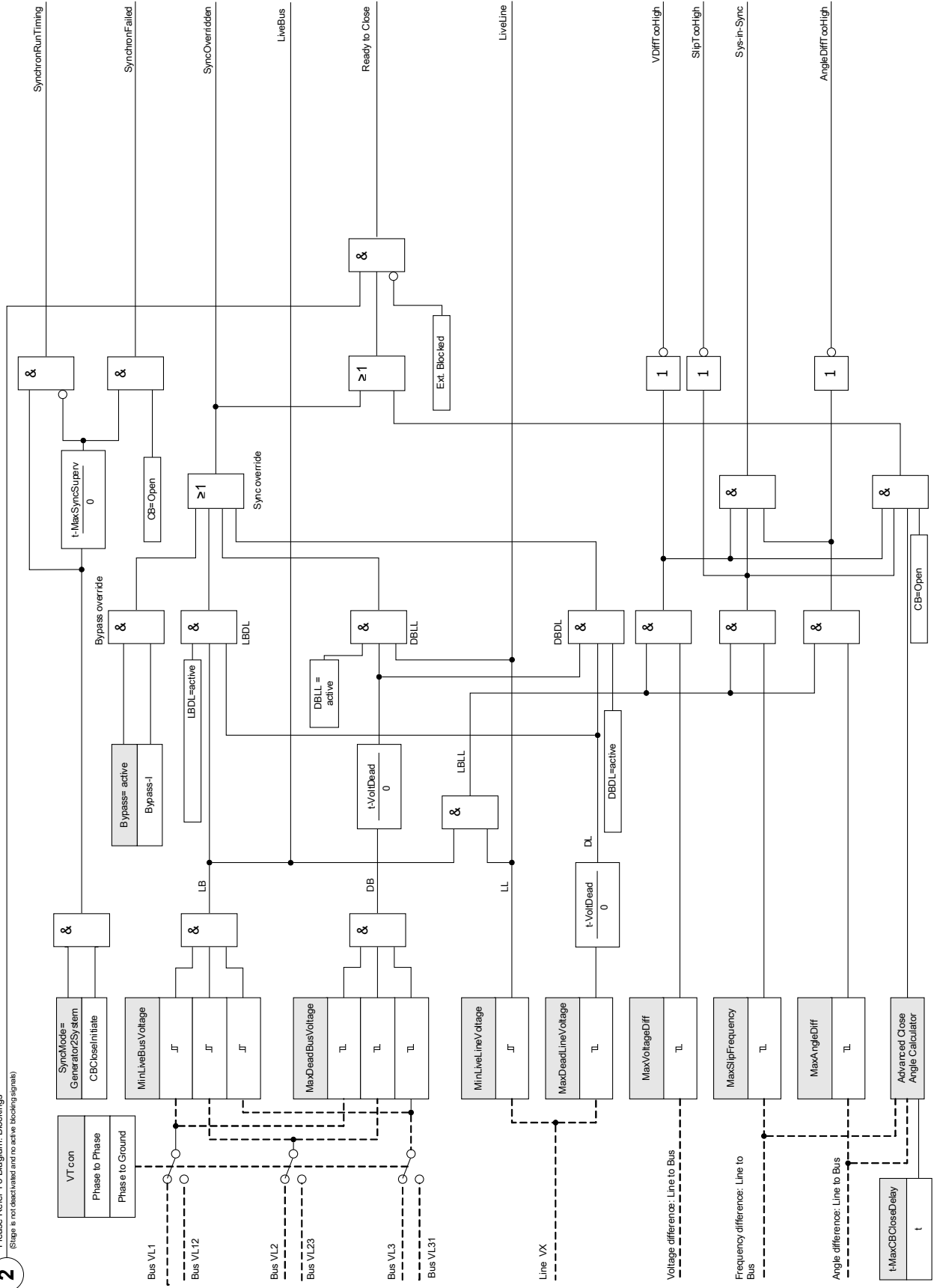



## Working Principle Synchrocheck (System-to-System)

(Please refer to the block diagram on next page.)

The synchrocheck function for two systems is very similar to the synchrocheck function for generator-to-system except there is no need to take the breaker closing time into account. The synchrocheck element measures the three phase-to-neutral voltages »VL1«, »VL2«, and »VL3« or the three phase-to-phase voltages »VL1-L2«, »VL2-L3«, and »VL3-L1« of the station voltage bus bar. The line voltage  $V_x$  is measured by the fourth voltage input. If all synchronous conditions are fulfilled (i. e.:  $\Delta V$  [VoltageDiff],  $\Delta F$  [SlipFrequency], and  $\Delta\phi$  [AngleDiff]) are within the limits, a signal will be issued that both systems are synchronous.

Sync: SyncMode= System2System

2

Please Refer To Diagram: Blockings  
(Shape is not deactivated and no active blocking signals)

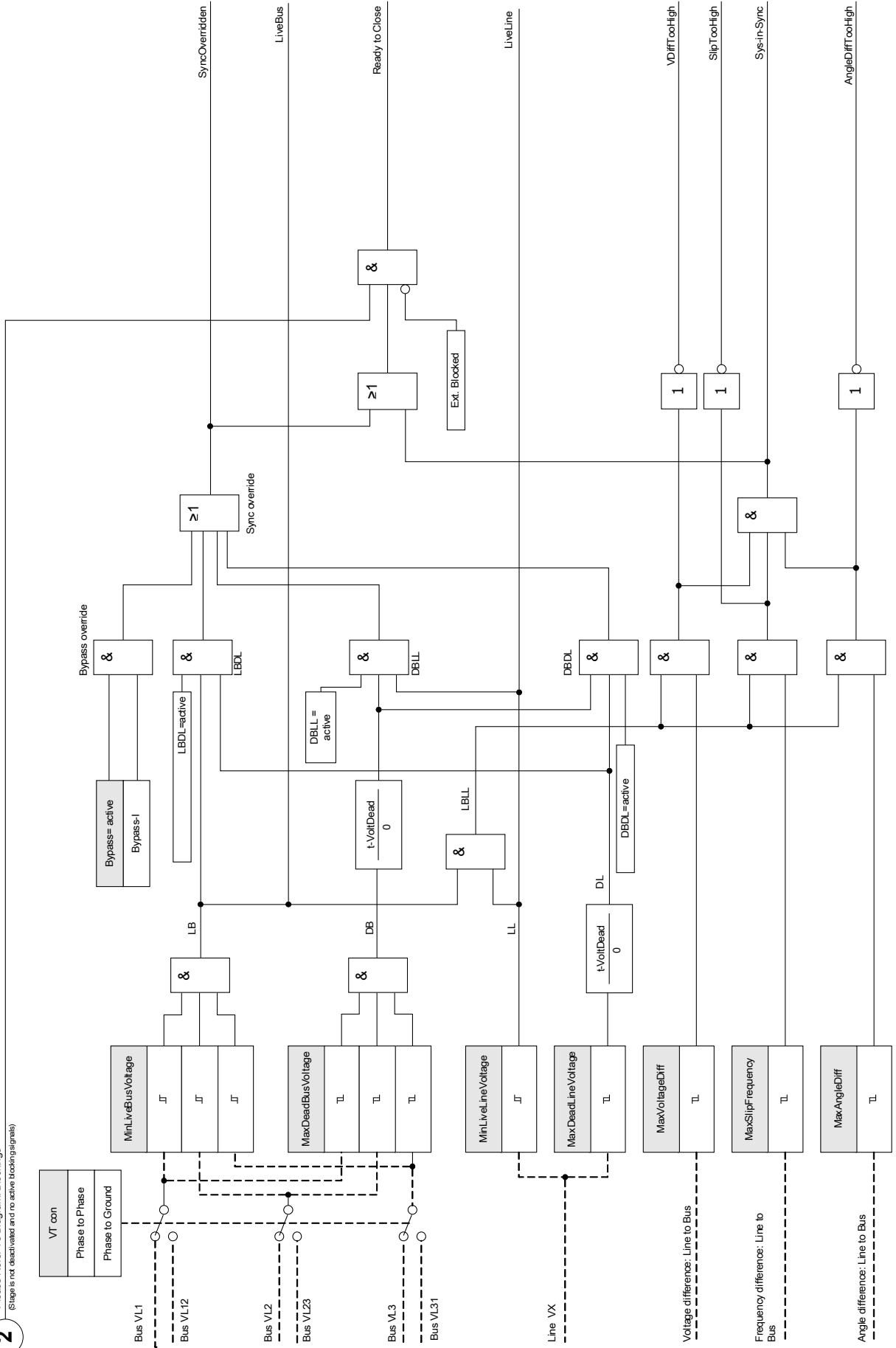

## Synchrocheck Override Conditions

If enabled the following conditions can override the synchrocheck function:

- LBDL = Live Bus – Dead Line
- DBLL = Dead Bus – Live Line
- DBDL = Dead Bus – Dead Line

Also the synchrocheck function can be bypassed by an external source.







**When the synchrocheck function is overridden or bypassed, synchronization has to be secured by other synchronizing systems before breaker closing!**

### Device Planning Parameters of the Synchrocheck Module

<i>Parameter</i>	<i>Description</i>	<i>Options</i>	<i>Default</i>	<i>Menu path</i>
Mode 	Mode	do not use, use	do not use	[Device planning]

## Global Protection Parameters of the Synchrocheck Module

Parameter	Description	Setting range	Default	Menu path
ExBlo1 	External blocking of the module, if blocking is activated (allowed) within a parameter set and if the state of the assigned signal is true.	1..n, Assignment List	--	[Protection Para /Global Prot Para /Intercon-Prot /Sync]
ExBlo2 	External blocking of the module, if blocking is activated (allowed) within a parameter set and if the state of the assigned signal is true.	1..n, Assignment List	--	[Protection Para /Global Prot Para /Intercon-Prot /Sync]
Bypass 	The Synchrocheck will be bypassed if the state of the assigned signal (logic input) becomes true.	1..n, DI-LogicList	--	[Protection Para /Global Prot Para /Intercon-Prot /Sync]
CB Pos Detect 	Criterion by which the Circuit Breaker Switch Position is to be detected.	--, SG[1].Pos, SG[2].Pos, SG[3].Pos, SG[4].Pos, SG[5].Pos, SG[6].Pos	SG[1].Pos	[Protection Para /Global Prot Para /Intercon-Prot /Sync]
CBCloseInitiate 	Breaker Close Initiate with synchronism check from any control sources (e.g. HMI / SCADA). If the state of the assigned signal becomes true, a Breaker Close will be initiated (Trigger Source).	1..n, SyncRequestList	--	[Protection Para /Global Prot Para /Intercon-Prot /Sync]



### Setting Group Parameters of the Synchrocheck Fault Module

Parameter	Description	Setting range	Default	Menu path
 Function	Permanent activation or deactivation of module/stage.	inactive, active	inactive	[Protection Para /<1..4> /Intercon-Prot /Sync /General settings]
 ExBlo Fc	Activate (allow) or inactivate (disallow) blocking of the module/stage. This parameter is only effective if a signal is assigned to the corresponding global protection parameter. If the signal becomes true, those modules/stages are blocked that are parameterized "ExBlo Fc=active".	inactive, active	inactive	[Protection Para /<1..4> /Intercon-Prot /Sync /General settings]
 Bypass Fc	Allowing to bypass the Synchrocheck, if the state signal that is assigned to the parameter with the same name within the Global Parameters (logic input) becomes true.	inactive, active	inactive	[Protection Para /<1..4> /Intercon-Prot /Sync /General settings]
 SyncMode	Synchrocheck mode: GENERATOR2SYSTEM = Synchronizing generator to system (breaker close initiate needed). SYSTEM2SYSTEM = SynchronCheck between two systems (Stand-Alone, no breaker info needed)	System2System, Generator2System	System2System	[Protection Para /<1..4> /Intercon-Prot /Sync /Mode / Times]
 t- MaxCBCCloseDelay	Maximum circuit breaker close time delay (Only used for GENERATOR-SYSTEM working mode and is critical for a correct synchronized switching)  Only available if: SyncMode = System2System	0.00 - 300.00s	0.05s	[Protection Para /<1..4> /Intercon-Prot /Sync /Mode / Times]
 t-MaxSyncSuperv	Synchron-Run timer: Max. time allowed for synchronizing process after a close initiate. Only used for GENERATOR2SYSTEM working mode.  Only available if: SyncMode = System2System	0.00 - 3000.00s	30.00s	[Protection Para /<1..4> /Intercon-Prot /Sync /Mode / Times]
 MinLiveBusVoltage	Minimum Live Bus voltage (Live bus detected, when all three phase bus voltages are above this limit).	0.10 - 1.50Vn	0.65Vn	[Protection Para /<1..4> /Intercon-Prot /Sync /DeadLiveVLevels]

Protective Elements

Parameter	Description	Setting range	Default	Menu path
 MaxDeadBusVoltage e	Maximum Dead Bus voltage (Dead bus detected, when all three phase bus voltages are below this limit).	0.01 - 1.00Vn	0.03Vn	[Protection Para /<1..4> /Intercon-Prot /Sync /DeadLiveVLevels]
 MinLiveLineVoltage	Minimum Live Line voltage (Live line detected, when line voltage above this limit).	0.10 - 1.50Vn	0.65Vn	[Protection Para /<1..4> /Intercon-Prot /Sync /DeadLiveVLevels]
 MaxDeadLineVoltage	Maximum Dead Line voltage (Dead Line detected, when line voltage below this limit).	0.01 - 1.00Vn	0.03Vn	[Protection Para /<1..4> /Intercon-Prot /Sync /DeadLiveVLevels]
 t-VoltDead	Voltage dead time (A Dead Bus/Line condition will be accepted only if the voltage falls below the set dead voltage levels longer than this time setting).	0.000 - 300.000s	0.167s	[Protection Para /<1..4> /Intercon-Prot /Sync /DeadLiveVLevels]
 MaxVoltageDiff	Maximum voltage difference between bus and line voltage phasors (Delta V)for synchronism (Related to bus voltage secondary rating)	0.01 - 1.00Vn	0.24Vn	[Protection Para /<1..4> /Intercon-Prot /Sync /Conditions]
 MaxSlipFrequency	Maximum frequency difference (Slip: Delta f) between bus and line voltage allowed for synchronism	0.01 - 2.00Hz	0.20Hz	[Protection Para /<1..4> /Intercon-Prot /Sync /Conditions]
 MaxAngleDiff	Maximum phase angle difference (Delta-Phi in degree) between bus and line voltages allowed for synchronism	1 - 60°	20°	[Protection Para /<1..4> /Intercon-Prot /Sync /Conditions]

## Protective Elements

<i>Parameter</i>	<i>Description</i>	<i>Setting range</i>	<i>Default</i>	<i>Menu path</i>
DBDL 	Enable/disable Dead-Bus AND Dead-Line synchronism overriding	inactive, active	inactive	[Protection Para /<1..4> /Intercon-Prot /Sync /Override]
DBLL 	Enable/disable Dead-Bus AND Live-Line synchronism overriding	inactive, active	inactive	[Protection Para /<1..4> /Intercon-Prot /Sync /Override]
LBDL 	Enable/disable Live-Bus AND Dead-Line synchronism overriding	inactive, active	inactive	[Protection Para /<1..4> /Intercon-Prot /Sync /Override]



## Synchrocheck Module Input States

<i>Name</i>	<i>Description</i>	<i>Assignment via</i>
ExBlo1-I	Module input state: External blocking1	[Protection Para /Global Prot Para /Intercon-Prot /Sync]
ExBlo2-I	Module input state: External blocking2	[Protection Para /Global Prot Para /Intercon-Prot /Sync]
Bypass-I	State of the module input: Bypass	[Protection Para /Global Prot Para /Intercon-Prot /Sync]
CBCloseInitiate-I	State of the module input: Breaker Close Initiate with synchronism check from any control sources (e.g. HMI / SCADA). If the state of the assigned signal becomes true, a Breaker Close will be initiated (Trigger Source).	[Protection Para /Global Prot Para /Intercon-Prot /Sync]

## Signals of the Synchrocheck Module (Output States)

<i>Signal</i>	<i>Description</i>
active	Signal: active
ExBlo	Signal: External Blocking
LiveBus	Signal: Live-Bus flag: 1=Live-Bus, 0=Voltage is below the LiveBus threshold
LiveLine	Signal: Live Line flag: 1=Live-Line, 0=Voltage is below the LiveLine threshold
SynchronRunTiming	Signal: SynchronRunTiming
SynchronFailed	Signal: This signal indicates a failed synchronization. It is set for 5s when the circuit breaker is still open after the Synchron-Run-timer has timed out.
SyncOverridden	Signal: Synchronism Check is overridden because one of the Synchronism overriding conditions (DB/DL or ExtBypass) is met.
VDiffTooHigh	Signal: Voltage difference between bus and line too high.
SlipTooHigh	Signal: Frequency difference (slip frequency) between bus and line voltages too high.
AngleDiffTooHigh	Signal: Phase Angle difference between bus and line voltages too high.
Sys-in-Sync	Signal: Bus and line voltages are in synchronism according to the system synchronism criteria.
Ready to Close	Signal: Ready to Close

## Values of the Syncrocheck

<i>Value</i>	<i>Description</i>	<i>Default</i>	<i>Size</i>	<i>Menu path</i>
Slip Freq	Slip frequency	0Hz	0 - 70.000Hz	[Operation /Measured values /Synchronism]
Volt Diff	Voltage difference between bus and line.	0V	0 - 500000.0V	[Operation /Measured values /Synchronism]
Angle Diff	Angle difference between bus and line voltages.	0°	-360.0 - 360.0°	[Operation /Measured values /Synchronism]
f Bus	Bus frequency	0Hz	0 - 70.000Hz	[Operation /Measured values /Synchronism]
f Line	Line frequency	0Hz	0 - 70.000Hz	[Operation /Measured values /Synchronism]
V Bus	Bus Voltage	0V	0 - 500000.0V	[Operation /Measured values /Synchronism]
V Line	Line Voltage	0V	0 - 500000.0V	[Operation /Measured values /Synchronism]
Angle Bus	Bus Angle (Reference)	0°	0 - 360°	[Operation /Measured values /Synchronism]
Angle Line	Line Angle	0°	0 - 360°	[Operation /Measured values /Synchronism]

## Signals that Trigger a Syncrocheck

<i>Name</i>	<i>Description</i>
--	No assignment
SG[1].Sync ON request	Signal: Synchronous ON request
SG[2].Sync ON request	Signal: Synchronous ON request
SG[3].Sync ON request	Signal: Synchronous ON request
SG[4].Sync ON request	Signal: Synchronous ON request
SG[5].Sync ON request	Signal: Synchronous ON request

## Protective Elements

<i>Name</i>	<i>Description</i>
SG[6].Sync ON request	Signal: Synchronous ON request
DI Slot X1.DI 1	Signal: Digital Input
DI Slot X1.DI 2	Signal: Digital Input
DI Slot X1.DI 3	Signal: Digital Input
DI Slot X1.DI 4	Signal: Digital Input
DI Slot X1.DI 5	Signal: Digital Input
DI Slot X1.DI 6	Signal: Digital Input
DI Slot X1.DI 7	Signal: Digital Input
DI Slot X1.DI 8	Signal: Digital Input
DI Slot X6.DI 1	Signal: Digital Input
DI Slot X6.DI 2	Signal: Digital Input
DI Slot X6.DI 3	Signal: Digital Input
DI Slot X6.DI 4	Signal: Digital Input
DI Slot X6.DI 5	Signal: Digital Input
DI Slot X6.DI 6	Signal: Digital Input
DI Slot X6.DI 7	Signal: Digital Input
DI Slot X6.DI 8	Signal: Digital Input
Logics.LE1.Gate Out	Signal: Output of the logic gate
Logics.LE1.Timer Out	Signal: Timer Output
Logics.LE1.Out	Signal: Latched Output (Q)
Logics.LE1.Out inverted	Signal: Negated Latched Output (Q NOT)
Logics.LE2.Gate Out	Signal: Output of the logic gate
Logics.LE2.Timer Out	Signal: Timer Output
Logics.LE2.Out	Signal: Latched Output (Q)
Logics.LE2.Out inverted	Signal: Negated Latched Output (Q NOT)
Logics.LE3.Gate Out	Signal: Output of the logic gate
Logics.LE3.Timer Out	Signal: Timer Output
Logics.LE3.Out	Signal: Latched Output (Q)
Logics.LE3.Out inverted	Signal: Negated Latched Output (Q NOT)
Logics.LE4.Gate Out	Signal: Output of the logic gate
Logics.LE4.Timer Out	Signal: Timer Output
Logics.LE4.Out	Signal: Latched Output (Q)
Logics.LE4.Out inverted	Signal: Negated Latched Output (Q NOT)
Logics.LE5.Gate Out	Signal: Output of the logic gate
Logics.LE5.Timer Out	Signal: Timer Output
Logics.LE5.Out	Signal: Latched Output (Q)
Logics.LE5.Out inverted	Signal: Negated Latched Output (Q NOT)
Logics.LE6.Gate Out	Signal: Output of the logic gate
Logics.LE6.Timer Out	Signal: Timer Output
Logics.LE6.Out	Signal: Latched Output (Q)

## Protective Elements

<i>Name</i>	<i>Description</i>
Logics.LE6.Out inverted	Signal: Negated Latched Output (Q NOT)
Logics.LE7.Gate Out	Signal: Output of the logic gate
Logics.LE7.Timer Out	Signal: Timer Output
Logics.LE7.Out	Signal: Latched Output (Q)
Logics.LE7.Out inverted	Signal: Negated Latched Output (Q NOT)
Logics.LE8.Gate Out	Signal: Output of the logic gate
Logics.LE8.Timer Out	Signal: Timer Output
Logics.LE8.Out	Signal: Latched Output (Q)
Logics.LE8.Out inverted	Signal: Negated Latched Output (Q NOT)
Logics.LE9.Gate Out	Signal: Output of the logic gate
Logics.LE9.Timer Out	Signal: Timer Output
Logics.LE9.Out	Signal: Latched Output (Q)
Logics.LE9.Out inverted	Signal: Negated Latched Output (Q NOT)
Logics.LE10.Gate Out	Signal: Output of the logic gate
Logics.LE10.Timer Out	Signal: Timer Output
Logics.LE10.Out	Signal: Latched Output (Q)
Logics.LE10.Out inverted	Signal: Negated Latched Output (Q NOT)
Logics.LE11.Gate Out	Signal: Output of the logic gate
Logics.LE11.Timer Out	Signal: Timer Output
Logics.LE11.Out	Signal: Latched Output (Q)
Logics.LE11.Out inverted	Signal: Negated Latched Output (Q NOT)
Logics.LE12.Gate Out	Signal: Output of the logic gate
Logics.LE12.Timer Out	Signal: Timer Output
Logics.LE12.Out	Signal: Latched Output (Q)
Logics.LE12.Out inverted	Signal: Negated Latched Output (Q NOT)
Logics.LE13.Gate Out	Signal: Output of the logic gate
Logics.LE13.Timer Out	Signal: Timer Output
Logics.LE13.Out	Signal: Latched Output (Q)
Logics.LE13.Out inverted	Signal: Negated Latched Output (Q NOT)
Logics.LE14.Gate Out	Signal: Output of the logic gate
Logics.LE14.Timer Out	Signal: Timer Output
Logics.LE14.Out	Signal: Latched Output (Q)
Logics.LE14.Out inverted	Signal: Negated Latched Output (Q NOT)
Logics.LE15.Gate Out	Signal: Output of the logic gate
Logics.LE15.Timer Out	Signal: Timer Output
Logics.LE15.Out	Signal: Latched Output (Q)
Logics.LE15.Out inverted	Signal: Negated Latched Output (Q NOT)
Logics.LE16.Gate Out	Signal: Output of the logic gate
Logics.LE16.Timer Out	Signal: Timer Output
Logics.LE16.Out	Signal: Latched Output (Q)

## Protective Elements

<i>Name</i>	<i>Description</i>
Logics.LE16.Out inverted	Signal: Negated Latched Output (Q NOT)
Logics.LE17.Gate Out	Signal: Output of the logic gate
Logics.LE17.Timer Out	Signal: Timer Output
Logics.LE17.Out	Signal: Latched Output (Q)
Logics.LE17.Out inverted	Signal: Negated Latched Output (Q NOT)
Logics.LE18.Gate Out	Signal: Output of the logic gate
Logics.LE18.Timer Out	Signal: Timer Output
Logics.LE18.Out	Signal: Latched Output (Q)
Logics.LE18.Out inverted	Signal: Negated Latched Output (Q NOT)
Logics.LE19.Gate Out	Signal: Output of the logic gate
Logics.LE19.Timer Out	Signal: Timer Output
Logics.LE19.Out	Signal: Latched Output (Q)
Logics.LE19.Out inverted	Signal: Negated Latched Output (Q NOT)
Logics.LE20.Gate Out	Signal: Output of the logic gate
Logics.LE20.Timer Out	Signal: Timer Output
Logics.LE20.Out	Signal: Latched Output (Q)
Logics.LE20.Out inverted	Signal: Negated Latched Output (Q NOT)
Logics.LE21.Gate Out	Signal: Output of the logic gate
Logics.LE21.Timer Out	Signal: Timer Output
Logics.LE21.Out	Signal: Latched Output (Q)
Logics.LE21.Out inverted	Signal: Negated Latched Output (Q NOT)
Logics.LE22.Gate Out	Signal: Output of the logic gate
Logics.LE22.Timer Out	Signal: Timer Output
Logics.LE22.Out	Signal: Latched Output (Q)
Logics.LE22.Out inverted	Signal: Negated Latched Output (Q NOT)
Logics.LE23.Gate Out	Signal: Output of the logic gate
Logics.LE23.Timer Out	Signal: Timer Output
Logics.LE23.Out	Signal: Latched Output (Q)
Logics.LE23.Out inverted	Signal: Negated Latched Output (Q NOT)
Logics.LE24.Gate Out	Signal: Output of the logic gate
Logics.LE24.Timer Out	Signal: Timer Output
Logics.LE24.Out	Signal: Latched Output (Q)
Logics.LE24.Out inverted	Signal: Negated Latched Output (Q NOT)
Logics.LE25.Gate Out	Signal: Output of the logic gate
Logics.LE25.Timer Out	Signal: Timer Output
Logics.LE25.Out	Signal: Latched Output (Q)
Logics.LE25.Out inverted	Signal: Negated Latched Output (Q NOT)
Logics.LE26.Gate Out	Signal: Output of the logic gate
Logics.LE26.Timer Out	Signal: Timer Output
Logics.LE26.Out	Signal: Latched Output (Q)

## Protective Elements

<i>Name</i>	<i>Description</i>
Logics.LE26.Out inverted	Signal: Negated Latched Output (Q NOT)
Logics.LE27.Gate Out	Signal: Output of the logic gate
Logics.LE27.Timer Out	Signal: Timer Output
Logics.LE27.Out	Signal: Latched Output (Q)
Logics.LE27.Out inverted	Signal: Negated Latched Output (Q NOT)
Logics.LE28.Gate Out	Signal: Output of the logic gate
Logics.LE28.Timer Out	Signal: Timer Output
Logics.LE28.Out	Signal: Latched Output (Q)
Logics.LE28.Out inverted	Signal: Negated Latched Output (Q NOT)
Logics.LE29.Gate Out	Signal: Output of the logic gate
Logics.LE29.Timer Out	Signal: Timer Output
Logics.LE29.Out	Signal: Latched Output (Q)
Logics.LE29.Out inverted	Signal: Negated Latched Output (Q NOT)
Logics.LE30.Gate Out	Signal: Output of the logic gate
Logics.LE30.Timer Out	Signal: Timer Output
Logics.LE30.Out	Signal: Latched Output (Q)
Logics.LE30.Out inverted	Signal: Negated Latched Output (Q NOT)
Logics.LE31.Gate Out	Signal: Output of the logic gate
Logics.LE31.Timer Out	Signal: Timer Output
Logics.LE31.Out	Signal: Latched Output (Q)
Logics.LE31.Out inverted	Signal: Negated Latched Output (Q NOT)
Logics.LE32.Gate Out	Signal: Output of the logic gate
Logics.LE32.Timer Out	Signal: Timer Output
Logics.LE32.Out	Signal: Latched Output (Q)
Logics.LE32.Out inverted	Signal: Negated Latched Output (Q NOT)
Logics.LE33.Gate Out	Signal: Output of the logic gate
Logics.LE33.Timer Out	Signal: Timer Output
Logics.LE33.Out	Signal: Latched Output (Q)
Logics.LE33.Out inverted	Signal: Negated Latched Output (Q NOT)
Logics.LE34.Gate Out	Signal: Output of the logic gate
Logics.LE34.Timer Out	Signal: Timer Output
Logics.LE34.Out	Signal: Latched Output (Q)
Logics.LE34.Out inverted	Signal: Negated Latched Output (Q NOT)
Logics.LE35.Gate Out	Signal: Output of the logic gate
Logics.LE35.Timer Out	Signal: Timer Output
Logics.LE35.Out	Signal: Latched Output (Q)
Logics.LE35.Out inverted	Signal: Negated Latched Output (Q NOT)
Logics.LE36.Gate Out	Signal: Output of the logic gate
Logics.LE36.Timer Out	Signal: Timer Output
Logics.LE36.Out	Signal: Latched Output (Q)

## Protective Elements

<i>Name</i>	<i>Description</i>
Logics.LE36.Out inverted	Signal: Negated Latched Output (Q NOT)
Logics.LE37.Gate Out	Signal: Output of the logic gate
Logics.LE37.Timer Out	Signal: Timer Output
Logics.LE37.Out	Signal: Latched Output (Q)
Logics.LE37.Out inverted	Signal: Negated Latched Output (Q NOT)
Logics.LE38.Gate Out	Signal: Output of the logic gate
Logics.LE38.Timer Out	Signal: Timer Output
Logics.LE38.Out	Signal: Latched Output (Q)
Logics.LE38.Out inverted	Signal: Negated Latched Output (Q NOT)
Logics.LE39.Gate Out	Signal: Output of the logic gate
Logics.LE39.Timer Out	Signal: Timer Output
Logics.LE39.Out	Signal: Latched Output (Q)
Logics.LE39.Out inverted	Signal: Negated Latched Output (Q NOT)
Logics.LE40.Gate Out	Signal: Output of the logic gate
Logics.LE40.Timer Out	Signal: Timer Output
Logics.LE40.Out	Signal: Latched Output (Q)
Logics.LE40.Out inverted	Signal: Negated Latched Output (Q NOT)
Logics.LE41.Gate Out	Signal: Output of the logic gate
Logics.LE41.Timer Out	Signal: Timer Output
Logics.LE41.Out	Signal: Latched Output (Q)
Logics.LE41.Out inverted	Signal: Negated Latched Output (Q NOT)
Logics.LE42.Gate Out	Signal: Output of the logic gate
Logics.LE42.Timer Out	Signal: Timer Output
Logics.LE42.Out	Signal: Latched Output (Q)
Logics.LE42.Out inverted	Signal: Negated Latched Output (Q NOT)
Logics.LE43.Gate Out	Signal: Output of the logic gate
Logics.LE43.Timer Out	Signal: Timer Output
Logics.LE43.Out	Signal: Latched Output (Q)
Logics.LE43.Out inverted	Signal: Negated Latched Output (Q NOT)
Logics.LE44.Gate Out	Signal: Output of the logic gate
Logics.LE44.Timer Out	Signal: Timer Output
Logics.LE44.Out	Signal: Latched Output (Q)
Logics.LE44.Out inverted	Signal: Negated Latched Output (Q NOT)
Logics.LE45.Gate Out	Signal: Output of the logic gate
Logics.LE45.Timer Out	Signal: Timer Output
Logics.LE45.Out	Signal: Latched Output (Q)
Logics.LE45.Out inverted	Signal: Negated Latched Output (Q NOT)
Logics.LE46.Gate Out	Signal: Output of the logic gate
Logics.LE46.Timer Out	Signal: Timer Output
Logics.LE46.Out	Signal: Latched Output (Q)

## Protective Elements

<i>Name</i>	<i>Description</i>
Logics.LE46.Out inverted	Signal: Negated Latched Output (Q NOT)
Logics.LE47.Gate Out	Signal: Output of the logic gate
Logics.LE47.Timer Out	Signal: Timer Output
Logics.LE47.Out	Signal: Latched Output (Q)
Logics.LE47.Out inverted	Signal: Negated Latched Output (Q NOT)
Logics.LE48.Gate Out	Signal: Output of the logic gate
Logics.LE48.Timer Out	Signal: Timer Output
Logics.LE48.Out	Signal: Latched Output (Q)
Logics.LE48.Out inverted	Signal: Negated Latched Output (Q NOT)
Logics.LE49.Gate Out	Signal: Output of the logic gate
Logics.LE49.Timer Out	Signal: Timer Output
Logics.LE49.Out	Signal: Latched Output (Q)
Logics.LE49.Out inverted	Signal: Negated Latched Output (Q NOT)
Logics.LE50.Gate Out	Signal: Output of the logic gate
Logics.LE50.Timer Out	Signal: Timer Output
Logics.LE50.Out	Signal: Latched Output (Q)
Logics.LE50.Out inverted	Signal: Negated Latched Output (Q NOT)
Logics.LE51.Gate Out	Signal: Output of the logic gate
Logics.LE51.Timer Out	Signal: Timer Output
Logics.LE51.Out	Signal: Latched Output (Q)
Logics.LE51.Out inverted	Signal: Negated Latched Output (Q NOT)
Logics.LE52.Gate Out	Signal: Output of the logic gate
Logics.LE52.Timer Out	Signal: Timer Output
Logics.LE52.Out	Signal: Latched Output (Q)
Logics.LE52.Out inverted	Signal: Negated Latched Output (Q NOT)
Logics.LE53.Gate Out	Signal: Output of the logic gate
Logics.LE53.Timer Out	Signal: Timer Output
Logics.LE53.Out	Signal: Latched Output (Q)
Logics.LE53.Out inverted	Signal: Negated Latched Output (Q NOT)
Logics.LE54.Gate Out	Signal: Output of the logic gate
Logics.LE54.Timer Out	Signal: Timer Output
Logics.LE54.Out	Signal: Latched Output (Q)
Logics.LE54.Out inverted	Signal: Negated Latched Output (Q NOT)
Logics.LE55.Gate Out	Signal: Output of the logic gate
Logics.LE55.Timer Out	Signal: Timer Output
Logics.LE55.Out	Signal: Latched Output (Q)
Logics.LE55.Out inverted	Signal: Negated Latched Output (Q NOT)
Logics.LE56.Gate Out	Signal: Output of the logic gate
Logics.LE56.Timer Out	Signal: Timer Output
Logics.LE56.Out	Signal: Latched Output (Q)



## Protective Elements

<i>Name</i>	<i>Description</i>
Logics.LE56.Out inverted	Signal: Negated Latched Output (Q NOT)
Logics.LE57.Gate Out	Signal: Output of the logic gate
Logics.LE57.Timer Out	Signal: Timer Output
Logics.LE57.Out	Signal: Latched Output (Q)
Logics.LE57.Out inverted	Signal: Negated Latched Output (Q NOT)
Logics.LE58.Gate Out	Signal: Output of the logic gate
Logics.LE58.Timer Out	Signal: Timer Output
Logics.LE58.Out	Signal: Latched Output (Q)
Logics.LE58.Out inverted	Signal: Negated Latched Output (Q NOT)
Logics.LE59.Gate Out	Signal: Output of the logic gate
Logics.LE59.Timer Out	Signal: Timer Output
Logics.LE59.Out	Signal: Latched Output (Q)
Logics.LE59.Out inverted	Signal: Negated Latched Output (Q NOT)
Logics.LE60.Gate Out	Signal: Output of the logic gate
Logics.LE60.Timer Out	Signal: Timer Output
Logics.LE60.Out	Signal: Latched Output (Q)
Logics.LE60.Out inverted	Signal: Negated Latched Output (Q NOT)
Logics.LE61.Gate Out	Signal: Output of the logic gate
Logics.LE61.Timer Out	Signal: Timer Output
Logics.LE61.Out	Signal: Latched Output (Q)
Logics.LE61.Out inverted	Signal: Negated Latched Output (Q NOT)
Logics.LE62.Gate Out	Signal: Output of the logic gate
Logics.LE62.Timer Out	Signal: Timer Output
Logics.LE62.Out	Signal: Latched Output (Q)
Logics.LE62.Out inverted	Signal: Negated Latched Output (Q NOT)
Logics.LE63.Gate Out	Signal: Output of the logic gate
Logics.LE63.Timer Out	Signal: Timer Output
Logics.LE63.Out	Signal: Latched Output (Q)
Logics.LE63.Out inverted	Signal: Negated Latched Output (Q NOT)
Logics.LE64.Gate Out	Signal: Output of the logic gate
Logics.LE64.Timer Out	Signal: Timer Output
Logics.LE64.Out	Signal: Latched Output (Q)
Logics.LE64.Out inverted	Signal: Negated Latched Output (Q NOT)
Logics.LE65.Gate Out	Signal: Output of the logic gate
Logics.LE65.Timer Out	Signal: Timer Output
Logics.LE65.Out	Signal: Latched Output (Q)
Logics.LE65.Out inverted	Signal: Negated Latched Output (Q NOT)
Logics.LE66.Gate Out	Signal: Output of the logic gate
Logics.LE66.Timer Out	Signal: Timer Output
Logics.LE66.Out	Signal: Latched Output (Q)

## Protective Elements

<i>Name</i>	<i>Description</i>
Logics.LE66.Out inverted	Signal: Negated Latched Output (Q NOT)
Logics.LE67.Gate Out	Signal: Output of the logic gate
Logics.LE67.Timer Out	Signal: Timer Output
Logics.LE67.Out	Signal: Latched Output (Q)
Logics.LE67.Out inverted	Signal: Negated Latched Output (Q NOT)
Logics.LE68.Gate Out	Signal: Output of the logic gate
Logics.LE68.Timer Out	Signal: Timer Output
Logics.LE68.Out	Signal: Latched Output (Q)
Logics.LE68.Out inverted	Signal: Negated Latched Output (Q NOT)
Logics.LE69.Gate Out	Signal: Output of the logic gate
Logics.LE69.Timer Out	Signal: Timer Output
Logics.LE69.Out	Signal: Latched Output (Q)
Logics.LE69.Out inverted	Signal: Negated Latched Output (Q NOT)
Logics.LE70.Gate Out	Signal: Output of the logic gate
Logics.LE70.Timer Out	Signal: Timer Output
Logics.LE70.Out	Signal: Latched Output (Q)
Logics.LE70.Out inverted	Signal: Negated Latched Output (Q NOT)
Logics.LE71.Gate Out	Signal: Output of the logic gate
Logics.LE71.Timer Out	Signal: Timer Output
Logics.LE71.Out	Signal: Latched Output (Q)
Logics.LE71.Out inverted	Signal: Negated Latched Output (Q NOT)
Logics.LE72.Gate Out	Signal: Output of the logic gate
Logics.LE72.Timer Out	Signal: Timer Output
Logics.LE72.Out	Signal: Latched Output (Q)
Logics.LE72.Out inverted	Signal: Negated Latched Output (Q NOT)
Logics.LE73.Gate Out	Signal: Output of the logic gate
Logics.LE73.Timer Out	Signal: Timer Output
Logics.LE73.Out	Signal: Latched Output (Q)
Logics.LE73.Out inverted	Signal: Negated Latched Output (Q NOT)
Logics.LE74.Gate Out	Signal: Output of the logic gate
Logics.LE74.Timer Out	Signal: Timer Output
Logics.LE74.Out	Signal: Latched Output (Q)
Logics.LE74.Out inverted	Signal: Negated Latched Output (Q NOT)
Logics.LE75.Gate Out	Signal: Output of the logic gate
Logics.LE75.Timer Out	Signal: Timer Output
Logics.LE75.Out	Signal: Latched Output (Q)
Logics.LE75.Out inverted	Signal: Negated Latched Output (Q NOT)
Logics.LE76.Gate Out	Signal: Output of the logic gate
Logics.LE76.Timer Out	Signal: Timer Output
Logics.LE76.Out	Signal: Latched Output (Q)

## Protective Elements

---

<i>Name</i>	<i>Description</i>
Logics.LE76.Out inverted	Signal: Negated Latched Output (Q NOT)
Logics.LE77.Gate Out	Signal: Output of the logic gate
Logics.LE77.Timer Out	Signal: Timer Output
Logics.LE77.Out	Signal: Latched Output (Q)
Logics.LE77.Out inverted	Signal: Negated Latched Output (Q NOT)
Logics.LE78.Gate Out	Signal: Output of the logic gate
Logics.LE78.Timer Out	Signal: Timer Output
Logics.LE78.Out	Signal: Latched Output (Q)
Logics.LE78.Out inverted	Signal: Negated Latched Output (Q NOT)
Logics.LE79.Gate Out	Signal: Output of the logic gate
Logics.LE79.Timer Out	Signal: Timer Output
Logics.LE79.Out	Signal: Latched Output (Q)
Logics.LE79.Out inverted	Signal: Negated Latched Output (Q NOT)
Logics.LE80.Gate Out	Signal: Output of the logic gate
Logics.LE80.Timer Out	Signal: Timer Output
Logics.LE80.Out	Signal: Latched Output (Q)
Logics.LE80.Out inverted	Signal: Negated Latched Output (Q NOT)

## V 012 – Voltage Asymmetry [47]

Available elements:

V012[1] .V012[2] .V012[3] .V012[4] .V012[5] .V012[6]

Within the Device planning menu this module can be projected in order to supervise the positive phase sequence voltage for over- or undervoltage or the negative phase sequence system for overvoltage. This module is based on the 3-phase voltages.

The module is alarmed, if the threshold is exceeded. The module will trip, if the measured values remain for the duration of the delay timer above the threshold continuously.

In case that the negative phase sequence voltage is monitored, the threshold »  $V2>$  « can be combined with an additional percentage criterion »  $\%V2/V1$  « (AND-connected) in order to prevent faulty tripping in case of a lack of voltage within the positive phase sequence system.

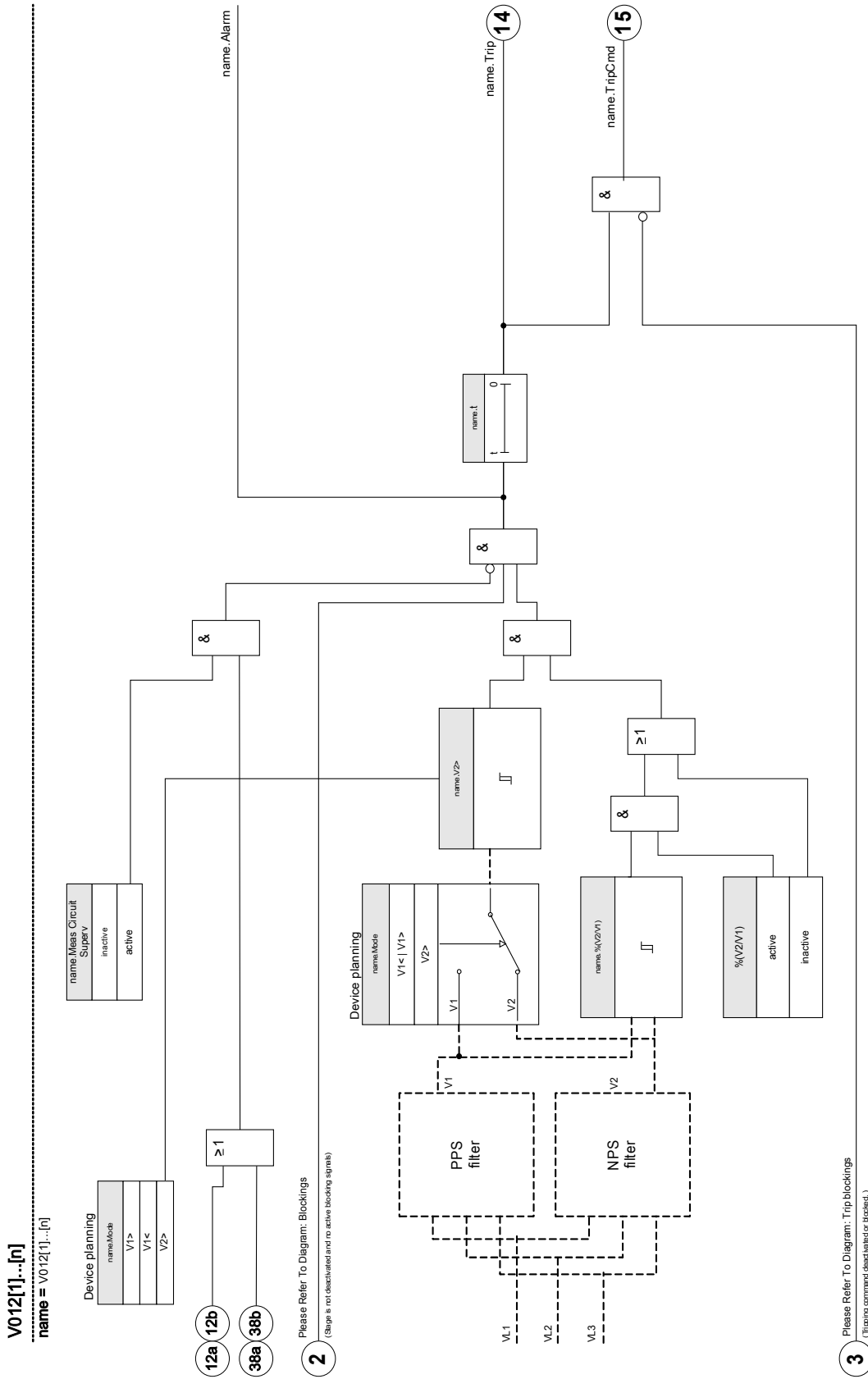

Application Options of the V 012 Module	Setting in	Option
ANSI 47 – Negative Sequence Overvoltage  (Supervision of the Negative Phase Sequence System)  Setting within the Device Planning ( $V2>$ )	Device Planning Menu	$\%V2/V1$ : The Module trips, if the threshold $U2>$ <b>and</b> the ratio of negative to positive phase sequence voltage is exceeded (after the delay timer has expired).  This criterion is to be activated and parametrized within the parameter set.
ANSI 59U1 Overvoltage within the Positive Phase Sequence System  Setting within the Device Planning ( $V1>$ )	Device Planning Menu	-
ANSI 27U1 Undervoltage within the Positive Phase Sequence System  Setting within the Device Planning ( $V1<$ )	Device Planning Menu	-



## Device planning parameters of the asymmetry module

Parameter	Description	Options	Default	Menu path
Mode 	Unbalance Protection: Supervision of the Voltage System	do not use, V1>, V1<, V2>	do not use	[Device planning]



## Global protection parameter of the asymmetry-module

Parameter	Description	Setting range	Default	Menu path
ExBlo1 	External blocking of the module, if blocking is activated (allowed) within a parameter set and if the state of the assigned signal is true.1	1..n, Assignment List	--	[Protection Para /Global Prot Para /V-Prot /V012[1]]
ExBlo2 	External blocking of the module, if blocking is activated (allowed) within a parameter set and if the state of the assigned signal is true.2	1..n, Assignment List	--	[Protection Para /Global Prot Para /V-Prot /V012[1]]
ExBlo TripCmd 	External blocking of the Trip Command of the module/the stage, if blocking is activated (allowed) within a parameter set and if the state of the assigned signal is true.	1..n, Assignment List	--	[Protection Para /Global Prot Para /V-Prot /V012[1]]

Parameter set parameters of the asymmetry module

Parameter	Description	Setting range	Default	Menu path
 Function	Permanent activation or deactivation of module/stage.	inactive, active	inactive	[Protection Para <1..4> /V-Prot /V012[1]]
 ExBlo Fc	Activate (allow) or inactivate (disallow) blocking of the module/stage. This parameter is only effective if a signal is assigned to the corresponding global protection parameter. If the signal becomes true, those modules/stages are blocked that are parameterized "ExBlo Fc=active".	inactive, active	inactive	[Protection Para <1..4> /V-Prot /V012[1]]
 Blo TripCmd	Permanent blocking of the Trip Command of the module/stage.	inactive, active	inactive	[Protection Para <1..4> /V-Prot /V012[1]]
 ExBlo TripCmd Fc	Activate (allow) or inactivate (disallow) blocking of the module/stage. This parameter is only effective if a signal is assigned to the corresponding global protection parameter. If the signal becomes true, those modules/stages are blocked that are parameterized "ExBlo TripCmd Fc=active".	inactive, active	inactive	[Protection Para <1..4> /V-Prot /V012[1]]
 V1>	Positive Phase Sequence Overvoltage  Only available if: Device planning: V012.Mode = V1>	0.01 - 1.50Vn	1.00Vn	[Protection Para <1..4> /V-Prot /V012[1]]
 V1<	Positive Phase Sequence Undervoltage  Only available if: Device planning: V012.Mode = V1<	0.01 - 1.50Vn	1.00Vn	[Protection Para <1..4> /V-Prot /V012[1]]
 V2>	Negative Phase Sequence Overvoltage  Only available if: Device planning: V012.Mode = V2>	0.01 - 1.50Vn	1.00Vn	[Protection Para <1..4> /V-Prot /V012[1]]
 %(V2/V1)	The %(V2/V1) setting is the unbalance trip pickup setting. It is defined by the ratio of negative sequence voltage to positive sequence voltage (% Unbalance=V2/V1). Phase sequence will be taken into account automatically.	inactive, active	inactive	[Protection Para <1..4> /V-Prot /V012[1]]

## Protective Elements

Parameter	Description	Setting range	Default	Menu path
 %(V2/V1)	The %(V2/V1) setting is the unbalance trip pickup setting. It is defined by the ratio of negative sequence voltage to positive sequence voltage (% Unbalance=V2/V1). Phase sequence will be taken into account automatically.  Only available if: %(V2/V1) = use	2 - 40%	20%	[Protection Para /<1..4> /V-Prot /V012[1]]
 t	Tripping delay	0.00 - 300.00s	0.00s	[Protection Para /<1..4> /V-Prot /V012[1]]
 Meas Circuit Superv	Measuring Circuit Supervision	inactive, active	inactive	[Protection Para /<1..4> /V-Prot /V012[1]]

## States of the inputs of the asymmetry module

Name	Description	Assignment via
ExBlo1-I	Module input state: External blocking1	[Protection Para /Global Prot Para /V-Prot /V012[1]]
ExBlo2-I	Module input state: External blocking2	[Protection Para /Global Prot Para /V-Prot /V012[1]]
ExBlo TripCmd-I	Module input state: External Blocking of the Trip Command	[Protection Para /Global Prot Para /V-Prot /V012[1]]



**Signals of the asymmetry module (states of the outputs)**

<i>Signal</i>	<i>Description</i>
active	Signal: active
ExBlo	Signal: External Blocking
Blo TripCmd	Signal: Trip Command blocked
ExBlo TripCmd	Signal: External Blocking of the Trip Command
Alarm	Signal: Alarm voltage asymmetry
Trip	Signal: Trip
TripCmd	Signal: Trip Command

## Commissioning: Asymmetry Protection

### *Object to be tested*

Test of the asymmetry protection elements.

### *Necessary means*

- 3-phase AC voltage source
- Timer for measuring of the tripping time
- Voltmeter

### *Testing the tripping values (Example)*

Set the pickup value for the voltage in the negative phase sequence to  $0.5 V_n$ . Set the tripping delay to 1 s.

In order to generate a negative phase sequence voltage interchange the wiring of two phases (VL2 and VL3).

### *Testing the trip delay*

Start the timer and abrupt change (switch) to 1.5 times of the set tripping value. Measure the trip delay.

### *Successful test result*

The measured threshold values and trip delays comply with those specified in the adjustment list. Permissible deviations/tolerances can be taken from the Technical Data.

## PQS - Power [32, 37]

Available stages:

PQS[1] .PQS[2] .PQS[3] .PQS[4] .PQS[5] .PQS[6]

Each of the elements can be used as P<, P>, Pr>, Q<, Q>, Qr>, S< or S> within the device planning.

P< and P> are settable and effective in positive active power range, Q< and Q> in positive reactive power range. These modes are used for protecting against underload or overload in positive power direction.

The apparent power makes S< or S> effective like a circle in all power quadrants. Protection is against underload and overload.

In reverse mode, Pr> is effective in negative active power range and Qr> in negative reactive power range. Both modes protect against power direction reversing from positive into negative direction.

The following graphics show the areas that are protected by the corresponding modes.

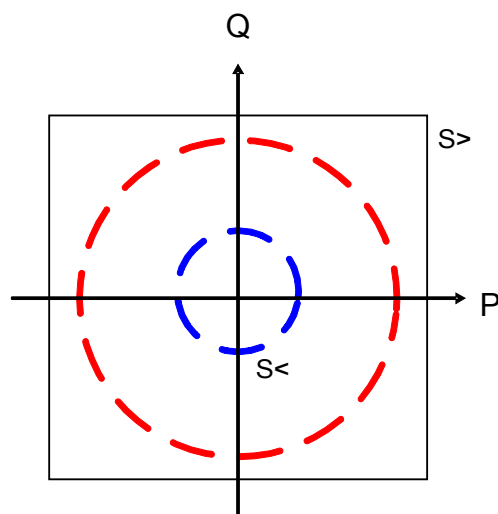
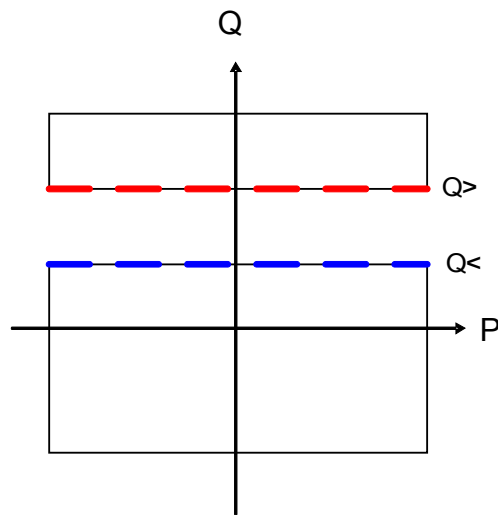
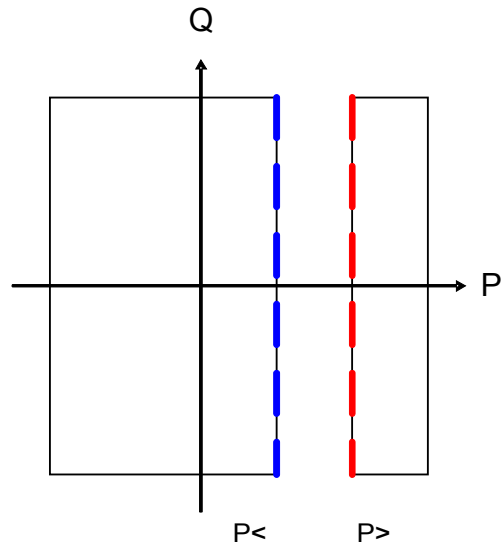

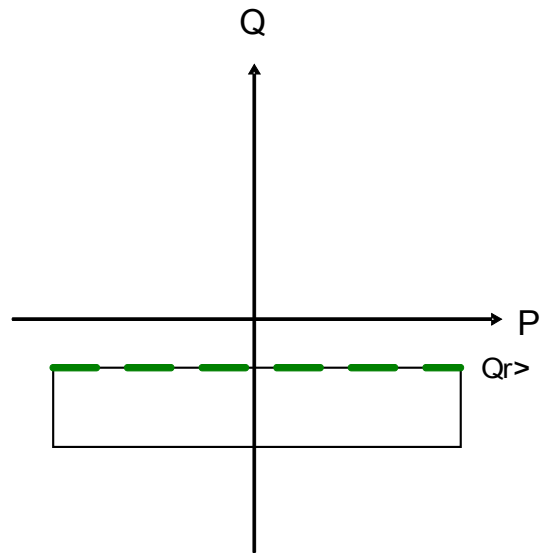
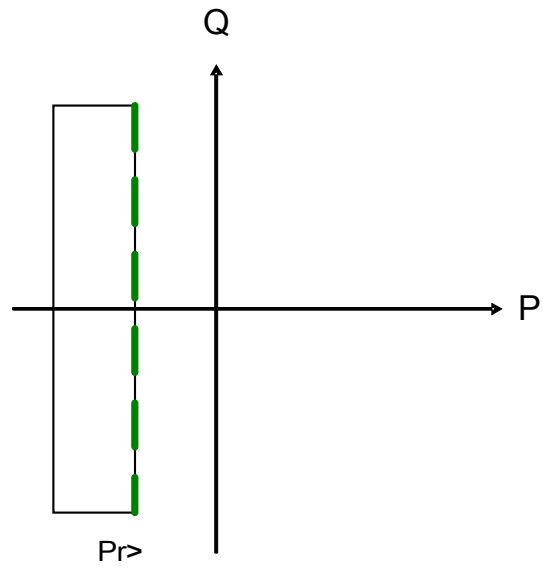

PQS[1]...[n]

name = PQS[1]...[n]

2 Please Refer To Diagram: Blockings  
(Stage is not deactivatd and no active blocking signal)

38a 38b

name.Alarm 14

40

name.Trip

name.TripCmd 15

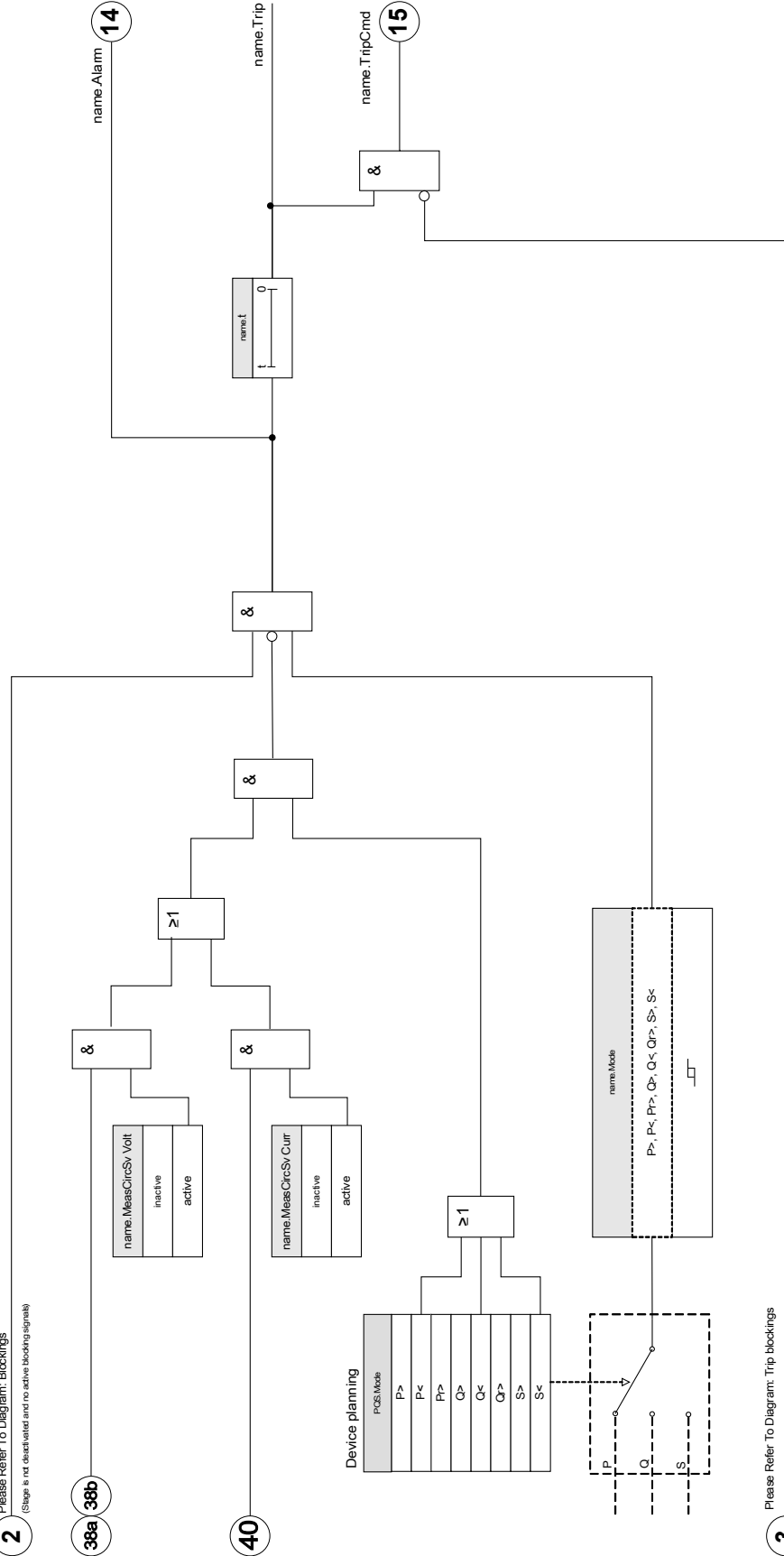



3 Please Refer To Diagram: Trip blockings  
(Tripping command deactivated or blocked.)







### Device planning parameters of the Power Protection module

Parameter	Description	Options	Default	Menu path
Mode 	Mode	do not use, P>, P<, Pr<, Pr>, Q>, Q<, Qr<, Qr>, S>, S<	PQS[1]: P> PQS[2]: do not use PQS[3]: do not use PQS[4]: do not use PQS[5]: do not use PQS[6]: do not use	[Device planning]

### Global protection parameter of the Power Protection-module







Parameter	Description	Setting range	Default	Menu path
ExBlo1 	External blocking of the module, if blocking is activated (allowed) within a parameter set and if the state of the assigned signal is true.	1..n, Assignment List	-.-	[Protection Para /Global Prot Para /P-Prot /PQS[1]]
ExBlo2 	External blocking of the module, if blocking is activated (allowed) within a parameter set and if the state of the assigned signal is true.	1..n, Assignment List	-.-	[Protection Para /Global Prot Para /P-Prot /PQS[1]]
ExBlo TripCmd 	External blocking of the Trip Command of the module/the stage, if blocking is activated (allowed) within a parameter set and if the state of the assigned signal is true.	1..n, Assignment List	-.-	[Protection Para /Global Prot Para /P-Prot /PQS[1]]

Parameter set parameters of the Power Protection module





Parameter	Description	Setting range	Default	Menu path
Function 	Permanent activation or deactivation of module/stage.	inactive, active	PQS[1]: active PQS[2]: inactive PQS[3]: inactive PQS[4]: inactive PQS[5]: inactive PQS[6]: inactive	[Protection Para /<1..4> /P-Prot /PQS[1]]
ExBlo Fc 	Activate (allow) or inactivate (disallow) blocking of the module/stage. This parameter is only effective if a signal is assigned to the corresponding global protection parameter. If the signal becomes true, those modules/stages are blocked that are parameterized "ExBlo Fc=active".	inactive, active	inactive	[Protection Para /<1..4> /P-Prot /PQS[1]]
Blo TripCmd 	Permanent blocking of the Trip Command of the module/stage.	inactive, active	inactive	[Protection Para /<1..4> /P-Prot /PQS[1]]
ExBlo TripCmd Fc 	Activate (allow) or inactivate (disallow) blocking of the module/stage. This parameter is only effective if a signal is assigned to the corresponding global protection parameter. If the signal becomes true, those modules/stages are blocked that are parameterized "ExBlo TripCmd Fc=active".	inactive, active	inactive	[Protection Para /<1..4> /P-Prot /PQS[1]]
MeasCircSv Volt 	Measuring Circuit Supervision Voltage  Only available if: Device planning: PQS.Mode = P< Only available if: Device planning: PQS.Mode = Q< Only available if: Device planning: PQS.Mode = S<	inactive, active	inactive	[Protection Para /<1..4> /P-Prot /PQS[1]]
MeasCircSv Curr 	Measuring Circuit Supervision Curent  Only available if: Device planning: PQS.Mode = P< Only available if: Device planning: PQS.Mode = Q< Only available if: Device planning: PQS.Mode = S<	inactive, active	inactive	[Protection Para /<1..4> /P-Prot /PQS[1]]
P> 	Over(load) Active Power Pickup Value. Can be used for monitoring the maximum allowed forward power limits of transformers or overhead lines. Definition for Sn is as follows: Sn = SQRT(3) * VT secondary rating * CT secondary rating (I=1/5A) for wye or Sn = 3 * VT secondary rating/SQRT(3) * CT secondary rating (I=1/5A) for delta connections.  Only available if: Device planning: PQS.Mode = P>	0.003 - 10.000Sn	PQS[1]: 1.0Sn PQS[2]: 1.20Sn PQS[3]: 1.20Sn PQS[4]: 1.20Sn PQS[5]: 1.20Sn PQS[6]: 1.20Sn	[Protection Para /<1..4> /P-Prot /PQS[1]]



Protective Elements

Parameter	Description	Setting range	Default	Menu path
P< 	Under(load) Active Power Pickup Value (e.g. caused by idling motors). Definition for Sn is as follows: $S_n = \text{SQRT}(3) * \text{VT secondary rating} * \text{CT secondary rating} (I=1/5A)$ for wye or $S_n = 3 * \text{VT secondary rating}/\text{SQRT}(3) * \text{CT secondary rating} (I=1/5A)$ for delta connections.  Only available if: Device planning: PQS.Mode = P<	0.003 - 10.000Sn	0.80Sn	[Protection Para <1..4> /P-Prot /PQS[1]]
Pr> 	Overload Reverse Active Power Pickup Value. Protection against reverse feeding into the power supply network. Definition for Sn is as follows: $S_n = \text{SQRT}(3) * \text{VT secondary rating} * \text{CT secondary rating} (I=1/5A)$ for wye or $S_n = 3 * \text{VT secondary rating}/\text{SQRT}(3) * \text{CT secondary rating} (I=1/5A)$ for delta connections.  Only available if: Device planning: PQS.Mode = Pr>	0.003 - 10.000Sn	0.020Sn	[Protection Para <1..4> /P-Prot /PQS[1]]
Pr< 	Under Reverse Definition for Sn is as follows: $S_n = \text{SQRT}(3) * \text{VT secondary rating} * \text{CT secondary rating} (I=1/5A)$ for wye or $S_n = 3 * \text{VT secondary rating}/\text{SQRT}(3) * \text{CT secondary rating} (I=1/5A)$ for delta connections.  Only available if: Device planning: PQS.Mode = P	0.003 - 10.000Sn	0.80Sn	[Protection Para <1..4> /P-Prot /PQS[1]]
Q> 	Over(load) Reactive Power Pickup Value. Monitoring the maximum allowed reactive power of the electrical equipment like transformers or overhead lines). If the maximum value is exceeded a condensator bank could be switched off. Definition for Sn is as follows: $S_n = \text{SQRT}(3) * \text{VT secondary rating} * \text{CT secondary rating} (I=1/5A)$ for wye or $S_n = 3 * \text{VT secondary rating}/\text{SQRT}(3) * \text{CT secondary rating} (I=1/5A)$ for delta connections.  Only available if: Device planning: PQS.Mode = Q>	0.003 - 10.000Sn	1.20Sn	[Protection Para <1..4> /P-Prot /PQS[1]]
Q< 	Under(load) Reactive Power Pickup Value. Monitoring the minimum value of the reactive power. If it falls below the set value a condensator bank could be switched on. Definition for Sn is as follows: $S_n = \text{SQRT}(3) * \text{VT secondary rating} * \text{CT secondary rating} (I=1/5A)$ for wye or $S_n = 3 * \text{VT secondary rating}/\text{SQRT}(3) * \text{CT secondary rating} (I=1/5A)$ for delta connections.  Only available if: Device planning: PQS.Mode = Q<	0.003 - 10.000Sn	0.80Sn	[Protection Para <1..4> /P-Prot /PQS[1]]
Qr> 	Overload Reverse Reactive Power Pickup Value Definition for Sn is as follows: $S_n = \text{SQRT}(3) * \text{VT secondary rating} * \text{CT secondary rating} (I=1/5A)$ for wye or $S_n = 3 * \text{VT secondary rating}/\text{SQRT}(3) * \text{CT secondary rating} (I=1/5A)$ for delta connections.  Only available if: Device planning: PQS.Mode = Qr>	0.003 - 10.000Sn	0.020Sn	[Protection Para <1..4> /P-Prot /PQS[1]]

Protective Elements

Parameter	Description	Setting range	Default	Menu path
 Qr<	Under Reverse Definition for Sn is as follows: $S_n = \sqrt{3} * VT \text{ secondary rating} * CT \text{ secondary rating} (I=1/5A)$ for wye or $S_n = 3 * VT \text{ secondary rating} / \sqrt{3} * CT \text{ secondary rating} (I=1/5A)$ for delta connections.  Only available if: Device planning: PQS.Mode = Q	0.003 - 10.000Sn	0.80Sn	[Protection Para /<1..4> /P-Prot /PQS[1]]
 S>	Over(load) Apparent Power Pickup Value Definition for Sn is as follows: $S_n = \sqrt{3} * VT \text{ secondary rating} * CT \text{ secondary rating} (I=1/5A)$ for wye or $S_n = 3 * VT \text{ secondary rating} / \sqrt{3} * CT \text{ secondary rating} (I=1/5A)$ for delta connections.  Only available if: Device planning: PQS.Mode = S>	0.02 - 10.00Sn	1.20Sn	[Protection Para /<1..4> /P-Prot /PQS[1]]
 S<	Under(load) Apparent Power Pickup Value Definition for Sn is as follows: $S_n = \sqrt{3} * VT \text{ secondary rating} * CT \text{ secondary rating} (I=1/5A)$ for wye or $S_n = 3 * VT \text{ secondary rating} / \sqrt{3} * CT \text{ secondary rating} (I=1/5A)$ for delta connections.  Only available if: Device planning: PQS.Mode = S<	0.02 - 10.00Sn	0.80Sn	[Protection Para /<1..4> /P-Prot /PQS[1]]
 t	Tripping delay	0.00 - 1100.00s	PQS[1]: 1.00s PQS[2]: 0.01s PQS[3]: 0.01s PQS[4]: 0.01s PQS[5]: 0.01s PQS[6]: 0.01s	[Protection Para /<1..4> /P-Prot /PQS[1]]
 PowMeasMethod	Determines if the active power, reactive power and apparent power are calculated on the basis of RMS or DFT.	Fundamental, True RMS	Fundamental	[Protection Para /<1..4> /P-Prot /PQS[1]]

## States of the inputs of the Power Protection module

<i>Name</i>	<i>Description</i>	<i>Assignment via</i>
ExBlo1-I	Module input state: External blocking	[Protection Para /Global Prot Para /P-Prot /PQS[1]]
ExBlo2-I	Module input state: External blocking	[Protection Para /Global Prot Para /P-Prot /PQS[1]]
ExBlo TripCmd-I	Module input state: External Blocking of the Trip Command	[Protection Para /Global Prot Para /P-Prot /PQS[1]]

## Signals of the Power Protection module (states of the outputs)

<i>Signal</i>	<i>Description</i>
active	Signal: active
ExBlo	Signal: External Blocking
Blo TripCmd	Signal: Trip Command blocked
ExBlo TripCmd	Signal: External Blocking of the Trip Command
Alarm	Signal: Alarm Power Protection
Trip	Signal: Trip Power Protection
TripCmd	Signal: Trip Command

## Commissioning Examples for the Power Protection Module

### *Object to be tested*

- Testing the projected Power Protection Modules.
- P>
- P<
- Pr
- Q>
- Q<
- Qr
- S>
- S<

### *Necessary means*

- 3-phase AC voltage source
- 3-phase AC current source
- Timer

### *Procedure – Testing the wiring*

- Feed rated voltage and rated current to the measuring inputs of the relay.
- Adjust the current pointers 30° lagging to the voltage pointers.
- The following measuring values have to be shown:  
P=0.86 P<sub>n</sub>  
Q=0.5 Q<sub>n</sub>  
S=1 S<sub>n</sub>

### **NOTICE**

If the measured values are shown with a negative (algebraic) sign check the wiring.

### **NOTICE**

The examples shown within this chapter have to be carried out with the tripping values and tripping delays that apply to your switchboard.

If you are testing „greater than thresholds“ (e.g. P>) start by 80% of the tripping value and increase the object to be tested until the relay picks up.

In case that you are testing „less than thresholds“ (e.g. P<) start by 120% of the tripping value and reduce the object to be tested until the relay picks up.

If you are testing tripping delays of „greater than“ modules (e.g. P>) start a timer simultaneously with an abrupt change of the object to be tested from 80% of the tripping value to 120% of the tripping value.

If you are testing tripping delays of „less than“ modules (e.g. P<) start a timer simultaneously with an abrupt change of the object to be tested from 120% of the tripping value to 80% of the tripping value.

**NOTICE**

P>

**Testing the threshold values (Example, Threshold 1.1 Pn)**

- Feed rated voltage and 0.9 times rated current in phase to the measuring inputs of the relay (PF=1).
- The measured values for the active power „P“ must show a positive algebraic sign.
- Set the tripping threshold (e.g. 1.1 Pn).
- In order to test the tripping thresholds feed 0.9 times rated current to the measuring inputs of the relay. Increase the current slowly until the relay picks up. Ensure that the angle between current and voltage remains constant. Compare the tripping value to the parameterized.

**Testing the tripping delay (Example, Threshold 1.1 Pn)**

- Feed rated voltage and rated current in phase to the measuring inputs of the relay (PF=1).
- The measured values for the active power „P“ must show a positive algebraic sign.
- Set the tripping threshold (e.g. 1.1 Pn).
- In order to test the tripping delay feed 0.9 times rated current to the measuring inputs of the relay. Increase the current with an abrupt change to 1.2 In. Ensure that the angle between current and voltage remains constant. Measure the tripping delay at the output of the relay.

*Successful test result*

The measured total tripping delays or individual tripping delays, threshold values and fallback ratios correspond with those values, specified in the adjustment list. Permissible deviations/tolerances can be found under Technical Data.

**NOTICE**

Q>

**Testing the threshold values (Example, Threshold 1,1 Qn)**

- Feed rated voltage and 0.9 times rated current (90° phase shift) to the measuring inputs of the relay (PF=0).
- The measured values for the active power „Q“ must show a positive algebraic sign.
- Set the tripping threshold (e.g. 1.1 Qn).
- In order to test the tripping thresholds feed 0.9 times rated current to the measuring inputs of the relay. Increase the current slowly until the relay picks up. Ensure that the angle between current and voltage remains constant. Compare the tripping value to the parameterized.

**Testing the tripping delay (Example, Threshold 1.1 Qn)**

- Feed rated voltage and rated current (90° phase shift) to the measuring inputs of the relay (PF=0).
- The measured values for the active power „Q“ must show a positive algebraic sign.
- Set the tripping threshold (e.g. 1.1 Qn).
- In order to test the tripping delay feed 0.9 times rated current to the measuring inputs of the relay. Increase the current with an abrupt change to 1.2 In. Ensure that the angle between current and voltage remains constant. Measure the tripping delay at the output of the relay.

*Successful test result*

The measured total tripping delays or individual tripping delays, threshold values and fallback ratios correspond with those values, specified in the adjustment list. Permissible deviations/tolerances can be found under Technical Data.

**NOTICE**

P<

**Testing the threshold values (Example, Threshold 0.3 P<sub>n</sub>)**

- Feed rated voltage and rated current in phase to the measuring inputs of the relay (PF=1).
- The measured values for the active power „P“ must show a positive algebraic sign.
- Set the tripping threshold (e.g. 0.3 P<sub>n</sub>).
- In order to test the tripping thresholds feed 0.5 times rated current to the measuring inputs of the relay. Reduce the current slowly until the relay picks up. Ensure that the angle between current and voltage remains constant. Compare the tripping value to the parameterized.

**Testing the tripping delay (Example, Threshold 0.3 P<sub>n</sub>)**

- Feed rated voltage and rated current in phase to the measuring inputs of the relay (PF=1).
- The measured values for the active power „P“ must show a positive algebraic sign.
- Set the tripping threshold (e.g. 0.3 P<sub>n</sub>).
- In order to test the tripping delay feed 0.5 times rated current to the measuring inputs of the relay. Increase the current with an abrupt change to 0.2 I<sub>n</sub>. Ensure that the angle between current and voltage remains constant. Measure the tripping delay at the output of the relay.

*Successful test result*

The measured total tripping delays or individual tripping delays, threshold values and fallback ratios correspond with those values, specified in the adjustment list. Permissible deviations/tolerances can be found under Technical Data.

**NOTICE**

Q<

**Testing the threshold values (Example, Threshold 0.3 Qn)**

- Feed rated voltage and 0.9 times rated current (90° phase shift) to the measuring inputs of the relay (PF=0).
- The measured values for the active power „Q“ must show a positive algebraic sign.
- Set the tripping threshold (e.g. 0.3 Qn).
- In order to test the tripping thresholds feed 0.5 times rated current to the measuring inputs of the relay. Reduce the current slowly until the relay picks up. Ensure that the angle between current and voltage remains constant. Compare the tripping value to the parameterized.

**Testing the tripping delay (Example, Threshold 0.3 Qn)**

- Feed rated voltage and 0.9 times rated current (90° phase shift) to the measuring inputs of the relay (PF=0).
- The measured values for the active power „Q“ must show a positive algebraic sign.
- Set the tripping threshold (e.g. 0.3 Qn).
- In order to test the tripping delay feed 0.5 times rated current to the measuring inputs of the relay. Increase the current with an abrupt change to 0.2 In. Ensure that the angle between current and voltage remains constant. Measure the tripping delay at the output of the relay.

*Successful test result*

The measured total tripping delays or individual tripping delays, threshold values and fallback ratios correspond with those values, specified in the adjustment list. Permissible deviations/tolerances can be found under Technical Data.



**NOTICE**

Pr

**Testing the threshold values (Example, Threshold 0.2 P<sub>n</sub>)**

- Feed rated voltage and rated current with 180 degree phase shift between voltage and current pointers to the measuring inputs of the relay.
- The measured values for the active power „P“ must show a negative algebraic sign.
- Set the tripping threshold (e. g. 0.2 P<sub>n</sub>).
- In order to test the tripping thresholds feed 0.1 times rated current to the measuring inputs of the relay. Increase the current slowly until the relay picks up. Ensure that the angle between current and voltage remains constant. Compare the tripping value to the parameterized.

**Testing the tripping delay (Example, Threshold 0.2 P<sub>n</sub>)**

- Feed rated voltage and rated current with 180 degree phase shift between voltage and current pointers to the measuring inputs of the relay.
- The measured values for the active power „P“ must show a negative algebraic sign.
- Set the tripping threshold (e.g. 0.2 P<sub>n</sub>).
- In order to test the tripping delay feed 0.1 times rated current to the measuring inputs of the relay. Increase the current with an abrupt change to 0.3 I<sub>n</sub>. Ensure that the angle between current and voltage remains constant. Measure the tripping delay at the output of the relay.

*Successful test result*

The measured total tripping delays or individual tripping delays, threshold values and fallback ratios correspond with those values, specified in the adjustment list. Permissible deviations/tolerances can be found under Technical Data.

**NOTICE**

Qr

**Testing the threshold values (Example, Threshold 0.2 Qn)**

- Feed rated voltage and rated current with -90 degree phase shift between voltage and current pointers to the measuring inputs of the relay.
- The measured values for the active power „Q“ must show a negative algebraic sign.
- Set the tripping threshold (e. g. 0.2 Qn).
- In order to test the tripping delay feed 0.1 times rated current to the measuring inputs of the relay. Increase the current slowly until the relay picks up. Ensure that the angle between current and voltage remains constant. Measure the tripping delay at the output of the relay.

**Testing the tripping delay (Example, Threshold 0.2 Qn)**

- Feed rated voltage and rated current with -90 degree phase shift between voltage and current pointers to the measuring inputs of the relay.
- The measured values for the active power „Q“ must show a negative algebraic sign.
- Set the tripping threshold (e. g. 0.2 Qn).
- In order to test the tripping thresholds feed 0.1 times rated current to the measuring inputs of the relay. Increase the current with an abrupt change to 0.3 In. Ensure that the angle between current and voltage remains constant. Compare the tripping value to the parameterized.

*Successful test result*

The measured total tripping delays or individual tripping delays, threshold values and fallback ratios correspond with those values, specified in the adjustment list. Permissible deviations/tolerances can be found under Technical Data.

**NOTICE**

S>

**Testing the threshold values**

- Feed 80% of the S> threshold to the measuring inputs of the relay.
- Increase the fed power slowly until the relay picks up. Compare the measured value at the time of tripping to the parameterized setting.

**Testing the tripping delay**

- Feed 80% of the S> threshold to the measuring inputs of the relay.
- Increase the fed power with an abrupt change to 120% of the S> threshold. Measure the tripping delay at the output of the relay.

*Successful test result*

The measured total tripping delays or individual tripping delays, threshold values and fallback ratios correspond with those values, specified in the adjustment list. Permissible deviations/tolerances can be found under Technical Data.

**NOTICE**

S<

**Testing the threshold values**

- Feed 120% of the S< threshold to the measuring inputs of the relay.
- Reduce the fed power slowly until the relay picks up. Compare the measured value at the time of tripping to the parameterized setting.

**Testing the tripping delay**

- Feed 120% of the S< threshold to the measuring inputs of the relay.
- Reduce the fed power with an abrupt change to 80% of the S< threshold. Measure the tripping delay at the output of the relay.

*Successful test result*

The measured total tripping delays or individual tripping delays, threshold values and fallback ratios correspond with those values, specified in the adjustment list. Permissible deviations/tolerances can be found under Technical Data.

## PF - Power Factor [55]

Available stages:

PF[1].PF[2]

These Element supervises the Power Factor within a defined area (limits).

The area is defined by four parameters.

- The Trigger quadrant (lead or lag).
- The Threshold (Power Factor value)
- The Reset quadrant (lead or lag).
- The Reset Value (Power Factor value)

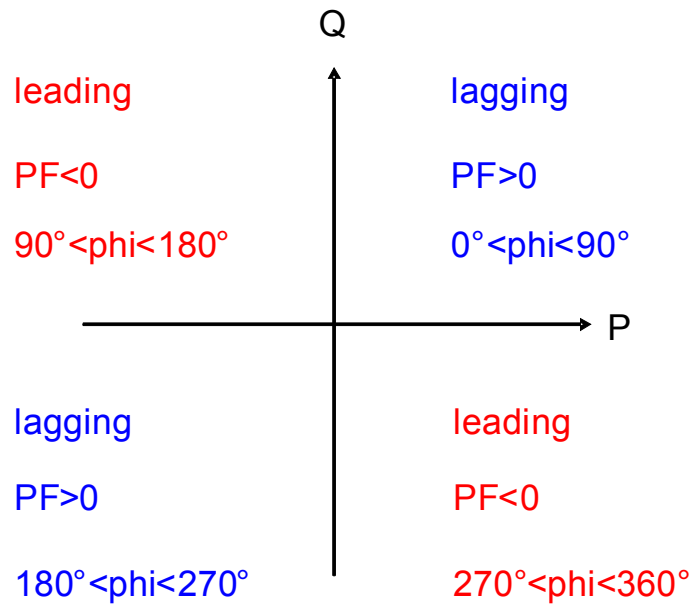





## Device planning parameters of the Power Factor module

<i>Parameter</i>	<i>Description</i>	<i>Options</i>	<i>Default</i>	<i>Menu path</i>
Mode 	Mode	do not use, use	do not use	[Device planning]

## Global protection parameter of the Power Factor-module





<i>Parameter</i>	<i>Description</i>	<i>Setting range</i>	<i>Default</i>	<i>Menu path</i>
ExBlo1 	External blocking of the module, if blocking is activated (allowed) within a parameter set and if the state of the assigned signal is true.	1..n, Assignment List	-.-	[Protection Para /Global Prot Para /PF-Prot /PF[1]]
ExBlo2 	External blocking of the module, if blocking is activated (allowed) within a parameter set and if the state of the assigned signal is true.	1..n, Assignment List	-.-	[Protection Para /Global Prot Para /PF-Prot /PF[1]]
ExBlo TripCmd 	External blocking of the Trip Command of the module/the stage, if blocking is activated (allowed) within a parameter set and if the state of the assigned signal is true.	1..n, Assignment List	-.-	[Protection Para /Global Prot Para /PF-Prot /PF[1]]

**Parameter set parameters of the Power Factor module**

Parameter	Description	Setting range	Default	Menu path
 Function	Permanent activation or deactivation of module/stage.	inactive, active	inactive	[Protection Para /<1..4> /PF-Prot /PF[1]]
 ExBlo Fc	Activate (allow) or inactivate (disallow) blocking of the module/stage. This parameter is only effective if a signal is assigned to the corresponding global protection parameter. If the signal becomes true, those modules/stages are blocked that are parameterized "ExBlo Fc=active".	inactive, active	inactive	[Protection Para /<1..4> /PF-Prot /PF[1]]
 Blo TripCmd	Permanent blocking of the Trip Command of the module/stage.	inactive, active	inactive	[Protection Para /<1..4> /PF-Prot /PF[1]]
 ExBlo TripCmd Fc	Activate (allow) or inactivate (disallow) blocking of the module/stage. This parameter is only effective if a signal is assigned to the corresponding global protection parameter. If the signal becomes true, those modules/stages are blocked that are parameterized "ExBlo TripCmd Fc=active".	inactive, active	inactive	[Protection Para /<1..4> /PF-Prot /PF[1]]
 Measuring method	Measuring method: fundamental or rms	Fundamental, True RMS	Fundamental	[Protection Para /<1..4> /PF-Prot /PF[1]]
 Trig Mode	Trigger Mode. Should the Module be triggered if the Current Phasor is leading to the Voltage Phasor = Lead? Or should the Module be triggered if the Current Phasor is lagging to the Voltage Phasor = Lag?	leading, lagging	lagging	[Protection Para /<1..4> /PF-Prot /PF[1]]
 Trigger-PF	This is the power factor where the relay will pick-up.	0.5 - 0.99	0.8	[Protection Para /<1..4> /PF-Prot /PF[1]]
 Res Mode	Trigger Mode. Should the Module be triggered if the Current Phasor is leading to the Voltage Phasor = Lead? Or should the Module be triggered if the Current Phasor is lagging to the Voltage Phasor = Lag?	leading, lagging	leading	[Protection Para /<1..4> /PF-Prot /PF[1]]



## Protective Elements

Parameter	Description	Setting range	Default	Menu path
Reset-PF 	This setting is the power factor, at which the relay will reset the power factor trip. It is like setting a hysteresis for the Trigger setting.	0.5 - 0.99	0.99	[Protection Para <1..4> /PF-Prot /PF[1]]
t 	Tripping delay	0.00 - 300.00s	0.00s	[Protection Para <1..4> /PF-Prot /PF[1]]
Pre-trig Comp 	Pickup (Pre-trigger) time for the Compensation Signal. When this timer is elapsed the compensation signal will be activated.	0.00 - 300.00s	5.00s	[Protection Para <1..4> /PF-Prot /PF[1]]
Post-trig Comp 	Post-trigger time of the Compensation Signal. When this timer is elapsed the compensation signal will be deactivated.	0.00 - 300.00s	5.00s	[Protection Para <1..4> /PF-Prot /PF[1]]

## States of the inputs of the Power Factor module

Name	Description	Assignment via
ExBlo1-I	Module input state: External blocking	[Protection Para /Global Prot Para /PF-Prot /PF[1]]
ExBlo2-I	Module input state: External blocking	[Protection Para /Global Prot Para /PF-Prot /PF[1]]
ExBlo TripCmd-I	Module input state: External Blocking of the Trip Command	[Protection Para /Global Prot Para /PF-Prot /PF[1]]

**Signals of the Power Factor module (states of the outputs)**

<i>Signal</i>	<i>Description</i>
active	Signal: active
ExBlo	Signal: External Blocking
Blo TripCmd	Signal: Trip Command blocked
ExBlo TripCmd	Signal: External Blocking of the Trip Command
Alarm	Signal: Alarm Power Factor
Trip	Signal: Trip Power Factor
TripCmd	Signal: Trip Command
Compensator	Signal: Compensation Signal
Impossible	Signal: Alarm Power Factor Impossible

## Commissioning: Power Factor [55]

### Object to be tested

- Testing the projected Power Factor Modules

### Necessary means

- 3-phase AC voltage source
- 3-phase AC current source
- Timer

### Procedure – Testing the wiring

- Feed rated voltage and rated current to the measuring inputs of the relay.
- Adjust the current pointers 30° lagging to the voltage pointers.
- The following measuring values have to be shown:  
P=0.86 Pn  
Q=0.5 Qn  
S=1 Sn

### NOTICE

If the measured values are shown with a negative (algebraic) sign check the wiring.

### NOTICE

In this example PF-Trigger is set to 0.86 = 30° (lagging) and PF-Reset is set to 0.86 = 30° leading.

**Carry out the test with the settings (trigger and reset) that fit to your switchboard.**

### Testing the threshold values (Trigger) (PF Trigger: Example = 0.86 lagging)

- Feed rated voltage and rated current in phase to the measuring inputs of the relay (PF=1).
- Adjust the angle between voltage and current (current pointer lagging) until the relay picks up.
- Write down the pickup value.

### Testing the Reset (PF Reset: Example = 0.86 leading)

- Reduce the angle between voltage and current beyond PF = 1 (current pointer leading) until the alarm drops off.
- Write down the reset value.

*Testing the trip delay (PF Trigger: Example = 0.86 lagging)*

- Feed rated voltage and rated current in phase to the measuring inputs of the relay (PF=1).
- Adjust the angle between voltage and current (current pointer lagging) with an abrupt change to PF = 0.707 (45°) lagging.
- Measure the tripping delay at the output of the relay. Compare the measured tripping time to the parameterized.

*Successful test result*

The measured total tripping delays, threshold and reset values correspond with those values, specified in the adjustment list. Permissible deviations/tolerances can be found under Technical Data.

## Q->&V< Reactive-Power/Undervoltage Protection

Available Elements:

Q->&V<

The number of distributed energy resources (DER) raises continuously. At the same time the controllable power reserve through large-scale power plants decreases.

Therefore various grid codes requirements and regulations stipulate that mains parallel distributed power plants, consisting of one or more power generation units feeding power into the MV grid, have to support the mains voltage in case of failures.

In case of failure the voltage close to the short circuit location drops nearly to zero. Around the fault location a potential gradient area is built whose expansion can be restricted by feeding reactive-power into the grid. At mains failures (voltage drop) the Q->&V< protection prevents the expansion of the potential gradient area for the case that any further reactive-power is taken from the mains.

The function of this protection module is not the protection of the power generation system itself, but more the decoupling of the power generation system when it takes reactive current from the mains in case the voltage drops below a certain value. This protection is an upstream system protection.

The Q->&V< protection module with decoupling and auto reclosing function is implemented as an autonomous protection element acc. to the German regulations <sup>1</sup> and <sup>2</sup> mentioned below.

The comprehensive setting and configuration possibilities of this protection element allow the adaptation of connected energy resources to various grid conditions.

For the correct function of this protection module you have to

- Configure the »General Settings«,
- Select and set the decoupling method.
- Configure the reconnection of the power generation units.

### General Settings

For each parameter set [Protection Para\Set [x]\Q->&U<] the general settings »General Settings« can be configured.

Here the entire function of this protection element can be activated or de-activated.

By activating the voltage transformer supervision a malfunction of this protection module can be prevented.

---

<sup>1</sup> TransmissionCode 2007, Netz- und Systemregeln der deutschen Übertragungsnetzbetreiber, Version 1.1, August 2007, Verband der Netzbetreiber –VDN – e.V. beim VDEW siehe Kap. 3.3.13.5 (6)

<sup>2</sup> Technische Richtlinie „Erzeugungsanlagen am Mittelspannungsnetz“, Richtlinie für Anschluss und Parallelbetrieb von Erzeugungsanlagen am Mittelspannungsnetz, Ausgabe Juni 2008, BDEW Bundesverband der Energie- und Wasserwirtschaft e.V., siehe Kap. 3.2.3.2 – Blindleistungs-Unterspannungsschutz Q->&U<

### Parameter Setting of Decoupling

To support the decreasing voltage (voltage drop) during faults the electric utilities require the following behaviour by the connected energy resources:

“During voltage dips under 85% of rated voltage (380/220/110 kV, e. g. 110 kV x 0.85 = 93.5 kV) and simultaneous reactive-power demand at the PCC = point of common coupling (under-excited operation), the connected energy resource has to be decoupled after 0.5 s.

The voltage value refers to the highest value of the three phase to phase voltages. The decoupling has to be done at the generator circuit breaker.“

**NOTICE**

The reactive-power of the positive phase sequence system (Q1) is evaluated.

The voltage supervision only monitors the phase to phase voltages. This prevents any influence on the measurement through neutral point displacement in resonant earthed systems.

In the menu [Protection Para\Set[x]\Q->&U<] the »Decoupling« parameters can be set.

The reactive-power demand from the grid can be detected by two different methods. Therefore the decoupling method »QV-Method« has to be selected first.

- Power Angle Supervision (method 1)
- Pure Reactive Power Supervision (method 2)

*Method 1: Power Angle Supervision*

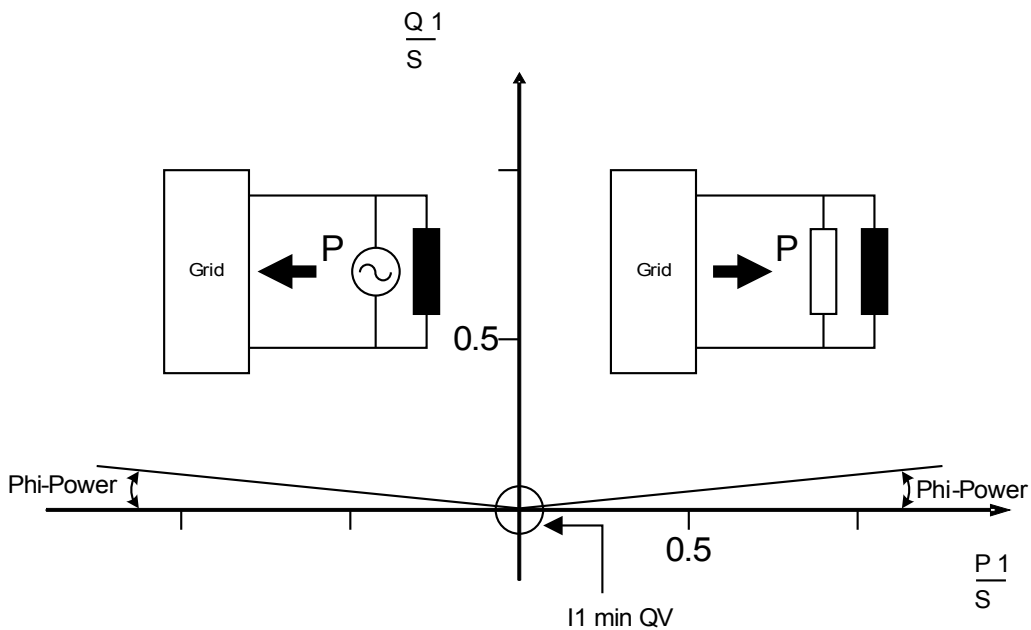

Method 2: Pure Reactive Power Supervision

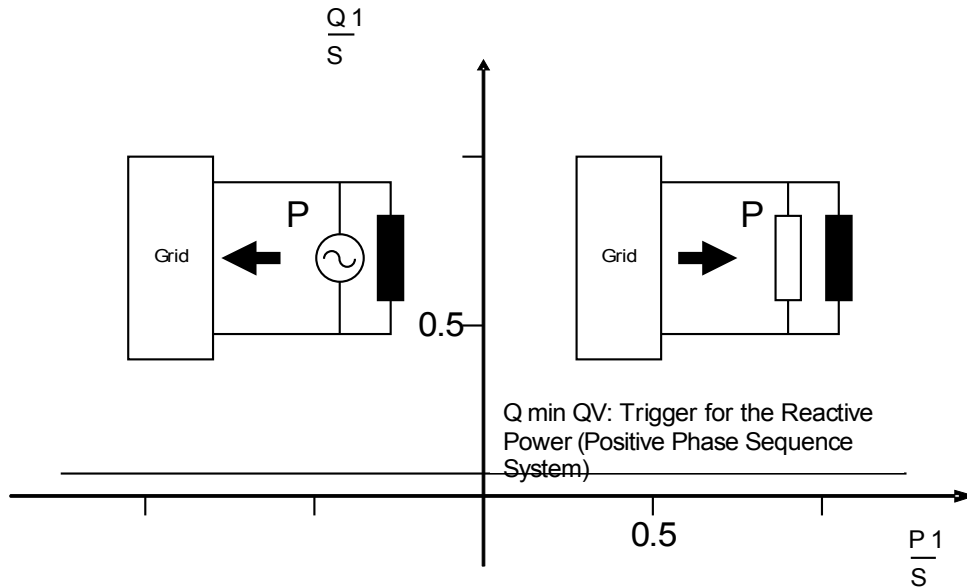

A minimum current supervision (I1) in the positive phase sequence system prevents a hyperfunction of the reactive-power supervision at lower power levels.

For the power angle supervision, the minimum current supervision is always active. For the pure reactive-power supervision the minimum current supervision is optional.

When using the power angle supervision (method 1):

- Set the power factor »Phi-Power« (Default setting 3°).
- Select a suitable minimum current »I min QV« (Default setting 0.1 In) which prevents false trippings.

When using the pure reactive power supervision (method 2):

- Set the reactive-power threshold »Q min QV«(Default setting 0.05 Sn).
- Optionally select a suitable minimum current »I min QV« (Default setting 0.1 In) to prevent false trippings.

Two timer elements are available »t1-QV« und »t2-QV«. Both timer elements will be started at pick-up of the Q->U< module.

*First timer element (Decoupling of the power generation unit)*

When several mains parallel power generation units feed one PCC, the first timer element can give a trip command to the generator circuit breaker of the power generation unit (Default setting 0.5 s)

*Second timer element (Decoupling at the PCC)*

For the case, that tripping of the first timer element (decoupling of a certain power generation unit) does not have the expected effect the second timer element can give a trip command to the circuit breaker at the PCC (Default setting 1.5 s). This decouples the entire DER from the grid.

Q->&V<

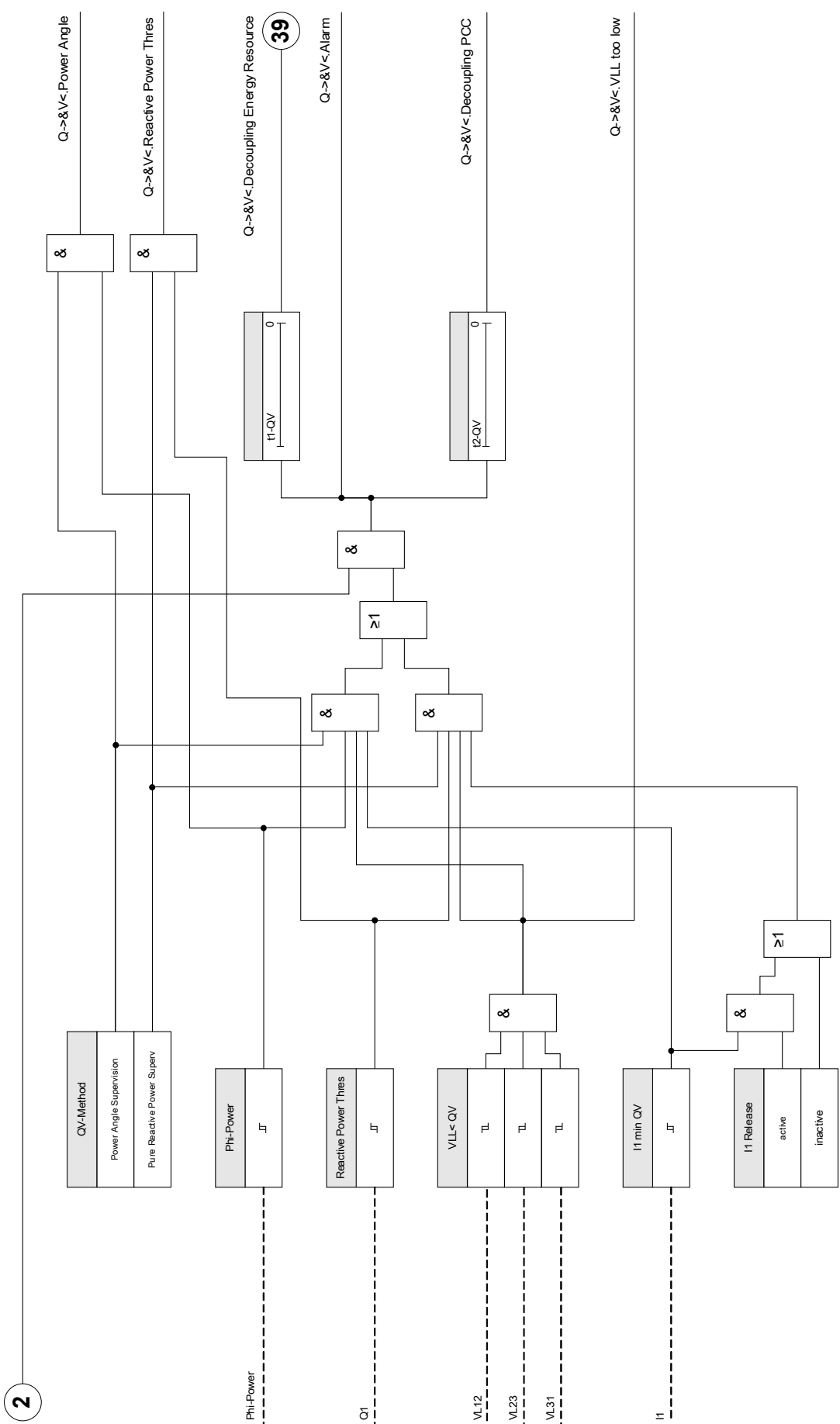



## Reclosing

The reclosing function after a mains decoupling is based on the requirements of the Transmission-Code (TC2007)<sup>[1]</sup> and the German directive „Erzeugungsanlagen am MS-Netz“<sup>[2]</sup>.

To monitor the reclosing conditions after a mains decoupling, a reclosing function has been implemented additionally to the decoupling function.

Mains voltage (phase to phase) and frequency are the main criteria for reclosing. Always the mains side voltage at the generator circuit breaker has to be evaluated.

The reclosing function is only one of the system functions for mains decoupling and return synchronizing. Triggering of the reclosing function is only possible after a trip of the first timer element (decoupling of a power generation unit).

After a trip of the circuit breaker at the PCC by the decoupling function, reclosing has to be done manually.



### **WARNING**

**Danger of asynchronously reclosing:**

**The reclosing function does not substitute a synchronizing device.**

**Before connecting different electrical networks, synchronism has to be secured.**

After decoupling by the  $Q \rightarrow V$  module or other decoupling functions, like  $V \rightarrow V$ ,  $V \rightarrow V$ ,  $f \rightarrow$  the reclosing release signal for reclosing the circuit breaker of the power generating unit will be blocked for a preset time interval (default setting 10 min.).

This is to wait until all switching operations are completed. The reclosing release only will be issued, when after elapse of the mains recovery time the thresholds for mains voltage and frequency are met.

### *Release logic for the PCC circuit breaker*

If the PCC circuit breaker has tripped reclosing has to be done manually. A special blocking logic is not necessary.

### **NOTICE**

**If a power generating unit should be reconnected by the generator circuit breaker the voltage transformers have to be installed at the mains side of the circuit breaker.**

Release logic for the PCC circuit breaker.

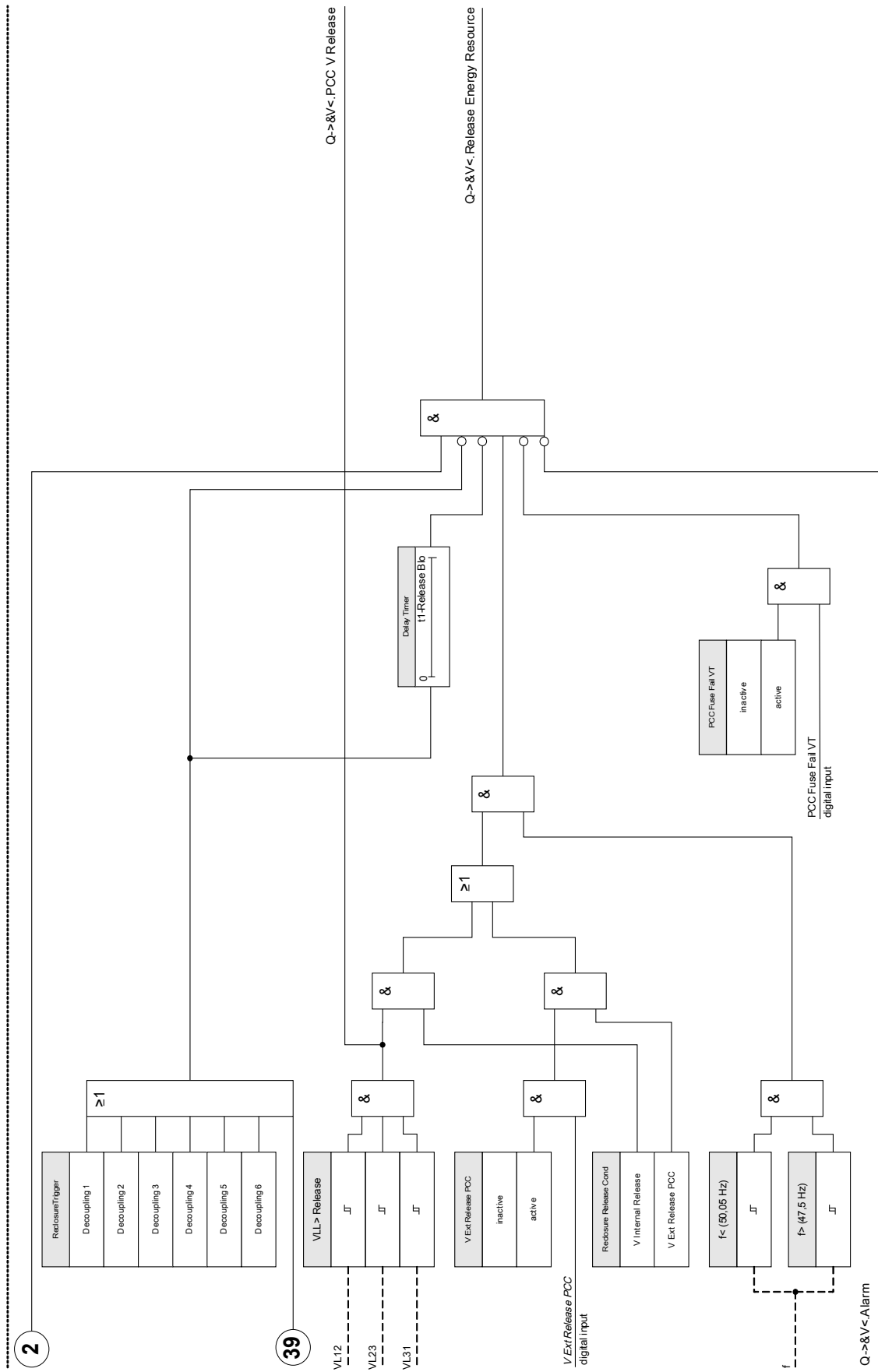

## Voltage release via remote control connection from the PCC

### NOTICE

This method has to be used, if the PCC is on the HV side.

This method can be used, if the PCC is on the MV side.

If reclosing should be done via remote control signal from the PCC:

In the menu [Protection Para\Set[x]\Q->&U<\General settings] the parameter »*PCC-Release Fc*« has to be set to »*active*«. With this setting the voltage release signal from the PCC is used (e. g. signal via digital input)

Additionally the parameter »*Reclosure Release Cond*« in the menu [Protection Para\Set[x]\Q->&U<\Reclosure\Reclosure Trigger] has to be set to »*PCC (Extremal Release)*«

Also the remote control release signal has to be assigned to the parameter »*PCC-Release*« in the menu [Protection Para\Global Prot Para\Q->&V<]

## Voltage release by measured voltage values

### NOTICE

This method can be used, if the PCC is on the MV side.

If the PCC is on the MV side, the device can measure the phase to phase voltages on the mains side and decide if the mains voltage has stabilized sufficiently for reclosing.

For this method the parameter »*V Ext Release PCC Fk*« in the menu [Protection Para\Set[x]\Q->&V<\General settings] has to be set to »*inactive*«.

Additionally the parameter »*Reclosure Release Cond*« in the menu [Protection Para\Set[x]\Q->&V<\Reclosure\Reclosure Release] has to be set to »*Internal Release*«

## PCC in HV systems

According to the TransmissionCode 2007 <sup>[1]</sup> the following condition has to be observed:

After decoupling of a DER caused by overfrequency, underfrequency, undervoltage, overvoltage or after isolated operation, automatic synchronizing of the generators to the grid is only allowed under the following conditions:

- The voltage in a 110 kV system is higher than 105 kV
- The voltage in a 220 kV system is higher than 210 kV
- The voltage in a 380 kV system is higher than 370 kV

The voltage values refer to the lowest voltage of the three phase to phase voltages.

### NOTICE

**It is required that the PCC and also the DER are equipped with a decoupling devices.**

**It is required that the decoupling device of the PCC controls the PCC's circuit breaker.**

**It is required that the decoupling device of the power generation unit controls the generator circuit breaker.**

Reclosing Conditions:

Before reclosing a power generation unit, it has to be secured, that mains voltage has been stabilized sufficiently. For this a corresponding remote signal has to be available.

Set the parameter »*Reclosure Release Cond*« in the menu [Protection Para\Set[x]\Q->&V<\Reclosure\Reclosure Release] to »*V Ext Release PCC*«. The required parameter settings are described in the chapter »*General Settings*«.

Set the blocking signals in the menu [Protection Para\Set[x]\Q->&V<\Reclosure\Reclosure Trigger] which start the mains recovery time (OR logic).

Select a sufficiently long recovery time »*t1-Release Blo*« in the menu [Protection Para\Set[x]\Q->&V<\Reclosure\Reclosure Release Cond]. Reclosing is only possible after this timer has been elapsed.

In the menu [Protection Para\Set[x]\Q->&V<\Reclosure\Reclosure Release Cond] the frequency range to be met for reclosing can be set.

## PCC in MV systems

### **NOTICE**

It is required that the PCC and also the DER are equipped with a decoupling devices.

It is required that the decoupling device of the PCC controls the PCC's circuit breaker.

It is required that the decoupling device of the power generation unit controls the generator circuit breaker.

The German regulation „Erzeugungsanlagen am MS-Netz“ (BDEW, Issue June 2008 <sup>[2]</sup>) recommends to have a time delay (some minutes) between mains voltage recovery and reclosure after a trip of a decoupling system as a result of a mains failure. This is to wait until all switching operations are completed. Usually this is the case after 10 minutes. A reclosing of the DER is only permitted, when the mains voltage is >95% of  $V_n$  and the frequency is in the range of 47.5 Hz to 50.05 Hz.

Set the blocking signals in the menu

[Protection Para\Set[x]\Q->&V<\Reclosure\Reclosure Trigger] which start the mains recovery time (OR logic).

Select a sufficiently long recovery time »t1-Release Blo« in the menu

[Protection Para\Set[x]\Q->&V<\Reclosure\Reclosure Release Cond]. Reclosing is only possible after this timer has been elapsed.





In the menu [Protection Para\Set[x]\Q->&V<\Reclosure\Reclosure Release Cond] the frequency range to be met for reclosing can be set.

For the case, that the reclosure release should be realized via internal measurement values, the mains voltage threshold »VLL>« can be set in the menu [Protection Para\Set[x]\Q->&V<\Reclosure\Reclosure Release Cond] (default 0.95  $V_n$ ). For reclosing all phase to phase voltages have to be above this threshold. The required parameter settings are described in the chapter »General Settings«.

## Device Planning Parameters of the Q->&V< Module

Parameter	Description	Options	Default	Menu path
Mode 	Mode	do not use, use	do not use	[Device planning]



## Global Protection Parameters of the Q->&V< Module

Parameter	Description	Setting range	Default	Menu path
ExBlo1 	External blocking of the module, if blocking is activated (allowed) within a parameter set and if the state of the assigned signal is true.	1..n, Assignment List	--	[Protection Para /Global Prot Para /Intercon-Prot /Q->&V<]
ExBlo2 	External blocking of the module, if blocking is activated (allowed) within a parameter set and if the state of the assigned signal is true.	1..n, Assignment List	--	[Protection Para /Global Prot Para /Intercon-Prot /Q->&V<]
V Ext Release PCC 	Release Signal by the Point of Common Coupling. The line-to-line voltage is greater than 95% of VN.	1..n, Assignment List	--	[Protection Para /Global Prot Para /Intercon-Prot /Q->&V<]
PCC Fuse Fail VT 	Blocking if the fuse of a voltage transformer has tripped at the PCC.	1..n, Dig Inputs	--	[Protection Para /Global Prot Para /Intercon-Prot /Q->&V<]





## Decoupling Functions of the Q-&gt;&amp;V&lt; Module

<i>Name</i>	<i>Description</i>
-.-	No assignment
V[1].TripCmd	Signal: Trip Command
V[2].TripCmd	Signal: Trip Command
V[3].TripCmd	Signal: Trip Command
V[4].TripCmd	Signal: Trip Command
V[5].TripCmd	Signal: Trip Command
V[6].TripCmd	Signal: Trip Command
df/dt.TripCmd	Signal: Trip Command
delta phi.TripCmd	Signal: Trip Command
Intertripping.TripCmd	Signal: Trip Command
P.TripCmd	Signal: Trip Command
Q.TripCmd	Signal: Trip Command
LVRT.TripCmd	Signal: Trip Command
VG[1].TripCmd	Signal: Trip Command
VG[2].TripCmd	Signal: Trip Command
f[1].TripCmd	Signal: Trip Command
f[2].TripCmd	Signal: Trip Command
f[3].TripCmd	Signal: Trip Command
f[4].TripCmd	Signal: Trip Command
f[5].TripCmd	Signal: Trip Command
f[6].TripCmd	Signal: Trip Command
PF[1].TripCmd	Signal: Trip Command
PF[2].TripCmd	Signal: Trip Command

## Setting Group Parameters of the Q-&gt;&amp;V&lt; Module

Parameter	Description	Setting range	Default	Menu path
Function 	Permanent activation or deactivation of module/stage.	inactive, active	inactive	[Protection Para <1..4> /Intercon-Prot /Q->&V< /General settings]
ExBlo Fc 	Activate (allow) or inactivate (disallow) blocking of the module/stage. This parameter is only effective if a signal is assigned to the corresponding global protection parameter. If the signal becomes true, those modules/stages are blocked that are parameterized "ExBlo Fc=active".	inactive, active	inactive	[Protection Para <1..4> /Intercon-Prot /Q->&V< /General settings]
Meas Circuit Superv 	Measuring Circuit Supervision	inactive, active	inactive	[Protection Para <1..4> /Intercon-Prot /Q->&V< /General settings]
V Ext Release PCC Fc 	Activate the release signal of the Point of Common Coupling. The line-to-line voltage is greater than 95% of VN.	inactive, active	inactive	[Protection Para <1..4> /Intercon-Prot /Q->&V< /General settings]
QV-Method 	Selection of the Q(V)-Method: Power Angle or Reactive Power Threshold	Power Angle Supervision, Pure Reactive Power Superv	Power Angle Supervision	[Protection Para <1..4> /Intercon-Prot /Q->&V< /Decoupling]
I1 Release 	Activation of the "I1 Minimum Current"-Criterion.  Only available if: QV-Method = Power Angle Supervision	inactive, active	active	[Protection Para <1..4> /Intercon-Prot /Q->&V< /Decoupling]
I1 min QV 	Activation of an "I1 Minimum Current" of the rated current of the (distributed) energy resource can prevent faulty tripping.  Only available if: Activation of the "I1 Minimum Current"-Criterion. = active	0.01 - 0.20In	0.10In	[Protection Para <1..4> /Intercon-Prot /Q->&V< /Decoupling]



Parameter	Description	Setting range	Default	Menu path
VLL < QV 	Undervoltage threshold (line-to-line voltage!)	0.70 - 1.00Vn	0.85Vn	[Protection Para /<1..4> /Intercon-Prot /Q->&V< /Decoupling]
Phi-Power 	Trigger Phi-Power (Positive Phase Sequence System)  Only available if: QV-Method = Power Angle Supervision	0 - 10°	3°	[Protection Para /<1..4> /Intercon-Prot /Q->&V< /Decoupling]
Q min QV 	Trigger for the Reactive Power (Positive Phase Sequence System)  Only available if: QV-Method = Pure Reactive Power Superv	0.01 - 0.20Sn	0.05Sn	[Protection Para /<1..4> /Intercon-Prot /Q->&V< /Decoupling]
t1-QV 	First timer. If this timer has elapsed, a trip signal will be issued to the (local) energy resource.	0.00 - 2.00s	0.5s	[Protection Para /<1..4> /Intercon-Prot /Q->&V< /Decoupling]
t2-QV 	Second timer. If this timer is elapsed, the an trip signal will be issued to the PCC (Point of Common Coupling)	0.00 - 4.00s	1.5s	[Protection Para /<1..4> /Intercon-Prot /Q->&V< /Decoupling]
Reconnect. Release Cond 	This signal indicates that the mains voltage is recovered.	V Internal Release, V Ext Release PCC	V Internal Release	[Protection Para /<1..4> /Intercon-Prot /Q->&V< /Reconnection /Release]
PCC Fuse Fail VT Fk 	Blocking if the fuse of a voltage transformer has tripped at the PCC.  Only available if: Reclosure Release Cond = V Ext Release PCC	inactive, active	inactive	[Protection Para /<1..4> /Intercon-Prot /Q->&V< /Reconnection /Release]

## Protective Elements

<i>Parameter</i>	<i>Description</i>	<i>Setting range</i>	<i>Default</i>	<i>Menu path</i>
Decoupling1 	Decoupling function, that blocks the reclosure.	Reconnect Trigger	-.-	[Protection Para /<1..4> /Intercon-Prot /Q->&V< /Reconnection /Reconnect Trigger]
Decoupling2 	Decoupling function, that blocks the reclosure.	Reconnect Trigger	-.-	[Protection Para /<1..4> /Intercon-Prot /Q->&V< /Reconnection /Reconnect Trigger]
Decoupling3 	Decoupling function, that blocks the reclosure.	Reconnect Trigger	-.-	[Protection Para /<1..4> /Intercon-Prot /Q->&V< /Reconnection /Reconnect Trigger]
Decoupling4 	Decoupling function, that blocks the reclosure.	Reconnect Trigger	-.-	[Protection Para /<1..4> /Intercon-Prot /Q->&V< /Reconnection /Reconnect Trigger]
Decoupling5 	Decoupling function, that blocks the reclosure.	Reconnect Trigger	-.-	[Protection Para /<1..4> /Intercon-Prot /Q->&V< /Reconnection /Reconnect Trigger]

## Protective Elements

Parameter	Description	Setting range	Default	Menu path
Decoupling6 	Decoupling function, that blocks the reclosure.	Reconnect Trigger	.-	[Protection Para /<1..4> /Intercon-Prot /Q->&V< /Reconnection /Reconnect Trigger]
VLL> Release 	Minimum voltage (line-to-line) for reclosure (Restoration Voltage)  Only available if: Reclosure Release Cond = V Internal Release	0.70 - 1.00Vn	0.95Vn	[Protection Para /<1..4> /Intercon-Prot /Q->&V< /Reconnection /Release]
f< 	Lower voltage (line-to-line) limit for the reclosure (Restoration Voltage)	40.00 - 69.90Hz	47.5Hz	[Protection Para /<1..4> /Intercon-Prot /Q->&V< /Reconnection /Release]
f> 	Upper frequency limit for the reclosure	40.00 - 69.90Hz	50.05Hz	[Protection Para /<1..4> /Intercon-Prot /Q->&V< /Reconnection /Release]
t1-Release Blo 	Time stage (delay) for the reclosure of the energy resources	0.00 - 3600.00s	600s	[Protection Para /<1..4> /Intercon-Prot /Q->&V< /Reconnection /Release]

### Input States of the Q->&V< Module

<i>Name</i>	<i>Description</i>	<i>Assignment via</i>
ExBlo1-I	Module input state: External blocking1	[Protection Para /Global Prot Para /Intercon-Prot /Q->&V<]
ExBlo2-I	Module input state: External blocking2	[Protection Para /Global Prot Para /Intercon-Prot /Q->&V<]
V Ext Release PCC-I	Module input state: Release signal is being generated by the PCC (External Release)	[Protection Para /Global Prot Para /Intercon-Prot /Q->&V<]
PCC Fuse Fail VT-I	State of the module input: Blocking if the fuse of a voltage transformer has tripped at the PCC.	[Protection Para /Global Prot Para /Intercon-Prot /Q->&V<]

**Q->&V< Module Signals (Output States)**

<i>Signal</i>	<i>Description</i>
active	Signal: active
ExBlo	Signal: External Blocking
Fuse Fail VT Blo	Signal: Blocked by Fuse Failure (VT)
Alarm	Signal: Alarm Reactive Power Undervoltage Protection
Decoupling Energy Resource	Signal: Decoupling of the (local) Energy Resource
Decoupling PCC	Signal: Decoupling at the Point of Common Coupling
PCC V Release	Signal: Voltage Release from the Point of Common Coupling
Release Energy Resource	Signal: Release Energy Resource. Internal (local) voltage release
Power Angle	Signal: Admissible power angle exceeded
Reactive Power Thres	Signal: Admissible Reactive Power Threshold exceeded
VLL too low	Signal: Line-to-Line voltage too low

## LVRT – Low Voltage Ride Through

Available Elements:

### LVRT

#### *Why LVRT? - Motivation for LVRT*

The rapid development of distributed resources (DR) based on the renewable energy such as wind, solar and others has been changing the electric power system and concepts for its control, protection, metering and communication rapidly, too.

One of the important challenges for the interconnection between the DR and local electric power system (EPS) is the behaviour of the DR during disturbances within the electrical power system. Most of the disturbances within the EPS are characterized mainly by non-permanent system voltage collapses (voltage dip/sag) with different time durations.

According to traditional protection concepts a distributed energy resource should be tripped as fast as possible from the grid in case of a significant low voltage condition. This is no longer acceptable because of the continuous rising share of distributed energy resources within the energy market. Uncontrolled disconnecting significant parts of the power generation during disturbances within the grid endangers the system stability of the electrical power system.

It was reported<sup>3</sup> that during system fault with low voltage drops, a complete 5000 MW wind park (without LVRT capability) was decoupled from the electrical power system. The consequence was a dangerous system voltage and frequency instability.

Based on experiences like that, lots of electric utilities and state public utilities have issued interconnection standards which require Low-Voltage-Ride-Through (LVRT) capability during EPS disturbances.

#### *What does LVRT mean in detail?*

It is no longer allowed to decouple/disconnect a DR from the grid just because of a non-permanent voltage dip. Protective relays and control units have to take this into account.

Instead of that, the distributed resource has to be able to ride through such disturbances according to a LVRT profile. The shape of this LVRT profile is very similar according to the different guidelines within different countries or local utilities. But they could differ in details.

By means of LVRT the system stability is improved in situations, when the contribution of DRs is needed mostly. The importance of LVRT will rise with the growing share of DRs within the electrical power system.

Based on the technical requirements mentioned above, a LVRT protection function was developed for the *HighPROTEC* product line which covers the LVRT profiles (capabilities) defined by all relevant national and local grid interconnection standards.

The following drawing shows details on the different LVRT standards in different countries. Please note, that the standards and hence the grid codes are in some countries still under development.

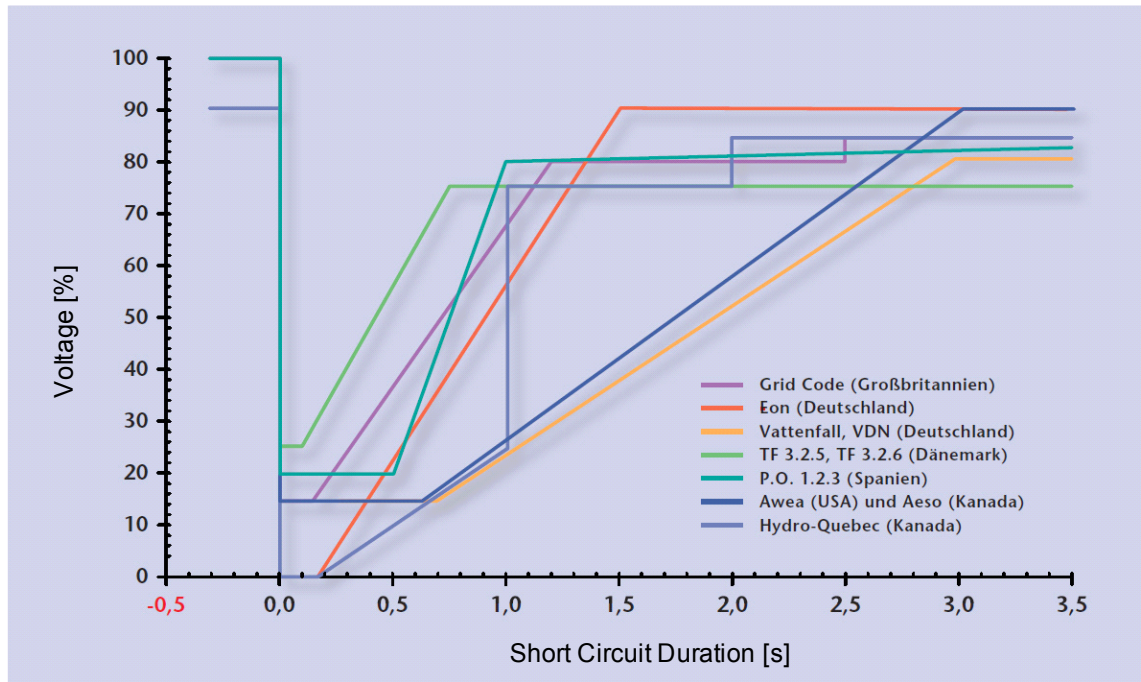

Source: eBWK Bd. 60 (2008) Nr. 4

Authors: Dipl.-Ing. Thomas Smolka, Dr.-Ing. Karl-Heinz Weck, Zertifizierungstelle der FGH e.V., Mannheim, sowie Dipl.-Ing. (FH) Matthias Bartsch, Enercon GmbH, Aurich.

## Functional Principle of the LVRT

From the grid operators point of view, a LVRT profile defines a voltage profile which a distributed generator, that is connected to the grid, should be able to ride through a low voltage event if the voltage at the point of common coupling remains above the LVRT borderline defined by the LVRT profile after a disturbance. The distributed generator is only allowed to disconnect from the grid if the voltage at the point of common coupling drops below the LVRT borderline. In other words, a LVRT protection function is a time-dependent voltage supervision according to a predefined voltage profile. The time-dependent voltage supervision will be started, as soon as the voltage at the point of common coupling falls below the start voltage level. The LVRT will be stopped, as soon as the voltage rises above the recover voltage level.

## Auto Reclosure controlled LVRT

As already mentioned, the purpose of LVRT is to keep the DR connected to the grid in case of a non-permanent voltage dip/sag. For faults within the electrical power system by which auto-reclosing function is used to coordinate with the short circuit protections like overcurrent or distance protections, it is to expect that more than one voltage dips are coming one after another in a time period which is determined by the preset auto-reclosing dead times and protection relay operating times. Voltage dips/sags caused by the dead times of auto reclosings are non-permanent. Hence the protective device has to be able to detect voltage sags/dips in accordance with an auto reclosure and issues a trip command in that case that the voltage drops below the profile or that all parameterized auto reclosure shots were unsuccessful.

The following figure<sup>1</sup> depicts the voltage excursion by an unsuccessful two-shot Auto-Reclosing. According to some grid codes<sup>1</sup> it is obligated for a distributed generation to ride through a series of temporary voltage dips, but can be disconnected from the electrical power system immediately for a permanent fault. This kind of applications can be realized easily using the feature of »AR-controlled LVRT« in LVRT protection function.

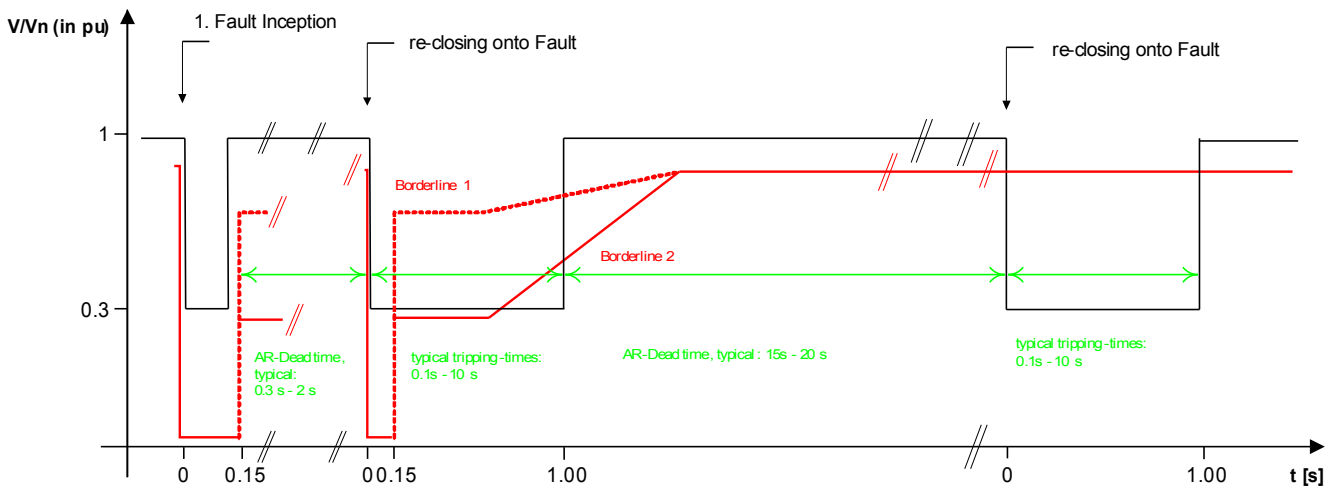

Source: Technische Richtlinie, Erzeugungsanlagen am Mittelspannungsnetz, Ausgabe Juni 2008, BDEW Bundesverband der Energie- und Wasserwirtschaft e.V. (Page 89).

Figure: Run of voltage curve during an unsuccessful two-shot auto reclosure

### Functional Description of the LVRT

The LVRT element is designed for distributed generation resources that operate in parallel with the grid. It supervises system voltage disturbances by comparing them with a configurable voltage profile that is triggered once the system voltage falls below a configurable start value »Vstart«.

Once triggered, the LVRT element supervises the system voltage consecutively and determines if the voltage excursion is above or below of the preset voltage profile. A trip signal is only issued if the voltage excursion exits the "Ride-Through" region and goes into the "Tripping" region.



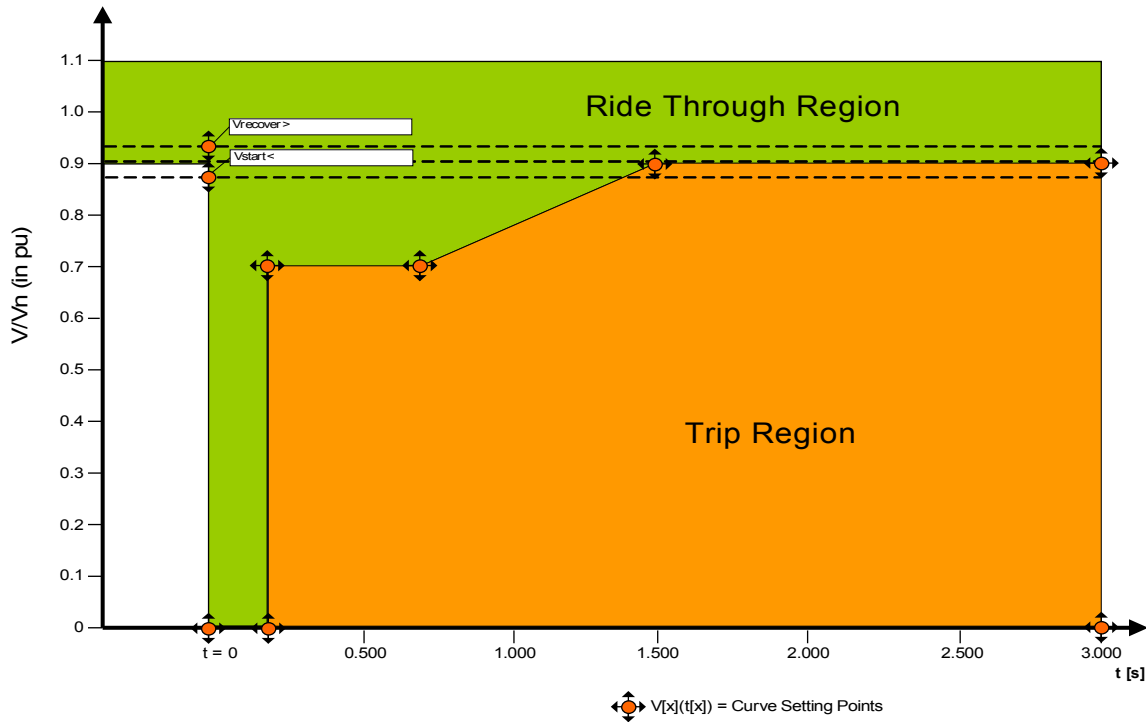

The LVRT element will change into standby again as soon as the system voltage recovers: That means, the voltage has risen above the preset recover voltage » *Vrecover*«.

*Auto Reclosure controlled LVRT*

In case that the LVRT should be able to ride through auto reclosures, the parameter » *ARControlledLVRT*« has to be set to » *active*«.

In order to supervise the Low Voltage Ride Through, the user has to set a supervision timer which defines the complete Multi-Shot AR-runtime. In addition to that the number of permitted LVRTs has to be set. This is usually the number of auto reclosure attempts. The actual LVRT supervision will be controlled to ride through the preset LVRT voltage pattern. By reaching the preset number of LVRT events » *NumberOfLVRT*«, the actual LVRT supervision assumes that the detected system fault is permanent, ignores the voltage profile and issues a tripping command instantaneously in order to disconnect the distributed resource from the electrical power system at the point of common coupling.

**LVRT**

name = LVRT[1]...[n]

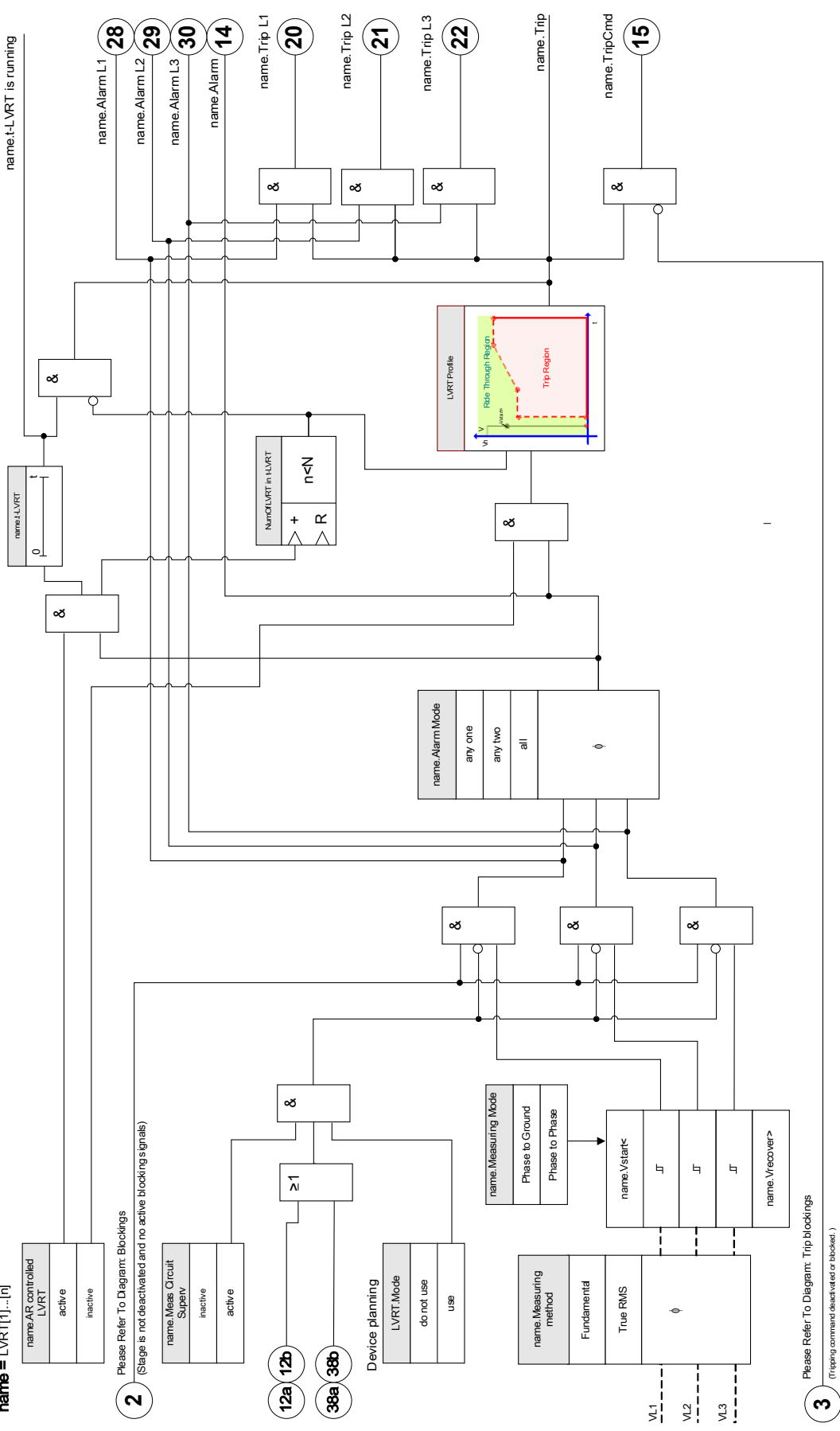

2 Please Refer To Diagram: Blockings  
(Stage is not deactivated and no active blocking signals)

12a 12b  
38a 38b

Device planning  
LVRT.Mode  
do not use  
use





name.Measuring method  
Fundamental  
True RMS  
φ  
name.Vstart<  
JT  
JT  
JT  
name.Vrecover>

3 Please Refer To Diagram: Trip blockings  
(Tripping command deactivated or blocked.)







### Device Planning Parameters of the Low-Voltage-Ride-Through

Parameter	Description	Options	Default	Menu path
Mode 	Mode	do not use, LVRT	do not use	[Device planning]







### Setting Group Parameters of the Low-Voltage-Ride-Through

Parameter	Description	Setting range	Default	Menu path
Function 	Permanent activation or deactivation of module/stage.	inactive, active	inactive	[Protection Para /<1..4> /Intercon-Prot /LVRT /General settings]
ExBlo Fc 	Activate (allow) or inactivate (disallow) blocking of the module/stage. This parameter is only effective if a signal is assigned to the corresponding global protection parameter. If the signal becomes true, those modules/stages are blocked that are parameterized "ExBlo Fc=active".	inactive, active	inactive	[Protection Para /<1..4> /Intercon-Prot /LVRT /General settings]
Blo TripCmd 	Permanent blocking of the Trip Command of the module/stage.	inactive, active	inactive	[Protection Para /<1..4> /Intercon-Prot /LVRT /General settings]
ExBlo TripCmd Fc 	Activate (allow) or inactivate (disallow) blocking of the module/stage. This parameter is only effective if a signal is assigned to the corresponding global protection parameter. If the signal becomes true, those modules/stages are blocked that are parameterized "ExBlo TripCmd Fc=active".	inactive, active	inactive	[Protection Para /<1..4> /Intercon-Prot /LVRT /General settings]
Measuring Mode 	Measuring/Supervision Mode: Determines if the phase-to-phase or phase-to-earth voltages are to be supervised	Phase to Ground, Phase to Phase	Phase to Ground	[Protection Para /<1..4> /Intercon-Prot /LVRT /General settings]

Protective Elements

Parameter	Description	Setting range	Default	Menu path
 Measuring method	Measuring method: fundamental or rms	Fundamental, True RMS	Fundamental	[Protection Para /<1..4> /Intercon-Prot /LVRT /General settings]
 Alarm Mode	Alarm criterion for the voltage protection stage.	any one, any two, all	any one	[Protection Para /<1..4> /Intercon-Prot /LVRT /General settings]
 Meas Circuit Superv	Measuring Circuit Supervision  Only available if: Device planning: LVRT.Mode = use	inactive, active	inactive	[Protection Para /<1..4> /Intercon-Prot /LVRT /General settings]
 AR controlled LVRT	AR controlled Low Voltage Ride Through  Only available if: Device planning: LVRT.Mode = use	inactive, active	inactive	[Protection Para /<1..4> /Intercon-Prot /LVRT /General settings]
 Number of LVRT	Number of LVRT events, after that a disconnection of DR is allowed.  Only available if: Device planning: LVRT.Mode = use Number of LVRT events, after that a disconnection of DR is allowed. Number of LVRT events, after that a disconnection of DR is allowed.	1 - 6	1	[Protection Para /<1..4> /Intercon-Prot /LVRT /General settings]
 t-LVRT	This supervision timer will be started by a LVRT event if during this time a number of "AR-controlled Events" has been effective. This timer will be stopped, if the number permitted LVRT-Events is exceeded.  Only available if: Device planning: LVRT.Mode = use This supervision timer will be started by a LVRT event if during this time a number of "AR-controlled Events" has been effective. This timer will be stopped, if the number permitted LVRT-Events is exceeded. This supervision timer will be started by a LVRT event if during this time a number of "AR-controlled Events" has been effective. This timer will be stopped, if the number permitted LVRT-Events is exceeded.	0.00 - 3000.00s	30.00s	[Protection Para /<1..4> /Intercon-Prot /LVRT /General settings]

## Protective Elements

Parameter	Description	Setting range	Default	Menu path
Vstart< 	A LVRT cycle will be started as soon as the voltage falls below this threshold  Only available if: Device planning: LVRT.Mode = use	0.00 - 1.50Vn	0.90Vn	[Protection Para <1..4> /Intercon-Prot /LVRT /LVRT Profile]
Vrecover> 	A LVRT cycle will be terminated as soon as the voltage rises above this threshold  Only available if: Device planning: LVRT.Mode = use	0.10 - 1.50Vn	0.93Vn	[Protection Para <1..4> /Intercon-Prot /LVRT /LVRT Profile]
V(t1) 	Point on curve  Only available if: Device planning: LVRT.Mode = use	0.00 - 1.50Vn	0.00Vn	[Protection Para <1..4> /Intercon-Prot /LVRT /LVRT Profile]
t1 	Tripping delay  Only available if: Device planning: LVRT.Mode = use	0.00 - 20.00s	0.00s	[Protection Para <1..4> /Intercon-Prot /LVRT /LVRT Profile]
V(t2) 	Point on curve  Only available if: Device planning: LVRT.Mode = use	0.00 - 1.50Vn	0.00Vn	[Protection Para <1..4> /Intercon-Prot /LVRT /LVRT Profile]
t2 	Tripping delay  Only available if: Device planning: LVRT.Mode = use	0.00 - 20.00s	0.15s	[Protection Para <1..4> /Intercon-Prot /LVRT /LVRT Profile]
V(t3) 	Point on curve  Only available if: Device planning: LVRT.Mode = use	0.00 - 1.50Vn	0.30Vn	[Protection Para <1..4> /Intercon-Prot /LVRT /LVRT Profile]

## Protective Elements



Parameter	Description	Setting range	Default	Menu path
t3 	Tripping delay Only available if: Device planning: LVRT.Mode = use	0.00 - 20.00s	0.15s	[Protection Para <1..4> /Intercon-Prot /LVRT /LVRT Profile]
V(t4) 	Point on curve Only available if: Device planning: LVRT.Mode = use	0.00 - 1.50Vn	0.30Vn	[Protection Para <1..4> /Intercon-Prot /LVRT /LVRT Profile]
t4 	Tripping delay Only available if: Device planning: LVRT.Mode = use	0.00 - 20.00s	0.6s	[Protection Para <1..4> /Intercon-Prot /LVRT /LVRT Profile]
V(t5) 	Point on curve Only available if: Device planning: LVRT.Mode = use	0.00 - 1.50Vn	0.90Vn	[Protection Para <1..4> /Intercon-Prot /LVRT /LVRT Profile]
t5 	Tripping delay Only available if: Device planning: LVRT.Mode = use	0.00 - 20.00s	1.50s	[Protection Para <1..4> /Intercon-Prot /LVRT /LVRT Profile]
V(t6) 	Point on curve Only available if: Device planning: LVRT.Mode = use	0.00 - 1.50Vn	0.90Vn	[Protection Para <1..4> /Intercon-Prot /LVRT /LVRT Profile]
t6 	Tripping delay Only available if: Device planning: LVRT.Mode = use	0.00 - 20.00s	3.00s	[Protection Para <1..4> /Intercon-Prot /LVRT /LVRT Profile]

Protective Elements

Parameter	Description	Setting range	Default	Menu path
V(t7) 	Point on curve  Only available if: Device planning: LVRT.Mode = use	0.00 - 1.50Vn	0.90Vn	[Protection Para <1..4> /Intercon-Prot /LVRT /LVRT Profile]
t7 	Tripping delay  Only available if: Device planning: LVRT.Mode = use	0.00 - 20.00s	3.00s	[Protection Para <1..4> /Intercon-Prot /LVRT /LVRT Profile]
V(t8) 	Point on curve  Only available if: Device planning: LVRT.Mode = use	0.00 - 1.50Vn	0.90Vn	[Protection Para <1..4> /Intercon-Prot /LVRT /LVRT Profile]
t8 	Tripping delay  Only available if: Device planning: LVRT.Mode = use	0.00 - 20.00s	3.00s	[Protection Para <1..4> /Intercon-Prot /LVRT /LVRT Profile]
V(t9) 	Point on curve  Only available if: Device planning: LVRT.Mode = use	0.00 - 1.50Vn	0.90Vn	[Protection Para <1..4> /Intercon-Prot /LVRT /LVRT Profile]
t9 	Tripping delay  Only available if: Device planning: LVRT.Mode = use	0.00 - 20.00s	3.00s	[Protection Para <1..4> /Intercon-Prot /LVRT /LVRT Profile]
V(t10) 	Point on curve  Only available if: Device planning: LVRT.Mode = use	0.00 - 1.50Vn	0.90Vn	[Protection Para <1..4> /Intercon-Prot /LVRT /LVRT Profile]

Parameter	Description	Setting range	Default	Menu path
t10 	Tripping delay  Only available if: Device planning: LVRT.Mode = use	0.00 - 20.00s	3.00s	[Protection Para /<1..4> /Intercon-Prot /LVRT /LVRT Profile]

### Global Protection Parameters of the Low-Voltage-Ride-Through

Parameter	Description	Setting range	Default	Menu path
ExBlo1 	External blocking of the module, if blocking is activated (allowed) within a parameter set and if the state of the assigned signal is true.	1..n, Assignment List	.-	[Protection Para /Global Prot Para /Intercon-Prot /LVRT]
ExBlo2 	External blocking of the module, if blocking is activated (allowed) within a parameter set and if the state of the assigned signal is true.	1..n, Assignment List	.-	[Protection Para /Global Prot Para /Intercon-Prot /LVRT]
ExBlo TripCmd 	External blocking of the Trip Command of the module/the stage, if blocking is activated (allowed) within a parameter set and if the state of the assigned signal is true.	1..n, Assignment List	.-	[Protection Para /Global Prot Para /Intercon-Prot /LVRT]

### Inputs of the Low-Voltage-Ride-Through

Name	Description	Assignment via
ExBlo1-I	Module input state: External blocking1	[Protection Para /Global Prot Para /Intercon-Prot /LVRT]
ExBlo2-I	Module input state: External blocking2	[Protection Para /Global Prot Para /Intercon-Prot /LVRT]
ExBlo TripCmd-I	Module input state: External Blocking of the Trip Command	[Protection Para /Global Prot Para /Intercon-Prot /LVRT]



## Signals (Output States) of the Low-Voltage-Ride-Through

<i>Signal</i>	<i>Description</i>
active	Signal: active
ExBlo	Signal: External Blocking
Blo TripCmd	Signal: Trip Command blocked
ExBlo TripCmd	Signal: External Blocking of the Trip Command
Alarm L1	Signal: Alarm L1
Alarm L2	Signal: Alarm L2
Alarm L3	Signal: Alarm L3
Alarm	Signal: Alarm voltage stage
Trip L1	Signal: General Trip Phase L1
Trip L2	Signal: General Trip Phase L2
Trip L3	Signal: General Trip Phase L3
Trip	Signal: Trip
TripCmd	Signal: Trip Command
t-LVRT is running	Signal: t-LVRT is running

## Counter Values of the Low-Voltage-Ride-Through

<i>Value</i>	<i>Description</i>	<i>Menu path</i>
NumOfLVRT in t-LVRT	LVRT counter during ongoing LVRT i.e. while supervision timer is running (t-LVRT)	[Operation /Count and RevData /LVRT]
Cr Tot Numb of LVRT	Counter Total number of LVRTs.	[Operation /Count and RevData /LVRT]
Cr Tot Numb of LVRT Trip	Counter Total number of LVRTs that caused a Trip.	[Operation /Count and RevData /LVRT]

## Direct Commands of the Low-Voltage-Ride-Through

<i>Parameter</i>	<i>Description</i>	<i>Setting range</i>	<i>Default</i>	<i>Menu path</i>
Res LVRT Cr 	Reset LVRT counter.	inactive, active	inactive	[Operation /Reset]

### References:

<sup>1</sup> Technische Richtlinie „Erzeugungsanlagen am Mittelspannungsnetz – Richtlinie für Anschluss und Parallelbetrieb von Erzeugungsanlagen am Mittelspannungsnetz“, Juni 2008, BDEW, Berlin

<sup>2</sup> IEEE Std 1547™-2003, IEEE Standard for Interconnecting Distributed Resources with Electric Power Systems.

<sup>3</sup> Title: Can China Wind Power meet the challenge of “Low-Voltage-Ride-Through” Date: 18.05.2011 Author: Shi Feng-Lei.  
<http://energy.people.com.cn/GB/14667118.html>.

## Intertripping (Remote)

Elements:

Intertripping

**NOTICE**

All elements of the external protection are identically structured.

This module enables intertripping (executing external trip commands)

**name** = Remote Trip



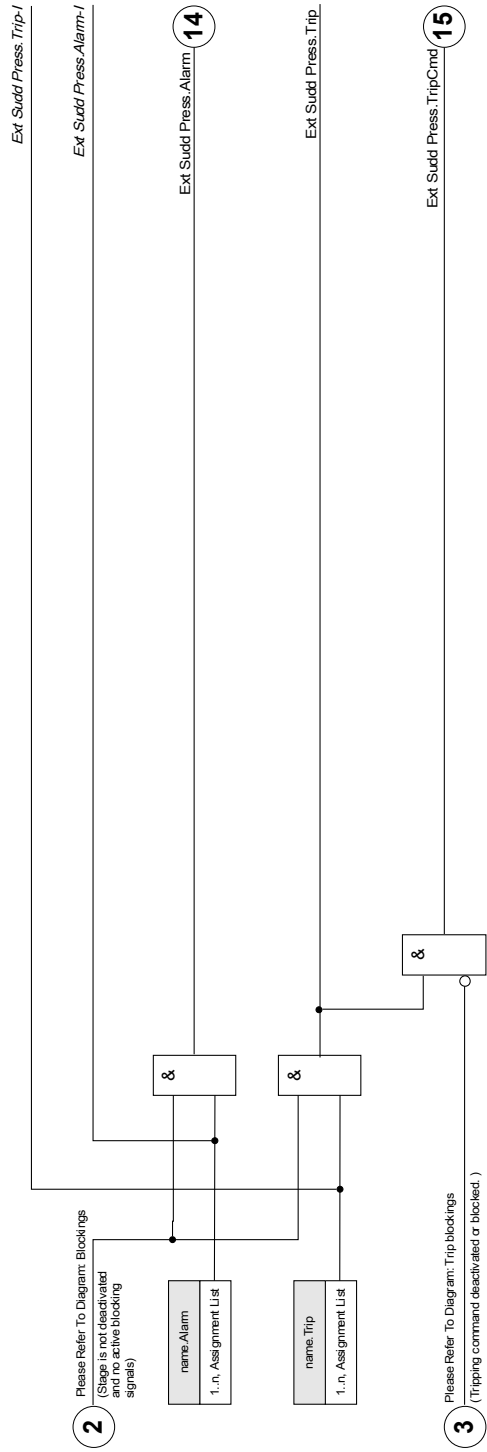

**Remote Trip**







### Device Planning Parameters of the External Trip Module

Parameter	Description	Options	Default	Menu path
Mode 	Mode	do not use, use	do not use	[Device planning]

### Global Protection Parameters of the External External Trip Module

Parameter	Description	Setting range	Default	Menu path
ExBlo1 	External blocking of the module, if blocking is activated (allowed) within a parameter set and if the state of the assigned signal is true.	1..n, Assignment List	-.-	[Protection Para /Global Prot Para /Intercon-Prot /Mains Decouplg /Intertripping]
ExBlo2 	External blocking of the module, if blocking is activated (allowed) within a parameter set and if the state of the assigned signal is true.	1..n, Assignment List	-.-	[Protection Para /Global Prot Para /Intercon-Prot /Mains Decouplg /Intertripping]
ExBlo TripCmd 	External blocking of the Trip Command of the module/the stage, if blocking is activated (allowed) within a parameter set and if the state of the assigned signal is true.	1..n, Assignment List	-.-	[Protection Para /Global Prot Para /Intercon-Prot /Mains Decouplg /Intertripping]
Alarm 	Assignment for External Alarm	1..n, Assignment List	-.-	[Protection Para /Global Prot Para /Intercon-Prot /Mains Decouplg /Intertripping]
Trip 	External trip of the CB if the state of the assigned signal is true.	1..n, Assignment List	-.-	[Protection Para /Global Prot Para /Intercon-Prot /Mains Decouplg /Intertripping]

## Setting Group Parameters of the External External Trip Module

<i>Parameter</i>	<i>Description</i>	<i>Setting range</i>	<i>Default</i>	<i>Menu path</i>
Function 	Permanent activation or deactivation of module/stage.	inactive, active	inactive	[Protection Para /<1..4> /Intercon-Prot /Mains Decouplg /Intertripping]
ExBlo Fc 	Activate (allow) or inactivate (disallow) blocking of the module/stage. This parameter is only effective if a signal is assigned to the corresponding global protection parameter. If the signal becomes true, those modules/stages are blocked that are parameterized "ExBlo Fc=active".	inactive, active	inactive	[Protection Para /<1..4> /Intercon-Prot /Mains Decouplg /Intertripping]
Blo TripCmd 	Permanent blocking of the Trip Command of the module/stage.	inactive, active	inactive	[Protection Para /<1..4> /Intercon-Prot /Mains Decouplg /Intertripping]
ExBlo TripCmd Fc 	Activate (allow) or inactivate (disallow) blocking of the module/stage. This parameter is only effective if a signal is assigned to the corresponding global protection parameter. If the signal becomes true, those modules/stages are blocked that are parameterized "ExBlo TripCmd Fc=active".	inactive, active	inactive	[Protection Para /<1..4> /Intercon-Prot /Mains Decouplg /Intertripping]

## External Trip Module Input States

<i>Name</i>	<i>Description</i>	<i>Assignment via</i>
ExBlo1-I	Module input state: External blocking1	[Protection Para /Global Prot Para /Intercon-Prot /Mains Decouplg /Intertripping]
ExBlo2-I	Module input state: External blocking2	[Protection Para /Global Prot Para /Intercon-Prot /Mains Decouplg /Intertripping]
ExBlo TripCmd-I	Module input state: External Blocking of the Trip Command	[Protection Para /Global Prot Para /Intercon-Prot /Mains Decouplg /Intertripping]
Alarm-I	Module input state: Alarm	[Protection Para /Global Prot Para /Intercon-Prot /Mains Decouplg /Intertripping]
Trip-I	Module input state: Trip	[Protection Para /Global Prot Para /Intercon-Prot /Mains Decouplg /Intertripping]

## External Trip Module Signals (Output States)

<i>Signal</i>	<i>Description</i>
active	Signal: active
ExBlo	Signal: External Blocking
Blo TripCmd	Signal: Trip Command blocked
ExBlo TripCmd	Signal: External Blocking of the Trip Command
Alarm	Signal: Alarm
Trip	Signal: Trip
TripCmd	Signal: Trip Command

## **Commissioning: External Trip**

*Object to be tested:*

Test of the Intertripping (Remote) module.

*Necessary means:*

Dependent on the application.

*Procedure:*

Simulate the functionality of the Intertripping Trip (pickup, trip, blockings) by (de-)energizing of the digital inputs.

*Successful test result:*

All external pickups, external trips, and external blockings are correctly recognized and processed by the device.



## f - Frequency [81O/U, 78, 81R]

Available elements:  
 f[1] .f[2] .f[3] .f[4] .f[5] .f[6]

**NOTICE** All frequency protective elements are identically structured.

### Frequency - Measuring Principle

**NOTICE** The frequency is calculated as the average of the measured values of the three phase frequencies. Only valid measured frequency values are taken into account. If a phase voltage is no longer measurable, this phase will be excluded from the calculation of the average value.

The measuring principle of the frequency supervision is based in general on the time measurement of complete cycles, whereby a new measurement is started at each zero passage. The influence of harmonics on the measuring result is thus minimized.

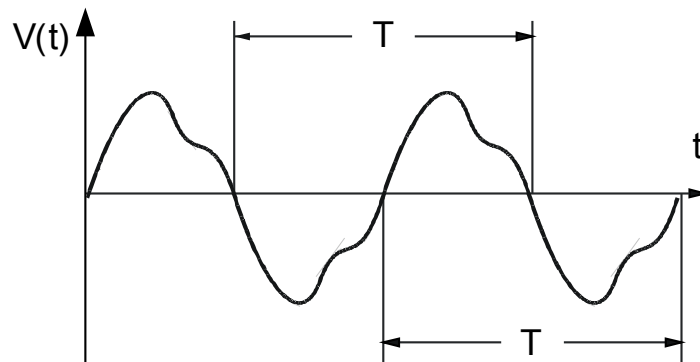

Frequency tripping is sometimes not desired by low measured voltages which for instance occur during alternator acceleration. All frequency supervision functions are blocked if the voltage is lower 0.15 times  $V_n$ .

### Frequency Functions

Due to its various frequency functions, the device is very flexible. That makes it suitable for a wide range of applications, where frequency supervision is an important criterion.

In the *Device Planning* menu, the User can decide how to use each of the six frequency elements.

f[1] to f[6] can be assigned as:

- f< – Underfrequency;
- f> – Overfrequency;
- df/dt - Rate of Change of Frequency;
- f< + df/dt – Underfrequency and Rate of Change of Frequency;

- $f > + df/dt$  - Overfrequency and Rate of Change of Frequency;
- $f < + DF/DT$  - Underfrequency and absolute frequency change per definite time interval;
- $f > + DF/DT$  - Overfrequency and absolute frequency change per definite time interval and
- $\Delta\phi$  - Vector Surge

### $f <$ - Underfrequency

This protection element provides a pickup threshold and a tripping delay. If the frequency falls below the set pickup threshold, an alarm will be issued instantaneously. If the frequency remains under the set pickup threshold until the tripping delay has elapsed, a tripping command will be issued.

With this setting, the frequency element protects electrical generators, consumers, or electrical operating equipment in general against underfrequency.

### $f >$ - Overfrequency

This protection element provides a pickup threshold and a tripping delay. If the frequency exceeds the set pickup threshold, an alarm will be issued instantaneously. If the frequency remains above the set tripping pickup until the tripping delay has elapsed, a tripping command will be issued.

With this setting the frequency element protects electrical generators, consumers, or electrical operating equipment in general against overfrequency.

## Working Principle $f <$ and $f >$

(Please refer to the block diagram on next page.)

The frequency element supervises the three phase voltages »VL1«, »VL2« and »VL3«. If all of the three phase voltages are below 15%  $V_n$ , the frequency calculation is blocked. According to the frequency supervision mode set in the Device Planning ( $f <$  or  $f >$ ), the phase voltages are compared to the set pickup threshold for over- or under-frequency. If in any of the phases, the frequency exceeds or falls below the set pickup threshold and if there are no blocking commands for the frequency element, an alarm is issued instantaneously and the tripping delay timer is started. When the frequency still exceeds or is below the set pickup threshold after the tripping delay timer has elapsed, a tripping command will be issued.

f[1]...[n]  
 name = f[1]...[n]

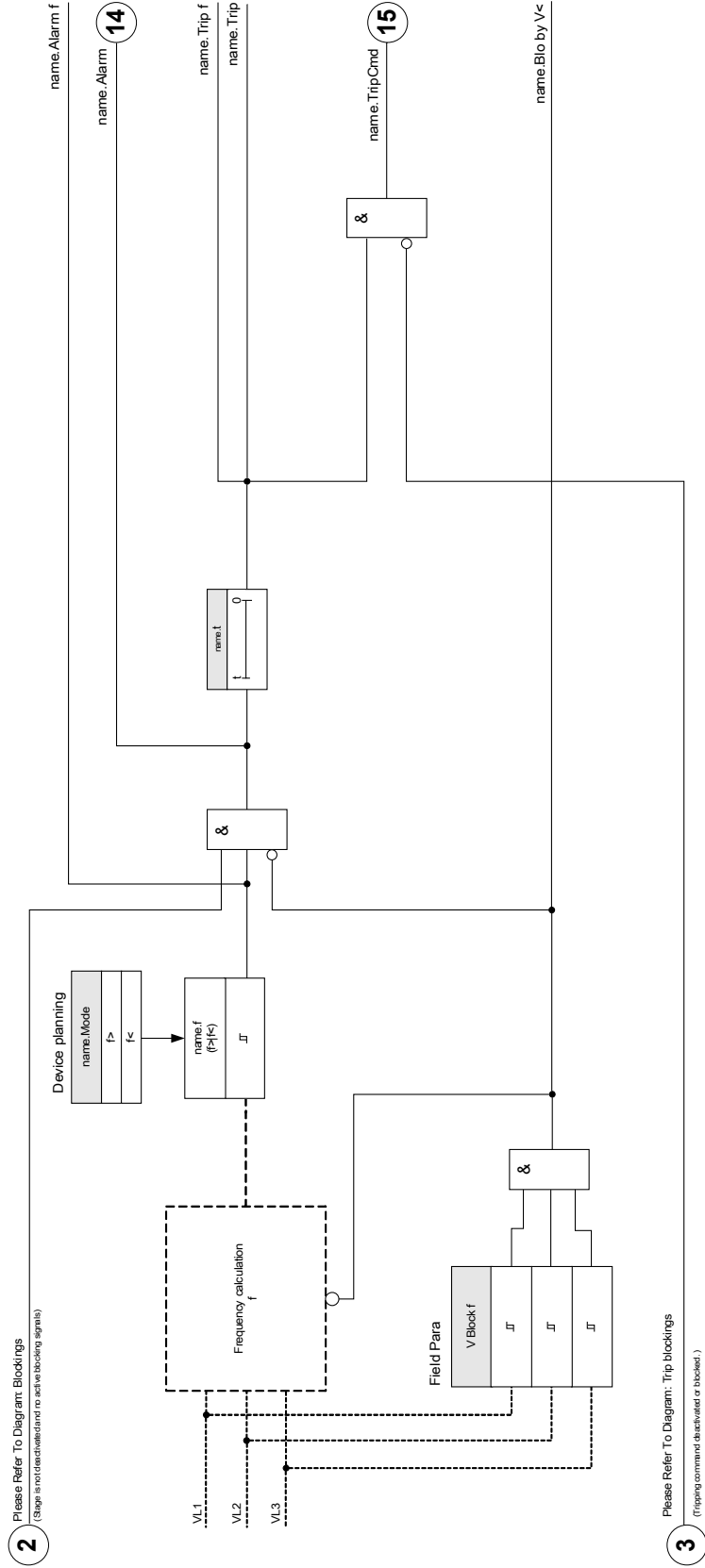

2 Please Refer To Diagram: Blockings  
 (Stage is not identified to active blocking signals)

3 Please Refer To Diagram: Trip blockings  
 (Tripping command deactivated or blocked.)

### *df/dt - Rate of Change of Frequency*

Electrical generators running in parallel with the mains, (e. g. industrial internal power supply plants), should be separated from the mains when failure in the intra-system occurs for the following reasons:

- Damage to electrical generators must be prevented when mains voltage is recovering asynchronously, (e. g. after a short interruption).
- The industrial internal power supply must be maintained.

A reliable criterion of detecting mains failure is the measurement of the rate of change of frequency ( $df/dt$ ). The precondition for this is a load flow via the mains coupling point. At mains failure the load flow change spontaneously leads to an increasing or decreasing frequency. At active power deficit of the internal power station, a linear drop of the frequency occurs and a linear increase occurs at power excess. Typical frequency gradients during application of "mains decoupling" are in the range of 0.5 Hz/s up to over 2 Hz/s.

The protective device detects the instantaneous frequency gradient ( $df/dt$ ) of each mains voltage period. Through multiple evaluations of the frequency gradient in sequence the continuity of the directional change (sign of the frequency gradient) is determined. Because of this special measuring procedure a high safety in tripping and thus a high stability against transient processes, (e. g. switching procedure) are achieved.

The frequency gradient (rate of change of frequency [ $df/dt$ ]) may have a negative or positive sign, depending on frequency increase (positive sign) or decrease (negative sign).

In the frequency parameter sets, the User can define the kind of  $df/dt$  mode:

- Positive  $df/dt$  = the frequency element detects an increase in frequency
- Negative  $df/dt$  = the frequency element detects a decrease in frequency and
- Absolute  $df/dt$  (positive and negative) = the frequency element detects both, increase and decrease in frequency

This protection element provides a tripping threshold and a tripping delay. If the frequency gradient  $df/dt$  exceeds or falls below the set tripping threshold, an alarm will be issued instantaneously. If the frequency gradient remains still above/below the set tripping threshold until the tripping delay has elapsed, a tripping command will be issued.

### **Working Principle $df/dt$**

(Please refer to the block diagram on next page)

The frequency element supervises the three phase voltages »VL1«, »VL2« and »VL3«. If any of the three phase voltages is below 15%  $V_n$ , the frequency calculation is blocked. According to the frequency supervision mode set in the Device Planning ( $df/dt$ ), the phase voltages are compared to the set frequency gradient ( $df/dt$ ) threshold. If in any of the phases, the frequency gradient exceeds or falls below the set pickup threshold (acc. to the set  $df/dt$  mode) and if there are no blocking commands for the frequency element, an alarm is issued instantaneously and the tripping delay timer is started. When the frequency gradient still exceeds or is below the set pickup threshold after the tripping delay timer has elapsed, a tripping command will be issued.

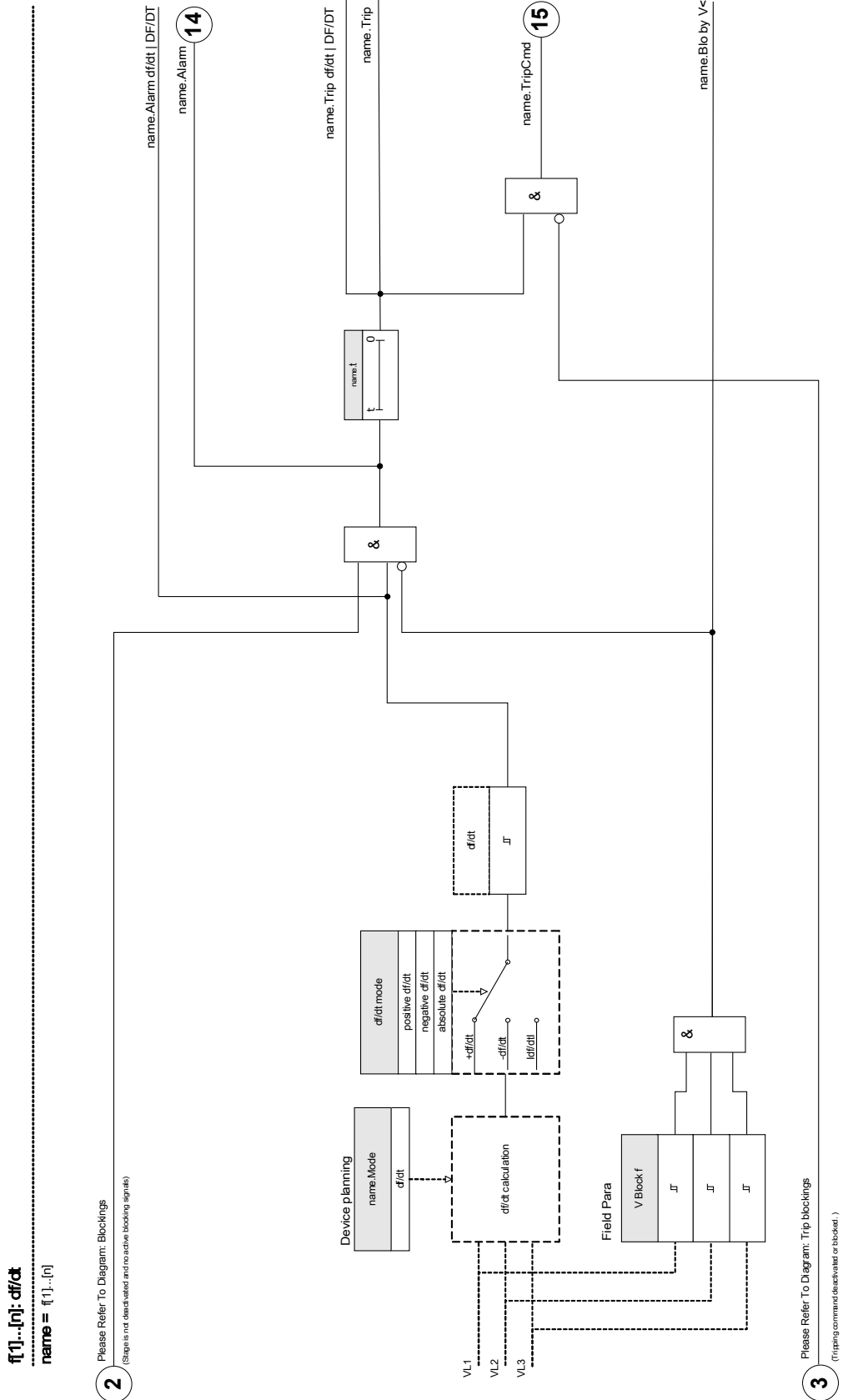

*f< and df/dt – Underfrequency and Rate of Change of Frequency*

With this setting the frequency element supervises if the frequency falls below a set pickup threshold and if the frequency gradient exceeds a set threshold at the same time.

In the selected frequency parameter set f[X], an underfrequency pickup threshold f<, a frequency gradient df/dt and a tripping delay can be set.

Whereby:

- Positive df/dt = the frequency element detects an increase in frequency
- Negative df/dt = the frequency element detects a decrease in frequency and
- Absolute df/dt (positive and negative) = the frequency element detects both, increase and decrease in frequency

*f> and df/dt – Overfrequency and Rate of Change of Frequency*

With this setting the frequency element supervises if the frequency exceeds a set pickup threshold and if the frequency gradient exceeds a set threshold at the same time.

In the selected frequency parameter set f[X], an overfrequency pickup threshold f>, a frequency gradient df/dt and a tripping delay can be set.

Whereby:

- Positive df/dt = the frequency element detects an increase in frequency
- Negative df/dt = the frequency element detects a decrease in frequency and
- Absolute df/dt (positive and negative) = the frequency element detects both, increase and decrease in frequency

**Working Principle f< and df/dt | f> and df/dt**

(Please refer to the block diagram on next page)

The frequency element supervises the three phase voltages »VL1«, »VL2« and »VL3«. If any of the three phase voltages is below 15% Vn, the frequency calculation is blocked. According to the frequency supervision mode set in the Device Planning (f< and df/dt or f> and dt/dt), the phase voltages are compared to the set frequency pickup threshold and the set frequency gradient (df/dt) threshold. If in any of the phases, both - the frequency and the frequency gradient exceed or fall below the set thresholds and if there are no blocking commands for the frequency element, an alarm is issued instantaneously and the tripping delay timer is started. When the frequency and the frequency gradient still exceed or are below the set threshold after the tripping delay timer has elapsed, a tripping command will be issued.

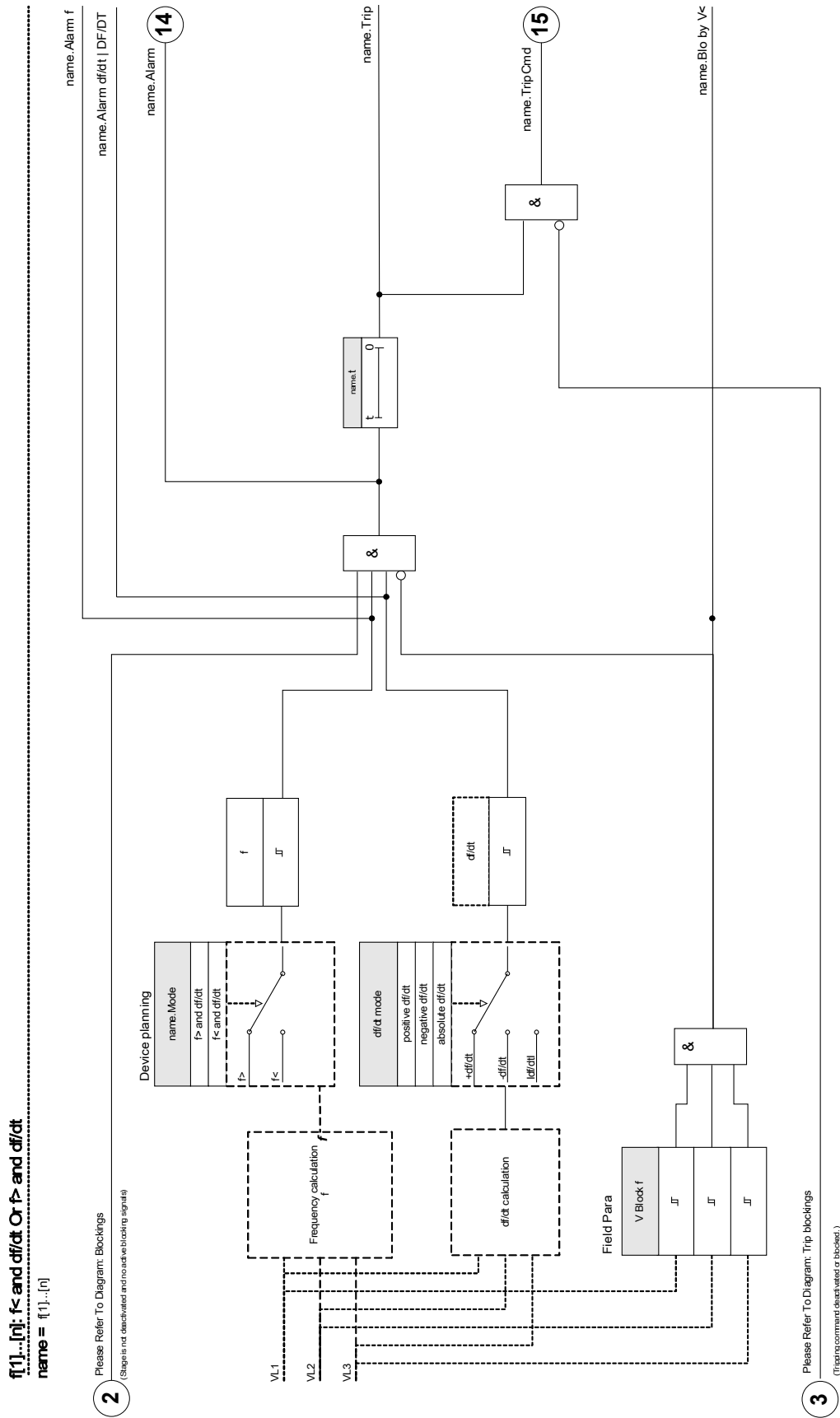

f< and DF/DT – Underfrequency and DF/DT

With this setting the frequency element supervises the frequency and the absolute frequency difference during a definite time interval.

In the selected frequency parameter set  $f[X]$ , an underfrequency pickup threshold  $f<$ , a threshold for the absolute frequency difference (frequency decrease)  $DF$  and supervision interval  $DT$  can be set.

*$f>$  and  $DF/DT$  – Overfrequency and  $DF/DT$*

With this setting the frequency element supervises the frequency and the absolute frequency difference during a definite time interval.

In the selected frequency parameter set  $f[X]$ , an overfrequency pickup threshold  $f>$ , a threshold for the absolute frequency difference (frequency increase)  $DF$  and supervision interval  $DT$  can be set.

**Working principle  $f<$  and  $DF/DT$  |  $f>$  and  $DF/DT$**

(please refer to block diagram on next page)

The frequency element supervises the three phase voltages » $VL1$ «, » $VL2$ « and » $VL3$ «. If any of the three phase voltages is below 15%  $V_n$ , the frequency calculation is blocked. According to the frequency supervision mode set in the Device Planning ( $f<$  and  $DF/DT$  or  $f>$  and  $DF/DT$ ), the phase voltages are compared to the set frequency pickup threshold and the set frequency decrease or increase threshold  $DF$ .

If in any of the phases, the frequency exceeds or falls below the set pickup threshold and if there are no blocking commands for the frequency element, an alarm is issued instantaneously. At the same time the timer for the supervision interval  $DT$  is started. When, during the supervision interval  $DT$ , the frequency still exceeds or is below the set pickup threshold and the frequency decrease/increase reaches the set threshold  $DF$ , a tripping command will be issued.

*Working Principle of  $DF/DT$  Function*

(Please refer to  $f(t)$  diagram after the block diagram)

Case 1:

When the frequency falls below a set  $f<$  threshold at  $t_1$ , the  $DF/DT$  element energizes. If the frequency difference (decrease) does not reach the set value  $DF$  before the time interval  $DT$  has expired, no trip will occur. The frequency element remains blocked until the frequency falls below the underfrequency threshold  $f<$  again.

Case 2:

When the frequency falls below a set  $f<$  threshold at  $t_4$ , the  $DF/DT$  element energizes. If the frequency difference (decrease) reaches the set value  $DF$  before the time interval  $DT$  has expired ( $t_5$ ), a trip command is issued.



**f(1)..*n*: f< and DF/DT Or f> and DF/DT**  
**name = f(1)..*n***

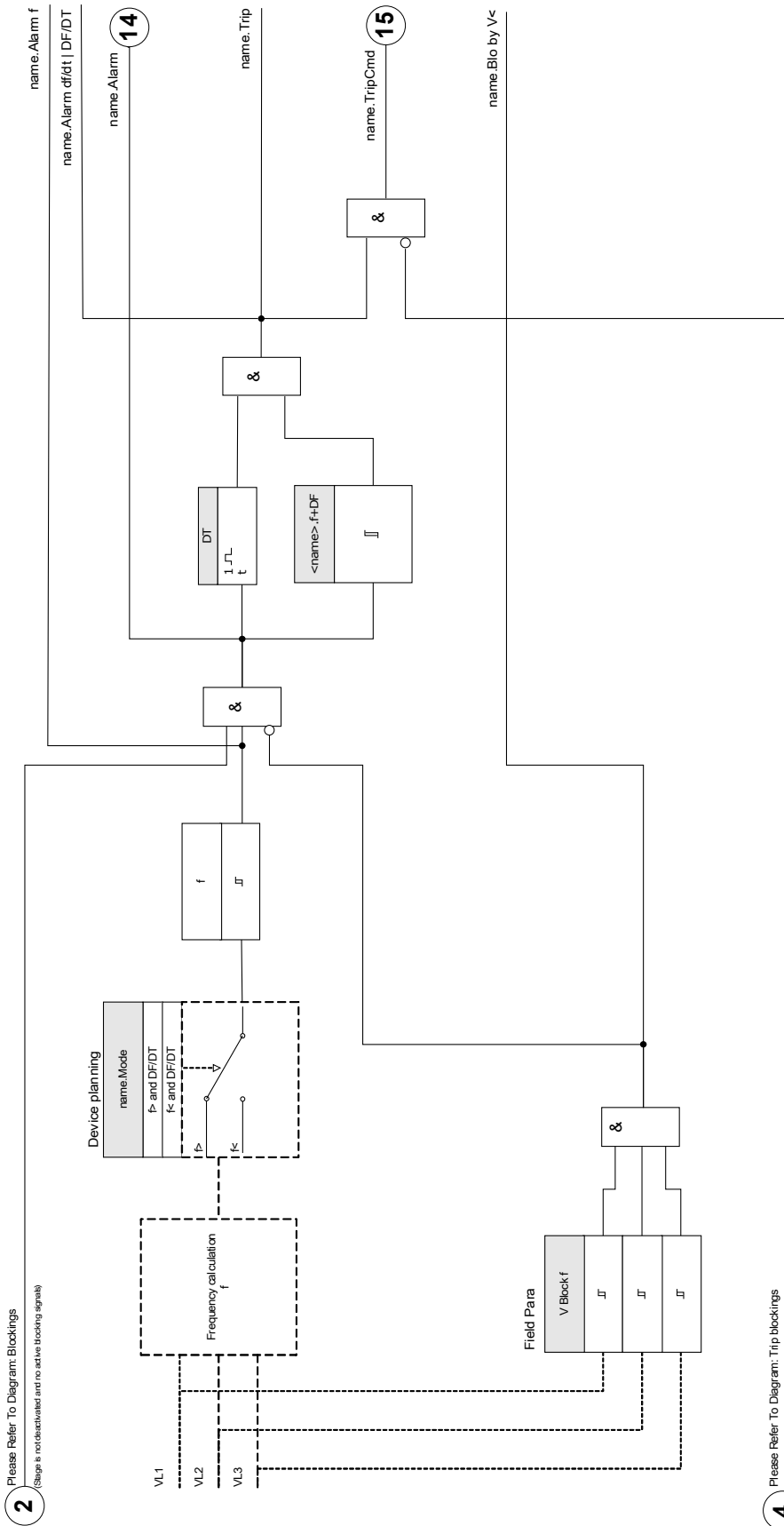

**2** Please Refer To Diagram:Blockings  
 (Stage is not deactivated and no active blocking signals)

**4** Please Refer To Diagram: Trip blockings  
 (Tripping command deactivated or blocked )

f(1)..*n*]; k and DF/DT  
 name = f(1)..*n*

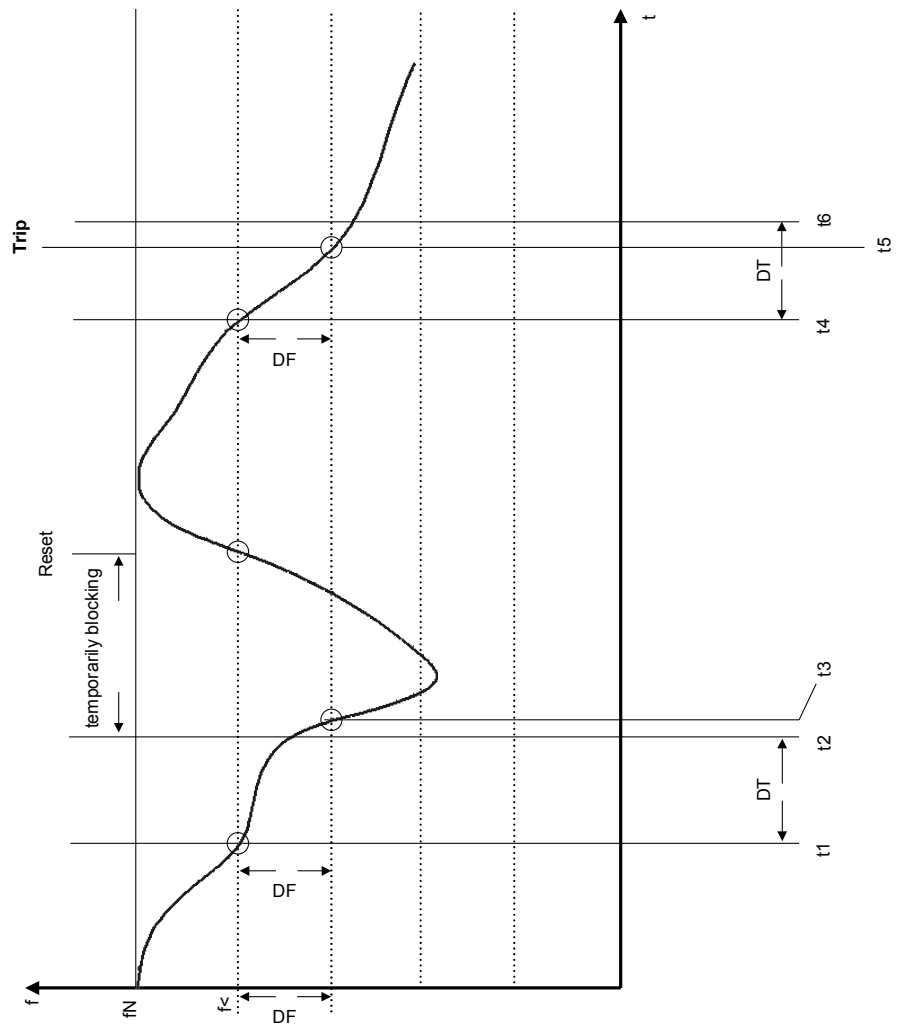

### *Delta phi - Vector Surge*

The vector surge supervision protects synchronous generators in mains parallel operation due to very fast decoupling in case of mains failure. Very dangerous are mains auto reclosings for synchronous generators. The mains voltage returning typically after 300 ms can hit the generator in asynchronous position. A very fast decoupling is also necessary in case of long time mains failures.

Generally there are two different applications:

Only mains parallel operation - no single operation:

In this application the vector surge supervision protects the generator by tripping the generator circuit breaker in case of mains failure.

Mains parallel operation and single operation:

For this application the vector surge supervision trips the mains circuit breaker. Here it is insured that the gen.-set is not blocked when it is required as an emergency set.

A very fast decoupling in case of mains failures for synchronous generators is very difficult. Voltage supervision units cannot be used because the synchronous alternator as well as the consumer impedance support the decreasing voltage.

In this situation the mains voltage drops only after some 100 ms below the pickup threshold of the voltage supervision and therefore a safe detection of mains auto reclosings is not possible with voltage supervision only.

Frequency supervision is partially unsuitable because only a highly loaded generator decreases its speed within 100 ms. Current relays detect a fault only when short-circuit type currents exist, but cannot avoid their development. Power relays are able to pickup within 200 ms, but they also cannot prevent the power rising to short-circuit values. Since power changes are also caused by sudden loaded alternators, the use of power relays can be problematic.

Whereas the vector surge supervision of the device detects mains failures within 60 ms without the restrictions described above because it is specially designed for applications where very fast decoupling from the mains is required. Adding the typical operating time of a circuit breaker or contactor, the total disconnection time remains below 150 ms.

Basic requirement for tripping of the generator/mains monitor is a change in load of more than 15 - 20% of the rated load. Slow changes of the system frequency, for instance at regulating processes (adjustment of speed regulator) do not cause the relay to trip.

Trippings can also be caused by short-circuits within the grid, because a voltage vector surge higher than the preset value can occur. The magnitude of the voltage vector surge depends on the distance between the short-circuit and the generator. This function is also of advantage to the Power Utility Company because the mains short-circuit capacity and, consequently, the energy feeding the short-circuit is limited.

To prevent a possible false tripping, the vector surge measuring is blocked at a low input voltage  $<15\% V_n$ . The undervoltage lockout acts faster than the vector surge measurement.

Vector surge tripping is blocked by a phase loss so that a VT fault (e. g.: faulty VTs fuse) does not cause false tripping.

Measuring Principle of Vector Surge Supervision

Equivalent circuit at synchronous generator in parallel with the mains.

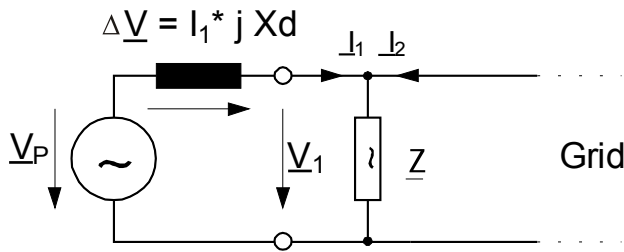

Voltage vectors at mains parallel operation.

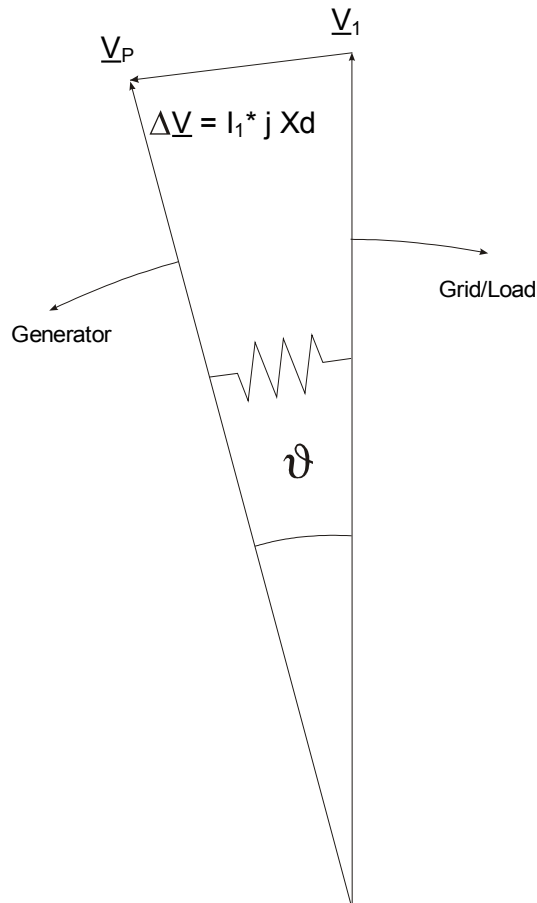

The rotor displacement angle between stator and rotor is dependent on the mechanical moving torque of the generator. The mechanical shaft power is balanced with the electrical fed mains power and, therefore the synchronous speed keeps constant.

Equivalent circuit at mains failure.

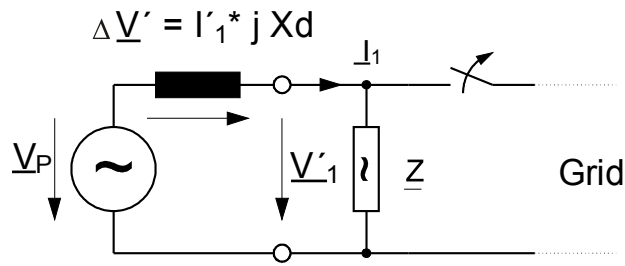

In case of mains failure or auto reclosing the generator suddenly feeds a very high consumer load. The rotor displacement angle is decreased repeatedly and the voltage vector  $V_1$  changes its direction ( $V_1'$ ).

Voltage vectors at mains failure.

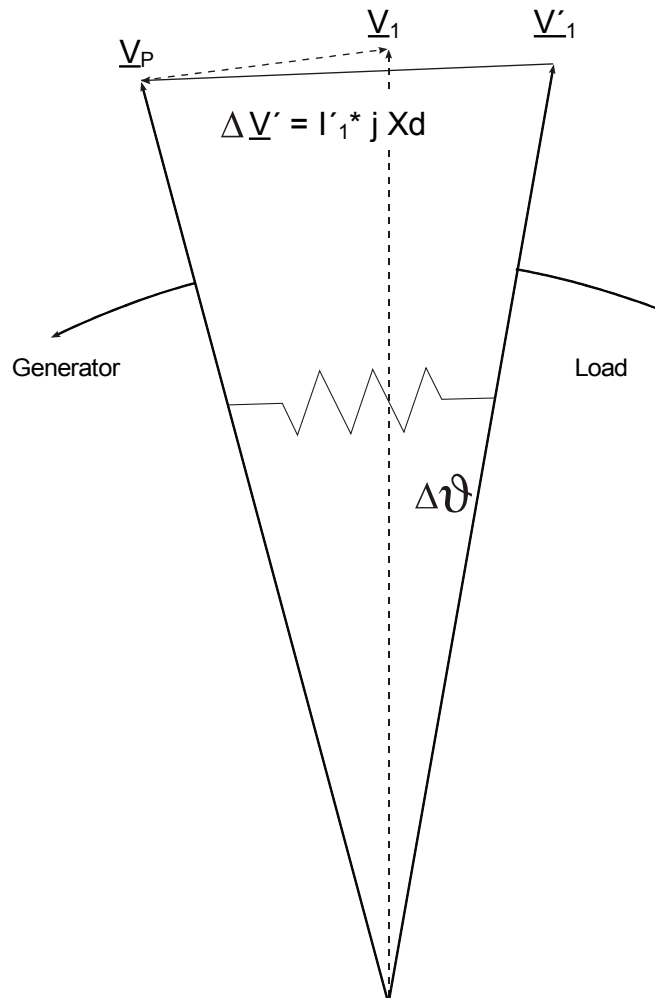

Voltage vector surge.

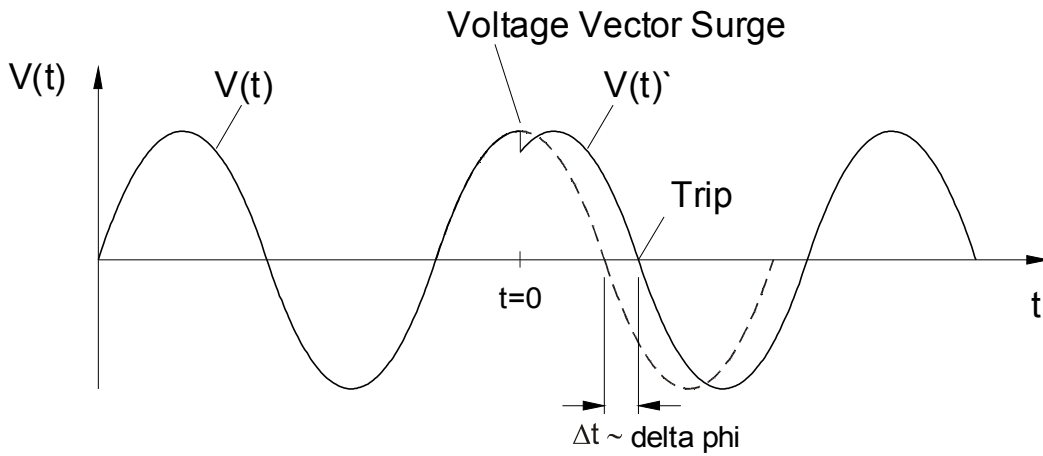

As shown in the voltage/time diagram the instantaneous value of the voltage jumps to another value and the phase position changes. This is called phase or vector surge.

The relay measures the cycle duration. A new measuring is started at each zero passage. The measured cycle duration is internally compared with a reference time and from this the deviation of the cycle duration of the voltage signal is ascertained. In case of a vector surge as shown in the above graphic, the zero passage occurs either earlier or later. The established deviation of the cycle duration is in compliance with the vector surge angle. If the vector surge angle exceeds the set value, the relay trips immediately.

Tripping of the vector surge is blocked in case of loss of one or more phases of the measuring voltage.

### Working Principle delta phi

(Please refer to the block diagram on next page)

The vector surge element supervises the three phase voltages »VL1«, »VL2« and »VL3«. If any of the three phase voltages is below 15%  $V_n$ , the vector surge calculation is blocked. According to the frequency supervision mode set in the Device Planning (delta phi), the phase voltages are compared to the set vector surge threshold. If in any of the phases, the vector surge exceeds the set threshold and if there are no blocking commands for the frequency element, an alarm and a trip command is issued instantaneously.

**f[1]...[n]: delta phi**  
**name = f[1]...[n]**

**2** Please Refer To Diagram: Blockings  
 (Range is not discarded and nonactive blocking signals)

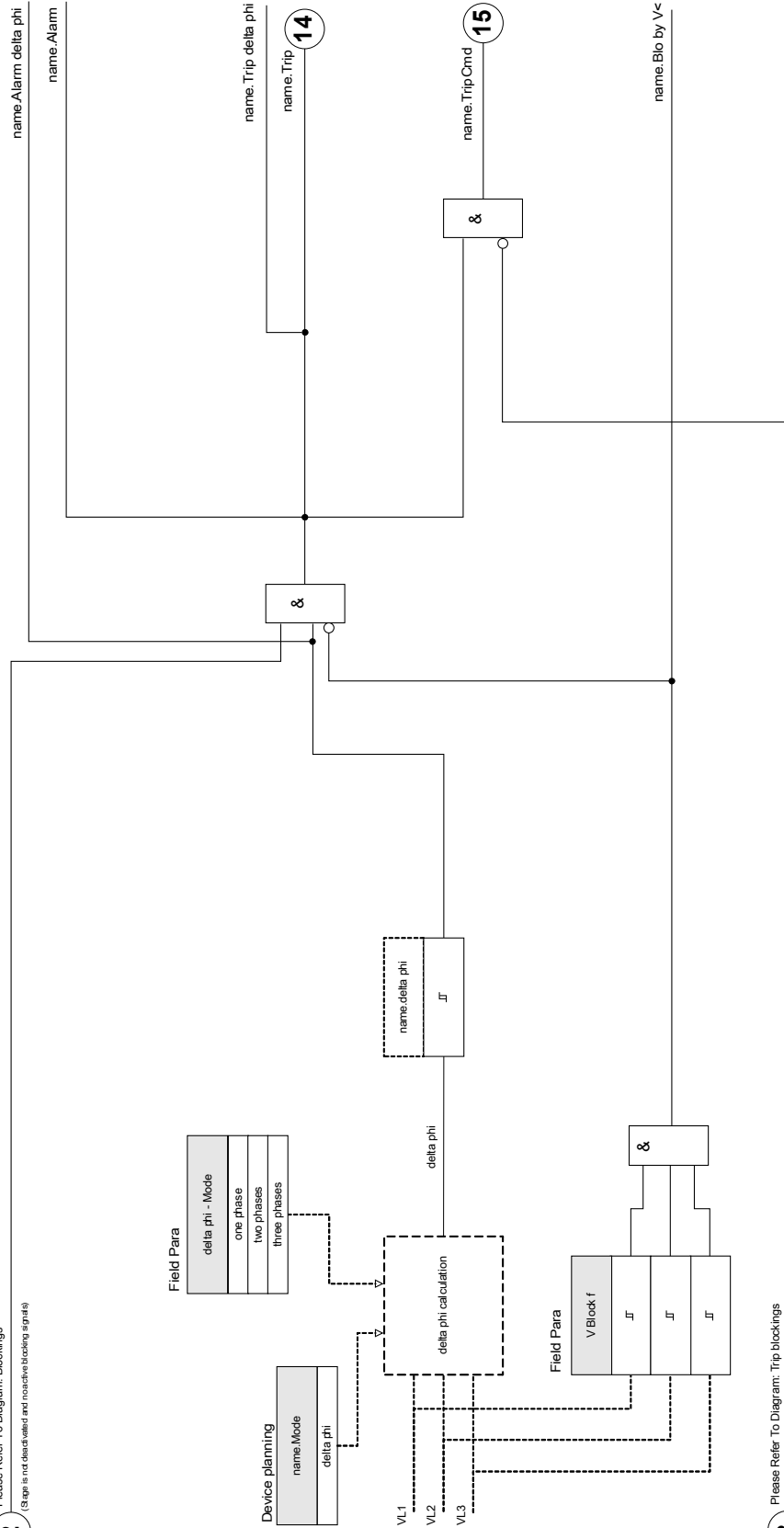



**3** Please Refer To Diagram: Trip blockings  
 (Trip command disabled or locked.)

### Device Planning Parameters of the Frequency Protection Module









Parameter	Description	Options	Default	Menu path
Mode 	Mode	do not use, f<, f>, f< and df/dt, f> and df/dt, f< and DF/DT, f> and DF/DT, df/dt, delta phi	f[1]: f< f[2]: f> f[3]: do not use f[4]: do not use f[5]: do not use f[6]: do not use	[Device planning]

### Global Protection Parameters of the Frequency Protection Module





Parameter	Description	Setting range	Default	Menu path
ExBlo1 	External blocking of the module, if blocking is activated (allowed) within a parameter set and if the state of the assigned signal is true.	1..n, Assignment List	-.-	[Protection Para /Global Prot Para /f-Prot /f[1]]
ExBlo2 	External blocking of the module, if blocking is activated (allowed) within a parameter set and if the state of the assigned signal is true.	1..n, Assignment List	-.-	[Protection Para /Global Prot Para /f-Prot /f[1]]
ExBlo TripCmd 	External blocking of the Trip Command of the module/the stage, if blocking is activated (allowed) within a parameter set and if the state of the assigned signal is true.	1..n, Assignment List	-.-	[Protection Para /Global Prot Para /f-Prot /f[1]]



### Setting Group Parameters of the Frequency Protection Module

Parameter	Description	Setting range	Default	Menu path
Function 	Permanent activation or deactivation of module/stage.	inactive, active	f[1]: active f[2]: active f[3]: inactive f[4]: inactive f[5]: inactive f[6]: inactive	[Protection Para /<1..4> /f-Prot /f[1]]
ExBlo Fc 	Activate (allow) or inactivate (disallow) blocking of the module/stage. This parameter is only effective if a signal is assigned to the corresponding global protection parameter. If the signal becomes true, those modules/stages are blocked that are parameterized "ExBlo Fc=active".	inactive, active	inactive	[Protection Para /<1..4> /f-Prot /f[1]]
Blo TripCmd 	Permanent blocking of the Trip Command of the module/stage.	inactive, active	inactive	[Protection Para /<1..4> /f-Prot /f[1]]
ExBlo TripCmd Fc 	Activate (allow) or inactivate (disallow) blocking of the module/stage. This parameter is only effective if a signal is assigned to the corresponding global protection parameter. If the signal becomes true, those modules/stages are blocked that are parameterized "ExBlo TripCmd Fc=active".	inactive, active	inactive	[Protection Para /<1..4> /f-Prot /f[1]]
f> 	Pickup value for overfrequency.  Only available if: Device planning: f.Mode = f> Or f> and df/dt Or f> and DF/DT	40.00 - 69.95Hz	51.00Hz	[Protection Para /<1..4> /f-Prot /f[1]]
f< 	Pickup value for underfrequency.  Only available if: Device planning: f.Mode = f< Or f< and df/dt Or f< and DF/DT	40.00 - 69.95Hz	49.00Hz	[Protection Para /<1..4> /f-Prot /f[1]]
t 	Tripping delay  Only available if: Device planning: f.Mode = f< Or f>Or f> and df/dt Or f< and df/dt	0.00 - 3600.00s	1.00s	[Protection Para /<1..4> /f-Prot /f[1]]
df/dt 	Measured value (calculated): Rate-of-frequency-change.  Only available if: Device planning: f.Mode = df/dt Or f< and df/dt Or f> and df/dt	0.100 - 10.000Hz/s	1.000Hz/s	[Protection Para /<1..4> /f-Prot /f[1]]

## Protective Elements

Parameter	Description	Setting range	Default	Menu path
t-df/dt 	Trip delay df/dt	0.00 - 300.00s	1.00s	[Protection Para /<1..4> /f-Prot /f[1]]
DF 	Frequency difference for the maximum admissible variation of the mean of the rate of frequency-change. This function is inactive if DF=0.  Only available if: Device planning: f.Mode = f< and DF/DT Or f> and DF/DT	0.0 - 10.0Hz	1.00Hz	[Protection Para /<1..4> /f-Prot /f[1]]
DT 	Time interval of the maximum admissible rate-of-frequency-change.  Only available if: Device planning: f.Mode = f< and DF/DT Or f> and DF/DT	0.1 - 10.0s	1.00s	[Protection Para /<1..4> /f-Prot /f[1]]
df/dt mode 	df/dt mode  Only available if: Device planning: f.Mode = df/dt Or f< and df/dt Or f> and df/dt Only available if: Device planning: f.Mode = df/dt Or f< and df/dt Or f> and df/dt Only available if: Device planning: f.Mode = df/dt	absolute df/dt, positive df/dt, negative df/dt	absolute df/dt	[Protection Para /<1..4> /f-Prot /f[1]]
delta phi 	Measured value (calculated): Vector surge  Only available if: Device planning: f.Mode = delta phi	1 - 30°	10°	[Protection Para /<1..4> /f-Prot /f[1]]

## Frequency Protection Module Input States

<i>Name</i>	<i>Description</i>	<i>Assignment via</i>
ExBlo1-I	Module input state: External blocking1	[Protection Para /Global Prot Para /f-Prot /f[1]]
ExBlo2-I	Module input state: External blocking2	[Protection Para /Global Prot Para /f-Prot /f[1]]
ExBlo TripCmd-I	Module input state: External Blocking of the Trip Command	[Protection Para /Global Prot Para /f-Prot /f[1]]

## Frequency Protection Module Signals (Output States)

<i>Signal</i>	<i>Description</i>
active	Signal: active
ExBlo	Signal: External Blocking
Blo by V<	Signal: Module is blocked by undervoltage.
Blo TripCmd	Signal: Trip Command blocked
ExBlo TripCmd	Signal: External Blocking of the Trip Command
Alarm f	Signal: Alarm Frequency Protection
Alarm df/dt   DF/DT	Alarm instantaneous or average value of the rate-of-frequency-change
Alarm delta phi	Signal: Alarm Vector Surge
Alarm	Signal: Alarm Frequency Protection (collective signal)
Trip f	Signal: Frequency has exceeded the limit.
Trip df/dt   DF/DT	Signal: Trip df/dt or DF/DT
Trip delta phi	Signal: Trip Vector Surge
Trip	Signal: Trip Frequency Protection (collective signal)
TripCmd	Signal: Trip Command

## Commissioning: Overfrequency [ $f >$ ]

### *Object to be tested*

All configured overfrequency protection stages.

### *Necessary means*

- Three-phase voltage source with variable frequency and
- Timer

### *Procedure*

#### *Testing the threshold values*

- Keep on increasing the frequency until the respective frequency element is activated;
- Note the frequency value and
- Disconnect the test voltage.

#### *Testing the trip delay*

- Set the test voltage to nominal frequency and
- Now connect a frequency jump (activation value) and then start a timer. Measure the tripping time at the relay output.

#### *Testing the fallback ratio*

Reduce the measuring quantity to less than 99.95% of the trip value (or 0.05%  $f_n$ ). The relay must only fall back at 99.95% of the trip value at the earliest (or 0.05%  $f_n$ ).

### *Successful test result*

Permissible deviations/tolerances can be taken from the Technical Data.

## Commissioning: Underfrequency [ $f <$ ]

For all configured underfrequency elements, this test can be carried out similar to the test for overfrequency protection (by using the related underfrequency values).

Please consider the following deviations:

- For testing the threshold values, the frequency has to be decreased until the protection element is activated.
- For detection of the fallback ratio, the measuring quantity has to be increased to more than 100.05% of the trip value (or 0.05%  $f_n$ ). At 100.05% of the trip value the relay is to fall back at the earliest (or 0.05%  $f_n$ ).

## Commissioning: $df/dt$ - Rate of Change of Frequency

### *Object to be tested*

All frequency protection stages that are projected as  $df/dt$ .

### *Necessary means*

- Three-phase voltage source and
- Frequency generator that can generate and measure a linear, defined rate of change of frequency.

### *Procedure*

#### *Testing the threshold values*

- Keep on increasing the rate of change of frequency until the respective element is activated.
- Note the value.

#### *Testing the trip delay*

- Set the test voltage to nominal frequency.
- Now apply a step change (sudden change) that is 1.5 times the setting value (example: apply 3 Hz per second if the setting value is 2 Hz per second) and
- Measure the tripping time at the relay output. Compare the measured tripping time to the configured tripping time.

### *Successful test result:*

Permissible deviations/tolerances and dropout ratios can be taken from the Technical Data.

## Commissioning: $f <$ and $-df/dt$ – underfrequency and Rate of Change of Frequency

### *Object to be tested:*

All frequency protection stages that are projected as  $f <$  and  $-df/dt$ .

### *Necessary means:*

- Three-phase voltage source and
- Frequency generator that can generate and measure a linear, defined rate of change of frequency.

### *Procedure:*

#### *Testing the threshold values*

- Feed nominal voltage and nominal frequency to the device
- Decrease the frequency below the  $f <$  threshold and
- Apply a rate of change of frequency (step change) that is below the setting value (example apply -1 Hz per second if the setting value is -0.8 Hz per second). After the tripping delay is expired the relay has to trip.

### *Successful test result*

Permissible deviations/tolerances and dropout ratios can be taken from the Technical Data.

## Commissioning: $f >$ and $df/dt$ – overfrequency and Rate of Change of Frequency

### *Object to be tested*

All frequency protection stages that are projected as  $f >$  and  $df/dt$ .

### *Necessary means*

- Three-phase voltage source and.
- Frequency generator that can generate and measure a linear, defined rate of change of frequency.

### *Procedure*

#### *Testing the threshold values*

- Feed nominal voltage and nominal frequency to the device.
- Increase the frequency above the  $f >$  threshold and.
- Apply a rate of change of frequency (step change) that is above the setting value (example apply 1 Hz per second if the setting value is 0.8 Hz per second). After the tripping delay is expired the relay has to trip.

### *Successful test result:*

Permissible deviations/tolerances and dropout ratios can be taken from the Technical Data.

## Commissioning: $f <$ and DF/DT – Underfrequency and DF/DT

### *Object to be tested:*

All frequency protection stages that are projected as  $f <$  and Df/Dt.

### *Necessary means:*

- Three-phase voltage source and
- Frequency generator that can generate and measure a defined frequency change.

### *Procedure:*

#### *Testing the threshold values*

- Feed nominal voltage and nominal frequency to the device:
- Decrease the frequency below the  $f <$  threshold and
- Apply a defined frequency change (step change) that is above the setting value (example: apply a frequency change of 1 Hz during the set time interval DT if the setting value DF is 0.8 Hz). The relay has to trip immediately.

### *Successful test result*

Permissible deviations/tolerances and dropout ratios can be taken from the Technical Data.

## Commissioning: $f >$ and DF/DT – Overfrequency and DF/DT

### *Object to be tested:*

All frequency protection stages that are projected as  $f >$  and Df/Dt.

### *Necessary means:*

- Three-phase voltage source and
- Frequency generator that can generate and measure a defined frequency change.

### *Procedure:*

#### *Testing the threshold values*

- Feed nominal voltage and nominal frequency to the device:
- Increase the frequency above the  $f >$  threshold and
- Apply a defined frequency change (step change) that is above the setting value (example: apply a frequency change of 1 Hz during the set time interval DT if the setting value DF is 0.8 Hz). The relay has to trip immediately.

### *Successful test result:*

Permissible deviations/tolerances and dropout ratios can be taken from the Technical Data.

## Commissioning: delta phi - Vector Surge

### *Object to be tested:*

All frequency protection stages that are projected as delta phi (vector surge).

### *Necessary means:*

- Three-phase voltage source that can generate a definite step (sudden change) of the voltage pointers (phase shift).

### *Procedure:*

#### *Testing the threshold values*

- Apply a vector surge (sudden change) that is 1.5 times the setting value (example: if the setting value is  $10^\circ$  apply  $15^\circ$ ).

### *Successful test result:*

Permissible deviations/tolerances and dropout ratio can be taken from the Technical Data.



## AR - Automatic Reclosure [79]

### AR

The autoreclosure is used to minimize outages on overhead lines. The majority<sup>1</sup> (>60% in medium voltage and >85% in high voltage) of faults (arc flash over) on overhead lines are temporary and can be cleared by means of the autoreclosure element.

### **NOTICE**

Deproject the autoreclosure element within the device planning if the protective device is used in order to protect cables, generators or transformers.

### Features

The autoreclose function is designed with diverse very comprehensive yet flexible features which meet all requirements of different utility concepts and technical applications.

The available features of the autoreclose function can be summarized as follows:

- Flexible assignment of initiate functions for individual shots.
- Maximum six autoreclose shots.
- Dynamic adjustment of protection setting values (e.g. pickup, time delay tripping curve etc.) during autoreclose process via adaptive set concept.
- Reclose shots per hour limit.
- Autorecloser wear monitor with maintenance alarm.
- Programmable reclosing blocking feature.
- Auto zone coordination with downstream reclosers.
- Automatic manual-breaker-close blocking feature.
- Manual/Auto reset lockout (panel, contact input, communications, etc)
- Autoreclose with Synchron-Check (only in conjunction with internal Sync-Check and Control modules).
- External AR shot counter increment is possible.
- Automatic autoreclose result evaluation (successful/unsuccessful).
- Separate counters to register total, successful/unsuccessful reclosing numbers.

---

1: VDE-Verlag: Schutztechnik in elektrischen Netzen 1, Page179, ISBN 3-8007-1753-0

The following table gives a folder (structure) overview:

AR Menu Folder	Purpose
<p><b>AR</b></p> <p>Path: [Protection Para\Global Prot Para\AR]</p>	<p>Within this menu, external blockings, external lockings, external shot increments and external resets can be assigned. <b>Those external events can only become effective, if they have been activated (allowed) within the General Settings. Please see table row below.</b></p>
<p><b>General Settings</b></p> <p>Path: [Protection Para\Set[x]\AR\General Settings]</p>	<p>Within this menu several general settings can be activated: The function itself, external blocking, zone coordination, external locking and external shot increment can be set to active. <b>The corresponding trigger events (e.g. digital inputs) have to be assigned within the corresponding global protection parameters. Please see table row above.</b></p> <p>Furthermore, this menu contains some timers, the number of permitted reclosure attempts, the alarm mode (trip/alarm) and the reset mode can be set</p>
<p><b>Shot Manager</b></p> <p>Path: [Protection Para\Set[x]\AR\Shot Manager]</p>	<p>In Shot-manager setting menu the control logics between individual shots and protective functions will be specified. For each shot (inclusive the pre shot) the trigger (start) events can be assigned.</p> <p>For each shot, maximum 4 initiate functions (protective functions which are dedicated to start this shot) can be selected from an available protective function list.</p> <p>When the autoreclosure process is running in the shot X stage, the corresponding protection and control settings will be used to control the operation during this stage.</p> <p>In addition to that the dead times have to be set. For each shot, its dead time will be set individually, except for the shot 0, for which no dead timer setting is necessary. The shot 0 is just a virtual state to define the time before the first shot is to issue. Each dead timer specifies the time duration which has to be expired before the reclosure command for this shot can be issued.</p>
<p><b>Wear Monitor</b></p> <p>Path: [Protection Para\Set[x]\AR\Wear Monitor]</p>	<p>This setting group contains all parameters which monitor the wear and maintenance conditions related to the autoreclosure operations. The corresponding information and control can be useful for an optimal autoreclosure application.</p>
<p><b>Blo Fc</b></p> <p>Path: [Protection Para\Set[x]\AR\Blo Fc]</p>	<p>This group of settings specifies the protection functions by which the autoreclosure function must be blocked even if the autoreclosure function is already initiated.</p> <p><b>Note the difference between the protection function which can be blocked by auto-recloser and the function(s) here to block the auto-recloser.</b></p>

### AR States

The following diagram shows the state transitions between the various states of the autoreclosure function. This diagram visualizes the run time logic and timing sequence according to the state transition direction and the events which trigger the transitions.

State transition diagram

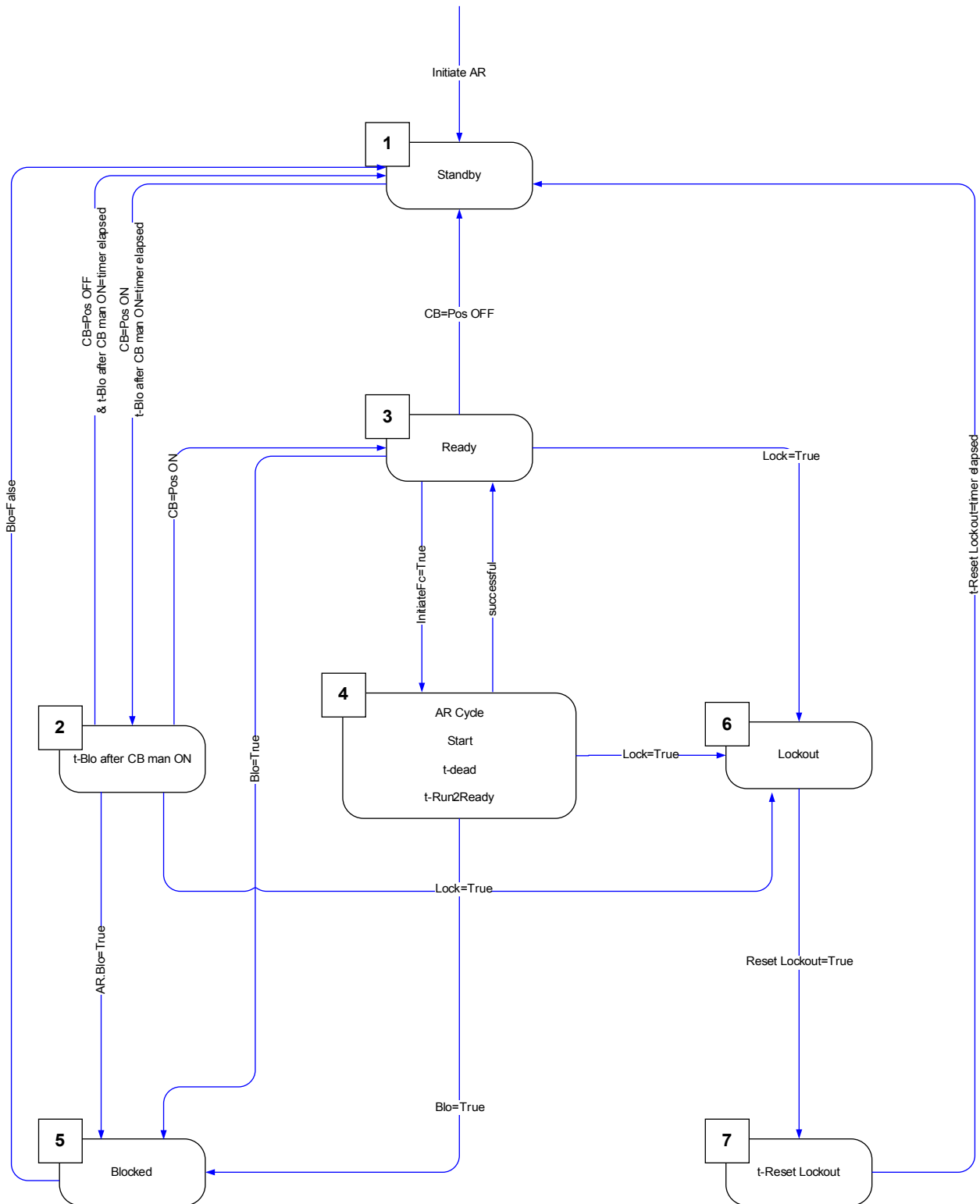

In general, the autoreclosure function is only active (will be initiated) when all of the following conditions are met:

- Autoreclosure function is enabled (In AR General Setting: Function =active)
  - The breaker (CB) is configured within the “AR/General Settings”.
  - Autoreclosure is not blocked by the blocking inputs (ExBlo1/2).
- 

### 1 *Standby*

The autoreclosure is in this state when the following conditions are met:

- The breaker is in the open position.
- The autoreclose function is not initiated from any initiate (start) functions.
- No external or internal AR blocking signals are present.

## **NOTICE**

No autoreclose shot operation is possible if the autoreclose function is within Standby state.

---

### 2 *t-manual close block*

Suppose that the breaker is open and the AR state is in Standby state. Then the breaker is closed manually. The event “CB Pos On” starts a Manual-Close-Blocking timer and results in a state transition from »STANDBY« to a transit state - »T-BLO AFTER CB MAN ON«. The autoreclosure function changes into the »READY« state only as the Manual-Close-Blocking timer elapses and the breaker is closed. By means of the manual close blocking timer a faulty starting of the autoreclose function in case of a Switch-OnTo-Fault condition is prevented.

---

### 3 *Ready*

An activated autoreclose function is considered to be in »READY« state when all of the following conditions are true:

- The breaker is in closed position.
- The Manual-Close-Block-timer elapses after a breaker manual/remote close operation.

- The autoreclose function is not initiated from any initiate (start) functions.
- No external or internal AR blocking signals are present.

**NOTICE**

An autoreclose start is only possible if the autoreclose function is in Ready state.

---

**4** *Run (Cycle)*

The »RUN« state can only be reached if the following conditions are fulfilled:

- The autoreclose was in »READY« state before.
- The breaker was in closed position before.
- No external or internal AR Blocking signals exist.
- At least one of the assigned initiate functions is true (triggers the Autoreclosure).

**NOTICE**

A complete autoreclose process with multi-shot reclosing will be accomplished inside the Run state.

If the autoreclose gets into the »RUN« state, the autoreclose function transfers its control to a »RUN« state control automat with several subordinate states which will be described in detail in the next chapter (AR Cycle).

---

**5** *Blocked*

An activated autoreclose function goes into the »BLOCKED« state when one of the assigned blocking function is true.

The autoreclose function exits the »BLOCKED« state if the assigned blocking signal is no longer present.

---

## 6 Lockout

An activated autoreclose function goes into the »LOCKOUT« state when one of the following conditions is true:

- An unsuccessful autoreclose is detected after all programmed autoreclose shots. The fault is of permanent nature.
- Reclose failure (incomplete sequence)
- Autoreclose rate per hour exceeds the limit
- Fault timer elapses (tripping time too long)
- Breaker failure during AR starting
- Manual breaker close operation during autoreclose process
- At least one protective function is still tripping before reclose command is issued

The autoreclose function exits the »LOCKOUT« state if the programmed lockout reset signal asserts and programmed Lockout Reset timer elapses.

### **NOTICE**

A Service Alarm (Service Alarm 1 or Service Alarm 2) will not lead to a lockout of the AR function.

## AR Cycle (Shot)

### 4 Run (Cylce)

The following drawing shows in detail an AR run cycle.

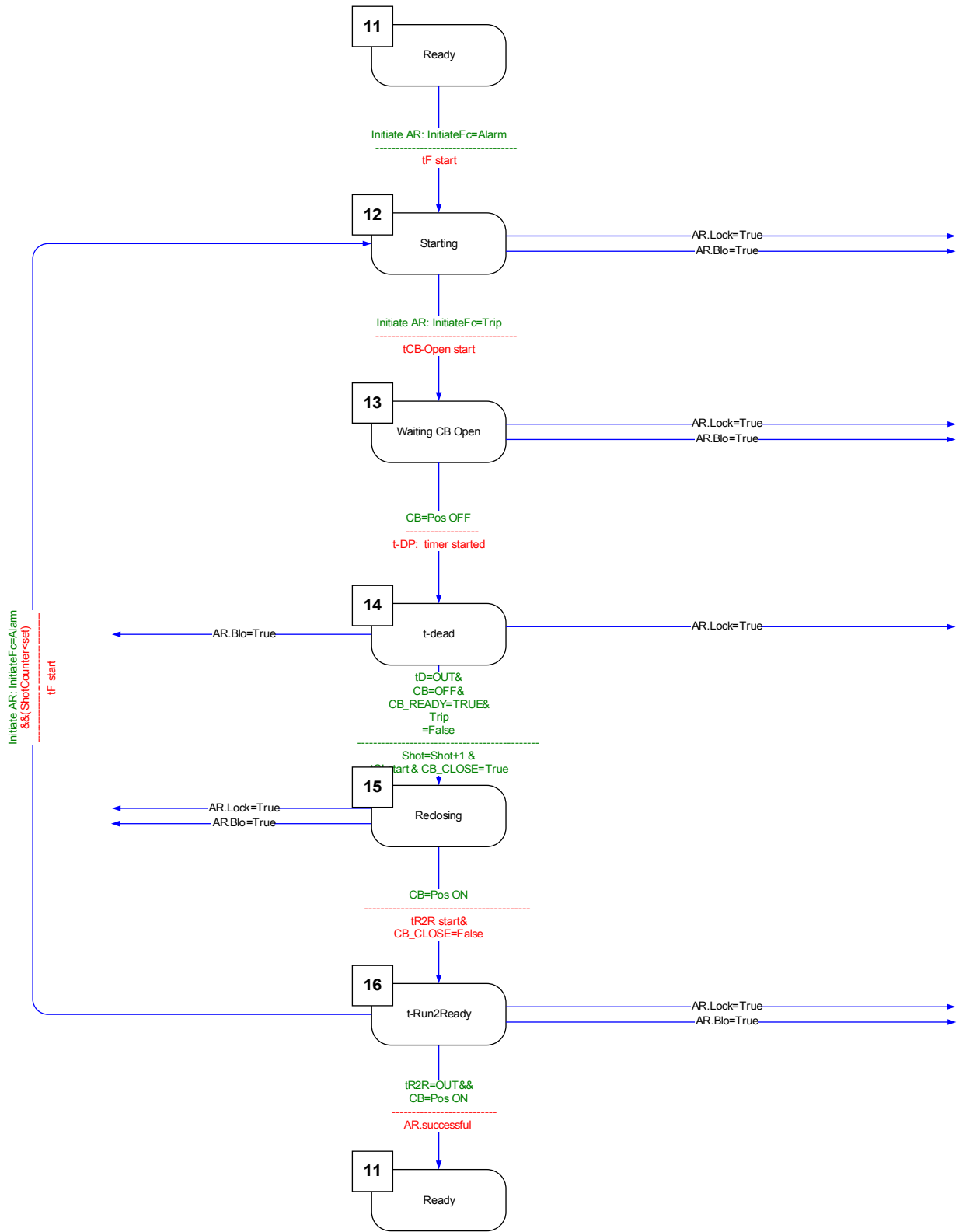

### 11 *Ready*

An activated autoreclose function is considered to be in »READY« state when all of the following conditions are true:

- The breaker is in closed position.
  - The Manual-Close-Block-timer elapses after a breaker manual/remote close operation.
  - The autoreclose function is not initiated from any initiate (start) functions.
  - No external or internal AR blocking signals are present.
- 

### 12 *Run*

This is the first subordinate state after the autoreclosure process goes from »READY« into »RUN« state triggered from the first AR initiate event. During the »RUNNING« state, the auto reclosure element supervises the trip signal of the initiate function while a preset fault timer is timing. The autoreclosure element transfers to the »WAITING BKR OPEN« state by receiving the trip signal if the fault timer does NOT time out and there are no other blocking and lockout conditions.

---

### 13 *Waiting Bkr Open*

While in the »WAITING BKR OPEN« state, the autoreclosure supervises if the breaker is really tripped (open) after receiving the trip flag of the initiate protection function within a preset breaker supervision time (200ms). If this is the case, the autoreclosure starts the programmed dead timer and goes to the dead timing state »*t-dead*«.

---

### 14 *t-dead*

While in the dead timing state »*t-dead*«, the preset dead timer for current AR shot is timing and cannot be interrupted unless there are any blocking or lockout conditions coming.

After dead timer elapses, the autoreclosure issues the breaker reclosing command and goes into the next state: »RECLOSING«, only if the following conditions are met:

- The breaker is in open position,
  - The breaker is ready for next reclosing operation (if the CB Ready logic input is used)
  - No pickup from current (assigned) AR initiate function(s)
-



- No trip from current (assigned) AR initiate function(s)
- No general tripping command

Before issuing the breaker reclosing command, the current shot counter will be incremented. This is very important for the shot-controlled initiate and blocking functions.

Before entering into the »RECLOSING« state, the preset breaker reclosing supervision timer (»*t-Brk-ON-cmd*«) will be started, too.

---

### 15 *Reclosing*

If there is no other blocking or lockout conditions and the breaker is closed while the breaker reclosing supervision timer is timing, the autoreclosure starts the »*t-Run2Ready*« timer and goes into the state:

»T-RUN2READY«.

---

### 16 *t-Run2Ready*

*Successful Autoreclosure:*

While in »T-RUN2READY« state, if there is no other blocking or lockout conditions and no more faults detected within the »*t-Run2Ready*« timer, the autoreclosure logic will leave the »RUN« state and goes back to the »READY« state. The flag "successful" is set.

*Unsuccessful Autoreclose:*

If a fault is detected again (the shot-controlled initiate function is triggering) while »*t-Run2Ready*« timer is still timing, the autoreclosure control transfers to the »RUNNING« state again. For a permanent fault, the process described before will be repeated until all programmed shots were operated and the autoreclose process changes into the »LOCKOUT« state. The flag "failed" is set.

---

## Timing Diagrams

Auto Reclosing timing diagram for *unsuccessful* 2-shot auto reclosing scheme with acceleration at pre-shot

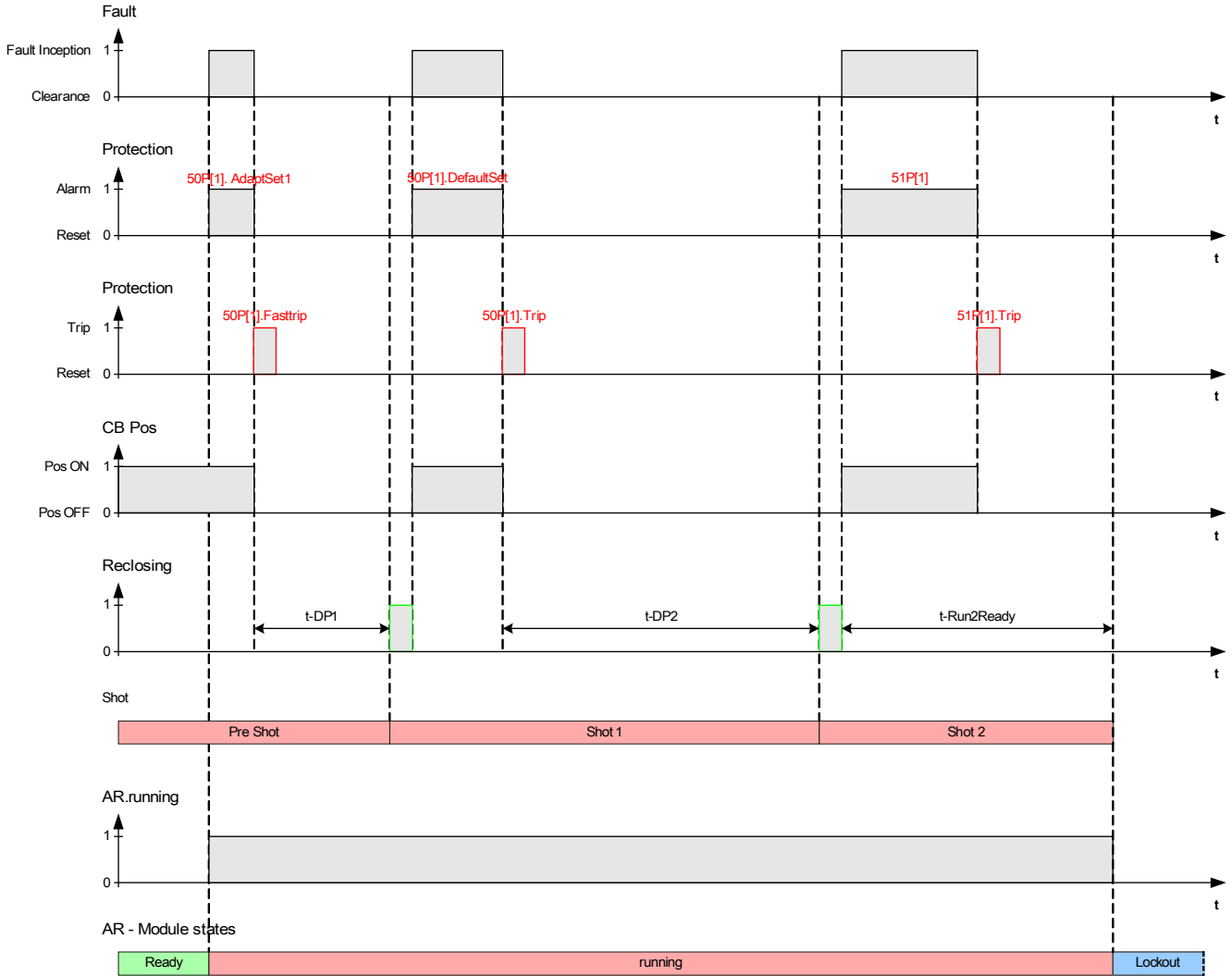

Auto Reclosing timing diagram for **successful** 2-shot auto reclosing scheme with acceleration at pre-shot

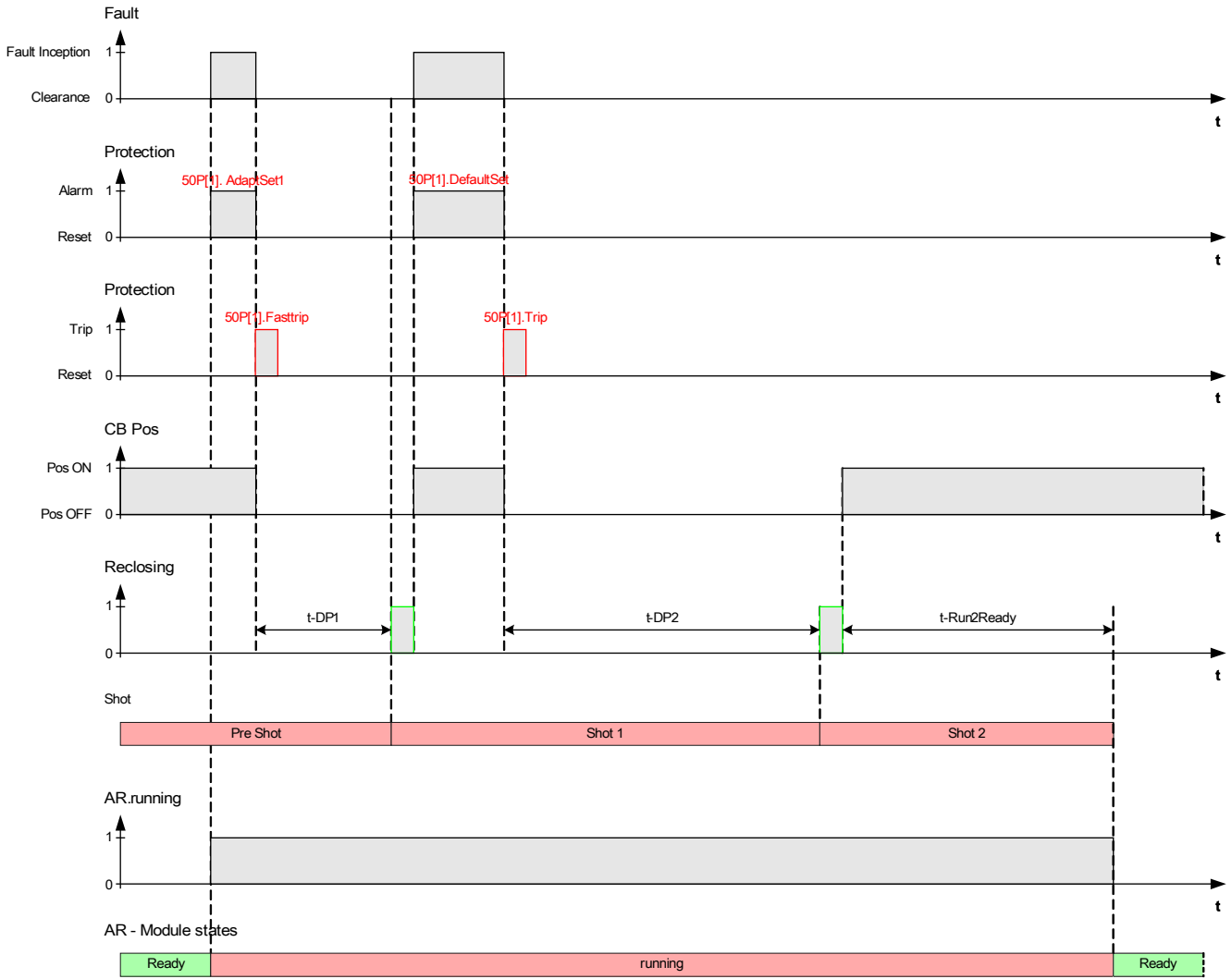

*Auto Reclosing States during manual breaker closing*

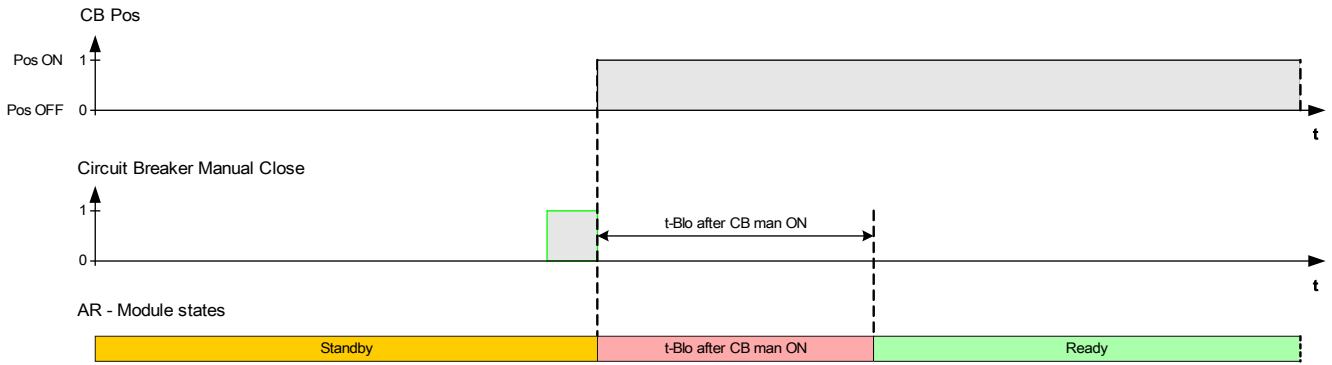

*Protection Trip while Manual Close Blocking time is Timing*

What happens if while the timer manual close block time is timing down the protective device gets a trip signal?

While the timer manual close block time is timing, any trip during this time period trips the breaker. The manual close block timer doesn't care about that and timing further until it times out.

After it times out, the AR-module looks at the breaker status again, and sees that the breaker is open. The AR goes to the »STANDBY« state, no autoreclose is possible (Note: The AR doesn't go to »LOCKOUT« state!)

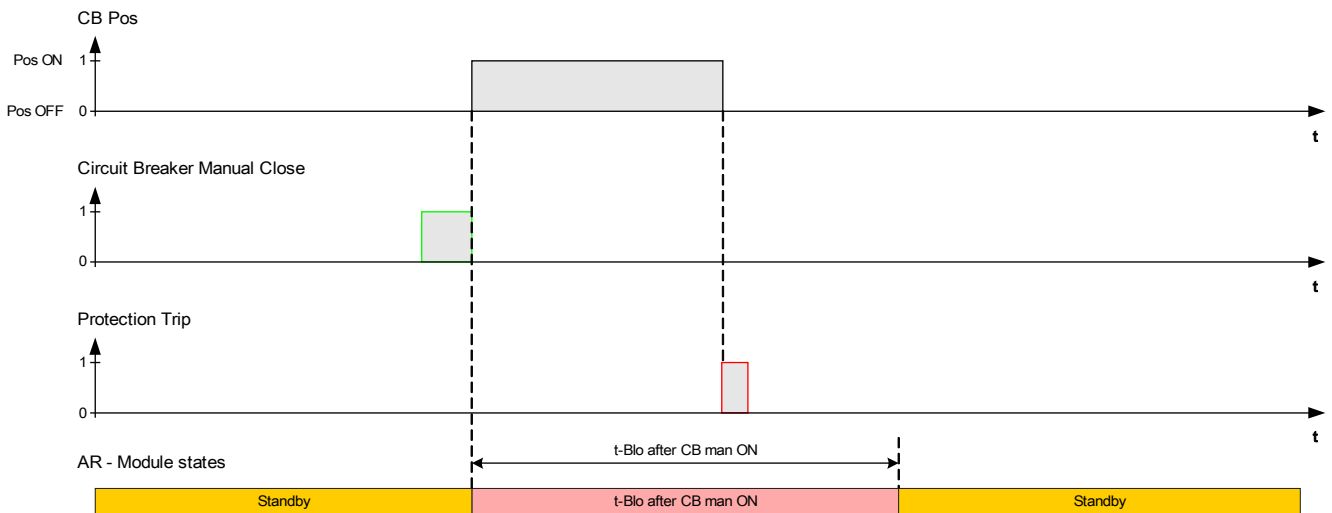

*AR Lockout Reset Logic in case lockout Reset coming before manual breaker closed*

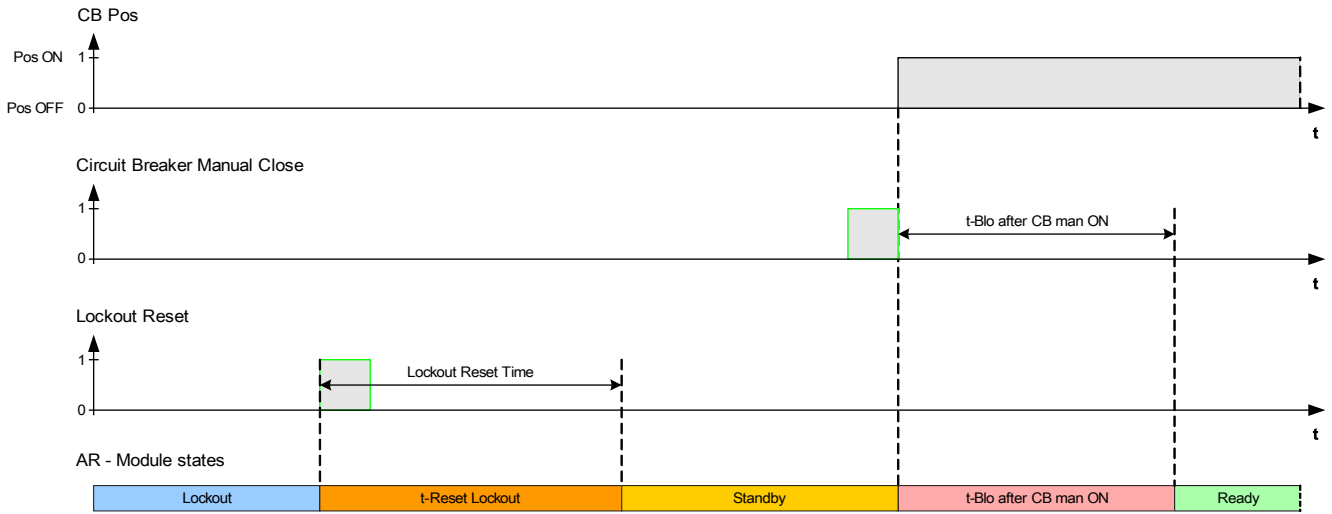

*AR Lockout Reset Logic in case lockout Reset coming after manual breaker closed*

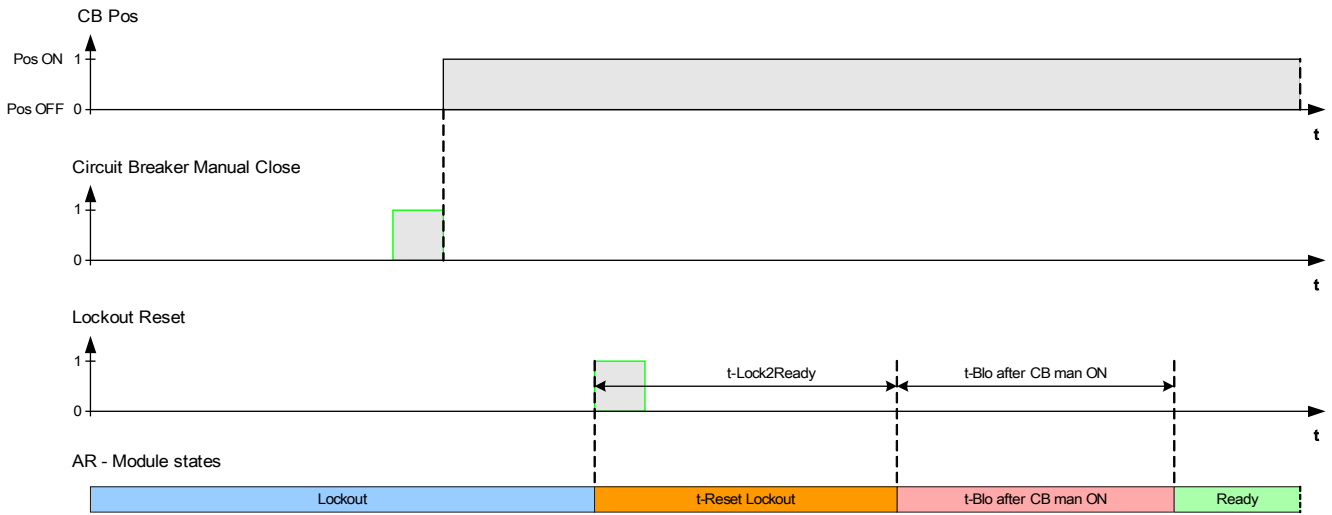

## Zone Coordination

### General Description

#### *What does Zone Coordination mean?*

Zone Coordination means, that the upstream protection device is doing a virtual autoreclosure while the downstream protective device is doing a “real” autoreclosure. By means of the zone coordination selectivity can be kept, even if a downstream protective device changes its tripping characteristic after a reclosure cycle. The virtual autoreclosure of the upstream device follows the downstream autoreclosure.

#### *What application can be realized by means of Zone Coordination?*

A radial distribution system is protected by an upstream protective device (with a circuit breaker) and a downstream protective device with a reclosure and fuse. By means of the zone coordination a “fuse saving scheme” might be realised. In order to “save fuses” the downstream protective device might trip for the first reclosure attempt at low tripping values (undergrade the fuse, trying to avoid a damaging of the fuse). If the reclosure attempt fails the tripping values might be risen (overgrade the fuse) for the second reclosure attempt (using higher tripping values/characteristics).

#### *What is essential?*

The triggering thresholds of the upstream and the downstream devices have to be the same but the tripping times have to be selectively.

#### *How is Zone Coordination activated?*

The zone coordination function is part of the autoreclosure element and it can be enabled by setting the parameter »Zone coordination« as »active« within the menu [Protection Para/AR/General Settings] for an upstream feeder protection device.



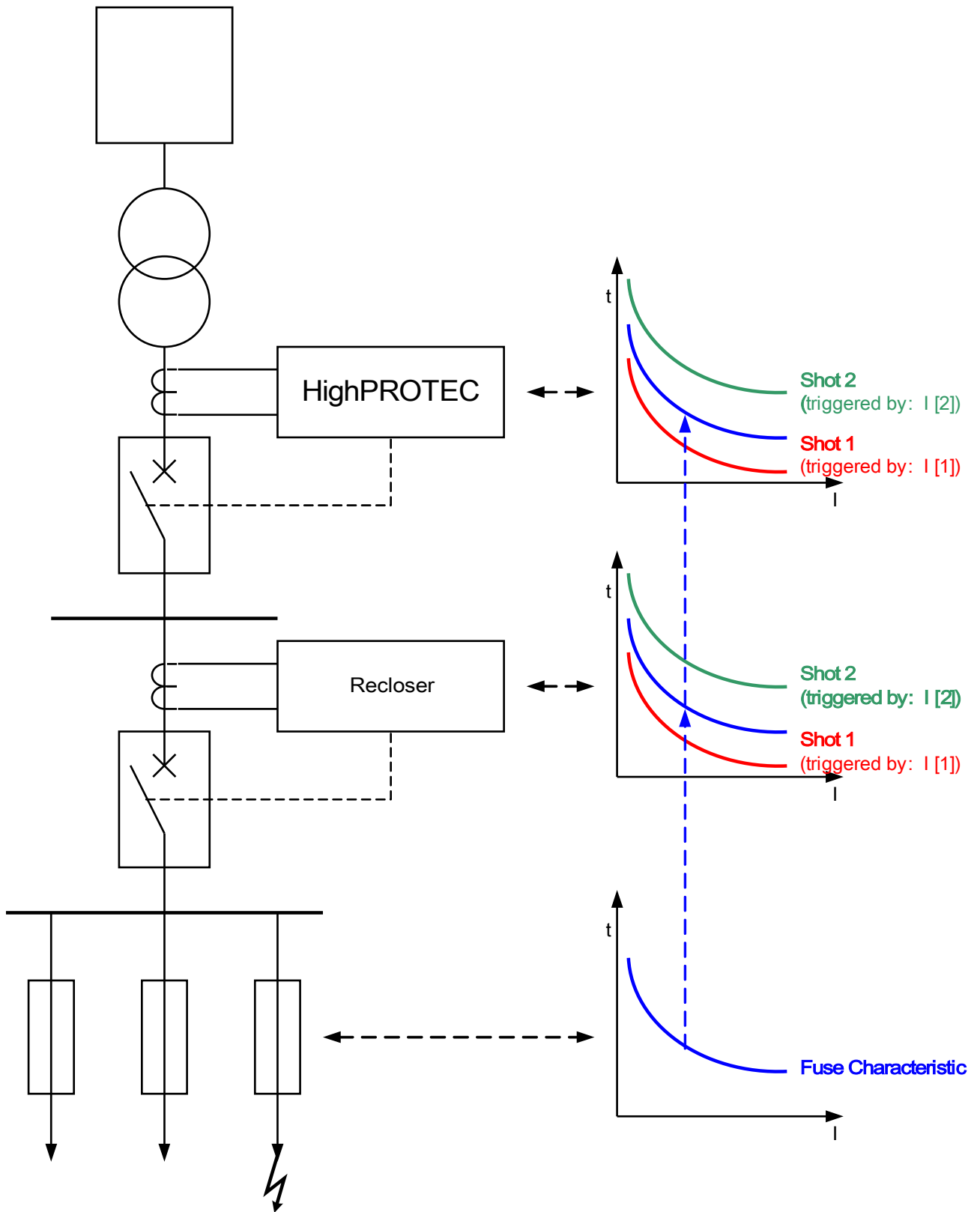

#### *How does the Zone Coordination work (within the upstream protection device)?*

When the zone coordination function is enabled, it works similar to a normal autoreclose function with the same setting parameters: maximum reclosure attempts, dead timer for each shot, initiate functions for each shot and other timers for autoreclose process, but with the following zone coordination features to coordinate with the downstream reclosers:

- The corresponding dead timer for each shot will be started even the breaker of the upstream feeder relay is NOT tripped from the assigned initiate protective functions.
- The dead timer begins timing once the autoreclose senses a drawback of the assigned overcurrent protection pickup signal. This exhibits that the fault current was tripped by the downstream recloser opening.
- The shot counter of an enabled zone coordination will be incremented after the dead timer elapses, even there is no breaker reclosing command issued and meanwhile the »T-RUN2READY« timer is started.
- If a permanent fault exists after the downstream recloser is reclosed, the fault current makes the upstream overcurrent protection picks up again, but with the pickup thresholds or operating curves controlled by the incremented shot number. In this way, the upstream feeder will “follow” the protective settings of downstream recloser shot by shot.
- For a transient fault the autoreclose with zone coordination will not be initiated again because of absence of the fault current and will be reset normally after the expiration of the reset timer »t-Run2Ready«.



### Direct Commands of the Automatic Reclosure Module







<i>Parameter</i>	<i>Description</i>	<i>Setting range</i>	<i>Default</i>	<i>Menu path</i>
Res TotNo suc unsuc 	Reset all statistic AR counters: Total number of AR, successful and unsuccessful no of AR.	inactive, active	inactive	[Operation /Reset]
Res Service Cr 	Reset the Service Counters	inactive, active	inactive	[Operation /Reset]
Reset Lock via HMI 	Reset the AR Lockout via the panel.	inactive, active	inactive	[Operation /Reset]
Res Max Shots / h Cr 	Resetting the Counter for the maximum allowed shots per hour.	inactive, active	inactive	[Operation /Reset]

### Device Planning Parameters of the Module Automatic Reclosure







<i>Parameter</i>	<i>Description</i>	<i>Options</i>	<i>Default</i>	<i>Menu path</i>
Mode 	Mode	do not use, use	do not use	[Device planning]







### Global Protection Parameters of the Module Automatic Reclosure

Parameter	Description	Setting range	Default	Menu path
CB 	Circuit Breaker Module	--, SG[1], SG[2], SG[3], SG[4], SG[5], SG[6].	SG[1].	[Protection Para /Global Prot Para /AR]
ExBlo1 	External blocking of the module, if blocking is activated (allowed) within a parameter set and if the state of the assigned signal is true.	1..n, Assignment List	--	[Protection Para /Global Prot Para /AR]
ExBlo2 	External blocking of the module, if blocking is activated (allowed) within a parameter set and if the state of the assigned signal is true.	1..n, Assignment List	--	[Protection Para /Global Prot Para /AR]
Ex Shot Inc 	The AR Shot counter will be incremented by this external Signal. This can be used for Zone Coordination (of upstream Auto Reclosure devices).	1..n, DI-LogicList	--	[Protection Para /Global Prot Para /AR]
Ex Lock 	The auto reclosure will locked out by this external Signal (set into the lockout state).	1..n, DI-LogicList	--	[Protection Para /Global Prot Para /AR]
DI Reset Ex Lock 	The Lockout State of the AR can be resetted by a digital input.	1..n, DI-LogicList	--	[Protection Para /Global Prot Para /AR]
Scada Reset Ex Lock 	The Lockout State of the AR can be resetted by Scada.	Communication Commands	--	[Protection Para /Global Prot Para /AR]



### Setting Group Parameters of the Module Automatic Reclosure

Parameter	Description	Setting range	Default	Menu path
 Function	Permanent activation or deactivation of module/stage.	inactive, active	inactive	[Protection Para /<1..4> /AR /General settings]
 ExBlo Fc	Activate (allow) or inactivate (disallow) blocking of the module/stage. This parameter is only effective if a signal is assigned to the corresponding global protection parameter. If the signal becomes true, those modules/stages are blocked that are parameterized "ExBlo Fc=active".	inactive, active	inactive	[Protection Para /<1..4> /AR /General settings]
 Zone coordination	Zone coordination: Sequence coordination is to keep upstream reclosers in step with the downstream ones for fast and delay curve operation, thus avoiding overtripping.	inactive, active	inactive	[Protection Para /<1..4> /AR /General settings]
 Ex Shot Inc Fc	The AR Shot counter will be incremented by this external Signal. This can be used for Zone Coordination (of upstream Auto Reclosure devices). Note: This parameter enables the functionality only. The assignment has to be set within the global parameters.	inactive, active	inactive	[Protection Para /<1..4> /AR /General settings]
 Ex Lock Fc	The auto reclosure will be locked out by this external Signal. Note: This parameter enables the functionality only. The assignment has to be set within the global parameters.	inactive, active	inactive	[Protection Para /<1..4> /AR /General settings]
 Reset Mode	Reset Mode	auto, HMI, DI, Scada, HMI And Scada, HMI And DI, Scada And DI, HMI And DI	auto	[Protection Para /<1..4> /AR /General settings]
 Attempts	Maximum number of permitted reclosure attempts.	1 - 6	1	[Protection Para /<1..4> /AR /General settings]

Protective Elements

Parameter	Description	Setting range	Default	Menu path
 Initiate Mode	Initiate Mode	Alarm, TripCmd	Alarm	[Protection Para /<1..4> /AR /General settings]
 t-start	Start timer - While the start timer runs down, an AR attempt can be started. Only if the trip command is given within the start time/duration an AR attempt could be started. The location and the resistance of the fault have a big influence on the tripping time. The start time has an impact on whether an AR attempt should be started when the fault is far away or high resistance.  Only available if: Initiate Mode = TripCmd	0.01 - 9999.00s	1s	[Protection Para /<1..4> /AR /General settings]
 t-DP1	Dead time between trip and reclosure attempt for phase faults.  Only available if: Attempts = 1-6	0.01 - 9999.00s	1s	[Protection Para /<1..4> /AR /Shot Manager /Shot Ctrl1]
 t-DP2	Dead time between trip and reclosure attempt for phase faults.  Only available if: Attempts = 2-6	0.01 - 9999.00s	1s	[Protection Para /<1..4> /AR /Shot Manager /Shot Ctrl2]
 t-DP3	Dead time between trip and reclosure attempt for phase faults.  Only available if: Attempts = 3-6	0.01 - 9999.00s	1s	[Protection Para /<1..4> /AR /Shot Manager /Shot Ctrl3]
 t-DP4	Dead time between trip and reclosure attempt for phase faults.  Only available if: Attempts = 4-6	0.1 - 9999.00s	1s	[Protection Para /<1..4> /AR /Shot Manager /Shot Ctrl4]
 t-DP5	Dead time between trip and reclosure attempt for phase faults.  Only available if: Attempts = 5-6	0.01 - 9999.00s	1s	[Protection Para /<1..4> /AR /Shot Manager /Shot Ctrl5]

Protective Elements

Parameter	Description	Setting range	Default	Menu path
t-DP6 	Dead time between trip and reclosure attempt for phase faults.  Only available if: Attempts = 6	0.01 - 9999.00s	1s	[Protection Para /<1..4> /AR /Shot Manager /Shot Ctrl6]
t-DE1 	Dead time between trip and reclosure attempt for earth faults	0.01 - 9999.00s	1s	[Protection Para /<1..4> /AR /Shot Manager /Shot Ctrl1]
t-DE2 	Dead time between trip and reclosure attempt for earth faults	0.01 - 9999.00s	1s	[Protection Para /<1..4> /AR /Shot Manager /Shot Ctrl2]
t-DE3 	Dead time between trip and reclosure attempt for earth faults	0.01 - 9999.00s	1s	[Protection Para /<1..4> /AR /Shot Manager /Shot Ctrl3]
t-DE4 	Dead time between trip and reclosure attempt for earth faults	0.01 - 9999.00s	1s	[Protection Para /<1..4> /AR /Shot Manager /Shot Ctrl4]
t-DE5 	Dead time between trip and reclosure attempt for earth faults	0.01 - 9999.00s	1s	[Protection Para /<1..4> /AR /Shot Manager /Shot Ctrl5]
t-DE6 	Dead time between trip and reclosure attempt for earth faults	0.01 - 9999.00s	1s	[Protection Para /<1..4> /AR /Shot Manager /Shot Ctrl6]
t-Blo after CB man ON 	This timer will be started if the circuit breaker was switched on manually. While this timer is running, AR cannot be started.	0.01 - 9999.00s	10.0s	[Protection Para /<1..4> /AR /General settings]

Protective Elements

Parameter	Description	Setting range	Default	Menu path
t-Lock2Ready 	This timer is started by the lockout reset signal, and before the timer expire the AR cannot go to any other state.	0.01 - 9999.00s	10.0s	[Protection Para <1..4> /AR /General settings]
t-Run2Ready 	Examination Time: If the Circuit Breaker remains after an reclosure attempt for the duration of this timer in the Closed position, the AR has been successful and the AR module returns into the ready state.	0.01 - 9999.00s	10.0s	[Protection Para <1..4> /AR /General settings]
t-Blo2Ready 	The release (de-blocking) of the AR will be delayed for this time, if there is no blocking signal anymore.	0.01 - 9999.00s	10.0s	[Protection Para <1..4> /AR /General settings]
t-AR Supervision 	AR Overall supervision time (> sum of all the timers used by AR)	1.00 - 9999.00s	100.0s	[Protection Para <1..4> /AR /General settings]
Service Alarm 1 	As soon as the AR-Counter exceeds this number of reclosure attempts an alarm will be given out (overhauling of the CB)	1 - 65535	1000	[Protection Para <1..4> /AR /Wear Monitor]
Service Alarm 2 	Too many auto reclosure attempts. If the parameterized number of AR cycles is reached, an alarm will be given out.	1 - 65535	65535	[Protection Para <1..4> /AR /Wear Monitor]
Max AR/h 	Maximum Number of permitted Auto Reclosure Cycles per hour.	1 - 20	10	[Protection Para <1..4> /AR /Wear Monitor]
Initiate AR: InitiateFc1 	Initiate Auto Reclosure : Initiate Function	Start fct	-	[Protection Para <1..4> /AR /Shot Manager /Pre Shot Ctrl]
Initiate AR: InitiateFc2 	Initiate Auto Reclosure : Initiate Function	Start fct	-	[Protection Para <1..4> /AR /Shot Manager /Pre Shot Ctrl]

Protective Elements

Parameter	Description	Setting range	Default	Menu path
Initiate AR: InitiateFc3 	Initiate Auto Reclosure : Initiate Function	Start fct	-	[Protection Para /<1..4> /AR /Shot Manager /Pre Shot Ctrl]
Initiate AR: InitiateFc4 	Initiate Auto Reclosure : Initiate Function	Start fct	-	[Protection Para /<1..4> /AR /Shot Manager /Pre Shot Ctrl]
Shot 1: InitiateFc1 	Automatic Reclosure Attempt : Initiate Function Only available if: Attempts = 1-6	Start fct	-	[Protection Para /<1..4> /AR /Shot Manager /Shot Ctrl1]
Shot 1: InitiateFc2 	Automatic Reclosure Attempt : Initiate Function Only available if: Attempts = 1-6	Start fct	-	[Protection Para /<1..4> /AR /Shot Manager /Shot Ctrl1]
Shot 1: InitiateFc3 	Automatic Reclosure Attempt : Initiate Function Only available if: Attempts = 1-6	Start fct	-	[Protection Para /<1..4> /AR /Shot Manager /Shot Ctrl1]
Shot 1: InitiateFc4 	Automatic Reclosure Attempt : Initiate Function Only available if: Attempts = 1-6	Start fct	-	[Protection Para /<1..4> /AR /Shot Manager /Shot Ctrl1]
Shot 2: InitiateFc1 	Automatic Reclosure Attempt : Initiate Function Only available if: Attempts = 2-6	Start fct	-	[Protection Para /<1..4> /AR /Shot Manager /Shot Ctrl2]

## Protective Elements





<i>Parameter</i>	<i>Description</i>	<i>Setting range</i>	<i>Default</i>	<i>Menu path</i>
Shot 2: InitiateFc2 	Automatic Reclosure Attempt : Initiate Function Only available if: Attempts = 2-6	Start fct	-	[Protection Para /<1..4> /AR /Shot Manager /Shot Ctrl2]
Shot 2: InitiateFc3 	Automatic Reclosure Attempt : Initiate Function Only available if: Attempts = 2-6	Start fct	-	[Protection Para /<1..4> /AR /Shot Manager /Shot Ctrl2]
Shot 2: InitiateFc4 	Automatic Reclosure Attempt : Initiate Function Only available if: Attempts = 2-6	Start fct	-	[Protection Para /<1..4> /AR /Shot Manager /Shot Ctrl2]
Shot 3: InitiateFc1 	Automatic Reclosure Attempt : Initiate Function Only available if: Attempts = 3-6	Start fct	-	[Protection Para /<1..4> /AR /Shot Manager /Shot Ctrl3]
Shot 3: InitiateFc2 	Automatic Reclosure Attempt : Initiate Function Only available if: Attempts = 3-6	Start fct	-	[Protection Para /<1..4> /AR /Shot Manager /Shot Ctrl3]
Shot 3: InitiateFc3 	Automatic Reclosure Attempt : Initiate Function Only available if: Attempts = 3-6	Start fct	-	[Protection Para /<1..4> /AR /Shot Manager /Shot Ctrl3]
Shot 3: InitiateFc4 	Automatic Reclosure Attempt : Initiate Function Only available if: Attempts = 3-6	Start fct	-	[Protection Para /<1..4> /AR /Shot Manager /Shot Ctrl3]

Protective Elements

Parameter	Description	Setting range	Default	Menu path
Shot 4: InitiateFc1 	Automatic Reclosure Attempt : Initiate Function Only available if: Attempts = 4-6	Start fct	-	[Protection Para /<1..4> /AR /Shot Manager /Shot Ctrl4]
Shot 4: InitiateFc2 	Automatic Reclosure Attempt : Initiate Function Only available if: Attempts = 4-6	Start fct	-	[Protection Para /<1..4> /AR /Shot Manager /Shot Ctrl4]
Shot 4: InitiateFc3 	Automatic Reclosure Attempt : Initiate Function Only available if: Attempts = 4-6	Start fct	-	[Protection Para /<1..4> /AR /Shot Manager /Shot Ctrl4]
Shot 4: InitiateFc4 	Automatic Reclosure Attempt : Initiate Function Only available if: Attempts = 4-6	Start fct	-	[Protection Para /<1..4> /AR /Shot Manager /Shot Ctrl4]
Shot 5: InitiateFc1 	Automatic Reclosure Attempt : Initiate Function Only available if: Attempts = 5-6	Start fct	-	[Protection Para /<1..4> /AR /Shot Manager /Shot Ctrl5]
Shot 5: InitiateFc2 	Automatic Reclosure Attempt : Initiate Function Only available if: Attempts = 5-6	Start fct	-	[Protection Para /<1..4> /AR /Shot Manager /Shot Ctrl5]
Shot 5: InitiateFc3 	Automatic Reclosure Attempt : Initiate Function Only available if: Attempts = 5-6	Start fct	-	[Protection Para /<1..4> /AR /Shot Manager /Shot Ctrl5]



## Protective Elements

<i>Parameter</i>	<i>Description</i>	<i>Setting range</i>	<i>Default</i>	<i>Menu path</i>
Shot 5: InitiateFc4 	Automatic Reclosure Attempt : Initiate Function  Only available if: Attempts = 5-6	Start fct	-	[Protection Para /<1..4> /AR /Shot Manager /Shot Ctrl5]
Shot 6: InitiateFc1 	Automatic Reclosure Attempt : Initiate Function  Only available if: Attempts = 6	Start fct	-	[Protection Para /<1..4> /AR /Shot Manager /Shot Ctrl6]
Shot 6: InitiateFc2 	Automatic Reclosure Attempt : Initiate Function  Only available if: Attempts = 6	Start fct	-	[Protection Para /<1..4> /AR /Shot Manager /Shot Ctrl6]
Shot 6: InitiateFc3 	Automatic Reclosure Attempt : Initiate Function  Only available if: Attempts = 6	Start fct	-	[Protection Para /<1..4> /AR /Shot Manager /Shot Ctrl6]
Shot 6: InitiateFc4 	Automatic Reclosure Attempt : Initiate Function  Only available if: Attempts = 6	Start fct	-	[Protection Para /<1..4> /AR /Shot Manager /Shot Ctrl6]

## Module Automatic Reclosure Input States

<i>Name</i>	<i>Description</i>	<i>Assignment via</i>
ExBlo1-I	Module input state: External blocking1	[Protection Para /Global Prot Para /AR]
ExBlo2-I	Module input state: External blocking2	[Protection Para /Global Prot Para /AR]
Ex Shot Inc-I	Module input state: The AR Shot counter will be incremented by this external Signal. This can be used for Zone Coordination (of upstream Auto Reclosure devices). Note: This parameter enables the functionality only. The assignment has to be set within the global parameters.	[Protection Para /Global Prot Para /AR]
Ex Lock-I	Module input state: External AR lockout.	[Protection Para /Global Prot Para /AR]
DI Reset Ex Lock-I	Module input state: Resetting the lockout state of the AR (if the resetting via digital inputs has been selected).	[Protection Para /Global Prot Para /AR]
Scada Reset Ex Lock-I	Module input state: Resetting the Lockout State of the AR by Communication.	[Protection Para /Global Prot Para /AR]







## Module Automatic Reclosure Signals (Output States)

<i>Signal</i>	<i>Description</i>
active	Signal: active
ExBlo	Signal: External Blocking
Standby	Signal: Standby
t-Blo after CB man ON	Signal: AR blocked after circuit breaker was switched on manually. This timer will be started if the circuit breaker was switched on manually. While this timer is running, AR cannot be started.
Ready	Signal: Ready to shoot
running	Signal: Auto Reclosing running
t-dead	Signal: Dead time between trip and reclosure attempt
CB ON Cmd	Signal: CB switch ON Command
t-Run2Ready	Signal: Examination Time: If the Circuit Breaker remains after a reclosure attempt for the duration of this timer in the Closed position, the AR has been successful and the AR module returns into the ready state.
Lock	Signal: Auto Reclosure is locked out
t-Reset Lockout	Signal: Delay Timer for resetting the AR lockout. The reset of the AR lockout state will be delayed for this time, after the reset signal (e.g digital input or Scada) has been detected .
Blo	Signal: Auto Reclosure is blocked
t-Blo Reset	Signal: Delay Timer for resetting the AR blocking. The release (de-blocking) of the AR will be delayed for this time, if there is no blocking signal anymore.
successful	Signal: Auto Reclosing successful
failed	Signal: Auto Reclosing failure
t-AR Supervision	Signal: AR Supervision
Pre Shot	Pre Shot Control
Shot 1	Shot Control
Shot 2	Shot Control
Shot 3	Shot Control
Shot 4	Shot Control
Shot 5	Shot Control
Shot 6	Shot Control
Service Alarm 1	Signal: AR - Service Alarm 1, too many switching operations
Service Alarm 2	Signal: AR - Service Alarm 2 - too many switching operations
Max Shots / h exceeded	Signal: The maximum allowed number of shots per hour has been exceeded.
Res Statistics Cr	Signal: Reset all statistic AR counters: Total number of AR, successful and unsuccessful no of AR.
Res Service Cr	Signal: Reset the Service Counters for Alarm and Blocking
Reset Lockout	Signal: The AR Lockout has been resetted via the panel.
Res Max Shots / h	Signal: The Counter for the maximum allowed shots per hour has been resetted.
ARRecCState	Signal: AutoReclosing states defined by IEC61850:1=Ready/2=In Progress/3=Successful

## Automatic Reclosure Module Values

<i>Value</i>	<i>Description</i>	<i>Default</i>	<i>Size</i>	<i>Menu path</i>
AR Shot No.	Counter - Auto Reclosure Attempts	0	0 - 6	[Operation /Count and RevData /AR]
Total number Cr	Total number of all executed Automatic Reclosures Attempts	0	0 - 65536	[Operation /Count and RevData /AR]
Cr successfl	Total number of successfully executed Automatic Reclosures	0	0 - 65536	[Operation /Count and RevData /AR]
Cr failed	Total number of unsuccessfully executed automatic reclosure attempts	0	0 - 65536	[Operation /Count and RevData /AR]
Cr Service Alarm1	Remaining numbers of ARs until Service Alarm 1	1000	0 - 1000	[Operation /Count and RevData /AR]
Cr Service Alarm2	Remaining numbers of ARs until Service Alarm 2	65536	0 - 65536	[Operation /Count and RevData /AR]
Max Shots / h Cr	Counter for the maximum allowed shots per hour.	0	0 - 65536	[Operation /Count and RevData /AR]

### Setting Group Parameters of the AR Abort Functions

Parameter	Description	Setting range	Default	Menu path
abort: 1 	Abort the AR-cycle, if the state of the assigned signal is true. If the state of this function is true the AR will be aborted.	Block Fc	-.-	[Protection Para /<1..4> /AR /Block Fc]
abort: 2 	Abort the AR-cycle, if the state of the assigned signal is true. If the state of this function is true the AR will be aborted.	Block Fc	-.-	[Protection Para /<1..4> /AR /Block Fc]
abort: 3 	Abort the AR-cycle, if the state of the assigned signal is true. If the state of this function is true the AR will be aborted.	Block Fc	-.-	[Protection Para /<1..4> /AR /Block Fc]
abort: 4 	Abort the AR-cycle, if the state of the assigned signal is true. If the state of this function is true the AR will be aborted.	Block Fc	-.-	[Protection Para /<1..4> /AR /Block Fc]
abort: 5 	Abort the AR-cycle, if the state of the assigned signal is true. If the state of this function is true the AR will be aborted.	Block Fc	-.-	[Protection Para /<1..4> /AR /Block Fc]
abort: 6 	Abort the AR-cycle, if the state of the assigned signal is true. If the state of this function is true the AR will be aborted.	Block Fc	-.-	[Protection Para /<1..4> /AR /Block Fc]

## AR Abort Functions

<i>Name</i>	<i>Description</i>
--	No assignment
I[1].TripCmd	Signal: Trip Command
I[2].TripCmd	Signal: Trip Command
I[3].TripCmd	Signal: Trip Command
I[4].TripCmd	Signal: Trip Command
I[5].TripCmd	Signal: Trip Command
I[6].TripCmd	Signal: Trip Command
IG[1].TripCmd	Signal: Trip Command
IG[2].TripCmd	Signal: Trip Command
IG[3].TripCmd	Signal: Trip Command
IG[4].TripCmd	Signal: Trip Command
ThR.TripCmd	Signal: Trip Command
I2>[1].TripCmd	Signal: Trip Command
I2>[2].TripCmd	Signal: Trip Command
V[1].TripCmd	Signal: Trip Command
V[2].TripCmd	Signal: Trip Command
V[3].TripCmd	Signal: Trip Command
V[4].TripCmd	Signal: Trip Command
V[5].TripCmd	Signal: Trip Command
V[6].TripCmd	Signal: Trip Command
df/dt.TripCmd	Signal: Trip Command
delta phi.TripCmd	Signal: Trip Command
Intertripping.TripCmd	Signal: Trip Command
P.TripCmd	Signal: Trip Command
Q.TripCmd	Signal: Trip Command
LVRT.TripCmd	Signal: Trip Command
VG[1].TripCmd	Signal: Trip Command
VG[2].TripCmd	Signal: Trip Command
V012[1].TripCmd	Signal: Trip Command
V012[2].TripCmd	Signal: Trip Command
V012[3].TripCmd	Signal: Trip Command
V012[4].TripCmd	Signal: Trip Command
V012[5].TripCmd	Signal: Trip Command
V012[6].TripCmd	Signal: Trip Command
f[1].TripCmd	Signal: Trip Command
f[2].TripCmd	Signal: Trip Command
f[3].TripCmd	Signal: Trip Command
f[4].TripCmd	Signal: Trip Command

## Protective Elements

<i>Name</i>	<i>Description</i>
f[5].TripCmd	Signal: Trip Command
f[6].TripCmd	Signal: Trip Command
PQS[1].TripCmd	Signal: Trip Command
PQS[2].TripCmd	Signal: Trip Command
PQS[3].TripCmd	Signal: Trip Command
PQS[4].TripCmd	Signal: Trip Command
PF[1].TripCmd	Signal: Trip Command
PF[2].TripCmd	Signal: Trip Command
Q->&V<.Decoupling Energy Resource	Signal: Decoupling of the (local) Energy Resource
Q->&V<.Decoupling PCC	Signal: Decoupling at the Point of Common Coupling
ExP[1].TripCmd	Signal: Trip Command
ExP[2].TripCmd	Signal: Trip Command
ExP[3].TripCmd	Signal: Trip Command
ExP[4].TripCmd	Signal: Trip Command
SOTF.enabled	Signal: Switch Onto Fault enabled. This Signal can be used to modify Overcurrent Protection Settings.
CLPU.enabled	Signal: Cold Load enabled
CBF.Alarm	Signal: Circuit Breaker Failure
TCS.Alarm	Signal: Alarm Trip Circuit Supervision
Logics.LE1.Gate Out	Signal: Output of the logic gate
Logics.LE1.Timer Out	Signal: Timer Output
Logics.LE1.Out	Signal: Latched Output (Q)
Logics.LE1.Out inverted	Signal: Negated Latched Output (Q NOT)
Logics.LE2.Gate Out	Signal: Output of the logic gate
Logics.LE2.Timer Out	Signal: Timer Output
Logics.LE2.Out	Signal: Latched Output (Q)
Logics.LE2.Out inverted	Signal: Negated Latched Output (Q NOT)
Logics.LE3.Gate Out	Signal: Output of the logic gate
Logics.LE3.Timer Out	Signal: Timer Output
Logics.LE3.Out	Signal: Latched Output (Q)
Logics.LE3.Out inverted	Signal: Negated Latched Output (Q NOT)
Logics.LE4.Gate Out	Signal: Output of the logic gate
Logics.LE4.Timer Out	Signal: Timer Output
Logics.LE4.Out	Signal: Latched Output (Q)
Logics.LE4.Out inverted	Signal: Negated Latched Output (Q NOT)
Logics.LE5.Gate Out	Signal: Output of the logic gate
Logics.LE5.Timer Out	Signal: Timer Output
Logics.LE5.Out	Signal: Latched Output (Q)
Logics.LE5.Out inverted	Signal: Negated Latched Output (Q NOT)
Logics.LE6.Gate Out	Signal: Output of the logic gate

## Protective Elements

<i>Name</i>	<i>Description</i>
Logics.LE6.Timer Out	Signal: Timer Output
Logics.LE6.Out	Signal: Latched Output (Q)
Logics.LE6.Out inverted	Signal: Negated Latched Output (Q NOT)
Logics.LE7.Gate Out	Signal: Output of the logic gate
Logics.LE7.Timer Out	Signal: Timer Output
Logics.LE7.Out	Signal: Latched Output (Q)
Logics.LE7.Out inverted	Signal: Negated Latched Output (Q NOT)
Logics.LE8.Gate Out	Signal: Output of the logic gate
Logics.LE8.Timer Out	Signal: Timer Output
Logics.LE8.Out	Signal: Latched Output (Q)
Logics.LE8.Out inverted	Signal: Negated Latched Output (Q NOT)
Logics.LE9.Gate Out	Signal: Output of the logic gate
Logics.LE9.Timer Out	Signal: Timer Output
Logics.LE9.Out	Signal: Latched Output (Q)
Logics.LE9.Out inverted	Signal: Negated Latched Output (Q NOT)
Logics.LE10.Gate Out	Signal: Output of the logic gate
Logics.LE10.Timer Out	Signal: Timer Output
Logics.LE10.Out	Signal: Latched Output (Q)
Logics.LE10.Out inverted	Signal: Negated Latched Output (Q NOT)
Logics.LE11.Gate Out	Signal: Output of the logic gate
Logics.LE11.Timer Out	Signal: Timer Output
Logics.LE11.Out	Signal: Latched Output (Q)
Logics.LE11.Out inverted	Signal: Negated Latched Output (Q NOT)
Logics.LE12.Gate Out	Signal: Output of the logic gate
Logics.LE12.Timer Out	Signal: Timer Output
Logics.LE12.Out	Signal: Latched Output (Q)
Logics.LE12.Out inverted	Signal: Negated Latched Output (Q NOT)
Logics.LE13.Gate Out	Signal: Output of the logic gate
Logics.LE13.Timer Out	Signal: Timer Output
Logics.LE13.Out	Signal: Latched Output (Q)
Logics.LE13.Out inverted	Signal: Negated Latched Output (Q NOT)
Logics.LE14.Gate Out	Signal: Output of the logic gate
Logics.LE14.Timer Out	Signal: Timer Output
Logics.LE14.Out	Signal: Latched Output (Q)
Logics.LE14.Out inverted	Signal: Negated Latched Output (Q NOT)
Logics.LE15.Gate Out	Signal: Output of the logic gate
Logics.LE15.Timer Out	Signal: Timer Output
Logics.LE15.Out	Signal: Latched Output (Q)
Logics.LE15.Out inverted	Signal: Negated Latched Output (Q NOT)
Logics.LE16.Gate Out	Signal: Output of the logic gate



## Protective Elements

<i>Name</i>	<i>Description</i>
Logics.LE16.Timer Out	Signal: Timer Output
Logics.LE16.Out	Signal: Latched Output (Q)
Logics.LE16.Out inverted	Signal: Negated Latched Output (Q NOT)
Logics.LE17.Gate Out	Signal: Output of the logic gate
Logics.LE17.Timer Out	Signal: Timer Output
Logics.LE17.Out	Signal: Latched Output (Q)
Logics.LE17.Out inverted	Signal: Negated Latched Output (Q NOT)
Logics.LE18.Gate Out	Signal: Output of the logic gate
Logics.LE18.Timer Out	Signal: Timer Output
Logics.LE18.Out	Signal: Latched Output (Q)
Logics.LE18.Out inverted	Signal: Negated Latched Output (Q NOT)
Logics.LE19.Gate Out	Signal: Output of the logic gate
Logics.LE19.Timer Out	Signal: Timer Output
Logics.LE19.Out	Signal: Latched Output (Q)
Logics.LE19.Out inverted	Signal: Negated Latched Output (Q NOT)
Logics.LE20.Gate Out	Signal: Output of the logic gate
Logics.LE20.Timer Out	Signal: Timer Output
Logics.LE20.Out	Signal: Latched Output (Q)
Logics.LE20.Out inverted	Signal: Negated Latched Output (Q NOT)
Logics.LE21.Gate Out	Signal: Output of the logic gate
Logics.LE21.Timer Out	Signal: Timer Output
Logics.LE21.Out	Signal: Latched Output (Q)
Logics.LE21.Out inverted	Signal: Negated Latched Output (Q NOT)
Logics.LE22.Gate Out	Signal: Output of the logic gate
Logics.LE22.Timer Out	Signal: Timer Output
Logics.LE22.Out	Signal: Latched Output (Q)
Logics.LE22.Out inverted	Signal: Negated Latched Output (Q NOT)
Logics.LE23.Gate Out	Signal: Output of the logic gate
Logics.LE23.Timer Out	Signal: Timer Output
Logics.LE23.Out	Signal: Latched Output (Q)
Logics.LE23.Out inverted	Signal: Negated Latched Output (Q NOT)
Logics.LE24.Gate Out	Signal: Output of the logic gate
Logics.LE24.Timer Out	Signal: Timer Output
Logics.LE24.Out	Signal: Latched Output (Q)
Logics.LE24.Out inverted	Signal: Negated Latched Output (Q NOT)
Logics.LE25.Gate Out	Signal: Output of the logic gate
Logics.LE25.Timer Out	Signal: Timer Output
Logics.LE25.Out	Signal: Latched Output (Q)
Logics.LE25.Out inverted	Signal: Negated Latched Output (Q NOT)
Logics.LE26.Gate Out	Signal: Output of the logic gate

## Protective Elements

<i>Name</i>	<i>Description</i>
Logics.LE26.Timer Out	Signal: Timer Output
Logics.LE26.Out	Signal: Latched Output (Q)
Logics.LE26.Out inverted	Signal: Negated Latched Output (Q NOT)
Logics.LE27.Gate Out	Signal: Output of the logic gate
Logics.LE27.Timer Out	Signal: Timer Output
Logics.LE27.Out	Signal: Latched Output (Q)
Logics.LE27.Out inverted	Signal: Negated Latched Output (Q NOT)
Logics.LE28.Gate Out	Signal: Output of the logic gate
Logics.LE28.Timer Out	Signal: Timer Output
Logics.LE28.Out	Signal: Latched Output (Q)
Logics.LE28.Out inverted	Signal: Negated Latched Output (Q NOT)
Logics.LE29.Gate Out	Signal: Output of the logic gate
Logics.LE29.Timer Out	Signal: Timer Output
Logics.LE29.Out	Signal: Latched Output (Q)
Logics.LE29.Out inverted	Signal: Negated Latched Output (Q NOT)
Logics.LE30.Gate Out	Signal: Output of the logic gate
Logics.LE30.Timer Out	Signal: Timer Output
Logics.LE30.Out	Signal: Latched Output (Q)
Logics.LE30.Out inverted	Signal: Negated Latched Output (Q NOT)
Logics.LE31.Gate Out	Signal: Output of the logic gate
Logics.LE31.Timer Out	Signal: Timer Output
Logics.LE31.Out	Signal: Latched Output (Q)
Logics.LE31.Out inverted	Signal: Negated Latched Output (Q NOT)
Logics.LE32.Gate Out	Signal: Output of the logic gate
Logics.LE32.Timer Out	Signal: Timer Output
Logics.LE32.Out	Signal: Latched Output (Q)
Logics.LE32.Out inverted	Signal: Negated Latched Output (Q NOT)
Logics.LE33.Gate Out	Signal: Output of the logic gate
Logics.LE33.Timer Out	Signal: Timer Output
Logics.LE33.Out	Signal: Latched Output (Q)
Logics.LE33.Out inverted	Signal: Negated Latched Output (Q NOT)
Logics.LE34.Gate Out	Signal: Output of the logic gate
Logics.LE34.Timer Out	Signal: Timer Output
Logics.LE34.Out	Signal: Latched Output (Q)
Logics.LE34.Out inverted	Signal: Negated Latched Output (Q NOT)
Logics.LE35.Gate Out	Signal: Output of the logic gate
Logics.LE35.Timer Out	Signal: Timer Output
Logics.LE35.Out	Signal: Latched Output (Q)
Logics.LE35.Out inverted	Signal: Negated Latched Output (Q NOT)
Logics.LE36.Gate Out	Signal: Output of the logic gate

## Protective Elements

<i>Name</i>	<i>Description</i>
Logics.LE36.Timer Out	Signal: Timer Output
Logics.LE36.Out	Signal: Latched Output (Q)
Logics.LE36.Out inverted	Signal: Negated Latched Output (Q NOT)
Logics.LE37.Gate Out	Signal: Output of the logic gate
Logics.LE37.Timer Out	Signal: Timer Output
Logics.LE37.Out	Signal: Latched Output (Q)
Logics.LE37.Out inverted	Signal: Negated Latched Output (Q NOT)
Logics.LE38.Gate Out	Signal: Output of the logic gate
Logics.LE38.Timer Out	Signal: Timer Output
Logics.LE38.Out	Signal: Latched Output (Q)
Logics.LE38.Out inverted	Signal: Negated Latched Output (Q NOT)
Logics.LE39.Gate Out	Signal: Output of the logic gate
Logics.LE39.Timer Out	Signal: Timer Output
Logics.LE39.Out	Signal: Latched Output (Q)
Logics.LE39.Out inverted	Signal: Negated Latched Output (Q NOT)
Logics.LE40.Gate Out	Signal: Output of the logic gate
Logics.LE40.Timer Out	Signal: Timer Output
Logics.LE40.Out	Signal: Latched Output (Q)
Logics.LE40.Out inverted	Signal: Negated Latched Output (Q NOT)
Logics.LE41.Gate Out	Signal: Output of the logic gate
Logics.LE41.Timer Out	Signal: Timer Output
Logics.LE41.Out	Signal: Latched Output (Q)
Logics.LE41.Out inverted	Signal: Negated Latched Output (Q NOT)
Logics.LE42.Gate Out	Signal: Output of the logic gate
Logics.LE42.Timer Out	Signal: Timer Output
Logics.LE42.Out	Signal: Latched Output (Q)
Logics.LE42.Out inverted	Signal: Negated Latched Output (Q NOT)
Logics.LE43.Gate Out	Signal: Output of the logic gate
Logics.LE43.Timer Out	Signal: Timer Output
Logics.LE43.Out	Signal: Latched Output (Q)
Logics.LE43.Out inverted	Signal: Negated Latched Output (Q NOT)
Logics.LE44.Gate Out	Signal: Output of the logic gate
Logics.LE44.Timer Out	Signal: Timer Output
Logics.LE44.Out	Signal: Latched Output (Q)
Logics.LE44.Out inverted	Signal: Negated Latched Output (Q NOT)
Logics.LE45.Gate Out	Signal: Output of the logic gate
Logics.LE45.Timer Out	Signal: Timer Output
Logics.LE45.Out	Signal: Latched Output (Q)
Logics.LE45.Out inverted	Signal: Negated Latched Output (Q NOT)
Logics.LE46.Gate Out	Signal: Output of the logic gate

## Protective Elements

<i>Name</i>	<i>Description</i>
Logics.LE46.Timer Out	Signal: Timer Output
Logics.LE46.Out	Signal: Latched Output (Q)
Logics.LE46.Out inverted	Signal: Negated Latched Output (Q NOT)
Logics.LE47.Gate Out	Signal: Output of the logic gate
Logics.LE47.Timer Out	Signal: Timer Output
Logics.LE47.Out	Signal: Latched Output (Q)
Logics.LE47.Out inverted	Signal: Negated Latched Output (Q NOT)
Logics.LE48.Gate Out	Signal: Output of the logic gate
Logics.LE48.Timer Out	Signal: Timer Output
Logics.LE48.Out	Signal: Latched Output (Q)
Logics.LE48.Out inverted	Signal: Negated Latched Output (Q NOT)
Logics.LE49.Gate Out	Signal: Output of the logic gate
Logics.LE49.Timer Out	Signal: Timer Output
Logics.LE49.Out	Signal: Latched Output (Q)
Logics.LE49.Out inverted	Signal: Negated Latched Output (Q NOT)
Logics.LE50.Gate Out	Signal: Output of the logic gate
Logics.LE50.Timer Out	Signal: Timer Output
Logics.LE50.Out	Signal: Latched Output (Q)
Logics.LE50.Out inverted	Signal: Negated Latched Output (Q NOT)
Logics.LE51.Gate Out	Signal: Output of the logic gate
Logics.LE51.Timer Out	Signal: Timer Output
Logics.LE51.Out	Signal: Latched Output (Q)
Logics.LE51.Out inverted	Signal: Negated Latched Output (Q NOT)
Logics.LE52.Gate Out	Signal: Output of the logic gate
Logics.LE52.Timer Out	Signal: Timer Output
Logics.LE52.Out	Signal: Latched Output (Q)
Logics.LE52.Out inverted	Signal: Negated Latched Output (Q NOT)
Logics.LE53.Gate Out	Signal: Output of the logic gate
Logics.LE53.Timer Out	Signal: Timer Output
Logics.LE53.Out	Signal: Latched Output (Q)
Logics.LE53.Out inverted	Signal: Negated Latched Output (Q NOT)
Logics.LE54.Gate Out	Signal: Output of the logic gate
Logics.LE54.Timer Out	Signal: Timer Output
Logics.LE54.Out	Signal: Latched Output (Q)
Logics.LE54.Out inverted	Signal: Negated Latched Output (Q NOT)
Logics.LE55.Gate Out	Signal: Output of the logic gate
Logics.LE55.Timer Out	Signal: Timer Output
Logics.LE55.Out	Signal: Latched Output (Q)
Logics.LE55.Out inverted	Signal: Negated Latched Output (Q NOT)
Logics.LE56.Gate Out	Signal: Output of the logic gate

## Protective Elements

<i>Name</i>	<i>Description</i>
Logics.LE56.Timer Out	Signal: Timer Output
Logics.LE56.Out	Signal: Latched Output (Q)
Logics.LE56.Out inverted	Signal: Negated Latched Output (Q NOT)
Logics.LE57.Gate Out	Signal: Output of the logic gate
Logics.LE57.Timer Out	Signal: Timer Output
Logics.LE57.Out	Signal: Latched Output (Q)
Logics.LE57.Out inverted	Signal: Negated Latched Output (Q NOT)
Logics.LE58.Gate Out	Signal: Output of the logic gate
Logics.LE58.Timer Out	Signal: Timer Output
Logics.LE58.Out	Signal: Latched Output (Q)
Logics.LE58.Out inverted	Signal: Negated Latched Output (Q NOT)
Logics.LE59.Gate Out	Signal: Output of the logic gate
Logics.LE59.Timer Out	Signal: Timer Output
Logics.LE59.Out	Signal: Latched Output (Q)
Logics.LE59.Out inverted	Signal: Negated Latched Output (Q NOT)
Logics.LE60.Gate Out	Signal: Output of the logic gate
Logics.LE60.Timer Out	Signal: Timer Output
Logics.LE60.Out	Signal: Latched Output (Q)
Logics.LE60.Out inverted	Signal: Negated Latched Output (Q NOT)
Logics.LE61.Gate Out	Signal: Output of the logic gate
Logics.LE61.Timer Out	Signal: Timer Output
Logics.LE61.Out	Signal: Latched Output (Q)
Logics.LE61.Out inverted	Signal: Negated Latched Output (Q NOT)
Logics.LE62.Gate Out	Signal: Output of the logic gate
Logics.LE62.Timer Out	Signal: Timer Output
Logics.LE62.Out	Signal: Latched Output (Q)
Logics.LE62.Out inverted	Signal: Negated Latched Output (Q NOT)
Logics.LE63.Gate Out	Signal: Output of the logic gate
Logics.LE63.Timer Out	Signal: Timer Output
Logics.LE63.Out	Signal: Latched Output (Q)
Logics.LE63.Out inverted	Signal: Negated Latched Output (Q NOT)
Logics.LE64.Gate Out	Signal: Output of the logic gate
Logics.LE64.Timer Out	Signal: Timer Output
Logics.LE64.Out	Signal: Latched Output (Q)
Logics.LE64.Out inverted	Signal: Negated Latched Output (Q NOT)
Logics.LE65.Gate Out	Signal: Output of the logic gate
Logics.LE65.Timer Out	Signal: Timer Output
Logics.LE65.Out	Signal: Latched Output (Q)
Logics.LE65.Out inverted	Signal: Negated Latched Output (Q NOT)
Logics.LE66.Gate Out	Signal: Output of the logic gate

## Protective Elements

<i>Name</i>	<i>Description</i>
Logics.LE66.Timer Out	Signal: Timer Output
Logics.LE66.Out	Signal: Latched Output (Q)
Logics.LE66.Out inverted	Signal: Negated Latched Output (Q NOT)
Logics.LE67.Gate Out	Signal: Output of the logic gate
Logics.LE67.Timer Out	Signal: Timer Output
Logics.LE67.Out	Signal: Latched Output (Q)
Logics.LE67.Out inverted	Signal: Negated Latched Output (Q NOT)
Logics.LE68.Gate Out	Signal: Output of the logic gate
Logics.LE68.Timer Out	Signal: Timer Output
Logics.LE68.Out	Signal: Latched Output (Q)
Logics.LE68.Out inverted	Signal: Negated Latched Output (Q NOT)
Logics.LE69.Gate Out	Signal: Output of the logic gate
Logics.LE69.Timer Out	Signal: Timer Output
Logics.LE69.Out	Signal: Latched Output (Q)
Logics.LE69.Out inverted	Signal: Negated Latched Output (Q NOT)
Logics.LE70.Gate Out	Signal: Output of the logic gate
Logics.LE70.Timer Out	Signal: Timer Output
Logics.LE70.Out	Signal: Latched Output (Q)
Logics.LE70.Out inverted	Signal: Negated Latched Output (Q NOT)
Logics.LE71.Gate Out	Signal: Output of the logic gate
Logics.LE71.Timer Out	Signal: Timer Output
Logics.LE71.Out	Signal: Latched Output (Q)
Logics.LE71.Out inverted	Signal: Negated Latched Output (Q NOT)
Logics.LE72.Gate Out	Signal: Output of the logic gate
Logics.LE72.Timer Out	Signal: Timer Output
Logics.LE72.Out	Signal: Latched Output (Q)
Logics.LE72.Out inverted	Signal: Negated Latched Output (Q NOT)
Logics.LE73.Gate Out	Signal: Output of the logic gate
Logics.LE73.Timer Out	Signal: Timer Output
Logics.LE73.Out	Signal: Latched Output (Q)
Logics.LE73.Out inverted	Signal: Negated Latched Output (Q NOT)
Logics.LE74.Gate Out	Signal: Output of the logic gate
Logics.LE74.Timer Out	Signal: Timer Output
Logics.LE74.Out	Signal: Latched Output (Q)
Logics.LE74.Out inverted	Signal: Negated Latched Output (Q NOT)
Logics.LE75.Gate Out	Signal: Output of the logic gate
Logics.LE75.Timer Out	Signal: Timer Output
Logics.LE75.Out	Signal: Latched Output (Q)
Logics.LE75.Out inverted	Signal: Negated Latched Output (Q NOT)
Logics.LE76.Gate Out	Signal: Output of the logic gate

## Protective Elements

---

<i>Name</i>	<i>Description</i>
Logics.LE76.Timer Out	Signal: Timer Output
Logics.LE76.Out	Signal: Latched Output (Q)
Logics.LE76.Out inverted	Signal: Negated Latched Output (Q NOT)
Logics.LE77.Gate Out	Signal: Output of the logic gate
Logics.LE77.Timer Out	Signal: Timer Output
Logics.LE77.Out	Signal: Latched Output (Q)
Logics.LE77.Out inverted	Signal: Negated Latched Output (Q NOT)
Logics.LE78.Gate Out	Signal: Output of the logic gate
Logics.LE78.Timer Out	Signal: Timer Output
Logics.LE78.Out	Signal: Latched Output (Q)
Logics.LE78.Out inverted	Signal: Negated Latched Output (Q NOT)
Logics.LE79.Gate Out	Signal: Output of the logic gate
Logics.LE79.Timer Out	Signal: Timer Output
Logics.LE79.Out	Signal: Latched Output (Q)
Logics.LE79.Out inverted	Signal: Negated Latched Output (Q NOT)
Logics.LE80.Gate Out	Signal: Output of the logic gate
Logics.LE80.Timer Out	Signal: Timer Output
Logics.LE80.Out	Signal: Latched Output (Q)
Logics.LE80.Out inverted	Signal: Negated Latched Output (Q NOT)

## AR Start Functions

<i>Name</i>	<i>Description</i>
-	No assignment
I[1]	Phase Overcurrent Stage
I[2]	Phase Overcurrent Stage
I[3]	Phase Overcurrent Stage
I[4]	Phase Overcurrent Stage
I[5]	Phase Overcurrent Stage
I[6]	Phase Overcurrent Stage
IG[1]	Earth current protection - Stage
IG[2]	Earth current protection - Stage
IG[3]	Earth current protection - Stage
IG[4]	Earth current protection - Stage
I2>[1]	Unbalanced Load-Stage
I2>[2]	Unbalanced Load-Stage
ExP[1]	External Protection - Module
ExP[2]	External Protection - Module
ExP[3]	External Protection - Module
ExP[4]	External Protection - Module

## Scada Commands of the Auto Reclosure

<i>Name</i>	<i>Description</i>
--	No assignment
Modbus.Scada Cmd 1	Scada Command
Modbus.Scada Cmd 2	Scada Command
Modbus.Scada Cmd 3	Scada Command
Modbus.Scada Cmd 4	Scada Command
Modbus.Scada Cmd 5	Scada Command
Modbus.Scada Cmd 6	Scada Command
Modbus.Scada Cmd 7	Scada Command
Modbus.Scada Cmd 8	Scada Command
Modbus.Scada Cmd 9	Scada Command
Modbus.Scada Cmd 10	Scada Command
Modbus.Scada Cmd 11	Scada Command
Modbus.Scada Cmd 12	Scada Command
Modbus.Scada Cmd 13	Scada Command
Modbus.Scada Cmd 14	Scada Command
Modbus.Scada Cmd 15	Scada Command
Modbus.Scada Cmd 16	Scada Command



## Protective Elements

---

<i>Name</i>	<i>Description</i>
IEC 103.Scada Cmd 1	Scada Command
IEC 103.Scada Cmd 2	Scada Command
IEC 103.Scada Cmd 3	Scada Command
IEC 103.Scada Cmd 4	Scada Command
IEC 103.Scada Cmd 5	Scada Command
IEC 103.Scada Cmd 6	Scada Command
IEC 103.Scada Cmd 7	Scada Command
IEC 103.Scada Cmd 8	Scada Command
IEC 103.Scada Cmd 9	Scada Command
IEC 103.Scada Cmd 10	Scada Command
Profibus.Scada Cmd 1	Scada Command
Profibus.Scada Cmd 2	Scada Command
Profibus.Scada Cmd 3	Scada Command
Profibus.Scada Cmd 4	Scada Command
Profibus.Scada Cmd 5	Scada Command
Profibus.Scada Cmd 6	Scada Command
Profibus.Scada Cmd 7	Scada Command
Profibus.Scada Cmd 8	Scada Command
Profibus.Scada Cmd 9	Scada Command
Profibus.Scada Cmd 10	Scada Command
Profibus.Scada Cmd 11	Scada Command
Profibus.Scada Cmd 12	Scada Command
Profibus.Scada Cmd 13	Scada Command
Profibus.Scada Cmd 14	Scada Command
Profibus.Scada Cmd 15	Scada Command
Profibus.Scada Cmd 16	Scada Command

## ExP - External Protection

Available stages:

ExP[1] , ExP[2] , ExP[3] , ExP[4]

### **NOTICE**

All 4 stages of the external protection ExP[1]...[4] are identically structured.

By using the module *External Protection* the following can be incorporated into the device function: trip commands, alarms and blockades of external protection facilities. Devices which are not provided with a communication interface can be connected to the control system as well.

Exp[1]..[n]



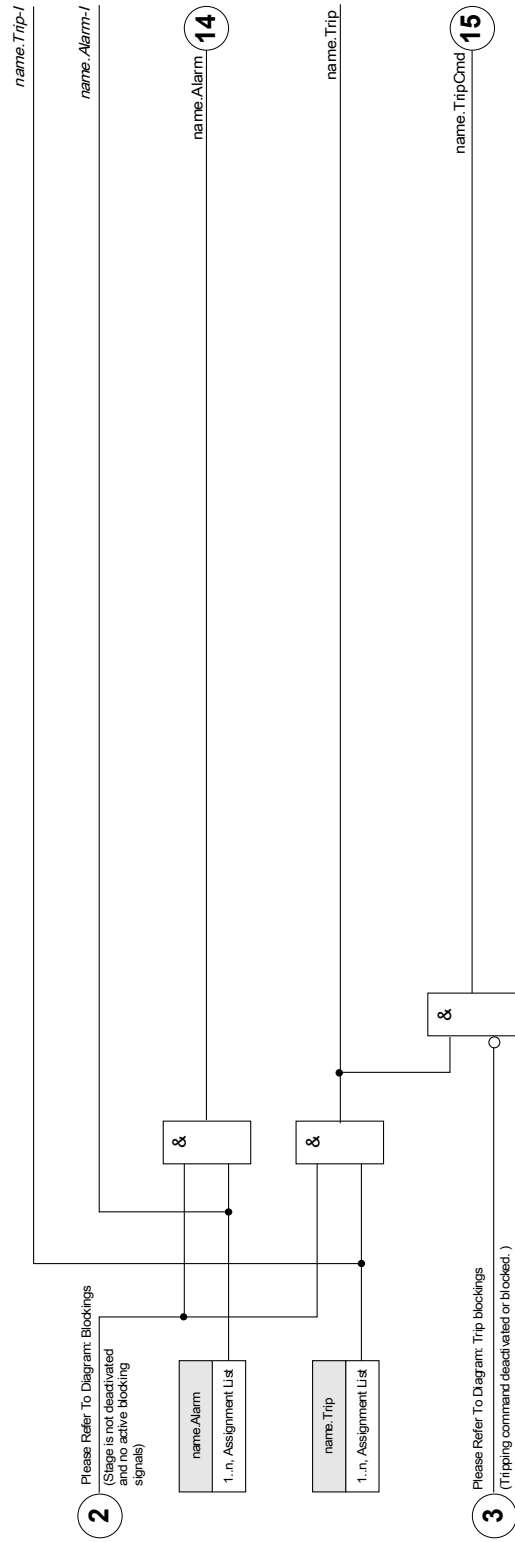

name = Exp[1]..[n]







## Device Planning Parameters of the Module External Protection

Parameter	Description	Options	Default	Menu path
Mode 	Mode	do not use, use	do not use	[Device planning]

## Global Protection Parameters of the Module External Protection

Parameter	Description	Setting range	Default	Menu path
ExBlo1 	External blocking of the module, if blocking is activated (allowed) within a parameter set and if the state of the assigned signal is true.	1..n, Assignment List	--	[Protection Para /Global Prot Para /ExP /ExP[1]]
ExBlo2 	External blocking of the module, if blocking is activated (allowed) within a parameter set and if the state of the assigned signal is true.	1..n, Assignment List	--	[Protection Para /Global Prot Para /ExP /ExP[1]]
ExBlo TripCmd 	External blocking of the Trip Command of the module/the stage, if blocking is activated (allowed) within a parameter set and if the state of the assigned signal is true.	1..n, Assignment List	--	[Protection Para /Global Prot Para /ExP /ExP[1]]
Alarm 	Assignment for External Alarm	1..n, Assignment List	--	[Protection Para /Global Prot Para /ExP /ExP[1]]
Trip 	External trip of the CB if the state of the assigned signal is true.	1..n, Assignment List	--	[Protection Para /Global Prot Para /ExP /ExP[1]]

### Setting Group Parameters of the Module External Protection

Parameter	Description	Setting range	Default	Menu path
 Function	Permanent activation or deactivation of module/stage.	inactive, active	inactive	[Protection Para /<1..4> /ExP /ExP[1]]
 ExBlo Fc	Activate (allow) or inactivate (disallow) blocking of the module/stage. This parameter is only effective if a signal is assigned to the corresponding global protection parameter. If the signal becomes true, those modules/stages are blocked that are parameterized "ExBlo Fc=active".	inactive, active	inactive	[Protection Para /<1..4> /ExP /ExP[1]]
 Blo TripCmd	Permanent blocking of the Trip Command of the module/stage.	inactive, active	inactive	[Protection Para /<1..4> /ExP /ExP[1]]
 ExBlo TripCmd Fc	Activate (allow) or inactivate (disallow) blocking of the module/stage. This parameter is only effective if a signal is assigned to the corresponding global protection parameter. If the signal becomes true, those modules/stages are blocked that are parameterized "ExBlo TripCmd Fc=active".	inactive, active	inactive	[Protection Para /<1..4> /ExP /ExP[1]]

## Module External Protection Input States

<i>Name</i>	<i>Description</i>	<i>Assignment via</i>
ExBlo1-I	Module input state: External blocking1	[Protection Para /Global Prot Para /ExP /ExP[1]]
ExBlo2-I	Module input state: External blocking2	[Protection Para /Global Prot Para /ExP /ExP[1]]
ExBlo TripCmd-I	Module input state: External Blocking of the Trip Command	[Protection Para /Global Prot Para /ExP /ExP[1]]
Alarm-I	Module input state: Alarm	[Protection Para /Global Prot Para /ExP /ExP[1]]
Trip-I	Module input state: Trip	[Protection Para /Global Prot Para /ExP /ExP[1]]

## Module External Protection Signals (Output States)

<i>Signal</i>	<i>Description</i>
active	Signal: active
ExBlo	Signal: External Blocking
Blo TripCmd	Signal: Trip Command blocked
ExBlo TripCmd	Signal: External Blocking of the Trip Command
Alarm	Signal: Alarm
Trip	Signal: Trip
TripCmd	Signal: Trip Command

## Commissioning: External Protection

### *Object to be tested*

Test of the module External Protection

### *Necessary means*

- Depending on the application

### *Procedure*

Simulate the functionality of the External Protection (Alarm, Trip, Blockings...) by (de-)energizing of the digital inputs.

### *Successful test result*

All external alarms, external trips and external blockings are correctly recognized and processed by the device.

# Supervision

## CBF- Circuit Breaker Failure

Available elements:

CBF

### Principle – General Use

The breaker failure (BF) protection is used to provide backup protection in the event that a breaker fails to operate properly during fault clearing. A breaker failure condition is recognized if current is still flowing through the breaker after tripping or opening breaker commands have been issued for a specified time. The User can select different trigger modes. In addition, up to three additional trigger events can be assigned from all the protection modules.

### Trigger Modes

There are three trigger modes for the breaker failure available. In addition, there are three assignable trigger inputs available.

- *All Trips*: All trip signals that are assigned to this breaker (within the trip manager) will start the BF module.
- *Current Trips*: All current trips that are assigned to this breaker (within the trip manager) will start the BF module.
- *External Trips*: All external trips that are assigned to this breaker (within the trip manager) will start the BF module.
- In addition, the User can also select *none* (e.g.: if the User intends to use one of the three additional assignable trigger inputs).

#### **NOTICE**

Those trips can exclusively start the breaker failures that are assigned within the trip manager to the breaker that is to be supervised.

#### **NOTICE**

Select the winding side from which the measured currents should be taken in case this protective device is a transformer differential protection.

#### **NOTICE**

This Notice applies to protective devices that offer control functionality only! This protective element requires, that a switchgear (circuit breaker) is assigned to it. It is allowed only to assign switchgears (circuit breaker) to this protective element, whose measuring transformers provide measuring data to the protective device.

### Breaker Failure Lockout

The signal of the Circuit Breaker Failure is latched. This signal can be used within the interlockings of the circuit breaker.



**CBF**

name = CBF

Please Refer To Diagram: Blockings  
(Stage is not deactivated and no active blocking signals)

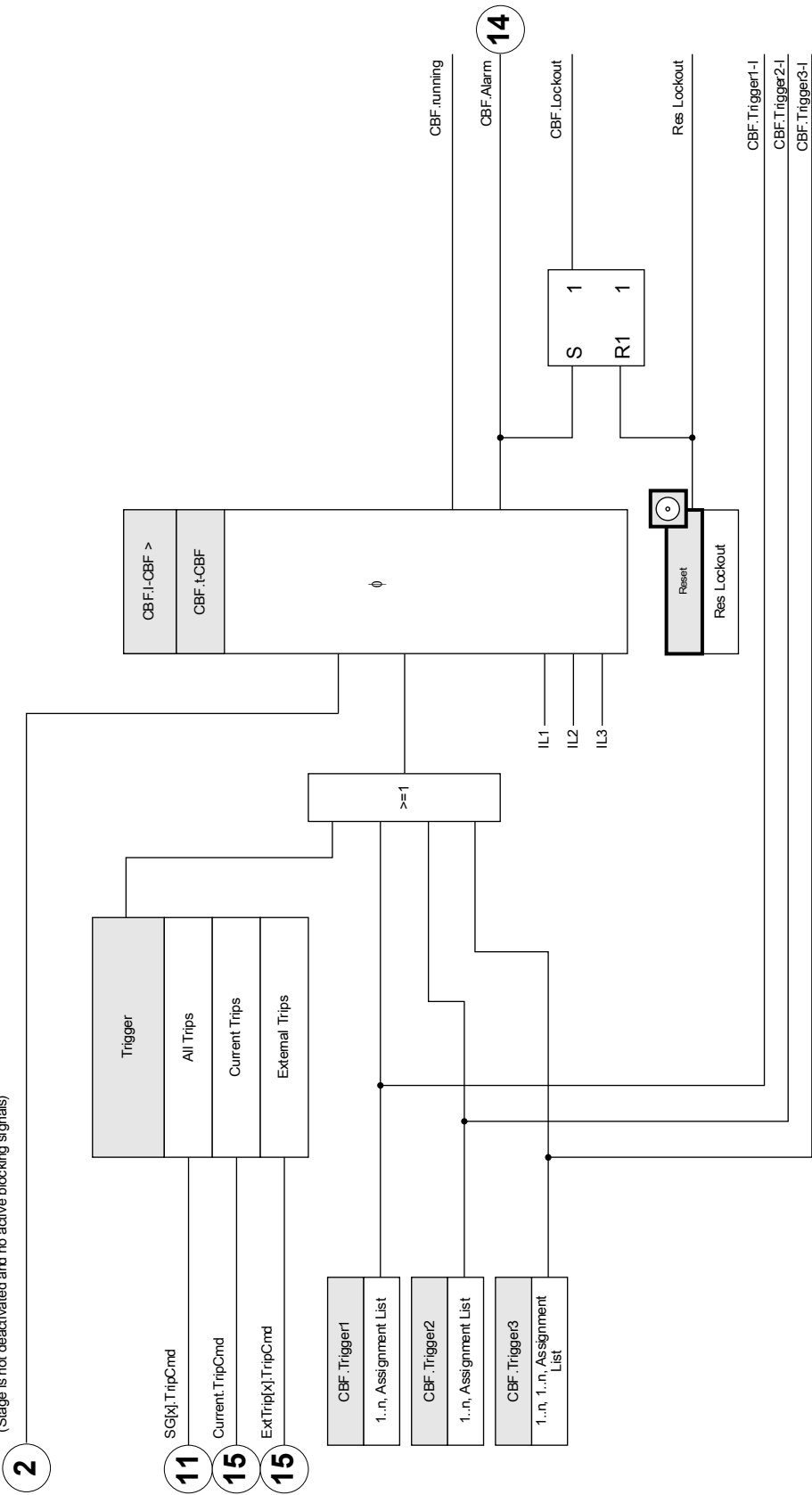

### *Explanation:*

By triggering the CBF element, a delay timer will be started. Once the timer is started, it won't be stopped if the trigger falls back.

The timer will be stopped, if the current magnitudes fall below the set threshold. The CBF function is now in the rejected mode until the trigger falls back.

Once the delay timer has expired and if the current magnitudes of any of the three phase currents still exceed the set threshold, the Circuit Breaker Failure signal will be issued (becomes active).

This signal will remain active as long as the current magnitudes exceed the set threshold. This signal will become inactive (falls back) as soon as all current magnitudes fall below the set threshold, e.g. if the upstream protective device has interrupted the current (OFF command to the upstream breaker) by processing the CBF signal of the downstream breaker.

Once a Breaker Failure is detected, the Breaker Failure signal will set a Lockout Signal. The Lockout Signal is a persistent alarm and has to be acknowledged manually at the HMI.

### Device Planning Parameters of the CBF

Parameter	Description	Options	Default	Menu path
Mode 	Mode	do not use, use	do not use	[Device planning]

### Global Protection Parameters of the CBF

Parameter	Description	Setting range	Default	Menu path
CB 	Selection of the Circuit Breaker to be monitored.	-. , SG[1]. , SG[2]. , SG[3]. , SG[4]. , SG[5]. , SG[6].	SG[1].	[Protection Para /Global Prot Para /Supervision /CBF]
ExBlo1 	External blocking of the module, if blocking is activated (allowed) within a parameter set and if the state of the assigned signal is true.	1..n, Assignment List	-. -	[Protection Para /Global Prot Para /Supervision /CBF]
ExBlo2 	External blocking of the module, if blocking is activated (allowed) within a parameter set and if the state of the assigned signal is true.	1..n, Assignment List	-. -	[Protection Para /Global Prot Para /Supervision /CBF]
Trigger 	Determining the trigger mode for the Breaker Failure.	-. , All Trips, Current Trips, External Trips	-. -	[Protection Para /Global Prot Para /Supervision /CBF]
Trigger1 	Trigger that will start the CBF	Trigger	-. -	[Protection Para /Global Prot Para /Supervision /CBF]
Trigger2 	Trigger that will start the CBF	Trigger	-. -	[Protection Para /Global Prot Para /Supervision /CBF]

## Supervision

---

<i>Parameter</i>	<i>Description</i>	<i>Setting range</i>	<i>Default</i>	<i>Menu path</i>
Trigger3 	Trigger that will start the CBF	Trigger	.-	[Protection Para /Global Prot Para /Supervision /CBF]

## Direct Commands of the CBF





<i>Parameter</i>	<i>Description</i>	<i>Setting range</i>	<i>Default</i>	<i>Menu path</i>
Res Lockout 	Reset Lockout	inactive, active	inactive	[Operation /Reset]

## Setting Group Parameters of the CBF

### NOTICE

In order to prevent a faulty activation of the BF Module, the pickup (alarm) time must be greater than the sum of:

- The close-open time of the breaker (please refer to the technical data of the manufacturer of the breaker);
- + The tripping delay of the device (please refer to the Technical Data section);
- + The security margin; and
- + The operating time.

Parameter	Description	Setting range	Default	Menu path
Function 	Permanent activation or deactivation of module/stage.	inactive, active	inactive	[Protection Para /<1..4> /Supervision /CBF]
ExBlo Fc 	Activate (allow) or inactivate (disallow) blocking of the module/stage. This parameter is only effective if a signal is assigned to the corresponding global protection parameter. If the signal becomes true, those modules/stages are blocked that are parameterized "ExBlo Fc=active".	inactive, active	inactive	[Protection Para /<1..4> /Supervision /CBF]
I-CBF > 	Current level that needs to exist after Trip Command has been given.	0.02 - 0.10In	0.02In	[Protection Para /<1..4> /Supervision /CBF]
t-CBF 	If the delay time is expired, an CBF alarm is given out.	0.00 - 10.00s	0.20s	[Protection Para /<1..4> /Supervision /CBF]

## CBF Input States

<i>Name</i>	<i>Description</i>	<i>Assignment via</i>
ExBlo1-I	Module input state: External blocking1	[Protection Para /Global Prot Para /Supervision /CBF]
ExBlo2-I	Module input state: External blocking2	[Protection Para /Global Prot Para /Supervision /CBF]
Trigger1	Module Input: Trigger that will start the CBF	[Protection Para /Global Prot Para /Supervision /CBF]
Trigger2	Module Input: Trigger that will start the CBF	[Protection Para /Global Prot Para /Supervision /CBF]
Trigger3	Module Input: Trigger that will start the CBF	[Protection Para /Global Prot Para /Supervision /CBF]

## CBF Signals (Output States)

<i>Signal</i>	<i>Description</i>
active	Signal: active
ExBlo	Signal: External Blocking
running	Signal: CBF-Module started
Alarm	Signal: Circuit Breaker Failure
Lockout	Signal: Lockout
Res Lockout	Signal: Reset Lockout

## CBF Trigger (Current Trips) Functions

*These trips will start the BF module if all trips have been selected as the trigger event.*

<i>Name</i>	<i>Description</i>
--	No assignment
I[1].TripCmd	Signal: Trip Command
I[2].TripCmd	Signal: Trip Command
I[3].TripCmd	Signal: Trip Command
I[4].TripCmd	Signal: Trip Command
I[5].TripCmd	Signal: Trip Command
I[6].TripCmd	Signal: Trip Command
IG[1].TripCmd	Signal: Trip Command
IG[2].TripCmd	Signal: Trip Command
IG[3].TripCmd	Signal: Trip Command
IG[4].TripCmd	Signal: Trip Command
ThR.TripCmd	Signal: Trip Command
I2>[1].TripCmd	Signal: Trip Command
I2>[2].TripCmd	Signal: Trip Command
V[1].TripCmd	Signal: Trip Command
V[2].TripCmd	Signal: Trip Command
V[3].TripCmd	Signal: Trip Command
V[4].TripCmd	Signal: Trip Command
V[5].TripCmd	Signal: Trip Command
V[6].TripCmd	Signal: Trip Command
df/dt.TripCmd	Signal: Trip Command
delta phi.TripCmd	Signal: Trip Command
Intertripping.TripCmd	Signal: Trip Command
P.TripCmd	Signal: Trip Command
Q.TripCmd	Signal: Trip Command
LVRT.TripCmd	Signal: Trip Command
VG[1].TripCmd	Signal: Trip Command
VG[2].TripCmd	Signal: Trip Command
V012[1].TripCmd	Signal: Trip Command
V012[2].TripCmd	Signal: Trip Command
V012[3].TripCmd	Signal: Trip Command
V012[4].TripCmd	Signal: Trip Command
V012[5].TripCmd	Signal: Trip Command
V012[6].TripCmd	Signal: Trip Command
f[1].TripCmd	Signal: Trip Command
f[2].TripCmd	Signal: Trip Command

<i>Name</i>	<i>Description</i>
f[3].TripCmd	Signal: Trip Command
f[4].TripCmd	Signal: Trip Command
f[5].TripCmd	Signal: Trip Command
f[6].TripCmd	Signal: Trip Command
PQS[1].TripCmd	Signal: Trip Command
PQS[2].TripCmd	Signal: Trip Command
PQS[3].TripCmd	Signal: Trip Command
PQS[4].TripCmd	Signal: Trip Command
PQS[5].TripCmd	Signal: Trip Command
PQS[6].TripCmd	Signal: Trip Command
PF[1].TripCmd	Signal: Trip Command
PF[2].TripCmd	Signal: Trip Command
ExP[1].TripCmd	Signal: Trip Command
ExP[2].TripCmd	Signal: Trip Command
ExP[3].TripCmd	Signal: Trip Command
ExP[4].TripCmd	Signal: Trip Command
DI Slot X1.DI 1	Signal: Digital Input
DI Slot X1.DI 2	Signal: Digital Input
DI Slot X1.DI 3	Signal: Digital Input
DI Slot X1.DI 4	Signal: Digital Input
DI Slot X1.DI 5	Signal: Digital Input
DI Slot X1.DI 6	Signal: Digital Input
DI Slot X1.DI 7	Signal: Digital Input
DI Slot X1.DI 8	Signal: Digital Input
DI Slot X6.DI 1	Signal: Digital Input
DI Slot X6.DI 2	Signal: Digital Input
DI Slot X6.DI 3	Signal: Digital Input
DI Slot X6.DI 4	Signal: Digital Input
DI Slot X6.DI 5	Signal: Digital Input
DI Slot X6.DI 6	Signal: Digital Input
DI Slot X6.DI 7	Signal: Digital Input
DI Slot X6.DI 8	Signal: Digital Input
Logics.LE1.Gate Out	Signal: Output of the logic gate
Logics.LE1.Timer Out	Signal: Timer Output
Logics.LE1.Out	Signal: Latched Output (Q)
Logics.LE1.Out inverted	Signal: Negated Latched Output (Q NOT)
Logics.LE2.Gate Out	Signal: Output of the logic gate
Logics.LE2.Timer Out	Signal: Timer Output
Logics.LE2.Out	Signal: Latched Output (Q)
Logics.LE2.Out inverted	Signal: Negated Latched Output (Q NOT)



<i>Name</i>	<i>Description</i>
Logics.LE3.Gate Out	Signal: Output of the logic gate
Logics.LE3.Timer Out	Signal: Timer Output
Logics.LE3.Out	Signal: Latched Output (Q)
Logics.LE3.Out inverted	Signal: Negated Latched Output (Q NOT)
Logics.LE4.Gate Out	Signal: Output of the logic gate
Logics.LE4.Timer Out	Signal: Timer Output
Logics.LE4.Out	Signal: Latched Output (Q)
Logics.LE4.Out inverted	Signal: Negated Latched Output (Q NOT)
Logics.LE5.Gate Out	Signal: Output of the logic gate
Logics.LE5.Timer Out	Signal: Timer Output
Logics.LE5.Out	Signal: Latched Output (Q)
Logics.LE5.Out inverted	Signal: Negated Latched Output (Q NOT)
Logics.LE6.Gate Out	Signal: Output of the logic gate
Logics.LE6.Timer Out	Signal: Timer Output
Logics.LE6.Out	Signal: Latched Output (Q)
Logics.LE6.Out inverted	Signal: Negated Latched Output (Q NOT)
Logics.LE7.Gate Out	Signal: Output of the logic gate
Logics.LE7.Timer Out	Signal: Timer Output
Logics.LE7.Out	Signal: Latched Output (Q)
Logics.LE7.Out inverted	Signal: Negated Latched Output (Q NOT)
Logics.LE8.Gate Out	Signal: Output of the logic gate
Logics.LE8.Timer Out	Signal: Timer Output
Logics.LE8.Out	Signal: Latched Output (Q)
Logics.LE8.Out inverted	Signal: Negated Latched Output (Q NOT)
Logics.LE9.Gate Out	Signal: Output of the logic gate
Logics.LE9.Timer Out	Signal: Timer Output
Logics.LE9.Out	Signal: Latched Output (Q)
Logics.LE9.Out inverted	Signal: Negated Latched Output (Q NOT)
Logics.LE10.Gate Out	Signal: Output of the logic gate
Logics.LE10.Timer Out	Signal: Timer Output
Logics.LE10.Out	Signal: Latched Output (Q)
Logics.LE10.Out inverted	Signal: Negated Latched Output (Q NOT)
Logics.LE11.Gate Out	Signal: Output of the logic gate
Logics.LE11.Timer Out	Signal: Timer Output
Logics.LE11.Out	Signal: Latched Output (Q)
Logics.LE11.Out inverted	Signal: Negated Latched Output (Q NOT)
Logics.LE12.Gate Out	Signal: Output of the logic gate
Logics.LE12.Timer Out	Signal: Timer Output
Logics.LE12.Out	Signal: Latched Output (Q)
Logics.LE12.Out inverted	Signal: Negated Latched Output (Q NOT)

<i>Name</i>	<i>Description</i>
Logics.LE13.Gate Out	Signal: Output of the logic gate
Logics.LE13.Timer Out	Signal: Timer Output
Logics.LE13.Out	Signal: Latched Output (Q)
Logics.LE13.Out inverted	Signal: Negated Latched Output (Q NOT)
Logics.LE14.Gate Out	Signal: Output of the logic gate
Logics.LE14.Timer Out	Signal: Timer Output
Logics.LE14.Out	Signal: Latched Output (Q)
Logics.LE14.Out inverted	Signal: Negated Latched Output (Q NOT)
Logics.LE15.Gate Out	Signal: Output of the logic gate
Logics.LE15.Timer Out	Signal: Timer Output
Logics.LE15.Out	Signal: Latched Output (Q)
Logics.LE15.Out inverted	Signal: Negated Latched Output (Q NOT)
Logics.LE16.Gate Out	Signal: Output of the logic gate
Logics.LE16.Timer Out	Signal: Timer Output
Logics.LE16.Out	Signal: Latched Output (Q)
Logics.LE16.Out inverted	Signal: Negated Latched Output (Q NOT)
Logics.LE17.Gate Out	Signal: Output of the logic gate
Logics.LE17.Timer Out	Signal: Timer Output
Logics.LE17.Out	Signal: Latched Output (Q)
Logics.LE17.Out inverted	Signal: Negated Latched Output (Q NOT)
Logics.LE18.Gate Out	Signal: Output of the logic gate
Logics.LE18.Timer Out	Signal: Timer Output
Logics.LE18.Out	Signal: Latched Output (Q)
Logics.LE18.Out inverted	Signal: Negated Latched Output (Q NOT)
Logics.LE19.Gate Out	Signal: Output of the logic gate
Logics.LE19.Timer Out	Signal: Timer Output
Logics.LE19.Out	Signal: Latched Output (Q)
Logics.LE19.Out inverted	Signal: Negated Latched Output (Q NOT)
Logics.LE20.Gate Out	Signal: Output of the logic gate
Logics.LE20.Timer Out	Signal: Timer Output
Logics.LE20.Out	Signal: Latched Output (Q)
Logics.LE20.Out inverted	Signal: Negated Latched Output (Q NOT)
Logics.LE21.Gate Out	Signal: Output of the logic gate
Logics.LE21.Timer Out	Signal: Timer Output
Logics.LE21.Out	Signal: Latched Output (Q)
Logics.LE21.Out inverted	Signal: Negated Latched Output (Q NOT)
Logics.LE22.Gate Out	Signal: Output of the logic gate
Logics.LE22.Timer Out	Signal: Timer Output
Logics.LE22.Out	Signal: Latched Output (Q)
Logics.LE22.Out inverted	Signal: Negated Latched Output (Q NOT)

<i>Name</i>	<i>Description</i>
Logics.LE23.Gate Out	Signal: Output of the logic gate
Logics.LE23.Timer Out	Signal: Timer Output
Logics.LE23.Out	Signal: Latched Output (Q)
Logics.LE23.Out inverted	Signal: Negated Latched Output (Q NOT)
Logics.LE24.Gate Out	Signal: Output of the logic gate
Logics.LE24.Timer Out	Signal: Timer Output
Logics.LE24.Out	Signal: Latched Output (Q)
Logics.LE24.Out inverted	Signal: Negated Latched Output (Q NOT)
Logics.LE25.Gate Out	Signal: Output of the logic gate
Logics.LE25.Timer Out	Signal: Timer Output
Logics.LE25.Out	Signal: Latched Output (Q)
Logics.LE25.Out inverted	Signal: Negated Latched Output (Q NOT)
Logics.LE26.Gate Out	Signal: Output of the logic gate
Logics.LE26.Timer Out	Signal: Timer Output
Logics.LE26.Out	Signal: Latched Output (Q)
Logics.LE26.Out inverted	Signal: Negated Latched Output (Q NOT)
Logics.LE27.Gate Out	Signal: Output of the logic gate
Logics.LE27.Timer Out	Signal: Timer Output
Logics.LE27.Out	Signal: Latched Output (Q)
Logics.LE27.Out inverted	Signal: Negated Latched Output (Q NOT)
Logics.LE28.Gate Out	Signal: Output of the logic gate
Logics.LE28.Timer Out	Signal: Timer Output
Logics.LE28.Out	Signal: Latched Output (Q)
Logics.LE28.Out inverted	Signal: Negated Latched Output (Q NOT)
Logics.LE29.Gate Out	Signal: Output of the logic gate
Logics.LE29.Timer Out	Signal: Timer Output
Logics.LE29.Out	Signal: Latched Output (Q)
Logics.LE29.Out inverted	Signal: Negated Latched Output (Q NOT)
Logics.LE30.Gate Out	Signal: Output of the logic gate
Logics.LE30.Timer Out	Signal: Timer Output
Logics.LE30.Out	Signal: Latched Output (Q)
Logics.LE30.Out inverted	Signal: Negated Latched Output (Q NOT)
Logics.LE31.Gate Out	Signal: Output of the logic gate
Logics.LE31.Timer Out	Signal: Timer Output
Logics.LE31.Out	Signal: Latched Output (Q)
Logics.LE31.Out inverted	Signal: Negated Latched Output (Q NOT)
Logics.LE32.Gate Out	Signal: Output of the logic gate
Logics.LE32.Timer Out	Signal: Timer Output
Logics.LE32.Out	Signal: Latched Output (Q)
Logics.LE32.Out inverted	Signal: Negated Latched Output (Q NOT)

## Supervision

<i>Name</i>	<i>Description</i>
Logics.LE33.Gate Out	Signal: Output of the logic gate
Logics.LE33.Timer Out	Signal: Timer Output
Logics.LE33.Out	Signal: Latched Output (Q)
Logics.LE33.Out inverted	Signal: Negated Latched Output (Q NOT)
Logics.LE34.Gate Out	Signal: Output of the logic gate
Logics.LE34.Timer Out	Signal: Timer Output
Logics.LE34.Out	Signal: Latched Output (Q)
Logics.LE34.Out inverted	Signal: Negated Latched Output (Q NOT)
Logics.LE35.Gate Out	Signal: Output of the logic gate
Logics.LE35.Timer Out	Signal: Timer Output
Logics.LE35.Out	Signal: Latched Output (Q)
Logics.LE35.Out inverted	Signal: Negated Latched Output (Q NOT)
Logics.LE36.Gate Out	Signal: Output of the logic gate
Logics.LE36.Timer Out	Signal: Timer Output
Logics.LE36.Out	Signal: Latched Output (Q)
Logics.LE36.Out inverted	Signal: Negated Latched Output (Q NOT)
Logics.LE37.Gate Out	Signal: Output of the logic gate
Logics.LE37.Timer Out	Signal: Timer Output
Logics.LE37.Out	Signal: Latched Output (Q)
Logics.LE37.Out inverted	Signal: Negated Latched Output (Q NOT)
Logics.LE38.Gate Out	Signal: Output of the logic gate
Logics.LE38.Timer Out	Signal: Timer Output
Logics.LE38.Out	Signal: Latched Output (Q)
Logics.LE38.Out inverted	Signal: Negated Latched Output (Q NOT)
Logics.LE39.Gate Out	Signal: Output of the logic gate
Logics.LE39.Timer Out	Signal: Timer Output
Logics.LE39.Out	Signal: Latched Output (Q)
Logics.LE39.Out inverted	Signal: Negated Latched Output (Q NOT)
Logics.LE40.Gate Out	Signal: Output of the logic gate
Logics.LE40.Timer Out	Signal: Timer Output
Logics.LE40.Out	Signal: Latched Output (Q)
Logics.LE40.Out inverted	Signal: Negated Latched Output (Q NOT)
Logics.LE41.Gate Out	Signal: Output of the logic gate
Logics.LE41.Timer Out	Signal: Timer Output
Logics.LE41.Out	Signal: Latched Output (Q)
Logics.LE41.Out inverted	Signal: Negated Latched Output (Q NOT)
Logics.LE42.Gate Out	Signal: Output of the logic gate
Logics.LE42.Timer Out	Signal: Timer Output
Logics.LE42.Out	Signal: Latched Output (Q)
Logics.LE42.Out inverted	Signal: Negated Latched Output (Q NOT)

<i>Name</i>	<i>Description</i>
Logics.LE43.Gate Out	Signal: Output of the logic gate
Logics.LE43.Timer Out	Signal: Timer Output
Logics.LE43.Out	Signal: Latched Output (Q)
Logics.LE43.Out inverted	Signal: Negated Latched Output (Q NOT)
Logics.LE44.Gate Out	Signal: Output of the logic gate
Logics.LE44.Timer Out	Signal: Timer Output
Logics.LE44.Out	Signal: Latched Output (Q)
Logics.LE44.Out inverted	Signal: Negated Latched Output (Q NOT)
Logics.LE45.Gate Out	Signal: Output of the logic gate
Logics.LE45.Timer Out	Signal: Timer Output
Logics.LE45.Out	Signal: Latched Output (Q)
Logics.LE45.Out inverted	Signal: Negated Latched Output (Q NOT)
Logics.LE46.Gate Out	Signal: Output of the logic gate
Logics.LE46.Timer Out	Signal: Timer Output
Logics.LE46.Out	Signal: Latched Output (Q)
Logics.LE46.Out inverted	Signal: Negated Latched Output (Q NOT)
Logics.LE47.Gate Out	Signal: Output of the logic gate
Logics.LE47.Timer Out	Signal: Timer Output
Logics.LE47.Out	Signal: Latched Output (Q)
Logics.LE47.Out inverted	Signal: Negated Latched Output (Q NOT)
Logics.LE48.Gate Out	Signal: Output of the logic gate
Logics.LE48.Timer Out	Signal: Timer Output
Logics.LE48.Out	Signal: Latched Output (Q)
Logics.LE48.Out inverted	Signal: Negated Latched Output (Q NOT)
Logics.LE49.Gate Out	Signal: Output of the logic gate
Logics.LE49.Timer Out	Signal: Timer Output
Logics.LE49.Out	Signal: Latched Output (Q)
Logics.LE49.Out inverted	Signal: Negated Latched Output (Q NOT)
Logics.LE50.Gate Out	Signal: Output of the logic gate
Logics.LE50.Timer Out	Signal: Timer Output
Logics.LE50.Out	Signal: Latched Output (Q)
Logics.LE50.Out inverted	Signal: Negated Latched Output (Q NOT)
Logics.LE51.Gate Out	Signal: Output of the logic gate
Logics.LE51.Timer Out	Signal: Timer Output
Logics.LE51.Out	Signal: Latched Output (Q)
Logics.LE51.Out inverted	Signal: Negated Latched Output (Q NOT)
Logics.LE52.Gate Out	Signal: Output of the logic gate
Logics.LE52.Timer Out	Signal: Timer Output
Logics.LE52.Out	Signal: Latched Output (Q)
Logics.LE52.Out inverted	Signal: Negated Latched Output (Q NOT)

<i>Name</i>	<i>Description</i>
Logics.LE53.Gate Out	Signal: Output of the logic gate
Logics.LE53.Timer Out	Signal: Timer Output
Logics.LE53.Out	Signal: Latched Output (Q)
Logics.LE53.Out inverted	Signal: Negated Latched Output (Q NOT)
Logics.LE54.Gate Out	Signal: Output of the logic gate
Logics.LE54.Timer Out	Signal: Timer Output
Logics.LE54.Out	Signal: Latched Output (Q)
Logics.LE54.Out inverted	Signal: Negated Latched Output (Q NOT)
Logics.LE55.Gate Out	Signal: Output of the logic gate
Logics.LE55.Timer Out	Signal: Timer Output
Logics.LE55.Out	Signal: Latched Output (Q)
Logics.LE55.Out inverted	Signal: Negated Latched Output (Q NOT)
Logics.LE56.Gate Out	Signal: Output of the logic gate
Logics.LE56.Timer Out	Signal: Timer Output
Logics.LE56.Out	Signal: Latched Output (Q)
Logics.LE56.Out inverted	Signal: Negated Latched Output (Q NOT)
Logics.LE57.Gate Out	Signal: Output of the logic gate
Logics.LE57.Timer Out	Signal: Timer Output
Logics.LE57.Out	Signal: Latched Output (Q)
Logics.LE57.Out inverted	Signal: Negated Latched Output (Q NOT)
Logics.LE58.Gate Out	Signal: Output of the logic gate
Logics.LE58.Timer Out	Signal: Timer Output
Logics.LE58.Out	Signal: Latched Output (Q)
Logics.LE58.Out inverted	Signal: Negated Latched Output (Q NOT)
Logics.LE59.Gate Out	Signal: Output of the logic gate
Logics.LE59.Timer Out	Signal: Timer Output
Logics.LE59.Out	Signal: Latched Output (Q)
Logics.LE59.Out inverted	Signal: Negated Latched Output (Q NOT)
Logics.LE60.Gate Out	Signal: Output of the logic gate
Logics.LE60.Timer Out	Signal: Timer Output
Logics.LE60.Out	Signal: Latched Output (Q)
Logics.LE60.Out inverted	Signal: Negated Latched Output (Q NOT)
Logics.LE61.Gate Out	Signal: Output of the logic gate
Logics.LE61.Timer Out	Signal: Timer Output
Logics.LE61.Out	Signal: Latched Output (Q)
Logics.LE61.Out inverted	Signal: Negated Latched Output (Q NOT)
Logics.LE62.Gate Out	Signal: Output of the logic gate
Logics.LE62.Timer Out	Signal: Timer Output
Logics.LE62.Out	Signal: Latched Output (Q)
Logics.LE62.Out inverted	Signal: Negated Latched Output (Q NOT)

<i>Name</i>	<i>Description</i>
Logics.LE63.Gate Out	Signal: Output of the logic gate
Logics.LE63.Timer Out	Signal: Timer Output
Logics.LE63.Out	Signal: Latched Output (Q)
Logics.LE63.Out inverted	Signal: Negated Latched Output (Q NOT)
Logics.LE64.Gate Out	Signal: Output of the logic gate
Logics.LE64.Timer Out	Signal: Timer Output
Logics.LE64.Out	Signal: Latched Output (Q)
Logics.LE64.Out inverted	Signal: Negated Latched Output (Q NOT)
Logics.LE65.Gate Out	Signal: Output of the logic gate
Logics.LE65.Timer Out	Signal: Timer Output
Logics.LE65.Out	Signal: Latched Output (Q)
Logics.LE65.Out inverted	Signal: Negated Latched Output (Q NOT)
Logics.LE66.Gate Out	Signal: Output of the logic gate
Logics.LE66.Timer Out	Signal: Timer Output
Logics.LE66.Out	Signal: Latched Output (Q)
Logics.LE66.Out inverted	Signal: Negated Latched Output (Q NOT)
Logics.LE67.Gate Out	Signal: Output of the logic gate
Logics.LE67.Timer Out	Signal: Timer Output
Logics.LE67.Out	Signal: Latched Output (Q)
Logics.LE67.Out inverted	Signal: Negated Latched Output (Q NOT)
Logics.LE68.Gate Out	Signal: Output of the logic gate
Logics.LE68.Timer Out	Signal: Timer Output
Logics.LE68.Out	Signal: Latched Output (Q)
Logics.LE68.Out inverted	Signal: Negated Latched Output (Q NOT)
Logics.LE69.Gate Out	Signal: Output of the logic gate
Logics.LE69.Timer Out	Signal: Timer Output
Logics.LE69.Out	Signal: Latched Output (Q)
Logics.LE69.Out inverted	Signal: Negated Latched Output (Q NOT)
Logics.LE70.Gate Out	Signal: Output of the logic gate
Logics.LE70.Timer Out	Signal: Timer Output
Logics.LE70.Out	Signal: Latched Output (Q)
Logics.LE70.Out inverted	Signal: Negated Latched Output (Q NOT)
Logics.LE71.Gate Out	Signal: Output of the logic gate
Logics.LE71.Timer Out	Signal: Timer Output
Logics.LE71.Out	Signal: Latched Output (Q)
Logics.LE71.Out inverted	Signal: Negated Latched Output (Q NOT)
Logics.LE72.Gate Out	Signal: Output of the logic gate
Logics.LE72.Timer Out	Signal: Timer Output
Logics.LE72.Out	Signal: Latched Output (Q)
Logics.LE72.Out inverted	Signal: Negated Latched Output (Q NOT)

## Supervision

---

<i>Name</i>	<i>Description</i>
Logics.LE73.Gate Out	Signal: Output of the logic gate
Logics.LE73.Timer Out	Signal: Timer Output
Logics.LE73.Out	Signal: Latched Output (Q)
Logics.LE73.Out inverted	Signal: Negated Latched Output (Q NOT)
Logics.LE74.Gate Out	Signal: Output of the logic gate
Logics.LE74.Timer Out	Signal: Timer Output
Logics.LE74.Out	Signal: Latched Output (Q)
Logics.LE74.Out inverted	Signal: Negated Latched Output (Q NOT)
Logics.LE75.Gate Out	Signal: Output of the logic gate
Logics.LE75.Timer Out	Signal: Timer Output
Logics.LE75.Out	Signal: Latched Output (Q)
Logics.LE75.Out inverted	Signal: Negated Latched Output (Q NOT)
Logics.LE76.Gate Out	Signal: Output of the logic gate
Logics.LE76.Timer Out	Signal: Timer Output
Logics.LE76.Out	Signal: Latched Output (Q)
Logics.LE76.Out inverted	Signal: Negated Latched Output (Q NOT)
Logics.LE77.Gate Out	Signal: Output of the logic gate
Logics.LE77.Timer Out	Signal: Timer Output
Logics.LE77.Out	Signal: Latched Output (Q)
Logics.LE77.Out inverted	Signal: Negated Latched Output (Q NOT)
Logics.LE78.Gate Out	Signal: Output of the logic gate
Logics.LE78.Timer Out	Signal: Timer Output
Logics.LE78.Out	Signal: Latched Output (Q)
Logics.LE78.Out inverted	Signal: Negated Latched Output (Q NOT)
Logics.LE79.Gate Out	Signal: Output of the logic gate
Logics.LE79.Timer Out	Signal: Timer Output
Logics.LE79.Out	Signal: Latched Output (Q)
Logics.LE79.Out inverted	Signal: Negated Latched Output (Q NOT)
Logics.LE80.Gate Out	Signal: Output of the logic gate
Logics.LE80.Timer Out	Signal: Timer Output
Logics.LE80.Out	Signal: Latched Output (Q)
Logics.LE80.Out inverted	Signal: Negated Latched Output (Q NOT)



*These trips will start the BF module if all current functions have been selected as the trigger event.*

<i>Name</i>	<i>Description</i>
-.-	No assignment
I[1].TripCmd	Signal: Trip Command
I[2].TripCmd	Signal: Trip Command
I[3].TripCmd	Signal: Trip Command
I[4].TripCmd	Signal: Trip Command
I[5].TripCmd	Signal: Trip Command
I[6].TripCmd	Signal: Trip Command
IG[1].TripCmd	Signal: Trip Command
IG[2].TripCmd	Signal: Trip Command
IG[3].TripCmd	Signal: Trip Command
IG[4].TripCmd	Signal: Trip Command
ThR.TripCmd	Signal: Trip Command
I2>[1].TripCmd	Signal: Trip Command
I2>[2].TripCmd	Signal: Trip Command
Intertripping.TripCmd	Signal: Trip Command

*These trips will start the BF module if external trips have been selected as the trigger event.*

<i>Name</i>	<i>Description</i>
-.-	No assignment
Intertripping.TripCmd	Signal: Trip Command
ExP[1].TripCmd	Signal: Trip Command
ExP[2].TripCmd	Signal: Trip Command
ExP[3].TripCmd	Signal: Trip Command
ExP[4].TripCmd	Signal: Trip Command

## Commissioning: Circuit Breaker Failure Protection

### NOTICE

The time that is configured for the BF MUST NOT be below the breaker control time, otherwise an unwanted operation of the BF is caused by any protective trip.

#### *Object to Be Tested:*

Test of the breaker failure protection.

#### *Necessary Means:*

- Current source;
- Ammeter; and
- Timer.

### NOTICE

When testing, the applied test current must always be higher than the tripping threshold »*I-CBF*«. If the test current falls below the threshold while the breaker is in the "Off" position, no pickup will be generated.

#### *Procedure (Single-Phase):*

For testing the tripping time of the CBF protection, a test current has to be higher than the threshold value of one of the current protection modules that are assigned to trigger the CBF protection. The CBF trip delay can be measured from the time when one of the triggering inputs becomes active to the time when the CBF protection trip is asserted.

To avoid wiring errors, checked to make sure the breaker in the upstream system switches off.

The time, measured by the timer, should be in line with the specified tolerances.

### WARNING

Re-connect the control cable to the breaker!

#### *Successful Test Result:*

The actual times measured comply with the setpoint times. The breaker in the higher-level section switches off.

## TCS - Trip Circuit Supervision [74TC]

Available elements:

TCS

The trip circuit monitoring is used for monitoring if the trip circuit is ready for operations. The monitoring can be fulfilled in two ways. The first assumes only »Aux On (52a)« is used in the trip circuit. The second assumes that, in addition to »Aux On (52a)«, »Aux Off(52b)« is also used for the circuit monitoring.

With »Aux On (52a)«, only in the trip circuit, the monitoring is only effective when the breaker is closed while if both »Aux On (52a)«, and »Aux Off(52b)« are used, the trip circuit will be monitored all time as long as the control power is on.

Note that the digital inputs used for this purpose must be configured properly based on the trip circuit control voltage. If the trip circuit is detected broken, an alarm will be issued with a specified delay, which must be longer than the time when a trip contact is closed to the time when the breaker status is clearly recognized by the relay.

### **NOTICE**

In Slot 1 has 2 digital inputs, each of which has a separate root (contact separation) for the trip circuit supervision.

### **NOTICE**

This Notice applies to protective devices that offer control functionality only! This protective element requires, that a switchgear (circuit breaker is assigned to it.

In this case, the trip circuit supply voltage serves also as supply voltage for the digital inputs and so the supply voltage failure of a trip circuit can be detected directly.

In order to identify a conductor failure in the trip circuit on the supply line or in the trip coil, the off-coil has to be looped-in to the supervision circuit.

The time delay is to be set in a way that switching actions cannot cause false trips in this module.

Connection example: Trip circuit supervision with two CB auxiliary contacts.

TCS

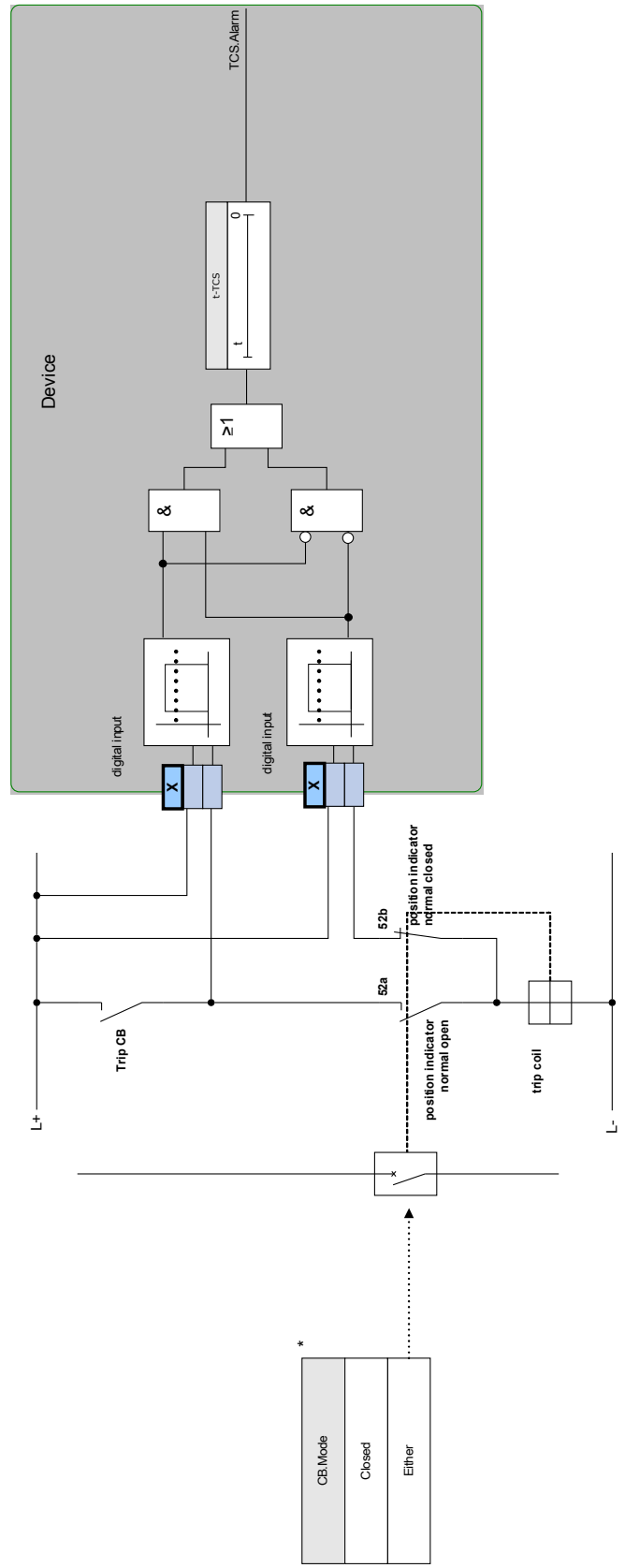

\*

CB.Mode
Closed
Either

\*This signal is the output of the switchgear that is assigned to this protective element. This applies to protective devices that offer control functionality.

TCS

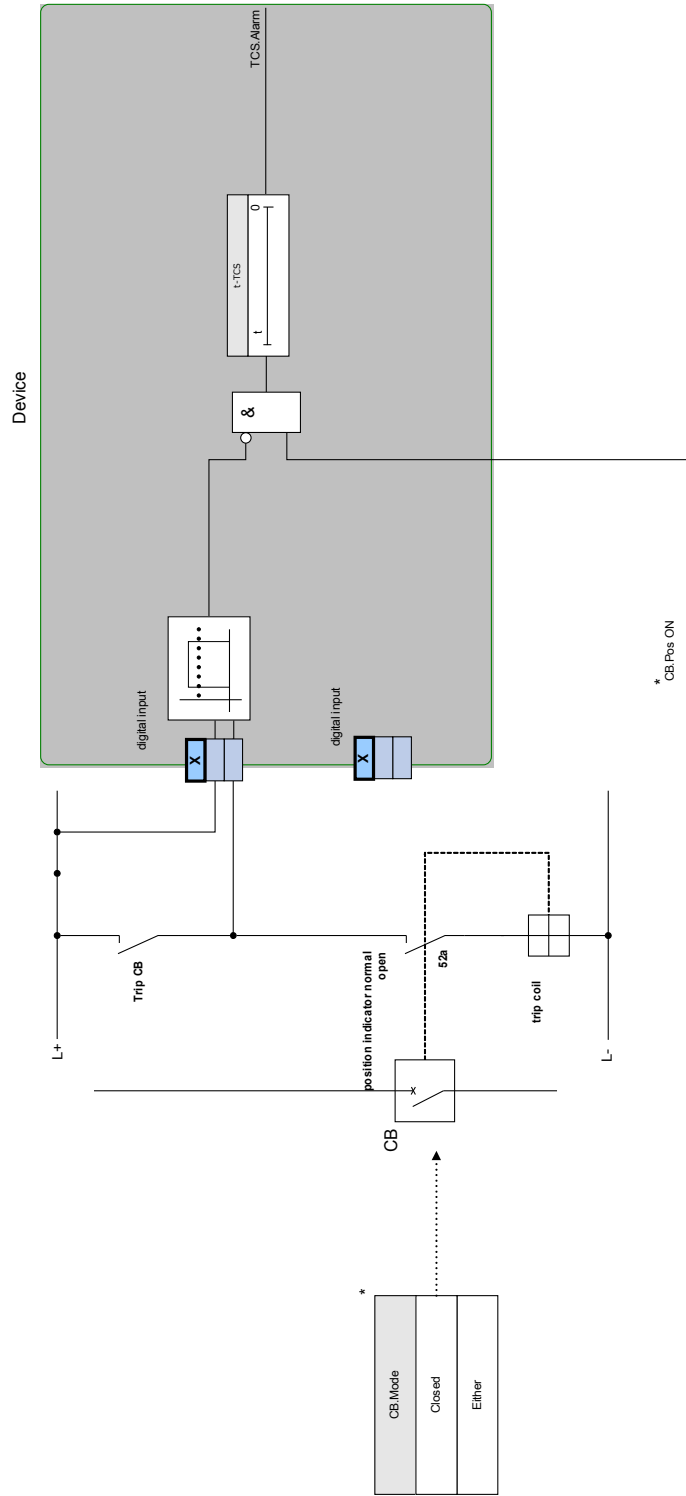

\*This signal is the output of the switchgear that is assigned to this protective element. This applies to protective devices that offer control functionality.

Connection example: Trip circuit supervision with one CB auxiliary contact (Aux On (52a)) only.

**Device Planning Parameters of the Trip Circuit Supervision**



<i>Parameter</i>	<i>Description</i>	<i>Options</i>	<i>Default</i>	<i>Menu path</i>
Mode 	Mode	do not use, use	do not use	[Device planning]

## Global Protection Parameters of the Trip Circuit Supervision

Parameter	Description	Setting range	Default	Menu path
CB Pos Detect 	Criterion by which the Circuit Breaker Switch Position is to be detected.	-.-, SG[1].Pos, SG[2].Pos, SG[3].Pos, SG[4].Pos, SG[5].Pos, SG[6].Pos	-.-	[Protection Para /Global Prot Para /Supervision /TCS]
Mode 	Select if trip circuit is going to be monitored when the breaker is closed or when the breaker is either open or close.	Closed, Either	Closed	[Protection Para /Global Prot Para /Supervision /TCS]
Input 1 	Select the input configured to monitor the trip coil when the breaker is closed.	1..n, Dig Inputs	-.-	[Protection Para /Global Prot Para /Supervision /TCS]
Input 2 	Select the input configured to monitor the trip coil when the breaker is open. Only available if Mode set to "Either".  Only available if: Mode = Either	1..n, Dig Inputs	-.-	[Protection Para /Global Prot Para /Supervision /TCS]
ExBlo1 	External blocking of the module, if blocking is activated (allowed) within a parameter set and if the state of the assigned signal is true.	1..n, Assignment List	-.-	[Protection Para /Global Prot Para /Supervision /TCS]
ExBlo2 	External blocking of the module, if blocking is activated (allowed) within a parameter set and if the state of the assigned signal is true.	1..n, Assignment List	-.-	[Protection Para /Global Prot Para /Supervision /TCS]



## Setting Group Parameters of the Trip Circuit Supervision

<i>Parameter</i>	<i>Description</i>	<i>Setting range</i>	<i>Default</i>	<i>Menu path</i>
Function 	Permanent activation or deactivation of module/stage.	inactive, active	inactive	[Protection Para /<1..4> /Supervision /TCS]
ExBlo Fc 	Activate (allow) or inactivate (disallow) blocking of the module/stage. This parameter is only effective if a signal is assigned to the corresponding global protection parameter. If the signal becomes true, those modules/stages are blocked that are parameterized "ExBlo Fc=active".	inactive, active	inactive	[Protection Para /<1..4> /Supervision /TCS]
t-TCS 	Tripping delay time of the Trip Circuit Supervision	0.10 - 10.00s	0.2s	[Protection Para /<1..4> /Supervision /TCS]

## Trip Circuit Supervision Input States

<i>Name</i>	<i>Description</i>	<i>Assignment via</i>
Aux ON-I	Module Input State: Position indicator/check-back signal of the CB (52a)	[Protection Para /Global Prot Para /Supervision /TCS]
Aux OFF-I	Module input state: Position indicator/check-back signal of the CB (52b)	[Protection Para /Global Prot Para /Supervision /TCS]
ExBlo1-I	Module input state: External blocking1	[Protection Para /Global Prot Para /Supervision /TCS]
ExBlo2-I	Module input state: External blocking2	[Protection Para /Global Prot Para /Supervision /TCS]
CB Pos Detect-I	Module input state: Criterion by which the Circuit Breaker Switch Position is to be detected.	[Protection Para /Global Prot Para /Supervision /TCS]

## Trip Circuit Supervision Signals (Output States)

<i>Signal</i>	<i>Description</i>
active	Signal: active
ExBlo	Signal: External Blocking
Alarm	Signal: Alarm Trip Circuit Supervision
Not Possible	Not possible because no state indicator assigned to the breaker.

## Commissioning: Trip Circuit Supervision [74TC]

### **NOTICE**

For CBs that trip by means of little energy (e.g. via an optocoupler), it has to be ensured that the current applied by the digital inputs will not cause false tripping of the CB.

#### *Object to be tested*

Test of the trip circuit supervision.

#### *Procedure, part 1*

Simulate failure of the control voltage in the power circuits.

#### *Successful test result, part 1*

After expiry of »*t-TCS*« the trip circuit supervision TCS of the device should signal an alarm.

#### *Procedure, part 2*

Simulate a broken cable in the CB control circuit.

#### *Successful test result, part 2*

After expiry of »*t-TCS*« the trip circuit supervision TCS of the device should signal an alarm.

## CTS - Current Transformer Supervision [60L]

Available elements:

CTS

Wire breaks and failures within measuring circuits cause current transformer failures.

The module »CTS« can detect a failure of the CT if the calculated earth current does not match the measured one. If an adjustable threshold value (Difference of measured and calculated earth current) is exceeded, a CT failure can be assumed. This is signaled through a message/alarm.

The precondition is that the conductor currents are measured by the device and the earth current, for instance, by a ring core type current transformer.

The measuring principles of the circuit supervision are based on comparing the measured and the calculated residual currents:

In an ideal case these are:

$$(\vec{I}L1 + \vec{I}L2 + \vec{I}L3) + KI * \vec{I}G = 3 * I_0 + KI * \vec{I}G = 0$$

KI represents a correction factor which takes the different transformation ratio of the phase- and earth current transformers into account. The device automatically calculates this factor from the rated field parameters, i.e. the relation between the rated primary and secondary current values of the phase- and earth current transformers.

For compensating the current proportional ratio error of the measuring circuits, the dynamic correction factor Kd can be used. As a function of the measured max. current this factor is considering the linear rising measuring error.

The limiting value of the CT supervision is calculated as follows:

$\Delta I$  = deviation I (rated value)

Kd = correction factor

I<sub>max</sub> = current maximum

Limiting value =  $\Delta I + Kd \times I_{max}$

Precondition for identifying an error

$$3 * \vec{I}_0 + KI * \vec{I}G \geq \Delta I + Kd * I_{max}$$

The evaluation method of the circuit supervision by using factor Kd can be graphically represented as follows:

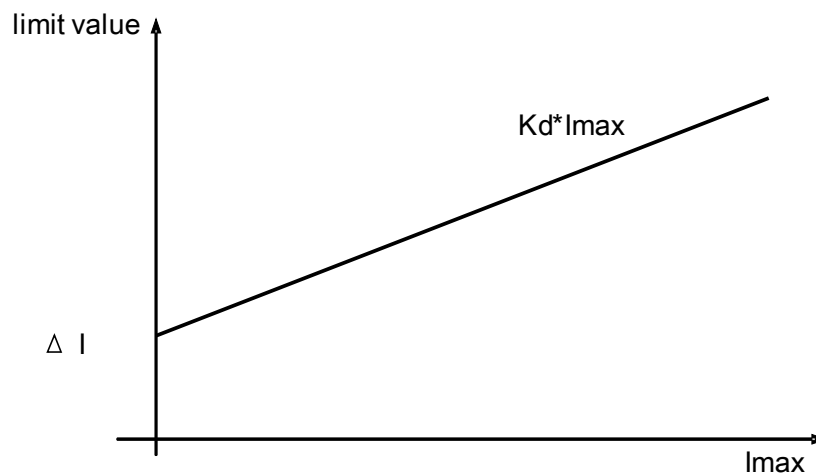

**CAUTION**

If the current is measured in two phases only (for instant only IL1/IL3) or if there is no separate earth current measuring (e.g. normally via a cable-type CT), the supervision function should be deactivated.

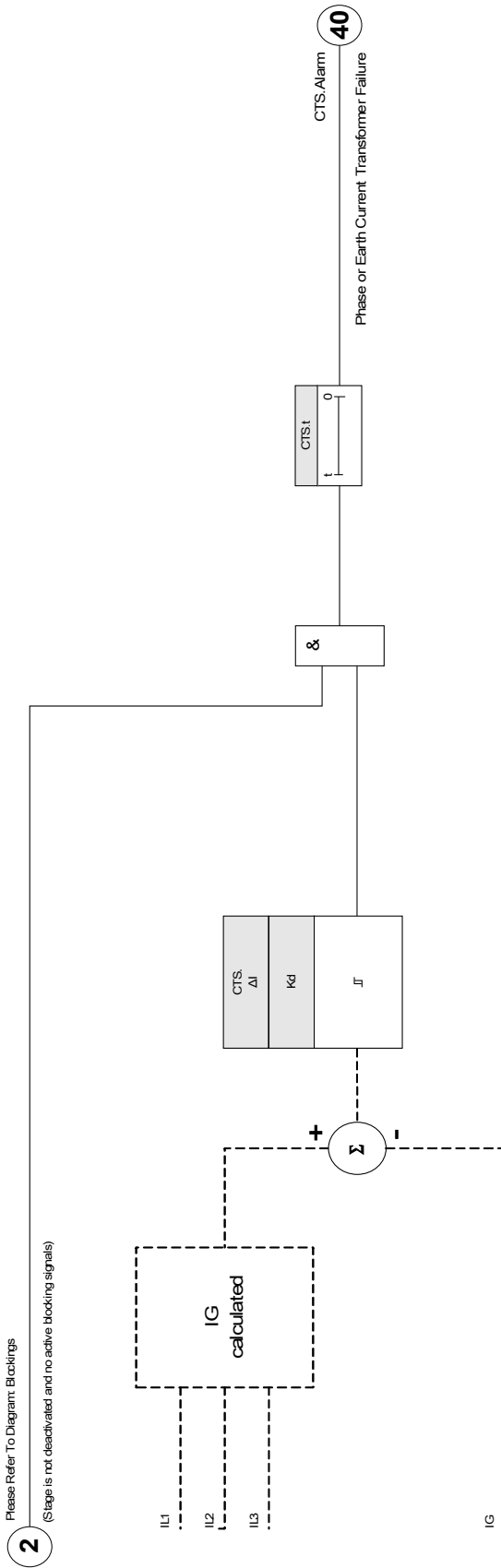

CTS







## Device Planning Parameters of the Current Transformer Supervision

<i>Parameter</i>	<i>Description</i>	<i>Options</i>	<i>Default</i>	<i>Menu path</i>
Mode 	Mode	do not use, use	do not use	[Device planning]

## Global Protection Parameter of the Current Transformer Supervision

<i>Parameter</i>	<i>Description</i>	<i>Setting range</i>	<i>Default</i>	<i>Menu path</i>
ExBlo1 	External blocking of the module, if blocking is activated (allowed) within a parameter set and if the state of the assigned signal is true.	1..n, Assignment List	-.-	[Protection Para /Global Prot Para /Supervision /CTS]
ExBlo2 	External blocking of the module, if blocking is activated (allowed) within a parameter set and if the state of the assigned signal is true.	1..n, Assignment List	-.-	[Protection Para /Global Prot Para /Supervision /CTS]

## Setting Group Parameters of the Current Transformer Supervision

Parameter	Description	Setting range	Default	Menu path
Function 	Permanent activation or deactivation of module/stage.	inactive, active	inactive	[Protection Para /<1..4> /Supervision /CTS]
ExBlo Fc 	Activate (allow) or inactivate (disallow) blocking of the module/stage. This parameter is only effective if a signal is assigned to the corresponding global protection parameter. If the signal becomes true, those modules/stages are blocked that are parameterized "ExBlo Fc=active".	inactive, active	inactive	[Protection Para /<1..4> /Supervision /CTS]
$\Delta I$ 	In order to prevent faulty tripping of phase selective protection functions that use the current as tripping criterion. If the difference of the measured earth current and the calculated value $I_0$ is higher than the pick up value $\Delta I$ , an alarm event is generated after expiring of the excitation time. In such a case, a fuse failure, a broken wire or a faulty measuring circuit can be assumed.	0.10 - 1.00In	0.50In	[Protection Para /<1..4> /Supervision /CTS]
Alarm delay 	Alarm delay	0.1 - 9999.0s	1.0s	[Protection Para /<1..4> /Supervision /CTS]
Kd 	Dynamic correction factor for the evaluation of the difference between calculated and measured earth current. This correction factor allows transformer faults, caused by higher currents, to be compensated.	0.00 - 0.99	0.00	[Protection Para /<1..4> /Supervision /CTS]

## Current Transformer Supervision Input States

<i>Name</i>	<i>Description</i>	<i>Assignment via</i>
ExBlo1-I	Module input state: External blocking1	[Protection Para /Global Prot Para /Supervision /CTS]
ExBlo2-I	Module input state: External blocking2	[Protection Para /Global Prot Para /Supervision /CTS]

## Current Transformer Supervision Signals (Outputs States)

<i>Signal</i>	<i>Description</i>
active	Signal: active
ExBlo	Signal: External Blocking
Alarm	Signal: Alarm Current Transformer Measuring Circuit Supervision



## Commissioning: Current Transformer Failure Supervision

### NOTICE

#### Precondition:

1. Measurement of all three phase currents (are applied to the measuring inputs of the device).
2. The earth current is detected via a cable-type transformer (not in Holmgreen connection).

#### *Object to be tested*

Check of the CT supervision (by comparing the calculated with the measured earth current).

#### *Necessary means*

- Three-phase current source

#### *Procedure, part 1*

- Set the limiting value of the CTS to » $\Delta I = 0.1 \cdot I_n$ «.
- Feed a three-phase, symmetrical current system (approx. nominal current) to the secondary side.
- Disconnect the current of one phase from one of the measuring inputs (the symmetrical feeding at secondary side has to be maintained).
- Make sure that the signal »CTS.ALARM« is generated now.

#### *Successful test result, part 1*

- The signal »CTS.ALARM« is generated.

#### *Procedure, part 2*

- Feed a three-phase, symmetrical current system (approx. nominal current) to the secondary side.
- Feed a current that is higher than the threshold value for the measuring circuit supervision to the earth current measuring input.
- Ascertain that the signal »CTS.ALARM« is generated now.

#### *Successful test result, part 2*

The signal »CTS.ALARM« is generated.

## LOP - Loss of Potential

Available elements:

LOP

### Loss of Potential - Evaluating Measured Quantities

#### NOTICE

Precondition:

1. The residual voltage is measured via the residual voltage measuring input.
2. Phase voltages are applied to the voltage measuring inputs (no line-to-line voltages)

#### NOTICE

Calculation of the residual voltage is only possible, if phase voltages (star) were applied to the voltage measuring inputs and »VT con = phase-to-neutral« is set in the field parameters.

#### NOTICE

This Notice applies to protective devices that offer control functionality only! This protective element requires, that a switchgear (circuit breaker) is assigned to it. It is allowed only to assign switchgears (circuit breaker) to this protective element, whose measuring transformers provide measuring data to the protective device.

The LOP function detects the loss of voltage in any of the voltage input measuring circuits. Faulty tripping of protective elements that take undervoltage into account can be prevented by means of this supervision element. The following measured values and information to detect an Phase VT Failure condition:

- Three-phase voltages;
- Ratio of negative-to-positive sequence voltages;
- Zero sequence voltage;
- Three-phase currents;
- Residual current (I<sub>0</sub>);
- Pickup flags from all overcurrent elements; and
- Breaker status

After a set time delay time an Alarm »LOP.LOP B<sub>Lo</sub>« will be issued.

*How to set up the Loss of Potential (Evaluating Measured Quantities)*

- Set the Alarm Time Delay »t-Alarm«.

- To prevent a malfunction of the VT supervision assign those Alarms of instantaneous overcurrent elements that should block the Loss of Potential element.
- It is necessary to set the parameter »*LOP.LOPB Enable*« to »*active*«. Otherwise the Measuring circuit supervision cannot block undervoltage depending elements in case of a loss of potential.

How to make the Loss of Potential (Evaluating Measured Quantities) effective

The Loss of Potential respectively measuring circuit supervision can be used to block protective elements like undervoltage protection in order to prevent faulty tripping.

- Set the parameter »*Measuring Circuit Supervision=active*« within those protective elements that should be blocked by the Loss of Potential supervision.

### Loss of Potential - Fuse Failure

*VT Supervision via digital inputs (Fuse Failure)*

The module »*LOP*« is capable of detecting a fuse failure at the secondary side of the VTs as long as the automatic circuit breakers of the VTs are connected with the device via a digital input and if this input is assigned to the module »*LOP*«.

*Setting the Parameters for detecting a fuse failure (FF) of a phase voltage transformer*

In order to detect a fuse failure of a phase voltage transformer via digital input, please proceed as follows:

- Assign a digital input onto the parameter »*LOP.Ex FF VT*« that represents the state of the automatic circuit breaker of the phase voltage transformer.
- Set the parameter »*Measuring Crcuit Supervison=active*« within all those protective elements, that should be blocked by a fuse failure.

*Setting the Parameters for detecting a fuse failure (FF) of a earth phase voltage transformer*

In order to detect a fuse failure of a phase voltage transformer via digital input, please proceed as follows:

- Assign a digital input onto the parameter »*LOP.Ex FF EVT*« that represents the state of the automatic circuit breaker of the phase voltage transformer.
- Set the parameter »*Measuring Crcuit Supervison=active*« within all those protective elements, that should be blocked by a fuse failure.

**LOP**

name = LOP

2

Please Refer To Diagram: Blockings

(Stage is not deactivated and no active blocking signals)

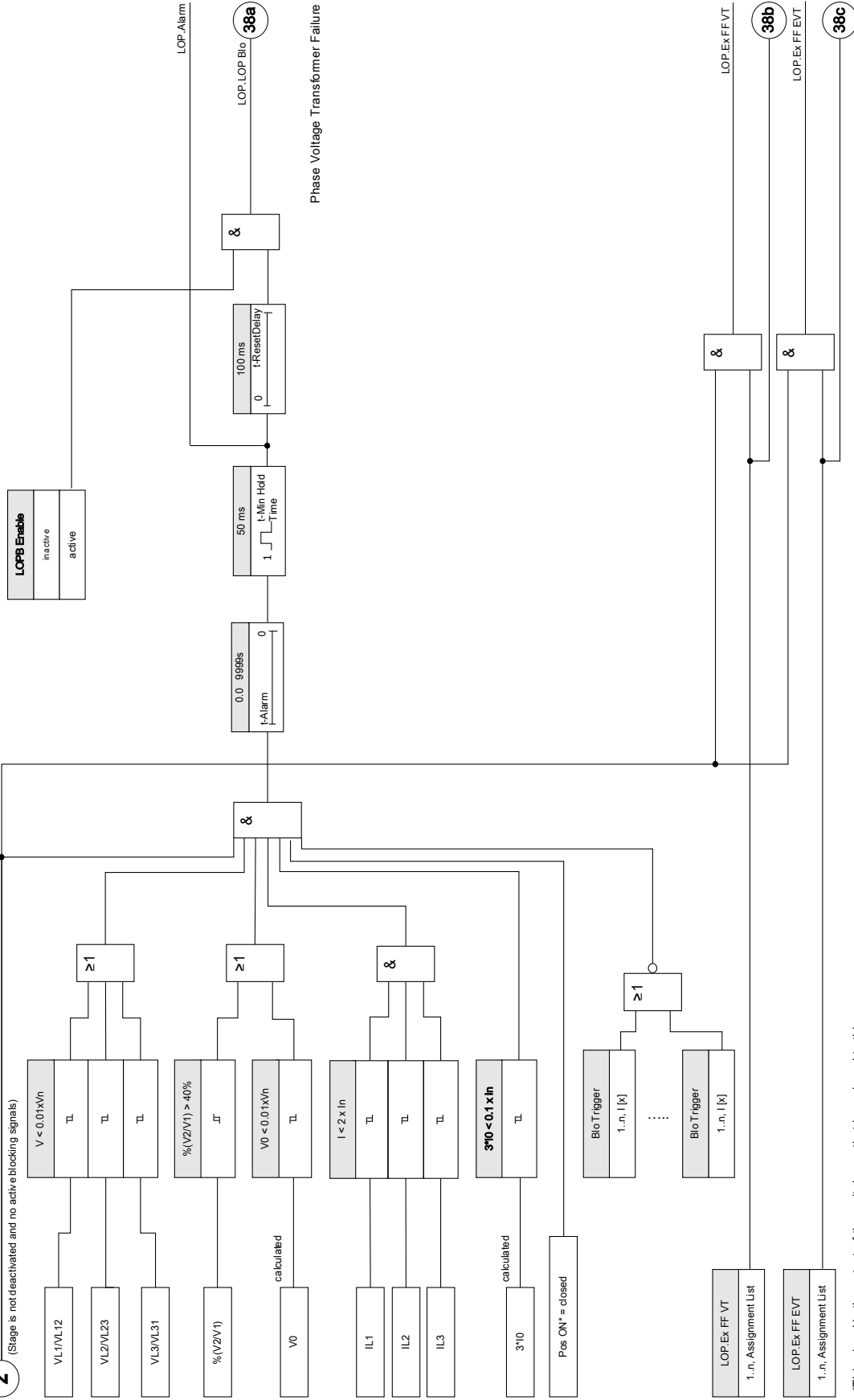





\*This signal is the output of the switchgear that is assigned to this protective element. This applies to protective devices that offer control functionality.

### Device Planning Parameters of the LOP Module





Parameter	Description	Options	Default	Menu path
Mode 	Mode	do not use, use	do not use	[Device planning]

### Global Protection Parameters of the LOP Module

Parameter	Description	Setting range	Default	Menu path
CB Pos Detect 	Criterion by which the Circuit Breaker Switch Position is to be detected.	-. , SG[1].Pos, SG[2].Pos, SG[3].Pos, SG[4].Pos, SG[5].Pos, SG[6].Pos	SG[1].Pos	[Protection Para /Global Prot Para /Supervision /LOP]
ExBlo1 	External blocking of the module, if blocking is activated (allowed) within a parameter set and if the state of the assigned signal is true.	1..n, Assignment List	-. -	[Protection Para /Global Prot Para /Supervision /LOP]
ExBlo2 	External blocking of the module, if blocking is activated (allowed) within a parameter set and if the state of the assigned signal is true.	1..n, Assignment List	-. -	[Protection Para /Global Prot Para /Supervision /LOP]
Blo Trigger1 	An Alarm of this protective element will block the Loss of Potential Detection.	Blo Trigger	-. -	[Protection Para /Global Prot Para /Supervision /LOP]
Blo Trigger2 	An Alarm of this protective element will block the Loss of Potential Detection.	Blo Trigger	-. -	[Protection Para /Global Prot Para /Supervision /LOP]
Blo Trigger3 	An Alarm of this protective element will block the Loss of Potential Detection.	Blo Trigger	-. -	[Protection Para /Global Prot Para /Supervision /LOP]

<i>Parameter</i>	<i>Description</i>	<i>Setting range</i>	<i>Default</i>	<i>Menu path</i>
Blo Trigger4 	An Alarm of this protective element will block the Loss of Potential Detection.	Blo Trigger	-.-	[Protection Para /Global Prot Para /Supervision /LOP]
Blo Trigger5 	An Alarm of this protective element will block the Loss of Potential Detection.	Blo Trigger	-.-	[Protection Para /Global Prot Para /Supervision /LOP]
Ex FF VT 	Alarm Fuse Failure Voltage Transformers	1..n, Assignment List	-.-	[Protection Para /Global Prot Para /Supervision /LOP]
Ex FF EVT 	Alarm Fuse Failure Earth Voltage Transformers	1..n, Assignment List	-.-	[Protection Para /Global Prot Para /Supervision /LOP]

## Setting Group Parameters of the LOP Module

<i>Parameter</i>	<i>Description</i>	<i>Setting range</i>	<i>Default</i>	<i>Menu path</i>
Function 	Permanent activation or deactivation of module/stage.	inactive, active	inactive	[Protection Para /<1..4> /Supervision /LOP]
ExBlo Fc 	Activate (allow) or inactivate (disallow) blocking of the module/stage. This parameter is only effective if a signal is assigned to the corresponding global protection parameter. If the signal becomes true, those modules/stages are blocked that are parameterized "ExBlo Fc=active".	inactive, active	inactive	[Protection Para /<1..4> /Supervision /LOP]
LOPB Enable 	Activate (allow) or inactivate (disallow) blocking by the module LOP.	inactive, active	inactive	[Protection Para /<1..4> /Supervision /LOP]
t-Alarm 	Pickup Delay	0 - 9999.0s	0.1s	[Protection Para /<1..4> /Supervision /LOP]

## LOP Module Input States

<i>Name</i>	<i>Description</i>	<i>Assignment via</i>
ExBlo1-I	Module input state: External blocking1	[Protection Para /Global Prot Para /Supervision /LOP]
ExBlo2-I	Module input state: External blocking2	[Protection Para /Global Prot Para /Supervision /LOP]
Pos	Module input state: Circuit Breaker Position (0 = Indeterminate, 1 = OFF, 2 = ON, 3 = Disturbed)	[Protection Para /Global Prot Para /Supervision /LOP]
Ex FF VT-I	State of the module input: Alarm Fuse Failure Voltage Transformers	[Protection Para /Global Prot Para /Supervision /LOP]
Ex FF EVT-I	State of the module input: Alarm Fuse Failure Earth Voltage Transformers	[Protection Para /Global Prot Para /Supervision /LOP]
Blo Trigger1-I	State of the module input: An Alarm of this protective element will block the Loss of Potential Detection.	[Protection Para /Global Prot Para /Supervision /LOP]
Blo Trigger2-I	State of the module input: An Alarm of this protective element will block the Loss of Potential Detection.	[Protection Para /Global Prot Para /Supervision /LOP]
Blo Trigger3-I	State of the module input: An Alarm of this protective element will block the Loss of Potential Detection.	[Protection Para /Global Prot Para /Supervision /LOP]
Blo Trigger4-I	State of the module input: An Alarm of this protective element will block the Loss of Potential Detection.	[Protection Para /Global Prot Para /Supervision /LOP]



<i>Name</i>	<i>Description</i>	<i>Assignment via</i>
Blo Trigger5-l	State of the module input: An Alarm of this protective element will block the Loss of Potential Detection.	[Protection Para /Global Prot Para /Supervision /LOP]

### LOP Module Signals (Output States)

<i>Signal</i>	<i>Description</i>
active	Signal: active
ExBlo	Signal: External Blocking
Alarm	Signal: Alarm Loss of Potential
LOP Blo	Signal: Loss of Potential blocks other elements.
Ex FF VT	Signal: Ex FF VT
Ex FF EVT	Signal: Alarm Fuse Failure Earth Voltage Transformers

### Blocking Trigger

<i>Name</i>	<i>Description</i>
-.-	No assignment
I[1].Alarm	Signal: Alarm
I[2].Alarm	Signal: Alarm
I[3].Alarm	Signal: Alarm
I[4].Alarm	Signal: Alarm
I[5].Alarm	Signal: Alarm
I[6].Alarm	Signal: Alarm
IG[1].Alarm	Signal: Alarm IG
IG[2].Alarm	Signal: Alarm IG
IG[3].Alarm	Signal: Alarm IG
IG[4].Alarm	Signal: Alarm IG

## Commissioning: Loss of Potential

*Object to be tested:*

Test of the module LOP.

*Necessary means:*

- Three-phase current source
- Three-phase voltage source.

*Procedure*

*Test part 1:*

Examine if the output signal »LOP B<sub>LO</sub>« becomes true if:

- Any of the three-phase voltages becomes less  $0.01 \cdot V_n$  Volt
- The residual voltage is less than  $0.01 \cdot V_n$  Volt or the  $\%V_2/V_1$  ratio is greater 40%
- All three-phase currents are less than  $2 \cdot I_{pu}$  (rated current)
- The residual current is less than  $0.1 I_{pu}$  (rated current)
- No pickup of an IOC element which should block VT Supervision
- The breaker is closed.

*Successful test result part 1:*

The output signals only become true if all the above mentioned conditions are fulfilled.

*Test part 2:*

Set the parameter »*Measuring Circuit Supervision=active*« within those protective elements that should be blocked by the Loss of Potential supervision (like undervoltage protection., voltage controlled overcurrent protection...).

Check those protective elements if they are blocked if the Loss of Potential supervision has generated a block command.

*Successful test result part 2:*

All protective elements that should be blocked in case of Loss of Potential supervision are blocked if the conditions (Procedure part 1) are fulfilled.

## Commissioning: Loss of Potential (FF via DI)

### *Object to be tested:*

Check if the auto fuse failure is correctly identified by the device.

### *Procedure*

- Disconnect the automatic circuit breaker of the VTs (all poles to be dead)

### *Successful test result*

- The state of the respective digital input changes.
- All protective elements are blocked which should not have an unwanted operation caused by a fuse failure  
»*Measuring Circuit Supervision=active*«.

## Self Supervision

*HighPROTEC* devices are continuously monitored and supervised through different methods during normal operation as well as during start-up phase.

Results of this supervision may be:

- messages appearing within event-recorder (from release 1.2 or later),
- indications within the display or Smart view,
- corrective measures,
- disabling of protection functions,
- restart of the device
- 

or any combination out of these.

In case of failures that cannot be corrected immediately three restarts within 20 minutes are accepted before the device will be deactivated. The device should be removed in for service in such case. Contact data and address can be found at the end of this manual.

In case of any failures the recorders of the device should be left untouched to ensure an easy diagnosis and proper repair at the factory. Besides the records and visible indications to the customer there exists internal information about failures. These allow service personnel to make a detailed analysis of files with failure reports, at least at factory site.

Self supervision is applied by different functions at different cyclic or noncyclic timings to the following parts and functions of the device:

- faultless cyclic execution of software,
- functional capability of memory boards,
- consistency of data,
- functional capability of hardware sub-assemblies and
- faultless operation of the measuring unit.

Faultless cyclic operation of software is supervised by timing analysis and checking results of different functions. Errors of the software function (watchdog function) lead to restarting the device and switching off the self-supervision relay (life-contact). Also the System-OK LED will blink red, after three unsuccessful attempts to restart the device within a time-period of 20 minutes.

The main processor cyclically monitors the operation of the signal processor and initiates corrective actions or restart of the device in case of faulty operation.

Data and files are generally secured against unintended overwriting or faulty changes by checksums.

The measuring unit continuously checks the measured data by comparing received data with data from a second channel sampled in parallel.

The auxiliary voltage is monitored continuously. If the voltage of one of the different supply circuits falls below a certain threshold, a restart of the device is initiated. If the voltage staggers around the threshold, the device also starts again after several seconds. Additionally the level of all internal supply voltage groups are continuously monitored.

Independent of these separate monitoring functions, the intermediate voltage circuit is buffered until all important and relevant operational and fault-data have been saved and the device initiates a restart.

## Error messages / -codes

After a reboot of the device the reason for rebooting will be displayed under [Operation/Status Display/Sys/Reset].

For more information about the reboot reason please follow this chapter.

The reboot will also be logged within the event recorder. Rebooting causes an event named: Sys.reboot.

Numerical reboot codes:

<i>Error messages / -codes</i>	
1.	Reboot after clean switching off of the device normal reboot after clean shut down of the device.
2.	Reboot by user command user-initiated reboot through panel-command.
3.	Super reset: reset to factory settings
4.	Restart by debugger; internally for system-analysis purpose.
5.	Restart because of configuration changes.
6.	General failure: reboot.
7.	Reboot by SW-system abort (HOST-side); summary of several reboot reasons detected by software, i.e. wrong pointer, corrupted files etc.
8.	Reboot by watchdog timeout (HOST-side) - Signaling if the protection-class-task hangs.
9.	Reboot by system abort (DSP-side); summary of several reboot reasons detected by software, i.e. wrong pointer, DSP-side.
10.	Reboot by watchdog timeout (DSP-side) - Appears when DSP sequence needs too long for one cycle.
11.	Loss of auxiliary voltage or low voltage reboot after loss of auxiliary voltage or voltage dropping below reboot-level but not becoming zero.
12.	Faulty memory access: message of MMU (memory mapping unit) that prohibited memory access has occurred.

# Programmable Logic

Available Elements (Equations):  
[Logics](#)

## General Description

The Protective Relay includes programmable Logic Equations for programming output relays, blocking of protective functions and custom logic functions in the relay.

The logic provides control of the output relays based on the state of the inputs that can be chosen from the assignment list (protective function pickups, protective function states, breaker states, system alarms, and module inputs). The user can use the outputs signals of a Logic Equation as inputs in higher equations (e.g. the output signal of Logic Equation 10 might be used as an input of Logic Equation 11).

### Principle Overview

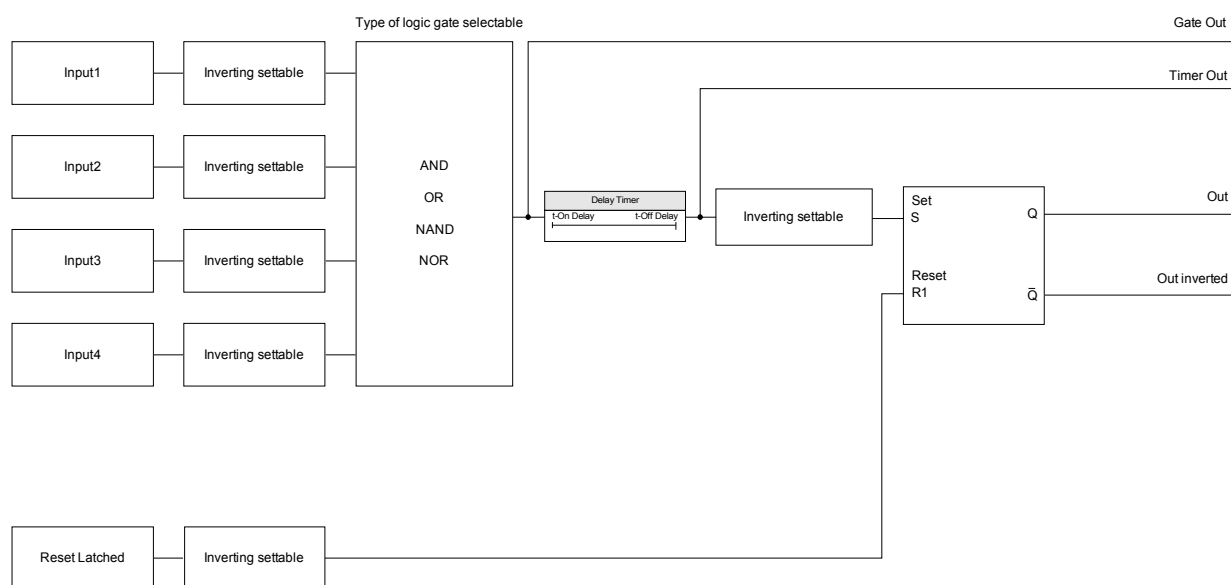

Detailed Overview – Overall Logic diagram

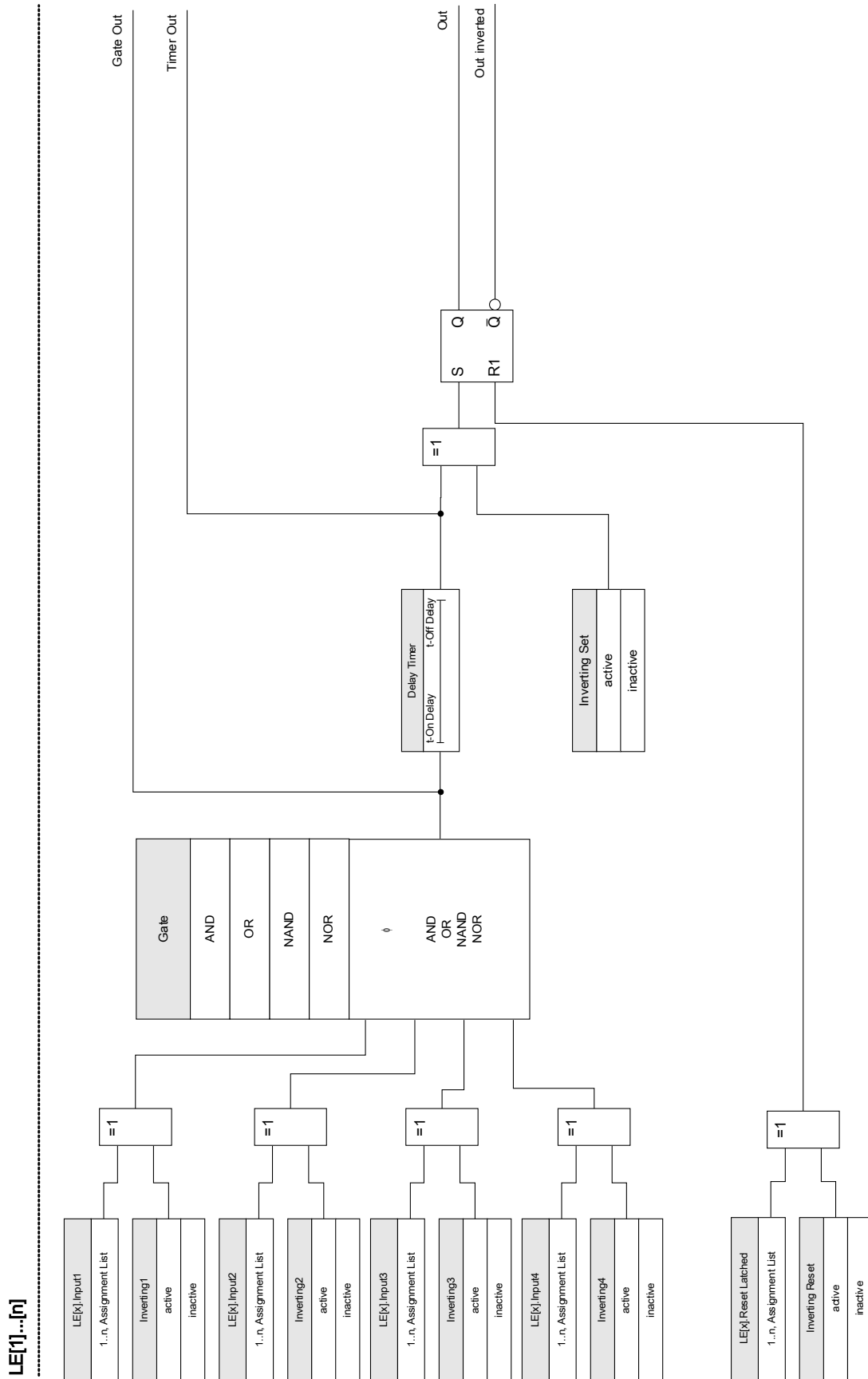

## Available Gates (Operators)

Within the Logic Equation, the following Gates can be used:

Gate

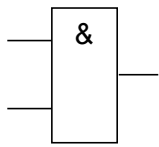

AND

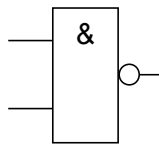

NAND

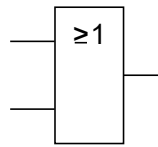

OR

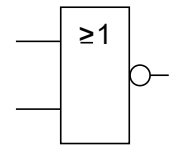

NOR

## Input Signals

The user can assign up to 4 Input signals (from the assignment list) to the inputs of the gate.

As an option, each of the 4 input signals can be inverted (negated)

## Timer Gate (On Delay and Off Delay)

The output of the gate can be delayed. The user has the option to set an On and an Off delay.

## Latching

The timer issues two signals. An unlatched and a latched signal. The latched input can optionally be inverted. In order to reset the latched signal the user has to assign a reset signal from the assignment list. The reset signal can also optionally be inverted.



## Cascading Logical Outputs

The device will evaluate output states of the Logic Equations starting from Logic Equation 1 up to the Logic Equation with the highest number. This evaluation (device) cycle will be continuously repeated.

### *Cascading Logic Equations in an ascending sequence*

Cascading in an ascending sequence means that the user uses the output signal of “Logic Equation  $n$ ” as input of “Logic Equation  $n+1$ ”. If the state of “Logic Equation  $n$ ” changes, the state of the output of “Logic Equation  $n+1$ ” will be updated within the same cycle.

### *Cascading Logic Equations in a descending sequence*

Cascading in a descending sequence means that the user uses the output signal of “Logic Equation  $n+1$ ” as input of “Logic Equation  $n$ ”. If the output of “Logic Equation  $n+1$ ” changes, this change of the feed back signal at the input of “Logic Equation  $n$ ” will be delayed for one cycle.

#### **Cascading in Ascending Order**

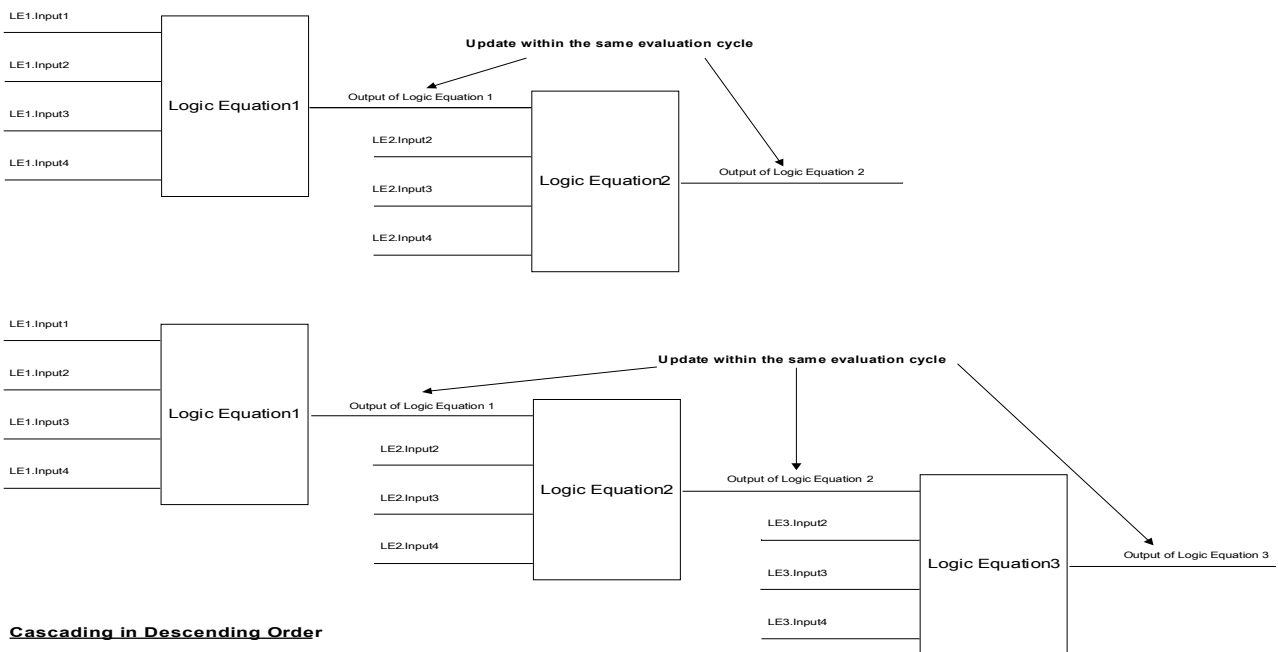

#### **Cascading in Descending Order**

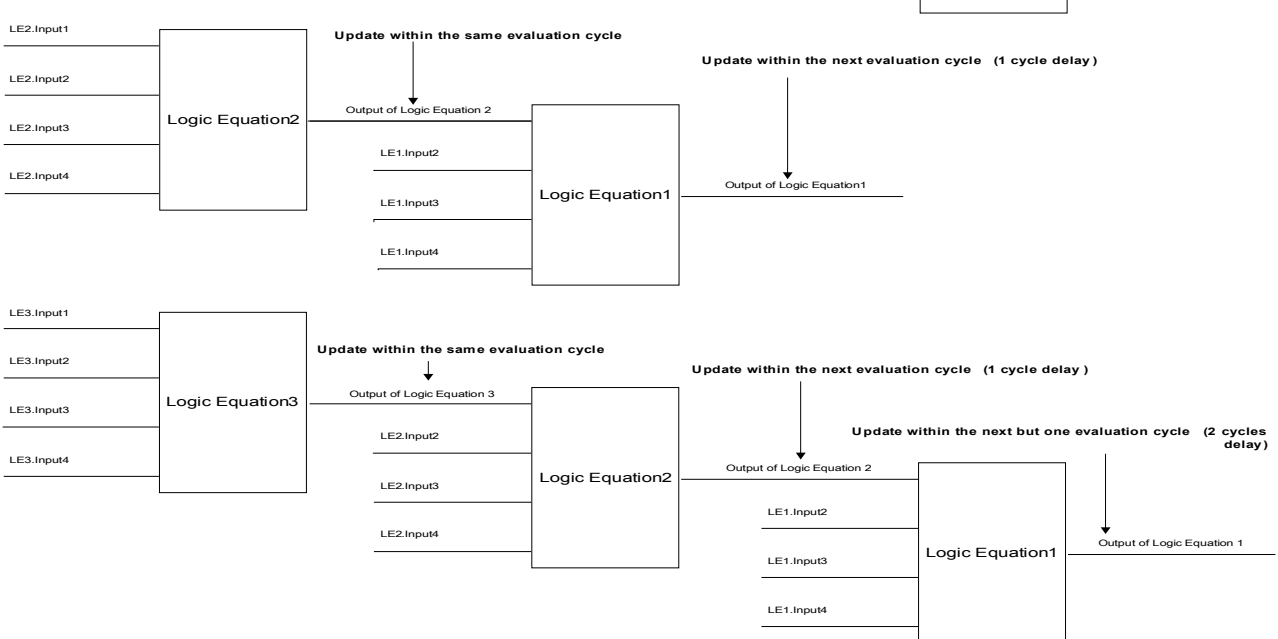

## Programmable Logic at the Panel



**WARNING**

WARNING improper use of Logic Equations might result in personal injury or damage the electrical equipment.

Don't use Logic Equations unless that you can ensure the safe functionality.

*How to configure a Logic Equation?*

- Call up menu [Logics/LE [x]]:
- Set the Input Signals (where necessary, invert them).
- If required, configure the timer («*On delay*» and «*Off delay*»).
- If the latched output signal is used assign a reset signal to the reset input.
- Within the «status display», the user can check the status of the logical inputs and outputs of the Logic Equation.

In case that Logic Equations should be cascaded the user has to be aware of timing delays (cycles) in case of descending sequences (Please refer to section: Cascading Logical Outputs).

By means the Status Display [Operation/Status Display] the logical states can be verified.]

## Programmable Logic via Smart view



**WARNING**

WARNING improper use of Logic Equations might result in personal injury or damage the electrical equipment.

Don't use Logic Equations unless that you can ensure the safe functionality.

**NOTICE**

It is recommended to configure the logic via Smart view.

### *How to configure a Logic Equation?*

- Call up menu [Logics/LE [x]:
  
- Call up the Logic Editor
  
- Set the Input Signals (where necessary, invert them).
  
- If required, configure the timer («*On delay*» and «*Off delay*»).
  
- If the latched output signal is used assign a reset signal to the reset input.
  
- Within the «status display», the user can check the status of the logical inputs and outputs of the Logic Equation.





In case that Logic Equations should be cascaded the user has to be aware of timing delays (cycles) in case of descending sequences (Please refer to section: Cascading Logical Outputs).





By means the Status Display [Operation/Status Display] the logical states can be verified.]

### Device Planning Parameters of the Programmable Logic

<i>Parameter</i>	<i>Description</i>	<i>Options</i>	<i>Default</i>	<i>Menu path</i>
No of Equations: 	Number of required Logic Equations:	0, 5, 10, 20, 40, 80	20	[Device planning]

## Global Protection Parameter of the Programmable Logic

Parameter	Description	Setting range	Default	Menu path
LE1.Gate 	Logic gate	AND, OR, NAND, NOR	AND	[Logics /LE 1]
LE1.Input1 	Assignment of the Input Signal	1..n, Assignment List	--	[Logics /LE 1]
LE1.Inverting1 	Inverting the input signals.  Only available if an input signal has been assigned.	inactive, active	inactive	[Logics /LE 1]
LE1.Input2 	Assignment of the Input Signal	1..n, Assignment List	--	[Logics /LE 1]
LE1.Inverting2 	Inverting the input signals.  Only available if an input signal has been assigned.	inactive, active	inactive	[Logics /LE 1]
LE1.Input3 	Assignment of the Input Signal	1..n, Assignment List	--	[Logics /LE 1]
LE1.Inverting3 	Inverting the input signals.  Only available if an input signal has been assigned.	inactive, active	inactive	[Logics /LE 1]
LE1.Input4 	Assignment of the Input Signal	1..n, Assignment List	--	[Logics /LE 1]
LE1.Inverting4 	Inverting the input signals.  Only available if an input signal has been assigned.	inactive, active	inactive	[Logics /LE 1]
LE1.t-On Delay 	Switch On Delay	0.00 - 36000.00s	0.00s	[Logics /LE 1]

<i>Parameter</i>	<i>Description</i>	<i>Setting range</i>	<i>Default</i>	<i>Menu path</i>
LE1.t-Off Delay 	Switch Off Delay	0.00 - 36000.00s	0.00s	[Logics /LE 1]
LE1.Reset Latched 	Reset Signal for the Latching	1..n, Assignment List	--	[Logics /LE 1]
LE1.Inverting Reset 	Inverting Reset Signal for the Latching	inactive, active	inactive	[Logics /LE 1]
LE1.Inverting Set 	Inverting the Setting Signal for the Latching	inactive, active	inactive	[Logics /LE 1]

### Programmable Logic Inputs

<i>Name</i>	<i>Description</i>	<i>Assignment via</i>
LE1.Gate In1-I	State of the module input: Assignment of the Input Signal	[Logics /LE 1]
LE1.Gate In2-I	State of the module input: Assignment of the Input Signal	[Logics /LE 1]
LE1.Gate In3-I	State of the module input: Assignment of the Input Signal	[Logics /LE 1]
LE1.Gate In4-I	State of the module input: Assignment of the Input Signal	[Logics /LE 1]
LE1.Reset Latch-I	State of the module input: Reset Signal for the Latching	[Logics /LE 1]

### Programmable Logic Outputs

<i>Signal</i>	<i>Description</i>
LE1.Gate Out	Signal: Output of the logic gate
LE1.Timer Out	Signal: Timer Output
LE1.Out	Signal: Latched Output (Q)
LE1.Out inverted	Signal: Negated Latched Output (Q NOT)

## Commissioning

Before starting work on an opened switchboard it is imperative that the complete switchboard is dead and the following 5 safety regulations are always met: ,

### DANGER

Safety precautions:

- Disconnect from the power supply
- Secure against reconnection
- Verify if the equipment is dead
- Connect to ground and short-circuit all phases
- Cover or safeguard all live adjacent parts

### DANGER

The secondary circuit of a current transformer must never be opened during operation. The prevailing high voltages are dangerous to life.

### WARNING

Even when the auxiliary voltage is switched off, it is likely that there are still hazardous voltages at the component connections.

All locally applicable national and international installation and safety regulations for working at electrical power installations must always be followed (e.g. VDE, EN, DIN, IEC).

### WARNING

Prior to the initial voltage connection, the following must be guaranteed:

- Correct grounding of the device
- That all signal circuits are tested
- That all control circuits are tested
- Transformer wiring is checked
- Correct rating of the CTs
- Correct burden of the CTs
- That the operational conditions are in line with the Technical Data
- Correct rating of the transformer protection
- Function of the transformer fuses
- Correct wiring of all digital inputs
- Polarity and capacity of the supply voltage
- Correct wiring of the analogue inputs and outputs

### NOTICE

The permissible deviations of measuring values and device adjustment are dependent on the technical data/tolerances.

## Commissioning/Protection Test

### WARNING

Putting into operation/Protection test must be carried out by authorized and qualified personnel. Before the device is put into operation the related documentation has to be read and understood.

### WARNING

With any test of the protection functions the following has to be checked:

- Is activation/tripping saved in the event recorder?
- Is tripping saved in the fault recorder?
- Is tripping saved in the disturbance recorder?
- Are all signals/messages correctly generated?
- Do all general parameterized blocking functions work properly?
- Do all temporary parameterized (via DI) blocking functions work properly?
- To enable checks on all LEDs and relay functions, these have to be provided with the relevant alarm and tripping functions of the respective protection functions/elements. This has to be tested in practical operation.

### WARNING

Check of all temporary blockings (via digital inputs):

- In order to avoid malfunctions, all blockings related to tripping/non-tripping of protection function have to be tested. The test can be very complex and should therefore be performed by the same people who set up the protection concept.

### CAUTION

Check of all general trip blockings:

- All general trip blockings have to be tested.

### NOTICE

Prior to the initial operation of the protection device all tripping times and values shown in the adjustment list have to be confirmed by a secondary test

### NOTICE

Any description of functions, parameters, inputs or outputs that does not match the device in hand, can be ignored.



## Putting out of Operation – Plug out the Relay



**WARNING**

Warning! Dismounting the relay will lead to a loss of the protection functionality. Ensure that there is a back-up protection. If you are not aware of the consequences of dismantling the device – stop! Don't start.



**WARNING**

Inform SCADA before you start.

Switch-off the power supply.

Ensure, that the cabinet is dead and that there are no voltages that could lead to personal injury.

Plug-out the terminals at the rear-side of the device. Do not pull any cable – pull on the plugs! If it is stuck use for example a screw driver.

Fasten the cables and terminals in the cabinet by means of cable clips to ensure that no accidental electrical connections are caused.

Hold the device at the front-side while opening the mounting nuts.

Remove the device carefully out of the cabinet.

In case no other device is to be mounted or replaced cover/close the cut-out in the front-door.

Close the cabinet.

## **Service and Commissioning Support**

Within the service menu various functions support maintenance and commissioning of the device.

### **General**

Within the menu [Service/General], the user can initiate a reboot of the device.

### Forcing the Relay Output Contacts

#### **NOTICE**

The parameters, their defaults and setting ranges have to be taken from Relay Output Contacts section.

#### Principle – General Use

#### **⚠ DANGER**

The User **MUST ENSURE** that the relay output contacts operate normally after the maintenance is completed. If the relay output contacts do not operate normally, the protective device **WILL NOT** provide protection.

For commissioning purposes or for maintenance, relay output contacts can be set by force.

Within this mode [Service/Test Mode/Force OR/BO Slot X(2/5)], relay output contacts can be set by force:

- Permanent; or
- Via timeout.

If they are set with a timeout, they will only keep their “Force Position” as long as this timer runs. If the timer expires, the relay will operate normally. If they are set as Permanent, they will keep the “Force Position” continuously.

There are two options available:

- Forcing a single relay »Force ORx«; and
- Forcing an entire group of relay output contacts »Force all Outs«.

Forcing an entire group takes precedence over forcing a single relay output contact!

#### **NOTICE**

A relay output contact will NOT follow a force command as long as it is disarmed at the same time.

#### **NOTICE**

A relay output contact will follow a force command:

- If it is not disarmed; and
- If the Direct Command is applied to the relay(s).

Keep in mind, that the forcing of all relay output contacts (of the same assembly group) takes precedence over the force command of a single relay output contact.

## Disarming the Relay Output Contacts

### NOTICE

The parameters, their defaults, and setting ranges have to be taken from the Relay Output Contacts section.

### Principle – General Use

Within this mode [Service/Test Mode/DISARMED], entire groups of relay output contacts can be disabled. By means of this test mode, contact outputs switching actions of the relay output contacts are prevented. If the relay output contacts are disarmed, maintenance actions can be carried out without the risk of taking entire processes off-line.

### ⚠ DANGER

The User **MUST ENSURE** that the relay output contacts are **ARMED AGAIN** after the maintenance is complete. If they are not armed, the protective device **WILL NOT** provide protection.

### NOTICE

Zone Interlocking Output and the Supervision Contact cannot be disarmed.

Within this mode [Service/Test Mode/DISARMED] entire groups of relay output contacts can be disarmed:

- Permanent; or
- Via timeout.

If they are set with a timeout, they will only keep their “Disarm Position” as long as this timer runs. If the timer expires, the relay output contacts will operate normally. If they are set Permanent, they will keep the “Disarm State” continuously.

### NOTICE

A relay output contact will NOT be disarmed as long as:

- It's latched (and not yet reset).
- As long as a running t-OFF-delay timer is not yet expired (hold time of a relay output contact).
- The Disarm Control is not set to active.
- The Direct Command is not applied.

**NOTICE**

A relay output contact will be disarmed if it's not latched and

- There is no running t-OFF-delay timer (hold time of a relay output contact) and
  
- The DISARM Control is set to active and
  
- The Direct Command Disarm is applied.

## Forcing RTDs\*

\* = Availability depends on ordered device.

### NOTICE

The parameters, their defaults, and setting ranges have to be taken from RTD/UTRD section.

## Principle – General Use

### ! DANGER

The User **MUST ENSURE** that the RTDs operate normally after the maintenance is completed. If the RTDs do not operate normally, the protective device **WILL NOT** provide protection.

For commissioning purposes or for maintenance, RTD temperatures can be set by force.

Within this mode [Service/Test Mode/URTD], RTD temperatures can be set by force:

- Permanent; or
- Via timeout.

If they are set with a timeout, they will keep their “Forced Temperature” only as long as this timer runs. If the timer expires, the RTD will operate normally. If they are set as »*Permanent*«, they will keep the “Forced Temperature” continuously. This menu will show the measured values of the RTDs until the User activates the force mode by calling up the »*Function*«. As soon as the force mode is activated, the shown values will be frozen as long as this mode is active. Now the User can force RTD values. As soon as the force mode is deactivated, measured values will be shown again.

## Forcing Analog Outputs\*

\* = Availability depends on ordered device.

### NOTICE

The parameters, their defaults, and setting ranges have to be taken from Analog Output section.

## Principle – General Use

### ! DANGER

The User **MUST ENSURE** that the Analog Outputs operate normally after maintenance is completed. Do not use this mode if forced Analog Outputs cause issues in external processes.

For commissioning purposes or for maintenance, Analog Outputs can be set by force.

Within this mode [Service/Test Mode/Analog Output(x)], Analog Outputs can be set by force:

- Permanent; or
- Via timeout.

If they are set with a timeout, they will only keep their “Forced Value” as long as this timer runs. If the timer expires, the Analog Output will operate normally. If they are set as »*Permanent*«, they will keep the “Forced Value” continuously. This menu will show the current value that is assigned onto the Analog Output until the User activates the force mode by calling up the »*Function*«. As soon as the force mode is activated, the shown values will be frozen as long as this mode is active. Now the User can force Analog Output values. As soon as the force mode is deactivated, measured values will be shown again.

## Forcing Analog Inputs\*

\* = Availability depends on ordered device.

### NOTICE

The parameters, their defaults, and setting ranges have to be taken from Analog Inputs section.

## Principle – General Use

### ! DANGER

The User **MUST ENSURE** that the Analog Inputs operate normally after maintenance is completed.

For commissioning purposes or for maintenance, Analog Inputs can be set by force.

Within this mode [Service/Test Mode (Prot inhibit)/WARNING! Cont?/Analog Inputs], Analog Inputs can be set by force:

- Permanent; or
- Via timeout.

If they are set with a timeout, they will only keep their “Forced Value” as long as this timer runs. If the timer expires, the Analog Input will operate normally. If they are set as »*Permanent*«, they will keep the “Forced Value” continuously. This menu will show the current value that is fed to the Analog Input until the User activates the force mode by calling up the »*Function*«. As soon as the force mode is activated, the shown value will be frozen as long as this mode is active. Now the User can force the Analog Input value. As soon as the force mode is deactivated, measured value will be shown again.



## Failure Simulator (Sequencer)\*

Available Elements:

Sgen

\* = Availability depends on ordered device.

For commissioning support and in order to analyze failures, the protective device offers the option to simulate measuring quantities. The simulation menu can be found within the [Service/Test Mode/Sgen] menu.

The simulation cycle consists of three states:

- Pre-failure;
- Failure; and
- Post-failure State (Phase).

Within the [Service/Test Mode/Sgen/Configuration/Times] sub-menu, the duration of each phase can be set. In addition; the measuring quantities to be simulated can be determined (e.g.: voltages, currents, and the corresponding angles) for each phase (and ground). The simulation will be terminated, if a phase current exceeds 0.1 times  $I_n$ . A simulation can be restarted, five seconds after the current has fallen below 0.1 times  $I_n$ .

**⚠ DANGER** Setting the device into the simulation mode means taking the protective device out of operation for the duration of the simulation. Do not use this feature during operation of the device if the User cannot guarantee that there is a running and properly working backup protection.

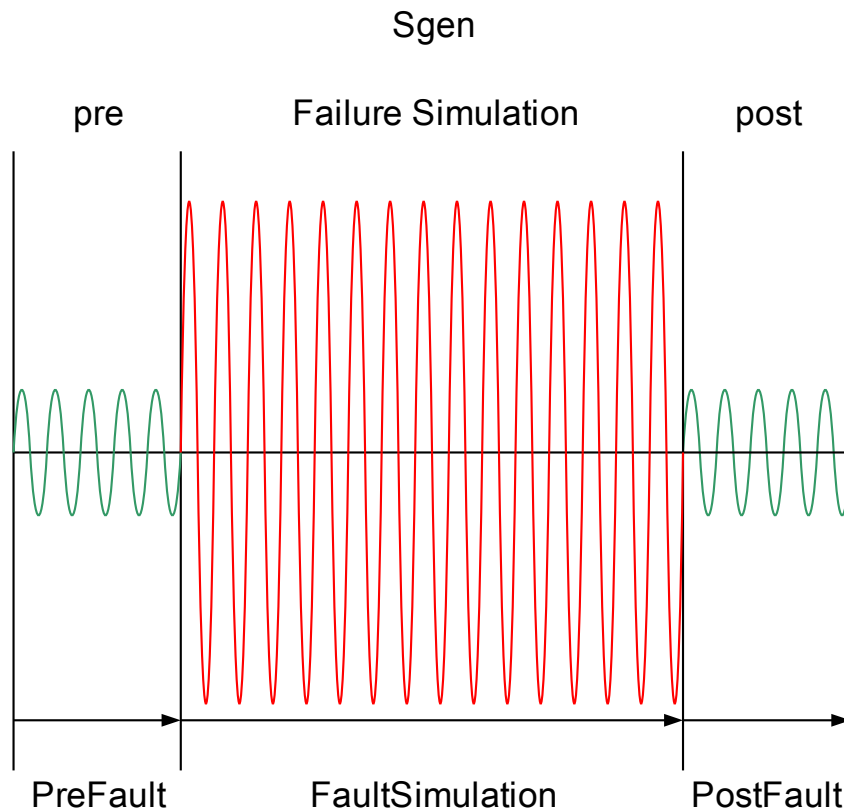

The energy counters will be stopped while the failure simulator is running.

**NOTICE**

The simulation voltages are always phase to neutral voltages, irrespectively of the mains voltage transformers' connection method (Phase-to-phase / Wey / Open Delta).

Application Options of the Fault Simulator\*\*:



<i>Stop Options</i>	Cold Simulation (Option 1)	Hot Simulation (Option 2)
<p><b>Do not stop</b></p> <p>Run complete: Pre Failure, Failure, Post Failure.</p> <p>How To?: Call up [Service/Test Mode/Sgen /Process] Ex Force Post = no assignment</p> <p>Press/Call up Start Simulation.</p>	<p><b>Simulation without tripping the breaker:</b></p> <p>Blocking protective Trips to the Breaker. That means verifying if the protective device generates a trip without energizing the trip coil of the breaker (similar to disarm the output relay).</p> <p>How To?: Call up [Service/Test Mode/Sgen /Process]</p> <p>TripCmd Mode = No TripCmd</p>	<p><b>Simulation is authorized to trip the breaker:</b></p> <p>How To?: Call up [Service/Test Mode/Sgen /Process] TripCmd Mode = With TripCmd</p>
<p><b>Stop by external signal</b></p> <p>Force Post: As soon as this signal becomes true, the Fault Simulation will be forced to switch into the Post Failure mode.</p> <p>How To?: Call up [Service/Test Mode/Sgen /Process] Ex Force Post = Assigned Signal</p>		
<p><b>Manual stop</b></p> <p>As soon as this signal becomes true, the Fault Simulation will be terminated and the device changes back to normal operation.</p> <p>How To?: Call up [Service/Test Mode/Sgen /Process] Press/Call up Stop Simulation.</p>		

\*\*Please note: Due to internal dependencies, the frequency of the simulation module is 0.16% greater than the rated one.

### Device Planning Parameters of the Failure Simulator

Parameter	Description	Options	Default	Menu path
Mode 	Mode	do not use, use	use	[Device planning]



### Global Protection Parameter of the Failure Simulator

Parameter	Description	Setting range	Default	Menu path
PreFault 	Pre Fault Duration	0.00 - 300.00s	0.0s	[Service /Test (Prot inhibit) /Sgen /Configuration /Times]
FaultSimulation 	Duration of Fault Simulation	0.00 - 10800.00s	0.0s	[Service /Test (Prot inhibit) /Sgen /Configuration /Times]
PostFault 	PostFault	0.00 - 300.00s	0.0s	[Service /Test (Prot inhibit) /Sgen /Configuration /Times]
TripCmd Mode 	Trip Command Mode	No TripCmd, With TripCmd	No TripCmd	[Service /Test (Prot inhibit) /Sgen /Process]
Ex Start Simulation 	External Start of Fault Simulation (Using the test parameters)	1..n, Assignment List	.-	[Service /Test (Prot inhibit) /Sgen /Process]
ExBlo 	External blocking of the module, if blocking is activated (allowed) within a parameter set and if the state of the assigned signal is true.	1..n, Assignment List	SG[1].Pos ON	[Service /Test (Prot inhibit) /Sgen /Process]

Parameter	Description	Setting range	Default	Menu path
Ex ForcePost 	Force Post state. Abort simulation.	1..n, Assignment List	.-	[Service /Test (Prot inhibit) /Sgen /Process]

### Voltage Parameter of the Failure Simulator

Parameter	Description	Setting range	Default	Menu path
VL1 	Voltage Fundamental Magnitude in Pre State: phase L1	0.00 - 1.50Vn	1.0Vn	[Service /Test (Prot inhibit) /Sgen /Configuration /PreFault /Voltage]
VL2 	Voltage Fundamental Magnitude in Pre State: phase L2	0.00 - 1.50Vn	1.0Vn	[Service /Test (Prot inhibit) /Sgen /Configuration /PreFault /Voltage]
VL3 	Voltage Fundamental Magnitude in Pre State: phase L3	0.00 - 1.50Vn	1.0Vn	[Service /Test (Prot inhibit) /Sgen /Configuration /PreFault /Voltage]
VX 	Voltage Fundamental Magnitude in Pre State: VX	0.00 - 1.50Vn	0.0Vn	[Service /Test (Prot inhibit) /Sgen /Configuration /PreFault /Voltage]
phi VL1 	Start Position respectively Start Angle of the Voltage Phasor during Pre-Phase:phase L1	-360 - 360°	0°	[Service /Test (Prot inhibit) /Sgen /Configuration /PreFault /Voltage]

Parameter	Description	Setting range	Default	Menu path
phi VL2 	Start Position respectively Start Angle of the Voltage Phasor during Pre-Phase:phase L2	-360 - 360°	240°	[Service /Test (Prot inhibit) /Sgen /Configuration /PreFault /Voltage]
phi VL3 	Start Position respectively Start Angle of the Voltage Phasor during Pre-Phase:phase L3	-360 - 360°	120°	[Service /Test (Prot inhibit) /Sgen /Configuration /PreFault /Voltage]
phi VX meas 	Start Position respectively Start Angle of the Voltage Phasor during Pre-Phase: VX	-360 - 360°	0°	[Service /Test (Prot inhibit) /Sgen /Configuration /PreFault /Voltage]
VL1 	Voltage Fundamental Magnitude in Fault State: phase L1	0.00 - 1.50Vn	0.5Vn	[Service /Test (Prot inhibit) /Sgen /Configuration /FaultSimulation /Voltage]
VL2 	Voltage Fundamental Magnitude in Fault State: phase L2	0.00 - 1.50Vn	0.5Vn	[Service /Test (Prot inhibit) /Sgen /Configuration /FaultSimulation /Voltage]
VL3 	Voltage Fundamental Magnitude in Fault State: phase L3	0.00 - 1.50Vn	0.5Vn	[Service /Test (Prot inhibit) /Sgen /Configuration /FaultSimulation /Voltage]





Parameter	Description	Setting range	Default	Menu path
VX 	Voltage Fundamental Magnitude in Fault State: phase VX	0.00 - 1.50Vn	0.5Vn	[Service /Test (Prot inhibit) /Sgen /Configuration /FaultSimulation /Voltage]
phi VL1 	Start Position respectively Start Angle of the Voltage Phasor during Fault-Phase:phase L1	-360 - 360°	0°	[Service /Test (Prot inhibit) /Sgen /Configuration /FaultSimulation /Voltage]
phi VL2 	Start Position respectively Start Angle of the Voltage Phasor during Fault-Phase:phase L2	-360 - 360°	240°	[Service /Test (Prot inhibit) /Sgen /Configuration /FaultSimulation /Voltage]
phi VL3 	Start Position respectively Start Angle of the Voltage Phasor during Fault-Phase:phase L3	-360 - 360°	120°	[Service /Test (Prot inhibit) /Sgen /Configuration /FaultSimulation /Voltage]
phi VX meas 	Start Position respectively Start Angle of the Voltage Phasor during Fault-Phase: VX	-360 - 360°	0°	[Service /Test (Prot inhibit) /Sgen /Configuration /FaultSimulation /Voltage]
VL1 	Voltage Fundamental Magnitude during Post phase: phase L1	0.00 - 1.50Vn	1.0Vn	[Service /Test (Prot inhibit) /Sgen /Configuration /PostFault /Voltage]

Parameter	Description	Setting range	Default	Menu path
VL2 	Voltage Fundamental Magnitude during Post phase: phase L2	0.00 - 1.50Vn	1.0Vn	[Service /Test (Prot inhibit) /Sgen /Configuration /PostFault /Voltage]
VL3 	Voltage Fundamental Magnitude during Post phase: phase L3	0.00 - 1.50Vn	1.0Vn	[Service /Test (Prot inhibit) /Sgen /Configuration /PostFault /Voltage]
VX 	Voltage Fundamental Magnitude during Post phase: phase VX	0.00 - 1.50Vn	0.0Vn	[Service /Test (Prot inhibit) /Sgen /Configuration /PostFault /Voltage]
phi VL1 	Start Position respectively Start Angle of the Voltage Phasor during Post phase: phase L1	-360 - 360°	0°	[Service /Test (Prot inhibit) /Sgen /Configuration /PostFault /Voltage]
phi VL2 	Start Position respectively Start Angle of the Voltage Phasor during Post phase: phase L2	-360 - 360°	240°	[Service /Test (Prot inhibit) /Sgen /Configuration /PostFault /Voltage]
phi VL3 	Start Position respectively Start Angle of the Voltage Phasor during Post phase: phase L3	-360 - 360°	120°	[Service /Test (Prot inhibit) /Sgen /Configuration /PostFault /Voltage]



Parameter	Description	Setting range	Default	Menu path
phi VX meas 	Start Position respectively Start Angle of the Voltage Phasor during Post phase: phase VX	-360 - 360°	0°	[Service /Test (Prot inhibit) /Sgen /Configuration /PostFault /Voltage]



**Current Parameter of the Failure Simulator**

Parameter	Description	Setting range	Default	Menu path
IL1 	Current Fundamental Magnitude in Pre State: phase L1	0.00 - 40.00In	0.0In	[Service /Test (Prot inhibit) /Sgen /Configuration /PreFault /Current]
IL2 	Current Fundamental Magnitude in Pre State: phase L2	0.00 - 40.00In	0.0In	[Service /Test (Prot inhibit) /Sgen /Configuration /PreFault /Current]
IL3 	Current Fundamental Magnitude in Pre State: phase L3	0.00 - 40.00In	0.0In	[Service /Test (Prot inhibit) /Sgen /Configuration /PreFault /Current]
IG meas 	Current Fundamental Magnitude in Pre State: IG	0.00 - 25.00In	0.0In	[Service /Test (Prot inhibit) /Sgen /Configuration /PreFault /Current]

Parameter	Description	Setting range	Default	Menu path
phi IL1 	Start Position respectively Start Angle of the Current Phasor during Pre-Phase:phase L1	-360 - 360°	0°	[Service /Test (Prot inhibit) /Sgen /Configuration /PreFault /Current]
phi IL2 	Start Position respectively Start Angle of the Current Phasor during Pre-Phase:phase L2	-360 - 360°	240°	[Service /Test (Prot inhibit) /Sgen /Configuration /PreFault /Current]
phi IL3 	Start Position respectively Start Angle of the Current Phasor during Pre-Phase:phase L3	-360 - 360°	120°	[Service /Test (Prot inhibit) /Sgen /Configuration /PreFault /Current]
phi IG meas 	Start Position respectively Start Angle of the Current Phasor during Pre-Phase: IG	-360 - 360°	0°	[Service /Test (Prot inhibit) /Sgen /Configuration /PreFault /Current]
IL1 	Current Fundamental Magnitude in Fault State: phase L1	0.00 - 40.00In	0.0In	[Service /Test (Prot inhibit) /Sgen /Configuration /FaultSimulation /Current]
IL2 	Current Fundamental Magnitude in Fault State: phase L2	0.00 - 40.00In	0.0In	[Service /Test (Prot inhibit) /Sgen /Configuration /FaultSimulation /Current]

Parameter	Description	Setting range	Default	Menu path
IL3 	Current Fundamental Magnitude in Fault State: phase L3	0.00 - 40.00In	0.0In	[Service /Test (Prot inhibit) /Sgen /Configuration /FaultSimulation /Current]
IG meas 	Current Fundamental Magnitude in Fault State: IG	0.00 - 25.00In	0.0In	[Service /Test (Prot inhibit) /Sgen /Configuration /FaultSimulation /Current]
phi IL1 	Start Position respectively Start Angle of the Current Phasor during Fault-Phase:phase L1	-360 - 360°	0°	[Service /Test (Prot inhibit) /Sgen /Configuration /FaultSimulation /Current]
phi IL2 	Start Position respectively Start Angle of the Current Phasor during Fault-Phase:phase L2	-360 - 360°	240°	[Service /Test (Prot inhibit) /Sgen /Configuration /FaultSimulation /Current]
phi IL3 	Start Position respectively Start Angle of the Current Phasor during Fault-Phase:phase L3	-360 - 360°	120°	[Service /Test (Prot inhibit) /Sgen /Configuration /FaultSimulation /Current]
phi IG meas 	Start Position respectively Start Angle of the Current Phasor during Fault-Phase: IG	-360 - 360°	0°	[Service /Test (Prot inhibit) /Sgen /Configuration /FaultSimulation /Current]

Parameter	Description	Setting range	Default	Menu path
IL1 	Current Fundamental Magnitude during Post phase: phase L1	0.00 - 40.00In	0.0In	[Service /Test (Prot inhibit) /Sgen /Configuration /PostFault /Current]
IL2 	Current Fundamental Magnitude during Post phase: phase L2	0.00 - 40.00In	0.0In	[Service /Test (Prot inhibit) /Sgen /Configuration /PostFault /Current]
IL3 	Current Fundamental Magnitude during Post phase: phase L3	0.00 - 40.00In	0.0In	[Service /Test (Prot inhibit) /Sgen /Configuration /PostFault /Current]
IG meas 	Current Fundamental Magnitude during Post phase: IG	0.00 - 25.00In	0.0In	[Service /Test (Prot inhibit) /Sgen /Configuration /PostFault /Current]
phi IL1 	Start Position respectively Start Angle of the Current Phasor during Post phase: phase L1	-360 - 360°	0°	[Service /Test (Prot inhibit) /Sgen /Configuration /PostFault /Current]
phi IL2 	Start Position respectively Start Angle of the Current Phasor during Post phase: phase L2	-360 - 360°	240°	[Service /Test (Prot inhibit) /Sgen /Configuration /PostFault /Current]

<i>Parameter</i>	<i>Description</i>	<i>Setting range</i>	<i>Default</i>	<i>Menu path</i>
phi IL3 	Start Position respectively Start Angle of the Current Phasor during Post phase: phase L3	-360 - 360°	120°	[Service /Test (Prot inhibit) /Sgen /Configuration /PostFault /Current]
phi IG meas 	Start Position respectively Start Angle of the Current Phasor during Post phase: IG	-360 - 360°	0°	[Service /Test (Prot inhibit) /Sgen /Configuration /PostFault /Current]



### States of the Inputs of the Failure Simulator

Name	Description	Assignment via
Ex Start Simulation-I	State of the module input:External Start of Fault Simulation (Using the test parameters)	[Service /Test (Prot inhibit) /Sgen /Process]
ExBlo	Module input state: External blocking	[Service /Test (Prot inhibit) /Sgen /Process]
Ex ForcePost-I	State of the module input:Force Post state. Abort simulation.	[Service /Test (Prot inhibit) /Sgen /Process]

### Signals of the Failure Simulator (States of the Outputs)

Signal	Description
Running	Signal; Measuring value simulation is running
State	Signal: Wave generation states: 0=Off, 1=PreFault, 2=Fault, 3=PostFault, 4=InitReset

### Direct Commands of the Failure Simulator

Parameter	Description	Setting range	Default	Menu path
Start Simulation 	Start Fault Simulation (Using the test parameters)	inactive, active	inactive	[Service /Test (Prot inhibit) /Sgen /Process]
Stop Simulation 	Stopp Fault Simulation (Using the test parameters)	inactive, active	inactive	[Service /Test (Prot inhibit) /Sgen /Process]

### Failure Simulator Values

## Commissioning

---

<i>Value</i>	<i>Description</i>	<i>Default</i>	<i>Size</i>	<i>Menu path</i>
State	Wave generation states: 0=Off, 1=PreFault, 2=Fault, 3=PostFault, 4=InitReset	Off	Off, PreFault, FaultSimulation, PostFault, Init Res	[Service /Test (Prot inhibit) /Sgen /State]

## Technical Data

### **NOTICE**

Use Copper conductors only, 75°C.  
Conductor size AWG 14 [2.5 mm<sup>2</sup>].

## Climatic Environmental Conditions

<b>Storage Temperature:</b>	<b>Operating Temperature:</b>
-30°C up to +70°C (-22°F to 158°F)	-20°C up to +60°C (-4°F to 140°F)

Permissible Humidity at Ann. Average: <75% rel. (on 56d up to 95% rel.)  
 Permissible Installation Altitude: <2000 m (6561.67 ft) above sea level  
 If 4000 m (13123.35 ft) altitude apply a changed classification of the operating and test voltages may be necessary.

## Degree of Protection EN 60529

HMI front panel with seal	IP54
HMI front panel without seal	IP50
Rear side terminals	IP20

## Routine Test

Insulation test acc. to IEC60255-5: All tests to be carried out against earth and other input- and output circuits  
 Aux. voltage supply, digital inputs, current measuring inputs, signal relay outputs: 2.5 kV (eff) / 50 Hz  
 Voltage measuring inputs: 3.0 kV (eff) / 50 Hz  
 All wire-bound communication interfaces: 1.5 kV DC



## Housing

Housing B2: height/-width (7 Pushbuttons/Door Mounting)	173 mm (6.811")/ 212.7 mm (8.374")
Housing B2: height/-width (8 Pushbuttons/Door Mounting)	183 mm (7.205")/ 212.7 mm (8.374")
Housing B2: height/-width (7 and 8 Pushbuttons/19")	173 mm (6.811" / 4U)/ 212.7 mm (8.374" / 42 HP)
Housing depth (incl. terminals):	208 mm (8.189")
Material, housing:	Aluminum extruded section
Material, front panel:	Aluminum/Foil front
Mounting position:	Horizontal ( $\pm 45^\circ$ around the X-axis must be permitted)
Weight:	approx. 4.2 kg (9.259 lb)

## Current and Earth Current Measurement

### Plug-in Connectors with Integrated Short-Circuiter

(Conventional Current Inputs)

Nominal currents:	1 A / 5 A	
Max. measuring range:	up to 40 x I <sub>n</sub> (phase currents) up to 25 x I <sub>n</sub> (earth current standard) up to 2.5 x I <sub>n</sub> (earth current sensitive)	
Continuous loading capacity:	Phase current/Earth current 4 x I <sub>n</sub> /continuously	Earth current sensitive 2 x I <sub>n</sub> /continuously
Overcurrent proof:	Phase current/Earth current 30 x I <sub>n</sub> /10 s 100 x I <sub>n</sub> /1 s 250 x I <sub>n</sub> /10 ms (1 half-wave)	Earth current sensitive 10 x I <sub>n</sub> /10 s 25 x I <sub>n</sub> /1 s 100 x I <sub>n</sub> /10 ms (1 half-wave)
Power consumption:	Phase current inputs: at I <sub>n</sub> = 1 A S = 25 mVA at I <sub>n</sub> = 5 A S = 120 mVA  Earth current input: at I <sub>n</sub> = 1 A S = 25 mVA at I <sub>n</sub> = 5 A S = 120 mVA	Sensitive earth current input: at I <sub>n</sub> = 1 A S = 170 mVA at I <sub>n</sub> = 0.1 A S = 1.7 mVA at I <sub>n</sub> = 5 A S = 540 mVA at I <sub>n</sub> = 0.5 A S = 5.4 mVA
Frequency range:	50 Hz / 60 Hz ±10%	
Terminals:	Screw-type terminals with integrated short-circuiters (contacts)	
Screws:	M4, captive type acc. to VDEW	
Connection Cross Sections:	1 x or 2 x 2.5 mm <sup>2</sup> (2 x AWG 14) with wire end ferrule 1 x or 2 x 4.0 mm <sup>2</sup> (2 x AWG 12) with ring cable sleeve or cable sleeve 1 x or 2 x 6 mm <sup>2</sup> (2 x AWG 10) with ring cable sleeve or cable sleeve	
	The current measuring board's terminal blocks may be used as with 2 (double) conductors AWG 10,12,14 otherwise with single conductors only.	

## Voltage and Residual Voltage Measurement

Nominal voltages: 60 - 520 V (can be configured)

Max. measuring range: 800 V AC

Continuous loading capacity: 800 V AC

Power consumption:  
at  $V_n = 100\text{ V}$   $S = 22\text{ mVA}$   
at  $V_n = 110\text{ V}$   $S = 25\text{ mVA}$   
at  $V_n = 230\text{ V}$   $S = 110\text{ mVA}$   
at  $V_n = 400\text{ V}$   $S = 330\text{ mVA}$

Frequency range: 50 Hz or 60 Hz  $\pm 10\%$

Terminals: Screw-type terminals

## Frequency Measurement

Nominal frequencies: 50 Hz / 60 Hz

## Voltage Supply

Aux. Voltage: 24V - 270 V DC/48 - 230 V AC (-20/+10%)  $\approx$

Buffer time in case of supply failure:  $\geq$  50 ms at minimal aux. voltage  
Note: communication could be interrupted

**NOTICE** After this time has elapsed,  
the device switches off.

Max. permissible making current: 18 A peak value for  $<0.25$  ms  
12 A peak value for  $<1$  ms

The voltage supply must be protected by a fuse of:

- 2,5 A time-lag miniature fuse 5x20 mm (approx. 1/5" x 0.8") according to IEC 60127
- 3,5 A time-lag miniature fuse 6,3x32 mm (approx. 1/4" x 1 1/4") according to UL 248-14

## Power Consumption

Power supply range:	Power consumption in idle mode	Max. power consumption
24-270 V DC:	8 W	13 W
48-230 V AC (for frequencies of 50-60 Hz):	8W / 16 VA	13 W / 21 VA

## Display

Display type: LCD with LED background illumination  
Resolution graphics display: 128 x 128 pixel

LED-Type: Two colored: red/green  
Number of LEDs, Housing B2: 15

## Front Interface RS232

Baud rates: 115200 Baud  
Handshake: RTS and CTS  
Connection: 9-pole D-Sub plug

## Real Time Clock

Running reserve of the real time clock: 1 year min.

## Digital Inputs

Max. input voltage: 300 V DC/259 V AC  
 Input current: DC <4 mA  
 AC <16 mA

Reaction time: <20 ms

Fallback Time:  
 Shorted inputs <30 ms  
 Open inputs <90 ms

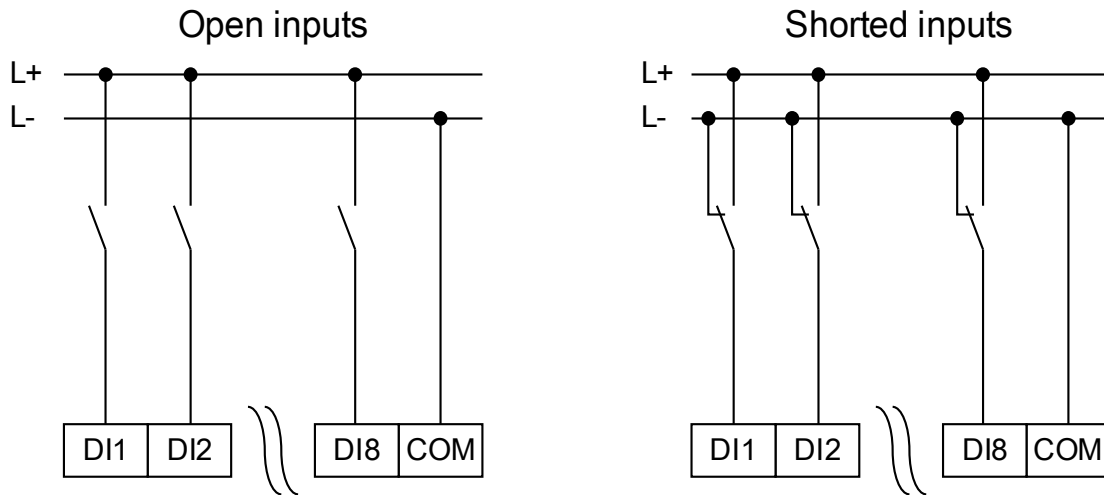

(Safe state of the digital inputs)

4 Switching thresholds:  $U_n = 24 \text{ V DC}, 48 \text{ V DC}, 60 \text{ V DC}, 110 \text{ V AC/DC}, 230 \text{ V AC/DC}$

$U_n = 24 \text{ V DC}$ :

Switching threshold 1 ON: min. 19.2 V DC  
 Switching threshold 1 OFF: max. 9.6 V DC

$U_n = 48 \text{ V}/60 \text{ V DC}$ :

Switching threshold 2 ON: Min. 42.6 V DC  
 Switching threshold 2 OFF: max. 21.3 V DC

$U_n = 110 \text{ V AC/DC}$ :

Switching threshold 3 ON: min. 88.0 V DC/88.0 V AC  
 Switching threshold 3 OFF: max. 44.0 V DC/44.0 V AC

$U_n = 230 \text{ V AC/DC}$ :

Switching threshold 4 ON: min. 184 V DC/184 V AC  
 Switching threshold 4 OFF: max. 92 V DC/92 V AC

Terminals: Screw-type terminals

## Binary Output Relays

Continuous current:	5 A AC/DC
Max. Switch-on current:	25 A AC/DC for 4 s 30 A / 230 Vac according to ANSI IEEE Std C37.90-2005 30 A / 250 Vdc according to ANSI IEEE Std C37.90-2005
Max. breaking current:	5 A AC up to 240 V AC 5 A DC up to 30 V (resistive) 0.3 A DC at 250 V (resistive)
Max. switching voltage:	250 V AC/250 V DC
Switching capacity:	1250 VA
Contact type:	1 changeover contact
Terminals:	Screw-type terminals

## Supervision Contact (SC)

Continuous current:	5 A AC/DC
Max. Switch-on current:	15 A AC/DC for 4 s
Max. breaking current:	5 A AC up to 250 V AC 5 A DC up to 30 V (resistive) 0.25 A DC at 250 V (resistive)
Max. switching voltage:	250 V AC/250 V DC
Switching capacity:	1250 VA
Contact type:	1 changeover contact
Terminals:	Screw-type terminals

## Time Synchronization IRIG

Nominal input voltage:	5 V
Connection:	Screw-type terminals (twisted pair)

## RS485\*

Master/Slave: Slave  
Connection: 9-pole D-Sub socket  
(external terminating resistors/in D-Sub)  
or 6 screw-clamping terminals RM 3.5 mm (138 MIL)  
(terminating resistors internal)

### CAUTION

In case that the RS485 interface is realized via terminals, the communication cable has to be shielded. The shielding has to be fixed at the screw that is marked with the ground symbol (rear side of the device).

## Fibre Optic\*

Master/Slave: Slave  
Connection: ST-Plug

## URTD-Interface\*

Connection: Versatile Link

\*availability depends on device

## Boot phase

After switching on the power supply the protection will be available in approximately 12 seconds. After approximately 120 (depending on the configuration) seconds the boot phase is completed (HMI and Communication initialized).



## Standards

### Approvals

- GOST-R
- UL- File No.: E217753
- CSA File No.: 251990\*\*
- CEI 0-16\* (Tested by EuroTest Laboratori S.r.l, Italy)\*

### Design Standards

Generic standard	EN 61000-6-2 EN 61000-6-3
Product standard	IEC 60255-6 EN 50178 UL 508 (Industrial Control Equipment) CSA C22.2 No. 14-95 (Industrial Control Equipment) ANSI C37.90

### High Voltage Tests (IEC 60255-6)

#### *High frequency interference test*

IEC 60255-22-1 class 3	Within one circuit	1 kV/2 s
	Circuit to earth	2.5 kV/2 s
	Circuit to circuit	2.5 kV/2 s

#### *Insulation voltage test*

IEC 60255-5 EN 50178	All circuits to other circuits and exposed conductive parts	2.5 kV (eff.)/50Hz, 1 min.
	Except interfaces	1,5 kV DC, 1 min.
	and Voltage measuring input	3 kV (eff.)/50 Hz, 1 min.

#### *Impulse voltage test*

IEC 60255-5	5 kV/0.5J, 1.2/50 $\mu$ s
-------------	---------------------------

\* = applies to MRU4

\*\* = applies to (MRA4, MRU4, MRI4, MRDT4, MRM4)

## EMC Immunity Tests

### *Fast transient disturbance immunity test (Burst)*

IEC 60255-22-4	Power supply, mains inputs	±4 kV, 2.5 kHz
IEC 61000-4-4 class 4	Other in- and outputs	±2 kV, 5 kHz

### *Surge immunity test*

IEC 61000-4-5 class 4	Within one circuit	2 kV
	Circuit to earth	4 kV
Class 3	Communication cables to earth	2 kV

### *Electrical discharge immunity test*

IEC 60255-22-2	Air discharge	8 kV
IEC 61000-4-2 class 3	Contact discharge	6 kV

### *Radiated radio-frequency electromagnetic field immunity test*

IEC 61000-4-3	26 MHz – 80 MHz	10 V/m
ANSI C37.90.2	80 MHz – 1 GHz	35 V/m
	1 GHz – 3 GHz	10 V/m

### *Immunity to conducted disturbances induced by radio frequency fields*

IEC 61000-4-6 class 3		10 V
--------------------------	--	------

### *Power frequency magnetic field immunity test*

IEC 61000-4-8 class 4	continues 3 sec	30 A/m 300 A/m
--------------------------	--------------------	-------------------

## EMC Emission Tests

### *Radio interference suppression test*

IEC/CISPR11		Limit value class B
-------------	--	---------------------

### *Radio interference radiation test*

IEC/CISPR11		Limit value class B
-------------	--	---------------------

## Environmental Tests

<i>Classification:</i> IEC 60068-1	Climatic classification	20/060/56
IEC 60721-3-1	Classification of ambient conditions (Storage)	1K5/1B1/1C1L/1S1/1M2 but min. -30°C
IEC 60721-3-2	Classification of ambient conditions (Transportation)	2K4/2B1/2C1/2S1/2M2 but min. -30°C
IEC 60721-3-3	Classification of ambient conditions (Stationary use at weather protected locations)	3K6/3B1/3C1/3S1/3M2 but min. -20°C/max +60°C
<i>Test Ad: Cold</i> IEC 60068-2-1	Temperature test duration	-20°C 16 h
<i>Test Ad: Cold</i> CEI 0-16* (IEC 60068-2-1)	Temperature test duration	-25°C 16 h
<i>Test Bd: Dry Heat</i> IEC 60068-2-2	Temperature Relative humidity test duration	60°C <50% 72 h
<i>Test Bd: Dry Heat</i> CEI 0-16* (IEC 60068-2-2)	Temperature Relative humidity test duration	70°C <50% 72 h
<i>Test Db: Damp Heat (cyclic)</i> IEC 60068-2-30	Temperature Relative humidity Cycles (12 + 12-hour)	60°C 95% 2

\* applies to MRU4 only

## Mechanical Tests

### *Test Fc: Vibration response test*

IEC 60068-2-6	(10 Hz – 59 Hz)	0.035 mm
IEC 60255-21-1	Displacement	
class 1	(59Hz – 150Hz)	0.5 gn
	Acceleration	
	Number of cycles in each axis	1

### *Test Fc: Vibration endurance test*

IEC 60068-2-6	(10 Hz – 150 Hz)	1.0 gn
IEC 60255-21-1	Acceleration	
class 1	Number of cycles in each axis	20

### *Test Ea: Shock tests*

IEC 60068-2-27	Shock response test	5 gn, 11 ms, 3 impulses in each direction
IEC 60255-21-2		
class 1	Shock resistance test	15 gn, 11 ms, 3 impulses in each direction

### *Test Eb: Shock endurance test*

IEC 60068-2-29	Shock endurance test	10 gn, 16 ms, 1000 impulses in each direction
IEC 60255-21-2		
class 1		

### *Test Fe: Earthquake test*

IEC 60068-3-3	Single axis earthquake vibration test	3 – 7 Hz: Horizontal 10 mm, 1 cycle each axis
KTA 3503		
IEC 60255-21-3		
class 2		7 – 35 Hz Horizontal: 2 gn, 1 cycle each axis

# Specifications

## Specifications of the Real Time Clock

Resolution:	1 ms
Tolerance:	<1 minute / month (+20°C [68°F]) <±1ms if synchronized via IRIG-B

## Time Synchronisation Tolerances

The different protocols for time synchronisation vary in their accuracy:

<b><i>Used Protocol</i></b>	<b><i>Time drift over one month</i></b>	<b><i>Deviation to time generator</i></b>
Without time synchronization	<1 min (+20°C)	Time drifts
IRIG-B	Dependent on the time drift of the time generator	<±1 ms
SNTP	Dependent on the time drift of the time generator	<±1 ms
IEC60870-5-103	Dependent on the time drift of the time generator	<±1 ms
Modbus TCP	Dependent on the time drift of the time generator	Dependent on the network load
Modbus RTU	Dependent on the time drift of the time generator	<±1 ms

## Specifications of the Measured Value Acquisition Phase and Ground Current Measuring

Frequency Range:	50 Hz / 60 Hz $\pm$ 10% <sup>*1)</sup>
Accuracy:	Class 0.5
Amplitude Error if $I < I_n$ :	$\pm$ 0.5% of the rated current <sup>*2) *3)</sup>
Amplitude Error if $I > I_n$ :	$\pm$ 0.5% of the measured current <sup>*2) *3)</sup>
Amplitude Error if $I > 2 I_n$ :	$\pm$ 1.0% of the measured current <sup>*2) *3)</sup>
Harmonics:	Up to 20% 3rd harmonic $\pm$ 2% Up to 20% 5th harmonic $\pm$ 2%
Frequency Influence:	$<\pm$ 2% / Hz in the range of $\pm$ 5 Hz of the configured nominal frequency
Temperature Influence:	$<\pm$ 1% within the range of 0°C to +60°C (+32°F to +140°F)

\*1) Wide frequency range (10..70Hz) is active outside 50Hz/60Hz  $\pm$ 10%. DFT values get more inaccurate, protective elements which have DFT values as input may be blocked automatically.

\*2) Accuracy for True RMS values in wide frequency range: 30...70Hz same accuracy like specified above.  $<$ 30Hz accuracy is  $<$ 3%. True RMS values are updated only every full cycle (period time).

\*3) For earth current sensitive the precision does not depend on the nominal value but is referenced to 100 mA (with  $I_n = 1$  A) respectively. 500 mA (with  $I_n = 5$  A)

## Phase-to-ground and Residual Voltage Measurement

Frequency Range:	50 Hz / 60 Hz $\pm$ 10% <sup>*1)</sup>
Accuracy for <u>measured</u> values:	Class 0.5
Amplitude error for $V < V_n$ :	$\pm$ 0.5% of rated voltage or $\pm$ 0.5 V <sup>*2)</sup>
Amplitude error for $V > V_n$ :	$\pm$ 0.5% of measured voltage or $\pm$ 0.5 V <sup>*2)</sup>
Accuracy for <u>calculated</u> values:	Class 1.0
Amplitude error for $V < V_n$ :	$\pm$ 1.0% of rated voltage or $\pm$ 1.0 V <sup>*2)</sup>
Amplitude error for $V > V_n$ :	$\pm$ 1.0% of calculated voltage or $\pm$ 1.0 V <sup>*2)</sup>
Harmonics:	Up to 20% 3rd harmonic $\pm$ 1% Up to 20% 5th harmonic $\pm$ 1%
Frequency influence:	$<\pm$ 2% / Hz in the range of $\pm$ 5 Hz of the configured nominal frequency
Temperature influence:	$<\pm$ 1% within the range of 0°C up to +60°C

\*1) Wide frequency range (10..70Hz) is active outside 50Hz/60Hz  $\pm$ 10%. DFT values get more inaccurate, protective elements which have DFT values as input may be blocked automatically.

\*2) Accuracy for True RMS values in wide frequency range: 30...70Hz same accuracy like specified above.  $<$ 30Hz accuracy is  $<$ 3%. True RMS values are updated only every full cycle (period time).

## Frequency measurement

Nominal frequency:	50 Hz / 60 Hz
Precision:	$\pm 0.05\%$ of $f_n$ within the range of 40-70 Hz at voltages $>50$ V
Voltage dependency:	frequency acquisition of 5 V – 800 V

## Energy measurement\*

Energy counter error	1.5% of measured energy or 1.5% $S_n \cdot 1h$
----------------------	--

## Power Measurement\*

S, P, Q:	$<\pm 1\%$ of the measured value or 0.1% $S_n$ (for fundamental) $<\pm 2\%$ of the measured value or 0.1% $S_n$ (for RMS)
----------	--

## Power Factor Measurement\*

PF:	$\pm 0.01$ of measured power factor or $1^\circ$ $I > 30\% I_n$ and $S > 2\% S_n$
-----	--

\*)Tolerance at  $0.8 \dots 1.2 \times V_n$  (with  $V_n=100V$ ),  $|PF|>0.5$ , at  $f_n$ , symmetrically feeded  
 $S_n=1.73 \cdot V_T \text{ rating} \cdot CT \text{ rating}$

## Protection Elements Accuracy

### NOTICE

The tripping delay relates to the time between alarm and trip.  
 The accuracy of the operating time relates to the time between fault entry and the time when the protection element is picked-up.

Reference conditions for all Protection Elements: sine wave, at rated frequency, THD < 1%

<b>Overcurrent Protection Elements:</b> <b>I[x]</b>	<b>Accuracy</b> <sup>*1) *2)</sup>
I>	±1.5% of the setting value or ±1% In
Dropout Ratio	97% or 0.5% In
t	DEFT ±1% or ±10 ms
Operating Time At testing current >= 2 times pickup value	<35ms (directional elements: <40ms)
Disengaging Time	<45ms
t-char	±5% (according to selected curve)
t-reset (Reset Mode = t-delay)	±1% or ±10 ms

<b>Overcurrent Protection Elements:</b> <b>I[x]</b> with selected Measuring method = I2 (Negative phase sequence current)	<b>Accuracy</b> <sup>*3)</sup>
I>	±2% of the setting value or ±1% In
Dropout Ratio	97% or 0.5% In
t	DEFT ±1% or ±10 ms
Operating Time At testing current >= 2 times pickup value	<60ms
Disengaging Time	<45ms

\*1) When RMS is selected and |f - fn| > 5Hz: operating and disengaging time < 4 cycles.

If f < 30Hz, pickup accuracy ±6% of the setting value or 5% In.

\*2) For directional elements, accuracy of MTA: ±3° at I > 20% In.

\*3) works only in frequency range |f - fn| < 5Hz.

<b>Ground Current Elements:</b> <b>IG[x]</b>	<b>Accuracy</b> <sup>*1) *2) *3)</sup>
IG>	±1.5% of the setting value or ±1% In
Dropout Ratio	97% or 0.5% x In
t	DEFT ±1% or ±10 ms
Operating time Starting from IG higher than 1.1 x IG>	<35ms (directional elements: <40ms)
Disengaging Time	<45ms
t-char	±5% (according to selected curve)
t-reset (Reset Mode = t-delay)	±1% or ±10 ms
VE>	±1.5% of the setting value or ±1% Vn
Dropout Ratio	97% or 0.5% Vn

\*1) When RMS is selected and |f - fn| > 5Hz: operating and disengaging time < 4 cycles.

If f < 30Hz, pickup accuracy < ±6% of the setting value or 5% In.

\*2) For directional elements, accuracy of MTA: ±3° at IG > 20% In.

\*3) For earth current sensitive the precision does not depend on the nominal value but is referenced to 100 mA (with In = 1 A) respectively 500 mA (with In = 5 A)



**NOTICE**

Because detection of direction is based on DFT values, direction elements works only in nominal range ( $fN \pm 5\text{Hz}$ ).

<b>Phase Directional Sensitivity: I[x]</b>	<b>Value</b>	<b>Release Level</b>	<b>Blocking Level</b>
I - V (3-phases)	I V	10 mA 0.35 V	5 mA 0.25 V

<b>Ground Directional Sensitivity: IG[x]</b>	<b>Value</b>	<b>Release Level</b>	<b>Blocking Level</b>
IG meas - 3V0	IG meas IG (sensitive) 3V0	10 mA 1 mA 0.35 V	5 mA 0.5 mA 0.25 V
IG calc - 3V0	IG calc 3V0	18 mA 1 V	11 mA 0.8 V
IG calc - Ipol (IG meas )	IG calc IG meas IG (sensitive)	18 mA 10 mA 1 mA	11 mA 5 mA 0.5 mA
IG meas - Neg, IG calc - Neg	I2 V2	10 mA 0.35 V	5 mA 0.25 V

<b>Thermal Replica: ThR</b>	<b>Accuracy</b>
Ib	$\pm 2\%$ of the setting value or 1% In
Alarm ThR	$\pm 1.5\%$ of the setting value

<b>Inrush Supervision: IH2</b>	<b>Accuracy</b>
IH2/IH1	$\pm 1\%$ In
Dropout Ratio	5% IH2 or 1% In
Operating Time	<30 ms <sup>*1)</sup>

\*1) Inrush supervision is possible, if the fundamental Harmonic (IH1) > 0.1 In and 2<sup>nd</sup> Harmonic (IH2) > 0.01 In.

<b>Current unbalance: I2&gt;[x]</b>	<b>Accuracy <sup>*1)</sup></b>
I2>	$\pm 2\%$ of the setting value or 1% In
Dropout Ratio	97% or 0.5% x In
%(I2/I1)	$\pm 1\%$
t	DEFT $\pm 1\%$ or $\pm 10$ ms
Operating Time	<60 ms
Disengaging Time	<40 ms
K	$\pm 5\%$ INV
T-cool	$\pm 5\%$ INV

\*1) Negative-sequence current I2 must be  $\geq 0.01 \times I_n$ , I1 must be  $\geq 0.1 \times I_n$ .

<b>Voltage Protection:</b> <b>V[x]</b>	<b>Accuracy <sup>*1)</sup></b>
Pickup	±1.5% of the setting value or 1% Vn
Dropout Ratio	97% or 0.5% Vn for V> 103% or 0.5% Vn for V<
t	DEFT ±1% or ±10 ms
Operating Time Starting from V higher than 1.1 x pickup value for V> or V lower than 0.9 x pickup value for V<	<35 ms
Disengaging Time	<45 ms

<b>Residual Voltage Protection:</b> <b>VG[x]</b>	<b>Accuracy <sup>*1)</sup></b>
Pickup	±1.5% of the setting value or 1% Vn
Dropout Ratio	97% or 0.5% Vn for VG> 103% or 0.5% Vn for VG<
t	DEFT ±1% or ±10 ms
Operating Time Starting from V higher than 1.1 x pickup value for VG> or V lower than 0.9 x pickup value for VG<	<35 ms
Disengaging Time	<45 ms

\*1) When RMS is selected and  $|f - fn| > 5\text{Hz}$ : operating and disengaging time < 4 cycles or ±1%.  
If  $f < 30\text{Hz}$ , pickup accuracy < ±6% of the setting value or 5% Vn.

<b>Low Voltage Ride Through Protection:</b> <b>LVRT</b>	<b>Accuracy <sup>*1)</sup></b>
Voltage Pickup (Start)	±1.5% of the setting value or 1% Vn
Voltage Dropout Ratio (Recover)	Adjustable, at least 0.5% Vn
Tripping time delay	±1% from settings or ±10 ms
Operating Time Starting from V lower than 0.9 x pickup value	<35 ms
Disengaging Time	<45 ms

\*1) When RMS is selected and  $|f - fn| > 5\text{Hz}$ : operating and disengaging time < 4 cycles or ±1%.  
If  $f < 30\text{Hz}$ , pickup accuracy < ±6% of the setting value or 5% Vn.

<b>Voltage unbalance:</b> <b>V012[x]</b>	<b>Accuracy <sup>*1)</sup></b>
Threshold	±2% of the setting value or 1% Vn
Dropout Ratio	97% or 0.5% x Vn for V1> or V2> 103% or 0.5% x Vn for V1<
%(V2/V1)	±1%
t	DEFT ±1% or ±10 ms
Operating Time	<60 ms
Disengaging Time	<40 ms

\*1) Negative-sequence voltage V2 must be  $\geq 0.01 \times Vn$ , V1 must be  $\geq 0.1 \times Vn$ .

Specifications

<b>Over Frequency Protection:</b> <b>f&gt;[x]</b>	<b>Accuracy <sup>1)</sup></b>
f>	±10 mHz at fn
Dropout ratio	99.95% or 0.05% fn
t	±1% or ±10 ms
Operating time Starting from f higher than f> + 0.02 Hz + 0.1 Hz + 2.0 Hz	< 100 ms typically 70 ms typically 50 ms
Disengaging time	< 120 ms

<sup>1)</sup> Accuracy is given for rated frequency fn±10%

<b>Under Frequency Protection:</b> <b>f&lt;[x]</b>	<b>Accuracy <sup>1)</sup></b>
f<	±10 mHz at fn
Dropout ratio	100.05% or 0.05% fn
t	±1% or ±10 ms
Operating time Starting from f lower than f< - 0.02 Hz - 0.1 Hz - 2.0 Hz	< 100 ms typically 70 ms typically 50 ms
Disengaging time	< 120 ms
V Block f	±1.5% of the setting value or 1% Vn
Dropout ratio	103% or 0.5% Vn

<sup>1)</sup> Accuracy is given for rated frequency fn±10%

<b>Rate of Change of Frequency:</b> <b>df/dt</b>	<b>Accuracy <sup>1)</sup></b>
df/dt	±0.1 Hz/s <sup>2)</sup>
t	±1% or ±10 ms
Operating time Starting from fn and df/dt > pickup + 0.1 Hz/s At df/dt > 2-times pick up At df/dt > 5-times pick up	< 200 ms typically <100 ms typically < 70 ms
Disengaging time	<120 ms

<sup>1)</sup> Accuracy is given for rated frequency fn±10%

<sup>2)</sup> 10% additional tolerance per Hz deviation from nominal frequency fn (e.g. at 45Hz, tolerance is 0.15Hz/s).

<b>Rate of Change of Frequency:</b> <b>DF/DT</b>	<b>Accuracy</b>
DF	±20 mHz at fn
DT	±1% or ±10 ms

<b>Vector surge:</b> <b>delta phi</b>	<b>Accuracy</b>
delta phi	±0.5° [1-30°] at Vn and fn
Operating time	<40 ms

<b>Power Factor:</b> <b>PF[x]</b>	<b>Accuracy</b>
Trigger-PF	± 0.01 (absolute) or ±1°
Reset-PF	± 0.01 (absolute) or ±1°
t-trip	±1% or ±10 ms
Operating time	<sup>*)</sup>
Measuring Method = Fundamental	<130 ms
Measuring Method = True RMS	<200 ms

<sup>1)</sup> The calculation of the Power Factor will be available 300 ms after the required measuring values (I > 2.5% In and V > 20% Vn) have energized the measuring inputs.

<b>Directional Power Protection: PQS[x] with Mode = S&gt; or S&lt;</b>	<b>Accuracy <sup>*1)</sup> <sup>*2)</sup></b>
Threshold	±3% or ±0.1% Sn
Dropout Ratio	97% or 1 VA for S> 103% or 1 VA for S<
t	±1% or ±10 ms
Operating time	75 ms
Disengaging time	75 ms

<b>Directional Power Protection: PQS[x] with Mode = P&gt; P&lt; or Pr&gt;/Pr&lt;</b>	<b>Accuracy <sup>*1)</sup> <sup>*2)</sup></b>
Threshold	±3% or ±0.1% Sn
Dropout Ratio	97% or 1 VA for P> and Pr> 103% or 1 VA for P< and Pr<  for setting values ≤ 0.1 Sn: 58% or 0.5 VA for P> and Pr> 142% or 0.5 VA for P< and Pr<  for setting values ≤ 0.01 Sn 58% or 0.2 VA for P> and Pr> 142% or 0.2 VA for P> and Pr>
t	±1% or ±10 ms
Operating time	75 ms
Disengaging time	75 ms

<b>Directional Power Protection: PQS[x] with Mode = Q&gt;/Q&lt; or Qr&gt;/Qr&lt;</b>	<b>Accuracy <sup>*1)</sup> <sup>*2)</sup></b>
Threshold	±3% or ±0.1% Sn
Dropout Ratio	97% or 1 VA for Q> and Qr> 103% or 1 VA for Q< and Qr<  for setting values ≤ 0.1 Sn: 58% or 0.5 VA for Q> and Qr> 142% or 0.5 VA for Q< and Qr<  for setting values ≤ 0.01 Sn 58% or 0.2 VA for Q> and Qr> 142% or 0.2 VA for Q> and Qr>
t	±1% or ±10 ms
Operating time	75 ms
Disengaging time	75 ms

\*1) Common reference conditions: at |PF|>0.5, symmetrically fed, at fn and 0.8 - 1.3 x Vn (Vn=100V)

\*2) If RMS is selected and |f - fn| > 5Hz: operating and disengaging time < 6 cycles or ±1%.

If f < 30Hz, pickup accuracy < ±6% of the setting value or 5% Sn. Q[x] protection elements may be blocked if |f - fn| > 5Hz.

If DFT is selected protection elements are blocked if |f - fn| > 5Hz

<b>Auto Reclosing: AR</b>	<b>Accuracy</b>
t (all timers)	±1% or ±20 ms

<b>Sync-Check: Sync</b>	<b>Accuracy</b>
Voltage measurement	±1.5% of the setting value or 1% Vn
Slip Frequency measurement	±20 mHz at fn
Angle measurement	±2°
Angle Compensation measurement	±4°
t (all timers)	±1% or ±10 ms

<b>Q-&gt;&amp;V&lt; / Decoupling</b>	<b>Tolerance</b>
I min QV	±1.5% of the setting value or ±1% In
Dropout Ratio	95%
VLL< QV	±1,5% of the setting value or ±1% Vn
Dropout Ratio	102% or 0.5% Vn
Phi-Power	±1°
Q min QV	±3% of the setting value or ±0.1% Sn
Dropout Ratio	95%
t1-QV	±1% or ±10 ms
t2-QV	±1% or ±10 ms
Operating Time	<40 ms
Disengaging Time	<40 ms

<b>Q-&gt;&amp;V&lt; / Reclosure</b>	<b>Tolerance</b>
VLL>	±1.5% of the setting value or ±1% Vn
Dropout Ratio	98% or 0.5% Vn
f<	±20 mHz at fn
Dropout Ratio	100.05% or 0.05% fn
f>	±20 mHz at fn
Dropout Ratio	99.95% or 0.05% fn
t1-Release	±1% or ±10 ms
Operating Time	<40 ms
Disengaging Time	<40 ms

<b>Switch onto Fault: SOTF</b>	<b>Accuracy</b>
Operating time	<35 ms
I<	±1.5% of the setting value or 1% In
t-enable	±1% or ±10 ms

<b>Cold Load Pickup: CLPU</b>	<b>Accuracy</b>
Threshold	±1.5% of the setting value or 1% In
Operating time	<35 ms
I<	±1.5% of the setting value or 1% In
t-Load OFF	±1% or ±15 ms
t-Max Block	±1% or ±15 ms
Settle Time	±1% or ±15 ms

Specifications

---

<b>Circuit Breaker Failure Protection: CBF</b>	<b>Accuracy</b>
I-CBF>	±1.5% of the setting value or 1% In
t-CBF	±1% or ±10 ms
Operating Time Starting from I Higher than 1.3 x I-CBF>	<40 ms
Disengaging Time	<40 ms

<b>Trip Circuit Supervision: TCS</b>	<b>Accuracy</b>
t-TCS	±1% or ±10 ms

<b>Current Transformer Supervision: CTS</b>	<b>Accuracy</b>
ΔI	±2% of the setting value or 1.5% In
Dropout Ratio	94%
Alarm delay	±1% or ± 10 ms

<b>Loss of Potential: LOP</b>	<b>Accuracy</b>
t-Pickup	±1% or ±10 ms

## Assignment List

The »ASSIGNMENT LIST« [below](#) summarizes all module outputs (signals) and inputs (e.g. states of the assignments).

<i>Name</i>	<i>Description</i>
--	No assignment
Prot.available	Signal: Protection is available
Prot.active	Signal: active
Prot.ExBlo	Signal: External Blocking
Prot.Blo TripCmd	Signal: Trip Command blocked
Prot.ExBlo TripCmd	Signal: External Blocking of the Trip Command
Prot.Alarm L1	Signal: General-Alarm L1
Prot.Alarm L2	Signal: General-Alarm L2
Prot.Alarm L3	Signal: General-Alarm L3
Prot.Alarm G	Signal: General-Alarm - Earth fault
Prot.Alarm	Signal: General Alarm
Prot.Trip L1	Signal: General Trip L1
Prot.Trip L2	Signal: General Trip L2
Prot.Trip L3	Signal: General Trip L3
Prot.Trip G	Signal: General Trip Ground fault
Prot.Trip	Signal: General Trip
Prot.Res Fault a Mains No	Signal: Resetting of fault number and number of grid faults.
Prot.I dir fwd	Signal: Phase current failure forward direction
Prot.I dir rev	Signal: Phase current failure reverse direction
Prot.I dir n poss	Signal: Phase fault - missing reference voltage
Prot.IG calc dir fwd	Signal: Ground fault (calculated) forward
Prot.IG calc rev dir	Signal: Ground fault (calculated) reverse direction
Prot.IG calc dir n poss	Signal: Ground fault (calculated) direction detection not possible
Prot.IG meas dir fwd	Signal: Ground fault (measured) forward
Prot.IG meas rev dir	Signal: Ground fault (measured) reverse direction
Prot.IG meas dir n poss	Signal: Ground fault (measured) direction detection not possible
Prot.f(VL123)<10Hz	Frequency of the measuring channels 1-3 (VL1,VL2,VL3) is lower than 10Hz.
Prot.f(VL123)>10Hz	Frequency of the measuring channels 1-3 (VL1,VL2,VL3) is greater than 10Hz.
Prot.f(VL123)<70Hz	Frequency of the measuring channels 1-3 (VL1,VL2,VL3) is lower than 70Hz.
Prot.f(VL123)>70Hz	Frequency of the measuring channels 1-3 (VL1,VL2,VL3) is greater than 70Hz.
Prot.DFT Invalid	DFT values of fundamental and harmonics (except VX) are not valid. They depend on period time of frequency and measured channels 1-3 (VL1,VL2,VL3).
Prot.DFT Valid	DFT values of fundamental and harmonics (except VX) are valid. They depend on period time of frequency and measured channels 1-3 (VL1,VL2,VL3).
Prot.f(VX)<10Hz	Frequency of the measuring channel 4 (VX) is lower than 10Hz.
Prot.f(VX)>10Hz	Frequency of the measuring channel 4 (VX) is greater than 10Hz.

## Assignment List

Name	Description
Prot.f(VX)<70Hz	Frequency of the measuring channel 4 (VX) is lower than 70Hz.
Prot.f(VX)>70Hz	Frequency of the measuring channel 4 (VX) is greater than 70Hz.
Prot.DFT Invalid (VX)	DFT values of fundamental and harmonics of VX (only) are not valid.
Prot.DFT Valid (VX)	DFT values of fundamental and harmonics of VX (only) are valid.
Prot.ExBlo1-I	Module input state: External blocking1
Prot.ExBlo2-I	Module input state: External blocking2
Prot.ExBlo TripCmd-I	Module input state: External Blocking of the Trip Command
Ctrl.Local	Switching Authority: Local
Ctrl.Remote	Switching Authority: Remote
Ctrl.NonInterl	Non-Interlocking is active
Ctrl.SG Indeterm	Minimum one Switchgear is moving (Position cannot be determined).
Ctrl.SG Disturb	Minimum one Switchgear is disturbed.
Ctrl.NonInterl-I	Non-Interlocking
SG[1].SI SingleContactInd	Signal: The Position of the Switchgear is detected by one auxiliary contact (pole) only. Thus indeterminate and disturbed Positions cannot be detected.
SG[1].Pos not ON	Signal: Pos not ON
SG[1].Pos ON	Signal: Circuit Breaker is in ON-Position
SG[1].Pos OFF	Signal: Circuit Breaker is in OFF-Position
SG[1].Pos Indeterm	Signal: Circuit Breaker is in Indeterminate Position
SG[1].Pos Disturb	Signal: Circuit Breaker Disturbed - Undefined Breaker Position. The Position Indicators contradict themselves. After expiring of a supervision timer this signal becomes true.
SG[1].Ready	Signal: Circuit breaker is ready for operation.
SG[1].t-Dwell	Signal: Dwell time
SG[1].Removed	Signal: The withdrawable circuit breaker is Removed
SG[1].Interl ON	Signal: One or more IL_On inputs are active.
SG[1].Interl OFF	Signal: One or more IL_Off inputs are active.
SG[1].CES succesf	Signal: Command Execution Supervision: Switching command executed successfully.
SG[1].CES Disturbed	Signal: Command Execution Supervision: Switching Command unsuccessful. Switchgear in disturbed position.
SG[1].CES Fail TripCmd	Signal: Command Execution Supervision: Command execution failed because trip command is pending.
SG[1].CES SwitchDir	Signal: Command Execution Supervision respectively Switching Direction Control: This signal becomes true, if a switch command is issued even though the switchgear is already in the requested position. Example: A switchgear that is already OFF should be switched OFF again (doubly). The same applies to CLOSE commands.
SG[1].CES ON d OFF	Signal: Command Execution Supervision: On Command during a pending OFF Command.
SG[1].CES SG not ready	Signal: Command Execution Supervision: Switchgear not ready
SG[1].CES Fiel Interl	Signal: Command Execution Supervision: Switching Command not executed because of field interlocking.
SG[1].CES SyncTimeout	Signal: Command Execution Supervision: Switching Command not executed. No Synchronization signal while t-sync was running.
SG[1].CES SG removed	Signal: Command Execution Supervision: Switching Command unsuccessful, Switchgear removed.
SG[1].Prot ON	Signal: ON Command issued by the Prot module
SG[1].TripCmd	Signal: Trip Command



## Assignment List

<i>Name</i>	<i>Description</i>
SG[1].Ack TripCmd	Signal: Acknowledge Trip Command
SG[1].ON incl Prot ON	Signal: The ON Command includes the ON Command issued by the Protection module.
SG[1].OFF incl TripCmd	Signal: The OFF Command includes the OFF Command issued by the Protection module.
SG[1].Position Ind manipul	Signal: Position Indicators faked
SG[1].SGwear Slow SG	Signal: Alarm, the circuit breaker (load-break switch) becomes slower
SG[1].Res SGwear SI SG	Signal: Resetting the slow Switchgear Alarm
SG[1].ON Cmd	Signal: ON Command issued to the switchgear. Depending on the setting the signal may include the ON command of the Prot module.
SG[1].OFF Cmd	Signal: OFF Command issued to the switchgear. Depending on the setting the signal may include the OFF command of the Prot module.
SG[1].ON Cmd manual	Signal: ON Cmd manual
SG[1].OFF Cmd manual	Signal: OFF Cmd manual
SG[1].Sync ON request	Signal: Synchronous ON request
SG[1].Aux ON-I	Module Input State: Position indicator/check-back signal of the CB (52a)
SG[1].Aux OFF-I	Module input state: Position indicator/check-back signal of the CB (52b)
SG[1].Ready-I	Module input state: CB ready
SG[1].Sys-in-Sync-I	State of the module input: This signals has to become true within the synchronization time. If not, switching is unsuccessful.
SG[1].Removed-I	State of the module input: The withdrawable circuit breaker is Removed
SG[1].Ack TripCmd-I	State of the module input: Acknowledgement Signal (only for automatic acknowledgement) Module input signal
SG[1].Interl ON1-I	State of the module input: Interlocking of the ON command
SG[1].Interl ON2-I	State of the module input: Interlocking of the ON command
SG[1].Interl ON3-I	State of the module input: Interlocking of the ON command
SG[1].Interl OFF1-I	State of the module input: Interlocking of the OFF command
SG[1].Interl OFF2-I	State of the module input: Interlocking of the OFF command
SG[1].Interl OFF3-I	State of the module input: Interlocking of the OFF command
SG[1].SCmd ON-I	State of the module input: Switching ON Command, e.g. the state of the Logics or the state of the digital input
SG[1].SCmd OFF-I	State of the module input: Switching OFF Command, e.g. the state of the Logics or the state of the digital input
SG[1].Operations Alarm	Signal: Service Alarm, too many Operations
SG[1].Isum Intr trip: IL1	Signal: Maximum permissible Summation of the interrupting (tripping) currents exceeded: IL1
SG[1].Isum Intr trip: IL2	Signal: Maximum permissible Summation of the interrupting (tripping) currents exceeded: IL2
SG[1].Isum Intr trip: IL3	Signal: Maximum permissible Summation of the interrupting (tripping) currents exceeded: IL3
SG[1].Isum Intr trip	Signal: Maximum permissible Summation of the interrupting (tripping) currents exceeded in at least one phase.
SG[1].Res TripCmd Cr	Signal: Resetting of the Counter: total number of trip commands
SG[1].Res Sum trip	Signal: Reset summation of the tripping currents
SG[1].WearLevel Alarm	Signal: Threshold for the Alarm
SG[1].WearLevel Lockout	Signal: Threshold for the Lockout Level
SG[1].Res SGwear Curve	Signal: Reset of the Circuit Breaker (load-break switch) Wear maintenance curve.

## Assignment List

<i>Name</i>	<i>Description</i>
SG[1].Isum Intr ph Alm	Signal: Alarm, the per hour Sum (Limit) of interrupting currents has been exceeded.
SG[1].Res Isum Intr ph Alm	Signal: Reset of the Alarm, "the per hour Sum (Limit) of interrupting currents has been exceeded".
SG[2].SI SingleContactInd	Signal: The Position of the Switchgear is detected by one auxiliary contact (pole) only. Thus indeterminate and disturbed Positions cannot be detected.
SG[2].Pos not ON	Signal: Pos not ON
SG[2].Pos ON	Signal: Circuit Breaker is in ON-Position
SG[2].Pos OFF	Signal: Circuit Breaker is in OFF-Position
SG[2].Pos Indeterm	Signal: Circuit Breaker is in Indeterminate Position
SG[2].Pos Disturb	Signal: Circuit Breaker Disturbed - Undefined Breaker Position. The Position Indicators contradict themselves. After expiring of a supervision timer this signal becomes true.
SG[2].Ready	Signal: Circuit breaker is ready for operation.
SG[2].t-Dwell	Signal: Dwell time
SG[2].Removed	Signal: The withdrawable circuit breaker is Removed
SG[2].Interl ON	Signal: One or more IL_On inputs are active.
SG[2].Interl OFF	Signal: One or more IL_Off inputs are active.
SG[2].CES succesf	Signal: Command Execution Supervision: Switching command executed successfully.
SG[2].CES Disturbed	Signal: Command Execution Supervision: Switching Command unsuccessful. Switchgear in disturbed position.
SG[2].CES Fail TripCmd	Signal: Command Execution Supervision: Command execution failed because trip command is pending.
SG[2].CES SwitchDir	Signal: Command Execution Supervision respectively Switching Direction Control: This signal becomes true, if a switch command is issued even though the switchgear is already in the requested position. Example: A switchgear that is already OFF should be switched OFF again (doubly). The same applies to CLOSE commands.
SG[2].CES ON d OFF	Signal: Command Execution Supervision: On Command during a pending OFF Command.
SG[2].CES SG not ready	Signal: Command Execution Supervision: Switchgear not ready
SG[2].CES Fiel Interl	Signal: Command Execution Supervision: Switching Command not executed because of field interlocking.
SG[2].CES SyncTimeout	Signal: Command Execution Supervision: Switching Command not executed. No Synchronization signal while t-sync was running.
SG[2].CES SG removed	Signal: Command Execution Supervision: Switching Command unsuccessful, Switchgear removed.
SG[2].Prot ON	Signal: ON Command issued by the Prot module
SG[2].TripCmd	Signal: Trip Command
SG[2].Ack TripCmd	Signal: Acknowledge Trip Command
SG[2].ON incl Prot ON	Signal: The ON Command includes the ON Command issued by the Protection module.
SG[2].OFF incl TripCmd	Signal: The OFF Command includes the OFF Command issued by the Protection module.
SG[2].Position Ind manipul	Signal: Position Indicators faked
SG[2].SGwear Slow SG	Signal: Alarm, the circuit breaker (load-break switch) becomes slower
SG[2].Res SGwear SI SG	Signal: Resetting the slow Switchgear Alarm
SG[2].ON Cmd	Signal: ON Command issued to the switchgear. Depending on the setting the signal may include the ON command of the Prot module.
SG[2].OFF Cmd	Signal: OFF Command issued to the switchgear. Depending on the setting the signal may include the OFF command of the Prot module.
SG[2].ON Cmd manual	Signal: ON Cmd manual
SG[2].OFF Cmd manual	Signal: OFF Cmd manual

## Assignment List

<i>Name</i>	<i>Description</i>
SG[2].Sync ON request	Signal: Synchronous ON request
SG[2].Aux ON-I	Module Input State: Position indicator/check-back signal of the CB (52a)
SG[2].Aux OFF-I	Module input state: Position indicator/check-back signal of the CB (52b)
SG[2].Ready-I	Module input state: CB ready
SG[2].Sys-in-Sync-I	State of the module input: This signals has to become true within the synchronization time. If not, switching is unsuccessful.
SG[2].Removed-I	State of the module input: The withdrawable circuit breaker is Removed
SG[2].Ack TripCmd-I	State of the module input: Acknowledgement Signal (only for automatic acknowledgement) Module input signal
SG[2].Interl ON1-I	State of the module input: Interlocking of the ON command
SG[2].Interl ON2-I	State of the module input: Interlocking of the ON command
SG[2].Interl ON3-I	State of the module input: Interlocking of the ON command
SG[2].Interl OFF1-I	State of the module input: Interlocking of the OFF command
SG[2].Interl OFF2-I	State of the module input: Interlocking of the OFF command
SG[2].Interl OFF3-I	State of the module input: Interlocking of the OFF command
SG[2].SCmd ON-I	State of the module input: Switching ON Command, e.g. the state of the Logics or the state of the digital input
SG[2].SCmd OFF-I	State of the module input: Switching OFF Command, e.g. the state of the Logics or the state of the digital input
SG[2].Operations Alarm	Signal: Service Alarm, too many Operations
SG[2].Isum Intr trip: IL1	Signal: Maximum permissible Summation of the interrupting (tripping) currents exceeded: IL1
SG[2].Isum Intr trip: IL2	Signal: Maximum permissible Summation of the interrupting (tripping) currents exceeded: IL2
SG[2].Isum Intr trip: IL3	Signal: Maximum permissible Summation of the interrupting (tripping) currents exceeded: IL3
SG[2].Isum Intr trip	Signal: Maximum permissible Summation of the interrupting (tripping) currents exceeded in at least one phase.
SG[2].Res TripCmd Cr	Signal: Resetting of the Counter: total number of trip commands
SG[2].Res Sum trip	Signal: Reset summation of the tripping currents
SG[2].WearLevel Alarm	Signal: Threshold for the Alarm
SG[2].WearLevel Lockout	Signal: Threshold for the Lockout Level
SG[2].Res SGwear Curve	Signal: Reset of the Circuit Breaker (load-break switch) Wear maintenance curve.
SG[2].Isum Intr ph Alm	Signal: Alarm, the per hour Sum (Limit) of interrupting currents has been exceeded.
SG[2].Res Isum Intr ph Alm	Signal: Reset of the Alarm, "the per hour Sum (Limit) of interrupting currents has been exceeded".
SG[3].SI SingleContactInd	Signal: The Position of the Switchgear is detected by one auxiliary contact (pole) only. Thus indeterminate and disturbed Positions cannot be detected.
SG[3].Pos not ON	Signal: Pos not ON
SG[3].Pos ON	Signal: Circuit Breaker is in ON-Position
SG[3].Pos OFF	Signal: Circuit Breaker is in OFF-Position
SG[3].Pos Indeterm	Signal: Circuit Breaker is in Indeterminate Position
SG[3].Pos Disturb	Signal: Circuit Breaker Disturbed - Undefined Breaker Position. The Position Indicators contradict themselves. After expiring of a supervision timer this signal becomes true.
SG[3].Ready	Signal: Circuit breaker is ready for operation.
SG[3].t-Dwell	Signal: Dwell time

## Assignment List

<i>Name</i>	<i>Description</i>
SG[3].Removed	Signal: The withdrawable circuit breaker is Removed
SG[3].Interl ON	Signal: One or more IL_On inputs are active.
SG[3].Interl OFF	Signal: One or more IL_Off inputs are active.
SG[3].CES succesf	Signal: Command Execution Supervision: Switching command executed successfully.
SG[3].CES Disturbed	Signal: Command Execution Supervision: Switching Command unsuccessful. Switchgear in disturbed position.
SG[3].CES Fail TripCmd	Signal: Command Execution Supervision: Command execution failed because trip command is pending.
SG[3].CES SwitchDir	Signal: Command Execution Supervision respectively Switching Direction Control: This signal becomes true, if a switch command is issued even though the switchgear is already in the requested position. Example: A switchgear that is already OFF should be switched OFF again (doubly). The same applies to CLOSE commands.
SG[3].CES ON d OFF	Signal: Command Execution Supervision: On Command during a pending OFF Command.
SG[3].CES SG not ready	Signal: Command Execution Supervision: Switchgear not ready
SG[3].CES Fiel Interl	Signal: Command Execution Supervision: Switching Command not executed because of field interlocking.
SG[3].CES SyncTimeout	Signal: Command Execution Supervision: Switching Command not executed. No Synchronization signal while t-sync was running.
SG[3].CES SG removed	Signal: Command Execution Supervision: Switching Command unsuccessful, Switchgear removed.
SG[3].Prot ON	Signal: ON Command issued by the Prot module
SG[3].TripCmd	Signal: Trip Command
SG[3].Ack TripCmd	Signal: Acknowledge Trip Command
SG[3].ON incl Prot ON	Signal: The ON Command includes the ON Command issued by the Protection module.
SG[3].OFF incl TripCmd	Signal: The OFF Command includes the OFF Command issued by the Protection module.
SG[3].Position Ind manipul	Signal: Position Indicators faked
SG[3].SGwear Slow SG	Signal: Alarm, the circuit breaker (load-break switch) becomes slower
SG[3].Res SGwear SI SG	Signal: Resetting the slow Switchgear Alarm
SG[3].ON Cmd	Signal: ON Command issued to the switchgear. Depending on the setting the signal may include the ON command of the Prot module.
SG[3].OFF Cmd	Signal: OFF Command issued to the switchgear. Depending on the setting the signal may include the OFF command of the Prot module.
SG[3].ON Cmd manual	Signal: ON Cmd manual
SG[3].OFF Cmd manual	Signal: OFF Cmd manual
SG[3].Sync ON request	Signal: Synchronous ON request
SG[3].Aux ON-I	Module Input State: Position indicator/check-back signal of the CB (52a)
SG[3].Aux OFF-I	Module input state: Position indicator/check-back signal of the CB (52b)
SG[3].Ready-I	Module input state: CB ready
SG[3].Sys-in-Sync-I	State of the module input: This signals has to become true within the synchronization time. If not, switching is unsuccessful.
SG[3].Removed-I	State of the module input: The withdrawable circuit breaker is Removed
SG[3].Ack TripCmd-I	State of the module input: Acknowledgement Signal (only for automatic acknowledgement) Module input signal
SG[3].Interl ON1-I	State of the module input: Interlocking of the ON command
SG[3].Interl ON2-I	State of the module input: Interlocking of the ON command
SG[3].Interl ON3-I	State of the module input: Interlocking of the ON command

## Assignment List

<i>Name</i>	<i>Description</i>
SG[3].Interl OFF1-I	State of the module input: Interlocking of the OFF command
SG[3].Interl OFF2-I	State of the module input: Interlocking of the OFF command
SG[3].Interl OFF3-I	State of the module input: Interlocking of the OFF command
SG[3].SCmd ON-I	State of the module input: Switching ON Command, e.g. the state of the Logics or the state of the digital input
SG[3].SCmd OFF-I	State of the module input: Switching OFF Command, e.g. the state of the Logics or the state of the digital input
SG[3].Operations Alarm	Signal: Service Alarm, too many Operations
SG[3].Isum Intr trip: IL1	Signal: Maximum permissible Summation of the interrupting (tripping) currents exceeded: IL1
SG[3].Isum Intr trip: IL2	Signal: Maximum permissible Summation of the interrupting (tripping) currents exceeded: IL2
SG[3].Isum Intr trip: IL3	Signal: Maximum permissible Summation of the interrupting (tripping) currents exceeded: IL3
SG[3].Isum Intr trip	Signal: Maximum permissible Summation of the interrupting (tripping) currents exceeded in at least one phase.
SG[3].Res TripCmd Cr	Signal: Resetting of the Counter: total number of trip commands
SG[3].Res Sum trip	Signal: Reset summation of the tripping currents
SG[3].WearLevel Alarm	Signal: Threshold for the Alarm
SG[3].WearLevel Lockout	Signal: Threshold for the Lockout Level
SG[3].Res SGwear Curve	Signal: Reset of the Circuit Breaker (load-break switch) Wear maintenance curve.
SG[3].Isum Intr ph Alm	Signal: Alarm, the per hour Sum (Limit) of interrupting currents has been exceeded.
SG[3].Res Isum Intr ph Alm	Signal: Reset of the Alarm, "the per hour Sum (Limit) of interrupting currents has been exceeded".
SG[4].SI SingleContactInd	Signal: The Position of the Switchgear is detected by one auxiliary contact (pole) only. Thus indeterminate and disturbed Positions cannot be detected.
SG[4].Pos not ON	Signal: Pos not ON
SG[4].Pos ON	Signal: Circuit Breaker is in ON-Position
SG[4].Pos OFF	Signal: Circuit Breaker is in OFF-Position
SG[4].Pos Indeterm	Signal: Circuit Breaker is in Indeterminate Position
SG[4].Pos Disturb	Signal: Circuit Breaker Disturbed - Undefined Breaker Position. The Position Indicators contradict themselves. After expiring of a supervision timer this signal becomes true.
SG[4].Ready	Signal: Circuit breaker is ready for operation.
SG[4].t-Dwell	Signal: Dwell time
SG[4].Removed	Signal: The withdrawable circuit breaker is Removed
SG[4].Interl ON	Signal: One or more IL_On inputs are active.
SG[4].Interl OFF	Signal: One or more IL_Off inputs are active.
SG[4].CES succesf	Signal: Command Execution Supervision: Switching command executed successfully.
SG[4].CES Disturbed	Signal: Command Execution Supervision: Switching Command unsuccessful. Switchgear in disturbed position.
SG[4].CES Fail TripCmd	Signal: Command Execution Supervision: Command execution failed because trip command is pending.
SG[4].CES SwitchDir	Signal: Command Execution Supervision respectively Switching Direction Control: This signal becomes true, if a switch command is issued even though the switchgear is already in the requested position. Example: A switchgear that is already OFF should be switched OFF again (doubly). The same applies to CLOSE commands.
SG[4].CES ON d OFF	Signal: Command Execution Supervision: On Command during a pending OFF Command.
SG[4].CES SG not ready	Signal: Command Execution Supervision: Switchgear not ready

## Assignment List

<i>Name</i>	<i>Description</i>
SG[4].CES Fiel Interl	Signal: Command Execution Supervision: Switching Command not executed because of field interlocking.
SG[4].CES SyncTimeout	Signal: Command Execution Supervision: Switching Command not executed. No Synchronization signal while t-sync was running.
SG[4].CES SG removed	Signal: Command Execution Supervision: Switching Command unsuccessful, Switchgear removed.
SG[4].Prot ON	Signal: ON Command issued by the Prot module
SG[4].TripCmd	Signal: Trip Command
SG[4].Ack TripCmd	Signal: Acknowledge Trip Command
SG[4].ON incl Prot ON	Signal: The ON Command includes the ON Command issued by the Protection module.
SG[4].OFF incl TripCmd	Signal: The OFF Command includes the OFF Command issued by the Protection module.
SG[4].Position Ind manipul	Signal: Position Indicators faked
SG[4].SGwear Slow SG	Signal: Alarm, the circuit breaker (load-break switch) becomes slower
SG[4].Res SGwear SI SG	Signal: Resetting the slow Switchgear Alarm
SG[4].ON Cmd	Signal: ON Command issued to the switchgear. Depending on the setting the signal may include the ON command of the Prot module.
SG[4].OFF Cmd	Signal: OFF Command issued to the switchgear. Depending on the setting the signal may include the OFF command of the Prot module.
SG[4].ON Cmd manual	Signal: ON Cmd manual
SG[4].OFF Cmd manual	Signal: OFF Cmd manual
SG[4].Sync ON request	Signal: Synchronous ON request
SG[4].Aux ON-I	Module Input State: Position indicator/check-back signal of the CB (52a)
SG[4].Aux OFF-I	Module input state: Position indicator/check-back signal of the CB (52b)
SG[4].Ready-I	Module input state: CB ready
SG[4].Sys-in-Sync-I	State of the module input: This signals has to become true within the synchronization time. If not, switching is unsuccessful.
SG[4].Removed-I	State of the module input: The withdrawable circuit breaker is Removed
SG[4].Ack TripCmd-I	State of the module input: Acknowledgement Signal (only for automatic acknowledgement) Module input signal
SG[4].Interl ON1-I	State of the module input: Interlocking of the ON command
SG[4].Interl ON2-I	State of the module input: Interlocking of the ON command
SG[4].Interl ON3-I	State of the module input: Interlocking of the ON command
SG[4].Interl OFF1-I	State of the module input: Interlocking of the OFF command
SG[4].Interl OFF2-I	State of the module input: Interlocking of the OFF command
SG[4].Interl OFF3-I	State of the module input: Interlocking of the OFF command
SG[4].SCmd ON-I	State of the module input: Switching ON Command, e.g. the state of the Logics or the state of the digital input
SG[4].SCmd OFF-I	State of the module input: Switching OFF Command, e.g. the state of the Logics or the state of the digital input
SG[4].Operations Alarm	Signal: Service Alarm, too many Operations
SG[4].Isum Intr trip: IL1	Signal: Maximum permissible Summation of the interrupting (tripping) currents exceeded: IL1
SG[4].Isum Intr trip: IL2	Signal: Maximum permissible Summation of the interrupting (tripping) currents exceeded: IL2
SG[4].Isum Intr trip: IL3	Signal: Maximum permissible Summation of the interrupting (tripping) currents exceeded: IL3



## Assignment List

<i>Name</i>	<i>Description</i>
SG[4].Isum Intr trip	Signal: Maximum permissible Summation of the interrupting (tripping) currents exceeded in at least one phase.
SG[4].Res TripCmd Cr	Signal: Resetting of the Counter: total number of trip commands
SG[4].Res Sum trip	Signal: Reset summation of the tripping currents
SG[4].WearLevel Alarm	Signal: Threshold for the Alarm
SG[4].WearLevel Lockout	Signal: Threshold for the Lockout Level
SG[4].Res SGwear Curve	Signal: Reset of the Circuit Breaker (load-break switch) Wear maintenance curve.
SG[4].Isum Intr ph Alm	Signal: Alarm, the per hour Sum (Limit) of interrupting currents has been exceeded.
SG[4].Res Isum Intr ph Alm	Signal: Reset of the Alarm, "the per hour Sum (Limit) of interrupting currents has been exceeded".
SG[5].SI SingleContactInd	Signal: The Position of the Switchgear is detected by one auxiliary contact (pole) only. Thus indeterminate and disturbed Positions cannot be detected.
SG[5].Pos not ON	Signal: Pos not ON
SG[5].Pos ON	Signal: Circuit Breaker is in ON-Position
SG[5].Pos OFF	Signal: Circuit Breaker is in OFF-Position
SG[5].Pos Indeterm	Signal: Circuit Breaker is in Indeterminate Position
SG[5].Pos Disturb	Signal: Circuit Breaker Disturbed - Undefined Breaker Position. The Position Indicators contradict themselves. After expiring of a supervision timer this signal becomes true.
SG[5].Ready	Signal: Circuit breaker is ready for operation.
SG[5].t-Dwell	Signal: Dwell time
SG[5].Removed	Signal: The withdrawable circuit breaker is Removed
SG[5].Interl ON	Signal: One or more IL_On inputs are active.
SG[5].Interl OFF	Signal: One or more IL_Off inputs are active.
SG[5].CES succesf	Signal: Command Execution Supervision: Switching command executed successfully.
SG[5].CES Disturbed	Signal: Command Execution Supervision: Switching Command unsuccessful. Switchgear in disturbed position.
SG[5].CES Fail TripCmd	Signal: Command Execution Supervision: Command execution failed because trip command is pending.
SG[5].CES SwitchDir	Signal: Command Execution Supervision respectively Switching Direction Control: This signal becomes true, if a switch command is issued even though the switchgear is already in the requested position. Example: A switchgear that is already OFF should be switched OFF again (doubly). The same applies to CLOSE commands.
SG[5].CES ON d OFF	Signal: Command Execution Supervision: On Command during a pending OFF Command.
SG[5].CES SG not ready	Signal: Command Execution Supervision: Switchgear not ready
SG[5].CES Fiel Interl	Signal: Command Execution Supervision: Switching Command not executed because of field interlocking.
SG[5].CES SyncTimeout	Signal: Command Execution Supervision: Switching Command not executed. No Synchronization signal while t-sync was running.
SG[5].CES SG removed	Signal: Command Execution Supervision: Switching Command unsuccessful, Switchgear removed.
SG[5].Prot ON	Signal: ON Command issued by the Prot module
SG[5].TripCmd	Signal: Trip Command
SG[5].Ack TripCmd	Signal: Acknowledge Trip Command
SG[5].ON incl Prot ON	Signal: The ON Command includes the ON Command issued by the Protection module.
SG[5].OFF incl TripCmd	Signal: The OFF Command includes the OFF Command issued by the Protection module.
SG[5].Position Ind manipul	Signal: Position Indicators faked

## Assignment List

<i>Name</i>	<i>Description</i>
SG[5].SGwear Slow SG	Signal: Alarm, the circuit breaker (load-break switch) becomes slower
SG[5].Res SGwear SI SG	Signal: Resetting the slow Switchgear Alarm
SG[5].ON Cmd	Signal: ON Command issued to the switchgear. Depending on the setting the signal may include the ON command of the Prot module.
SG[5].OFF Cmd	Signal: OFF Command issued to the switchgear. Depending on the setting the signal may include the OFF command of the Prot module.
SG[5].ON Cmd manual	Signal: ON Cmd manual
SG[5].OFF Cmd manual	Signal: OFF Cmd manual
SG[5].Sync ON request	Signal: Synchronous ON request
SG[5].Aux ON-I	Module Input State: Position indicator/check-back signal of the CB (52a)
SG[5].Aux OFF-I	Module input state: Position indicator/check-back signal of the CB (52b)
SG[5].Ready-I	Module input state: CB ready
SG[5].Sys-in-Sync-I	State of the module input: This signals has to become true within the synchronization time. If not, switching is unsuccessful.
SG[5].Removed-I	State of the module input: The withdrawable circuit breaker is Removed
SG[5].Ack TripCmd-I	State of the module input: Acknowledgement Signal (only for automatic acknowledgement) Module input signal
SG[5].Interl ON1-I	State of the module input: Interlocking of the ON command
SG[5].Interl ON2-I	State of the module input: Interlocking of the ON command
SG[5].Interl ON3-I	State of the module input: Interlocking of the ON command
SG[5].Interl OFF1-I	State of the module input: Interlocking of the OFF command
SG[5].Interl OFF2-I	State of the module input: Interlocking of the OFF command
SG[5].Interl OFF3-I	State of the module input: Interlocking of the OFF command
SG[5].SCmd ON-I	State of the module input: Switching ON Command, e.g. the state of the Logics or the state of the digital input
SG[5].SCmd OFF-I	State of the module input: Switching OFF Command, e.g. the state of the Logics or the state of the digital input
SG[5].Operations Alarm	Signal: Service Alarm, too many Operations
SG[5].Isum Intr trip: IL1	Signal: Maximum permissible Summation of the interrupting (tripping) currents exceeded: IL1
SG[5].Isum Intr trip: IL2	Signal: Maximum permissible Summation of the interrupting (tripping) currents exceeded: IL2
SG[5].Isum Intr trip: IL3	Signal: Maximum permissible Summation of the interrupting (tripping) currents exceeded: IL3
SG[5].Isum Intr trip	Signal: Maximum permissible Summation of the interrupting (tripping) currents exceeded in at least one phase.
SG[5].Res TripCmd Cr	Signal: Resetting of the Counter: total number of trip commands
SG[5].Res Sum trip	Signal: Reset summation of the tripping currents
SG[5].WearLevel Alarm	Signal: Threshold for the Alarm
SG[5].WearLevel Lockout	Signal: Threshold for the Lockout Level
SG[5].Res SGwear Curve	Signal: Reset of the Circuit Breaker (load-break switch) Wear maintenance curve.
SG[5].Isum Intr ph Alm	Signal: Alarm, the per hour Sum (Limit) of interrupting currents has been exceeded.
SG[5].Res Isum Intr ph Alm	Signal: Reset of the Alarm, "the per hour Sum (Limit) of interrupting currents has been exceeded".
SG[6].SI SingleContactInd	Signal: The Position of the Switchgear is detected by one auxiliary contact (pole) only. Thus indeterminate and disturbed Positions cannot be detected.



## Assignment List

<i>Name</i>	<i>Description</i>
SG[6].Pos not ON	Signal: Pos not ON
SG[6].Pos ON	Signal: Circuit Breaker is in ON-Position
SG[6].Pos OFF	Signal: Circuit Breaker is in OFF-Position
SG[6].Pos Indeterm	Signal: Circuit Breaker is in Indeterminate Position
SG[6].Pos Disturb	Signal: Circuit Breaker Disturbed - Undefined Breaker Position. The Position Indicators contradict themselves. After expiring of a supervision timer this signal becomes true.
SG[6].Ready	Signal: Circuit breaker is ready for operation.
SG[6].t-Dwell	Signal: Dwell time
SG[6].Removed	Signal: The withdrawable circuit breaker is Removed
SG[6].Interl ON	Signal: One or more IL_On inputs are active.
SG[6].Interl OFF	Signal: One or more IL_Off inputs are active.
SG[6].CES succesf	Signal: Command Execution Supervision: Switching command executed successfully.
SG[6].CES Disturbed	Signal: Command Execution Supervision: Switching Command unsuccessful. Switchgear in disturbed position.
SG[6].CES Fail TripCmd	Signal: Command Execution Supervision: Command execution failed because trip command is pending.
SG[6].CES SwitchDir	Signal: Command Execution Supervision respectively Switching Direction Control: This signal becomes true, if a switch command is issued even though the switchgear is already in the requested position. Example: A switchgear that is already OFF should be switched OFF again (doubly). The same applies to CLOSE commands.
SG[6].CES ON d OFF	Signal: Command Execution Supervision: On Command during a pending OFF Command.
SG[6].CES SG not ready	Signal: Command Execution Supervision: Switchgear not ready
SG[6].CES Fiel Interl	Signal: Command Execution Supervision: Switching Command not executed because of field interlocking.
SG[6].CES SyncTimeout	Signal: Command Execution Supervision: Switching Command not executed. No Synchronization signal while t-sync was running.
SG[6].CES SG removed	Signal: Command Execution Supervision: Switching Command unsuccessful, Switchgear removed.
SG[6].Prot ON	Signal: ON Command issued by the Prot module
SG[6].TripCmd	Signal: Trip Command
SG[6].Ack TripCmd	Signal: Acknowledge Trip Command
SG[6].ON incl Prot ON	Signal: The ON Command includes the ON Command issued by the Protection module.
SG[6].OFF incl TripCmd	Signal: The OFF Command includes the OFF Command issued by the Protection module.
SG[6].Position Ind manipul	Signal: Position Indicators faked
SG[6].SGwear Slow SG	Signal: Alarm, the circuit breaker (load-break switch) becomes slower
SG[6].Res SGwear SI SG	Signal: Resetting the slow Switchgear Alarm
SG[6].ON Cmd	Signal: ON Command issued to the switchgear. Depending on the setting the signal may include the ON command of the Prot module.
SG[6].OFF Cmd	Signal: OFF Command issued to the switchgear. Depending on the setting the signal may include the OFF command of the Prot module.
SG[6].ON Cmd manual	Signal: ON Cmd manual
SG[6].OFF Cmd manual	Signal: OFF Cmd manual
SG[6].Sync ON request	Signal: Synchronous ON request
SG[6].Aux ON-I	Module Input State: Position indicator/check-back signal of the CB (52a)
SG[6].Aux OFF-I	Module input state: Position indicator/check-back signal of the CB (52b)

## Assignment List

<i>Name</i>	<i>Description</i>
SG[6].Ready-I	Module input state: CB ready
SG[6].Sys-in-Sync-I	State of the module input: This signals has to become true within the synchronization time. If not, switching is unsuccessful.
SG[6].Removed-I	State of the module input: The withdrawable circuit breaker is Removed
SG[6].Ack TripCmd-I	State of the module input: Acknowledgement Signal (only for automatic acknowledgement) Module input signal
SG[6].Interl ON1-I	State of the module input: Interlocking of the ON command
SG[6].Interl ON2-I	State of the module input: Interlocking of the ON command
SG[6].Interl ON3-I	State of the module input: Interlocking of the ON command
SG[6].Interl OFF1-I	State of the module input: Interlocking of the OFF command
SG[6].Interl OFF2-I	State of the module input: Interlocking of the OFF command
SG[6].Interl OFF3-I	State of the module input: Interlocking of the OFF command
SG[6].SCmd ON-I	State of the module input: Switching ON Command, e.g. the state of the Logics or the state of the digital input
SG[6].SCmd OFF-I	State of the module input: Switching OFF Command, e.g. the state of the Logics or the state of the digital input
SG[6].Operations Alarm	Signal: Service Alarm, too many Operations
SG[6].Isum Intr trip: IL1	Signal: Maximum permissible Summation of the interrupting (tripping) currents exceeded: IL1
SG[6].Isum Intr trip: IL2	Signal: Maximum permissible Summation of the interrupting (tripping) currents exceeded: IL2
SG[6].Isum Intr trip: IL3	Signal: Maximum permissible Summation of the interrupting (tripping) currents exceeded: IL3
SG[6].Isum Intr trip	Signal: Maximum permissible Summation of the interrupting (tripping) currents exceeded in at least one phase.
SG[6].Res TripCmd Cr	Signal: Resetting of the Counter: total number of trip commands
SG[6].Res Sum trip	Signal: Reset summation of the tripping currents
SG[6].WearLevel Alarm	Signal: Threshold for the Alarm
SG[6].WearLevel Lockout	Signal: Threshold for the Lockout Level
SG[6].Res SGwear Curve	Signal: Reset of the Circuit Breaker (load-break switch) Wear maintenance curve.
SG[6].Isum Intr ph Alm	Signal: Alarm, the per hour Sum (Limit) of interrupting currents has been exceeded.
SG[6].Res Isum Intr ph Alm	Signal: Reset of the Alarm, "the per hour Sum (Limit) of interrupting currents has been exceeded".
I[1].active	Signal: active
I[1].ExBlo	Signal: External Blocking
I[1].Ex rev Interl	Signal: External reverse Interlocking
I[1].Blo TripCmd	Signal: Trip Command blocked
I[1].ExBlo TripCmd	Signal: External Blocking of the Trip Command
I[1].IH2 Blo	Signal: Blocking the trip command by an inrush
I[1].Alarm L1	Signal: Alarm L1
I[1].Alarm L2	Signal: Alarm L2
I[1].Alarm L3	Signal: Alarm L3
I[1].Alarm	Signal: Alarm
I[1].Trip L1	Signal: General Trip Phase L1
I[1].Trip L2	Signal: General Trip Phase L2

## Assignment List

<i>Name</i>	<i>Description</i>
I[1].Trip L3	Signal: General Trip Phase L3
I[1].Trip	Signal: Trip
I[1].TripCmd	Signal: Trip Command
I[1].DefaultSet	Signal: Default Parameter Set
I[1].AdaptSet 1	Signal: Adaptive Parameter 1
I[1].AdaptSet 2	Signal: Adaptive Parameter 2
I[1].AdaptSet 3	Signal: Adaptive Parameter 3
I[1].AdaptSet 4	Signal: Adaptive Parameter 4
I[1].ExBlo1-I	Module input state: External blocking1
I[1].ExBlo2-I	Module input state: External blocking2
I[1].ExBlo TripCmd-I	Module input state: External Blocking of the Trip Command
I[1].Ex rev Interl-I	Module input state: External reverse interlocking
I[1].AdaptSet1-I	Module input state: Adaptive Parameter1
I[1].AdaptSet2-I	Module input state: Adaptive Parameter2
I[1].AdaptSet3-I	Module input state: Adaptive Parameter3
I[1].AdaptSet4-I	Module input state: Adaptive Parameter4
I[2].active	Signal: active
I[2].ExBlo	Signal: External Blocking
I[2].Ex rev Interl	Signal: External reverse Interlocking
I[2].Blo TripCmd	Signal: Trip Command blocked
I[2].ExBlo TripCmd	Signal: External Blocking of the Trip Command
I[2].IH2 Blo	Signal: Blocking the trip command by an inrush
I[2].Alarm L1	Signal: Alarm L1
I[2].Alarm L2	Signal: Alarm L2
I[2].Alarm L3	Signal: Alarm L3
I[2].Alarm	Signal: Alarm
I[2].Trip L1	Signal: General Trip Phase L1
I[2].Trip L2	Signal: General Trip Phase L2
I[2].Trip L3	Signal: General Trip Phase L3
I[2].Trip	Signal: Trip
I[2].TripCmd	Signal: Trip Command
I[2].DefaultSet	Signal: Default Parameter Set
I[2].AdaptSet 1	Signal: Adaptive Parameter 1
I[2].AdaptSet 2	Signal: Adaptive Parameter 2
I[2].AdaptSet 3	Signal: Adaptive Parameter 3
I[2].AdaptSet 4	Signal: Adaptive Parameter 4
I[2].ExBlo1-I	Module input state: External blocking1
I[2].ExBlo2-I	Module input state: External blocking2
I[2].ExBlo TripCmd-I	Module input state: External Blocking of the Trip Command
I[2].Ex rev Interl-I	Module input state: External reverse interlocking

## Assignment List

<i>Name</i>	<i>Description</i>
I[2].AdaptSet1-I	Module input state: Adaptive Parameter1
I[2].AdaptSet2-I	Module input state: Adaptive Parameter2
I[2].AdaptSet3-I	Module input state: Adaptive Parameter3
I[2].AdaptSet4-I	Module input state: Adaptive Parameter4
I[3].active	Signal: active
I[3].ExBlo	Signal: External Blocking
I[3].Ex rev Interl	Signal: External reverse Interlocking
I[3].Blo TripCmd	Signal: Trip Command blocked
I[3].ExBlo TripCmd	Signal: External Blocking of the Trip Command
I[3].IH2 Blo	Signal: Blocking the trip command by an inrush
I[3].Alarm L1	Signal: Alarm L1
I[3].Alarm L2	Signal: Alarm L2
I[3].Alarm L3	Signal: Alarm L3
I[3].Alarm	Signal: Alarm
I[3].Trip L1	Signal: General Trip Phase L1
I[3].Trip L2	Signal: General Trip Phase L2
I[3].Trip L3	Signal: General Trip Phase L3
I[3].Trip	Signal: Trip
I[3].TripCmd	Signal: Trip Command
I[3].DefaultSet	Signal: Default Parameter Set
I[3].AdaptSet 1	Signal: Adaptive Parameter 1
I[3].AdaptSet 2	Signal: Adaptive Parameter 2
I[3].AdaptSet 3	Signal: Adaptive Parameter 3
I[3].AdaptSet 4	Signal: Adaptive Parameter 4
I[3].ExBlo1-I	Module input state: External blocking1
I[3].ExBlo2-I	Module input state: External blocking2
I[3].ExBlo TripCmd-I	Module input state: External Blocking of the Trip Command
I[3].Ex rev Interl-I	Module input state: External reverse interlocking
I[3].AdaptSet1-I	Module input state: Adaptive Parameter1
I[3].AdaptSet2-I	Module input state: Adaptive Parameter2
I[3].AdaptSet3-I	Module input state: Adaptive Parameter3
I[3].AdaptSet4-I	Module input state: Adaptive Parameter4
I[4].active	Signal: active
I[4].ExBlo	Signal: External Blocking
I[4].Ex rev Interl	Signal: External reverse Interlocking
I[4].Blo TripCmd	Signal: Trip Command blocked
I[4].ExBlo TripCmd	Signal: External Blocking of the Trip Command
I[4].IH2 Blo	Signal: Blocking the trip command by an inrush
I[4].Alarm L1	Signal: Alarm L1
I[4].Alarm L2	Signal: Alarm L2

## Assignment List

<i>Name</i>	<i>Description</i>
I[4].Alarm L3	Signal: Alarm L3
I[4].Alarm	Signal: Alarm
I[4].Trip L1	Signal: General Trip Phase L1
I[4].Trip L2	Signal: General Trip Phase L2
I[4].Trip L3	Signal: General Trip Phase L3
I[4].Trip	Signal: Trip
I[4].TripCmd	Signal: Trip Command
I[4].DefaultSet	Signal: Default Parameter Set
I[4].AdaptSet 1	Signal: Adaptive Parameter 1
I[4].AdaptSet 2	Signal: Adaptive Parameter 2
I[4].AdaptSet 3	Signal: Adaptive Parameter 3
I[4].AdaptSet 4	Signal: Adaptive Parameter 4
I[4].ExBlo1-I	Module input state: External blocking1
I[4].ExBlo2-I	Module input state: External blocking2
I[4].ExBlo TripCmd-I	Module input state: External Blocking of the Trip Command
I[4].Ex rev Interl-I	Module input state: External reverse interlocking
I[4].AdaptSet1-I	Module input state: Adaptive Parameter1
I[4].AdaptSet2-I	Module input state: Adaptive Parameter2
I[4].AdaptSet3-I	Module input state: Adaptive Parameter3
I[4].AdaptSet4-I	Module input state: Adaptive Parameter4
I[5].active	Signal: active
I[5].ExBlo	Signal: External Blocking
I[5].Ex rev Interl	Signal: External reverse Interlocking
I[5].Blo TripCmd	Signal: Trip Command blocked
I[5].ExBlo TripCmd	Signal: External Blocking of the Trip Command
I[5].IH2 Blo	Signal: Blocking the trip command by an inrush
I[5].Alarm L1	Signal: Alarm L1
I[5].Alarm L2	Signal: Alarm L2
I[5].Alarm L3	Signal: Alarm L3
I[5].Alarm	Signal: Alarm
I[5].Trip L1	Signal: General Trip Phase L1
I[5].Trip L2	Signal: General Trip Phase L2
I[5].Trip L3	Signal: General Trip Phase L3
I[5].Trip	Signal: Trip
I[5].TripCmd	Signal: Trip Command
I[5].DefaultSet	Signal: Default Parameter Set
I[5].AdaptSet 1	Signal: Adaptive Parameter 1
I[5].AdaptSet 2	Signal: Adaptive Parameter 2
I[5].AdaptSet 3	Signal: Adaptive Parameter 3
I[5].AdaptSet 4	Signal: Adaptive Parameter 4

## Assignment List

<i>Name</i>	<i>Description</i>
I[5].ExBlo1-I	Module input state: External blocking1
I[5].ExBlo2-I	Module input state: External blocking2
I[5].ExBlo TripCmd-I	Module input state: External Blocking of the Trip Command
I[5].Ex rev Interl-I	Module input state: External reverse interlocking
I[5].AdaptSet1-I	Module input state: Adaptive Parameter1
I[5].AdaptSet2-I	Module input state: Adaptive Parameter2
I[5].AdaptSet3-I	Module input state: Adaptive Parameter3
I[5].AdaptSet4-I	Module input state: Adaptive Parameter4
I[6].active	Signal: active
I[6].ExBlo	Signal: External Blocking
I[6].Ex rev Interl	Signal: External reverse Interlocking
I[6].Blo TripCmd	Signal: Trip Command blocked
I[6].ExBlo TripCmd	Signal: External Blocking of the Trip Command
I[6].IH2 Blo	Signal: Blocking the trip command by an inrush
I[6].Alarm L1	Signal: Alarm L1
I[6].Alarm L2	Signal: Alarm L2
I[6].Alarm L3	Signal: Alarm L3
I[6].Alarm	Signal: Alarm
I[6].Trip L1	Signal: General Trip Phase L1
I[6].Trip L2	Signal: General Trip Phase L2
I[6].Trip L3	Signal: General Trip Phase L3
I[6].Trip	Signal: Trip
I[6].TripCmd	Signal: Trip Command
I[6].DefaultSet	Signal: Default Parameter Set
I[6].AdaptSet 1	Signal: Adaptive Parameter 1
I[6].AdaptSet 2	Signal: Adaptive Parameter 2
I[6].AdaptSet 3	Signal: Adaptive Parameter 3
I[6].AdaptSet 4	Signal: Adaptive Parameter 4
I[6].ExBlo1-I	Module input state: External blocking1
I[6].ExBlo2-I	Module input state: External blocking2
I[6].ExBlo TripCmd-I	Module input state: External Blocking of the Trip Command
I[6].Ex rev Interl-I	Module input state: External reverse interlocking
I[6].AdaptSet1-I	Module input state: Adaptive Parameter1
I[6].AdaptSet2-I	Module input state: Adaptive Parameter2
I[6].AdaptSet3-I	Module input state: Adaptive Parameter3
I[6].AdaptSet4-I	Module input state: Adaptive Parameter4
IG[1].active	Signal: active
IG[1].ExBlo	Signal: External Blocking
IG[1].Ex rev Interl	Signal: External reverse Interlocking
IG[1].Blo TripCmd	Signal: Trip Command blocked

## Assignment List

<i>Name</i>	<i>Description</i>
IG[1].ExBlo TripCmd	Signal: External Blocking of the Trip Command
IG[1].Alarm	Signal: Alarm IG
IG[1].Trip	Signal: Trip
IG[1].TripCmd	Signal: Trip Command
IG[1].IGH2 Blo	Signal: blocked by an inrush
IG[1].DefaultSet	Signal: Default Parameter Set
IG[1].AdaptSet 1	Signal: Adaptive Parameter 1
IG[1].AdaptSet 2	Signal: Adaptive Parameter 2
IG[1].AdaptSet 3	Signal: Adaptive Parameter 3
IG[1].AdaptSet 4	Signal: Adaptive Parameter 4
IG[1].ExBlo1-I	Module input state: External blocking1
IG[1].ExBlo2-I	Module input state: External blocking2
IG[1].ExBlo TripCmd-I	Module input state: External Blocking of the Trip Command
IG[1].Ex rev Inter-I	Module input state: External reverse interlocking
IG[1].AdaptSet1-I	Module input state: Adaptive Parameter1
IG[1].AdaptSet2-I	Module input state: Adaptive Parameter2
IG[1].AdaptSet3-I	Module input state: Adaptive Parameter3
IG[1].AdaptSet4-I	Module input state: Adaptive Parameter4
IG[2].active	Signal: active
IG[2].ExBlo	Signal: External Blocking
IG[2].Ex rev Interl	Signal: External reverse Interlocking
IG[2].Blo TripCmd	Signal: Trip Command blocked
IG[2].ExBlo TripCmd	Signal: External Blocking of the Trip Command
IG[2].Alarm	Signal: Alarm IG
IG[2].Trip	Signal: Trip
IG[2].TripCmd	Signal: Trip Command
IG[2].IGH2 Blo	Signal: blocked by an inrush
IG[2].DefaultSet	Signal: Default Parameter Set
IG[2].AdaptSet 1	Signal: Adaptive Parameter 1
IG[2].AdaptSet 2	Signal: Adaptive Parameter 2
IG[2].AdaptSet 3	Signal: Adaptive Parameter 3
IG[2].AdaptSet 4	Signal: Adaptive Parameter 4
IG[2].ExBlo1-I	Module input state: External blocking1
IG[2].ExBlo2-I	Module input state: External blocking2
IG[2].ExBlo TripCmd-I	Module input state: External Blocking of the Trip Command
IG[2].Ex rev Interl-I	Module input state: External reverse interlocking
IG[2].AdaptSet1-I	Module input state: Adaptive Parameter1
IG[2].AdaptSet2-I	Module input state: Adaptive Parameter2
IG[2].AdaptSet3-I	Module input state: Adaptive Parameter3
IG[2].AdaptSet4-I	Module input state: Adaptive Parameter4

## Assignment List

<i>Name</i>	<i>Description</i>
IG[3].active	Signal: active
IG[3].ExBlo	Signal: External Blocking
IG[3].Ex rev Interl	Signal: External reverse Interlocking
IG[3].Blo TripCmd	Signal: Trip Command blocked
IG[3].ExBlo TripCmd	Signal: External Blocking of the Trip Command
IG[3].Alarm	Signal: Alarm IG
IG[3].Trip	Signal: Trip
IG[3].TripCmd	Signal: Trip Command
IG[3].IGH2 Blo	Signal: blocked by an inrush
IG[3].DefaultSet	Signal: Default Parameter Set
IG[3].AdaptSet 1	Signal: Adaptive Parameter 1
IG[3].AdaptSet 2	Signal: Adaptive Parameter 2
IG[3].AdaptSet 3	Signal: Adaptive Parameter 3
IG[3].AdaptSet 4	Signal: Adaptive Parameter 4
IG[3].ExBlo1-I	Module input state: External blocking1
IG[3].ExBlo2-I	Module input state: External blocking2
IG[3].ExBlo TripCmd-I	Module input state: External Blocking of the Trip Command
IG[3].Ex rev Interl-I	Module input state: External reverse interlocking
IG[3].AdaptSet1-I	Module input state: Adaptive Parameter1
IG[3].AdaptSet2-I	Module input state: Adaptive Parameter2
IG[3].AdaptSet3-I	Module input state: Adaptive Parameter3
IG[3].AdaptSet4-I	Module input state: Adaptive Parameter4
IG[4].active	Signal: active
IG[4].ExBlo	Signal: External Blocking
IG[4].Ex rev Interl	Signal: External reverse Interlocking
IG[4].Blo TripCmd	Signal: Trip Command blocked
IG[4].ExBlo TripCmd	Signal: External Blocking of the Trip Command
IG[4].Alarm	Signal: Alarm IG
IG[4].Trip	Signal: Trip
IG[4].TripCmd	Signal: Trip Command
IG[4].IGH2 Blo	Signal: blocked by an inrush
IG[4].DefaultSet	Signal: Default Parameter Set
IG[4].AdaptSet 1	Signal: Adaptive Parameter 1
IG[4].AdaptSet 2	Signal: Adaptive Parameter 2
IG[4].AdaptSet 3	Signal: Adaptive Parameter 3
IG[4].AdaptSet 4	Signal: Adaptive Parameter 4
IG[4].ExBlo1-I	Module input state: External blocking1
IG[4].ExBlo2-I	Module input state: External blocking2
IG[4].ExBlo TripCmd-I	Module input state: External Blocking of the Trip Command
IG[4].Ex rev Interl-I	Module input state: External reverse interlocking



## Assignment List

<i>Name</i>	<i>Description</i>
IG[4].AdaptSet1-I	Module input state: Adaptive Parameter1
IG[4].AdaptSet2-I	Module input state: Adaptive Parameter2
IG[4].AdaptSet3-I	Module input state: Adaptive Parameter3
IG[4].AdaptSet4-I	Module input state: Adaptive Parameter4
ThR.active	Signal: active
ThR.ExBlo	Signal: External Blocking
ThR.Blo TripCmd	Signal: Trip Command blocked
ThR.ExBlo TripCmd	Signal: External Blocking of the Trip Command
ThR.Alarm	Signal: Alarm Thermal Overload
ThR.Trip	Signal: Trip
ThR.TripCmd	Signal: Trip Command
ThR.Res Thermal Cap	Signal: Resetting Thermal Replica
ThR.ExBlo1-I	Module input state: External blocking1
ThR.ExBlo2-I	Module input state: External blocking2
ThR.ExBlo TripCmd-I	Module input state: External Blocking of the Trip Command
I2>[1].active	Signal: active
I2>[1].ExBlo	Signal: External Blocking
I2>[1].Blo TripCmd	Signal: Trip Command blocked
I2>[1].ExBlo TripCmd	Signal: External Blocking of the Trip Command
I2>[1].Alarm	Signal: Alarm Negative Sequence
I2>[1].Trip	Signal: Trip
I2>[1].TripCmd	Signal: Trip Command
I2>[1].ExBlo1-I	Module input state: External blocking1
I2>[1].ExBlo2-I	Module input state: External blocking2
I2>[1].ExBlo TripCmd-I	Module input state: External Blocking of the Trip Command
I2>[2].active	Signal: active
I2>[2].ExBlo	Signal: External Blocking
I2>[2].Blo TripCmd	Signal: Trip Command blocked
I2>[2].ExBlo TripCmd	Signal: External Blocking of the Trip Command
I2>[2].Alarm	Signal: Alarm Negative Sequence
I2>[2].Trip	Signal: Trip
I2>[2].TripCmd	Signal: Trip Command
I2>[2].ExBlo1-I	Module input state: External blocking1
I2>[2].ExBlo2-I	Module input state: External blocking2
I2>[2].ExBlo TripCmd-I	Module input state: External Blocking of the Trip Command
IH2.active	Signal: active
IH2.ExBlo	Signal: External Blocking
IH2.Blo L1	Signal: Blocked L1
IH2.Blo L2	Signal: Blocked L2
IH2.Blo L3	Signal: Blocked L3

## Assignment List

<i>Name</i>	<i>Description</i>
IH2.Blo IG meas	Signal: Blocking of the ground (earth) protection module (measured ground current)
IH2.Blo IG calc	Signal: Blocking of the ground (earth) protection module (calculated ground current)
IH2.3-ph Blo	Signal: Inrush was detected in at least one phase - trip command blocked.
IH2.ExBlo1-I	Module input state: External blocking1
IH2.ExBlo2-I	Module input state: External blocking2
V[1].active	Signal: active
V[1].ExBlo	Signal: External Blocking
V[1].Blo TripCmd	Signal: Trip Command blocked
V[1].ExBlo TripCmd	Signal: External Blocking of the Trip Command
V[1].Alarm L1	Signal: Alarm L1
V[1].Alarm L2	Signal: Alarm L2
V[1].Alarm L3	Signal: Alarm L3
V[1].Alarm	Signal: Alarm voltage stage
V[1].Trip L1	Signal: General Trip Phase L1
V[1].Trip L2	Signal: General Trip Phase L2
V[1].Trip L3	Signal: General Trip Phase L3
V[1].Trip	Signal: Trip
V[1].TripCmd	Signal: Trip Command
V[1].ExBlo1-I	Module input state: External blocking1
V[1].ExBlo2-I	Module input state: External blocking2
V[1].ExBlo TripCmd-I	Module input state: External Blocking of the Trip Command
V[2].active	Signal: active
V[2].ExBlo	Signal: External Blocking
V[2].Blo TripCmd	Signal: Trip Command blocked
V[2].ExBlo TripCmd	Signal: External Blocking of the Trip Command
V[2].Alarm L1	Signal: Alarm L1
V[2].Alarm L2	Signal: Alarm L2
V[2].Alarm L3	Signal: Alarm L3
V[2].Alarm	Signal: Alarm voltage stage
V[2].Trip L1	Signal: General Trip Phase L1
V[2].Trip L2	Signal: General Trip Phase L2
V[2].Trip L3	Signal: General Trip Phase L3
V[2].Trip	Signal: Trip
V[2].TripCmd	Signal: Trip Command
V[2].ExBlo1-I	Module input state: External blocking1
V[2].ExBlo2-I	Module input state: External blocking2
V[2].ExBlo TripCmd-I	Module input state: External Blocking of the Trip Command
V[3].active	Signal: active
V[3].ExBlo	Signal: External Blocking
V[3].Blo TripCmd	Signal: Trip Command blocked

## Assignment List

<i>Name</i>	<i>Description</i>
V[3].ExBlo TripCmd	Signal: External Blocking of the Trip Command
V[3].Alarm L1	Signal: Alarm L1
V[3].Alarm L2	Signal: Alarm L2
V[3].Alarm L3	Signal: Alarm L3
V[3].Alarm	Signal: Alarm voltage stage
V[3].Trip L1	Signal: General Trip Phase L1
V[3].Trip L2	Signal: General Trip Phase L2
V[3].Trip L3	Signal: General Trip Phase L3
V[3].Trip	Signal: Trip
V[3].TripCmd	Signal: Trip Command
V[3].ExBlo1-I	Module input state: External blocking1
V[3].ExBlo2-I	Module input state: External blocking2
V[3].ExBlo TripCmd-I	Module input state: External Blocking of the Trip Command
V[4].active	Signal: active
V[4].ExBlo	Signal: External Blocking
V[4].Blo TripCmd	Signal: Trip Command blocked
V[4].ExBlo TripCmd	Signal: External Blocking of the Trip Command
V[4].Alarm L1	Signal: Alarm L1
V[4].Alarm L2	Signal: Alarm L2
V[4].Alarm L3	Signal: Alarm L3
V[4].Alarm	Signal: Alarm voltage stage
V[4].Trip L1	Signal: General Trip Phase L1
V[4].Trip L2	Signal: General Trip Phase L2
V[4].Trip L3	Signal: General Trip Phase L3
V[4].Trip	Signal: Trip
V[4].TripCmd	Signal: Trip Command
V[4].ExBlo1-I	Module input state: External blocking1
V[4].ExBlo2-I	Module input state: External blocking2
V[4].ExBlo TripCmd-I	Module input state: External Blocking of the Trip Command
V[5].active	Signal: active
V[5].ExBlo	Signal: External Blocking
V[5].Blo TripCmd	Signal: Trip Command blocked
V[5].ExBlo TripCmd	Signal: External Blocking of the Trip Command
V[5].Alarm L1	Signal: Alarm L1
V[5].Alarm L2	Signal: Alarm L2
V[5].Alarm L3	Signal: Alarm L3
V[5].Alarm	Signal: Alarm voltage stage
V[5].Trip L1	Signal: General Trip Phase L1
V[5].Trip L2	Signal: General Trip Phase L2
V[5].Trip L3	Signal: General Trip Phase L3

## Assignment List

<i>Name</i>	<i>Description</i>
V[5].Trip	Signal: Trip
V[5].TripCmd	Signal: Trip Command
V[5].ExBlo1-I	Module input state: External blocking1
V[5].ExBlo2-I	Module input state: External blocking2
V[5].ExBlo TripCmd-I	Module input state: External Blocking of the Trip Command
V[6].active	Signal: active
V[6].ExBlo	Signal: External Blocking
V[6].Blo TripCmd	Signal: Trip Command blocked
V[6].ExBlo TripCmd	Signal: External Blocking of the Trip Command
V[6].Alarm L1	Signal: Alarm L1
V[6].Alarm L2	Signal: Alarm L2
V[6].Alarm L3	Signal: Alarm L3
V[6].Alarm	Signal: Alarm voltage stage
V[6].Trip L1	Signal: General Trip Phase L1
V[6].Trip L2	Signal: General Trip Phase L2
V[6].Trip L3	Signal: General Trip Phase L3
V[6].Trip	Signal: Trip
V[6].TripCmd	Signal: Trip Command
V[6].ExBlo1-I	Module input state: External blocking1
V[6].ExBlo2-I	Module input state: External blocking2
V[6].ExBlo TripCmd-I	Module input state: External Blocking of the Trip Command
df/dt.active	Signal: active
df/dt.ExBlo	Signal: External Blocking
df/dt.Blo by V<	Signal: Module is blocked by undervoltage.
df/dt.Blo TripCmd	Signal: Trip Command blocked
df/dt.ExBlo TripCmd	Signal: External Blocking of the Trip Command
df/dt.Alarm	Signal: Alarm Frequency Protection (collective signal)
df/dt.Trip	Signal: Trip Frequency Protection (collective signal)
df/dt.TripCmd	Signal: Trip Command
df/dt.ExBlo1-I	Module input state: External blocking1
df/dt.ExBlo2-I	Module input state: External blocking2
df/dt.ExBlo TripCmd-I	Module input state: External Blocking of the Trip Command
delta phi.active	Signal: active
delta phi.ExBlo	Signal: External Blocking
delta phi.Blo by V<	Signal: Module is blocked by undervoltage.
delta phi.Blo TripCmd	Signal: Trip Command blocked
delta phi.ExBlo TripCmd	Signal: External Blocking of the Trip Command
delta phi.Alarm	Signal: Alarm Frequency Protection (collective signal)
delta phi.Trip	Signal: Trip Frequency Protection (collective signal)
delta phi.TripCmd	Signal: Trip Command

## Assignment List

<i>Name</i>	<i>Description</i>
delta phi.ExBlo1-I	Module input state: External blocking1
delta phi.ExBlo2-I	Module input state: External blocking2
delta phi.ExBlo TripCmd-I	Module input state: External Blocking of the Trip Command
Intertripping.active	Signal: active
Intertripping.ExBlo	Signal: External Blocking
Intertripping.Blo TripCmd	Signal: Trip Command blocked
Intertripping.ExBlo TripCmd	Signal: External Blocking of the Trip Command
Intertripping.Alarm	Signal: Alarm
Intertripping.Trip	Signal: Trip
Intertripping.TripCmd	Signal: Trip Command
Intertripping.ExBlo1-I	Module input state: External blocking1
Intertripping.ExBlo2-I	Module input state: External blocking2
Intertripping.ExBlo TripCmd-I	Module input state: External Blocking of the Trip Command
Intertripping.Alarm-I	Module input state: Alarm
Intertripping.Trip-I	Module input state: Trip
P.active	Signal: active
P.ExBlo	Signal: External Blocking
P.Blo TripCmd	Signal: Trip Command blocked
P.ExBlo TripCmd	Signal: External Blocking of the Trip Command
P.Alarm	Signal: Alarm Power Protection
P.Trip	Signal: Trip Power Protection
P.TripCmd	Signal: Trip Command
P.ExBlo1-I	Module input state: External blocking
P.ExBlo2-I	Module input state: External blocking
P.ExBlo TripCmd-I	Module input state: External Blocking of the Trip Command
Q.active	Signal: active
Q.ExBlo	Signal: External Blocking
Q.Blo TripCmd	Signal: Trip Command blocked
Q.ExBlo TripCmd	Signal: External Blocking of the Trip Command
Q.Alarm	Signal: Alarm Power Protection
Q.Trip	Signal: Trip Power Protection
Q.TripCmd	Signal: Trip Command
Q.ExBlo1-I	Module input state: External blocking
Q.ExBlo2-I	Module input state: External blocking
Q.ExBlo TripCmd-I	Module input state: External Blocking of the Trip Command
LVRT.active	Signal: active
LVRT.ExBlo	Signal: External Blocking
LVRT.Blo TripCmd	Signal: Trip Command blocked
LVRT.ExBlo TripCmd	Signal: External Blocking of the Trip Command
LVRT.Alarm L1	Signal: Alarm L1

## Assignment List

<i>Name</i>	<i>Description</i>
LVRT.Alarm L2	Signal: Alarm L2
LVRT.Alarm L3	Signal: Alarm L3
LVRT.Alarm	Signal: Alarm voltage stage
LVRT.Trip L1	Signal: General Trip Phase L1
LVRT.Trip L2	Signal: General Trip Phase L2
LVRT.Trip L3	Signal: General Trip Phase L3
LVRT.Trip	Signal: Trip
LVRT.TripCmd	Signal: Trip Command
LVRT.t-LVRT is running	Signal: t-LVRT is running
LVRT.ExBlo1-I	Module input state: External blocking1
LVRT.ExBlo2-I	Module input state: External blocking2
LVRT.ExBlo TripCmd-I	Module input state: External Blocking of the Trip Command
VG[1].active	Signal: active
VG[1].ExBlo	Signal: External Blocking
VG[1].Blo TripCmd	Signal: Trip Command blocked
VG[1].ExBlo TripCmd	Signal: External Blocking of the Trip Command
VG[1].Alarm	Signal: Alarm Residual Voltage Supervision-stage
VG[1].Trip	Signal: Trip
VG[1].TripCmd	Signal: Trip Command
VG[1].ExBlo1-I	Module input state: External blocking1
VG[1].ExBlo2-I	Module input state: External blocking2
VG[1].ExBlo TripCmd-I	Module input state: External Blocking of the Trip Command
VG[2].active	Signal: active
VG[2].ExBlo	Signal: External Blocking
VG[2].Blo TripCmd	Signal: Trip Command blocked
VG[2].ExBlo TripCmd	Signal: External Blocking of the Trip Command
VG[2].Alarm	Signal: Alarm Residual Voltage Supervision-stage
VG[2].Trip	Signal: Trip
VG[2].TripCmd	Signal: Trip Command
VG[2].ExBlo1-I	Module input state: External blocking1
VG[2].ExBlo2-I	Module input state: External blocking2
VG[2].ExBlo TripCmd-I	Module input state: External Blocking of the Trip Command
V012[1].active	Signal: active
V012[1].ExBlo	Signal: External Blocking
V012[1].Blo TripCmd	Signal: Trip Command blocked
V012[1].ExBlo TripCmd	Signal: External Blocking of the Trip Command
V012[1].Alarm	Signal: Alarm voltage asymmetry
V012[1].Trip	Signal: Trip
V012[1].TripCmd	Signal: Trip Command
V012[1].ExBlo1-I	Module input state: External blocking1

## Assignment List

<i>Name</i>	<i>Description</i>
V012[1].ExBlo2-I	Module input state: External blocking2
V012[1].ExBlo TripCmd-I	Module input state: External Blocking of the Trip Command
V012[2].active	Signal: active
V012[2].ExBlo	Signal: External Blocking
V012[2].Blo TripCmd	Signal: Trip Command blocked
V012[2].ExBlo TripCmd	Signal: External Blocking of the Trip Command
V012[2].Alarm	Signal: Alarm voltage asymmetry
V012[2].Trip	Signal: Trip
V012[2].TripCmd	Signal: Trip Command
V012[2].ExBlo1-I	Module input state: External blocking1
V012[2].ExBlo2-I	Module input state: External blocking2
V012[2].ExBlo TripCmd-I	Module input state: External Blocking of the Trip Command
V012[3].active	Signal: active
V012[3].ExBlo	Signal: External Blocking
V012[3].Blo TripCmd	Signal: Trip Command blocked
V012[3].ExBlo TripCmd	Signal: External Blocking of the Trip Command
V012[3].Alarm	Signal: Alarm voltage asymmetry
V012[3].Trip	Signal: Trip
V012[3].TripCmd	Signal: Trip Command
V012[3].ExBlo1-I	Module input state: External blocking1
V012[3].ExBlo2-I	Module input state: External blocking2
V012[3].ExBlo TripCmd-I	Module input state: External Blocking of the Trip Command
V012[4].active	Signal: active
V012[4].ExBlo	Signal: External Blocking
V012[4].Blo TripCmd	Signal: Trip Command blocked
V012[4].ExBlo TripCmd	Signal: External Blocking of the Trip Command
V012[4].Alarm	Signal: Alarm voltage asymmetry
V012[4].Trip	Signal: Trip
V012[4].TripCmd	Signal: Trip Command
V012[4].ExBlo1-I	Module input state: External blocking1
V012[4].ExBlo2-I	Module input state: External blocking2
V012[4].ExBlo TripCmd-I	Module input state: External Blocking of the Trip Command
V012[5].active	Signal: active
V012[5].ExBlo	Signal: External Blocking
V012[5].Blo TripCmd	Signal: Trip Command blocked
V012[5].ExBlo TripCmd	Signal: External Blocking of the Trip Command
V012[5].Alarm	Signal: Alarm voltage asymmetry
V012[5].Trip	Signal: Trip
V012[5].TripCmd	Signal: Trip Command
V012[5].ExBlo1-I	Module input state: External blocking1

## Assignment List

<i>Name</i>	<i>Description</i>
V012[5].ExBlo2-I	Module input state: External blocking2
V012[5].ExBlo TripCmd-I	Module input state: External Blocking of the Trip Command
V012[6].active	Signal: active
V012[6].ExBlo	Signal: External Blocking
V012[6].Blo TripCmd	Signal: Trip Command blocked
V012[6].ExBlo TripCmd	Signal: External Blocking of the Trip Command
V012[6].Alarm	Signal: Alarm voltage asymmetry
V012[6].Trip	Signal: Trip
V012[6].TripCmd	Signal: Trip Command
V012[6].ExBlo1-I	Module input state: External blocking1
V012[6].ExBlo2-I	Module input state: External blocking2
V012[6].ExBlo TripCmd-I	Module input state: External Blocking of the Trip Command
f[1].active	Signal: active
f[1].ExBlo	Signal: External Blocking
f[1].Blo by V<	Signal: Module is blocked by undervoltage.
f[1].Blo TripCmd	Signal: Trip Command blocked
f[1].ExBlo TripCmd	Signal: External Blocking of the Trip Command
f[1].Alarm f	Signal: Alarm Frequency Protection
f[1].Alarm df/dt   DF/DT	Alarm instantaneous or average value of the rate-of-frequency-change
f[1].Alarm delta phi	Signal: Alarm Vector Surge
f[1].Alarm	Signal: Alarm Frequency Protection (collective signal)
f[1].Trip f	Signal: Frequency has exceeded the limit.
f[1].Trip df/dt   DF/DT	Signal: Trip df/dt or DF/DT
f[1].Trip delta phi	Signal: Trip Vector Surge
f[1].Trip	Signal: Trip Frequency Protection (collective signal)
f[1].TripCmd	Signal: Trip Command
f[1].ExBlo1-I	Module input state: External blocking1
f[1].ExBlo2-I	Module input state: External blocking2
f[1].ExBlo TripCmd-I	Module input state: External Blocking of the Trip Command
f[2].active	Signal: active
f[2].ExBlo	Signal: External Blocking
f[2].Blo by V<	Signal: Module is blocked by undervoltage.
f[2].Blo TripCmd	Signal: Trip Command blocked
f[2].ExBlo TripCmd	Signal: External Blocking of the Trip Command
f[2].Alarm f	Signal: Alarm Frequency Protection
f[2].Alarm df/dt   DF/DT	Alarm instantaneous or average value of the rate-of-frequency-change
f[2].Alarm delta phi	Signal: Alarm Vector Surge
f[2].Alarm	Signal: Alarm Frequency Protection (collective signal)
f[2].Trip f	Signal: Frequency has exceeded the limit.
f[2].Trip df/dt   DF/DT	Signal: Trip df/dt or DF/DT



## Assignment List

<i>Name</i>	<i>Description</i>
f[2].Trip delta phi	Signal: Trip Vector Surge
f[2].Trip	Signal: Trip Frequency Protection (collective signal)
f[2].TripCmd	Signal: Trip Command
f[2].ExBlo1-l	Module input state: External blocking1
f[2].ExBlo2-l	Module input state: External blocking2
f[2].ExBlo TripCmd-l	Module input state: External Blocking of the Trip Command
f[3].active	Signal: active
f[3].ExBlo	Signal: External Blocking
f[3].Blo by V<	Signal: Module is blocked by undervoltage.
f[3].Blo TripCmd	Signal: Trip Command blocked
f[3].ExBlo TripCmd	Signal: External Blocking of the Trip Command
f[3].Alarm f	Signal: Alarm Frequency Protection
f[3].Alarm df/dt   DF/DT	Alarm instantaneous or average value of the rate-of-frequency-change
f[3].Alarm delta phi	Signal: Alarm Vector Surge
f[3].Alarm	Signal: Alarm Frequency Protection (collective signal)
f[3].Trip f	Signal: Frequency has exceeded the limit.
f[3].Trip df/dt   DF/DT	Signal: Trip df/dt or DF/DT
f[3].Trip delta phi	Signal: Trip Vector Surge
f[3].Trip	Signal: Trip Frequency Protection (collective signal)
f[3].TripCmd	Signal: Trip Command
f[3].ExBlo1-l	Module input state: External blocking1
f[3].ExBlo2-l	Module input state: External blocking2
f[3].ExBlo TripCmd-l	Module input state: External Blocking of the Trip Command
f[4].active	Signal: active
f[4].ExBlo	Signal: External Blocking
f[4].Blo by V<	Signal: Module is blocked by undervoltage.
f[4].Blo TripCmd	Signal: Trip Command blocked
f[4].ExBlo TripCmd	Signal: External Blocking of the Trip Command
f[4].Alarm f	Signal: Alarm Frequency Protection
f[4].Alarm df/dt   DF/DT	Alarm instantaneous or average value of the rate-of-frequency-change
f[4].Alarm delta phi	Signal: Alarm Vector Surge
f[4].Alarm	Signal: Alarm Frequency Protection (collective signal)
f[4].Trip f	Signal: Frequency has exceeded the limit.
f[4].Trip df/dt   DF/DT	Signal: Trip df/dt or DF/DT
f[4].Trip delta phi	Signal: Trip Vector Surge
f[4].Trip	Signal: Trip Frequency Protection (collective signal)
f[4].TripCmd	Signal: Trip Command
f[4].ExBlo1-l	Module input state: External blocking1
f[4].ExBlo2-l	Module input state: External blocking2
f[4].ExBlo TripCmd-l	Module input state: External Blocking of the Trip Command

## Assignment List

<i>Name</i>	<i>Description</i>
f[5].active	Signal: active
f[5].ExBlo	Signal: External Blocking
f[5].Blo by V<	Signal: Module is blocked by undervoltage.
f[5].Blo TripCmd	Signal: Trip Command blocked
f[5].ExBlo TripCmd	Signal: External Blocking of the Trip Command
f[5].Alarm f	Signal: Alarm Frequency Protection
f[5].Alarm df/dt   DF/DT	Alarm instantaneous or average value of the rate-of-frequency-change
f[5].Alarm delta phi	Signal: Alarm Vector Surge
f[5].Alarm	Signal: Alarm Frequency Protection (collective signal)
f[5].Trip f	Signal: Frequency has exceeded the limit.
f[5].Trip df/dt   DF/DT	Signal: Trip df/dt or DF/DT
f[5].Trip delta phi	Signal: Trip Vector Surge
f[5].Trip	Signal: Trip Frequency Protection (collective signal)
f[5].TripCmd	Signal: Trip Command
f[5].ExBlo1-l	Module input state: External blocking1
f[5].ExBlo2-l	Module input state: External blocking2
f[5].ExBlo TripCmd-l	Module input state: External Blocking of the Trip Command
f[6].active	Signal: active
f[6].ExBlo	Signal: External Blocking
f[6].Blo by V<	Signal: Module is blocked by undervoltage.
f[6].Blo TripCmd	Signal: Trip Command blocked
f[6].ExBlo TripCmd	Signal: External Blocking of the Trip Command
f[6].Alarm f	Signal: Alarm Frequency Protection
f[6].Alarm df/dt   DF/DT	Alarm instantaneous or average value of the rate-of-frequency-change
f[6].Alarm delta phi	Signal: Alarm Vector Surge
f[6].Alarm	Signal: Alarm Frequency Protection (collective signal)
f[6].Trip f	Signal: Frequency has exceeded the limit.
f[6].Trip df/dt   DF/DT	Signal: Trip df/dt or DF/DT
f[6].Trip delta phi	Signal: Trip Vector Surge
f[6].Trip	Signal: Trip Frequency Protection (collective signal)
f[6].TripCmd	Signal: Trip Command
f[6].ExBlo1-l	Module input state: External blocking1
f[6].ExBlo2-l	Module input state: External blocking2
f[6].ExBlo TripCmd-l	Module input state: External Blocking of the Trip Command
PQS[1].active	Signal: active
PQS[1].ExBlo	Signal: External Blocking
PQS[1].Blo TripCmd	Signal: Trip Command blocked
PQS[1].ExBlo TripCmd	Signal: External Blocking of the Trip Command
PQS[1].Alarm	Signal: Alarm Power Protection
PQS[1].Trip	Signal: Trip Power Protection

## Assignment List

<i>Name</i>	<i>Description</i>
PQS[1].TripCmd	Signal: Trip Command
PQS[1].ExBlo1-I	Module input state: External blocking
PQS[1].ExBlo2-I	Module input state: External blocking
PQS[1].ExBlo TripCmd-I	Module input state: External Blocking of the Trip Command
PQS[2].active	Signal: active
PQS[2].ExBlo	Signal: External Blocking
PQS[2].Blo TripCmd	Signal: Trip Command blocked
PQS[2].ExBlo TripCmd	Signal: External Blocking of the Trip Command
PQS[2].Alarm	Signal: Alarm Power Protection
PQS[2].Trip	Signal: Trip Power Protection
PQS[2].TripCmd	Signal: Trip Command
PQS[2].ExBlo1-I	Module input state: External blocking
PQS[2].ExBlo2-I	Module input state: External blocking
PQS[2].ExBlo TripCmd-I	Module input state: External Blocking of the Trip Command
PQS[3].active	Signal: active
PQS[3].ExBlo	Signal: External Blocking
PQS[3].Blo TripCmd	Signal: Trip Command blocked
PQS[3].ExBlo TripCmd	Signal: External Blocking of the Trip Command
PQS[3].Alarm	Signal: Alarm Power Protection
PQS[3].Trip	Signal: Trip Power Protection
PQS[3].TripCmd	Signal: Trip Command
PQS[3].ExBlo1-I	Module input state: External blocking
PQS[3].ExBlo2-I	Module input state: External blocking
PQS[3].ExBlo TripCmd-I	Module input state: External Blocking of the Trip Command
PQS[4].active	Signal: active
PQS[4].ExBlo	Signal: External Blocking
PQS[4].Blo TripCmd	Signal: Trip Command blocked
PQS[4].ExBlo TripCmd	Signal: External Blocking of the Trip Command
PQS[4].Alarm	Signal: Alarm Power Protection
PQS[4].Trip	Signal: Trip Power Protection
PQS[4].TripCmd	Signal: Trip Command
PQS[4].ExBlo1-I	Module input state: External blocking
PQS[4].ExBlo2-I	Module input state: External blocking
PQS[4].ExBlo TripCmd-I	Module input state: External Blocking of the Trip Command
PQS[5].active	Signal: active
PQS[5].ExBlo	Signal: External Blocking
PQS[5].Blo TripCmd	Signal: Trip Command blocked
PQS[5].ExBlo TripCmd	Signal: External Blocking of the Trip Command
PQS[5].Alarm	Signal: Alarm Power Protection
PQS[5].Trip	Signal: Trip Power Protection

## Assignment List

<i>Name</i>	<i>Description</i>
PQS[5].TripCmd	Signal: Trip Command
PQS[5].ExBlo1-I	Module input state: External blocking
PQS[5].ExBlo2-I	Module input state: External blocking
PQS[5].ExBlo TripCmd-I	Module input state: External Blocking of the Trip Command
PQS[6].active	Signal: active
PQS[6].ExBlo	Signal: External Blocking
PQS[6].Blo TripCmd	Signal: Trip Command blocked
PQS[6].ExBlo TripCmd	Signal: External Blocking of the Trip Command
PQS[6].Alarm	Signal: Alarm Power Protection
PQS[6].Trip	Signal: Trip Power Protection
PQS[6].TripCmd	Signal: Trip Command
PQS[6].ExBlo1-I	Module input state: External blocking
PQS[6].ExBlo2-I	Module input state: External blocking
PQS[6].ExBlo TripCmd-I	Module input state: External Blocking of the Trip Command
PF[1].active	Signal: active
PF[1].ExBlo	Signal: External Blocking
PF[1].Blo TripCmd	Signal: Trip Command blocked
PF[1].ExBlo TripCmd	Signal: External Blocking of the Trip Command
PF[1].Alarm	Signal: Alarm Power Factor
PF[1].Trip	Signal: Trip Power Factor
PF[1].TripCmd	Signal: Trip Command
PF[1].Compensator	Signal: Compensation Signal
PF[1].Impossible	Signal: Alarm Power Factor Impossible
PF[1].ExBlo1-I	Module input state: External blocking
PF[1].ExBlo2-I	Module input state: External blocking
PF[1].ExBlo TripCmd-I	Module input state: External Blocking of the Trip Command
PF[2].active	Signal: active
PF[2].ExBlo	Signal: External Blocking
PF[2].Blo TripCmd	Signal: Trip Command blocked
PF[2].ExBlo TripCmd	Signal: External Blocking of the Trip Command
PF[2].Alarm	Signal: Alarm Power Factor
PF[2].Trip	Signal: Trip Power Factor
PF[2].TripCmd	Signal: Trip Command
PF[2].Compensator	Signal: Compensation Signal
PF[2].Impossible	Signal: Alarm Power Factor Impossible
PF[2].ExBlo1-I	Module input state: External blocking
PF[2].ExBlo2-I	Module input state: External blocking
PF[2].ExBlo TripCmd-I	Module input state: External Blocking of the Trip Command
Q->&V<.active	Signal: active
Q->&V<.ExBlo	Signal: External Blocking

## Assignment List

<i>Name</i>	<i>Description</i>
Q->&V<.Fuse Fail VT Blo	Signal: Blocked by Fuse Failure (VT)
Q->&V<.Alarm	Signal: Alarm Reactive Power Undervoltage Protection
Q->&V<.Decoupling Energy Resource	Signal: Decoupling of the (local) Energy Resource
Q->&V<.Decoupling PCC	Signal: Decoupling at the Point of Common Coupling
Q->&V<.PCC V Release	Signal: Voltage Release from the Point of Common Coupling
Q->&V<.Release Energy Resource	Signal: Release Energy Resource. Internal (local) voltage release
Q->&V<.Power Angle	Signal: Admissible power angle exceeded
Q->&V<.Reactive Power Thres	Signal: Admissible Reactive Power Threshold exceeded
Q->&V<.VLL too low	Signal: Line-to-Line voltage too low
Q->&V<.ExBlo1-I	Module input state: External blocking1
Q->&V<.ExBlo2-I	Module input state: External blocking2
Q->&V<.V Ext Release PCC-I	Module input state: Release signal is being generated by the PCC (External Release)
Q->&V<.PCC Fuse Fail VT-I	State of the module input: Blocking if the fuse of a voltage transformer has tripped at the PCC.
AR.active	Signal: active
AR.ExBlo	Signal: External Blocking
AR.Standby	Signal: Standby
AR.t-Blo after CB man ON	Signal: AR blocked after circuit breaker was switched on manually. This timer will be started if the circuit breaker was switched on manually. While this timer is running, AR cannot be started.
AR.Ready	Signal: Ready to shoot
AR.running	Signal: Auto Reclosing running
AR.t-dead	Signal: Dead time between trip and reclosure attempt
AR.CB ON Cmd	Signal: CB switch ON Command
AR.t-Run2Ready	Signal: Examination Time: If the Circuit Breaker remains after a reclosure attempt for the duration of this timer in the Closed position, the AR has been successful and the AR module returns into the ready state.
AR.Lock	Signal: Auto Reclosure is locked out
AR.t-Reset Lockout	Signal: Delay Timer for resetting the AR lockout. The reset of the AR lockout state will be delayed for this time, after the reset signal (e.g digital input or Scada) has been detected .
AR.Blo	Signal: Auto Reclosure is blocked
AR.t-Blo Reset	Signal: Delay Timer for resetting the AR blocking. The release (de-blocking) of the AR will be delayed for this time, if there is no blocking signal anymore.
AR.successful	Signal: Auto Reclosing successful
AR.failed	Signal: Auto Reclosing failure
AR.t-AR Supervision	Signal: AR Supervision
AR.Pre Shot	Pre Shot Control
AR.Shot 1	Shot Control
AR.Shot 2	Shot Control
AR.Shot 3	Shot Control
AR.Shot 4	Shot Control
AR.Shot 5	Shot Control
AR.Shot 6	Shot Control

## Assignment List

<i>Name</i>	<i>Description</i>
AR.Service Alarm 1	Signal: AR - Service Alarm 1, too many switching operations
AR.Service Alarm 2	Signal: AR - Service Alarm 2 - too many switching operations
AR.Max Shots / h exceeded	Signal: The maximum allowed number of shots per hour has been exceeded.
AR.Res Statistics Cr	Signal: Reset all statistic AR counters: Total number of AR, successful and unsuccessful no of AR.
AR.Res Service Cr	Signal: Reset the Service Counters for Alarm and Blocking
AR.Reset Lockout	Signal: The AR Lockout has been resetted via the panel.
AR.Res Max Shots / h	Signal: The Counter for the maximum allowed shots per hour has been resetted.
AR.ExBlo1-I	Module input state: External blocking1
AR.ExBlo2-I	Module input state: External blocking2
AR.Ex Shot Inc-I	Module input state: The AR Shot counter will be incremented by this external Signal. This can be used for Zone Coordination (of upstream Auto Reclosure devices). Note: This parameter enables the functionality only. The assignment has to be set within the global parameters.
AR.Ex Lock-I	Module input state: External AR lockout.
AR.DI Reset Ex Lock-I	Module input state: Resetting the lockout state of the AR (if the resetting via digital inputs has been selected).
AR.Scada Reset Ex Lock-I	Module input state: Resetting the Lockout State of the AR by Communication.
Sync.active	Signal: active
Sync.ExBlo	Signal: External Blocking
Sync.LiveBus	Signal: Live-Bus flag: 1=Live-Bus, 0=Voltage is below the LiveBus threshold
Sync.LiveLine	Signal: Live Line flag: 1=Live-Line, 0=Voltage is below the LiveLine threshold
Sync.SynchronRunTiming	Signal: SynchronRunTiming
Sync.SynchronFailed	Signal: This signal indicates a failed synchronization. It is set for 5s when the circuit breaker is still open after the Synchron-Run-timer has timed out.
Sync.SyncOverridden	Signal:Synchronism Check is overridden because one of the Synchronism overriding conditions (DB/DL or ExtBypass) is met.
Sync.VDiffTooHigh	Signal: Voltage difference between bus and line too high.
Sync.SlipTooHigh	Signal: Frequency difference (slip frequency) between bus and line voltages too high.
Sync.AngleDiffTooHigh	Signal: Phase Angle difference between bus and line voltages too high.
Sync.Sys-in-Sync	Signal: Bus and line voltages are in synchronism according to the system synchronism criteria.
Sync.Ready to Close	Signal: Ready to Close
Sync.ExBlo1-I	Module input state: External blocking1
Sync.ExBlo2-I	Module input state: External blocking2
Sync.Bypass-I	State of the module input: Bypass
Sync.CBCloseInitiate-I	State of the module input: Breaker Close Initiate with synchronism check from any control sources (e.g. HMI / SCADA). If the state of the assigned signal becomes true, a Breaker Close will be initiated (Trigger Source).
ExP[1].active	Signal: active
ExP[1].ExBlo	Signal: External Blocking
ExP[1].Blo TripCmd	Signal: Trip Command blocked
ExP[1].ExBlo TripCmd	Signal: External Blocking of the Trip Command
ExP[1].Alarm	Signal: Alarm
ExP[1].Trip	Signal: Trip

## Assignment List

<i>Name</i>	<i>Description</i>
Exp[1].TripCmd	Signal: Trip Command
Exp[1].ExBlo1-I	Module input state: External blocking1
Exp[1].ExBlo2-I	Module input state: External blocking2
Exp[1].ExBlo TripCmd-I	Module input state: External Blocking of the Trip Command
Exp[1].Alarm-I	Module input state: Alarm
Exp[1].Trip-I	Module input state: Trip
Exp[2].active	Signal: active
Exp[2].ExBlo	Signal: External Blocking
Exp[2].Blo TripCmd	Signal: Trip Command blocked
Exp[2].ExBlo TripCmd	Signal: External Blocking of the Trip Command
Exp[2].Alarm	Signal: Alarm
Exp[2].Trip	Signal: Trip
Exp[2].TripCmd	Signal: Trip Command
Exp[2].ExBlo1-I	Module input state: External blocking1
Exp[2].ExBlo2-I	Module input state: External blocking2
Exp[2].ExBlo TripCmd-I	Module input state: External Blocking of the Trip Command
Exp[2].Alarm-I	Module input state: Alarm
Exp[2].Trip-I	Module input state: Trip
Exp[3].active	Signal: active
Exp[3].ExBlo	Signal: External Blocking
Exp[3].Blo TripCmd	Signal: Trip Command blocked
Exp[3].ExBlo TripCmd	Signal: External Blocking of the Trip Command
Exp[3].Alarm	Signal: Alarm
Exp[3].Trip	Signal: Trip
Exp[3].TripCmd	Signal: Trip Command
Exp[3].ExBlo1-I	Module input state: External blocking1
Exp[3].ExBlo2-I	Module input state: External blocking2
Exp[3].ExBlo TripCmd-I	Module input state: External Blocking of the Trip Command
Exp[3].Alarm-I	Module input state: Alarm
Exp[3].Trip-I	Module input state: Trip
Exp[4].active	Signal: active
Exp[4].ExBlo	Signal: External Blocking
Exp[4].Blo TripCmd	Signal: Trip Command blocked
Exp[4].ExBlo TripCmd	Signal: External Blocking of the Trip Command
Exp[4].Alarm	Signal: Alarm
Exp[4].Trip	Signal: Trip
Exp[4].TripCmd	Signal: Trip Command
Exp[4].ExBlo1-I	Module input state: External blocking1
Exp[4].ExBlo2-I	Module input state: External blocking2
Exp[4].ExBlo TripCmd-I	Module input state: External Blocking of the Trip Command

## Assignment List

<i>Name</i>	<i>Description</i>
Exp[4].Alarm-I	Module input state: Alarm
Exp[4].Trip-I	Module input state: Trip
SOTF.active	Signal: active
SOTF.ExBlo	Signal: External Blocking
SOTF.Ex rev Interl	Signal: External reverse Interlocking
SOTF.enabled	Signal: Switch Onto Fault enabled. This Signal can be used to modify Overcurrent Protection Settings.
SOTF.AR Blo	Signal: Blocked by AR
SOTF.I<	Signal: No Load Current.
SOTF.ExBlo1-I	Module input state: External blocking
SOTF.ExBlo2-I	Module input state: External blocking
SOTF.Ex rev Interl-I	Module input state: External reverse interlocking
SOTF.Ext SOTF-I	Module input state: External Switch Onto Fault Alarm
CLPU.active	Signal: active
CLPU.ExBlo	Signal: External Blocking
CLPU.Ex rev Interl	Signal: External reverse Interlocking
CLPU.enabled	Signal: Cold Load enabled
CLPU.detected	Signal: Cold Load detected
CLPU.AR Blo	Signal: Blocked by AR
CLPU.I<	Signal: No Load Current.
CLPU.Load Inrush	Signal: Load Inrush
CLPU.Settle Time	Signal: Settle Time
CLPU.ExBlo1-I	Module input state: External blocking
CLPU.ExBlo2-I	Module input state: External blocking
CLPU.Ex rev Interl-I	Module input state: External reverse interlocking
CBF.active	Signal: active
CBF.ExBlo	Signal: External Blocking
CBF.running	Signal: CBF-Module started
CBF.Alarm	Signal: Circuit Breaker Failure
CBF.Lockout	Signal: Lockout
CBF.Res Lockout	Signal: Reset Lockout
CBF.ExBlo1-I	Module input state: External blocking1
CBF.ExBlo2-I	Module input state: External blocking2
CBF.Trigger1	Module Input: Trigger that will start the CBF
CBF.Trigger2	Module Input: Trigger that will start the CBF
CBF.Trigger3	Module Input: Trigger that will start the CBF
TCS.active	Signal: active
TCS.ExBlo	Signal: External Blocking
TCS.Alarm	Signal: Alarm Trip Circuit Supervision
TCS.Not Possible	Not possible because no state indicator assigned to the breaker.
TCS.Aux ON-I	Module Input State: Position indicator/check-back signal of the CB (52a)



## Assignment List

<i>Name</i>	<i>Description</i>
TCS.Aux OFF-I	Module input state: Position indicator/check-back signal of the CB (52b)
TCS.ExBlo1-I	Module input state: External blocking1
TCS.ExBlo2-I	Module input state: External blocking2
CTS.active	Signal: active
CTS.ExBlo	Signal: External Blocking
CTS.Alarm	Signal: Alarm Current Transformer Measuring Circuit Supervision
CTS.ExBlo1-I	Module input state: External blocking1
CTS.ExBlo2-I	Module input state: External blocking2
LOP.active	Signal: active
LOP.ExBlo	Signal: External Blocking
LOP.Alarm	Signal: Alarm Loss of Potential
LOP.LOP Blo	Signal: Loss of Potential blocks other elements.
LOP.Ex FF VT	Signal: Ex FF VT
LOP.Ex FF EVT	Signal: Alarm Fuse Failure Earth Voltage Transformers
LOP.ExBlo1-I	Module input state: External blocking1
LOP.ExBlo2-I	Module input state: External blocking2
LOP.Ex FF VT-I	State of the module input: Alarm Fuse Failure Voltage Transformers
LOP.Ex FF EVT-I	State of the module input: Alarm Fuse Failure Earth Voltage Transformers
LOP.Blo Trigger1-I	State of the module input: An Alarm of this protective element will block the Loss of Potential Detection.
LOP.Blo Trigger2-I	State of the module input: An Alarm of this protective element will block the Loss of Potential Detection.
LOP.Blo Trigger3-I	State of the module input: An Alarm of this protective element will block the Loss of Potential Detection.
LOP.Blo Trigger4-I	State of the module input: An Alarm of this protective element will block the Loss of Potential Detection.
LOP.Blo Trigger5-I	State of the module input: An Alarm of this protective element will block the Loss of Potential Detection.
DI Slot X1.DI 1	Signal: Digital Input
DI Slot X1.DI 2	Signal: Digital Input
DI Slot X1.DI 3	Signal: Digital Input
DI Slot X1.DI 4	Signal: Digital Input
DI Slot X1.DI 5	Signal: Digital Input
DI Slot X1.DI 6	Signal: Digital Input
DI Slot X1.DI 7	Signal: Digital Input
DI Slot X1.DI 8	Signal: Digital Input
DI Slot X6.DI 1	Signal: Digital Input
DI Slot X6.DI 2	Signal: Digital Input
DI Slot X6.DI 3	Signal: Digital Input
DI Slot X6.DI 4	Signal: Digital Input
DI Slot X6.DI 5	Signal: Digital Input
DI Slot X6.DI 6	Signal: Digital Input
DI Slot X6.DI 7	Signal: Digital Input
DI Slot X6.DI 8	Signal: Digital Input
BO Slot X2.BO 1	Signal: Binary Output Relay

## Assignment List

<i>Name</i>	<i>Description</i>
BO Slot X2.BO 2	Signal: Binary Output Relay
BO Slot X2.BO 3	Signal: Binary Output Relay
BO Slot X2.BO 4	Signal: Binary Output Relay
BO Slot X2.BO 5	Signal: Binary Output Relay
BO Slot X2.BO 6	Signal: Binary Output Relay
BO Slot X2.DISARMED!	Signal: CAUTION! RELAYS DISARMED in order to safely perform maintenance while eliminating the risk of taking an entire process off-line. (Note: The Self Supervision Contact cannot be disarmed). YOU MUST ENSURE that the relays are ARMED AGAIN after maintenance
BO Slot X2.Outs forced	Signal: The State of at least one Relay Output has been set by force. That means that the state of at least one Relay is forced and hence does not show the state of the assigned signals.
BO Slot X5.BO 1	Signal: Binary Output Relay
BO Slot X5.BO 2	Signal: Binary Output Relay
BO Slot X5.BO 3	Signal: Binary Output Relay
BO Slot X5.BO 4	Signal: Binary Output Relay
BO Slot X5.BO 5	Signal: Binary Output Relay
BO Slot X5.BO 6	Signal: Binary Output Relay
BO Slot X5.DISARMED!	Signal: CAUTION! RELAYS DISARMED in order to safely perform maintenance while eliminating the risk of taking an entire process off-line. (Note: The Self Supervision Contact cannot be disarmed). YOU MUST ENSURE that the relays are ARMED AGAIN after maintenance.
BO Slot X5.Outs forced	Signal: The State of at least one Relay Output has been set by force. That means that the state of at least one Relay is forced and hence does not show the state of the assigned signals.
Event rec.Res all records	Signal: All records deleted
Disturb rec.recording	Signal: Recording
Disturb rec.memory full	Signal: Memory full
Disturb rec.Clear fail	Signal: Clear failure in memory
Disturb rec.Res all records	Signal: All records deleted
Disturb rec.Res rec	Signal: Delete record
Disturb rec.Man Trigger	Signal: Manual Trigger
Disturb rec.Start1-I	State of the module input:: Trigger event / start recording if:
Disturb rec.Start2-I	State of the module input:: Trigger event / start recording if:
Disturb rec.Start3-I	State of the module input:: Trigger event / start recording if:
Disturb rec.Start4-I	State of the module input:: Trigger event / start recording if:
Disturb rec.Start5-I	State of the module input:: Trigger event / start recording if:
Disturb rec.Start6-I	State of the module input:: Trigger event / start recording if:
Disturb rec.Start7-I	State of the module input:: Trigger event / start recording if:
Disturb rec.Start8-I	State of the module input:: Trigger event / start recording if:
Fault rec.Res rec	Signal: Delete record
Fault rec.Man Trigger	Signal: Manual Trigger
Fault rec.Start1-I	State of the module input:: Trigger event / start recording if:
Fault rec.Start2-I	State of the module input:: Trigger event / start recording if:
Fault rec.Start3-I	State of the module input:: Trigger event / start recording if:
Fault rec.Start4-I	State of the module input:: Trigger event / start recording if:

## Assignment List

<i>Name</i>	<i>Description</i>
Fault rec.Start5-l	State of the module input:: Trigger event / start recording if:
Fault rec.Start6-l	State of the module input:: Trigger event / start recording if:
Fault rec.Start7-l	State of the module input:: Trigger event / start recording if:
Fault rec.Start8-l	State of the module input:: Trigger event / start recording if:
Trend rec.Hand Reset	Hand Reset
PQSCr.Cr Ofw Ws Net	Signal: Counter Overflow Ws Net
PQSCr.Cr Ofw Wp Net	Signal: Counter Overflow Wp Net
PQSCr.Cr Ofw Wp+	Signal: Counter Overflow Wp+
PQSCr.Cr Ofw Wp-	Signal: Counter Overflow Wp-
PQSCr.Cr Ofw Wq Net	Signal: Counter Overflow Wq Net
PQSCr.Cr Ofw Wq+	Signal: Counter Overflow Wq+
PQSCr.Cr Ofw Wq-	Signal: Counter Overflow Wq-
PQSCr.Ws Net Res Cr	Signal: Ws Net Reset Counter
PQSCr.Wp Net Res Cr	Signal: Wp Net Reset Counter
PQSCr.Wp+ Res Cr	Signal: Wp+ Reset Counter
PQSCr.Wp- Res Cr	Signal: Wp- Reset Counter
PQSCr.Wq Net Res Cr	Signal: Wq Net Reset Counter
PQSCr.Wq+ Res Cr	Signal: Wq+ Reset Counter
PQSCr.Wq- Res Cr	Signal: Wq- Reset Counter
PQSCr.Res all Energy Cr	Signal: Reset of all Energy Counters
PQSCr.Cr OfwW Ws Net	Signal: Counter Ws Net will overflow soon
PQSCr.Cr OfwW Wp Net	Signal: Counter Wp Net will overflow soon
PQSCr.Cr OfwW Wp+	Signal: Counter Wp+ will overflow soon
PQSCr.Cr OfwW Wp-	Signal: Counter Wp- will overflow soon
PQSCr.Cr OfwW Wq Net	Signal: Counter Wq Net will overflow soon
PQSCr.Cr OfwW Wq+	Signal: Counter Wq+ will overflow soon
PQSCr.Cr OfwW Wq-	Signal: Counter Wq- will overflow soon
Modbus.Transmission	Signal: SCADA active
Modbus.Scada Cmd 1	Scada Command
Modbus.Scada Cmd 2	Scada Command
Modbus.Scada Cmd 3	Scada Command
Modbus.Scada Cmd 4	Scada Command
Modbus.Scada Cmd 5	Scada Command
Modbus.Scada Cmd 6	Scada Command
Modbus.Scada Cmd 7	Scada Command
Modbus.Scada Cmd 8	Scada Command
Modbus.Scada Cmd 9	Scada Command
Modbus.Scada Cmd 10	Scada Command
Modbus.Scada Cmd 11	Scada Command
Modbus.Scada Cmd 12	Scada Command

## Assignment List

<i>Name</i>	<i>Description</i>
Modbus.Scada Cmd 13	Scada Command
Modbus.Scada Cmd 14	Scada Command
Modbus.Scada Cmd 15	Scada Command
Modbus.Scada Cmd 16	Scada Command
IEC61850.VirtInp1	Signal: Virtual Input (IEC61850 GGIO Ind)
IEC61850.VirtInp2	Signal: Virtual Input (IEC61850 GGIO Ind)
IEC61850.VirtInp3	Signal: Virtual Input (IEC61850 GGIO Ind)
IEC61850.VirtInp4	Signal: Virtual Input (IEC61850 GGIO Ind)
IEC61850.VirtInp5	Signal: Virtual Input (IEC61850 GGIO Ind)
IEC61850.VirtInp6	Signal: Virtual Input (IEC61850 GGIO Ind)
IEC61850.VirtInp7	Signal: Virtual Input (IEC61850 GGIO Ind)
IEC61850.VirtInp8	Signal: Virtual Input (IEC61850 GGIO Ind)
IEC61850.VirtInp9	Signal: Virtual Input (IEC61850 GGIO Ind)
IEC61850.VirtInp10	Signal: Virtual Input (IEC61850 GGIO Ind)
IEC61850.VirtInp11	Signal: Virtual Input (IEC61850 GGIO Ind)
IEC61850.VirtInp12	Signal: Virtual Input (IEC61850 GGIO Ind)
IEC61850.VirtInp13	Signal: Virtual Input (IEC61850 GGIO Ind)
IEC61850.VirtInp14	Signal: Virtual Input (IEC61850 GGIO Ind)
IEC61850.VirtInp15	Signal: Virtual Input (IEC61850 GGIO Ind)
IEC61850.VirtInp16	Signal: Virtual Input (IEC61850 GGIO Ind)
IEC61850.VirtOut1-I	Module input state: Binary state of the Virtual Output (GGIO)
IEC61850.VirtOut2-I	Module input state: Binary state of the Virtual Output (GGIO)
IEC61850.VirtOut3-I	Module input state: Binary state of the Virtual Output (GGIO)
IEC61850.VirtOut4-I	Module input state: Binary state of the Virtual Output (GGIO)
IEC61850.VirtOut5-I	Module input state: Binary state of the Virtual Output (GGIO)
IEC61850.VirtOut6-I	Module input state: Binary state of the Virtual Output (GGIO)
IEC61850.VirtOut7-I	Module input state: Binary state of the Virtual Output (GGIO)
IEC61850.VirtOut8-I	Module input state: Binary state of the Virtual Output (GGIO)
IEC61850.VirtOut9-I	Module input state: Binary state of the Virtual Output (GGIO)
IEC61850.VirtOut10-I	Module input state: Binary state of the Virtual Output (GGIO)
IEC61850.VirtOut11-I	Module input state: Binary state of the Virtual Output (GGIO)
IEC61850.VirtOut12-I	Module input state: Binary state of the Virtual Output (GGIO)
IEC61850.VirtOut13-I	Module input state: Binary state of the Virtual Output (GGIO)
IEC61850.VirtOut14-I	Module input state: Binary state of the Virtual Output (GGIO)
IEC61850.VirtOut15-I	Module input state: Binary state of the Virtual Output (GGIO)
IEC61850.VirtOut16-I	Module input state: Binary state of the Virtual Output (GGIO)
IEC 103.Scada Cmd 1	Scada Command
IEC 103.Scada Cmd 2	Scada Command
IEC 103.Scada Cmd 3	Scada Command
IEC 103.Scada Cmd 4	Scada Command

## Assignment List

<i>Name</i>	<i>Description</i>
IEC 103.Scada Cmd 5	Scada Command
IEC 103.Scada Cmd 6	Scada Command
IEC 103.Scada Cmd 7	Scada Command
IEC 103.Scada Cmd 8	Scada Command
IEC 103.Scada Cmd 9	Scada Command
IEC 103.Scada Cmd 10	Scada Command
IEC 103.Transmission	Signal: SCADA active
IEC 103.Fail phy Interf	Failure in the physical interface
IEC 103.Failure Event lost	Failure event lost
Profibus.Data OK	Data within the Input field are OK (Yes=1)
Profibus.SubModul Err	Assignable Signal, Failure in Sub-Module, Communication Failure.
Profibus.Connection active	Connection active
Profibus.Scada Cmd 1	Scada Command
Profibus.Scada Cmd 2	Scada Command
Profibus.Scada Cmd 3	Scada Command
Profibus.Scada Cmd 4	Scada Command
Profibus.Scada Cmd 5	Scada Command
Profibus.Scada Cmd 6	Scada Command
Profibus.Scada Cmd 7	Scada Command
Profibus.Scada Cmd 8	Scada Command
Profibus.Scada Cmd 9	Scada Command
Profibus.Scada Cmd 10	Scada Command
Profibus.Scada Cmd 11	Scada Command
Profibus.Scada Cmd 12	Scada Command
Profibus.Scada Cmd 13	Scada Command
Profibus.Scada Cmd 14	Scada Command
Profibus.Scada Cmd 15	Scada Command
Profibus.Scada Cmd 16	Scada Command
IRIG-B.active	Signal: active
IRIG-B.inverted	Signal: IRIG-B inverted
IRIG-B.Control Signal1	Signal: IRIG-B Control Signal
IRIG-B.Control Signal2	Signal: IRIG-B Control Signal
IRIG-B.Control Signal4	Signal: IRIG-B Control Signal
IRIG-B.Control Signal5	Signal: IRIG-B Control Signal
IRIG-B.Control Signal6	Signal: IRIG-B Control Signal
IRIG-B.Control Signal7	Signal: IRIG-B Control Signal
IRIG-B.Control Signal8	Signal: IRIG-B Control Signal
IRIG-B.Control Signal9	Signal: IRIG-B Control Signal
IRIG-B.Control Signal10	Signal: IRIG-B Control Signal
IRIG-B.Control Signal11	Signal: IRIG-B Control Signal

## Assignment List

<i>Name</i>	<i>Description</i>
IRIG-B.Control Signal12	Signal: IRIG-B Control Signal
IRIG-B.Control Signal13	Signal: IRIG-B Control Signal
IRIG-B.Control Signal14	Signal: IRIG-B Control Signal
IRIG-B.Control Signal15	Signal: IRIG-B Control Signal
IRIG-B.Control Signal16	Signal: IRIG-B Control Signal
IRIG-B.Control Signal17	Signal: IRIG-B Control Signal
IRIG-B.Control Signal18	Signal: IRIG-B Control Signal
SNTP.SNTP active	Signal: If there is no valid SNTP signal for 120 sec, SNTP is regarded as inactive.
Statistics.ResFc all	Signal: Resetting of all Statistic values (Current Demand, Power Demand, Min, Max)
Statistics.ResFc Vavg	Signal: Resetting of the sliding average calculation.
Statistics.ResFc I Demand	Signal: Resetting of Statistics - Current Demand (avg, peak avg)
Statistics.ResFc P Demand	Signal: Resetting of Statistics - Power Demand (avg, peak avg)
Statistics.ResFc Max	Signal: Resetting of all Maximum values
Statistics.ResFc Min	Signal: Resetting of all Minimum values
Statistics.StartFc 3-I	State of the module input: (StartFunc3_h)
Statistics.StartFc 1-I	State of the module input: Start of Statistics 1
Statistics.StartFc 2-I	State of the module input: Start of Statistics 2
SysA.active	Signal: active
SysA.ExBlo	Signal: External Blocking
SysA.Alarm Watt Power	Signal: Alarm permitted Active Power exceeded
SysA.Alarm VAr Power	Signal: Alarm permitted Reactive Power exceeded
SysA.Alarm VA Power	Signal: Alarm permitted Apparent Power exceeded
SysA.Alarm Watt Demand	Signal: Alarm averaged Active Power exceeded
SysA.Alarm VAr Demand	Signal: Alarm averaged Reactive Power exceeded
SysA.Alarm VA Demand	Signal: Alarm averaged Apparent Power exceeded
SysA.Alm Current Demd	Signal: Alarm averaged demand current
SysA.Alarm I THD	Signal: Alarm Total Harmonic Distortion Current
SysA.Alarm V THD	Signal: Alarm Total Harmonic Distortion Voltage
SysA.Trip Watt Power	Signal: Trip permitted Active Power exceeded
SysA.Trip VAr Power	Signal: Trip permitted Reactive Power exceeded
SysA.Trip VA Power	Signal: Trip permitted Apparent Power exceeded
SysA.Trip Watt Demand	Signal: Trip averaged Active Power exceeded
SysA.Trip VAr Demand	Signal: Trip averaged Reactive Power exceeded
SysA.Trip VA Demand	Signal: Trip averaged Apparent Power exceeded
SysA.Trip Current Demand	Signal: Trip averaged demand current
SysA.Trip I THD	Signal: Trip Total Harmonic Distortion Current
SysA.Trip V THD	Signal: Trip Total Harmonic Distortion Voltage
SysA.ExBlo-I	Module input state: External blocking
Logics.LE1.Gate Out	Signal: Output of the logic gate
Logics.LE1.Timer Out	Signal: Timer Output

## Assignment List

<i>Name</i>	<i>Description</i>
Logics.LE1.Out	Signal: Latched Output (Q)
Logics.LE1.Out inverted	Signal: Negated Latched Output (Q NOT)
Logics.LE1.Gate In1-I	State of the module input: Assignment of the Input Signal
Logics.LE1.Gate In2-I	State of the module input: Assignment of the Input Signal
Logics.LE1.Gate In3-I	State of the module input: Assignment of the Input Signal
Logics.LE1.Gate In4-I	State of the module input: Assignment of the Input Signal
Logics.LE1.Reset Latch-I	State of the module input: Reset Signal for the Latching
Logics.LE2.Gate Out	Signal: Output of the logic gate
Logics.LE2.Timer Out	Signal: Timer Output
Logics.LE2.Out	Signal: Latched Output (Q)
Logics.LE2.Out inverted	Signal: Negated Latched Output (Q NOT)
Logics.LE2.Gate In1-I	State of the module input: Assignment of the Input Signal
Logics.LE2.Gate In2-I	State of the module input: Assignment of the Input Signal
Logics.LE2.Gate In3-I	State of the module input: Assignment of the Input Signal
Logics.LE2.Gate In4-I	State of the module input: Assignment of the Input Signal
Logics.LE2.Reset Latch-I	State of the module input: Reset Signal for the Latching
Logics.LE3.Gate Out	Signal: Output of the logic gate
Logics.LE3.Timer Out	Signal: Timer Output
Logics.LE3.Out	Signal: Latched Output (Q)
Logics.LE3.Out inverted	Signal: Negated Latched Output (Q NOT)
Logics.LE3.Gate In1-I	State of the module input: Assignment of the Input Signal
Logics.LE3.Gate In2-I	State of the module input: Assignment of the Input Signal
Logics.LE3.Gate In3-I	State of the module input: Assignment of the Input Signal
Logics.LE3.Gate In4-I	State of the module input: Assignment of the Input Signal
Logics.LE3.Reset Latch-I	State of the module input: Reset Signal for the Latching
Logics.LE4.Gate Out	Signal: Output of the logic gate
Logics.LE4.Timer Out	Signal: Timer Output
Logics.LE4.Out	Signal: Latched Output (Q)
Logics.LE4.Out inverted	Signal: Negated Latched Output (Q NOT)
Logics.LE4.Gate In1-I	State of the module input: Assignment of the Input Signal
Logics.LE4.Gate In2-I	State of the module input: Assignment of the Input Signal
Logics.LE4.Gate In3-I	State of the module input: Assignment of the Input Signal
Logics.LE4.Gate In4-I	State of the module input: Assignment of the Input Signal
Logics.LE4.Reset Latch-I	State of the module input: Reset Signal for the Latching
Logics.LE5.Gate Out	Signal: Output of the logic gate
Logics.LE5.Timer Out	Signal: Timer Output
Logics.LE5.Out	Signal: Latched Output (Q)
Logics.LE5.Out inverted	Signal: Negated Latched Output (Q NOT)
Logics.LE5.Gate In1-I	State of the module input: Assignment of the Input Signal
Logics.LE5.Gate In2-I	State of the module input: Assignment of the Input Signal

## Assignment List

<i>Name</i>	<i>Description</i>
Logics.LE5.Gate In3-I	State of the module input: Assignment of the Input Signal
Logics.LE5.Gate In4-I	State of the module input: Assignment of the Input Signal
Logics.LE5.Reset Latch-I	State of the module input: Reset Signal for the Latching
Logics.LE6.Gate Out	Signal: Output of the logic gate
Logics.LE6.Timer Out	Signal: Timer Output
Logics.LE6.Out	Signal: Latched Output (Q)
Logics.LE6.Out inverted	Signal: Negated Latched Output (Q NOT)
Logics.LE6.Gate In1-I	State of the module input: Assignment of the Input Signal
Logics.LE6.Gate In2-I	State of the module input: Assignment of the Input Signal
Logics.LE6.Gate In3-I	State of the module input: Assignment of the Input Signal
Logics.LE6.Gate In4-I	State of the module input: Assignment of the Input Signal
Logics.LE6.Reset Latch-I	State of the module input: Reset Signal for the Latching
Logics.LE7.Gate Out	Signal: Output of the logic gate
Logics.LE7.Timer Out	Signal: Timer Output
Logics.LE7.Out	Signal: Latched Output (Q)
Logics.LE7.Out inverted	Signal: Negated Latched Output (Q NOT)
Logics.LE7.Gate In1-I	State of the module input: Assignment of the Input Signal
Logics.LE7.Gate In2-I	State of the module input: Assignment of the Input Signal
Logics.LE7.Gate In3-I	State of the module input: Assignment of the Input Signal
Logics.LE7.Gate In4-I	State of the module input: Assignment of the Input Signal
Logics.LE7.Reset Latch-I	State of the module input: Reset Signal for the Latching
Logics.LE8.Gate Out	Signal: Output of the logic gate
Logics.LE8.Timer Out	Signal: Timer Output
Logics.LE8.Out	Signal: Latched Output (Q)
Logics.LE8.Out inverted	Signal: Negated Latched Output (Q NOT)
Logics.LE8.Gate In1-I	State of the module input: Assignment of the Input Signal
Logics.LE8.Gate In2-I	State of the module input: Assignment of the Input Signal
Logics.LE8.Gate In3-I	State of the module input: Assignment of the Input Signal
Logics.LE8.Gate In4-I	State of the module input: Assignment of the Input Signal
Logics.LE8.Reset Latch-I	State of the module input: Reset Signal for the Latching
Logics.LE9.Gate Out	Signal: Output of the logic gate
Logics.LE9.Timer Out	Signal: Timer Output
Logics.LE9.Out	Signal: Latched Output (Q)
Logics.LE9.Out inverted	Signal: Negated Latched Output (Q NOT)
Logics.LE9.Gate In1-I	State of the module input: Assignment of the Input Signal
Logics.LE9.Gate In2-I	State of the module input: Assignment of the Input Signal
Logics.LE9.Gate In3-I	State of the module input: Assignment of the Input Signal
Logics.LE9.Gate In4-I	State of the module input: Assignment of the Input Signal
Logics.LE9.Reset Latch-I	State of the module input: Reset Signal for the Latching
Logics.LE10.Gate Out	Signal: Output of the logic gate



## Assignment List

<i>Name</i>	<i>Description</i>
Logics.LE10.Timer Out	Signal: Timer Output
Logics.LE10.Out	Signal: Latched Output (Q)
Logics.LE10.Out inverted	Signal: Negated Latched Output (Q NOT)
Logics.LE10.Gate In1-I	State of the module input: Assignment of the Input Signal
Logics.LE10.Gate In2-I	State of the module input: Assignment of the Input Signal
Logics.LE10.Gate In3-I	State of the module input: Assignment of the Input Signal
Logics.LE10.Gate In4-I	State of the module input: Assignment of the Input Signal
Logics.LE10.Reset Latch-I	State of the module input: Reset Signal for the Latching
Logics.LE11.Gate Out	Signal: Output of the logic gate
Logics.LE11.Timer Out	Signal: Timer Output
Logics.LE11.Out	Signal: Latched Output (Q)
Logics.LE11.Out inverted	Signal: Negated Latched Output (Q NOT)
Logics.LE11.Gate In1-I	State of the module input: Assignment of the Input Signal
Logics.LE11.Gate In2-I	State of the module input: Assignment of the Input Signal
Logics.LE11.Gate In3-I	State of the module input: Assignment of the Input Signal
Logics.LE11.Gate In4-I	State of the module input: Assignment of the Input Signal
Logics.LE11.Reset Latch-I	State of the module input: Reset Signal for the Latching
Logics.LE12.Gate Out	Signal: Output of the logic gate
Logics.LE12.Timer Out	Signal: Timer Output
Logics.LE12.Out	Signal: Latched Output (Q)
Logics.LE12.Out inverted	Signal: Negated Latched Output (Q NOT)
Logics.LE12.Gate In1-I	State of the module input: Assignment of the Input Signal
Logics.LE12.Gate In2-I	State of the module input: Assignment of the Input Signal
Logics.LE12.Gate In3-I	State of the module input: Assignment of the Input Signal
Logics.LE12.Gate In4-I	State of the module input: Assignment of the Input Signal
Logics.LE12.Reset Latch-I	State of the module input: Reset Signal for the Latching
Logics.LE13.Gate Out	Signal: Output of the logic gate
Logics.LE13.Timer Out	Signal: Timer Output
Logics.LE13.Out	Signal: Latched Output (Q)
Logics.LE13.Out inverted	Signal: Negated Latched Output (Q NOT)
Logics.LE13.Gate In1-I	State of the module input: Assignment of the Input Signal
Logics.LE13.Gate In2-I	State of the module input: Assignment of the Input Signal
Logics.LE13.Gate In3-I	State of the module input: Assignment of the Input Signal
Logics.LE13.Gate In4-I	State of the module input: Assignment of the Input Signal
Logics.LE13.Reset Latch-I	State of the module input: Reset Signal for the Latching
Logics.LE14.Gate Out	Signal: Output of the logic gate
Logics.LE14.Timer Out	Signal: Timer Output
Logics.LE14.Out	Signal: Latched Output (Q)
Logics.LE14.Out inverted	Signal: Negated Latched Output (Q NOT)
Logics.LE14.Gate In1-I	State of the module input: Assignment of the Input Signal

## Assignment List

<i>Name</i>	<i>Description</i>
Logics.LE14.Gate In2-I	State of the module input: Assignment of the Input Signal
Logics.LE14.Gate In3-I	State of the module input: Assignment of the Input Signal
Logics.LE14.Gate In4-I	State of the module input: Assignment of the Input Signal
Logics.LE14.Reset Latch-I	State of the module input: Reset Signal for the Latching
Logics.LE15.Gate Out	Signal: Output of the logic gate
Logics.LE15.Timer Out	Signal: Timer Output
Logics.LE15.Out	Signal: Latched Output (Q)
Logics.LE15.Out inverted	Signal: Negated Latched Output (Q NOT)
Logics.LE15.Gate In1-I	State of the module input: Assignment of the Input Signal
Logics.LE15.Gate In2-I	State of the module input: Assignment of the Input Signal
Logics.LE15.Gate In3-I	State of the module input: Assignment of the Input Signal
Logics.LE15.Gate In4-I	State of the module input: Assignment of the Input Signal
Logics.LE15.Reset Latch-I	State of the module input: Reset Signal for the Latching
Logics.LE16.Gate Out	Signal: Output of the logic gate
Logics.LE16.Timer Out	Signal: Timer Output
Logics.LE16.Out	Signal: Latched Output (Q)
Logics.LE16.Out inverted	Signal: Negated Latched Output (Q NOT)
Logics.LE16.Gate In1-I	State of the module input: Assignment of the Input Signal
Logics.LE16.Gate In2-I	State of the module input: Assignment of the Input Signal
Logics.LE16.Gate In3-I	State of the module input: Assignment of the Input Signal
Logics.LE16.Gate In4-I	State of the module input: Assignment of the Input Signal
Logics.LE16.Reset Latch-I	State of the module input: Reset Signal for the Latching
Logics.LE17.Gate Out	Signal: Output of the logic gate
Logics.LE17.Timer Out	Signal: Timer Output
Logics.LE17.Out	Signal: Latched Output (Q)
Logics.LE17.Out inverted	Signal: Negated Latched Output (Q NOT)
Logics.LE17.Gate In1-I	State of the module input: Assignment of the Input Signal
Logics.LE17.Gate In2-I	State of the module input: Assignment of the Input Signal
Logics.LE17.Gate In3-I	State of the module input: Assignment of the Input Signal
Logics.LE17.Gate In4-I	State of the module input: Assignment of the Input Signal
Logics.LE17.Reset Latch-I	State of the module input: Reset Signal for the Latching
Logics.LE18.Gate Out	Signal: Output of the logic gate
Logics.LE18.Timer Out	Signal: Timer Output
Logics.LE18.Out	Signal: Latched Output (Q)
Logics.LE18.Out inverted	Signal: Negated Latched Output (Q NOT)
Logics.LE18.Gate In1-I	State of the module input: Assignment of the Input Signal
Logics.LE18.Gate In2-I	State of the module input: Assignment of the Input Signal
Logics.LE18.Gate In3-I	State of the module input: Assignment of the Input Signal
Logics.LE18.Gate In4-I	State of the module input: Assignment of the Input Signal
Logics.LE18.Reset Latch-I	State of the module input: Reset Signal for the Latching

## Assignment List

<i>Name</i>	<i>Description</i>
Logics.LE19.Gate Out	Signal: Output of the logic gate
Logics.LE19.Timer Out	Signal: Timer Output
Logics.LE19.Out	Signal: Latched Output (Q)
Logics.LE19.Out inverted	Signal: Negated Latched Output (Q NOT)
Logics.LE19.Gate In1-I	State of the module input: Assignment of the Input Signal
Logics.LE19.Gate In2-I	State of the module input: Assignment of the Input Signal
Logics.LE19.Gate In3-I	State of the module input: Assignment of the Input Signal
Logics.LE19.Gate In4-I	State of the module input: Assignment of the Input Signal
Logics.LE19.Reset Latch-I	State of the module input: Reset Signal for the Latching
Logics.LE20.Gate Out	Signal: Output of the logic gate
Logics.LE20.Timer Out	Signal: Timer Output
Logics.LE20.Out	Signal: Latched Output (Q)
Logics.LE20.Out inverted	Signal: Negated Latched Output (Q NOT)
Logics.LE20.Gate In1-I	State of the module input: Assignment of the Input Signal
Logics.LE20.Gate In2-I	State of the module input: Assignment of the Input Signal
Logics.LE20.Gate In3-I	State of the module input: Assignment of the Input Signal
Logics.LE20.Gate In4-I	State of the module input: Assignment of the Input Signal
Logics.LE20.Reset Latch-I	State of the module input: Reset Signal for the Latching
Logics.LE21.Gate Out	Signal: Output of the logic gate
Logics.LE21.Timer Out	Signal: Timer Output
Logics.LE21.Out	Signal: Latched Output (Q)
Logics.LE21.Out inverted	Signal: Negated Latched Output (Q NOT)
Logics.LE21.Gate In1-I	State of the module input: Assignment of the Input Signal
Logics.LE21.Gate In2-I	State of the module input: Assignment of the Input Signal
Logics.LE21.Gate In3-I	State of the module input: Assignment of the Input Signal
Logics.LE21.Gate In4-I	State of the module input: Assignment of the Input Signal
Logics.LE21.Reset Latch-I	State of the module input: Reset Signal for the Latching
Logics.LE22.Gate Out	Signal: Output of the logic gate
Logics.LE22.Timer Out	Signal: Timer Output
Logics.LE22.Out	Signal: Latched Output (Q)
Logics.LE22.Out inverted	Signal: Negated Latched Output (Q NOT)
Logics.LE22.Gate In1-I	State of the module input: Assignment of the Input Signal
Logics.LE22.Gate In2-I	State of the module input: Assignment of the Input Signal
Logics.LE22.Gate In3-I	State of the module input: Assignment of the Input Signal
Logics.LE22.Gate In4-I	State of the module input: Assignment of the Input Signal
Logics.LE22.Reset Latch-I	State of the module input: Reset Signal for the Latching
Logics.LE23.Gate Out	Signal: Output of the logic gate
Logics.LE23.Timer Out	Signal: Timer Output
Logics.LE23.Out	Signal: Latched Output (Q)
Logics.LE23.Out inverted	Signal: Negated Latched Output (Q NOT)

## Assignment List

<i>Name</i>	<i>Description</i>
Logics.LE23.Gate In1-I	State of the module input: Assignment of the Input Signal
Logics.LE23.Gate In2-I	State of the module input: Assignment of the Input Signal
Logics.LE23.Gate In3-I	State of the module input: Assignment of the Input Signal
Logics.LE23.Gate In4-I	State of the module input: Assignment of the Input Signal
Logics.LE23.Reset Latch-I	State of the module input: Reset Signal for the Latching
Logics.LE24.Gate Out	Signal: Output of the logic gate
Logics.LE24.Timer Out	Signal: Timer Output
Logics.LE24.Out	Signal: Latched Output (Q)
Logics.LE24.Out inverted	Signal: Negated Latched Output (Q NOT)
Logics.LE24.Gate In1-I	State of the module input: Assignment of the Input Signal
Logics.LE24.Gate In2-I	State of the module input: Assignment of the Input Signal
Logics.LE24.Gate In3-I	State of the module input: Assignment of the Input Signal
Logics.LE24.Gate In4-I	State of the module input: Assignment of the Input Signal
Logics.LE24.Reset Latch-I	State of the module input: Reset Signal for the Latching
Logics.LE25.Gate Out	Signal: Output of the logic gate
Logics.LE25.Timer Out	Signal: Timer Output
Logics.LE25.Out	Signal: Latched Output (Q)
Logics.LE25.Out inverted	Signal: Negated Latched Output (Q NOT)
Logics.LE25.Gate In1-I	State of the module input: Assignment of the Input Signal
Logics.LE25.Gate In2-I	State of the module input: Assignment of the Input Signal
Logics.LE25.Gate In3-I	State of the module input: Assignment of the Input Signal
Logics.LE25.Gate In4-I	State of the module input: Assignment of the Input Signal
Logics.LE25.Reset Latch-I	State of the module input: Reset Signal for the Latching
Logics.LE26.Gate Out	Signal: Output of the logic gate
Logics.LE26.Timer Out	Signal: Timer Output
Logics.LE26.Out	Signal: Latched Output (Q)
Logics.LE26.Out inverted	Signal: Negated Latched Output (Q NOT)
Logics.LE26.Gate In1-I	State of the module input: Assignment of the Input Signal
Logics.LE26.Gate In2-I	State of the module input: Assignment of the Input Signal
Logics.LE26.Gate In3-I	State of the module input: Assignment of the Input Signal
Logics.LE26.Gate In4-I	State of the module input: Assignment of the Input Signal
Logics.LE26.Reset Latch-I	State of the module input: Reset Signal for the Latching
Logics.LE27.Gate Out	Signal: Output of the logic gate
Logics.LE27.Timer Out	Signal: Timer Output
Logics.LE27.Out	Signal: Latched Output (Q)
Logics.LE27.Out inverted	Signal: Negated Latched Output (Q NOT)
Logics.LE27.Gate In1-I	State of the module input: Assignment of the Input Signal
Logics.LE27.Gate In2-I	State of the module input: Assignment of the Input Signal
Logics.LE27.Gate In3-I	State of the module input: Assignment of the Input Signal
Logics.LE27.Gate In4-I	State of the module input: Assignment of the Input Signal

## Assignment List

<i>Name</i>	<i>Description</i>
Logics.LE27.Reset Latch-I	State of the module input: Reset Signal for the Latching
Logics.LE28.Gate Out	Signal: Output of the logic gate
Logics.LE28.Timer Out	Signal: Timer Output
Logics.LE28.Out	Signal: Latched Output (Q)
Logics.LE28.Out inverted	Signal: Negated Latched Output (Q NOT)
Logics.LE28.Gate In1-I	State of the module input: Assignment of the Input Signal
Logics.LE28.Gate In2-I	State of the module input: Assignment of the Input Signal
Logics.LE28.Gate In3-I	State of the module input: Assignment of the Input Signal
Logics.LE28.Gate In4-I	State of the module input: Assignment of the Input Signal
Logics.LE28.Reset Latch-I	State of the module input: Reset Signal for the Latching
Logics.LE29.Gate Out	Signal: Output of the logic gate
Logics.LE29.Timer Out	Signal: Timer Output
Logics.LE29.Out	Signal: Latched Output (Q)
Logics.LE29.Out inverted	Signal: Negated Latched Output (Q NOT)
Logics.LE29.Gate In1-I	State of the module input: Assignment of the Input Signal
Logics.LE29.Gate In2-I	State of the module input: Assignment of the Input Signal
Logics.LE29.Gate In3-I	State of the module input: Assignment of the Input Signal
Logics.LE29.Gate In4-I	State of the module input: Assignment of the Input Signal
Logics.LE29.Reset Latch-I	State of the module input: Reset Signal for the Latching
Logics.LE30.Gate Out	Signal: Output of the logic gate
Logics.LE30.Timer Out	Signal: Timer Output
Logics.LE30.Out	Signal: Latched Output (Q)
Logics.LE30.Out inverted	Signal: Negated Latched Output (Q NOT)
Logics.LE30.Gate In1-I	State of the module input: Assignment of the Input Signal
Logics.LE30.Gate In2-I	State of the module input: Assignment of the Input Signal
Logics.LE30.Gate In3-I	State of the module input: Assignment of the Input Signal
Logics.LE30.Gate In4-I	State of the module input: Assignment of the Input Signal
Logics.LE30.Reset Latch-I	State of the module input: Reset Signal for the Latching
Logics.LE31.Gate Out	Signal: Output of the logic gate
Logics.LE31.Timer Out	Signal: Timer Output
Logics.LE31.Out	Signal: Latched Output (Q)
Logics.LE31.Out inverted	Signal: Negated Latched Output (Q NOT)
Logics.LE31.Gate In1-I	State of the module input: Assignment of the Input Signal
Logics.LE31.Gate In2-I	State of the module input: Assignment of the Input Signal
Logics.LE31.Gate In3-I	State of the module input: Assignment of the Input Signal
Logics.LE31.Gate In4-I	State of the module input: Assignment of the Input Signal
Logics.LE31.Reset Latch-I	State of the module input: Reset Signal for the Latching
Logics.LE32.Gate Out	Signal: Output of the logic gate
Logics.LE32.Timer Out	Signal: Timer Output
Logics.LE32.Out	Signal: Latched Output (Q)

## Assignment List

<i>Name</i>	<i>Description</i>
Logics.LE32.Out inverted	Signal: Negated Latched Output (Q NOT)
Logics.LE32.Gate In1-I	State of the module input: Assignment of the Input Signal
Logics.LE32.Gate In2-I	State of the module input: Assignment of the Input Signal
Logics.LE32.Gate In3-I	State of the module input: Assignment of the Input Signal
Logics.LE32.Gate In4-I	State of the module input: Assignment of the Input Signal
Logics.LE32.Reset Latch-I	State of the module input: Reset Signal for the Latching
Logics.LE33.Gate Out	Signal: Output of the logic gate
Logics.LE33.Timer Out	Signal: Timer Output
Logics.LE33.Out	Signal: Latched Output (Q)
Logics.LE33.Out inverted	Signal: Negated Latched Output (Q NOT)
Logics.LE33.Gate In1-I	State of the module input: Assignment of the Input Signal
Logics.LE33.Gate In2-I	State of the module input: Assignment of the Input Signal
Logics.LE33.Gate In3-I	State of the module input: Assignment of the Input Signal
Logics.LE33.Gate In4-I	State of the module input: Assignment of the Input Signal
Logics.LE33.Reset Latch-I	State of the module input: Reset Signal for the Latching
Logics.LE34.Gate Out	Signal: Output of the logic gate
Logics.LE34.Timer Out	Signal: Timer Output
Logics.LE34.Out	Signal: Latched Output (Q)
Logics.LE34.Out inverted	Signal: Negated Latched Output (Q NOT)
Logics.LE34.Gate In1-I	State of the module input: Assignment of the Input Signal
Logics.LE34.Gate In2-I	State of the module input: Assignment of the Input Signal
Logics.LE34.Gate In3-I	State of the module input: Assignment of the Input Signal
Logics.LE34.Gate In4-I	State of the module input: Assignment of the Input Signal
Logics.LE34.Reset Latch-I	State of the module input: Reset Signal for the Latching
Logics.LE35.Gate Out	Signal: Output of the logic gate
Logics.LE35.Timer Out	Signal: Timer Output
Logics.LE35.Out	Signal: Latched Output (Q)
Logics.LE35.Out inverted	Signal: Negated Latched Output (Q NOT)
Logics.LE35.Gate In1-I	State of the module input: Assignment of the Input Signal
Logics.LE35.Gate In2-I	State of the module input: Assignment of the Input Signal
Logics.LE35.Gate In3-I	State of the module input: Assignment of the Input Signal
Logics.LE35.Gate In4-I	State of the module input: Assignment of the Input Signal
Logics.LE35.Reset Latch-I	State of the module input: Reset Signal for the Latching
Logics.LE36.Gate Out	Signal: Output of the logic gate
Logics.LE36.Timer Out	Signal: Timer Output
Logics.LE36.Out	Signal: Latched Output (Q)
Logics.LE36.Out inverted	Signal: Negated Latched Output (Q NOT)
Logics.LE36.Gate In1-I	State of the module input: Assignment of the Input Signal
Logics.LE36.Gate In2-I	State of the module input: Assignment of the Input Signal
Logics.LE36.Gate In3-I	State of the module input: Assignment of the Input Signal

## Assignment List

<i>Name</i>	<i>Description</i>
Logics.LE36.Gate In4-I	State of the module input: Assignment of the Input Signal
Logics.LE36.Reset Latch-I	State of the module input: Reset Signal for the Latching
Logics.LE37.Gate Out	Signal: Output of the logic gate
Logics.LE37.Timer Out	Signal: Timer Output
Logics.LE37.Out	Signal: Latched Output (Q)
Logics.LE37.Out inverted	Signal: Negated Latched Output (Q NOT)
Logics.LE37.Gate In1-I	State of the module input: Assignment of the Input Signal
Logics.LE37.Gate In2-I	State of the module input: Assignment of the Input Signal
Logics.LE37.Gate In3-I	State of the module input: Assignment of the Input Signal
Logics.LE37.Gate In4-I	State of the module input: Assignment of the Input Signal
Logics.LE37.Reset Latch-I	State of the module input: Reset Signal for the Latching
Logics.LE38.Gate Out	Signal: Output of the logic gate
Logics.LE38.Timer Out	Signal: Timer Output
Logics.LE38.Out	Signal: Latched Output (Q)
Logics.LE38.Out inverted	Signal: Negated Latched Output (Q NOT)
Logics.LE38.Gate In1-I	State of the module input: Assignment of the Input Signal
Logics.LE38.Gate In2-I	State of the module input: Assignment of the Input Signal
Logics.LE38.Gate In3-I	State of the module input: Assignment of the Input Signal
Logics.LE38.Gate In4-I	State of the module input: Assignment of the Input Signal
Logics.LE38.Reset Latch-I	State of the module input: Reset Signal for the Latching
Logics.LE39.Gate Out	Signal: Output of the logic gate
Logics.LE39.Timer Out	Signal: Timer Output
Logics.LE39.Out	Signal: Latched Output (Q)
Logics.LE39.Out inverted	Signal: Negated Latched Output (Q NOT)
Logics.LE39.Gate In1-I	State of the module input: Assignment of the Input Signal
Logics.LE39.Gate In2-I	State of the module input: Assignment of the Input Signal
Logics.LE39.Gate In3-I	State of the module input: Assignment of the Input Signal
Logics.LE39.Gate In4-I	State of the module input: Assignment of the Input Signal
Logics.LE39.Reset Latch-I	State of the module input: Reset Signal for the Latching
Logics.LE40.Gate Out	Signal: Output of the logic gate
Logics.LE40.Timer Out	Signal: Timer Output
Logics.LE40.Out	Signal: Latched Output (Q)
Logics.LE40.Out inverted	Signal: Negated Latched Output (Q NOT)
Logics.LE40.Gate In1-I	State of the module input: Assignment of the Input Signal
Logics.LE40.Gate In2-I	State of the module input: Assignment of the Input Signal
Logics.LE40.Gate In3-I	State of the module input: Assignment of the Input Signal
Logics.LE40.Gate In4-I	State of the module input: Assignment of the Input Signal
Logics.LE40.Reset Latch-I	State of the module input: Reset Signal for the Latching
Logics.LE41.Gate Out	Signal: Output of the logic gate
Logics.LE41.Timer Out	Signal: Timer Output



## Assignment List

<i>Name</i>	<i>Description</i>
Logics.LE41.Out	Signal: Latched Output (Q)
Logics.LE41.Out inverted	Signal: Negated Latched Output (Q NOT)
Logics.LE41.Gate In1-I	State of the module input: Assignment of the Input Signal
Logics.LE41.Gate In2-I	State of the module input: Assignment of the Input Signal
Logics.LE41.Gate In3-I	State of the module input: Assignment of the Input Signal
Logics.LE41.Gate In4-I	State of the module input: Assignment of the Input Signal
Logics.LE41.Reset Latch-I	State of the module input: Reset Signal for the Latching
Logics.LE42.Gate Out	Signal: Output of the logic gate
Logics.LE42.Timer Out	Signal: Timer Output
Logics.LE42.Out	Signal: Latched Output (Q)
Logics.LE42.Out inverted	Signal: Negated Latched Output (Q NOT)
Logics.LE42.Gate In1-I	State of the module input: Assignment of the Input Signal
Logics.LE42.Gate In2-I	State of the module input: Assignment of the Input Signal
Logics.LE42.Gate In3-I	State of the module input: Assignment of the Input Signal
Logics.LE42.Gate In4-I	State of the module input: Assignment of the Input Signal
Logics.LE42.Reset Latch-I	State of the module input: Reset Signal for the Latching
Logics.LE43.Gate Out	Signal: Output of the logic gate
Logics.LE43.Timer Out	Signal: Timer Output
Logics.LE43.Out	Signal: Latched Output (Q)
Logics.LE43.Out inverted	Signal: Negated Latched Output (Q NOT)
Logics.LE43.Gate In1-I	State of the module input: Assignment of the Input Signal
Logics.LE43.Gate In2-I	State of the module input: Assignment of the Input Signal
Logics.LE43.Gate In3-I	State of the module input: Assignment of the Input Signal
Logics.LE43.Gate In4-I	State of the module input: Assignment of the Input Signal
Logics.LE43.Reset Latch-I	State of the module input: Reset Signal for the Latching
Logics.LE44.Gate Out	Signal: Output of the logic gate
Logics.LE44.Timer Out	Signal: Timer Output
Logics.LE44.Out	Signal: Latched Output (Q)
Logics.LE44.Out inverted	Signal: Negated Latched Output (Q NOT)
Logics.LE44.Gate In1-I	State of the module input: Assignment of the Input Signal
Logics.LE44.Gate In2-I	State of the module input: Assignment of the Input Signal
Logics.LE44.Gate In3-I	State of the module input: Assignment of the Input Signal
Logics.LE44.Gate In4-I	State of the module input: Assignment of the Input Signal
Logics.LE44.Reset Latch-I	State of the module input: Reset Signal for the Latching
Logics.LE45.Gate Out	Signal: Output of the logic gate
Logics.LE45.Timer Out	Signal: Timer Output
Logics.LE45.Out	Signal: Latched Output (Q)
Logics.LE45.Out inverted	Signal: Negated Latched Output (Q NOT)
Logics.LE45.Gate In1-I	State of the module input: Assignment of the Input Signal
Logics.LE45.Gate In2-I	State of the module input: Assignment of the Input Signal



## Assignment List

<i>Name</i>	<i>Description</i>
Logics.LE45.Gate In3-I	State of the module input: Assignment of the Input Signal
Logics.LE45.Gate In4-I	State of the module input: Assignment of the Input Signal
Logics.LE45.Reset Latch-I	State of the module input: Reset Signal for the Latching
Logics.LE46.Gate Out	Signal: Output of the logic gate
Logics.LE46.Timer Out	Signal: Timer Output
Logics.LE46.Out	Signal: Latched Output (Q)
Logics.LE46.Out inverted	Signal: Negated Latched Output (Q NOT)
Logics.LE46.Gate In1-I	State of the module input: Assignment of the Input Signal
Logics.LE46.Gate In2-I	State of the module input: Assignment of the Input Signal
Logics.LE46.Gate In3-I	State of the module input: Assignment of the Input Signal
Logics.LE46.Gate In4-I	State of the module input: Assignment of the Input Signal
Logics.LE46.Reset Latch-I	State of the module input: Reset Signal for the Latching
Logics.LE47.Gate Out	Signal: Output of the logic gate
Logics.LE47.Timer Out	Signal: Timer Output
Logics.LE47.Out	Signal: Latched Output (Q)
Logics.LE47.Out inverted	Signal: Negated Latched Output (Q NOT)
Logics.LE47.Gate In1-I	State of the module input: Assignment of the Input Signal
Logics.LE47.Gate In2-I	State of the module input: Assignment of the Input Signal
Logics.LE47.Gate In3-I	State of the module input: Assignment of the Input Signal
Logics.LE47.Gate In4-I	State of the module input: Assignment of the Input Signal
Logics.LE47.Reset Latch-I	State of the module input: Reset Signal for the Latching
Logics.LE48.Gate Out	Signal: Output of the logic gate
Logics.LE48.Timer Out	Signal: Timer Output
Logics.LE48.Out	Signal: Latched Output (Q)
Logics.LE48.Out inverted	Signal: Negated Latched Output (Q NOT)
Logics.LE48.Gate In1-I	State of the module input: Assignment of the Input Signal
Logics.LE48.Gate In2-I	State of the module input: Assignment of the Input Signal
Logics.LE48.Gate In3-I	State of the module input: Assignment of the Input Signal
Logics.LE48.Gate In4-I	State of the module input: Assignment of the Input Signal
Logics.LE48.Reset Latch-I	State of the module input: Reset Signal for the Latching
Logics.LE49.Gate Out	Signal: Output of the logic gate
Logics.LE49.Timer Out	Signal: Timer Output
Logics.LE49.Out	Signal: Latched Output (Q)
Logics.LE49.Out inverted	Signal: Negated Latched Output (Q NOT)
Logics.LE49.Gate In1-I	State of the module input: Assignment of the Input Signal
Logics.LE49.Gate In2-I	State of the module input: Assignment of the Input Signal
Logics.LE49.Gate In3-I	State of the module input: Assignment of the Input Signal
Logics.LE49.Gate In4-I	State of the module input: Assignment of the Input Signal
Logics.LE49.Reset Latch-I	State of the module input: Reset Signal for the Latching
Logics.LE50.Gate Out	Signal: Output of the logic gate

## Assignment List

<i>Name</i>	<i>Description</i>
Logics.LE50.Timer Out	Signal: Timer Output
Logics.LE50.Out	Signal: Latched Output (Q)
Logics.LE50.Out inverted	Signal: Negated Latched Output (Q NOT)
Logics.LE50.Gate In1-I	State of the module input: Assignment of the Input Signal
Logics.LE50.Gate In2-I	State of the module input: Assignment of the Input Signal
Logics.LE50.Gate In3-I	State of the module input: Assignment of the Input Signal
Logics.LE50.Gate In4-I	State of the module input: Assignment of the Input Signal
Logics.LE50.Reset Latch-I	State of the module input: Reset Signal for the Latching
Logics.LE51.Gate Out	Signal: Output of the logic gate
Logics.LE51.Timer Out	Signal: Timer Output
Logics.LE51.Out	Signal: Latched Output (Q)
Logics.LE51.Out inverted	Signal: Negated Latched Output (Q NOT)
Logics.LE51.Gate In1-I	State of the module input: Assignment of the Input Signal
Logics.LE51.Gate In2-I	State of the module input: Assignment of the Input Signal
Logics.LE51.Gate In3-I	State of the module input: Assignment of the Input Signal
Logics.LE51.Gate In4-I	State of the module input: Assignment of the Input Signal
Logics.LE51.Reset Latch-I	State of the module input: Reset Signal for the Latching
Logics.LE52.Gate Out	Signal: Output of the logic gate
Logics.LE52.Timer Out	Signal: Timer Output
Logics.LE52.Out	Signal: Latched Output (Q)
Logics.LE52.Out inverted	Signal: Negated Latched Output (Q NOT)
Logics.LE52.Gate In1-I	State of the module input: Assignment of the Input Signal
Logics.LE52.Gate In2-I	State of the module input: Assignment of the Input Signal
Logics.LE52.Gate In3-I	State of the module input: Assignment of the Input Signal
Logics.LE52.Gate In4-I	State of the module input: Assignment of the Input Signal
Logics.LE52.Reset Latch-I	State of the module input: Reset Signal for the Latching
Logics.LE53.Gate Out	Signal: Output of the logic gate
Logics.LE53.Timer Out	Signal: Timer Output
Logics.LE53.Out	Signal: Latched Output (Q)
Logics.LE53.Out inverted	Signal: Negated Latched Output (Q NOT)
Logics.LE53.Gate In1-I	State of the module input: Assignment of the Input Signal
Logics.LE53.Gate In2-I	State of the module input: Assignment of the Input Signal
Logics.LE53.Gate In3-I	State of the module input: Assignment of the Input Signal
Logics.LE53.Gate In4-I	State of the module input: Assignment of the Input Signal
Logics.LE53.Reset Latch-I	State of the module input: Reset Signal for the Latching
Logics.LE54.Gate Out	Signal: Output of the logic gate
Logics.LE54.Timer Out	Signal: Timer Output
Logics.LE54.Out	Signal: Latched Output (Q)
Logics.LE54.Out inverted	Signal: Negated Latched Output (Q NOT)
Logics.LE54.Gate In1-I	State of the module input: Assignment of the Input Signal

## Assignment List

<i>Name</i>	<i>Description</i>
Logics.LE54.Gate In2-I	State of the module input: Assignment of the Input Signal
Logics.LE54.Gate In3-I	State of the module input: Assignment of the Input Signal
Logics.LE54.Gate In4-I	State of the module input: Assignment of the Input Signal
Logics.LE54.Reset Latch-I	State of the module input: Reset Signal for the Latching
Logics.LE55.Gate Out	Signal: Output of the logic gate
Logics.LE55.Timer Out	Signal: Timer Output
Logics.LE55.Out	Signal: Latched Output (Q)
Logics.LE55.Out inverted	Signal: Negated Latched Output (Q NOT)
Logics.LE55.Gate In1-I	State of the module input: Assignment of the Input Signal
Logics.LE55.Gate In2-I	State of the module input: Assignment of the Input Signal
Logics.LE55.Gate In3-I	State of the module input: Assignment of the Input Signal
Logics.LE55.Gate In4-I	State of the module input: Assignment of the Input Signal
Logics.LE55.Reset Latch-I	State of the module input: Reset Signal for the Latching
Logics.LE56.Gate Out	Signal: Output of the logic gate
Logics.LE56.Timer Out	Signal: Timer Output
Logics.LE56.Out	Signal: Latched Output (Q)
Logics.LE56.Out inverted	Signal: Negated Latched Output (Q NOT)
Logics.LE56.Gate In1-I	State of the module input: Assignment of the Input Signal
Logics.LE56.Gate In2-I	State of the module input: Assignment of the Input Signal
Logics.LE56.Gate In3-I	State of the module input: Assignment of the Input Signal
Logics.LE56.Gate In4-I	State of the module input: Assignment of the Input Signal
Logics.LE56.Reset Latch-I	State of the module input: Reset Signal for the Latching
Logics.LE57.Gate Out	Signal: Output of the logic gate
Logics.LE57.Timer Out	Signal: Timer Output
Logics.LE57.Out	Signal: Latched Output (Q)
Logics.LE57.Out inverted	Signal: Negated Latched Output (Q NOT)
Logics.LE57.Gate In1-I	State of the module input: Assignment of the Input Signal
Logics.LE57.Gate In2-I	State of the module input: Assignment of the Input Signal
Logics.LE57.Gate In3-I	State of the module input: Assignment of the Input Signal
Logics.LE57.Gate In4-I	State of the module input: Assignment of the Input Signal
Logics.LE57.Reset Latch-I	State of the module input: Reset Signal for the Latching
Logics.LE58.Gate Out	Signal: Output of the logic gate
Logics.LE58.Timer Out	Signal: Timer Output
Logics.LE58.Out	Signal: Latched Output (Q)
Logics.LE58.Out inverted	Signal: Negated Latched Output (Q NOT)
Logics.LE58.Gate In1-I	State of the module input: Assignment of the Input Signal
Logics.LE58.Gate In2-I	State of the module input: Assignment of the Input Signal
Logics.LE58.Gate In3-I	State of the module input: Assignment of the Input Signal
Logics.LE58.Gate In4-I	State of the module input: Assignment of the Input Signal
Logics.LE58.Reset Latch-I	State of the module input: Reset Signal for the Latching

## Assignment List

<i>Name</i>	<i>Description</i>
Logics.LE59.Gate Out	Signal: Output of the logic gate
Logics.LE59.Timer Out	Signal: Timer Output
Logics.LE59.Out	Signal: Latched Output (Q)
Logics.LE59.Out inverted	Signal: Negated Latched Output (Q NOT)
Logics.LE59.Gate In1-I	State of the module input: Assignment of the Input Signal
Logics.LE59.Gate In2-I	State of the module input: Assignment of the Input Signal
Logics.LE59.Gate In3-I	State of the module input: Assignment of the Input Signal
Logics.LE59.Gate In4-I	State of the module input: Assignment of the Input Signal
Logics.LE59.Reset Latch-I	State of the module input: Reset Signal for the Latching
Logics.LE60.Gate Out	Signal: Output of the logic gate
Logics.LE60.Timer Out	Signal: Timer Output
Logics.LE60.Out	Signal: Latched Output (Q)
Logics.LE60.Out inverted	Signal: Negated Latched Output (Q NOT)
Logics.LE60.Gate In1-I	State of the module input: Assignment of the Input Signal
Logics.LE60.Gate In2-I	State of the module input: Assignment of the Input Signal
Logics.LE60.Gate In3-I	State of the module input: Assignment of the Input Signal
Logics.LE60.Gate In4-I	State of the module input: Assignment of the Input Signal
Logics.LE60.Reset Latch-I	State of the module input: Reset Signal for the Latching
Logics.LE61.Gate Out	Signal: Output of the logic gate
Logics.LE61.Timer Out	Signal: Timer Output
Logics.LE61.Out	Signal: Latched Output (Q)
Logics.LE61.Out inverted	Signal: Negated Latched Output (Q NOT)
Logics.LE61.Gate In1-I	State of the module input: Assignment of the Input Signal
Logics.LE61.Gate In2-I	State of the module input: Assignment of the Input Signal
Logics.LE61.Gate In3-I	State of the module input: Assignment of the Input Signal
Logics.LE61.Gate In4-I	State of the module input: Assignment of the Input Signal
Logics.LE61.Reset Latch-I	State of the module input: Reset Signal for the Latching
Logics.LE62.Gate Out	Signal: Output of the logic gate
Logics.LE62.Timer Out	Signal: Timer Output
Logics.LE62.Out	Signal: Latched Output (Q)
Logics.LE62.Out inverted	Signal: Negated Latched Output (Q NOT)
Logics.LE62.Gate In1-I	State of the module input: Assignment of the Input Signal
Logics.LE62.Gate In2-I	State of the module input: Assignment of the Input Signal
Logics.LE62.Gate In3-I	State of the module input: Assignment of the Input Signal
Logics.LE62.Gate In4-I	State of the module input: Assignment of the Input Signal
Logics.LE62.Reset Latch-I	State of the module input: Reset Signal for the Latching
Logics.LE63.Gate Out	Signal: Output of the logic gate
Logics.LE63.Timer Out	Signal: Timer Output
Logics.LE63.Out	Signal: Latched Output (Q)
Logics.LE63.Out inverted	Signal: Negated Latched Output (Q NOT)

## Assignment List

<i>Name</i>	<i>Description</i>
Logics.LE63.Gate In1-I	State of the module input: Assignment of the Input Signal
Logics.LE63.Gate In2-I	State of the module input: Assignment of the Input Signal
Logics.LE63.Gate In3-I	State of the module input: Assignment of the Input Signal
Logics.LE63.Gate In4-I	State of the module input: Assignment of the Input Signal
Logics.LE63.Reset Latch-I	State of the module input: Reset Signal for the Latching
Logics.LE64.Gate Out	Signal: Output of the logic gate
Logics.LE64.Timer Out	Signal: Timer Output
Logics.LE64.Out	Signal: Latched Output (Q)
Logics.LE64.Out inverted	Signal: Negated Latched Output (Q NOT)
Logics.LE64.Gate In1-I	State of the module input: Assignment of the Input Signal
Logics.LE64.Gate In2-I	State of the module input: Assignment of the Input Signal
Logics.LE64.Gate In3-I	State of the module input: Assignment of the Input Signal
Logics.LE64.Gate In4-I	State of the module input: Assignment of the Input Signal
Logics.LE64.Reset Latch-I	State of the module input: Reset Signal for the Latching
Logics.LE65.Gate Out	Signal: Output of the logic gate
Logics.LE65.Timer Out	Signal: Timer Output
Logics.LE65.Out	Signal: Latched Output (Q)
Logics.LE65.Out inverted	Signal: Negated Latched Output (Q NOT)
Logics.LE65.Gate In1-I	State of the module input: Assignment of the Input Signal
Logics.LE65.Gate In2-I	State of the module input: Assignment of the Input Signal
Logics.LE65.Gate In3-I	State of the module input: Assignment of the Input Signal
Logics.LE65.Gate In4-I	State of the module input: Assignment of the Input Signal
Logics.LE65.Reset Latch-I	State of the module input: Reset Signal for the Latching
Logics.LE66.Gate Out	Signal: Output of the logic gate
Logics.LE66.Timer Out	Signal: Timer Output
Logics.LE66.Out	Signal: Latched Output (Q)
Logics.LE66.Out inverted	Signal: Negated Latched Output (Q NOT)
Logics.LE66.Gate In1-I	State of the module input: Assignment of the Input Signal
Logics.LE66.Gate In2-I	State of the module input: Assignment of the Input Signal
Logics.LE66.Gate In3-I	State of the module input: Assignment of the Input Signal
Logics.LE66.Gate In4-I	State of the module input: Assignment of the Input Signal
Logics.LE66.Reset Latch-I	State of the module input: Reset Signal for the Latching
Logics.LE67.Gate Out	Signal: Output of the logic gate
Logics.LE67.Timer Out	Signal: Timer Output
Logics.LE67.Out	Signal: Latched Output (Q)
Logics.LE67.Out inverted	Signal: Negated Latched Output (Q NOT)
Logics.LE67.Gate In1-I	State of the module input: Assignment of the Input Signal
Logics.LE67.Gate In2-I	State of the module input: Assignment of the Input Signal
Logics.LE67.Gate In3-I	State of the module input: Assignment of the Input Signal
Logics.LE67.Gate In4-I	State of the module input: Assignment of the Input Signal

## Assignment List

<i>Name</i>	<i>Description</i>
Logics.LE67.Reset Latch-I	State of the module input: Reset Signal for the Latching
Logics.LE68.Gate Out	Signal: Output of the logic gate
Logics.LE68.Timer Out	Signal: Timer Output
Logics.LE68.Out	Signal: Latched Output (Q)
Logics.LE68.Out inverted	Signal: Negated Latched Output (Q NOT)
Logics.LE68.Gate In1-I	State of the module input: Assignment of the Input Signal
Logics.LE68.Gate In2-I	State of the module input: Assignment of the Input Signal
Logics.LE68.Gate In3-I	State of the module input: Assignment of the Input Signal
Logics.LE68.Gate In4-I	State of the module input: Assignment of the Input Signal
Logics.LE68.Reset Latch-I	State of the module input: Reset Signal for the Latching
Logics.LE69.Gate Out	Signal: Output of the logic gate
Logics.LE69.Timer Out	Signal: Timer Output
Logics.LE69.Out	Signal: Latched Output (Q)
Logics.LE69.Out inverted	Signal: Negated Latched Output (Q NOT)
Logics.LE69.Gate In1-I	State of the module input: Assignment of the Input Signal
Logics.LE69.Gate In2-I	State of the module input: Assignment of the Input Signal
Logics.LE69.Gate In3-I	State of the module input: Assignment of the Input Signal
Logics.LE69.Gate In4-I	State of the module input: Assignment of the Input Signal
Logics.LE69.Reset Latch-I	State of the module input: Reset Signal for the Latching
Logics.LE70.Gate Out	Signal: Output of the logic gate
Logics.LE70.Timer Out	Signal: Timer Output
Logics.LE70.Out	Signal: Latched Output (Q)
Logics.LE70.Out inverted	Signal: Negated Latched Output (Q NOT)
Logics.LE70.Gate In1-I	State of the module input: Assignment of the Input Signal
Logics.LE70.Gate In2-I	State of the module input: Assignment of the Input Signal
Logics.LE70.Gate In3-I	State of the module input: Assignment of the Input Signal
Logics.LE70.Gate In4-I	State of the module input: Assignment of the Input Signal
Logics.LE70.Reset Latch-I	State of the module input: Reset Signal for the Latching
Logics.LE71.Gate Out	Signal: Output of the logic gate
Logics.LE71.Timer Out	Signal: Timer Output
Logics.LE71.Out	Signal: Latched Output (Q)
Logics.LE71.Out inverted	Signal: Negated Latched Output (Q NOT)
Logics.LE71.Gate In1-I	State of the module input: Assignment of the Input Signal
Logics.LE71.Gate In2-I	State of the module input: Assignment of the Input Signal
Logics.LE71.Gate In3-I	State of the module input: Assignment of the Input Signal
Logics.LE71.Gate In4-I	State of the module input: Assignment of the Input Signal
Logics.LE71.Reset Latch-I	State of the module input: Reset Signal for the Latching
Logics.LE72.Gate Out	Signal: Output of the logic gate
Logics.LE72.Timer Out	Signal: Timer Output
Logics.LE72.Out	Signal: Latched Output (Q)

## Assignment List

<i>Name</i>	<i>Description</i>
Logics.LE72.Out inverted	Signal: Negated Latched Output (Q NOT)
Logics.LE72.Gate In1-I	State of the module input: Assignment of the Input Signal
Logics.LE72.Gate In2-I	State of the module input: Assignment of the Input Signal
Logics.LE72.Gate In3-I	State of the module input: Assignment of the Input Signal
Logics.LE72.Gate In4-I	State of the module input: Assignment of the Input Signal
Logics.LE72.Reset Latch-I	State of the module input: Reset Signal for the Latching
Logics.LE73.Gate Out	Signal: Output of the logic gate
Logics.LE73.Timer Out	Signal: Timer Output
Logics.LE73.Out	Signal: Latched Output (Q)
Logics.LE73.Out inverted	Signal: Negated Latched Output (Q NOT)
Logics.LE73.Gate In1-I	State of the module input: Assignment of the Input Signal
Logics.LE73.Gate In2-I	State of the module input: Assignment of the Input Signal
Logics.LE73.Gate In3-I	State of the module input: Assignment of the Input Signal
Logics.LE73.Gate In4-I	State of the module input: Assignment of the Input Signal
Logics.LE73.Reset Latch-I	State of the module input: Reset Signal for the Latching
Logics.LE74.Gate Out	Signal: Output of the logic gate
Logics.LE74.Timer Out	Signal: Timer Output
Logics.LE74.Out	Signal: Latched Output (Q)
Logics.LE74.Out inverted	Signal: Negated Latched Output (Q NOT)
Logics.LE74.Gate In1-I	State of the module input: Assignment of the Input Signal
Logics.LE74.Gate In2-I	State of the module input: Assignment of the Input Signal
Logics.LE74.Gate In3-I	State of the module input: Assignment of the Input Signal
Logics.LE74.Gate In4-I	State of the module input: Assignment of the Input Signal
Logics.LE74.Reset Latch-I	State of the module input: Reset Signal for the Latching
Logics.LE75.Gate Out	Signal: Output of the logic gate
Logics.LE75.Timer Out	Signal: Timer Output
Logics.LE75.Out	Signal: Latched Output (Q)
Logics.LE75.Out inverted	Signal: Negated Latched Output (Q NOT)
Logics.LE75.Gate In1-I	State of the module input: Assignment of the Input Signal
Logics.LE75.Gate In2-I	State of the module input: Assignment of the Input Signal
Logics.LE75.Gate In3-I	State of the module input: Assignment of the Input Signal
Logics.LE75.Gate In4-I	State of the module input: Assignment of the Input Signal
Logics.LE75.Reset Latch-I	State of the module input: Reset Signal for the Latching
Logics.LE76.Gate Out	Signal: Output of the logic gate
Logics.LE76.Timer Out	Signal: Timer Output
Logics.LE76.Out	Signal: Latched Output (Q)
Logics.LE76.Out inverted	Signal: Negated Latched Output (Q NOT)
Logics.LE76.Gate In1-I	State of the module input: Assignment of the Input Signal
Logics.LE76.Gate In2-I	State of the module input: Assignment of the Input Signal
Logics.LE76.Gate In3-I	State of the module input: Assignment of the Input Signal



## Assignment List

<i>Name</i>	<i>Description</i>
Logics.LE76.Gate In4-I	State of the module input: Assignment of the Input Signal
Logics.LE76.Reset Latch-I	State of the module input: Reset Signal for the Latching
Logics.LE77.Gate Out	Signal: Output of the logic gate
Logics.LE77.Timer Out	Signal: Timer Output
Logics.LE77.Out	Signal: Latched Output (Q)
Logics.LE77.Out inverted	Signal: Negated Latched Output (Q NOT)
Logics.LE77.Gate In1-I	State of the module input: Assignment of the Input Signal
Logics.LE77.Gate In2-I	State of the module input: Assignment of the Input Signal
Logics.LE77.Gate In3-I	State of the module input: Assignment of the Input Signal
Logics.LE77.Gate In4-I	State of the module input: Assignment of the Input Signal
Logics.LE77.Reset Latch-I	State of the module input: Reset Signal for the Latching
Logics.LE78.Gate Out	Signal: Output of the logic gate
Logics.LE78.Timer Out	Signal: Timer Output
Logics.LE78.Out	Signal: Latched Output (Q)
Logics.LE78.Out inverted	Signal: Negated Latched Output (Q NOT)
Logics.LE78.Gate In1-I	State of the module input: Assignment of the Input Signal
Logics.LE78.Gate In2-I	State of the module input: Assignment of the Input Signal
Logics.LE78.Gate In3-I	State of the module input: Assignment of the Input Signal
Logics.LE78.Gate In4-I	State of the module input: Assignment of the Input Signal
Logics.LE78.Reset Latch-I	State of the module input: Reset Signal for the Latching
Logics.LE79.Gate Out	Signal: Output of the logic gate
Logics.LE79.Timer Out	Signal: Timer Output
Logics.LE79.Out	Signal: Latched Output (Q)
Logics.LE79.Out inverted	Signal: Negated Latched Output (Q NOT)
Logics.LE79.Gate In1-I	State of the module input: Assignment of the Input Signal
Logics.LE79.Gate In2-I	State of the module input: Assignment of the Input Signal
Logics.LE79.Gate In3-I	State of the module input: Assignment of the Input Signal
Logics.LE79.Gate In4-I	State of the module input: Assignment of the Input Signal
Logics.LE79.Reset Latch-I	State of the module input: Reset Signal for the Latching
Logics.LE80.Gate Out	Signal: Output of the logic gate
Logics.LE80.Timer Out	Signal: Timer Output
Logics.LE80.Out	Signal: Latched Output (Q)
Logics.LE80.Out inverted	Signal: Negated Latched Output (Q NOT)
Logics.LE80.Gate In1-I	State of the module input: Assignment of the Input Signal
Logics.LE80.Gate In2-I	State of the module input: Assignment of the Input Signal
Logics.LE80.Gate In3-I	State of the module input: Assignment of the Input Signal
Logics.LE80.Gate In4-I	State of the module input: Assignment of the Input Signal
Logics.LE80.Reset Latch-I	State of the module input: Reset Signal for the Latching
Sgen.Running	Signal; Measuring value simulation is running
Sgen.Ex Start Simulation-I	State of the module input: External Start of Fault Simulation (Using the test parameters)



## Assignment List

<i>Name</i>	<i>Description</i>
Sgen.ExBlo	Module input state: External blocking
Sgen.Ex ForcePost-I	State of the module input:Force Post state. Abort simulation.
Sys.PS 1	Signal: Parameter Set 1
Sys.PS 2	Signal: Parameter Set 2
Sys.PS 3	Signal: Parameter Set 3
Sys.PS 4	Signal: Parameter Set 4
Sys.PSS manual	Signal: Manual Switch over of a Parameter Set
Sys.PSS via Scada	Signal: Parameter Set Switch via Scada
Sys.PSS via Inp fct	Signal: Parameter Set Switch via input function
Sys.min 1 param changed	Signal: At least one parameter has been changed
Sys.Setting Lock Bypass	Signal: Short-period unlock of the Setting Lock
Sys.Ack LED	Signal: LEDs acknowledgement
Sys.Ack BO	Signal: Acknowledgement of the Binary Outputs
Sys.Ack Scada	Signal: Acknowledge Scada
Sys.Ack TripCmd	Signal: Reset Trip Command
Sys.Ack LED-HMI	Signal: LEDs acknowledgement :HMI
Sys.Ack BO-HMI	Signal: Acknowledgement of the Binary Outputs :HMI
Sys.Ack Scada-HMI	Signal: Acknowledge Scada :HMI
Sys.Ack TripCmd-HMI	Signal: Reset Trip Command :HMI
Sys.Ack LED-Scada	Signal: LEDs acknowledgement :SCADA
Sys.Ack BO-Scada	Signal: Acknowledgement of the Binary Outputs :SCADA
Sys.Ack Counter-Scada	Signal: Reset of all Counters :SCADA
Sys.Ack Scada-Scada	Signal: Acknowledge Scada :SCADA
Sys.Ack TripCmd-Scada	Signal: Reset Trip Command :SCADA
Sys.Res OperationsCr	Signal:: Res OperationsCr
Sys.Res AlarmCr	Signal:: Res AlarmCr
Sys.Res TripCmdCr	Signal:: Res TripCmdCr
Sys.Res TotalCr	Signal:: Res TotalCr
Sys.Ack LED-I	Module input state: LEDs acknowledgement by digital input
Sys.Ack BO-I	Module input state: Acknowledgement of the binary Output Relays
Sys.Ack Scada-I	Module input state: Acknowledge Scada via digital input. The replica that SCADA has got from the device is to be reset.
Sys.PS1-I	State of the module input respectively of the signal, that should activate this Parameter Setting Group.
Sys.PS2-I	State of the module input respectively of the signal, that should activate this Parameter Setting Group.
Sys.PS3-I	State of the module input respectively of the signal, that should activate this Parameter Setting Group.
Sys.PS4-I	State of the module input respectively of the signal, that should activate this Parameter Setting Group.

### List of the Digital Inputs

The following list comprises all Digital Inputs. This list is used in various Protective Elements (e.g. TCS, Q->&V<...). The availability and the number of entries depends on the type of device.

<i>Name</i>	<i>Description</i>
-.-	No assignment
DI Slot X1.DI 1	Signal: Digital Input
DI Slot X1.DI 2	Signal: Digital Input
DI Slot X1.DI 3	Signal: Digital Input
DI Slot X1.DI 4	Signal: Digital Input
DI Slot X1.DI 5	Signal: Digital Input
DI Slot X1.DI 6	Signal: Digital Input
DI Slot X1.DI 7	Signal: Digital Input
DI Slot X1.DI 8	Signal: Digital Input
DI Slot X6.DI 1	Signal: Digital Input
DI Slot X6.DI 2	Signal: Digital Input
DI Slot X6.DI 3	Signal: Digital Input
DI Slot X6.DI 4	Signal: Digital Input
DI Slot X6.DI 5	Signal: Digital Input
DI Slot X6.DI 6	Signal: Digital Input
DI Slot X6.DI 7	Signal: Digital Input
DI Slot X6.DI 8	Signal: Digital Input

**Signals of the Digital Inputs and Logic**

The following list comprises the signals of the Digital Inputs and the Logic. This list is used in various protective elements.

<i>Name</i>	<i>Description</i>
-.-	No assignment
DI Slot X1.DI 1	Signal: Digital Input
DI Slot X1.DI 2	Signal: Digital Input
DI Slot X1.DI 3	Signal: Digital Input
DI Slot X1.DI 4	Signal: Digital Input
DI Slot X1.DI 5	Signal: Digital Input
DI Slot X1.DI 6	Signal: Digital Input
DI Slot X1.DI 7	Signal: Digital Input
DI Slot X1.DI 8	Signal: Digital Input
DI Slot X6.DI 1	Signal: Digital Input
DI Slot X6.DI 2	Signal: Digital Input
DI Slot X6.DI 3	Signal: Digital Input
DI Slot X6.DI 4	Signal: Digital Input
DI Slot X6.DI 5	Signal: Digital Input
DI Slot X6.DI 6	Signal: Digital Input
DI Slot X6.DI 7	Signal: Digital Input
DI Slot X6.DI 8	Signal: Digital Input
Logics.LE1.Gate Out	Signal: Output of the logic gate
Logics.LE1.Timer Out	Signal: Timer Output
Logics.LE1.Out	Signal: Latched Output (Q)
Logics.LE1.Out inverted	Signal: Negated Latched Output (Q NOT)
Logics.LE2.Gate Out	Signal: Output of the logic gate
Logics.LE2.Timer Out	Signal: Timer Output
Logics.LE2.Out	Signal: Latched Output (Q)
Logics.LE2.Out inverted	Signal: Negated Latched Output (Q NOT)
Logics.LE3.Gate Out	Signal: Output of the logic gate
Logics.LE3.Timer Out	Signal: Timer Output
Logics.LE3.Out	Signal: Latched Output (Q)
Logics.LE3.Out inverted	Signal: Negated Latched Output (Q NOT)
Logics.LE4.Gate Out	Signal: Output of the logic gate
Logics.LE4.Timer Out	Signal: Timer Output
Logics.LE4.Out	Signal: Latched Output (Q)
Logics.LE4.Out inverted	Signal: Negated Latched Output (Q NOT)
Logics.LE5.Gate Out	Signal: Output of the logic gate
Logics.LE5.Timer Out	Signal: Timer Output
Logics.LE5.Out	Signal: Latched Output (Q)

## Assignment List

<i>Name</i>	<i>Description</i>
Logics.LE5.Out inverted	Signal: Negated Latched Output (Q NOT)
Logics.LE6.Gate Out	Signal: Output of the logic gate
Logics.LE6.Timer Out	Signal: Timer Output
Logics.LE6.Out	Signal: Latched Output (Q)
Logics.LE6.Out inverted	Signal: Negated Latched Output (Q NOT)
Logics.LE7.Gate Out	Signal: Output of the logic gate
Logics.LE7.Timer Out	Signal: Timer Output
Logics.LE7.Out	Signal: Latched Output (Q)
Logics.LE7.Out inverted	Signal: Negated Latched Output (Q NOT)
Logics.LE8.Gate Out	Signal: Output of the logic gate
Logics.LE8.Timer Out	Signal: Timer Output
Logics.LE8.Out	Signal: Latched Output (Q)
Logics.LE8.Out inverted	Signal: Negated Latched Output (Q NOT)
Logics.LE9.Gate Out	Signal: Output of the logic gate
Logics.LE9.Timer Out	Signal: Timer Output
Logics.LE9.Out	Signal: Latched Output (Q)
Logics.LE9.Out inverted	Signal: Negated Latched Output (Q NOT)
Logics.LE10.Gate Out	Signal: Output of the logic gate
Logics.LE10.Timer Out	Signal: Timer Output
Logics.LE10.Out	Signal: Latched Output (Q)
Logics.LE10.Out inverted	Signal: Negated Latched Output (Q NOT)
Logics.LE11.Gate Out	Signal: Output of the logic gate
Logics.LE11.Timer Out	Signal: Timer Output
Logics.LE11.Out	Signal: Latched Output (Q)
Logics.LE11.Out inverted	Signal: Negated Latched Output (Q NOT)
Logics.LE12.Gate Out	Signal: Output of the logic gate
Logics.LE12.Timer Out	Signal: Timer Output
Logics.LE12.Out	Signal: Latched Output (Q)
Logics.LE12.Out inverted	Signal: Negated Latched Output (Q NOT)
Logics.LE13.Gate Out	Signal: Output of the logic gate
Logics.LE13.Timer Out	Signal: Timer Output
Logics.LE13.Out	Signal: Latched Output (Q)
Logics.LE13.Out inverted	Signal: Negated Latched Output (Q NOT)
Logics.LE14.Gate Out	Signal: Output of the logic gate
Logics.LE14.Timer Out	Signal: Timer Output
Logics.LE14.Out	Signal: Latched Output (Q)
Logics.LE14.Out inverted	Signal: Negated Latched Output (Q NOT)
Logics.LE15.Gate Out	Signal: Output of the logic gate
Logics.LE15.Timer Out	Signal: Timer Output
Logics.LE15.Out	Signal: Latched Output (Q)

## Assignment List

<i>Name</i>	<i>Description</i>
Logics.LE15.Out inverted	Signal: Negated Latched Output (Q NOT)
Logics.LE16.Gate Out	Signal: Output of the logic gate
Logics.LE16.Timer Out	Signal: Timer Output
Logics.LE16.Out	Signal: Latched Output (Q)
Logics.LE16.Out inverted	Signal: Negated Latched Output (Q NOT)
Logics.LE17.Gate Out	Signal: Output of the logic gate
Logics.LE17.Timer Out	Signal: Timer Output
Logics.LE17.Out	Signal: Latched Output (Q)
Logics.LE17.Out inverted	Signal: Negated Latched Output (Q NOT)
Logics.LE18.Gate Out	Signal: Output of the logic gate
Logics.LE18.Timer Out	Signal: Timer Output
Logics.LE18.Out	Signal: Latched Output (Q)
Logics.LE18.Out inverted	Signal: Negated Latched Output (Q NOT)
Logics.LE19.Gate Out	Signal: Output of the logic gate
Logics.LE19.Timer Out	Signal: Timer Output
Logics.LE19.Out	Signal: Latched Output (Q)
Logics.LE19.Out inverted	Signal: Negated Latched Output (Q NOT)
Logics.LE20.Gate Out	Signal: Output of the logic gate
Logics.LE20.Timer Out	Signal: Timer Output
Logics.LE20.Out	Signal: Latched Output (Q)
Logics.LE20.Out inverted	Signal: Negated Latched Output (Q NOT)
Logics.LE21.Gate Out	Signal: Output of the logic gate
Logics.LE21.Timer Out	Signal: Timer Output
Logics.LE21.Out	Signal: Latched Output (Q)
Logics.LE21.Out inverted	Signal: Negated Latched Output (Q NOT)
Logics.LE22.Gate Out	Signal: Output of the logic gate
Logics.LE22.Timer Out	Signal: Timer Output
Logics.LE22.Out	Signal: Latched Output (Q)
Logics.LE22.Out inverted	Signal: Negated Latched Output (Q NOT)
Logics.LE23.Gate Out	Signal: Output of the logic gate
Logics.LE23.Timer Out	Signal: Timer Output
Logics.LE23.Out	Signal: Latched Output (Q)
Logics.LE23.Out inverted	Signal: Negated Latched Output (Q NOT)
Logics.LE24.Gate Out	Signal: Output of the logic gate
Logics.LE24.Timer Out	Signal: Timer Output
Logics.LE24.Out	Signal: Latched Output (Q)
Logics.LE24.Out inverted	Signal: Negated Latched Output (Q NOT)
Logics.LE25.Gate Out	Signal: Output of the logic gate
Logics.LE25.Timer Out	Signal: Timer Output
Logics.LE25.Out	Signal: Latched Output (Q)

## Assignment List

<i>Name</i>	<i>Description</i>
Logics.LE25.Out inverted	Signal: Negated Latched Output (Q NOT)
Logics.LE26.Gate Out	Signal: Output of the logic gate
Logics.LE26.Timer Out	Signal: Timer Output
Logics.LE26.Out	Signal: Latched Output (Q)
Logics.LE26.Out inverted	Signal: Negated Latched Output (Q NOT)
Logics.LE27.Gate Out	Signal: Output of the logic gate
Logics.LE27.Timer Out	Signal: Timer Output
Logics.LE27.Out	Signal: Latched Output (Q)
Logics.LE27.Out inverted	Signal: Negated Latched Output (Q NOT)
Logics.LE28.Gate Out	Signal: Output of the logic gate
Logics.LE28.Timer Out	Signal: Timer Output
Logics.LE28.Out	Signal: Latched Output (Q)
Logics.LE28.Out inverted	Signal: Negated Latched Output (Q NOT)
Logics.LE29.Gate Out	Signal: Output of the logic gate
Logics.LE29.Timer Out	Signal: Timer Output
Logics.LE29.Out	Signal: Latched Output (Q)
Logics.LE29.Out inverted	Signal: Negated Latched Output (Q NOT)
Logics.LE30.Gate Out	Signal: Output of the logic gate
Logics.LE30.Timer Out	Signal: Timer Output
Logics.LE30.Out	Signal: Latched Output (Q)
Logics.LE30.Out inverted	Signal: Negated Latched Output (Q NOT)
Logics.LE31.Gate Out	Signal: Output of the logic gate
Logics.LE31.Timer Out	Signal: Timer Output
Logics.LE31.Out	Signal: Latched Output (Q)
Logics.LE31.Out inverted	Signal: Negated Latched Output (Q NOT)
Logics.LE32.Gate Out	Signal: Output of the logic gate
Logics.LE32.Timer Out	Signal: Timer Output
Logics.LE32.Out	Signal: Latched Output (Q)
Logics.LE32.Out inverted	Signal: Negated Latched Output (Q NOT)
Logics.LE33.Gate Out	Signal: Output of the logic gate
Logics.LE33.Timer Out	Signal: Timer Output
Logics.LE33.Out	Signal: Latched Output (Q)
Logics.LE33.Out inverted	Signal: Negated Latched Output (Q NOT)
Logics.LE34.Gate Out	Signal: Output of the logic gate
Logics.LE34.Timer Out	Signal: Timer Output
Logics.LE34.Out	Signal: Latched Output (Q)
Logics.LE34.Out inverted	Signal: Negated Latched Output (Q NOT)
Logics.LE35.Gate Out	Signal: Output of the logic gate
Logics.LE35.Timer Out	Signal: Timer Output
Logics.LE35.Out	Signal: Latched Output (Q)

## Assignment List

---

<i>Name</i>	<i>Description</i>
Logics.LE35.Out inverted	Signal: Negated Latched Output (Q NOT)
Logics.LE36.Gate Out	Signal: Output of the logic gate
Logics.LE36.Timer Out	Signal: Timer Output
Logics.LE36.Out	Signal: Latched Output (Q)
Logics.LE36.Out inverted	Signal: Negated Latched Output (Q NOT)
Logics.LE37.Gate Out	Signal: Output of the logic gate
Logics.LE37.Timer Out	Signal: Timer Output
Logics.LE37.Out	Signal: Latched Output (Q)
Logics.LE37.Out inverted	Signal: Negated Latched Output (Q NOT)
Logics.LE38.Gate Out	Signal: Output of the logic gate
Logics.LE38.Timer Out	Signal: Timer Output
Logics.LE38.Out	Signal: Latched Output (Q)
Logics.LE38.Out inverted	Signal: Negated Latched Output (Q NOT)
Logics.LE39.Gate Out	Signal: Output of the logic gate
Logics.LE39.Timer Out	Signal: Timer Output
Logics.LE39.Out	Signal: Latched Output (Q)
Logics.LE39.Out inverted	Signal: Negated Latched Output (Q NOT)
Logics.LE40.Gate Out	Signal: Output of the logic gate
Logics.LE40.Timer Out	Signal: Timer Output
Logics.LE40.Out	Signal: Latched Output (Q)
Logics.LE40.Out inverted	Signal: Negated Latched Output (Q NOT)
Logics.LE41.Gate Out	Signal: Output of the logic gate
Logics.LE41.Timer Out	Signal: Timer Output
Logics.LE41.Out	Signal: Latched Output (Q)
Logics.LE41.Out inverted	Signal: Negated Latched Output (Q NOT)
Logics.LE42.Gate Out	Signal: Output of the logic gate
Logics.LE42.Timer Out	Signal: Timer Output
Logics.LE42.Out	Signal: Latched Output (Q)
Logics.LE42.Out inverted	Signal: Negated Latched Output (Q NOT)
Logics.LE43.Gate Out	Signal: Output of the logic gate
Logics.LE43.Timer Out	Signal: Timer Output
Logics.LE43.Out	Signal: Latched Output (Q)
Logics.LE43.Out inverted	Signal: Negated Latched Output (Q NOT)
Logics.LE44.Gate Out	Signal: Output of the logic gate
Logics.LE44.Timer Out	Signal: Timer Output
Logics.LE44.Out	Signal: Latched Output (Q)
Logics.LE44.Out inverted	Signal: Negated Latched Output (Q NOT)
Logics.LE45.Gate Out	Signal: Output of the logic gate
Logics.LE45.Timer Out	Signal: Timer Output
Logics.LE45.Out	Signal: Latched Output (Q)

## Assignment List

<i>Name</i>	<i>Description</i>
Logics.LE45.Out inverted	Signal: Negated Latched Output (Q NOT)
Logics.LE46.Gate Out	Signal: Output of the logic gate
Logics.LE46.Timer Out	Signal: Timer Output
Logics.LE46.Out	Signal: Latched Output (Q)
Logics.LE46.Out inverted	Signal: Negated Latched Output (Q NOT)
Logics.LE47.Gate Out	Signal: Output of the logic gate
Logics.LE47.Timer Out	Signal: Timer Output
Logics.LE47.Out	Signal: Latched Output (Q)
Logics.LE47.Out inverted	Signal: Negated Latched Output (Q NOT)
Logics.LE48.Gate Out	Signal: Output of the logic gate
Logics.LE48.Timer Out	Signal: Timer Output
Logics.LE48.Out	Signal: Latched Output (Q)
Logics.LE48.Out inverted	Signal: Negated Latched Output (Q NOT)
Logics.LE49.Gate Out	Signal: Output of the logic gate
Logics.LE49.Timer Out	Signal: Timer Output
Logics.LE49.Out	Signal: Latched Output (Q)
Logics.LE49.Out inverted	Signal: Negated Latched Output (Q NOT)
Logics.LE50.Gate Out	Signal: Output of the logic gate
Logics.LE50.Timer Out	Signal: Timer Output
Logics.LE50.Out	Signal: Latched Output (Q)
Logics.LE50.Out inverted	Signal: Negated Latched Output (Q NOT)
Logics.LE51.Gate Out	Signal: Output of the logic gate
Logics.LE51.Timer Out	Signal: Timer Output
Logics.LE51.Out	Signal: Latched Output (Q)
Logics.LE51.Out inverted	Signal: Negated Latched Output (Q NOT)
Logics.LE52.Gate Out	Signal: Output of the logic gate
Logics.LE52.Timer Out	Signal: Timer Output
Logics.LE52.Out	Signal: Latched Output (Q)
Logics.LE52.Out inverted	Signal: Negated Latched Output (Q NOT)
Logics.LE53.Gate Out	Signal: Output of the logic gate
Logics.LE53.Timer Out	Signal: Timer Output
Logics.LE53.Out	Signal: Latched Output (Q)
Logics.LE53.Out inverted	Signal: Negated Latched Output (Q NOT)
Logics.LE54.Gate Out	Signal: Output of the logic gate
Logics.LE54.Timer Out	Signal: Timer Output
Logics.LE54.Out	Signal: Latched Output (Q)
Logics.LE54.Out inverted	Signal: Negated Latched Output (Q NOT)
Logics.LE55.Gate Out	Signal: Output of the logic gate
Logics.LE55.Timer Out	Signal: Timer Output
Logics.LE55.Out	Signal: Latched Output (Q)



## Assignment List

---

<i>Name</i>	<i>Description</i>
Logics.LE55.Out inverted	Signal: Negated Latched Output (Q NOT)
Logics.LE56.Gate Out	Signal: Output of the logic gate
Logics.LE56.Timer Out	Signal: Timer Output
Logics.LE56.Out	Signal: Latched Output (Q)
Logics.LE56.Out inverted	Signal: Negated Latched Output (Q NOT)
Logics.LE57.Gate Out	Signal: Output of the logic gate
Logics.LE57.Timer Out	Signal: Timer Output
Logics.LE57.Out	Signal: Latched Output (Q)
Logics.LE57.Out inverted	Signal: Negated Latched Output (Q NOT)
Logics.LE58.Gate Out	Signal: Output of the logic gate
Logics.LE58.Timer Out	Signal: Timer Output
Logics.LE58.Out	Signal: Latched Output (Q)
Logics.LE58.Out inverted	Signal: Negated Latched Output (Q NOT)
Logics.LE59.Gate Out	Signal: Output of the logic gate
Logics.LE59.Timer Out	Signal: Timer Output
Logics.LE59.Out	Signal: Latched Output (Q)
Logics.LE59.Out inverted	Signal: Negated Latched Output (Q NOT)
Logics.LE60.Gate Out	Signal: Output of the logic gate
Logics.LE60.Timer Out	Signal: Timer Output
Logics.LE60.Out	Signal: Latched Output (Q)
Logics.LE60.Out inverted	Signal: Negated Latched Output (Q NOT)
Logics.LE61.Gate Out	Signal: Output of the logic gate
Logics.LE61.Timer Out	Signal: Timer Output
Logics.LE61.Out	Signal: Latched Output (Q)
Logics.LE61.Out inverted	Signal: Negated Latched Output (Q NOT)
Logics.LE62.Gate Out	Signal: Output of the logic gate
Logics.LE62.Timer Out	Signal: Timer Output
Logics.LE62.Out	Signal: Latched Output (Q)
Logics.LE62.Out inverted	Signal: Negated Latched Output (Q NOT)
Logics.LE63.Gate Out	Signal: Output of the logic gate
Logics.LE63.Timer Out	Signal: Timer Output
Logics.LE63.Out	Signal: Latched Output (Q)
Logics.LE63.Out inverted	Signal: Negated Latched Output (Q NOT)
Logics.LE64.Gate Out	Signal: Output of the logic gate
Logics.LE64.Timer Out	Signal: Timer Output
Logics.LE64.Out	Signal: Latched Output (Q)
Logics.LE64.Out inverted	Signal: Negated Latched Output (Q NOT)
Logics.LE65.Gate Out	Signal: Output of the logic gate
Logics.LE65.Timer Out	Signal: Timer Output
Logics.LE65.Out	Signal: Latched Output (Q)

## Assignment List

<i>Name</i>	<i>Description</i>
Logics.LE65.Out inverted	Signal: Negated Latched Output (Q NOT)
Logics.LE66.Gate Out	Signal: Output of the logic gate
Logics.LE66.Timer Out	Signal: Timer Output
Logics.LE66.Out	Signal: Latched Output (Q)
Logics.LE66.Out inverted	Signal: Negated Latched Output (Q NOT)
Logics.LE67.Gate Out	Signal: Output of the logic gate
Logics.LE67.Timer Out	Signal: Timer Output
Logics.LE67.Out	Signal: Latched Output (Q)
Logics.LE67.Out inverted	Signal: Negated Latched Output (Q NOT)
Logics.LE68.Gate Out	Signal: Output of the logic gate
Logics.LE68.Timer Out	Signal: Timer Output
Logics.LE68.Out	Signal: Latched Output (Q)
Logics.LE68.Out inverted	Signal: Negated Latched Output (Q NOT)
Logics.LE69.Gate Out	Signal: Output of the logic gate
Logics.LE69.Timer Out	Signal: Timer Output
Logics.LE69.Out	Signal: Latched Output (Q)
Logics.LE69.Out inverted	Signal: Negated Latched Output (Q NOT)
Logics.LE70.Gate Out	Signal: Output of the logic gate
Logics.LE70.Timer Out	Signal: Timer Output
Logics.LE70.Out	Signal: Latched Output (Q)
Logics.LE70.Out inverted	Signal: Negated Latched Output (Q NOT)
Logics.LE71.Gate Out	Signal: Output of the logic gate
Logics.LE71.Timer Out	Signal: Timer Output
Logics.LE71.Out	Signal: Latched Output (Q)
Logics.LE71.Out inverted	Signal: Negated Latched Output (Q NOT)
Logics.LE72.Gate Out	Signal: Output of the logic gate
Logics.LE72.Timer Out	Signal: Timer Output
Logics.LE72.Out	Signal: Latched Output (Q)
Logics.LE72.Out inverted	Signal: Negated Latched Output (Q NOT)
Logics.LE73.Gate Out	Signal: Output of the logic gate
Logics.LE73.Timer Out	Signal: Timer Output
Logics.LE73.Out	Signal: Latched Output (Q)
Logics.LE73.Out inverted	Signal: Negated Latched Output (Q NOT)
Logics.LE74.Gate Out	Signal: Output of the logic gate
Logics.LE74.Timer Out	Signal: Timer Output
Logics.LE74.Out	Signal: Latched Output (Q)
Logics.LE74.Out inverted	Signal: Negated Latched Output (Q NOT)
Logics.LE75.Gate Out	Signal: Output of the logic gate
Logics.LE75.Timer Out	Signal: Timer Output
Logics.LE75.Out	Signal: Latched Output (Q)

## Assignment List

---

<i>Name</i>	<i>Description</i>
Logics.LE75.Out inverted	Signal: Negated Latched Output (Q NOT)
Logics.LE76.Gate Out	Signal: Output of the logic gate
Logics.LE76.Timer Out	Signal: Timer Output
Logics.LE76.Out	Signal: Latched Output (Q)
Logics.LE76.Out inverted	Signal: Negated Latched Output (Q NOT)
Logics.LE77.Gate Out	Signal: Output of the logic gate
Logics.LE77.Timer Out	Signal: Timer Output
Logics.LE77.Out	Signal: Latched Output (Q)
Logics.LE77.Out inverted	Signal: Negated Latched Output (Q NOT)
Logics.LE78.Gate Out	Signal: Output of the logic gate
Logics.LE78.Timer Out	Signal: Timer Output
Logics.LE78.Out	Signal: Latched Output (Q)
Logics.LE78.Out inverted	Signal: Negated Latched Output (Q NOT)
Logics.LE79.Gate Out	Signal: Output of the logic gate
Logics.LE79.Timer Out	Signal: Timer Output
Logics.LE79.Out	Signal: Latched Output (Q)
Logics.LE79.Out inverted	Signal: Negated Latched Output (Q NOT)
Logics.LE80.Gate Out	Signal: Output of the logic gate
Logics.LE80.Timer Out	Signal: Timer Output
Logics.LE80.Out	Signal: Latched Output (Q)
Logics.LE80.Out inverted	Signal: Negated Latched Output (Q NOT)

We appreciate your comments about the content of our publications.

Please send comments to: [kemp.doc@woodward.com](mailto:kemp.doc@woodward.com)

Please include the manual number from the front cover of this publication.

Woodward Kempen GmbH reserves the right to update any portion of this publication at any time. Information provided by Woodward Kempen GmbH is believed to be correct and reliable. However, Woodward Kempen GmbH assumes no responsibility unless otherwise expressly undertaken.

This is the original manual (source).

© Woodward Kempen GmbH , all rights reserved



**Woodward Kempen GmbH**

Krefelder Weg 47 · D – 47906 Kempen (Germany)  
Postfach 10 07 55 (P.O.Box) · D – 47884 Kempen (Germany)  
Phone: +49 (0) 21 52 145 1

**Internet**

[www.woodward.com](http://www.woodward.com)

**Sales**

Phone: +49 (0) 21 52 145 331 · Telefax: +49 (0) 21 52 145 354  
e-mail: [CustomerServiceEMEA\\_PG@woodward.com](mailto:CustomerServiceEMEA_PG@woodward.com)

**Service**

Phone: +49 (0) 21 52 145 600 · Telefax: +49 (0) 21 52 145 455  
e-mail: [SupportPGD\\_Europe@woodward.com](mailto:SupportPGD_Europe@woodward.com)