



MRMV4

Motor Protection

Version: 3.6

Original document · English

Revision: - (Build 42227)

© 2019

Manual (original)

Woodward Kempen GmbH

Krefelder Weg 47 • D-47906 Kempen (Germany)

Postfach 10 07 55 (P.O.Box) • D-47884 Kempen (Germany)

Telephone: +49 (0) 21 52 145 1

© 2019 Woodward Kempen GmbH

Table of Contents

1	MRMV4 - Motor Protection	11
1.1	Comments on the Manual	12
1.1.1	Important Definitions	15
1.1.2	Symbols and Definitions	20
1.1.2.1	Symbols in Function Diagrams	21
1.2	Information About the Device	24
1.2.1	Order Form of the Device	26
1.2.2	Navigation - Operation	28
1.2.2.1	Front Panel Parts	29
1.2.2.2	Softkey Symbols	31
1.3	Modules, Settings, Signals and Values	32
1.3.1	Parameter Settings	36
1.3.2	Adaptive Parameter Sets	41
1.3.3	Status Display	44
1.3.4	Menu Structure	45
1.3.5	Device Planning	47
1.3.6	Field Parameters	48
1.3.7	Device Parameters	49
1.3.8	Reset Counters, Values and Records	50
1.4	Security	51
1.4.1	Network Security	52
1.4.2	Passwords	53
1.4.3	Connection Passwords, Smart view Access	54
1.4.4	Access Level Passwords	56
1.4.5	Access Levels	58
1.4.6	Reset to Factory Defaults, Reset All Passwords	61
1.5	Acknowledgments	63
1.6	Measuring Values	68
1.7	Statistics	70
1.7.1	Configuration of the Minimum and Maximum Values	70
1.7.2	Configuration of the Average Value Calculation	70
1.7.2.1	Configuration of the Current-Based Average Value Calculation*	70
1.7.2.2	Configuration of the Voltage-Based Average Value Calculation*	71
1.7.2.3	Configuration of the Power-Based Average Value Calculation*	72
1.8	Smart view	73
1.9	DataVisualizer	73
2	Hardware	74
2.1	Dimension Drawings	74
2.2	MRMV4 - Installation and Wiring	78
2.2.1	Grounding	78
2.2.2	Overview of Slots - Assembly Groups	79

2.2.3	Communication Protocol Codes	80
2.2.4	Legend for Wiring Diagrams.	83
2.3	Slot X1	85
2.3.1	DI8-X Power Supply and Digital Inputs.	86
2.4	Slot X2	90
2.4.1	BO-6 X - Assembly Group with 6 output relays.	91
2.5	Slot X3	93
2.5.1	TI - Standard Phase and Ground Current Measuring Input Card.	94
2.5.2	TIs - Phase and Sensitive Ground Current Measuring Card	97
2.5.3	Current Transformers (CT)	100
2.5.3.1	Sensitive Ground Current Measurement.	100
2.5.3.2	Current Transformer Connection Examples	101
2.5.3.3	Connecting the Current Inputs.	106
2.5.3.4	CT Requirements	108
2.6	Slot X4	111
2.6.1	TU - Voltage Measuring Inputs.	112
2.6.2	Voltage Transformers	115
2.7	Slot X5	119
2.7.1	AN-O4 - Assembly Group with 4 Analog Outputs.	120
2.8	Slot X6	122
2.9	Slot X100: Ethernet Interface.	123
2.9.1	Ethernet - RJ45.	124
2.10	Slot X102: Protection Communication	125
2.10.1	Interface for the URTD Module.	126
2.11	Slot X103: Data Communication	127
2.11.1	Modbus® RTU / IEC 60870-5-103 via RS485	128
2.11.2	Profibus DP/ Modbus® RTU / IEC 60870-5-103 via Fiber Optic.	132
2.11.3	Profibus DP via D-SUB	133
2.11.4	Modbus® RTU / IEC 60870-5-103 via D-SUB	134
2.11.5	Ethernet / TCP/IP via Fiber Optics.	135
2.12	Slot X104: IRIG-B00X and Selfsupervision Contact.	136
2.12.1	Self-Supervision Contact (SC)/Life-Contact and IRIG-B00X.	137
2.13	PC Interface - X120	138
2.14	Input, Output and LED Settings	139
2.14.1	LEDs.	139
2.14.2	Configuration of the Digital Inputs.	142
2.14.3	Output Relays Settings.	145
2.14.4	Configuration of the Analog Outputs	148
3	Communication Protocols	151
3.1	General SCADA (Communication) Setting	151
3.2	TCP/IP Settings.	152
3.3	Profibus	153
3.4	IEC 61850.	154

3.5	DNP3	156
3.5.1	Application Example: Setting a Relay	159
3.5.2	Deadband Settings in DNP3	159
3.6	IEC60870-5-103	163
3.7	Configurable Communication Protocols	166
3.7.1	IEC 60870-5-104	167
3.7.2	Modbus®	170
3.7.3	Data-Point Mapping Using the SCADAPTER	175
3.8	Time Synchronization	177
3.8.1	SNTP	180
3.8.2	IRIG-B00X	182
4	Protective Elements	184
4.1	Module Prot: General Protection	184
4.1.1	General Alarms and General Trips	186
4.1.2	Blockings	191
4.1.2.1	Blocking the Tripping Command	193
4.1.2.2	Activate, Deactivate or Block a Protection Function Temporarily	194
4.1.2.3	Activate, Deactivate or Block the Phase Current Modules	195
4.1.2.4	Activate, Deactivate or Block the Ground (Earth) Current Modules	197
4.2	MStart – Motor Start and Control Module [48, 66]	199
4.2.1	Start Control	201
4.2.2	Delayed Protection Enabling During Motor Starts	203
4.2.3	Motor Start Blocked	207
4.2.4	Blocking Conditions	208
4.2.5	Start Limits	209
4.2.6	Stop Cycle	210
4.2.7	Anti-Backspin Delay Time (ABS)	210
4.2.8	External Start Blocking	210
4.2.9	Thermal Block	210
4.2.10	Forced Starting	210
4.2.11	Reversing or Non-Reversing Starter	211
4.2.12	Motor Start / Transition Trips	212
4.2.13	Incomplete Sequence Report Back Time (INSQ)	214
4.2.14	Zero Speed Switch (ZSS ON or OFF)	215
4.2.15	Long Acceleration Time (LAT)	216
4.2.16	Motor Cold / Warm Detection	217
4.2.17	Emergency Override	218
4.3	ThM – Thermal Model [49M, 49R]	219
4.3.1	LRC - Locked Rotor during Start	223
4.4	UTC – Ultimate Trip Current	224
4.4.1	Motor Protection Curves	225
4.5	MLS – Mechanical Load Shedding	228
4.5.1	Commissioning: Mechanical Load Shedding	229

4.6	Jam – Locked Rotor Protection [51LR].	231
4.6.1	Commissioning: JAM [51LR].	232
4.7	I< – Undercurrent [37].	234
4.7.1	Commissioning: Undercurrent [ANSI 37].	236
4.8	I – Overcurrent Protection.	238
4.8.1	Characteristics.	239
4.8.1.1	DEFT – Definite Time-Overcurrent	241
4.8.1.2	IEC Normal Inverse.	242
4.8.1.3	IEC Very Inverse [VINV].	243
4.8.1.4	IEC Extremely Inverse - Characteristic.	244
4.8.1.5	IEC Long Time Inverse - Characteristic [LINV].	245
4.8.1.6	ANSI Moderately Inverse [MINV] - Characteristic	246
4.8.1.7	ANSI Very Inverse [VINV].	247
4.8.1.8	ANSI Extremely Inverse - Characteristic.	248
4.8.1.9	R Inverse [RINV] - Characteristic	249
4.8.1.10	Therm Flat [TF] - Characteristic	250
4.8.1.11	IT - Characteristic.	251
4.8.1.12	I2T - Characteristic.	252
4.8.1.13	I4T - Characteristic.	253
4.8.2	Functionality.	254
4.8.3	51V - Voltage Restraint Overcurrent.	255
4.8.4	I2> – Negative-Sequence Overcurrent [51Q].	257
4.8.5	Voltage Controlled Overcurrent Protection [51C].	259
4.8.6	I>> – IOC Function.	260
4.8.7	Commissioning: Overcurrent Protection, non-directional [50, 51].	260
4.8.8	Commissioning: Overcurrent Protection, Non-directional [ANSI 51V].	261
4.8.9	Commissioning: Negative Sequence Overcurrent	262
4.9	IG – Ground (Earth) Overcurrent Protection [50N/G, 51N/G, 67N/G].	264
4.9.1	Characteristics.	266
4.9.1.1	DEFT – Definite Time-Overcurrent	268
4.9.1.2	IEC Normal Inverse.	269
4.9.1.3	IEC Very Inverse [VINV].	270
4.9.1.4	IEC Extremely Inverse - Characteristic.	271
4.9.1.5	IEC Long Time Inverse - Characteristic [LINV].	272
4.9.1.6	ANSI Moderately Inverse [MINV] - Characteristic	273
4.9.1.7	ANSI Very Inverse [VINV].	274
4.9.1.8	ANSI Extremely Inverse - Characteristic.	275
4.9.1.9	R Inverse [RINV] - Characteristic	276
4.9.1.10	RXIDG.	277
4.9.1.11	Therm Flat [TF] - Characteristic	278
4.9.1.12	IT - Characteristic.	279
4.9.1.13	I2T - Characteristic.	280
4.9.1.14	I4T - Characteristic.	281
4.9.2	Ground (Earth) Overcurrent – Functionality	282

4.9.3	Special Notes on Earth Fault Current Transformers	284
4.9.4	Commissioning: Ground Fault Protection – non-directional [50N/G, 51N/G].	284
4.10	I _{2>} and %I _{2/I1>} – Unbalanced Load [46].	285
4.10.1	Commissioning: Current Unbalance Module.	287
4.11	V - Voltage Protection [27,59].	290
4.11.1	Commissioning: Overvoltage Protection [59].	294
4.11.2	Commissioning: Undervoltage Protection [27].	295
4.12	VG, VX – Voltage Supervision [27A, 59A].	296
4.12.1	Commissioning: Residual Voltage Protection – Measured [59N].	298
4.12.2	Commissioning: Residual Voltage Protection – Calculated [59N].	298
4.13	f - Frequency [81O/U, 78, 81R].	300
4.13.1	Operating Modes “f<”, “f>”	302
4.13.2	Operating Mode “df/dt”	304
4.13.3	Operating Modes “f< and df/dt”, “f> and df/dt”.	306
4.13.4	Operating Modes “f< and DF/DT”, “f> and DF/DT”	308
4.13.5	Operating Mode “delta phi” – [ANSI 78V].	311
4.13.6	Commissioning: Overfrequency [f>]	316
4.13.7	Commissioning: Underfrequency [f<]	316
4.13.8	Commissioning: df/dt - ROCOF.	316
4.13.9	Commissioning: f< and -df/dt – Underfrequency and ROCOF.	317
4.13.10	Commissioning: f> and df/dt – Overfrequency and ROCOF	318
4.13.11	Commissioning: f< and DF/DT – Underfrequency and DF/DT.	318
4.13.12	Commissioning: f> and DF/DT – Overfrequency and DF/DT.	319
4.13.13	Commissioning: delta phi - Vector Surge	319
4.14	V 012 – Voltage Asymmetry [47]	320
4.14.1	Commissioning: Asymmetry Protection	321
4.15	PQS - Power [32, 37].	323
4.15.1	Setting the Thresholds.	325
4.15.2	Commissioning Examples for the Power Protection Module.	326
4.16	PF - Power Factor [55].	335
4.16.1	Commissioning: Power Factor [55].	336
4.17	ExP - External Protection	338
4.17.1	Commissioning: External Protection.	338
4.18	RTD Protection Module [26/38/49].	340
4.19	URTDII Module Interface.	345
4.20	Supervision.	349
4.20.1	CBF – Circuit Breaker Failure [50BF*/62BF].	349
4.20.1.1	Principle – General Use.	349
4.20.1.2	Functionality.	352
4.20.1.3	Commissioning Example: Supervision Scheme 50BF.	352
4.20.2	TCS - Trip Circuit Supervision [74TC]	354
4.20.2.1	Commissioning: Trip Circuit Supervision [74TC].	355
4.20.3	CTS - Current Transformer Supervision [60L].	357
4.20.3.1	Commissioning: Current Transformer Failure Supervision.	358

4.20.4	LOP – Loss of Potential [60]	360
4.20.4.1	Loss of Potential - Evaluating Measured Quantities	360
4.20.4.2	Loss of Potential - Fuse Failure	361
4.20.4.3	Commissioning: Loss of Potential.	363
4.20.4.4	Commissioning: Loss of Potential (FF via DI)	363
4.20.5	Phase Sequence Supervision	365
5	Control / Switchgear-Manager	366
5.1	Switchgear Control.	367
5.1.1	Settings within the Protection Device.	370
5.1.2	Switch.	372
5.1.3	Invisible Switch.	373
5.1.4	Circuit Breaker	374
5.1.5	Circuit Breaker1	375
5.1.6	Disconnecter (Isolator).	376
5.1.7	Disconnecter-Earthing Combination.	377
5.1.8	Earthing Switch	378
5.1.9	Fuse-Load Switch	379
5.1.10	Fuse-Load Switch – Disconnecter.	380
5.1.11	Fused-Disconnecter (Isolator).	381
5.1.12	Load Switch	382
5.1.13	Load Switch – Disconnecter	383
5.1.14	Three Position Switch.	384
5.1.15	Withdrawable Circuit Breaker.	386
5.1.16	Withdrawable Fuse Load Switch.	388
5.2	Switchgear Configuration.	389
5.3	Switchgear Wear	398
5.4	Control - Example: Switching of a Circuit Breaker	401
6	System Alarms	403
7	Recorders.	407
7.1	Disturbance Recorder.	409
7.2	Fault Recorder	414
7.3	Event Recorder.	419
7.4	Trend Recorder.	420
7.5	Motor Start Recorder	421
7.6	Statistic Recorder.	424
7.7	History Function.	425
8	Programmable Logic	427
9	Self-Supervision	432
9.1	Device Start (Reboot).	435
9.2	Self-Supervision Messages.	437
9.3	Syslog.	438

9.4	Device Taken out of Service (“Device Stopped”)	440
10	Commissioning	441
10.1	Commissioning/Protection Test.	442
10.2	Putting out of Operation – Plug out the Relay.	443
10.3	Service and Commissioning Support	444
10.3.1	General	444
10.3.2	Phase Sequence.	444
10.3.3	Forcing the Relay Output Contacts.	444
10.3.4	Disarming the Relay Output Contacts	445
10.3.5	Forcing RTDs*.	446
10.3.6	Forcing Analog Outputs*	447
10.3.7	Fault Simulator (Sequencer)*	448
11	Servicing and Maintenance	451
12	Technical Data	453
12.1	Specifications / Tolerances	463
12.1.1	Specifications of the Real Time Clock.	463
12.1.2	Specifications of the Measured Value Acquisition.	464
12.1.3	Protection Elements Accuracy	466
12.1.3.1	Phase Overcurrent Protection.	466
12.1.3.2	Earth (Ground) Overcurrent Protection.	468
12.1.3.3	Thermal Protection.	469
12.1.3.4	Motor Protection.	470
12.1.3.5	Current-Related Protection.	472
12.1.3.6	Voltage-Related Protection.	473
12.1.3.7	Frequency Protection	475
12.1.3.8	Power-Related Protection	477
12.1.3.9	Miscellaneous Protection and Supervision	480
13	Appendix	481
13.1	Standards.	481
13.1.1	Approvals.	481
13.1.2	Design Standards.	482
13.1.3	Electrical Tests	483
13.1.4	Environmental Tests.	486
13.1.5	Mechanical Tests	488
13.2	IEC 60870-104 Interoperability.	490
13.2.1	System or device	490
13.2.2	Network configuration	490
13.2.3	Physical layer.	491
13.2.4	Link layer	491
13.2.5	Application layer.	492
13.2.6	Basic application functions.	498

Table of Contents

13.3	Abbreviations, and Acronyms.	503
13.4	List of ANSI Codes	510
13.5	Revision History	513
13.5.1	Version: 3.6	514
13.5.2	Version: 3.4	518
13.5.3	Version: 3.1	521
13.5.4	Version: 3.0.b.	522
13.5.5	Version: 3.0	523
14	Index.	527

1 MRMV4 - Motor Protection

The MRMV4 is a protection relay which uses the latest Dual-Core-Processor Technology to provide precise and reliable protective functions and is very easy to operate. The MRMV4 provides all necessary functions to protect low and medium voltage motors at all power levels. The protection functions are based on current and voltage measurement and supervise all thermal conditions, motor start sequence, stall and locked rotor, undercurrent and incomplete sequence.

Overcurrent and earth overcurrent protection as well as unbalanced load protection are included in the protection package. The status and operation of the motor will also be monitored by means of the statistic and trend recorder. All important events and measuring values will be logged by means of the start, event, failure and disturbance recorder.

The intuitive operating concept with plausibility checks and extensive commissioning functions such as the built-in fault simulator allows a safe and time-optimized maintenance and commissioning. The parameter setting and evaluation software *Smart view* can be used consistently across the entire family of devices.

Functional Overview

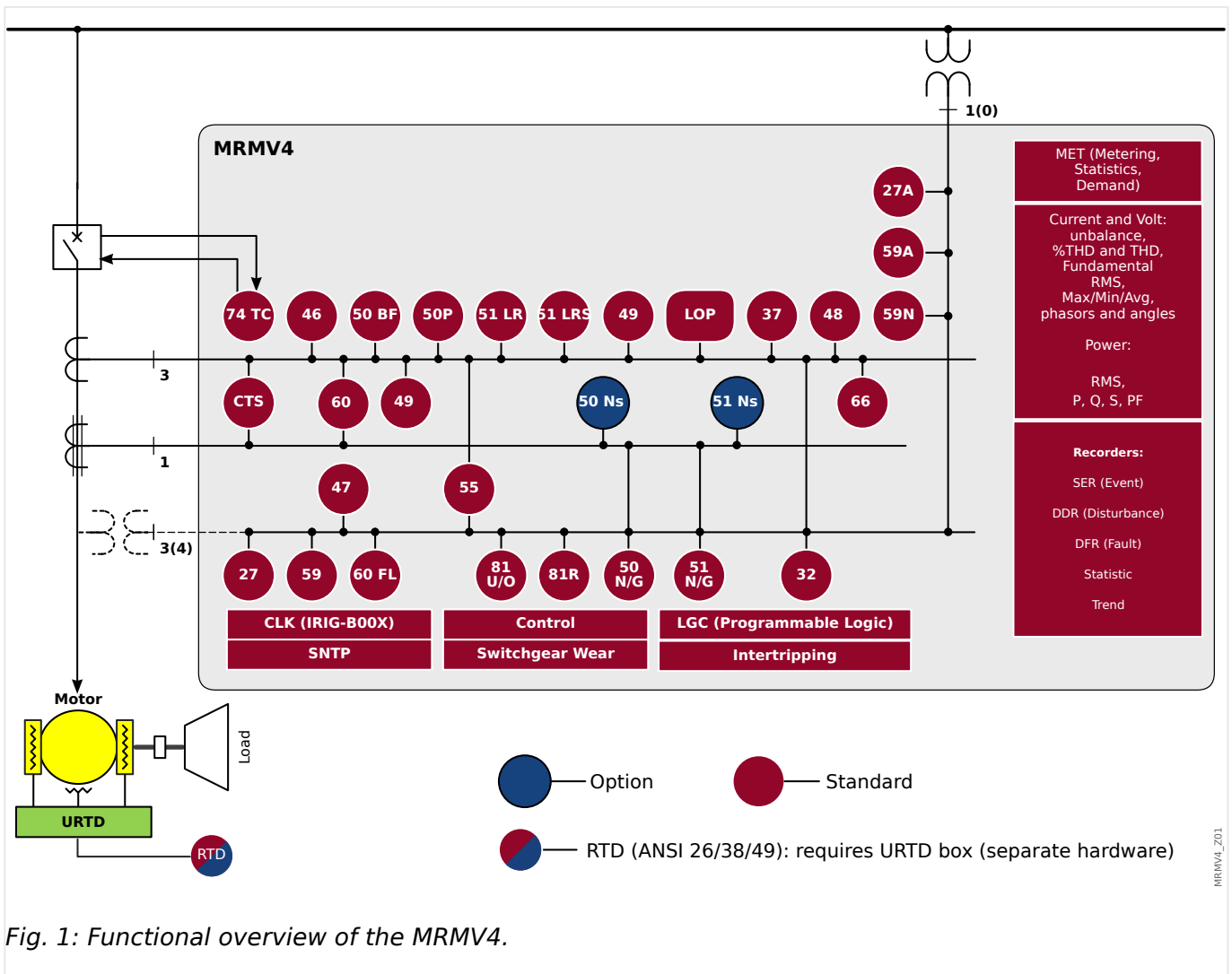

Fig. 1: Functional overview of the MRMV4.

1.1 Comments on the Manual

This manual explains in general the tasks of device planning, parameter setting, installation, commissioning, operation and maintenance of the HighPROTEC devices.

The manual serves as working basis for:

- Engineers in the protection field,
- commissioning engineers,
- people dealing with setting, testing and maintenance of protection and control devices,
- as well as trained personnel for electrical installations and power stations.

All functions concerning the type code will be defined. Should there be a description of any functions, parameters or inputs/outputs which do not apply to the device in use, please ignore that information.

All details and references are explained to the best of our knowledge and are based on our experience and observations.

This manual describes the (optionally) full featured versions of the devices.

All technical information and data included in this manual reflect their state at the time this document was issued. We reserve the right to carry out technical modifications in line with further development without changing this manual and without previous notice. Hence no claim can be brought based on the information and descriptions this manual includes.

Text, graphic and formulae do not always apply to the actual delivery scope. The drawings and graphics are not true to scale. We do not accept any liability for damage and operational failures caused by operating errors or disregarding the directions of this manual.

No part of this manual is allowed to be reproduced or passed on to others in any form, unless *Woodward* have approved in writing.

This user manual is part of the delivery scope when purchasing the device. In case the device is passed on (sold) to a third party, the manual has to be handed over as well.

Any repair work carried out on the device requires skilled and competent personnel who need to be well aware especially of the local safety regulations and have the necessary experience for working on electronic protection devices and power installations (provided by evidence).

Information Concerning Liability and Warranty

Woodward does not accept any liability for damage resulting from conversions or changes carried out on the device or planning (projecting) work, parameter setting or adjustment changes done by the customer.

The warranty expires after a device has been opened by others than *Woodward* specialists.

Warranty and liability conditions stated in *Woodward* General Terms and Conditions are not supplemented by the above mentioned explanations.

Structure of This Manual

- Safety first! Make yourself familiar with the most important safety messages used throughout this manual: [↳ “Important Definitions”](#). Moreover, there is general information about the delivery scope ([↳ “Information About the Device”](#)) and this manual and the conventions and symbols used here ([↳ “Symbols and Definitions”](#)).
- A general overview of the protection functions available with the MRMV4 can be found as a function diagram: [↳ “1 Functional Overview”](#). Note that the availability of some functions depends on the ordered device type. See [↳ “Order Form of the Device”](#) for the available variants.
- The MRMV4 uses a special modular concept for its settings, measured values and signals. Although this concept of modules and parameters is simple and straightforward it is strongly recommended, especially for beginners, to make oneself familiar with it: [↳ “Modules, Settings, Signals and Values”](#)
- *Smart view* is the operating program that can be installed on a Windows PC. It can connect to the MRMV4, and it can be used to do configuration work and retrieve data (measuring and statistics values, fault records, etc.) from the MRMV4. A few introductory words are here: [↳ “Smart view”](#); however, for a detailed description you can consult the full *Smart view* Manual as a separate document.
- The hardware aspects (e. g. dimension diagrams and connection diagrams) can be found here: [↳ “Hardware”](#)
- Various Security settings might have to be done, because the MRMV4 is delivered with no access restrictions and a very simple standard password that does not offer any safety at all. Unless you are sure that no special access restrictions are required for your application, it is strictly recommended to check the “Security” chapter: [↳ “Security”](#)
- A few settings are related to the MRMV4 itself: [↳ “Device Parameters”](#)
- The MRMV4 makes a lot of measured values available and maintains statistics of some more values: [↳ “Measuring Values”](#) and [↳ “Statistics”](#) describe what concepts and settings are related to this.
- The various communication protocols that the MRMV4 makes available for communicating with the substation are described in [↳ “Communication Protocols”](#).
- The MRMV4 can control a switchgear device. In general, one will probably use it to control a circuit breaker, that is tripped by the protection functions in case of a fault. [↳ “Control / Switchgear-Manager”](#) describes the various aspects of the Control functionality.
- The multitude of protection functions is described in sub-chapters within the “Protection Functions” chapter: [↳ “Protective Elements”](#). Keep in mind that there is one “master protection” module that governs all protection functions: [↳ “Module Prot: General Protection”](#). And furthermore, it is not only important to know how to activate a protection module, it is also essential to know about the blocking of a module: [↳ “Blockings”](#)
- Various kinds of events (disturbances, detected faults, etc.) are recorded by the MRMV4, so that you need to know how to access these records: [↳ “Recorders”](#)
- The MRMV4 offers programmable logic equations for programming inputs, outputs, blocking of protective functions, and custom logic functions in the relay: [↳ “Programmable Logic”](#)

- In addition to the various protection functions, the MRMV4 also features various supervision functions. The main difference is that – contrast to a protection function – a supervision function does not issue any trip signal, but generates an alarm signal under special circumstances. This alarm signal can be used to block protection functions, or it can be assigned to any of the LEDs or some output: [↪](#) **“Supervision”**
- Commissioning aspects for the MRMV4: [↪](#) **“Commissioning”**. But note that protection-specific commissioning descriptions are sub-chapters within the respective chapters for the protection functions.
- Technical data, tolerances, and applicable standards: [↪](#) **“Technical Data”**
- The last chapter in this document is the Index. There is one speciality with it: Under the initial “☸”, it lists the numbered signals “generated” in logic diagrams (see [↪](#) **“Symbols and Definitions”**).

Related Documents

- MRMV4 Reference Manual (MRMV4-3.6-EN-REF): All settings, signals and values available with the MRMV4 are listed here with their respective menu paths, default values and value ranges.
- Smart view Manual (SMARTV-x.xx-EN-MAN): The Technical Manual of the *Smart view* operating software.
- HighPROTEC Troubleshooting Guide (HPT-3.6-EN-TSG): A description of all device-internal (error or warning) messages that the MRMV4 might issue. (See also [↪](#) **“Self-Supervision Messages”**.)

This document should also be consulted whenever the »System OK« (“Operational”) LED is not constantly green after the boot phase ([↪](#) **“12 Boot Phase”**).

- Wiring Diagrams (HPT-3.6-EN-WDG) – [English only]: For each available device variant (ordered by typecode), this document has a related diagram showing (schematically) the rear view of the MRMV4, with all hardware modules fitted and terminal connections.
- SCADA reference documents:
 - IEC 60870-5-103 Data Point List
 - Modbus Data Point List
 - Profibus Data Point List
 - IEC 61850 Model Implementation Conformance Statement (MICS) – [English only]
 - IEC 61850 Protocol Implementation Conformance Statement (PICS) – [English only]
 - IEC 61850 Protocol Implementation Extra Information for Testing (PIXIT) – [English only]
 - IEC 61850 Tissue Implementation Conformance Statement (TICS) – [English only]

1.1.1 Important Definitions

The types of messages shown below serve the safety of life and limb as well as for the appropriate operating life of the device.

DANGER!



DANGER indicates an immediately dangerous situation that will result in death or serious injury if it is not avoided.

WARNING!



WARNING indicates a hazardous situation that can result in death or serious injury if it is not avoided.

CAUTION!



CAUTION indicates a possibly hazardous situation that can result in minor or moderate injuries if it is not avoided.

NOTICE!



NOTICE is used to address practices not related to personal injury.



This symbol indicates useful tips and recommendations as well as information for efficient and trouble-free operation.

Safety Messages Printed on the Housing of the MRMV4

These safety messages are printed on the housing of the MRMV4 as part of the connection diagram:

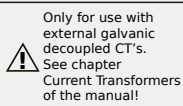

DANGER!

The current measuring inputs may exclusively be connected to current measuring transformers (with galvanic separation).

See  **“TI - Standard Phase and Ground Current Measuring Input Card”** for details and more important safety instructions.

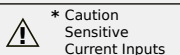

WARNING!

This variant of the MRMV4 features sensitive inputs for measuring the ground (earth) current. (These are marked by an asterisk “*”.)

The technical data of the sensitive ground (earth) measuring input are different from the technical data of the phase current measuring inputs. If the rating of the CTs is not right (overrated), then the normal operational conditions may not be recognized.

Please refer to the Technical Data chapter (↳ “Technical Data”) and to ↳ “TI - Standard Phase and Ground Current Measuring Input Card” for details and more important safety instructions.

Proper Use of the Device and of This Manual

CAUTION!



Do not put the MRMV4 in service until it has been configured and commissioned.

Read the User Manual.

For configuring the required protection functions, read ↳ “Module Prot: General Protection” and the related chapters within ↳ “Protective Elements”.

For commissioning, read ↳ “Commissioning” and the “Commissioning” sections within the chapters that are related to the required protection functions.

WARNING!



FOLLOW INSTRUCTIONS

Read this entire manual and all other publications pertaining to the work to be performed before installing, operating, or servicing this equipment. Practice all plant and safety instructions and precautions. Failure to follow instructions can cause personal injury and/or property damage.

WARNING!



PROPER USE

Any unauthorized modifications to or use of this equipment outside its specified mechanical, electrical, or other operating limits may cause personal injury and/or property damage, including damage to the equipment. Any such unauthorized modifications: (1) constitute “misuse” and/or “negligence” within the meaning of the product warranty thereby excluding warranty coverage for any resulting damage, and (2) invalidate product certifications or listings.

The programmable devices subject to this manual are designed for protection and also control of power installations and operational devices that are fed by voltage sources with a fixed frequency, i.e. fixed at 50 or 60 Hertz. They are not intended for use with Variable Frequency Drives. The devices are further designed for installation in low-voltage (LV) compartments of medium voltage (MV) switchgear panels or in de-centralized protection panels. The programming and parameterization has to meet all requirements of the protection concept (of the equipment that is to be protected). You must ensure that the device will properly recognize and manage (e. g. switch off the circuit breaker) on the basis of your programming and parameterization all operational conditions (failures). The proper use requires a backup protection by an additional protective device. Before starting any operation and after any modification of the programming (parameterization) test make a documentary proof that your programming and parameterization meets the requirements of your protection concept.

The Self-Supervision Contact (Life-Contact) has to be wired with the substation automation system in order to supervise and monitor the state of health of the programmable protective device. It is very important that an alarm annunciation is driven from the programmable protective device self-supervision contact (Life-Contact) that requires immediate attention when tripped. The alarm indicates that the protective device is no longer protecting the circuit and the system should be serviced.

Typical applications for this product family/device line are for instance:

- Feeder protection
- Mains protection
- Machine protection
- Transformer Protection
- Generator Protection

Any usage beyond these applications the devices are not designed for. This applies also to the use as a partly completed machinery. The manufacturer cannot be held liable for any resulting damage, the user alone bears the risk for this. As to the appropriate use of the device: The technical data and tolerances specified by *Woodward* have to be met.



Out-of-date documentation?

This publication may have been revised or updated since this copy was produced. To verify that you have the latest revision, please visit the download section of our website.

Please check the web site of Woodward for the latest revision of this Technical Manual and if there is an Errata Sheet with updated information.

- Visit the company website (\Rightarrow www.woodward.com) and search for the documents you are interested in. (The ID of every document is printed on its cover page.)
- Alternatively, every HighPROTEC device has a QR code printed on it. Scan this code, and you are taken to an online directory that contains all relevant documents in the most recent version.

Important Information

WARNING!



In line with the customer's requirement the devices are combined in a modular way (in compliance with the order code). The terminal assignment of the device can be found on the top of the device (wiring diagram).

CAUTION!



Electrostatic Discharge Awareness

All electronic equipment is electro static-sensitive, some components more than others. To protect these components from electro static damage, you must take special precautions to minimize or eliminate electrostatic discharges. Follow these precautions when working with or near the control.

1. Before doing maintenance on the electronic control, discharge the static electricity on your body to ground by touching and holding a grounded metal object (pipes, cabinets, equipment, etc.).
2. Avoid the build-up of static electricity on your body by not wearing clothing made of synthetic materials. Wear cotton or cotton-blend materials as much as possible because these do not store static electric charges as much as synthetics.
3. Keep plastic, vinyl, and Styrofoam materials (such as plastic or Styrofoam cups, cup holders, cigarette packages, cellophane wrappers, vinyl books or folders, plastic bottles, and plastic ash trays) away from the control, the modules, and the work area as much as possible.
4. Do not remove any printed circuit board (PCB) from the control cabinet unless absolutely necessary. If you must remove the PCB from the control cabinet, follow these precautions:
 - Verify the safe isolation from supply. All connectors have to be unplugged.
 - Do not touch any part of the PCB except the edges.
 - Do not touch the electrical conductors, the connectors, or the components with conductive devices or with your hands.
 - When replacing a PCB, keep the new PCB in the plastic antistatic protective bag it comes in until you are ready to install it. Immediately after removing the old PCB from the control cabinet, place it in the antistatic protective bag.

To prevent damage to electronic components caused by improper handling, read and observe the precautions in the *Woodward* manual 82715, "Guide for Handling and Protection of Electronic Controls, Printed Circuit Boards, and Modules".

Woodward reserves the right to update any portion of this publication at any time. Information provided by *Woodward* is believed to be correct and reliable. However, no responsibility is assumed by *Woodward* unless otherwise expressly undertaken.

© 2019 Woodward. All Rights Reserved.

1.1.2 Symbols and Definitions

Connection Diagram that is Printed on the Housing

There is a connection (wiring) diagram fixed onto the housing of the MRMV4. This diagram shows all terminals for this particular device variant.

A table of the symbols that can appear in this diagram can be found here:  “Legend for Wiring Diagrams”

Load Reference Arrow System

- It is common practice to either use the “Load Reference Arrow System” for loads (consumed energy) or the “Generator Reference System” for generators (generated energy).
- All HighPROTEC protection devices (except generator protection devices) use exclusively the “**Load Reference Arrow System**”. Generator protection devices are working based on the “**Generator Reference System**”.
- This applies to directions and phase angles. The phase angle is defined as the angle between the current phasor and the voltage phasor.
- Current and voltage arrows are to be counted positive in the direction of the arrow.

Typographical Conventions

- »Parameters are indicated by right and left double arrow heads and written in italic.«
- »SIGNALS are indicated by right and left double arrow heads and small caps.«
- [Paths are indicated by brackets.]
- *Software and Device names are written in italic.*
- Module and Instance (Element) names are displayed italic and underlined.
- »Pushbuttons, Modes and Menu entries are indicated by right and left double arrow heads.«
- ①②③ Image References

Numbered Signals in Function Diagrams

The signals labeled by encircled numbers are meant to signify connections between different diagrams. So, if you find such an encircled number somewhere “on the left side” of a diagram you might want to look up in which other diagram this particular signal has been generated.

Therefore all encircled numbers appearing “on the right side” (i. e. as an output signal) of a diagram are listed as part of the Index chapter.

1.1.2.1 Symbols in Function Diagrams

	<h4>Setting Values</h4> <p>The upper box in the diagram on the left is the usual symbol of a setting value in a function diagram. The setting name is specified by its module and parameter name, separated by a dot “.” one from the other.</p> <p>Second example: Thanks to the high degree of modularisation in HighPROTEC protection devices, the logic depicted in some function diagrams is often valid for several modules. In these cases, only a symbolic module name, for example: “<i>name</i>”, is given. In the heading part of the diagram, the meaning of “<i>name</i>” is specified as a list of modules to which the diagram applies.</p> <p>In rare cases it is necessary to also specify the menu path (or at least the top-level menu item), because it would be too inconvenient to specify this particular setting only based on module name and parameter name. In the third example, the setting »<i>delta phi - Mode</i>« is marked as a Field Parameter (i. e. to be found within menu branch [Field Para]).</p> <p>Another remark: All diagrams in this document show a small label, in this case: “HPT_Y05”. This is the diagram name, i. e. a unique identifier for the diagram. Of course, this is not a setting name, nor any other part of the depicted logic. All function diagrams have an identifier with the characters “_Y”.)</p>
	<h4>Input and Output Signals</h4> <p>A binary (output) signal is shown on top.</p> <p>Below the dashed line indicates a measured value (i. e. an analog signal).</p> <p>Bottom row, left: Numbered input signal; right: numbered output signal: From the technical point of view, there is no difference to “normal” (non-numbered) signals. But these signals appear in several different diagrams, and the numbering helps to identify and locate them across the Technical Manual.</p> <p>Therefore all encircled numbers appearing “on the right side” (i. e. as an output signal) of a diagram are listed as part of the Index chapter, so that you can look up where a particular signal has been “generated”.</p>

	<p>If the setting value of parameter »name . VX Source« is set to “measured”, then output 1 is active and output 2 is inactive.</p> <p>If the setting value of parameter »name . VX Source« is set to “calculated”, then output 1 is inactive and output 2 is active.</p>
	<p>The setting value of parameter »name . ExBlo1« is not a choice from a simple, fixed selection list, but it is another parameter (usually a binary output signal) that is assigned from a parameter list.</p> <p>This means that the setting parameter assumes the value of the assigned parameter. In case of a binary output signal, for example, it means that the parameter »name . ExBlo1« is active whenever the assigned output signal is active.</p> <p>If no signal has been assigned then the output is always inactive (and only the “no assignment” box, which is not connected in this example, would be active).</p>
	<p>Two types of comparator (“Schmitt triggers”):</p> <p>Top row: If the analog input value (here: the voltage ratio $\%(V2/V1)$) is greater than the specified threshold (here: 0.4) then the output becomes active (=logical “1”).</p> <p>Bottom row: This type has the opposite functionality: If the analog value IL1 is below the threshold (here: the setting value of parameter $I <$) then the output becomes active.</p>
	<p>Timer stage: If the input becomes active, then the output becomes active after the time t_{on} (setting value of »t-On Delay«) has elapsed (switch-on delay).</p> <p>If the input becomes inactive again, then the output signal becomes inactive after the other specified duration has elapsed (switch-off delay t_{off}, setting value of »t-Off Delay«).</p>
	<p>Hold time: This is a pulse which is triggered by the input (and in this case, the pulse duration is settable via parameter).</p>
	<p>The usual set of logic operators: AND, OR, eXclusive OR (from left to right). The second input of the XOR operator is negated.</p>

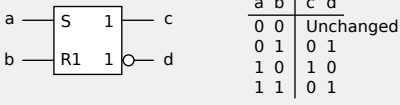
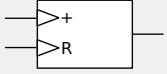
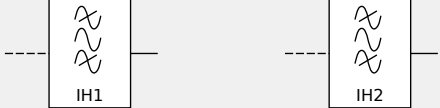
 <table border="1" data-bbox="438 224 590 331"> <thead> <tr> <th>a</th> <th>b</th> <th>c</th> <th>d</th> </tr> </thead> <tbody> <tr> <td>0</td> <td>0</td> <td colspan="2">Unchanged</td> </tr> <tr> <td>0</td> <td>1</td> <td>0</td> <td>1</td> </tr> <tr> <td>1</td> <td>0</td> <td>1</td> <td>0</td> </tr> <tr> <td>1</td> <td>1</td> <td>0</td> <td>1</td> </tr> </tbody> </table> <p style="text-align: right; margin-right: 20px;">HPT_YX2</p>	a	b	c	d	0	0	Unchanged		0	1	0	1	1	0	1	0	1	1	0	1	<p>RS flip-flop with reset priority.</p>
a	b	c	d																		
0	0	Unchanged																			
0	1	0	1																		
1	0	1	0																		
1	1	0	1																		
 <p style="text-align: right; margin-right: 20px;">HPT_YX3</p>	<p>Edge-triggered counter.</p>																				
 <p style="text-align: right; margin-right: 20px;">HPT_YX4</p>	<p>Band-pass filter (left: IH1, right: IH2).</p>																				

1.2 Information About the Device

Scope of Delivery



The delivery scope includes:

(1)	The transportation box
(2)	The protective device
(3)	The mounting nuts
(4)	The test report
(5)	The product DVD that includes the manuals and related documentation as well as the parameter setting and evaluation software <i>Smart view</i> .

Please check the consignment for completeness on arrival (delivery note).

Please ascertain whether the type plate, connection diagram, type code and description of the device tally.

If you have any doubts please contact our Service Department (contact address to be found on the reverse of the manual).

Storage

The devices must not be stored outdoors. The storing facilities have to be sufficiently ventilated and must be dry (see Technical Data, [↪ "Technical Data"](#)).

Battery

The purpose of the battery is to buffer the real-time clock in case of an outage of the protective device's power supply.

Since it is not used for normal operation of the MRMV4, it is not expected under normal conditions that a replacement be necessary during the life-time of the MRMV4. If, however, it happens that the battery needs to be replaced the MRMV4 has to be sent to the manufacturer as a service request.

Removal of the Battery after Life-Time of the MRMV4

The battery has to be soldered out or alternatively the contacts have to be pinched off.

Please see the product safety data sheet of the battery manufacturer for further information (Panasonic, battery type BR2032 - => <http://panasonic.net/ec/>). See also  "1.2 Waste Disposal" below.

Waste Disposal

This protective device contains a battery, and therefore it is labeled with the following symbol according to the EU Directive 2006/66/EC:

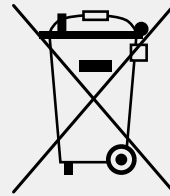

Batteries can be harmful to the environment. Damaged or unusable batteries must be disposed of in a container that is specially reserved for this purpose.

In general, appropriate local guidelines and regulations must be followed when disposing of electrical devices and batteries.

1.2.1 Order Form of the Device

Motor Protection											
MRMV4						-2	#	#	#	#	#
Housing	Display	Digital Inputs	Binary output relays	Analog Inputs / Outputs	Interf. for ext. RTD Box						
B2	LCD, 128 x 64 pixel	8	7	0 / 4	✓		A				
B2	LCD, 128 x 64 pixel	8	13	0 / 4	✓		C				
Hardware variant 2											
Phase Current 5 A/1 A, Ground Current 5 A/1 A								0			
Phase Current 5 A/1 A, Sensitive Ground Current 5 A/1 A								1			
Housing and mounting											
Door mounting									A		
Door mounting 19" (flush mounting)									B		
Communication protocol											
Without protocol										A	
Modbus RTU, IEC60870-5-103, DNP3.0 RTU <i>RS485 / terminals*</i>										B	
Modbus TCP, DNP3.0 TCP/UDP <i>Ethernet 100 MB / RJ45*</i>										C	
Profibus-DP <i>optic fiber / ST connector*</i>										D	
Profibus-DP <i>RS485 / D-SUB*</i>										E	
Modbus RTU, IEC60870-5-103, DNP3.0 RTU <i>optic fiber / ST connector*</i>										F	
Modbus RTU, IEC60870-5-103, DNP3.0 RTU <i>RS485 / D-SUB*</i>										G	
IEC61850, Modbus TCP, DNP3.0 TCP/UDP <i>Ethernet 100MB / RJ45*</i>										H	
IEC60870-5-103, Modbus RTU, DNP3.0 RTU <i>RS485 / terminals</i>										I	
Modbus TCP, DNP3.0 TCP/UDP <i>Ethernet 100 MB/RJ45*</i>											
IEC61850, Modbus TCP, DNP3.0 TCP/UDP <i>Optical Ethernet 100MB / LC duplex connector*</i>										K	
Modbus TCP, DNP3.0 TCP/UDP <i>Optical Ethernet 100MB / LC duplex connector*</i>										L	
IEC60870-5-103, Modbus RTU, DNP3.0 RTU <i>RS485 / terminals</i>										T	
IEC61850, Modbus TCP, DNP3.0 TCP/UDP <i>Ethernet 100 MB / RJ45*</i>											
Harsh Environment Option											

Motor Protection						
MRMV4	-2	#	#	#	#	#
None						A
Conformal Coating						B
Available menu languages						
English (USA) / German / Spanish / Russian / Polish / Portuguese (BR) / French / Romanian						

NOTICE!	
	(*) Within every communication option only one communication protocol is usable.

Smart view can be used in parallel via the Ethernet interface (RJ45).

The parameterizing- and disturbance analyzing software *Smart view* is included in the delivery of HighPROTEC devices.

All devices are equipped with an IRIG-B interface for time synchronization.

With control functions for up to 6 switchgears and logic up to 80 equations.

1.2.2 Navigation - Operation

The following illustration applies to protective devices with "B2" housing and a small display, in particular the MRMV4:

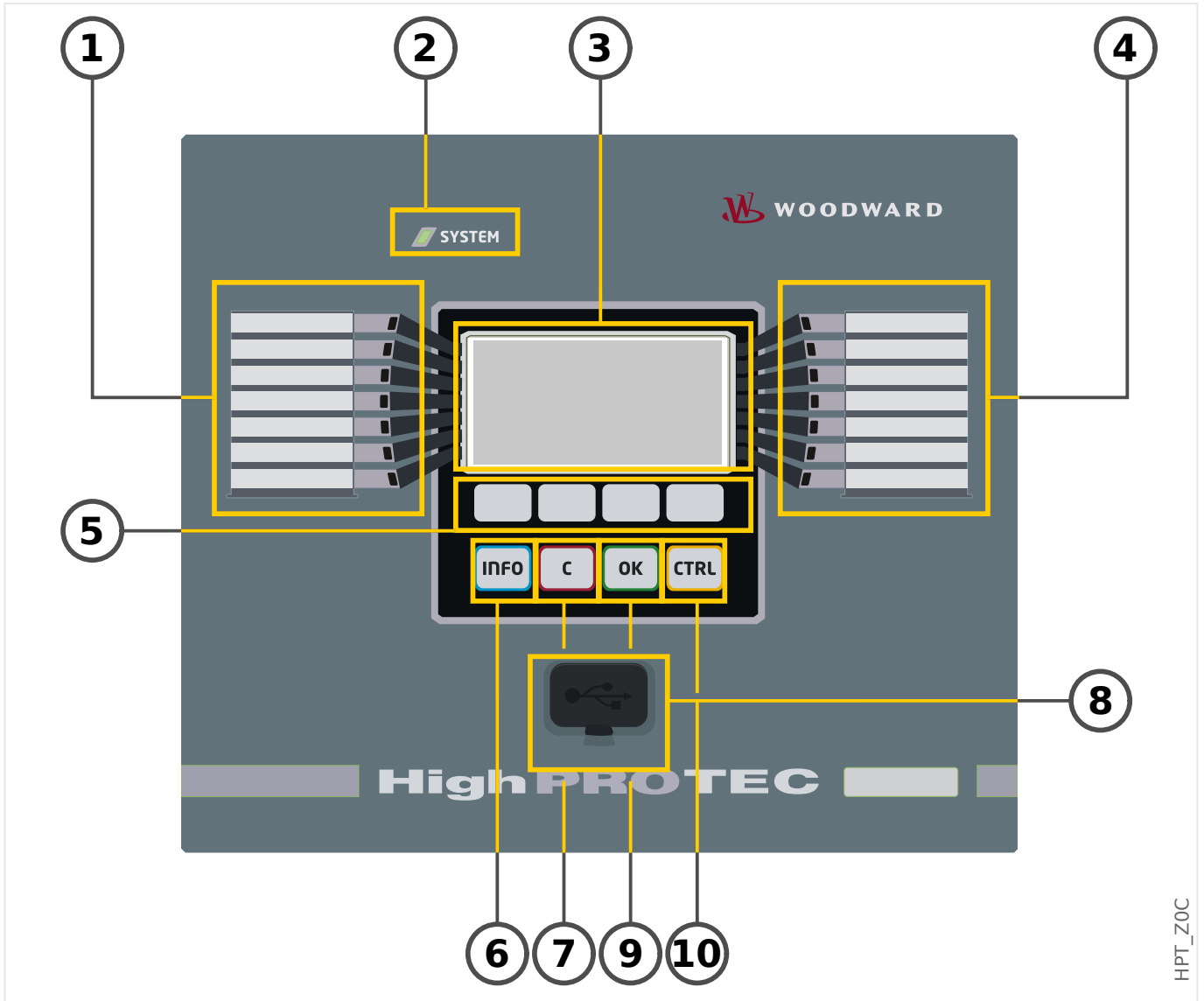

1.2.2.1 Front Panel Parts

(1) Programmable LEDs

Messages inform you about operational conditions, system data or other device particulars. They additionally provide you with information regarding failures and functioning of the device as well as other states of the device and the equipment.

Various signals can be freely allocated to LEDs out of the »assignment list«. (The available signals can be found in the Reference Manual.)

(2) LED »System OK« (“Operational”)

The »System OK« (“Operational”) LED is constantly green when – after the boot phase,  “12 Boot Phase” – the protection functions of the MRMV4 are working. In any other case consult the *Troubleshooting Guide*.

(3) Display

Via the display you can check operational data and edit parameters.

(4) Programmable LEDs group B (right)

Messages inform you about operational conditions, system data or other device particulars. They additionally provide you with information regarding failures and functioning of the device as well as other states of the device and the equipment.

Various signals can be freely allocated to LEDs out of the »assignment list«. (The available signals can be found in the Reference Manual.)

(5) Softkeys

The functions of the »SOFTKEYS« are contextual. On the bottom line of the display the present functions are displayed via symbols. See  “Softkey Symbols”

(6) »INFO« Key (Signals/Messages)

The present LED assignment is displayed. The direct select key can be actuated at any time.

In order to leave the LED menu (or submenu) press the softkey “◀” (Left) one (or two) times.

Further information:  “LEDs”

(7) »C« Key

To abort parameter changes and to acknowledge signals (including LED test). During cold restart: Reset password and / or parameters.

Further information how to abort changes during normal configuration work:  “Parameter Settings”

Further information how to acknowledge signals:  “Acknowledgments”

In particular, manual acknowledgment including LED test:  “1.5 Manual Acknowledgment (by Pressing the C Key at the Panel)”

Reset dialog during a cold restart:  “Reset to Factory Defaults, Reset All Passwords”

(8) USB Interface (Smart view Connection)

Connection to the PC software *Smart view* can be done via this USB interface.

(9) »OK« Key















When using the »OK« key parameter changes are temporarily stored. If the »OK« key is pressed again, those changes are stored definitely.

(10) »CTRL« Key

Direct Access to the Control Page, see  "5 Single-Line Diagram".

1.2.2.2 Softkey Symbols

The following symbols are used to label the function of a Softkey:

Softkey	Meaning
	Via Softkey »up« you can scroll upwards. You go to the prior menu point/one parameter up by scrolling upwards.
	Via Softkey »down« you can scroll downwards. You go to the next menu point/one parameter down by scrolling downwards.
	Via Softkey »left« you will go one step back. You can leave the submenu. You go back to the previous page of menu tree.
	Via Softkey »right« you can enter the selected submenu.
	Via Softkey »Top of list« you jump directly to the top of a list.
	Via Softkey »Bottom of list« you jump directly to the end of a list.
	Via Softkey »+« the currently selected digit is incremented. (Continuous pressure: fast repeat).
	Via Softkey »-« the currently selected digit is decremented. (Continuous pressure: fast repeat).
	Via Softkey »left« you select the digit left to the previously selected one.
	Via Softkey »right« you select the digit right to the previously selected one.
	Via the »Wrench« symbol you can change the selected parameter (i. e. enter the parameter setting mode).
	Via the »Key« symbol you are asked for password authorization, then you can change the selected parameter.
	Via Softkey »delete« the selected data is deleted.
	Fast forward scrolling is possible via Softkey »Fast forward«.
	Fast backward scrolling is possible via Softkey »Fast backward«.

1.3 Modules, Settings, Signals and Values

The MRMV4 is a digital protection device that holds various data in its internal memory. Some data is meant to be changed by the user to adapt the functionality to the respective application, other data types are set by the device during run-time and are therefore read-only from the user's perspective.

All settings, device planning and checking the state of signals at run-time can be done:

- Directly at the device; or
- By way of the *Smart view* software application.

Modules

The firmware of the MRMV4 can be thought of being sub-divided in several independent function blocks. Throughout our Technical Documentation, we are talking of “modules” (or sometimes of “functions”). Every protection function, for example, is a module of its own. For HighPROTEC devices, this is a fundamental concept: For example, the functionality of calculating statistical data is a module (named »Statistics«), every communication protocol is a module, the general functionality of controlling switchgear devices is a module (named »Ctrl«), there is even a general protection module (named »Prot«) that interacts with all specific protection modules.



It is important to know that every parameter and every signal and value is always part of exactly one module (even if the module name might not be displayed on the panel for the sake of simplicity).

Modules can interact with each other, either because this is a fixed implemented part of the firmware, or if the user has assigned some signal of a module to a parameter (that becomes a module input this way). An example for a fixed implemented interaction is that the trip signal of any protection module always triggers the trip signal of the general »Prot« module and, vice versa, if the »Prot« trip is blocked, then the trip of all protection functions is blocked.

Some modules exist in several (identical) instances, which can be activated and configured independently. These can be used to have several protection stages. However, there is one fundamental difference to the MRMV4: The functionality of all instances (of a particular module) is always identical (except for the differences that are due to different setting values).

There is the following naming convention: If several instances of a module »Module« exist, then these are named »Module[1]«, »Module[2]«, ... (or, as a short form for descriptions: »Module[x]«).

Types of Settings, Signals and Values

Settings (also called parameters)

- Parameters are data that can be modified by the user, to adapt the functionality of the respective application.

Smart view users can save all settings to a file. This is a file with a filename of the form *.ErPara. It can be (re-)loaded at any later time, and the setting values contained therein can be transferred to some (other) MRMV4 protection device. (For details see the *Smart view* manual.)

(Remark: There are a few exceptions, where a particular setting is always stored within the device and never saved to a *.ErPara file. This is the case if it is not

desirable to directly transfer the setting value from one device to another; the TCP/IP settings are an example for this.)

There are several types of parameters, depending on the type of data they can hold. For the user, it is not necessary to know details, but it can be good to know that there are numerical parameters (e. g. overcurrent thresholds) and parameters which hold one option out of a selection list. These select options can either be fixed values (e. g. the choice of communication protocol), or they can be a signal (so that during run-time, the actual parameter value equals the state of the assigned signal). This case of a signal assignment is what has been mentioned above as a “module input”.

- Some parameter properties depend on the value of particular other parameters. For example, the “device planning” parameters (in the [Device planning] menu) do not only activate or deactivate protection functions but also control the visibility of their related parameters.

Some parameters depend on others not only with respect to visibility, but also default values and/or available value ranges. (For example, the range of some protection parameters depend on the CT ratio.)

- There are parameters that exist only once, named “Global Parameters”.

These are usually within the [Global Prot Para] menu.

- Setting Group Parameters can be found in menu branches [Set 1] ... [Set 4]: These are protection parameters that have a “four-fold” existence: The user can set four values, and each of these is member of a particular “parameter set” (Set 1 to Set 4). At any time only one of these four parameter sets is active, which has the effect that the respective set value is active. (This is always independent of the protection function: It always affects all protection functions at the same time if one switches to another parameter set.)
- By means of Adaptive Parameter Sets you can modify single parameters dynamically during run-time: Setting values are defined to be dependent on the “True/False” value of a particular Boolean signal. It is possible to define up to four Boolean signals for value switching, which means that – together with the base value – such an Adaptive Parameter can have up to five alternative values (per parameter set, which makes a total sum of up to 20 values). Which one gets actively used at a particular moment of time, will then depend on the run-time value of the (up to four) related Boolean parameters.

In contrast to Setting Group Parameters, Adaptive Parameter Sets are “local”, i. e. they are effective only within the protection function where they had been activated.

Note, however, that not all protection functions support Adaptive Parameter Sets.

Since some users are maybe not quite familiar with the concept of Adaptive Parameter Sets there is a dedicated chapter with a more detailed description. See  “Adaptive Parameter Sets”.

Direct Commands

- **Direct Commands** are part of the “menu tree”, just like a setting parameter, but they are meant to be executed immediately. Therefore Direct Commands are **NOT** part of a *.HtpPara parameter file.



Typical examples are the Direct Commands for resetting Counters.

On the panel (and on a listing window of Smart view), Direct Commands are marked by a special “push button switch” symbol “⊖”, so that the user can immediately recognize them.

Signals

- *Signals* are run-time states, i. e. depend on the result of a protection function or on the state of a Digital Input.

Signals are part of the “menu tree”. They can all be found in the menu path [Operation / Status Display].

- Some *Signals* represent the state of the installation/equipment (e. g.: position indicators of the breaker).
- Some *Signals* are assessments of the state of the grid and the equipment (e. g.: System OK, Transformer failure detected).
- Some *Signals* represent decisions that are taken by the device (e. g.: Trip Command) based on the parameter settings.
- Many signals can be *assigned* to particular parameters. This means the function of this parameter depends on the run-time state of the signal. For example, every protection function features several blocking parameters. (See also  “Blockings”.) If a signal has been assigned to a blocking parameter then the respective protection function gets blocked as soon as the run-time state of the assigned signal becomes “True”.
- In the same way can signals also be assigned to the LEDs of the MRMV4, so that an LED is lit as soon as the assigned signal becomes “True”. (See also  “LEDs”.)

Input States (for a module input)

- Input States are special signals and are part of the “menu tree”. For every parameter to which a signal can be assigned, there is a related Input State. At run-time, the Input State reflects the current state of the assigned signal. This way the dependencies in the behavior of a protection function can be traced.

There is the following naming convention: If a parameter to which a signal can be assigned is named »Name«, then the related Input State has the name »Name-I«.

Counters, Values

- *Values* are more or less volatile data that are constantly kept up to date during run-time.
- The most common (and most important) type of *Values* is the set of *Measured Values* (e. g. the current and/or voltage values measured at the CT/VT, frequency values); we are going to use the term *Measured Values* also for values that are derived from measured values by calculation, e. g. the power value calculated from current and voltage). Of course, the set of available *Measured Values* depends on the capabilities of the particular protection device.

See  “Measuring Values” for information on measured values.

- A *Statistical Value* is a special type of “calculated measured values”, and can be a maximum, minimum or average value; this helps to analyse the development of a measured value in time. For most *Statistical Values*, there is a related Direct Command, which can be used to reset the statistics.

See  “Statistics” for information on statistics.

- Another important type is the *Counters*. Whereas *Measured Values* are usually floating-point numbers (mostly with a related unit of measurement), do *Counters*

hold a digital, integer number. For most *Counters*, there is a related Direct Command, which can be used to reset the Counter value to 0.

1.3.1 Parameter Settings

Parameter Setting at the HMI

Every parameter belongs to an access area. Editing and changing of a parameter requires a sufficient access authorization. See  "Access Level Passwords" for a detailed description of access areas.

The user can obtain the required access authorizations by unlocking access areas in advance of parameter changes or context-dependent. In the following sections both options will be explained.

Option 1: Direct Authorization for an Access Area

Call up menu [Device Para / Security / Access Level].

Select the required access level respectively navigate to the required access authorization (level). Enter the required password. If the correct password has been entered, the required access authorization will be obtained. In order to do the parameter changes please proceed as follows:

- Move to the parameter you want to change by using the Softkeys. If the parameter is selected, the lower right corner of the display should show a »Wrench« symbol.



This symbol indicates, that the parameter is unlocked and can be edited, because the required access authorization is available. Confirm the Softkey »Wrench«, in order to edit the parameter. Change the parameter.

Now you can:

- save the change you made and have them adopted by the system or:
- change additional parameters and save finally all the altered parameters and have them adopted by the system.

To save parameter changes immediately,

- press the »OK« key for saving changed parameters directly and to have them adopted by the device. Confirm the parameter changes by pressing the »Yes« Softkey or dismiss by pressing »No«.

To change additional parameters and save afterwards,

- move to other parameters and change them

NOTICE!



A star symbol in front of the changed parameters indicates that the modifications have only been saved temporarily, they are not yet finally stored and adopted by the device.

In order to make things easier to follow, especially where complex parameter changes are involved, on every superior/higher-ranking menu level the intended change of the parameter is indicated by the star symbol ("star trace"). This makes it possible to control or follow up from the main menu level at any time where parameter changes have been made and have not been saved finally.

In addition to the star trace to the temporary saved parameter changes, a general parameter changing symbol is faded-in at the left corner of the display, and so it is possible from each point of the menu tree to see that there are temporary (not yet active) parameter changes.

Note that when using *Smart view* for changing parameters, the red star symbol in the menu tree indicates that parameters changes have not yet been saved in a parameter file.

Press the »OK« key to initiate the final storage of all parameter changes. Confirm the parameter changes by pressing the »Yes« softkey or dismiss by pressing Softkey »No«.

NOTICE!



If the display shows a Key Symbol  instead of a Wrench-Symbol, this will indicate, that the required access authorization is not available.

In order to edit this parameter, a password is required, that provides the required authorization.

NOTICE!



Plausibility check: In order to prevent obvious wrong settings the device monitors constantly all temporary saved parameter changes. If the device detects an implausibility, this is indicated by a question mark in front of the respective parameter.

In order to make things easier to follow up, especially where complex parameter changes are involved, on every superior/higher-ranking menu level, above the temporarily saved parameters an invalidity is indicated by the question mark (plausibility trace). This makes it possible to control or follow from the main menu level at any time where implausibilities are intended to be saved.

In addition to the question mark trace to the temporary saved implausible parameter changes a general implausibility symbol/question mark is faded-in at the left corner of the display, and so it is possible to see from each point of the menu tree that implausibilities have been detected by the device.

A star/parameter change indication is always overwritten by the question mark/implausibility symbol.

If a device detects an implausibility, it rejects saving and adopting of the parameters.

Option 2: Context-dependent Access Authorization

Navigate to the parameter, that is to be changed. If the parameter is selected, the lower right corner of the display shows a »Key«-Symbol.



This symbol indicates, that the device is still within the »Read Only-Lv0« level (↳↳ «Access Level Passwords»), or that the current level does not provide sufficient access rights to allow editing of this parameter.

Press this Softkey and enter the password that provides access to this parameter. (This page provides also information, which password/access authorization is required to do changes on this parameter.)

Please change the parameter settings.

Now you can:

- save the change you made and have them adopted by the system or:
- change additional parameters and save finally all the altered parameters and have them adopted by the system.

To save parameter changes immediately,

- press the »OK« key for saving changed parameters directly and to have them adopted by the device. Confirm the parameter changes by pressing the »Yes« Softkey or dismiss by pressing »No«.

To change additional parameters and save afterwards,

- move to other parameters and change them

NOTICE!



A star symbol in front of the changed parameters indicates that the modifications have only been saved temporarily, they are not yet finally stored and adopted by the device.

In order to make things easier to follow, especially where complex parameter changes are involved, on every superior/higher-ranking menu level the intended change of the parameter is indicated by the star symbol (star trace). This makes it possible to control or follow up from the main menu level at any time where parameter changes have been made and have not been saved finally.

In addition to the star trace to the temporary saved parameter changes, a general parameter changing symbol is faded-in at the left corner of the display, and so it is possible from each point of the menu tree to see that there are temporary (not yet active) parameter changes.

Note that when using *Smart view* for changing parameters, the red star symbol in the menu tree indicates that parameters changes have not yet been saved in a parameter file.

Press the »OK« key to initiate the final storage of all parameter changes. Confirm the parameter changes by pressing the »Yes« Softkey or dismiss by pressing Softkey »No«.

NOTICE!



Plausibility check: In order to prevent obvious wrong settings the device monitors constantly all temporary saved parameter changes. If the device detects an implausibility, this is indicated by a question mark in front of the respective parameter.

In order to make things easier to follow up, especially where complex parameter changes are involved, on every superior/higher-ranking menu level, above the temporary saved parameters an invalidity is indicated by the question mark (plausibility trace). This makes it possible to control or follow from the main menu level at any time where implausibilities are intended to be saved.

In addition to the question mark trace to the temporary saved implausible parameter changes a general implausibility symbol/question mark is faded-in at the left corner of the display, and so it is possible to see from each point of the menu tree that implausibilities have been detected by the device.

A star/parameter change indication is always overwritten by the question mark/implausibility symbol.

If a device detects an implausibility, it rejects saving and adopting of the parameters.

Setting Groups

The setting parameter [Protection Para / PSet-Switch] »PSet-Switch« allows for the following activities:

- Explicitly activate one of the four setting groups (“PS1” ... “PS4”).
- Assign a signal to each setting group that sets this group to active (setting value “PSS via Inp fct”, and additionally assign the respective signals for the switch-over:

If, for example, a particular signal shall switch to setting group PS2, then this signal has to be assigned to the setting parameter [Protection Para / PSet-Switch] »PS2: *activated by*«.

- Enable SCADA to switch the setting groups (setting value “PSS via Scada”).

Option	Setting Group Switch
Manual Selection	Switch over, if another setting group is chosen manually via parameter »PSet-Switch«.
Via Input Function (e.g. Digital Input)	<p>Switch over if exactly one of the four assigned signals becomes active. Note that the setting group is not changed if more than one activation signal is present at the same time.</p> <p>Example:</p> <p>Signal DI3 is assigned to parameter »PS3: <i>activated by</i>«. DI3 is active “1”.</p> <p>DI4 is assigned to »PS4: <i>activated by</i>«. DI4 is inactive “0”.</p> <p>If it is required to switch from parameter set 3 to parameter set 4 it must be made sure that DI3 becomes inactive first. Then DI4 has to become active.</p>

Option	Setting Group Switch
	Even if DI4 becomes inactive afterwards, parameter set 4 remains active, until there is a new distinct request (e. g. DI3 becomes active and all the other assignments are inactive)
Via SCADA	Switch over if there is a distinct SCADA request.

NOTICE!





Setting group switch: Whenever another setting group gets activated, all memory-related values (e. g. timers) are reset for all protection functions.

Configuration change: Whenever changes are made to the settings of protection parameters (device planning, global parameters or setting group parameters for more than one setting group) all protection functionality is completely deactivated for a short time. This means that all protection modules are inactive for some time, so that they can be restarted with the new settings. This way it is made sure that all protection behavior is consistent with respect to the new settings.

An **exception** from this is a configuration change that is restricted to settings from only one setting group. In this case all protection function are only reset (exactly as for a setting group switch, see above).

Setting Lock

By means of the Setting Lock, parameter settings can be locked against any changes as long as the assigned signal is true (active). The Setting Lock can be activated via [Field Para / General Settings] »Setting Lock«.

Bypass of the Setting Lock

The setting lock can be temporarily canceled in case that it is not possible (or desirable) to change the status of the signal that activates the setting lock.

The Setting Lock can be bypassed by means of the following Direct Control Parameter: [Field Para / General Settings] »Setting Lock Bypass«

The protective device will fall back into the Setting Lock as follows:

- Directly after a parameter change has been saved, or
- 10 minutes after the bypass has been activated.

1.3.2 Adaptive Parameter Sets

By means of Adaptive Parameter Sets you can modify dynamically setting values within a protection module.

NOTICE!



Adaptive Parameter Sets are available only for a few protection modules (essentially only the overcurrent protection modules).

From the practical point of view, there is one essential difference to the ordinary parameters sets (see [↳](#) “1.3 Types of Settings, Signals and Values”): Switching to another parameter set affects **all** protection functions at once. This can increase your commissioning and testing efforts considerably if you “only” want to modify the behavior of one particular protection function.

Contrast to this, Adaptive Parameter Sets are “local”, i. e. they are effective only within the protection function where they had been activated. (See below how to do this.)

You can assign a digital signal to any of the parameters [Protection Para / Global Prot Para / I-Prot / “module”] »AdaptSet 1«, ..., »AdaptSet 4«. (“module” means the name of a protection module that features Adaptive Parameter Sets, for example: [I[1]]).

These four assignment parameters are always “Global Parameters” (i. e. within the menu branch [Protection Para / Global Prot Para]). For example, let us make the following assignment: »AdaptSet 1« = “V[1] . Alarm”, see the upper dialog window ① in the diagram below.

With this assignment, the *Smart view* dialog window for the “Setting Group Parameters”, for example the menu branch [Protection Para / Set 1 / I-Prot / I[1]], is getting enhanced by an additional column ②, as shown in the bottom dialog window in the diagram below.

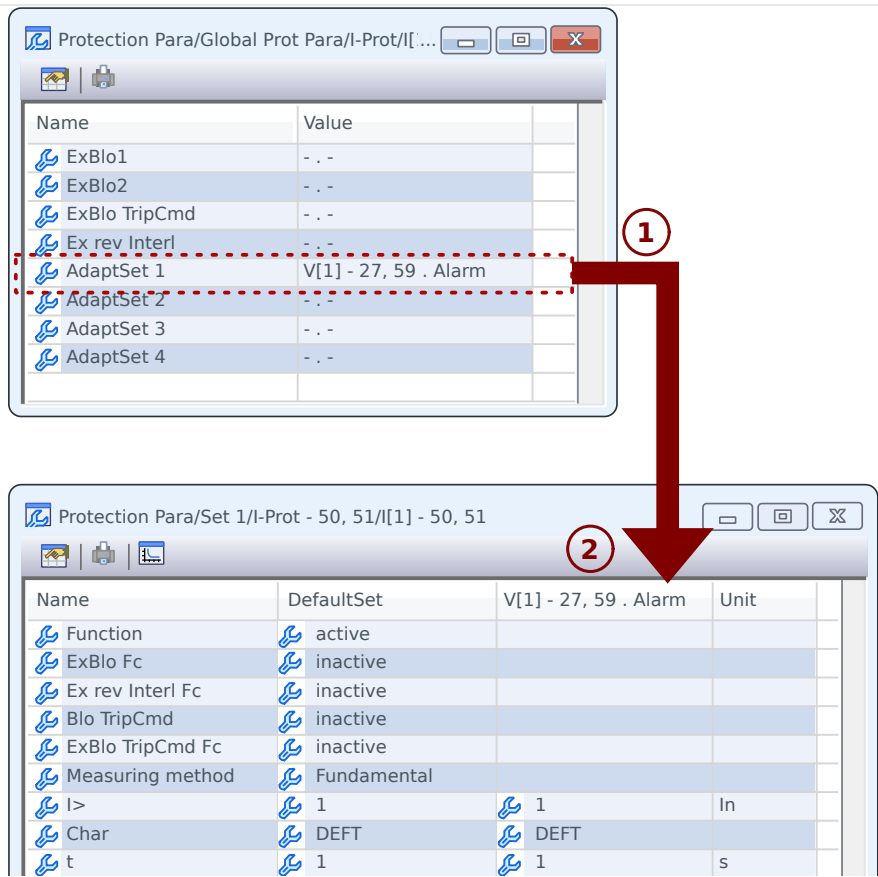

Fig. 2: An assignment to an Adaptive Set parameter adds alternative values to Setting Group parameters.

By this Adaptive Set assignment, most Setting Group Parameters receive an additional, alternative value. At first this new value is identical to the DefaultSet value, but it can be edited the same way. (Double-click it and modify it according to your needs.)

The idea is simple: The protection parameters use the alternative »AdaptSet 1« value as soon as the assigned signal “V[1] . Alarm” becomes true.

Since there are four normal setting groups, and each of these can have up to four Adaptive Sets plus the DefaultSet, this means that parameters supporting Adaptive Sets can have up to 20 different setting values.

NOTICE!



Adaptive Parameters fall back automatically as soon as the assigned signal, that has activated them, has fallen back.

In case several assigned signals are active at a particular moment in time the following holds:

Adaptive Set 1 is dominant to Adaptive Set 2. Adaptive Set 2 is dominant to Adaptive Set 3. Adaptive Set 3 is dominant to Adaptive Set 4.

Application Examples for Adaptive Parameter Sets

- AR: auto-reclosing with 2 shots
 - 1st shot DEFT characteristic, normal tripping stage

- 2nd shot INV characteristic, sensitive tripping stage
- CLPU: cold load pickup
 - Motor start, de-sensibilize current protection
- SOTF: switch on to fault
 - De-sensibilize current protection
- ANSI 51C: voltage controlled over current
 - Generator, motor, de-sensibilize current protection

1.3.3 Status Display

In the status display within the »Operation« menu, the present state of all signals can be viewed. This means the User is able to see if the individual signals are active or inactive at that moment. The User can see all signals sorted by protective elements/modules.

State of the Module Input / Signal is...	The State is Shown at the Panel as...
"inactive" / False / »0«	<input type="checkbox"/>
"active" / True / »1«	<input checked="" type="checkbox"/>

1.3.4 Menu Structure

The menu structure offers the following top-level menu entries. You enter a menu branch with Softkey ►. Softkeys ▲ and ▼ let you navigate to the previous or next one.

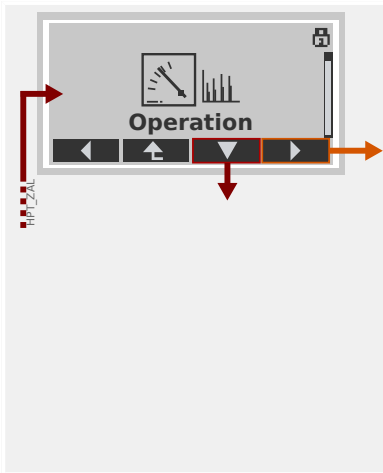
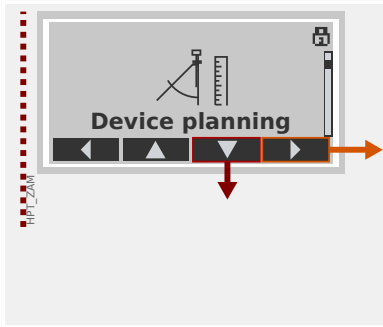
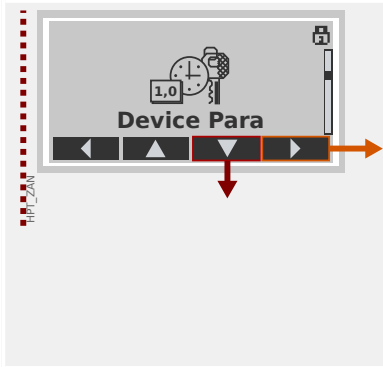
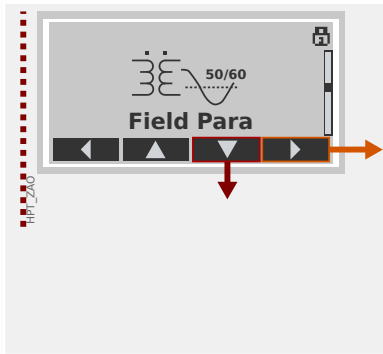
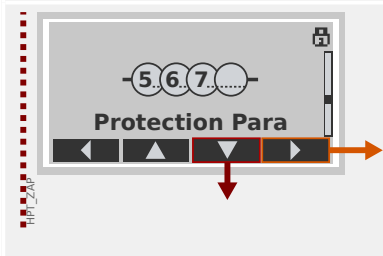
	<p>Operation</p> <p>Here you can find run-time data.</p> <ul style="list-style-type: none"> • Measured Values • Statistics • Status Display • Counter and RevData • Fault recorder, Event recorder, Disturbance recorder • Self-Supervision • Acknowledge, reset
	<p>Device planning</p> <p>This will usually be your first step during commissioning:</p> <p>Activate the elements that you need, deactivate elements that are not needed.</p> <p>Select the protocol for (SCADA) communication with the substation.</p>
	<p>Device Parameters</p> <p>This menu branch features all settings that are directly related to the device, for example:</p> <ul style="list-style-type: none"> • Digital inputs and outputs • LEDs • Settings for the Recorders • Communication settings
	<p>Field settings</p> <p>Usually the second commissioning step: Configure the properties of the field, for example:</p> <ul style="list-style-type: none"> • Nominal frequency, voltage, current • CT and VT ratios • VT connection type (Phase to Ground, Phase to Phase)
	<p>Protection Parameters</p> <p>All protection settings, which are related to a specific protection function, can be found here.</p> <p>For each protection function, the settings are grouped into the following setting types:</p>

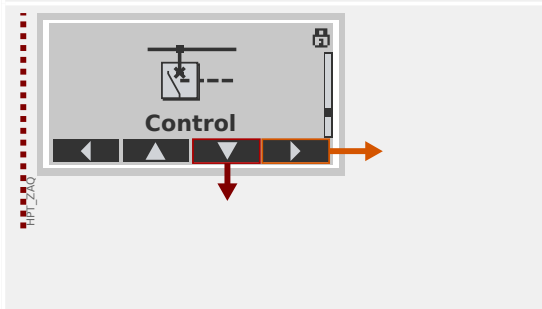
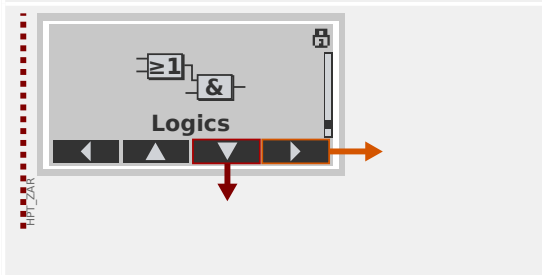
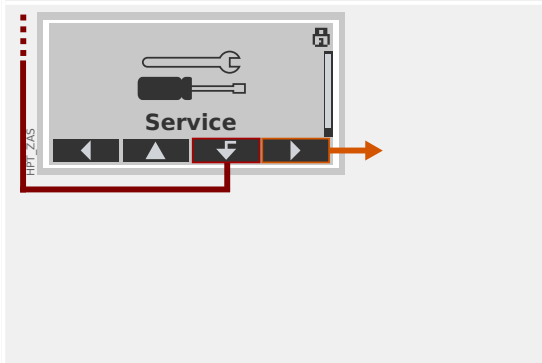
	<ul style="list-style-type: none"> • Global Protection Parameter • Set 1 ... Set 4 • PSet-Switch (Switching Parameter Set)
	<p>Control</p> <p>Settings for switchgear devices.</p> <ul style="list-style-type: none"> • The HighPROTEC devices named “MR...” can control 1 switchgear device. • The HighPROTEC devices named “MC...” can control up to 6 switchgear devices.
	<p>Programmable Logic</p> <ul style="list-style-type: none"> • Up to 80 logic equations • 4 selectable gates • 4 inputs, 4 outputs per equation • timer and memory functions
	<p>Service</p> <p>This menu branch is primarily needed for testing purposes. For example:</p> <ul style="list-style-type: none"> • Force / disarm outputs • Force / disarm analog input and outputs • Use the internal signal/fault generator • Reboot the protection device

1.3.5 Device Planning

“Device Planning” means to change the functional range to a degree that suits the protection task to be fulfilled (i. e.: the device deactivates all functions that are not needed, and shows only the active ones).

There is a top-level menu item [Device planning] that is dedicated to this; it collects a setting parameter for each function which can be set to “-” or “use”. (In some cases there are additional setting options, for example with devices featuring direction determination).

If the user, for example, activates the voltage protection function, all menu branches related to this function appear in the menu tree. All corresponding events, signals, etc., are activated as well.

WARNING!



It **MUST** be taken into account that Device Planning changes the functionality of the device.

If, for example, the user cancels the directional feature of the overcurrent protections, the device will no longer trip in a directional way but merely in a non-directional way. If the user deactivates a protection function, the device will no longer trip according to the criteria related to this protection function.

The manufacturer does not accept liability for any personal or material damage as a result of incorrect planning.

Contact your Woodward Customer Service representative for more information.

WARNING!



Beware of the inadvertent deactivating of protective functions/modules, because all the settings of a deactivated module get lost (i. e. are set back to their respective default values)!

This means: If the user is activating any of these modules again at some later time, all parameters of the re-activated modules need to be reconfigured.

1.3.6 Field Parameters

Within the field parameters you can set all parameters that are relevant for the primary side and the mains operational method like frequency, primary and secondary values.

All field parameters are accessible via the menu branch [Field Para].

See the *Reference Manual* for detailed tables of all settings that are available for the MRMV4.

1.3.7 Device Parameters

Date and Time

In the menu [Device Para / Time] »*Date and Time*« you can set date and time (including a sub-menu for timezone and Daylight-Saving settings).

Version

Within the menu [Device Para / Version] you can obtain information on the software and hardware version.

Display of ANSI-Codes

The display of ANSI codes on the device panel (HMI) can be activated via [Device Para / HMI] »*Display ANSI Device No.*«.

Smart view, however, has its own menu item for controlling the display of ANSI codes, which is independent of the device panel. (See the *Smart view* User Manual.)

1.3.8 Reset Counters, Values and Records

Manual Resets

In menu [Operation / Reset] you can:

- reset counters,
- delete records (e. g. disturbance records) and
- reset special things (like statistics, thermal replica...).

NOTICE!



Descriptions of the available reset commands can be found in a separate document, entitled "MRMV4 Reference Manual".

1.4 Security

General

CAUTION!



All security settings have to be made by the user of the MRMV4! It is strictly recommended that you adapt the security settings according to the local regulations and requirements at the end of the commissioning procedure.

The MRMV4 is delivered with maximum “open” settings, i. e. all access restrictions are deactivated. This way the commissioning is not complicated unnecessarily. But afterwards, when the MRMV4 is running, it is probably required to restrict the access to some extent. There are in particular the following aspects to consider:

By default, the *Smart view* access to the MRMV4 via the USB interface is permitted (without any password protection), but the the TCP/IP access over the network is deactivated (see [↪ “1.4.3 Connection Passwords, Smart view Access”](#)). However, it is recommended for security reasons to re-adjust these settings after commissioning at the latest.

CAUTION!



For security reasons it is strongly recommended to modify the default passwords ([↪ “1.4.2 Default Passwords”](#)) according to the security level that is required by your application (see [↪ “1.4.4 Changing Passwords”](#)), for example by defining different, level-specific passwords for the different access areas / levels. This way it is possible to make sure that different user groups get their individual access permissions.

Security-Related Settings Overview

The menu branch [Operation / Security] collects information about various security-related settings, in particular:

- For the connection passwords (see [↪ “1.4.3 Connection Passwords for Smart view Access”](#)) you can see whether these have been set to user-specific values, or are still at their factory default.
- You can see whether Smart view access is permitted (see [↪ “1.4.3 Access via Smart view”](#)).
- You can see which switching authority has been set (see [↪ “5.2 Switching Authority”](#)).
- You can see to which extent a reset to factory defaults has been enabled (see [↪ “Reset to Factory Defaults, Reset All Passwords”](#)).

(For a complete list of entries that are shown on this page, check the “Security” chapter in the “MRMV4 Reference Manual”.)

If IT security is a concern for your application, it is recommended to check all these entries during commissioning, but of course without trusting them blindly: If, for example, someone has set the USB connection password simply to “**1**” then this security page shows the entry »Passw. for USB conn.« = “def. by user”; but the security level of such a password is obviously quite questionable.

Security-Related Messages

There is a special self-supervision recorder, named **Self-Supervision Messages**. It collects device-internal messages of various types, including security-related events (e. g. if a wrong password has been entered). It is recommended to check these entries from time to time.

A sub-set of these messages, restricted to only the security-related messages, can (also) be accessed at the menu branch [Operation / Security / Security Logger].

1.4.1 Network Security

SCADA Communication

It is to be noted that there are always certain security risks related to the use of SCADA protocols. Detailed information can be found in the technical literature.



Intranet Security

If the Ethernet interface of the MRMV4 is connected to a network it is the responsibility of the user to maintain all necessary means required for the security of the company network. In particular, it must be guaranteed that external access (i. e. out of the internet) to the MRMV4 has been made impossible. Please keep yourself informed about up-to-date technology (firewalls, VPN etc.)!

1.4.2 Passwords

Password Types

There are two different types of passwords:

- **Connection passwords** enable the user to establish a connection with the operating software Smart view. (See  “Connection Passwords, Smart view Access”.)
- **Access level passwords** are required for any changes to the device settings. (See  “Access Level Passwords”.)

Remark: **Connection passwords** have been introduced with HighPROTEC Release **3.6**. The main reason is that as of Release 3.6, all connections between MRMV4 and *Smart view* are fully encrypted, using state-of-the-art cryptographic algorithms. (See also  “1.4.3 Smart view Connections”.)

NOTICE!



The set passwords are stored in a permanent part of the MRMV4 memory so that they “survive” a firmware upgrade. (This is true of both password types.)

Default Passwords

The factory default is for **all** (communication and access level) passwords some standard value that does not provide any security against unauthorized access:

- The connection passwords have an empty text as default (i. e. these are not asked for).
- All access level passwords have the default value »**1234**«.

Time Penalty for Wrong Password Entry

Entering *wrong* passwords (regardless whether connection password or access level password, and regardless whether via HMI or *Smart view*) triggers a “time penalty” stage: The MRMV4 blocks any further password entry for an increasing amount of time, until a correct password has been entered. A dedicated message informs the user about this

blocking. This timer affects only the password entry (i. e. the Softkey  on the HMI), so that it does not prevent the user from doing some other, “password-free” activities during this blocking time.

Password Forgotten

By pressing the »C« key during a cold restart a reset dialog is launched (unless this has been explicitly disabled). It allows for resetting all passwords to the respective default (see  “1.4.2 Default Passwords”).

See  “Reset to Factory Defaults, Reset All Passwords” for details about this General Reset dialog.

1.4.3 Connection Passwords, Smart view Access

Smart view Connections

One of the fundamental requirements of »IT Security« is to make sure that no unauthorized person can eavesdrop on information that is exchanged between an operator and the MRMV4.

Therefore all connections between MRMV4 and *Smart view* are fully encrypted, using state-of-the-art cryptographic algorithms.

Woodward provides each installation of *Smart view* (version 4.70 or later) and each individual HighPROTEC device (release 3.6 or later) with cryptographic certificates, which are automatically exchanged when the connection is being established. The certificates are checked by both communication partners (MRMV4 and *Smart view*) to make sure that no other, unauthorized party has hitch-hiked the connection.

The additional security that comes with these cryptographic techniques is available by default, there is nothing that the user has to set up or has to take care of.

Access via Smart view

Another fundamental requirement of »IT Security« is to prevent unauthorized persons from accessing the own systems, including the protective device MRMV4. The MRMV4 offers access via its front panel and via the operating software *Smart view*.

Since the access via front panel is only possible for someone who is located directly in front of the device the risk should normally be rather low, compared to the risk of unauthorized access via *Smart view*, especially if the MRMV4 is part of an Ethernet / TCP/IP network.

- For security reasons, there is the option to deactivate the *Smart view* access via the USB interface; this can be done with the setting parameter [Device Para / Security / Communication] »*Smart view via USB*«. The factory default, however, is that this access type is permitted.
- In the same way, there is also the option to deactivate the *Smart view* access via Ethernet; this can be done with the setting parameter [Device Para / Security / Communication] »*Smart view via Eth*«. The factory default, however, is that this access type is permitted.

NOTICE!



If *Smart view* is used to deactivate the *Smart view* access, then the current session gets automatically terminated.

Connection Passwords for Smart view Access

There are two connection passwords. At the beginning of a new session, *Smart view* prompts the user for a password, and the connection is established only after the password has been correctly entered. (This password prompt is omitted only if an empty value has been defined for the respective password.)

- **USB connection** — The “local connection password” has to be entered for establishing a *Smart view* access via the USB interface. (The default, however, is an empty value.)

- **Remote network connection** — The “remote network connection password” has to be entered for establishing a *Smart view* access via Ethernet. (The default, however, is an empty value, but note that this access type is deactivated by default, see [↪ “1.4.3 Access via Smart view”](#).)

The connection passwords can be changed using *Smart view* by accessing the menu branch [Device Para / Security / Password] and making a double-click on the password to be changed.

Note that the two connection passwords are different from the access level passwords (described at [↪ “1.4.4 Password Entry at the Panel”](#)) with respect to the following:

- The connection passwords can be entered and be changed only within *Smart view* (not via the HMI of the MRMV4).

(Nevertheless, passwords are permanently stored by the MRMV4, not by *Smart view*. This way every HighPROTEC relay can have some individual connection password, if that is required.)

- Unlike the access level passwords ([↪ “1.4.4 Changing Passwords”](#)), the connection passwords are **not** restricted to the digits 1, 2, 3, 4 and are **not** restricted to a maximum length of 8 digits. (The length can be 64 characters and more.) In fact, a connection password can be any sequence of printable Unicode characters, including blanks.

WARNING!



The factory default for all passwords (see [↪ “1.4.2 Default Passwords”](#)) does not provide any security.

For security reasons, it is strictly recommended to adapt the default passwords to some individual passwords that meet the local security directives.

Depending on the security policy at your site it is also possible to define a blank value for each password. This has the effect that there is no more password prompt, i. e. the access restriction is lifted. However, we have to declare that from our point of view, this is strongly discouraged – at least for the “network password”.

1.4.4 Access Level Passwords

Access level passwords are required for any changes to the device settings, independent of whether the change is done via *Smart view* or directly at the HMI (panel).

There is a security level - a so-called access level (or access area) - associated with each setting parameter. See [↪ "Access Levels"](#) for a description of the existing access levels.

Whenever you want to change a setting, you have to enter the password for the associated access level. (Afterwards, this access level remains unlocked for some time, so that further changes within this level can be made without re-entering the password.)

Password Entry at the Panel

If one operates the MRMV4 directly at the HMI, then it is possible to use the Softkeys for entering an *access level password*.

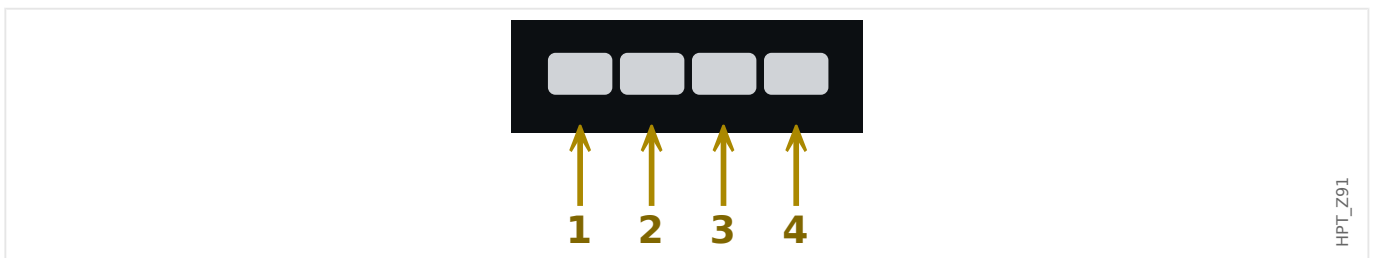

Example: For password (**3244**) press successively:

- Softkey 3
- Softkey 2
- Softkey 4
- Softkey 4

With an active *Smart view* connection, the passwords are requested by *Smart view*, so that they are entered via PC keyboard on request.

Changing Passwords

Access level passwords can be changed in menu [Device Para / Security / Password].

NOTICE!



An *access level password* must have a maximum length of 8 digits, and it must be a user-defined combination of the numerics 1, 2, 3 and 4. All other characters and keys won't be accepted.

Acknowledge without Entering a Password



For general information about acknowledgments see [↪ "Acknowledgments"](#). Information about access areas / levels can be found at [↪ "Access Levels"](#).

As of HighPROTEC Release 3.6, the LEDs can be acknowledged by pressing the »C« key for approx. 1 second. See  "1.5 Manual Acknowledgment (by Pressing the C Key at the Panel)" for details.

Deactivating Passwords during Commissioning

It is possible optionally to deactivate passwords temporarily during commissioning. It is not allowed to use this feature for other purposes than commissioning. In order to deactivate the password protection replace the existing password with an empty one for the corresponding access areas. All access authorizations (access areas) that are protected by an empty password are unlocked permanently. That means, that all parameters and settings within those areas can be modified anytime.

CAUTION!



You have to ensure that all passwords are activated again after the commissioning. That means, that all access areas have to be protected by sufficiently secure passwords.

Woodward will not take over any liability for any personal injuries or damages that are caused by deactivated password protection.

General Considerations

You have to ensure that the access authorizations are protected by secure passwords. These passwords have to be kept as a secret and to be known only by the authorized persons. The default passwords do not provide any security against unauthorized access.

A lock symbol in the upper right corner of the display indicates if there are any access authorizations active at the moment. That means, within the mode "Read Only-Lv0" a closed (locked) lock symbol will be shown in the upper right corner of the display. As soon as there are any access authorizations active (above the "Read Only-Lv0" level), the upper right corner of the display will show an unlocked (open) lock symbol.

During setting parameters the »C« key can be used for canceling the parameter changes. Because of that it is not possible to acknowledge (LEDs, Output Relays...) as long as there are non-saved (cached only) parameters.

The acknowledgment menu cannot be accessed as long as the parameter modifications are not taken over by the device (indicated by a star symbol in the upper left corner).

Existing passwords are persistent (assigned to a device). If an offline created parameter file is transmitted into a device, or if a parameter file is transmitted from one device to another, this will have no impact on existing passwords within the device.

1.4.5 Access Levels

The access levels are designed in form of two hierarchic strands.

The supervisor (administrator) password provides access to all parameters and settings.

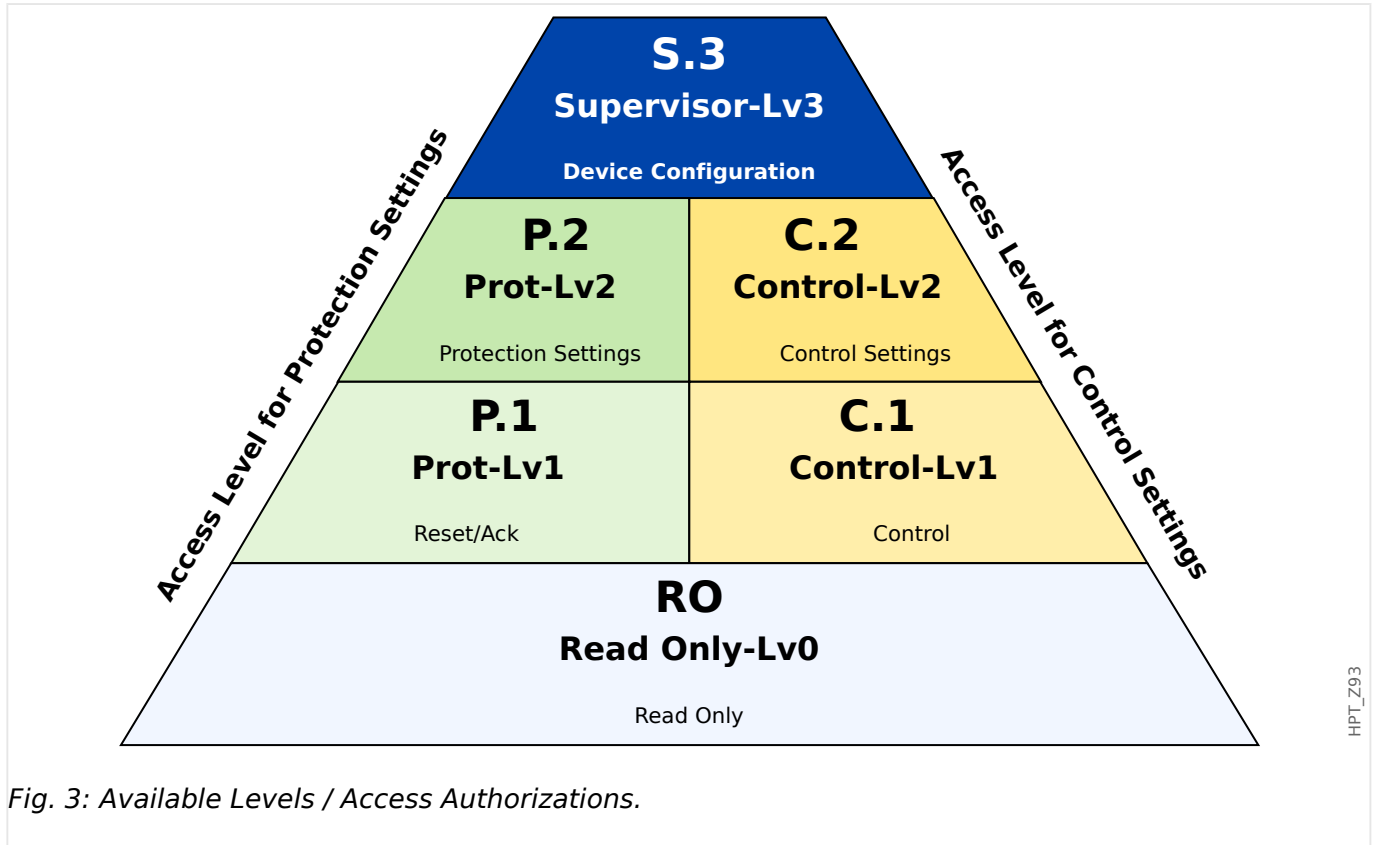





Fig. 3: Available Levels / Access Authorizations.

The following table shows the access areas. Note that each access area requires its own authorization password in order to access it. (However, for a MRMV4 that is reset to factory defaults all these passwords equal the same default password, see [↪ “1.4.6 Reset All Passwords”](#).)

Area Symbol	Access Area	Access to:
	Name of access level (panel / Smart view): Read Only-Lv0 Name of access level in Reference Manual: “RO”	Level 0 provides Read Only access to all settings and parameters of the device. The device will fall back into this level automatically after a configurable period or inactivity
	Password query on panel / Smart view: Prot-Lv1 Name of access level in Reference Manual:	This password provides access to the reset- and acknowledge options. In addition to that, it permits the execution of manual trigger signals.

Area Symbol	Access Area	Access to:
	"P.1"	
	Password query on panel / Smart view: Prot-Lv2 Name of access level in Reference Manual: "P.2"	This password provides access to the reset and acknowledge options. In addition to that it permits changing of protection settings and the configuration of the trip manager.
	Password query on panel / Smart view: Control-Lv1 Name of access level in Reference Manual: "C.1"	This password grants permission for switching operations (switching switchgears)
	Password query on panel / Smart view: Control-Lv2 Name of access level in Reference Manual: "C.2"	This password grants permission for switching operations (switching switchgears). In addition to that it gives access to the switchgear settings (switching authority, interlockings, general settings of switchgears, Breaker wear...).
	Password query on panel / Smart view: Supervisor-Lv3 Name of access level in Reference Manual: "S.3"	This password grants non-restricted access to all parameters and settings of the device (device configuration). This includes also the devices planning, device parameters (e.g. Date and Time), Field Parameters, Service Parameters and Logic Parameters.

NOTICE!



If the device was not active within the parameter setting mode for some time (can be set between 20 – 3600 seconds) it changes into »Read Only-Lv0« mode automatically. All unsaved parameter changes get canceled.

Check for unlocked access areas:

The menu [Device Para / Access Level] provides the information, which access areas (authorizations) are currently unlocked. Within this menu it is also possible to enter (unlock) a particular area.

However, the common way during every-day-use of the MRMV4 is not to use this [Access Level] menu, but to simply enter the menu path of a parameter to be changed, then start editing the parameter; at the end, immediately before the change is accepted, the user is asked for the appropriate password, which then unlocks the respective access area.

As soon as there is an unlocked access area (authorization) above »Read Only-Lv0«, this will be indicated by an unlocked lock symbol within the upper right corner of the device display.

If you want to explicitly set back (i. e. lock) the access area at the end (instead of waiting for the »t-max Edit/Access« timeout) you have to enter the »Read Only-Lv0« mode.

Unlock an access area at the panel:

Via the menu [Device Para / Access Level] it is possible to unlock or lock access areas (authorizations). After an access area has been unlocked all parameter changes or activities that are assigned to this (or a lower) level can be made without entering a password once again. However, the access permission is valid only for the panel; any access via *Smart view* has to be unlocked separately.

When no key is pressed for a time that can be specified via the [Device Para / HMI / Security] »t-max Edit/Access« setting, the access area is reset automatically to »Read Only-Lv0« and all unsaved parameter changes get canceled.

CAUTION!



Do not leave the MRMV4 unsupervised as long as there are still access areas (levels) unlocked (unlocked lock symbol on the display). If the access is no longer needed it is advisable to reset the permissions back to »Read Only-Lv0«.

Unlock an access area via Smart view:

After an access area (authorizations) has been unlocked by entering the password all parameter changes or activities that are assigned to this (or a lower) level can be made without entering a password once again. However, the access permission is valid only for this instance of *Smart view*; any access via panel or other *Smart view* instances has to be unlocked separately.

When no key is pressed for some (*Smart view*-internal) time the access area is automatically reset.

CAUTION!



Do not leave the MRMV4 unsupervised as long as *Smart view* still keeps some access area unlocked. Lock your PC during your absence, or at least reset the access permissions. This can be done by a double-click on the lock symbol in the status line on the bottom margin of the *Smart view* window (or, alternatively, via the menu [Device / Reset to Parameter "Read Only" Status] .

1.4.6 Reset to Factory Defaults, Reset All Passwords

There is a dedicated Reset dialog that allows for selecting any of the following options:

- **Reset to the factory defaults**, or
- **reset all passwords**.

This Reset dialog is available at the HMI only (i. e. **not** via *Smart view*).

Press the »C« key during a cold start until the Reset dialog appears.

NOTICE!



For technical reasons, this Reset dialog is available **only in English** language (independent of the regional language being used later, after the device has started).

Note furthermore that the dialog might not appear at all because it has been intentionally disabled (see below), or the option to reset all passwords has been disabled.

Reset to Factory Defaults

WARNING!



All parameter settings will be reset. All records will be deleted and statistic values and counters will be reset.

Exception: The operation hours counter is preserved.

1. From the Reset dialog, select »Reset to factory default«.
 - ⇒ There is a confirmation dialog, asking »Reset device to factory defaults and reboot?«
2. Confirm with »Yes«.
 - ⇒ The reset to factory defaults is executed, and the device restarts.

Reset All Passwords

It is possible to remove this option from the Reset dialog for security reasons (see below).

1. From the Reset dialog, select »Reset all passwords«.
 - ⇒ There is a confirmation dialog, asking »Reset all passwords?«
2. Confirm with »Yes«.
 - ⇒ The device starts using the standard passwords (see [↪](#) "1.4.2 Default Passwords").

WARNING!



The standard passwords (see [↪](#) “1.4.2 Default Passwords”) do not provide any security. For security reasons, it is strictly recommended to adapt the default passwords to some individual passwords that meet the local security directives.

Security Settings

For security reasons, the Reset dialog can be restricted or removed completely. The setting parameter [Device Para / Security / Miscellaneous] »*Config. Device Reset*« allows for specifying which resetting options shall be available:

- "*Fact.def.*", "*PW rst*": Both options -»Reset to factory default« and »Reset all passwords« - shall be available.
- *Only "Fact.defaults"*: Only the »Reset to factory default« option shall be available.
- *Reset deact.*: The Reset dialog shall be disabled.

CAUTION!



If the password should be lost and the »Reset all passwords« option has been made unavailable then the only chance to recover control is to reset the MRMV4 to factory default. If this option has been deactivated, too, then the MRMV4 has to be sent to Woodward as a service request.

1.5 Acknowledgments

The term “acknowledgment” means to reset the latching of a state.

Latching can be configured for the the following types of objects or states:

- LEDs
- Binary output relays
- SCADA signals
- A pending trip command

It is possible to acknowledge an individual object or signal (via a predefined external signal). But it is also possible to acknowledge latched states collectively, e. g. all LEDs at once.

The following acknowledgment types are available:

- **Individual acknowledgment** means to assign an external signal to a parameter that is specific to one individual latching state (e. g. LED number 3 that is located left to the display).

If the assigned signal becomes active, the latching gets acknowledged. (See below, [↪ “1.5 Individual Acknowledgment of a Latched State”](#)).

- **External acknowledgment** means to assign an external signal to a parameter that is related to several states (e. g. all LEDs).

If the assigned signal becomes active, the related set of states gets acknowledged. (See below, [↪ “1.5 External Acknowledgment”](#)).

- **Automatic acknowledgment** means that all latched LEDs get acknowledged automatically with a new alarm from any protection function or with a *General Alarm*, »Prot . Alarm«. (This feature is restricted to the LEDs; there is no automatic acknowledgment for binary outputs, SCADA signals or trip commands.)

(See below, [↪ “1.5 Automatic Acknowledgment”](#)).

- **Collective acknowledgment** means to manually acknowledge the latching of several states all at once.

There are several different Direct Commands available, each of which is related to a specific set of states to be acknowledged (see below, [↪ “1.5 Collective Acknowledgment \(via Smart view or at the Panel\)”](#)).

- **Manual acknowledgment** is a special way to execute a collective acknowledgment by simply pressing the »C« key at the panel.

The latching of several states are all acknowledged at once this way. (See below, [↪ “1.5 Manual Acknowledgment \(by Pressing the C Key at the Panel\)”](#)).

NOTICE!



Note that any latched state can be acknowledged only if the signal that initiated the setting is no longer active. This is a general rule that applies to all acknowledgment types.

Another general rule is that with the setting [Device Para / Acknowledge] »Remote Reset« = "inactive", only manual acknowledgments (↳ "1.5 Manual Acknowledgment (by Pressing the C Key at the Panel)") directly at the panel are functional. All other acknowledgement types, including collective acknowledgments using Smart view (↳ "1.5 Collective Acknowledgment (via Smart view or at the Panel)"), are silently ignored.

And in any case, the latching of binary outputs is always reset only after the timer »t-Off Delay« has elapsed.

Individual Acknowledgment of a Latched State

[Device Para / LEDs / LEDs group A / LED 1...7] »Ack signal«
 [Device Para / LEDs / LEDs group B / LED 1...7] »Ack signal«

✓ Assigned signal acknowledges an individual LED.			
---	--	--	--

[Device Para / Binary Outputs / BO Slot X x / BO y] »Acknowledgement«

	✓ Assigned signal acknowledges the binary output "y" at slot "x".		
--	---	--	--

[Control / SG / SG [x] / Trip Manager] »Ack TripCmd«

			✓ Assigned signal acknowledges the trip command of switchgear "SG [x]".
--	--	--	---

Remark: The menu branch does not show the abstract module name »SG [x]«. What you see instead is the switchgear designation that has been assigned via the Control Page (Single-Line diagram), i. e. something like »QA1«. (See ↳ "5 Single-Line Diagram".)

External Acknowledgment

The external acknowledgment is disabled if the parameter [Device Para / Acknowledge] »Remote Reset« is set to "inactive". This also blocks the acknowledgment via SCADA communication (e. g. Modbus).

[Device Para / Acknowledge] »Ack LED«

✓ Assigned signal acknowledges all LEDs.			
--	--	--	--

[Device Para / Acknowledge] »**Ack BO**«

✓ Assigned signal acknowledges all binary output relays.			
--	--	--	--

[Device Para / Acknowledge] »**Ack Scada**«

	✓ Assigned signal acknowledges latched SCADA signals.		
--	---	--	--

Automatic Acknowledgment

With an automatic acknowledgment all those LEDs for which this is activated get acknowledged with a protection alarm or with a *General Alarm*, »Prot . Alarm«.

This means that the automatic acknowledgment must be set individually for every LED that shall be acknowledged automatically this way.

[Device Para / LEDs / LEDs group A / LED 1...7] »**Latched**« = "**active, ack. by alarm**"[Device Para / LEDs / LEDs group B / LED 1...7] »**Latched**« = "**active, ack. by alarm**"

✓ A protection alarm acknowledges every LED with this setting value.			
--	--	--	--

Collective Acknowledgment (via Smart view or at the Panel)

Remark: As already stated above, the acknowledgment via *Smart view* requires the setting [Device Para / Acknowledge] »*Remote Reset*« = "active".

The following Direct Commands are available for acknowledgment:

[Operation / Acknowledge] »**SSV . Ack System LED** «

✓ Acknowledge a warning state signaled by the System-LED.			
---	--	--	--

Remark: The *Troubleshooting Guide* lists all System-LED signals that can potentially occur.

[Operation / Acknowledge] »**Sys . Ack LED**«

✓ All LEDs			
------------	--	--	--

[Operation / Acknowledge] »**Sys . Ack BO**«

✓ All binary output relays			
----------------------------	--	--	--

[Operation / Acknowledge] »Sys . Ack Scada«			
		✓ All SCADA signals	

[Operation / Acknowledge] »SG [x] . Ack TripCmd«			
			✓ Acknowledge the trip command of switchgear "SG [x]".

Remark: The menu branch does not show the abstract module name »SG [x]«. What you see instead is the switchgear designation that has been assigned via the Control Page (Single-Line diagram), i. e. something like »QA1«. (See [↪ "5 Single-Line Diagram"](#).)

[Operation / Acknowledge] »Sys . Ack BO LED Scd TCmd«			
✓ Acknowledge all LEDs,	✓ and all binary output relays,	✓ and all SCADA signals,	✓ and all Trip Commands.

At the panel, the menu [Operation / Acknowledge] can directly be accessed via the »C« key, see below ([↪ "1.5 Manual Acknowledgment \(by Pressing the C Key at the Panel\)"](#)).

Manual Acknowledgment (by Pressing the »C« Key at the Panel)

NOTICE!	
	<p>As long as you are within the parameter setting mode, you cannot acknowledge manually via »C« key (because within the parameter setting mode, this key has a different functionality).</p> <p>But it is still possible to access the menu [Operation / Acknowledge].</p>

It is possible to acknowledge the System-LED, the assignable LEDs, SCADA, binary output relays and / or a pending trip command by pressing the »C« key at the panel.

There are two acknowledgment methods available with pressing the »C« key:

- **Short keypress:** *With intermediate selection step:* By pressing the »C« key (for a short time) you enter the menu [Operation / Acknowledge]. There you select the items to be acknowledged via the Softkeys (LEDs, SCADA, binary output relays, trip command, or all of these, see [↪ "1.5 Collective Acknowledgment \(via Smart view or at the Panel\)"](#)). After this, you press the Softkey with the »Wrench-Symbol«.
- **Long keypress:** *Immediate acknowledge:* Items are acknowledged by simply pressing the »C« key (for ca. 1 second).

Moreover, you can configure which items shall be acknowledged by this "long keypress" feature (see below).

The setting parameter [Device Para / Acknowledge] »Ack via »C« key« decides about which categories shall be acknowledged with a "long keypress" of the »C« key:

- "Nothing" - Only the "short keypress" is functioning, i. e. you always explicitly select the items to be acknowledged.

- “Ack LEDs w/o passw.” - The “long keypress” acknowledges all LEDs, *without* any password entry. (This option is the factory default.)
- “Ack LEDs” - The “long keypress” acknowledges all LEDs (only the password will be asked for, see below).
- “Ack LEDs and relays” - The “long keypress” acknowledges all LEDs and all binary output relays (only the password will be asked for, see below).
- “Ack Everything” - The “long keypress” acknowledges all latched items (only the password will be asked for, see below):
 - All LEDs, and
 - all Relay Outputs, and
 - all latched SCADA signals, and
 - the trip command.



Whenever the LEDs are acknowledged an LED test is also executed: All LEDs flash in red color for a second, then flash in green color for a second.

NOTICE!



For all (manual and collective) acknowledgment types (except “Nothing” and “Ack LEDs w/o passw.”), note that you might be asked to enter the appropriate access-level password.

If there is the need to be able to acknowledge binary output relays, SCADA signals and trip command without entering any password then this is possible by an empty password for the level »Prot-Lv1«. Of course, this can be a potential security risk, so treat this option with care! For general information about passwords and security-related considerations, see  “Security”.

1.6 Measuring Values

Read out Measured Values

In menu [Operation / Measured Values] both measured and calculated values can be viewed. The measured values are ordered by »standard values« and »special values« (depending on the type of device).

Display Options

Menu [Device Para / Measurem Display] offers options to change the display of measured values.

Scaling of Measured Values

By means of the parameter [Device Para / Measurem Display / General Settings] »Scaling« the user can determine how measured values are to be displayed within the HMI and *Smart view*:

- Per unit values
- Primary values
- Secondary values

Power Units (applies only for devices with power measurement)

By means of the parameter [Device Para / Measurem Display / General Settings] »Power Units« the user can determine how measured values are to be displayed within the HMI and *Smart view*:

- Power Auto Scaling - Selects unit prefix (k, M, G) and decimal places for power values to best fit, depending on VT and CT primary settings.
- kW/kVAr/kVA - Set unit prefix to k (kW, kVAr or kVA)
- MW/MVAr/MVA - Set unit prefix to M (MW, MVAr or MVA)
- GW/GVAr/GVA - Set unit prefix to G (GW, GVAr or GVA)

Energy Units (applies only for devices with energy measurement)

By means of the parameter [Device Para / Measurem Display / General Settings] »Energy Units« the user can determine how measured values are to be displayed within the HMI and *Smart view*:

- Energy Auto Scaling - Selects unit prefix (k, M, G) and decimal places for power values to best fit, depending on VT and CT primary settings.
- kWh/kVArh/kVAh - Set unit prefix to k (kWh, kVArh or kVAh)
- MWh/MVArh/MVAh - Set unit prefix to M (MWh, MVArh or MVAh)
- GWh/GVArh/GVAh - Set unit prefix to G (GWh, GVArh or GVAh)

In case of an overflow of the counter, the counter will start counting again at zero. A corresponding signal will indicate the counter overflow.

	Counter overflow at:
• Energy Auto Scaling	Depends on the settings for the current and voltage transformers
• kWh/kVAh/kVAh	999 999.99
• MWh/MVAh/MVAh	999 999.99
• GWh/GVAh/GVAh	999 999.99

Temperature Unit (applies only for devices with temperature measurement)

By means of the parameter [Device Para / Measurem Display / General Settings] »*Temperature Unit*« the user can determine how temperatures (of measured values and settings) are displayed within the HMI and Smart view:

- ° Celsius
- ° Fahrenheit

Cutoff Level

In order to suppress noise within measured values that are close to zero the user has the option to set cutoff levels. By means of the cutoff levels, measuring quantities that are close to zero will be displayed as zero. These parameters have no impact on recorded values.

Phase Angles

The phase angles of current and voltage phasors are determined from the fundamental component and always refer to a particular reference phasor.

The reference phasor is usually the first voltage channel, i. e. VL1 or VL12 (depending on which one is measured directly – see also the setting parameter [Field Para / VT] »*VT con*«.)

If, however, it happens that the amplitude of the reference phasor becomes too small, the next possible measurement channel is used as the reference phasor, i. e. VL2 or VL23), and so on.

If all three phase voltages are too small, or if the protective device does not feature voltage measurement, then the first current measuring input IL1 (of the first current measuring card, i. e. slot X3) is used as the reference phasor. If this, too, is not healthy the MRMV4 proceeds with IL2, then IL3, then with the first current measuring input of the second current measuring card, if existing, and so forth.

By definition the reference phasor has a phase angle of 0°.

1.7 Statistics

In the menu [Operation / Statistics], the min., max. and average values of the measured and calculated measured quantities can be found.

1.7.1 Configuration of the Minimum and Maximum Values

The calculation of the minimum and maximum values is (re-)started with any of the following events:

- When a Reset signal becomes active (Min/Max),
- when the device is restarted
- after a configuration change.

Reset Minimum and Maximum Values (Peak Values/Pointers)

Menu [Device Para / Statistics / Min / Max]

»ResFc Min« – reset all minimum values

»ResFc Max« – reset all maximum values

A reset signal (e. g. a Digital Input) can be assigned to each of these two parameters.

The minimum and maximum values are reset with the rising edge of the corresponding reset signal.

View Minimum Values

Within menu [Operation / Statistics / Min]

View Maximum Values

Within menu [Operation / Statistics / Max]

1.7.2 Configuration of the Average Value Calculation

1.7.2.1 Configuration of the Current-Based Average Value Calculation*

*=Availability depends on the ordered device code.

Configure the Time Period for the Calculation of the Average and Peak Values

[Device Para / Statistics / Demand / Current Demand] »Window I Demand« =

- “sliding”: average calculation based on sliding period.
- “fixed”: average calculation is reset by the end of the period, that means with the next starting period.

Start Options for Current-Based Average Values and Peak Values

[Device Para / Statistics / Demand / Current Demand] »Start I Demand via:« =

- “Duration”: fixed or sliding period. The period duration is settable via »Duration I Demand«.
- “StartFct”: The average values are calculated based on the time period between two rising edges of a signal that has been assigned to parameter »Start I Demand Fc«.

Reset the Current-Based Average Values and Peak Values

Immediate reset via Direct Control:

[Operation / Reset/Acknowledge / Reset] »ResFc I Demand« - reset all values

It is also possible to assign a reset signal (e. g. a Digital Input) to the parameter [Device Para / Statistics / Demand / Current Demand] »ResFc I Demand«

In this case the values are reset with the rising edge of the reset signal.

View the Current-Based Average Values and Peak Values

Within the menu [Operation / Statistics / Demand]

Trip (Command) Option to Limit the Average Current Demand

Please refer to  “System Alarms”.

1.7.2.2 Configuration of the Voltage-Based Average Value Calculation*

*=Availability depends on the ordered device code.

Configure the Time Period for the Calculation of the Average Values

[Device Para / Statistics / Vavg] »Window Vavg« =

- “sliding”: average calculation based on sliding period.
- “fixed”: average calculation is reset by the end of the period, that means with the next starting period.

Start Options for Voltage-Based Average Values

[Device Para / Statistics / Vavg] »Start Vavg via:« =

- “Duration”: fixed or sliding period. The period duration is settable via »Duration Vavg«.
- “StartFct”: The average values are calculated based on the time period between two rising edges of a signal that has been assigned to parameter »Start Vavg Fc«.

Reset the Voltage-Based Average Values

Immediate reset via Direct Control:

[Operation / Reset] »ResFc Vavg« - reset all values

It is also possible to assign a reset signal (e. g. a Digital Input) to the parameter [Device Para / Statistics / Vavg] »ResFc Vavg«

In this case the values are reset with the rising edge of the reset signal.

View the Voltage-Based Average Values

Within the menu [Operation / Statistics]

1.7.2.3 Configuration of the Power-Based Average Value Calculation*

*=Availability depends on the ordered device code.

Configure the Time Period for the Calculation of the Average and Peak Values

[Device Para / Statistics / Demand / Power Demand] »Window P Demand« =

- “sliding”: average calculation based on sliding period.
- “fixed”: average calculation is reset by the end of the period, that means with the next starting period.

Start Options for Power-Based Average Values and Peak Values

[Device Para / Statistics / Demand / Power Demand] »Start P Demand via:« =

- “Duration”: fixed or sliding period. The period duration is settable via »Duration P Demand«.
- “StartFct”: The average values are calculated based on the time period between two rising edges of a signal that has been assigned to parameter »Start P Demand Fc«.

Reset the Power-Based Average Values and Peak Values

Immediate reset via Direct Control:

[Operation / Reset/Acknowledge / Reset] »ResFc P Demand« - reset all values

It is also possible to assign a reset signal (e. g. a Digital Input) to the parameter [Device Para / Statistics / Demand / Power Demand] »ResFc P Demand«

In this case the values are reset with the rising edge of the reset signal.

View the Power-Based Average Values and Peak Values

Within the menu [Operation / Statistics / Demand]

Trip (Command) Option to Limit the Average Current Demand

Please refer to  “System Alarms”.

1.8 Smart view

Smart view is a parameter setting and evaluation software. It has a Technical Manual of its own.

- Menu-controlled parameter setting incl. validity checks
- Offline configuration of all relay types
- Reading and evaluating of statistical data and measuring values
- Setting into operation assistance
- Display of the device status
- Fault analysis via event- and fault and waveform recorder

For a complete MRMV4 configuration it is recommended to use the *Smart view* setting and evaluation software, because it is too cumbersome to make a large amount of settings using the panel of the device.

For *Smart view*, a PC with Windows (7, 8.x or 10) operating system is required.

Moreover, a connecting cable is required for a direct connection of the MRMV4 with the PC. This cable requires an USB connector of type "Mini B" on the MRMV4 end (see also [↳ "PC Interface - X120"](#)). Alternatively, it is possible to establish a connection via Ethernet (TCP/IP), if the network permissions allow this and if the MRMV4 has been ordered with an Ethernet interface ([↳ "Communication Protocol Codes"](#), [↳ "Order Form of the Device"](#)) and if the necessary TCP/IP-settings (IP address, subnet mask, gateway) have already been made via the panel.

Secured Communication

For security reasons, it is possible to restrict or disable the connection between *Smart view* and the MRMV4. Moreover, a connection is established only after a connection password has been entered. See the Security chapter, [↳ "Connection Passwords, Smart view Access"](#), for details.

1.9 DataVisualizer

DataVisualizer is a waveform and event viewing software. It is installed automatically with *Smart view*. It can also be used as a standard COMTRADE file viewer.

- Open and review downloaded waveforms
- Customize waveform channel layout and views including channel overlapping and zooming
- Analyze sample by sample data points and line up the displayed analog waveform channels along with the recorded internal relay logic.
- Save window setups (snapshots) and print for reporting
- Open industry standard COMTRADE files from other intelligent electronic devices
- Convert downloaded waveform files to COMTRADE file format using "Export" feature

2 Hardware

2.1 Dimension Drawings

Three-Side-View - 19" Variant

NOTICE!



Depending on the connection method of the SCADA system used the needed space (depth) differs. If, for instance, a D-Sub-Plug is used, it has to be added to the depth dimension.

NOTICE!



The three-side-view shown in this section is valid only for 19" devices.

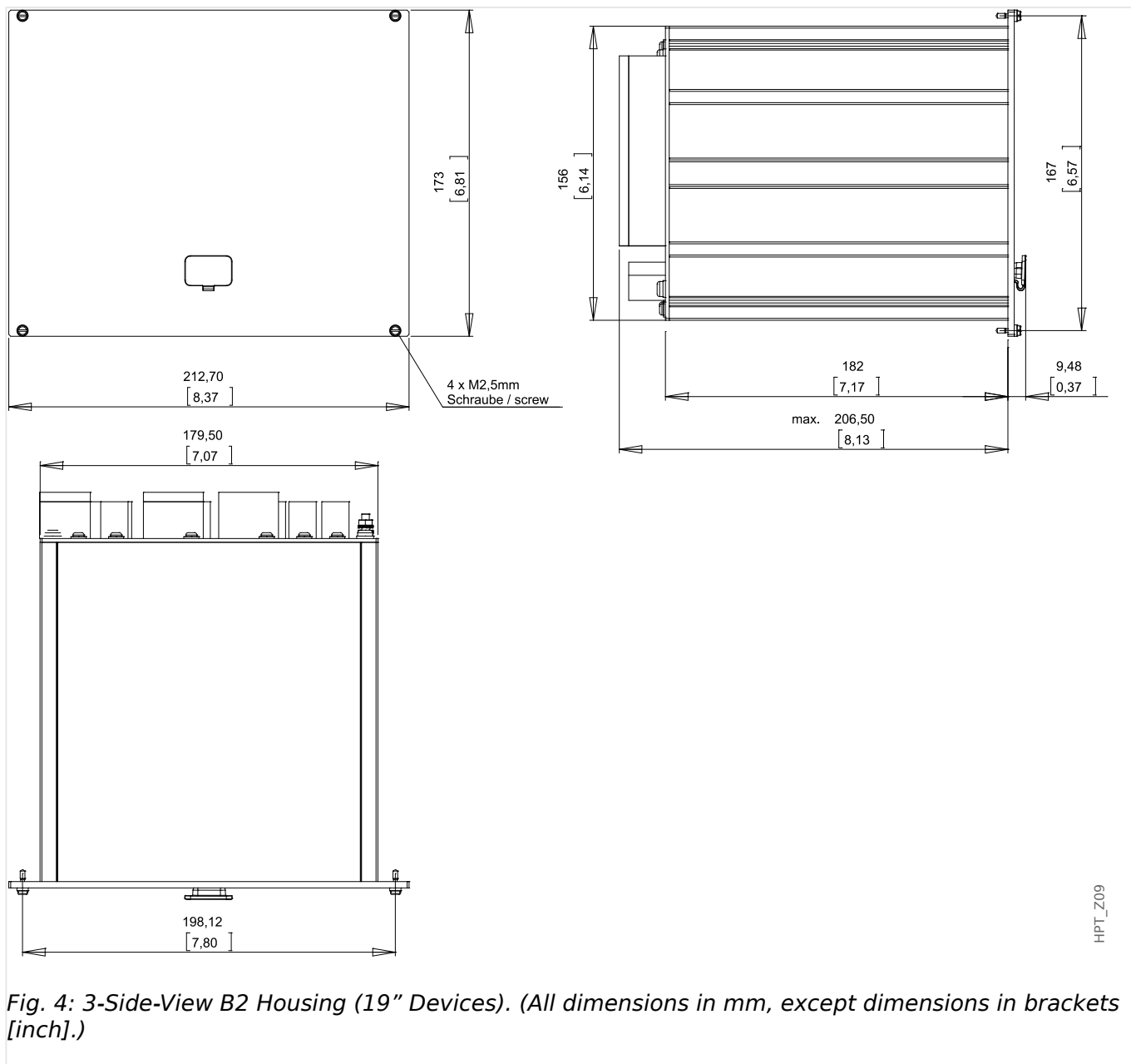

Fig. 4: 3-Side-View B2 Housing (19" Devices). (All dimensions in mm, except dimensions in brackets [inch].)

Three-Side-View - Variant for Door Mounting

NOTICE!



Dependent on the connection method of the SCADA system used the needed space (depth) differs. If, for instance, a D-Sub-Plug is used, it has to be added to the depth dimension.

NOTICE!



The installation diagram shown in this section is valid only for devices with 8 pushbuttons at the front side of the HMI. (INFO-, C-, OK-, CTRL-Pushbutton and 4 Softkeys (Pushbuttons)).

2 Hardware

2.1 Dimension Drawings

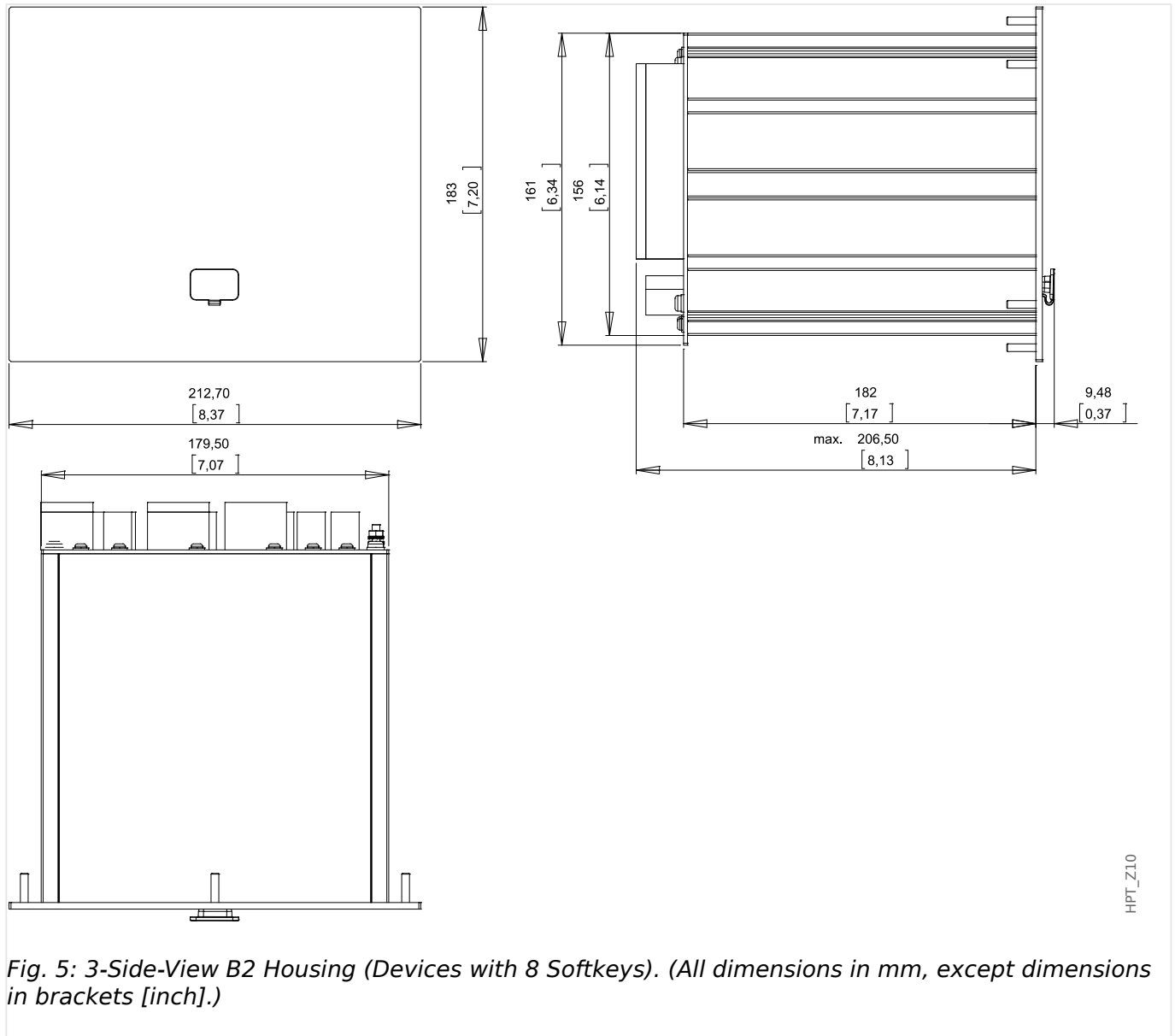

Fig. 5: 3-Side-View B2 Housing (Devices with 8 Softkeys). (All dimensions in mm, except dimensions in brackets [inch].)

Installation Diagram - Cutout for Door Mounting

WARNING!



Even when the auxiliary voltage is switched-off, unsafe voltages might remain at the device connections.

NOTICE!



The installation diagram shown in this section is exclusively valid for devices with 8 pushbuttons at the front side of the HMI. (INFO-, C-, OK-, CTRL-Pushbutton and 4 Softkeys (Pushbuttons)).

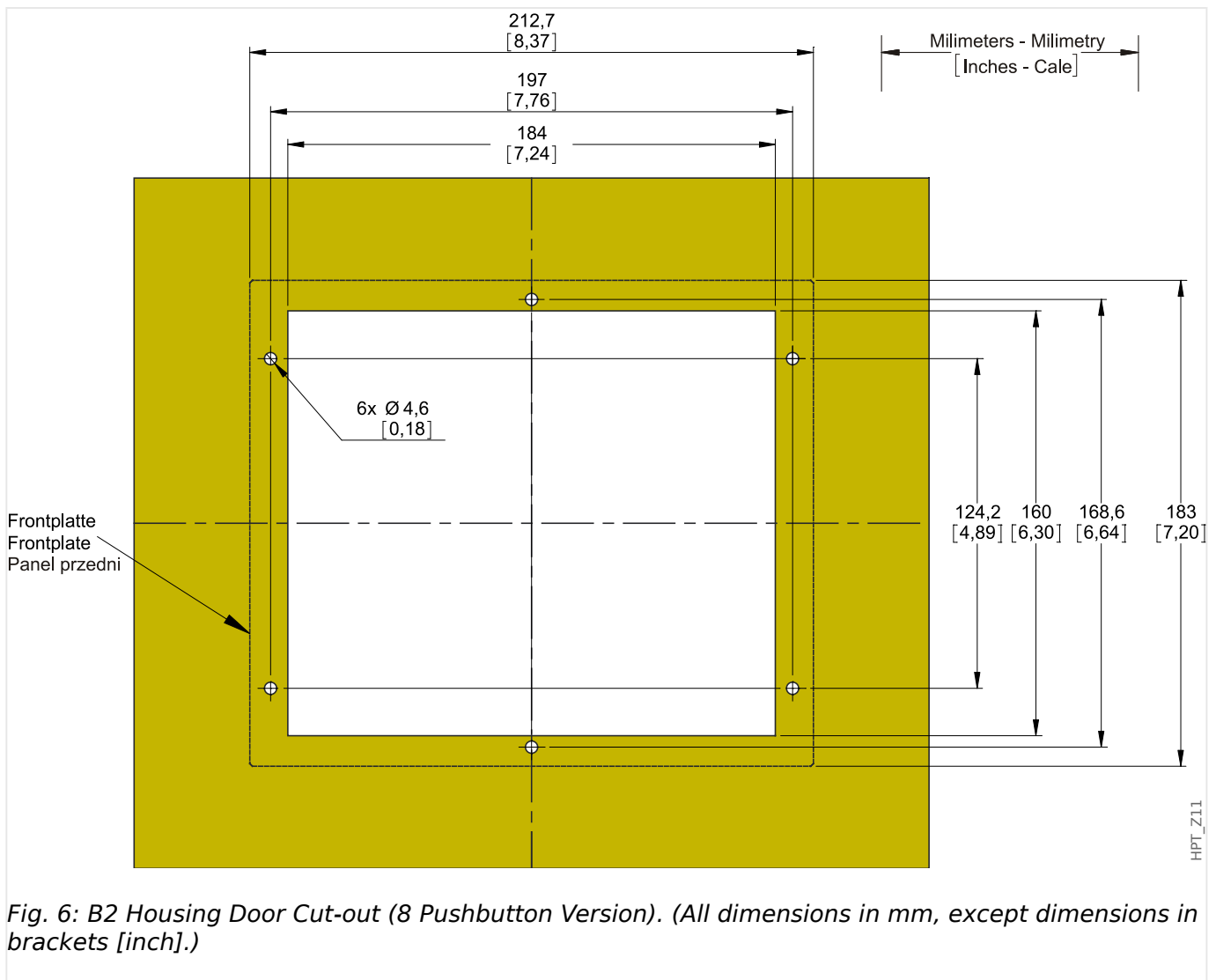

CAUTION!



Be careful. Do not overtighten the mountings nuts of the relay (M4 metric 4 mm). Check the torque by means of a torque wrench (1.7 Nm [15 in·lb]). Over-tightening the mounting nuts could cause personal injury or damage the relay.

2.2 MRMV4 - Installation and Wiring

2.2.1 Grounding

WARNING!



The housing must be carefully grounded. Connect a ground cable (protective earth, 4 to 6 mm² [AWG 11–9], tightening torque 1.7 Nm [15 lb·in]) to the housing, using the screw that is marked with the ground symbol (at the rear side of the device).

Moreover, the power supply card needs a separate ground connection (functional earth, min. 2.5 mm² [\leq AWG 13], tightening torque 0,56 – 0,79 Nm [5–7 lb·in]). See the “Terminal Marking” diagram in Section “DI-4 X - Power Supply and Digital Inputs” to check for the correct terminal.

All grounding connections (i. e. protective and functional earth) must be low-inductance, i. e. as short as possible, and national standards - if applicable - must be followed.

CAUTION!



The devices are very sensitive to electro-static discharges.

2.2.2 Overview of Slots - Assembly Groups

WARNING!



In line with the customer's requirement the devices are combined in a modular way (in compliance with the order code). In each of the slots an assembly-group may be integrated. In the following the terminal assignment of the individual assembly-groups are shown. The exact installation place of the individual modules can be learned from the connection diagram fixed at the top of your device.

Front Side

The front side of the MRMV4 equipped with a USB interface, that can be used to establish a connection with the setting software Smart view.

- slot X120

Rear Side

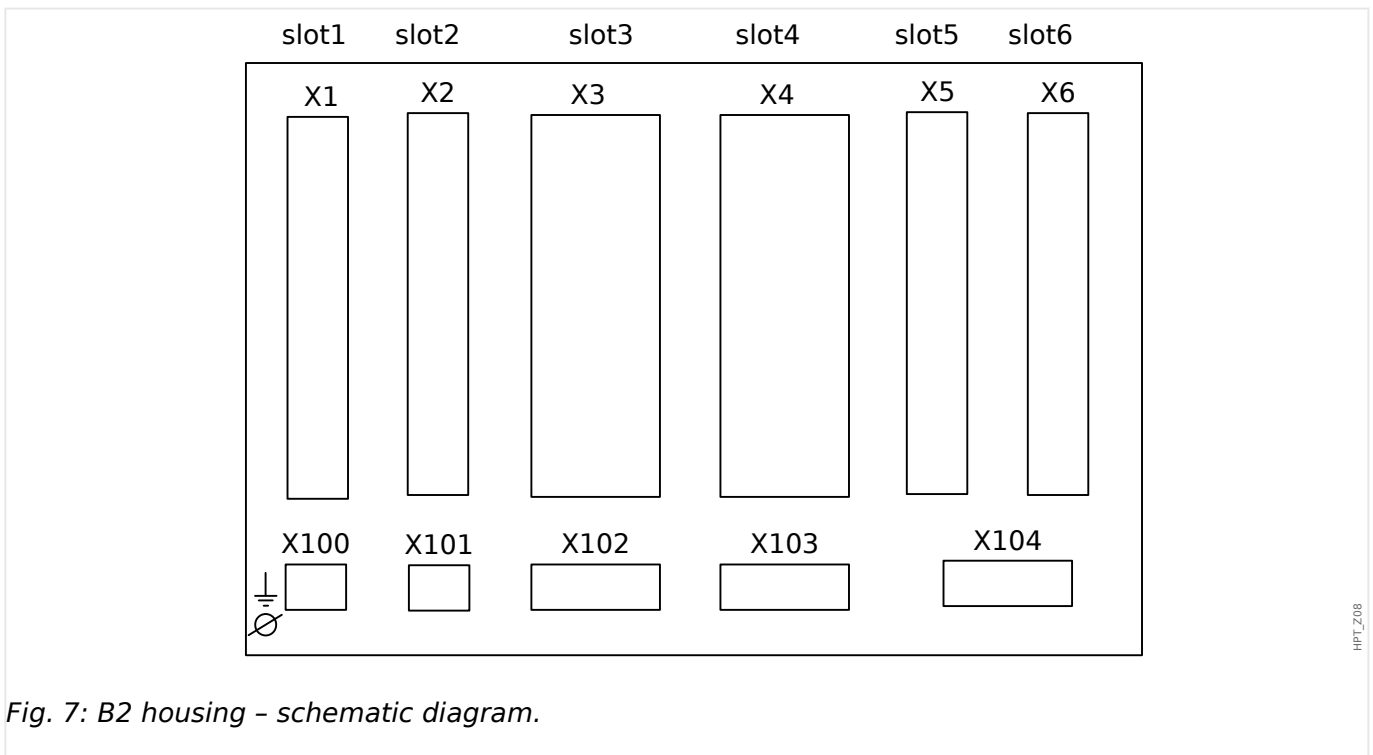
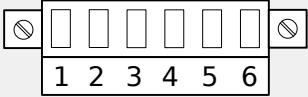
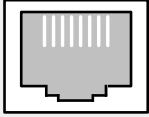
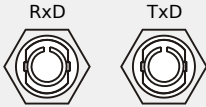
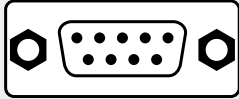
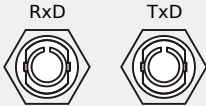
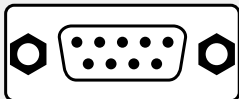

Fig. 7: B2 housing – schematic diagram.

slot X1	slot X2	slot X3	slot X4	slot X5	slot X6
slot X100		slot X103	slot X103	slot X104	

2.2.3 Communication Protocol Codes

The following table lists the “Communication Options” letters from the Order Code (see [↪ “Order Form of the Device”](#)), together with the respective communication interfaces and protocols that are available with this order option.

#	Interface	Available Communication Protocols
A	—	Without protocol
B	<p>RS485 / terminals</p> <p>↪ “Modbus® RTU / IEC 60870-5-103 via RS485”</p> 	<p>Modbus RTU, IEC 60870-5-103, DNP3.0 RTU</p> <p>↪ “Modbus®”</p> <p>↪ “IEC60870-5-103”</p> <p>↪ “DNP3”</p>
C	<p>Ethernet 100 MB / RJ45</p> <p>↪ “Ethernet - RJ45”</p> 	<p>Modbus TCP, DNP3.0 TCP/UDP, IEC 60870-5-104</p> <p>↪ “Modbus®”</p> <p>↪ “DNP3”</p> <p>↪ “IEC 60870-5-104”</p>
D	<p>optic fiber / ST connector</p> <p>↪ “Profibus DP/ Modbus® RTU / IEC 60870-5-103 via Fiber Optic”</p> 	<p>Profibus-DP</p> <p>↪ “Profibus”</p>
E	<p>RS485 / D-SUB</p> <p>↪ “Profibus DP via D-SUB”</p> 	<p>Profibus-DP</p> <p>↪ “Profibus”</p>
F	<p>optic fiber / ST connector</p> <p>↪ “Profibus DP/ Modbus® RTU / IEC 60870-5-103 via Fiber Optic”</p> 	<p>Modbus RTU, IEC 60870-5-103, DNP3.0 RTU</p> <p>↪ “Modbus®”</p> <p>↪ “IEC60870-5-103”</p> <p>↪ “DNP3”</p>
G	<p>RS485 / D-SUB</p> <p>↪ “Modbus® RTU / IEC 60870-5-103 via D-SUB”</p> 	<p>Modbus RTU, IEC 60870-5-103, DNP3.0 RTU</p> <p>↪ “Modbus®”</p> <p>↪ “IEC60870-5-103”</p> <p>↪ “DNP3”</p>

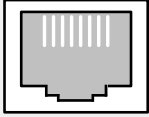
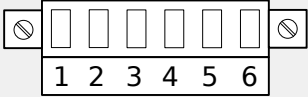
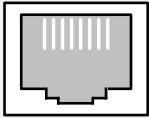
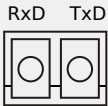
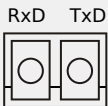
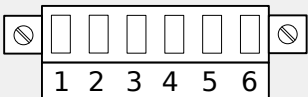
#	Interface	Available Communication Protocols
H	<p><i>Ethernet 100MB / RJ45</i></p> <p>↳ “Ethernet - RJ45”</p> 	<p>IEC 61850, Modbus TCP, DNP3.0 TCP/UDP, IEC 60870-5-104</p> <p>↳ “IEC 61850”</p> <p>↳ “Modbus®”</p> <p>↳ “DNP3”</p> <p>↳ “IEC 60870-5-104”</p>
I	<p><i>RS485 / terminals</i></p> <p>↳ “Modbus® RTU / IEC 60870-5-103 via RS485”</p>  <p><i>Ethernet 100 MB / RJ45</i></p> <p>↳ “Ethernet - RJ45”</p> 	<p>IEC 60870-5-103, Modbus RTU, DNP3.0 RTU Modbus TCP, DNP3.0 TCP/UDP, IEC 60870-5-104</p> <p>↳ “IEC60870-5-103”</p> <p>↳ “Modbus®”</p> <p>↳ “DNP3”</p> <p>↳ “IEC 60870-5-104”</p>
K	<p><i>Optical Ethernet 100MB / LC duplex connector</i></p> <p>↳ “Ethernet / TCP/IP via Fiber Optics”</p> 	<p>IEC 61850, Modbus TCP, DNP3.0 TCP/UDP, IEC 60870-5-104</p> <p>↳ “IEC 61850”</p> <p>↳ “Modbus®”</p> <p>↳ “DNP3”</p> <p>↳ “IEC 60870-5-104”</p>
L	<p><i>Optical Ethernet 100MB / LC duplex connector</i></p> <p>↳ “Ethernet / TCP/IP via Fiber Optics”</p> 	<p>Modbus TCP, DNP3.0 TCP/UDP, IEC 60870-5-104</p> <p>↳ “Modbus®”</p> <p>↳ “DNP3”</p> <p>↳ “IEC 60870-5-104”</p>
T	<p><i>RS485 / terminals</i></p> <p>↳ “Modbus® RTU / IEC 60870-5-103 via RS485”</p> 	<p>IEC 60870-5-103, Modbus RTU, DNP3.0 RTU IEC 61850, Modbus TCP, DNP3.0 TCP/UDP, IEC 60870-5-104</p> <p>↳ “IEC60870-5-103”</p> <p>↳ “Modbus®”</p> <p>↳ “DNP3”</p>

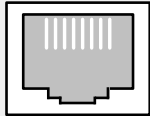
#	Interface	Available Communication Protocols
	<p data-bbox="197 241 512 277"><i>Ethernet 100 MB / RJ45</i></p> <p data-bbox="197 304 496 340">↳ "Ethernet - RJ45"</p> 	<p data-bbox="815 241 1126 277">↳ "IEC 60870-5-104"</p> <p data-bbox="815 304 1038 340">↳ "IEC 61850"</p>

2.2.4 Legend for Wiring Diagrams

In this legend designations of various device types are listed, e. g. transformer protection, motor protection, generator protection, etc. Therefore it can occur that not every designation actually appears on the wiring diagram of your device.

- FE — Connection of functional earth (see  “Grounding”)
- Power Supply — Connection for auxiliary power supply
- IL1 — Phase current input L1 (in some countries designated as “IA”)
- IL2 — Phase current input L2 (in some countries designated as “IB”)
- IL3 — Phase current input L3 (in some countries designated as “IC”)
- IG — Earth current input
- IL1 W1 ... IL3 W1 — Phase current input L1...L3, winding side 1
- IL1 W2 ... IL3 W2 — Phase current input L1...L3, winding side 2
- IG W1, IG W2 — Earth current input, winding side 1/2
- VL1 — Phase-to-neutral voltage L1 (in some countries designated as “VA”)
- VL2 — Phase-to-neutral voltage L2 (in some countries designated as “VB”)
- VL3 — Phase-to-neutral voltage L3 (in some countries designated as “VC”)
- VL12 — Phase-to-phase voltage V12 (in some countries designated as “VAB”)
- VL23 — Phase-to-phase voltage V23 (in some countries designated as “VBC”)
- VL31 — Phase-to-phase voltage V31 (in some countries designated as “VCA”)
- VX — Fourth voltage measuring input for measuring residual voltage or for Synchro-check
- BO — Binary output relay
- NO / NC — Contact output, normally open / closed
- DI — Digital input
- COM — Common connection of digital inputs
- Out+, AnOut — Analog output + (0/4...20 mA or 0...10 V)
- In-, AnIn — Analog input (0/4...20 mA or 0...10 V)
- n.c. — Not connected
- DO NOT USE — Do not use
- SC — Self-supervision contact
- GND — Ground
- HF Shield — Connection cable shield

- Fiber Optics — Fiber optic connection

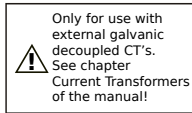

- — Only for use with external galvanic decoupled CTs. See chapter [Current Transformers of the manual](#). See [↳ “TI - Standard Phase and Ground Current Measuring Input Card”](#).



- — Caution Sensitive Current Inputs. See [↳ “TIs - Phase and Sensitive Ground Current Measuring Card”](#).

2.3 Slot X1

- Power Supply Card with Digital Inputs

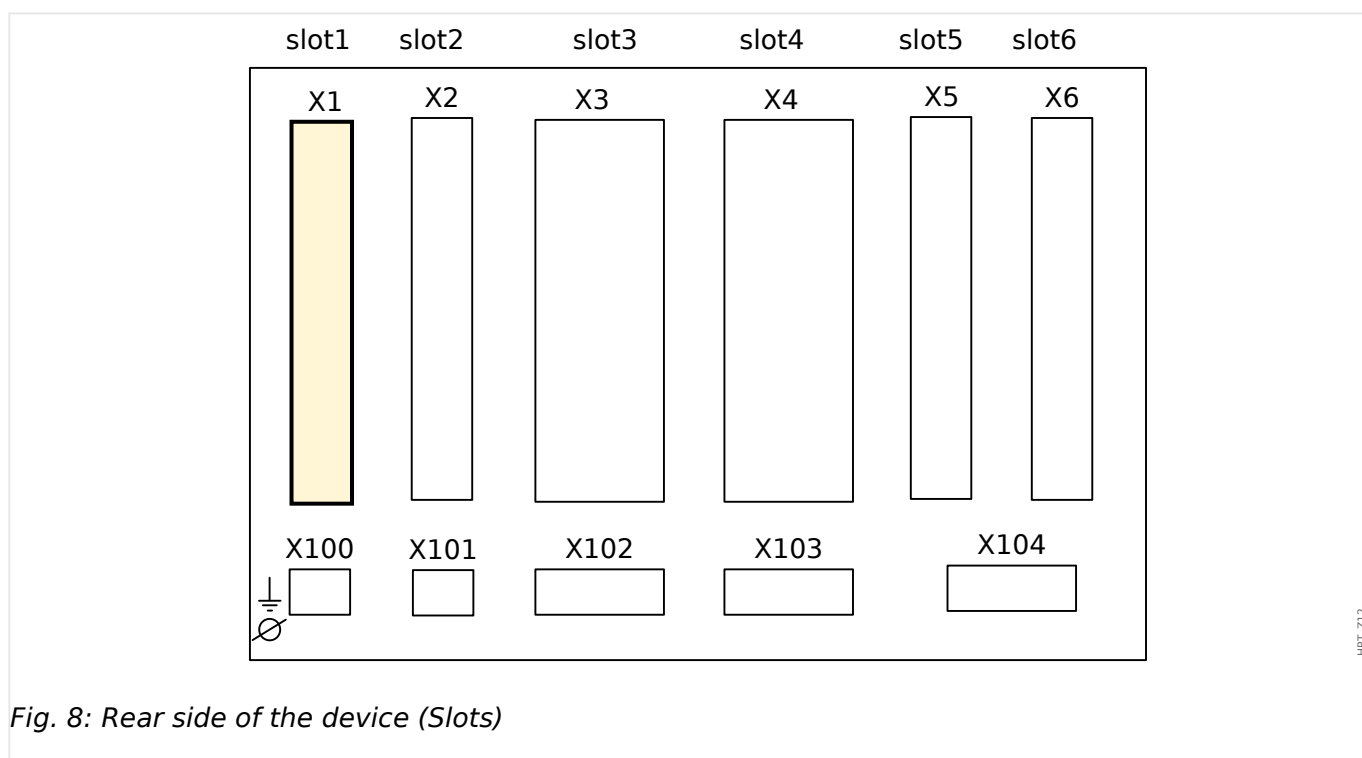

Fig. 8: Rear side of the device (Slots)

The type of power supply card and the number of digital inputs on it used in this slot is dependent on the **ordered device type**. The different variants have a different scope of functions.

Available assembly groups in this slot:

- **DI-8 X1**: This assembly group comprises a wide-range power supply unit; and two non-grouped digital inputs and 6 digital inputs (grouped).

NOTICE!



The available combinations can be gathered from the **ordering code**.

2.3.1 DI8-X Power Supply and Digital Inputs

WARNING!



In addition to the grounding of the housing (protective earth, see [↗](#) “Grounding”) there must be an additional ground cable connected to the power supply card (functional earth, min. 2.5 mm² [\leq AWG 13], tightening torque 0,56 – 0,79 Nm [5–7 lb•in]).

Connect this ground cable to terminal No. 1, see “[↗](#) Fig. 9” below.

All grounding connections (i. e. protective and functional earth) must be low-inductance, i. e. as short as possible, and national standards - if applicable - must be followed.

WARNING!



Ensure the correct tightening torques (see diagram).

Connection cross section: min. 0.25 mm² (AWG 23) ... max. 2.5 mm² (AWG 14) with or without wire end ferrule.

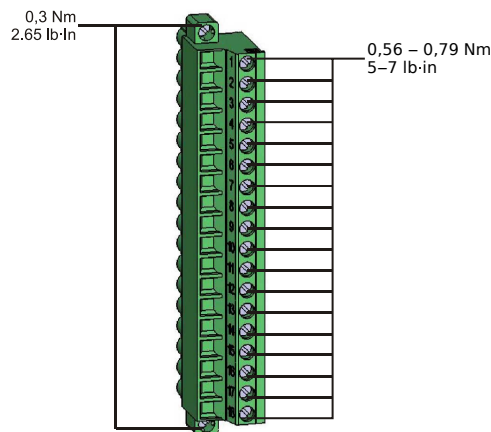

HPT_Z13

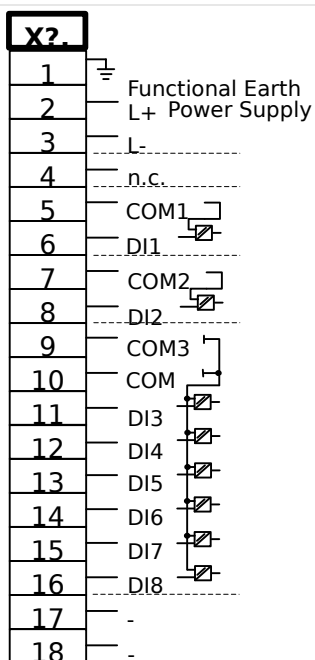

Fig. 9: Terminals

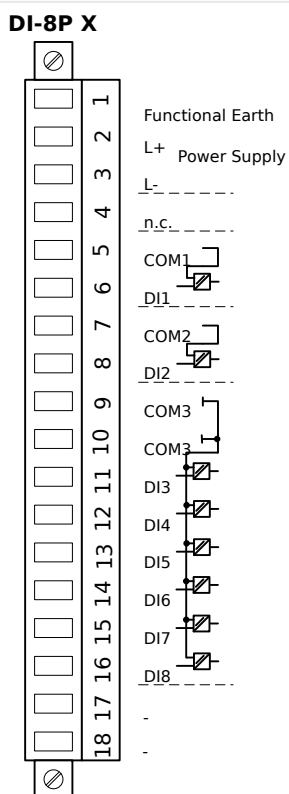

Fig. 10: Electro-mechanical assignment

This assembly group comprises:

- a wide-range power supply unit
- 6 digital inputs, grouped

- 2 digital inputs, non-grouped
- Connector for the functional earth (which **must** be connected, see the “Warning” message above)

Auxiliary Voltage Supply

- The aux. voltage inputs (wide-range power supply unit) are non-polarized. The device can be supplied with AC or DC voltage.
- The permissible voltage range is: 24 ... 270 VDC / 48 ... 230 VAC (–20/+10%)
- There is a fuse built into the wide-range power supply unit: 6.3 A time-lag.

(This fuse is not to be replaced by the user, but is necessary for safe operation.)

Moreover, the voltage supply must be protected by an external fuse as follows:

- 2.5 A time-lag miniature fuse 5 x 20 mm (approx. 1/5 x 0.8 in.) according to IEC 60127
- 3.5 A time-lag miniature fuse 6.3 x 32 mm (approx. 1/4 x 1 ¼ in.) according to UL 248-14

Digital Inputs

The module is provided with 8 digital inputs.

The assignment of the digital inputs is described in  “Configuration of the Digital Inputs”.

Check the “MRMV4 Reference Manual” (MRMV4-3.6-EN-REF, separate document) for available signal assignments.

CAUTION!



When using DC supply, the negative potential has to be connected to the common terminal (COM1, COM2, COM3 - please see the terminal marking).

CAUTION!



For each digital input group the related voltage input range has to be parameterized. Wrong switching thresholds can result in malfunctions/wrong signal transfer times.

The digital inputs are provided with different switching thresholds (settable via parameter [Device Para / Digital Inputs / DI Slot Xx / Group y] »*Nom voltage*«). For each group the following switching thresholds can be defined:

- “24 VDC”
- “48 VDC”
- “60 VDC”
- “110 VDC”

- "230 VDC"
- "110 VAC"
- "230 VAC"

If a voltage >80% of the set switching threshold is applied at the digital input, the state change is recognized (physically "1"). If the voltage is below 40% of the set switching threshold, the device detects physically "0".

2.4 Slot X2

- Relay Output Card

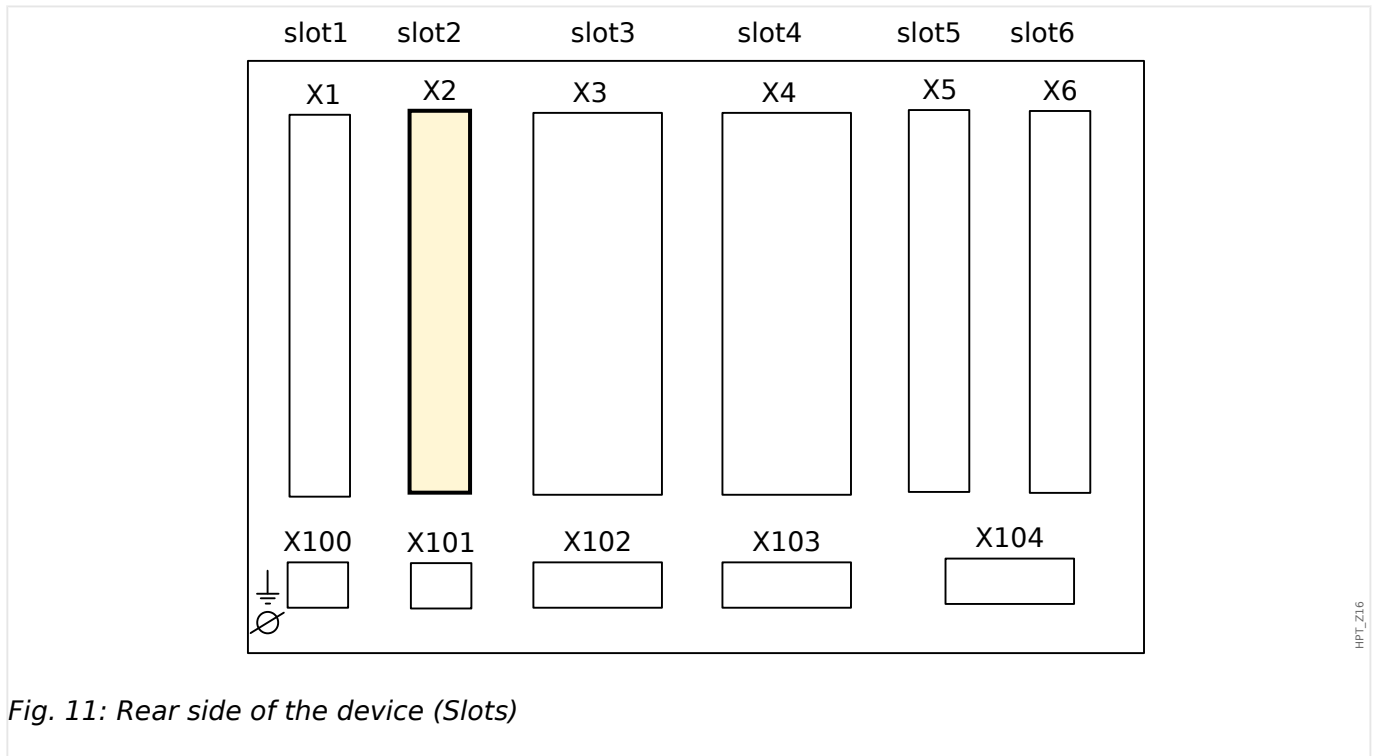

Fig. 11: Rear side of the device (Slots)

The type of card in this slot is dependent on the **ordered device type**. The different variants have a different scope of functions.

Available assembly groups in this slot:

- **OR6**: Assembly Group with 6 output relays.

All output relays are Changeover (Form C) contacts.

NOTICE!



The available combinations can be gathered from the **ordering code**.

2.4.1 BO-6 X - Assembly Group with 6 output relays

WARNING!



Ensure the correct tightening torques (see diagram).

Connection cross section: min. 0.25 mm² (AWG 23) ... max. 2.5 mm² (AWG 14) with or without wire end ferrule.

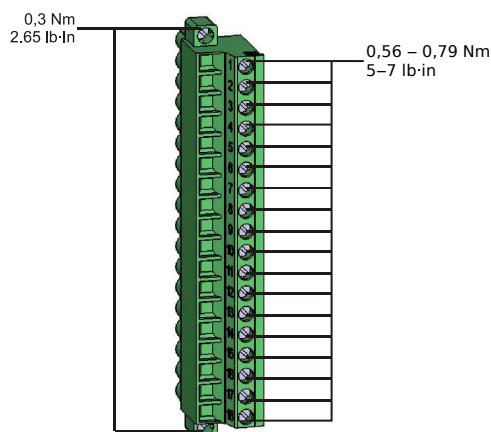

HPT_Z13

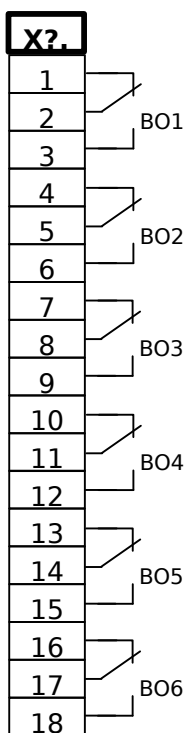

HPT_Z17

Fig. 12: Terminals

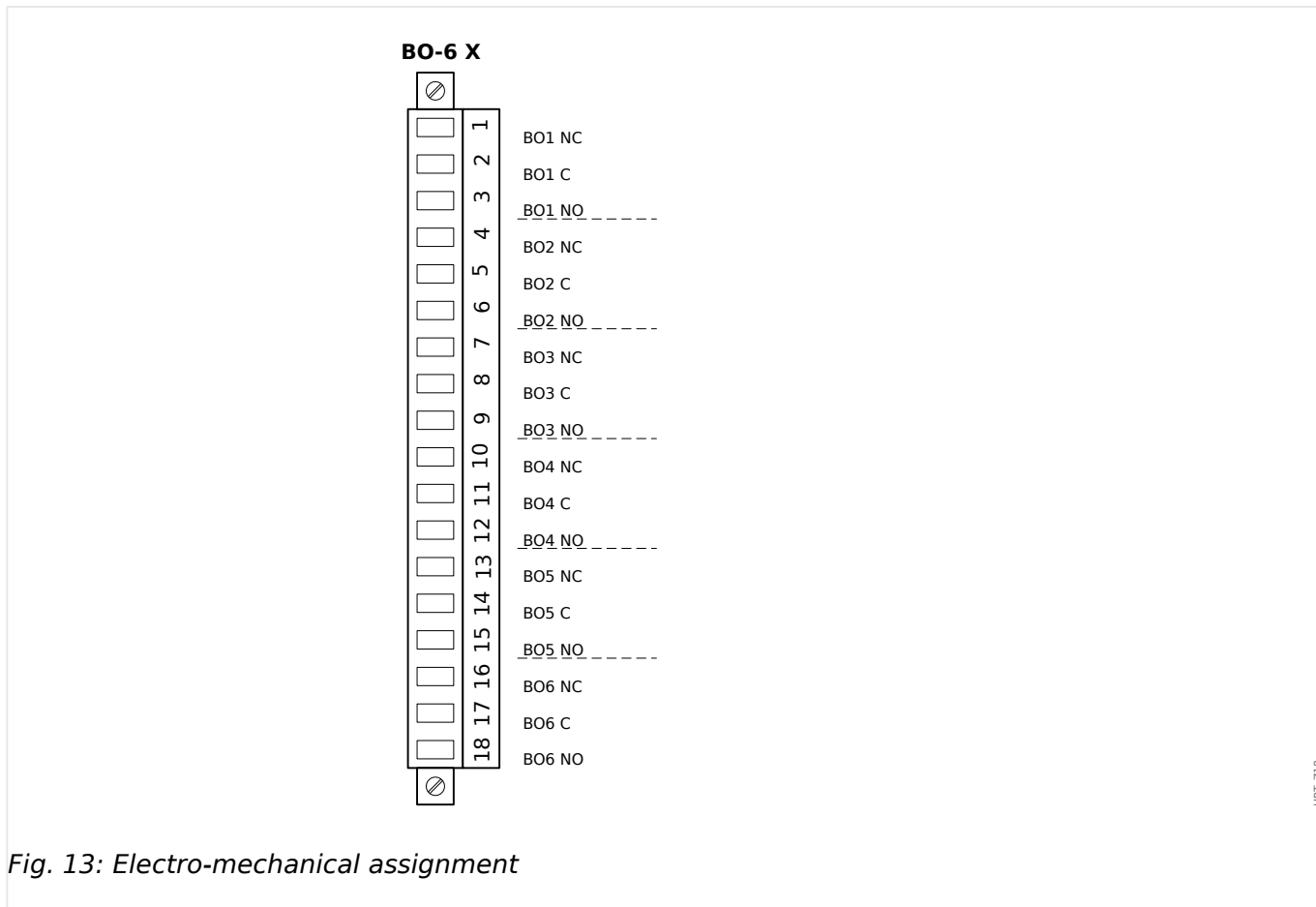

Fig. 13: Electro-mechanical assignment

Binary Output Relays

The Output Relays are potential-free contacts. The assignment of the Output Relays is described in [↳ "Output Relays Settings"](#). Check the "MRMV4 Reference Manual" (MRMV4-3.6-EN-REF, separate document) for a list of signals that can be assigned.

CAUTION!



Please carefully consider the current carrying capacity of the Output Relays. Please refer to the Technical Data ([↳ "Technical Data"](#)).

2.5 Slot X3

- CT - Current Transformer Measuring Inputs

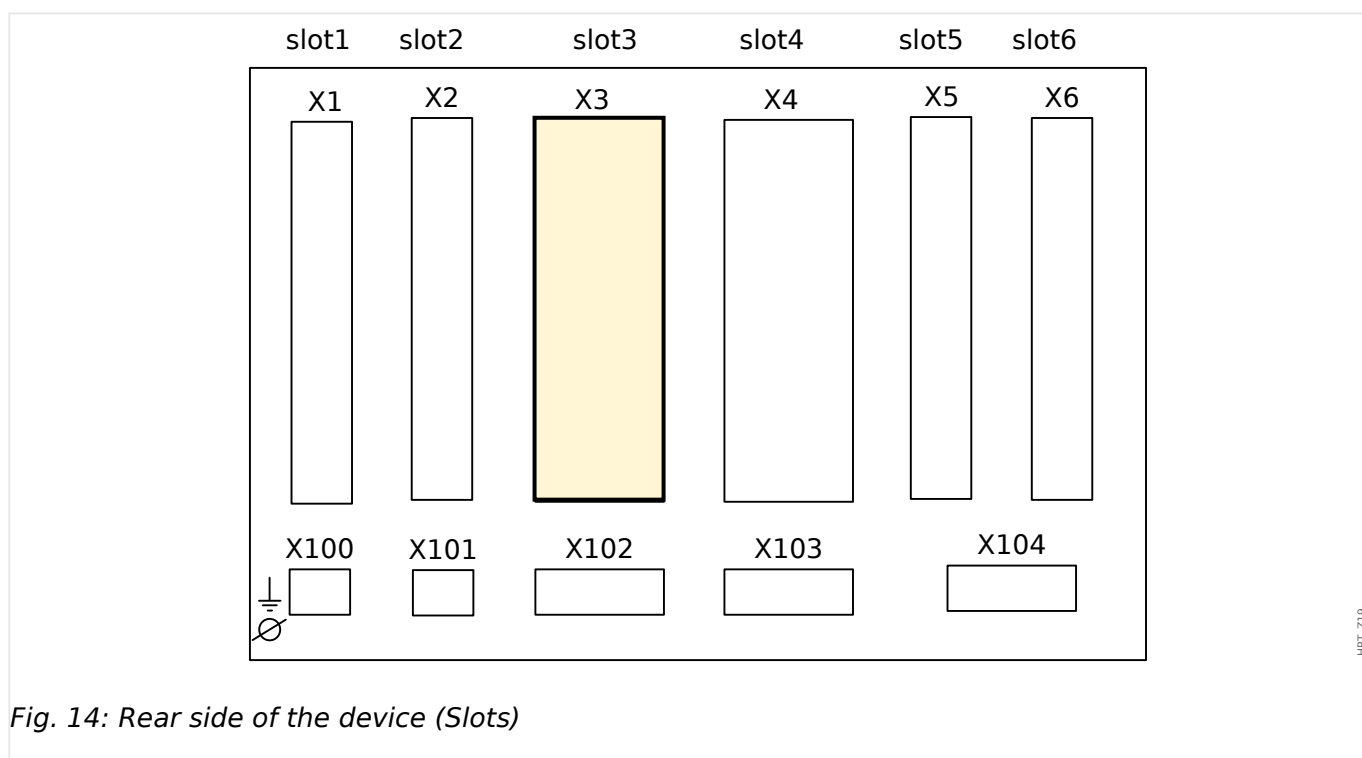

Fig. 14: Rear side of the device (Slots)

Available assembly groups in this slot:

- **Tl**: Phase and Ground Current Measuring Input Card, standard sensitivity.
- **Tls**: Phase and Ground Current Measuring Input Card with sensitive ground current inputs. The technical data of the sensitive ground measuring input are different from the technical data of the phase current measuring inputs. Please refer to the Technical Data chapter (↪ **“Technical Data”**).

2.5.1 TI - Standard Phase and Ground Current Measuring Input Card

This measuring card is provided with 4 current measuring inputs: three for measuring the phase currents and one for measuring of the earth current. Each of the current measuring inputs has a measuring input for 1 A and 5 A.

The input for earth current measuring either can be connected to a cable-type current transformer or alternatively it is possible to connect the summation current path of the phase current transformer to this input (Holmgreen connection).

DANGER!



Current transformers have to be earthed on their secondary side.

DANGER!



Interrupting the secondary circuits of current transformers causes hazardous voltages.

The secondary side of the current transformers have to be short circuited before the current circuit to the device is opened.

DANGER!



The current measuring inputs may exclusively be connected to current measuring transformers (with galvanic separation).

WARNING!



- Do not interchange the inputs (1 A/5 A)
- Make sure the transformation ratios and the power of the CTs are correctly rated. If the rating of the CTs is not right (overrated), then the normal operational conditions may not be recognized. The pickup value of the measuring unit amounts approx. 3% of the rated current of the device. Also the CTs need a current greater than approx 3% of the rated current to ensure sufficient accuracy. Example: For a 600 A CT (primary current) any currents below 18 A cannot be detected any more.
- Overloading can result in destruction of the measuring inputs or faulty signals. Overloading means that in case of a short-circuit the current-carrying capacity of the measuring inputs could be exceeded.

WARNING!



Ensure the correct tightening torques (see diagram).

Connection cross section:

- 1 x or 2 x 2.5 mm² (2 x AWG 14) with wire end ferrule, or:
- 1 x or 2 x 4.0 mm² (2 x AWG 12) with ring cable sleeve or cable sleeve, or:
- 1 x or 2 x 6 mm² (2 x AWG 10) with ring cable sleeve or cable sleeve.

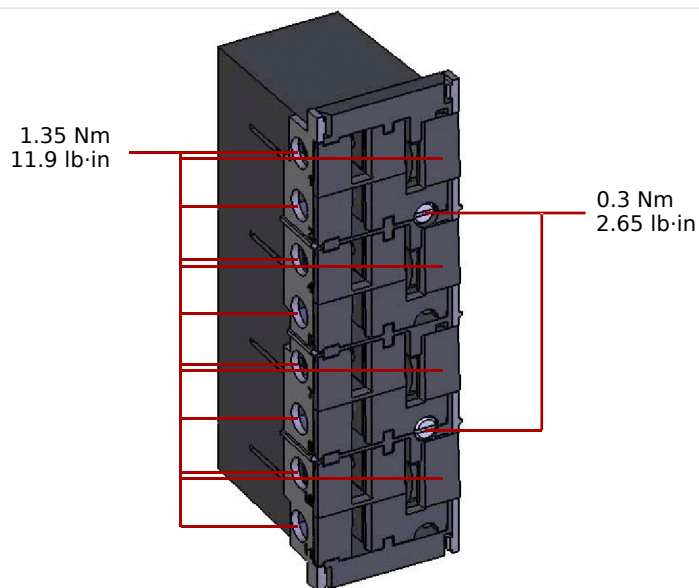

HPT_Z21

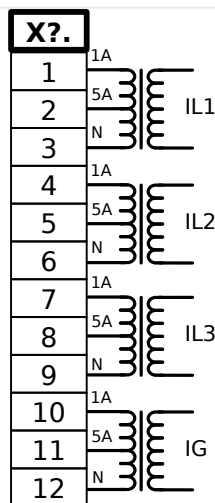

HPT_Z22

Fig. 15: TI - Terminal Marking

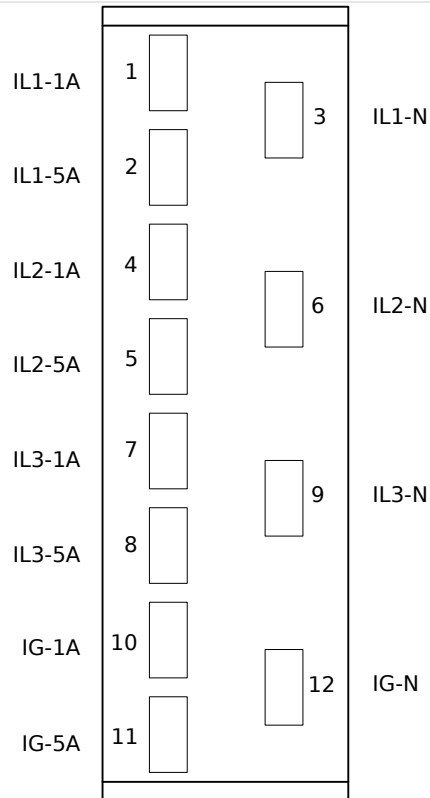

Fig. 16: TI - Electro-mechanical assignment

2.5.2 TIs - Phase and Sensitive Ground Current Measuring Card

The sensitive ground current measuring card “TIs” is provided with 4 current measuring inputs: three for measuring the phase currents and one for measuring of the earth current.

The technical data of the sensitive ground measuring input are different from the technical data of the phase current measuring inputs. Please refer to the Technical Data chapter ([↪](#) “Technical Data”).

The input for earth current measuring either can be connected to a cable-type current transformer or alternatively it is possible to connect the summation current path of the phase current transformer to this input (Holmgreen connection).

DANGER!



Current transformers have to be earthed on their secondary side.

DANGER!



Interrupting the secondary circuits of current transformers causes hazardous voltages.

The secondary side of the current transformers have to be short circuited before the current circuit to the device is opened.

DANGER!



The current measuring inputs may exclusively be connected to current measuring transformers (with galvanic separation).

WARNING!



- Do not interchange the inputs (1 A/5 A)
- Make sure the transformation ratios and the power of the CTs are correctly rated. If the rating of the CTs is not right (overrated), then the normal operational conditions may not be recognized. The pickup value of the measuring unit amounts approx. 3% of the rated current of the device. Also the CTs need a current greater than approx 3% of the rated current to ensure sufficient accuracy. Example: For a 600 A CT (primary current) any currents below 18 A cannot be detected any more.
- Overloading can result in destruction of the measuring inputs or faulty signals. Overloading means that in case of a short-circuit the current-carrying capacity of the measuring inputs could be exceeded.

WARNING!



Ensure the correct tightening torques (see diagram).

Connection cross section:

- 1 x or 2 x 2.5 mm² (2 x AWG 14) with wire end ferrule, or:
- 1 x or 2 x 4.0 mm² (2 x AWG 12) with ring cable sleeve or cable sleeve, or:
- 1 x or 2 x 6 mm² (2 x AWG 10) with ring cable sleeve or cable sleeve.

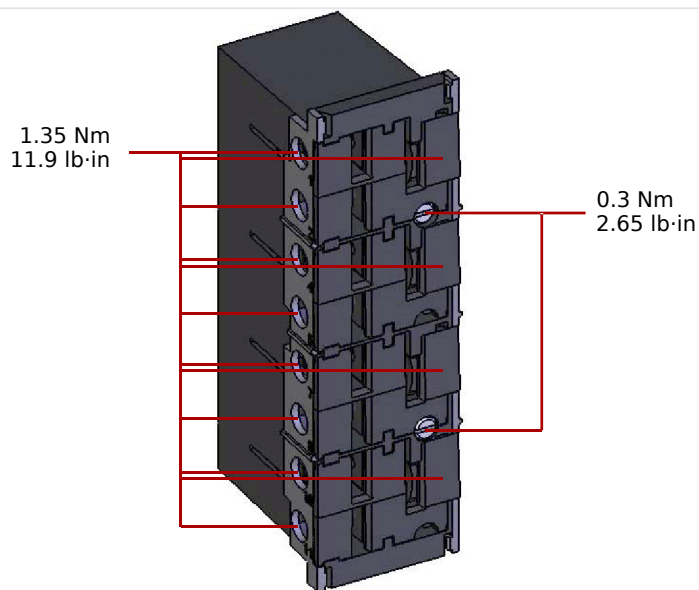

HPT_Z21

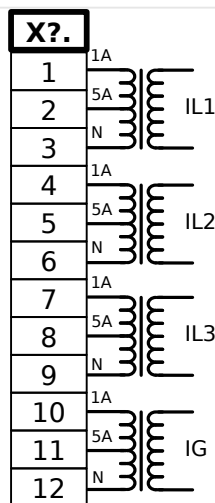

HPT_Z22

Fig. 17: TIs - Terminals

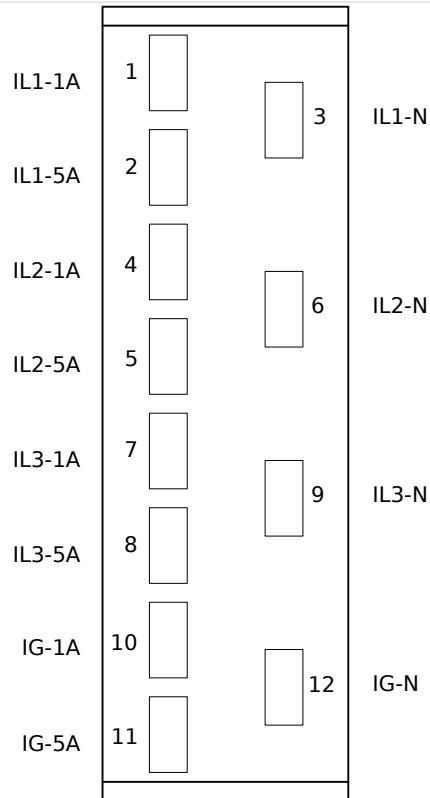

HPT_Z23

Fig. 18: TIs - Electro-mechanical assignment

2.5.3 Current Transformers (CT)

Check the installation direction.

DANGER!



It is imperative that the secondary sides of measuring transformers be grounded.

DANGER!



The current measuring inputs may exclusively be connected to current measuring transformers (with galvanic separation).

WARNING!



CT secondary circuits must always to be low burdened or short-circuited during operation.

NOTICE!



For current and voltage sensing function external wired and appropriate current and voltage transformer shall be used, based on the required input measurement ratings. Those devices provide the necessary insulation functionality.

All current measuring inputs can be provided with 1 A or 5 A nominal. Make sure that the wiring is correct.

2.5.3.1 Sensitive Ground Current Measurement

The proper use of sensitive current measuring inputs is the measurement of small currents like they could occur in isolated and high resistance grounded networks.

Due to the sensitiveness of these measuring inputs don't use them for the measurement of ground short circuit currents like they occur in solidly earthed networks.

If a sensitive measuring input should be used for the measurement of ground short circuit currents, it has to be ensured, that the measuring currents are transformed by a matching transformer according to the technical data of the protective device.

2.5.3.2 Current Transformer Connection Examples

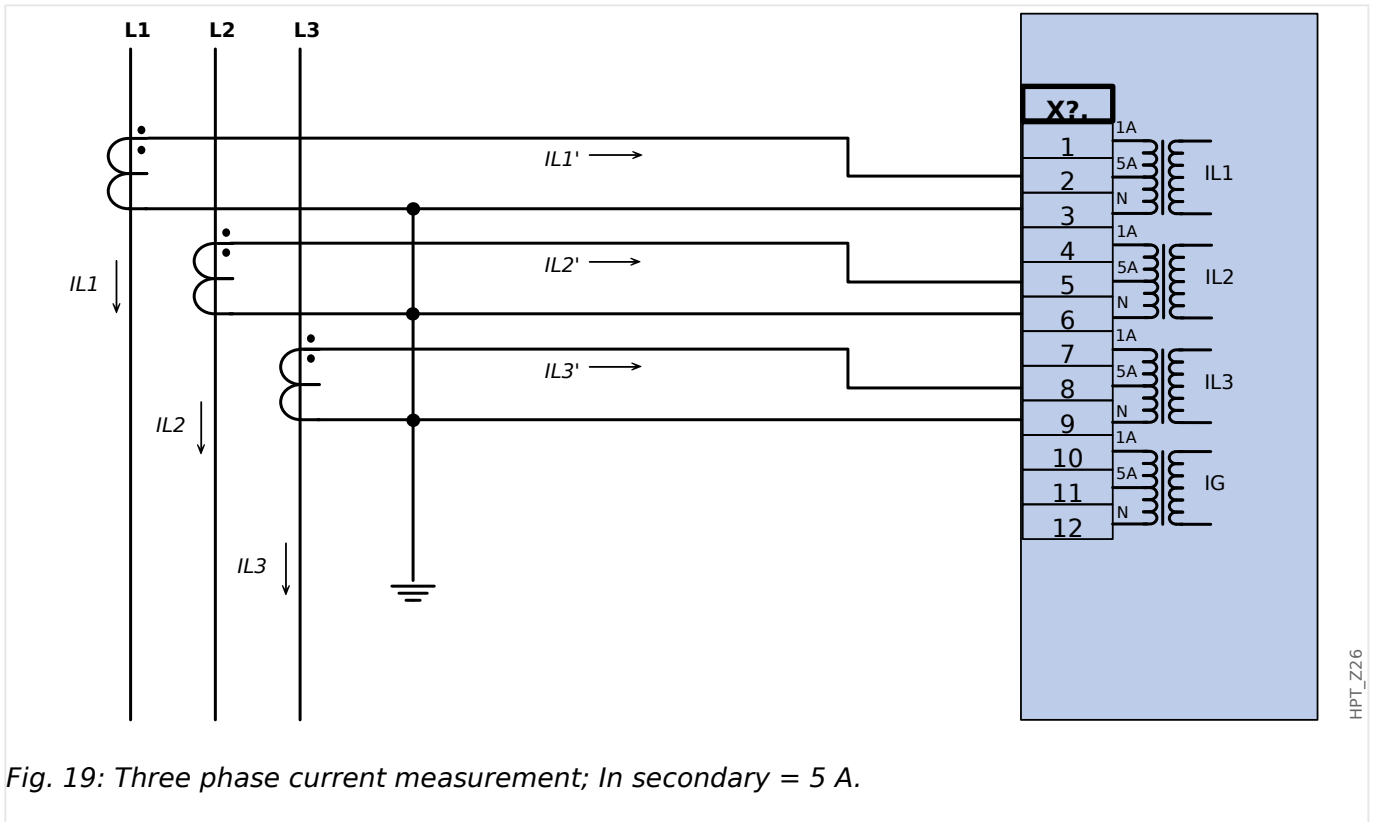

Fig. 19: Three phase current measurement; In secondary = 5 A.

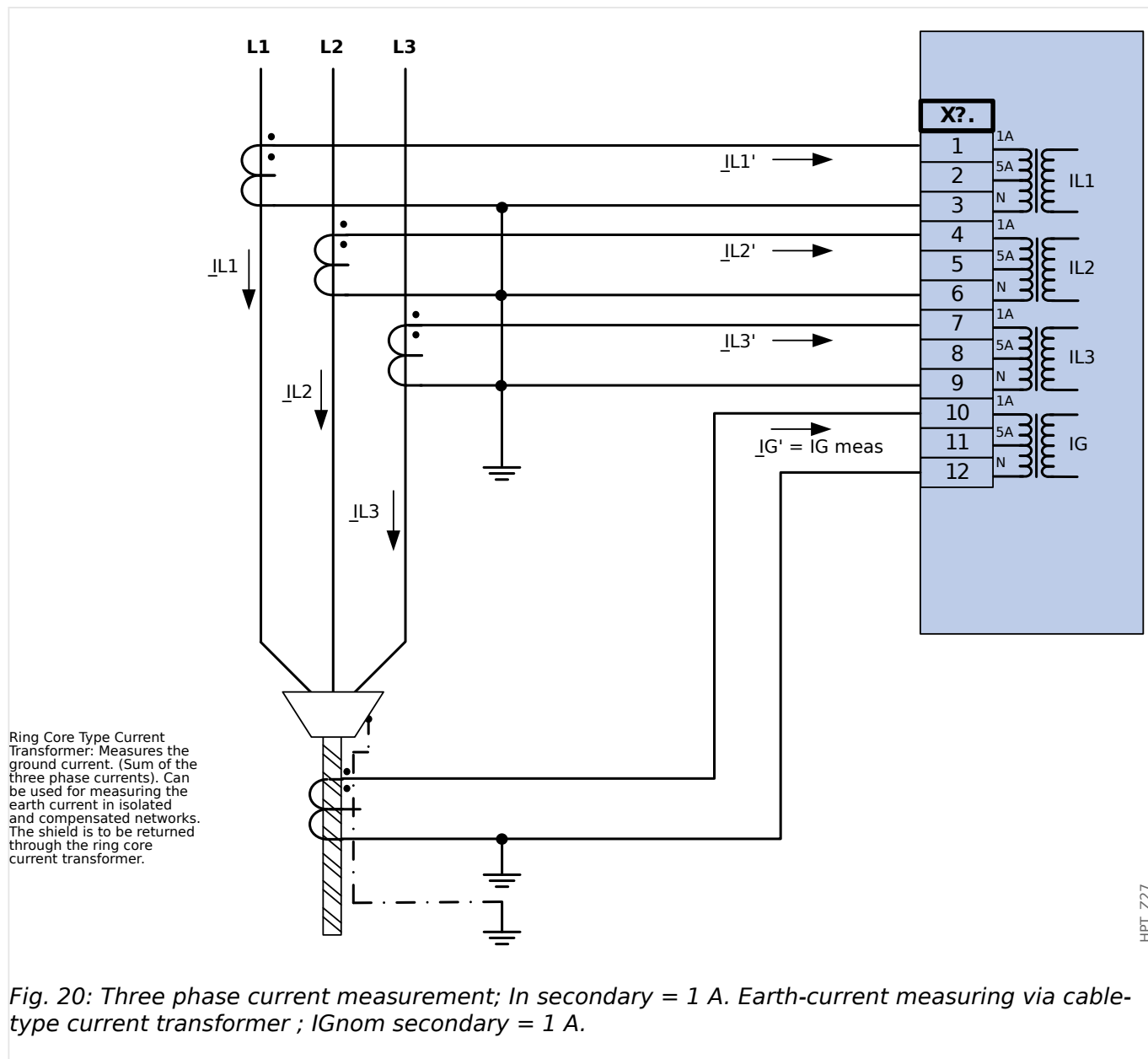
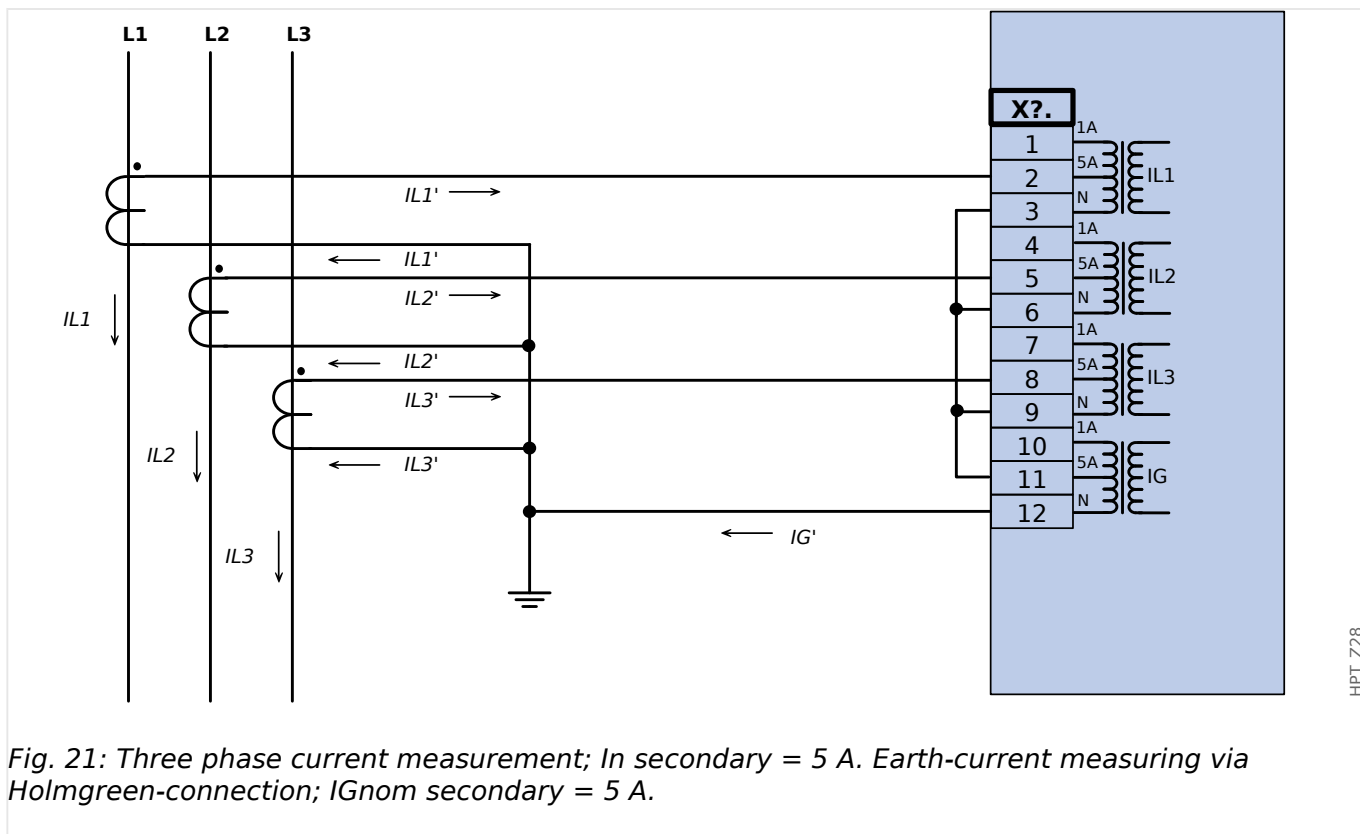

Fig. 20: Three phase current measurement; In secondary = 1 A. Earth-current measuring via cable-type current transformer ; I_Gnom secondary = 1 A.

WARNING!



The shielding at the dismantled end of the line has to be put through the cable-type current transformer and has to be grounded at the cable side.



HPT_Z28

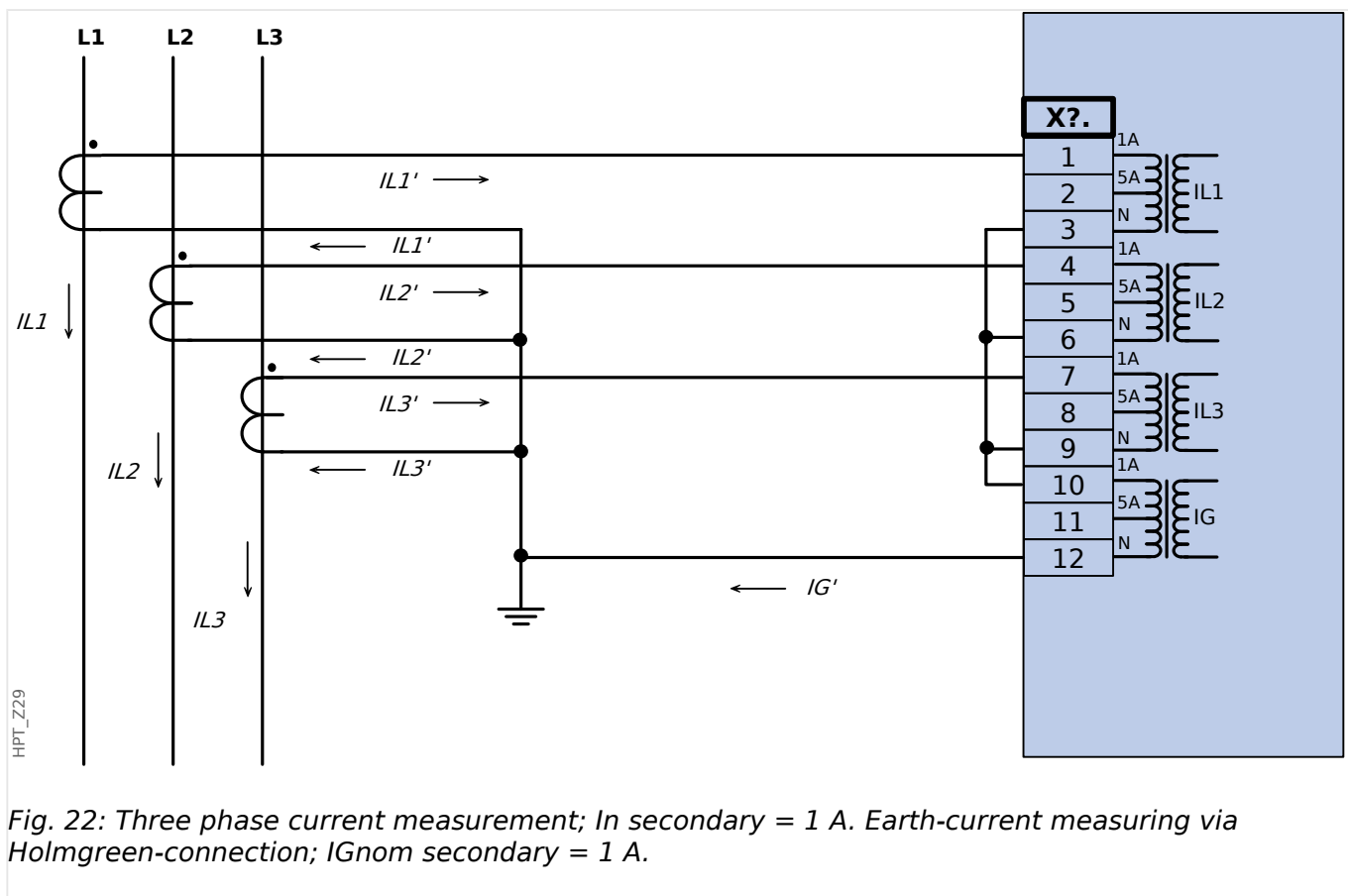

HPT_Z29

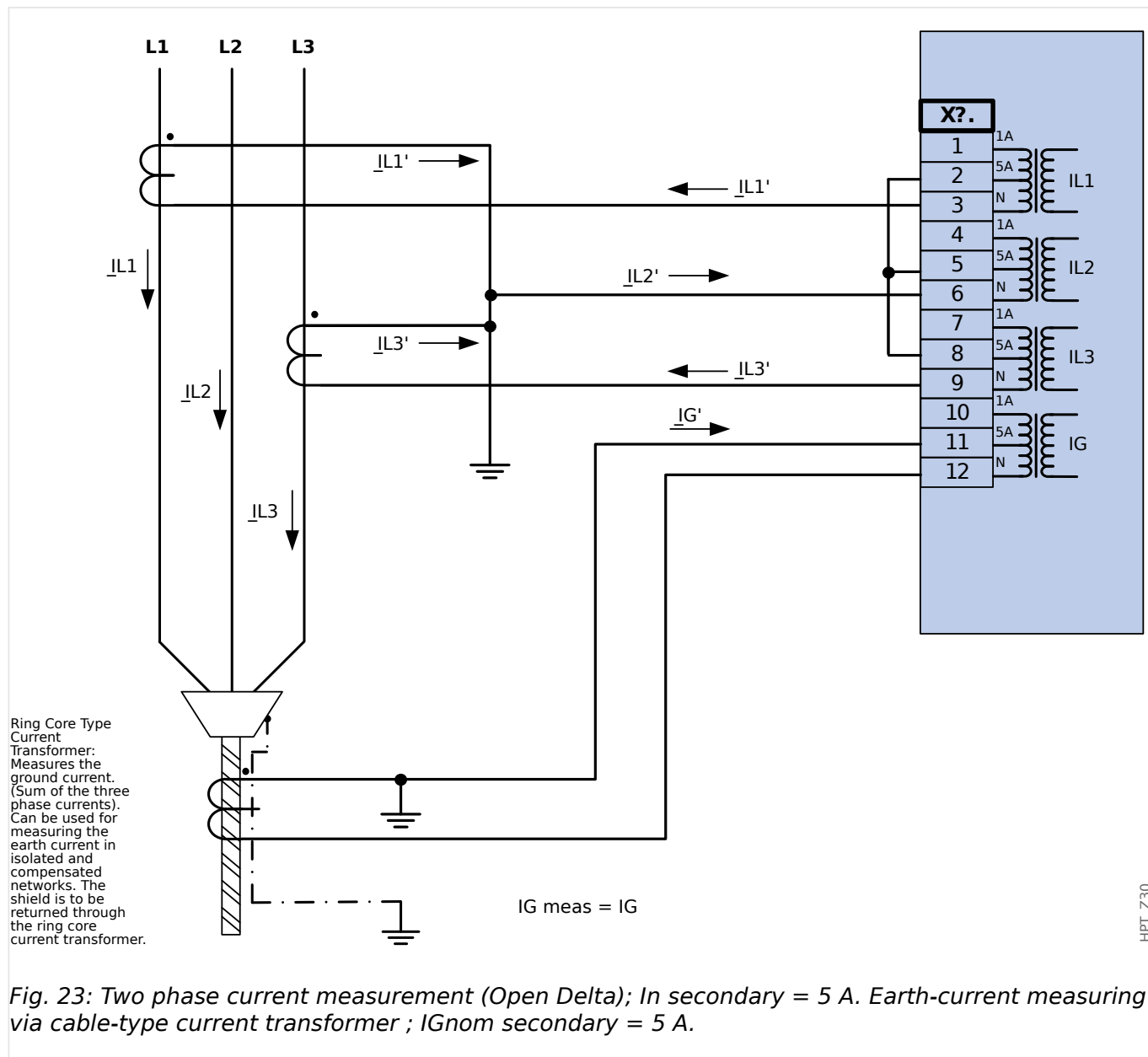

WARNING!



The shielding at the dismantled end of the line has to be put through the cable-type current transformer and has to be grounded at the cable side.

- Do not use IG calc! Use IG meas instead.
- The measured current IL2 is not valid for unsymmetrical conditions.

Therefore protection functions using IL2 (or values derived from IL2, e. g. I1, I2) may not work correctly.

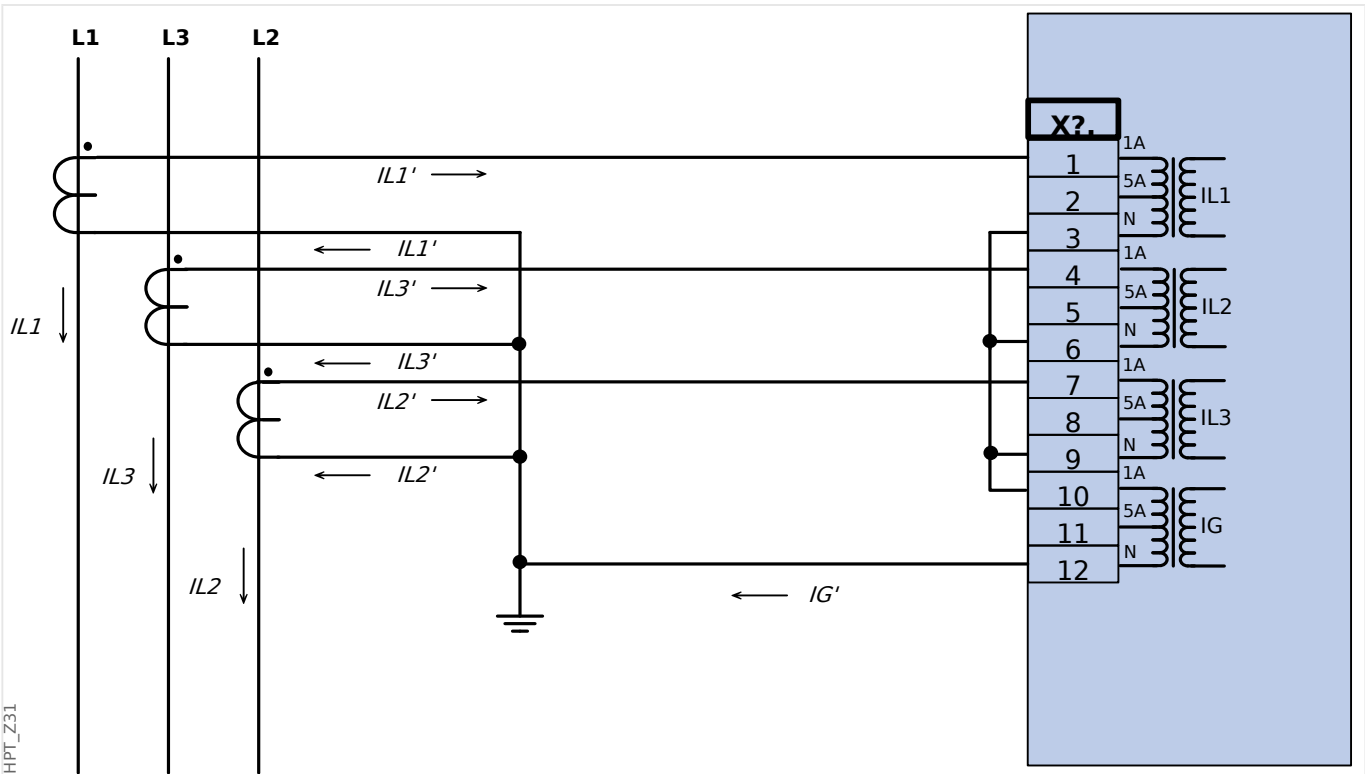

Fig. 24: Three phase current measurement; In secondary = 1 A. Earth-current measuring via Holmgreen-connection; IGnom secondary = 1 A.

2.5.3.3 Connecting the Current Inputs

The Phase and Ground Current Measuring Input Card supports both pin-terminal connections and ring-terminal connections.

CAUTION!



You have to follow national standards and directives. It might be that not all connection types are permissible in your country.

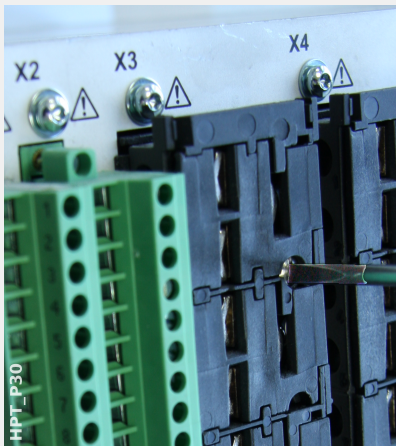

For either connection type, the first step is to remove the terminals from the device by opening the screws.

Remark: This removable part is a shorting block.

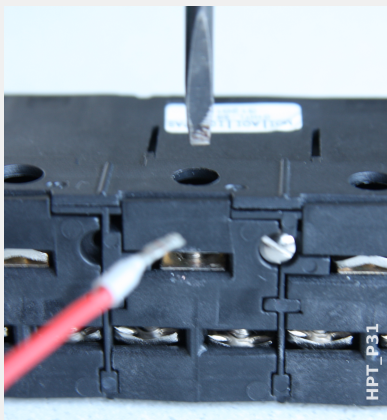

For the pin-terminal connection type, insert the cables and fasten them by the screws that are located at the side of the input card.

Attention should be paid to the tightening torque,  Fig. .

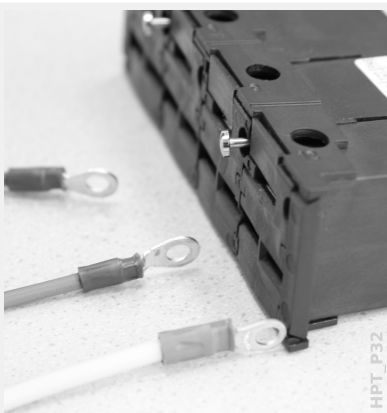

For the ring-terminal connection type, there is one intermediate step to be done.



Move the slider aside, so that the screws and metal contact become fully accessible.

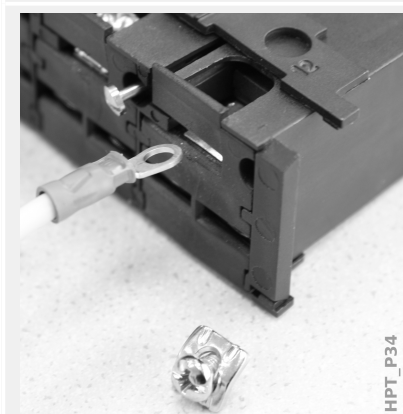



Every terminal consists of a screw with a non-losable metal contact. Screw (plus contact) can be unscrewed completely.

After removing screw and contact you can insert the ring. Then re-insert screw plus contact so that the screw goes through the ring. Tighten the screw.

Attention should be paid to the tightening torque,  Fig. .

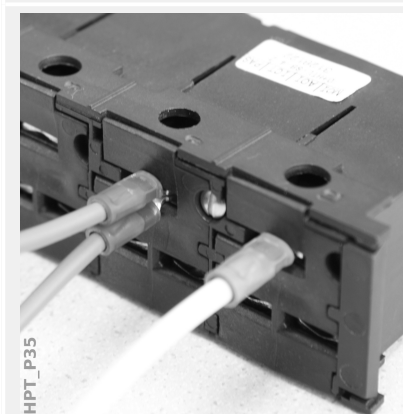
Finally move the slider back into its “closed” position.



Remark: As long as the cable cross-sections are within the limits given in the Technical Data chapter ( “Technical Data”,  Tab.) it is also possible to insert two rings into one terminal, as shown here. This is useful for setting up the neutral point connection.

2.5.3.4 CT Requirements

WARNING!



In addition to the considerations in this chapter and the requirements mentioned, all applicable national and international standards and regulations have to be followed.

Symbols

The following table gives an overview of the symbols that are used in the CT requirement section.

K_{SSC}	Rated symmetrical short-circuit current factor
K_{td}	Transient dimensioning factor considering DC component of fault current
K	Total dimensioning factor
$I_{psc,max}$	Primary maximum symmetrical short circuit current
I_{pr}	Primary rated current of the CT
I_{sr}	Secondary rated current of the CT
R_{ct}	Secondary internal wiring resistance of the CT
R_b	Rated resistive burden
R'_b	Connected resistive burden of the CT
$S_{nom,ct}$	Nominal apparent power of the CT
ALF	Accuracy limit factor
ALF'	Effective Accuracy limit factor considering connected burden
E_k	Rated knee point e.m.f.
V_s	Secondary terminal voltage
$V_{s,t,max}$	Maximum secondary terminal voltage

When dimensioning current transformers, transient effects like the DC-component of short circuit currents have to be considered. For this purpose the CT requirements are split into a symmetrical short-circuit current and a transient DC current part.

The calculation is started with K_{SSC} for the maximum symmetrical short-circuit current at the primary side of the current transformer.

$$K_{SSC} = \frac{I_{psc,max}}{I_{pr}}$$

The value $I_{psc,max}$ as well as the transient dimensioning factor K_{td} depend on the main active protection function. These can be determined according to the following data:

Overcurrent Protection

Recommended class according to IEC 61869-100 (2017-01)	10P, 5P
K_{td}	1
K_{SSC}	According to the equation above, and ≥ 20
$I_{psc,max}$	Maximum threshold setting of $I_{>}$

For most CT classes it is necessary to make sure that the requirements in the following table are fulfilled. For this the total dimensioning factor is needed:

$$K = K_{SSC} \cdot K_{td}$$

CT class	Requirement
P, PR	$K \leq ALF'$, with: $ALF' = ALF \cdot \frac{R_{ct} + R_b}{R_{ct} + R'_b}$
PX, PXR	$E_k \geq \frac{K}{1.2} \cdot I_{sr} \cdot (R_{ct} + R'_b)$
IEEE / ANSI C-class	$V_s \geq K \cdot I_{sr} \cdot (R_{ct} + R'_b)$ Order CTs with the next higher voltage rating than V_s .
TPX, TPY, TPZ	Order CTs with the determined minimum of K_{SSC} and K_{td} .

Remanence is not considered at this time. Nevertheless it can lead to problems, especially for external faults when using differential protection. To consider remanence the dimensioning factor has to be chosen higher and/or anti remanence class CTs like PR, TPY and PXR can be used.

The requirements for distance protection apply to the fault cases 3 and 4 in IEC 60255-121 (2014). Nevertheless only fault case 3 has to be considered by the user for the calculation of the CT requirements according to this guide.

If the fault current rises over time the CT may be under-dimensioned for the corresponding protection functions. When planning a new installation it makes sense to use CTs with a higher total dimensioning factor than necessary to add some backup reserves for the future.

Example: Overcurrent Protection

Current Transformer:	$I_{pr} = 500 \text{ A}$ $I_{sr} = 1 \text{ A}$ $R_{ct} = 1.5 \Omega$
Overcurrent setting:	$I_{>} = 25 I_n = 25 \cdot 500 \text{ A} = 12500 \text{ A}$
Rated resistive burden:	$R_b = S_{nom,ct} / I_{sr}^2 = 5 \text{ VA} / (1 \text{ A})^2 = 5 \Omega$

Connected burden:

$$R'_b = 2.5 \Omega$$

Start by calculating K_{SSC} with the setting threshold for the maximum symmetrical short-circuit current:

$$K_{SSC} = \frac{I_{psc,max}}{I_{pr}} = \frac{25 \cdot 500 \text{ A}}{500 \text{ A}} = 25$$

This fulfills the additional condition for overcurrent protection $K_{SSC} \geq 20$, and $K_{td} = 1$ (see requirements table above,  Tab.).

The total dimensioning factor is calculated from this:

$$K = K_{SSC} \cdot K_{td} = 25 \cdot 1 = 25$$

These data are already sufficient to select a TPX class CT.

For a P class CT, however, additional calculations are necessary. We are going to check for a 5P20 5 VA whether it fits the protection application:

$$ALF = 20$$

$$R_b = 5 \Omega$$

$$ALF' = ALF \cdot \frac{R_{ct} + R_b}{R_{ct} + R'_b} = 20 \cdot \frac{1.5 \Omega + 5 \Omega}{1.5 \Omega + 2.5 \Omega} = 32.5 \geq K = 25$$

The selected CT is sufficient for the given application.

2.6 Slot X4

- VT - Voltage Transformer Measuring Inputs

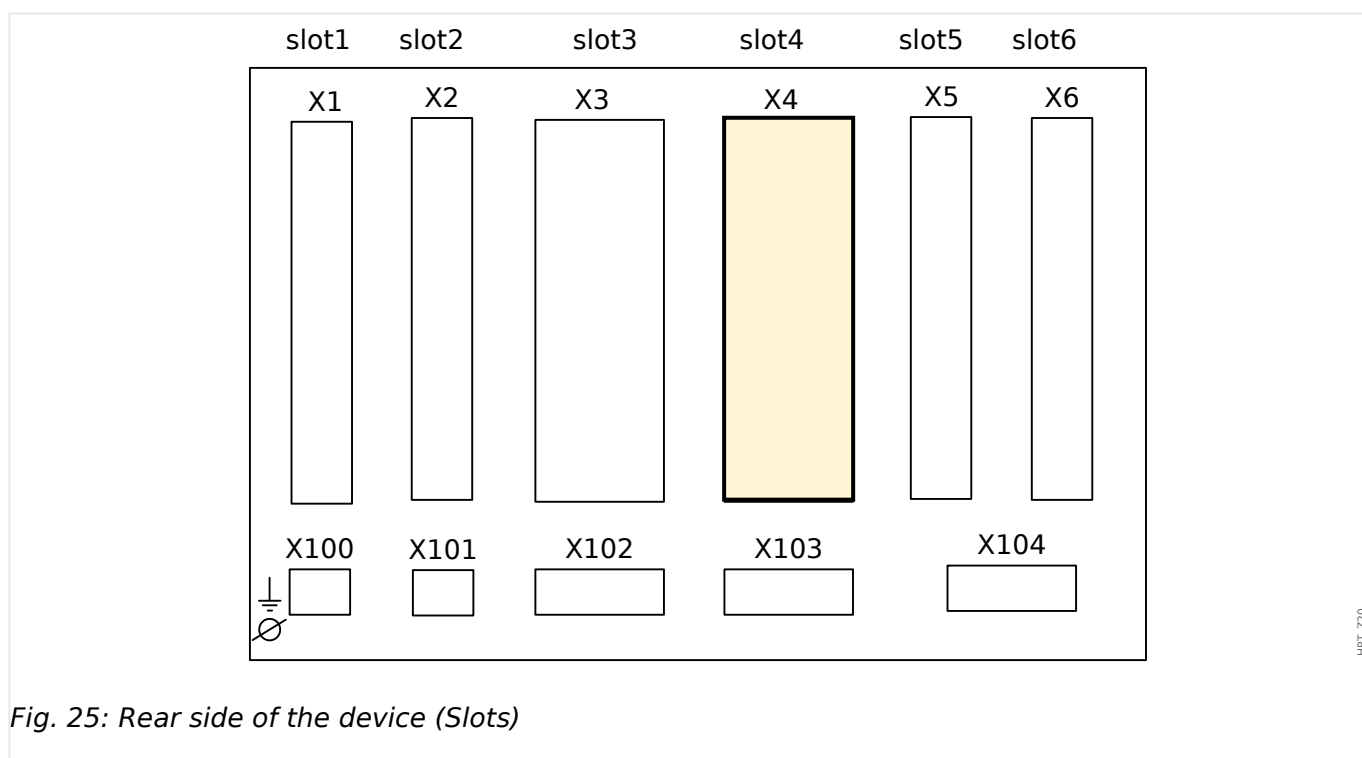

Fig. 25: Rear side of the device (Slots)

The type of card in this slot is dependent on the **ordered device type**. The different variants have a different scope of functions.

Available assembly groups in this slot:

- **TI**: Standard ground current measuring card.
- **TI**: Sensitive Ground current measuring card. The technical data of the sensitive ground measuring input are different from the technical data of the phase current measuring inputs. Please refer to the Technical Data chapter ([↳ "Technical Data"](#)).
- **TU**: Voltage measuring assembly group.

NOTICE!



The available combinations can be gathered from the **ordering code**.

2.6.1 TU - Voltage Measuring Inputs

WARNING!

 Ensure the correct tightening torques (see diagram).
Connection cross section: min. 0.5 mm² (AWG 20) ... max. 6.0 mm² (AWG 10) with or without wire end ferrule.

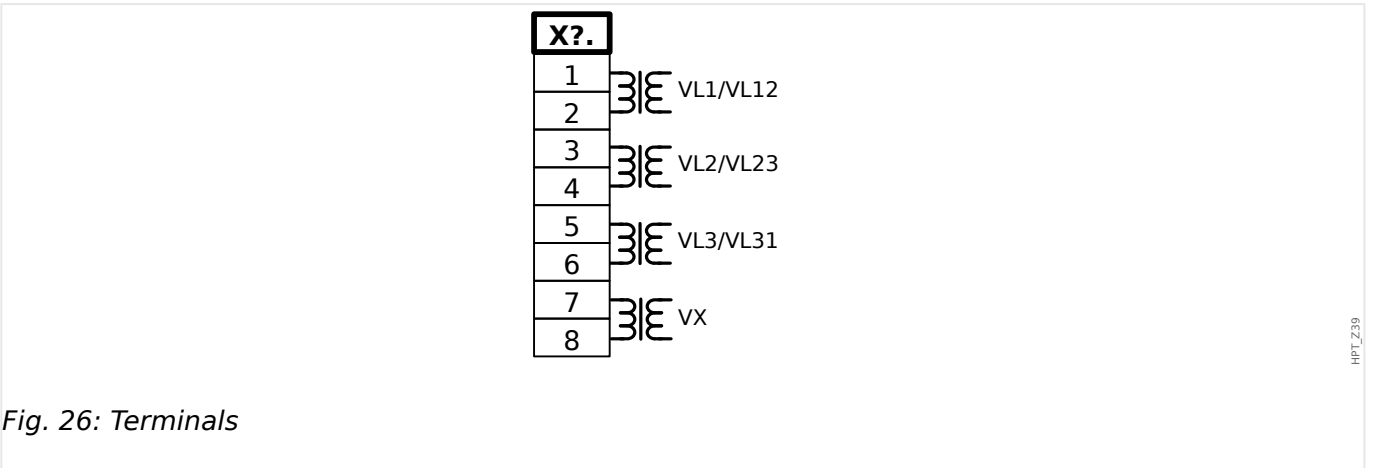
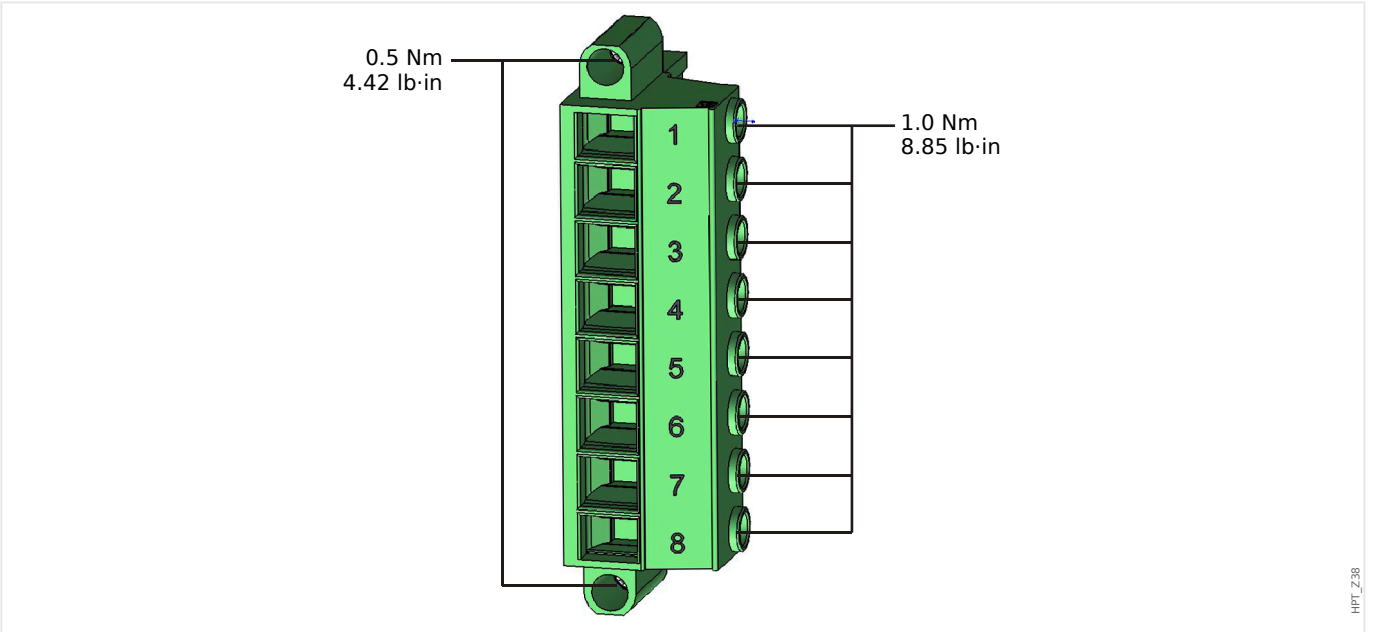

Fig. 26: Terminals

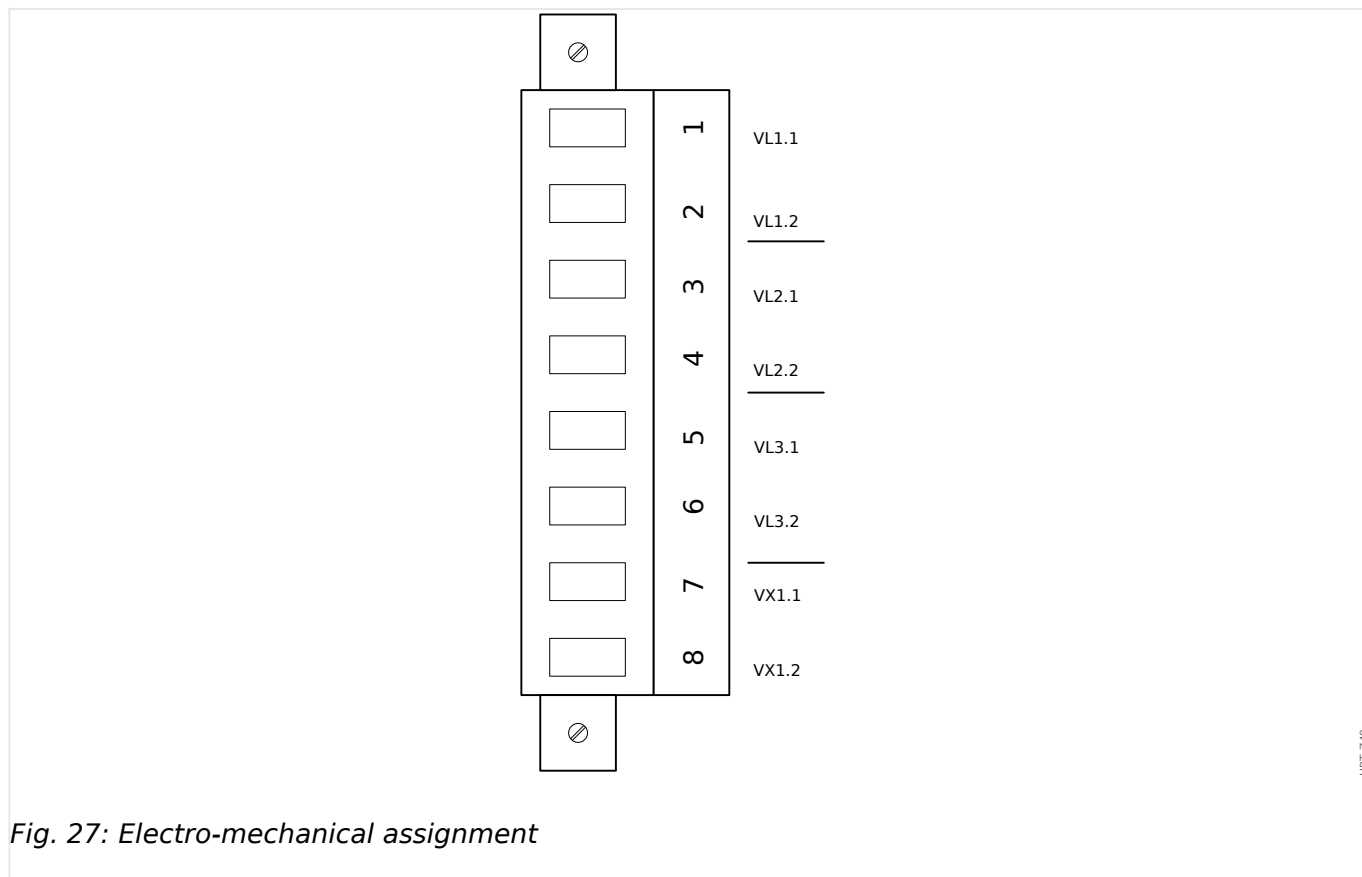

Fig. 27: Electro-mechanical assignment

Voltage Measuring Inputs

The “TU” card is provided with 4 voltage measuring inputs:

- The voltage measuring range is **0 - 800 V** (for each input).
- Three inputs are for the phase voltages:
 - either phase-to-phase voltages (*VL12*, *VL23*, *VL31*),
 - or phase-to-neutral voltages (*VL1*, *VL2*, *VL3*)
- The 4th input is for the residual voltage *VX*.

The correct connection type of the voltage measuring inputs has to be set in the [Field Para] menu:

- Setting [Field Para / VT] »VT con« = “Phase to Ground” - phase-to-neutral (star)
- Setting [Field Para / VT] »VT con« = “Phase to Phase” - phase-to-phase (Open Delta respectively V-Connection)

CAUTION!



The phase sequence (rotating field) of your power supply system has to be taken in to account. Make sure that the voltage transformers and measuring inputs are wired correctly.

For the V-connection the parameter »VT con« has to be set to "Phase to Phase".

Please refer to the Technical Data ([↪](#) "Technical Data").

2.6.2 Voltage Transformers

Check the installation direction of the VTs.

DANGER!



It is imperative that the secondary sides of measuring transformers be grounded.

NOTICE!



For current and voltage sensing function external wired and appropriate current and voltage transformer shall be used, based on the required input measurement ratings. Those devices provide the necessary insulation functionality.

Check of the Voltage Measuring Values

Connect a three-phase measuring voltage equal to the rated voltage to the relay.

NOTICE!



Take connection of the measuring transformers (star connection/open delta connection) duly into account.

Take into account the technical data of the voltage transformer inputs.

Now adjust voltage values in the nominal voltage range with the corresponding nominal frequency which are not likely to cause overvoltage- or undervoltage trips.

Compare the values shown in the device display with the readings of the measuring instruments. The deviation must be according to the technical data.

NOTICE!



When r.m.s. value measuring instruments are used, higher deviations can arise if the fed voltage has a very high harmonic content. Since the device is provided with a filter for the harmonics, only the fundamental oscillation is evaluated (exception: thermal protection functions). If, however, an r.m.s. value forming measuring instrument is used, the harmonics are also measured.

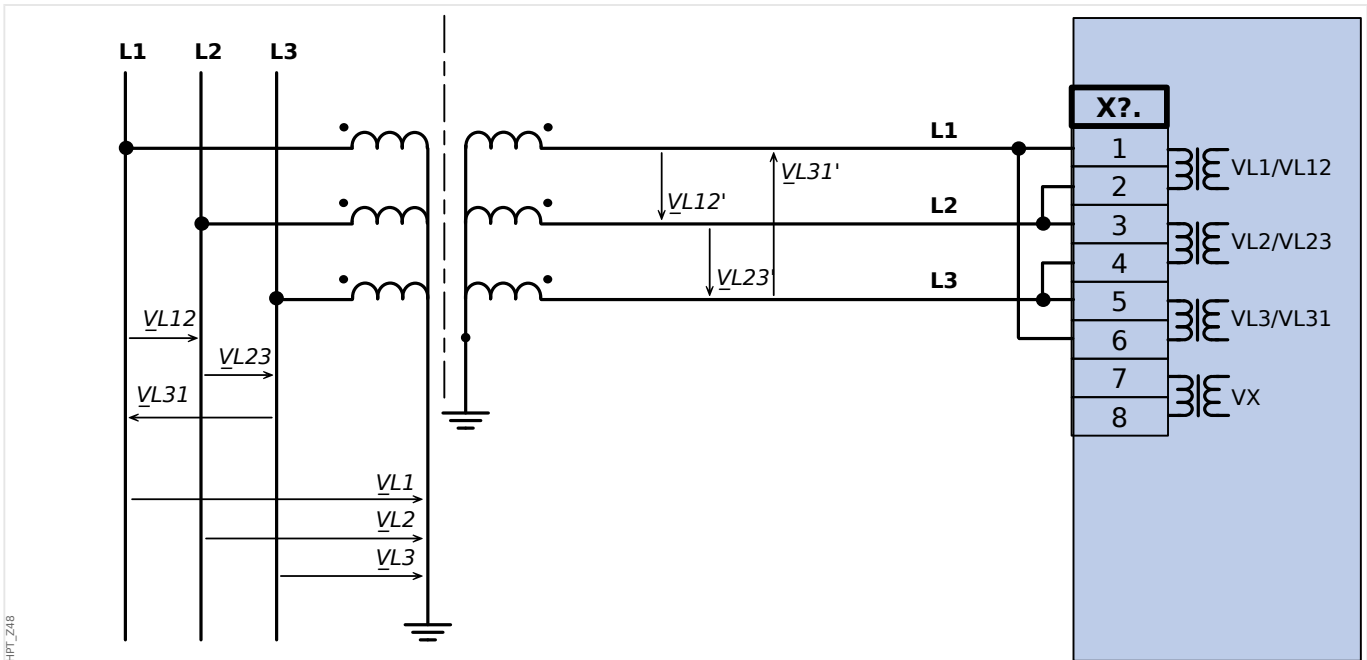
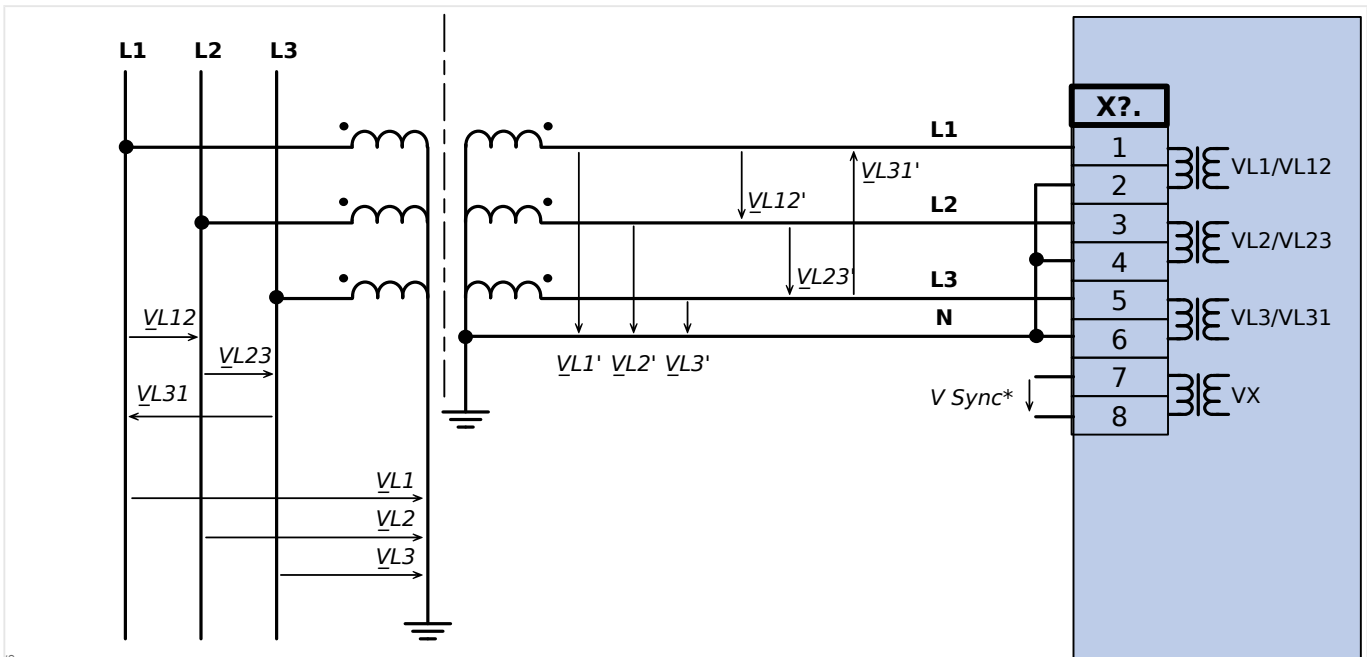

Fig. 30: Three-phase voltage measurement - wiring of the measurement inputs: "delta-connection"

WARNING!



Calculation of the residual voltage V_G is not possible



* V Sync: * Availability dependent on device type

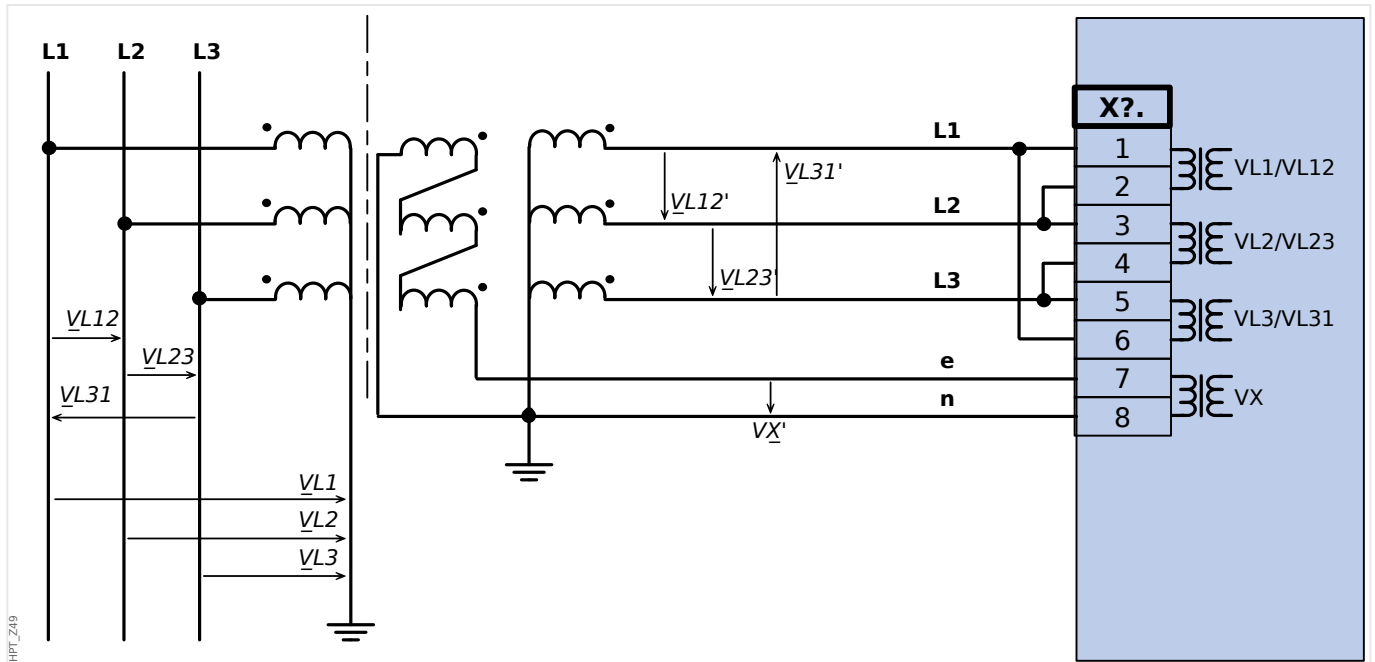

Fig. 31: Three-phase voltage measurement - wiring of the measurement inputs: "delta-connection" Measurement of the residual voltage VG via auxilliary windings (e-n) "broken delta"

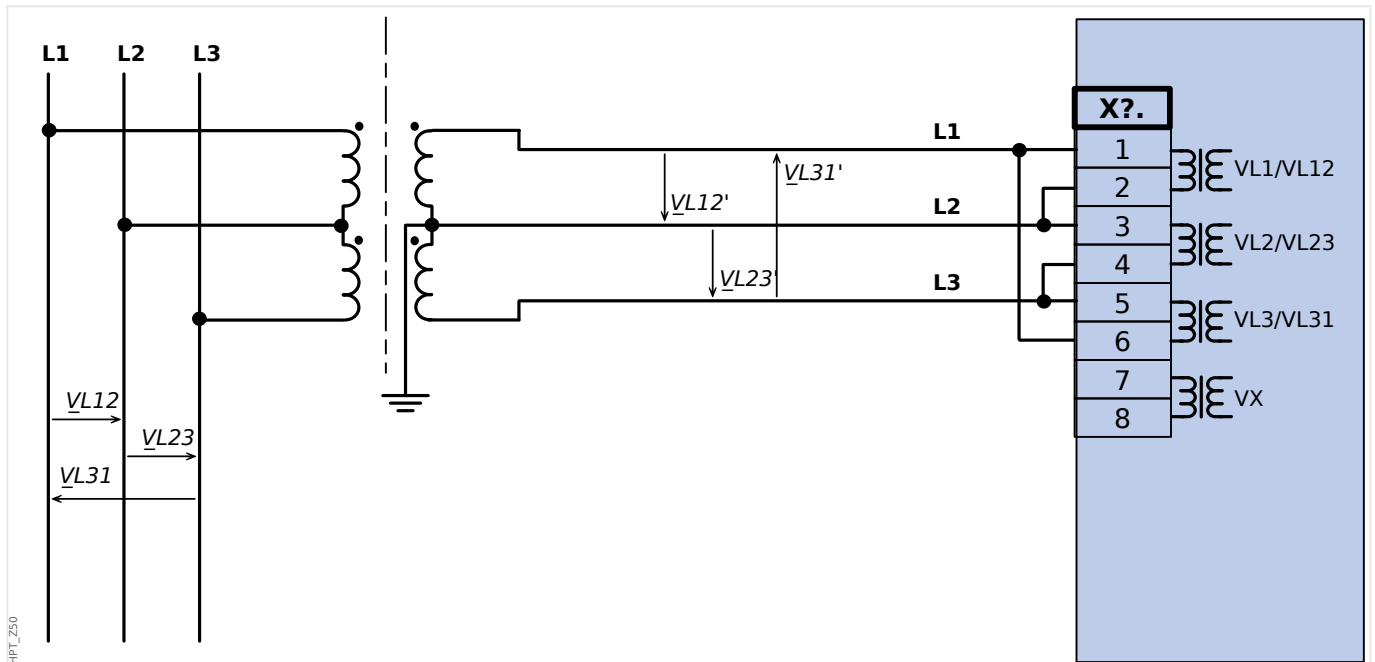
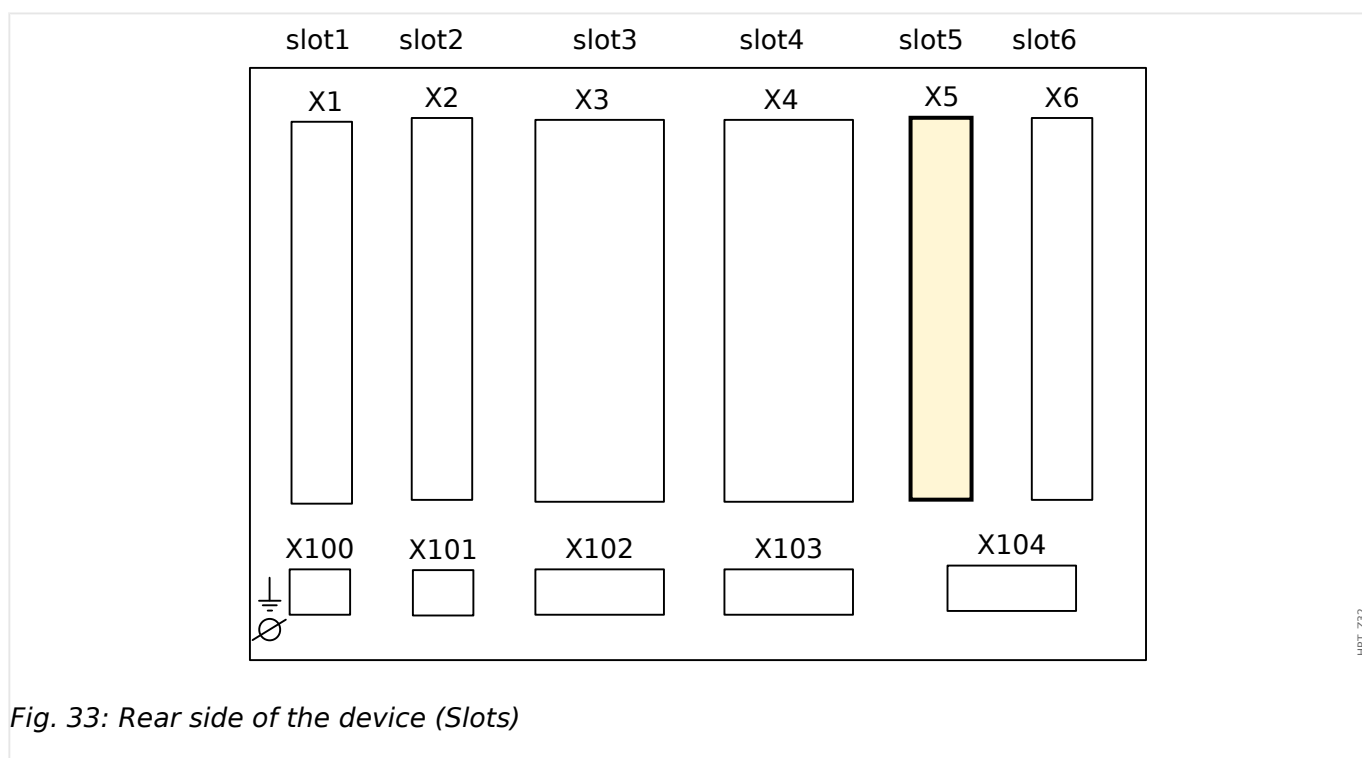

Fig. 32: Two-phase voltage measurement - wiring of the measuring inputs: "Open Delta"

2.7 Slot X5

- Analog Outputs



The type of card in this slot is dependent on the **ordered device type**. The different variants have a different scope of functions.

Available assembly groups in this slot:

- **OR6**: Assembly Group with 6 output relays.

All output relays are Changeover (Form C) contacts.

NOTICE!



The available combinations can be gathered from the **ordering code**.

2.7.1 AN-O4 - Assembly Group with 4 Analog Outputs

WARNING!

 Ensure the correct tightening torques (see diagram).
 Connection cross section: min. 0.25 mm² (AWG 23) ... max. 2.5 mm² (AWG 14) with or without wire end ferrule.

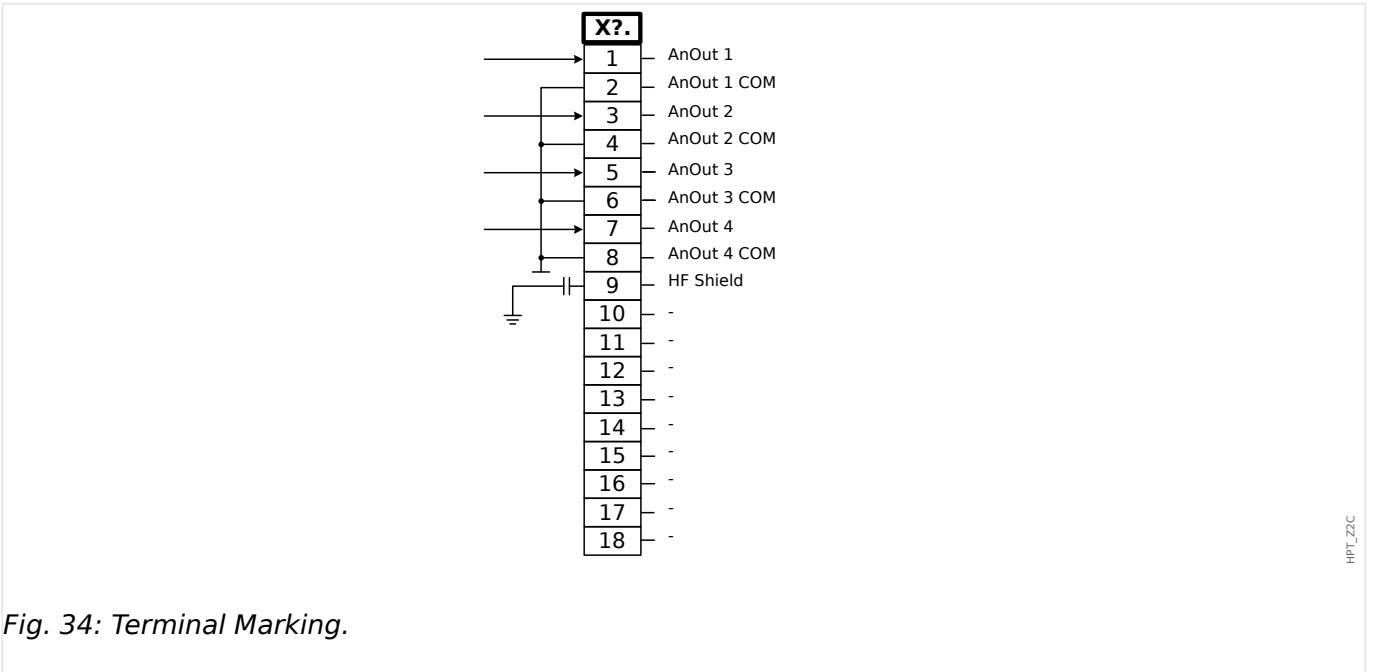
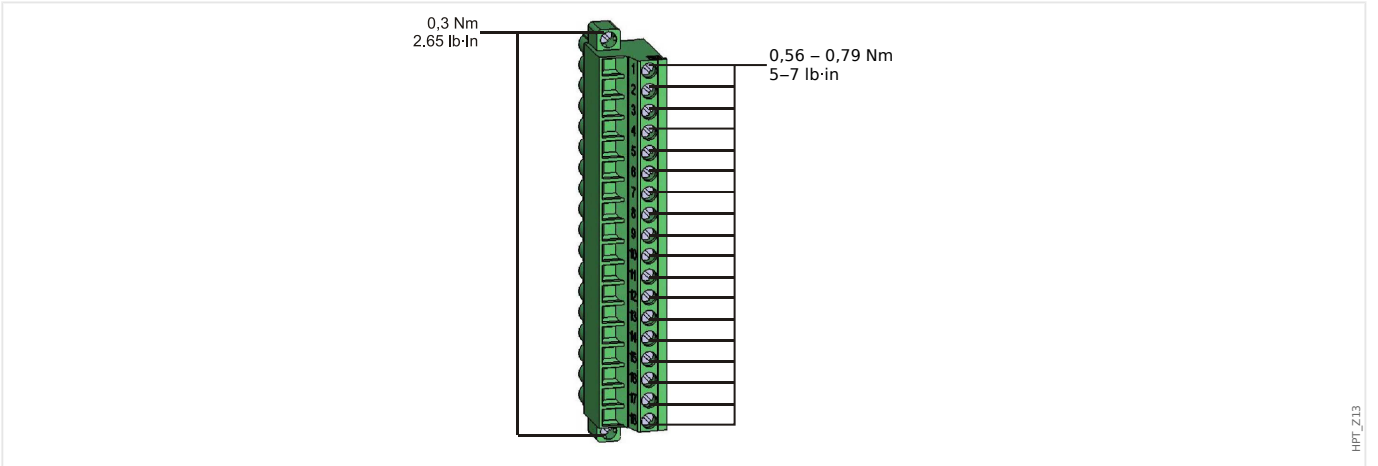

Fig. 34: Terminal Marking.

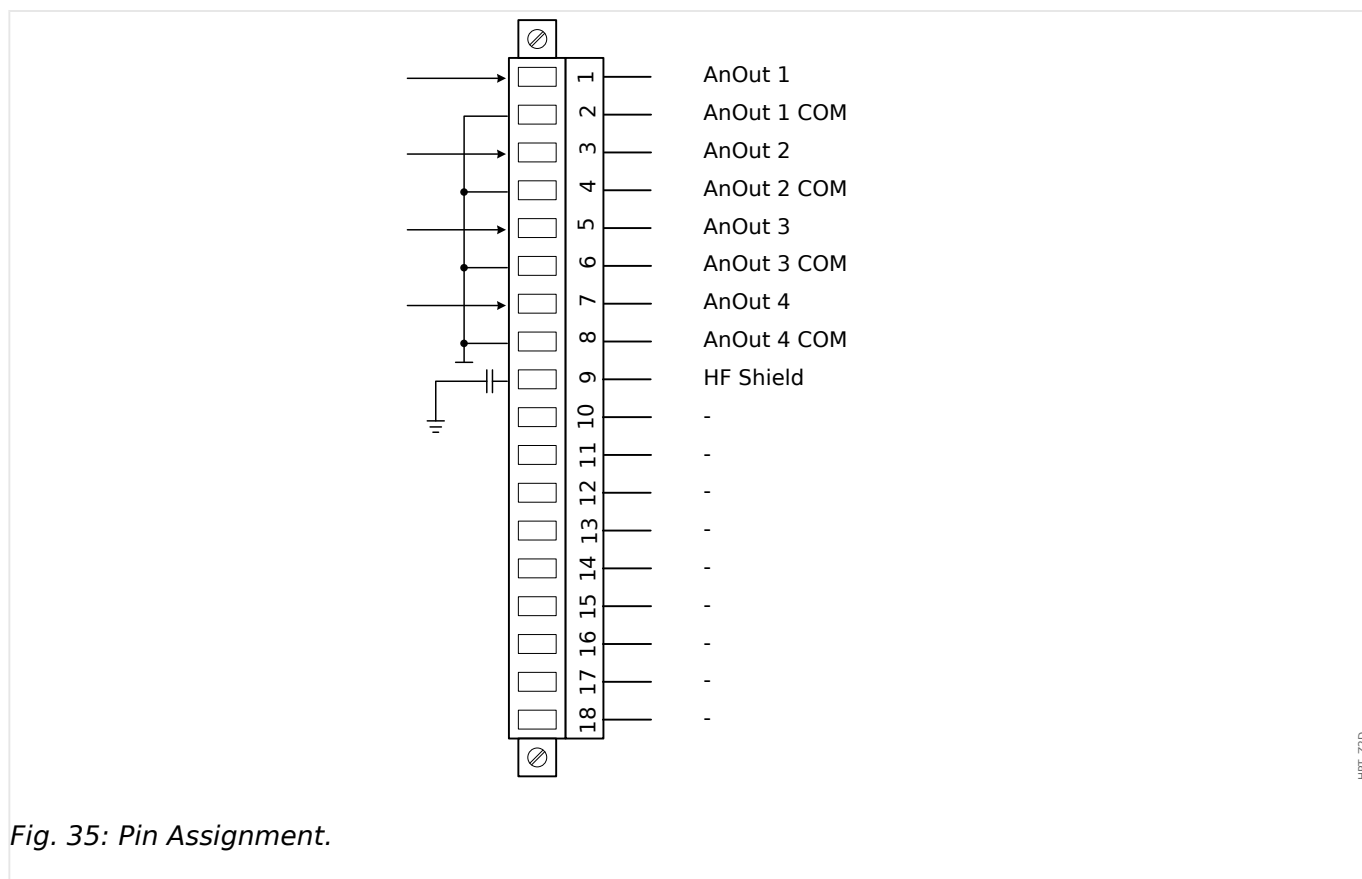

Fig. 35: Pin Assignment.

Analog Outputs

There are 4 Analog Output channels that are configurable to either output 0...20 mA, 4...20 mA, or 0...10 V. Each of the 4 channels can be independently programmed to either of these three output modes.

For details on the Analog Output, please refer to the Technical Data, [↪ “Technical Data”](#).

2.8 Slot X6

- Relay Output Card

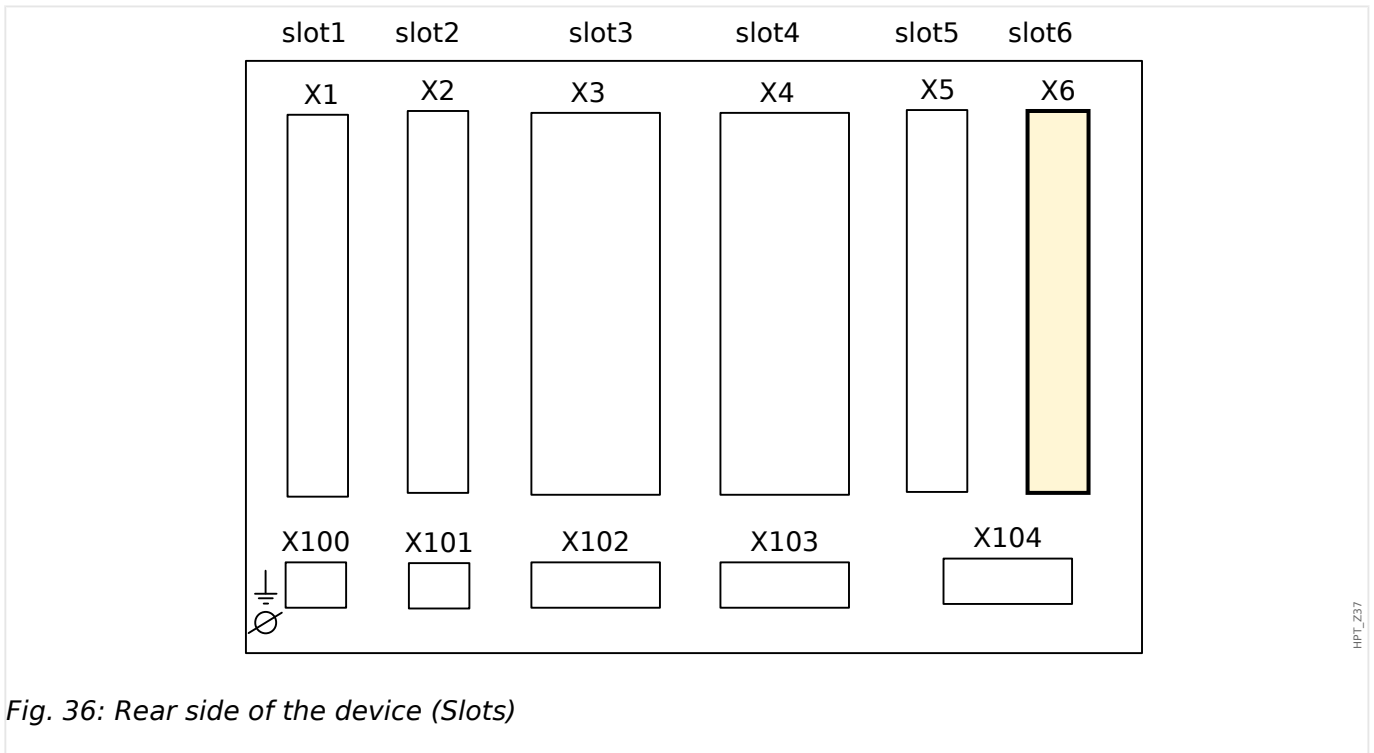

Fig. 36: Rear side of the device (Slots)

The type of card in this slot is dependent on the **ordered device type**. The different variants have a different scope of functions.

Available assembly groups in this slot:

- **TU**: Voltage measuring assembly group.
- **OR6**: Assembly Group with 6 output relays.

All output relays are Changeover (Form C) contacts.

NOTICE!



The available combinations can be gathered from the **ordering code**.

2.9 Slot X100: Ethernet Interface

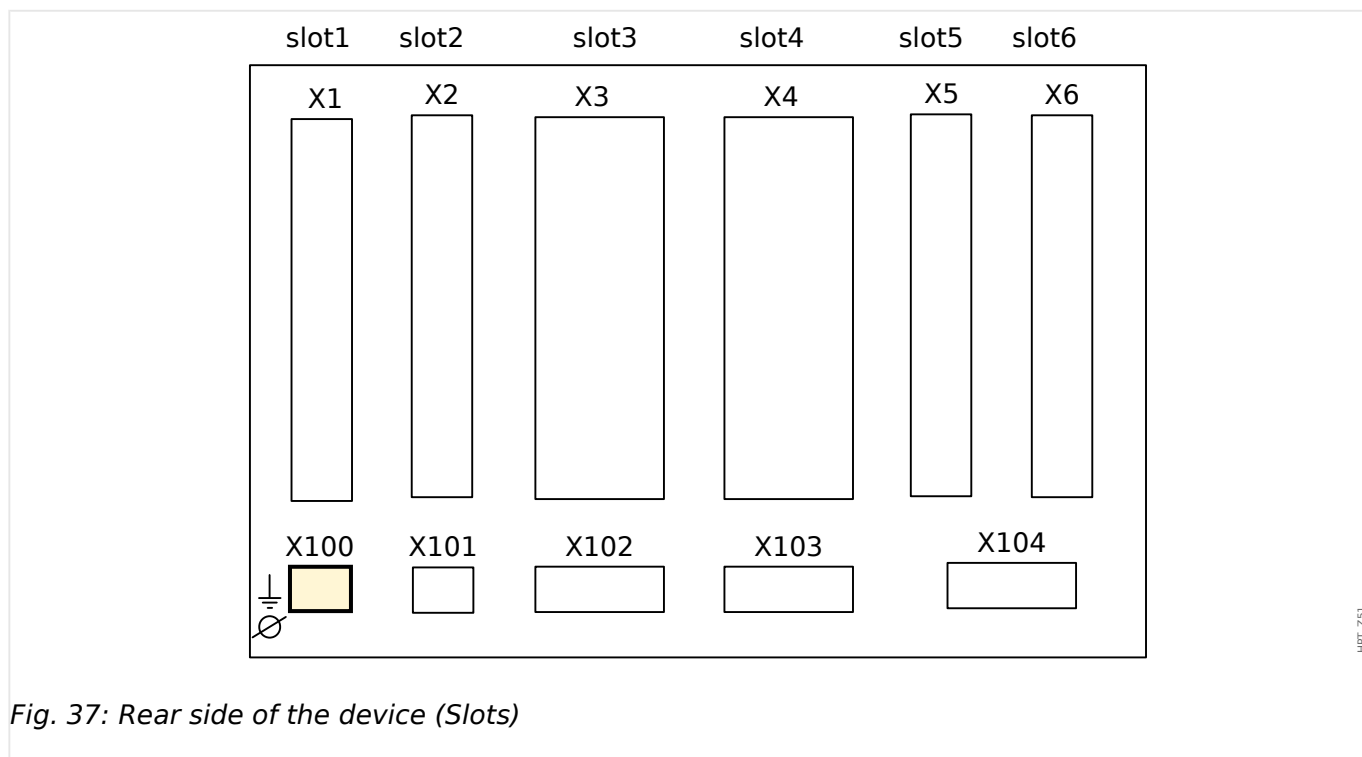

Fig. 37: Rear side of the device (Slots)

An Ethernet interface may be available depending on the **ordered device type**.

NOTICE!



The available combinations can be gathered from the **ordering code**.

2.9.1 Ethernet - RJ45

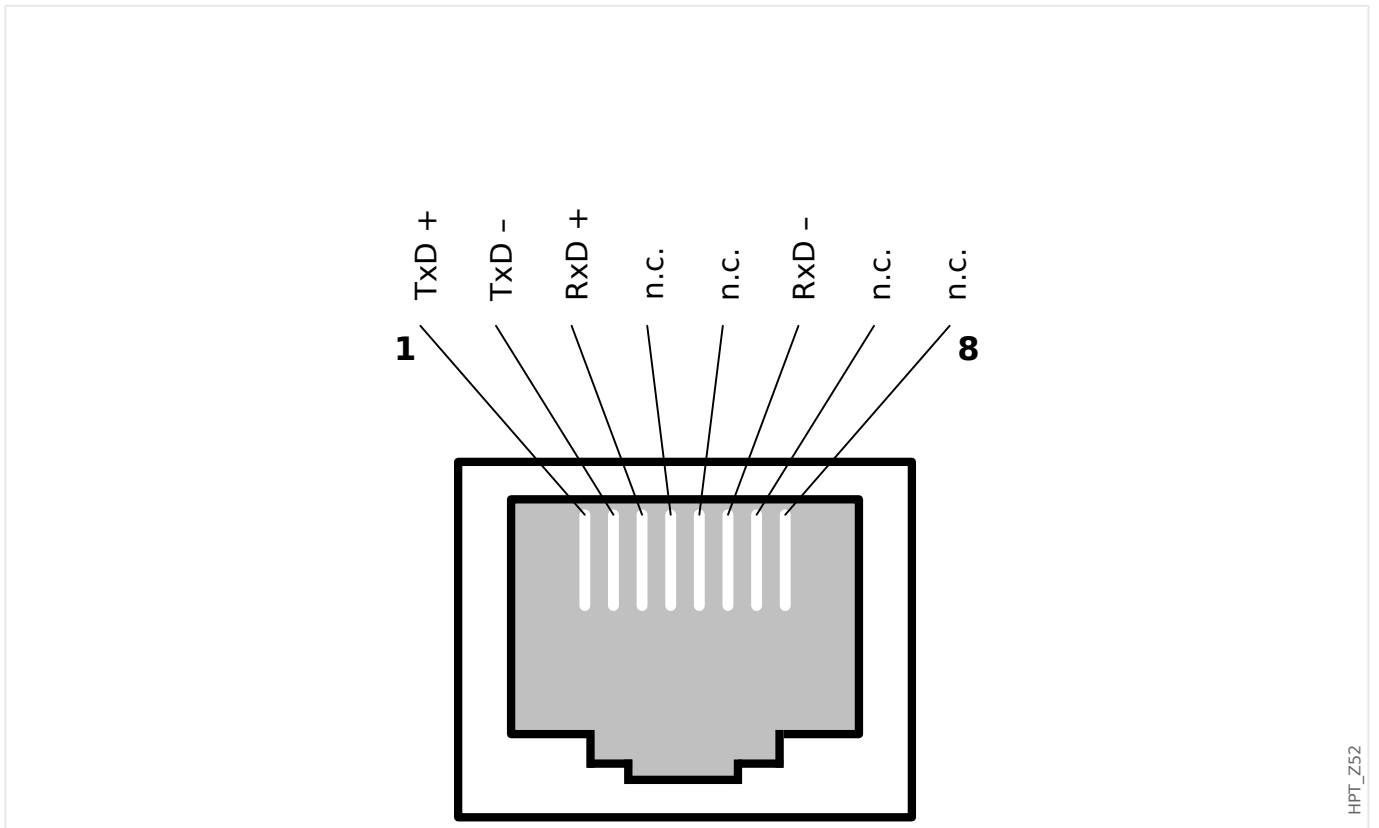

2.10 Slot X102: Protection Communication

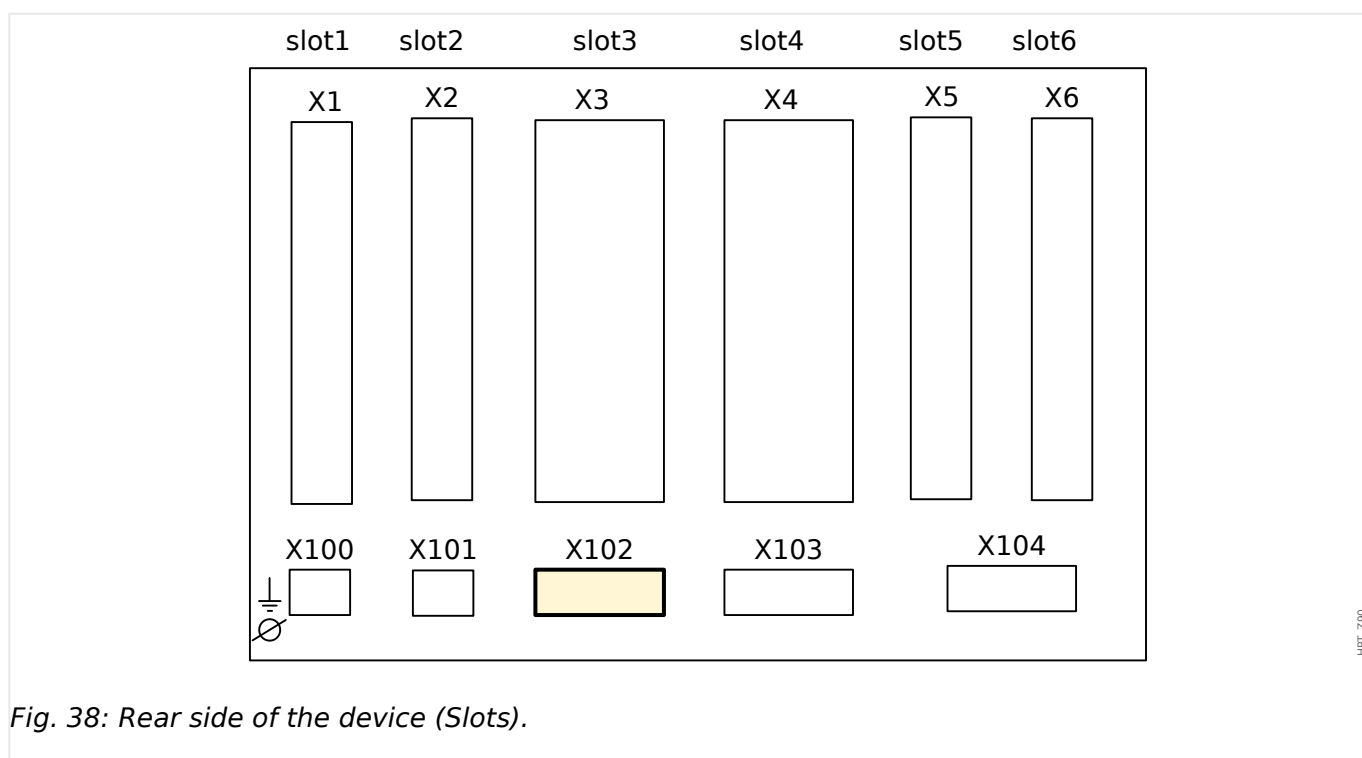

Fig. 38: Rear side of the device (Slots).

The Protection Communication interface is available in slot **X102**.

Available assembly groups in this slot:

- Fiber optics interface for the »ProtCom« (Protection Communication) module.

2.10.1 Interface for the URTD Module

The Universal Resistance-Temperature Detector (URTD) module has to be connected to the protective device at the special fiber optic interface (1 optical slave).

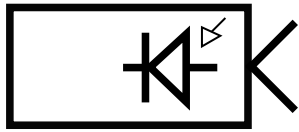

E_F45

Fig. 39: Interface for the External URTD Module - Terminal Marking



E_F46

Fig. 40: Interface External URTD Module - Terminal Marking

2.11 Slot X103: Data Communication

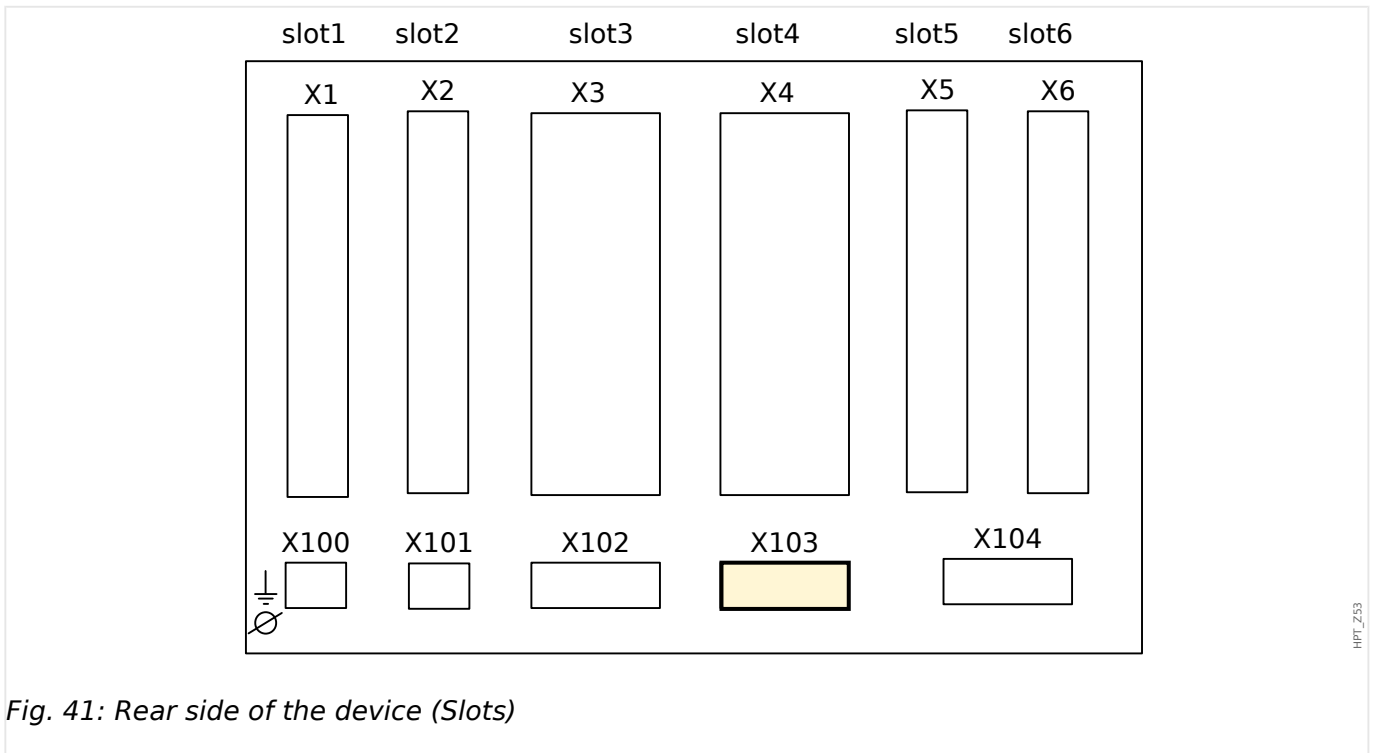

Fig. 41: Rear side of the device (Slots)

The data communication interface in the **X103** slot is dependent on the **ordered device type**. The scope of functions is dependent on the type of data communication interface.

Available assembly groups in this slot:

- **RS485 terminals** for Modbus, DNP and IEC
- **Fiber Optics interface** for Profibus, Modbus, DNP and IEC
- **D-SUB interface** for Modbus, DNP and IEC
- **D-SUB interface** for Profibus
- **Fiber Optics interface** for Ethernet

NOTICE!



The available combinations can be gathered from the **ordering code**.

2.11.1 Modbus® RTU / IEC 60870-5-103 via RS485

WARNING!



Ensure the correct tightening torques.

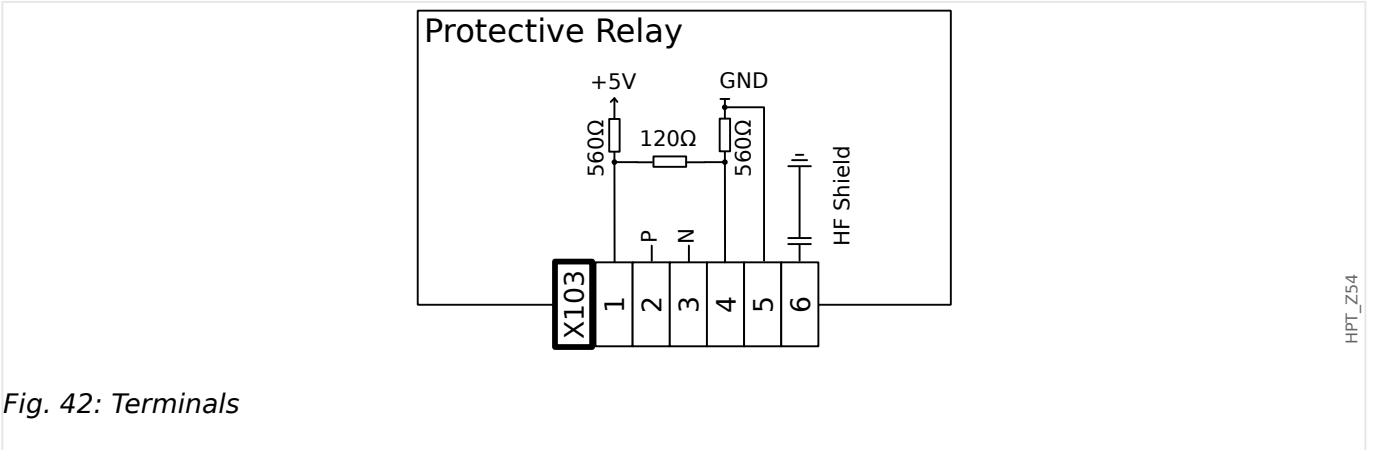
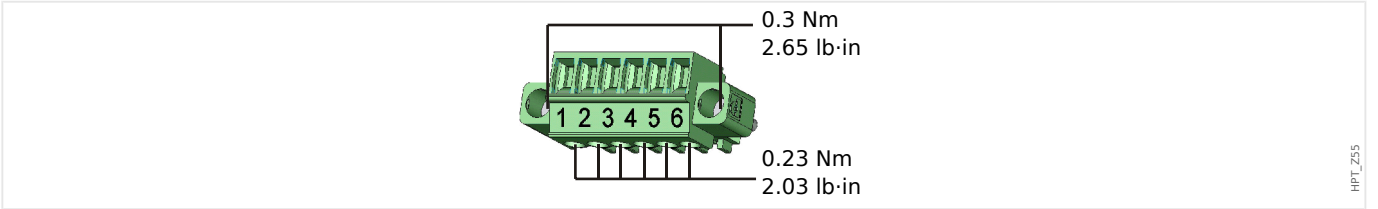

Fig. 42: Terminals

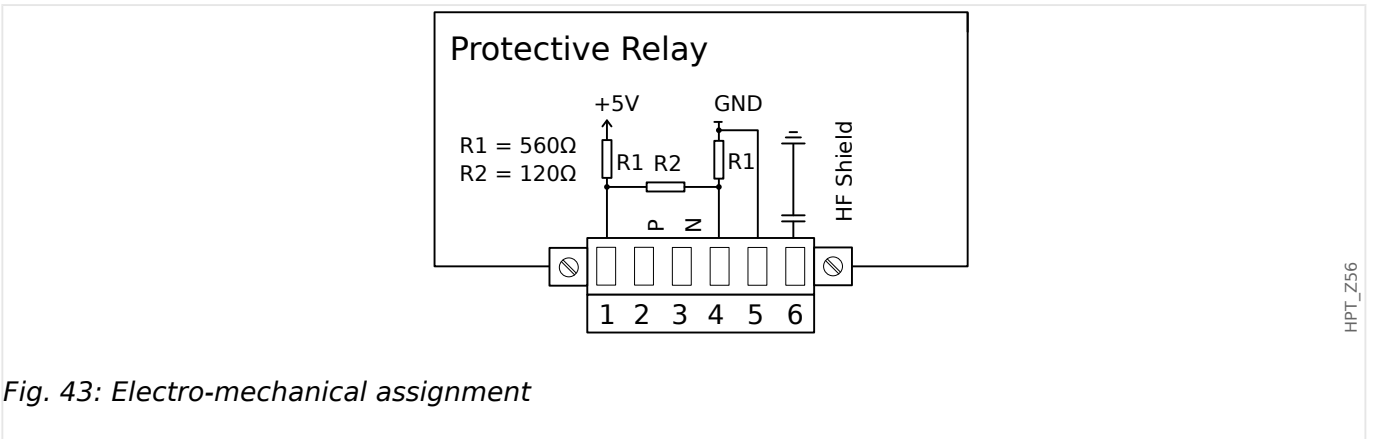



Fig. 43: Electro-mechanical assignment

NOTICE!



- The Modbus® / IEC 60870-5-103 connection cable must be shielded. The shielding has to be fixed at the screw beneath the interface at the rear side of the device.
- The communication is halfduplex.

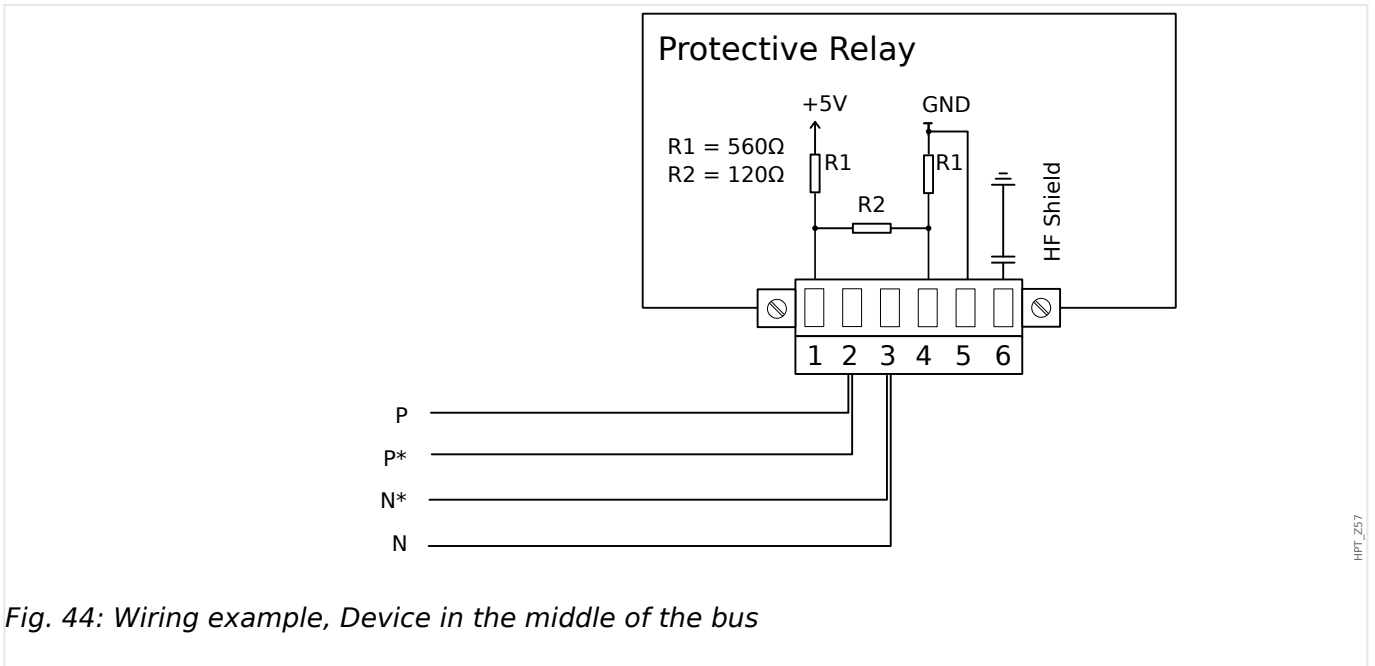

Fig. 44: Wiring example, Device in the middle of the bus

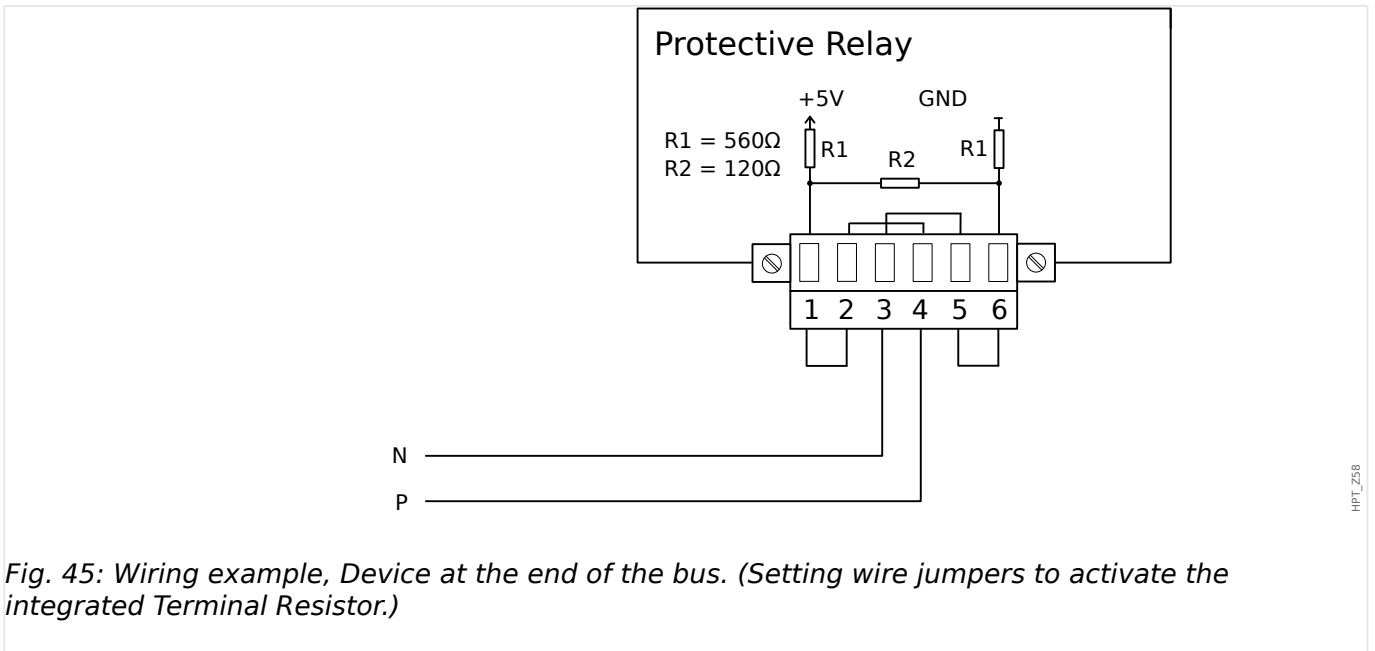

Fig. 45: Wiring example, Device at the end of the bus. (Setting wire jumpers to activate the integrated Terminal Resistor.)

2 Hardware

2.11 Slot X103: Data Communication

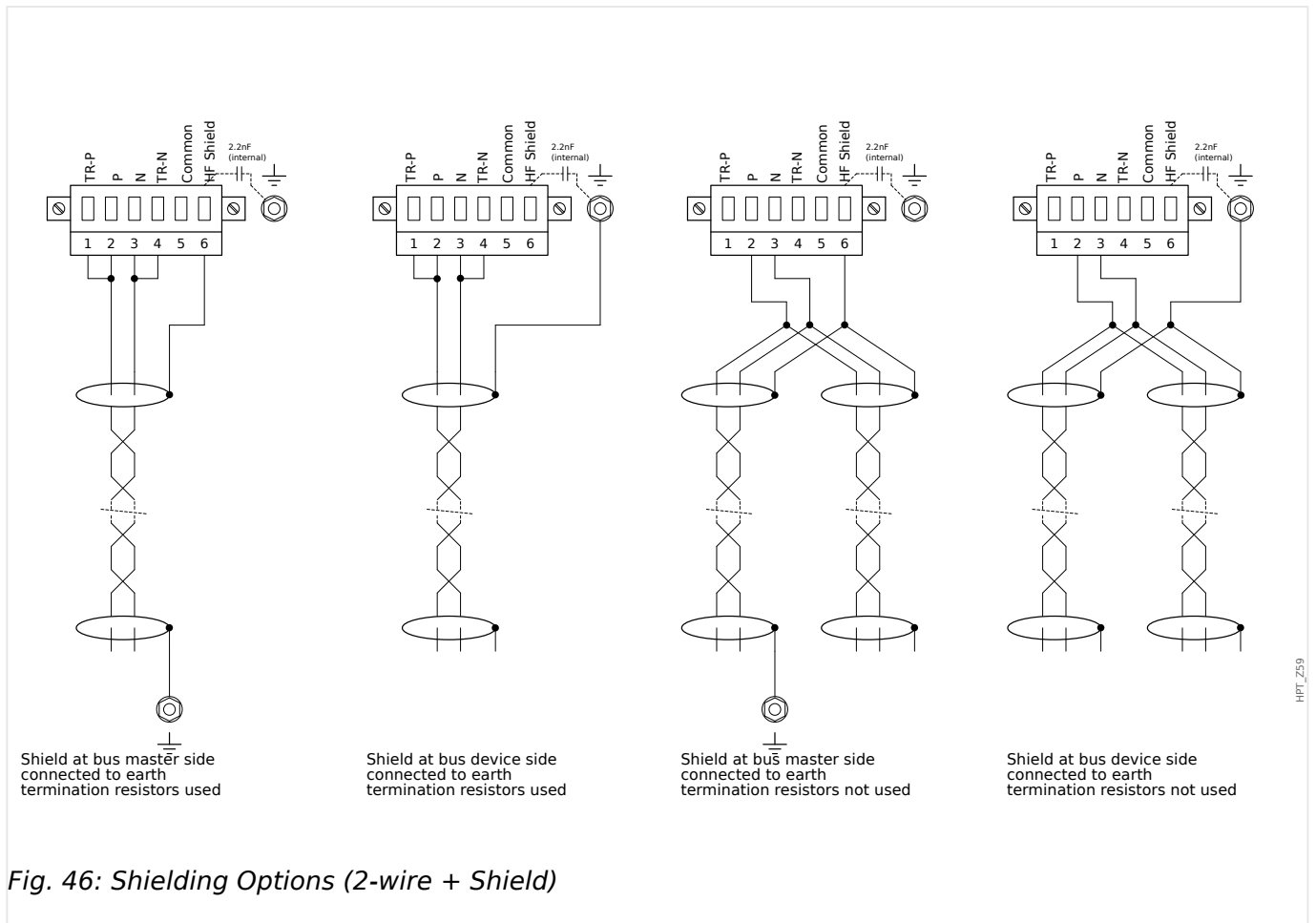
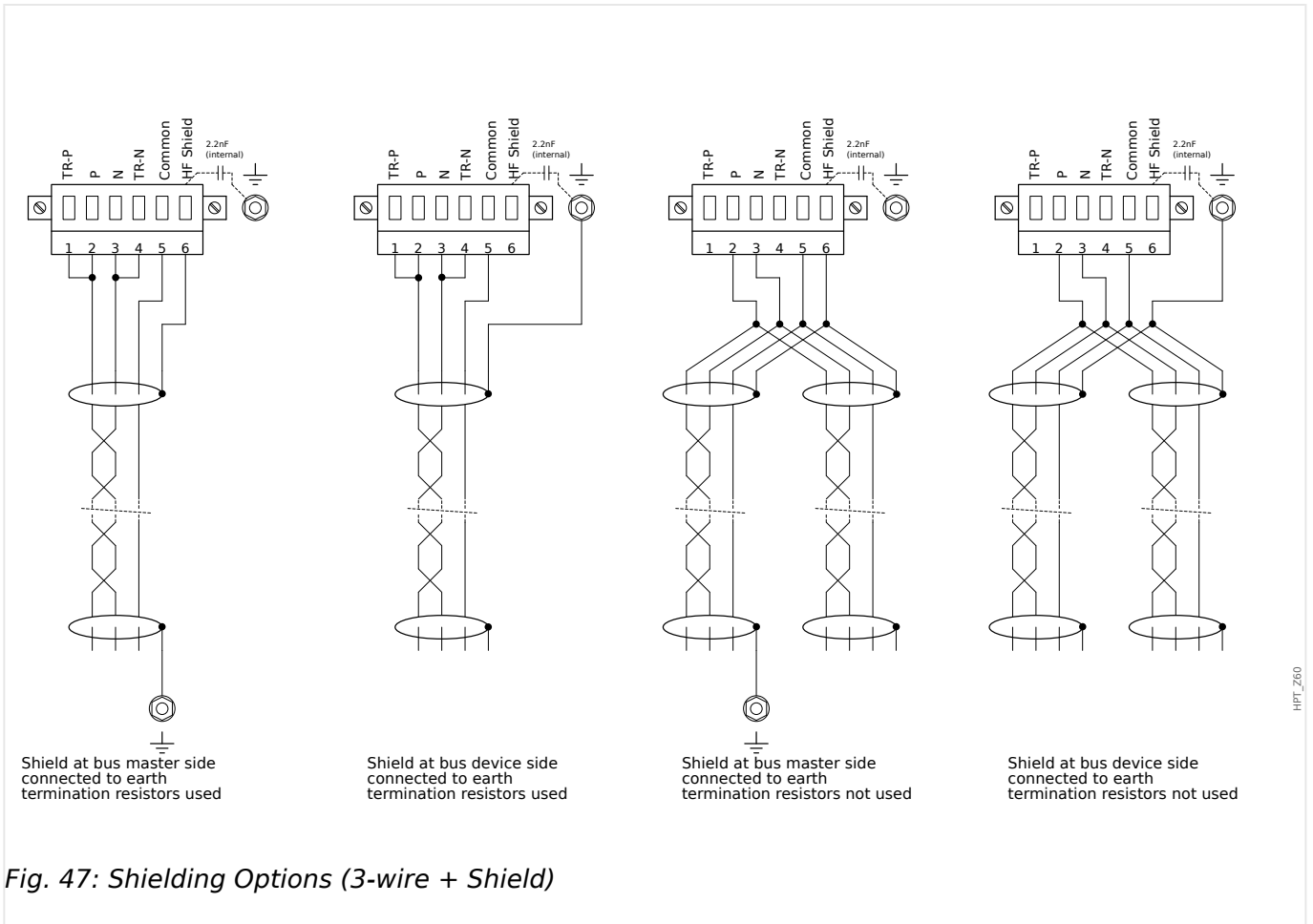
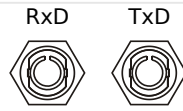

Fig. 46: Shielding Options (2-wire + Shield)



HPT_Z60

2.11.2 Profibus DP/ Modbus® RTU / IEC 60870-5-103 via Fiber Optic



HPT_Z61

Fig. 48: Fiber Optic – FO, ST connector

WARNING!



Do not look directly into the light beam that is emitted from the fiber optics connector!

Serious injury of the eyes can be consequence of ignoring this warning.

2.11.3 Profibus DP via D-SUB

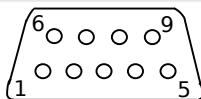

HPT_262

D-SUB assignment - bushing

- 1: Earthing/shielding
- 3: RxD TxD - P: High-Level
- 4: RTS-signal
- 5: DGND: Ground, neg. Potential of aux voltage supply
- 6: VP: pos. Potential of the aux voltage supply
- 8: RxD TxD - N: Low-Level

NOTICE!



The connection cable must be shielded. The shielding has to be fixed at the screw which is marked with the ground symbol at the back side of the device.

2.11.4 Modbus® RTU / IEC 60870-5-103 via D-SUB

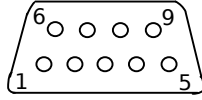

HPT_262

D-SUB assignment - bushing

- 1: Earthing/shielding
- 3: RxD TxD - P: High-Level
- 4: RTS-signal
- 5: DGND: Ground, neg. Potential of aux voltage supply
- 6: VP: pos. Potential of the aux voltage supply
- 8: RxD TxD - N: Low-Level

NOTICE!



The connection cable must be shielded.

2.11.5 Ethernet / TCP/IP via Fiber Optics

RxD TxD



HPT_Z03

Fig. 49: Fiber Optics – FO, LC duplex connector.

CAUTION!



After plugging in the LC connector, fasten the metal protecting cap.

The tightening torque for the screw is 0.3 Nm [2.65 lb·in].

WARNING!



Do not look directly into the light beam that is emitted from the fiber optics connector!

Serious injury of the eyes can be consequence of ignoring this warning.

2.12 Slot X104: IRIG-B00X and Selfsupervision Contact

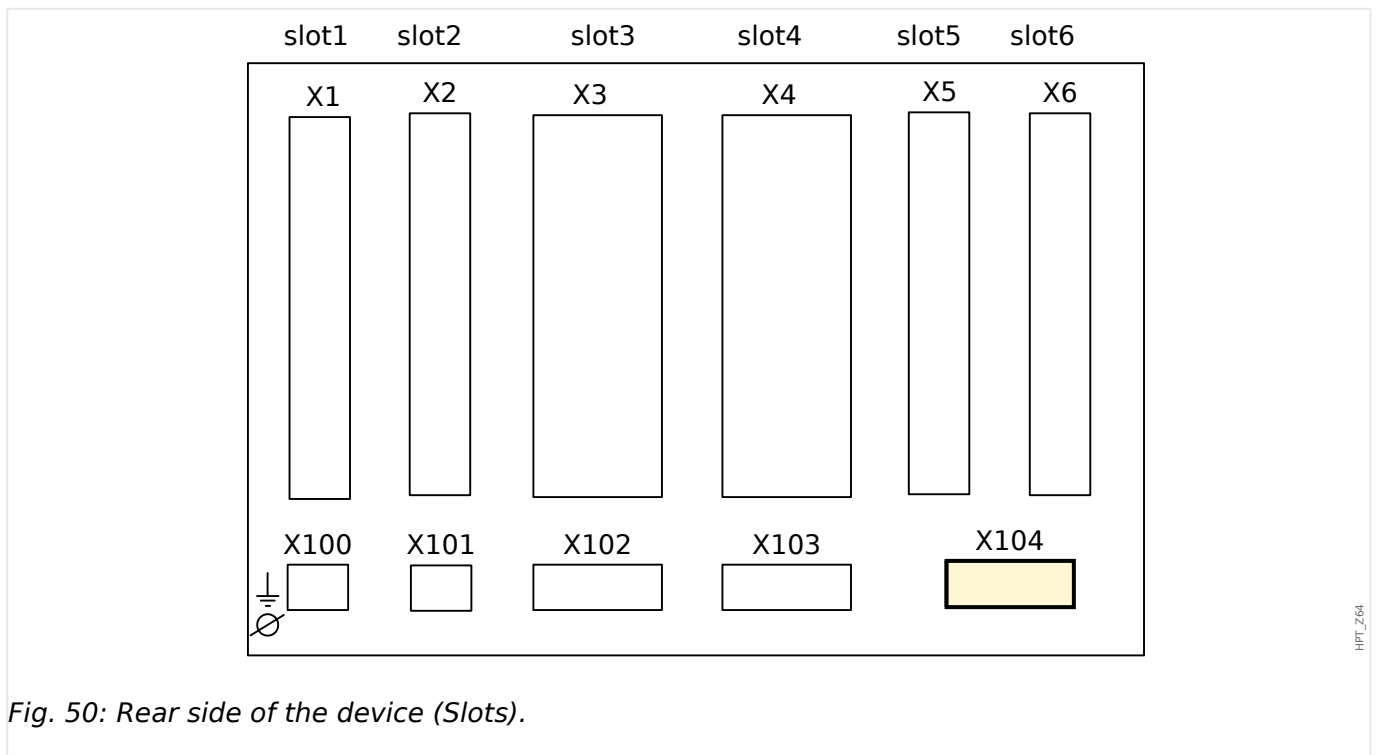

Fig. 50: Rear side of the device (Slots).

This slot comprises the IRIG-B00X and the Selfsupervision Contact.

Available assembly groups in this slot:

- IRIG-B00X, incl. Selfsupervision Contact

2.12.1 Self-Supervision Contact (SC)/Life-Contact and IRIG-B00X

WARNING!



Ensure the correct tightening torques.

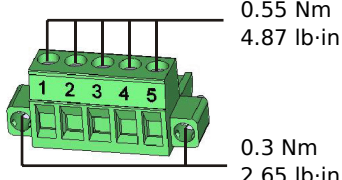

0.55 Nm
4.87 lb·in

0.3 Nm
2.65 lb·in

HPT_Z67

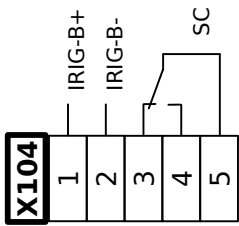

X104

1 2 3 4 5

IRIG-B+ IRIG-B- SC NC SC NO SC C

HPT_Z65

Fig. 51: Terminals

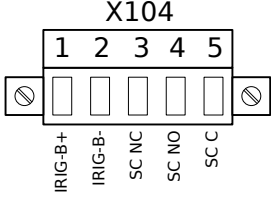

X104				
1	2	3	4	5
IRIG-B+	IRIG-B-	SC NC	SC NO	SC C

HPT_Z66

Fig. 52: Electro-mechanical assignment

Self-Supervision Contact

The Self-Supervision Contact contact (“SC”) cannot be configured. It is a changeover (Form “C”) contact that picks up when the device is free from internal faults. While the device is booting up, the “SC” relay remains dropped-off (unenergized). As soon as the system is properly started (and protection is active), it picks up and the assigned LED is activated accordingly (please refer to the Self Supervision chapter, [↗](#) “Self-Supervision”).

2.13 PC Interface - X120

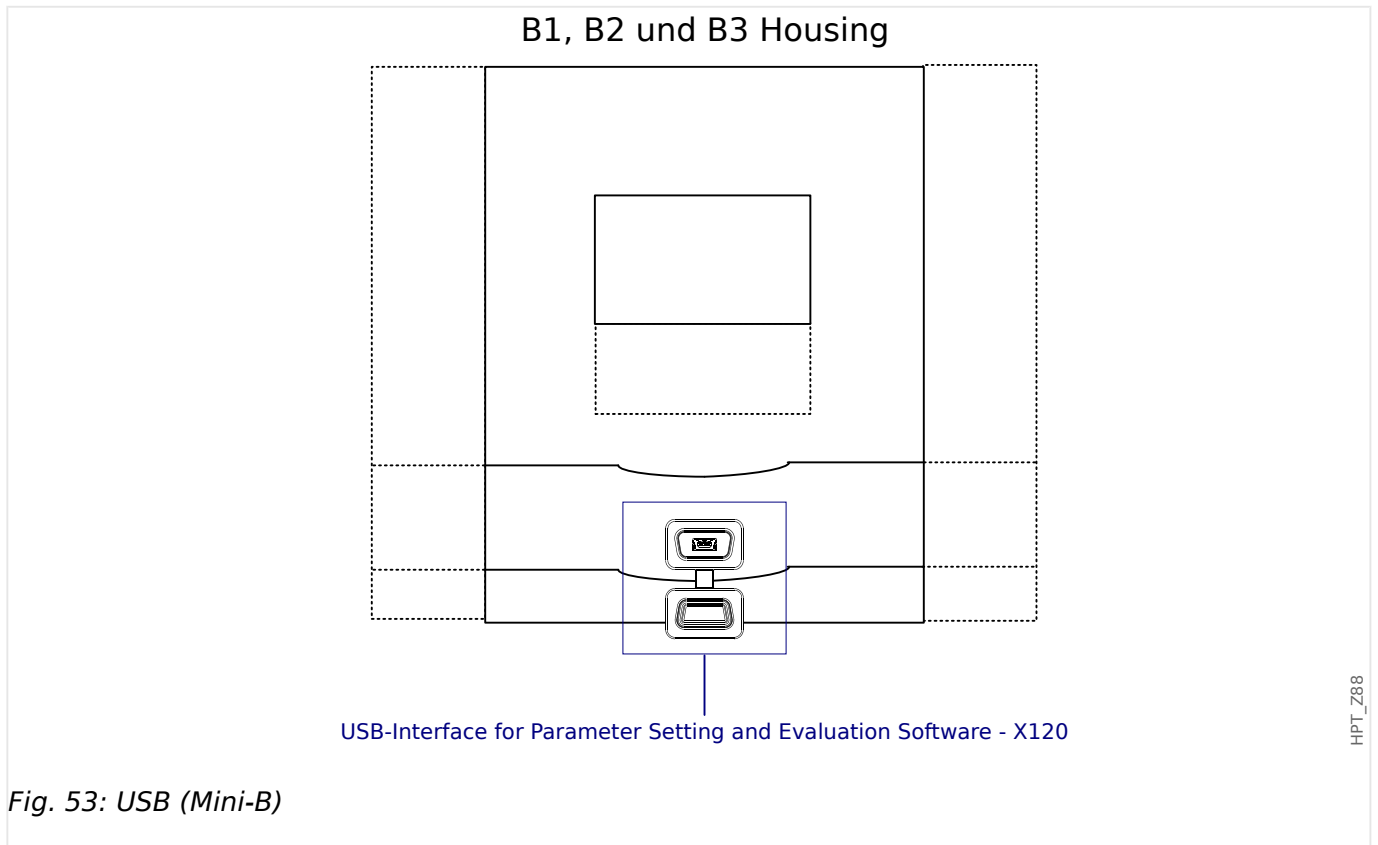

Fig. 53: USB (Mini-B)

2.14 Input, Output and LED Settings

2.14.1 LEDs

LED Configuration

The LEDs can be configured within the menu branches [Device Para / LEDs / LEDs group A] (LED column left to the display) and [Device Para / LEDs / LEDs group B] (LED column right to the display).

CAUTION!



Attention must be paid to ensure that there are no overlapping functions due to double or multiple LED assignment of colors and flashing codes.

NOTICE!



This chapter contains information on the LEDs that are placed on the left-hand side of the display (Group A).

If your device is also equipped with LEDs on the right-hand side of the display (Group B), the information given in this chapter is valid in the same way, and the only difference between "Group A" and "Group B" is within the menu paths.

Apart from the LED for System OK (that has a fixed function), each LED can be configured via the following parameters:

- »Assigned signals«: The parameters [Device Para / LEDs / LED x] »Assignment 1« to »Assignment 5« can be used to assign up to 5 trigger signals to "LED number x".
- »Inverting«: The parameters »Inverting 1« to »Inverting 5«, if set to "active", can be used to invert the respective trigger signal.

Note that for a **non-assigned** trigger signal (i. e. »Inverting n« = "-") the inverting is ineffective, so that the trigger signal is always simply treated as a binary "0" (False/inactive).

- »Latching/self holding function«: With the setting »Latched« = "active", the state that is set by the trigger signals is permanently stored. (See section "Latching" below, [↪ "2.14.1 Latching"](#).)
If »Latched« = "inactive", the LED always adopts the state of the assigned signals.
- »Ack signal«: This setting is available only if »Latched« = "active". It assigns a signal that will reset the latching of the LED. (This, however, is effective only if all assigned trigger signals have dropped out.)
- »LED active color«: The LED lights up in this color if at least one of the assigned trigger signals is active. Available setting values are: "-" (No assignment), "green", "red", "red flash", "green flash".
- »LED inactive color«: The LED lights up in this color when none of the allocated functions is active. (The available settings are the same as for the active color above.)

»INFO« *Push-Button*

Via the »INFO« button it is always possible to display the current status of the assigned trigger signals.

Main LED overview:

If the »INFO« key is pressed once, the »main overview of the left LEDs« are displayed.

If the »INFO« key is pressed a second time, the »main overview of the right LEDs« are displayed (if available).

By pressing the softkey »left« (or the »INFO« key a third time) you will leave the main LED menu.

The main overview shows the first assignments of the LEDs. Periodically the available softkeys will be shown.

LED multiple assignment page:

On the main overview page use the softkeys »up« and »down« to select an LED.«

From there you can enter the »LED multiple assignment page« by pressing softkey »right«.

This page gives you detailed information of all states assigned to this LED. An arrow symbol points to the LED whose assignments are currently displayed.

Via the softkeys »up« and »down« you can call up the next / previous LED.

By pressing the softkey »left« you will return to the main LED overview.

Latching

If an LED is configured as »Latched« = "active", it will keep its state - regardless whatever may happen - until it is acknowledged (see "Acknowledgment Options" below).

A latched LED gets reset only in any of the following cases and only after all assigned trigger signals have dropped out:

- It is acknowledged (either by the user at the HMI, or via SCADA), see below.
- It is reset (acknowledged) by the signal that has been assigned to the parameter »Ack signal«.
- It is re-configured to »Latched« = "inactive".
- If no trigger signal at all is assigned, i. e. **all** »Assignment n« have been set to "-".

Note that a latched LED does **not** get reset in case of a restart of the MRMV4: After a (warm or cold) restart, every latched LED will return to its individual (previously assumed) state.

Acknowledgment Options

Resetting a latched LED will always require an acknowledgment. (For a detailed description, see  "Acknowledgments".)

LEDs can be acknowledged by:

- Via the push-button »C« at the operating panel, see  “1.5 Manual Acknowledgment (by Pressing the C Key at the Panel)”.
- The LED can be acknowledged by the signal that has been assigned to the parameter »Ack signal«.
- All latched LEDs can be acknowledged at once by the signal that has been assigned to the parameter [Device Para / Acknowledge] »Ack LED«.
- All LEDs can be acknowledged at once via Communication (SCADA).
- All LEDs can be acknowledged at once automatically in case of an alarm from a protection function.

Remark: The two options, that allow for resetting all LEDs at once via signal or SCADA, are available only if [Device Para / Acknowledge] »Remote Reset« = “active”.

The last option, that allows for resetting all LEDs at once in case of a protection alarm, must be activated by setting: [Device Para / LEDs / LEDs group A / LED 1...n] »Latched« = “active, ack. by alarm”.

See also  “Acknowledgments” for more information.

NOTICE!



The Product-CD that is delivered with the device contains a PDF-Template in order to create and print out self adhesive films for LED assignment texts (front foil) by means of a laser printer. Recommendation: (AVERY Zweckform Art. Nr. 3482)

Functionality

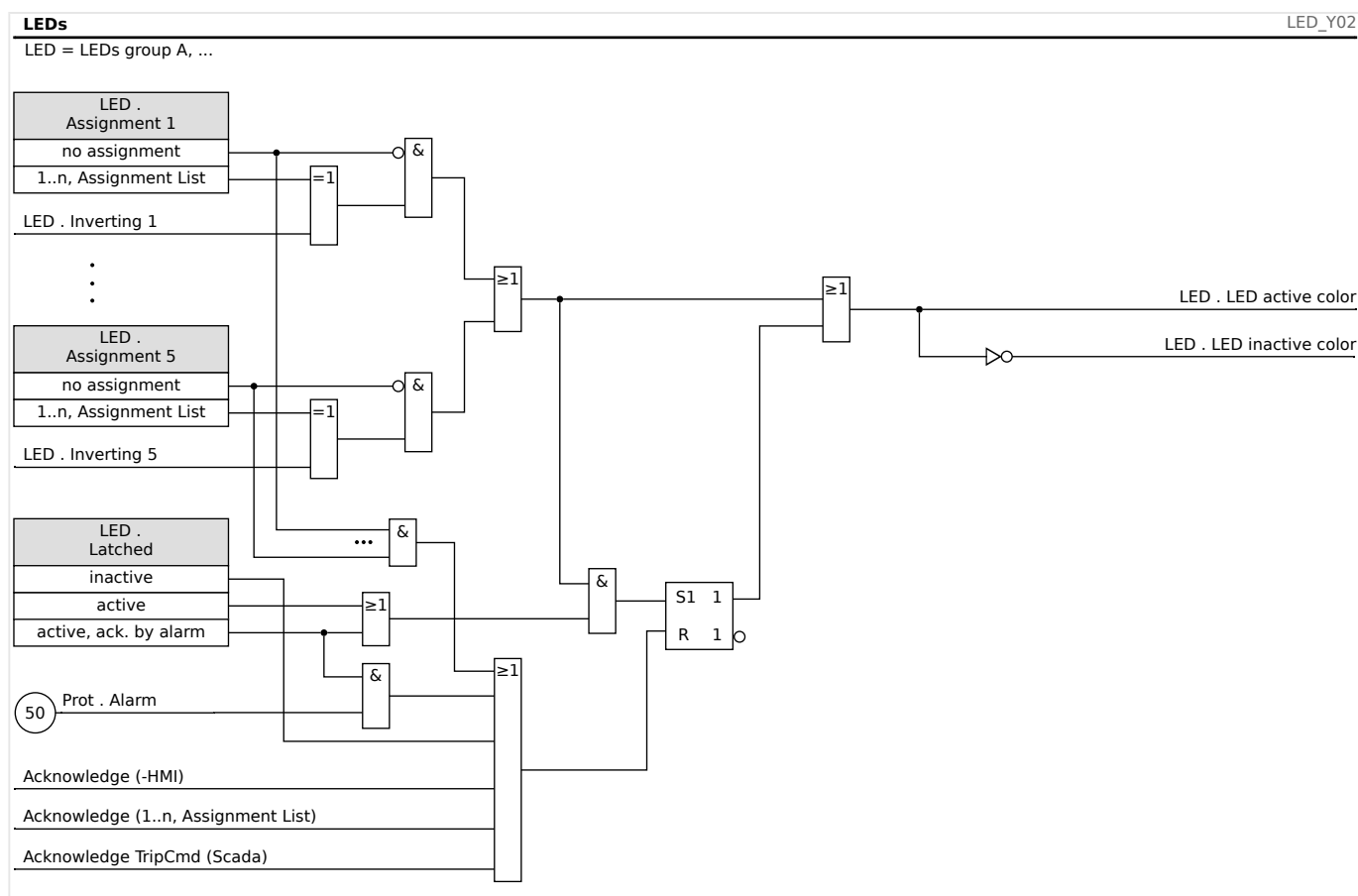

The »System OK« LED

This LED flashes green while the device is booting. After booting is complete, the LED for System OK lights up in green, signaling that the protection (function) is »activated«. Please refer to [↪](#) "Self-Supervision" and to the external document *Troubleshooting Guide* to find out further information on blink codes of the System OK LED.

The »System OK« LED cannot be parameterized.

2.14.2 Configuration of the Digital Inputs

The State of the Digital Inputs can be checked within the menu: [Operation / Status Display / name of the assembly group (e. g. "DI-8 X")]

The Digital Inputs can be configured within the menu: [Device Para / Digital Inputs / name of the assembly group (e. g. "DI-8 X") / Group X]

Set the following parameters for each of the digital inputs:

- »Nominal voltage«
- »Debouncing time«: A state change will only be adopted by the digital input after the debouncing time has expired.
- »Inverting« (where necessary)

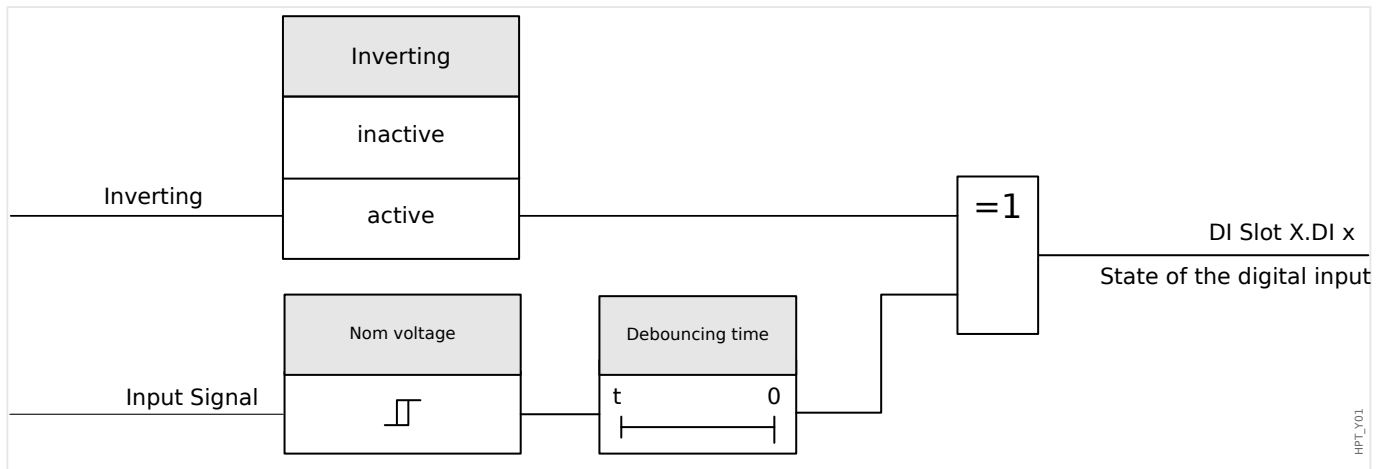

CAUTION!



The debouncing time will be started each time the state of the input signal alternates.

CAUTION!



In addition to the debouncing time that can be set via software, there is always a hardware debouncing time (approx 12 ms) that cannot be turned of.

There are two options available in order to determine where a Digital Input should be assigned to.

Assignment of Digital Inputs

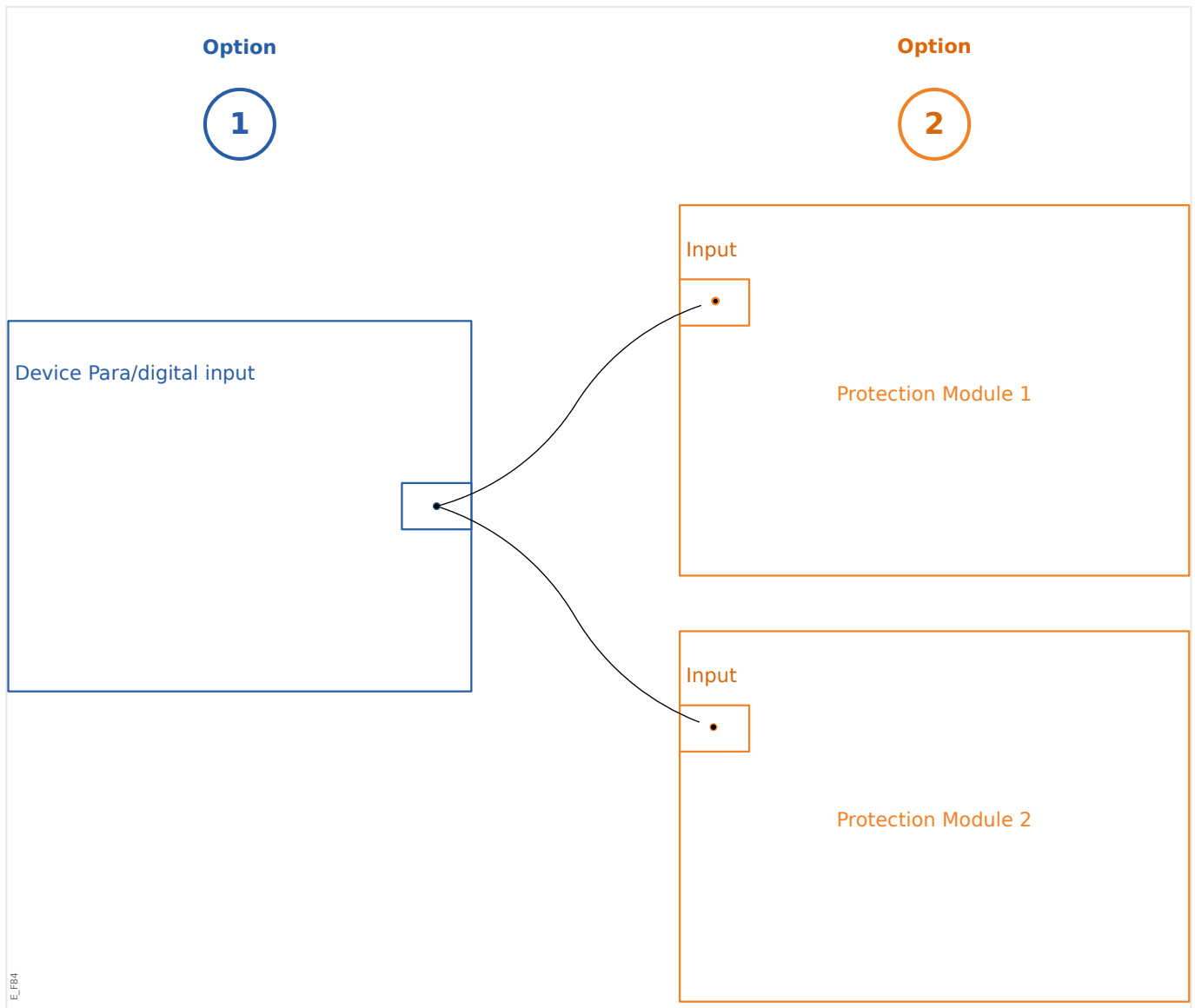

Option 1: Assigning a Digital Input onto one or multiple modules.

Adding an assignment:

Within menu [Device Para / Digital Inputs], Digital Inputs can be assigned onto one or multiple targets.

Call up the Digital Input (Arrow right on the DI). Click on the Softkey »Parameter Setting/Wrench«. Click on »Add« and assign a target. Assign where required additional targets.

Deleting an assignment:

Select as described above a Digital Input that should be edited at the HMI.

Call up the assignments of the Digital Input (Arrow-right on the DI) and select the assignment that should be removed/deleted (Please note, this has to be marked with the cursor). The assignment can now be deleted at the HMI by means of the Softkey »Parameter setting« and selection of »remove«. Confirm the parameter setting update.

Option 2: Connecting a Module Input with a Digital Input

Call a module. Within this module assign a Digital Input onto a module input.

Example: A protection module should be blocked depending on the state of a Digital Input. For this assign onto the blocking input within the Global Parameters the Digital Input (e. g. »ExBlo1«).

Checking the Assignments of a Digital Input

In order to check the targets that a Digital Input is assigned to please proceed as follows:

Call up menu [Device Para / Digital Inputs].

Navigate to the Digital Input that should be checked.

At the HMI:

A multiple assignment, that means if a Digital Input is used more than once (if it is assigned to multiple targets), this will be indicated by an ellipsis "..." next to a Digital Input. Call up this Digital Input by Softkey »Arrow right« in order to see the list of targets of this Digital Input.

2.14.3 Output Relays Settings

The State of the Relay Outputs can be checked within the menu: [Operation / Status Display / Name of the assembly group (e. g. BO-3 X)]

The Relay Outputs can be configured within the menu: [Device Para / Binary Outputs / Name of the assembly group (e. g. BO-3 X)]

The conditions of module outputs and signals/protective functions (such as reverse interlocking) can be passed by means of alarm relays. The alarm relays are potential-free contacts (which can be used as opening or closing contact). Each alarm relay can be assigned up to 7 functions out of the »assignment list«.

Set the following parameters for each of the binary output relays:

- »Assigned signals«: The parameters »Assignment 1« to »Assignment 7« can be used to assign up to 7 trigger signals (OR-connected).
- »Inverting«: The parameters »Inverting 1« to »Inverting 7«, if set to "active", can be used to invert the respective trigger signal.

Note that for a **non-assigned** trigger signal (i. e. »Assignment n« = "-") the inverting is ineffective, so that the trigger signal is always simply treated as a binary "0" (False/inactive).

- With the setting »Inverting« = "active", the (collective) state of the binary output relay can be inverted (open or closed circuit current principle).

Note that if **no signals at all** have been assigned (i. e. **all** »Assignment n« = "-") this inverting is ineffective, so that the (collective) state is always simply treated as a binary "0" (False/inactive).

- By the »Operating Mode« it can be determined whether the relay output works in working current or closed-circuit principle.
- With the setting »Latched« = "inactive", the relay contact continuously adopts the state of the assigned signals.
- With the setting »Latched« = "active", the state of the relay contact is stored permanently. (See also the "Latching" section below, [↪ "2.14.3 Latching"](#).)
- »Acknowledgement«: This setting is available only if »Latched« = "active". It assigns a signal that will reset the latching of the relay contact. (This, however, is effective only if all assigned trigger signals have dropped out.)

The relay contact can only be acknowledged after all signals that had initiated the setting of the relay have dropped out, and after the minimum retention time »t-Off Delay« has elapsed.

- »t-hold«: At signal changes, the minimal latching time ensures that the relay will be maintained picked-up or released for at least this period.

NOTICE!



The System OK alarm relay (SC) (watchdog) cannot be configured.

Latching

If a binary output is configured as »Latched« = “active”, it will keep its state - regardless whatever may happen - until it is acknowledged (see “Acknowledgment Options” below).

A latched binary output gets reset only in any of the following cases and only after all assigned trigger signals have dropped out:

- It is acknowledged (either by the user at the HMI, or via SCADA), see below.
- It is reset (acknowledged) by the signal that has been assigned to the parameter »Acknowledgement«.
- It is re-configured to »Latched« = “inactive”.
- If no trigger signal at all is assigned, i. e. **all** »Assignment n« have been set to “-”.

Note that a latched binary output does **not** get reset in case of a restart of the MRMV4: After a (warm or cold) restart, every latched output will return to its individual (previously assumed) state.

Acknowledgment Options

Resetting a binary output in a latched position will always require an acknowledgment. (For a detailed description, see  “Acknowledgments”.)



Binary output relays can be acknowledged:

- Via the push-button »C« at the operating panel.
- The relay output contact can be acknowledged by the signal that has been assigned to the parameter »Acknowledgement«.
- All binary output relays can be acknowledged at once by the signal that has been assigned to the parameter [Device Para / Acknowledge] »Ack BO«.
- All output relays can be acknowledged at once via SCADA.

Remark: The last two options, that allow for resetting all outputs at once, are available only if [Device Para / Acknowledge] »Remote Reset« = “active”.

WARNING!



Relay output contacts can be set by force or disarmed (for commissioning support. Please refer to the following chapters:  “Disarming the Relay Output Contacts”,  “Forcing the Relay Output Contacts”).

Functionality

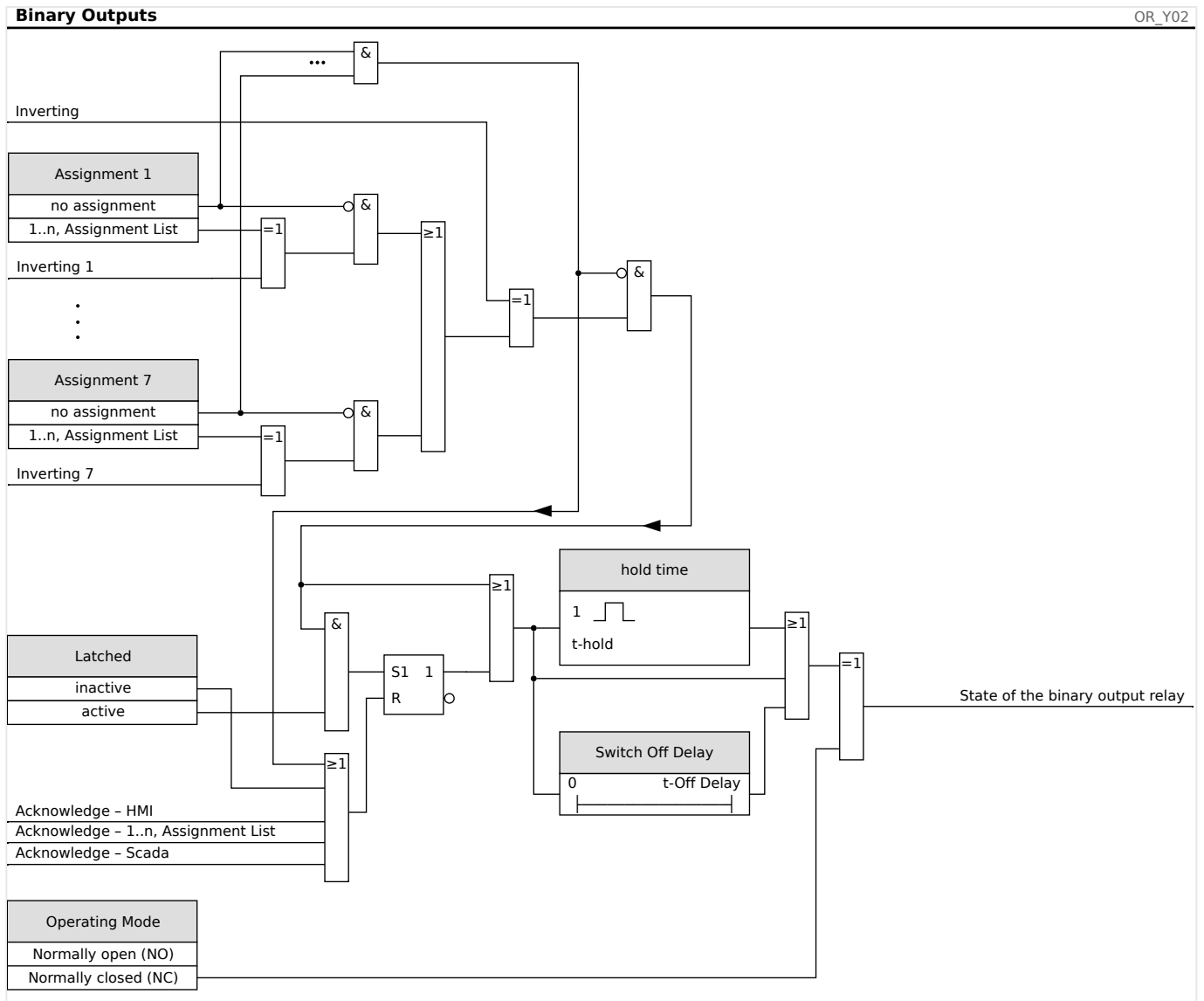

System Contact

The System OK alarm relay (SC) is the devices »life contact«. Its installation location depends on the housing type. Please refer to the wiring diagram of the device (WDC-contact).

The System-OK relay (SC) cannot be parameterized. The system contact is an operating current contact that picks-up, when the device is free from internal faults. While the device is booting up, the System OK relay (SC) remains dropped-off. As soon as the system was duly started up, the relay picks up and the assigned LED is activated accordingly (please refer to »Self-Supervision«).

2.14.4 Configuration of the Analog Outputs

The Analog Outputs can be programmed to output for three different ranges of either »0–20mA«, »4–20 mA«, or »0–10 Volts«.

These outputs can be configured by the user to represent the status of user-programmed parameters that are available from the relay. The settings for this feature can be found in the menu branch [Device Para / Analog Outputs].

The setting »Assignment« assigns a parameter to which the output will correlate.

Once the assignment has been made, the parameter »Range « selects the required output type / range of the parameter that shall correlate to the analog output.

The user defines a »Range min« and a »Range max«. The »Range min« determines the value at which value the transmission starts. Likewise, the »Range max« value determines the value that results in the end value of the transmission.

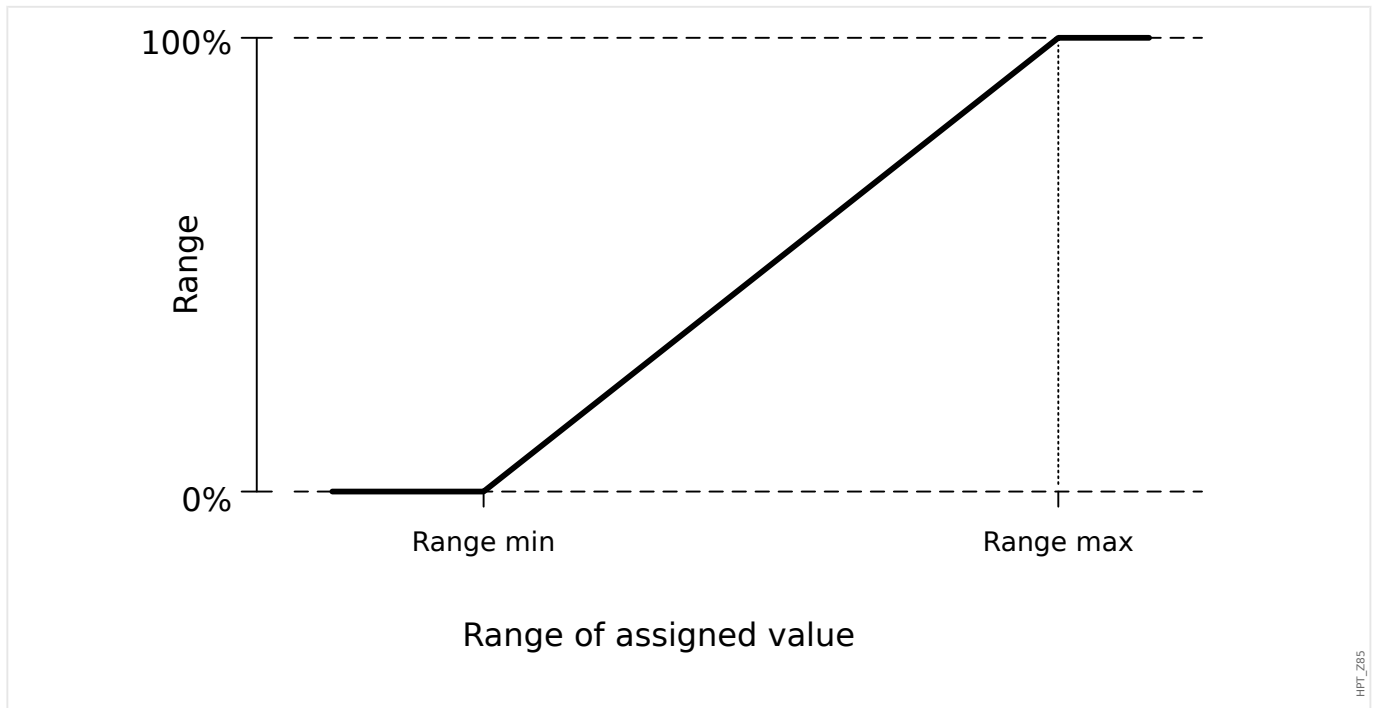

Setting Example: Analog Output with Active Power P*

*=only available in Devices that offer Power Protection

All settings/thresholds within the power module are to be set as per unit thresholds. Per definition S_n is to be used as scale basis.

$$S_n = \sqrt{3} \cdot (\text{Voltage Transformer}_{\text{Line-to-Line_Rated_Voltage}}) \cdot (\text{Current Transformer}_{\text{Rated_Current}})$$

If thresholds should base on primary side values:

$$S_n = \sqrt{3} \cdot (\text{Voltage Transformer}_{\text{Pri_Line-to-Line_Rated_Voltage}}) \cdot (\text{Current Transformer}_{\text{Pri_Rated_Current}})$$

If thresholds should base on secondary side values

$$S_n = \sqrt{3} \cdot (\text{Voltage Transformer}_{\text{Sec_Line-to-Line_Rated_Voltage}}) \cdot (\text{Current Transformer}_{\text{Sec_Rated_Current}})$$

Example - Field Data:

- Current Transformer: CT pri = 200 A; CT sec = 5 A
- Voltage Transformer: VT pri = 10 kV; VT sec = 100 V
- Active power range 1 MW to 4 MW is mapped to an Analog Outputs 0% to 100%.

Calculating setting for Range min and Range max based on primary side values:

Active power range is 1 MW to 4 MW.

First S_n has to be calculated:

$$S_n = \sqrt{3} \cdot (\text{Voltage Transformer}_{\text{Pri_Line-to-Line_Rated_Voltage}}) \cdot (\text{Current Transformer}_{\text{Pri_Rated_Current}})$$

$$S_n = 1.73 \cdot 10000 \text{ V} \cdot 200 \text{ A} = 3.464 \text{ MVA}$$

Calculating the range settings based to S_n :

$$\text{Range}_{\text{min}} (0\%) = 1 \text{ MW} / 3.464 \text{ MVA} = 0.29 S_n$$

$$\text{Range}_{\text{max}} (100\%) = 4 \text{ MW} / 3.464 \text{ MVA} = 1.15 S_n$$

Calculate the Analog Output percentage for specific value:

$$\text{AnalogOutput}(\text{InputValue}) = 100\% / (\text{Range}_{\text{max}} - \text{Range}_{\text{min}}) \cdot (\text{InputValue} - \text{Range}_{\text{min}})$$

For example for input value $1 S_n$:

$$\text{AnalogOutput}(1 S_n) = 100\% / 0.86 S_n \cdot (1 S_n - 0.29 S_n) = \mathbf{82.5\%}$$

The output current for the “4...20mA” type is then **17.7 mA** = 4 mA + 82.5% * (20 mA – 4 mA)

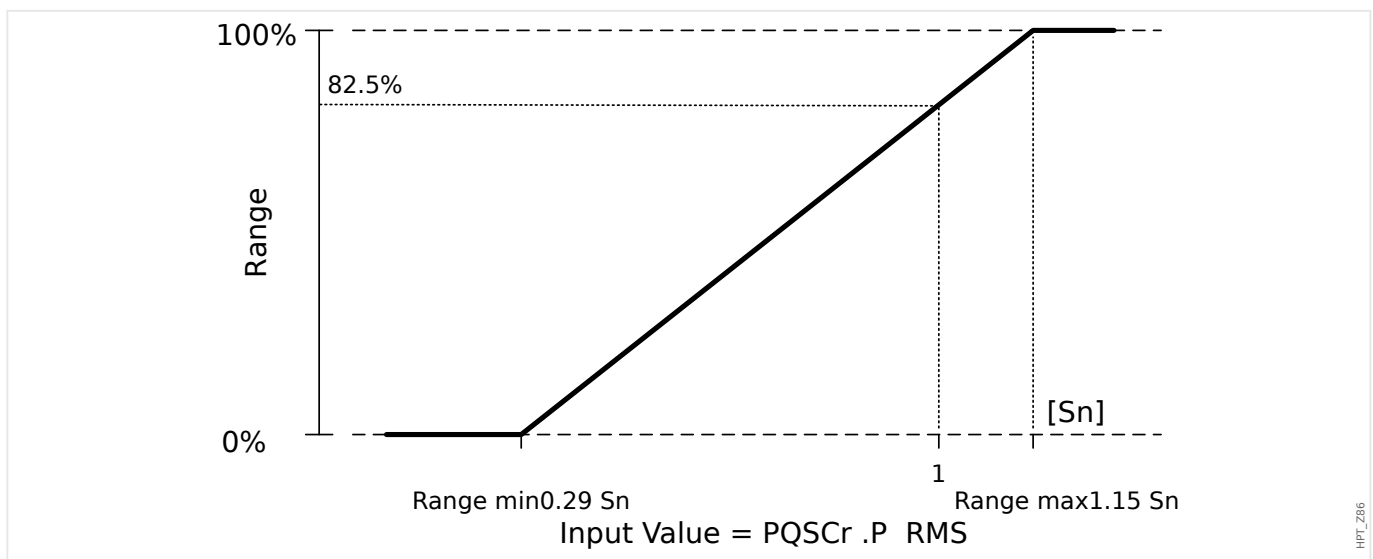

Setting Example: Analog Output with Power Factor PF*

*=only available in Devices that offer Power Protection

Since the sign of Power Factor PF follows the sign of Active Power P, one cannot conclude from the sign whether this is capacitive or inductive Reactive Power. Hence, for Analog

Output assignment the setting for PF output range uses a Power Factor with a “Sign Convention”:

a positive sign (+) PF, if Active and Reactive Power have the same sign

a negative sign (–) PF, if Active and Reactive Power have different signs

If, for example, Active Power is flowing into the load and Current lags the voltage for a inductive load, PF with sign convention uses a positive sign. This is important to set the right range settings for Analog Output.

We want to use an analog instrument with a 4...20mA linear scale, where the scale is in range from 0.8 capacitive to 0.3 inductive. The following settings shall be used:

$$\text{Range}_{\min} (0\%) = -0.8$$

$$\text{Range}_{\max} (100\%) = +0.3$$

Calculate the Analog Output percentage for specific value; for instance: $|\text{PF}|=1$ at $\varphi = 0^\circ$:

First the signed PF needs to be converted into a linear range:

$$\text{Range}_{\min}' (0\%) = -1 - (-0.8) = -0.2$$

$$\text{Range}_{\max}' (100\%) = +1 - (+0.3) = +0.7$$

$$\text{InputValue}' = +1 - (+1) = 0.0$$

$$\text{AnalogOutput}(\text{InputValue}') = 100\% / (\text{Range}_{\max}' - \text{Range}_{\min}') \cdot (\text{InputValue}' - \text{Range}_{\min}')$$

$$\text{AnalogOutput}(0) = 100\% / 0.9 \cdot 0.2 = 22.2\%$$

The output current for the “4...20mA” type is then **7.5 mA** = 4 mA + 22.2% * (20 mA – 4 mA)

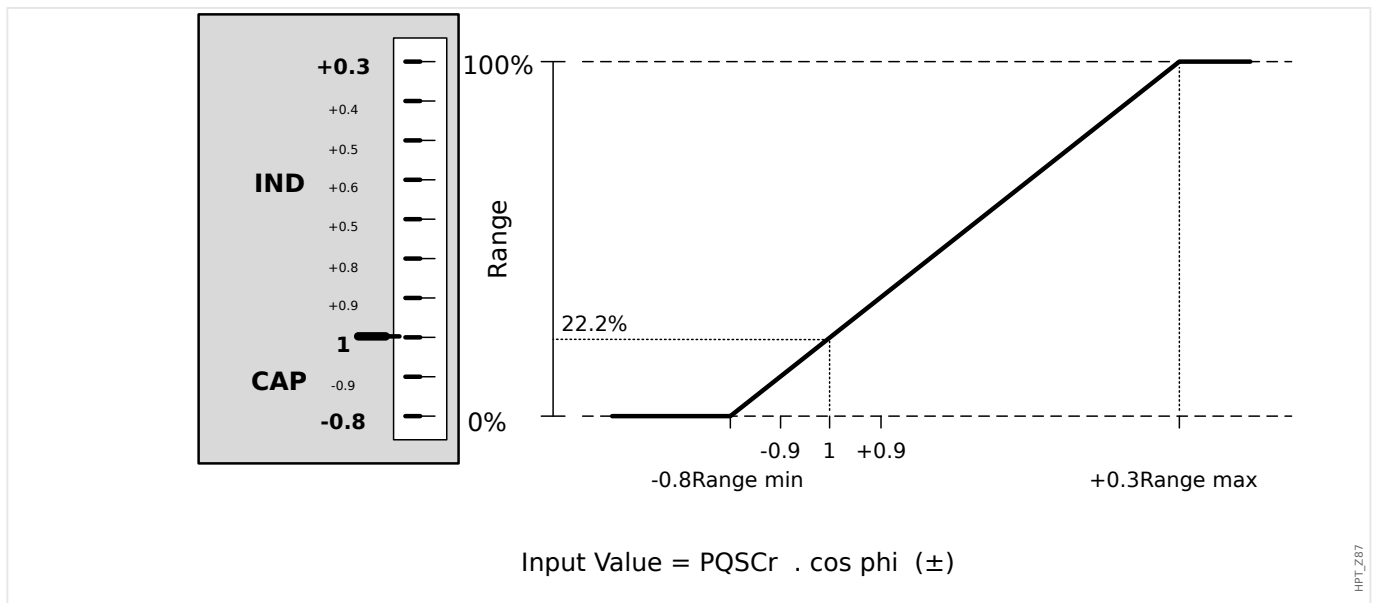

3 Communication Protocols

3.1 General SCADA (Communication) Setting

The set of available SCADA protocols depends on the ordered hardware variant (see [↪](#) “Order Form of the Device”, [↪](#) “Communication Protocol Codes”).

You have to define which one of the available SCADA protocols the MRMV4 shall use. This is done by setting [Device planning] »*Protocol*« to the required communication protocol.

After this, you have to make some more settings related to the selected protocol.

3.2 TCP/IP Settings

NOTICE!



Establishing a connection via TCP/IP to the device is only possible if your device is equipped with an Ethernet Interface (RJ45).

Contact your IT administrator in order to establish the network connection.

Within menu [Device Para / TCP/IP / TCP/IP config] the TCP/IP settings have to be set.

The following settings have to be made:

- »TCP/IP« - This can be set to “active”. (The default is “inactive” so that the protocol is not used.)

NOTICE!



The other TCP/IP settings - see below - can only be set after »TCP/IP« has been set to “active”.

- »IP address« - the IPv4 address of the MRMV4.
- »Subnet mask« - the subnet mask that defines the IP address range of your local network.
- »Default gateway« - the default gateway: This address is contacted for all connections to IP addresses outside your local network (i. e. for IP addresses not matching the range of the subnet mask).

The first-time setting of the TCP/IP Parameters can be done at the panel (HMI) or via Smart view with USB connection.

Moreover, there are some special settings in the menu branch [Device Para / TCP/IP / Advanced Settings], see the Reference Manual. Only in very rare situations will it be necessary to modify their default values.

3.3 Profibus

Configuration of the Devices

After selecting Profibus as the SCADA protocol (via setting [Device planning] »*Protocol*« = "Profibus"), enter the menu branch [Device Para / Profibus] ; there you have to set the following communication parameter:

- »*Slave ID*«, to allow clear identification of the device This is a number from 2 to 125, which must be unique among all Profibus devices in the network.

In addition to that the Master has to be provided with the GSD-file. The GSD-file can be taken from the Product-CD.

Some more (Profibus-related) parameters that might be interesting are listed in the Reference Manual.

Hardware Connection

- The hardware connection to the control system depends on the ordered hardware variant (see [↪ "Order Form of the Device"](#), [↪ "Communication Protocol Codes"](#)): At the rear side of the MRMV4, there is either an RS485 (D-SUB) interface or an optic fiber (ST connector) interface available for the Profibus connection.
- Connect bus and MRMV4.
- Up to 123 Slaves can be connected.
- In case of a D-SUB interface, terminate the Bus by means of an Terminate Resistor.

Error Handling

Information on physical communication errors (e. g. the detected baud rate) can be obtained from the Event Recorder (see [↪ "Event Recorder"](#)) or the status display (menu branch [Operation / Status Display]).

Error Handling - D-SUB Status LED

The Profibus D-SUB interface at the rear side of the device is equipped with a status LED.

- Baud Search — red flashing
- Baud Found — green flashing
- Data Exchange — green
- Profibus protocol not selected at [Device planning] »*SCADA . Protocol*« — red

3.4 IEC 61850

Introduction

To understand the functioning and mode of operation of a substation in an IEC 61850 automation environment, it is useful to compare the commissioning steps with those of a conventional substation in a Modbus TCP environment.

In a conventional substation the individual IEDs (Intelligent Electronic Devices) communicate in vertically direction with the higher level control center via SCADA. The horizontal communication is exclusively realized by wiring output relays (OR) and digital inputs (DI) among each other.

In an IEC 61850 environment communication between the IEDs takes place digitally (via Ethernet) by a service called GOOSE (Generic Object Oriented Substation Event). By means of this service information about events is submitted between each IED. Therefore each IED has to know about the functional capability of all other connected IEDs.

Each IEC 61850 capable device includes a description of its own functionality and communications skills (IED Capability Description, *.ICD).

By means of a Substation Configuration Tool to describe the structure of the substation, assignment of the devices to the primary technique, etc. a virtual wiring of the IEDs among each other and with other switch gear of the substation can be done. A description of the substation configuration will be generated in form of an *.SCD file. At last this file has to be submitted to each device. Now the IEDs are able to communicate closed among each other, react to interlockings and operate switch gear.

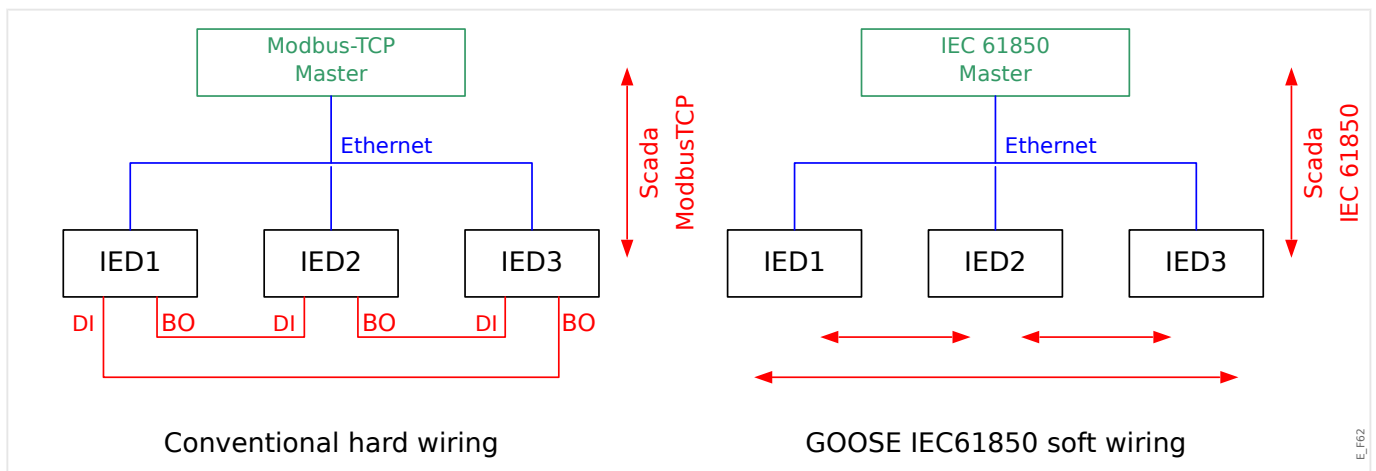

Commissioning steps for a conventional substation with modbus TCP environment:

- Parameter setting of the IEDs;
- Ethernet installation;
- TCP/IP settings for the IEDs;
- Wiring according to wiring scheme.

Commissioning steps for a substation with IEC 61850 environment:

- Parameter setting of the IEDs
- Ethernet installation
- TCP/IP settings for the IEDs

IEC 61850 configuration (software wiring):

- Exporting an ICD file from each device
- Configuration of the substation (generating an SCD file)
- Transmit SCD file to each device.

Generation / Export of a device specific ICD file

Please refer to chapter "IEC 61850" of the *Smart view* Manual.

Generation / Export of an SCD file

Please refer to chapter "IEC 61850" of the *Smart view* Manual.

Substation Configuration, Generation of .SCD file (Station Configuration Description)

The substation configuration, i. e. connection of all logical nodes of protection and control devices, as well as switch gear usually is done with a „Substation Configuration Tool“. Therefore the ICD files of all connected IEDs in the IEC 61850 environment have to be available. The result of the station wide "software wiring" can be exported in the form of an SCD file (Station Configuration Description).

Suitable Substation Configuration Tools (SCT) are available from the following companies:

- H&S, Hard- & Software Technologie GmbH & Co. KG, Dortmund (Germany) (⇒ www.hstech.de).
- Applied Systems Engineering Inc. (⇒ www.ase-systems.com)
- Kalki Communication Technologies Limited (⇒ www.kalkitech.com)

Import of the .SCD file into the device

Please refer to chapter "IEC 61850" of the *Smart view* Manual.

IEC 61850 Virtual Outputs

Additionally to the standardized logical node status information up to 64 free configurable status values can be assigned to 64 Virtual Outputs. This can be done in the menu [Device Para / IEC 61850 / Virt.Outp. 1...4].

IEC 61850 - Virtual Inputs

If there is an INPUT defined in the SCD file the status of the input can be checked at [Operation / Status Display / IEC 61850 / Virt.Inp. 1...4] »GOSINGGIO[1...4].Ind1...32.stVal«. For every status bit there is a corresponding Quality bit at [Operation / Status Display / IEC 61850 / Virt.Inp. 1...4] »GOSINGGIO[1...4].Ind1...32.q«.

GOOSE Status

The status of the GOOSE connection can be checked at [Operation / Status Display / IEC 61850 / State] »All Goose Subscriber active«. This signal summarizes the Quality of all Virtual Inputs (see above).

3.5 DNP3

DNP (Distributed Network Protocol) is for data and information exchange between SCADA (Master) and IEDs (Intelligent Electronic Devices). The DNP protocol has been developed in first releases for serial communication. Due to further development of the DNP protocol, it offers now also TCP and UDP communication options via Ethernet.

DNP Device Planning

Depending on the hardware of the protective device up to three DNP communication options are available within the Device Planning.

Enter the [Device planning] device planning menu and select the appropriate SCADA Protocol, depending on the device code.

- DNP3 RTU (via serial Port)
- DNP3 TCP (via Ethernet)
- DNP3 UDP (via Ethernet)

DNP Protocol General Settings

NOTICE!



Please note that unsolicited reporting is not available for serial communication, if more than one slave is connected to the serial communication (collisions). Do not use in these cases unsolicited reporting for DNP RTU.

Unsolicited reporting is available also for serial communication, if each slave is connected via a separated connection to the Master-System. That means, the master is equipped with a separate serial interface for each slave (multi serial cards).

Enter the menu [Device Para / DNP3 / Communication].

The Communication (General Settings) Settings have to be set according to the needs of the SCADA (Master) – System.

Self Addressing is available for DNP-TCP. That means that the Master and Slave id are auto-detected.

NOTICE!



Some Output signals (that are for a short time active only) have to be acknowledged separately (e. g. Trip signals) by the Communication System.

Point Mapping

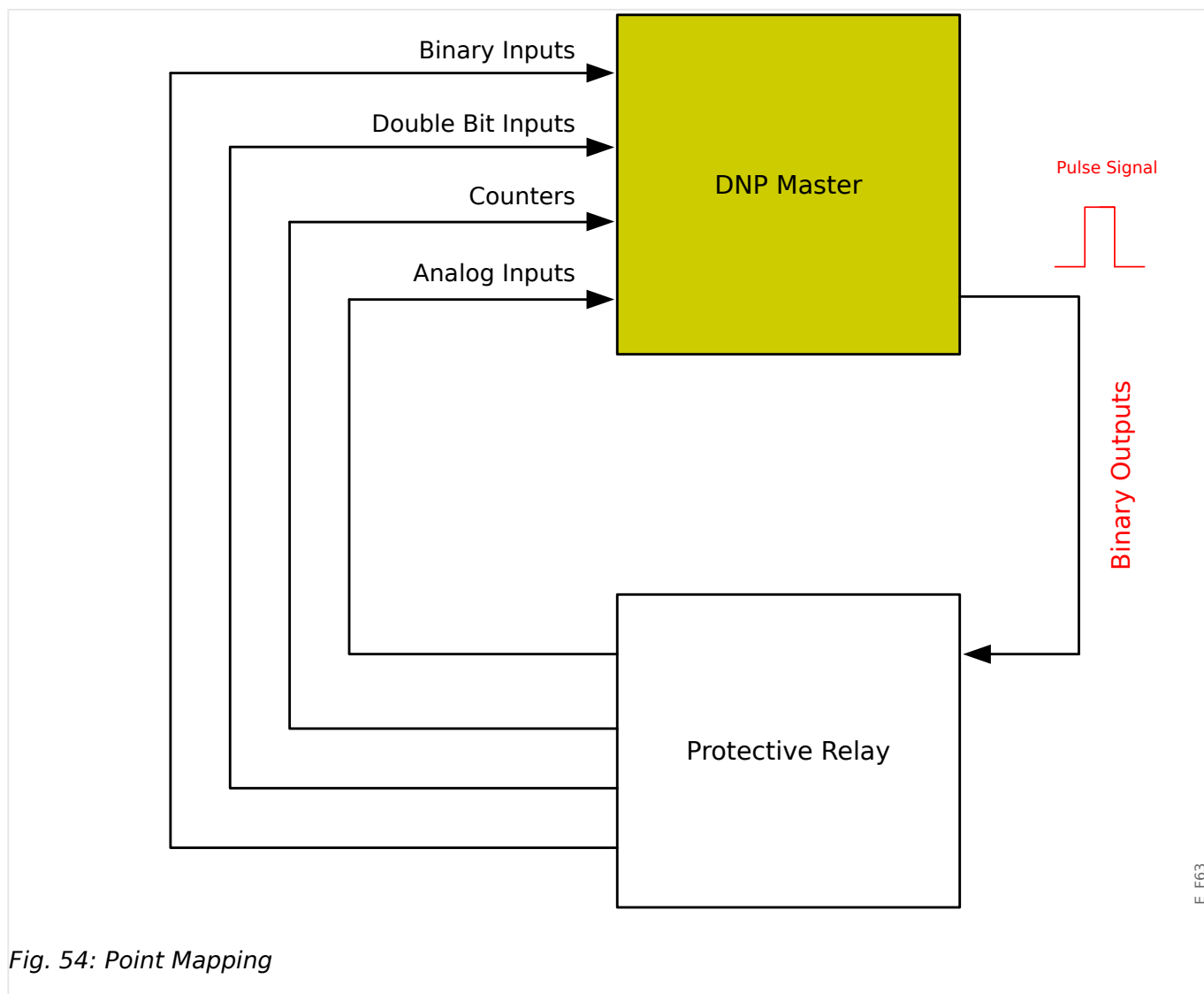

Fig. 54: Point Mapping

NOTICE!



Please take into account that the designations of inputs and outputs are set from the Masters perspective. This way of choosing the designations is due to a definition in the DNP standard. That means for example that Binary Inputs that can be set within the Device Parameters of the DNP protocol are the “Binary Inputs” of the Master.

Enter the menu [Device Para / DNP3 / Point map]. Once the general settings of the DNP protocol are done, the point mapping is to be done as a next step.

- Binary Inputs (States to be sent to the master):

Assign the required status signal (e. g. »Prot . Trip« to an available parameter [Device Para / DNP3 / Point map / Binary Inputs] »BinaryInput 0...63«.

- Double Bit Inputs (Breaker states to be sent to the master)

Assign the required signal (e. g. the breaker position »SG[1] . Pos« to an available parameter [Device Para / DNP3 / Point map / Double Bit Inputs] »DoubleBitInput 0...5«.

- Counters (Counters to be sent to the master)

Assign the required counter (e. g. the number of operating hours »Sys . Operating hours Cr« to an available parameter [Device Para / DNP3 / Point map / BinaryCounter] »*DoubleBitInput 0...7*«.

- Analog Inputs (e. g. measured values to be sent to the master). Please take into account that floating values have to be transmitted as integers. That means they have to be scaled (multiplied) with a scaling factor in order to bring them into the integer format.

Assign the required value (e. g. the phase current »CT . IL1« to an available parameter [Device Para / DNP3 / Point map / Analog Input] »*Analog value 0...31*«.

Then define the scaling for this parameter at [Device Para / DNP3 / Point map / Analog Input] »*Scale Factor 0...31*«.

Finally set the Deadband value for this parameter at [Device Para / DNP3 / Point map / Analog Input] »*Dead Band 0...31*«. This defines the value change for this data object (in percent of the maximum value) that will cause the protection device to re-send the changed value, and it is always a percentage of the *maximum* value. See also the examples given at  "Deadband Settings in DNP3".

Use Binary outputs in order to control e. g. LEDs or Relays within the protective device (via Logic).

Please try to avoid gaps that will slow down the performance of the DNP communication. That means do not leave unused inputs / outputs in between used inputs / outputs (e. g. do not use Binary Output 1 and 3 when 2 is unused).

3.5.1 Application Example: Setting a Relay

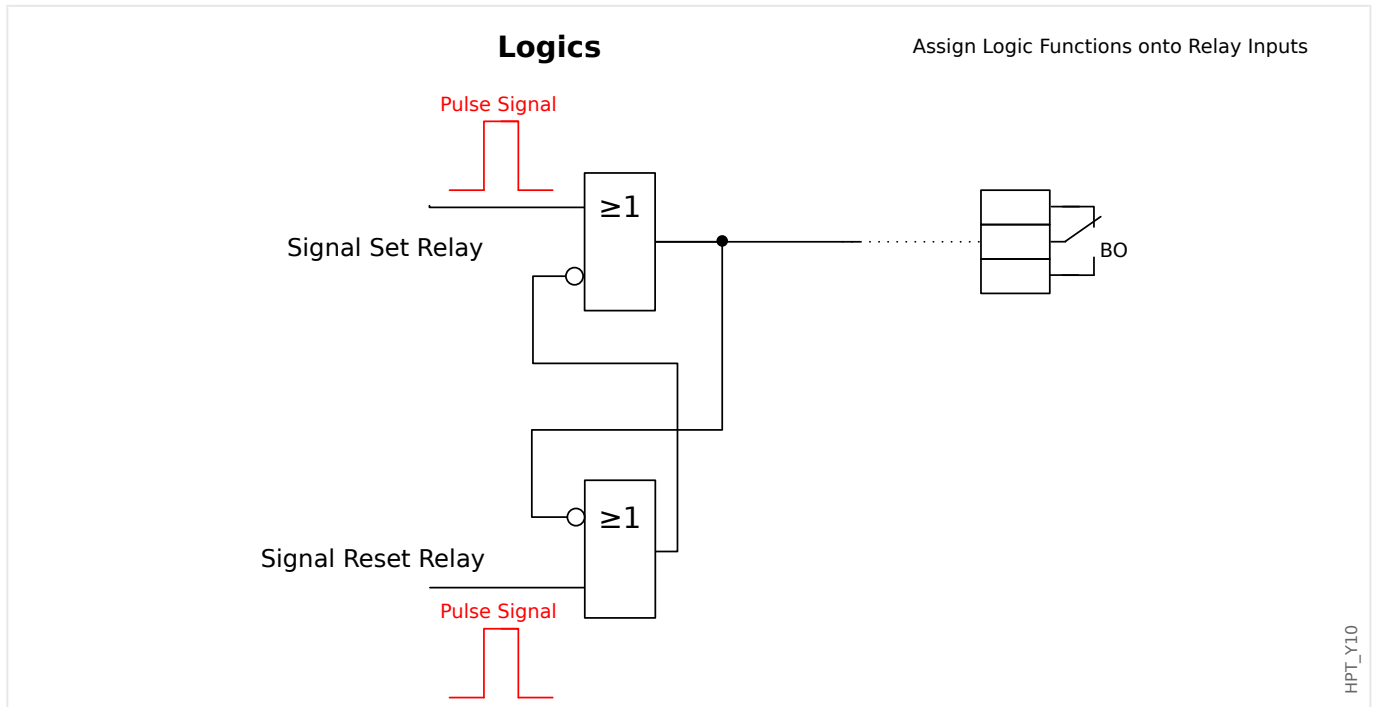

Binary Output signals of the DNP cannot directly be used in order to switch relays because the DNP Binary Outputs are pulse signals (by DNP definition, not steady state). Steady states can be created by means of Logic functions. The Logic Functions can be assigned onto the Relay Inputs.

Please note: You can use a Set/Reset element (Flip Flop) from Logics.

3.5.2 Deadband Settings in DNP3

The Deadband setting [Device Para / DNP3 / Point map / Analog Input] »*Dead Band 0... 31*« specifies for a measured (or statistical) value, for which change the updated value is transmitted again. The Deadband must always be specified in percent of the *maximum* value.

Examples for Deadband Settings

The Deadband setting shall be detailed by some examples.

Voltage (via "TU" Voltage Measuring Card)

- The voltage transformer card "TU" covers the voltage range 0 – 800 V. (See the "Technical Data" chapter in the manual.) In other words, the **maximum** value is **800 V**.
- The **rated** value (secondary) is **100 V**.
- Therefore the conversion factor from the percentage of the rated voltage to the *Deadband setting* is:

$$q = 100 \text{ V} / 800 \text{ V} = \mathbf{0.125}$$
- For example, a deadband value of **10%**, given as a percentage of the *rated* voltage, is required.

- Then the Deadband setting value must be as follows:

$$10\% \cdot q = 0.0125 = \mathbf{1.25\%}$$

Currents (1 A CT)

- The 1 A current transformers cover the range 0 – 40 A.
- The **rated** current (secondary) is **1 A**.
- Therefore the conversion factor from the percentage of the rated current to the *Deadband setting* is:

$$q = 1 \text{ A} / 40 \text{ A} = \mathbf{0.025}$$

- For example, a deadband value of **10%**, given as a percentage of the *rated* current, is required.
- Then the Deadband setting value must be as follows:

$$10\% \cdot q = 0.0025 = \mathbf{0.25\%}$$

Currents (5 A CT)

- The 5 A current transformers cover the range 0 – 200 A.
- The **rated** current (secondary) is **5 A**.
- Therefore the conversion factor from the percentage of the rated current to the *Deadband setting* is:

$$q = 5 \text{ A} / 200 \text{ A} = \mathbf{0.025}$$

- For example, a deadband value of **10%**, given as a percentage of the *rated* current, is required.
- Then the Deadband setting value must be as follows:

$$10\% \cdot q = 0.0025 = \mathbf{0.25\%}$$

Earth (Ground) Current (1 A CT)

- The standard current transformer card “TI” covers the range 0 – 25 A.
- The **rated** current (secondary) is **1 A**.
- Therefore the conversion factor from the percentage of the rated current to the *Deadband setting* is:

$$q = 1 \text{ A} / 25 \text{ A} = \mathbf{0.04}$$

- For example, a deadband value of **10%**, given as a percentage of the *rated* current, is required.
- Then the Deadband setting value must be as follows:

$$10\% \cdot q = 0.004 = \mathbf{0.4\%}$$

Sensitive Earth (Ground) Current (1 A CT)

- The sensitive current transformer card “TIs” covers the range 0 – 2.5 A.

- The **rated** current (secondary) is **1 A**.
- Therefore the conversion factor from the percentage of the rated current to the *Deadband setting* is:

$$q = 1 \text{ A} / 2.5 \text{ A} = \mathbf{0.4}$$

- For example, a deadband value of **1%**, given as a percentage of the *rated* current, is required.
- Then the Deadband setting value must be as follows:

$$1\% \cdot q = 0.004 = \mathbf{0.4\%}$$

Power (1 A CT and "TU" Voltage Measuring Card)

- The value range is 0 - 32000 VA.
- The **rated** power (secondary) is based on the rated voltage and the rated current (secondary): $100 \text{ V} \cdot 1 \text{ A} \cdot \sqrt{3} = \mathbf{173.21 \text{ VA}}$.
- Therefore the conversion factor from the percentage of the rated power to the *Deadband setting* is:

$$q = 173.21 \text{ VA} / 32000 \text{ VA} = \mathbf{0.00541}$$

- For example, a deadband value of **10%**, given as a percentage of the *rated* power, is required.
- Then the Deadband setting value must be as follows:

$$10\% \cdot q = 0.000541 = \mathbf{0.0541\%}$$

Power (5 A CT and "TU" Voltage Measuring Card)

- The value range is 0 - 160000 VA.
- The **rated** power (secondary) is based on the rated voltage and the rated current (secondary): $100 \text{ V} \cdot 5 \text{ A} \cdot \sqrt{3} = \mathbf{866.05 \text{ VA}}$.
- Therefore the conversion factor from the percentage of the rated power to the *Deadband setting* is:

$$q = 866.05 \text{ VA} / 160000 \text{ VA} = \mathbf{0.00541}$$

- For example, a deadband value of **10%**, given as a percentage of the *rated* power, is required.
- Then the Deadband setting value must be as follows:

$$10\% \cdot q = 0.000541 = \mathbf{0.0541\%}$$

Frequency (50 Hz Network)

- The value range is 40 - 70 Hz.
- The **rated** frequency is: **50 Hz**.
- Therefore the conversion factor from the percentage of the rated frequency to the *Deadband setting* is:

$$q = 50 \text{ Hz} / 70 \text{ Hz} = \mathbf{0.714}$$

- For example, a deadband value of **0.1%**, given as a percentage of the *rated* frequency, is required.
- Then the Deadband setting value must be as follows:

$$0.1\% \cdot q = 0.000714 = \mathbf{0.0714\%}$$

Frequency (60 Hz Network)

- The value range is 40 - 70 Hz (i. e. the same as for 50 Hz).
- The **rated** frequency is: **60 Hz**.
- Therefore the conversion factor from the percentage of the rated frequency to the *Deadband setting* is:

$$q = 60 \text{ Hz} / 70 \text{ Hz} = \mathbf{0.857}$$

- For example, a deadband value of **0.1%**, given as a percentage of the *rated* frequency, is required.
- Then the Deadband setting value must be as follows:

$$0.1\% \cdot q = 0.000857 = \mathbf{0.0857\%}$$

cos(φ)

This value is special because there is no rated value.

- The maximum value is 1.0.
- For example, a deadband value of **0.01** is required. (It makes not much sense to talk of percentages here.)
- Then the Deadband setting value must be as follows:

$$0.01 / 1.0 = \mathbf{1\%}$$

φ

- All angle values are given in degree units, i. e. the maximum value is 360°.
- For example, a deadband value of **1°** is required. (It makes no sense to talk of percentages here.)
- Then the Deadband setting value must be as follows:

$$1^\circ / 360^\circ = \mathbf{0.278\%}$$

3.6 IEC60870-5-103

In order to use the IEC60870-5-103 protocol it has to be assigned to the X103 Interface within the Device Planning. The device will reboot after setting this parameter.

Moreover, the IEC103 protocol has to be activated by setting [Device Para / IEC103] »*Function*« to “active”.

NOTICE!



The parameter X103 is only available if the device is at the rear side equipped with an interface like RS485 or Fiber Optic.

NOTICE!



If the device is equipped with an Fiber Optic Interface, the Optical Rest Position has to be set within the Device Parameters .

The time-controlled IEC60870-5-103 protocol is based on the Master-Slave working principle. This means that the substation control and protection system sends an enquiry or instruction to a certain device (slave address) which will then be answered or carried out accordingly.

The device meets the compatibility mode 2. Compatibility mode 3 is not supported.

The following IEC60870-5-103-functions will be supported:

- Initialization (Reset)
- Time Synchronization
- Reading out of time stamped, instantaneous signals
- General Queries
- Cyclic Signals
- General Commands
- Transmission of Disturbance Data

Initialization

The communication has to be reset by a Reset Command each time that the device is turned on or that communication parameters have been changed. The “Reset CU” Command resets. The relay acts on both Reset Commands (Reset CU or Reset FCB).

The relay acts on the reset command by an identification signal ASDU 5 (Application Service Data Unit), as a reason (Cause Of Transmission, COT) for the transmission of the answer either a “Reset CU” or a “Reset FCB” will be sent depending on the type of the reset command. This information can be part of the data section of the ASDU-signal.

Name of the Manufacturer

The section for the identification of the software contains three digits of the device code for the identification of the device type. Beside the upper mentioned identification number the device generates a communication start event.

Time Synchronization

Time and date of the relay can be set by means of the time synchronization function of the IEC60870-5-103 protocol. If the time synchronization signal is send out with a confirmation request, the device will answer with a confirmation signal.

Spontaneous Events

The events that are generated by the device will be forwarded to the master with numbers for standard function types / standard information. The data point list comprises all events that can be generated by the device.

Cyclic Measurement

The device generates on a cyclic base measured values by means of ASDU 9. They can be read out via a class 2 query. Please take into account that the measured values will be send out as multiples (1.2 or 2.4 times the rated value). How to set 1.2 or 2.4 as multiplier for a value can be taken from the data point list.

The parameter "Transm priv meas val" defines if additional measurement values should be transmitted in the private part. Public and private measured values are transmitted by ASDU9. That means that either a "private" or a "public" ASDU9 will be transmitted. If this parameter is set, the ASDU9 will contain additional measured values that are an enhancement of the standard. The "private" ASDU9 is send with a fixed function type and information number that does not depend the type of device. Please refer to the data point list.

Commands

The data point list comprises a list of the supported commands. Any command will be responded by the device with a positive or negative confirmation. If the command is executable, the execution with the corresponding reason for the transmission (COT) will be lead in at first, and subsequently the execution will be confirmed with COT1 within a ASDU9.

Disturbance Recording

The disturbances recorded by the device can be read out by means described in standard IEC60870-5-103. The device is in compliance with the VDEW-Control System by transmission of an ASDU 23 without disturbance records at the beginning of an GI-Cycle.

A disturbance record contains the following information:

- Analog Measured Values, IL1, IL2, IL3, IN, Voltages VL1, VL2, VL3, VEN;
- Binary States, transmitted as marks, e.g. Alarms and Trips.
- The Transmission ratio will not be supported. The transmission ratio is included in the "Multiplier".

Blocking the Transmission Direction

The relay supports the function to block the transmission in monitor direction. There are two ways to activate this blocking:

- Manual activation via Direct Control parameter »Activate Block MD«

- External activation, by assigning a signal to the setting parameter »*Ex activate Block MD*«

Test Mode



The relay supports the test mode (Cause of Transmission 7). There are two ways to activate the test mode:

- Manual activation via Direct Control parameter »*Activate test mode*«
- External activation, by assigning a signal to the setting parameter »*Ex activate test mode*«

3.7 Configurable Communication Protocols

Some of the SCADA protocols supported by the MRMV4 have an option to adapt the mapping of data objects to the protocol-internal addresses to one's own needs. This can be done using a separate PC software tool, *SCADAPTER*.

The protocols supporting such a re-mapping are currently as follows:

- IEC 60870-5-104,  “IEC 60870-5-104”
- Modbus,  “Modbus®”

For detailed information, see the *SCADAPTER* documentation and the respective protocol-specific chapters. The transfer of a new mapping to the MRMV4 is also described in  “Data-Point Mapping Using the *SCADAPTER*”.

3.7.1 IEC 60870-5-104

The IEC 60870-5-104 protocol is a standardized communication protocol. It is available with HighPROTEC devices that are equipped with an Ethernet interface.

Although there is a standard mapping of data-points that comes with the MRMV4 it is expected that most users want to adapt the mapping to their own needs. This can be done using a separate PC software tool, *SCADAPTER*.

NOTICE!



The IEC104 protocol is only available if the device is equipped with an Ethernet interface (either RJ45 or fiber optic with LC duplex connector) at the rear side.

NOTICE!



See  [“IEC 60870-104 Interoperability”](#) for the standard compatibility and implementation chapter.

Setup

At first the IEC104 protocol has to be selected as the SCADA protocol to be used:

Set [Device planning] »*Protocol*« to “IEC104”

Define the Common Address of the ASDU, so that the device can be uniquely identified:
[Device Para / IEC104 / General Settings] »*Common address*«.

(This setting is a Direct Command and therefore never saved as part of a parameter setting (*.HptPara) file, therefore it must be explicitly specified!)

Then the IEC104 protocol has to be activated by setting [Device Para / IEC104 / General Settings] »*Function*« to “active”.

Note that some settings in the menu branch [Device Para / IEC104 / Advanced] are intentionally implemented as “read-only” parameters, so that the network administrator can check the values, but a modification is not possible.

The setting [Device Para / IEC104 / Advanced] »*Update time*«, however, can be set to some time in the range 1 s ... 60 s: In case of cyclic transmission of measured values this setting defines the cycle duration (i. e. the time after that updated values are transmitted).

Whether a measured value is part of a cyclic transmission or not is an individual property of the data-point. For a user-defined data-point mapping, this property is settable. (See the documentation of the *SCADAPTER* for details.)

Information Object Address

The *SCADAPTER* configuration tool allows for creating and editing a mapping table that assigns data objects to their respective Information Object Address (“IOA”).

The IOA consists of three bytes according to the IEC104 companion standard. The *SCADAPTER* allows to set each byte separately, so that the user can assign each data object to an IOA according to the application-specific needs.

Data-Point Mapping of Measurement Values

In the *SCADAPTER* configuration tool, there is a setting »Deadband« for each measured (or statistical) value. It defines the value change that will cause the updated value to be transmitted again.

Cyclic transmission is defined for a measured value by setting the Deadband percentage for this measured value to zero.

A non-zero Deadband percentage always refers to the *maximum* value of the respective measured value, see the examples in the *SCADAPTER* documentation.

For each measurement value, one out of three different presentation modes can be selected in accordance with the IEC104 companion standard:

- »Short float« — The value is a floating-point number.
- »Scaled« — The value has a fixed number of decimal digits; the scaling is settable.
- »Normalized« — The value is relative to the nominal value.

Energy Counters

All energy values are always handled as data objects of type »Integrated total«.

Fault Counters

All fault counters are handled as data objects of type »Bitstring«.

Binary States

For all binary output states, one out of two different presentation modes can be selected in accordance with the IEC104 companion standard:

- Single-point — Single-point information (M_SP_TB_1),
- Double-point — Double-point information (M_DP_TB_1),
- Bitstring — Bitstring of 32 bit (M_BO_TB_1).

IEC Commands

The IEC104 protocol features 16 commands that are freely configurable. The commands can be used for various purposes, e. g. for acknowledging LEDs, output relays and latched trip commands, or for operating a switchgear.

Using an IEC104 command involves essentially a 2-step-configuration:

One step involves defining the protocol-related properties of the respective command using the *SCADAPTER* configuration tool.

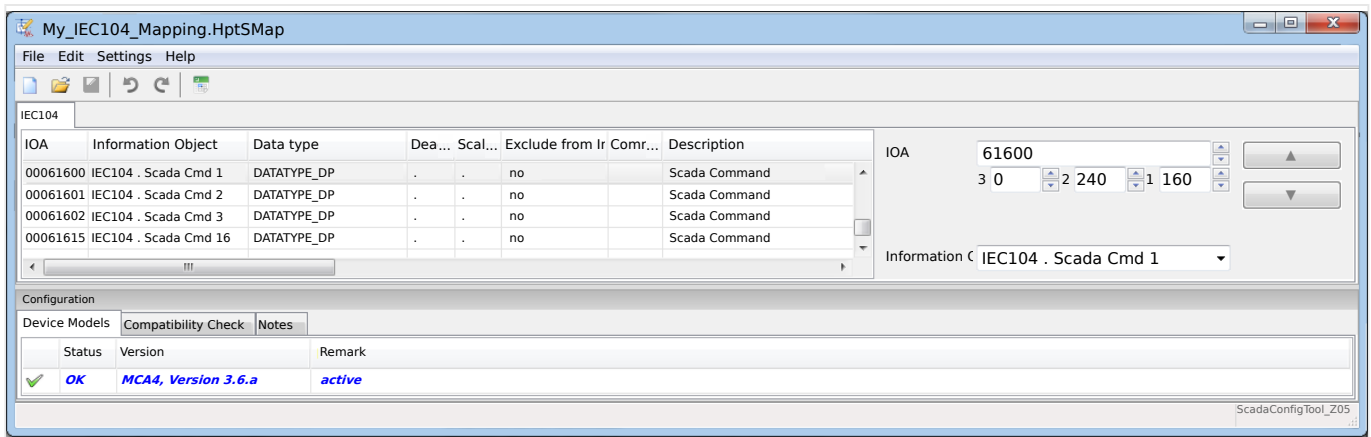

The other step involves a setting on the MRMV4: The commands are available as setting values(!) that can be assigned to the appropriate parameter.

If, for example, IEC104 command 2 shall acknowledge (reset the latching of) LED 1 of the MRMV4 then you have to make the following setting:

[Device Para / LEDs / LEDs group A / LED 1] »Assignment 1« = "IEC104 . Scada Cmd 2"

If, for example, the command shall *operate* output relay number 1 on slot X2:

[Device Para / Binary Outputs / BO Slot X2 / BO 1] »Assignment 1« = "IEC104 . Scada Cmd 2"

If, for example, the command shall *acknowledge* (reset the latching of) output relay number 1 on slot X2:

[Device Para / Binary Outputs / BO Slot X2 / BO 1] »Acknowledgement« = "IEC104 . Scada Cmd 2"

If, for example, the command shall *operate* (switch off) the switchgear SG[1]:

[Control / SG / SG[1] / Ex ON/OFF Cmd] »SCmd OFF« = "IEC104 . Scada Cmd 2"

For switchgear control, there are various more settings to be checked, of course. In particular, it is necessary that [Control / General Settings] »Switching Authority« is set to either "Remote" or to "Local and Remote". See [↪ "Control / Switchgear-Manager"](#) for details.

Anwendungsbeispiel - Setzen eines Ausgangsrelais

The concept of using the Programmable Logic to set up a steady state is identical to the description for the DNP3 protocol: [↪ "Application Example: Setting a Relay"](#)

Activate a User-Defined Data-Point Mapping

For information about how to create a mapping file and download or upload it to the MRMV4, see the *SCADAPTER* documentation and [↪ "Data-Point Mapping Using the SCADAPTER"](#). (Since the data-point mapping is a general feature that is usable for several communication protocols in the same way, it is described separately.)

3.7.2 Modbus®

Modbus® Protocol Configuration

The Modbus® communication protocol is available with HighPROTEC devices that are equipped with either a serial interface (“Modbus RTU”) or an Ethernet interface (“Modbus TCP”).

The standard protocol definition (mapping of data-points) that comes with the MRMV4 is sufficient for most applications, so that only a few settings have to be made (see below).

Only in the special case that the internal mapping of data-points needs to be adapted to an existing substation communication you can define an individual mapping using a separate PC software tool, *SCADAPTER*.

The time-controlled Modbus® protocol is based on the Master-Slave working principle. This means that the substation control and protection system sends an enquiry or instruction to a certain device (slave address) which will then be answered or carried out accordingly. If the enquiry/instruction cannot be answered/carried out (e. g. because of an invalid slave address), a failure message is returned to the master.

NOTICE!



Some signals (that are for a short time active only) have to be acknowledged separately (e.g. Trip signals) by the Communication System.

The Master (substation control and protection system) can query information from the device, such as:

- Type of unit version
- Measuring values/Statistical measured values
- Switch operating position
- State of device
- Time and date
- State of the device’s digital inputs
- Protection-/State alarms

The Master (control system) can give commands/instructions to the device, such as:

- Control of switchgear (where applicable depending on the applied device version)
- Change-over of parameter set
- Reset and acknowledgment of alarms/signals
- Adjustment of date and time
- Control of alarm relays

For detailed information on data point lists and error handling, please refer to the Modbus® documentation.

To allow configuration of the devices for Modbus[®] connection, some default values of the control system must be available.

Setup

At first the Modbus protocol has to be selected as the SCADA protocol to be used:

Set [Device planning] »*Protocol*«

- = “Modbus RTU” — use the Modbus[®] protocol over a serial connection
- = “Modbus TCP” — use the Modbus[®] protocol over Ethernet (TCP/IP)
- = “Modbus TCP/RTU” — use both Ethernet (TCP/IP) and serial interfaces for Modbus messages

Then continue with the settings described below for Modbus RTU or Modbus TCP, depending on your type of use.

Modbus RTU

Part 1: Configuration of the Devices

Enter the menu [Device Para / Modbus / Communication / RTU] and set the following communication parameters there:

- »*Slave ID*« — the Slave-address, required to allow clear identification of the device.
- »*Baud rate*« — the Baud rate that the serial interface shall use.

Also, select below indicated RS485 interface-related parameters from there, such as:

- Number of data bits
- One of the following supported communication variants: Number of data bits, even, odd, parity or no parity, number of stop bits.
- »*t-timeout*«: communication errors are only identified after expiry of a supervision time »*t-timeout*«.
- Response time (defining the period within which an enquiry from the master has to be answered).

Part 2: Hardware Connection

- For hardware connection to the control system, there is an RS485 interface at the rear side of the device (RS485, fiber optic or terminals).
- Connect bus and device (wiring).

Error Handling - Hardware Errors

Information on physical communication errors, such as:

- Baudrate Error
- Parity Error ...

can be obtained from the event recorder.

Error Handling - Errors on protocol level

If, for example, an invalid memory address is enquired, error codes will be returned by the device that need to be interpreted.

Modbus TCP

NOTICE!



Establishing a connection via TCP/IP to the device is only possible if your device is equipped with an Ethernet Interface (RJ45).

Contact your IT administrator in order to establish the network connection.

Part 1: Setting the TCP/IP Parameters

Call up [Device Para / TCP/IP / TCP/IP config] at the HMI (panel) and set the following parameters:

- TCP/IP address
- Subnet mask
- Gateway

Part 2: Configuration of the Devices

Call up »Device parameter/Modbus« and set the following communication parameters:

- Setting a Unit Identifier is only necessary if a TCP network should be coupled to a RTU network.
- If a different port than the default port 502 should be used please proceed as follows:
 - Choose "Private" within the TCP-Port-Configuration.
 - Set the port-number.
- Set the maximum accepted time of "no communication". If this time has expired - without any communication, the device concludes a failure within the master system or communication.
- Allow or disallow the blocking of SCADA commands.

Part 3: Hardware Connection

- There is a RJ45 interface at the rear side of the device for the hardware connection to the control system.
- Establish the connection to the device by means of a proper Ethernet cable.

SCADAPTER

The *SCADAPTER* is a PC tool of its own, therefore the details of its used are described in the *SCADAPTER* manual.

If you want to download a previous user-defined mapping from the MRMV4 so that you can use it as a template for further adaptations, then this is possible using *Smart view*. This is also true of the transfer of the edited mappings to the MRMV4. See  "Data-Point Mapping Using the *SCADAPTER*".

Then start the *SCADAPTER*. After selecting either [File / New] or [File / Open] you have to select a device model and the communication protocol (which is “Modbus” in this case). After this, you can see six tabs, “FC1” ... “FC6”. Each of these tabs features a table that holds the mapped data-objects.

FC

- The “Function Code” number decides about the type of data-objects that it can hold:
 - FC1, FC2 hold states (but no measurement values).
 - FC3, FC4 can hold all types except commands.
 - FC5, FC6 are for commands.
 - FC16 is for special multi-word messages (essentially for time-synchronization).

Please see the Modbus specification for details!

Address, Bit position

- This is the Modbus address to which the data-object shall be mapped.
- The bit position appears only where it makes sense to select it (in particular with binary states of 1 bit length).

Information Object, Description, Comment

- The data-object that shall be mapped, and some description text. The type of information that the data-object represents must be supported by the MRMV4, and therefore the selection list reads the supported entities from the device model file.
- The comment is some user-defined text without any technical functionality. It can be used for archiving some background information of the mapping.

Format, Bit size, Latched

- Select the format of the data-object:
 - “Int16” — Integer number with 16 bit length
 - “Int32” — Integer number with 32 bit length
 - “Uint32” — Unsigned (i.e. non-negative) integer number with 32 bit length
 - “Float” — Number in floating point representation (according to IEEE 754)
- The bit size is automatically set according to the format of the data-object.
- The “Latched” checkbox decides whether the Modbus information shall be latched (until an explicit acknowledgment).

Factor, Scaling

- Specify the factor and the scaling of the data (if these input fields are visible). The scaling can be as follows:
 - “Primary” — Scaling of the information object to primary value
 - “Secondary” — Scaling of the information object to secondary value
 - “Relative” — Scaling of the information object relative to nominal value

For information about how to upload the edited mapping to the MRMV4, see the *SCADAPTER* documentation and [↳ “Data-Point Mapping Using the SCADAPTER”](#). (Since the data-point mapping is a general feature that is usable for several communication protocols in the same way, it is described separately.)

3.7.3 Data-Point Mapping Using the SCADAPTER

Software Tools

The setup procedure for a user-defined data-point mapping always works the same way for all SCADA protocols that support user-defined mappings. A mapping of data objects is always based on a separate file of file-type (extension) *.HptSMap. This file is edited with a separate PC tool, *SCADAPTER*, and *Smart view* is used to download the currently active user mapping from the protection device (for further editing), or to upload and activate the edited new *.HptSMap mapping file.

NOTICE!



The factory default mapping cannot be downloaded for further editing.

Specify the Data-Point Mapping

The setting parameter [Device Para / protocol-name / Config. Data Obj.] »Type of SCADA mapping« can be set to either “Standard” or to “User-defined”.

- “Standard” means that the protection device uses the factory-default as data-point mapping (even if a user-defined mapping has already been uploaded to the MRMV4).
- “User-defined” means that the protection device uses the user-defined data-point mapping. (If no valid mapping file has been uploaded then the device reports this by setting the output value [Device Para / protocol-name / Advanced] »Update time« = “Error 1/2”.)

Transfer the Data-Point Mapping

If there is already a user-defined data-point mapping on the protection device, it is possible to download it and use it for further editing. (The factory default cannot be downloaded.)

Depending on the value of »Type of SCADA mapping«, the active mapping is either the factory default or a previously uploaded valid mapping file.

Both the download of a mapping file or a (later) upload of an edited mapping file has to be done via *Smart view*, to which the protection device has to be connected.

After the *Smart view* connection has been established and all device data has been retrieved, double-click the menu item [Device Para / protocol-name / Config. Data Obj.].

A dialog window is opened that features a »SCADA Configuration Transfer« button. (See **(1)** in the example figure below.)

Clicking on this button opens another dialog, »SCADA Point Mapping Configuration«. There are two buttons there, **(2)** and **(a)** in the figure below.

Button **(a)** performs the download: The protection devices sends its user-defined SCADA protocol mapping to the »SCADA Point Mapping Configuration«, then a »Save as« file-dialog appears, that allows the user to create a new *.HptSMap file from these protocol definitions. (This download is not possible for the (factory default) standard mapping.)

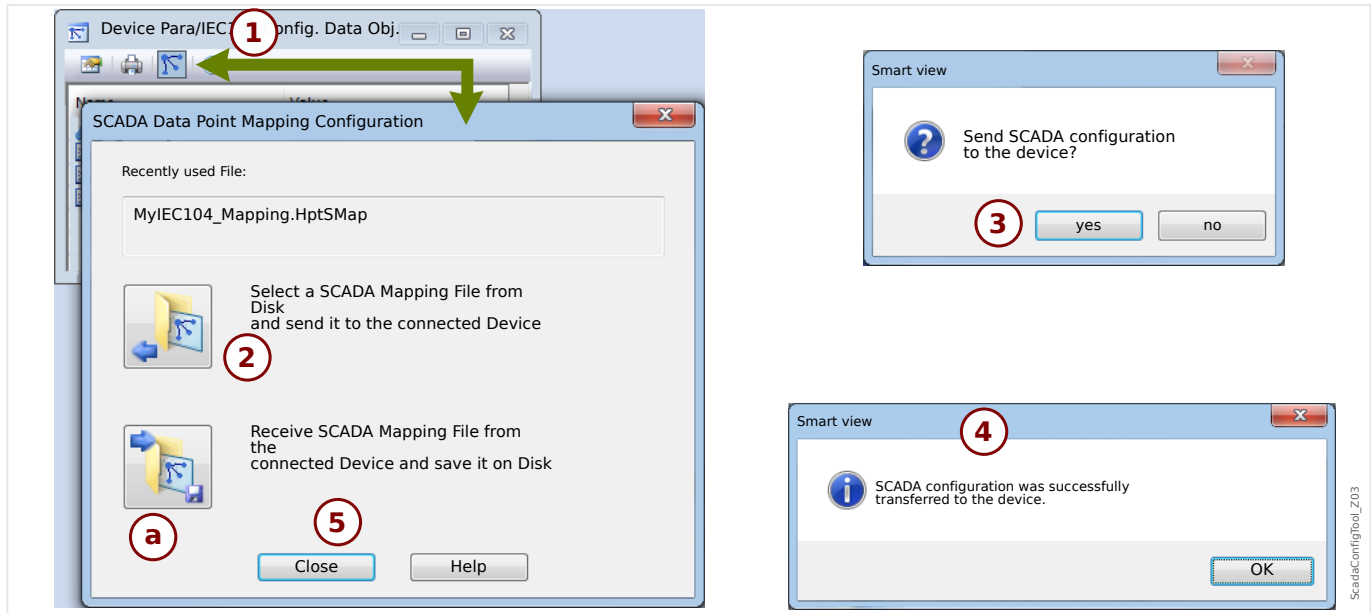

Fig. 55: Example of using Smart view to transfer the *.HptSMap to the protection device.

Button **(2)**, »Select a SCADA Mapping File from Disk and send it to the connected Device«, starts the upload of an edited mapping file. After clicking this button a file-select dialog opens.

Then navigate to the *.HptSMap file that keeps the required SCADA definitions and click »Open«.

Smart view opens and checks the *.HptSMap file. If it is compatible with the connected protection device a dialog asks the user whether the protocol definitions shall be transferred to the protection device [**(3)** in the diagram].

After clicking »yes« (and entering the password for the access level »Supervisor-Lv3«) the data is transferred, and the user is informed about the success **(4)**.

The user may now click »Close« **(5)** in the »SCADA Point Mapping Configuration« dialog, to return to the Smart view main window.

Finally the user-specific mapping must be activated by the setting [Device Para / protocol-name / Config. Data Obj.] »Type of SCADA mapping« = "User-defined".

Do not forget to transfer all (or all changed) settings (from Smart view) to the protection device. Moreover, it is recommended to have the "Automatic Refresh" active within Smart view, so that all entries within the [Config. Data Obj.] dialog get updated properly.

3.8 Time Synchronization

The device gives the user the ability to synchronize the device with a central time generator. This provides the following advantages:

- The time does not drift from the reference time. A continuously accumulating deviation of the reference time thereby will be balanced. Also refer to the Specifications (Tolerances Real Time Clock) section.
- All time synchronized devices operate with the same time. Therefore, logged events of the individual devices can be compared exactly and be evaluated (single events of the event recorder, waveform records).

The device's time can be synchronized via the following protocols:

- IRIG-B
- SNTP
- Communication protocol Modbus (RTU or TCP)
- Communication protocol IEC 60870-5-103
- Communication protocol IEC 60870-5-104
- Communication protocol DNP3

These protocols use different hardware interfaces and are different in accuracy. For further information, see  [“Specifications / Tolerances”](#).

Without time synchronization

This is possible, but not recommended for industry-standard applications.

IRIG-B

Hardware Interface	Recommended Application
IRIG-B Terminal	Recommend, if interface available.

SNTP

Hardware Interface	Recommended Application
RJ45 (Ethernet)	Recommend alternative to IRIG-B, especially when using IEC 61850 or Modbus TCP.

Modbus RTU

Hardware Interface	Recommended Application
RS485, D-SUB or Fiber Optic	Recommend when using Modbus RTU communication protocol and when no IRIG-B real time clock is available.

Modbus TCP

Hardware Interface	Recommended Application
RJ45 (Ethernet)	Limited recommendation when Modbus TCP communication protocol is used and when no IRIG-B real time clock or an SNTP server is available.

IEC 60870-5-103

Hardware Interface	Recommended Application
RS485, D-SUB or Fiber Optic	Recommended when using the IEC 60870-5-103 communication protocol and no IRIG-B real time clock is available.

IEC 60870-5-104

Hardware Interface	Recommended Application
RJ45 (Ethernet)	Recommended when using the IEC 60870-5-104 communication protocol and no IRIG-B real time clock is available.

DNP3

Hardware Interface	Recommended Application
RS485 or RJ45 (Ethernet)	Limited recommendation when using the DNP3 communication protocol and no IRIG-B real time clock or an SNTP server is available

Accuracy of Time Synchronization

The accuracy of the device's synchronized system time depends on several factors:

- Accuracy of the connected time generator;
- Synchronization protocol that is used; and
- If Modbus TCP, SNTP, IEC 60870-5-104 or DNP3 TCP/UDP is used: Network load and data package transmission times

NOTICE!



Please consider the accuracy of the used time generator. Deviations of the time generator's time cause the same deviations on the device's system time.

Selection of Timezone and Synchronization Protocol

The protection relay masters both UTC and local time. This means that the device can be synchronized with UTC time while using local time for user display.

Time Synchronization with UTC time (recommended):

Time synchronization is usually done using UTC time. This means for example that an IRIG-B time generator is sending UTC time information to the protection relay. This is the recommended use case, since here a continuous time synchronization can be ensured. There are no "leaps in time" through change of Daylight Saving Time.

To achieve that the device shows the current local time, the timezone and the change to Daylight Saving Time (i. e. the change between summer- and wintertime) can be configured.

Please carry out the following setting steps in the menu branch [Device Para / Time / Timezone]:

- Set the parameter »Time Zones« to your local timezone.
- Then configure the switching of daylight saving time.

Then, in the menu branch [Device Para / Time / TimeSync / TimeSync]:

- Set the parameter »TimeSync« to the used time synchronization protocol (e.g. "IRIG-B").
- Set the parameters of the synchronization protocol (refer to the according chapter).

Time Synchronization with local time:

Should the time synchronization however be done using local time, then please leave the timezone to "UTC+0 London" and do not use switching of daylight saving time.

NOTICE!

The synchronization of the relay's system time is exclusively done by the synchronization protocol selected in the menu [Device Para / Time / TimeSync / TimeSync].

Without Time Synchronization:

To achieve that the device shows the current local time, the timezone and the change to Daylight Saving Time can be configured.

Please carry out the following setting steps:

- In the menu branch [Device Para / Time / TimeSync / TimeSync], set the parameter »TimeSync« to "-".
- Then, in the menu branch [Device Para / Time / Timezone], set the parameter »Time Zones« to your local timezone.
- Then configure the switching of daylight saving time.
- Set date and time at [Device Para / Time] »Date and Time«.

3.8.1 SNTP

NOTICE!

! Important pre-condition: The device needs to have access to an SNTP server via the connected network. This server preferably should be installed locally.

Principle - General Use

SNTP is a standard protocol for time synchronisation via a network. For this at least one SNTP server has to be available within the network. The device can be configured for one or two SNTP servers.

The protection relay's system time will be synchronised with the connected SNTP server 1-4 times per minute. In turn the SNTP server synchronises its time via NTP with other NTP servers. This is the normal case. Alternatively it can synchronise its time via GPS, radio controlled clock or the like.

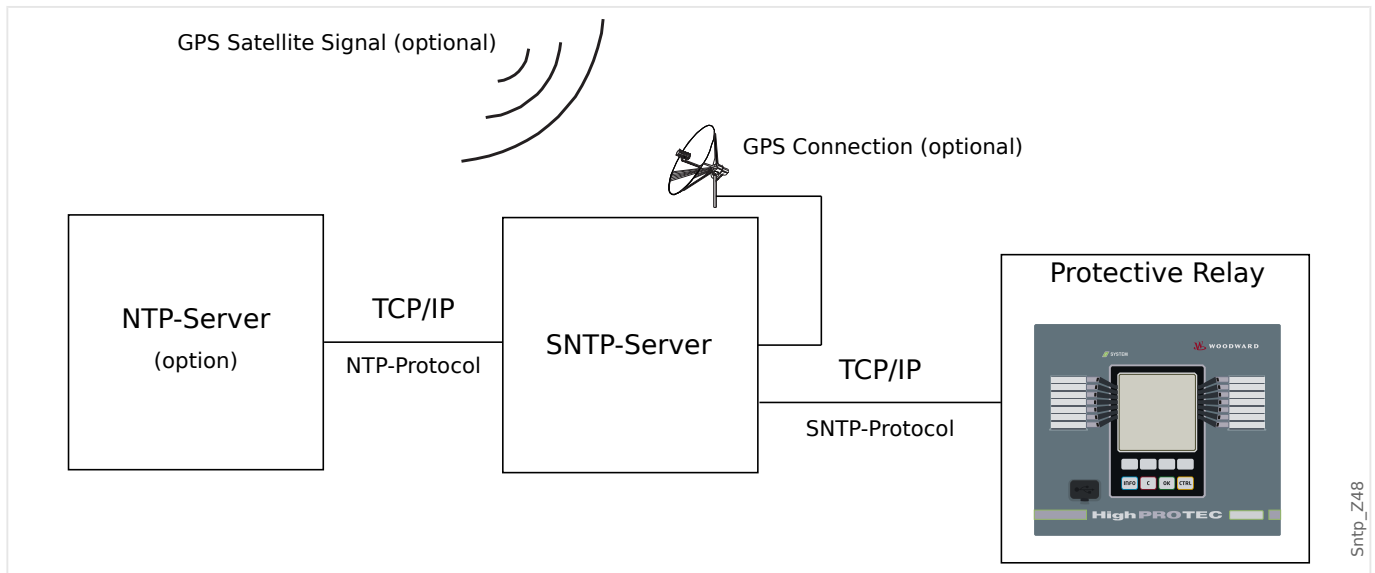

Accuracy

The accuracy of the used SNTP server and the excellence of its reference clock influences the accuracy of the protection relay's clock. Further information about accuracy: [↔ "Specifications / Tolerances"](#)

For further information about accuracy refer to the chapter "Specifications".

With each transmitted time information, the SNTP server also sends information about its accuracy:

- Stratum: The stratum indicates over how many interacting NTP-Servers the used SNTP server is connected to an atomic or radio controlled clock.
- Precision: This indicates the accuracy of the system time provided by the SNTP server.

Additionally the performance of the connected network (traffic and data package transmission times) has an influence on the accuracy of the time synchronisation.

Recommended is a locally installed SNTP server with an accuracy of ≤ 200 μ sec. If this cannot be realised, the connected server's excellence can be checked in the menu [Operation / Status Display / TimeSync / SNTP]:

- The server quality gives information about the accuracy of the used server. The quality should be GOOD or SUFFICIENT. A server with BAD quality should not be used, because this could cause fluctuations in time synchronisation.
- The network quality gives information about the network's load and data package transmission time. The quality should be GOOD or SUFFICIENT. A network with BAD quality should not be used, because this could cause fluctuations in time synchronisation.

Using two SNTP Servers

When configuring two SNTP servers, the device always synchronizes to server 1 by default.

If server 1 fails, the device automatically switches to server 2.

When (after a failure) server 1 recovers, the device switches back to server 1.

SNTP Commissioning

Activate the SNTP time synchronization by means of the [Device Para / Time / TimeSync] menu:

- Set the parameter »TimeSync« to "SNTP".
- Set the IP address of the first server in the SNTP menu.
- Set the IP address of the second server, if available.
- Set all configured servers to "active".

3.8.2 IRIG-B00X

NOTICE!



Requirement: An IRIG-B00X time code generator is needed. IRIG-B004 and higher will support/transmit the “year information”.

If you are using an IRIG time code that does not support the “year information” (IRIG-B000, IRIG-B001, IRIG-B002, IRIG-B003), you have to set the “year” manually within the device. In these cases the correct year information is a precondition for a properly working IRIG-B.

Principle - General Use

The IRIG-B standard is the most used standard to synchronize the time of protection devices in medium voltage applications.

The protection device supports IRIG-B according to the IRIG STANDARD 200-04.

This means that all time synchronization formats IRIG-B00X (IRIG-B000 / B001 / B002 / B003 / B004 / B005 / B006 / B007) are supported. It is recommended to use IRIG-B004 and higher which also transmits the “year information”.

The system time of the protection device is being synchronized with the connected IRIG-B code generator once a second. The accuracy of the used IRIG-B code generator can be increased by connecting a GPS-receiver to it.

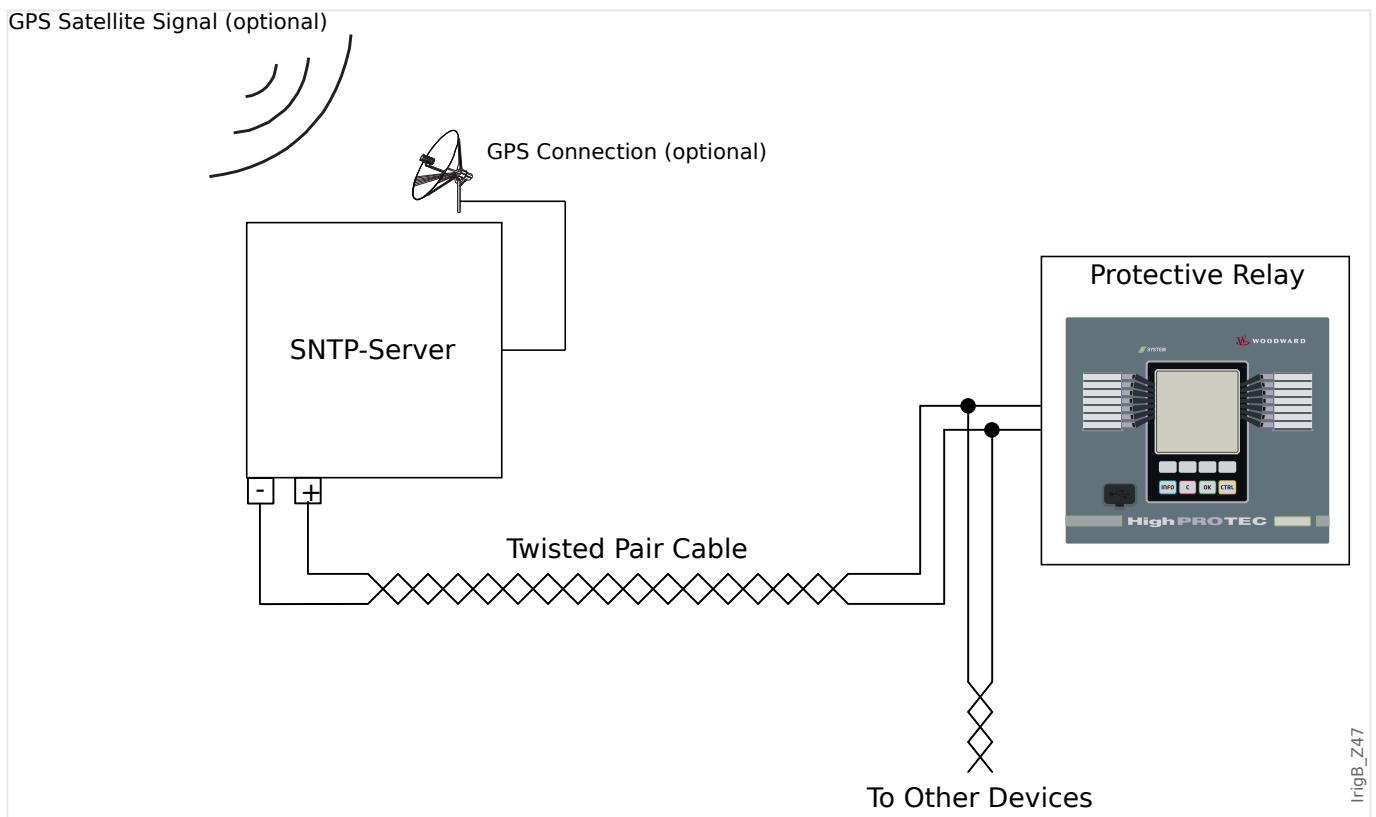

The location of the IRIG-B interface depends to the device type. Please refer to the wiring diagram supplied with the protective device.

IRIG-B Commissioning

Activate the IRIG-B synchronization within the menu [Device Para / Time / TimeSync]:

- Select »IRIG-B« in the time synchronization menu.
- Set the time synchronization in the [IRIG-B] menu to “active”.
- Select the IRIG-B type (choose B000 through B007).

Fault Analysis

If the device does not receive any IRIG-B time code for more than 60 s, the IRIG-B status switches from »active« to »inactive« and there is created an entry within the Event Recorder.

Check the IRIG-B functionality through the menu [Operation / Status Display / TimeSync / IRIG-B]:

Should the IRIG-B status not be reported as being “active”, please proceed as follows:

- To begin with check the IRIG-B wiring.
- Check, if the correct IRIG-B00X type is configured.

IRIG-B Control Commands

In addition to the date and time information, the IRIG-B code offers the option to transmit up to 18 control commands that can be processed by the protective device. They have to be set and issued by the IRIG-B code generator.

The MRMV4 offers up to 18 IRIG-B assignment options for those control commands in order to carry out the assigned action. As soon as a control command is transmitted the state of the corresponding signal »IRIG-B . Control Signal1« ... »IRIG-B . Control Signal18« becomes true.

These signals are available for assignment to some parameter, so that the functionality of this parameter is being triggered as soon as the control command is transmitted.

NOTICE!



IRIG-B control commands are not recorded by Event and Disturbance Recorders.

If it is required to have a control signal recorded, the best way is to use a Logic (1 gate) equation, because the Programmable Logic always gets recorded.

4 Protective Elements

4.1 Module Prot: General Protection

The module »Module General Protection« (»Prot«) serves as outer frame for all other protection modules, i. e. they are all enclosed by this module.

WARNING!



If in the »Prot« module the parameter [Protection Para / Global Prot Para / Prot] »Function« is set on “inactive” or in case the module is blocked, then **no** protective function of the MRMV4 is effective.

Blocking all Protective Elements Permanently

In order to permanently deactivate the entire protection navigate to the menu [Protection Para / Global Prot Para / Prot]:

- Set the parameter »Function« = “inactive”.

Blocking all Protective Elements Temporarily

In order to allow the temporary blocking of the entire protection navigate to the menu [Protection Para / Global Prot Para / Prot]:

- Set the parameter »ExBlo Fc« = “active”.
- Assign a blocking signal to »ExBlo1«.
- Optionally make assign a blocking signal to »ExBlo2«.

If any of the assigned signals becomes true, then the entire protection is blocked (as long as any of these signals stays true).

Blocking all Trip Commands Permanently

In order to permanently block all trip commands navigate to the menu [Protection Para / Global Prot Para / Prot]:

- Set the parameter »Blo TripCmd« = “active”.

Blocking all Trip Commands Temporarily

In order to allow the temporary blocking of all trip commands navigate to the menu [Protection Para / Global Prot Para / Prot]:

- Set the parameter »ExBlo TripCmd Fc« = “active”.
- Assign a blocking signal to »ExBlo TripCmd«.

If the assigned signal becomes true, then all trip commands are blocked (as long as this signal stays true).

Availability of the Protection Function

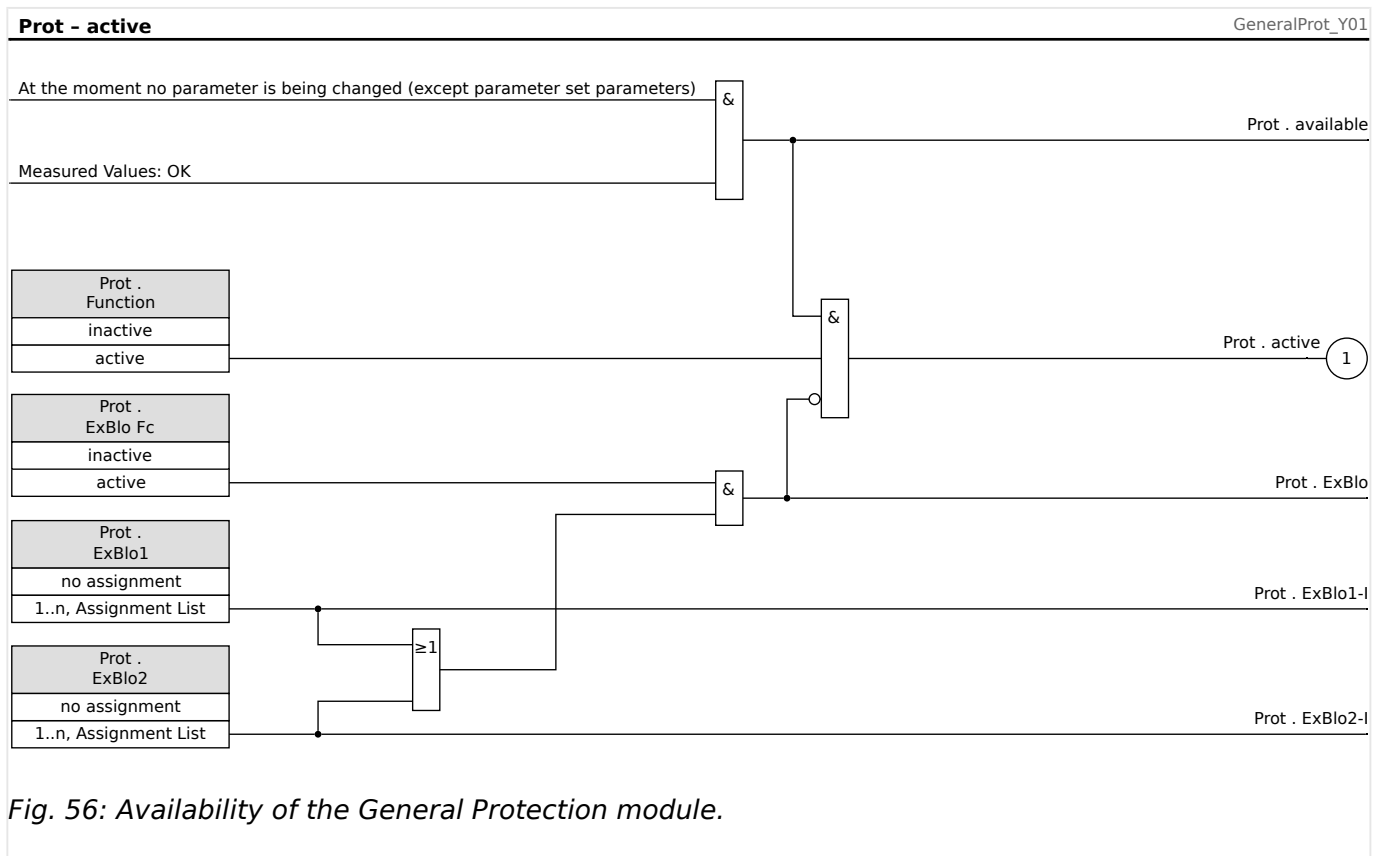

Fig. 56: Availability of the General Protection module.

4.1.1 General Alarms and General Trips

Each protective element generates its own alarm and trip signals. In general, all alarms and trip decision are passed on to the master module »Prot«, with one important exception:



If a protective element features a setting »*Superv. only*« (in the menu branch [Device planning]) then the alarms and trip decisions of this protective element are passed on to »Prot« only with the setting »*Superv. only*« = “no”.

If »*Superv. only*« = “yes” then the module works as a supervision element: Alarms and trip decisions are kept as element-specific states (i. e. these states can be checked at the menu branch [Operation / Status Display] and can be assigned as select options), but the module does not have a trip command, and the alarm/trip decisions do not result in a General Alarm or General Trip.

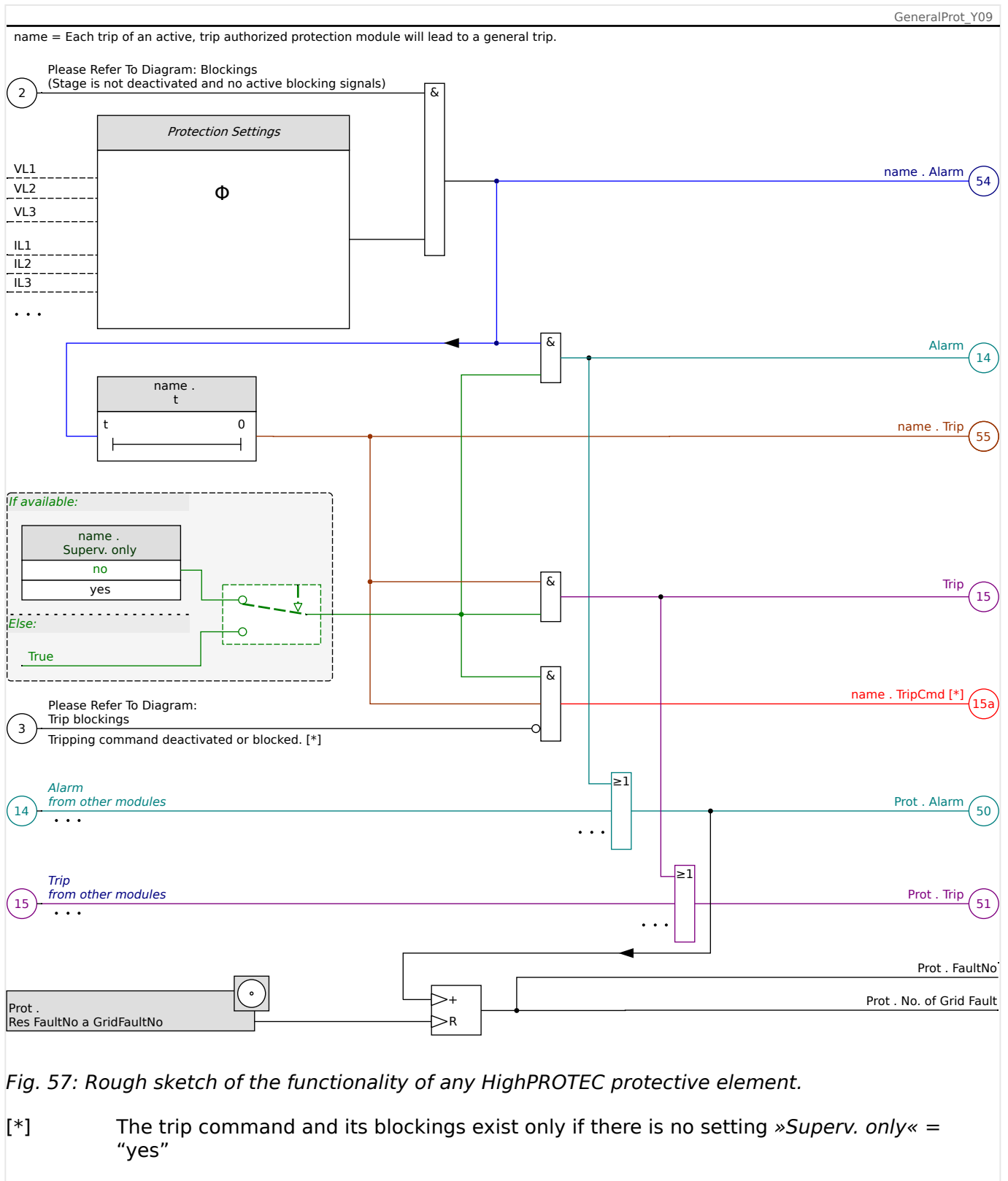

This diagram shows the basic idea behind a protective element. (Nevertheless, keep in mind that device-specific or protection-specific deviations are possible: Some devices do not feature voltage measurement, other do not feature current measurement, for some protection elements other timers and/or phase-specific algorithms are required, etc. So, for the exact functionality of a protection module please consult the respective chapter.)

Alarm

- If a protection module, named »name«, detects a fault it issues an alarm signal: »name . Alarm« - “(54)” in the diagram.
 - Unless there is a setting »name . Superv. only« = “yes” the alarm signal gets passed on - “(14)” in the diagram - to the master module »Prot« module and triggers a *General Alarm*: »Prot . Alarm« - “(50)” in the diagram.
 - Since also other protection elements can trigger a *General Alarm* one can say that the *General Alarm* is a collective signal OR-ed from all protection-specific alarms.

Trip

- If the fault criterion is still detected after a protection-specific timer stage »name . t« has elapsed then the module issues a trip signal: »name . Trip« - “(55)” in the diagram.
 - Unless there is a setting »name . Superv. only« = “yes” the trip signal gets passed on - “(15)” in the diagram - to the master module »Prot« module and triggers a *General Trip*: »Prot . Trip« - “(51)” in the diagram.
 - Since also other protection elements can trigger a *General Trip* one can say that the *General Trip* is a collective signal OR-ed from all protection-specific trips.

Trip Command (and its blocking exist only if there is no setting »Superv. only« = “yes”)

- If there is a *General Trip* the protection module issues a *trip command*: »name . TripCmd« - “(15a)” in the diagram, if the module's trip command is not blocked (see  “Blockings”).

Since also other protection elements can trigger a trip command, the MRMV4 offers a so-called *Trip Manager* for every circuit breaker, which allows for assigning trip commands to it (see  “5.2 Trip Manager - Assignment of commands”).

Phase-Selective Signals

In addition to the *General Alarm* and *General Trip* signals, the »Prot« module also features the respective phase-specific signals. These, too, can be triggered by any protection module »name« if it is able to detect 1p faults and unless there is a setting »name . Superv. only« = “yes”.

Examples: »Prot . Alarm L1« is a collective signal (OR-connected) for all alarms issued by any of the protective elements concerning phase L1.

»Prot . Trip L1« is a collective signal (OR-connected) for all trips issued by any of the protective elements concerning phase L1.

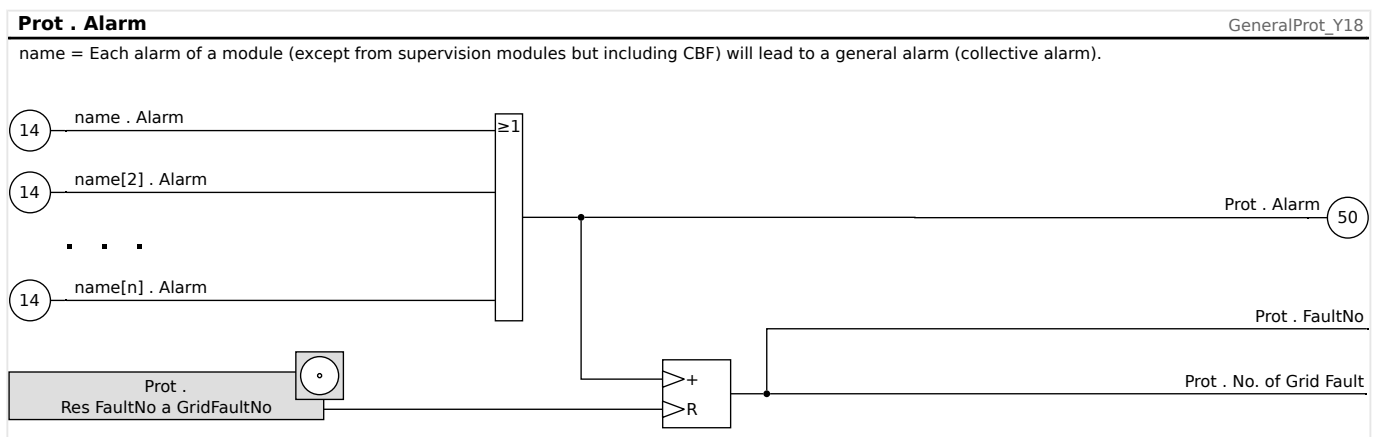

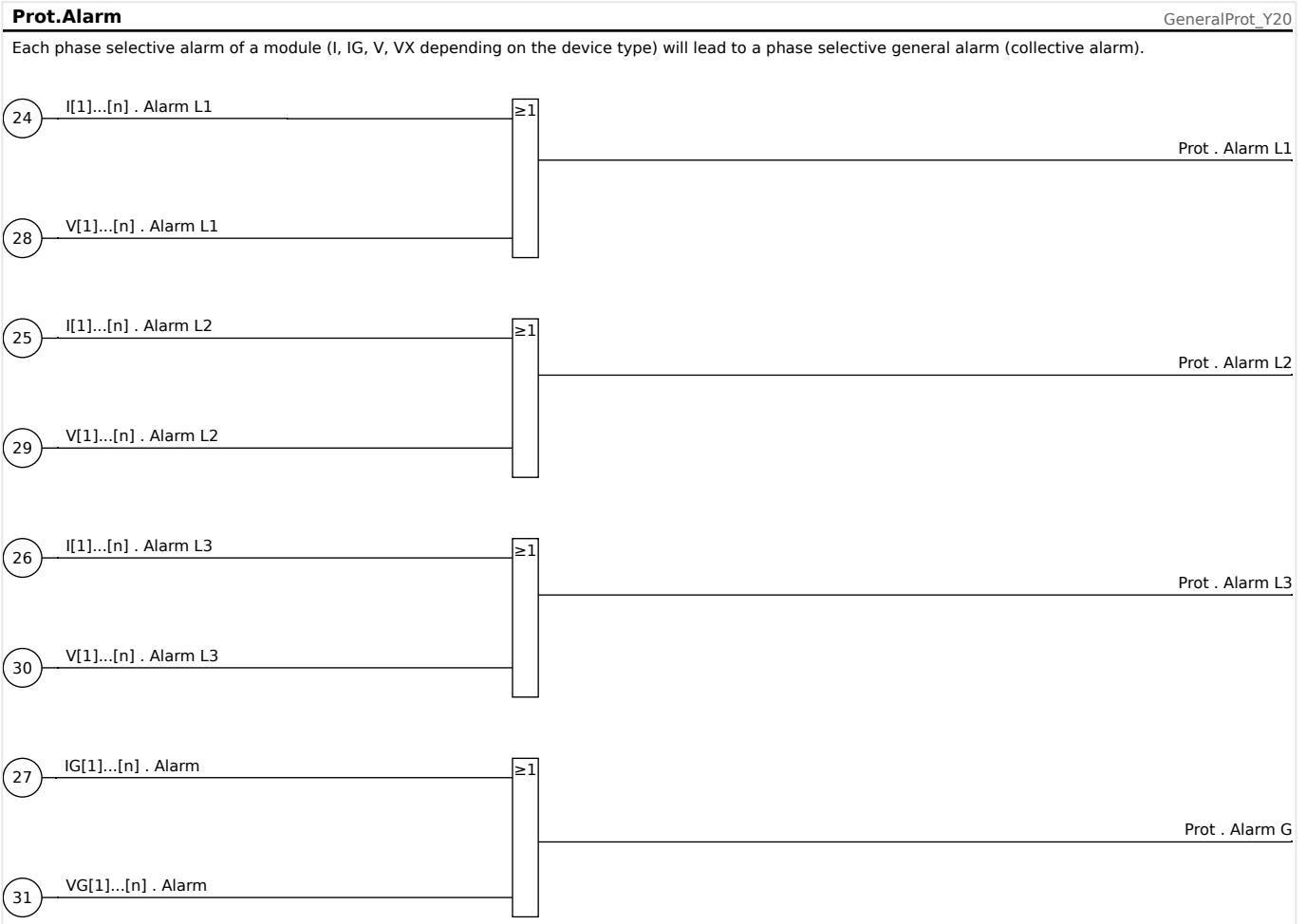
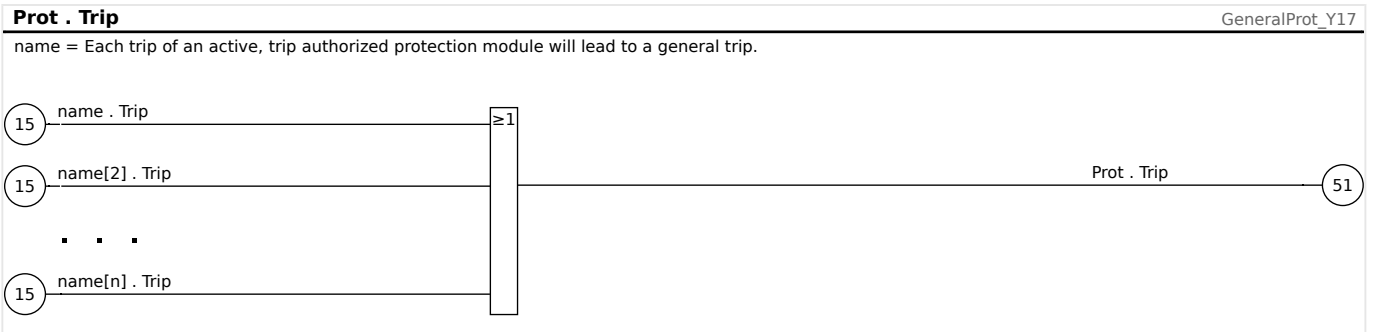

4 Protective Elements

4.1 Module Prot: General Protection

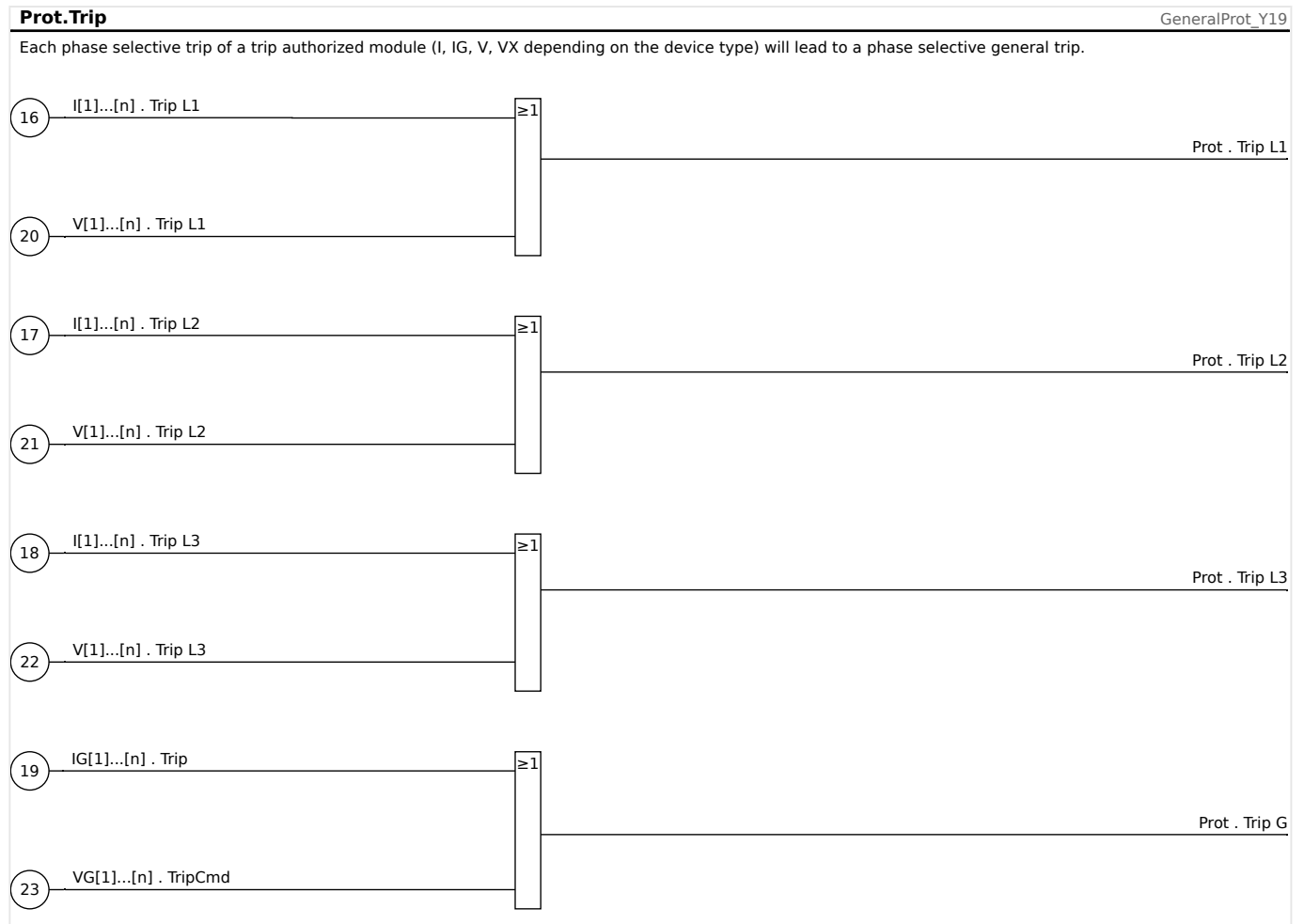

4.1.2 Blockings

The device provides a function for temporary and permanent blocking of the complete protection functionality or of single protection stages.

WARNING!



Make absolutely sure that no illogical or even life-threatening blockings are allocated.
Make sure that you do not carelessly deactivate protection functions which have to be available according to the protection concept.

Permanent Blocking

Switching ON or OFF the complete protection functionality:

In module »Prot« the complete protection of the device can be switched on or off. Set the parameter [Protection Para / Global Prot Para / Prot] »Function« to “active” or “inactive” in module »Prot«.

WARNING!



Only if in module »Prot« the parameter »Function« = “active”, the protection is activated; i. e. with »Function« = “inactive”, no protection function is operating. Then the device cannot protect any components.

Switching modules ON or OFF:

Each of the modules can be switched on or off (permanently). This is achieved when the parameter »Function« is set to “active” or “inactive” in the respective module.

Activating or deactivating the tripping command of a protection stage permanently:

In each of the protection stages the tripping command to the CB can be permanently blocked. For this purpose the parameter »Blo TripCmd« has to be set to “active”.

Temporary Blocking

To block the complete protection of the device temporarily by a signal:

In module »Prot« the complete protection of the device can be blocked temporarily by a signal. On condition that a module-external blocking is permitted »ExBlo Fc« = “active”. In addition to this, a related blocking signal from the »assignment list« must have been assigned. For the time the allocated blocking signal is active, the module is blocked.

WARNING!



If the module »Prot« is blocked the complete protection function does not work. As long as the blocking signal is active, the device does not protect any components.

To block a complete protection module temporarily by an active assignment:

- In order to establish a temporary blocking of a protection module the parameter »ExBlo Fc« of the module has to be set to “active”. This gives the permission: »This module can be blocked«.

- Within the general protection parameters a signal has to be assigned to »ExBlo1« or »ExBlo2«. The blocking only becomes active when the assigned signal is active.

To block the tripping command of a protection stage temporarily by an active assignment.

The tripping command of any of the protection modules can be blocked from external. In this case, external does not only mean from outside the device, but also from outside the module. Not only real external signals are permitted to be used as blocking signals, as for example, the state of a digital input, but you can also choose any other signal from the »assignment list«.

- In order to establish a temporary blockage of a protection stage, the parameter »ExBlo TripCmd Fc« of the module has to be set to "active". This gives the permission: »The tripping command of this stage can be blocked«.
- Within the general protection parameters, a signal has to be chosen additionally and assigned to the parameter »ExBlo TripCmd« from the »assignment list«. If the selected signal is activated, the temporary blockage becomes effective.

4.1.2.1 Blocking the Tripping Command

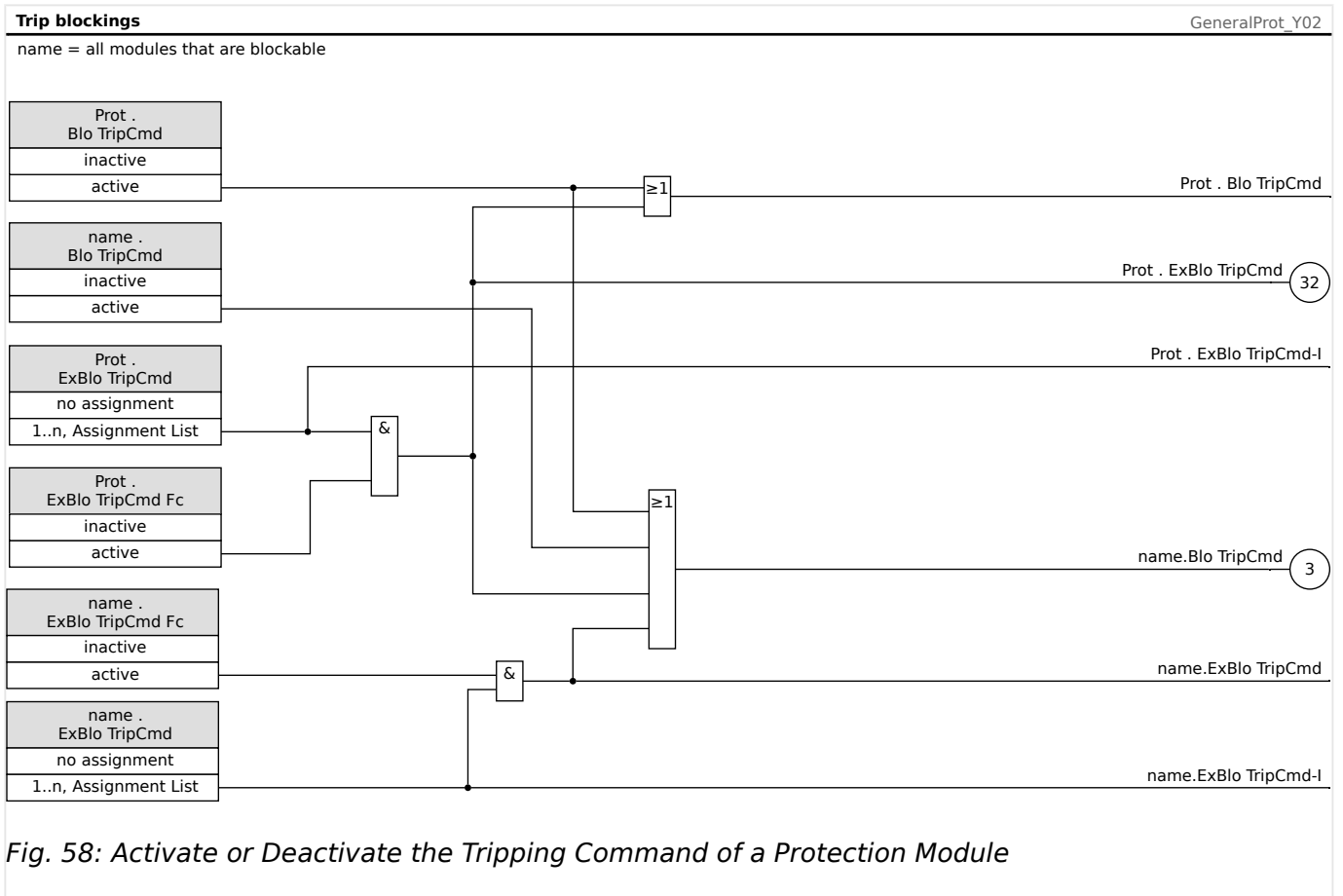

4.1.2.2 Activate, Deactivate or Block a Protection Function Temporarily

The following diagram applies to all protective elements except those for which a module-specific diagram follows underneath:

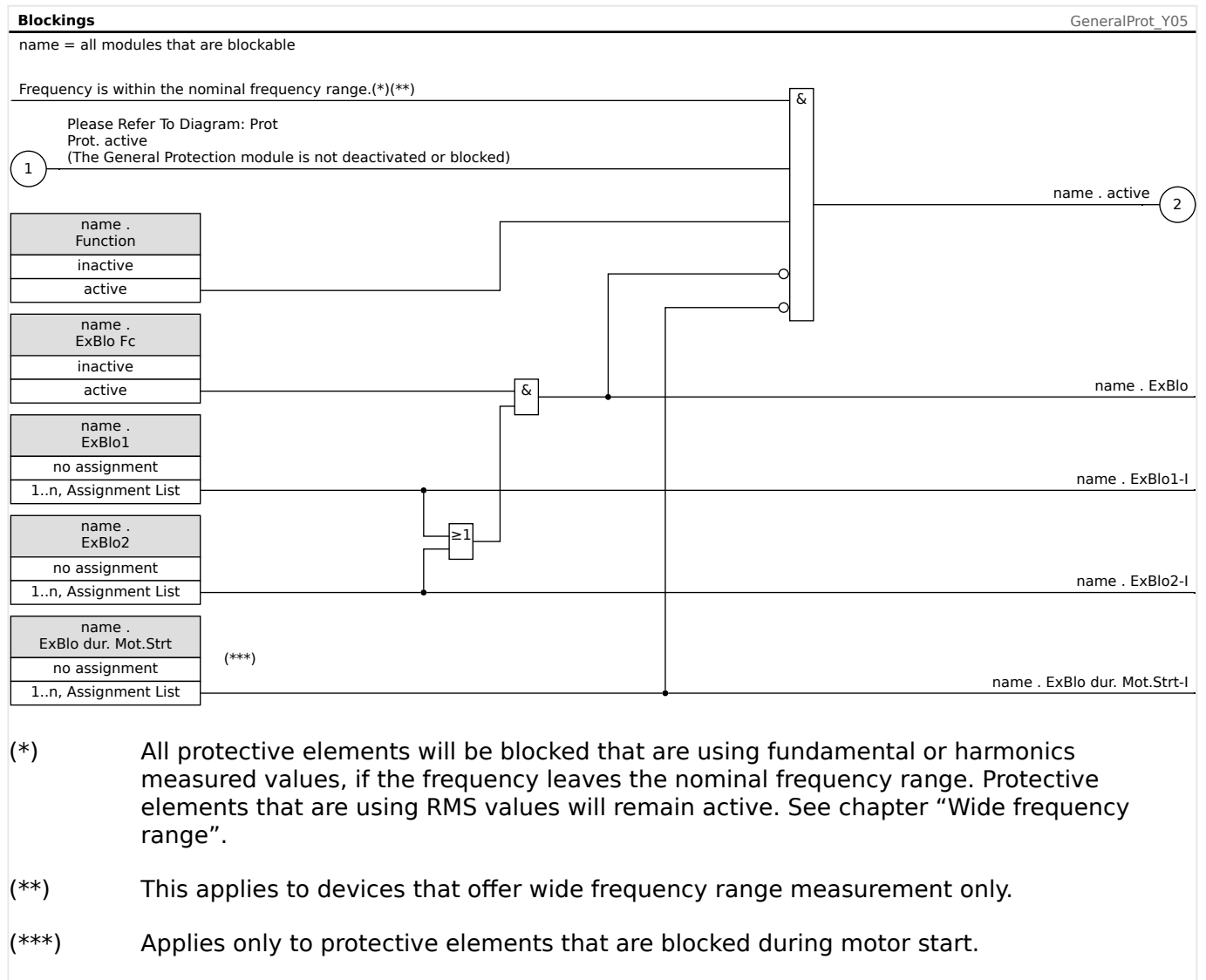

4.1.2.3 **Activate, Deactivate or Block the Phase Current Modules**

Current protective functions cannot only be blocked permanently (»*Function*« = "inactive") or temporarily by any blocking signal from the »assignment list«, but also by »reverse Interlocking«.

4 Protective Elements

4.1 Module Prot: General Protection

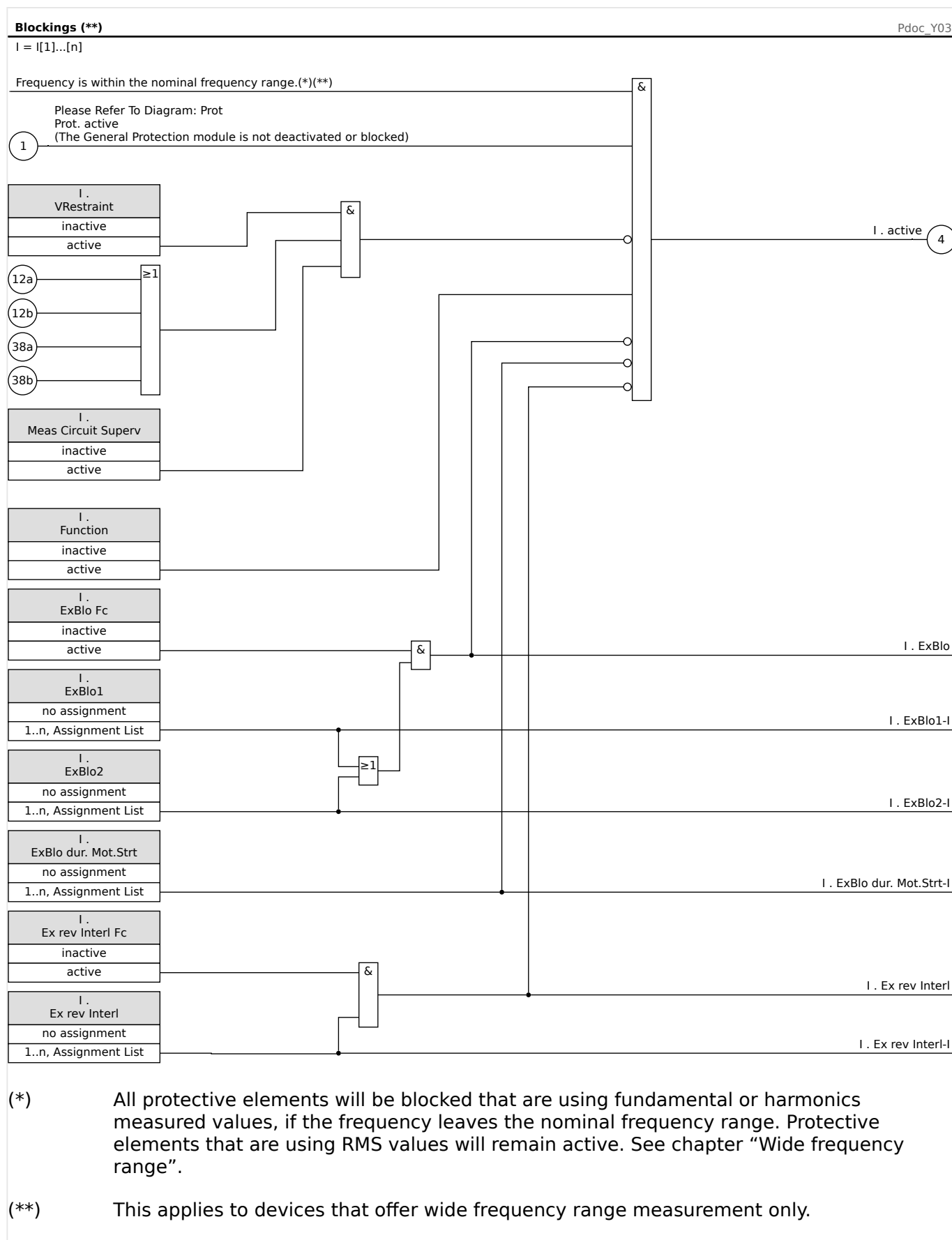

4.1.2.4 **Activate, Deactivate or Block the Ground (Earth) Current Modules**

Ground (earth) current protective functions cannot only be blocked permanently (»*Function*« = “inactive”) or temporarily by any blocking signal from the »assignment list«, but also by »reverse Interlocking«.

4 Protective Elements

4.1 Module Prot: General Protection

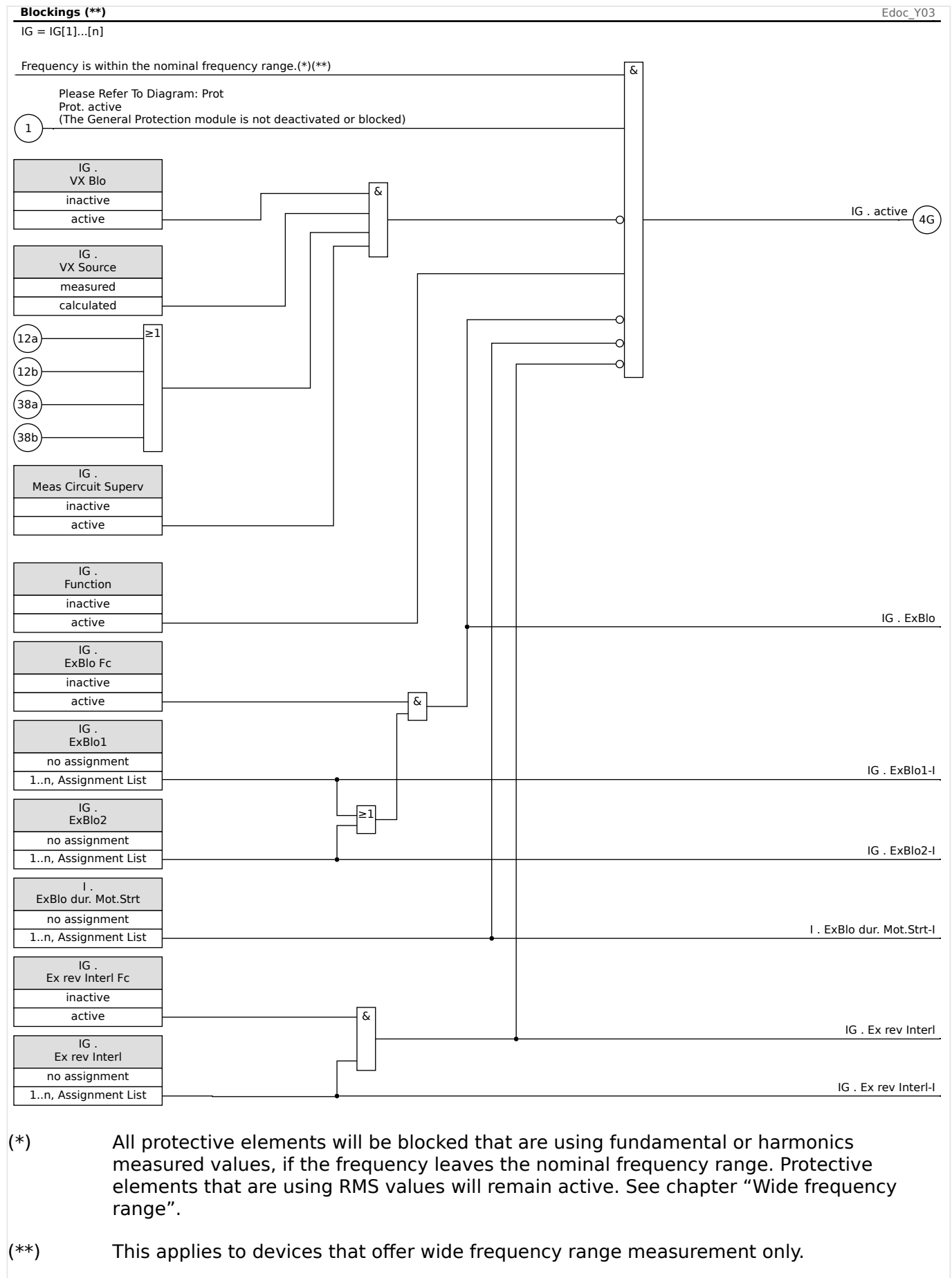

4.2 MStart - Motor Start and Control Module [48, 66]

General - Principle Use

The motor start control logic is the core control and protective function for a motor protection device. The logic comprises:

- Motor Operation States (↳ “4.2 Motor Operation States”)
- Motor Start Control (↳ “Start Control”)
- Motor Start Blockings (↳ “Blocking Conditions”)
- Motor Start / Transition Trips (↳ “Motor Start / Transition Trips”)
- Motor Cold / Warm Detection (↳ “Motor Cold / Warm Detection”)
- Emergency Override (↳ “Emergency Override”)

Motor Operation States

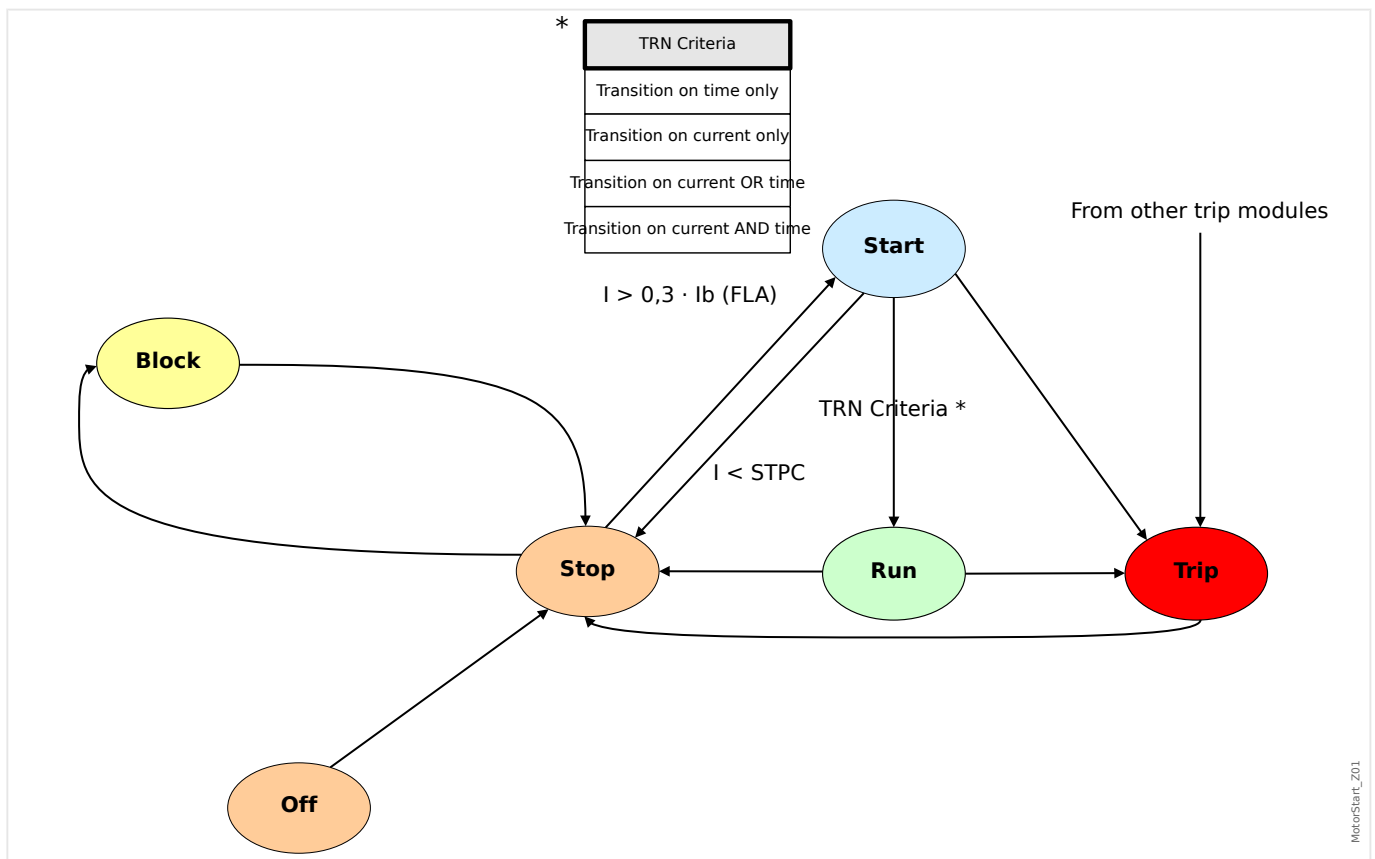

The basic motor operation states can be classified as four states that include:

- Start cycle;
- Run cycle;
- Stop cycle; and
- Trip state.

Under normal conditions, the motor operations should go through »stop«, »start«, »run«, and »stop« cycles that are referred to as a complete operation sequence; while under certain abnormal conditions, the motor could go from »start« to »stop«, or »start« to »trip«, or »run« to »trip«.

If other protection trips occur at either the »start« or »run« cycle, the motor will be forced to go to »trip« mode. After motor currents are terminated, the motor will go into the »stop« cycle.

4.2.1 Start Control

The parameters for the Start Control have to be set within menu [Protection Para / Global Prot Para / MStart / Start Control].

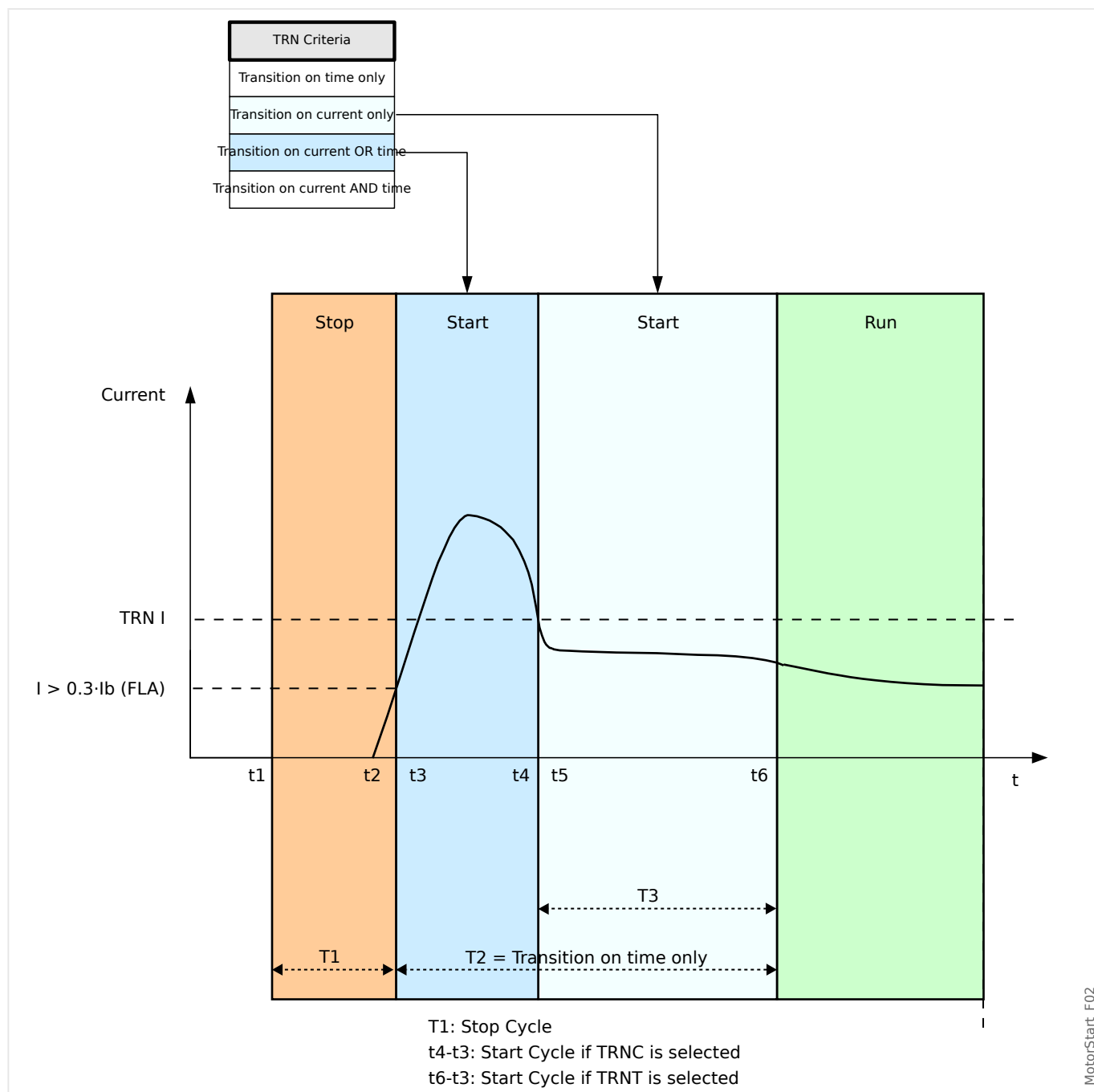

The Start Control Module drawing shows an example of how the protective device reacts to a normal operating-cycle current profile. Initially, the motor is stopped and the current is zero. As long as the protective device is not in a »trip« state, it permits contactor energization by closing its trip contact in series with the contactor. The contactor is energized by the operator or process control system through a normal two-wire or three-wire motor control scheme, external to the protective device. The protective device declares a motor start when it senses a motor current that exceeds 30% of the »Ib« (FLA) setting. Meanwhile, the transition timer »TRNT« begins to run. The protective device also monitors the large starting current, noting when the current falls below the transition level »TRNC«.

The Start to Run transition is based on the setting »TRN Criteria«, which has four transition behaviors for the User to select:

- TRN T-Transition to RUN after time setting TRNT only. Current is ignored.
- TRN C-Transition when starting current drops below the setting only. If the time set in TRNT expires before the current transition, the motor trips.
- TRN T or C-Transition on time or current, whichever comes first.
- TRN T and C-Transition on time and current. Both must occur, and the current must drop below the setting before the time delay expires. If the timer expires before the current falls below the set transition level, the motor trips.

If there is no transition trip, the protective device relay declares a successful transition to »RUN« cycle and the corresponding transition signal(s) (current or time, or both, depending on the settings and motor current) is set. The transition signal(s) is the part of the global output list, which can be assigned to any module input or relay output. If it is assigned to a relay output, it can control a reduced-voltage starter, switching to full running voltage.

Even if the transition control output contact is not used, the transition function can provide clear indications of the actual state of the motor (»START« versus »RUN«) on the front panel display and via data communications. A good way to do this is to use the settings of TRN Criteria = TRN T or C and TRNC = 130% of »I_b« (FLA). Modify the latter, if needed, to lie at a transition value between the starting current and post-start maximum load current. Set the transition timer well beyond the normal start time to avoid a transition trip.

4.2.2 Delayed Protection Enabling During Motor Starts

When the MRMV4 detects a motor start, various timers are started. Each of these timers blocks a protective function until the set delay expires. This way false trip decisions by these protection functions during the motor start are prevented.

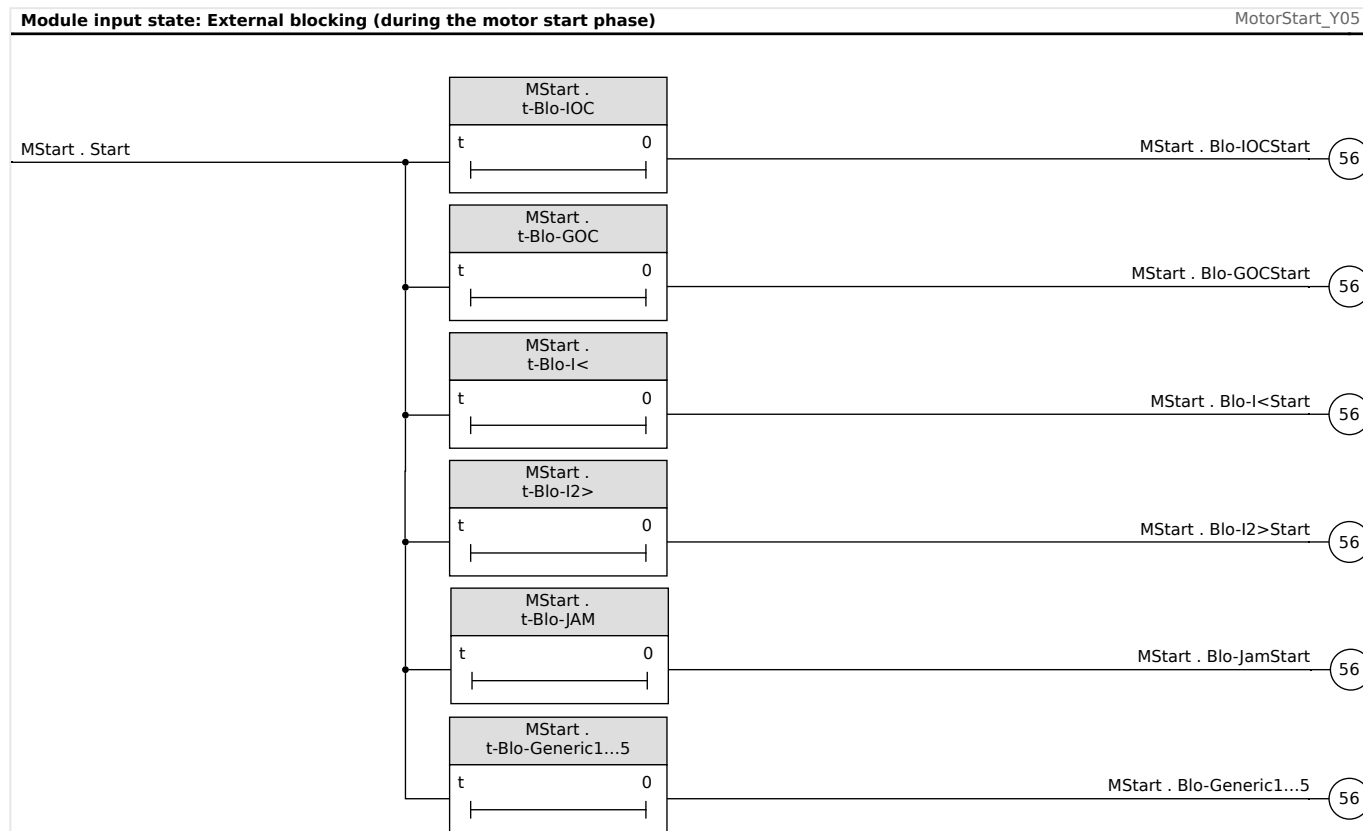

Fig. 59: Temporary blocking of current protection functions during motor start.

“1...5” These are five independent generic blocking signals with five delay timers. These are abstracted here to only one delay timer / signal for the sake of simplicity.

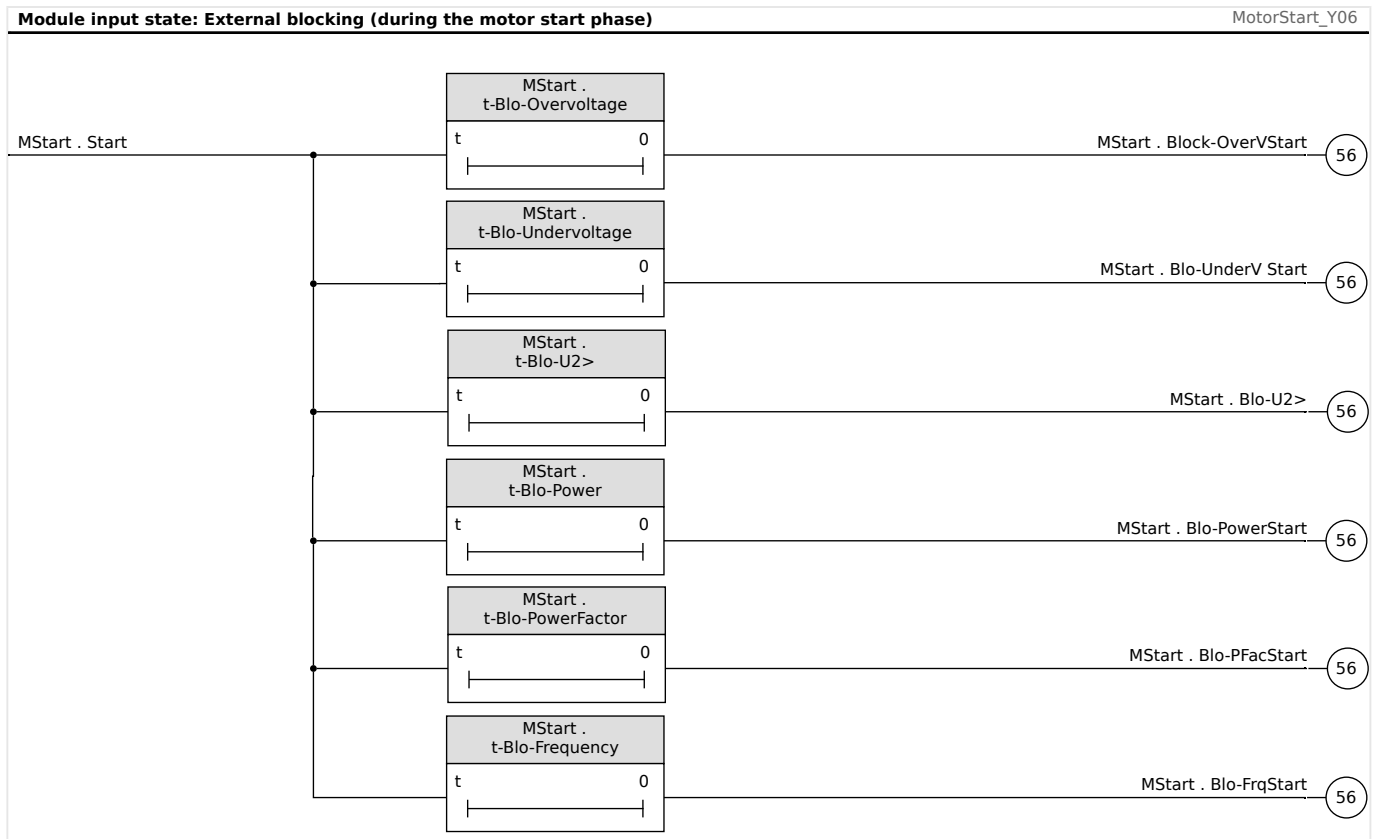

Fig. 60: Temporary blocking of voltage-related protection functions during motor start.

The setting parameters for all these start delays are available within the menu [Protection Para / Global Prot Para / MStart / Start Delay Timer].

- **IOC** (Instantaneous overcurrent):

The setting »*t-Blo-IOC*« defines the time (in seconds) after a start is recognized until the IOC trip and alarm functions are enabled. Use this delay to inhibit IOC tripping on a current peak caused by magnetic inrush when the motor is first energized (usually two to three cycles).

Note that within every »*I[x]*« module, a dedicated blocking parameter is defined by default for this purpose:

$$\text{»}I[x] . \text{ExBlo dur. Mot.Strt}\text{«} = \text{“MStart . Blo-IOCStart”}$$

- **GOC** (Ground fault):

The setting »*t-Blo-GOC*« defines the time (in seconds) after a start is recognized until the »*IG[x]*« protection modules (ANSI 50X, 50R and 50G) are enabled.

Note that within each »*IG[x]*« module, there is a dedicated blocking parameter, that must be defined for this purpose:

$$\text{»}IG[x] . \text{ExBlo dur. Mot.Strt}\text{«} = \text{“MStart . Blo-GOCStart”}$$

- **IUnbalance** (Current unbalance):

The setting »*t-Blo-I2>*« defines the time (in seconds) after a start is recognized until the »*I2>[x]*« protection modules (ANSI 46 current unbalance functions) are enabled.

Note that within every »I2>[x]« module, a dedicated blocking parameter is defined by default for this purpose:

»I2>[x] . ExBlo dur. Mot.Strt« = "MStart . Blo-I2>Start"

- **JAM:**

The setting »t-Blo-JAM« defines the time (in seconds) after a start is recognized until the »Jam[x]« protection modules (ANSI 50J functions) are enabled.

Note that within every »Jam[x]« module, a dedicated blocking parameter is defined by default for this purpose:

»Jam[x] . ExBlo dur. Mot.Strt« = "MStart . Blo-JamStart"

- **Voltage unbalance:**

The setting »t-Blo-U2>« defines the time (in seconds) after a start is recognized until the »V012[x]« protection modules (ANSI 47) are enabled.

Note that within each »V012[x]« module, there is a dedicated blocking parameter, that must be defined for this purpose:

»V012[x] . ExBlo dur. Mot.Strt« = "MStart . Blo-U2>"

- **Under- / Overvoltage:**

The settings »t-Blo-Undervoltage«, »t-Blo-Overvoltage« define the time (in seconds) after a start is recognized until the »V[x]« protection modules (ANSI 27 or 59) are enabled.

Note that within each »V[x]« module, there is a dedicated blocking parameter, that must be defined for this purpose:

For the case of undervoltage: »V[x] . ExBlo dur. Mot.Strt« = "MStart . Blo-UnderV Start"

For the case of overvoltage: »V[x] . ExBlo dur. Mot.Strt« = "MStart . Block-OverVStart"

- **Power** protection:

The setting »t-Blo-Power« defines the time (in seconds) after a start is recognized until the »PQS[x]« protection modules (ANSI 32, 37) are enabled.

Note that within every »PQS[x]« module, a dedicated blocking parameter is defined by default for this purpose:

»PQS[x] . ExBlo dur. Mot.Strt« = "MStart . Blo-PowerStart"

- **Power Factor:**

The setting »t-Blo-PowerFactor« defines the time (in seconds) after a start is recognized until the »PF[x]« protection modules (ANSI 55) are enabled.

Note that within each »PF[x]« module, there is a dedicated blocking parameter, that must be defined for this purpose:

»PF[x] . ExBlo dur. Mot.Strt« = "MStart . Blo-PFacStart"

- **Frequency** protection:

The setting »*t-Blo-Frequency*« defines the time (in seconds) after a start is recognized until the »*f[x]*« protection modules (ANSI 81) are enabled.

Note that within every »*f[x]*« module, a dedicated blocking parameter is defined by default for this purpose:

»*f[x] . ExBlo dur. Mot.Strt*« = "MStart . Blo-FrqStart"

- **Generic** start delay – These timers are not tied to anything, they can be used to block any module at the user's choice.

The settings »*t-Blo-Generic1*« ... »*t-Blo-Generic5*« define the time (in seconds) after a start is recognized until the blocking of some module ends.

Note that within the module to be blocked during the start phase, for example the module »*Exp[1]*«, you must configure one of the available blocking parameters, for instance:

»*Exp[1] . ExBlo1...2*« = "MStart . Blo-Generic1...5"

("1...2" means: Select any available blocking parameter, i. e. either number 1 or 2. In the same manner, "1...5" means: Select any of the available generic blocking signals, matching the respective delay timer.)

4.2.3 Motor Start Blocked

A Motor Start can be blocked by certain events, if any of the following conditions are noted - motor starts limit, starting frequency, thermal and mechanical constraints. The User may choose to use the states to block the motor from starting or use it as an alarm or indication.

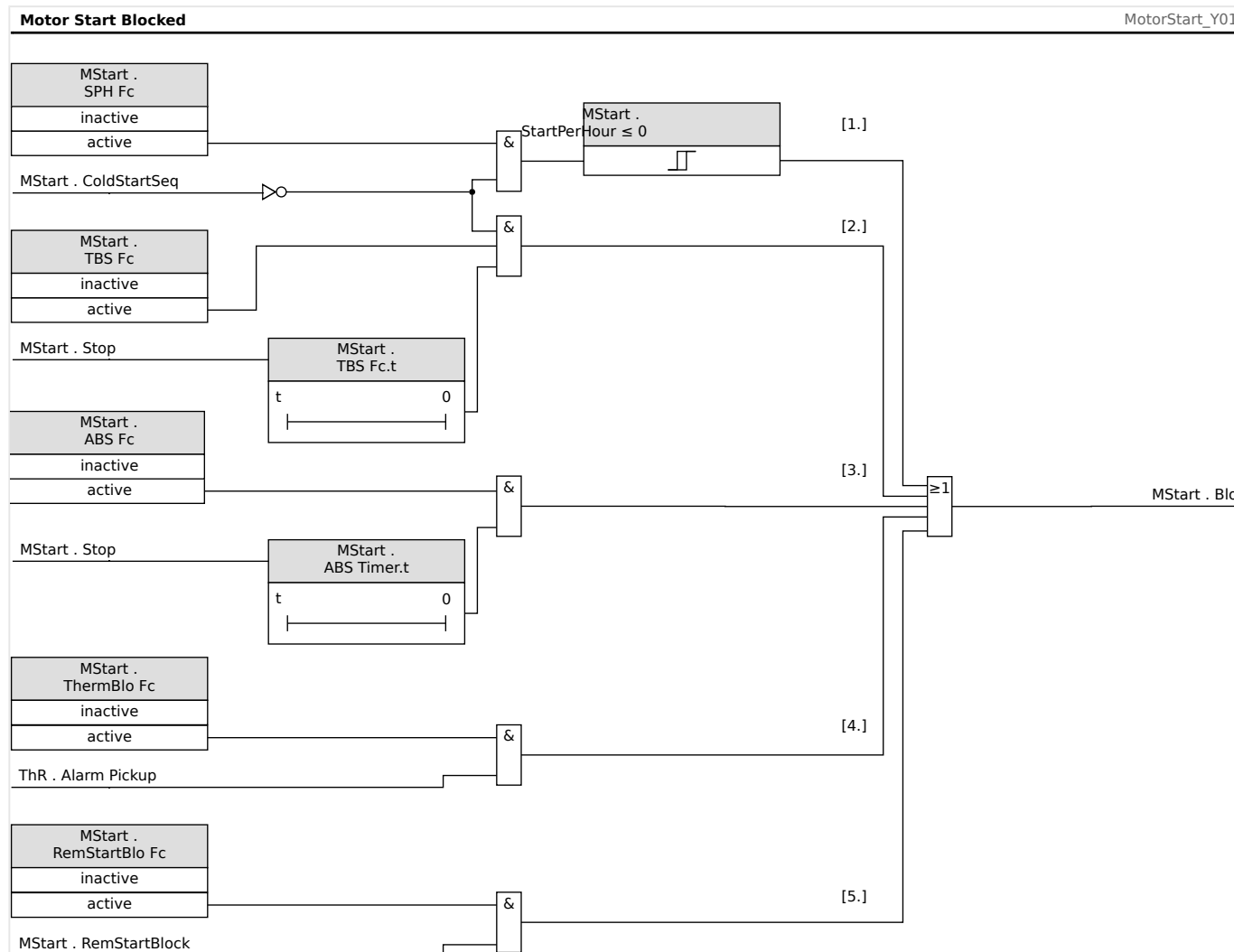

- [1.] Reason for Start Blocking: Too many starts per hour.
- [2.] Reason for Start Blocking: Waiting time between starts is not elapsed.
- [3.] Reason for Start Blocking: Reversing not allowed.
- [4.] Reason for Start Blocking: Thermal Blocking.
- [5.] Reason for Start Blocking: External Start Blocking.

4.2.4 Blocking Conditions

The reasons for a Motor Start Blocking are as follows:

The Motor Start will be blocked due to:

- There are too many starts per hour (if configured).
- The waiting time between starts is not elapsed (if configured).
- If the Anti Backspin protection detects a reversing of the motor (reversing not allowed, if configured).
- The thermal model blocks the motor (if configured).
- External Blocking becomes active (if configured).

When any of Anti-Backspin, thermal, and external blocks are on, the »MStart . Blo« signal is set. The »TBS« and »SPH« can activate the »MStart . Blo« signal only if the motor is not in a cold start sequence; »NOCS« block cannot activate the »MStart . Blo« signal.

4.2.5 Start Limits

Because motor starting consumes a considerable amount of thermal energy compared to its normal load conditions, the number of starts in a given time period must be monitored and controlled. The MRMV4 has three criteria that contribute to the start limits monitoring. These are:

- Settings in menu [Protection Para / Global Prot Para / MStart / Start Control]:
 - »NOCS« — Number of Cold Starts.
 - »TBS Fc« in combination with »TBS Timer« — Time between Starts.
 - »SPH Fc« in combination with »SPH« — Starts per Hour.
- Signals, that can be checked in menu [Operation / Status Display / MStart / Start Control]:
 - »ColdStartSeq« — Signal: Motor cold start sequence flag.
 - »NOCSBlocked« — Signal: Motor is prohibited to start due to number of cold start limits.
 - »SPHBlockAlarm« — Signal: Motor is prohibited to start due to starts per hour limits, would come active in the next stop.
 - »SPHBlocked« — Signal: Motor is prohibited to start due to starts per hour limits.
 - »TBSBlocked« — Signal: Motor is prohibited to start due to time between starts limits.
- Counters, that can be checked in menu [Operation / Measured Values / Motor]:
 - »ColdStartPermit« — Number of cold starts remaining.
 - »nSPHBlocks« — Number of start per hour blocks since last reset. .
 - »nTBSBlocks« — Number of time between start blocks since last reset..

Most motors can tolerate some number of consecutive cold starts before the time between starts is enforced. The MRMV4 treats a start as the first in a sequence of cold starts if the motor had been stopped for at least the time period »TBS Timer«, but at least for one hour.

Subsequent starts are treated as additional cold starts in the same sequence, only if they run no more than ten minutes, until the set number of cold starts is reached.

Once the motor is in the cold starting sequence, it ignores the »TBS« and »SPH« limits. The cold start sequence is terminated if the motor has run for more than ten minutes for a cold start before it exhausts »NOCS«. All starts after this are subject to time and count limits imposed by »TBS« and »SPH«.

If the motor reaches the »NOCS« limit in a cold start sequence, the »NOCSBlocked« block signal is set and the »TBS« timer is started.

When the »TBS« timer elapses while the »NOCSBlocked« block signal is still set, the cold start sequence is terminated and the »NOCSBlocked« block is released. Meanwhile, the »SPH« will start to count at the last start in the complete cold start sequence.

4.2.6 Stop Cycle

The run cycle continues until the motor current level falls below the Stop Current Threshold setting current on all three phases. Then a stop is declared. The start limits (also referred as Jogging start limits) and the anti-backspin time delay (ABS) are checked. If blocking conditions exist, the protective device can be configured to block a motor from starting. Remaining jogging block times are displayed and counted down, indicating how long to wait. If there are no such starting block conditions in effect, the protective device is ready for a new start.

4.2.7 Anti-Backspin Delay Time (ABS)

»ABS« sets the time in seconds before a motor restart is permitted after a trip or stop condition. This function can be set to »inactive«.

This function is used with a motor driving a pump working into a head, or any other load that tends to spin in a reverse direction (backspin) when the motor is de-energized. It blocks starting during the time when the motor might be rotating in reverse following a trip. Also, this function may be used simply to set idle time (time between stop and start) before a restart is permitted.

4.2.8 External Start Blocking

A motor can be blocked through a digital input. If this feature is enabled, the User must make sure that both the Motor Start and Digital Input modules are configured properly.

4.2.9 Thermal Block

Besides the previously mentioned start monitoring and controlling means, the motor can be blocked if the thermal capacity used exceeds the alarm level. It is the User's choice to turn on or off this feature and set an appropriate alarm level in the thermal model module.

4.2.10 Forced Starting

It is recommended that the user wires the »MStart.Blo« output to the motor trip circuit for preventing the motor from starting under these blocked conditions. If the User chooses not to do this for their applications, a Forced Starting signal will be set when the motor is started with the blocked conditions. This signal can only be reset manually through *Smart view* or from the front panel (please refer to section Emergency Override).

4.2.11 Reversing or Non-Reversing Starter

The MRMV4 uses the phase currents to calculate the symmetrical components (positive and negative system). Based on these the MRMV4 determines the phase rotation of the applied system. If the measurements fit to the setting [Field Para] »Phase Sequence«, the signal »MStart . Rotating forward« is set; otherwise the signal »MStart . Rotating backward« is set.

The setting [Field Para] »Reversing« specifies whether or not the starter for this motor is designed to reverse the phase sequence and to make the motor run in either direction.



The setting value »Reversing« = "active" specifies that a motor start with reversed phase sequence is an acceptable operating condition. In this case the MRMV4 accepts either sequence at the time of a start. The calculated symmetrical components (positive and negative system) get exchanged automatically if the reversed situation is recognized, and all protection functions that are based on these measurements continue without getting alarmed.

The setting value »Reversing« = "inactive" specifies that a motor start with reversed phase sequence is **not** an acceptable operating condition. In this case the »MStart« module trips and sets the following signals approximately 100 ms after the motor has been started:

- »MStart . TripPhaseReverse«
- »MStart . Trip«
- »MStart . TripCmd«

4.2.12 Motor Start / Transition Trips

The Motor will be tripped during the start phase, in case that:

- The Start Control detects an unsuccessful Start (see  “Start Control”).
- There is an Incomplete Start Sequence. The device detects via an digital input, that the external process is not properly started.
- If a reverse direction is detected but reversing is not allowed. (See  “Reversing or Non-Reversing Starter”.)
- If case of a Zero Speed Switch trip.

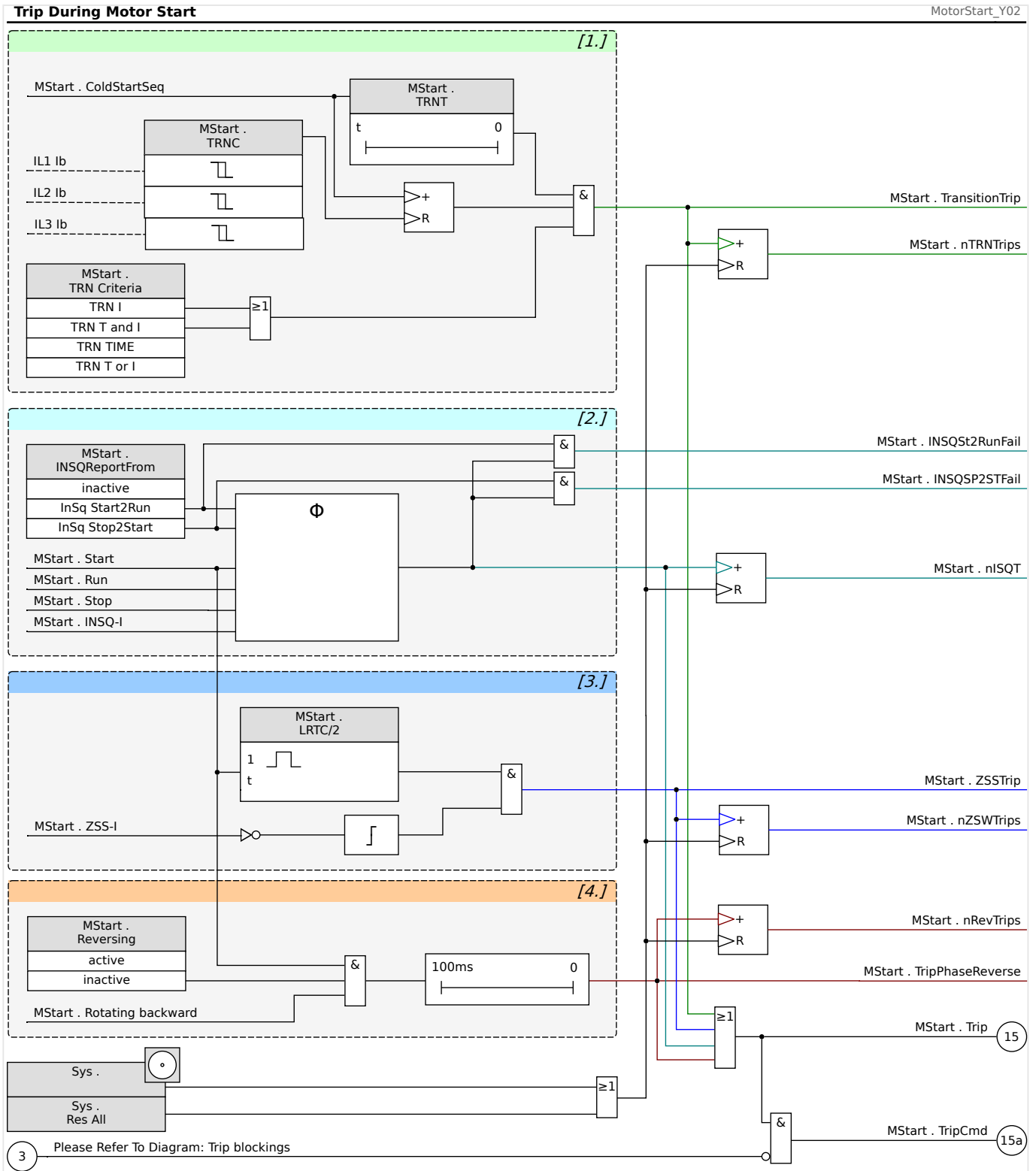

[1.] Trip during Motor Start. Reason: Motor Start Phase Supervision.

[2.] Trip during Motor Start. Reason: External Process Failure.

[3.] Trip during Motor Start. Reason: Zero Speed Switch Trip

[4.] Trip during Motor Start. Reason: Reversing not allowed.

4.2.13 Incomplete Sequence Report Back Time (INSQ)

The incomplete sequence function requires an input from the report back contact from the process that the motor is running. Shortly after the motor starts, the report back contact provides an indication that the process has started to operate as expected. If the process does not start up correctly, the contact does not close within the expected time. If a problem develops later on, the report back contact opens. In either case, the open contact state indicates that the motor should be tripped.

To use this function, set a time limit for report back here and define the start of report back timing. Connect the report back contact to one of the protective device Discrete Inputs. If this input is not energized before the set time expires, the relay will trip on an “Incomplete Sequence”.

Note that the input must be energized continuously after the time delay has expired to hold off this trip. Otherwise, if the incomplete sequence report back contact changes state for a period greater than 0.5 seconds, the relay will trip on an incomplete sequence. This delay allows for any momentary transient switching that may occur in the process report back contact, such as that which can occur in an open transition reduced voltage start.

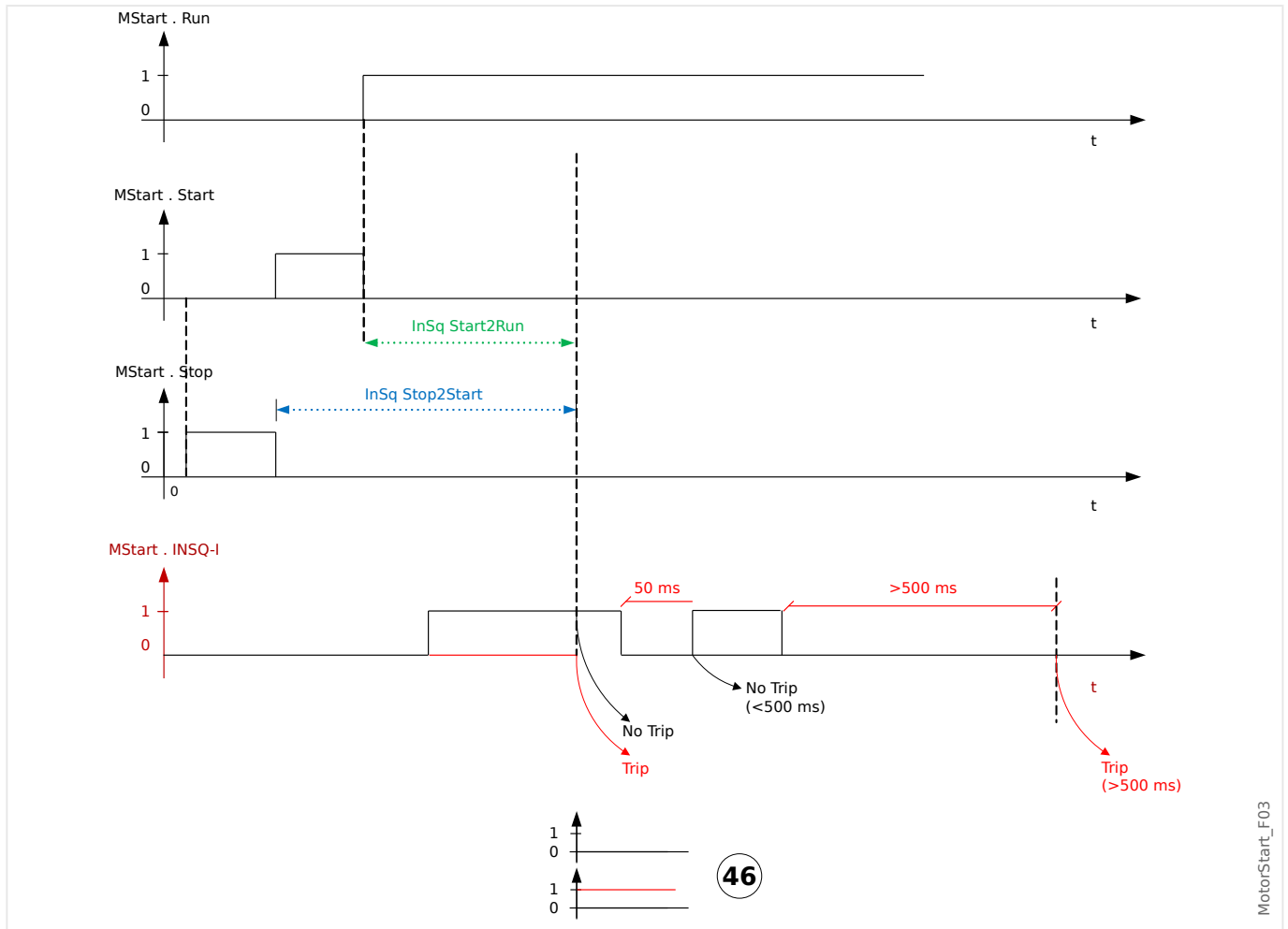

4.2.14 Zero Speed Switch (ZSS ON or OFF)

ZSS enables the function that verifies if the motor begins to physically spin after a start. It requires a zero-speed switch (digital switch) on the motor, which is closed at rest and opens as the rotor reaches (5%-10%) its normal speed. Connect the zero-speed switch contact to one of the protective device Digital Inputs. If the contact fails to open within »LRT/2« (one-half of locked-rotor time) after a start, the relay trips with a zero-speed switch trip message.

This protection is always useful, but is essential if the Long Acceleration Time (LAT) function setting is used.

With ZSS being enabled and being mapped to one of the digital inputs, the protective device checks the ZSS input status at the very moment it sees a start - it wants to sense the initially closed zero-speed switch, which opens shortly thereafter as the motor spins. If it fails to find the closed contact, it trips immediately. Check the wiring and contact for problems.

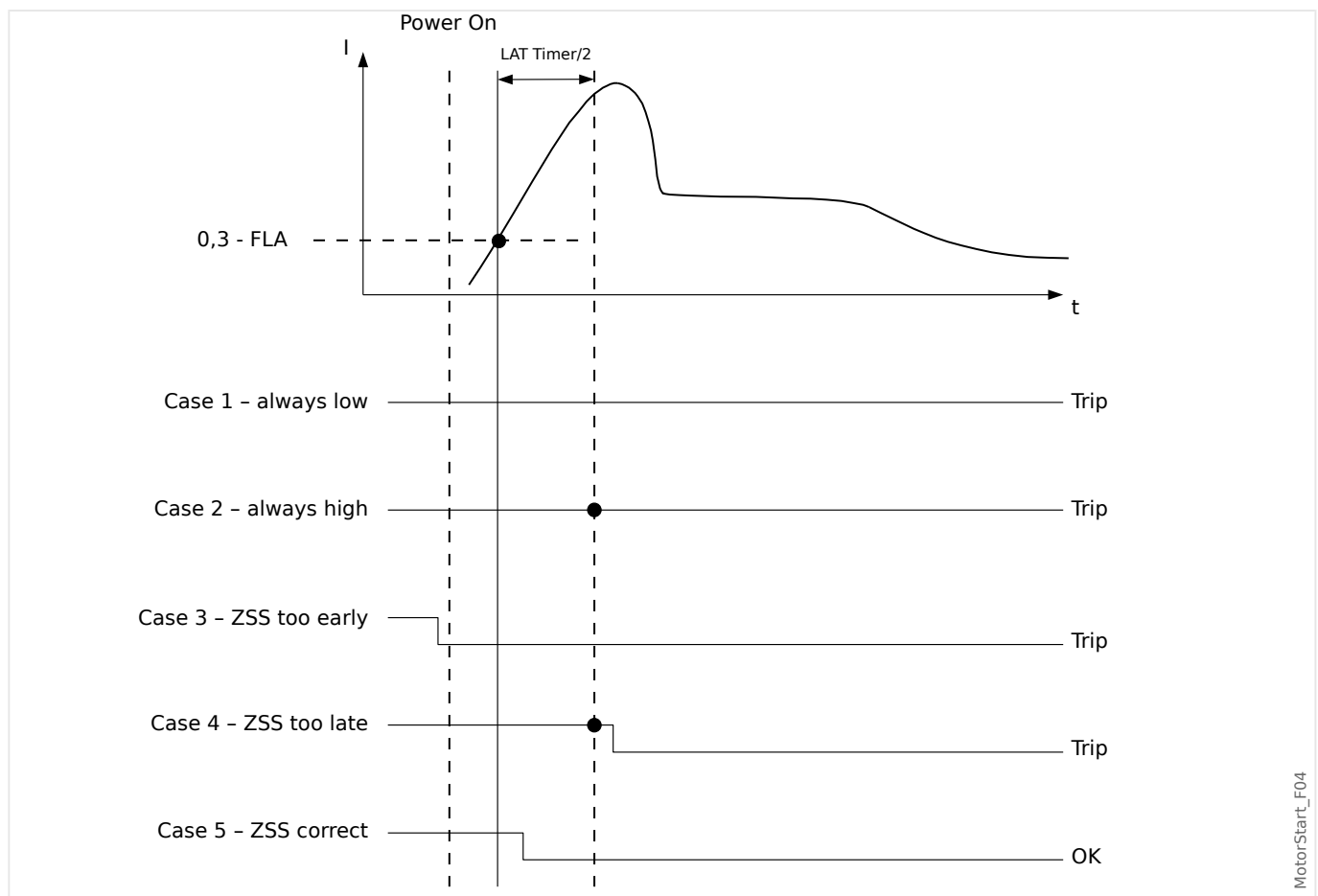

4.2.15 Long Acceleration Time (LAT)

When the LAT function is enabled, the »LAT« timer is used to set a time interval during which the motor is permitted to accelerate a high-inertia load, which is longer than the locked-rotor time. This function can be (and usually should be) set to »inactive«. If the thermal-model accumulator bucket fills to 100% during the long acceleration time, it is limited to that value and the thermal trip is held off until the LAT timer expires. By then, the thermal bucket level must have decreased (thermal model cooled) below 100% or the motor trips.

The LAT function should be used but not limited only on motors with a zero-speed switch (a normally-closed contact that opens when the motor actually begins to spin). Connect the zero-speed switch contact to one of the protective device Digital Inputs. The Zero-Speed Switch function must be enabled (ZSS ON). The protective device requires the zero-speed switch to open within LRT/2 (one-half of locked-rotor time) after a start, or the motor is tripped by the ZSS function. This protects a completely stalled motor from being damaged when the LAT timer blocks the locked-rotor thermal trip.

CAUTION!



The long acceleration time (LAT) function can block the critical LRC-LRT rotor thermal protection during a start and destroy the motor. Turn LAT OFF unless absolutely needed and the motor's suitability for this starting duty has been confirmed. Use only with zero speed switch function ZSS ON and switch input connected to protect a stalled motor.

The User can temporarily defeat the I2t thermal protection limit after a start by setting a Long Acceleration Time delay. This can be a dangerous setting that blocks thermal tripping and holds the bucket at a 100% level if the load takes a long time to reach running speed. An example is a motor spinning a large centrifuge. In using LAT, the User can take advantage of the partial cooling from airflow produced by the motor spinning at below-normal speed, as compared to unfanned heating of a locked rotor. The motor must be rated for this severe starting duty. Also, the User must ensure that the motor actually has begun to spin well before the locked-rotor time has expired. This is accomplished by connecting a zero-speed switch to a Digital Input and turning on ZSS function. The zero-speed switch is a contact that is closed when the motor is at rest, and opens as the motor begins to spin, usually at 5-10% of running speed. If ZSS is set to ON and the protective device relay does not sense the contact open in one-half the locked-rotor time setting, it trips the motor.

WARNING!



Turn OFF LAT unless the application specifically demands it. Use a zero speed switch with LAT. Using an LAT setting greater than locked rotor time without a zero speed switch temporarily defeats thermal protection and damages the motor if the rotor actually is locked.

If »LAT« is used, check the settings of transition time »TRNT« and jam start delay to be sure they are coordinated with the prolonged starting cycle.

4.2.16 Motor Cold / Warm Detection

The motor will be considered as cold (»Cold sequ = true«) after being in the »stop« mode for more than one hour if the time between starts timer is set to a lower value than 1 hour.

Else, the motor will fall back into the »cold« state if the time between starts timer is elapsed. By means of the Emergency Override function, the motor can be forced to switch to the cold state.

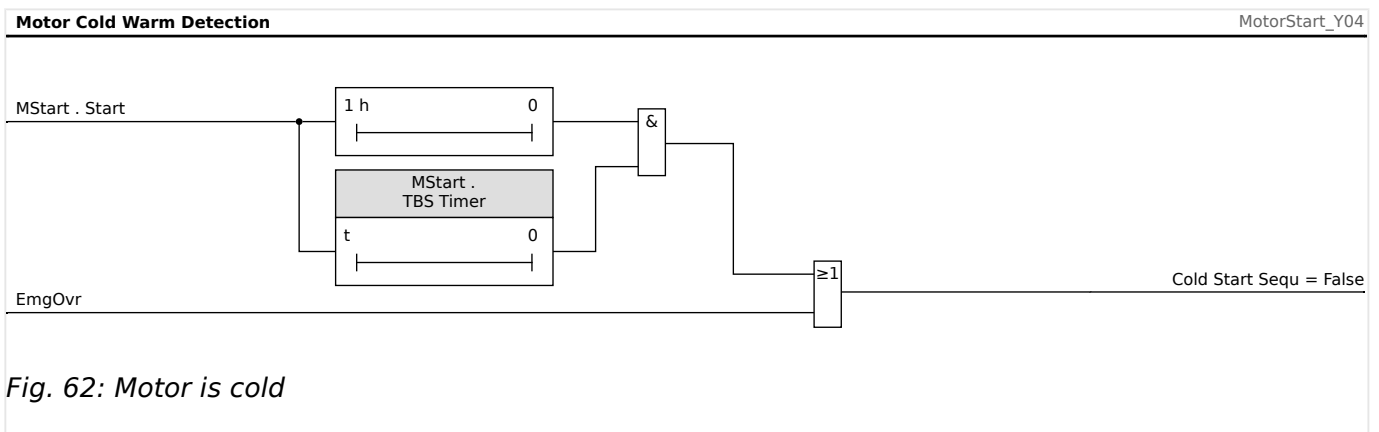
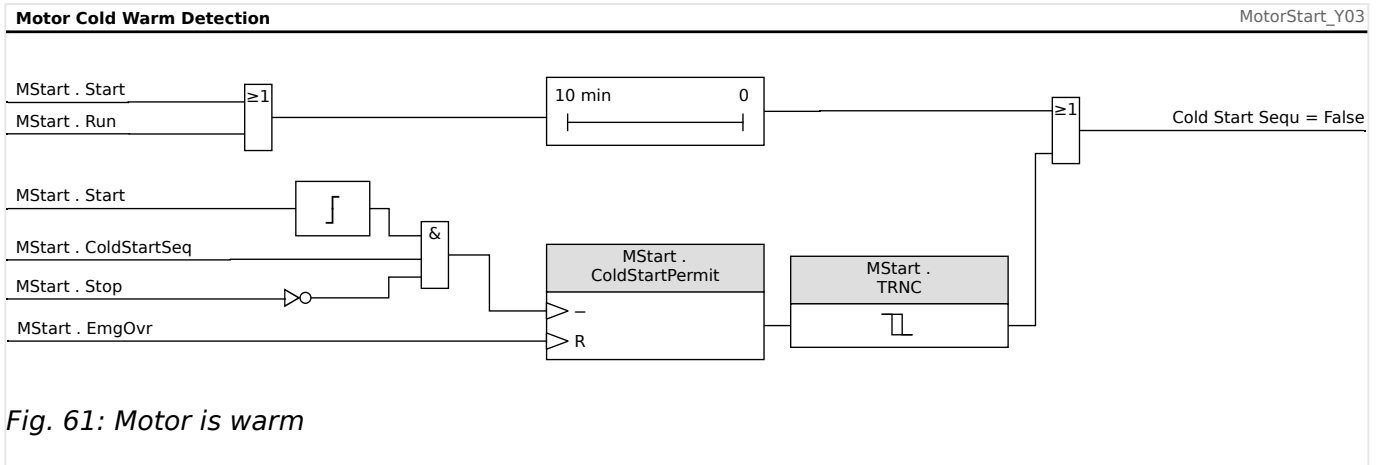

4.2.17 Emergency Override

The Emergency Override function can be enabled or disabled via the setting [Protection Para / Global Prot Para / MStart / Start Control] »*EmgOvr*«. The setting value also determines whether this function can be executed by a Digital Input (“DI”) or by a softkey at the HMI (“HMI”) or both (“DI or HMI”).

If enabled, an emergency override can be executed by pushing the »Emrg Override« Softkey at the front panel. In any case, an emergency override can be performed by a remote contact connected to any one of the digital inputs programmed as »EMG OVR«, or via front panel at [Operation / Reset / EmgOvr] »*EmergOverHMI*«. The as-shipped setting is disabled.

Emergency override allows a panic restart of a tripped motor without completely disabling protection. When the override request is received, the thermal-model accumulator bucket is drained to its initial level of 40°C (104°F). Cold starts are fully restored.

The motor protection is now in the state it would be in if the motor had been standing for a long time prior to the moment of the override. This allows an immediate restart of the motor. The override can also delay an impending thermal trip of a running motor. The emergency override action is counted in the history record, and noted with its time tag in the logbook record.

CAUTION!



The emergency override function clears and restarts all protective functions of the protective device. Using this function can damage the motor. Use it only for true emergencies, when it is known what caused the trip. Override permits the risk of motor damage to avoid an even more dangerous process situation caused by the tripping of the motor.

4.3 ThM - Thermal Model [49M, 49R]

Thermal Protection and Alarm

This protective device provides a thermal model. The thermal model can work with or without the URTD. The RTD-based direct temperature trips and alarms are independent of the thermal model. Without the URTD, meaning the URTD is not connected to the protective device or it is connected but not configured for the thermal protection trips, the thermal model protection will be solely based on the following settings:

- Full Load Ampere (FLA) - I_b ;
- Locked Rotor Current (LRC) - I_{LR} ;
- Maximum Allowable Stall Time (LRTC) - T_{LR} ;
- k-Factor;
- Thermal Model Trip Threshold if enabled;
- Trip Delay;
- Thermal Model Alarm Threshold if enabled; and
- Alarm Delay.

The first four settings (1...4) dictate the maximum allowable thermal limit curve of the protected equipment, and the last four settings (5...8) define the thermal trip and alarm curves relative to the thermal limit curve.

Mathematically, the thermal limit curve can be expressed as the following:

$$TripTime = \frac{I_{LR}^2 \cdot T_{LR}}{I_{ef}^2}$$

where for the effective heat current I_{ef} the following holds:

$$I_{ef} > k_{Factor} \cdot CT_{pri}$$

If the direct stator temperature measurements are available, the thermal replica model will be modified to include the heat loss between stator and rotor. As a result, the motor will be able to run longer under overload conditions. The heat loss serves as a cooling. At some point, the cooling effect will cancel the heat increment so that the thermal capacity used will reach some steady-state level that may be below the trip or alarm limit. This equivalently raises the »k-factor« and shifts the trip curve right.

If the thermal capacity used is held at a level that is below the trip threshold, the thermal model will not trip. To prevent the protected equipment from overheating, the direct temperature trip function must be enabled. Keep in mind that in order for the stator temperature to be effective in the thermal replica model, the following conditions must be met:

- The RTD channels must be configured to measure the winding temperatures; and
- These RTD channels must be enabled for trip.

In addition, at least one of these winding temperatures must be valid.

Knowing the maximum steady stator temperature Θ_S (°C), the thermal capacity used can be estimated by the following formula.

$$TC_{Used} \% = \left(\frac{\Theta_S}{240} + \frac{I_{ef}^2 \cdot 50}{I_{LR}^2 \cdot T_{LR}} \right)$$

when

$$I_{ef} > I_{th} \cdot FLA$$

Stator Temperature Effect on Current Threshold Curve

Take for example, $I_{LR} = 6 \cdot FLA$, $T_{LR} = 15$ s, and thermal trip level of 100%. The relationship between the effective current threshold and the stator temperature can be seen in the Stator Temperature Effect on Current Threshold Curve.

The diagram shows the following relationship: The lower the stator temperature, the higher the effective current threshold.

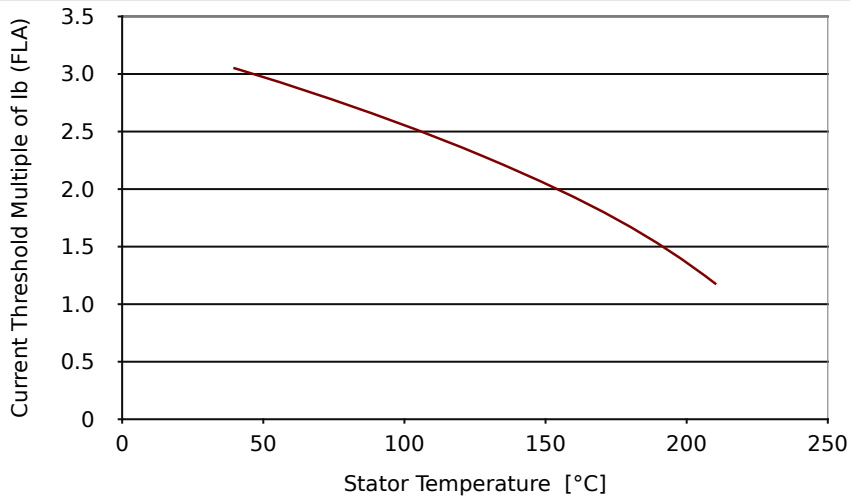

Fig. 63: Effective Current Threshold vs. Maximum Stator Temperature.

Without stator temperature, given the current threshold of $1.0 \cdot Ib$ (FLA) and $2.0 \cdot Ib$ (FLA) of the stator phase current, the thermal model will use the full thermal capacity in 139.54 seconds. However, if the stator temperature is known as 100°C (212°F), the effective ultimate trip current threshold is raised to $2.55 \cdot Ib$ (FLA) and the thermal capacity used will reach a steady state of 77.5%. As a result, the thermal model will never trip under this condition. From this example, it can be seen that the stator RTD could keep the motor running under overload condition. In this case, the appropriate direct stator temperature trip function must be enabled.

Thermal Replica Model Trip Curves

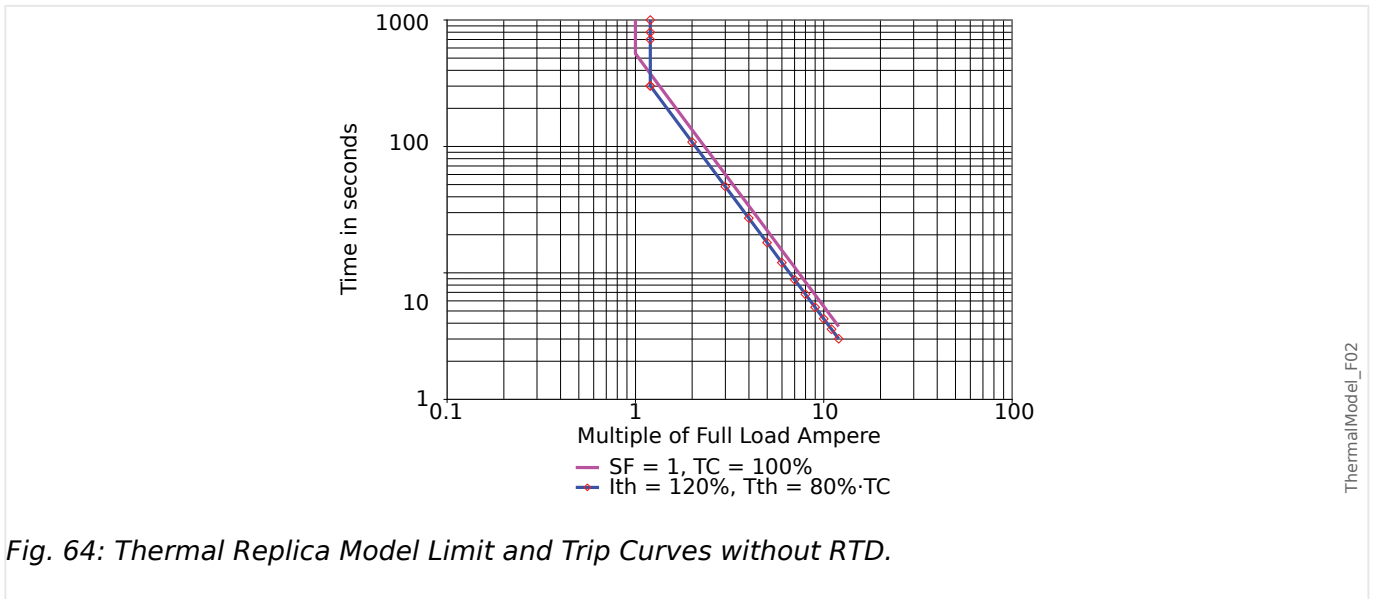

Fig. 64: Thermal Replica Model Limit and Trip Curves without RTD.

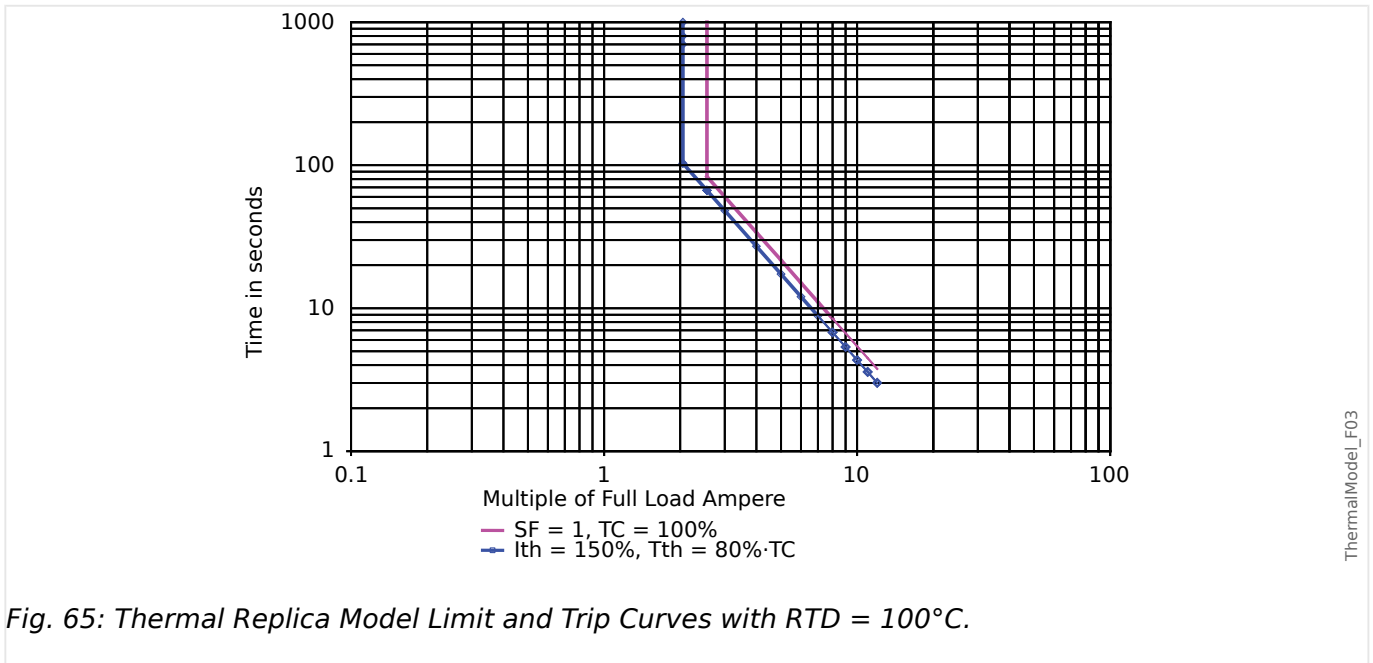

Fig. 65: Thermal Replica Model Limit and Trip Curves with RTD = 100°C.

In the Thermal Replica Model Trip Curves with and without RTD, the unmarked lines are the thermal limit curves and the marked lines are the trip curves. From the curve without RTD, it can be seen that one can change the thermal current threshold to shift the upper portion of the trip curve right to allow the motor to run at a higher overload condition than is specified with the service factor. From the curve with RTD, it can be seen that the stator RTD pushes the effective thermal current threshold to $2.55 \cdot I_b$ (FLA) on the thermal limit curve (unmarked line). The marked line is the trip curve with 80% thermal capacity trip threshold, so actual effective thermal current threshold for the trip curve is about $2.05 \cdot I_b$ (FLA). Although in this case, the thermal current threshold is set to $1.50 \cdot I_b$ (FLA), it is effectively raised to a higher level with the stator RTD. Keep in mind that thermal limit and trip curves shown are based on the example above. They will vary with other sets of the settings.

NOTICE!



With the setting [Protection Para / Set 1...4 / Temp-Prot / RTD / Windg Group] »*Windg Trip Function*« = “active”, the thermal model of the motor protection devices uses the hottest winding “WD” RTD value.

4.3.1 LRC - Locked Rotor during Start

Functional Description

The Locked-rotor protection function is an integral part of the thermal model and is used to protect the motor in the event that the motor fails to start or accelerate after being energized. The heating in the motor during this period of time can be higher significantly than the heating at rated current, ranging from 10 to 50 times the normal rated heating. The time that a motor can remain at a standstill after being energized varies with the applied voltage and has an I²T limit.

When determining the heat in the motor during this period of time, both the negative and positive sequence currents are used in the equation that approximates the heat generated in a locked rotor condition. The heat can be approximated by the equation:

$$I_H^2 = I_1^2 + K \cdot I_2^2$$

where:

I_1 = the per unit stator positive sequence current;

K = weighting factor for the value of I_2 resulting from the disproportionate heating caused by the negative sequence current component due to skin effect in the rotor bar; and

I_2 = per unit stator negative sequence current.

Settings for the Locked Rotor Current can be found under the menu branch [Field Para]. The LRC value is a multiplier of I_b (FLA).

4.4 UTC - Ultimate Trip Current

Functional Description

The Ultimate Trip Current (UTC) sets the current level at which a trip eventually occurs when no RTD stator temperature data is available.

The current level is settable to a value as a multiples of »Ib« (Full Load Amps, FLA). This value represents the vertical line on the upper portion of the non-RTD as shown in the protection trip curve labeled Motor Protection Curve Example 2 (without RTD). The ultimate trip current setting in this example is at 1 times the value of »Ib« (FLA).

The user has to set the k-Factor which can be calculated by the following formula:

$$k_{Factor} = \frac{UTC}{CT_{PRI}} = \frac{Overload_{factor} \cdot I_b}{CT_{PRI}}$$

Please note that the settings for k-Factor and Ib have to be set within the menu [Field Para / Motor Nominal Values].

The »Overload Factor« is found on the motor nameplate or in the manufacturer’s data. Note that the relay does not trip at the moment the current goes above »UTC« during motor running. Instead, it models the gradual stator heating for currents above »UTC« , and trips only after some time has passed. The trip time depends on a variety of setting and operating factors, including the motor nameplate data contained in other setting values.

Use a conservative value. In this case, a lower value of »UTC« than that dictated by the »k-Factor« if the motor ambient temperatures may rise above 40°C (104°F) and the optional URTD Module is not used, otherwise stator insulation damage or loss of motor life may occur. Also, consider lowering the »UTC« value if the motor is suitably rated, yet additional safety is critical for the application.

CAUTION!



If UTC is set above 100% times the service factor, motor damage could result.

In systems where an RTD is used the »UTC« pick-up point is biased by the measured temperature. This is shown in the example trip curve labeled “Motor Protection Curve Example 3” (with RTD) where you will see a shift in the »UTC« value to 2 times of »Ib« (FLA)

If stator temperature measurements are available, the algorithm may keep from tripping, even if the effective current is above the ultimate trip current setting, depending on stator temperature reports. It is still important to set a correct ultimate trip current so that the motor is well protected. If the RTDs, the module, or its communications to the relay fail, the algorithm falls back to use of »UTC«. Also, note that if all RTD channels are set to »OFF«, the algorithm reverts to the non-RTD calculation, which is based strictly on »UTC« .

4.4.1 Motor Protection Curves

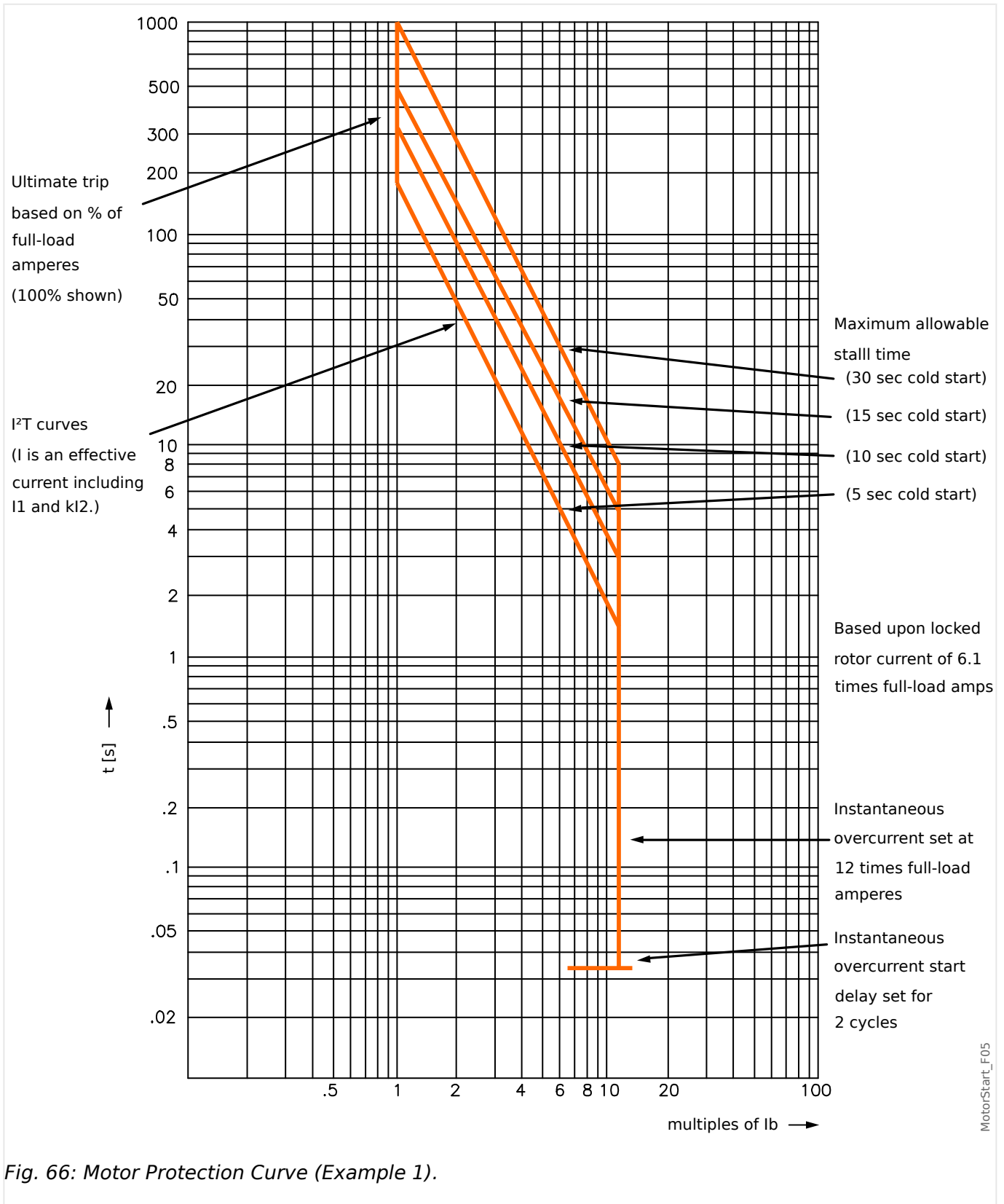

Fig. 66: Motor Protection Curve (Example 1).

4 Protective Elements
 4.4 UTC - Ultimate Trip Current

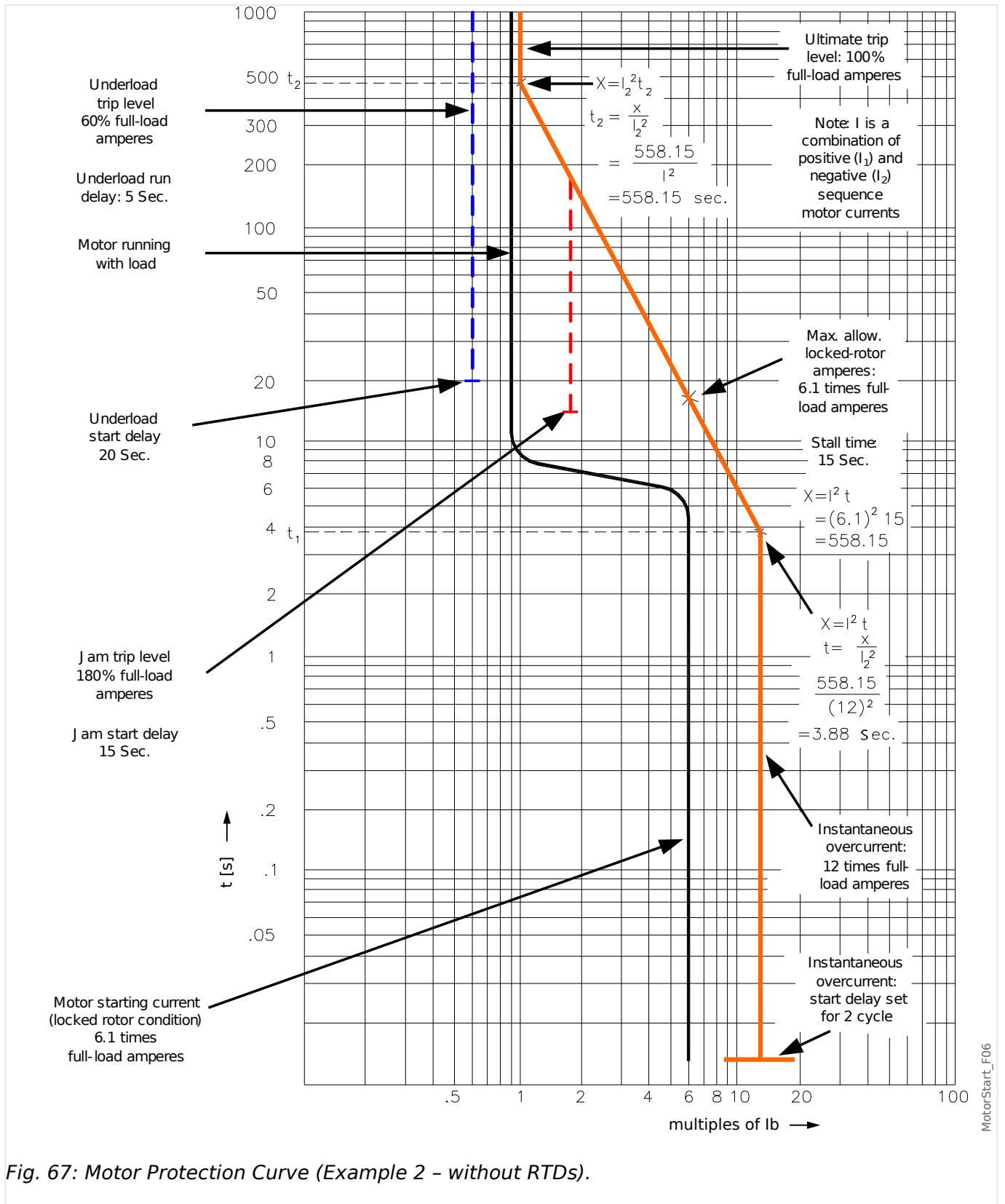

Fig. 67: Motor Protection Curve (Example 2 - without RTDs).

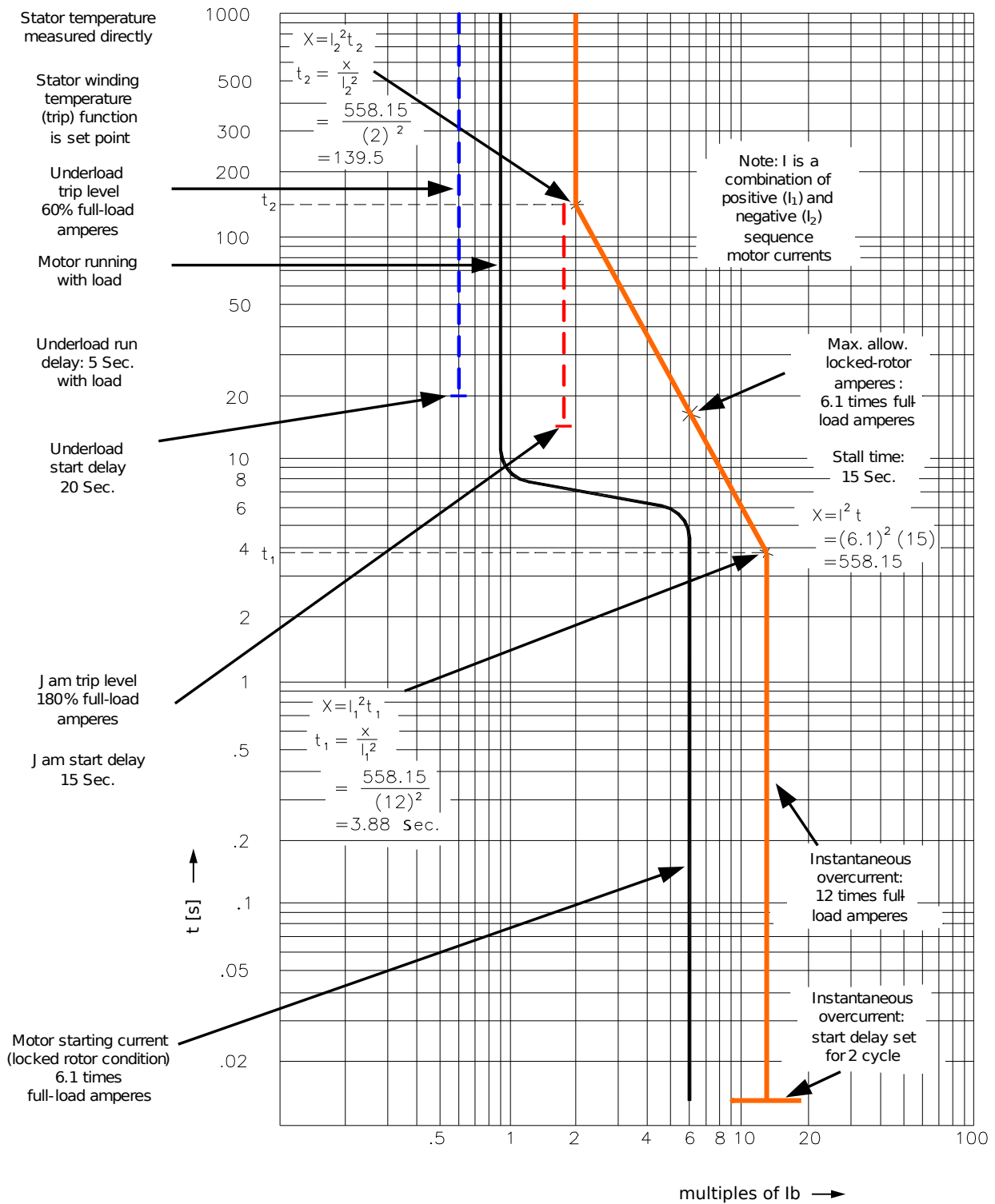

Fig. 68: Motor Protection Curve (Example 3 - with RTDs).

MotorStart_E07

4.5 MLS - Mechanical Load Shedding

Functional Description

In some applications, the protective device can forestall a JAM alarm or trip, or a thermal trip, by sending a signal to the process to reduce loading. The load-shedding function, if enabled, closes or opens a relay contact to shed process load when the motor load current goes above the threshold settable at [Protection Para / Set 1...4 / MLS] »Pickup Threshold«, for a time exceeding the delay [Protection Para / Set 1...4 / MLS] »t-Pickup Delay«.

The pickup-delay »Dropout Threshold« can be used to stop or reduce the flow of material into the driven process until the load current falls below the threshold.

The »t-Drop Delay« is the timer that has to elapse before the normal flow of material will be fed again into the process.

Set the load-shed current Pickup Threshold comfortably below the JAM trip level. It may be useful to even set it below the Ultimate Trip Current, particularly if Remote Temperature Detection is not used.

The load shed function is only active during the »RUN« state of the motor (see also [↳](#) "MStart - Motor Start and Control Module [48, 66]").

Note : Load Shedding function is only active when motor is in RUN mode.

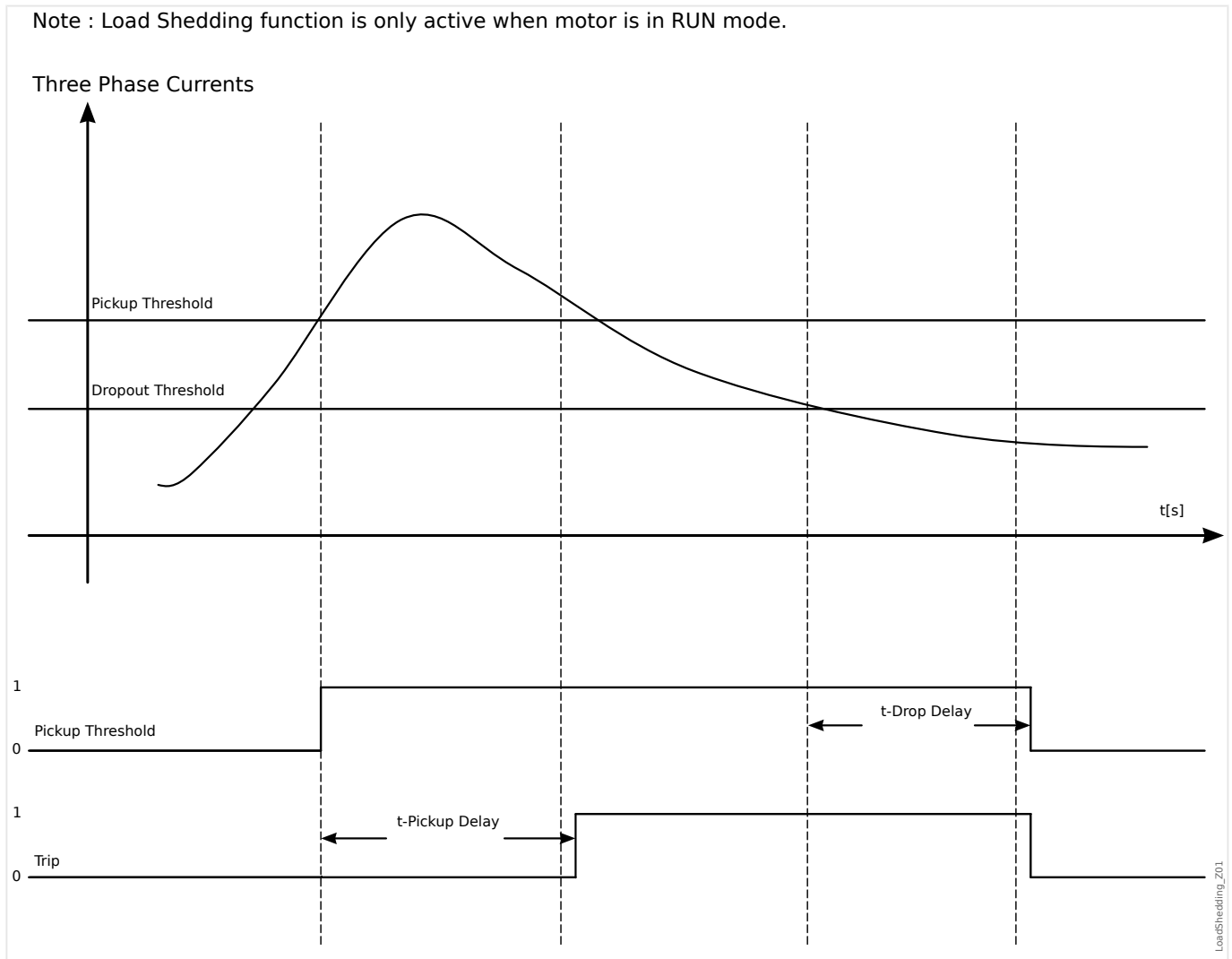

4.5.1 Commissioning: Mechanical Load Shedding

Object to be tested

- Testing the pick-up and drop-out thresholds
- Testing the delay times

Necessary means

- 3-phase current source
- Ammeter
- Timer for measuring of the tripping times

Procedure

Testing the threshold values (three-phase)

This test is only possible, if the motor is in run mode.

Testing pick-up threshold

The drop-out delay time should be "0s" for this test.

Feed in a testing current significantly lower than the threshold of the mechanical load shedding. The test current has to be increased until the relay is energized. When comparing the measured values with those of the ammeter, the deviation must be within the permissible tolerances.

Testing drop-out threshold

For testing the drop-out threshold the testing current has to be significantly greater than the pick-up threshold value. The test current has to be decreased until the relay is falls back. When comparing the measured values with those of the ammeter, the deviation must be within the permissible tolerances.

Testing the delay times

This test is only possible, if the motor is in run mode.

Testing the trip delay

For testing the pick-up delay , a timer is to be connected to the contact of the associated trip relay. Feed in a testing current significantly lower than the pick-up value, the test current has to be increased suddenly above the threshold. The timer is started when the limiting value of the tripping current exceeded the threshold and it is stopped when the relay trips and the operating time is elapsed.

Testing the drop-out delay

For testing the drop-out threshold, the testing current has to be significantly greater than the pick-up threshold. A timer is to be connected to the contact of the associated trip relay. The test current has to be decreased suddenly below the drop-out threshold. The timer has to be started when the limiting value of the tripping current falls below the threshold and it has to be stopped when the relay falls back.

Successful test result

4 Protective Elements

4.5 MLS – Mechanical Load Shedding

The measured tripping delays and threshold values comply with those values, specified in the adjustment list. Permissible deviations/tolerances can be found under Technical data (↳ **“Technical Data”**).

4.6 Jam - Locked Rotor Protection [51LR]

Description

When the motor is running, a current increase above normal load may be an indication of a malfunction in the load. JAM protection recognizes mechanical problems, such as broken drive gears.

The MRMV4 can be configured for a JAM alarm and/or a JAM trip. There are two JAM elements, »Jam[1]«, »Jam[2]«.

Refer to the JAM protection limit (the right vertical line in the “Underload and JAM Trip Function” curve example). In this curve example, the JAM trip is set at 150% of I_b (FLA).

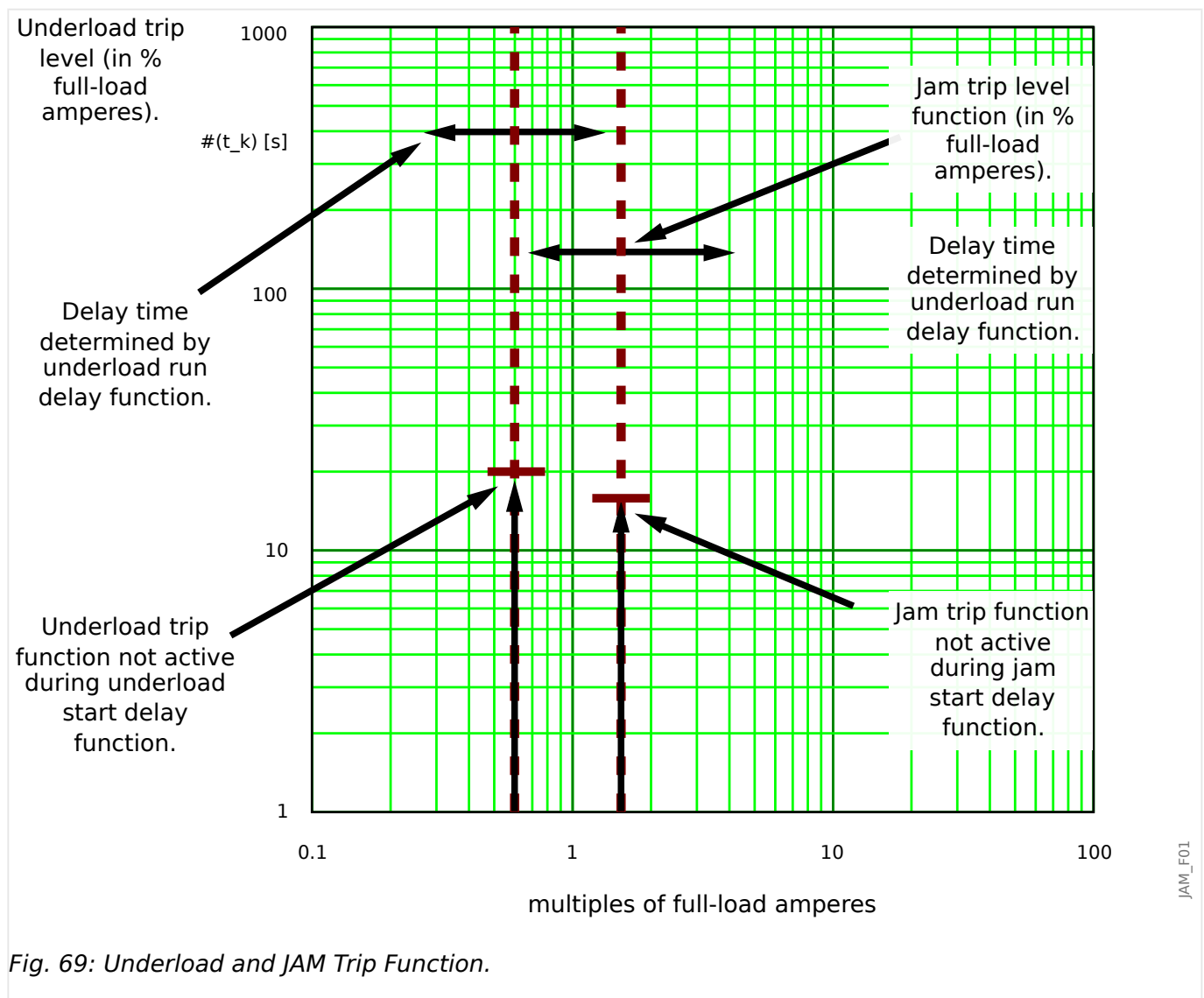

Fig. 69: Underload and JAM Trip Function.

The MRMV4 issues an alarm when the pickup [Protection Para / Set 1...4 / JAM-Prot / Jam[x]] »Pickup« is exceeded. If the timer [Device planning] Jam[x] . »Mode« = “active” and [Protection Para / Set 1...4 / JAM-Prot / Jam[x]] »t« has elapsed, a trip signal will be issued.

In the “Underload and JAM Trip Function” curve, the »Trip« settings are represented by vertical lines, well above the normal load current. This curve also applies to JAM setting configured as an alarm element (blocked trip command). The trips are held off by the delay timer »t«.

Use the start delay to block tripping and alarming until the motor current drops to continuous load level. Use run delays to avoid false alarms or trips for load transients.

Functionality

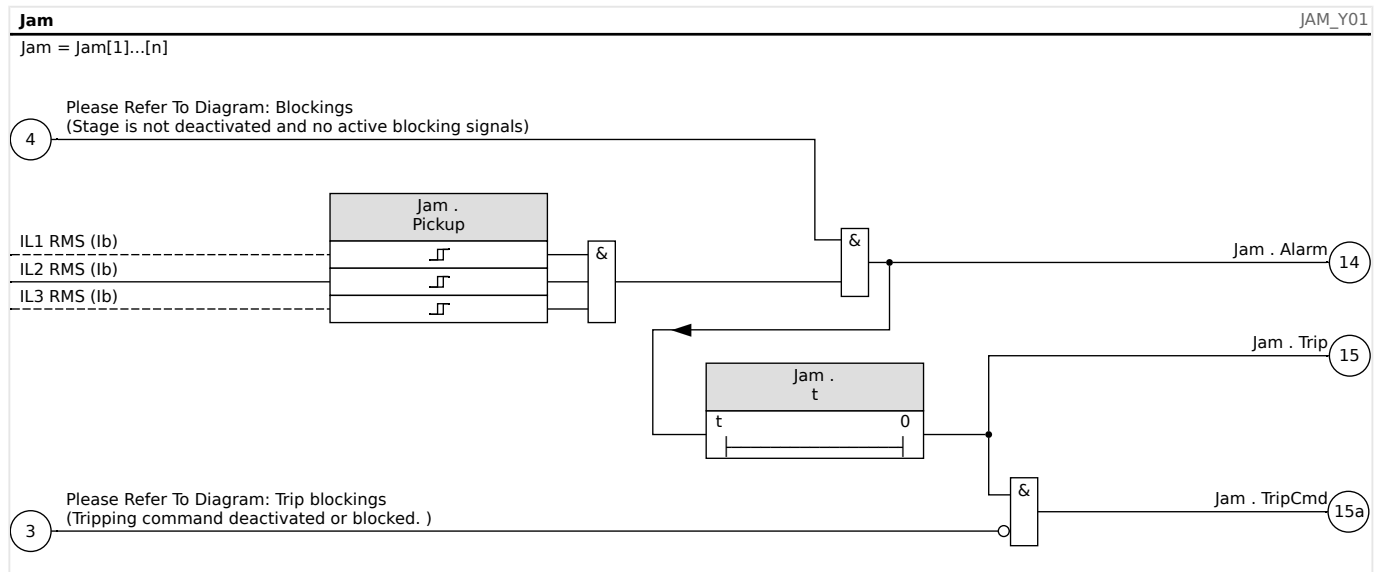

4.6.1 Commissioning: JAM [51LR]

Object to be tested

- Testing the pick-up value for JAM protection
- Testing the trip delay
- Testing the fallback ratio

Necessary means

- 3-phase current source
- Amperemeter
- Timer for measuring of the tripping time

Procedure:

Testing the threshold values (single-phase)

Feed in a testing current significantly smaller than the pick-up value.

For testing the threshold values and fallback values, the test current has to be increased until the relay is energized. When comparing the displayed values with those of the ammeter, the deviation must be within the permissible tolerances.

Testing the tripping delay

For testing the trip delay, a timer is to be connected to the contact of the associated trip relay. Feed in a testing current significantly smaller than the pick-up value, the test current has to be increased suddenly above the threshold value. The timer is started when the limiting value of the tripping current exceeded the threshold and the operating time is elapsed and it is stopped when the relay trips.

Testing the fallback ratio

Enlarge the measuring quantity to less than 97% of the trip value. The relay must only fall back at 98% of the trip value at the earliest.

Successful test result

The measured tripping delays, threshold values and fallback ratio comply with those values, specified in the adjustment list. Permissible deviations/tolerances can be found under Technical data (↳ ["Technical Data"](#)).

4.7 I< - Undercurrent [37]

Functional Description

When the motor is running, a current reduction might indicate a malfunction in the load. Underload protection recognizes mechanical problems, such as a blocked flow or loss of back pressure in a pump, or a broken drive belt or drive shaft.

Refer to the underload protection limit - the left vertical line in the “Underload and Jam Trip Function example”. In the example, the underload trip is set at 60% of I_b (FLA). The protective device can be configured for underload alarm (if the trip command is blocked) and underload trip.

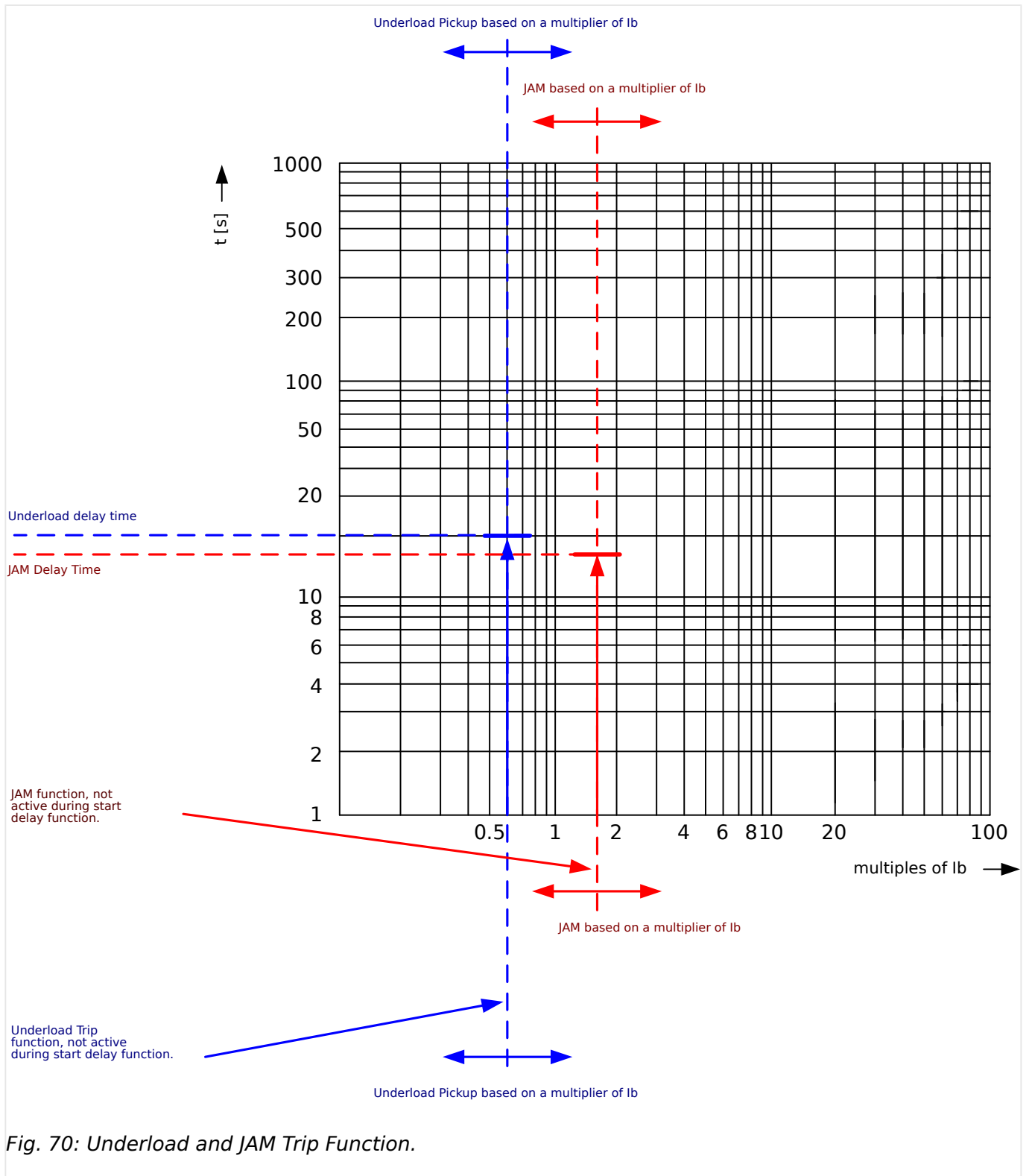
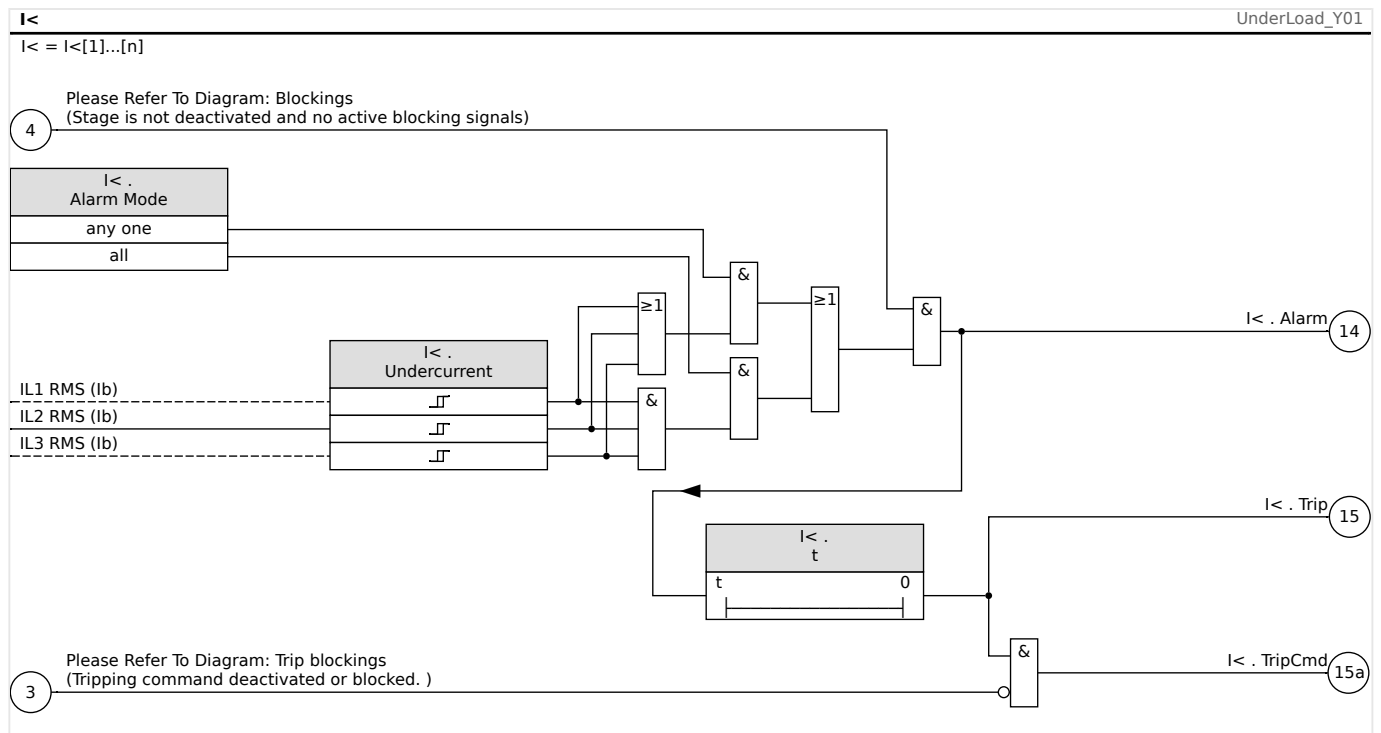

Fig. 70: Underload and JAM Trip Function.

These would be represented by two such vertical lines, both below the normal load current. Be sure to set the alarm level *above* the trip level. Each element has its own delay timer. Use the start delay to block tripping until the load stabilizes after a start. Use run delays to avoid false alarms or trips for load transients.



4.7.1 Commissioning: Undercurrent [ANSI 37]

Object to be tested

- Testing the pick-up value for Undercurrent protection
- Testing the trip delay
- Testing the fallback ratio

Necessary means

- 3-phase current source
- Amperemeter
- Timer for measuring of the tripping time

Procedure

Testing the threshold values(single-phase, three phase)

Feed in a testing current significantly greater than the pick-up value.

For testing the threshold values and fallback values, the test current has to be decreased until the relay is energized. When comparing the displayed values with those of the ammeter, the deviation must be within the permissible tolerances.

Testing the trip delay

For testing the trip delay, a timer is to be connected to the contact of the associated trip relay. Feed in a testing current significantly greater than the pick-up value, the test current has to be decreased suddenly below the threshold value. The timer is started when the limiting value of the tripping current falls below the threshold and the operating time is elapsed and it is stopped when the relay trips.

Testing the fallback ratio

Enlarge the measuring quantity to more than 103% of the trip value. The relay must only fall back at 103% of the trip value at the earliest.

Successful test result

The measured tripping delays, threshold values and fallback ratio comply with those specified in the adjustment list. Permissible deviations/tolerances can be taken from Technical Data.

4.8 I - Overcurrent Protection

The Phase Overcurrent module »I« covers the following ANSI protection functions:

- ANSI 50
- ANSI 51
- ANSI 51C
- ANSI 51Q
- ANSI 51V

NOTICE!



All overcurrent protective elements are identically structured.

NOTICE!



This module offers Adaptive Parameter Sets.

Parameters can be modified within parameter sets dynamically by means of Adaptive Parameter Sets. Please refer to  ["Adaptive Parameter Sets"](#).

ANSI 50, 51 - Overcurrent / Short-Circuit Protection, Non-Directional

This application option is set via the [Device planning] menu:

- [Device planning] »Mode« = "non directional"

No directional information is taken into account if the current protective element is planned as "non directional".

Options:

- [Protection Para / Set 1...4 / I-Prot / I[x]] »Measuring method« =
 - Fundamental
 - True RMS
 - I2

ANSI 51V - Voltage Restraint Overcurrent Protection

This application option is activated as follows:

Options:

- [Protection Para / Set 1...4 / I-Prot / I[x]] »Measuring method« =
 - Fundamental
 - True RMS

- I2
- »Measuring Mode« =
 - Phase to Phase
 - Phase to Ground

When the parameter »VRestraint« is set to “active” the overcurrent protection element works voltage restraint. That means, the overcurrent pickup threshold will be lowered during voltage drops. This results in a more sensitive overcurrent protection. For the voltage threshold »VRestraint max« additionally the »Measuring Mode« can be determined.

With the parameter [Protection Para / Set 1...4 / I-Prot / I[x]] »Measuring Mode« it can be determined, whether the “Phase to Phase” voltage or the “Phase to Ground” voltage is measured.

ANSI 51Q - Negative Phase Sequence Overcurrent Protection

This application option is activated as follows:

ANSI 51C - Voltage Controlled Overcurrent Protection

This application option is activated via Adaptive Parameters, see  “Adaptive Parameter Sets”.

Options:

- [Protection Para / Set 1...4 / I-Prot / I[x]] »Measuring method« =
 - Fundamental
 - True RMS
 - I2
- [Protection Para / Set n / V-Prot / V[x]] »Measuring Mode« =
 - Phase to Phase
 - Phase to Ground

Measuring Method

For each protection element it can be defined via setting »Measuring method«, whether the measurement is done on basis of the “Fundamental” or if “True RMS” measurement is used.

Alternatively the »Measuring method« can be set to “I2”. In this case the negative phase sequence current will be measured. This is to detect unbalanced faults.

4.8.1 Characteristics

For each element the following characteristics are available:

- **DEFT** – *Definite Time-Overcurrent*
- **Normal Inverse** (IEC) – *IEC Normal Inverse*

- **Very Inverse [VINV] (IEC) – IEC Very Inverse**
- **Long Time Inverse - Characteristic [LINV] (IEC) – IEC Long Time Inverse**
- **Extremely Inverse - Characteristic (IEC) – IEC Extremely Inverse**
- **Moderately Inverse [MINV] - Characteristic (ANSI) – ANSI Moderately Inverse**
- **Very Inverse [VINV] (ANSI) – ANSI Very Inverse**
- **Extremely Inverse - Characteristic (ANSI) – ANSI Extremely Inverse**
- **RINV – R Inverse**
- **Therm Flat [TF] - Characteristic – Thermal Flat**
- **IT - Characteristic**
- **I2T - Characteristic**
- **I4T - Characteristic**

Explanation for All Characteristics

- I: Fault current
- I>: If the pickup value is exceeded, the module/element starts to time out to trip.
Setting: [Protection Para / Set 1...4 / I-Prot / I[x]] »I/>«
- t for »Char« = “DEFT”:
 - Trip delay for $I > I>$, settable via [Protection Para / Set 1...4 / I-Prot / I[x]] »t«.
 - The reset delay for $I \leq I>$ always equals 0 (“instantaneous”).
- t for all characteristics except “DEFT”:
 - The trip delay for $I > I>$ is calculated based on the selected characteristics.
 - The reset delay for $I \leq I>$ is settable via »Reset Mode«, available options: “instantaneous”, “delayed” or “calculated”.
 - With option »Reset Mode« = “instantaneous”: Instantaneous reset: when the current drops below the pickup setting, the TOC time resets to zero within 2 cycles.
 - With option »Reset Mode« = “delayed”: The reset delay is settable at »t-reset delay«.
 - With option »Reset Mode« = “calculated”: The reset delay is calculated based on the selected characteristics.
- tchar (for all characteristics except “DEFT”):
 - Time multiplier/tripping characteristic factor. The setting range depends on the selected tripping curve.
 - Setting via [Protection Para / Set 1...4 / I-Prot / I[x]] »tchar«

4.8.1.2 IEC Normal Inverse

»Char« = IEC NINV

NOTICE!



Various reset modes are available: Resetting via characteristic, delayed and instantaneous. See [↳ “4.8.1 Explanation for All Characteristics”](#) for details.

Remark: For $I > 20 \cdot I_N$, the curve stops decreasing, the t-values are kept constant at the value for $I = 20 \cdot I_N$.

Reset	Trip
$t = \frac{0.14}{1 - \left(\frac{I}{I_N}\right)^2} \cdot t_{char}$	$t = \frac{0.14}{\left(\frac{I}{I_N}\right)^{0.02} - 1} \cdot t_{char}$
If: $\frac{I}{I_N} < 1$	If: $1 < \frac{I}{I_N} \leq 20$

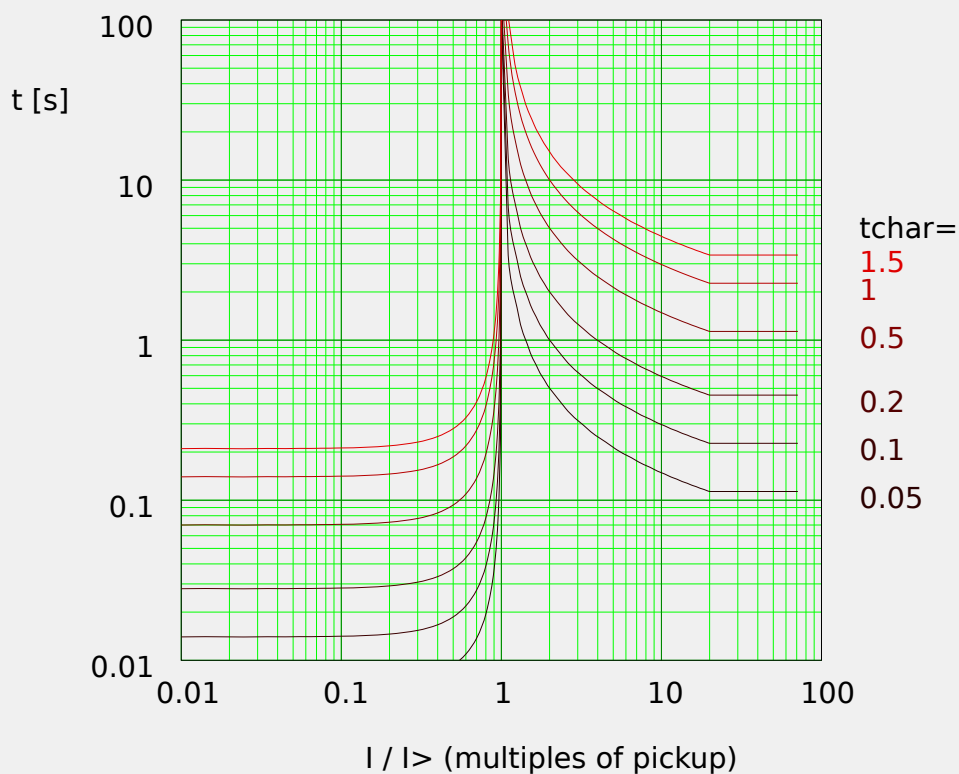

Pd0c_Z01

4.8.1.3 IEC Very Inverse [VINV]

»Char« = IEC VINV

NOTICE!



Various reset modes are available: Resetting via characteristic, delayed and instantaneous. See [↳ “4.8.1 Explanation for All Characteristics”](#) for details.

Remark: For $I > 20 \cdot I_N$, the curve stops decreasing, the t-values are kept constant at the value for $I = 20 \cdot I_N$.

Reset	Trip
$t = \frac{13.5}{1 - \left(\frac{I}{I_N}\right)^2} \cdot t_{char}$	$t = \frac{13.5}{\frac{I}{I_N} - 1} \cdot t_{char}$
If: $\frac{I}{I_N} < 1$	If: $1 < \frac{I}{I_N} \leq 20$

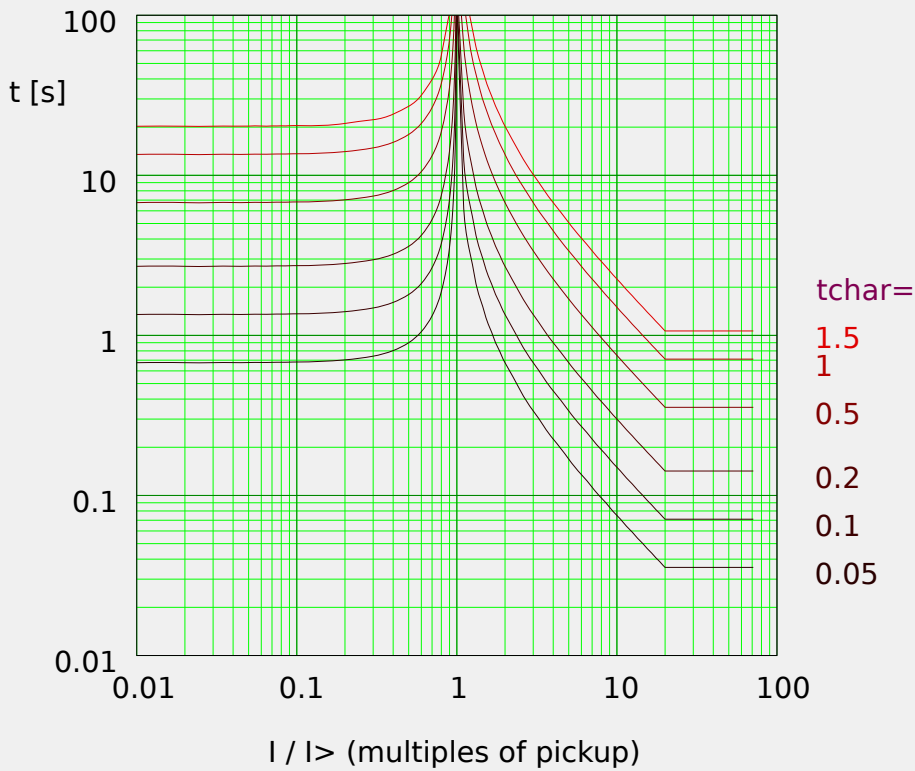

Pdoc_Z02

4.8.1.4 IEC Extremely Inverse - Characteristic

»Char« = IEC EINV

NOTICE!



Various reset modes are available: Resetting via characteristic, delayed and instantaneous. See [↳ “4.8.1 Explanation for All Characteristics”](#) for details.

Remark: For $I > 20 \cdot I_N$, the curve stops decreasing, the t-values are kept constant at the value for $I = 20 \cdot I_N$.

Reset	Trip
$t = \frac{80}{1 - \left(\frac{I}{I_N}\right)^2} \cdot t_{char}$	$t = \frac{80}{\left(\frac{I}{I_N}\right)^2 - 1} \cdot t_{char}$
If: $\frac{I}{I_N} < 1$	If: $1 < \frac{I}{I_N} \leq 20$

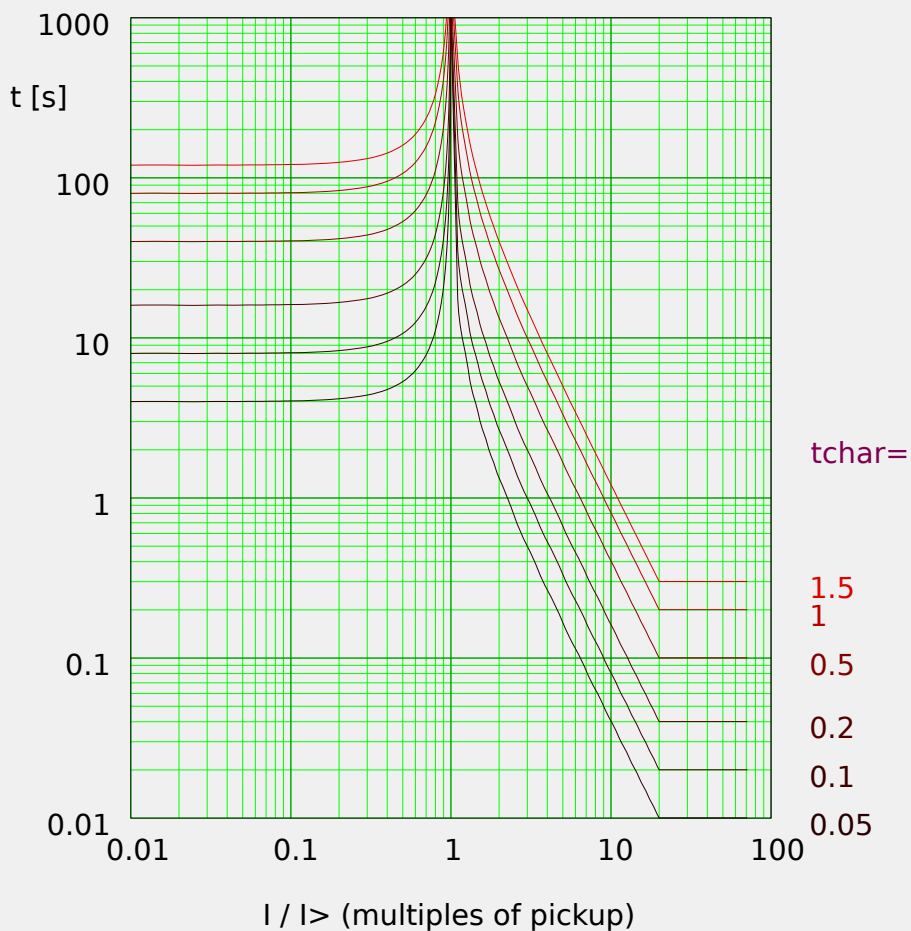

Pdoc_Z04

4.8.1.5 IEC Long Time Inverse - Characteristic [LINV]

»Char« = IEC LINV

NOTICE!



Various reset modes are available: Resetting via characteristic, delayed and instantaneous. See [↳ “4.8.1 Explanation for All Characteristics”](#) for details.

Remark: For $I > 20 \cdot I_N$, the curve stops decreasing, the t-values are kept constant at the value for $I = 20 \cdot I_N$.

Reset	Trip
$t = \frac{120}{1 - \left(\frac{I}{I_N}\right)^2} \cdot t_{char}$	$t = \frac{120}{\frac{I}{I_N} - 1} \cdot t_{char}$
If: $\frac{I}{I_N} < 1$	If: $1 < \frac{I}{I_N} \leq 20$

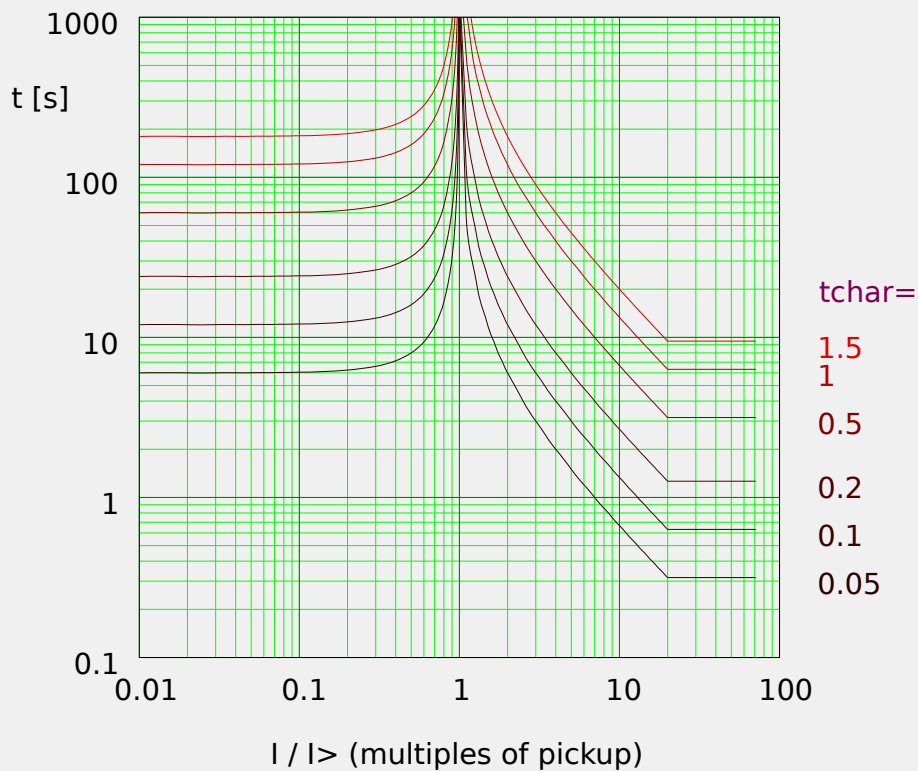

Pdoc_Z03

4.8.1.6 ANSI Moderately Inverse [MINV] - Characteristic

»Char« = IEC MINV

NOTICE!



Various reset modes are available: Resetting via characteristic, delayed and instantaneous. See [↳ “4.8.1 Explanation for All Characteristics”](#) for details.

Remark: For $I > 20 \cdot I_N$, the curve stops decreasing, the t-values are kept constant at the value for $I = 20 \cdot I_N$.

Reset	Trip
$t = \frac{4.85}{1 - \left(\frac{I}{I_N}\right)^2} \cdot t_{char}$	$t = \left(\frac{0.0515}{\left(\frac{I}{I_N}\right)^{0.02} - 1} + 0.1140 \right) \cdot t_{char}$
If: $\frac{I}{I_N} < 1$	If: $1 < \frac{I}{I_N} \leq 20$

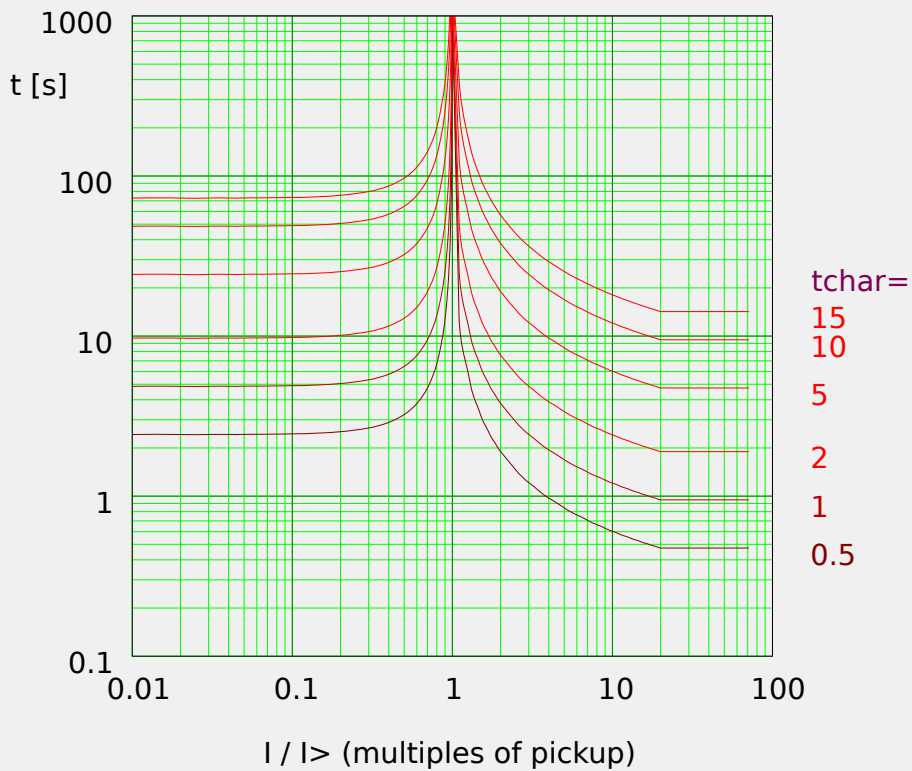

Pdoc_Z05

4.8.1.7 ANSI Very Inverse [VINV]

»Char« = ANSI VINV

NOTICE!



Various reset modes are available: Resetting via characteristic, delayed and instantaneous. See [↳ “4.8.1 Explanation for All Characteristics”](#) for details.

Remark: For $I > 20 \cdot I_{>}$, the curve stops decreasing, the t-values are kept constant at the value for $I = 20 \cdot I_{>}$.

Reset	Trip
$t = \frac{21.6}{1 - (\frac{I}{I_{>}})^2} \cdot t_{char}$	$t = \left(\frac{19.61}{(\frac{I}{I_{>}})^2 - 1} + 0.491 \right) \cdot t_{char}$
If: $\frac{I}{I_{>}} < 1$	If: $1 < \frac{I}{I_{>}} \leq 20$

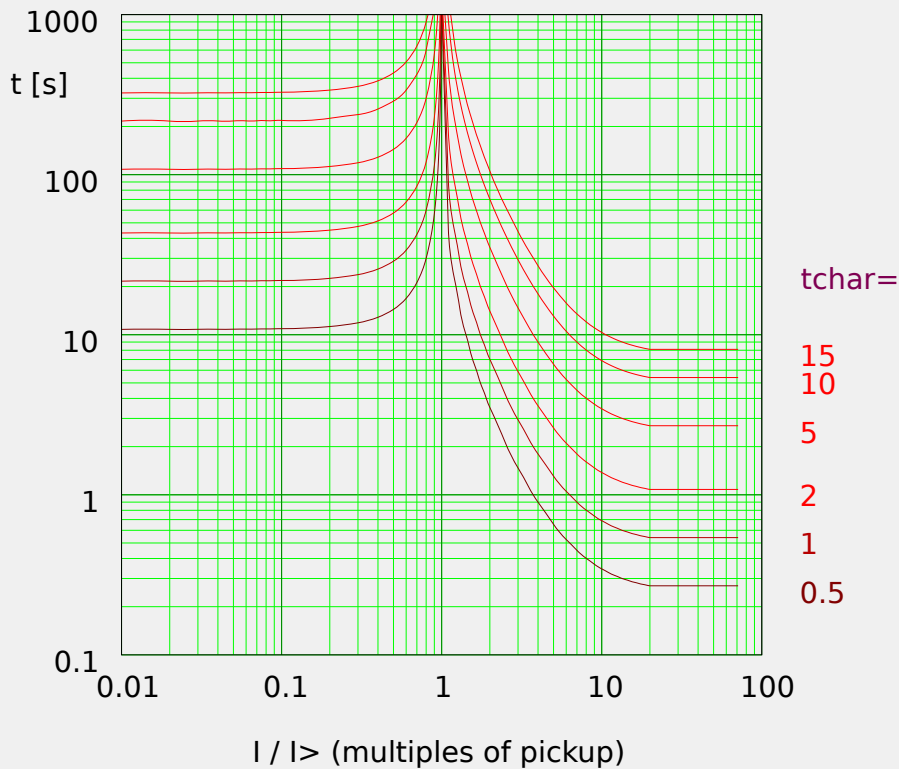

4.8.1.8 ANSI Extremely Inverse - Characteristic

»Char« = ANSI EINV

NOTICE!

!

Various reset modes are available: Resetting via characteristic, delayed and instantaneous. See [↳ “4.8.1 Explanation for All Characteristics”](#) for details.

Remark: For $I > 20 \cdot I_{>}$, the curve stops decreasing, the t-values are kept constant at the value for $I = 20 \cdot I_{>}$.

Reset	Trip
$t = \frac{29.1}{1 - (\frac{I}{I_{>}})^2} \cdot t_{char}$	$t = \left(\frac{28.2}{(\frac{I}{I_{>}})^2 - 1} + 0.1217 \right) \cdot t_{char}$
If: $\frac{I}{I_{>}} < 1$	If: $1 < \frac{I}{I_{>}} \leq 20$

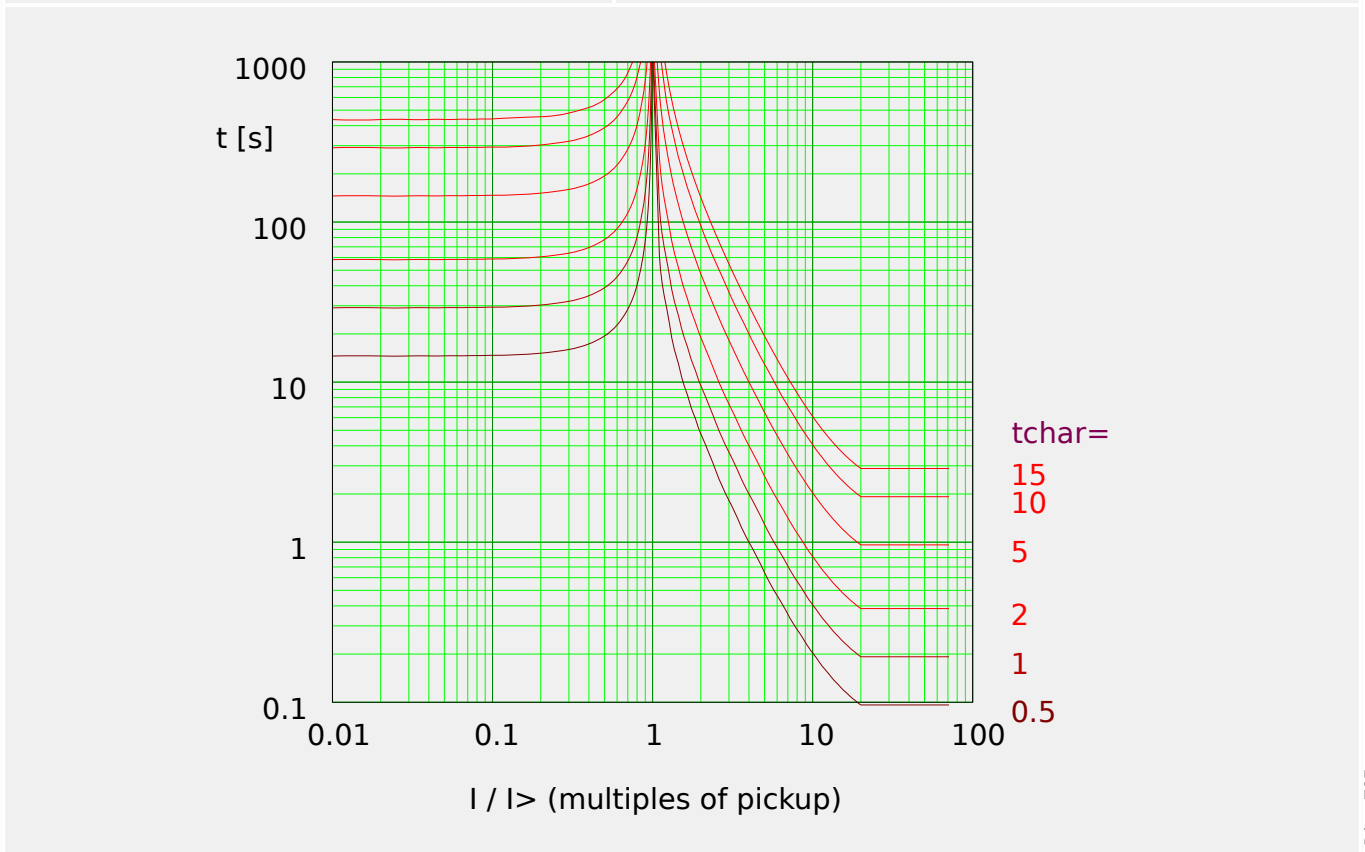

Pdoc_Z07

4.8.1.9 R Inverse [RINV] - Characteristic

»Char« = RINV

NOTICE!



Various reset modes are available: Resetting via characteristic, delayed and instantaneous. See [↳ “4.8.1 Explanation for All Characteristics”](#) for details.

Remark: For $I > 20 \cdot I_N$, the curve stops decreasing, the t-values are kept constant at the value for $I = 20 \cdot I_N$.

Reset	Trip
$t = \frac{1.0}{1 - \left(\frac{I}{I_N}\right)^2} \cdot t_{char}$	$t = \frac{1.0}{0.339 - \frac{0.236}{\left(\frac{I}{I_N}\right)}} \cdot t_{char}$
If: $\frac{I}{I_N} < 1$	If: $1 < \frac{I}{I_N} \leq 20$

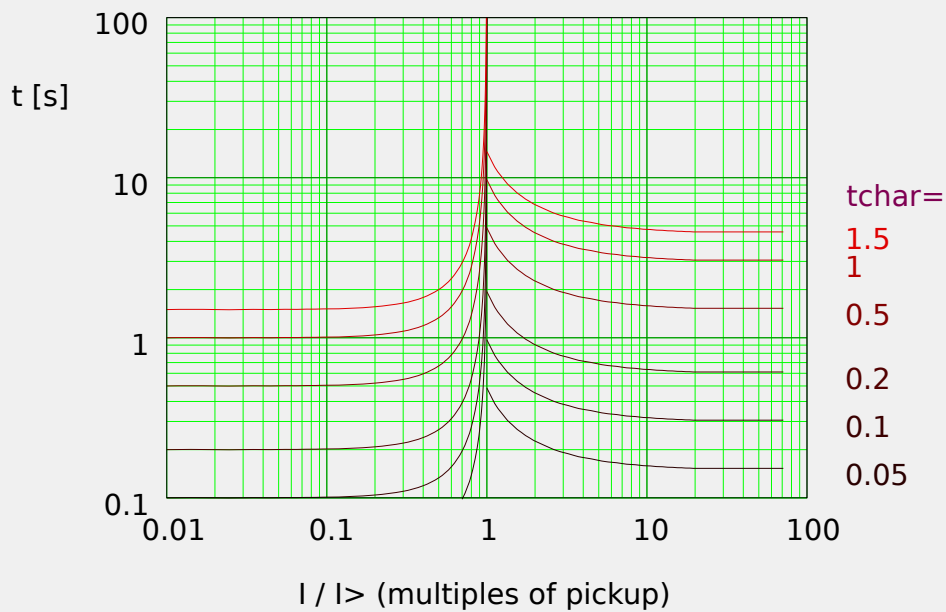

Pdoc_Z12

4.8.1.10 Therm Flat [TF] - Characteristic

»Char« = Therm Flat

NOTICE!



Various reset modes are available: Resetting via characteristic, delayed and instantaneous. See [↳ “4.8.1 Explanation for All Characteristics”](#) for details.

Reset	Trip
$t = (5 \cdot 3^2) \cdot tchar$	$t = (5 \cdot 3^0) \cdot tchar$
If: $\frac{I}{I_n} < 1$	If: $1 < \frac{I}{I_n}$

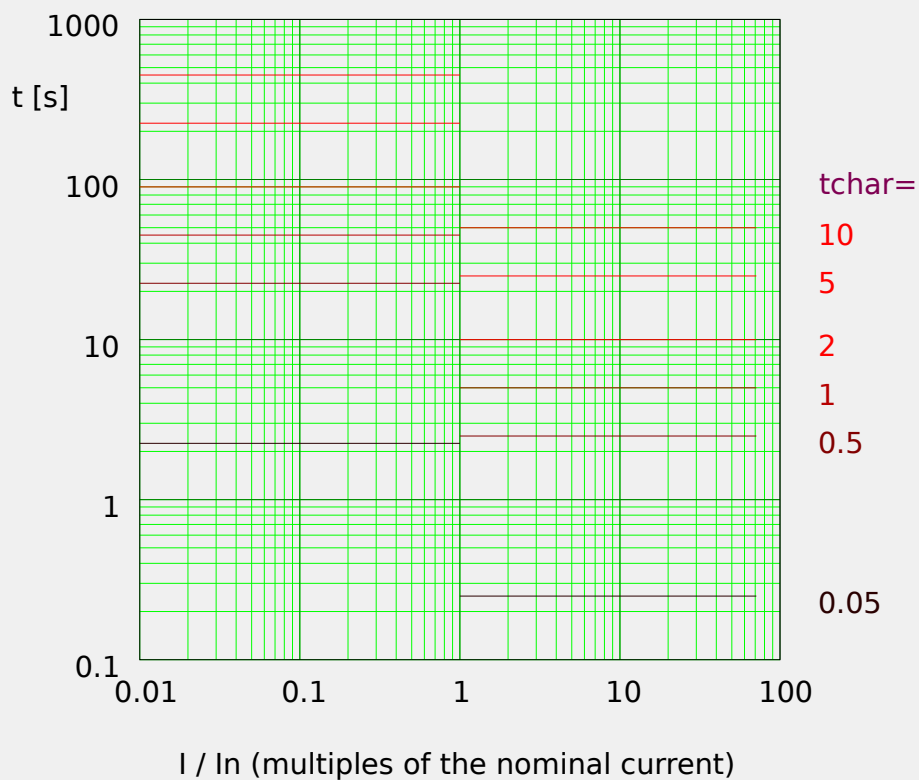

Pgdoc_Z08

4.8.1.11 IT - Characteristic

»Char« = IT

NOTICE!



Various reset modes are available: Resetting via characteristic, delayed and instantaneous. See [↳ “4.8.1 Explanation for All Characteristics”](#) for details.

Reset	Trip
$t = (5 \cdot 3^2) \cdot t_{char}$	$t = \frac{5 \cdot 3^1}{\left(\frac{I}{I_n}\right)^1} \cdot t_{char}$
lf: $\frac{I}{I_n} < 1$	lf: $1 < \frac{I}{I_n}$

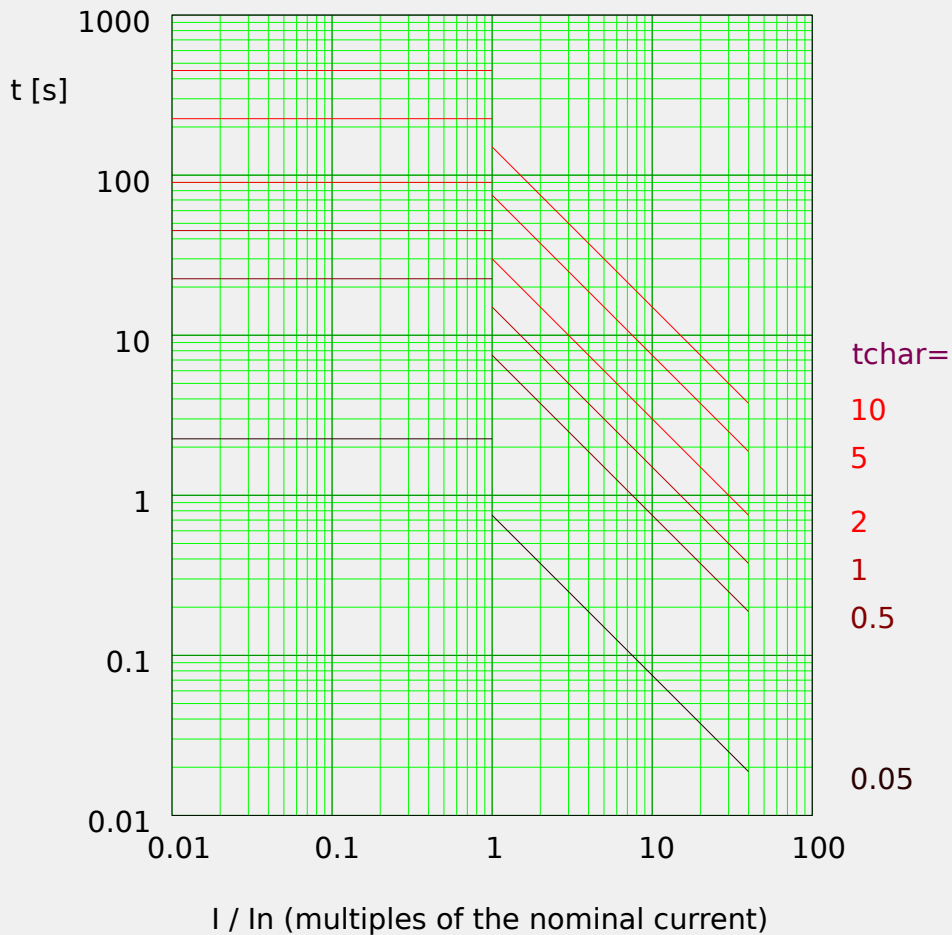

PdDoc_Z09

4.8.1.12 I2T - Characteristic

»Char« = I2T

NOTICE!



Various reset modes are available: Resetting via characteristic, delayed and instantaneous. See [↳ “4.8.1 Explanation for All Characteristics”](#) for details.

Reset	Trip
$t = (5 \cdot 3^2) \cdot t_{char}$	$t = \frac{5 \cdot 3^2}{\left(\frac{I}{I_n}\right)^2} \cdot t_{char}$
if: $\frac{I}{I_n} < 1$	if: $1 < \frac{I}{I_n}$

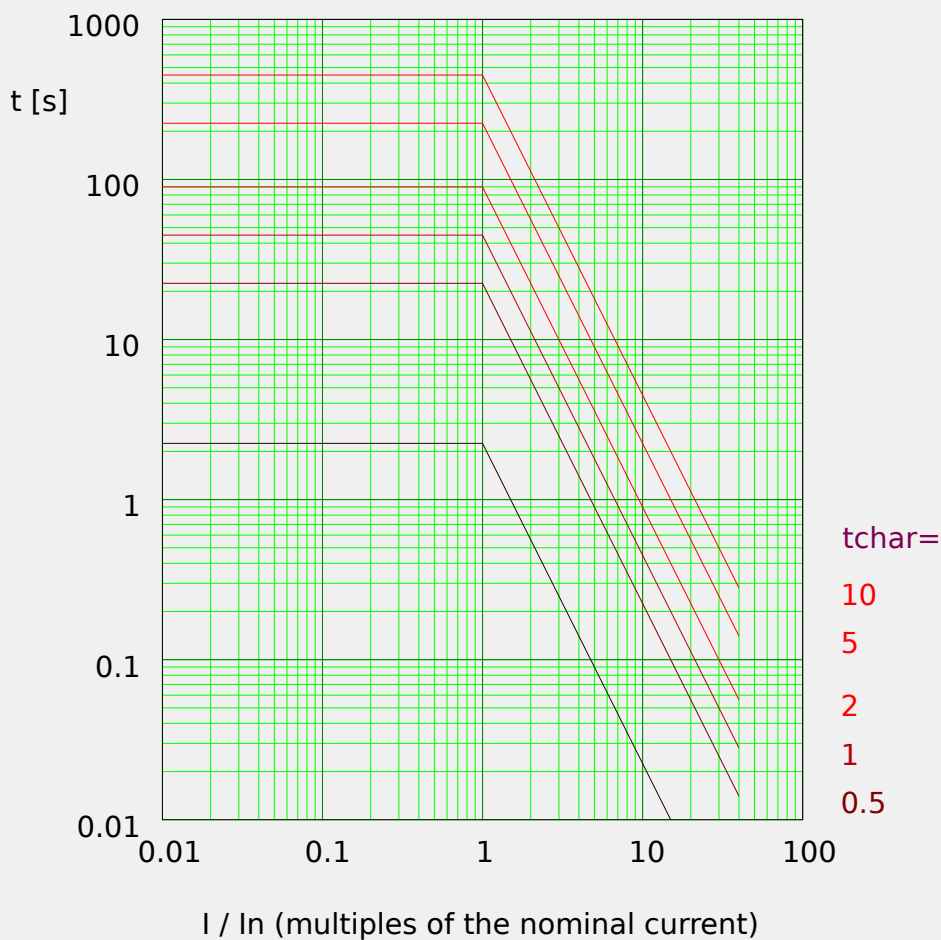

PdDoc_Z10

4.8.1.13 I4T - Characteristic

»Char« = I4T

NOTICE!



Various reset modes are available: Resetting via characteristic, delayed and instantaneous. See [↳ “4.8.1 Explanation for All Characteristics”](#) for details.

Reset	Trip
$t = (5 \cdot 3^2) \cdot t_{char}$	$t = \frac{5 \cdot 3^4}{\left(\frac{I}{I_n}\right)^4} \cdot t_{char}$
If: $\frac{I}{I_n} < 1$	If: $1 < \frac{I}{I_n}$

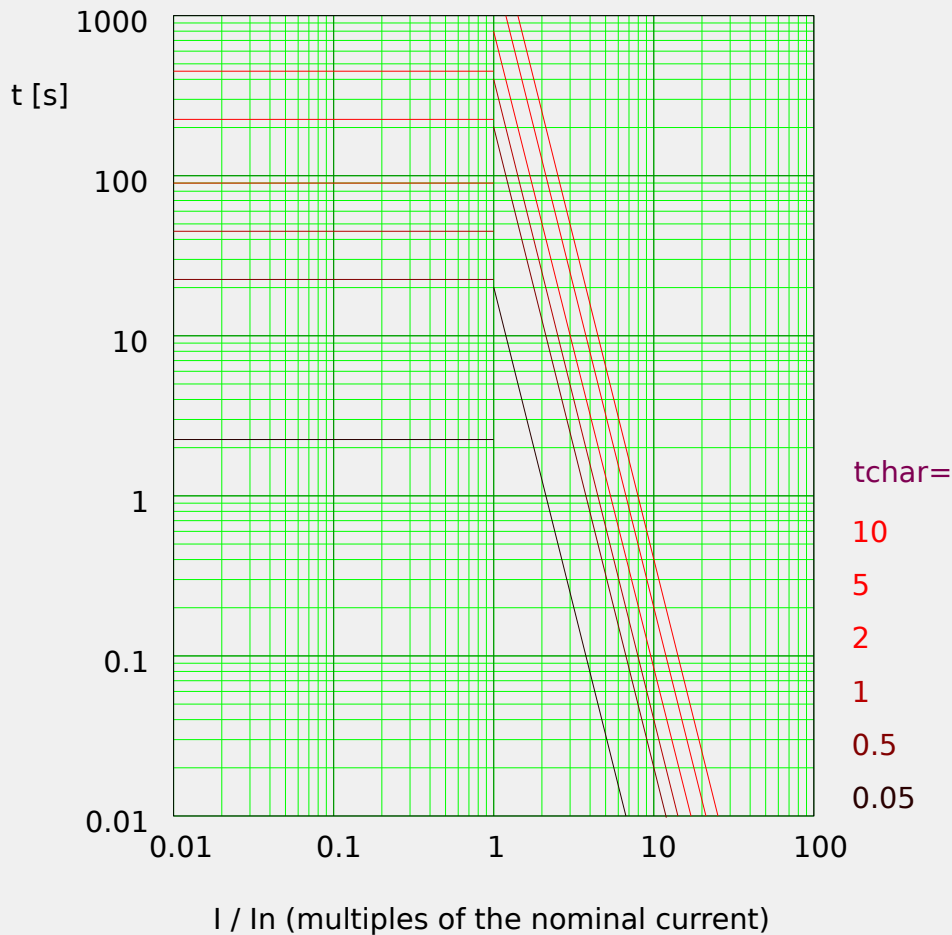

Pdoc_Z11

4.8.2 Functionality

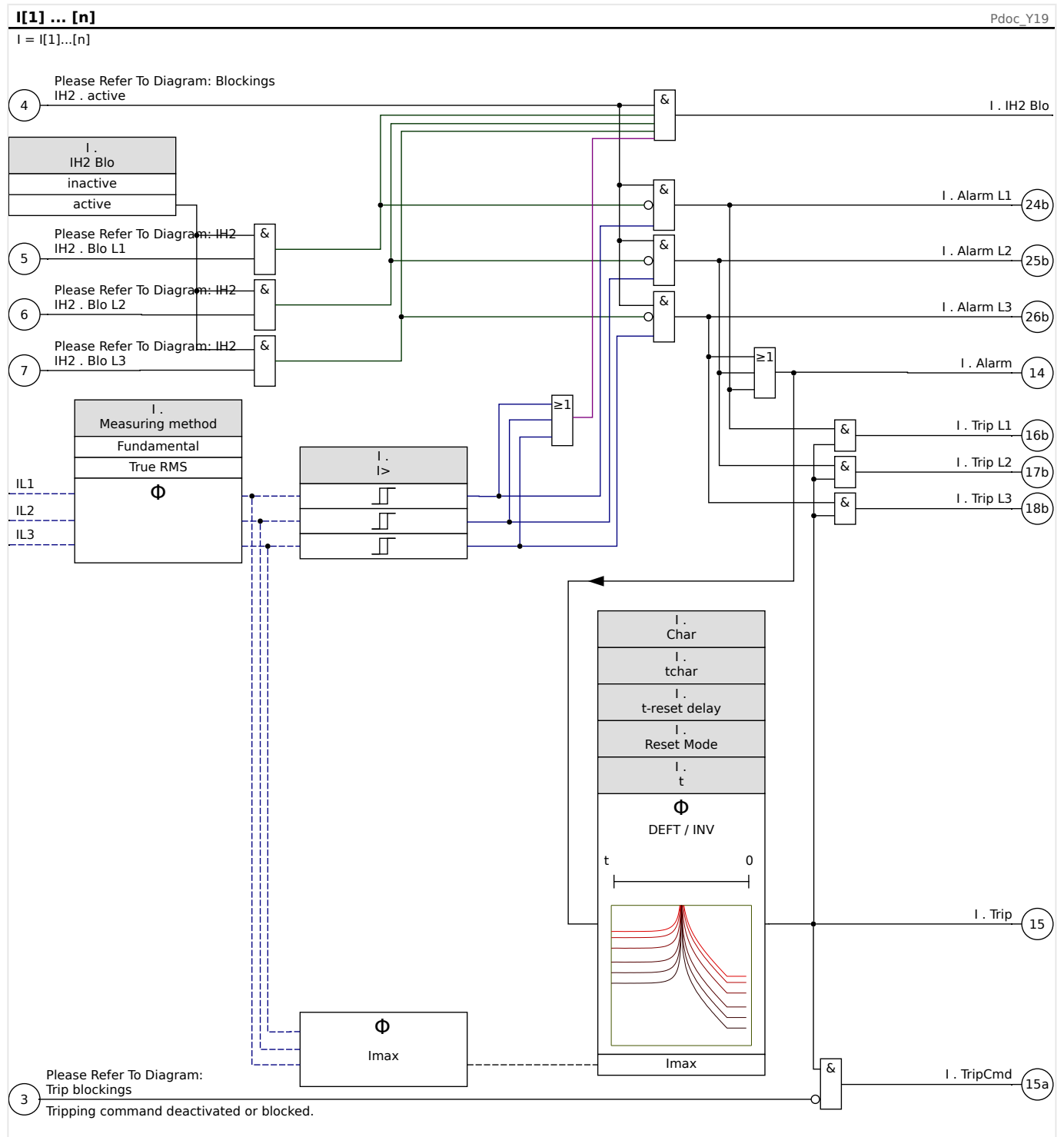

4.8.3 51V - Voltage Restraint Overcurrent

For activating this function, the parameter [Protection Para / Set 1...4 / I-Prot / I[x]] »VRestraint« has to be set to “active” in the parameter set of the corresponding overcurrent element I[x].

The 51V protection function restrains operation which reduces pickup levels. This allows the user to lower the pickup value of the 51V protection function with the corresponding phase input voltage (“Phase to Phase” or “Phase to Ground”, depending on the setting of [Protection Para / Set 1...4 / I-Prot / I[x]] »Measuring Mode«). When the minimum fault phase current is close to the load current, it may make the phase time overcurrent protection coordination difficult. In this case, an undervoltage function may be used to alleviate this situation. When the voltage is low, the phase time overcurrent pickup threshold may be set low accordingly, so that the phase time overcurrent protection may achieve adequate sensitivity and better coordination. The device uses a simple linear model to determine the effective pickup by characterizing the relationship between the voltage and the phase time overcurrent pickup threshold.

Once the voltage restraint protection function is activated, the effective phase time overcurrent pickup threshold is the calculated Pickup% times the phase time overcurrent pickup setting. The effective pickup threshold must be within the setting range allowed and, if it is less, the minimum pickup value will be used.

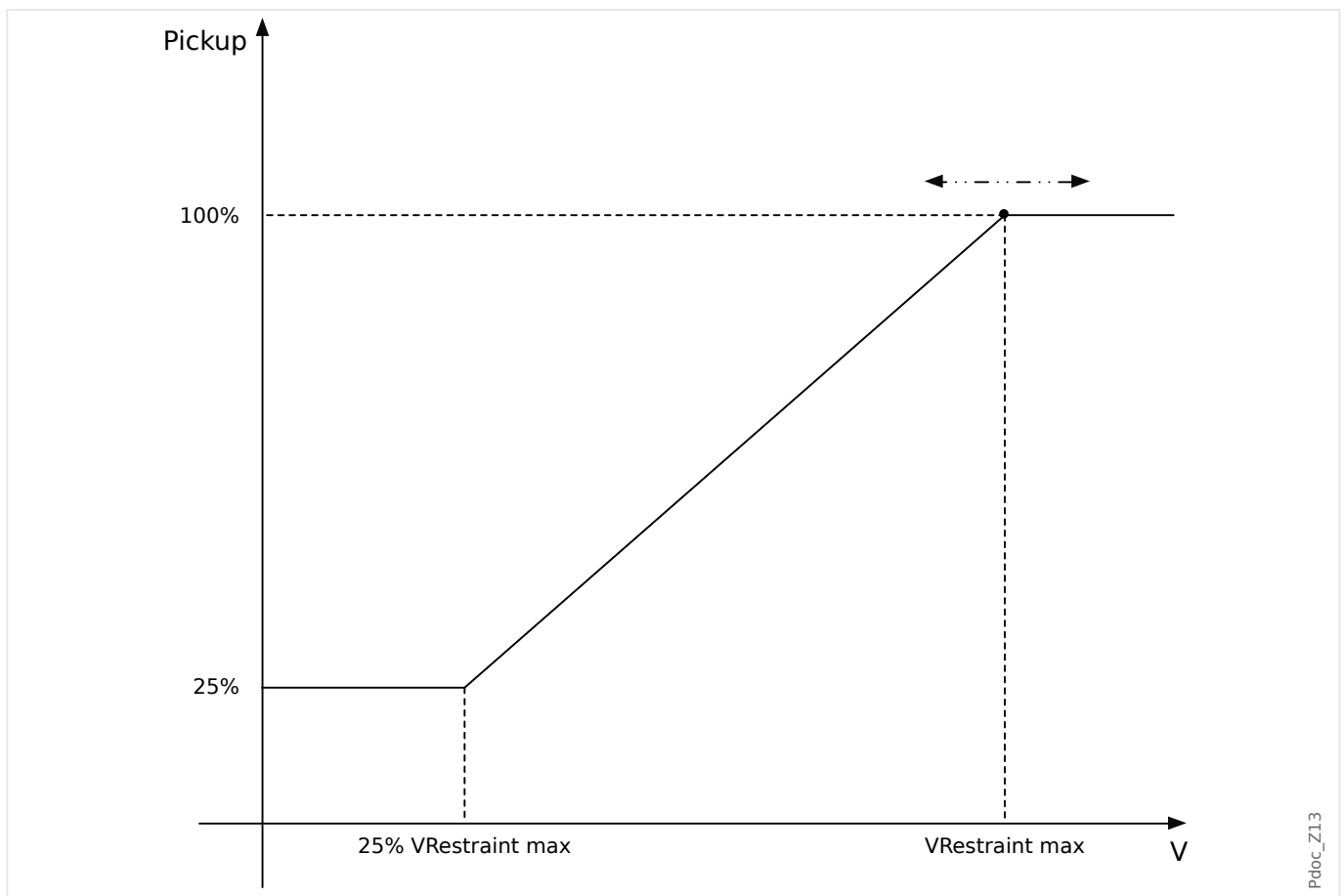

That means:

- $V_{\min} = 0.25 \cdot V_{\max}$;
- $\%Pickup_{\min} = 25\%$;
- $\%Pickup = 25\%$, if $V \leq V_{\min}$;

- %Pickup = $1 / V_{\max} \cdot (V - V_{\min}) + 25\%$, if $V_{\min} < V < V_{\max}$;
- %Pickup = 100%, if $V \geq V_{\max}$;

The tripping curves (characteristics) are not influenced by the voltage restraint function.

If the voltage transformer supervision is activated, the voltage restraint overcurrent protection element is blocked in case of m.c.b. trip to avoid false trippings.

NOTICE!



Definition of V_n :

V_n depends on the VT connection type and on the Measuring Mode setting in the current protection modules:

If [Field Para / VT] »VT con« = "Phase to Ground" **and** [Protection Para / Set n / I-Prot / I[x]] »Measuring Mode« = "Phase to Ground", then:

$$V_n = \frac{VT_{\text{sec}}}{\sqrt{3}}$$

If [Field Para / VT] »VT con« = "Phase to Ground" **and** [Protection Para / Set n / I-Prot / I[x]] »Measuring Mode« = "Phase to Phase", then:

$$V_n = VT_{\text{sec}}$$

If [Field Para / VT] »VT con« = "Phase to Phase", then:

$$V_n = VT_{\text{sec}}$$

(Remark: This means that if »VT con« = "Phase to Phase" then the setting »Measuring Mode« in the current modules is ignored.)

4.8.4 I2> - Negative-Sequence Overcurrent [51Q]

For activating this function, the parameter [Protection Para / Set n / I-Prot / I[x]] »*Measuring method*« has to be set to "I2" in the parameter set of the corresponding overcurrent element I[x].

The negative-sequence overcurrent protection function (I2>) is to be seen as an equivalent to the phase overcurrent protection with the exception that it uses negative-sequence current (I2>) as measured quantities instead of the three phase currents used by phase overcurrent protection function. The negative-sequence current used by I2> is derived from the following well-known symmetrical component transformation:

$$I_2 = \frac{1}{3}(I_{L1} + a^2I_{L2} + aI_{L3})$$

The pickup set value of a I2> protection function should be set in accordance of the negative-sequence current occurrence in the protected object.

Besides that, the negative-sequence overcurrent protection function (I2>) uses the same setting parameters as the phase overcurrent protection function, like trip and reset characteristics from both IEC/ANSI standards, time multiplier, etc.

The negative-sequence overcurrent protection function (I2>) can be used for line, generator, transformer and motor protection to protect the system from unbalanced faults. Because the I2> protection function operates on the negative-sequence current component which is normally absent during load conditions, the I2> can, therefore, be set more sensitive than the phase overcurrent protection functions. On the other hand, coordination of negative-sequence overcurrent protection function in a radial system does not mean automatically very long fault clearing time for the furthest upstream protection devices, because the tripping time of concerned negative-sequence overcurrent protection function needs only be coordinate with the next downstream device with the negative-sequence overcurrent protection function. This makes the I2> in many cases as an advantageous protection concept in addition to the phase overcurrent protection function.

WARNING!



If you are using inrush blockings, the tripping delay of the current protection functions must be at least 30 ms or more in order to prevent faulty trippings.

NOTICE!



At the moment of breaker closure, negative-sequence current might be the result of transients.

4 Protective Elements
 4.8 I - Overcurrent Protection

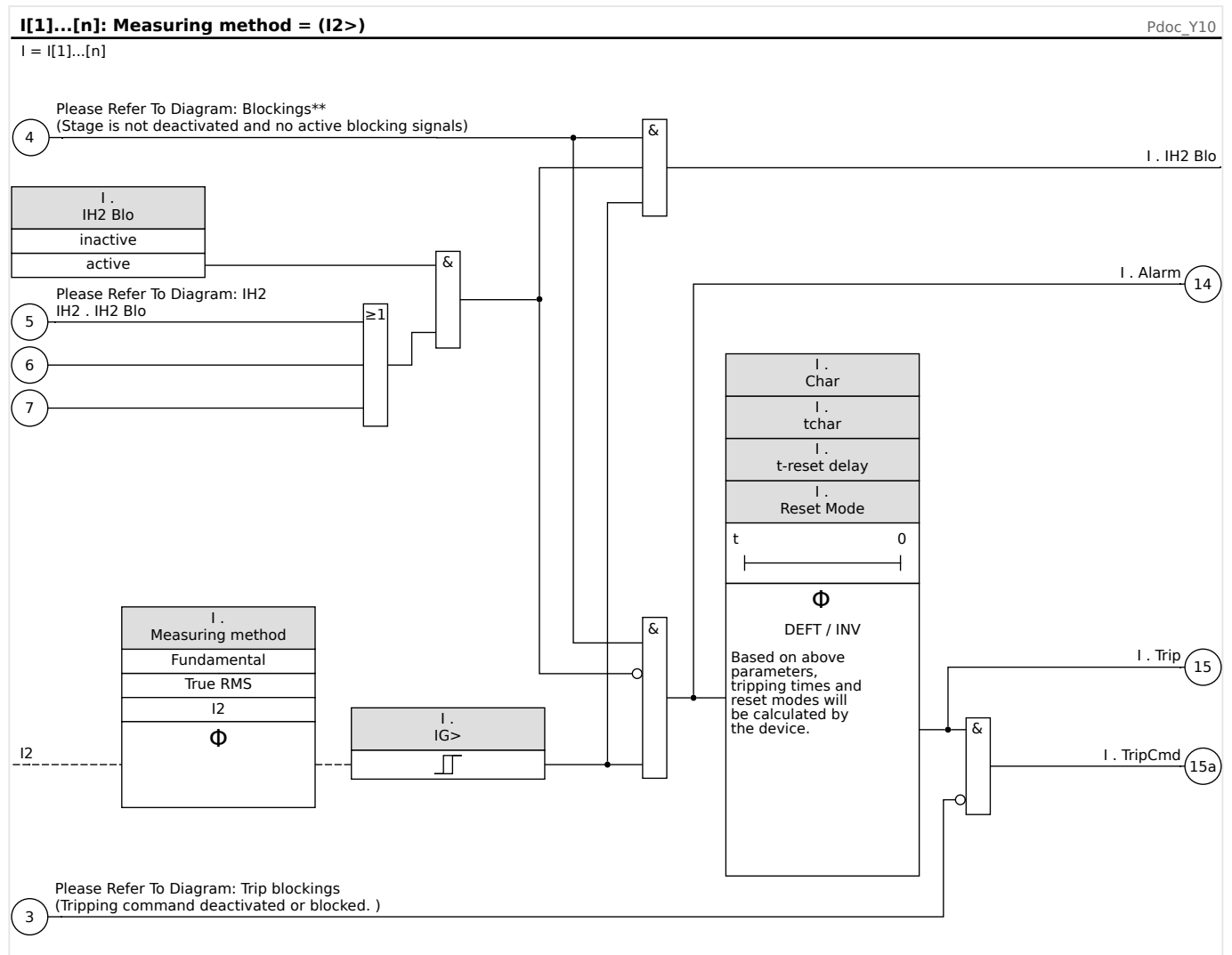

4.8.5 Voltage Controlled Overcurrent Protection [51C]

When a short-circuit is near the generator, the voltage might drop down. By means of **Adaptive Parameters** (please refer to  “Adaptive Parameter Sets”) the tripping times or tripping characteristics can be modified by the output signal of a voltage element (depending on a threshold). The device might change a load curve to a fault curve (taking influence on tripping time, trip curves and reset modes).

Please proceed as follows:

- Read and understand the section „Adaptive Parameter Sets“ ( “Adaptive Parameter Sets”).
- Do the device planning and set all required parameters for the Undervoltage element.
- Do the device planning and set all required parameters for the Overcurrent element.
- Set the **Adaptive Parameters** within the Overcurrent element in the relevant parameter sets (e. g. Curve multiplier, curve type...).
- Assign the Undervoltage alarm (pickup) within the **Global Parameters** as an activation signal for the corresponding **Adaptive Parameter Set** of the overcurrent element that should be modified.
- Check the functionality by a commissioning test.

4.8.6 I>> - IOC Function

The instantaneous overcurrent function (IOC) or 50P is intended to protect in the event of a high-current fault. The example IOC setting used in the Motor Protection Curve (see the Motor Protection Curve Examples in the Ultimate Trip Current Section) is 12 times (1,200%) of FLA. In general the instantaneous IOC should be at least 1.5 times LRC (Locked Rotor Current), well above the locked rotor current that is normally seen at the moment of a start.

IOC should trip fast and therefore no run or pickup delay is provided. A start delay is set at a minimum of 0.03 sec or more if needed to block IOC tripping on magnetizing inrush when the motor is first energized. An additional IOC tripping delay setting is set at a default of zero seconds.

IOC Trip Level

The IOC sets the instantaneous overcurrent trip limit in percentage of »Ib« (FLA) above at which the relay trips. This trip type can be set to inactive to deactivate this protective device element. For currents clearly above the setting, the IOC function picks up in 1.5 power cycles or less (at 50 Hz).

4.8.7 Commissioning: Overcurrent Protection, non-directional [50, 51]

Object to be tested

- Signals to be measured for each current protection element, the threshold values, total tripping time (recommended), or alternatively tripping delays and the fallback ratios; each time 3 x single-phase and 1 x three-phase.

NOTICE!



Especially in Holmgreen connections, wiring errors can easily happen, and these are then detected safely. Measuring the total tripping time can ensure that the secondary wiring is o.k. (from the terminal on, up to the trip coil of the CB).

NOTICE!



It is recommended to measure the total tripping time instead of the tripping delay. The tripping delay should be specified by the customer. The total tripping time is measured at the position signalling contact of the CB (not at the relay output!).

Total tripping time = tripping delay (please refer to the tolerances of the protection stages) + CB operating time (about 50 ms)

Please take the CB operating times from the technical data specified in the relevant documentation provided by the CB manufacturer.

Necessary means

- Current source
- May be: ampere meters
- Timer

Procedure

Testing the threshold values (3 x single-phase and 1 x three-phase)

Each time feed a current which is about 3-5% above the threshold value for activation/tripping. Then check the threshold values.

Testing the total tripping delay (recommendation)

Measure the total tripping times at the auxiliary contacts of the CB (CB tripping).

Testing the tripping delay (measuring at the relay output)

Measure the tripping times at the relay output.

Testing the fallback ratio

Reduce the current to 97% below the trip value and check the fallback ratio.

Successful test result

The measured total tripping delays or individual tripping delays, threshold values and fallback ratios correspond with those values, specified in the adjustment list. Permissible deviations/tolerances can be found under Technical Data.

4.8.8 Commissioning: Overcurrent Protection, Non-directional [ANSI 51V]

Object to be tested:

Signals to be measured for Voltage Restraint protection function: the threshold values, total tripping time (recommended), or alternatively tripping delays and the dropout ratios; each time 3 x single-phase and 1 x three-phase.

NOTICE!



It is recommended to measure the total tripping time instead of the tripping time. The tripping delay should be specified by the customer. The total tripping time is measured at the position signaling contacts of the CBs (not at the relay output!).

Total tripping time: = tripping delay (please refer to the tolerances of the protection stages) + CB operating time (about 50 ms)

Please take the CB switching times from the technical data, specified in the relevant documentation, provided by the CB manufacturer.

Necessary means:

- Current source;
- Voltage Source;
- Current and Voltage meters; and
- Timer.

Procedure:

Testing the threshold values (3 x single-phase and 1 x three-phase)

Feed %Pickup voltage. For each test performed, feed a current that is about 3-5% above the threshold value for activation/tripping. Then check if the pickup values are %Pickup of the value according to the standard overcurrent protection.

Testing the total tripping delay (recommendation)

Measure the total tripping times at the auxiliary contacts of the breakers (breaker tripping).

Testing the tripping delay (measuring at the relay output contact)

Measure the tripping times at the relay output contact.

Testing the dropout ratio

Reduce the current to 97% below the trip value and check the dropout ratio.

Successful test result

The measured total tripping delays or individual tripping delays, threshold values, and dropout ratios correspond with those values specified in the adjustment list. Permissible deviations/tolerances can be found under Technical Data.

4.8.9 Commissioning: Negative Sequence Overcurrent

Object to be tested

Signals to be measured for each current protection function: the threshold values, total tripping time (recommended), or alternatively tripping delays and the dropout ratios.

NOTICE!



It is recommended to measure the total tripping time instead of the tripping time. The tripping delay should be specified by the customer. The total tripping time is measured at the position signalling contacts of the CBs (not at the relay output!).

Total tripping time: = tripping delay (please refer to the tolerances of the protection stages) + CB operating time (about 50 ms)

Please take the CB switching times from the technical data, specified in the relevant documentation, provided by the CB manufacturer.

Necessary means:

- Current source
- Current meters
- Timer

Procedure:

Testing the threshold values

In order to get a negative-sequence current, please change the phase sequence at the terminals of the current source (in case of ABC sequence to ACB – in case of a ACB sequence to ABC).

For each test performed, feed a current that is about 3-5% above the threshold value for activation/tripping. Then check the threshold values.

Testing the total tripping delay (recommendation)

Measure the total tripping times at the auxiliary contacts of the breakers (breaker tripping).

Testing the tripping delay (measuring at the relay output contact)

Measure the tripping times at the relay output contact.

Testing the dropout ratio

Reduce the current to 97% below the trip value and check the dropout ratio.

Successful test result

The measured total tripping delays or individual tripping delays, threshold values, and dropout ratios correspond with those values specified in the adjustment list. Permissible deviations/tolerances can be found under Technical Data.

4.9 IG – Ground (Earth) Overcurrent Protection [50N/G, 51N/G, 67N/G]

The Ground Fault (Earth Overcurrent) module »IG« covers the following ANSI protection functions:

- ANSI 50N/G
- ANSI 51N/G

NOTICE!



All ground (earth) current elements are identically structured.

NOTICE!



This module offers Adaptive Parameter Sets.

Parameters can be modified within parameter sets dynamically by means of Adaptive Parameter Sets. Please see [↪](#) “Adaptive Parameter Sets”.

ANSI 50N/G – Ground (Earth) Overcurrent Protection, Non-Directional

This application option is set via the [Device planning] menu:

- [Device planning] »Mode« = “non directional”

No directional information is taken into account if the current protective element is planned as “non directional”.

Options:

- [Protection Para / Set 1...4 / I-Prot / IG[x]] »Measuring method« =
 - Fundamental
 - True RMS

ANSI 51N/G – Ground (Earth) Short-Circuit Protection, Non-Directional

This application option is set via the [Device planning] menu:

- [Device planning] »Mode« = “non directional”

No directional information is taken into account if the current protective element is planned as “non directional”.

Options:

- [Protection Para / Set 1...4 / I-Prot / IG[x]] »Measuring method« =
 - Fundamental
 - True RMS

Measuring Method

For each protection element it can be defined via setting »*Measuring method*«, whether the measurement is done on basis of the “Fundamental” or if “True RMS” measurement is used.

IG Source / VG Source

The parameters »*IG Source*« and »*VX Source*« determine whether the earth current and the residual voltage are “measured” or “calculated”.

4.9.1 Characteristics

For each element the parameter [Protection Para / Set 1...4 / I-Prot / IG[x]] »Char« selects any of the following characteristics:

- **DEFT** – *Definite Time-Overcurrent*
- **Normal Inverse** (IEC) – *IEC Normal Inverse*
- **Very Inverse [VINV]** (IEC) – *IEC Very Inverse*
- **Long Time Inverse - Characteristic [LINV]** (IEC) – *IEC Long Time Inverse*
- **Extremely Inverse - Characteristic** (IEC) – *IEC Extremely Inverse*
- **Moderately Inverse [MINV] - Characteristic** (ANSI) – *ANSI Moderately Inverse*
- **Very Inverse [VINV]** (ANSI) – *ANSI Very Inverse*
- **Extremely Inverse - Characteristic** (ANSI) – *ANSI Extremely Inverse*
- **RINV** – *R Inverse*
- **RXIDG**
- **Therm Flat [TF]** - *Characteristic – Thermal Flat*
- **IT** - *Characteristic*
- **I2T** - *Characteristic*
- **I4T** - *Characteristic*

Explanation for All Characteristics

- IG: Fault current
- IG>: If the pickup value is exceeded, the module/stage will be started.
Setting: [Protection Para / Set 1...4 / I-Prot / IG[x]] »IG>«
- t for »Char« = “**DEFT**”:
 - Trip delay for $IG > IG>$, settable via [Protection Para / Set 1...4 / I-Prot / IG[x]] »t«.
 - The reset delay for $IG \leq IG>$ always equals 0 (“instantaneous”).
- t for »Char« = “**RXIDG**”:
 - The trip delay for $IG > IG>$ is calculated based on the selected characteristics.
 - The reset delay for $IG \leq IG>$ is settable via »Reset Mode«, available options: “instantaneous” or “delayed”.
 - For »Reset Mode« = “delayed” is the reset delay settable at »t-reset delay«.
- t for all characteristics except “DEFT” and “RXIDG”:
 - The trip delay for $IG > IG>$ is calculated based on the selected characteristics.

- The reset delay for $IG \leq IG>$ is settable via »Reset Mode«, available options: “instantaneous”, “delayed” or “calculated”.
 - With option »Reset Mode« = “instantaneous”: Instantaneous reset: when the current drops below the pickup setting, the TOC time resets to zero within 2 cycles.
 - With option »Reset Mode« = “delayed”: The reset delay is settable at »t-reset delay«.
 - With option »Reset Mode« = “calculated”: The reset delay is calculated based on the selected characteristics.
- tchar (for all characteristics except “DEFT”):
 - Time multiplier/tripping characteristic factor. The setting range depends on the selected tripping curve.
 - Setting via [Protection Para / Set 1...4 / I-Prot / IG[x]] »tchar«

4.9.1.1 DEFT - Definite Time-Overcurrent

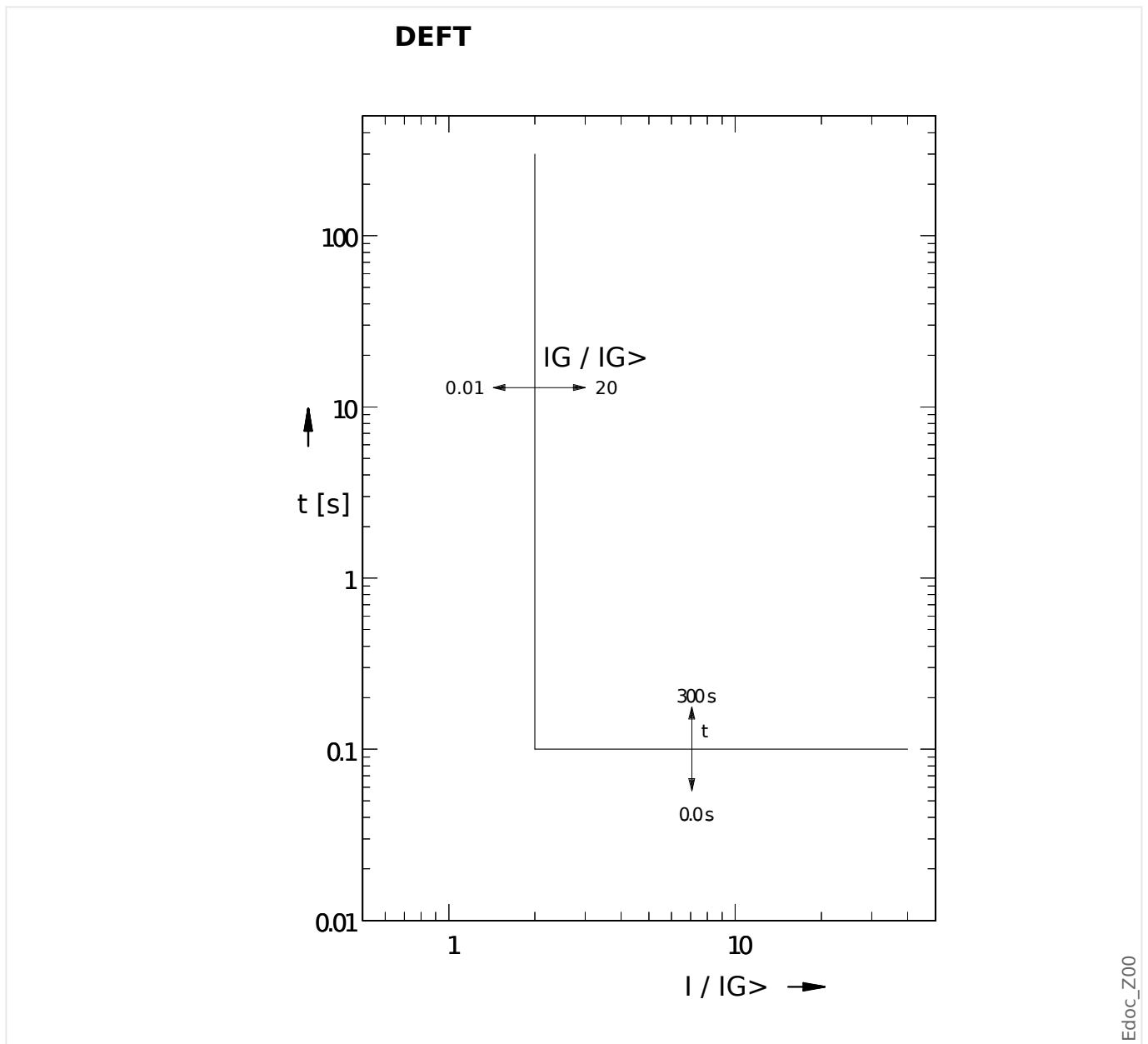

Trip delay for $I_G > I_{G>}$, settable via [Protection Para / Set 1...4 / I-Prot / IG[x]] »t«.

The reset delay for $I_G \leq I_{G>}$ always equals 0 ("instantaneous").

4.9.1.2 IEC Normal Inverse

»Char« = IEC NINV

NOTICE!



Various reset modes are available: Resetting via characteristic, delayed and instantaneous. See [↳ “4.9.1 Explanation for All Characteristics”](#) for details.

Remark: For $IG > 20 \cdot IG>$, the curve stops decreasing, the t-values are kept constant at the value for $IG = 20 \cdot IG>$.

Reset	Trip
$t = \frac{0.14}{1 - \left(\frac{IG}{IG>}\right)^2} \cdot tchar$	$t = \frac{0.14}{\left(\frac{IG}{IG>}\right)^{0.02} - 1} \cdot tchar$
If: $\frac{IG}{IG>} < 1$	If: $1 < \frac{IG}{IG>} \leq 20$

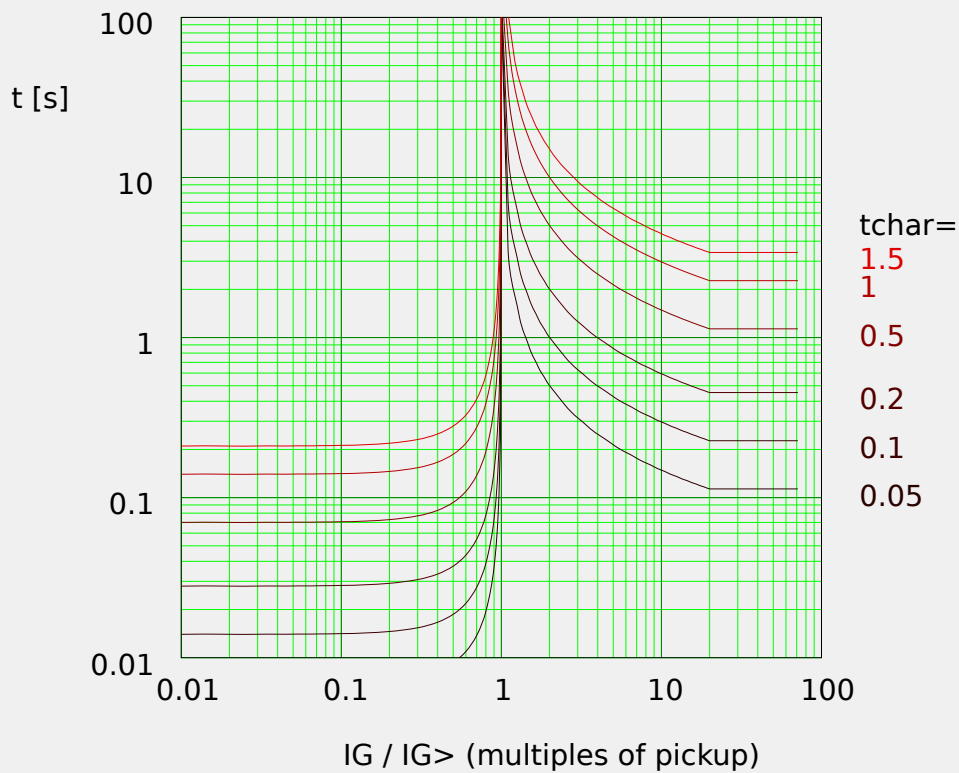

Edoc_Z01

4.9.1.3 IEC Very Inverse [VINV]

»Char« = IEC VINV

NOTICE!



Various reset modes are available: Resetting via characteristic, delayed and instantaneous. See [↳ “4.9.1 Explanation for All Characteristics”](#) for details.

Remark: For $IG > 20 \cdot IG>$, the curve stops decreasing, the t-values are kept constant at the value for $IG = 20 \cdot IG>$.

Reset	Trip
$t = \frac{13.5}{1 - \left(\frac{IG}{IG>}\right)^2} \cdot tchar$	$t = \frac{13.5}{\frac{IG}{IG>} - 1} \cdot tchar$
If: $\frac{IG}{IG>} < 1$	If: $1 < \frac{IG}{IG>} \leq 20$

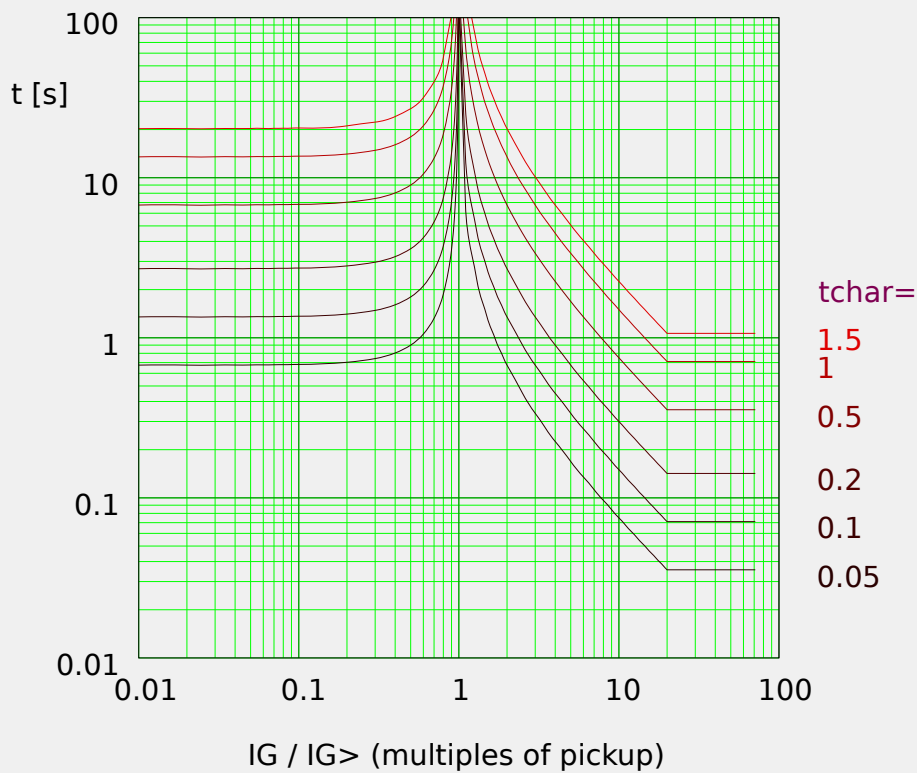

Edoc_Z02

4.9.1.4 IEC Extremely Inverse - Characteristic

»Char« = IEC EINV

NOTICE!



Various reset modes are available: Resetting via characteristic, delayed and instantaneous. See [↳ “4.9.1 Explanation for All Characteristics”](#) for details.

Remark: For $IG > 20 \cdot IG>$, the curve stops decreasing, the t-values are kept constant at the value for $IG = 20 \cdot IG>$.

Reset	Trip
$t = \frac{80}{1 - (\frac{IG}{IG>})^2} \cdot tchar$	$t = \frac{80}{(\frac{IG}{IG>})^2 - 1} \cdot tchar$
If: $\frac{IG}{IG>} < 1$	If: $1 < \frac{IG}{IG>} \leq 20$

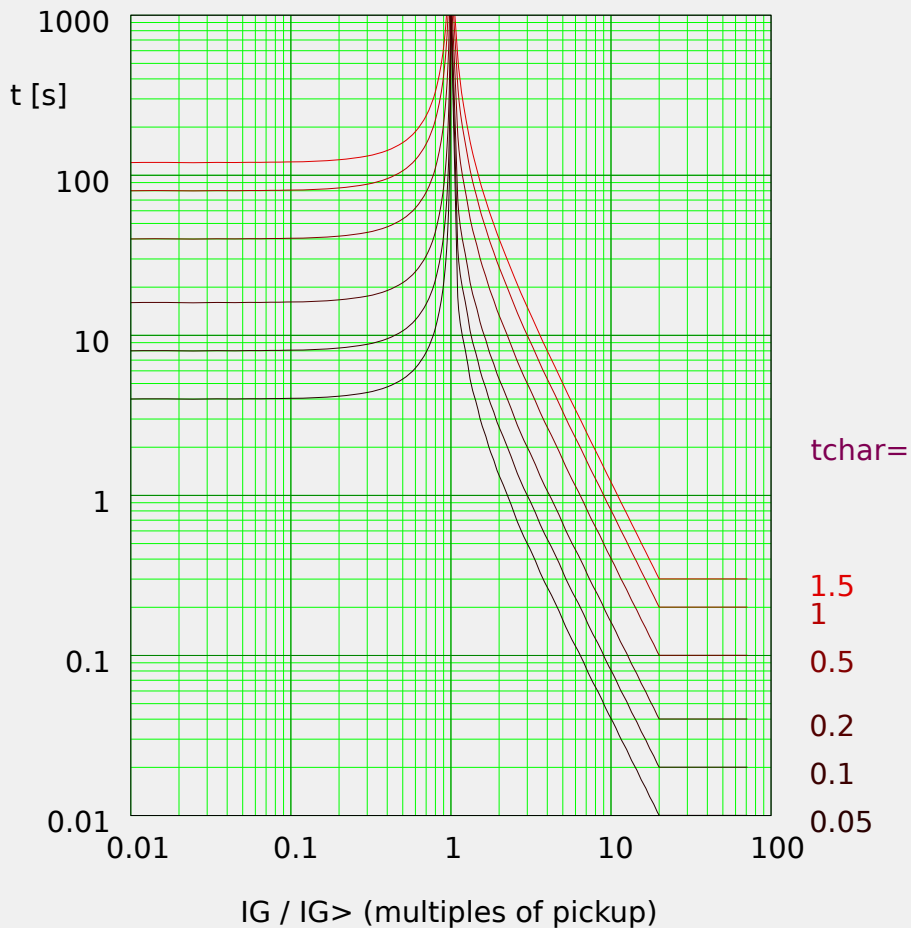

Edoc_Z04

4.9.1.5 IEC Long Time Inverse - Characteristic [LINV]

»Char« = IEC LINV

NOTICE!



Various reset modes are available: Resetting via characteristic, delayed and instantaneous. See [↳ “4.9.1 Explanation for All Characteristics”](#) for details.

Remark: For $IG > 20 \cdot IG>$, the curve stops decreasing, the t-values are kept constant at the value for $IG = 20 \cdot IG>$.

Reset	Trip
$t = \frac{120}{1 - \left(\frac{IG}{IG>}\right)^2} \cdot tchar$	$t = \frac{120}{\frac{IG}{IG>} - 1} \cdot tchar$
If: $\frac{IG}{IG>} < 1$	If: $1 < \frac{IG}{IG>} \leq 20$

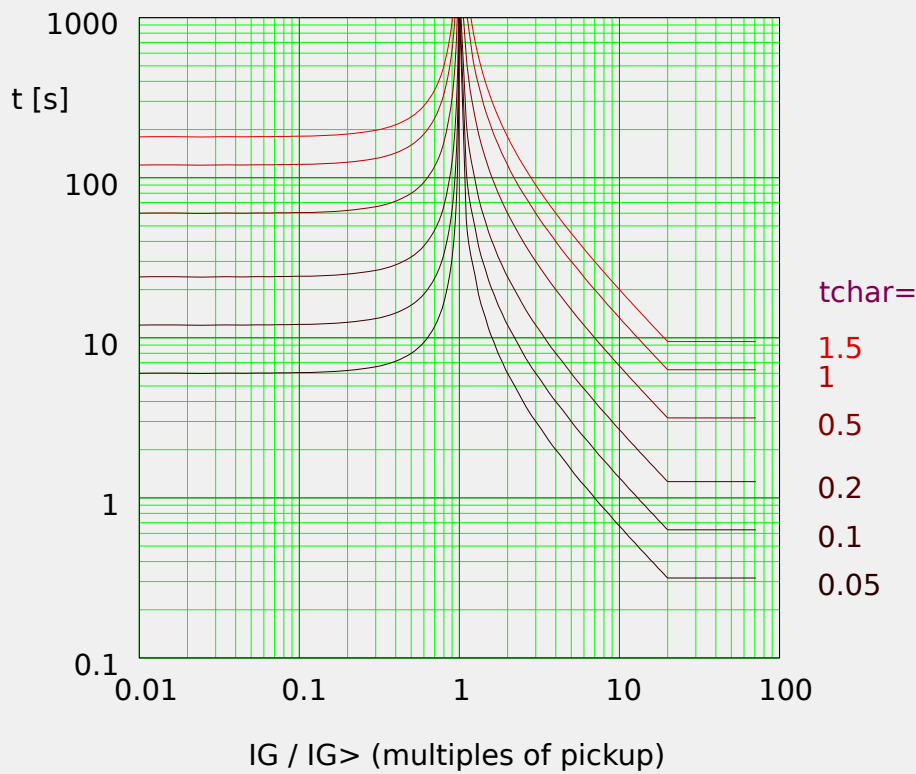

Edoc_Z03

4.9.1.6 ANSI Moderately Inverse [MINV] - Characteristic

»Char« = ANSI MINV

NOTICE!



Various reset modes are available: Resetting via characteristic, delayed and instantaneous. See [↳ “4.9.1 Explanation for All Characteristics”](#) for details.

Remark: For $IG > 20 \cdot IG>$, the curve stops decreasing, the t-values are kept constant at the value for $IG = 20 \cdot IG>$.

Reset	Trip
$t = \frac{4.85}{1 - \left(\frac{IG}{IG>}\right)^2} \cdot tchar$	$t = \left(\frac{0.0515}{\left(\frac{IG}{IG>}\right)^{0.02} - 1} + 0.1140 \right) \cdot tchar$
If: $\frac{IG}{IG>} < 1$	If: $1 < \frac{IG}{IG>} \leq 20$

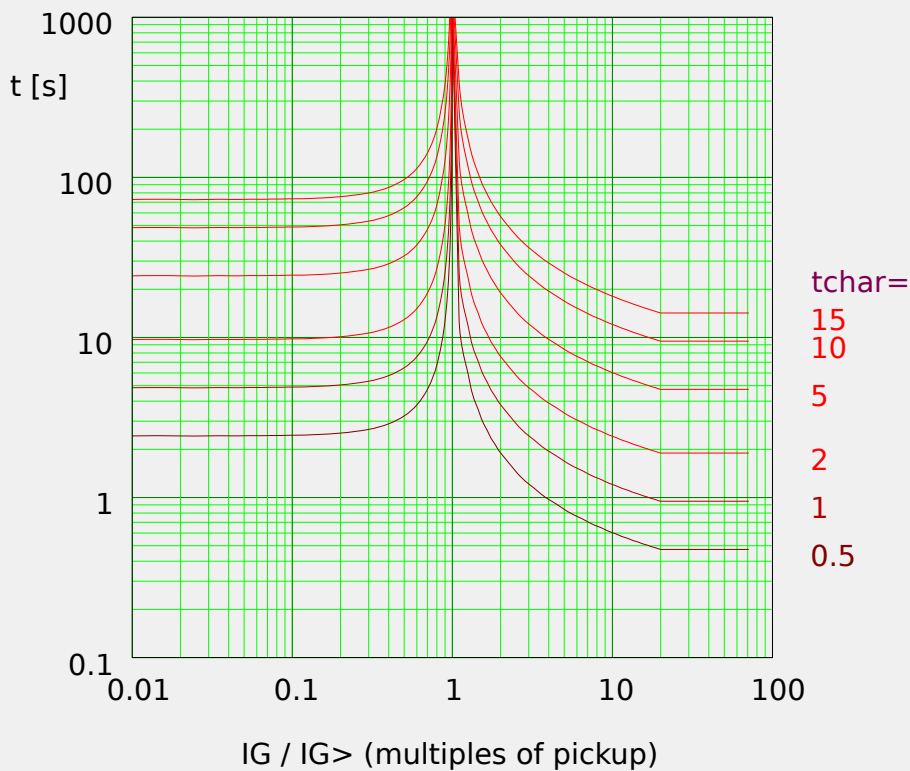

Edoc_Z05

4.9.1.7 ANSI Very Inverse [VINV]

»Char« = ANSI VINV

NOTICE!



Various reset modes are available: Resetting via characteristic, delayed and instantaneous. See [↳ “4.9.1 Explanation for All Characteristics”](#) for details.

Remark: For $IG > 20 \cdot IG>$, the curve stops decreasing, the t-values are kept constant at the value for $IG = 20 \cdot IG>$.

Reset	Trip
$t = \frac{21.6}{1 - \left(\frac{IG}{IG>}\right)^2} \cdot tchar$	$t = \left(\frac{19.61}{\left(\frac{IG}{IG>}\right)^2 - 1} + 0.491 \right) \cdot tchar$
If: $\frac{IG}{IG>} < 1$	If: $1 < \frac{IG}{IG>} \leq 20$

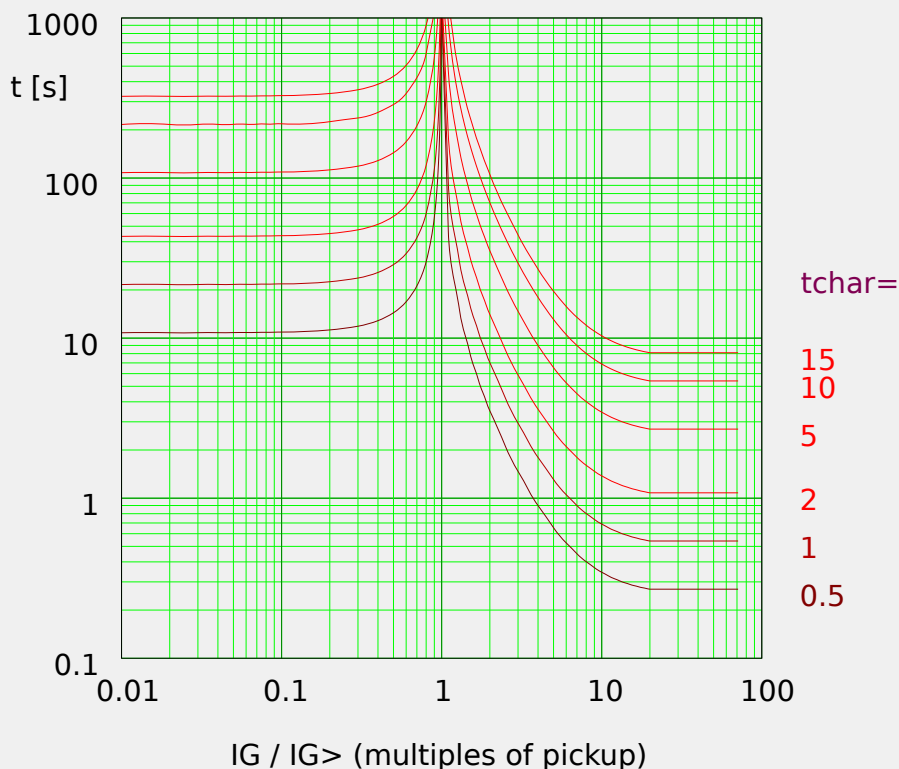

Edoc_Z06

4.9.1.8 ANSI Extremely Inverse - Characteristic

»Char« = ANSI EINV

NOTICE!



Various reset modes are available: Resetting via characteristic, delayed and instantaneous. See [↳ “4.9.1 Explanation for All Characteristics”](#) for details.

Remark: For $IG > 20 \cdot IG>$, the curve stops decreasing, the t-values are kept constant at the value for $IG = 20 \cdot IG>$.

Reset	Trip
$t = \frac{29.1}{1 - \left(\frac{IG}{IG>}\right)^2} \cdot tchar$	$t = \left(\frac{28.2}{\left(\frac{IG}{IG>}\right)^2 - 1} + 0.1217 \right) \cdot tchar$
If: $\frac{IG}{IG>} < 1$	If: $1 < \frac{IG}{IG>} \leq 20$

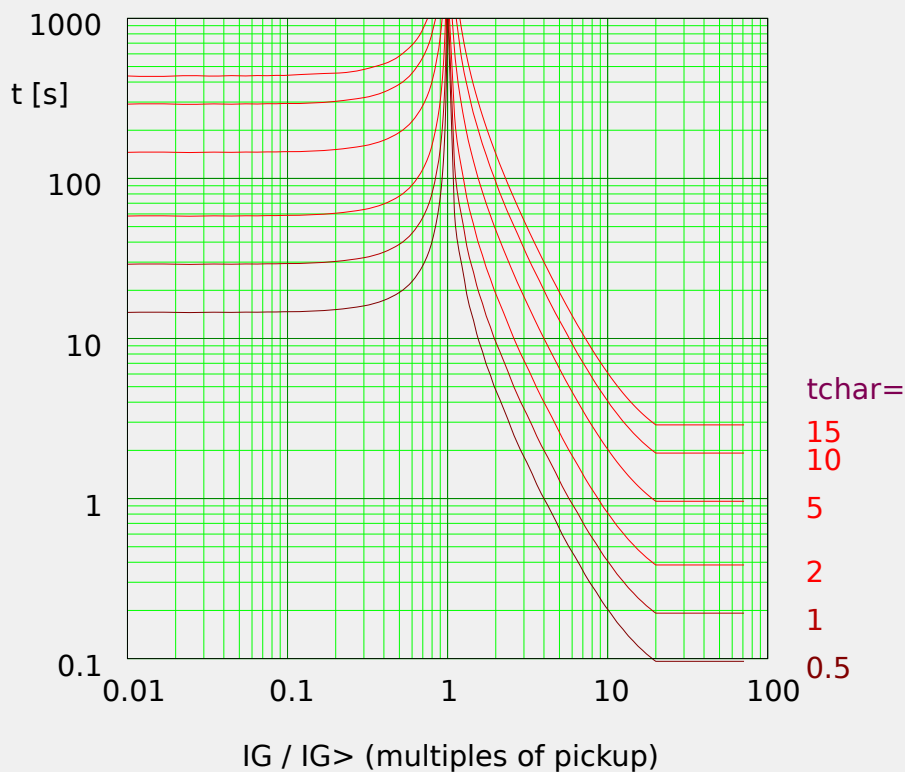

Edoc_Z07

4.9.1.9 R Inverse [RINV] - Characteristic

»Char« = RINV

NOTICE!



Various reset modes are available: Resetting via characteristic, delayed and instantaneous. See [↳ “4.9.1 Explanation for All Characteristics”](#) for details.

Remark: For $IG > 20 \cdot IG>$, the curve stops decreasing, the t-values are kept constant at the value for $IG = 20 \cdot IG>$.

Reset	Trip
$t = \frac{1.0}{1 - \left(\frac{IG}{IG>}\right)^2} \cdot tchar$	$t = \frac{1.0}{0.339 - \frac{0.236}{\left(\frac{IG}{IG>}\right)}} \cdot tchar$
If: $\frac{IG}{IG>} < 1$	If: $1 < \frac{IG}{IG>} \leq 20$

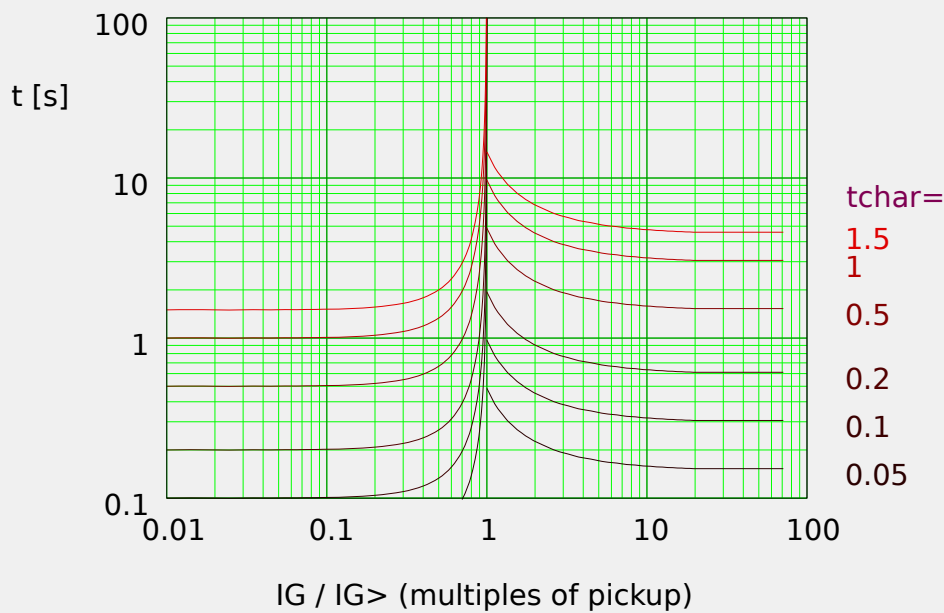

Edoc_Z12

4.9.1.10 RXIDG

»Char« = RXIDG

NOTICE!

Various reset modes are available: Fixed delay or instantaneous. See [↳ “4.9.1 Explanation for All Characteristics”](#) for details.

Remark: For $t = 0,02$ s, the curve stops decreasing, i. e. t is constant for greater values of I_G .

Trip

$$t = 5.8 - 1.35 \cdot \ln\left(\frac{I_G}{I_{G>} \cdot t_{char}}\right)$$

If: $1 < \frac{I_G}{I_{G>}}$ AND $t \geq 0.02$ s

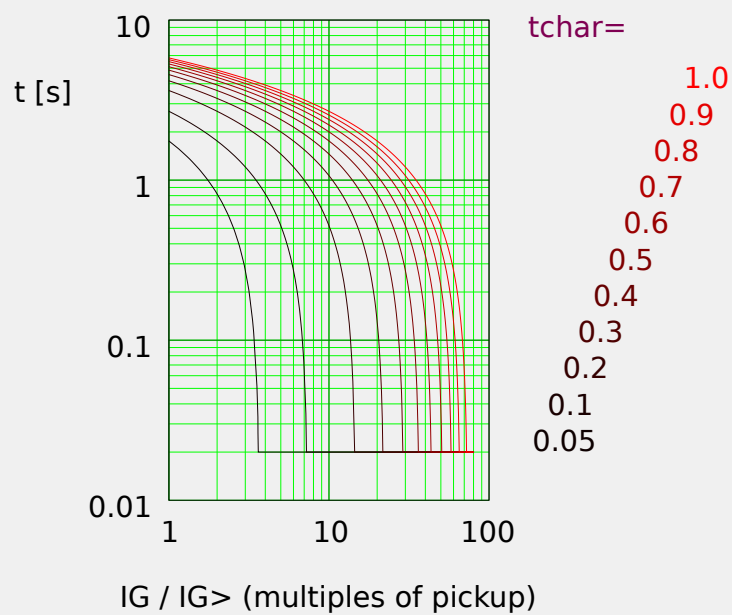

Edoc_Z1.3

4.9.1.11 Therm Flat [TF] - Characteristic

»Char« = Therm Flat

NOTICE!



Various reset modes are available: Resetting via characteristic, delayed and instantaneous. See [↳ “4.9.1 Explanation for All Characteristics”](#) for details.

Reset	Trip
$t = (5 \cdot 1^2) \cdot tchar$	$t = (5 \cdot 1^0) \cdot tchar$
If: $\frac{IG}{IGnom} < 1$	If: $1 < \frac{IG}{IGnom}$

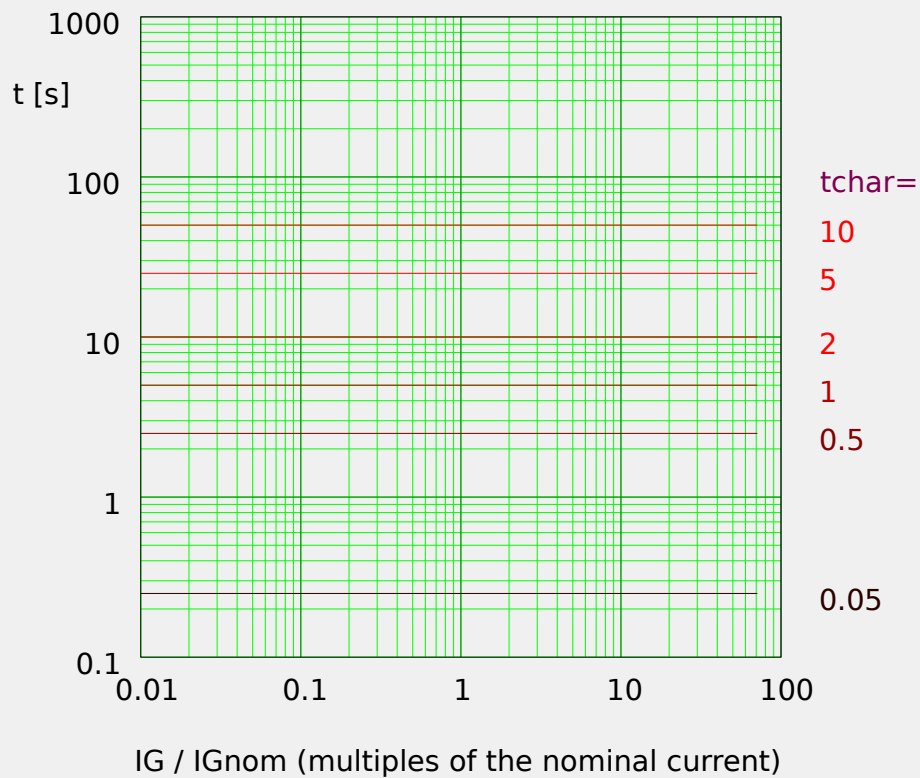

Edoc_Z08

4.9.1.12 IT - Characteristic

»Char« = IT

NOTICE!



Various reset modes are available: Resetting via characteristic, delayed and instantaneous. See [↳ “4.9.1 Explanation for All Characteristics”](#) for details.

Reset	Trip
$t = (5 \cdot 1^2) \cdot t_{char}$	$t = \frac{5 \cdot 1^1}{\left(\frac{I_G}{I_{Gnom}}\right)^1} \cdot t_{char}$
if: $\frac{I_G}{I_{Gnom}} < 1$	if: $1 < \frac{I_G}{I_{Gnom}}$

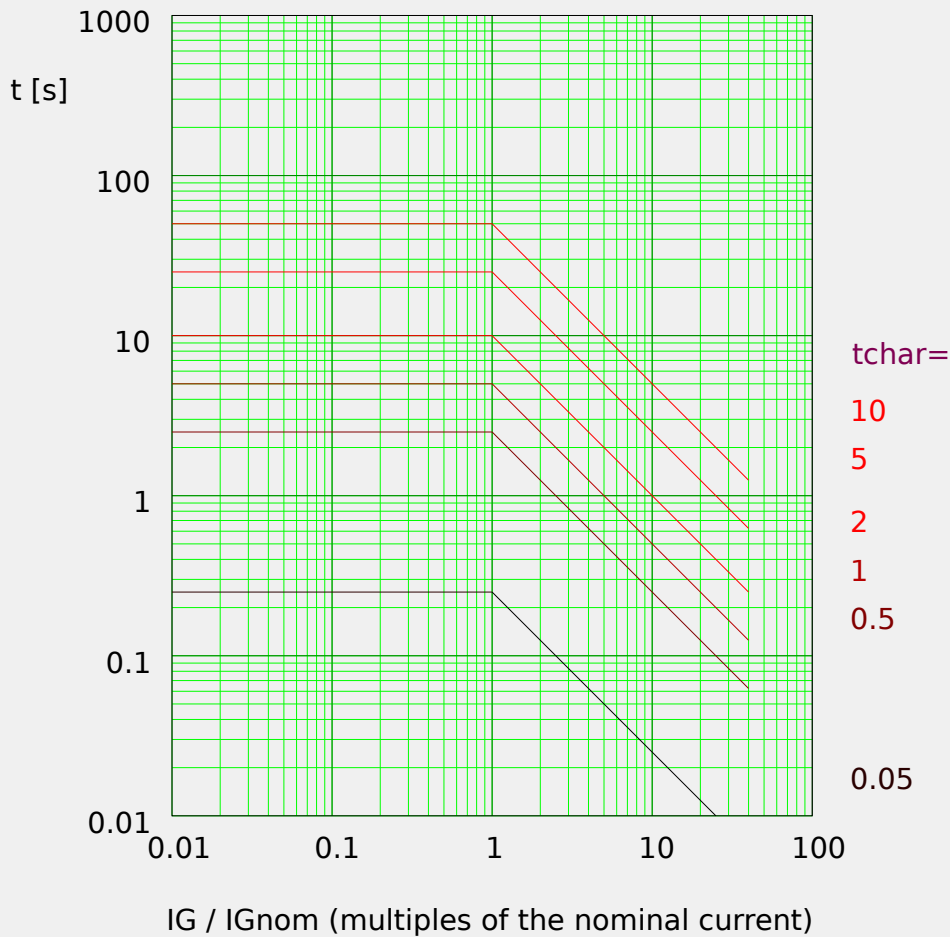

Edoc_Z09

4.9.1.13 I2T - Characteristic

»Char« = I2T

NOTICE!



Various reset modes are available: Resetting via characteristic, delayed and instantaneous. See [↳ “4.9.1 Explanation for All Characteristics”](#) for details.

Reset	Trip
$t = (5 \cdot 1^2) \cdot t_{char}$	$t = \frac{5 \cdot 1^2}{\left(\frac{I_G}{I_{Gnom}}\right)^2} \cdot t_{char}$
if: $\frac{I_G}{I_{Gnom}} < 1$	if: $1 < \frac{I_G}{I_{Gnom}}$

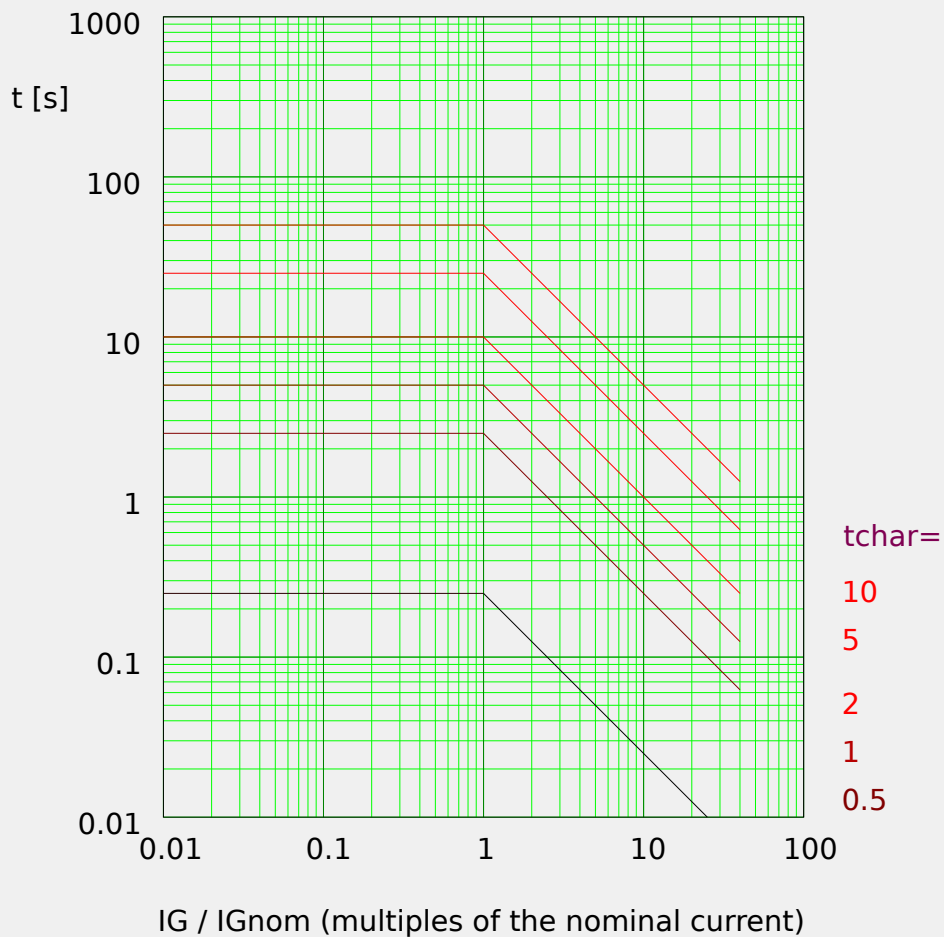

Edoc_Z10

4.9.1.14 I4T - Characteristic

»Char« = I4T

NOTICE!



Various reset modes are available: Resetting via characteristic, delayed and instantaneous. See [↳ “4.9.1 Explanation for All Characteristics”](#) for details.

Reset	Trip
$t = (5 \cdot 1^2) \cdot tchar$	$t = \frac{5 \cdot 1^4}{\left(\frac{IG}{IGnom}\right)^4} \cdot tchar$
lf: $\frac{IG}{IGnom} < 1$	lf: $1 < \frac{IG}{IGnom}$

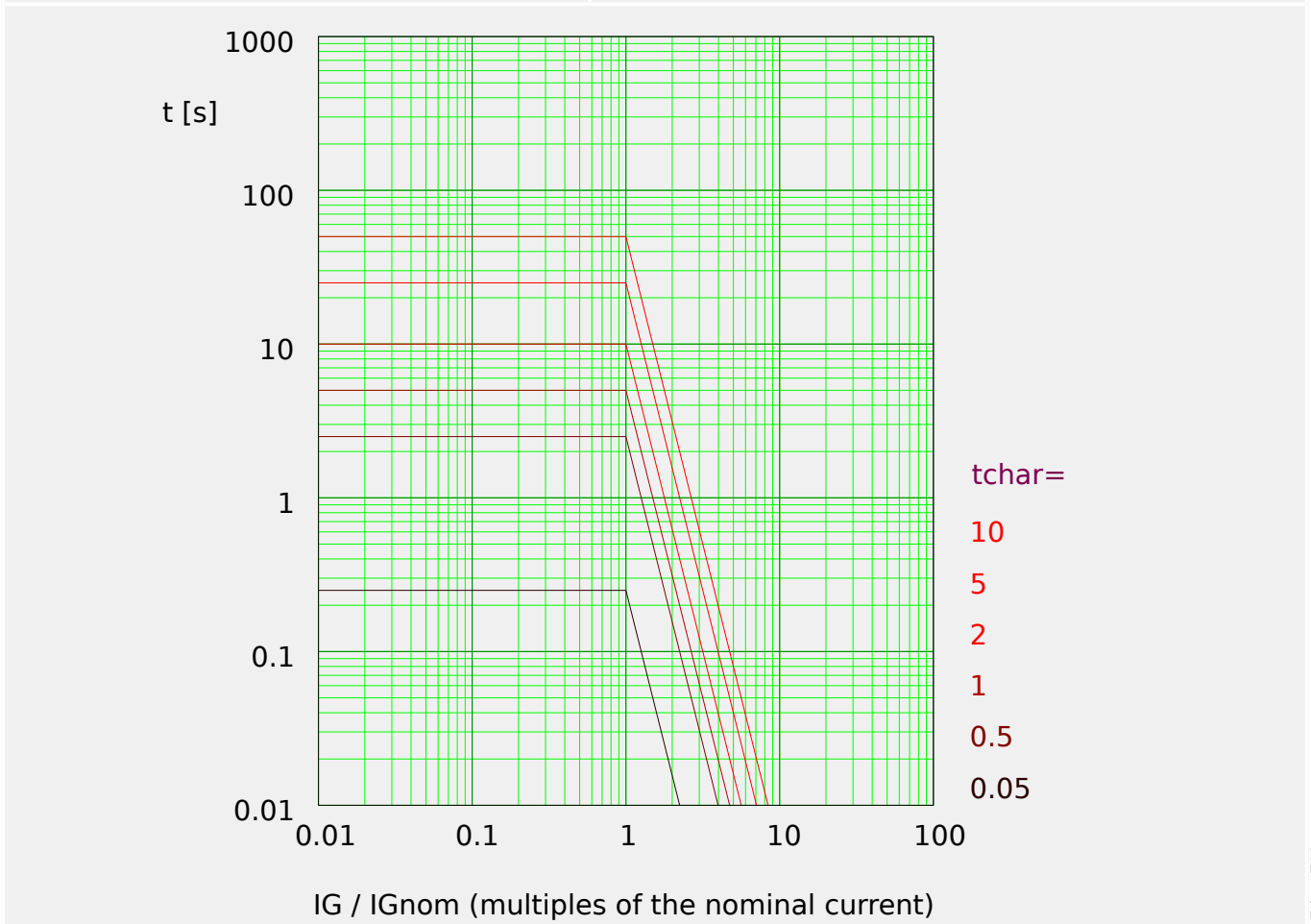

Edoc_Z11

4.9.2 Ground (Earth) Overcurrent - Functionality

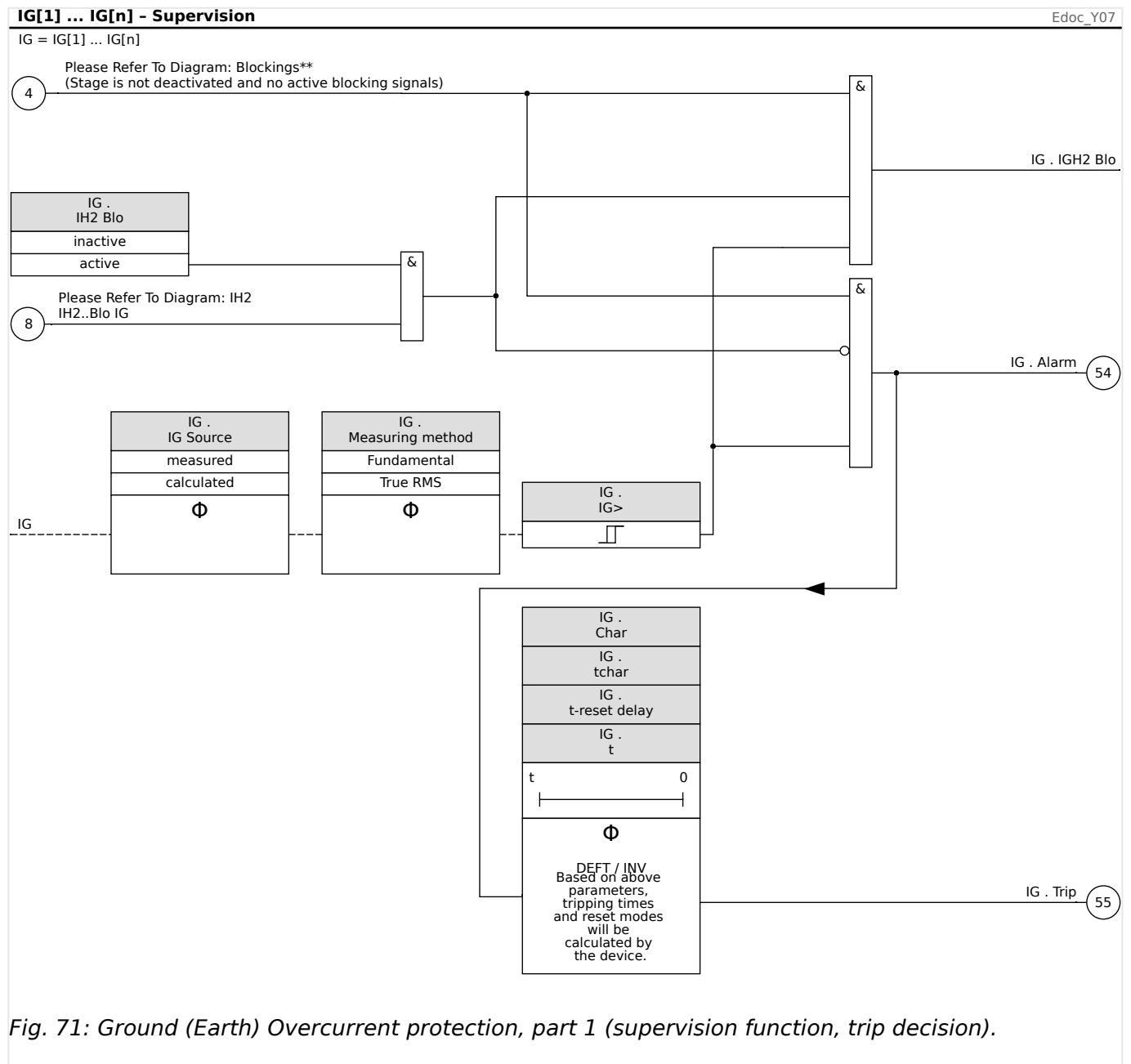
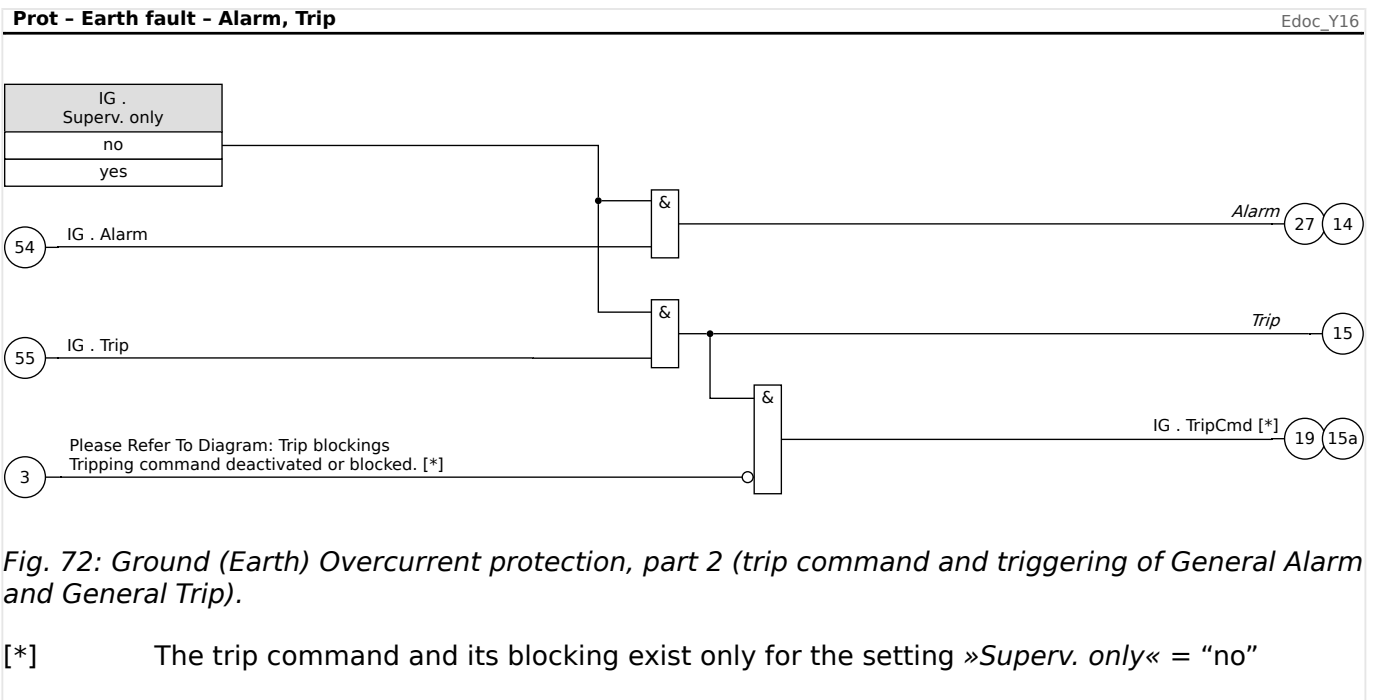

Fig. 71: Ground (Earth) Overcurrent protection, part 1 (supervision function, trip decision).



4.9.3 Special Notes on Earth Fault Current Transformers

Earth current measurement is usually been done with a summation current transformer (core-balance transformer). This CT has a large primary window through which all three-phase conductors can pass.

Note that the earth fault current settings are based on the earth CT rated **primary current (I_n)**, not on FLA or the phase CT ratio. For example, a pick-up setting of $0.10 \cdot I_n$ gives a trip or alarm for an actual earth leakage current of 5 A on the primary side of the sensor with a 50:5 CT.

This function is only useful for an earthed power system. The earth return is normally made from the neutral of the secondary wire winding of the supply power transformer. Resistance earthing is acceptable as long as the resulting fault current is at a level the protective device can be set to detect.

The earth CT, which provides sensitive protection for high-resistance earth faults, may saturate for a robust heavy-current earth fault in a solid-earthed system. Minimize the saturation problem by minimizing the burden. Use the shortest and heaviest leads possible between the earth CT and the relay. The relay itself has very low burden, usually much lower than the connecting wiring.

A residual connection – the wired summation of the phase CT circuits through the earth CT input – requires a much higher earth fault time setting to avoid false tripping. Thus sensitivity is not nearly as good as with a separate flux-canceling CT.

If the relay is installed where a residual connection is used, XCT should be set to the same value as CT Pri. The User must then set the earth fault trip level at a high value to avoid nuisance tripping from CT ratio errors, third harmonic and certain higher harmonics or other measurement errors producing false residual currents. Monitor the metered earth current during various loading conditions to ensure a good margin between these error currents and the earth fault trip current setting $50R [x]$. Also watch out for phase CTs that saturate during motor starting. The saturation produces a large residual current and an earth fault trip.

4.9.4 Commissioning: Ground Fault Protection - non-directional [50N/G, 51N/G]

Please test the non-directional ground (earth) overcurrent analog to the non-directional phase overcurrent protection, see  “Commissioning: Overcurrent Protection, non-directional [50, 51]”.

4.10 I2> and %I2/I1> - Unbalanced Load [46]

The »I2>« Current Unbalance module works similar to the »V012« Voltage Unbalance module. The positive and negative sequence currents are calculated from the 3-phase currents. The threshold setting (either »I2>« or »I2/FLA«) defines a minimum operating current magnitude of I2 for the ANSI 46 function to operate, which insures that the relay has a solid basis for initiating a current unbalance trip. The »%(I2/I1)« (option) setting is the unbalance trip pickup setting. It is defined by the ratio of negative sequence current to positive sequence current »%(I2/I1)«. (Of course, the determination of positive and negative sequence currents takes into account the phase sequence setting at [Field Para] »Phase Sequence«.)

(Remark: "FLA" = Ib: Full Load Amperes.)

NOTICE!



All »I2>« Current Unbalance modules are identically structured.

The condition for a trip of this module is that the negative sequence current I2 is above the set threshold **and** - if configured - the percentage current unbalance is above the setting »%(I2/I1)«. The module initiates a trip if this condition is fulfilled for a specific tripping delay time.

The permitted continuous unbalanced load current is [Protection Para / Set 1...4 / I-Prot / I2>[x]] »I2>«, and it is specified in units of In.

For the tripping delay time, there are two characteristics available as configuring options:

- If »Char« = "DEFT": The tripping delay is a setting value, which is available as the parameter »t«.
- If »Char« = "INV": The tripping delay is calculated by the MRMV4.

The principle of the definite time characteristic (DEFT) is as follows: The module trips if for the tripping delay time »t« the negative sequence current I2 is above the set threshold **and** (if configured) the percentage current unbalance is above the setting »%(I2/I1)«.

The principle of the inverse time characteristic (INV) is as follows: The protective device permanently calculates the heat (thermal) energy θ of the object to be protected. This happens all the time, independent of any alarm or tripping decisions. The module trips if for the tripping delay time t_{trip} - which is dependent on θ - **all** the following conditions are fulfilled:

- The negative sequence current I2 is above the set threshold (»I2>«), **and**
- the percentage current unbalance is above the setting »%(I2/I1)« (if configured) **and**
- the calculated thermal energy θ exceeds a maximum value θ_{max} , which is calculated based on the setting »K« for the thermal load capability.

For $\theta = 0$ the tripping delay time is calculated as follows:

$$t_{\text{Trip}} = \frac{K \cdot I_n^2}{I_2^2 - I_{2>}^2}$$

where:

t_{Trip}	= tripping delay in seconds.
K	= thermal load capability of the object while running with 100% unbalanced load current. This is an intrinsic property of the object that is to be protected, and therefore it must be specified as a setting value (Setting Group parameter »K«). It should be possible to obtain this value from the data sheet of the generator.
I_n	= nominal current, in case of »CurrentBase« = "Device Rating"
I_2	= unbalanced load current I_2 (calculated from measured current values)
$I_{2>}$	= Setting value »I2>«

In case of a still present residual heat, $\theta > 0$, the tripping delay t_{trip} is reduced accordingly, so that an earlier tripping occurs.

As long as the unbalanced load current I_2 is **greater** than the threshold »I2>« it is assumed that the object is *heating up*. During this phase, the heat (thermal) energy is calculated by an integration of the current value I_2 :

$$\theta(t) = \theta_{0,\text{cool}} + f \cdot \int |I_2|^2 dt$$

$\theta(t)$	= actual value of the thermal energy.
$\theta_{0,\text{cool}}$	= initial value at the beginning of the heating phase, i. e. the thermal energy at the end of the last cooling-down phase (or = 0, if the last cooling-down phase has ended, see below, or if there has not been any cooling-down phase yet).
f	= scaling factor.

As long as the unbalanced load current I_2 is **less** than the threshold (»I2>«) it is assumed that the object is *cooling down*.

During this phase, the heat (thermal) energy is calculated based on a cooling-down constant. This constant is another intrinsic property of the object that is to be protected, and therefore it must be specified as a setting value (Setting Group parameter » τ -cool«):

$$\theta(t) = \theta_{0,\text{heat}} \cdot e^{-\frac{t}{\tau_{\text{cool}}}}$$

$\theta(t)$	= actual value of the thermal energy,
$\theta_{0,\text{heat}}$	= initial value at the beginning of the cooling-down phase, i. e. the thermal energy at the end of the last heating-up phase
τ_{cool}	= object property, setting value » τ -cool«.

The cooling-down phase always continues as long as I_2 is below the threshold, i. e. $\theta(t)$ is calculated continuously. (Only after $\theta(t)$ has dropped below $0.01 \cdot \theta_{\text{max}}$ the calculation ends and θ gets reset to 0, i. e. a subsequent heating-up phase will start with initial value $\theta_{0,\text{cool}} = 0$.)

NOTICE!

The heat (thermal) energy is an auxiliary value that is calculated and maintained internally, i. e. it can neither be displayed at the HMI nor be retrieved via any communication protocol.

46[1] ... 46[n]

NPSI_Y01

46 = 46[1] ... 46[n]

Please Refer To Diagram: Blockings
(Stage is not deactivated and no active blocking signals)

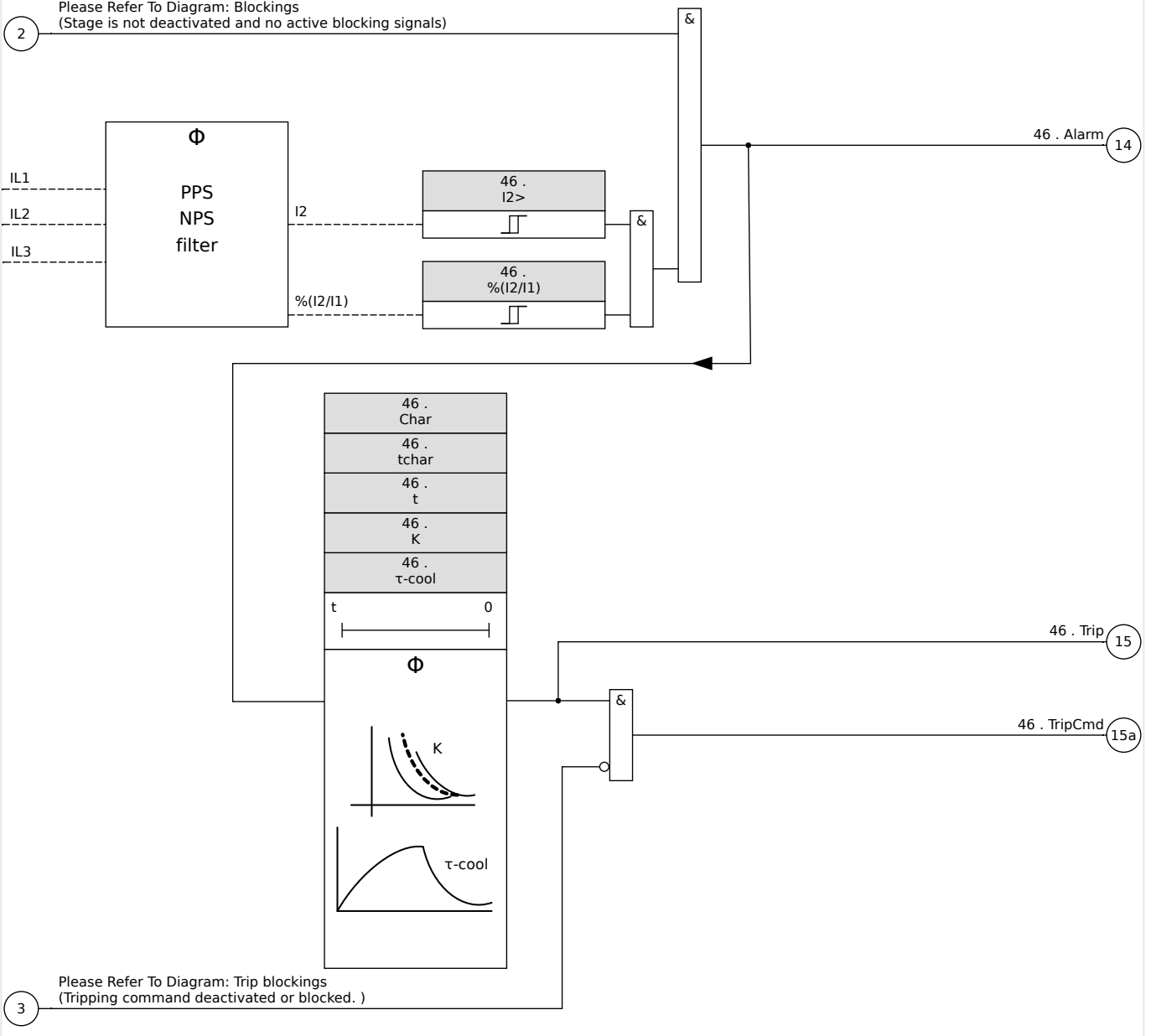

4.10.1 Commissioning: Current Unbalance Module

Object to be tested:

Test of the unbalanced load protection function.

Necessary means:

- Three-phase current source with adjustable current unbalance; and

- Timer.

Procedure:

Check the phase sequence:

- Ensure that the phase sequence is the same as that set in the field parameters.
- Feed-in a three-phase nominal current.
- Change to the »Measuring Values« menu.
- Check the measuring value for the unbalanced current »I2«. The measuring value displayed for »I2« should be zero (within the physical measuring accuracy).

NOTICE!



If the displayed magnitude for I2 is the same as that for the symmetrical nominal currents fed to the relay, it implies that the phase sequence of the currents seen by the relay is reversed.

- Now turn-off phase L1.
- Again check the measuring value of the unbalanced current »I2« in the »Measuring Values« menu. The measuring value of the asymmetrical current »I2« should now be 33%.
- Turn-on phase L1, but turn-off phase L2.
- Once again check the measuring value of the asymmetrical current I2 in the »Measuring Values« menu. The measuring value of the asymmetrical current »I2« should be again 33%.
- Turn-on phase L2, but turn-off phase L3.
- Again check the measuring value of asymmetrical current »I2« in the »Measuring Values« menu. The measuring value of the asymmetrical current »I2« should still be 33%.

Testing the trip delay:

- Apply a symmetrical three-phase current system (nominal currents).
- Switch off IL1 (the threshold value »Threshold« for »I2« must be below 33%).
- Measure the tripping time.

The present current unbalance »I2« corresponds with 1/3 of the existing phase current displayed.

Testing the threshold values

- Configure minimum »%I2/I1« setting (2%) and an arbitrary threshold value »Threshold« (I2).
- For testing the threshold value, a current has to be fed to phase A which is lower than three times the adjusted threshold value »Threshold« (I2).
- Feeding only phase A results in »%I2/I1 = 100%«, so the first condition »%I2/I1 >= 2%« is always fulfilled.

- Now increase the phase L1 current until the relay is activated.

Testing the dropout ratio of the threshold values

Having tripped the relay in the previous test, now decrease the phase A current. The dropout ratio must not be higher than 0.97 times the threshold value.

Testing %I2/I1

- Configure minimum threshold value »Threshold« (I2) ($0.01 \times I_n$) and set »%(I2/I1)« greater or equal to 10%.
- Apply a symmetrical three-phase current system (nominal currents). The measuring value of »%I2/I1« should be 0%.
- Now increase the phase L1 current. With this configuration, the threshold value »Threshold« (I2) should be reached before the measuring value of »%I2/I1« reaches the set »%(I2/I1)« ratio threshold.
- Continue increasing the phase 1 current until the relay is activated.

Testing the dropout ratio of %I2/I1

Having tripped the relay in the previous test, now decrease the phase L1 current. The dropout of »%I2/I1« has to be 1% below the »%(I2/I1)« setting.

Successful test result:

The measured trip delays, threshold values, and dropout ratios are within the permitted deviations/tolerances, specified under Technical Data.

4.11 V - Voltage Protection [27,59]

CAUTION!



If the VT measurement location is not at the bus bar side but at the output side, the following has to be taken into account:



When disconnecting the line it has to be ensured that by an »External Blocking« undervoltage tripping of the V<-elements cannot happen. This is realized through detecting of the CB position (via digital inputs).

When the aux. voltage is switched on and the measuring voltage has not yet been applied, undervoltage tripping has to be prevented by an »External Blocking«

CAUTION!



In case of a fuse failure, it is important to block the »V<-stages« so that an undesired operation can be prevented.



To do this, set »Meas Circuit Superv« to "active" and activate the required VT supervision module (e. g. LOP, VTS).

Moreover, set the tripping delay of the undervoltage protection »t« to some value that is longer than the detection time of the VT supervision module. Take into account the following times:

- VTS, fuse failure determination via digital input: **20 ms**
- VTS, determination via measurements and internal calculation: **20 ms**
- LOP, fuse failure determination via digital input: **20 ms**
- LOP, determination via measurements and internal calculation: **30 ms**

WARNING!



(For devices featuring the LOP module:)

Note furthermore that the LOP (Loss of Potential) module has a fixed built-in undervoltage threshold of **0.03·V_n**. Therefore, while commissioning the »V<-stages«, do not use a pickup value »V<« below 0.03·V_n because then the undervoltage module will always be blocked before it can trip.

NOTICE!



All voltage elements are identically structured and can optionally be projected as over- or undervoltage element.

If phase voltages are applied to the measuring inputs of the device and field parameter »VT con« is set to "Phase to Ground", the messages issued by the voltage protection module in case of actuation or trip should be interpreted as follows:

- »Alarm L1« or »Trip L1« - alarm or trip caused by phase voltage VL1.

- »Alarm L2« or »Trip L2« - alarm or trip caused by phase voltage VL2.
- »Alarm L3« or »Trip L3« - alarm or trip caused by phase voltage VL3.

If, however, line-to-line voltages are applied to the measuring inputs and field parameter »VT con« is set to "Phase to Phase", then the messages should be interpreted as follows:

- »Alarm L1« or »Trip L1« - alarm or trip caused by line-to-line voltage VL12.
- »Alarm L2« or »Trip L2« - alarm or trip caused by line-to-line voltage VL23.
- »Alarm L3« or »Trip L3« - alarm or trip caused by line-to-line voltage VL31.

The following table shows the application options of the voltage protection element.

Applications of the V-Protection Module	Setting:	Options
ANSI 27 Undervoltage protection	[Device planning] »Mode«, Setting value: V<	»Measuring method«: <ul style="list-style-type: none"> • Fundamental, • True RMS »Measuring Mode«: <ul style="list-style-type: none"> • Phase to Ground, Phase to Phase
10 minutes sliding average supervision V<	[Device planning] »Mode«, Setting value: V<	»Measuring method«: <ul style="list-style-type: none"> • Vavg »Measuring Mode«: <ul style="list-style-type: none"> • Phase to Ground, Phase to Phase
ANSI 59 Overvoltage protection	[Device planning] »Mode«, Setting value: V>	»Measuring method«: <ul style="list-style-type: none"> • Fundamental, • True RMS »Measuring Mode«: <ul style="list-style-type: none"> • Phase to Ground, Phase to Phase
Sliding average supervision V>	[Device planning] »Mode«, Setting value: V>	»Measuring method«: <ul style="list-style-type: none"> • Vavg »Measuring Mode«: <ul style="list-style-type: none"> • Phase to Ground, Phase to Phase

Measuring Method

For all voltage protection elements the setting »Measuring method« specifies whether the measurement is done on basis of the "Fundamental" or if "True RMS" measurement is used. In addition to that a sliding average supervision "Vavg" can be parametrized.

NOTICE!

The required settings for the calculation of the “average value” of the “sliding average value supervision” have to be taken within menu [Device Para / Statistics / Vavg].

Measuring Mode

If the measuring inputs of the voltage measuring card is fed with “Phase to Ground” voltages, the Field Parameter »VT con« has to be set to “Phase to Ground”. In this case, the user has the option to set the »Measuring Mode« of each phase voltage protection element to “Phase to Ground” or “Phase to Phase”. That means, he can determine for each phase voltage protection element how V_n shall be defined:

- »Measuring Mode« = “Phase to Ground” - $V_n = VT \text{ sec} / \sqrt{3}$
- »Measuring Mode« = “Phase to Phase” - $V_n = VT \text{ sec} = VT \text{ sec}$

If, however, the measuring inputs of the voltage measuring card are fed with “Phase to Phase” voltages (»VT con« = “Phase to Phase”), then the setting of »Measuring Mode« is ignored and internally set to “Phase to Phase” instead, so that $V_n = VT \text{ sec}$.

Minimum Current Threshold for Undervoltage Protection

For the voltage protection running in “undervoltage” mode –»Mode« = “V<” - there is the option to activate an undercurrent criterion. This is a “minimum current check”, which blocks the undervoltage protection as soon as **all** phase currents drop below a certain threshold value. And vice versa, if the phase currents get available again after such a dropout, the undervoltage protection is re-enabled only after a settable delay time.

The motivation for using this feature is that a situation where all phase currents are “dead” probably indicates an open circuit breaker, and it is probably not desirable that the undervoltage protection reacts to this event. The purpose of the delay time is to avoid an immediate trip during re-closing of the circuit breaker: Without this delay, there would be the risk that the undervoltage protection trips instantly because the voltages have not yet risen above the tripping threshold »V<« (although the phase currents might already be above the minimum current threshold).

The minimum current check is optional, in the sense that it has to be enabled via setting »Imin release check« = active).

After the minimum current check has been enabled, the threshold value is settable via »Threshold Imin«, i. e. the undervoltage protection is blocked as soon as **all** phase currents drop below this value.

The delay time for re-enabling the undervoltage protection (after any of the phase currents has become “live” again) can be set via »t-delay Imin«.

CAUTION!

If this minimum current check is active then you should be aware that without current flow, the undervoltage protection does not trip. So, depending on your application, there might be good reasons to not use this feature.

Functionality and Tripping Logic

For each of the voltage protection elements it can be defined if it picks up when over- or undervoltage is detected in one of three, two of three or in all three phases. The dropout ratio is settable.

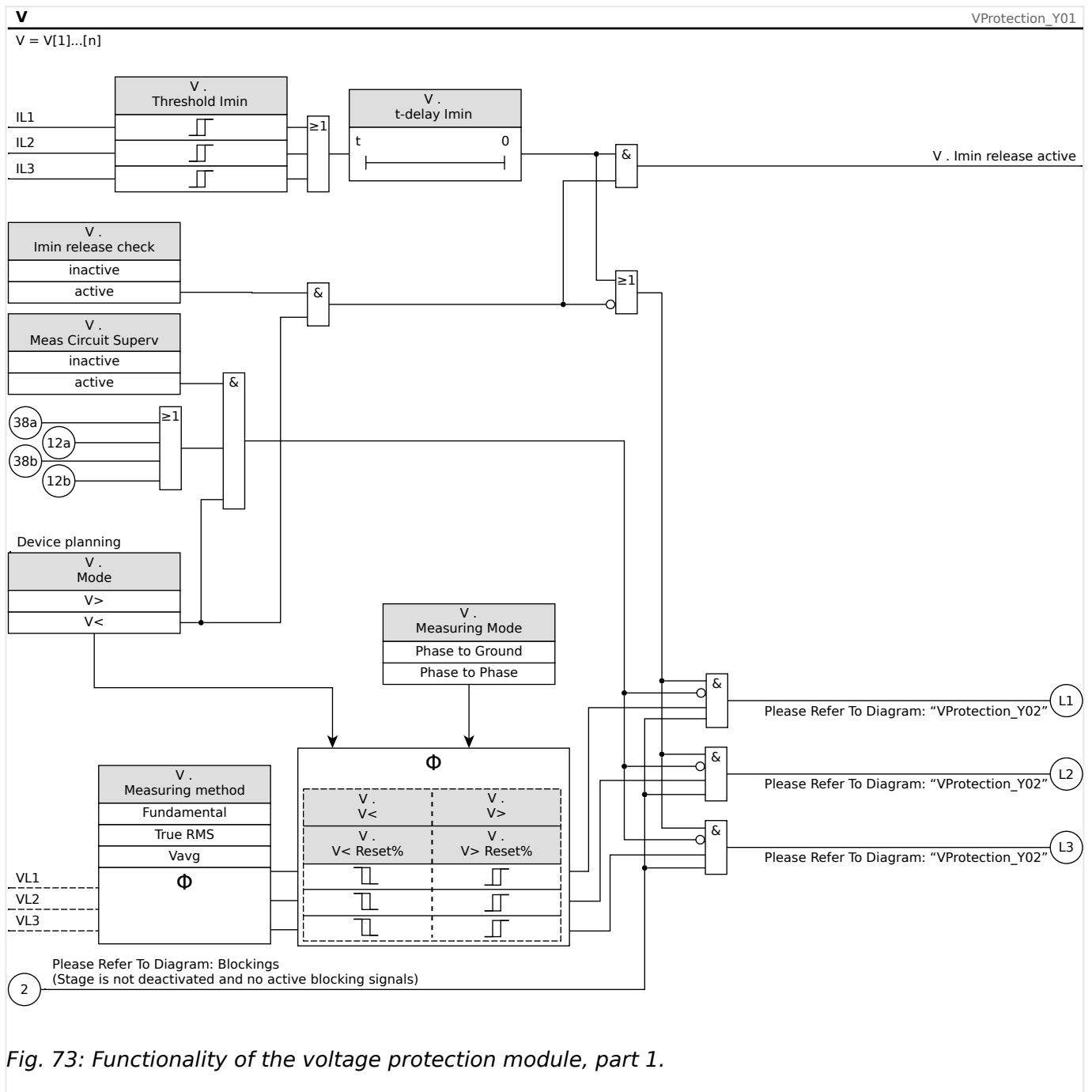
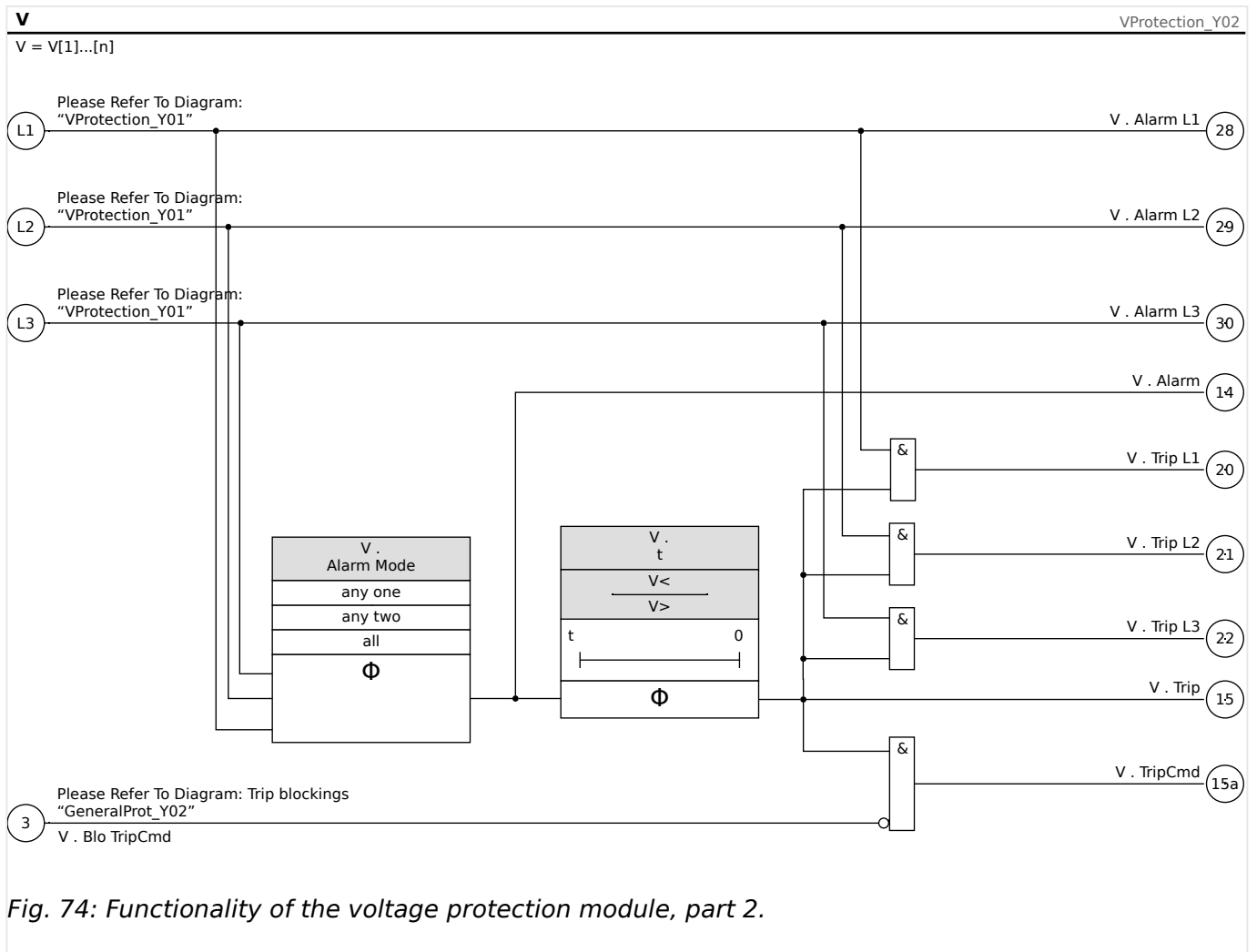

Fig. 73: Functionality of the voltage protection module, part 1.

4 Protective Elements

4.11 V - Voltage Protection [27,59]



4.11.1 Commissioning: Overvoltage Protection [59]

Object to be tested

Test of the overvoltage protection elements, 3 x single-phase and 1 x three-phase (for each element)

CAUTION!



Through testing the overvoltage protection stages, it can also be ensured that the wiring from the switchboard input terminals is correct. Wiring errors at the voltage measuring inputs might result in:

- False tripping of the directional current protection.

Example: Device suddenly trips in reverse direction but it does not trip in forward direction.

- Wrong or no power factor indication
- Errors with regard to power directions etc.

Necessary means

- 3-phase AC voltage source

- Timer for measuring of the tripping time
- Voltmeter

Procedure (3 x single-phase, 1 x three-phase, for each element)

Testing the threshold values

For testing the threshold values and fallback values, the test voltage has to be increased until the relay is activated. When comparing the displayed values with those of the voltmeter, the deviation must be within the permissible tolerances.

Testing the trip delay

For testing the trip delay, a timer is to be connected to the contact of the associated trip relay.

The timer is started when the limiting value of the tripping voltage is exceeded and it is stopped when the relay trips.

Testing the fallback ratio

Reduce the measuring quantity to less than (e. g.) 97% of the trip value. The relay must only fall back at 97% of the trip value at the earliest.

Successful test result

The measured threshold values, trip delays and fallback ratios comply with those specified in the adjustment list. Permissible deviations/tolerances can be taken from the Technical Data.

4.11.2 Commissioning: Undervoltage Protection [27]

This test can be carried out similar to the test for overvoltage protection (by using the related undervoltage values).

Please consider the following deviations:

- For testing the threshold values the test voltage has to be decreased until the relay is activated.
- For detection of the fallback value, the measuring quantity has to be increased so to achieve more than (e.g.) 103% of the trip value. At 103% of the trip value the relay is to fall back at the earliest.

4.12 VG, VX - Voltage Supervision [27A, 59A]

NOTICE!

! All elements of the voltage supervision of the fourth measuring input are identically structured.

This protective element can be used to (depending on device planning and setting) for the following purposes:

- Supervision of the calculated or measured residual voltage. The residual voltage can be calculated only if the phase voltages (star connection) are connected to the measuring inputs of the device.
- Supervision of another (auxiliary) voltage against overvoltage or undervoltage.

VG, VX Voltage Supervision Functionality

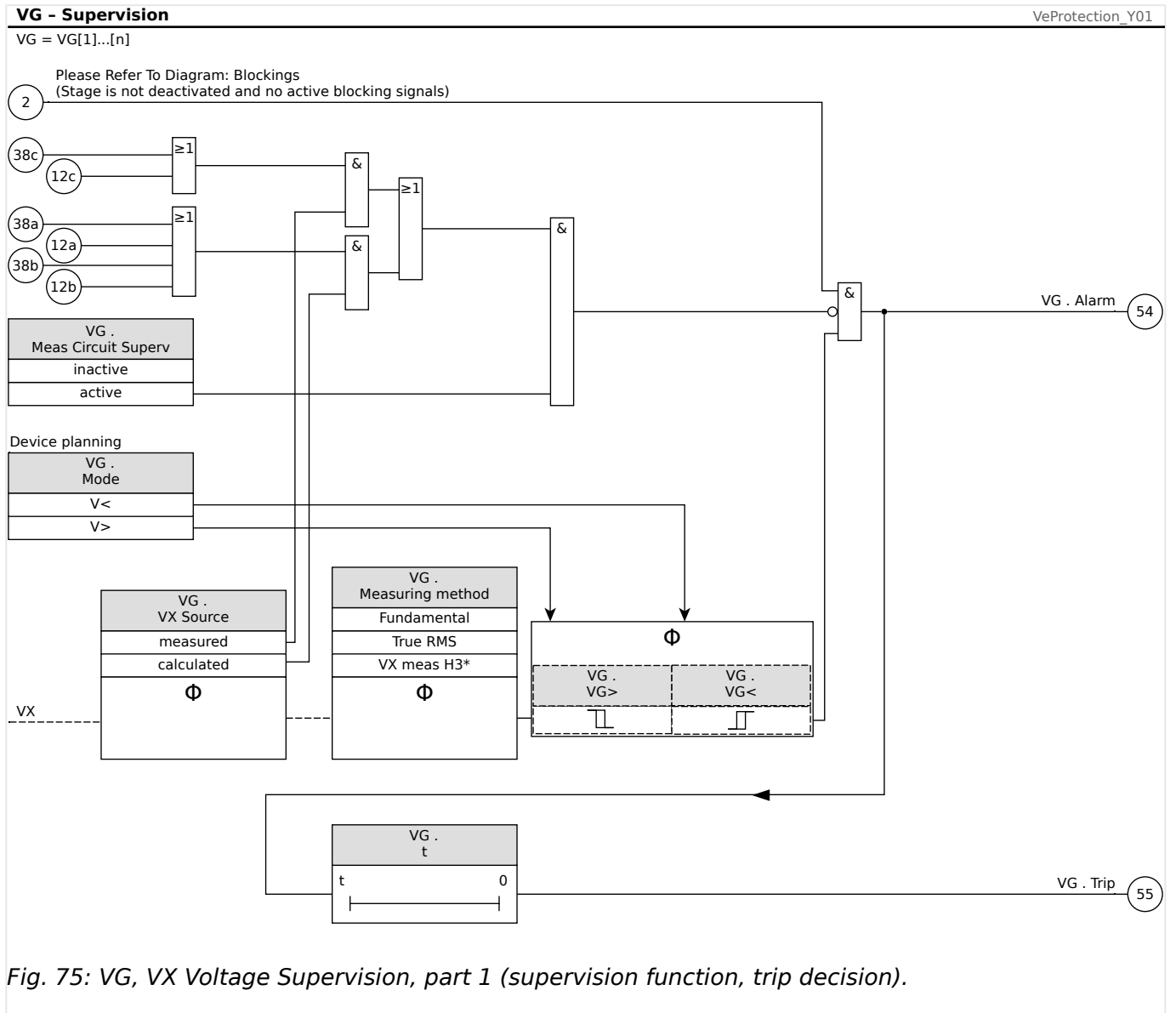
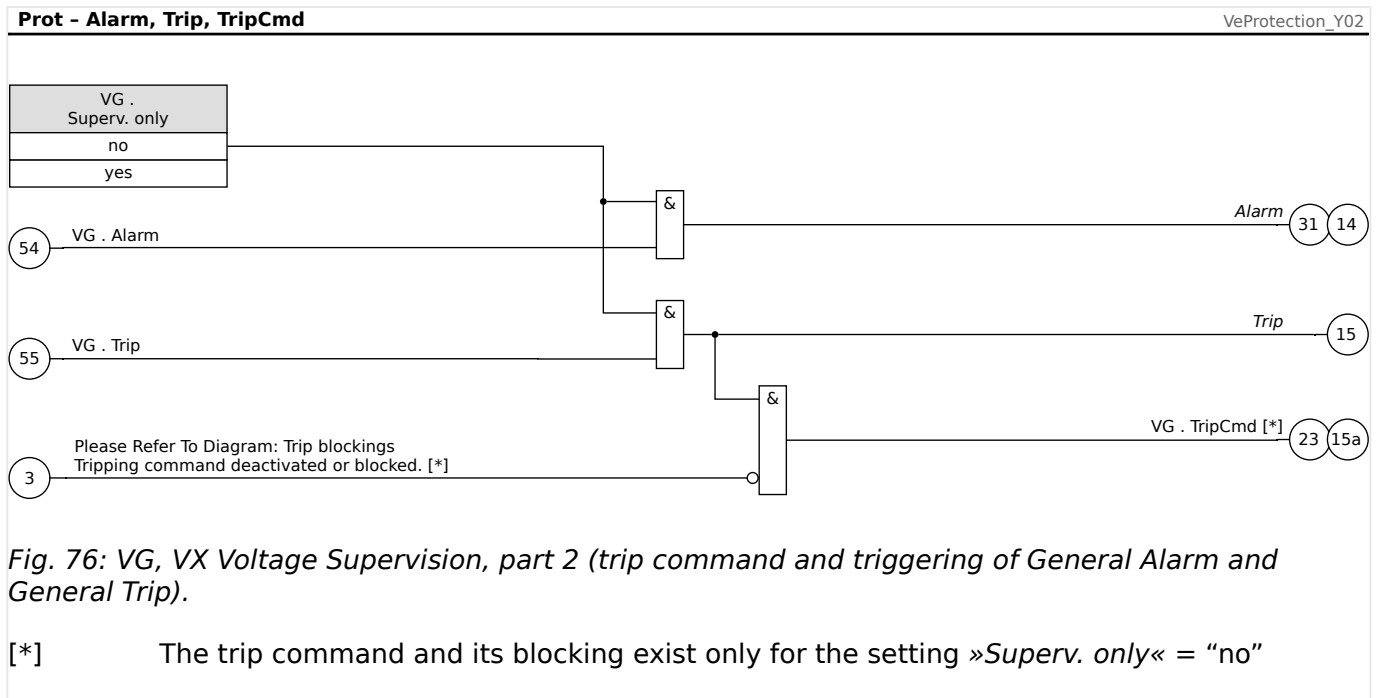

Fig. 75: VG, VX Voltage Supervision, part 1 (supervision function, trip decision).



ANSI 59N - Residual Voltage Protection (Measured or Calculated)

This application option is set via the [Device planning] menu:

- [Device planning] »Mode« = “V>”

Options:

- [Protection Para / Set 1...4 / V-Prot / VG[x]] »VX Source« =
 - measured
 - calculated

ANSI 59A - Supervision of an Auxiliary Voltage in Relation to Overvoltage

This application option is set as follows:

- [Device planning] »Mode« = “V>”
- [Protection Para / Set 1...4 / V-Prot / VG[x]] »VX Source« = “measured”

Options:

- [Protection Para / Set 1...4 / V-Prot / VG[x]] »Measuring method« =
 - Fundamental
 - True RMS

ANSI 27A - Supervision of an Auxiliary Voltage in Relation to Undervoltage

This application option is set as follows:

- [Device planning] »Mode« = “V<”
- [Protection Para / Set 1...4 / V-Prot / VG[x]] »VX Source« = “measured”

Options:

- [Protection Para / Set 1...4 / V-Prot / VG[x]] »Measuring method« =
 - Fundamental
 - True RMS

4.12.1 Commissioning: Residual Voltage Protection - Measured [59N]

Object to be tested

Residual voltage protection stages.

Necessary components

- 1-phase AC voltage source
- Timer for measuring of the tripping time
- Voltmeter

Procedure (for each element)

Testing the threshold values

For testing the threshold and fallback values, the test voltage at the measuring input for the residual voltage has to be increased until the relay is activated. When comparing the displayed values with those of the voltmeter, the deviation must be within the permissible tolerances.

Testing the trip delay

For testing the trip delay a timer is to be connected to the contact of the associated trip relay.

The timer is started when the limiting value of the tripping voltage is exceeded and it is stopped when the relay trips.

Testing the fallback ratio

Reduce the measuring quantity to less than 97% of the trip value. The relay must only fall back at 97% of the trip value at the latest.

Successful test result

The measured threshold values, trip delays and fallback ratios comply with those specified in the adjustment list. Permissible deviations/tolerances can be taken from the Technical Data.

4.12.2 Commissioning: Residual Voltage Protection - Calculated [59N]

Object to be tested

Test of the residual voltage protection elements

Necessary means

- 3-phase voltage source

NOTICE!



Calculation of the residual voltage is only possible if phase voltages (star) were applied to the voltage measuring inputs and if »VX Source=calculated« is set within the corresponding parameter set.

Procedure

- Feed a three-phase, symmetrical voltage system (V_n) into the voltage measuring inputs of the relay.
- Set the limiting value of $VX[x]$ to 90% V_n .
- Disconnect the phase voltage at two measuring inputs (symmetrical feeding at the secondary side has to be maintained).
- Now the »VX calc« measuring value has to be about 100% of the value V_n .
- Ascertain that the signal »VX.Alarm« or »VX.Trip« is generated now.

Successful test result

The signal »VX.Alarm« or »VX.Trip« is generated.

4.13 f - Frequency [810/U, 78, 81R]

NOTICE!

! All frequency protective elements are identically structured.

Frequency - Measuring Principle

NOTICE!

! The frequency is calculated as the average of the measured values of the three phase frequencies. Only valid measured frequency values are taken into account. If a phase voltage is no longer measurable, this phase will be excluded from the calculation of the average value.

The measuring principle of the frequency supervision is based in general on the time measurement of complete cycles, whereby the frequency value gets updated with every zero passage of the phase-to-phase voltages. The influence of the 2nd and higher harmonics on the measuring result is minimized by a low pass filter.

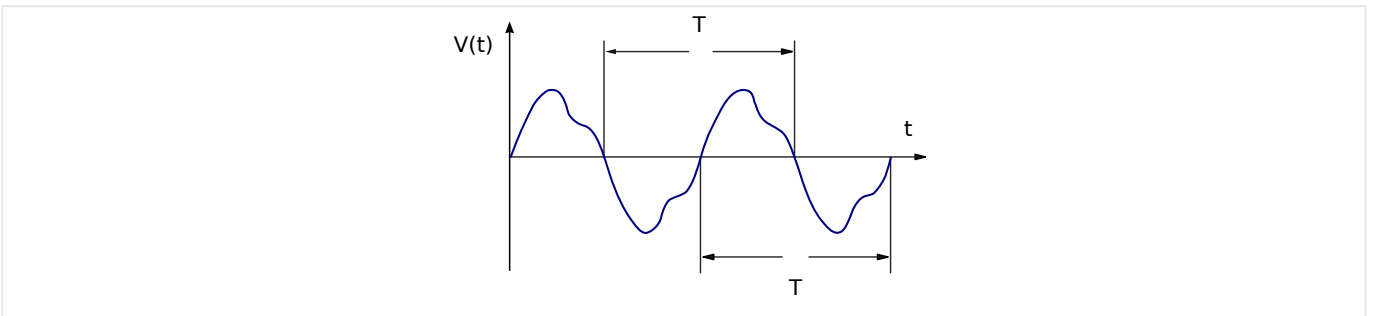

If frequency tripping is unwanted in case of low voltages it is possible to block frequency measurement together with all frequency-dependent protection functions. The undervoltage threshold for this blocking is settable at the parameter [Field Para / Frequency] »V Block f«.

After the voltages have risen above the threshold again the blocking is kept active for at least another 0.5 s, and furthermore, the frequency value is kept at 0 Hz for at least another 0.3 s, and df/dt is kept at 0 Hz/s for approx. 1 s.

A time-window for averaging helps to stabilize the frequency value against short-time fluctuations. The window-size is settable at [Field Para / Frequency] »Stab. window f«. Frequency measurement is usually stable against phase jumps up to 90°, i. e. phase jumps above 1° and voltage surges (>2%) are ignored almost completely. In such a case the frequency value is kept unchanged for at least 2 periods, and the df/dt value is set to 0 Hz/s, until the instability has gone and measuring window and stabilizing window have been run through.

NOTICE!









! Every increase of the stabilizing window (increase of the setting value »Stab. window f«) increases the duration of measurement and therefore the operating time. (See also ↪ »Protection Elements Accuracy«.)

Frequency Functions

Due to its various frequency functions, the device is very flexible. That makes it suitable for a wide range of applications, where frequency supervision is an important criterion.

In the Device Planning menu, the user can decide how to use each of the six frequency elements.

f[1] to f[6] can be assigned as:

- “f<” - Underfrequency (see  “Operating Modes “f<”, “f>””);
- “f>” - Overfrequency (see  “Operating Modes “f<”, “f>””);
- “df/dt” - Rate of Change of Frequency (see  “Operating Mode “df/dt””);
- “f< and df/dt” - Underfrequency and Rate of Change of Frequency (see  “Operating Modes “f< and df/dt”, “f> and df/dt””);
- “f> and df/dt” - Overfrequency and Rate of Change of Frequency (see  “Operating Modes “f< and df/dt”, “f> and df/dt””);
- “f< and DF/DT” - Underfrequency and absolute frequency change per definite time interval (see  “Operating Modes “f< and DF/DT”, “f> and DF/DT””);
- “f> and DF/DT” - Overfrequency and absolute frequency change per definite time interval (see  “Operating Modes “f< and DF/DT”, “f> and DF/DT””); and
- “delta phi” - Vector Surge (see  “Operating Mode “delta phi” - [ANSI 78V]”).

4.13.1 Operating Modes “f<”, “f>”

***f<* - Underfrequency**

This protection element provides a pickup threshold and a tripping delay. If the frequency falls below the set pickup threshold, an alarm will be issued instantaneously. If the frequency remains under the set pickup threshold until the tripping delay has elapsed, a tripping command will be issued.

***f>* - Overfrequency**

This protection element provides a pickup threshold and a tripping delay. If the frequency exceeds the set pickup threshold, an alarm will be issued instantaneously. If the frequency remains above the set tripping pickup until the tripping delay has elapsed, a tripping command will be issued.

Working Principle

The frequency element supervises the three phase-to-phase voltages VL12, VL23 and VL31. If all of the three phase-to-phase voltages are below a particular threshold the frequency calculation is blocked. (The threshold is settable, see the Measuring Principle at [↳ “4.13 Frequency - Measuring Principle”](#)).

According to the frequency supervision mode set in the [Device planning] menu ($\gg f[x]$. *Mode*« = “f<” or = “f>”), the evaluated phase voltages are compared to the set pickup threshold for over- or under-frequency. If in any of the phases, the frequency exceeds or falls below the set pickup threshold and if there are no blocking commands for the frequency element, an alarm is issued instantaneously and the tripping delay timer is started. When the frequency still exceeds or is below the set pickup threshold after the tripping delay timer has elapsed, a tripping command will be issued.

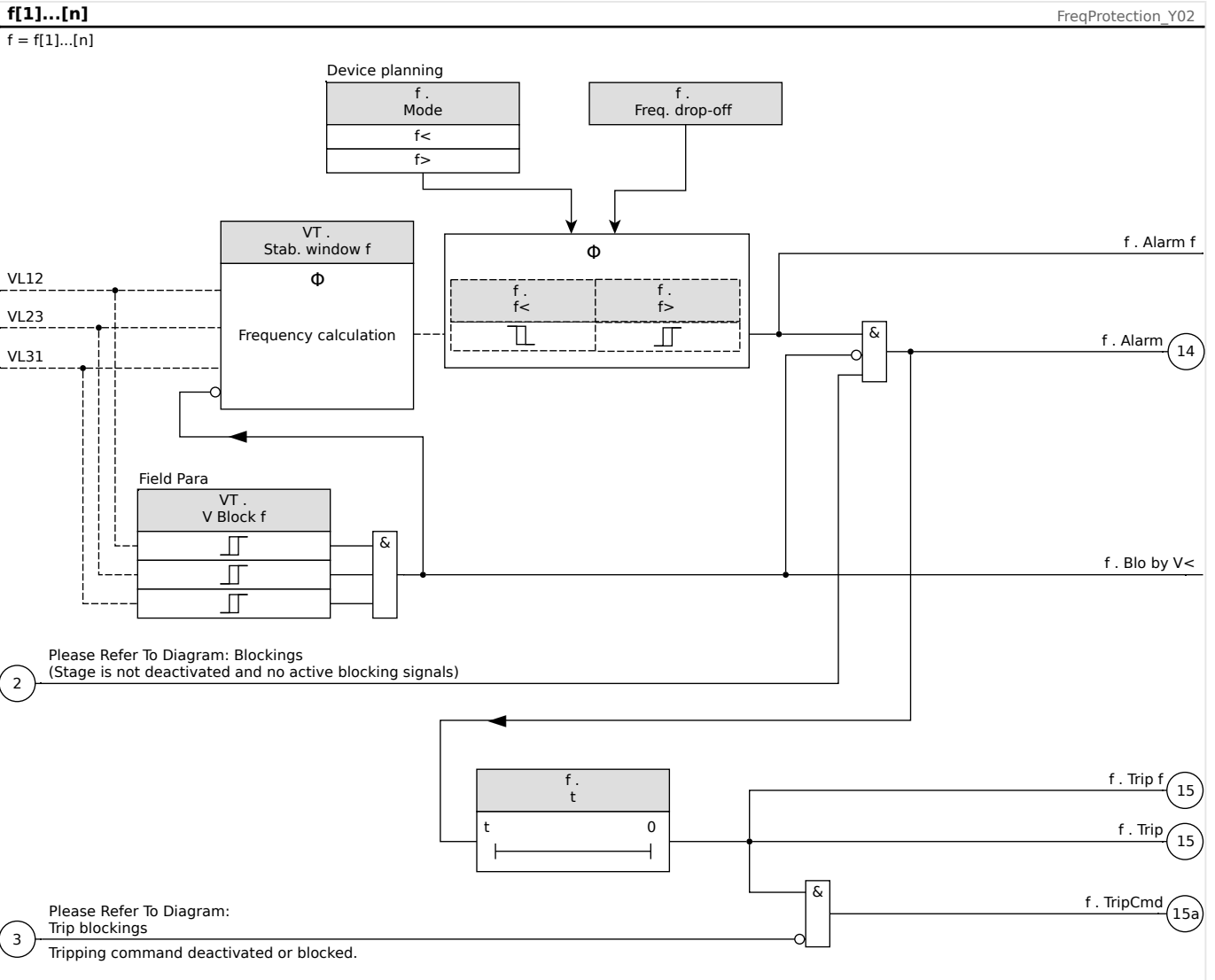

4.13.2 Operating Mode “df/dt”

df/dt - Rate of Change of Frequency

Electrical generators running in parallel with the mains, (e. g. industrial internal power supply plants), should be separated from the mains when failure in the intra-system occurs for the following reasons:

- Damage to electrical generators must be prevented when mains voltage is recovering asynchronously, (e. g. after a short interruption).
- The industrial internal power supply must be maintained.

A reliable criterion of detecting mains failure is the measurement of the rate of change of frequency (df/dt). The precondition for this is a load flow via the mains coupling point. At mains failure the load flow change spontaneously leads to an increasing or decreasing frequency. At active power deficit of the internal power station, a linear drop of the frequency occurs and a linear increase occurs at power excess. Typical frequency gradients during application of “mains decoupling” are in the range of 0.5 Hz/s up to over 2 Hz/s.

The MRMV4 determines the instantaneous frequency gradient (df/dt) of each mains voltage period, whereby the frequency gradient gets updated with every zero passage of the phase-to-phase voltages.

The accuracy of the frequency gradient can be improved by adjusting the size of a measuring window. This is done at the parameter [Field Para / Frequency] »Window df/dt«. The window size is min. 2 periods of the nominal frequency, and it can be extended up to 10 periods. (For example, if $f_N = 50$ Hz, then the max. window size is $10 \cdot 20$ ms = 200 ms.)

The determination of the frequency gradient is done based on the measured frequency value (before the averaging / stabilizing, see [↳ “4.13 Frequency - Measuring Principle”](#)). In addition, the accuracy of the frequency gradient can be further improved by adjusting the size of a stabilizing window. This is done at the parameter [Field Para / Frequency] »Stab. window df/dt«. (See [↳ “Protection Elements Accuracy”](#))

NOTICE!



Every increase of the measuring window or of the stabilizing window increases the duration of measurement and therefore the operating time.

Because of this special measuring procedure a high safety in tripping and thus a high stability against transient processes, (e. g. switching procedure) are achieved.

The frequency gradient (rate of change of frequency, df/dt) may have a negative or positive sign, depending on frequency increase (positive sign) or decrease (negative sign).

In the frequency parameter sets, the user can define the kind of df/dt mode:

- Positive df/dt = the frequency element detects an increase in frequency
- Negative df/dt = the frequency element detects a decrease in frequency and
- Absolute df/dt (positive and negative) = the frequency element detects both, increase and decrease in frequency

This protection element provides a tripping threshold and a tripping delay. If the frequency gradient df/dt exceeds or falls below the set tripping threshold, an alarm will be issued instantaneously. If the frequency gradient remains still above/below the set tripping threshold until the tripping delay has elapsed, a tripping command will be issued.

Working Principle

The frequency element supervises the three phase-to-phase voltages VL12, VL23 and VL31. If all of the three phase-to-phase voltages are below a particular threshold the frequency calculation is blocked. (The threshold is settable, see the Measuring Principle at [4.13 Frequency - Measuring Principle](#)).

According to the frequency supervision mode set in the [Device planning] menu ($\gg f[x]$. Mode = "df/dt"), the evaluated phase voltages are compared to the set frequency gradient (df/dt) threshold. If in any of the phases, the frequency gradient exceeds or falls below the set pickup threshold (acc. to the set df/dt mode) and if there are no blocking commands for the frequency element, an alarm is issued instantaneously and the tripping delay timer is started. When the frequency gradient still exceeds or is below the set pickup threshold after the tripping delay timer has elapsed, a tripping command will be issued.

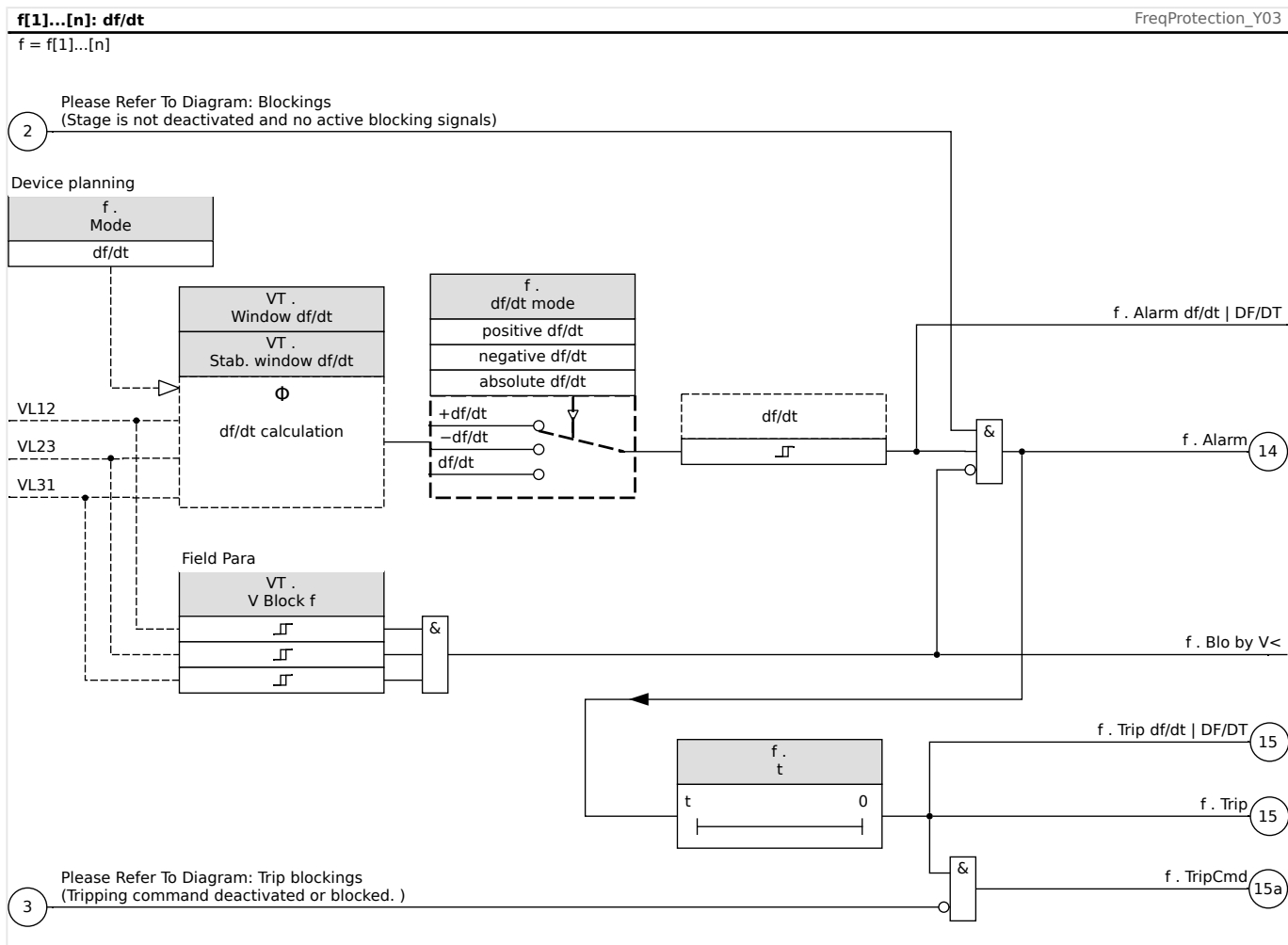

4.13.3 Operating Modes “f< and df/dt”, “f> and df/dt”

f< and df/dt - Underfrequency and Rate of Change of Frequency

With this setting the frequency element supervises if the frequency falls below a set pickup threshold and if the frequency gradient exceeds a set threshold at the same time.

In the selected frequency parameter set $f[X]$, an underfrequency pickup threshold $f<$, a frequency gradient df/dt and a tripping delay can be set.

Whereby:

- Positive df/dt = the frequency element detects an increase in frequency
- Negative df/dt = the frequency element detects a decrease in frequency and
- Absolute df/dt (positive and negative) = the frequency element detects both, increase and decrease in frequency

f> and df/dt - Overfrequency and Rate of Change of Frequency

With this setting the frequency element supervises if the frequency exceeds a set pickup threshold and if the frequency gradient exceeds a set threshold at the same time.

In the selected frequency parameter set $f[X]$, an overfrequency pickup threshold $f>$, a frequency gradient df/dt and a tripping delay can be set.

Whereby:

- Positive df/dt = the frequency element detects an increase in frequency
- Negative df/dt = the frequency element detects a decrease in frequency and
- Absolute df/dt (positive and negative) = the frequency element detects both, increase and decrease in frequency

Working Principle

The frequency element supervises the three phase-to-phase voltages VL12, VL23 and VL31. If all of the three phase-to-phase voltages are below a particular threshold the frequency calculation is blocked. (The threshold is settable, see the Measuring Principle at [↳ “4.13 Frequency - Measuring Principle”](#)).

According to the frequency supervision mode set in the [Device planning] menu ($\gg f[X]$. *Mode*« = “f< and df/dt” or = “f> and df/dt”), the evaluated phase voltages are compared to the set frequency pickup threshold and the set frequency gradient (df/dt) threshold. If in any of the phases, both the frequency and the frequency gradient exceed or fall below the set thresholds and if there are no blocking commands for the frequency element, an alarm is issued instantaneously and the tripping delay timer is started. When the frequency and the frequency gradient still exceed or are below the set threshold after the tripping delay timer has elapsed, a tripping command will be issued.

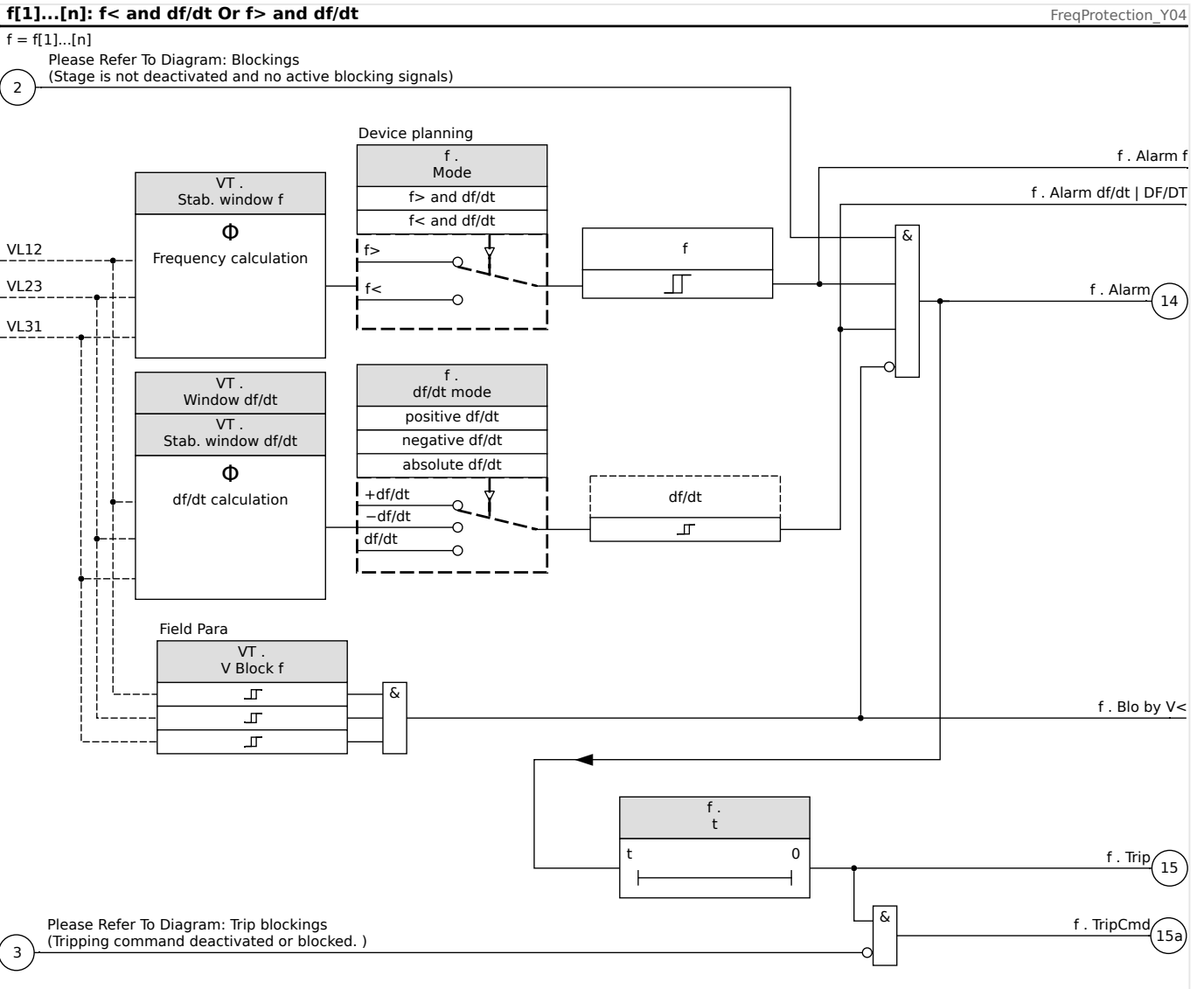

4.13.4 Operating Modes “f< and DF/DT”, “f> and DF/DT”

f< and DF/DT - Underfrequency and DF/DT

With this setting the frequency element supervises the frequency and the absolute frequency difference during a definite time interval.

In the selected frequency parameter set f[X], an underfrequency pickup threshold f<, a threshold for the absolute frequency difference (frequency decrease) DF and supervision interval DT can be set.

f> and DF/DT - Overfrequency and DF/DT

With this setting the frequency element supervises the frequency and the absolute frequency difference during a definite time interval.

In the selected frequency parameter set f[X], an overfrequency pickup threshold f>, a threshold for the absolute frequency difference (frequency increase) DF and supervision interval DT can be set.

Working Principle

The frequency element supervises the three phase-to-phase voltages VL12, VL23 and VL31. If all of the three phase-to-phase voltages are below a particular threshold the frequency calculation is blocked. (The threshold is settable, see the Measuring Principle at [↳ “4.13 Frequency - Measuring Principle”](#)).

According to the frequency supervision mode set in the [Device planning] menu ($\gg f[X]$. *Mode*« = “f< and DF/DT” or = “f> and DF/DT”), the evaluated phase voltages are compared to the set frequency pickup threshold and the set frequency decrease or increase threshold DF.

If in any of the phases, the frequency exceeds or falls below the set pickup threshold and if there are no blocking commands for the frequency element, an alarm is issued instantaneously. At the same time the timer for the supervision interval DT is started. When, during the supervision interval DT, the frequency still exceeds or is below the set pickup threshold and the frequency decrease/increase reaches the set threshold DF, a tripping command will be issued.

Working Principle of DF/DT Function:

(Please refer to the f(t) diagram, [↳ Fig. .\)](#)

Case 1:

When the frequency falls below a set f< threshold at t1, the DF/DT element energizes. If the frequency difference (decrease) does not reach the set value DF before the time interval DT has expired, no trip will occur. The frequency element remains blocked until the frequency falls below the underfrequency threshold f< again.

Case 2:

When the frequency falls below a set f< threshold at t4, the DF/DT element energizes. If the frequency difference (decrease) reaches the set value DF before the time interval DT has expired (t5), a trip command is issued.

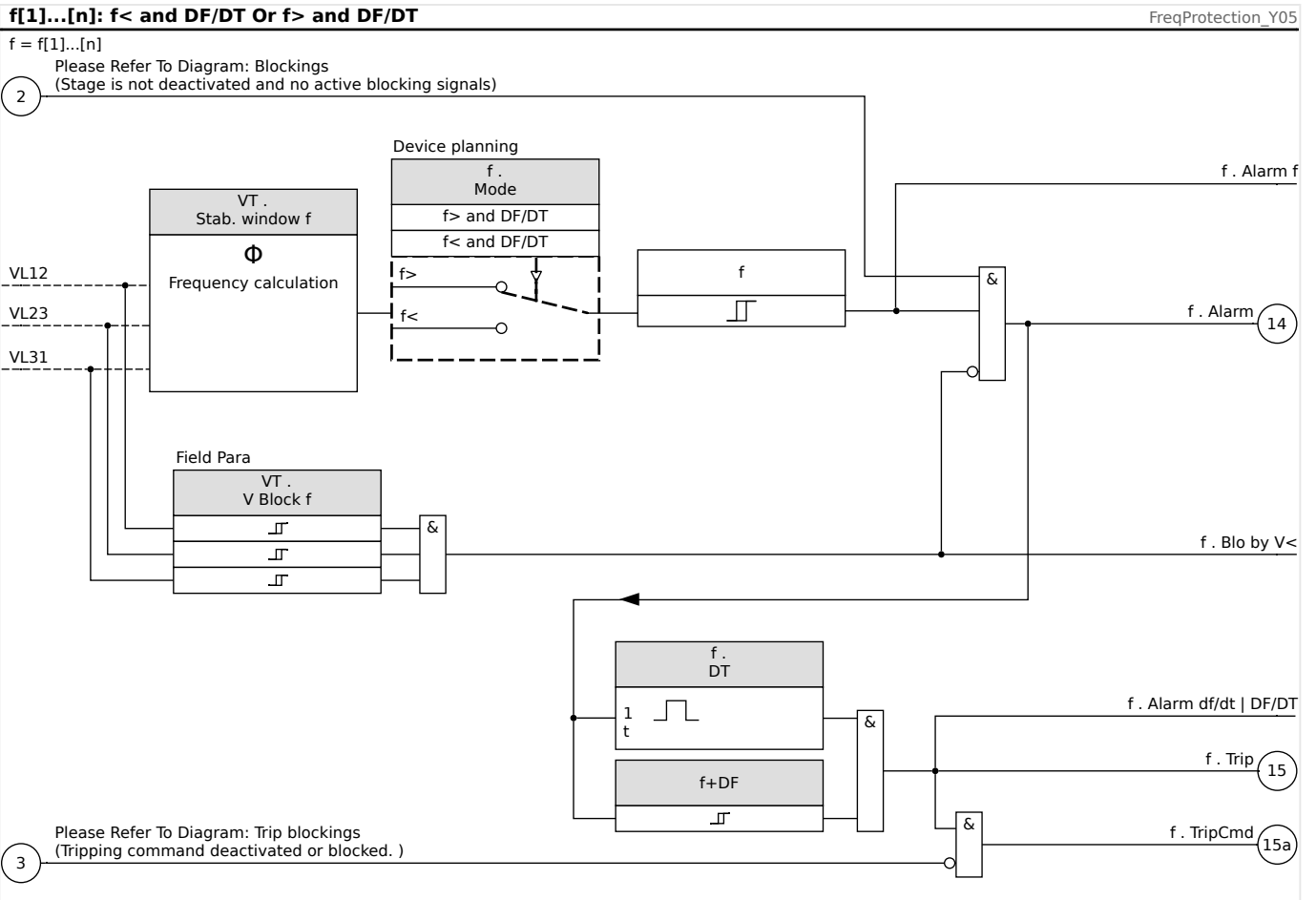

4 Protective Elements

4.13 f - Frequency [810/U, 78, 81R]

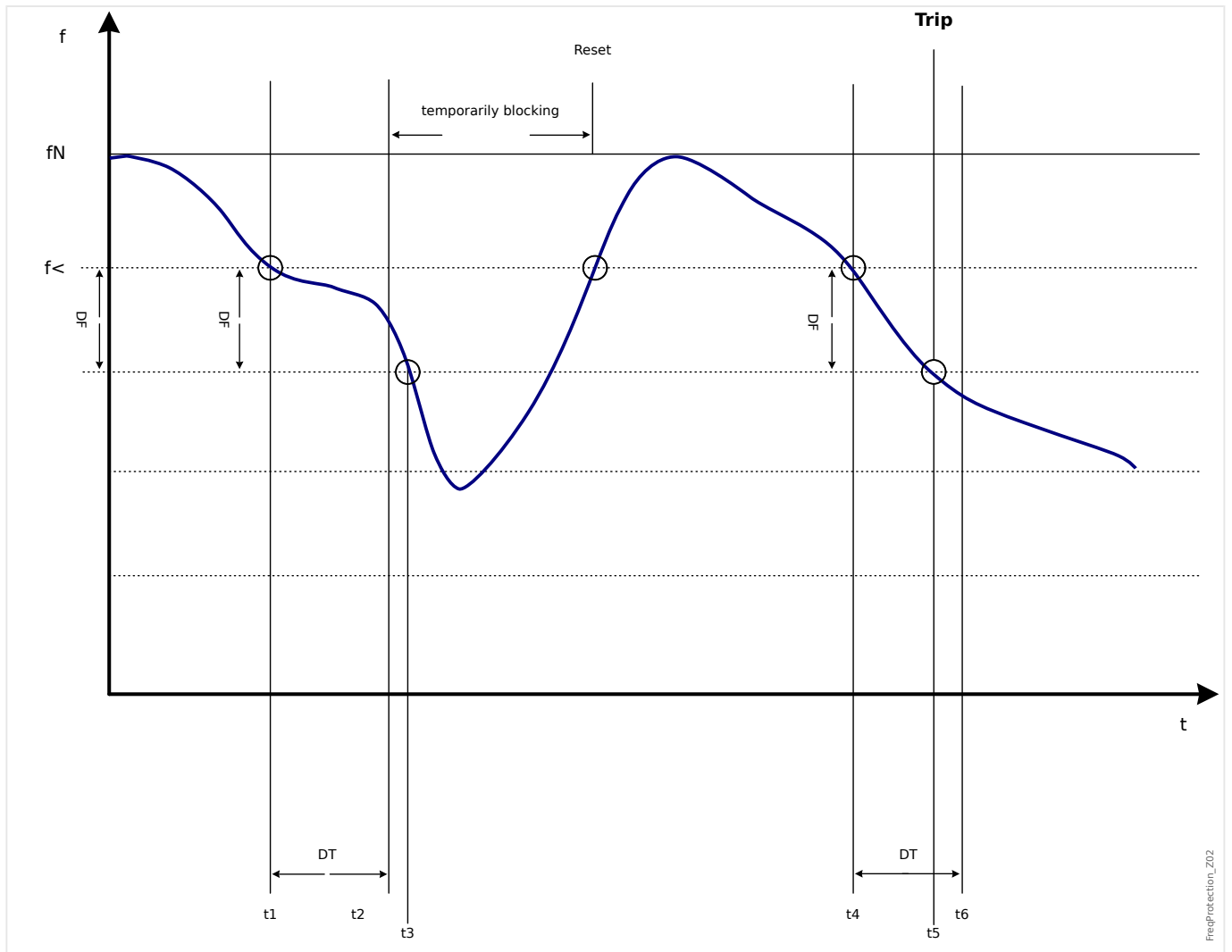

4.13.5 Operating Mode “delta phi” - [ANSI 78V]

Delta phi - Vector Surge

The vector surge supervision protects synchronous generators in mains parallel operation due to very fast decoupling in case of mains failure. Very dangerous are mains auto reclosings for synchronous generators. The mains voltage returning typically after 300 ms can hit the generator in asynchronous position. A very fast decoupling is also necessary in case of long time mains failures.

Generally there are two different applications:

Only mains parallel operation - no single operation:

In this application the vector surge supervision protects the generator by tripping the generator circuit breaker in case of mains failure.

Mains parallel operation and single operation:

For this application the vector surge supervision trips the mains circuit breaker. Here it is ensured that the gen.-set is not blocked when it is required as an emergency set.

A very fast decoupling in case of mains failures for synchronous generators is very difficult. Voltage supervision units cannot be used because the synchronous alternator as well as the consumer impedance support the decreasing voltage.

In this situation the mains voltage drops only after some 100 ms below the pickup threshold of the voltage supervision and therefore a safe detection of mains auto reclosings is not possible with voltage supervision only.

Frequency supervision is partially unsuitable because only a highly loaded generator decreases its speed within 100 ms. Current relays detect a fault only when short-circuit type currents exist, but cannot avoid their development. Power relays are able to pickup within 200 ms, but they also cannot prevent the power rising to short-circuit values. Since power changes are also caused by sudden loaded alternators, the use of power relays can be problematic.

Whereas the vector surge supervision of the device detects mains failures within 60 ms without the restrictions described above because it is specially designed for applications where very fast decoupling from the mains is required. Adding the typical operating time of a circuit breaker or contactor, the total disconnection time remains below 150 ms.

Basic requirement for tripping of the generator/mains monitor is a change in load of more than 15 - 20% of the rated load. Slow changes of the system frequency, for instance at regulating processes (adjustment of speed regulator) do not cause the relay to trip.

Trippings can also be caused by short-circuits within the grid, because a voltage vector surge higher than the preset value can occur. The magnitude of the voltage vector surge depends on the distance between the short-circuit and the generator. This function is also of advantage to the Power Utility Company because the mains short-circuit capacity and, consequently, the energy feeding the short-circuit is limited.

To prevent a possible false tripping, the vector surge measuring is blocked at a low input voltage, see the Measuring Principle at  “4.13 Frequency - Measuring Principle”. The undervoltage lockout acts faster than the vector surge measurement.

Vector surge tripping is blocked by a phase loss so that a VT fault (e. g.: faulty VTs fuse) does not cause false tripping.

Measuring Principle of Vector Surge Supervision

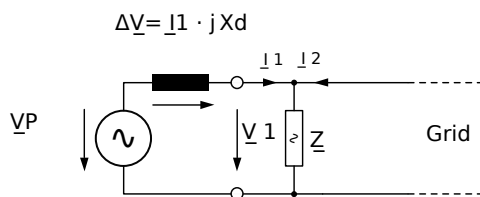

Fig. 77: Equivalent circuit at synchronous generator in parallel with the mains.

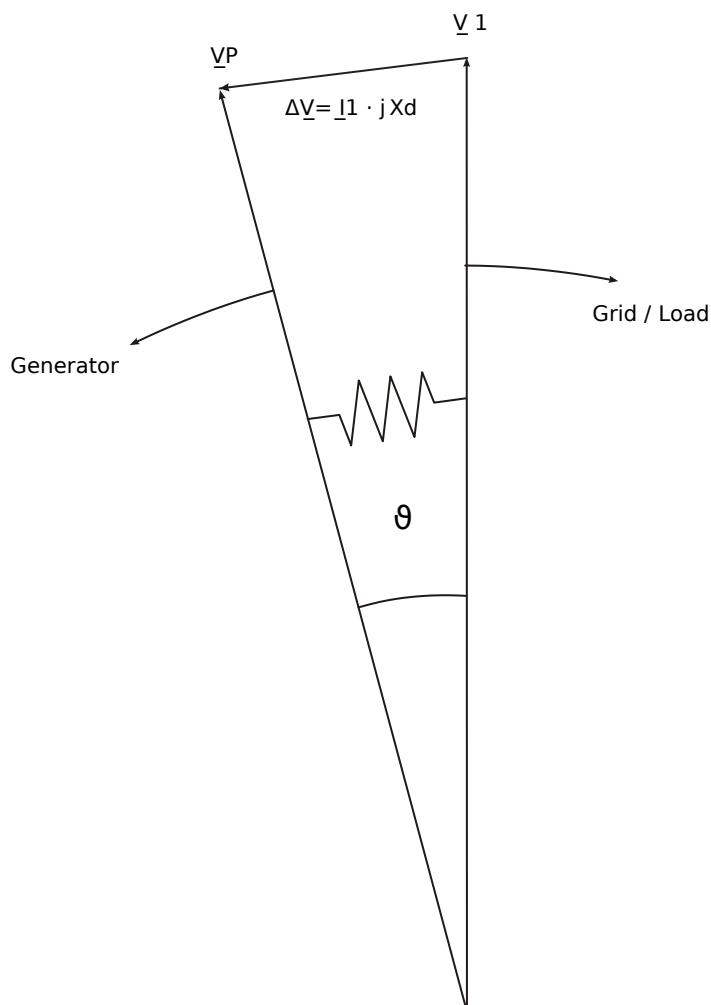
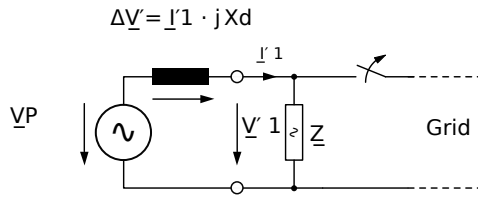

Fig. 78: Voltage vectors at mains parallel operation.

The rotor displacement angle between stator and rotor is dependent on the mechanical moving torque of the generator. The mechanical shaft power is balanced with the electrical fed mains power and, therefore the synchronous speed keeps constant.



FreqProtection_Z05

Fig. 79: Equivalent circuit at mains failure.

In case of mains failure or auto reclosing the generator suddenly feeds a very high consumer load. The rotor displacement angle is decreased repeatedly and the voltage vector V_1 changes its direction (V_1').

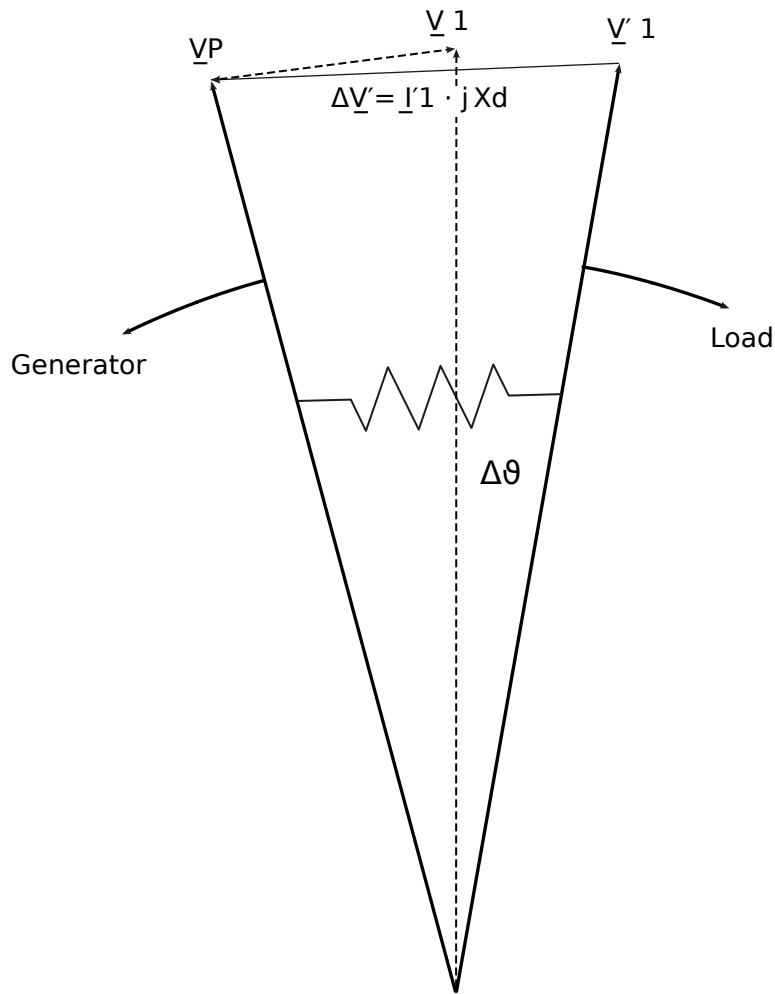

FreqProtection_Z06

Fig. 80: Voltage vectors at mains failure.

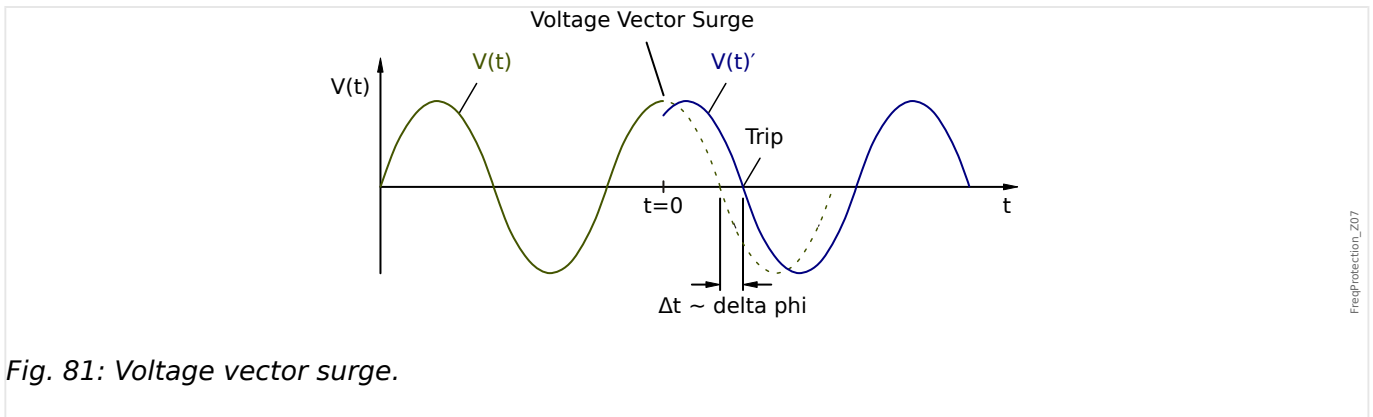

Fig. 81: Voltage vector surge.

As shown in the voltage/time diagram the instantaneous value of the voltage jumps to another value and the phase position changes. This is called phase or vector surge.

The relay measures the cycle duration. A new measuring is started at each zero passage. The measured cycle duration is internally compared with a reference time and from this the deviation of the cycle duration of the voltage signal is ascertained. In case of a vector surge as shown in the above graphic, the zero passage occurs either earlier or later. The established deviation of the cycle duration is in compliance with the vector surge angle.

If the vector surge angle exceeds the set value, the relay trips immediately.

Tripping of the vector surge is blocked in case of loss of one or more phases of the measuring

voltage.

Working Principle

The vector surge element supervises the three phase-to-phase voltages VL12, VL23 and VL31. If all of the three phase-to-phase voltages are below a particular threshold the frequency calculation is blocked. (The threshold is settable, see the Measuring Principle at [4.13 Frequency - Measuring Principle](#)).

According to the frequency supervision mode set in the [Device planning] menu ($\gg f[x]$. *Mode* = "delta phi"), the evaluated phase voltages are compared to the set vector surge threshold.

If, depending on the parameter setting, in all three, in two or in one of the phases, the vector surge exceeds the set threshold and if there are no blocking commands for the frequency element, an alarm and a trip command is issued instantaneously.

f[1]...[n]: delta phi

FreqProtection_Y01

f = f[1]...[n]

2 Please Refer To Diagram: Blockings
(Stage is not deactivated and no active blocking signals)

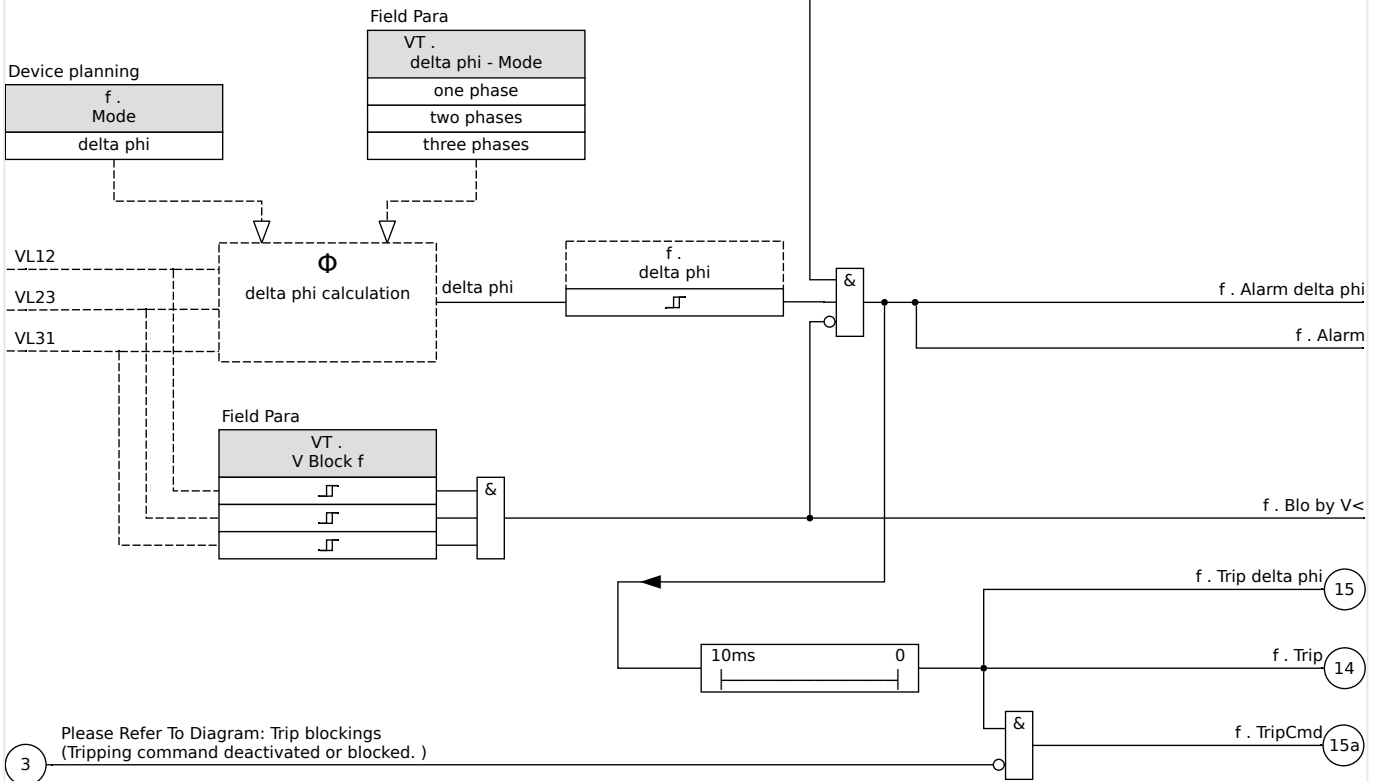

4.13.6 Commissioning: Overfrequency [f>]

Object to be tested

All configured overfrequency protection stages.

Necessary means

- Three-phase voltage source with variable frequency and
- Timer

Procedure - Testing the threshold values

- Keep on increasing the frequency until the respective frequency element is activated;
- Note the frequency value and
- Disconnect the test voltage.

Procedure - Testing the trip delay

- Set the test voltage to nominal frequency and
- Now connect a frequency jump (activation value) and then start a timer. Measure the tripping time at the relay output.

Testing the fallback ratio

Reduce the measuring quantity to less than 99.95% of the trip value (or 0.05% fn). The relay must only fall back at 99.95% of the trip value at the earliest (or 0.05% fn).

Successful test result

Permissible deviations/tolerances can be taken from the Technical Data ( "Protection Elements Accuracy").

4.13.7 Commissioning: Underfrequency [f<]

For all configured underfrequency elements, this test can be carried out similar to the test for overfrequency protection (by using the related underfrequency values).

Please consider the following deviations:

- For testing the threshold values, the frequency has to be decreased until the protection element is activated.
- For detection of the fallback ratio, the measuring quantity has to be increased to more than 100.05% of the trip value (or 0.05% fn). At 100.05% of the trip value the relay is to fall back at the earliest (or 0.05% fn).

4.13.8 Commissioning: df/dt - ROCOF

Object to be tested:

All frequency protection stages that are projected as df/dt.

Necessary means:

- Three-phase voltage source and
- Frequency generator that can generate and measure a linear, defined rate of change of frequency.

Procedure - Testing the threshold values:

- Keep on increasing the rate of change of frequency until the respective element is activated.
- Note the value.

Procedure - Testing the trip delay:

- Set the test voltage to nominal frequency.
- Now apply a step change (sudden change) that is 1.5 times the setting value (example: apply 3 Hz per second if the setting value is 2 Hz per second) and
- Measure the tripping time at the relay output. Compare the measured tripping time to the configured tripping time.

Successful test result:

Permissible deviations/tolerances and dropout ratios can be taken from the Technical Data ([↪ "Protection Elements Accuracy"](#)).

4.13.9 Commissioning: $f <$ and $-df/dt$ - Underfrequency and ROCOF

Object to be tested:

All frequency protection stages that are projected as $f <$ and $-df/dt$.

Necessary means:

- Three-phase voltage source and
- Frequency generator that can generate and measure a linear, defined rate of change of frequency.

Procedure - Testing the threshold values:

- Feed nominal voltage and nominal frequency to the device
- Decrease the frequency below the $f <$ threshold and
- Apply a rate of change of frequency (step change) that is below the setting value (example apply -1 Hz per second if the setting value is -0.8 Hz per second). After the tripping delay is expired the relay has to trip.

Successful test result

Permissible deviations/tolerances and dropout ratios can be taken from the Technical Data ([↪ "Protection Elements Accuracy"](#)).

4.13.10 Commissioning: $f >$ and df/dt - Overfrequency and ROCOF

Object to be tested

All frequency protection stages that are projected as $f >$ and df/dt .

Necessary means

- Three-phase voltage source and.
- Frequency generator that can generate and measure a linear, defined rate of change of frequency.

Procedure - Testing the threshold values:

- Feed nominal voltage and nominal frequency to the device.
- Increase the frequency above the $f >$ threshold and.
- Apply a rate of change of frequency (step change) that is above the setting value (example apply 1 Hz per second if the setting value is 0.8 Hz per second). After the tripping delay is expired the relay has to trip.

Successful test result:

Permissible deviations/tolerances and dropout ratios can be taken from the Technical Data (↳ "Protection Elements Accuracy").

4.13.11 Commissioning: $f <$ and DF/DT - Underfrequency and DF/DT

Object to be tested:

All frequency protection stages that are projected as $f <$ and Df/Dt .

Necessary means:

- Three-phase voltage source and
- Frequency generator that can generate and measure a defined frequency change.

Procedure - Testing the threshold values:

- Feed nominal voltage and nominal frequency to the device:
- Decrease the frequency below the $f <$ threshold and
- Apply a defined frequency change (step change) that is above the setting value (example: apply a frequency change of 1 Hz during the set time interval DT if the setting value DF is 0.8 Hz). The relay has to trip immediately.

Successful test result

Permissible deviations/tolerances and dropout ratios can be taken from the Technical Data (↳ "Protection Elements Accuracy").

4.13.12 Commissioning: $f >$ and DF/DT - Overfrequency and DF/DT

Object to be tested:

All frequency protection stages that are projected as $f >$ and Df/Dt .

Necessary means:

- Three-phase voltage source and.
- Frequency generator that can generate and measure a defined frequency change.

Procedure - Testing the threshold values:

- Feed nominal voltage and nominal frequency to the device:
- Increase the frequency above the $f >$ threshold and
- Apply a defined frequency change (step change) that is above the setting value (example: apply a frequency change of 1 Hz during the set time interval DT if the setting value DF is 0.8 Hz). The relay has to trip immediately.

Successful test result:

Permissible deviations/tolerances and dropout ratios can be taken from the Technical Data (↳ "Protection Elements Accuracy").

4.13.13 Commissioning: $\Delta\phi$ - Vector Surge

Object to be tested:

All frequency protection stages that are projected as $\Delta\phi$ (vector surge).

Necessary means:

- Three-phase voltage source that can generate a definite step (sudden change) of the voltage pointers (phase shift).

Procedure - Testing the threshold values:

- Apply a vector surge (sudden change) that is 1.5 times the setting value (example: if the setting value is 10° apply 15°).

Successful test result:

Permissible deviations/tolerances and dropout ratio can be taken from the Technical Data (↳ "Protection Elements Accuracy").

4.14 V 012 - Voltage Asymmetry [47]

Within the Device planning menu the module »V012« can be projected in order to supervise the positive phase sequence voltage for over- or undervoltage or the negative phase sequence system for overvoltage. This module is based on the 3-phase voltages.

The module is alarmed, if the threshold is exceeded. The module will trip, if the measured values remain for the duration of the delay timer above the threshold continuously.

In case that the negative phase sequence voltage is monitored (setting [Device planning] »V012 . Mode« = "V2>"), the threshold [Protection Para / Set x / V-Prot / V012[n]] »V2>« can be combined with an additional percentage criterion »%(V2/V1)« (AND-connected) in order to prevent faulty tripping in case of a lack of voltage within the positive phase sequence system.

ANSI 47 - Supervision of the Negative Phase Sequence System

This application option is set as follows:

- [Device planning] »V012 . Mode« = "V2>"

Options:

- [Protection Para / Set 1...4 / V-Prot / V012[x]] »%(V2/V1)« = unbalance trip pickup setting as a percentage.

The Module trips, if the threshold »V2>« **and** the ratio of negative to positive phase sequence voltage »%(V2/V1)« is exceeded (after the delay timer »t« has expired).

ANSI 59U1 - Overvoltage within the Positive Phase Sequence System

This application option is set as follows:

- [Device planning] »V012 . Mode« = "V1>"

ANSI 27U1 - Undervoltage within the Positive Phase Sequence System

This application option is set as follows:

- [Device planning] »V012 . Mode« = "V1<"

Functionality

- 3-phase AC voltage source
- Timer for measuring of the tripping time
- Voltmeter

Testing the tripping values (Example)

Set the pickup value for the voltage in the negative phase sequence to 0.5 Vn. Set the tripping delay to 1 s.

In order to generate a negative phase sequence voltage interchange the wiring of two phases (VL2 and VL3).

Testing the trip delay

Start the timer and abrupt change (switch) to 1.5 times of the set tripping value. Measure the trip delay.

Successful test result

The measured threshold values and trip delays comply with those specified in the adjustment list. Permissible deviations/tolerances can be taken from the Technical Data.

4.15 PQS - Power [32, 37]

Each of the elements can be used as $P<$, $P>$, $Pr>$, $Q<$, $Q>$, $Qr>$, $S<$ or $S>$ within the device planning.

$P<$ and $P>$ are settable and effective in positive active power range, $Q<$ and $Q>$ in positive reactive power range. These modes are used for protecting against underload or overload in positive power direction.

The apparent power makes $S<$ or $S>$ effective like a circle in all power quadrants. Protection is against underload and overload.

In reverse mode, $Pr>$ is effective in negative active power range and $Qr>$ in negative reactive power range. Both modes protect against power direction reversing from positive into negative direction.

The following graphics show the areas that are protected by the corresponding modes.

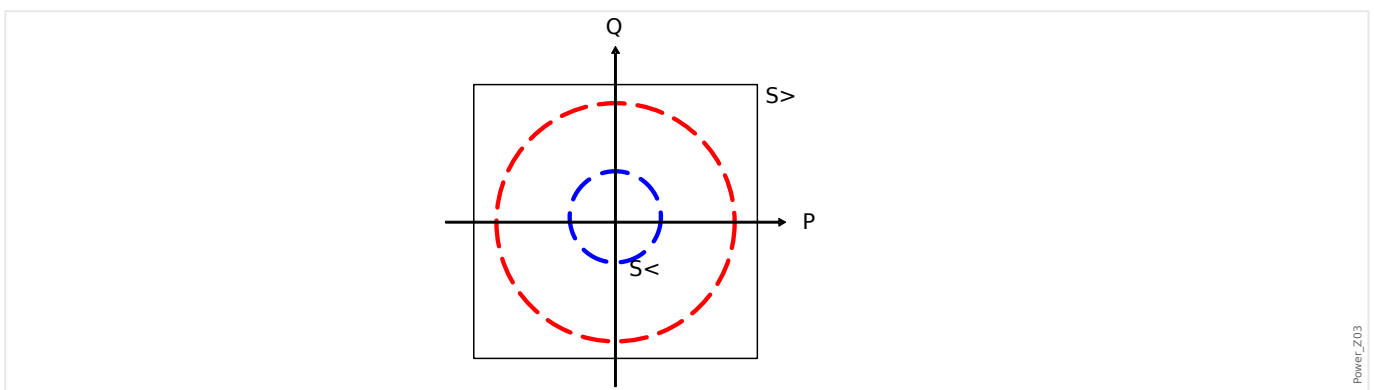
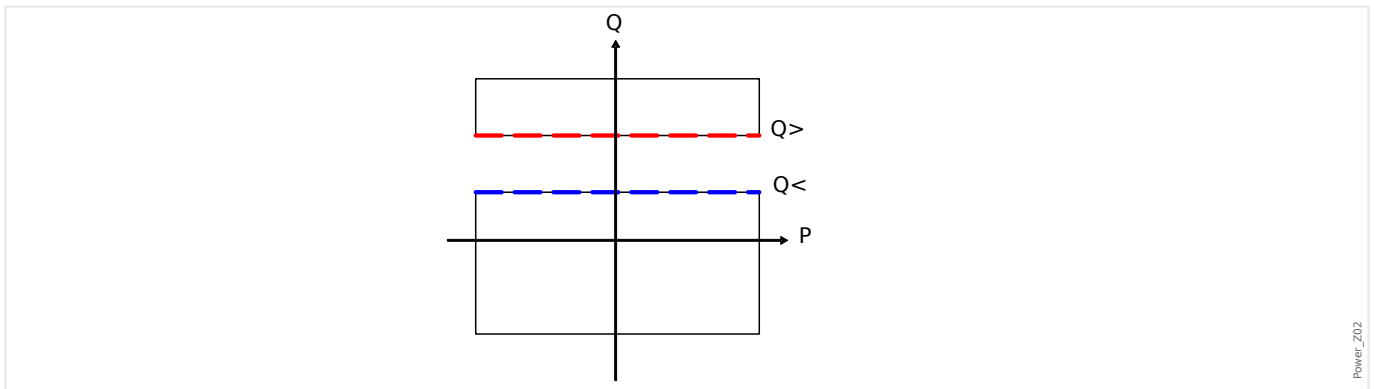
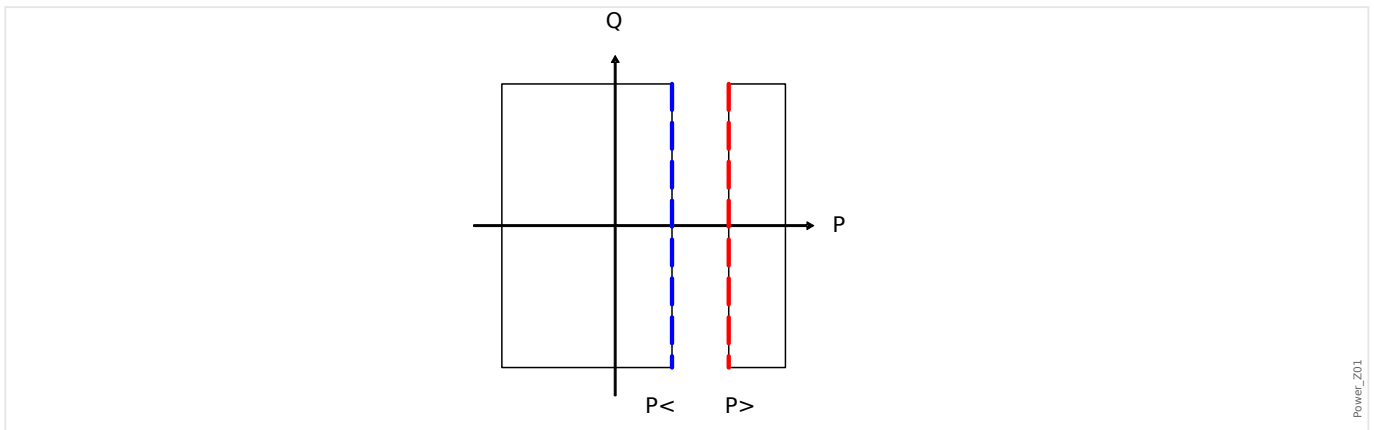

4 Protective Elements

4.15 PQS - Power [32, 37]

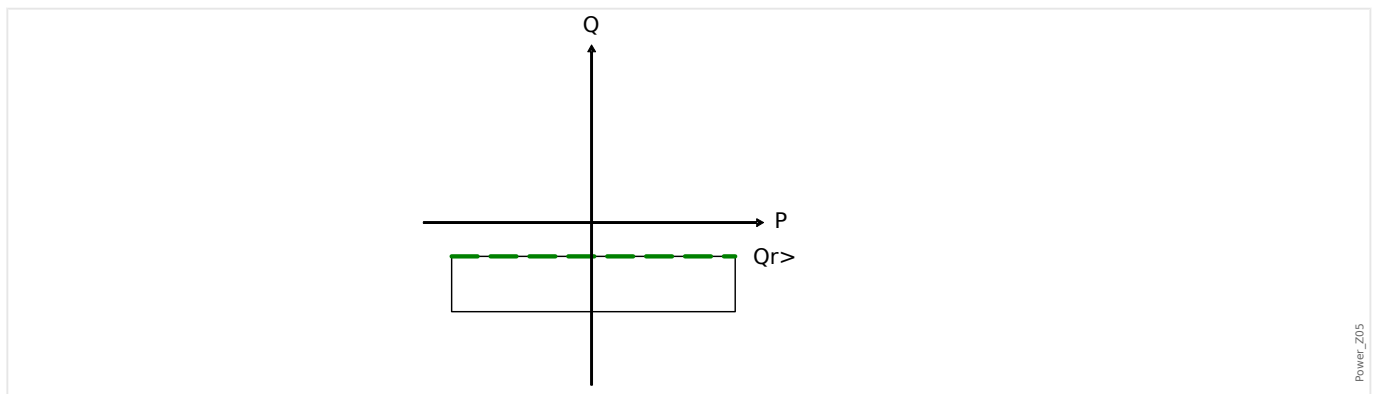
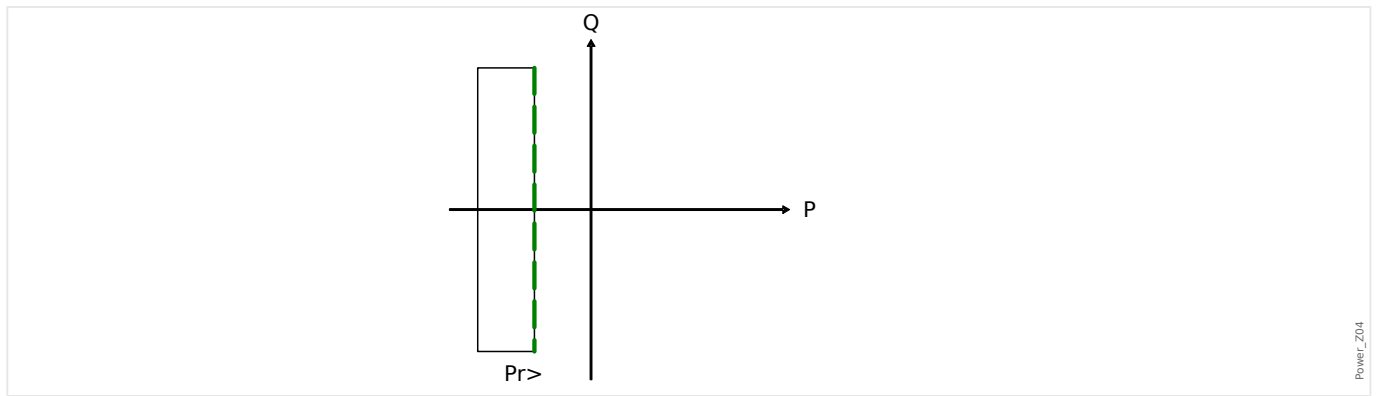

Functionality

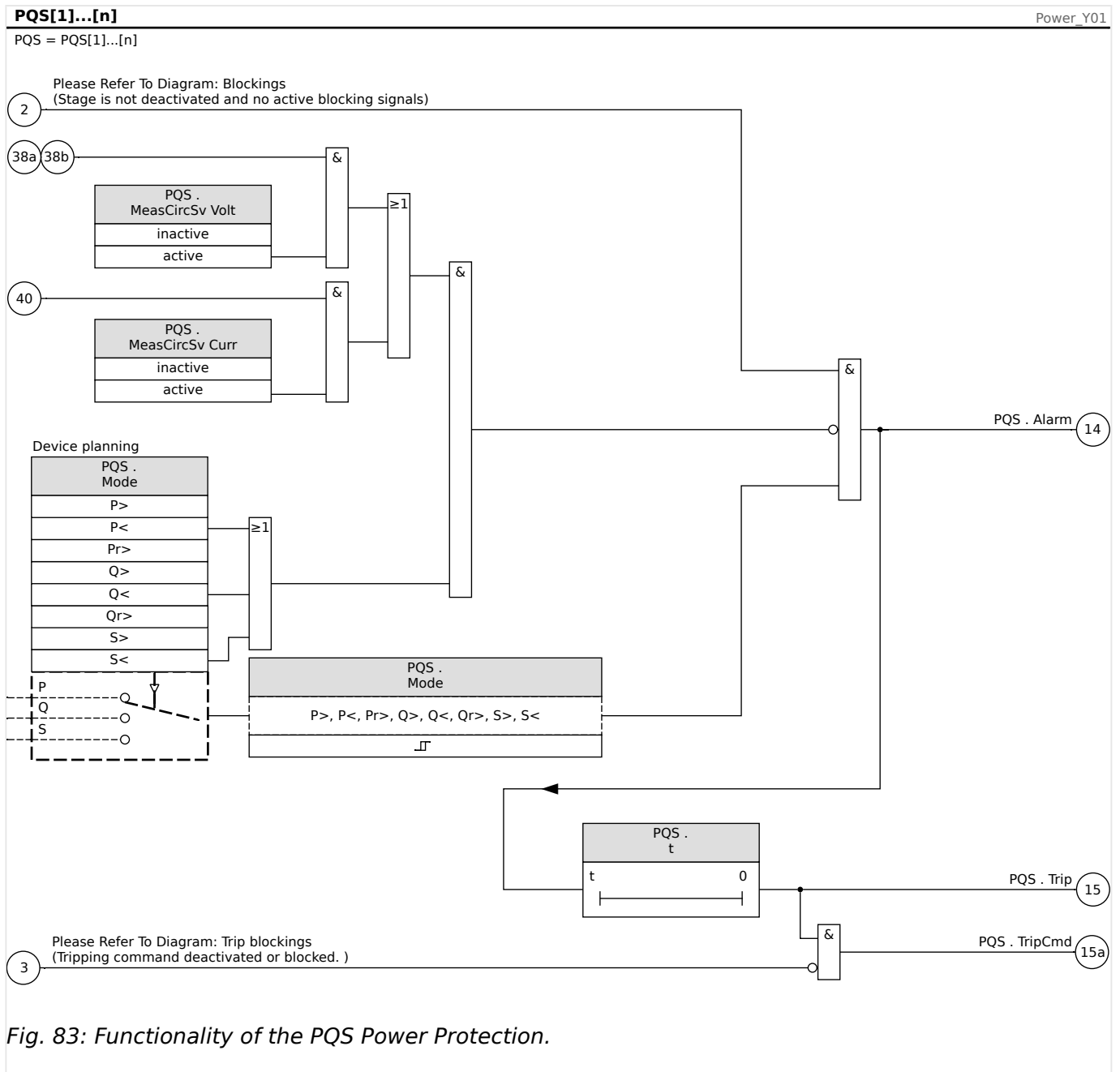

Fig. 83: Functionality of the PQS Power Protection.

4.15.1 Setting the Thresholds

All settings/thresholds within the power module are to be set as per unit thresholds. Per definition S_n is to be used as scale basis.

$$S_n = \sqrt{3} * \text{VoltageTransformerLine-to-Line_Rated_Voltage} * \text{CurrentTransformerRated_Current}$$

If thresholds should base on primary side values:

$$S_n = \sqrt{3} * \text{VoltageTransformerPri_Line-to-Line_Rated_Voltage} * \text{CurrentTransformerPri_Rated_Current}$$

If thresholds should base on secondary side values

$$S_n = \sqrt{3} * \text{VoltageTransformerSec_Line-to-Line_Rated_Voltage} * \text{CurrentTransformerSec_Rated_Current}$$

Example - Field Data

- CurrentTransformer CT pri =200 A; CT sec = 5 A
- VoltageTransformer VT pri = 10 kV; VT sec =100 V
- Generator rated power 2 MVA
- Reverse power should trip at 3%.

Setting Example 1 for Pr> based on primary side values

Reverse power should trip at 3%. That means 60 kW (on primary side).

First Sn is to be calculated:

$$S_n = \sqrt{3} * \text{VoltageTransformerPri_Line-to-Line_Rated_Voltage} * \text{CurrentTransformerPri_Rated_Current}$$

$$S_n = 1.73 * 10000 \text{ V} * 200 \text{ A} = 3.464 \text{ MVA}$$

The following threshold is to be set for Pr> within the device = 60 kW / Sn

$$Pr> = 60 \text{ kW} / 3464 \text{ kVA} = 0,0173 \text{ Sn}$$

Setting Example 1 for Pr> based on secondary side values

Reverse power should trip at 3%. That means 60 kW (on primary side).

First Sn is to be calculated:

$$S_n = \sqrt{3} * \text{VoltageTransformerSec_Line-to-Line_Rated_Voltage} * \text{CurrentTransformerSec_Rated_Current}$$

$$S_n = 1,73 * 100 \text{ V} * 5 \text{ A} = 866,05 \text{ VA}$$

Convert the reverse power onto the secondary side:

$$Pr_{sec>} = Pr_{Pri>} / (\text{VTPri_VLL Rated} / \text{VTSSec_VLL Rated} * \text{CTPri Rated Current} / \text{CTSec Rated Current}) = 60 \text{ kW} / 4000 = 15 \text{ W}$$

The following threshold is to be set for Pr> within the device = 15W /Sn

$$Pr> = 15 \text{ W} / 866 \text{ VA} = 0,0173 \text{ Sn}$$

4.15.2 Commissioning Examples for the Power Protection Module

Object to be tested

- Testing the projected Power Protection Modules.
- P>
- P<
- Pr
- Q>
- Q<
- Qr

- $S >$
- $S <$

Necessary means

- 3-phase AC voltage source
- 3-phase AC current source
- Timer

Procedure - Testing the wiring

- Feed rated voltage and rated current to the measuring inputs of the relay.
- Adjust the current pointers 30° lagging to the voltage pointers.
- The following measuring values have to be shown: $P=0.86$ $P_n Q=0.5$ $Q_n S=1$ S_n

NOTICE!



If the measured values are shown with a negative (algebraic) sign check the wiring.

NOTICE!



The examples shown within this chapter have to be carried out with the tripping values and tripping delays that apply to your switchboard.

If you are testing „greater than thresholds“ (e.g. $P >$) start by 80% of the tripping value and increase the object to be tested until the relay picks up.

In case that you are testing „less than thresholds“ (e.g. $P <$) start by 120% of the tripping value and reduce the object to be tested until the relay picks up.

If you are testing tripping delays of „greater than“ modules (e.g. $P >$) start a timer simultaneously with an abrupt change of the object to be tested from 80% of the tripping value to 120% of the tripping value.

If you are testing tripping delays of „less than“ modules (e.g. $P <$) start a timer simultaneously with an abrupt change of the object to be tested from 120% of the tripping value to 80% of the tripping value.

NOTICE!



P>

Testing the threshold values (Example, Threshold 1.1 Pn)

- Feed rated voltage and 0.9 times rated current in phase to the measuring inputs of the relay (PF=1).
- The measured values for the active power „P“ must show a positive algebraic sign.
- Set the tripping threshold (e.g. 1.1 Pn).
- In order to test the tripping thresholds feed 0.9 times rated current to the measuring inputs of the relay. Increase the current slowly until the relay picks up. Ensure that the angle between current and voltage remains constant. Compare the tripping value to the parameterized.

Testing the tripping delay (Example, Threshold 1.1 Pn)

- Feed rated voltage and rated current in phase to the measuring inputs of the relay (PF=1).
- The measured values for the active power „P“ must show a positive algebraic sign.
- Set the tripping threshold (e.g. 1.1 Pn).
- In order to test the tripping delay feed 0.9 times rated current to the measuring inputs of the relay. Increase the current with an abrupt change to 1.2 In. Ensure that the angle between current and voltage remains constant. Measure the tripping delay at the output of the relay.

Successful test result

The measured total tripping delays or individual tripping delays, threshold values and fallback ratios correspond with those values, specified in the adjustment list. Permissible deviations/tolerances can be found under Technical Data.

NOTICE!



Q>

Testing the threshold values (Example, Threshold 1,1 Qn)

- Feed rated voltage and 0.9 times rated current (90° phase shift) to the measuring inputs of the relay (PF=0).
- The measured values for the active power „Q“ must show a positive algebraic sign.
- Set the tripping threshold (e.g. 1.1 Qn).
- In order to test the tripping thresholds feed 0.9 times rated current to the measuring inputs of the relay. Increase the current slowly until the relay picks up. Ensure that the angle between current and voltage remains constant. Compare the tripping value to the parameterized.

Testing the tripping delay (Example, Threshold 1.1 Qn)

- Feed rated voltage and rated current (90° phase shift) to the measuring inputs of the relay (PF=0).
- The measured values for the active power „Q“ must show a positive algebraic sign.
- Set the tripping threshold (e.g. 1.1 Qn).
- In order to test the tripping delay feed 0.9 times rated current to the measuring inputs of the relay. Increase the current with an abrupt change to 1.2 I_n. Ensure that the angle between current and voltage remains constant. Measure the tripping delay at the output of the relay.

Successful test result

The measured total tripping delays or individual tripping delays, threshold values and fallback ratios correspond with those values, specified in the adjustment list. Permissible deviations/tolerances can be found under Technical Data.

NOTICE!



P<

Testing the threshold values (Example, Threshold 0.3 Pn)

- Feed rated voltage and rated current in phase to the measuring inputs of the relay (PF=1).
- The measured values for the active power „P“ must show a positive algebraic sign.
- Set the tripping threshold (e.g. 0.3 Pn).
- In order to test the tripping thresholds feed 0.5 times rated current to the measuring inputs of the relay. Reduce the current slowly until the relay picks up. Ensure that the angle between current and voltage remains constant. Compare the tripping value to the parameterized.

Testing the tripping delay (Example, Threshold 0.3 Pn)

- Feed rated voltage and rated current in phase to the measuring inputs of the relay (PF=1).
- The measured values for the active power „P“ must show a positive algebraic sign.
- Set the tripping threshold (e.g. 0.3 Pn).
- In order to test the tripping delay feed 0.5 times rated current to the measuring inputs of the relay. Increase the current with an abrupt change to 0.2 In. Ensure that the angle between current and voltage remains constant. Measure the tripping delay at the output of the relay.

Successful test result

The measured total tripping delays or individual tripping delays, threshold values and fallback ratios correspond with those values, specified in the adjustment list. Permissible deviations/tolerances can be found under Technical Data.

NOTICE!



Q<

Testing the threshold values (Example, Threshold $0.3 Q_n$)

- Feed rated voltage and 0.9 times rated current (90° phase shift) to the measuring inputs of the relay (PF=0).
- The measured values for the active power „Q“ must show a positive algebraic sign.
- Set the tripping threshold (e.g. $0.3 Q_n$).
- In order to test the tripping thresholds feed 0.5 times rated current to the measuring inputs of the relay. Reduce the current slowly until the relay picks up. Ensure that the angle between current and voltage remains constant. Compare the tripping value to the parameterized.

Testing the tripping delay (Example, Threshold $0.3 Q_n$)

- Feed rated voltage and 0.9 times rated current (90° phase shift) to the measuring inputs of the relay (PF=0).
- The measured values for the active power „Q“ must show a positive algebraic sign.
- Set the tripping threshold (e.g. $0.3 Q_n$).
- In order to test the tripping delay feed 0.5 times rated current to the measuring inputs of the relay. Increase the current with an abrupt change to $0.2 I_n$. Ensure that the angle between current and voltage remains constant. Measure the tripping delay at the output of the relay.

Successful test result

The measured total tripping delays or individual tripping delays, threshold values and fallback ratios correspond with those values, specified in the adjustment list. Permissible deviations/tolerances can be found under Technical Data.

NOTICE!



Pr

Testing the threshold values (Example, Threshold 0.2 Pn)

- Feed rated voltage and rated current with 180 degree phase shift between voltage and current pointers to the measuring inputs of the relay.
- The measured values for the active power „P“ must show a negative algebraic sign.
- Set the tripping threshold (e. g. 0.2 Pn).
- In order to test the tripping thresholds feed 0.1 times rated current to the measuring inputs of the relay. Increase the current slowly until the relay picks up. Ensure that the angle between current and voltage remains constant. Compare the tripping value to the parameterized.

Testing the tripping delay (Example, Threshold 0.2 Pn)

- Feed rated voltage and rated current with 180 degree phase shift between voltage and current pointers to the measuring inputs of the relay.
- The measured values for the active power „P“ must show a negative algebraic sign.
- Set the tripping threshold (e.g. 0.2 Pn).
- In order to test the tripping delay feed 0.1 times rated current to the measuring inputs of the relay. Increase the current with an abrupt change to 0.3 In. Ensure that the angle between current and voltage remains constant. Measure the tripping delay at the output of the relay.

Successful test result

The measured total tripping delays or individual tripping delays, threshold values and fallback ratios correspond with those values, specified in the adjustment list. Permissible deviations/tolerances can be found under Technical Data.

NOTICE!



Qr

Testing the threshold values (Example, Threshold 0.2 Qn)

- Feed rated voltage and rated current with -90 degree phase shift between voltage and current pointers to the measuring inputs of the relay.
- The measured values for the active power „Q“ must show a negative algebraic sign.
- Set the tripping threshold (e. g. 0.2 Qn).
- In order to test the tripping delay feed 0.1 times rated current to the measuring inputs of the relay. Increase the current slowly until the relay picks up. Ensure that the angle between current and voltage remains constant. Measure the tripping delay at the output of the relay.

Testing the tripping delay (Example, Threshold 0.2 Qn)

- Feed rated voltage and rated current with -90 degree phase shift between voltage and current pointers to the measuring inputs of the relay.
- The measured values for the active power „Q“ must show a negative algebraic sign.
- Set the tripping threshold (e. g. 0.2 Qn).
- In order to test the tripping thresholds feed 0.1 times rated current to the measuring inputs of the relay. Increase the current with an abrupt change to 0.3 In. Ensure that the angle between current and voltage remains constant. Compare the tripping value to the parameterized.

Successful test result

The measured total tripping delays or individual tripping delays, threshold values and fallback ratios correspond with those values, specified in the adjustment list. Permissible deviations/tolerances can be found under Technical Data.

NOTICE!



S>

Testing the threshold values

- Feed 80% of the S> threshold to the measuring inputs of the relay.
- Increase the fed power slowly until the relay picks up. Compare the measured value at the time of tripping to the parameterized setting.

Testing the tripping delay

- Feed 80% of the S> threshold to the measuring inputs of the relay.
- Increase the fed power with an abrupt change to 120% of the S> threshold. Measure the tripping delay at the output of the relay.

Successful test result

The measured total tripping delays or individual tripping delays, threshold values and fallback ratios correspond with those values, specified in the adjustment list. Permissible deviations/tolerances can be found under Technical Data.

NOTICE!



S<

Testing the threshold values

- Feed 120% of the S< threshold to the measuring inputs of the relay.
- Reduce the fed power slowly until the relay picks up. Compare the measured value at the time of tripping to the parameterized setting.

Testing the tripping delay

- Feed 120% of the S< threshold to the measuring inputs of the relay.
- Reduce the fed power with an abrupt change to 80% of the S< threshold. Measure the tripping delay at the output of the relay.

Successful test result

The measured total tripping delays or individual tripping delays, threshold values and fallback ratios correspond with those values, specified in the adjustment list. Permissible deviations/tolerances can be found under Technical Data.

4.16 PF - Power Factor [55]

The module PF supervises the Power Factor within a defined area (limits).

The area is defined by four parameters.

- The Trigger quadrant (lead or lag).
- The Threshold (Power Factor value)
- The Reset quadrant (lead or lag).
- The Reset Value (Power Factor value)

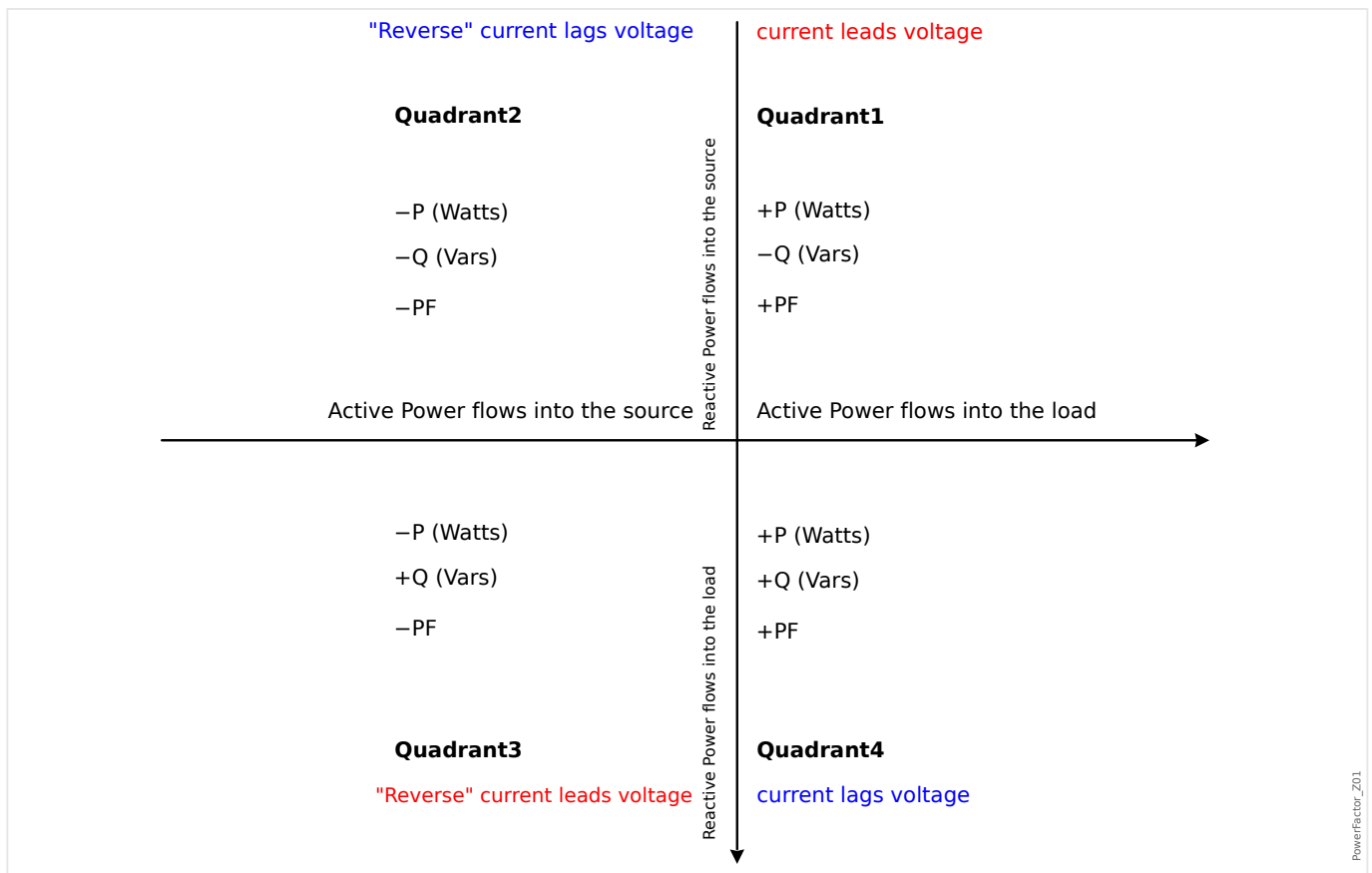

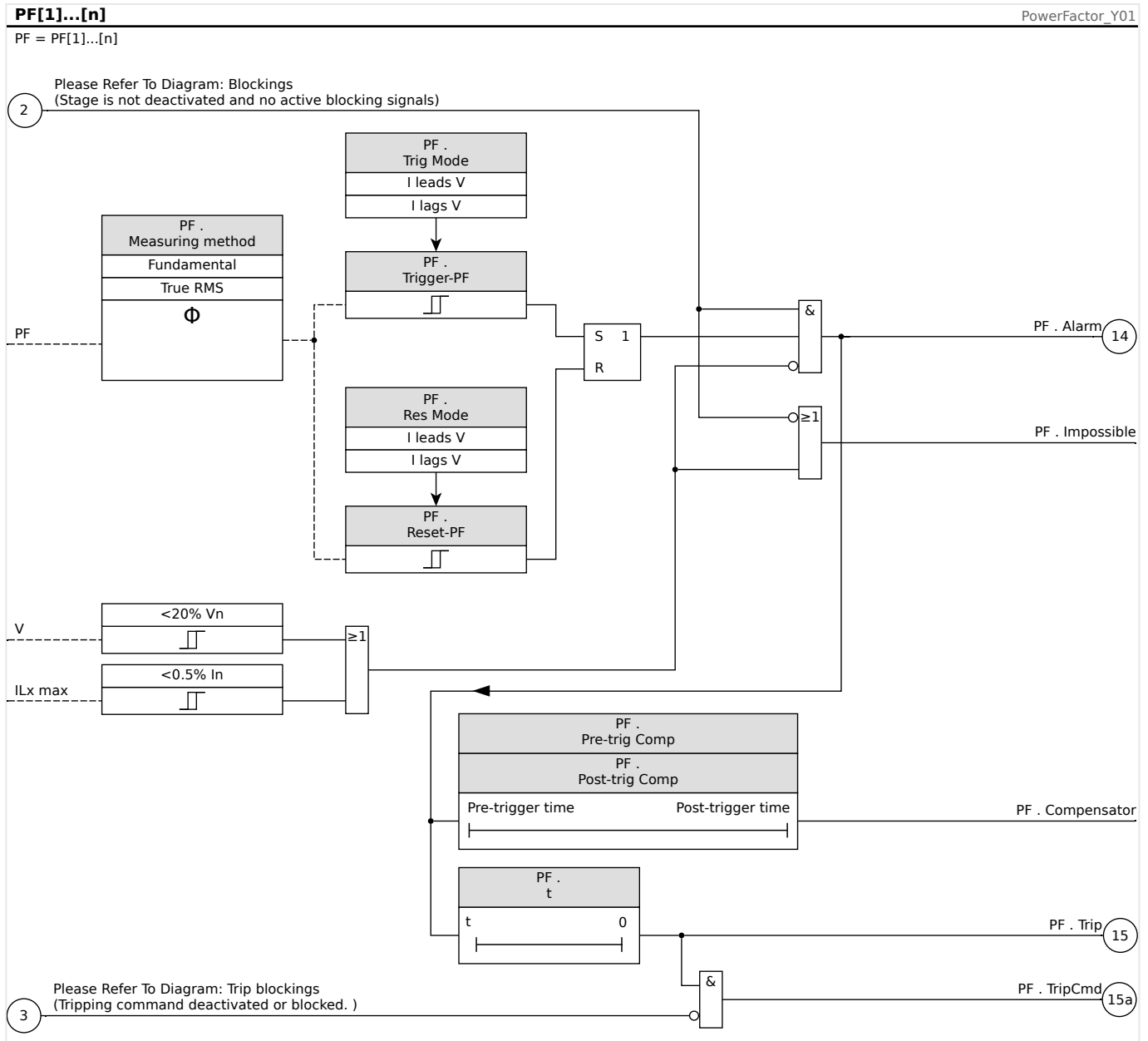

4.16.1 Commissioning: Power Factor [55]

Object to be tested

- Testing the projected Power Factor Modules

Necessary means

- 3-phase AC voltage source
- 3-phase AC current source
- Timer

Procedure - Testing the wiring

- Feed rated voltage and rated current to the measuring inputs of the relay.
- Adjust the current pointers 30° lagging to the voltage pointers.

- The following measuring values have to be shown: $P=0.86$ $P_nQ=0.5$ $Q_nS=1$ S_n

NOTICE!



If the measured values are shown with a negative (algebraic) sign check the wiring.

NOTICE!



In this example PF-Trigger is set to $0.86 = 30^\circ$ (lagging) and PF-Reset is set to $0.86 = 30^\circ$ leading.

Carry out the test with the settings (trigger and reset) that fit to your switchboard.

Testing the threshold values (Trigger) (PF Trigger: Example = 0.86 lagging)

- Feed rated voltage and rated current in phase to the measuring inputs of the relay ($PF=1$).
- Adjust the angle between voltage and current (current pointer lagging) until the relay picks up.
- Write down the pickup value.

Testing the Reset (PF Reset: Example = 0.86 leading)

- Reduce the angle between voltage and current beyond $PF = 1$ (current pointer leading) until the alarm drops off.
- Write down the reset value.

Testing the trip delay (PF Trigger: Example = 0.86 lagging)

- Feed rated voltage and rated current in phase to the measuring inputs of the relay ($PF=1$).
- Adjust the angle between voltage and current (current pointer lagging) with an abrupt change to $PF = 0.707$ (45°) lagging.
- Measure the tripping delay at the output of the relay. Compare the measured tripping time to the parameterized.

Successful test result

The measured total tripping delays, threshold and reset values correspond with those values, specified in the adjustment list. Permissible deviations/tolerances can be found under Technical Data.

4.17 Exp - External Protection

NOTICE!

!

All 4 stages of the external protection Exp[1] ... Exp[4] are identically structured.

By using the module External Protection the following can be incorporated into the device function: trip commands, alarms and blockades of external protection facilities. Devices which are not provided with a communication interface can be connected to the control system as well.

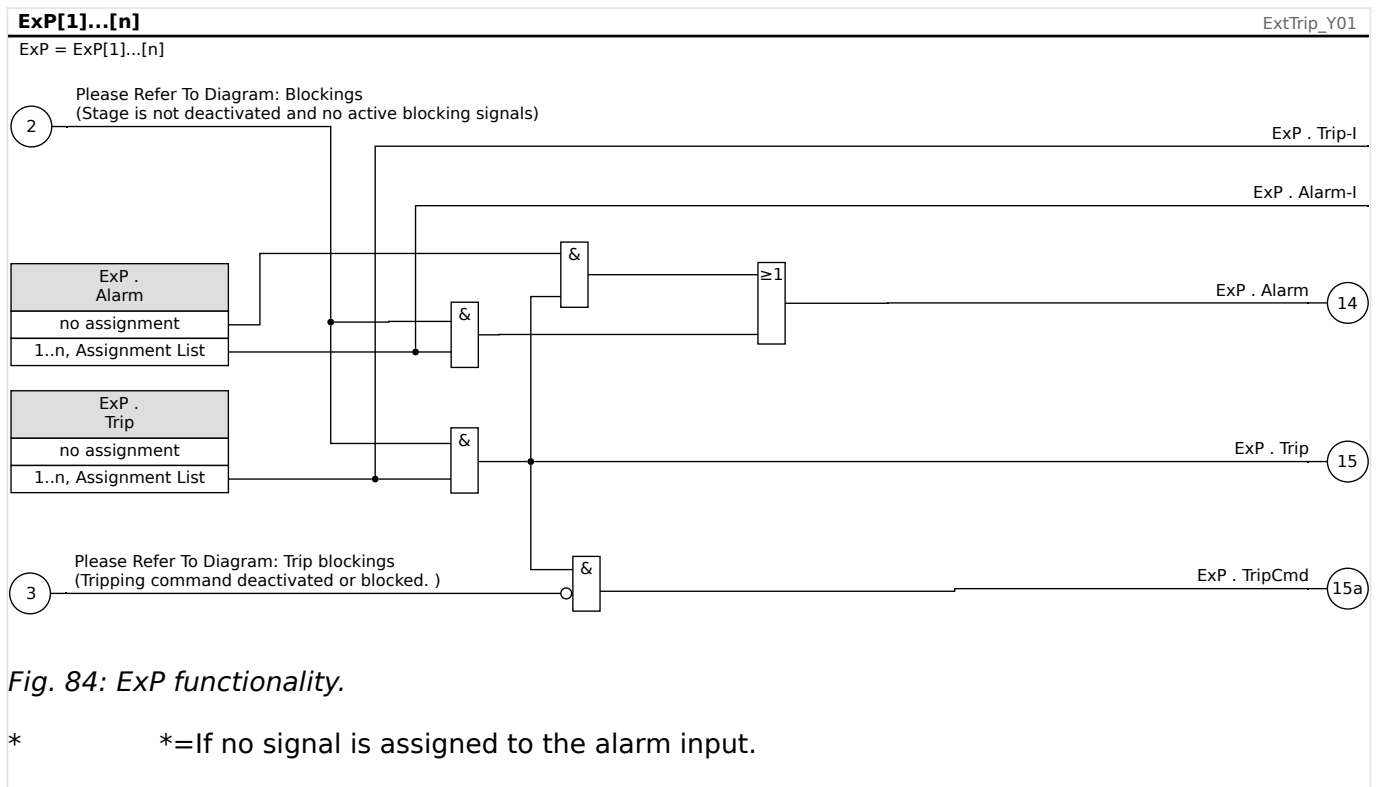

Fig. 84: Exp functionality.

4.17.1 Commissioning: External Protection

Object to be tested:

Test of the External Protection Module.

Necessary means:

Dependent on the application.

Procedure:

Simulate the functionality of the External Protection (pickup, trip, and blockings) by (de-)energizing the digital inputs:

After module activation via [Device planning] »Mode« = "use", assign an available Digital Input to the Global Parameters for pickup and trip, for example:

- [Protection Para / Global Prot Para / Exp / Exp[n]] »Alarm« = "DI Slot X1 . DI 1"

- [Protection Para / Global Prot Para / ExP / ExP[n]] »Trip« = “DI Slot X1 . DI 2”

The same for the blocking parameters, for example:

- [Protection Para / Global Prot Para / ExP / ExP[n]] »ExBlo1« = “DI Slot X1 . DI 3”

Successful test result:

All external pickups, external trips, and external blockings are correctly recognized and processed by the MRMV4. Check also the respective entries in the **Event recorder**.

4.18 RTD Protection Module [26/38/49]

General - Principle Use

NOTICE!



The Resistance-based Temperature Detector (RTD) Protection Module uses temperature data that are provided by a Universal Resistance-based Temperature Detector (URTD) module (please refer to  "URTDII Module Interface").

NOTICE!



If voting trip is required, please map the output used for tripping purposes: »RTD . Trip Group 1« or »RTD . Trip Group 2«.

The protective device provides tripping and alarming functions based on the direct temperature measurements read from the URTD device that has 11 temperature sensor channels. Each channel features a trip function without an intended delay and one alarm function with a delay.

- The "trip" function has only a threshold setting.
- Each individual »Alarm Function« will have a threshold setting range, and can be individually enabled or disabled. Since the temperature cannot change instantaneously (which is a way that temperature differs from current), the "delay" is essentially built in to the function due to the fact that the temperature will take some time to increase from room temperature to the "trip threshold" level.
- The dropout ratio for both trip and alarm is 0.99.
- The temperature rise is limited by the RTD driver.
- The entire function can be turned off or on, or individual channels can be turned off or on.

Channel Groups

The RTD channels are grouped:

- The channels Windg1 ... Windg6 belong to the group "Temperature of the Winding":
 - Settings can be made in menu branch [Protection Para / RTD / Windg 1 ... 6]
 - Status values can be found in menu branch [Operation / Status Display / Temp-Prot / RTD / Windg 1 ... 6]
 - Measured temperature values can be found in menu branch [Operation / Measured Values / URTD]
- The channels MotBear1, MotBear2 belong to the group "Temperature of the Motor Bearing":
 - Settings can be made in menu branch [Protection Para / RTD / MotBear 1 ... 2]
 - Status values can be found in menu branch [Operation / Status Display / Temp-Prot / RTD / MotBear 1 ... 2]

- Measured temperature values can be found in menu branch [Operation / Measured Values / URTD]
- The channels LoadBear1, LoadBear2 belong to the group “Temperature of the Load Bearing”:
 - Settings can be made in menu branch [Protection Para / RTD / LoadBear 1 ... 2]
 - Status values can be found in menu branch [Operation / Status Display / Temp-Prot / RTD / LoadBear 1 ... 2]
 - Measured temperature values can be found in menu branch [Operation / Measured Values / URTD]
- The channels Aux1, Aux2 belong to the group “Auxiliary Temperature Inputs”:
 - Settings can be made in menu branch [Protection Para / RTD / Aux 1 ... 2]
 - Status values can be found in menu branch [Operation / Status Display / Temp-Prot / RTD / Aux 1 ... 2]
 - Measured temperature values can be found in menu branch [Operation / Measured Values / URTD]

Within each group, always the hottest RTD is used.

Voting

Additionally, RTD voting schemes are available and user-programmable. The Voting feature must be activated and configured within the following menu, [Protection Para / Set n / Temp-Prot / RTD / Voting x]. Here, the setting »Function« has to be set to “active”.

Once activated, the number of channels that will be used by the voting feature is selected. This is set by way of the parameter »Voting x«. This parameter defines how many of the selected channels must be over its threshold level in order to get a voting trip. Each individual channel must be selected or deselected by setting to either “yes” or “no”. When selecting “yes”, the channel will be used in the voting process. Note that in order to be selected, each channel must also be active and the RTD module itself has to be active.

If for example, »Voting x« is set to “3”, and all channels are set to “yes”, and if any three of the selected channels exceed their individual threshold settings, a Vote trip will occur.

Please note that the voting trip will be issued as a RTD trip only, if the parameter »TripCmd Selection« is set to “Voting Trip” within the Global Protection Parameters of the RTD module. The Trip has to be assigned then within the trip manager to the Breaker.

Alarm, Timeout Alarm and Trip Principle for each RTD Sensor

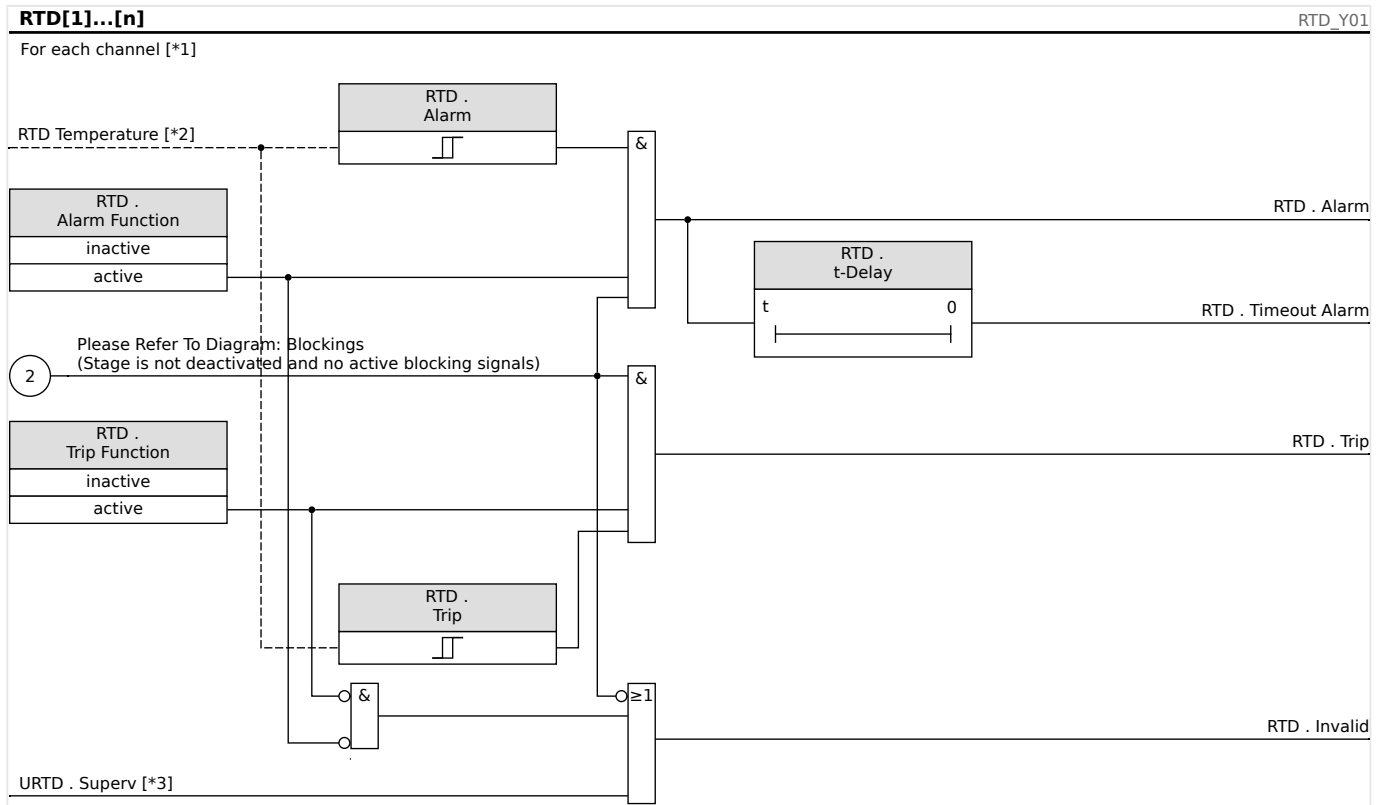

Fig. 85: The general working principle (delayed alarm, undelayed trip).

- [*1] RTD channels or the following groups: Windg1...6, MotBear1...2, LoadBear1...2, Aux1...2, see ["4.18 Channel Groups"](#)
- [*2] Within a group, always the hottest measured temperature is used.
- [*3] The supervision checks all RTDs that belong to a group.

The diagram shows the general working principle (delayed alarm, undelayed trip) of each of the RTD sensors. Note that some text-labels had to be simplified, to make the diagram valid for each group. Please consult the Reference Manual for exact listings of available parameters and signals.

Collective Alarm, Timeout Alarm and Trip Signals

The RTD sensors are assigned to four groups (depending on the ordered device). These four groups are OR-connected to the "AnyGroup". The AnyGroup generates an alarm, an timeout alarm and a trip signal if any of the sensors mounted into this issues the corresponding signal.

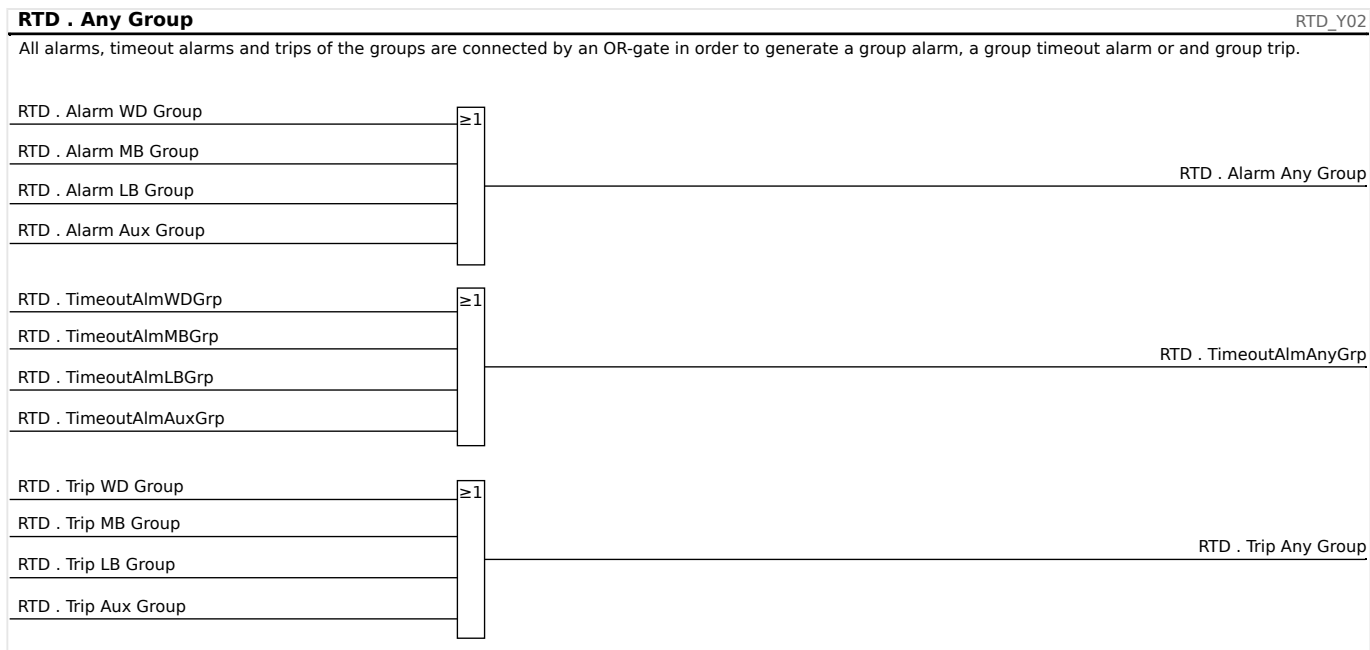

Trips of the Voting Groups

In order to use voting groups the user has to determine the sensors that should belong to a voting group and how many of them have to trip in order to generate a voting trip of the corresponding group.

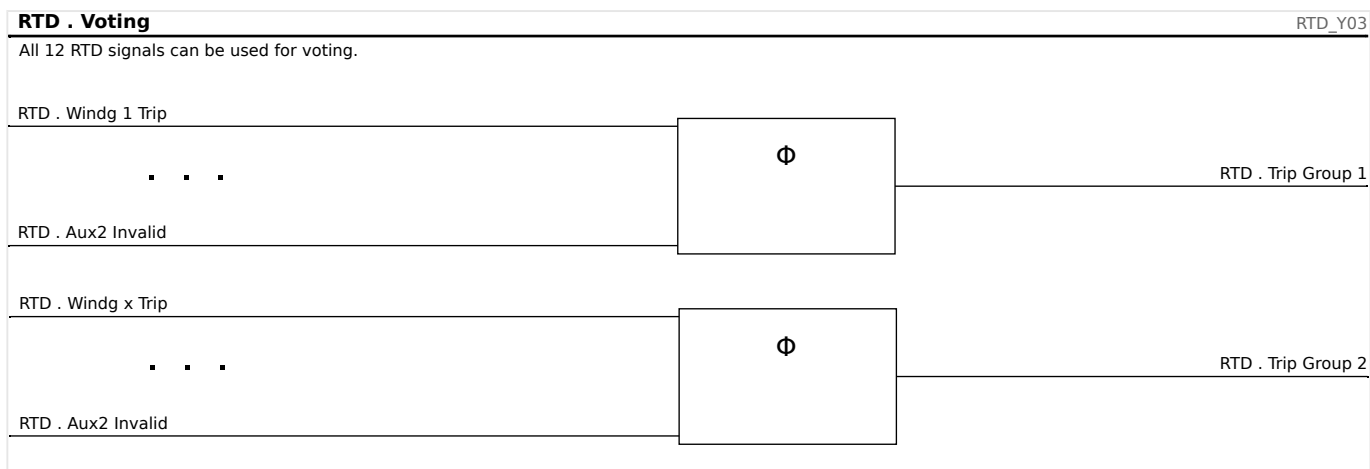

Collective Timeout Alarm Signal

All RTD sensor timeout alarms and all group timeouts are OR-connected.

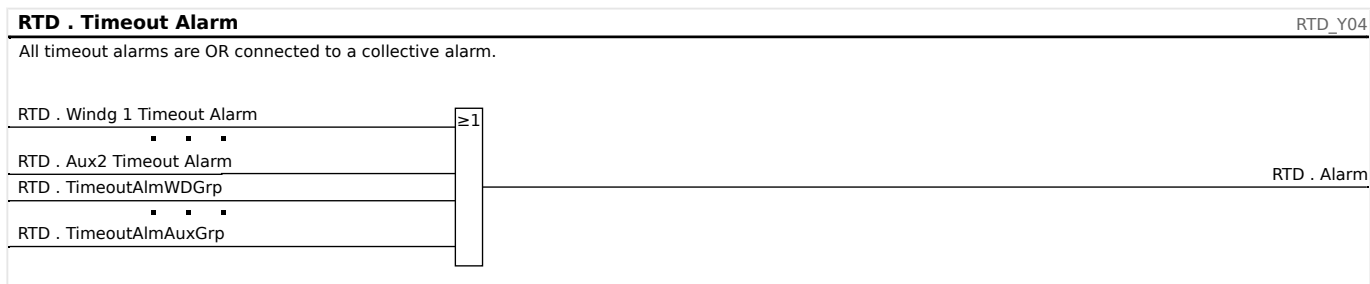

Collective Trip Signal

By means of the trip command selection »TripCmdSelection« the user determines if the RTD element should use for the final trip signal the OR-connected default RTD trips or if the RTD element should use the OR-connected voting trips.

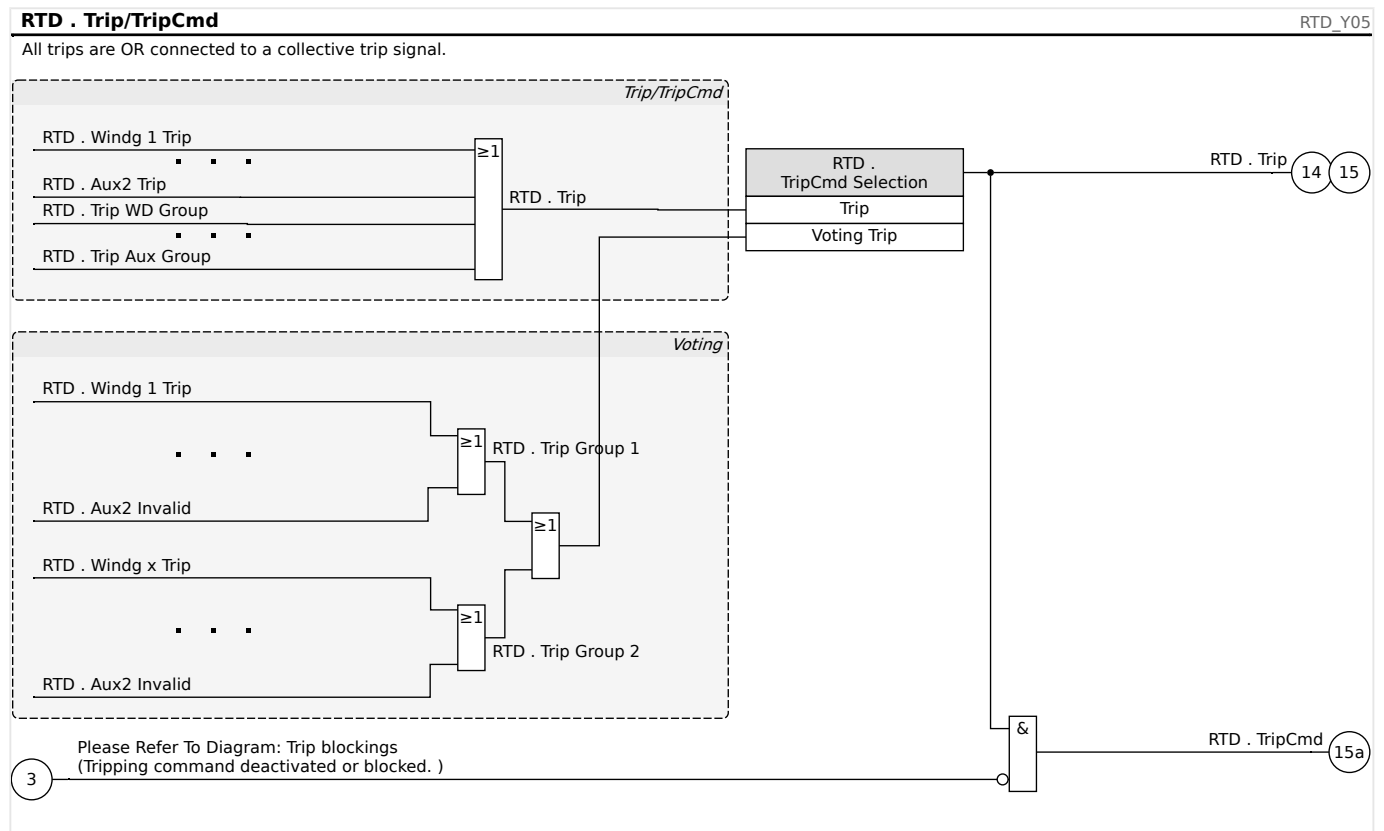

CAUTION!



Caution: A Block Trip Command blocks the trips of all RTDs.

4.19 URTDII Module Interface

Principle - General Use

The optional Universal Resistance-based Temperature Detector II (URTDII) Module provides temperature data to the protective device up to 12 RTDs embedded in the motor, generator, transformer, or cable connector and driven equipment. The temperature data will be shown as measured values and statistics in the Operating Data menu. In addition, each channel will be monitored. The measured data provided by the URTDII Module can also be used for temperature protection (please refer to the Temperature Protection section).

The URTDII conveys multiplexed temperature data back to the relay via a single optical fiber. The URTDII may be mounted remotely from the protective device. The fiber optic connector is located on the **X102** terminal of the protective device.

Consider the benefit of mounting the URTDII module away from the protective device and as close to the protected equipment as possible. The big bundle of RTD wires to the protected equipment becomes much shorter. The URTDII may be placed up to 400 ft (121.9 m) from the protective device with the optical fiber connection. Note that the URTDII will require a power supply connection at its remote location.

Connect a suitable source to the power terminals J10A-1 and J10A-2 on the URTDII module. Connect any of the Shield terminals to a non-current-carrying safety ground. It is recommended to have a ground connection on both sides of the unit.

Style	Power Supply
URTDII-01	48 – 240 VAC 48 – 250 VDC
URTDII-02	24 – 48 VDC

URTDII Module Fiber Optic Connection to the Protective Device

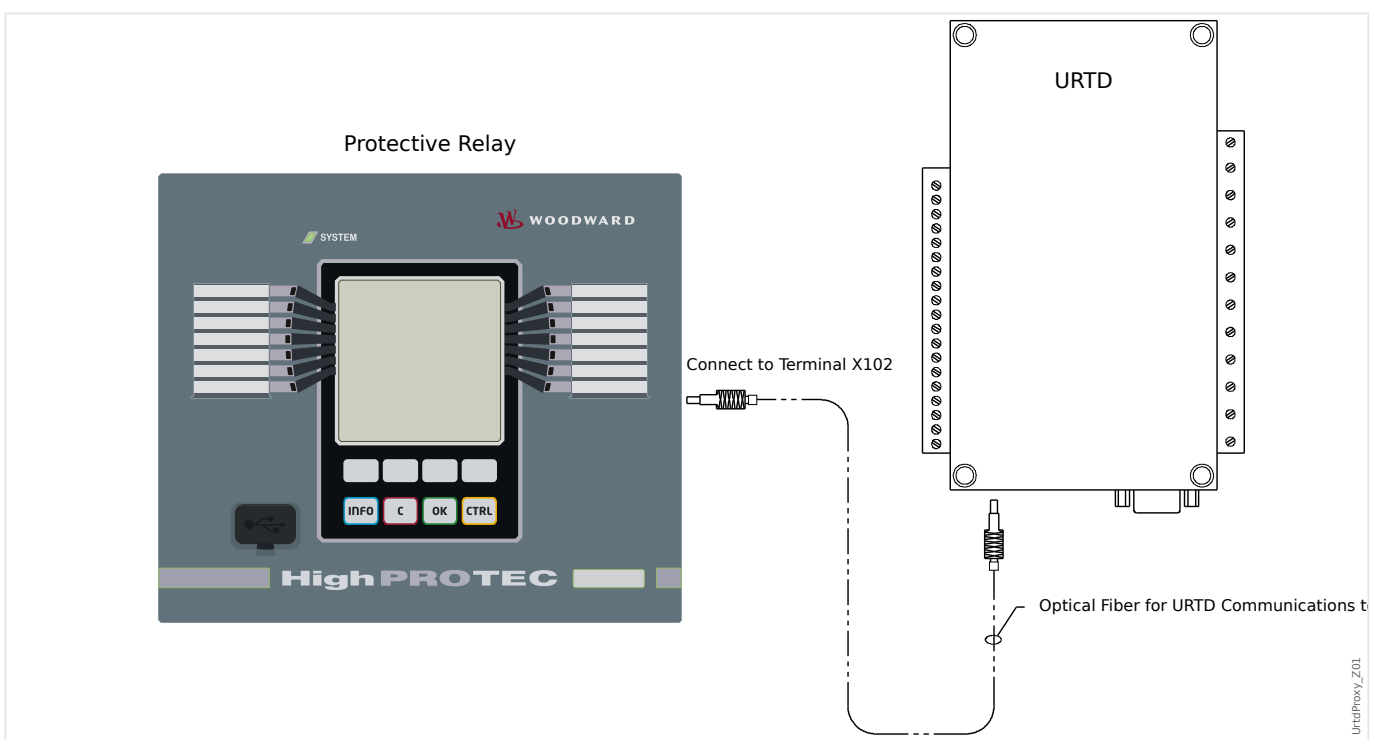

The figure above shows the fiber optic connections between the URTDII Module and the protective device. The protective device supports the optical fiber connection.

Preassembled plastic optical fibers with connectors can be ordered from any distributor of optical fiber products. In addition, these same distributors offer long rolls of cable with connectors that can be installed in the field. Some distributors will make custom lengths to order.

NOTICE!



Surplus length of a pre-cut fiber does not cause a problems. Simply coil and tie the excess fiber at a convenient point. Avoid high tie pressure. Bending radius of the fiber should be greater than 2 in. (50.8 mm).

The fiber termination at the URTDII simply snaps into or out of the connector. To connect the fiber termination at the protective device, push the plug of the fiber optic onto the device interface then turn it until it “snaps”.

CAUTION!



The protective device as well as the URTDII have various power supply options. Make certain that the power supply is acceptable for both units before connecting the same power supply to both devices.

NOTICE!



Consult the URTDII Module Instruction Leaflet for complete instructions.

Wiring RTDs to the URTDII Module

RTD Channel (avail. signals see Reference Manual)	URT DII Connect- ion Name	Terminals	Temperature Monitoring Point
Windg1	Group I, RTD1	J2-20, J2-21	RTD Temperature of the Motor Winding 1
Windg2	Group I, RTD2	J2-16, J2-17	RTD Temperature of the Motor Winding 2
Windg3	Group I, RTD3	J2-13, J2-14	RTD Temperature of the Motor Winding 3
Windg4	Group I, RTD4	J2-9, J2-10	RTD Temperature of the Motor Winding 4
Windg5	Group I, RTD5	J2-6, J2-7	RTD Temperature of the Motor Winding 5
Windg6	Group I, RTD6	J2-2, J2-3	RTD Temperature of the Motor Winding 6

RTD Channel (avail. signals see Reference Manual)	URTDII Connection Name	Terminals	Temperature Monitoring Point
MotBear1	Group II, RTD7	J10B-19, J10B-20	RTD Temperature of the Motor Bearing (1)
MotBear2	Group II, RTD8	J10B-15, J10B-16	RTD Temperature of the Motor Bearing (2)
LoadBear1	Group III, RTD9	J10B-12, J10B-13	RTD Temperature of the Load Bearing (1)
LoadBear2	Group III, RTD10	J10B-8, J10B-9	RTD Temperature of the Load Bearing (2)
Aux1	Group IV, RTD11	J10B-5, J10B-6	User Defined RTD Temperature.
Aux2	Group IV, RTD12	J10B-1, J10B-2	User Defined RTD Temperature.

Three URTD terminals are provided for each RTD input.

The three terminals for any unused RTD input channel should be wired together. For example, if MW5 and MW6 are unused, MW5 terminals J2-15, J2-16, and J2-17 should be wired together and MW6 terminals J2-19, J2-20, J2-21 should be separately wired together.

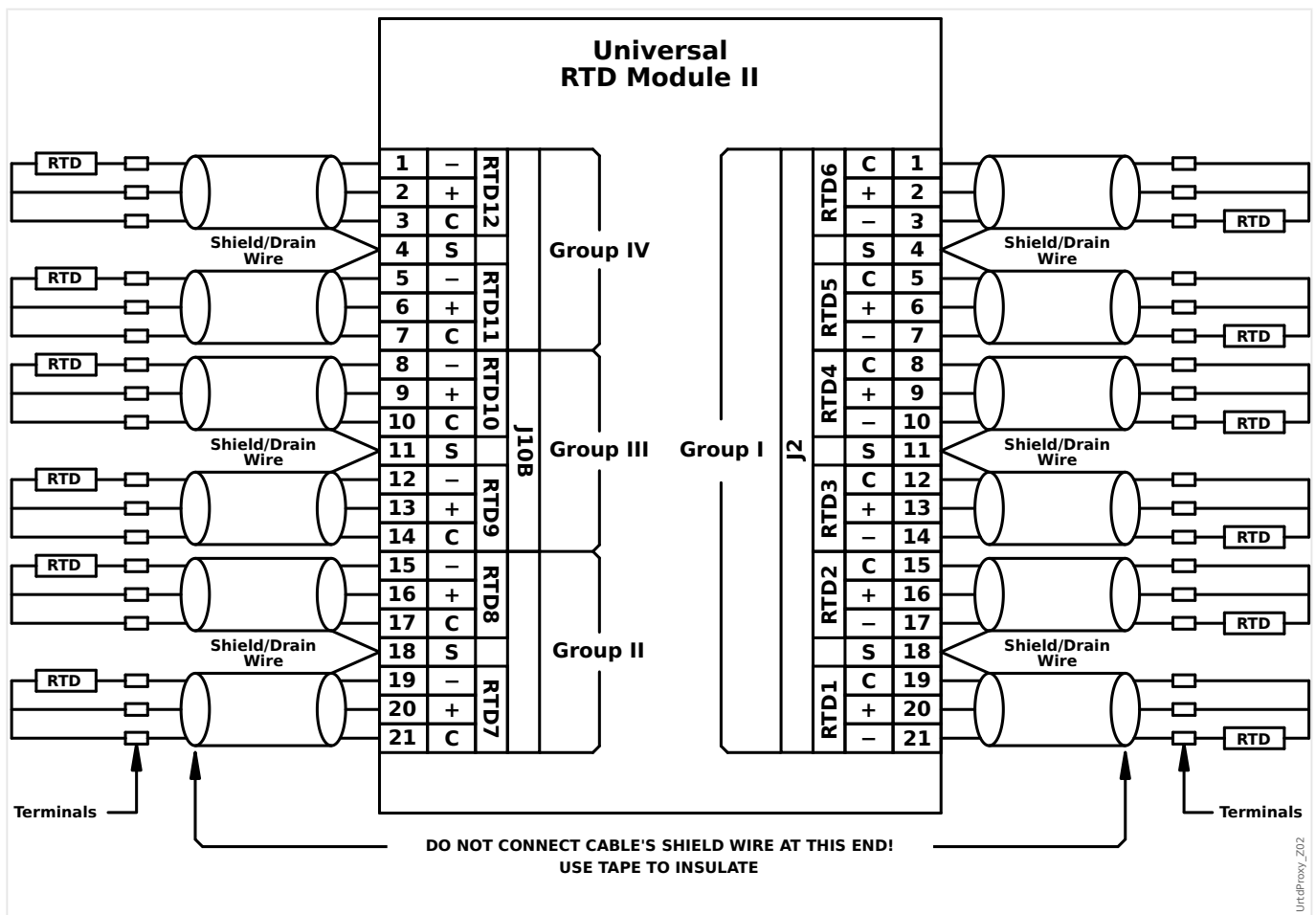

4 Protective Elements

4.19 URTDII Module Interface

See the figure above for wiring of RTDs to the URTD inputs. Use three-conductor shielded cable. Note the connection rules in the figure. When making connections to a two-lead RTD, connect two of the cable conductors to one of the RTD leads as shown. Make this connection as close to the protected object as possible. Connect the third cable conductor to the remaining RTD lead.

Connect the shield / drain wire to the Shield terminal as shown in the figure. The RTD cable shield should be connected only at the URTD end, and insulated at the RTD end. The RTD's themselves must not be grounded at the object to be protected.

Remember to set the URTDII module DIP switches according to the types of RTDs in each of the channels.

4.20 Supervision

4.20.1 CBF - Circuit Breaker Failure [50BF*/62BF]

* = only available in protective relays that offer current measurement.

4.20.1.1 Principle - General Use

The »CBF« module is used to provide backup protection in the event that a breaker fails to operate properly during fault clearing. This signal is to be used to trip the upstream breaker (e.g. infeed of a busbar) either via an output relay or via Communication (SCADA).

Depending on the ordered device type there are different/multiple schemes available to detect a breaker failure.

Supervision Schemes

The setting [Protection Para / Global Prot Para / Supervision / CBF] »Scheme« allows to select a supervision method that shall be used to detect a Breaker Failure. The following options are available:

- “50BF” — A supervision timer is started as soon as the »CBF« module is triggered by a trip signal. A Breaker Failure is detected and a signal is issued if the measured current does not fall below a set threshold within the set time.

This threshold can be set at [Protection Para / Set 1...4 / Supervision / CBF] »I-CBF >«.

- “CB Pos” — A supervision timer is started as soon as the »CBF« module is triggered by a trip signal. A Breaker Failure is detected and a signal is issued if the evaluation of the position indicators of the Breaker does not indicate that the breaker has successfully opened within the set time.

This scheme is recommended if Breaker Failures have to be detected while there is no or not much load flow (small currents). This might be the case if overvoltage or overfrequency is detected for a generator application that is running in stand-by.

- “50BF and CB Pos” — A supervision timer is started as soon as the »CBF« module is triggered by a trip signal. A Breaker Failure is detected and a signal is issued if the measured current does not fall below a set threshold and if simultaneously the evaluation of the position indicators of the Breaker does not indicate that the breaker successfully opened within the set time.

This scheme is recommended if Breaker Failures have to be double-checked. This scheme issues a trip command to the upstream breaker even if position indicators indicate misleadingly (faulty) that the breaker has been opened or if the current measurement indicates misleadingly (faulty) that the breaker is now in the open position.

Start/Trigger of the CBF Timer

The setting [Protection Para / Set 1...4 / Supervision / CBF] »t-CBF« defines a supervision time: The timer is started once the CBF module is triggered. Even if the trigger signal drops again, this timer continues. If the timer elapses (before it gets stopped by the breaker having successfully opened), the »CBF« module issues a trip. This trip signal is to be used to trip the upstream breaker (backup).

NOTICE!



In order to prevent a faulty activation of the »CBF« Module, the supervision time »t-CBF« must be greater than the sum of:

- Operating time of the protective relay
- + The close-open time of the breaker (please refer to the technical data of the manufacturer of the breaker);
- + Drop off time (current- or position indicators)
- + Security margin.

Stop the CBF Timer

The »t-CBF« timer is stopped if the opening of the breaker is detected. Depending on the supervision scheme (↳ [“4.20.1.1 Supervision Schemes”](#)) the timer is stopped if the current falls below the current threshold or if the position signals indicate the open position of the breaker or a combination of both. The »CBF« module remains in the state rejected until the trigger signal drops (falls back).

States

The »CBF« module switches into the rejected state if the circuit breaker failure triggers are still active while the open position of the breaker has been detected successfully.

The »CBF« module switches back into the Stand-by if the trigger signals drop (fall back).

Locking (Latching)

A locking signal will be issued simultaneously with the CBF-Signal (Trip). The locking signal is permanent. This signal has to be acknowledged at the HMI.

This signal can be used to block the breaker against a switching on attempt.

Triggers

The setting [Protection Para / Global Prot Para / Supervision / CBF] »Trigger« allows to select a trigger mode. In addition to that, there are three assignable trigger inputs available that might trigger the »CBF« module even if they are not assigned within the breaker manager onto the breaker that is to be monitored.

These additional trigger inputs can be set at [Protection Para / Global Prot Para / Supervision / CBF] »Trigger1« ... »Trigger3«.

The following options are available for »Trigger«:

- “All Trips” — All trip signals that are assigned to the breaker (within the trip manager, ↳ [“5.2 Trip Manager - Assignment of commands”](#)) start the »CBF« module.
- “External Trips” — All external trips that are assigned to the breaker (within the trip manager, ↳ [“5.2 Trip Manager - Assignment of commands”](#)) start the »CBF« module.

You can find all external trips in the Reference Manual (MRMV4-3.6-EN-REF), Chapter “Selection Lists”, as a table entitled “External Trips”.

- “Current Trips” — All current trips that are assigned to the breaker (within the trip manager, ↳ [“5.2 Trip Manager - Assignment of commands”](#)) start the »CBF« module.

You can find all current trips in the Reference Manual (MRMV4-3.6-EN-REF), Chapter “Selection Lists”, as a table entitled “Current Trips”.

- “- . -” — No assignment, the user intends to use one of the three additional assignable trigger inputs.

4.20.1.2 Functionality

Breaker Failure Protection for devices that offer current measurement

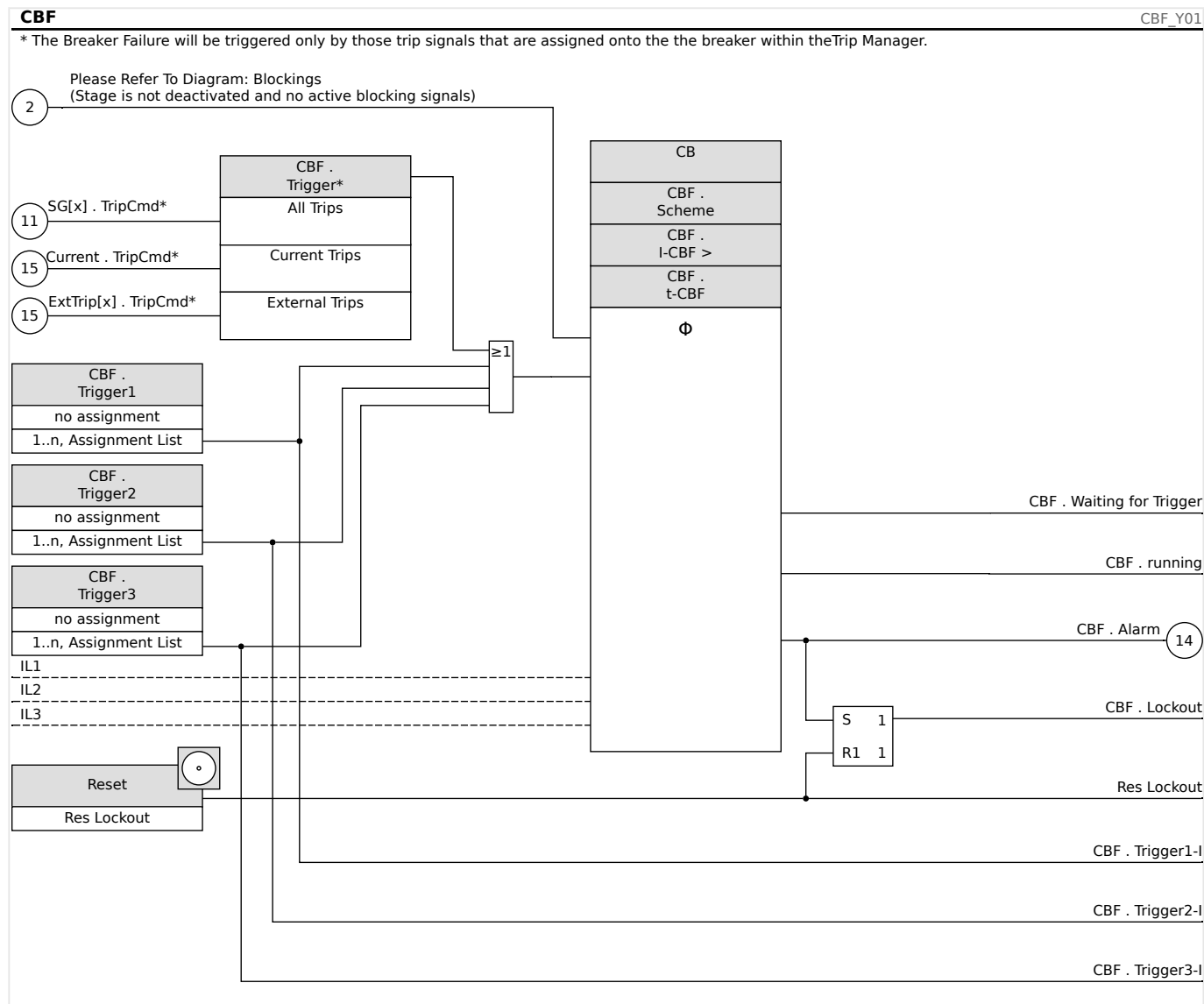

4.20.1.3 Commissioning Example: Supervision Scheme 50BF

Object to Be Tested:

Test of the breaker failure protection (Supervision Scheme 50BF).

Necessary Means:

- Current source;
- Ammeter; and
- Timer.

NOTICE!

When testing, the applied test current must always be higher than the tripping threshold »I-CBF«. If the test current falls below the threshold while the breaker is in the "Off" position, no pickup will be generated.

Procedure (Single-Phase):

For testing the tripping time of the CBF protection, a test current has to be higher than the threshold value of one of the current protection modules that are assigned to trigger the CBF protection. The CBF trip delay can be measured from the time when one of the triggering inputs becomes active to the time when the CBF protection trip is asserted.

To avoid wiring errors, checked to make sure the breaker in the upstream system switches off.

The time, measured by the timer, should be in line with the specified tolerances.

Successful Test Result:

The actual times measured comply with the setpoint times. The breaker in the higher-level section switches off.

WARNING!

Re-connect the control cable to the breaker!

4.20.2 TCS - Trip Circuit Supervision [74TC]

The trip circuit monitoring is used for monitoring if the trip circuit is ready for operations. The monitoring can be fulfilled in two ways. The first assumes only »Aux On (52a)« is used in the trip circuit. The second assumes that, in addition to »Aux On (52a), »Aux Off(52b)« is also used for the circuit monitoring.

With »Aux On (52a), only in the trip circuit, the monitoring is only effective when the breaker is closed while if both »Aux On (52a), and »Aux Off(52b)« are used, the trip circuit will be monitored all time as long as the control power is on.

Note that the digital inputs used for this purpose must be configured properly based on the trip circuit control voltage. If the trip circuit is detected broken, an alarm will be issued with a specified delay, which must be longer than the time when a trip contact is closed to the time when the breaker status is clearly recognized by the relay.

NOTICE!



In Slot 1 has 2 digital inputs, each of which has a separate root (contact separation) for the trip circuit supervision.

NOTICE!



This Notice applies to protective devices that offer control functionality only! This protective element requires, that a switchgear (circuit breaker is assigned to it.

In this case, the trip circuit supply voltage serves also as supply voltage for the digital inputs and so the supply voltage failure of a trip circuit can be detected directly.

In order to identify a conductor failure in the trip circuit on the supply line or in the trip coil, the off-coil has to be looped-in to the supervision circuit.

The time delay is to be set in a way that switching actions cannot cause false trips in this module.

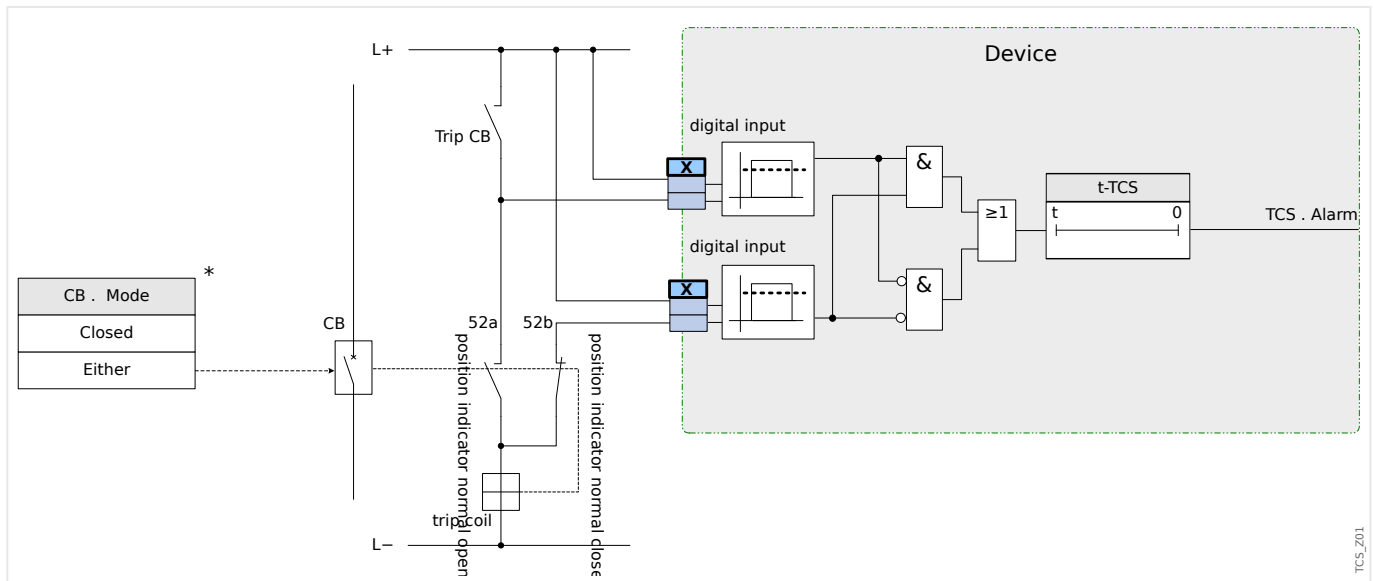

Fig. 86: Connection example: Trip circuit supervision with two CB auxiliary contacts »Aux ON« (52a) and »Aux OFF« (52b).

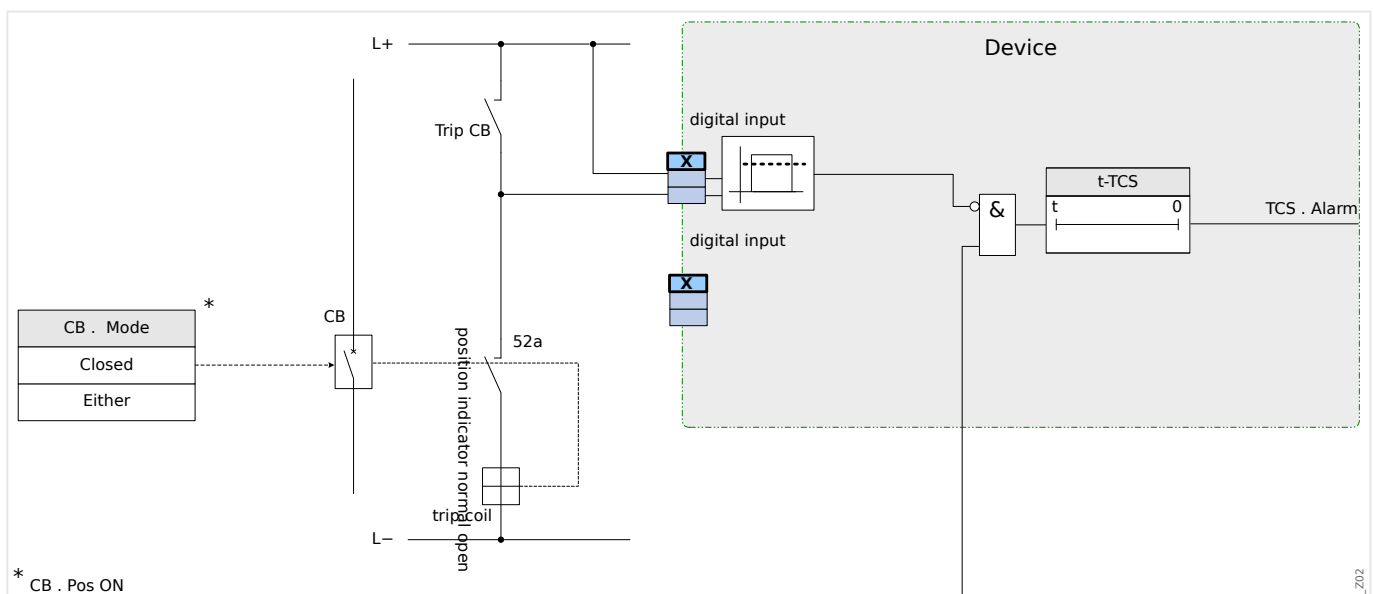

Fig. 87: Connection example: Trip circuit supervision with only one CB auxiliary contact »Aux ON« (52a).

4.20.2.1 Commissioning: Trip Circuit Supervision [74TC]

NOTICE!



For CBs that trip by means of little energy (e. g. via an optocoupler), it has to be ensured that the current applied by the digital inputs will not cause false tripping of the CB.

Object to be tested

Test of the trip circuit supervision.

Procedure, part 1

Simulate failure of the control voltage in the power circuits.

Successful test result, part 1

After expiry of »t-TCS« the trip circuit supervision TCS of the device should signal an alarm.

Procedure, part 2

Simulate a broken cable in the CB control circuit.

Successful test result, part 2

After expiry of »t-TCS« the trip circuit supervision TCS of the device should signal an alarm.

4.20.3 CTS - Current Transformer Supervision [60L]

Wire breaks and failures within measuring circuits cause current transformer failures.

The module »CTS« can detect a failure of the CT if the calculated earth current does not match the measured one. If an adjustable threshold value (Difference of measured and calculated earth current) is exceeded, a CT failure can be assumed. This is signaled through a message/alarm.

The precondition is that the conductor currents are measured by the device and the earth current, for instance, by a ring core type current transformer.

The measuring principles of the circuit supervision are based on comparing the measured and the calculated residual currents:

In an ideal case these are:

$$(\vec{I}_{L1} + \vec{I}_{L2} + \vec{I}_{L3}) + KI * \vec{I}_G = 3 * I_0 + KI * \vec{I}_G = 0$$

KI represents a correction factor which takes the different transformation ratio of the phase- and earth current transformers into account. The device automatically calculates this factor from the rated field parameters, i.e. the relation between the rated primary and secondary current values of the phase- and earth current transformers.

For compensating the current proportional ratio error of the measuring circuits, the dynamic correction factor Kd can be used. As a function of the measured max. current this factor is considering the linear rising measuring error.

The limiting value of the CT supervision is calculated as follows:

DI = deviation I (rated value)

Kd = correction factor

I_{max} = current maximum

Limiting value = DI + Kd x I_{max}

Precondition for identifying an error

$$3 * \vec{I}_0 + KI * \vec{I}_G \geq \Delta I + Kd * I_{max}$$

The evaluation method of the circuit supervision by using factor Kd can be graphically represented as follows:

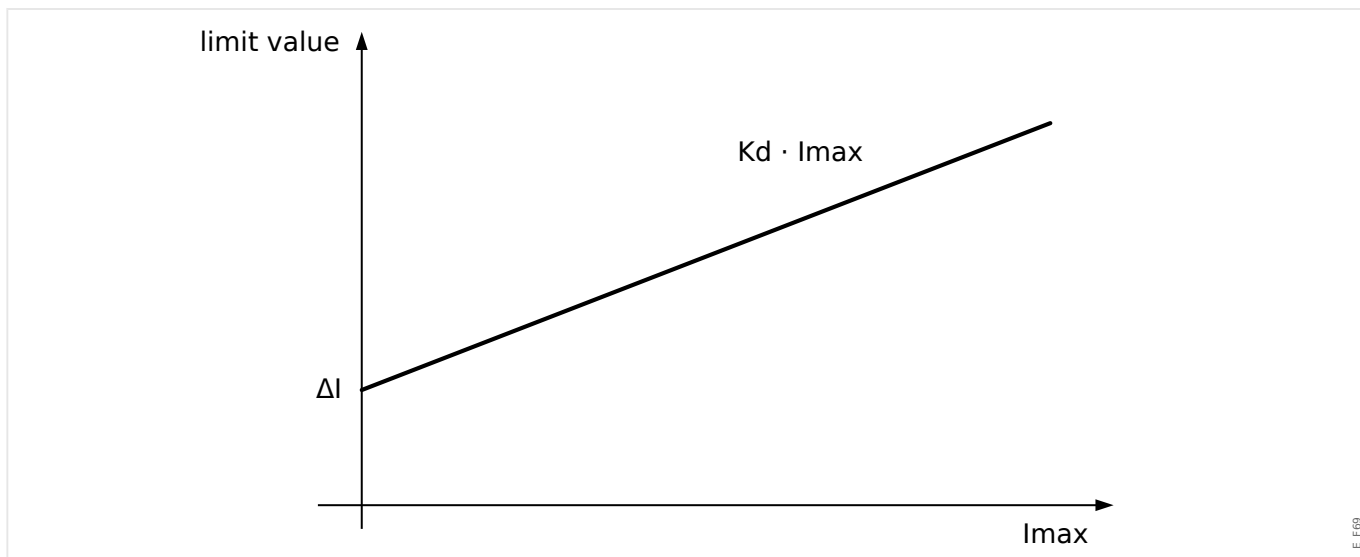

CAUTION!



If the current is measured in two phases only (for instant only IL1/IL3) or if there is no separate earth current measuring (e.g. normally via a cable-type CT), the supervision function should be deactivated.

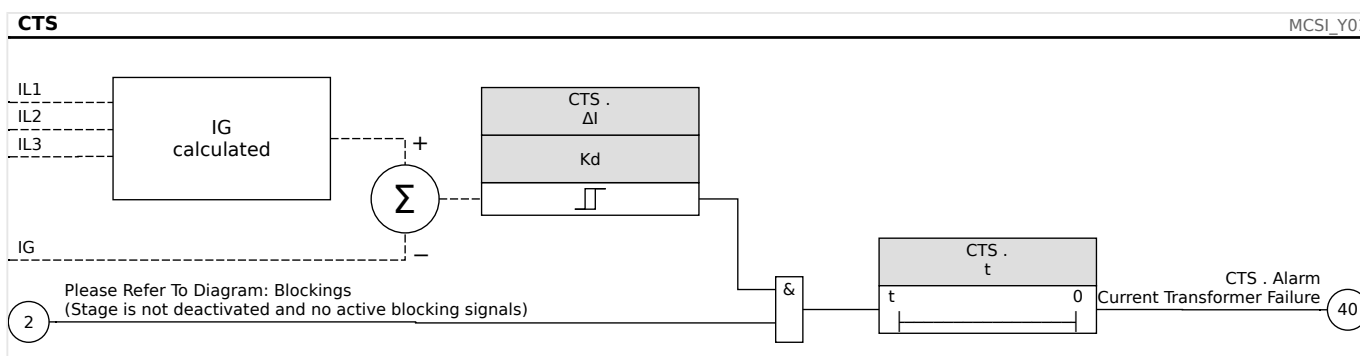

4.20.3.1 Commissioning: Current Transformer Failure Supervision

NOTICE!



Precondition:

- Measurement of all three phase currents (are applied to the measuring inputs of the device); and:
- The earth current is detected via a cable-type transformer (not in Holmgreen connection).

Object to be tested

Check of the CT supervision (by comparing the calculated with the measured earth current).

Necessary means

- Three-phase current source

Procedure, part 1

- Set the limiting value of the CTS to » $\Delta I=0.1 \cdot I_n$ «.
- Feed a three-phase, symmetrical current system (approx. nominal current) to the secondary side.
- Disconnect the current of one phase from one of the measuring inputs (the symmetrical feeding at secondary side has to be maintained).
- Make sure that the signal »CTS.Alarm« is generated now.

Successful test result, part 1

- The signal »CTS.Alarm« is generated.

Procedure, part 2

- Feed a three-phase, symmetrical current system (approx. nominal current) to the secondary side.
- Feed a current that is higher than the threshold value for the measuring circuit supervision to the earth current measuring input.
- Ascertain that the signal »CTS.Alarm« is generated now.

Successful test result, part 2

The signal »CTS.Alarm« is generated.

4.20.4 LOP - Loss of Potential [60]

4.20.4.1 Loss of Potential - Evaluating Measured Quantities

NOTICE!



Ensure that the LOP has enough time to block faulty tripping of modules that use LOP. That means, the delay time of the LOP should to be shorter than the tripping delay of modules that use LOP.

NOTICE!



In case of transformer protection relays the LOP element uses current and voltage measured at the winding side determined by paramter:

[Field Para / VT / VT Winding Side].

The LOP function detects the loss of voltage in any of the voltage input measuring circuits. Faulty tripping of protective elements that take voltage into account can be prevented by means of this supervision element. The following measured values and information to detect an Phase VT Failure condition:

- Three-phase voltages;
- Ratio of negative-to-positive sequence voltages;
- Zero sequence voltage;
- Three-phase currents;
- Residual current (I0);
- Pickup flags from all overcurrent elements; and
- Breaker status (option)

After a set time delay time an Alarm »LOP.LOP Blo« will be issued.

How to set up the Loss of Potential (Evaluating Measured Quantities)

- Set the Alarm Time Delay »t-Alarm«.
- To prevent a malfunction of the VT supervision for a system fault assign Alarms of overcurrent elements that should block the Loss of Potential element.
- It is necessary to set the parameter »LOP.LOP Blo Enable« to »active«. Otherwise the Measuring circuit supervision cannot block elements in case of a loss of potential.

How to make the Loss of Potential (Evaluating Measured Quantities) effective

The Loss of Potential respectively measuring circuit supervision can be used to block protective elements like undervoltage protection in order to prevent faulty tripping.

- Set the parameter »Measuring Circuit Supervision=active« within those protective elements that should be blocked by the Loss of Potential supervision.

4.20.4.2 Loss of Potential - Fuse Failure

VT Supervision via digital inputs (Fuse Failure)

The module »LOP« is capable of detecting a fuse failure at the secondary side of the VTs as long as the automatic circuit breakers of the VTs are connected with the device via a digital input and if this input is assigned to the module »LOP«.

Setting the Parameters for detecting a fuse failure (FF) of a phase voltage transformer

In order to detect a fuse failure of a phase voltage transformer via digital input, please proceed as follows:

- Assign a digital input onto the parameter »LOP.Ex FF VT« that represents the state of the automatic circuit breaker of the phase voltage transformer.
- Set the parameter »Measuring Crcuit Supervison=active« within all those protective elements, that should be blocked by a fuse failure.

Setting the Parameters for detecting a fuse failure (FF) of a earth phase voltage transformer

In order to detect a fuse failure of a phase voltage transformer via digital input, please proceed as follows:

- Assign a digital input onto the parameter »LOP.Ex FF EVT« that represents the state of the automatic circuit breaker of the phase voltage transformer.
- Set the parameter »Measuring Crcuit Supervison=active« within all those protective elements, that should be blocked by a fuse failure.

4 Protective Elements
4.20 Supervision

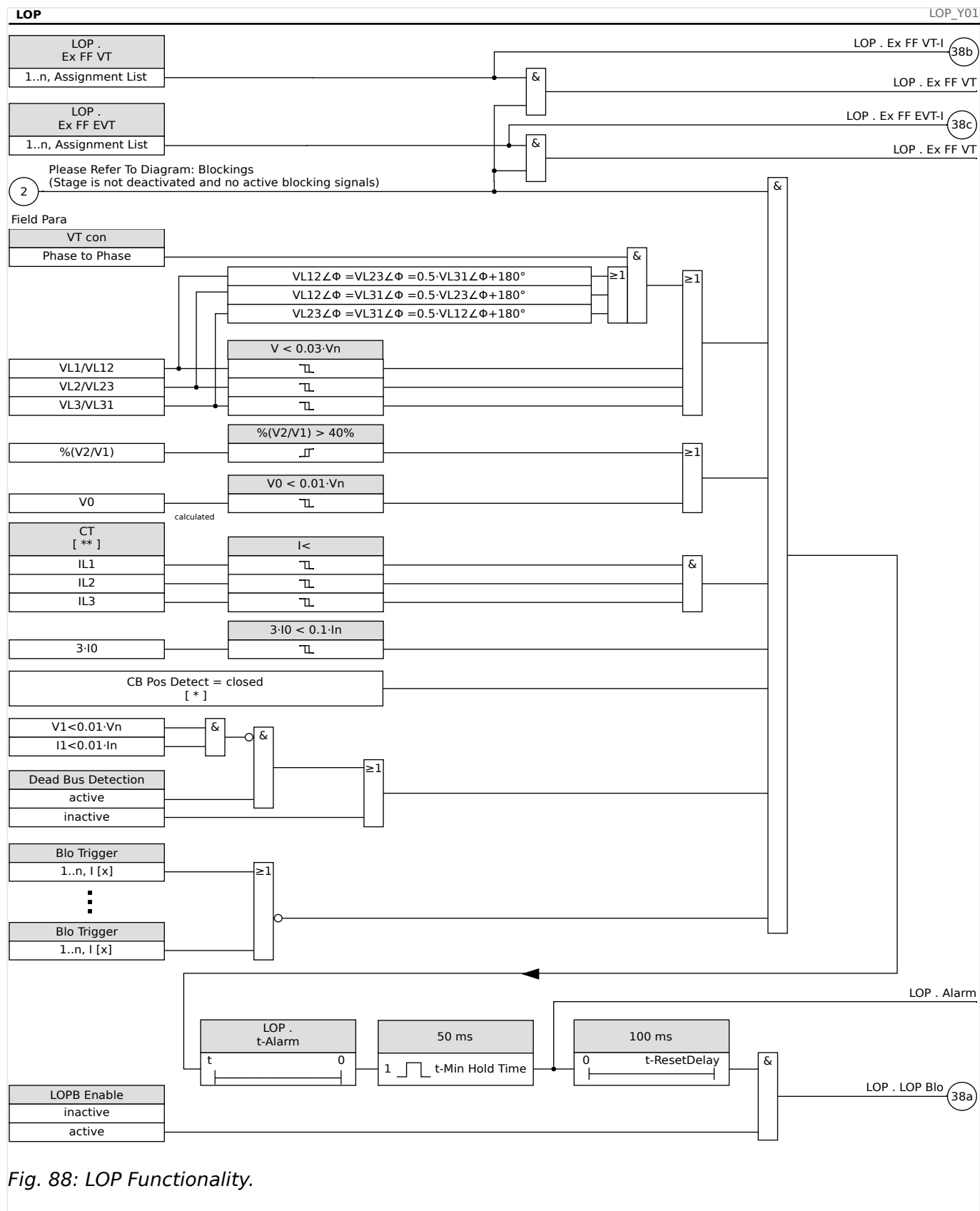

Fig. 88: LOP Functionality.

Notes:

- [*] The breaker position is not taken into account if no breaker is selected/assigned.

- **[**]** For devices with more than one CT, "CT" denotes the one at the side to which the VT is connected.

4.20.4.3 Commissioning: Loss of Potential

Object to be tested

Test of the module LOP.

Necessary means

- Three-phase current source
- Three-phase voltage source.

Procedure, Test part 1

Examine if the output signal »LOP Blo « becomes true if:

- Any of the three-phase voltages becomes less $0.01 \cdot V_n$ Volt
- The residual voltage is less than $0.01 \cdot V_n$ Volt or the $\%V_2/V_1$ ratio is greater 40%
- All three-phase currents are less than the load current / overcurrent detection ($I <$) threshold.
- The residual current is less than 0.1 Ipu (rated current)
- No pickup of an OC element which should blocks VT Supervision
- The breaker is closed (option, if a breaker is assigned).
- The offline detection has not detected a dead busbar (No current, no voltage measured).

Successful test result part 1:

The output signals only become true if all the above mentioned conditions are fulfilled.

Procedure, Test part 2

Set the parameter »Measuring Circuit Supervision=active« within those protective elements that should be blocked by the Loss of Potential supervision (like undervoltage protection, voltage controlled overcurrent protection...).

Check those protective elements if they are blocked if the Loss of Potential supervision has generated a block command.

Successful test result part 2:

All protective elements that should be blocked in case of Loss of Potential supervision are blocked if the conditions (Procedure part 1) are fulfilled.

4.20.4.4 Commissioning: Loss of Potential (FF via DI)

Object to be tested

Check if the auto fuse failure is correctly identified by the device.

Procedure

- Turn off the automatic circuit breaker of the VTs (all poles to be dead)

Successful test result:

- The state of the respective digital input changes.
- All protective elements are blocked which should not have an unwanted operation caused by a fuse failure »Measuring Circuit Supervision=active«.

4.20.5 Phase Sequence Supervision

The MRMV4 calculates the phase sequence at each measuring input (based on positive-sequence and negative-sequence components). The calculated phase sequence (i. e. „ACB“ or „ABC“) is permanently compared with the setting that has been made at [Field Para / General Settings] »Phase Sequence«.

The menu [Operation / Status Display / Supervision / Phase Sequence] contains a specific (warning) signal for each CT and VT. If the check of a CT / VT finds that the actual phase sequence is different from the setting under [Field Para] then the respective signal becomes true (active).

But note that for motor protection applications, there is the setting [Field Para / Motor Nominal Values] »Reversing« which allows (if set to “active”) or interdicts (if set to “inactive”) the reversed phase sequence for a motor start. This means: With the setting value “active”, both phase sequences are permissible, so that the »Phase seq. wrong« signal is never issued. In other words, the phase sequence supervision is useful only for the setting »Reversing« = “inactive”.

In general, the phase sequence supervision is useful during commissioning of the MRMV4 because it helps making sure that the »Phase Sequence« setting under [Field Para] is correct.

WARNING!



The supervision requires minimum values for the current (in case of a CT), or for the voltage (in case of a VT, respectively), otherwise the phase sequence cannot be reliably determined.

- For a VT: The minimum voltage is $0.1 \cdot V_n$.
- For a CT: The minimum current is $0.1 \cdot I_n$.

5 Control / Switchgear-Manager

WARNING!



Misconfiguration of switchgear could result in death or serious injury. This e. g. is the case when opening a disconnector under load or when switching a ground connector to live parts of a system.

Beside protection functions, protective relays more and more will take care about controlling switchgear, like breakers, load break switches, disconnectors and ground connectors.

A correct configuration of all switchgear is an indispensable precondition for the proper functioning of the protective device. This also is the case, when the switchgear are not controlled, but supervised only.

Single-Line Diagram

The single-line diagram includes the graphical description of the breaker and its designation (name) as well as its features (short-circuit proof or not ...). For displaying in the device's software, the switchgears' designations (e. g. **QA1**, **QA2**, instead of some abstract module name »SG[x]«) are taken from the single-line diagram (configuration file).

Beside switching properties a configuration file also includes a single line-diagram. Switching properties and single-line diagram are coupled via the the configuration file. Since the single-line diagram is independent of the device type, a new/other single line diagram can be imported into the configuration file.

NOTICE!



Whenever a configuration file is loaded into a protection device, a single line diagram will be always loaded at the same time.

This means, whenever a configuration file is transferred from one to another device, a suitable single-line diagram has to be loaded by means of the [Device planning] menu.

The user can create and modify Single Lines (pages) by means of the *Page Editor*. The Single Lines (Control Pages) have to be loaded into the protective device by means of *Smart view*. For details on the creation, modification and upload of Single Lines (Control Pages) please refer to the *Page Editor* manual (or contact the technical support). The *Page Editor* manual can be simply accessed via the *Page Editor*'s help menu.

5.1 Switchgear Control

Representation of a Switchgear in the Page Editor

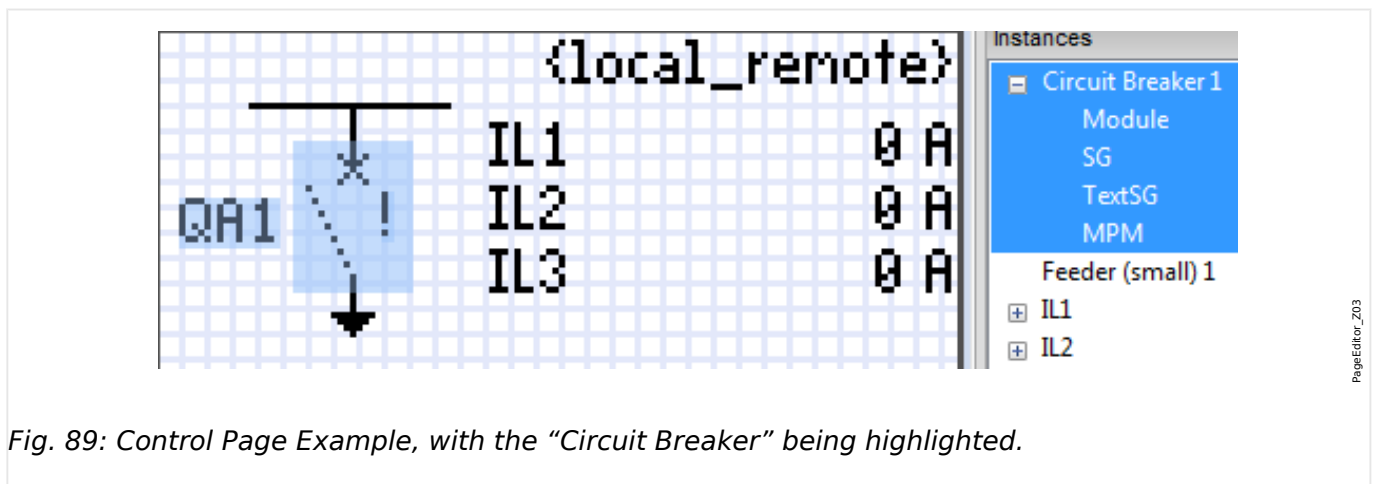

Fig. 89: Control Page Example, with the “Circuit Breaker” being highlighted.

Although a switchgear always appears using a fixed representation in the *Page Editor*, with an exclamation mark “!” being placed aside, this symbol features several representations: one for the closed switchgear, one for the open switchgear, one for the intermediate and faulty positions.

Once the single-line has been transferred to the protection device the switchgear is shown using the representation according to the configured position indication.

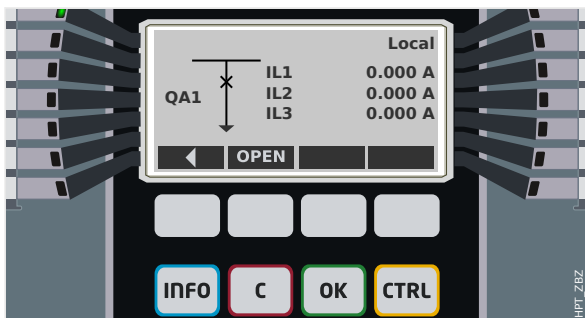

Fig. 90: Control Page Example, with the “Circuit Breaker” in closed position.

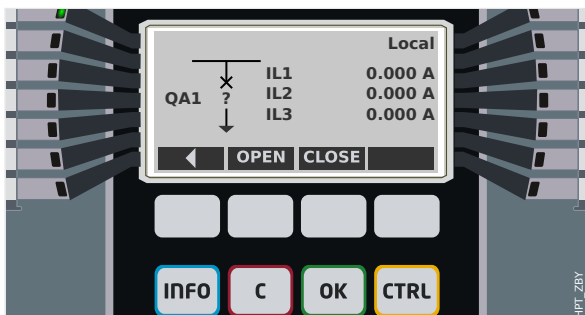

Fig. 91: Control Page Example, with the “Circuit Breaker” in faulty (or implausible) position.

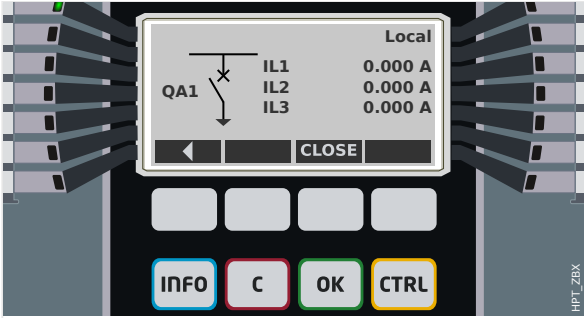

Fig. 92: Control Page Example, with the “Circuit Breaker” in open position.

Switchgear with the Property “Break Capability”

For each switchgear you can define in the *Page Editor* the “**Break Capability**” property. If this is set then you declare that the switchgear is a circuit breaker, that is capable to switch off the phase currents in case of a protection trip.

Therefore the MRMV4 makes the *Trip Manager* available only for switchgears with “Break Capability”. (For details about the Trip Manager, see [↳ “5.2 Trip Manager - Assignment of commands”](#).)

NOTICE!



HighPROTEC devices require that the first switching device, »SG[1]«, must have the “**Break Capability**” property set, because this is the switchgear to which a protection trip command is routed by default.

A Control Page without “Break Capability” for »SG[1]« will not pass the compatibility check in the *Page Editor*.

“Controlled” Switchgear

For each switchgear you can define in the *Page Editor* the “**Controlled**” property. If this is set then it shall be possible for the protection device to execute manual switching commands for the switchgear.

If this property is not set, but the “Break Capability” is set, then the switchgear can still be used for **protection** trip commands. However, it will not be available for manual switching operations.

If neither “Break Capability” nor “Controlled” is set then the switchgear is only monitored, i.e. the status / position is available, but it is not meant to be actively used by the protection device.

Changing the Order of the Switchgear in the Page Editor

This chapter is only relevant for devices with more than one switching device.

In general, the configured switching devices are presented by their user-defined names. This applies also to their representation on the HMI of the protective device and the dialogs within *Smart view*.

An exception to this representation are the switching device names in the SCADA protocols. SCADA protocols do not know the user-defined names of the switching devices, they are addressed via the number of the switchgear.

Therefore the *Page Editor* allows for changing the assignment to a particular switchgear number: Select the menu item [Configuration / Switching Device Order...] (keyboard-shortcut: »F6«). This opens a dialog window where all configured switchgear devices are listed with their respective number. After selecting any of these, buttons »Up« and »Down« can be used to modify the order.

NOTICE!



Due to application requirements the switching device number 1 should have enabled Break Capabilities. Other switching devices, if available, may be of arbitrary type.

The assignment of a switching device number to a type is checked by *Smart view*: A warning is displayed if the exchange of the user-defined Control Page changes the switching device type of any switching device number. This warning can be confirmed if the modification of the switching device type has been done by intention.

5.1.1 Settings within the Protection Device

Assignment of Position Indications (Digital Inputs)

Settings in the device menu [Control / SG / SG[x] / Pos Indicators Wiring]:

- »Aux ON« — The CB is in ON-position if the state of the assigned signal is true (52a).

Exception: For the **Earthing Switch part of the “Three Position Switch”**, this is called: »Aux GROUND« — The switchgear is in Earth-position if the state of the assigned signal is true.
- »Aux OFF« — The CB is in OFF-position if the state of the assigned signal is true (52b).

Exception: For the **“Disconnecter-Earthing Combination”**, this is called: »Aux GROUND« — The switchgear is in Earth-position if the state of the assigned signal is true.
- »Ready« — Circuit breaker is ready for operation if the state of the assigned signal is true. This digital input can be used by some protective elements (if they are available within the device) like Auto Reclosure (AR), e.g. as a trigger signal.
- »Removed« — The withdrawable circuit breaker is Removed

Setting of Supervision Timers

Settings in the device menu [Control / SG / SG[x] / General Settings]:

- »t-Move ON« — Time to move to the ON Position
- »t-Move OFF« — Time to move to the OFF Position

Assignment of Commands to Output Relays

Only available if the switchgear has been set **“Controlled”** in the *Page Editor* (see  [“5.1 “Controlled” Switchgear”](#)).

Settings in the device menu [Device Para / Binary Outputs / BO Slot Xx / BO y]:

- »Assignment 1« ... »Assignment 7« — for example for switchgear number 1 settable to “SG[1] . ON Cmd” / “SG[1] . OFF Cmd”

For details, see  [“Control / Switchgear-Manager”](#).

Optional: External OPEN/CLOSE Command

Only available if the switchgear has been set **“Controlled”** in the *Page Editor* (see  [“5.1 “Controlled” Switchgear”](#)).

Settings in the device menu [Control / SG / SG[x] / Ex ON/OFF Cmd]:

- »SCmd ON« — Switching ON Command, e.g. the state of the Logics or the state of the digital input
- »SCmd OFF« — Switching OFF Command, e.g. the state of the Logics or the state of the digital input

For details, see  [“5.2 Ex CLOSE / OPEN”](#).

Interlockings

Only available if the switchgear has been set “**Controlled**” in the *Page Editor* (see [↪](#) “5.1 “Controlled” Switchgear”).

Settings in the device menu [Control / SG / SG[x] / Interlockings]:

- »*Interl ON1*« ... »*Interl ON3*« — Interlocking of the ON command (i. e. close commands are rejected if the assigned signal is true).
- »*Interl OFF1*« ... »*Interl OFF3*« — Interlocking of the OFF command (i. e. open commands are rejected if the assigned signal is true).

For details, see [↪](#) “5.2 Interlockings”.

Trip Manager (Assignment of Trip Commands)

Only available if the property “**Break Capability**” has been set for this switchgear in the *Page Editor*.

Settings in the device menu [Control / SG / SG[x] / Trip Manager]:

- »*Off Cmd1*« ... — Off Command to the Circuit Breaker if the state of the assigned signal becomes true.
- »*t-TripCmd*« — Minimum hold time of the OFF-command (circuit breaker, load break switch)
- »*Latched*« — Defines whether the Trip Command is latched.
- »*Ack TripCmd*« — Acknowledgment of the Trip Command



For details, see [↪](#) “5.1 Switchgear with the Property “Break Capability”” and [↪](#) “5.2 Trip Manager - Assignment of commands”.

Optional: Switchgear Wear

See [↪](#) “Switchgear Wear”.

5.1.2 Switch

Generic switching device.

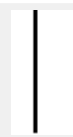
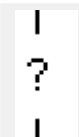
[Operation / Status Display / Control / SG[x]] »Pos«			
= 0 (Pos Indeterm)	= 1 (Pos OFF)	= 2 (Pos ON)	= 3 (Pos Disturb)
			

Assignment of Position Indications (Digital Inputs)

See [↪](#) “5.1.1 Assignment of Position Indications (Digital Inputs)”. These settings are available in the device menu:

[Control / SG / SG[x] / Pos Indicatr Wirng]			
»Aux ON«	»Aux OFF«	»Ready«	»Removed«
✓	✓	✓	✓

5.1.3 Invisible Switch

Switching device which is not visible on the single-line diagram, but available in the protection device.

(Since it is not existing on the single-line, it cannot be selected via the HMI (panel), and therefore cannot be operated manually.)

[Operation / Status Display / Control / SG[x]] »Pos«			
= 0 (Pos Indeterm)	= 1 (Pos OFF)	= 2 (Pos ON)	= 3 (Pos Disturb)
(Invisible)			





Assignment of Position Indications (Digital Inputs)

See  "5.1.1 Assignment of Position Indications (Digital Inputs)". These settings are available in the device menu:

[Control / SG / SG[x] / Pos Indicatrs Wirng]			
»Aux ON«	»Aux OFF«	»Ready«	»Removed«
✓	✓	✓	✓

5.1.4 Circuit Breaker

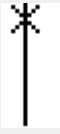
Switching device, capable of making, carrying and breaking currents under normal conditions and also making, carrying for a specified duration and breaking currents under specified abnormal conditions (e.g. short circuit).

[Operation / Status Display / Control / SG[x]] »Pos«			
= 0 (Pos Indeterm)	= 1 (Pos OFF)	= 2 (Pos ON)	= 3 (Pos Disturb)
			





Assignment of Position Indications (Digital Inputs)

See [↪](#) “5.1.1 Assignment of Position Indications (Digital Inputs)”. These settings are available in the device menu:

[Control / SG / SG[x] / Pos Indicatr Wirng]			
»Aux ON«	»Aux OFF«	»Ready«	»Removed«
✓	✓	✓	✓

5.1.5 Circuit Breaker1

Switching device, capable of making, carrying and breaking currents under normal conditions and also making, carrying for a specified duration and breaking currents under specified abnormal conditions (e.g. short circuit).

[Operation / Status Display / Control / SG[x]] »Pos«			
= 0 (Pos Indeterm)	= 1 (Pos OFF)	= 2 (Pos ON)	= 3 (Pos Disturb)
			





Assignment of Position Indications (Digital Inputs)

See  "5.1.1 Assignment of Position Indications (Digital Inputs)". These settings are available in the device menu:

[Control / SG / SG[x] / Pos Indicatr's Wirng]			
»Aux ON«	»Aux OFF«	»Ready«	»Removed«
✓	✓	✓	✓

5.1.6 Disconnecter (Isolator)

Switching device which provides, in the open position, an isolating distance.

[Operation / Status Display / Control / SG[x]] »Pos«			
= 0 (Pos Indeterm)	= 1 (Pos OFF)	= 2 (Pos ON)	= 3 (Pos Disturb)
			



Assignment of Position Indications (Digital Inputs)

See [↪](#) “5.1.1 Assignment of Position Indications (Digital Inputs)”. These settings are available in the device menu:

[Control / SG / SG[x] / Pos Indicatr Wirng]			
»Aux ON«	»Aux OFF«	»Ready«	»Removed«
✓	✓	—	—

5.1.7 Disconnecter-Earthing Combination

A switch which combines a disconnecter and an earthing switch. This switch has two positions (connected - earthed).

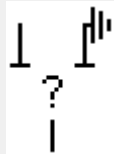
[Operation / Status Display / Control / SG[x]] »Pos«			
= 0 (Pos Indeterm)	= 1 (Pos OFF)	= 2 (Pos ON)	= 3 (Pos Disturb)
			





Assignment of Position Indications (Digital Inputs)

See  "5.1.1 Assignment of Position Indications (Digital Inputs)". These settings are available in the device menu:

[Control / SG / SG[x] / Pos Indicatr Wirng]			
»Aux ON«	»Aux GROUND«	»Ready«	»Removed«
✓	✓	—	—

5.1.8 Earthing Switch

Earthing Switch with short-circuit making capacity.

[Operation / Status Display / Control / SG[x]] »Pos«			
= 0 (Pos Indeterm)	= 1 (Pos OFF)	= 2 (Pos ON)	= 3 (Pos Disturb)
			





Assignment of Position Indications (Digital Inputs)

See [↪](#) “5.1.1 Assignment of Position Indications (Digital Inputs)”. These settings are available in the device menu:

[Control / SG / SG[x] / Pos Indicatrs Wirng]			
»Aux ON«	»Aux OFF«	»Ready«	»Removed«
✓	✓	—	—

5.1.9 Fuse-Load Switch

Switching device capable of making, carrying and breaking normal currents, in which a fuse-link forms the moving contact.

[Operation / Status Display / Control / SG[x]] »Pos«			
= 0 (Pos Indeterm)	= 1 (Pos OFF)	= 2 (Pos ON)	= 3 (Pos Disturb)
			

Assignment of Position Indications (Digital Inputs)





See  "5.1.1 Assignment of Position Indications (Digital Inputs)". These settings are available in the device menu:

[Control / SG / SG[x] / Pos Indicatr's Wirng]			
»Aux ON«	»Aux OFF«	»Ready«	»Removed«
✓	✓	✓	✓

5.1.10 Fuse-Load Switch - Disconnecter

Switching device capable of making, carrying and breaking normal currents.

Satisfies in the open position the isolating requirements for a disconnecter, in which a fuse-link forms the moving contact.

[Operation / Status Display / Control / SG[x]] »Pos«			
= 0 (Pos Indeterm)	= 1 (Pos OFF)	= 2 (Pos ON)	= 3 (Pos Disturb)
			





Assignment of Position Indications (Digital Inputs)

See [↳](#) “5.1.1 Assignment of Position Indications (Digital Inputs)”. These settings are available in the device menu:

[Control / SG / SG[x] / Pos Indicatrns Wirng]			
»Aux ON«	»Aux OFF«	»Ready«	»Removed«
✓	✓	✓	✓

5.1.11 Fused-Disconnecter (Isolator)

Switching device which provides, in the open position, an isolating distance, in which a fuse-link forms the moving contact.

[Operation / Status Display / Control / SG[x]] »Pos«			
= 0 (Pos Indeterm)	= 1 (Pos OFF)	= 2 (Pos ON)	= 3 (Pos Disturb)
			





Assignment of Position Indications (Digital Inputs)

See  "5.1.1 Assignment of Position Indications (Digital Inputs)". These settings are available in the device menu:

[Control / SG / SG[x] / Pos Indicatr's Wirng]			
»Aux ON«	»Aux OFF«	»Ready«	»Removed«
✓	✓	—	—

5.1.12 Load Switch

Switching device capable of making, carrying and breaking normal currents.

[Operation / Status Display / Control / SG[x]] »Pos«			
= 0 (Pos Indeterm)	= 1 (Pos OFF)	= 2 (Pos ON)	= 3 (Pos Disturb)
			

Assignment of Position Indications (Digital Inputs)

See [↪](#) “5.1.1 Assignment of Position Indications (Digital Inputs)”. These settings are available in the device menu:

[Control / SG / SG[x] / Pos Indicatr Wirng]			
»Aux ON«	»Aux OFF«	»Ready«	»Removed«
✓	✓	✓	✓

5.1.13 Load Switch - Disconnecter

Switching device capable of making, carrying and breaking normal currents.

Satisfies in the open position the isolating requirements for a disconnecter.

[Operation / Status Display / Control / SG[x]] »Pos«			
= 0 (Pos Indeterm)	= 1 (Pos OFF)	= 2 (Pos ON)	= 3 (Pos Disturb)

Assignment of Position Indications (Digital Inputs)

See [↪](#) “5.1.1 Assignment of Position Indications (Digital Inputs)”. These settings are available in the device menu:

[Control / SG / SG[x] / Pos Indicatrs Wirng]			
»Aux ON«	»Aux OFF«	»Ready«	»Removed«
✓	✓	✓	✓

5.1.14 Three Position Switch

A switch which combines a disconnecter and an earthing switch. This switch has three positions (connected - disconnected - earthed) and is intrinsically safe against maloperation.

[Operation / Status Display / Control / ...]				
[... / SG[1]] »Pos« = 0 (Pos Indeterm)	[... / SG[1]] »Pos« = 2 (Pos ON)	[... / SG[1]] »Pos« = 1 (Pos OFF)	[... / SG[1]] »Pos« = 1 (Pos OFF)	[... / SG[1]] »Pos« = 3 (Pos Disturb)
[SG[2]] »Pos« = 0 (Pos Indeterm)	[SG[2]] »Pos« = 1 (Pos OFF)	[SG[2]] »Pos« = 1 (Pos OFF)	[SG[2]] »Pos« = 2 (Pos GROUND)	[SG[2]] »Pos« = 3 (Pos Disturb)

The “Three Position Switch” is composed of two switchgears. One switchgear corresponds to the disconnecter of the “Three Position Switch”, and the second switchgear corresponds to the earthing switch.

The separation into two switchgears makes switching from the »Pos ON«-position via the »Pos OFF«-position into the »Pos GROUND«-position available.

From security aspects there are two clear switch positions »Isolating« and »Earth«. Thanks to this separation, individual supervision and switching timers for the earthing and isolating part can be set. In addition to that individual interlockings and device names (designations) can be set for the earthing and the isolating part.

NOTICE!

!

The Command Execution Supervision will issue the following message in case of a switching attempt from the earthing position (directly) into the isolator position and vice versa:

- [Operation / Status Display / Control / SG[x]] »CES SwitchDir«

The “Pos GROUND” position of the “Three Position Switch” is shown as “CB POS OFF” within the SCADA documentation (register maps)

Assignment of Position Indications (Digital Inputs)

See [↪](#) “5.1.1 Assignment of Position Indications (Digital Inputs)”. These settings are available in the device menu:

Disconnector, e. g. »SG[1]«:			
[Control / SG / SG[1] / Pos Indicatrns Wirng]			
»Aux ON«	»Aux OFF«	»Ready«	»Removed«
✓	✓	✓	✓

Earthing Switch, e. g. »SG[2]«:

[Control / SG / SG[2] / Pos Indicatrns Wirng]

»Aux GROUND«	»Aux OFF«	»Ready«	»Removed«
✓	✓	—	—

5.1.15 Withdrawable Circuit Breaker

Truck mounted (“Draw-Out”) circuit breaker.

[Operation / Status Display / Control / SG[x]]				
»Pos« (*) (*) the same value for both switchgears - see also remark below.				»Removed«
= 0 (Pos Indeterm)	= 1 (Pos OFF)	= 2 (Pos ON)	= 3 (Pos Disturb)	= 1

(*) Remark: The table above does not list all combinations of positions that are technically possible for the two switchgears, but only some typical “end positions” are shown as examples.

The “Withdrawable Circuit Breaker” is composed of two switchgears. One switchgear corresponds to the circuit breaker, and the second switchgear corresponds to the movable truck.

There is no fixed connection between the circuit breaker and the truck. An interlocking has to be set by the user because it is not allowed to withdraw the circuit breaker as long as it is in the closed position. The circuit breaker can be switched in the withdrawn and in the non-withdrawn position. The signals of the control circuit (low voltage) plug have to be wired and configured within the protective device. The control (supervision) is set to »Removed« when the control circuit plug is removed. The circuit breaker is set into the »Pos OFF«-position as long as the »Removed«-signal is active.

NOTICE!

It is not possible to manipulate the position signals of a withdrawn (removed) circuit breaker.

Assignment of Position Indications (Digital Inputs)

See [↪ “5.1.1 Assignment of Position Indications \(Digital Inputs\)”](#). These settings are available in the device menu:

Circuit Breaker, e. g. »SG[1]«:			
[Control / SG / SG[1] / Pos Indicatr Wirng]			
»Aux ON«	»Aux OFF«	»Ready«	»Removed«
✓	✓	✓	✓





Movable Truck, e. g. »SG[2]«:

[Control / SG / SG[2] / Pos Indicatrns Wirng]

»Aux ON«	»Aux OFF«	»Ready«	»Removed«
✓	✓	—	—

5.1.16 Withdrawable Fuse Load Switch

Truck mounted fuse load switch.

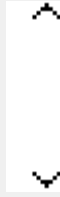
[Operation / Status Display / Control / SG[x]]				
»Pos« (*) (* the same value for both switchgears - see also remark below.)				»Removed«
= 0 (Pos Indeterm)	= 1 (Pos OFF)	= 2 (Pos ON)	= 3 (Pos Disturb)	= 1
				

(*) Remark: The table above does not list all combinations of positions that are technically possible for the two switchgears, but only some typical “end positions” are shown as examples.

The “Withdrawable Fuse Load Switch” is composed of two switchgears. One switchgear corresponds to the fuse load switch, and the second switchgear corresponds to the movable truck.

There is no fixed connection between the fuse load switch and the truck. An interlocking has to be set by the user because it is not allowed to withdraw the fuse load switch as long as it is in the closed position. The circuit breaker can be switched in the withdrawn and in the non-withdrawn position. The signals of the control circuit (low voltage) plug have to be wired and configured within the protective device. The control (supervision) is set to »Removed« when the control circuit plug is removed. The circuit breaker is set into the »Pos OFF«-position as long as the »Removed«-signal is active.

NOTICE!	
	It is not possible to manipulate the position signals of a withdrawn (removed) fuse load switch.

Assignment of Position Indications (Digital Inputs)

See  “5.1.1 Assignment of Position Indications (Digital Inputs)”. These settings are available in the device menu:

Fuse Load Switch, e. g. »SG[1]«:			
[Control / SG / SG[1] / Pos Indicatrns Wirng]			
»Aux ON«	»Aux OFF«	»Ready«	»Removed«
✓	✓	✓	✓

Movable Truck, e. g. »SG[2]«:

[Control / SG / SG[2] / Pos Indicatrns Wirng]

»Aux ON«	»Aux OFF«	»Ready«	»Removed«
✓	✓	—	—

5.2 Switchgear Configuration

Wiring

At first the switchgear positioning indicators have to be connected to the digital inputs of the protection device.

One of the position indicators' contact (either the »Aux CLOSE« or the »Aux OPEN«) **must** be connected necessarily. However, it is recommended to connect both position indicators.

Thereafter the command outputs (relay outputs) have to be connected with the switchgear.

NOTICE!



Please observe the following option: In the general settings of a breaker, the CLOSE/OPEN commands of a protection element can be issued to the same output relays, where the other control commands are issued.

If the commands are issued to different output relays the amount of wiring increases.

Setting of Supervision / Moving Times

In the menu [Control / SG / SG[x] / General Settings] the moving times »*t-Move ON*« and »*t-Move OFF*« of each individual switchgear have to be set.

Dependent on the type of switchgear it can be necessary to set further parameters, like the dwell time »*t-Dwell*«.

NOTICE!



The setting values of the timers »*t-Move ON*« and »*t-Move OFF*« are both monitoring **and** moving times, i. e. these are not only used for deciding about intermediate or faulty positions. In fact, it is important to be aware that also the maximum duration of the switching signal, that is issued to the switchgear, equals these values.

This means: Duration of »ON Cmd« equals »*t-Move ON*« at maximum, being limited by the indication of the switch's new position.

In the same way: Duration of »OFF Cmd« equals »*t-Move OFF*« at maximum, being limited by the indication of the switch's new position.

Assignment of Position Indications

The position indication is needed by the device to get (evaluate) the information about the current status /position of the breaker. The switchgear position indications are shown

in the devices display. Each position change of a switchgear results in a change of the corresponding switchgear symbol.

NOTICE!



It is recommended for the detection of a switchgear's position to always use both positioning indicators! If only one contact is used, no intermediate or disturbed positions can be detected.

A (reduced) transition supervision (time between issue of the command and position feedback indication of the switchgear) is also possible by one Aux contact.

In the menu [Control / SG / SG[x]] the assignments for the position indications have to be set.

*Detection of switchgear position with two Aux contacts - **Aux CLOSE and Aux OPEN (recommended!)***

For detection of their positions switchgear are provided with Aux contacts (Aux CLOSE and Aux OPEN). It is recommended to use both contacts to detect intermediate and disturbed positions too.

The protection device continuously supervises the status of the inputs »Aux ON-I« and »Aux OFF-I«.

These signals are validated based on the supervision timers »*t-Move ON*« and »*t-Move OFF*« validation functions. As a result, the switchgear position will be detected by the following signals:

- »Pos ON«
- »Pos OFF«
- »Pos Indeterm«
- »Pos Disturb«
- »Pos« (Signal: Circuit Breaker Position (0 = Indeterminate, 1 = OFF, 2 = ON, 3 = Disturbed))

Supervision of the CLOSE command

When a CLOSE command is initiated, the »*t-Move ON*« timer is started. While the timer is running, the »Pos Indeterm« state is true. If the command is executed and properly fed back from the switchgear before the timer has elapsed, »Pos ON« becomes true. Otherwise, if the timer has expired without receiving the expected new position indication, »Pos Disturb« becomes true.

Supervision of the OPEN command

When a CLOSE command is initiated, the »*t-Move OFF*« timer is started. While the timer is running, the »Pos Indeterm« state is true. If the command is executed and properly fed back from the switchgear before the timer has elapsed, »Pos OFF« becomes true. Otherwise, if the timer has expired without receiving the expected new position indication, »Pos Disturb« becomes true.

The following table shows how switchgear positions are validated:

States of the Digital Inputs		Validated Breaker Positions				
Aux ON-I	Aux OFF-I	Pos ON	Pos OFF	Pos Indeterm	Pos Disturb	Pos
0	0	0	0	1 (while a Moving timer is running)	0 (while a Moving timer is running)	0 Pos Indeterm
1	1	0	0	1 (while a Moving timer is running)	0 (while a Moving timer is running)	0 Pos Indeterm
0	1	0	1	0	0	1 Pos OFF
1	0	1	0	0	0	2 Pos ON
0	0	0	0	0 (Moving timer elapsed)	1 (Moving timer elapsed)	3 Pos Disturb
1	1	0	0	0 (Moving timer elapsed)	1 (Moving timer elapsed)	3 Pos Disturb

*Single Position Indication **Aux CLOSE or Aux OPEN***

If the single pole indication is used, the »SI SingleContactInd« becomes true.

The moving time supervision works only in one direction. If the Aux OPEN signal is connected to the device, only the "OPEN command" can be supervised and if the Aux CLOSE signal is connected to the device, only the "CLOSE command" can be supervised.

*Single Position Indication - **Aux CLOSE***

If only the Aux CLOSE signal is used for the Status Indication of a "CLOSE command", the switch command will also start the moving time, the position indication indicates an »Pos Indeterm« position during this time interval. When the switchgear reaches the end position indicated by the signals »Pos ON« and »CES succesf« before the timer has elapsed the signal »Pos Indeterm« disappears.

If the moving time elapsed before the switchgear has reached the end position, the switching operation was not successful and the Position Indication changes to »Pos

Disturb« and the signal »Pos Indeterm« disappears. After the moving time has elapsed, the timer »t-Dwell« is started (if set). During this time interval the Position Indication also indicates an »Pos Indeterm« state. When the »t-Dwell« has elapsed the Position Indication changes to »Pos ON«.

The following table shows how breaker positions are validated based on **Aux CLOSE**:

States of the Digital Inputs		Validated Breaker Positions				
Aux ON-I	Aux OFF-I	Pos ON	Pos OFF	Pos Indeterm	Pos Disturb	Pos
0	Not wired	0	0	1 (while »t-Move ON« is running)	0 (while »t-Move ON« is running)	0 Pos Indeterm
0	Not wired	0	1	0	0	1 Pos OFF
1	Not wired	1	0	0	0	2 Pos ON

If there is no digital input assigned to the »Aux CLOSE« contact, the position indication »Pos« has the value 3 (disturbed).

Single Position Indication - Aux OPEN

If only the Aux OPEN signal is used for the monitoring of the "OPEN command", the switch command will start the moving timer. The Position Indication will indicate an »Pos Indeterm« position. When the switchgear reaches its end position before the moving timer elapses, the »Pos OFF« and »CES succesf« signals are issued. At the same time the signal »Pos Indeterm« disappears.

If the moving time has elapsed before the switchgear has reached the OPEN position, the switching operation was not successful and the Position Indication changes to »Pos Disturb« and the signal »Pos Indeterm« disappears.

After the moving time has elapsed, the timer »t-Dwell« is started (if set). During this time interval the Position Indication »Pos Indeterm« is indicated. After the dwell time »t-Dwell« has elapsed, the OPEN position of the switchgear is indicated by the »Pos OFF« signal.

The following table shows how breaker positions are validated based on **Aux OPEN**:

States of the Digital Inputs		Validated Breaker Positions				
Aux ON-I	Aux OFF-I	Pos ON	Pos OFF	Pos Indeterm	Pos Disturb	Pos
Not wired	0	0	0	1 (while »t-Move	0 (while »t-Move	0 Pos Indeterm

States of the Digital Inputs		Validated Breaker Positions				
Aux ON-I	Aux OFF-I	Pos ON	Pos OFF	Pos Indeterm	Pos Disturb	Pos
				OFF« is running)	OFF« is running)	
Not wired	1	0	1	0	0	1 Pos OFF
Not wired	0	1	0	0	0	2 Pos ON

If there is no digital input assigned to the »Aux OPEN« contact, the position indication »Pos« has the value 3 (disturbed).

Interlockings

To avoid faulty operations, interlockings have to be provided. This can be realized mechanically or electrically.

For a controllable switchgear up to three interlockings can be assigned in both switching directions (CLOSE/OPEN). These interlockings prevent switching in the corresponding direction.

The protection OPEN command and the reclosing command of the Automatic Reclosure (AR module, availability depends on the ordered device type) are always executed without interlockings. If a protection OPEN command **must not** be issued, it must be blocked separately.

Further interlockings can be configured by means of the Logic module.

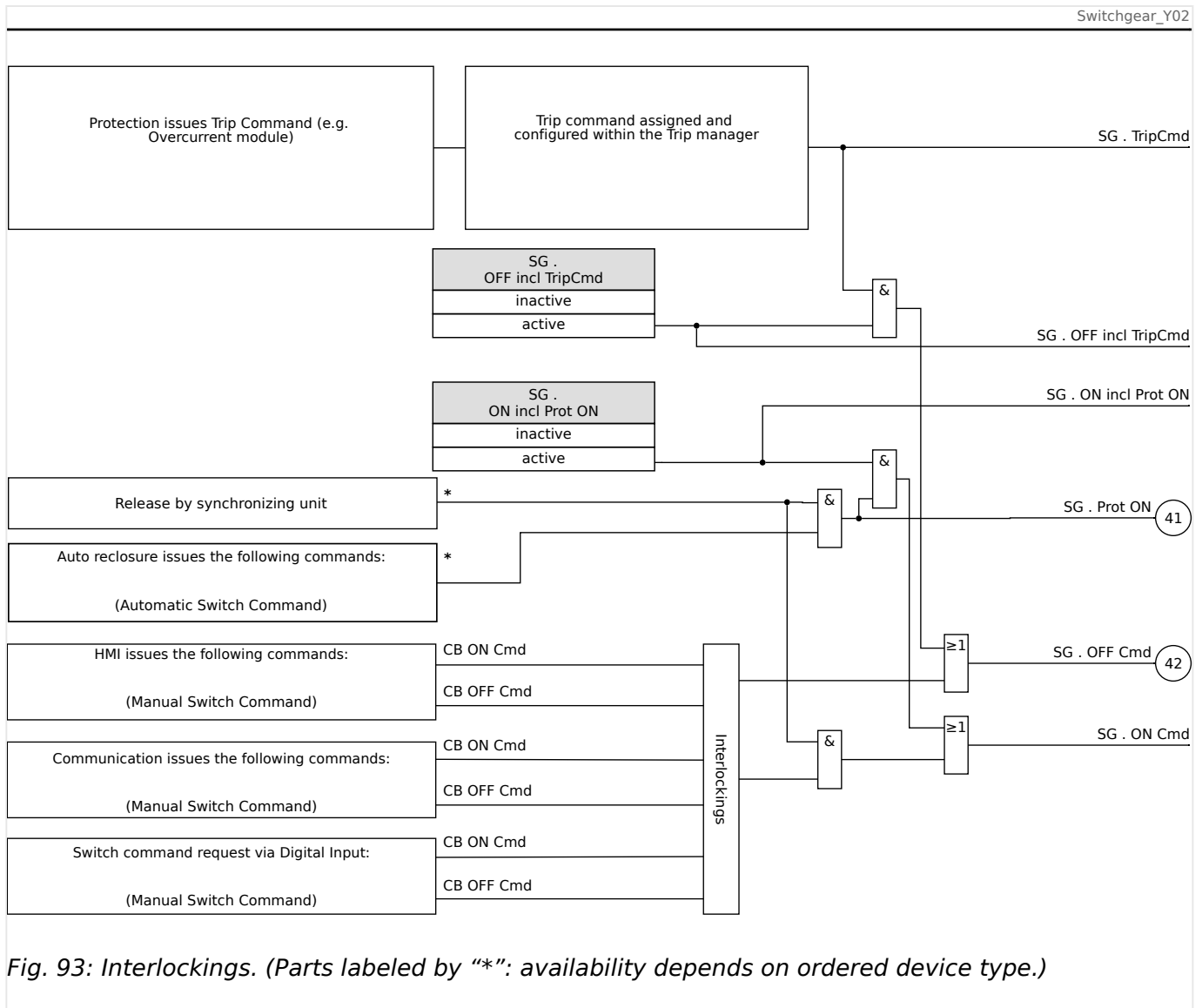

Trip Manager - Assignment of commands

The trip commands of the protection elements have to be assigned to those switchgear, that are make/break capable (Breaker). For every make/break capable switchgear a Trip Manager is provided.

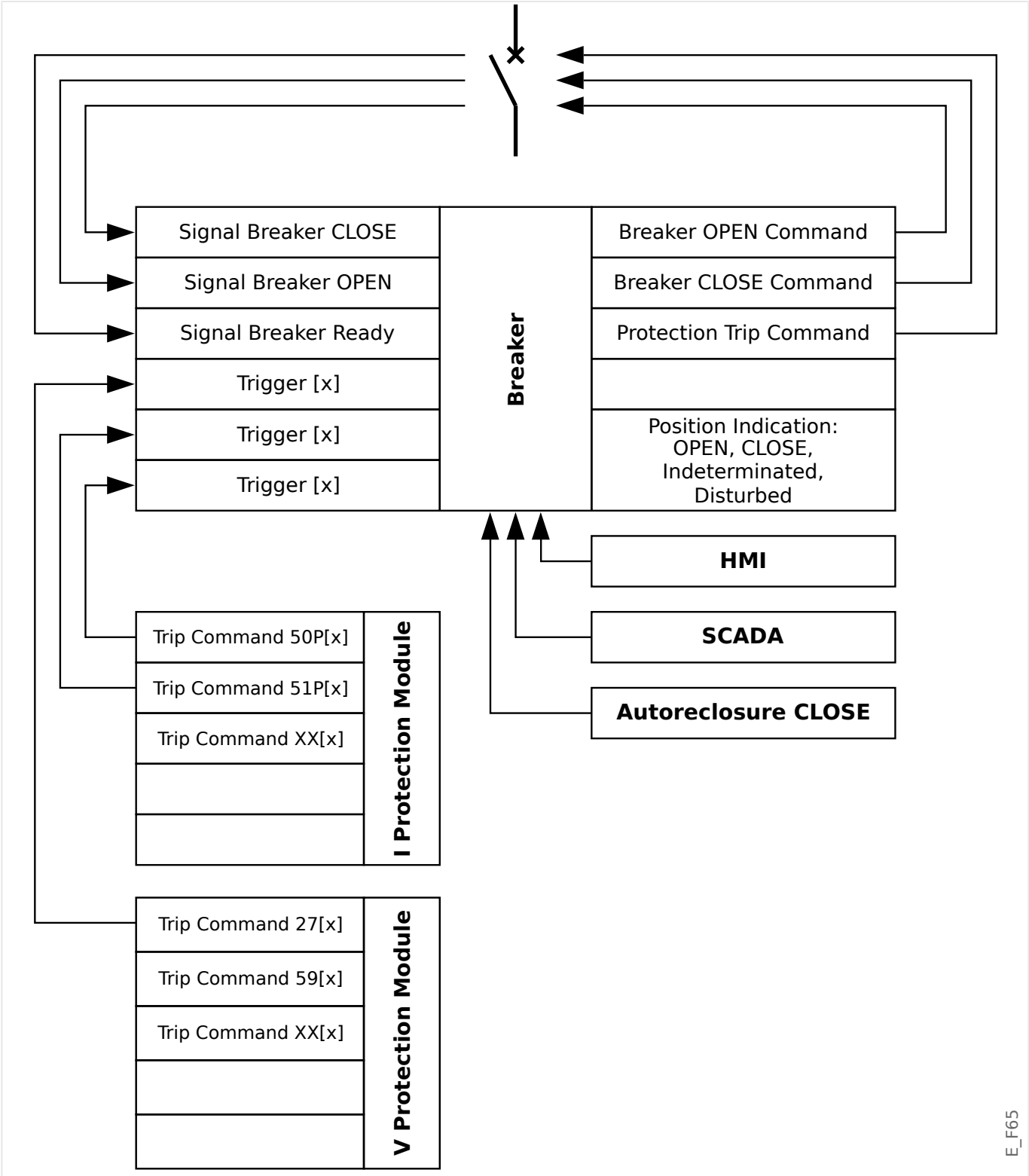

E_F65

In the menu [Control / Qxx / Trip Manager] (where “Qxx” corresponds to the designation of the switchgear, as it is defined in the single-line diagram), there are setting parameters »Off Cmd n«, to which you can assign the protection trip commands. In this so-called Trip Manager, all these assigned protection trip commands are combined by an “OR” logic, which then cause a switchgear trip command to be issued.

Only the switchgear trip command, that is issued by the Trip Manager, is actually sent to the switchgear. This means, that only tripping commands which are assigned in the Trip Manager lead to an operation of the switchgear.

In addition to that, the user can set the minimum hold time of the trip command within this module and define whether the trip command is latched or not (see also section „Latching“ below, [↪ “5.2 Latching”](#)).

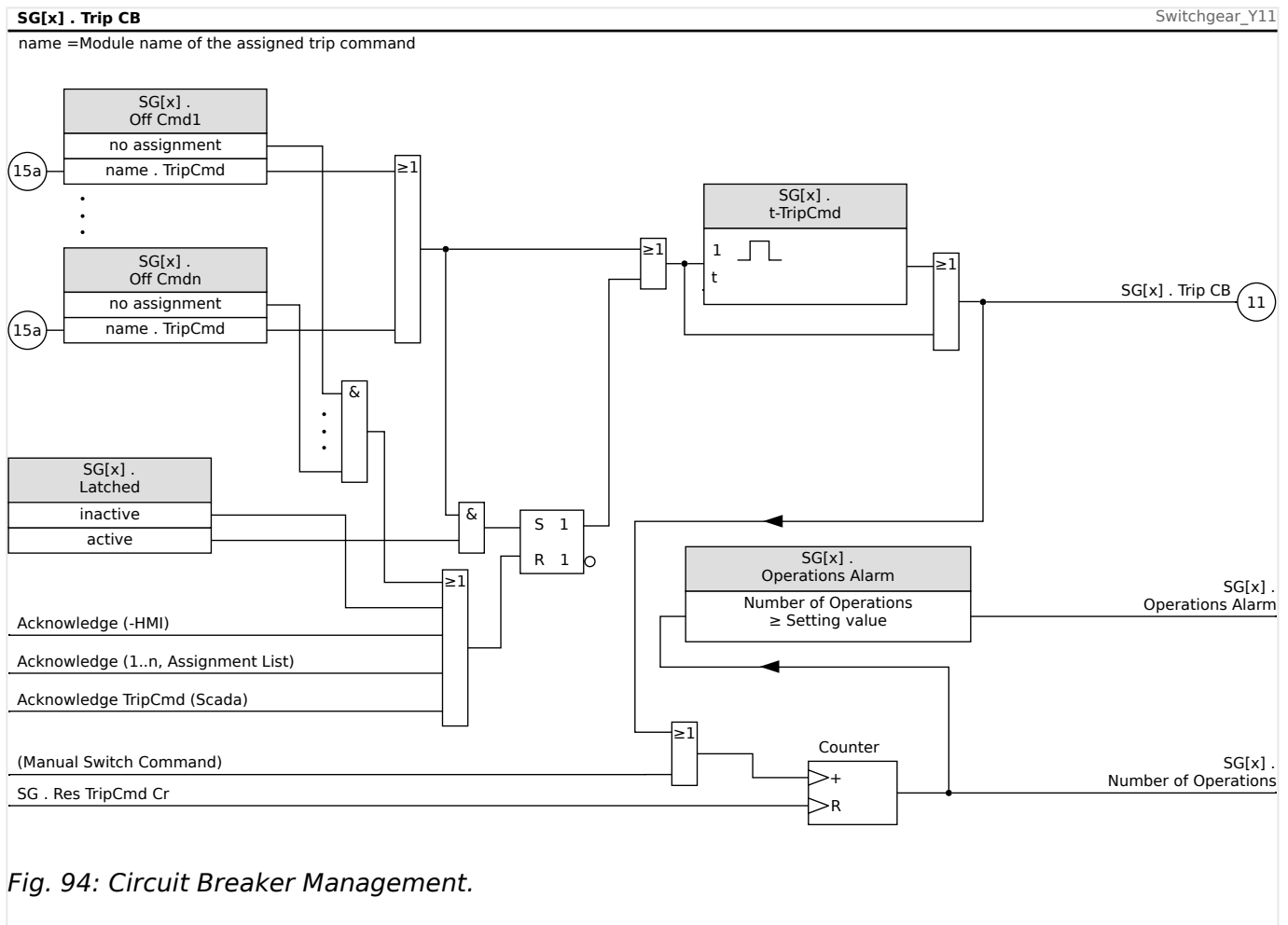

Fig. 94: Circuit Breaker Management.

Note that in the diagram above, “SG[x]” represents “switchgear number x”; however, the exact designation is defined in the single-line file, see also [↪ “5 Single-Line Diagram”](#).

Latching

If a tripping command is configured as »Latched« = “active”, it will stay active until it is acknowledged (see “Acknowledgment” chapter, [↪ “Acknowledgments”](#)).

A latched tripping command gets reset only in any of the following cases and only after all assigned trip commands of the protection elements have dropped out:

- It is acknowledged (either by the user at the HMI, or via SCADA), see [↪ “Acknowledgments”](#).
- It is reset (acknowledged) by the signal that has been assigned to the parameter »Ack TripCmd«.
- It is re-configured to »Latched« = “inactive”.
- If no protection trip command at all is assigned, i. e. **all** »Off Cmd n« have been set to “-”.

Ex CLOSE / OPEN

If it is required that the switchgear be opened or closed by an external signal, the user can assign one signal that triggers the CLOSE and one signal that triggers the OPEN command (e. g. digital inputs or output signals of the Logics).

The external CLOSE signal can be assigned to [Control / SG / SG[x] / Ex ON/OFF Cmd] »SCmd ON«.

The external OPEN signal can be assigned to [Control / SG / SG[x] / Ex ON/OFF Cmd] »SCmd OFF«.

An OPEN command has priority. CLOSE commands are slope-oriented, OPEN commands are level-oriented.

Switching via SCADA

Switching via SCADA commands is possible if [Control / General Settings] »Switching Authority« is set to either "Remote" or to "Local and Remote". (See also [↳ "5.2 Switching Authority"](#).)

For the example of switching via the IEC 60870-5-104 protocol, see [↳ "3.7.1 IEC Commands"](#). The principle is essentially the same for other protocols that support SCADA commands.

Switching Authority

The Switching Authority defines the types of switching commands that are allowed to be executed. It does not have any influence on trippings triggered by protection functions.

For the setting of the Switching Authority [Control / General Settings] »Switching Authority«, the following choices are possible:

- "None": Switching operations are blocked. (Note that protection tripping are still possible.)
- "Local": Switching operations only via push buttons at the panel.
- "Remote": Switching operations via SCADA, digital inputs, or internal signals.
- "Local and Remote": Switching operations via push buttons, SCADA, digital inputs, or internal signals.

Non-Interlocked Switching

For test purposes, during commissioning and temporarily operations, interlockings can be disabled.

WARNING!

Non-interlocked switching can lead to serious injuries or death!

For non-interlocked switching the setting [Control / General Settings] »Res NonIL« provides the following options:

- "single Operation": Non-interlocked switching for one single command
- "permanent": Permanent

- “timeout”: Non interlocked switching for a certain time

The set time for non-interlocked switching is set at the parameter »*Timeout NonIL*« and applies also for the “single Operation” mode.

Non-interlocked switching can also be activated by assigning a signal to »*Timeout NonIL*«.

Manual Manipulation of the Switchgear Position

In case of faulty position indication contacts (Aux contacts) or broken wires, the position indication resulted from the assigned signals can be manipulated (overwritten) manually, to keep the ability to switch the affected switchgear.

This is available at [Control / SG / SG[x] / General Settings] »*Manipulate Position*«.

A manipulated switchgear position is indicated on the display by an exclamation mark “!” besides the switchgear symbol.

WARNING!



Manipulation of the Switchgear Position can lead to serious injuries or death!

Double Operation Locking

All control commands to any switchgear in a bay have to be processed sequentially. During a running control command no other command will be handled.

Switch Direction Control

Switching commands are validated before execution. When the switchgear is already in the desired position, the switch command will not be issued again. (An opened circuit breaker cannot be opened again.) This also applies for switching command at the HMI or via SCADA.

Anti-Pumping

By pressing the CLOSE command Softkey only a single switching CLOSE impulse is sent, regardless how long the Softkey is pressed. The switchgear executes the close command only once.

5.3 Switchgear Wear

Switchgear Wear Features

The MRMV4 maintains various statistical values related to each switchgear.

- The number of switching operations is available at [Operation / Count and RevData / Control / SG[x]] »*TripCmd Cr*«.

At [Control / SG[x] / SG Wear] »*Operations Alarm*«, the user can set a limit for the maximum number of switching operations. If this limit is exceeded a related alarm signal is set at [Operation / Status Display / Control / SG[x]] »*Operations Alarm*«.

- The sum of the accumulated interrupted currents is available at [Operation / Count and RevData / Control / SG[x]] »*Sum trip IL1*«, ..., »*Sum trip IL3*«.

At [Control / SG[x] / SG Wear] »Isum Intr Alarm«, the user can set a threshold for the maximum allowed sum of interrupt currents. If this threshold is exceeded a related alarm signal is set at [Operation / Status Display / Control / SG[x]] »Isum Intr trip«, plus the respective phase-selective signals »Isum Intr trip: lxx«.

- The MRMV4 continuously maintains the “open capacity” at [Operation / Count and RevData / Control / SG[x]] »CB OPEN capacity« (as a percentage value). If it reaches 100% maintenance of the switchgear is mandatory.
- The signal [Operation / Status Display / Control / SG[x]] »SGwear Slow SG« reports that the switchgear has become slower. (See also [↳ “5.3 Slow Switchgear Alarm”](#).) This might indicate a malfunction at an early stage.
- The user can define a switchgear-specific wear curve, see below ([↳ “5.3 Switchgear Wear Curve”](#)). Based on this curve the MRMV4 sets an alarm signal at [Operation / Status Display / Control / SG[x]] »WearLevel Alarm«.
- The MRMV4 maintains the frequency of CLOSE/OPEN cycles: At [Control / SG[x] / SG Wear] »Isum Intr ph Alm«, the user can set a threshold for the maximum allowed sum of interrupt currents per hour. If this threshold is exceeded a related alarm signal is set at [Operation / Status Display / Control / SG[x]] »Isum Intr ph Alm«. By means of this alarm, excessive switchgear operations can be detected at an early stage.

Slow Switchgear Alarm

An increase of the close or opening time of the switchgear is an indication for the maintenance need. If the measured time exceeds the time »t-Move OFF« or »t-Move ON«, the signal [Operation / Status Display / Control / SG[x]] »SGwear Slow SG« is activated.

Switchgear Wear Curve

In order to keep the switchgear in good working condition, the switchgear needs to be monitored. The switchgear health (operation life) depends above all on:

- The number of CLOSE/OPEN cycles.
- The amplitudes of the interrupting currents.
- The frequency that the switchgear operates (Operations per hour).

The user has to maintain the switchgear accordingly to the maintenance schedule that is to be provided by the manufacturer (switchgear operation statistics). By means of up to ten points that the user can replicate the switchgear wear curve within menu [Control / SG / SG[x] / SG Wear]. Each point has two settings: the interrupt current in kilo amperes and the allowed operation counts. No matter how many points are used, the operation counts the last point as zero. The protective relay will interpolate the allowed operations based on the switchgear wear curve. When the interrupted current is greater than the interrupt current at the last point, the protective relay will assume zero operation counts.

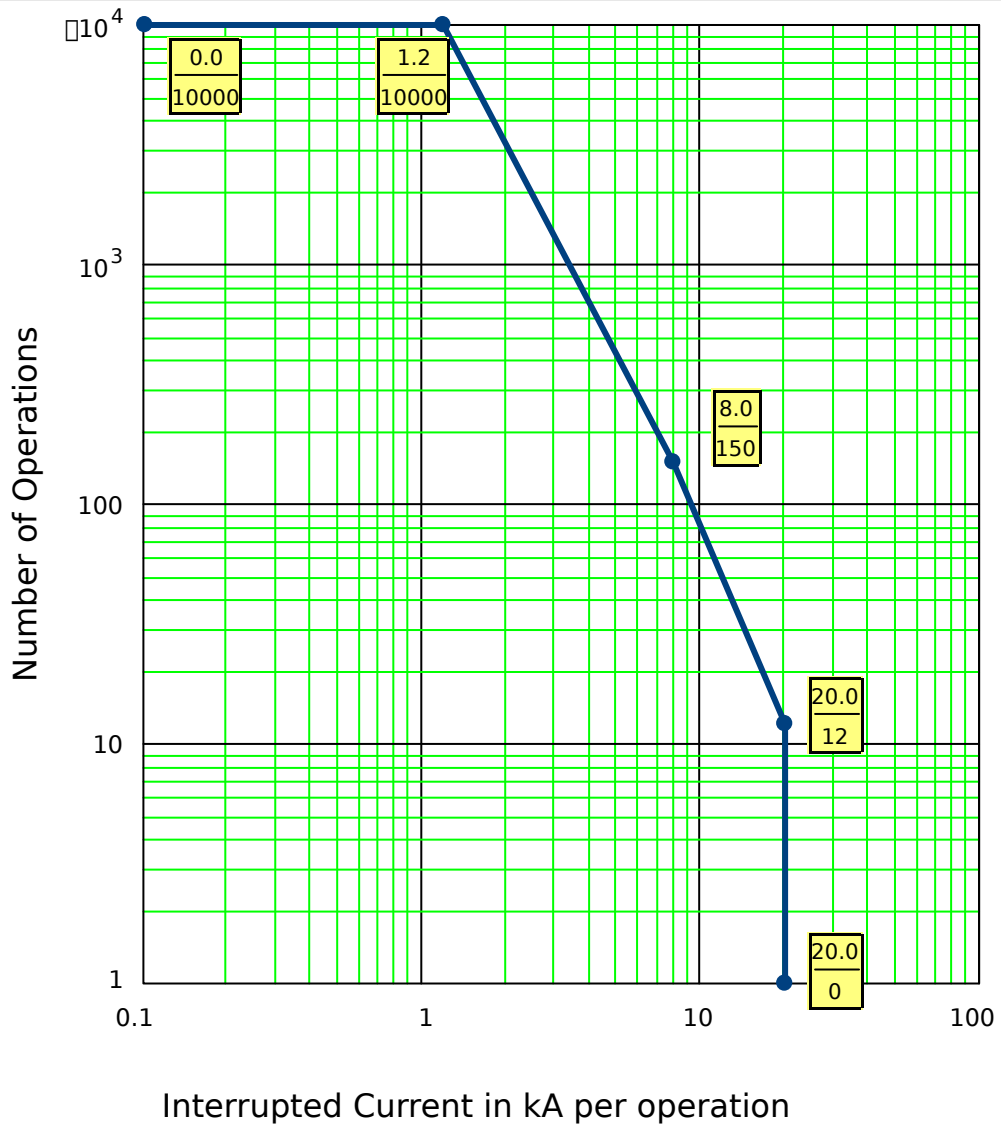

E_F67

Fig. 95: Breaker Maintenance Curve for a typical 25kV Circuit Breaker

5.4 Control - Example: Switching of a Circuit Breaker

The following example shows how to switch a circuit breaker via the HMI at the device.

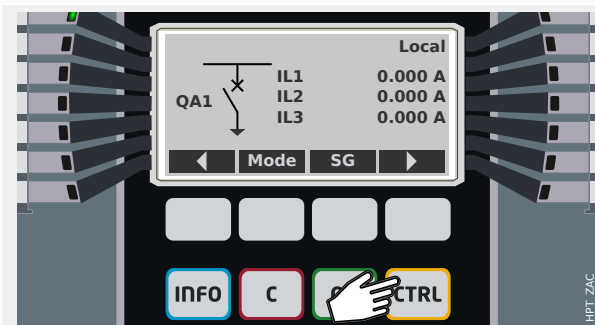

By pressing the »CTRL« key you enter a screen showing the single line, and you have direct access to related measuring values and control functions.

Remark: The switchgear name »QA1« is only an example; the available set of switchgear devices and their designations are dependent on your particular application.

A switching operation can be executed if the switching authority (which is displayed in the top right corner) is set to either "Local" or "Local and Remote".

Remark: Note that this single line screen as well as the two Softkeys "General Settings" and "SG" are also accessible via the main menu:

- The menu path [Control / Control Page] gives access to this single line page.
- The menu path [Control / General Settings] accesses the same menu branch as the Softkey "Mode".
- The menu path [Control / SG] accesses the same menu branch as the Softkey "SG".



The Softkey "Mode" takes you to the menu branch [Control / General Settings].

There you can do several switchgear-related settings, in particular (re-)define the switching authority.

For the »Switching Authority« setting the following options are available:

- "None": No control function.
- "Local": Control only via the buttons at the panel (HMI).
- "Remote": Control only via SCADA, digital inputs or internal signals.
- "Local and Remote": Control via HMI buttons, SCADA, digital inputs, or internal signals.

As already said, the setting has to be either "Local" or "Local and Remote" for this example.



The Softkey “SG” takes you to a screen that lists all connected switchgear devices.

(For HighPROTEC devices of type »MC...«, up to 6 switchgear devices are supported. A device of type »MR...« can control one switchgear device.)

After selecting a switchgear device, the Softkey “▶” (Enter) takes you to the menu that is dedicated to the selected switchgear device. There you can make various settings, e. g. control times, position indicators, external ON/OFF commands, interlockings.

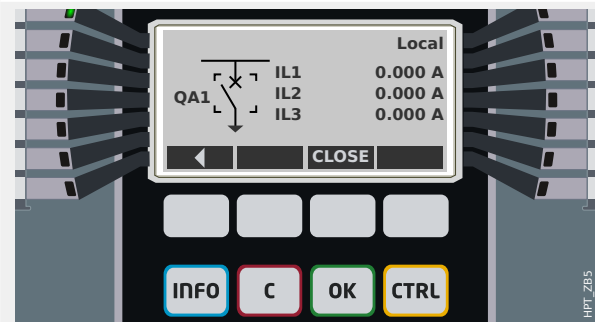

The Softkey “▶” (Enter) takes you to an enhanced single line (after you have entered the password for access level “Control-Lv1”). The switchgear device is highlighted by small markers (and in case of several implemented switchgear devices, the Softkey “Select” is visible, which allows you to select another one).

If the switching authority permits local switching there are Softkeys “OPEN” and “CLOSE” which allow for executing a switching operation. (Note that usually, i. e. with correct position status indication from the switchgear device, only one of these two Softkeys is visible: If, for instance, a particular switchgear device is already open, only the “CLOSE” is visible.)

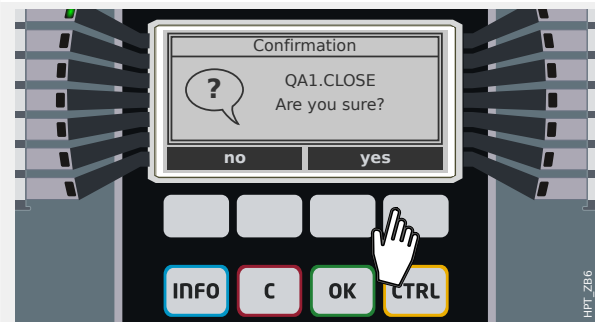

After pressing the “CLOSE” Softkey you get a confirmation dialog, which prevents unintended switching operations.

After pressing “yes” the switching operation is actually executed.

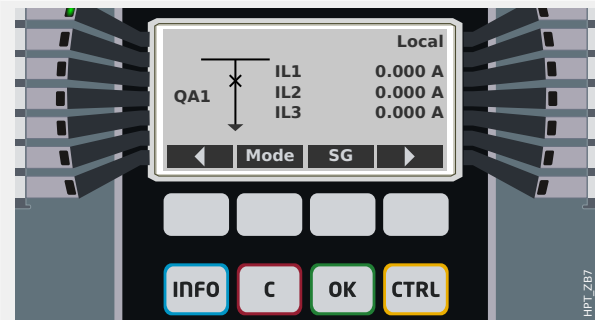

The new position of the switchgear device is shown on the display (as soon as it has been reached according to the feedback of the position indication, or after the configured switching time has elapsed).

Moreover, the functionality of the Softkeys changes so that the new permitted switching operations are available.

6 System Alarms

NOTICE!



Please note that Power Protection and (Active/Reactive/Apparent) Power Demand is only available within Protective Devices that offer current and voltage measurement.

After activation (via [Device planning] »SysA . Mode« = “use”) the user can configure within the System Alarms menu [SysA]:

- General Settings (activate/inactivate the Demand Management, optional assign a signal, that will block the Demand Management);
- Power Protection (Peak values);
- Demand Management (Current);
- Demand Management (Power);
- THD Protection.

Please note that all thresholds are to be set as primary values.

Demand Management

Demand is the average of system current or power over a time interval (window). Demand management supports the User to keep energy demand below target values bound by contract (with the energy supplier). If the contractual target values are exceeded, extra charges are to be paid to the energy supplier.

Therefore, demand management helps the User detect and avoid averaged peak loads that are taken into account for the billing. In order to reduce the demand charge respective to demand rate, peak loads, if possible, should be diversified. That means, if possible, avoiding large loads at the same time. In order to assist the User in analyzing the demand, demand management might inform the User by an alarm. The User might also use demand alarms and assign them on relays in order to perform load shedding (where applicable).

Demand management comprises:

- Power Demand
- Watt Demand (Active Power);
- VAr Demand (Reactive Power);
- VA Demand (Apparent Power);
- Current Demand.

Configuring the Demand

Configuring the demand is a two step procedure. Proceed as follows.

Step1: Configure the general settings within the [Device Para / Statistics / Demand] menu:

- Set the trigger source to »Duration«.
- Select a time base for the »window«.
- Determine if the window is »fixed« or »sliding«.
- If applicable assign a reset signal.

The interval time (window) can be set to fixed or sliding.

Example for a fixed window: If the range is set for 15 minutes, the protective device calculates the average current or power over the past 15 minutes and updates the value every 15 minutes.

Example for a sliding window: If the sliding window is selected and the interval is set to 15 minutes, the protective device calculates and updates the average current or power continuously, for the past 15 minutes (the newest measuring value replaces the oldest measuring value continuously).

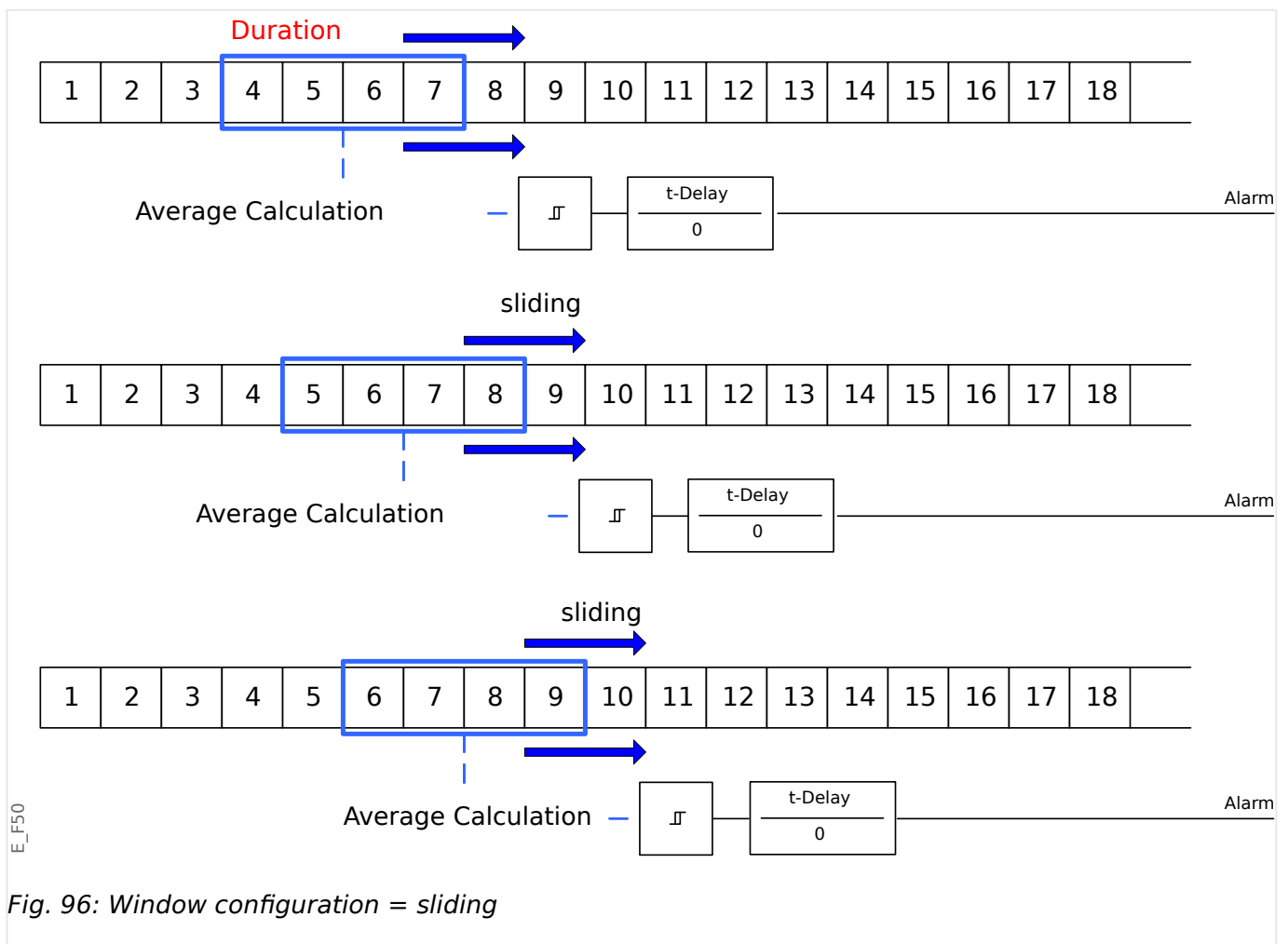

Fig. 96: Window configuration = sliding

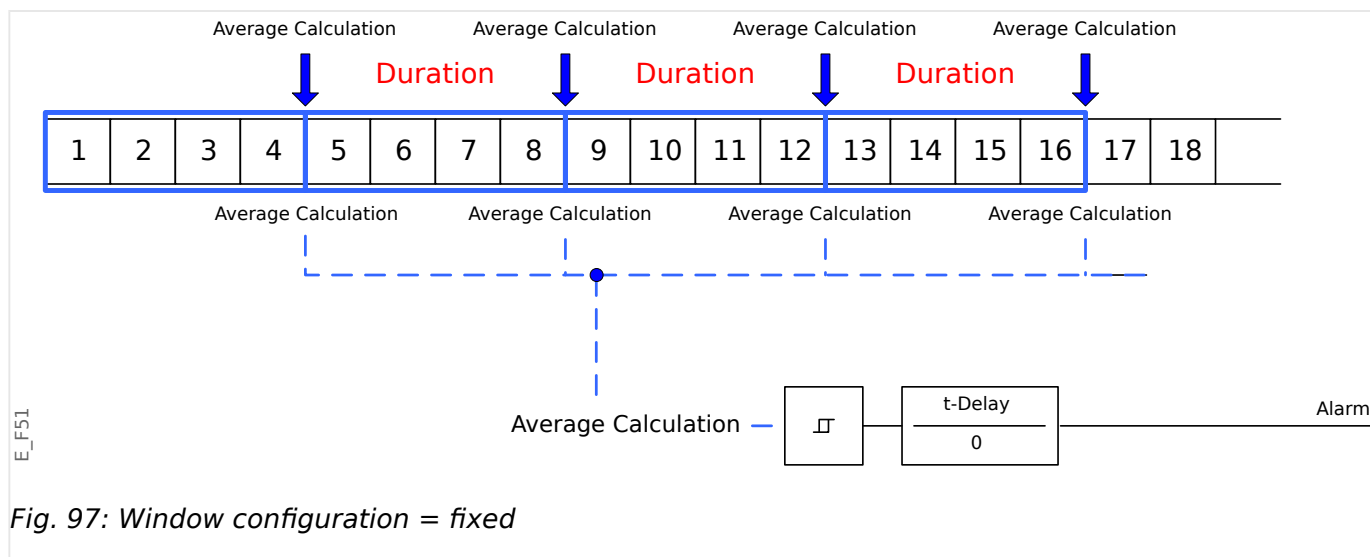

Fig. 97: Window configuration = fixed

Step 2:

- In addition, the Demand specific settings have to be configured in the [SysA] menu.
- Determine if the demand should generate an alarm or if it should run in the silent mode (»Alarm« = “active” or “inactive”).
- Set the threshold (»Threshold«).
- Where applicable, set a delay time (»t-Delay«) for the alarm.

Peak Values

The protective device also saves the peak demand values for current and power. The quantities represent the largest demand value since the demand values were last reset. Peak demands for current and system power are date and time stamped.

Within the [Device Para / Statistics / Demand] menu, the current Demand and Peak demand values can be seen.

Configuring the Peak Value Supervision

The supervision for the peak values can be configured within menu [SysA / Power] in order to monitor:

- Active Power (Watt),
- Reactive Power (VAr)
- Apparent Power (VA)

The specific settings are to be set within menu [SysA / Power].

- Determine if the peak value supervision should generate an alarm or if it should run in the silent mode. (Alarm active/inactive).
- Set the threshold.
- Where applicable, set a delay time for the alarm.

Min. and Max. Values.

Within [Operation] menu the minimum (min.) and maximum (max.) values can be seen. (See also  "Statistics".)

Minimum values since last reset: The minimum values are continuously compared to the last minimum value for that measuring value. If the new value is less than the last minimum, the value is updated. Within the [Device Para / Statistics] menu, a reset signal can be assigned.

Maximum values since last reset: The maximum values are continuously compared to the last maximum value for that measuring value. If the new value is greater than the last maximum, the value is updated. Within the [Device Para / Statistics] menu, a reset signal can be assigned.

THD Protection

In order to supervise power quality, the protective device can monitor the voltage (phase-to-phase) and current THDs.

Within the [SysA / THD] menu:

- Determine if an alarm is to be issued or not (*»Alarm«* = "active" or "inactive");
- Set the threshold (*»Threshold«*); and
- Where applicable, set a delay time for the alarm (*»t-Delay«*).

7 Recorders

The MRMV4 features several Recorders that collect log messages of particular types (in some non-volatile memory):

- The **Self-Supervision Messages** (↳ “Self-Supervision Messages”) collects device-internal messages of various types. These can be, for example, security-related events (e. g. if a wrong password has been entered), or Troubleshooting messages that are directly related to the functionality of the device.

The entries can be accessed at the menu branch [Operation / Self-Supervision / Messages].

- The **Disturbance Recorder** (↳ “Disturbance Recorder”) adds a new entry with each new disturbance event (that is configured as a trigger signal).

The entries can be accessed at the menu branch [Operation / Recorders / Disturb rec].

Moreover, a double-click on any entry within the Disturbance Recorder window in Smart view enables the user to save the data of this entry in an *.HptDr file that can be opened in the *DataVisualizer* PC software for graphical analysis.

- The **Fault Recorder** (↳ “Fault Recorder”) collects information about faults (e. g. Trip Causes).

The entries can be accessed at the menu branch [Operation / Recorders / Fault rec].

- The **Event Recorder** (↳ “Event Recorder”) collects status changes of binary states and counters of the various MRMV4 modules, so that the user can get an overview of what has happened recently.

The entries can be accessed at the menu branch [Operation / Recorders / Event rec].

- The **Motor Start Recorder** (↳ “Motor Start Recorder”) logs information during a motor start-up.

The entries can be accessed at the menu branch [Operation / Recorders / Start rec].

- The **Motor Statistic Recorder** (↳ “Statistic Recorder”) shows motor specific statistical data on a monthly base (i. e. one entry per month).

The entries can be accessed at the menu branch [Operation / Recorders / Statistic rec].

Moreover, via a double-click on an entry for some month in Smart view or via selecting an entry on the HMI using the Enter Softkey “▶” a list of detailed statistical data for this entry is shown.

- The **History Function** (↳ “History Function”) logs special counter values, sorted into the categories “TotalCr”, “OperationsCr”, “AlarmCr” and “TripCmdCr”.

The entries can be viewed at the menu branch [Operation / History].

- The **Trend Recorder** (↳ “Trend Recorder”) records analog measurement values over time.

A summary (timestamp, number of entries) can be accessed at the menu branch [Operation / Recorders / Trend rec].

Moreover, a double-click on this summary within the Trend Recorder window in Smart view enables the user to save all data in an *.HptTr file that can be opened in the *DataVisualizer* PC software for graphical analysis.

7.1 Disturbance Recorder

- Disturbance records can be downloaded (read out) by means of the parameter setting and evaluation software *Smart view*.
- The disturbance records can be viewed and analyzed within the *DataVisualizer*. (This is a tool that is always installed along with *Smart view*).
- Disturbance records can be converted into the COMTRADE file format by means of the *DataVisualizer*.

The disturbance recorder works with 32 samples per cycle. The disturbance recorder can be triggered by any of eight configurable start signals. The disturbance record contains the measuring values including pre-trigger-time. By means of *Smart view / DataVisualizer* the oscillographic curves of the analog (current, voltage) and digital channels/traces can be shown and evaluated in a graphical form. The disturbance recorder has a storage capacity of 120 s. The disturbance recorder is able to record up to 15 s (adjustable) per record. The amount of records depends on the size of each record.

Read Out Disturbance Records

Within the menu [Operation / Recorders / Disturb rec] you can see the accumulated disturbance records.

NOTICE!



Within the Menu [Operation / Recorders / Man Trigger] you can trigger the disturbance recorder manually.

Deleting Disturbance Records at the Panel

Within the menu [Operation / Recorders / Disturb rec] you can:

- Delete disturbance records.
- Choose via »SOFTKEY« »up« and »SOFTKEY« »down« the disturbance record that is to be deleted.
- Call up the detailed view of the disturbance record via »SOFTKEY« »right«.
- Confirm by pressing »SOFTKEY« »delete«
- Enter your password followed by pressing the key »OK«
- Choose whether only the current of whether all disturbance records should be deleted.
- Confirm by pressing »SOFTKEY« »OK«

Configuring the Disturbance Recorder

The disturbance recorder can be configured in the menu [Device Para / Recorders / Disturb rec].

Configure the max. recording time of a disturbance event. This can be set via the parameter »Max file size«, the maximum value is 15 s (including pre-trigger and post-trigger time). The pre-trigger and post-trigger times of the disturbance recorder are set

(via parameters »Pre-trigger time« and »Post-trigger time«) in percent of the »Max file size« value.

To trigger the disturbance recorder, up to 8 signals can be selected. The trigger signals are OR-linked. If a disturbance record has been written, a new disturbance record cannot be triggered until all trigger signals that have triggered the previous disturbance record are gone.

NOTICE!



If tT is the duration of the trigger signal and $tMax = \text{»Max file size«}$, $tPre = (\text{»Pre-trigger time«} \cdot tMax)$, $tPost = (\text{»Post-trigger time«} \cdot tMax)$, then the resulting durations are as follows:

- The actual pre-trigger timer always equals $tPre$
- The disturbance event is recorded for the time tEv , which is: $tEv = \min(tT, (tMax - tPre))$
- The actual post-trigger timer $tRest$ is: $tRest = \min(tPost, (tMax - tPre - tEv))$

Obviously, it can happen that – depending on the actual duration of the trigger signal and the setting $tPre$ – that $tEv < tT$, i. e. that the disturbance event does not get recorded completely. The only way to mitigate this risk (besides setting a smaller value for $tPre$) is to configure a larger value for $tMax$. This, however, has the consequence that a smaller number of events can be held in memory.

In the same way it can happen that no more post-trigger time is left (i. e. $tRest = 0$). Note that the recording always gets stopped after the configured time $tMax = \text{»Max file size«}$ has elapsed.

Moreover, decide about the behavior of the disturbance recorder in case the storage capacity has been used up: Do you want it to automatically overwrite the oldest recordings (»Auto overwriting« = "active"), or do you want it to stop making any further recordings (»Auto overwriting« = "inactive") until the memory has been cleared manually.

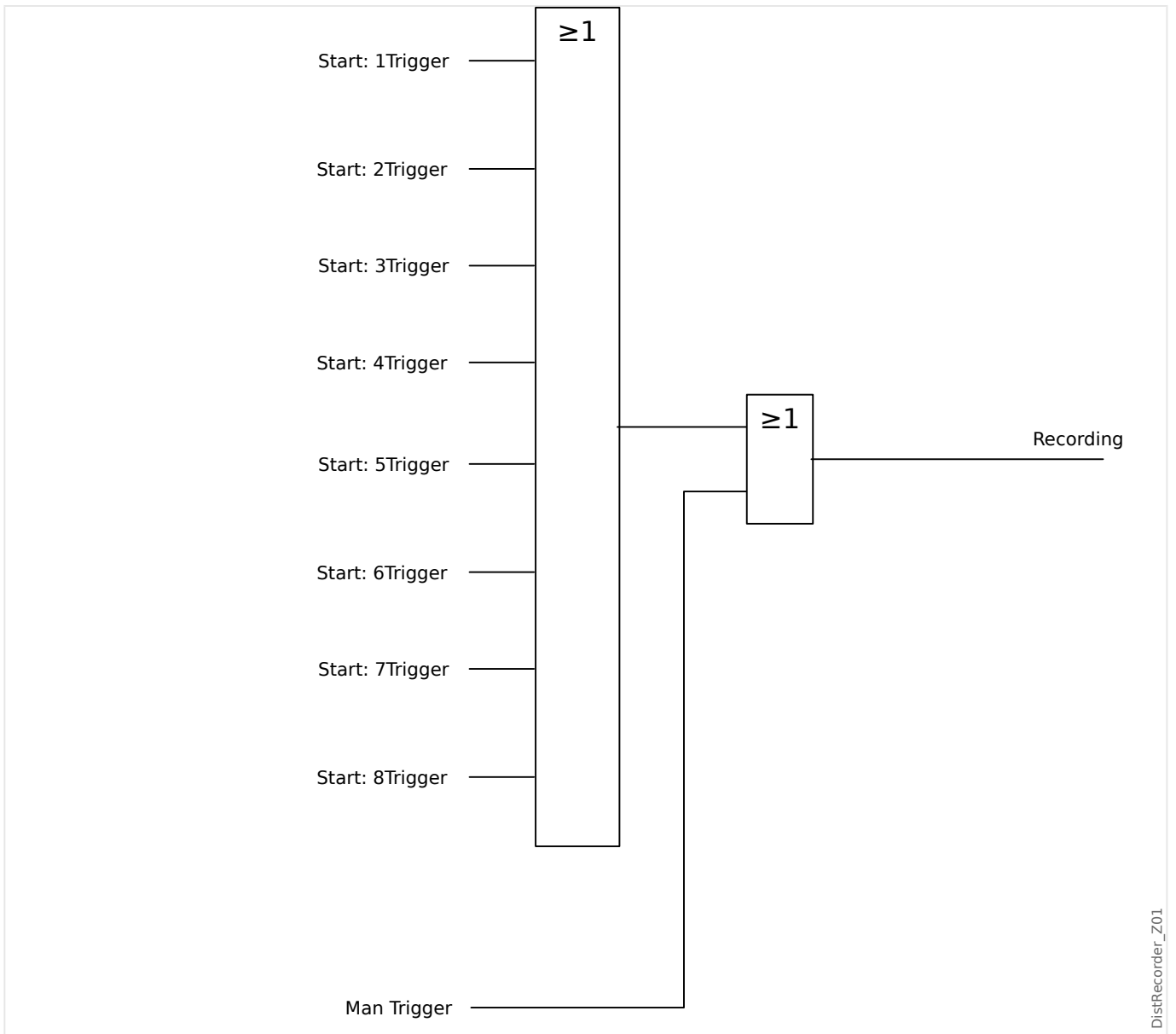

DistRecorder_Z01

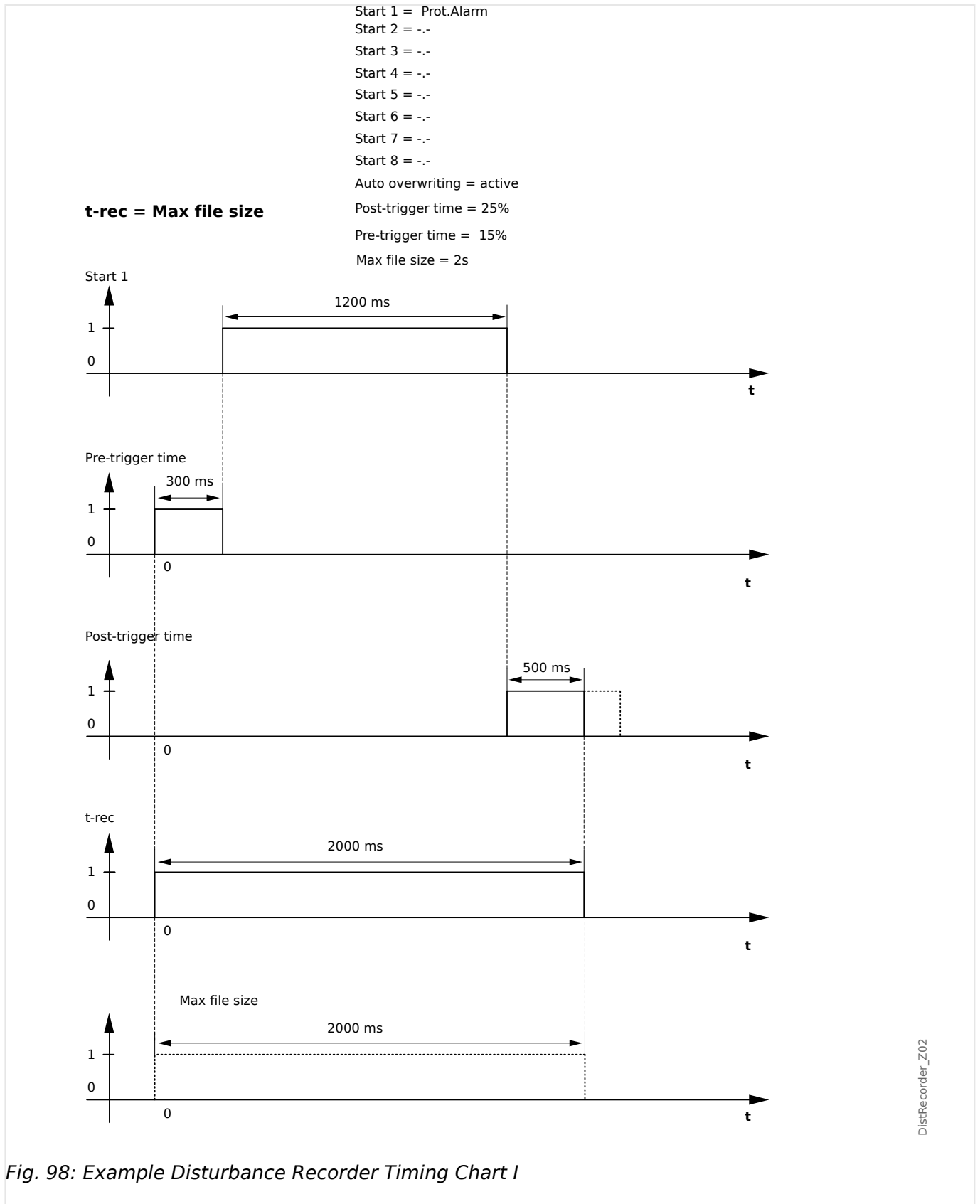

DistRecorder_Z02

Fig. 98: Example Disturbance Recorder Timing Chart I

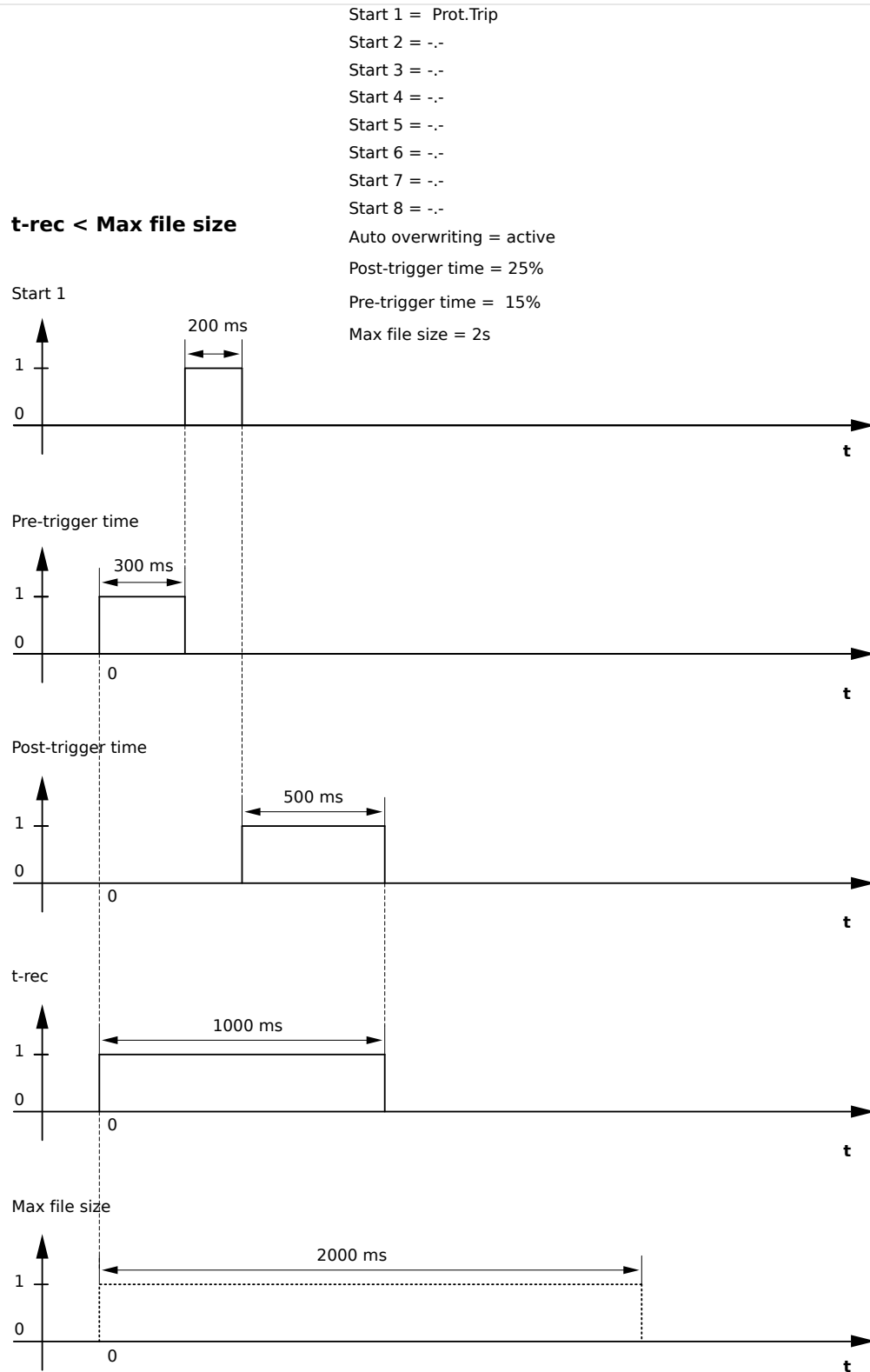

DistRecorder_Z03

Fig. 99: Example Disturbance Recorder Timing Chart II

7.2 Fault Recorder

Purpose of the Fault Recorder

The *Fault Recorder* provides compressed information about faults (e.g. Trip Causes). The compressed information can be read also at the HMI. This might be helpful for fast fault analysis. After a fault, a pop-up window will be sent onto the display in order to draw the user`s attention to the fault. The *Fault Recorder* will provide information on the causes of the fault. A detailed fault analysis (in oscillographic form) can be done by means of the Disturbance Recorder. The reference between the Fault Records and the corresponding Disturbance Records are the »Fault Number« and the »Grid Fault Number«.

Times and Durations

Time to Trip:	Time between <i>First Alarm</i> (»Prot . Alarm«) and <i>First Trip</i> (»Prot . Trip«) decision.
Fault Duration:	Time period from the rising edge of the General Pickup (»Prot . Alarm«) signal up to the falling edge of the General Pickup Signal. Please note that General Pickup is an or-connection (disjunction) of all Pickup signals. General Trip (»Prot . Trip«) is an OR-connection of all Trips.

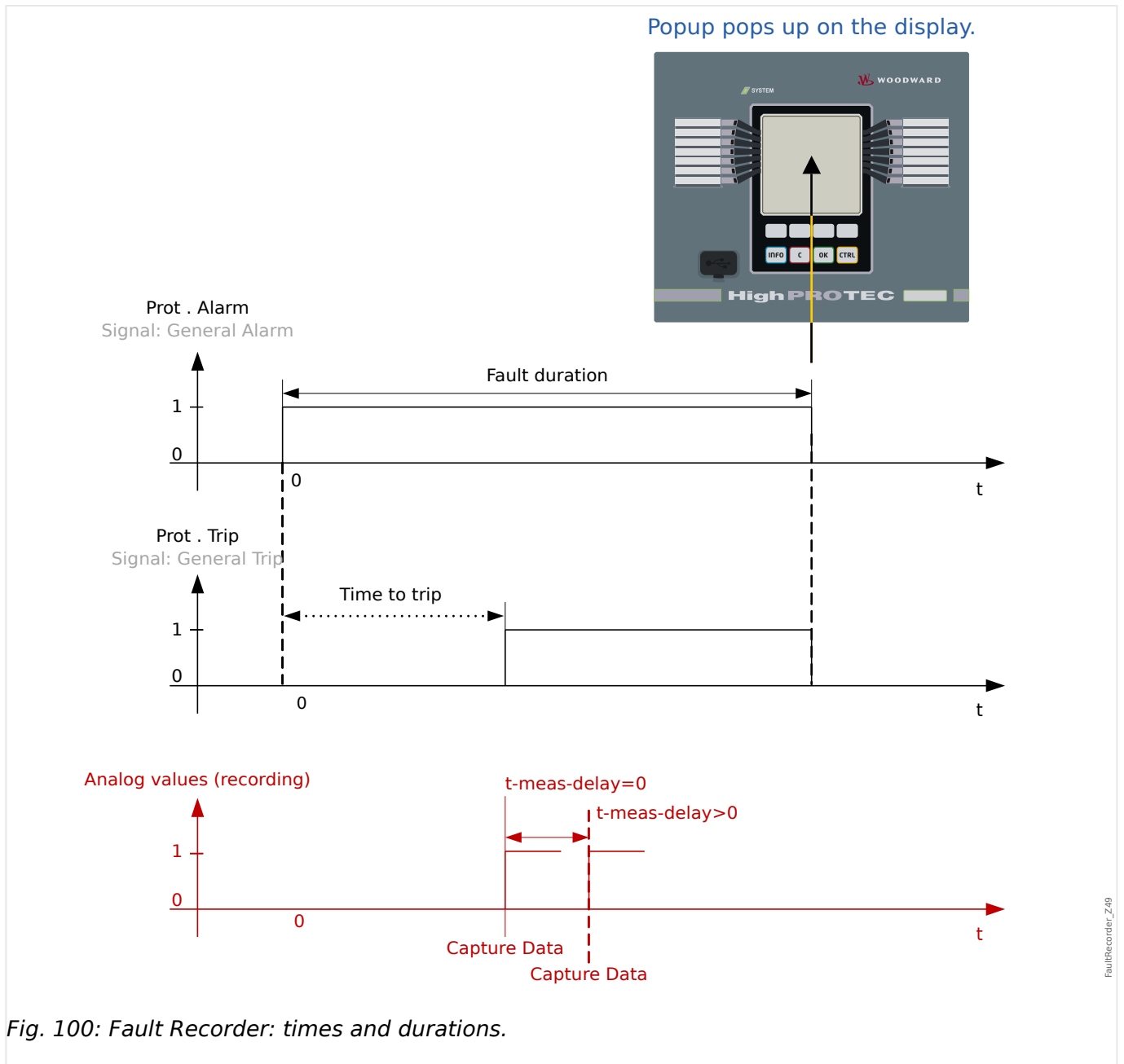

Fig. 100: Fault Recorder: times and durations.

Behaviour of the Fault Recorder

Who triggers the Fault Recorder?

The *Fault Recorder* will be triggered by the rising edge of the »Prot. Alarm« (General Pickup) signal. Please note that »Prot. Alarm« (General Pickup) is an or-connection of all Pickup signals. The first Pickup will trigger the Fault recorder.

At which point of time will the fault measurements be captured?

The fault measurements will be captured (written) when the trip decision is taken. The point in time, when the measurements are captured (after a trip) can be delayed optionally by the parameter [Device Para / Recorders / Fault rec /] »Fault rec . t-meas-delay«. This might be reasonable in order to achieve more reliable measuring values (e.g. in order to avoid measuring disturbances caused by significant DC-components).

Modes

If it is required that a fault record be written even if a general alarm has not lead to a trip, the parameter [Device Para / Recorders / Fault rec /] »Fault rec . Record-Mode« has to be set to "Alarms and Trips".

Set parameter »Record-Mode« to "Trips only" if an Alarm that is not followed by a trip decision shall not lead to a trip.

When does the overlay (pop-up) appears on the display of the HMI?

A pop-up appears on the HMI display when the General Pickup (»Prot . Alarm«) disappears.

NOTICE!



No time to trip will be shown if the pickup signal that triggers the fault recorder is issued by another protection module than the trip signal. This might happen if more than one protection module is involved into a fault.

NOTICE!



Please note: The parameter settings (thresholds, etc.) that are shown in a fault record are not part of the fault record itself. They are always read out from the current device setting. If it may be the case that the parameter settings shown in a fault record were updated, they are indicated with an asterisk symbol within the fault record.

To prevent this please proceed as follows:

Save any fault record that should be archived to your local network/hard disk before doing any parameter change. Delete all the fault records in your fault recorder afterwards.

Memory

The last stored fault record is saved (fail-safe) within the *Fault Recorder* (the others are saved within a memory that depends on the auxiliary power of the protective relay). If there is no more memory free, the oldest record will be overwritten (FIFO). Up to 20 records can be stored.

How to close the overlay/pop-up?

By using Softkey »OK«.

How to find out fast, if a fault has lead to a trip or not?

Within the overview menu of the fault recorder, faults that have led to a trip are indicated by a flash "⚡" icon (on the right-hand side).

Which fault record pops up?

The newest fault.

Content of a Fault Record

A fault record comprises information about:

Part 1: Common Information (independent of protection function)

Date and Time	Date and Time of the Fault
---------------	----------------------------

Part 1: Common Information (independent of protection function)	
FaultNo	This counter will be incremented with each fault (»Prot . Alarm«)
No. of Grid Fault	This counter will also be incremented with each »Prot . Alarm« with exception of the AR (this applies only to devices that offer auto reclosing).
Act Set	The active parameter set
Fault duration	Time period from the rising edge of the General Pickup (»Prot . Alarm«) signal up to the falling edge of the General Pickup Signal. Please note that General Pickup is an or-connection (disjunction) of all Pickup signals. General Trip (»Prot . Trip«) is an OR-connection of all Trips.
Time to trip	The time between pickup and trip. Please note: No time to trip will be shown if the first pickup and the first trip are issued by different protection modules.
Pickup	Name of the module that picked up first.
Trip	Name of the module that tripped first.
Active AdaptSet	In case that adaptive sets are used, the number of the active set will be displayed.

Part 2: Information specific to the protection function that detected the fault	
e. g. Fault type	<p>The bits of information given in this part depend on the protection module.</p> <p>For example, in case of phase-selective protection functions, there is also data about the single phases.</p>

Part 3: Information depending on the protection device	
Measured Values	<p>Various measuring values at the time of tripping (or delayed depending on parameter setting) will be displayed.</p> <p>The set of data depends on the measuring values that are available with the particular device.</p>

How to Navigate Within the Fault Recorder

Navigation within the Fault recorder	Softkey
Back to overview.	◀
Next (upper) item within this fault record.	▲
Previous fault record.	▶▶
Next (lower) item within this fault record.	▼

How to Read Out the Fault Recorder at the Panel

In order to read out a fault record there are two options available:

- Option 1: A Fault has popped up on the HMI (because a trip or pickup has occurred).
- Option 2: Call up the Fault recorder menu manually.

Option 1 (in case a fault record pops up on the display (overlay):

- Analyze the fault record by using Softkeys “▲” and “▼”.
- Or close the Pop-up by using the Softkey OK.

Option 2:

- Enter the menu branch [Operation / Recorders / Fault rec].
- Select a fault record.
- Analyze the fault record by using Softkeys “▲” and “▼”.

7.3 Event Recorder

The event recorder can register up to 300 events and the last (minimum) 50 saved events are recorded fail-safe. The following information is provided for any of the events:

Events are logged as follows:

Record No.	Sequential Number
Fault No.	Number of the ongoing fault. This counter is incremented by each General Pickup (»Prot . Alarm«).
No. of grid faults	A grid fault No. can have several Fault Nos. This counter is incremented by each General Pickup. (Exception AR: This applies only to devices that offer auto-reclosing).
Date of Record	Time stamp
Module Name	What has changed?
State	Changed Value

There are three different classes of events:

- **Alternation of binary states are shown as:**
 - 0->1 if the signal changes physically from »0« to »1«.
 - 1->0 if the signal changes physically from »1« to »0«.
- **Counters increment is shown as:**
 - Old Counter state -> New Counter state (e.g. 3->4)
- **Alternation of multiple states are shown as:**
 - Old state -> New state (e.g. 0->2)

Read the Event Recorder

- Enter the menu branch [Operation / Recorders / Event rec].
- Select an event.

7.4 Trend Recorder

Read the Trend Recorder

The Trend Recorder saves measured data in their time development.

- Enter the menu branch [Operation / Recorders / Trend rec].
- On the panel you can see a summary (timestamp, number of entries).

Due to the technical restrictions of the LCD display it is not possible to see any details of the recorded data.

- Via Smart view, however, you can make a double-click on the entry with the summary. This allows you to download the analog data from the MRMV4 and save it to a file (with the filename extension *.HptTr).

Afterwards the *.HptTr file can be opened with the DataVisualizer. Please see the DataVisualizer manual for a detailed description.

Configuring the Trend Recorder

The Trend Recorder can be configured within [Device Para / Recorders / Trend rec] menu.

The time interval defines the distance between two measuring points.

Up to ten values can be selected for recording.

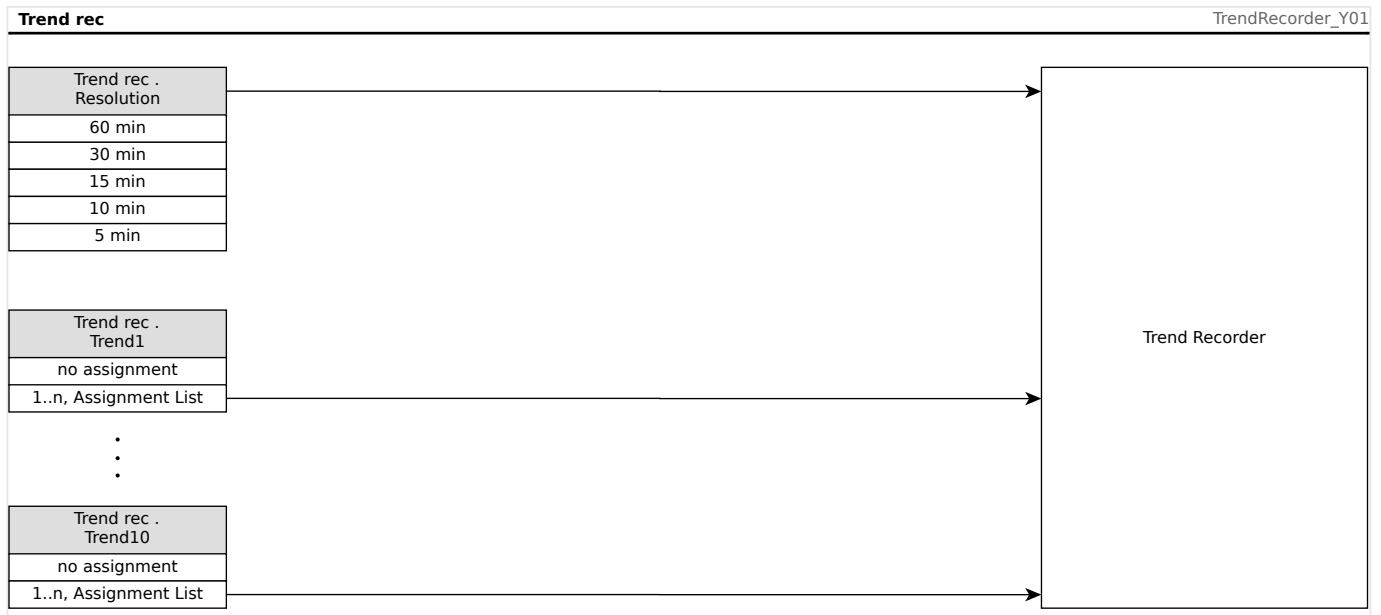

7.5 Motor Start Recorder

Manage Motor Start Records

The Motor Start Recorder logs information during a motor start-up. These records are stored in a fail-safe manner and the capacity allows for recording up to 5 start-ups. After 5 start-ups, every following start-up overwrites the recording of the oldest one (“First in First out” principle).

Every recording consists of a summary of information and recorded analog trends. However, the exact set of data is dependent on the ordered device variant. The summary data can be accessed using *Smart view* or via the front panel interface. This feature provides information recorded at the time of each start of the motor such as:

- Date of the motor start event
- Record number
- *IL1 max RMS, IL2 max RMS, IL3 max RMS, IG max RMS* – Maximum RMS phase current of the respective phase
- *Unbalance max* – Maximum current unbalance during the motor start-up
- *I avg* – Average current of all three phases at the time of the start-to-run transition
- *Speed* – The motor nominal speed (1 or 2)
- Time (duration) values:
 - *tS-tI* – The time that elapses from the start until the current value drops below the set start-up threshold
 - *tS-tR* – The time that elapses from the start until the motor is running, or – in case of an incomplete start sequence – until the trip command
- *I2T used* – Thermal capacity used, specified as percentage of the maximum thermal capacity
- *Start success* – This is set to 1 if the motor start has been successful (and equals 0 otherwise).

Smart view allows for storing the summary information as text files, or have them printed out.

The analog trends can be viewed using the *DataVisualizer* software. Examples for recorded analog trends are:







- Phase current values
- Current unbalance
- Thermal capacity
- Temperatures (in case an RTD box is fitted)

Read Motor Start Records via *Smart view*:

The start recorder data can be downloaded by means of *Smart view* from the device.

- Start *Smart view* if this has not been done already.

- If the data has not been downloaded from the device yet, select the menu item “Receive Start Recorder” in the “Device” menu.
- Within the navigation tree, go to the [Operation / Recorders] menu. Here the user will find the »*Start rec*« menu item.
- When »*Start rec*« is selected the Start Recorder Window appears.

	To access data that has been stored in the device using <i>Smart view</i> , the user must select the “Receive Start Recorder” button in the upper left hand corner of the “Start Rec” window. When clicked, the <i>Smart view</i> software will retrieve the highlighted record from the device.
	After selecting one of the max. 5 recordings a summary of the Start Recorder data can be retrieved (for the selected recording) by clicking the “Receive Summary Data” button in the upper left hand corner of the “Start Rec” window.
	A list of all currently available Start Records is viewable by selecting the “Refresh Start Recorder” button on the start recorder.
	It is possible to delete individual records that are stored on the protective device. First, select “Receive Start Recorder”, and then select the record to be deleted by clicking on the record number, followed by the selection of the “Delete Start Record” button in the upper left hand corner of the “Start Rec” window.
	To permanently remove all start records within a device's start recorder, select the “Delete All Start Records” button also located in the upper left hand corner of the “Start Rec” window. This removes all previously stored start records within the device to which the user is presently connected.
	Open a Start Record file from a local storage device. Please note that it is possible to compare an archived Start Record against archived Parameter settings that are also stored on a local device. Read the “Caution” information below (page L7).

When using *Smart view* to view the Start Recorder data, the Start Recorder features can also be found by right clicking anywhere within the “Start Rec” window.

NOTICE!



The “Print” button takes the user to the printing dialogue, where it is possible to export the summary into a text file. This is done the following way:

- Retrieve the data in the “Start Rec” window, as described above.
- Click on the button “Receive Summary Data”.
- Click on the “Print” button.
- Click on the button “Export to file”.
- Enter a valid file name.
- Select the file path.
- Click on the “Save” button.

Display Start Records:

When a Start Record is called up, a window with the following options pops up.

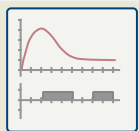

View motor start data graphically in the *DataVisualizer* software. In the *DataVisualizer* software the user can view the RMS value of the phase currents, thermal capacity used, and temperatures measured by the URTD module if a URTD is installed and attached to the relay.

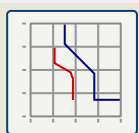

View motor start data overlaid with the Motor Protection Curves (Starting Profile Plot versus Protection limits). The user can view the average current recorded during the motor start versus protection elements such as 50P, or the Thermal Model. The user has the option to alter the displayed setting groups.

Please note: Protective elements that are not projected within the device planning are not visible.

The Starting Profile Plot offers two user scenarios:

- Adapt the protection settings to the recorded start curve: The user then sees the impact of parameter changes in the Profile Plot. By means of this the user can decide if the relay settings match the protection requirements.
- Analyze a Start Record: Since a Start Record does not include the relay settings, the user has to ensure that backups of the relay settings are available that were valid at the time of recording.

CAUTION!



Please note that the Starting Profile Plot shows the recorded average current versus the current relay settings. The relay settings itself are not part of a Start Record.

Adaptive parameters and their impacts wont be visible within the Starting Profile.

Blockings wont be visible within the Starting Profile.

Please make sure to save the setting files together with this record to guarantee the graph represents the conditions of when this event occurred.

7.6 Statistic Recorder

The Statistic Recorder shows motor specific statistical data on a monthly base. The Statistic Recorder can record up to 24 monthly reports. The reports are power fail safe stored.

In order to view information from the Statistic Recorder, the user has to select [Operation / Recorders / Statistic rec] from the menu tree.

When using Smart view, a double-click on the »Date of Record« shows detailed statistical information such as the number of starts, the number of successful starts, the average start time, the »average I2T« value during any start, and the average of all maximum currents value seen during each start.

7.7 History Function

The History function, accessible under the menu branch [Operation / History], can be utilized as a counter or log of specific occurrences monitored by the device. The types of occurrence that can be recorded include:

- Operations [OperationsCr];
- Alarms [AlarmCr];
- Trips [TripCmdCr]; and
- Totals [TotalCr].

To View the History Records at the HMI

- Enter the menu [Operation].
- Navigate to the menu item [History] by means of the Softkeys »down« (“▼”). Enter this menu by means of the Softkey »right« (“▶”).
- Scroll down by means of the Softkey “▼” within this list up to that menu you want to change in. Enter this submenu by pressing the Softkey “▶”.
- Scroll down by means of the Softkey “▼” within this list up to that counter/entry that you want to take a look at. Call up details of this counter by means of pressing the Softkey “▶”.

To Reset the History Records at the HMI

- Enter the menu [Operation].
- Navigate to the menu item [Reset] by means of the Softkey “▼”. Enter this menu by means of the Softkey “▶”.
- Navigate to the menu item [History] by means of the Softkeys »down« (“▼”). Enter this menu by means of the Softkey »right« (“▶”).
- Navigate to that group of counters/entries that you want to reset by means of the Softkey “▼”. Enter this menu by means of the Softkey “▶”.
- In order to reset that group of counters, press the Softkey »Parameter Setting«. Enter your password.
- Confirm the dialog »Execute?« by means of Softkey »Yes«.

To View the History Records with Smart view

- In case Smart view is not running – please start it.
- If device data has not been loaded yet – click »Receive Data From The Device« in the menu »Device».
- Double click the »History« icon within the »Operation« menu.
- Double click within menu »History« onto that group of counters you want to take a look at.
- In the window the details are shown in tabular form.

To Reset the History Records with Smart view

- In case Smart view is not running – please start it.
- If device data has not been loaded yet – click »Receive Data From The Device« in menu »Device.
- Double click the »Reset/Acknowledge« icon within the »Operation« menu.
- Double click the »History« icon.
- Double click within this menu onto that group of counters, that are to be reset. Enter, if necessary your password.

8 Programmable Logic

General Description

The Protective Relay includes programmable Logic Equations for programming output relays, blocking of protective functions and custom logic functions in the relay.

The logic provides control of the output relays based on the state of the inputs that can be chosen from the assignment list (protective function pickups, protective function states, breaker states, system alarms and module inputs - see [↳ “Modules, Settings, Signals and Values”](#)). The user can use the output signals of a logic equation as inputs in higher equations (e. g.: the output signal of logic equation 10 might be used as an input of logic equation 11).

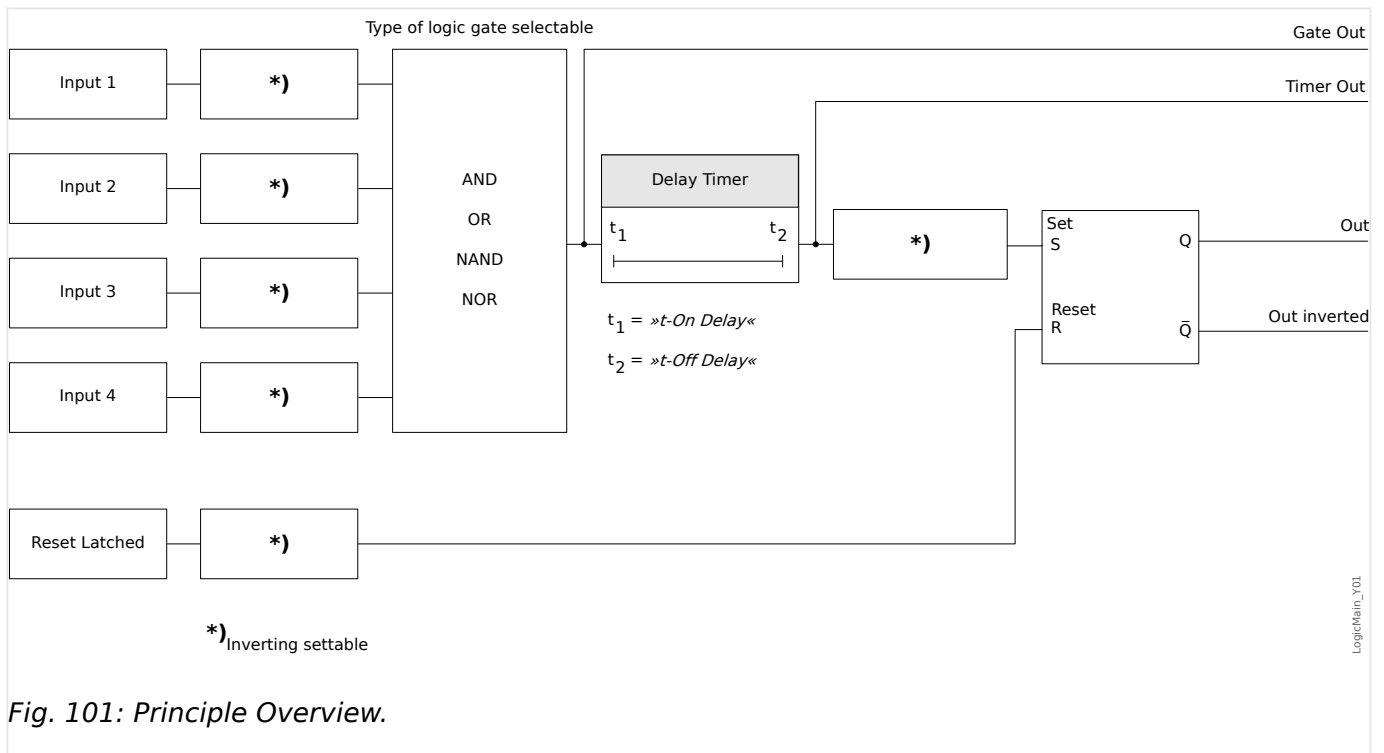

Fig. 101: Principle Overview.

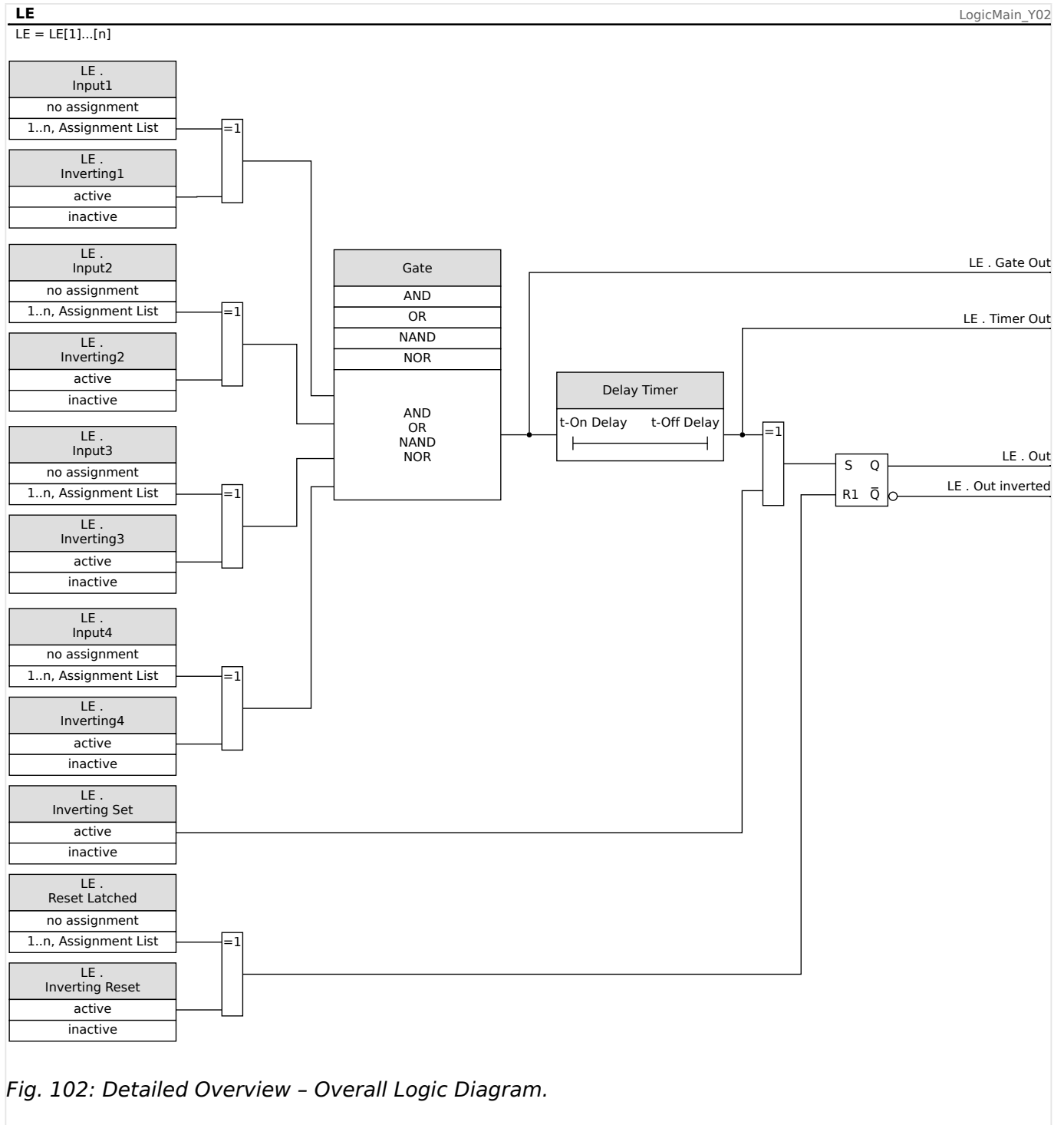

Fig. 102: Detailed Overview - Overall Logic Diagram.

Available Gates (Operators)

Within the Logic Equation, the following Gates can be used:

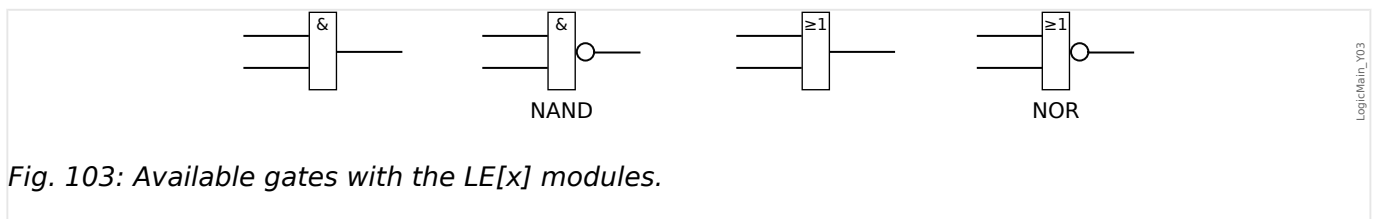

Fig. 103: Available gates with the LE[x] modules.

Input Signals

The user can assign up to 4 Input signals (from the assignment list) to the inputs of the gate.

As an option, each of the 4 input signals can be inverted (negated)

Timer Gate (On Delay and Off Delay)

The output of the gate can be delayed. The user has the option to set an On and an Off delay.

Latching

The logic equations issues two signals. An unlatched and a latched signal. The latched output is also available as an inverted output.

In order to reset the latched signal the user has to assign a reset signal from the assignment list. The reset signal can also optionally be inverted. The latching works based on reset priority. That means, the reset input is dominant.

Cascading Logical Outputs

The device will evaluate output states of the Logic Equations starting from Logic Equation 1 up to the Logic Equation with the highest number. This evaluation (device) cycle will be continuously repeated.

Cascading Logic Equations in an ascending sequence

Cascading in an ascending sequence means that the user uses the output signal of “Logic Equation n ” as input of “Logic Equation $n+1$ ”. If the state of “Logic Equation n ” changes, the state of the output of “Logic Equation $n+1$ ” will be updated within the same cycle.

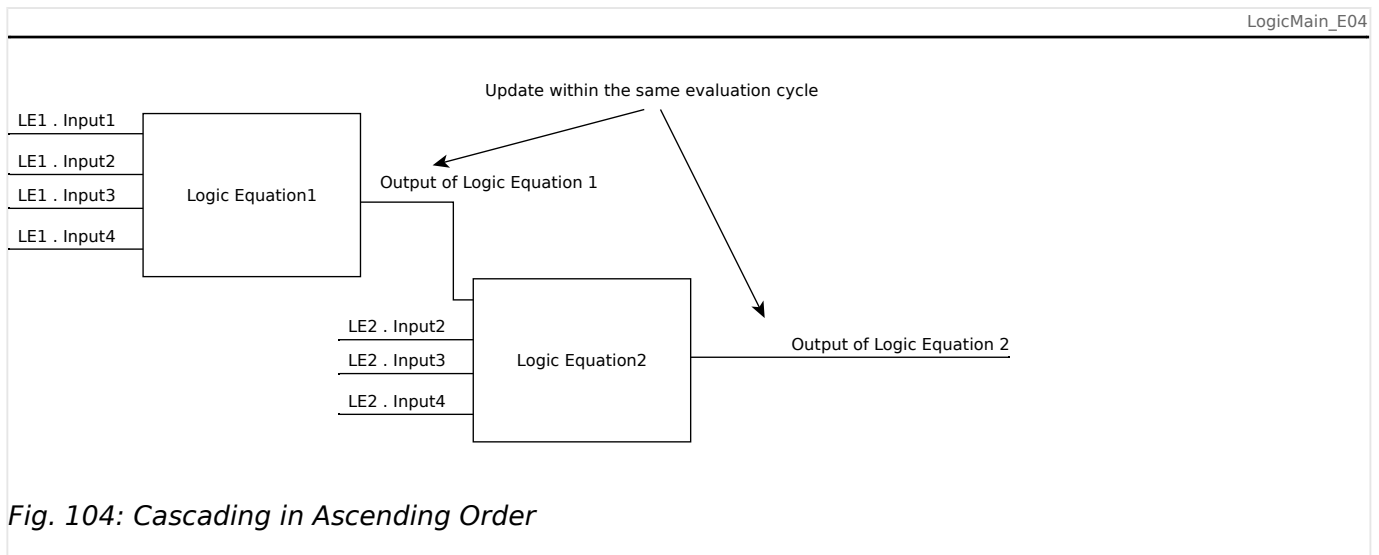

Fig. 104: Cascading in Ascending Order

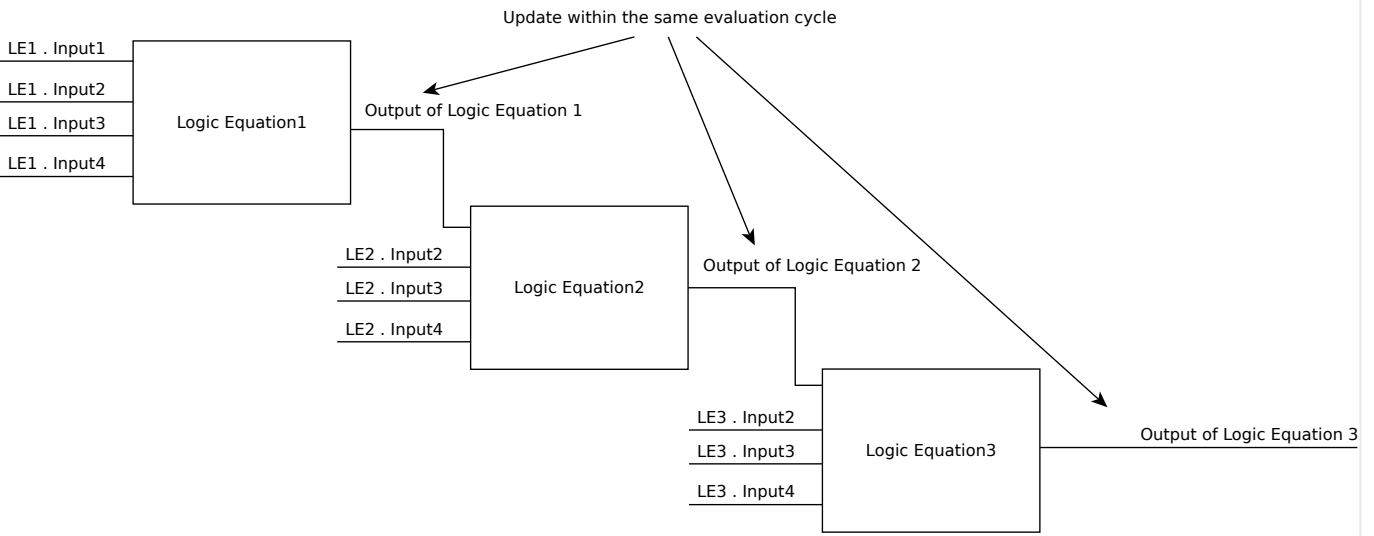

Fig. 105: Cascading in Ascending Order

Cascading Logic Equations in a descending sequence

Cascading in a descending sequence means that the user uses the output signal of “Logic Equation $n+1$ ” as input of “Logic Equation n ”. If the output of “Logic Equation $n+1$ ” changes, this change of the feed back signal at the input of “Logic Equation n ” will be delayed for one cycle.

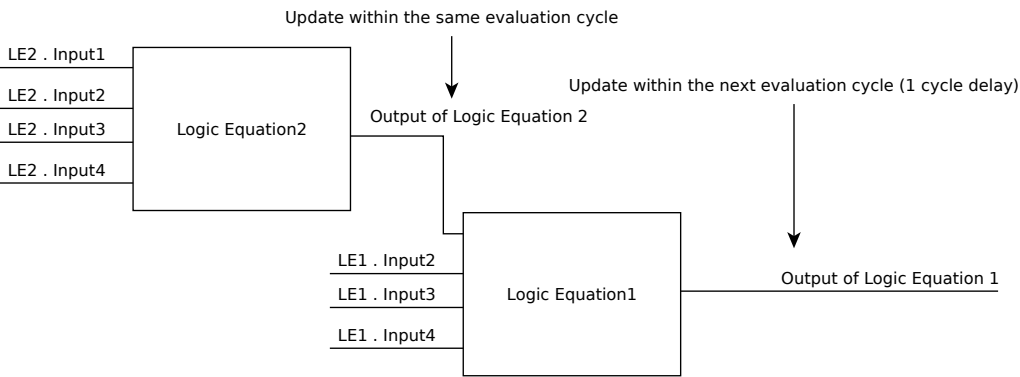

Fig. 106: Cascading in Descending Order

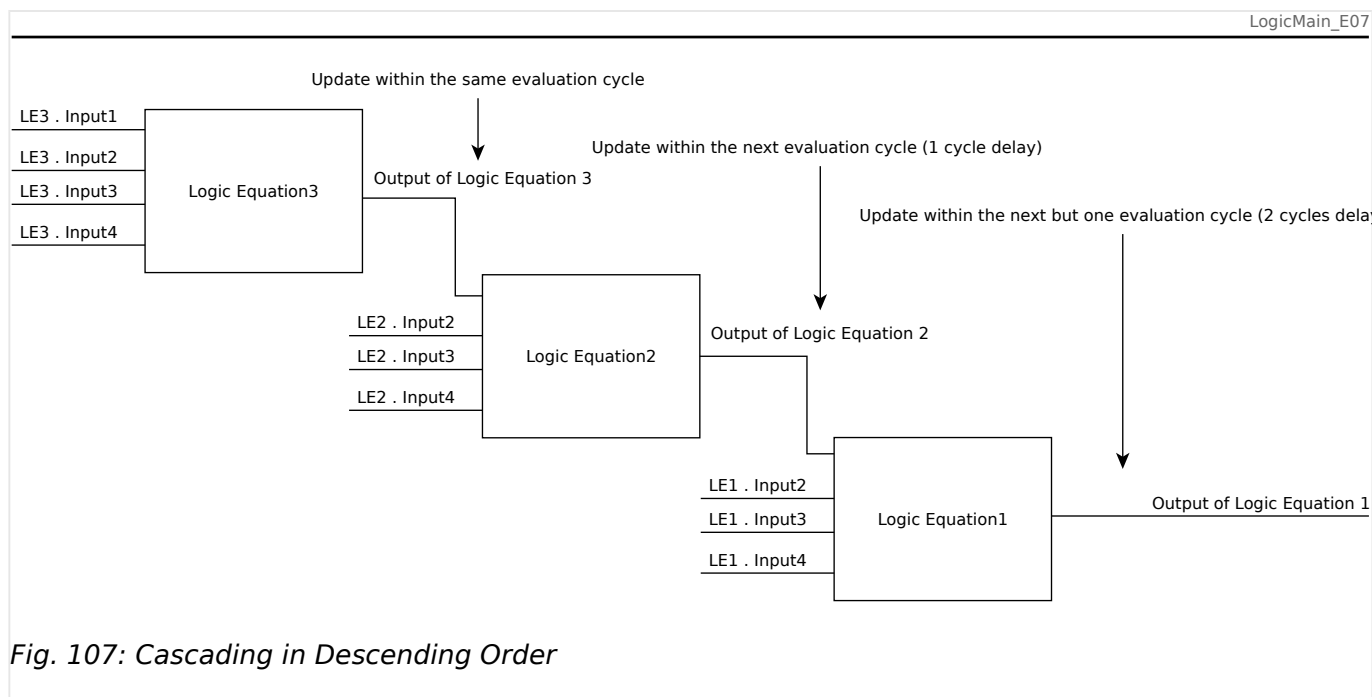

Fig. 107: Cascading in Descending Order

Programmable Logic at the Panel

WARNING!



WARNING improper use of Logic Equations might result in personal injury or damage the electrical equipment. Don't use Logic Equations unless that you can ensure the safe functionality.

How to configure a Logic Equation?

- Call up menu [Logics / LE x]:
- Set the Input Signals (where necessary, invert them).
- If required, configure the timers (»LEx.t-On Delay« and »LEx.t-Off Delay«).
- If the latched output signal is used assign a reset signal to the reset input.
- Within the »status display«, the user can check the status of the logical inputs and outputs of the Logic Equation.

In case that Logic Equations should be cascaded the user has to be aware of timing delays (cycles) in case of descending sequences (Please refer to section: Cascading Logical Outputs).

By means the Status Display [Operation / Status Display], the logical states can be verified.

9 Self-Supervision

The protection devices apply various check routines during normal operation and during the start-up phase to supervise themselves for faulty operation.

Self-Supervision within the devices		
Supervision of...	Supervised by...	Action on detected issue...
Start phase	The duration (permitted time) of the boot phase is monitored.	The device will be rebooted. ⇒ The device will be taken out of service after three unsuccessful start attempts.
Supervision of the duration of a protection cycle (Software cycle)	The maximum permitted time for a protection cycle is monitored by a timing analysis.	The self-supervision contact will be deenergized if the permitted time for a protection cycle is exceeded (first threshold). The protection device will be rebooted, if the protection cycle exceeds the second threshold.
Monitoring of the communication between Main and Digital Signal Processor (DSP)	The cyclic measured value processing of the DSP is monitored by the main processor.	The device will be rebooted, if a failure is detected. The self-supervision contact will be de-energized.
Analog-Digital-Converter	The DSP does a plausibility check on the digitalized data.	Protection will be blocked, if a failure is detected, in order to prevent faulty tripping.
Supervision of data consistency after an outage of the power supply (e.g. outage of the power supply while changing the parameter settings).	An internal logic detects fragmentary saved data after an outage of the power supply.	If the new data is incomplete or corrupt, it will be deleted during the reboot phase of the device. The device will continue to work with the last valid data set.
Data consistency in general	Generation of check-sums.	The device will be taken out of service in case that inconsistent data is detected that is not caused by an outage of the power supply (fatal internal error).
Parameter Setting (Device)	Protecting the parameter setting by plausibility checks.	Implausibilities within the parameter configuration can be detected by means of plausibility checks. Detected implausibilities are highlighted by a question mark symbol. Please refer to chapter parameter setting for detailed information.

Self-Supervision within the devices		
Supervision of...	Supervised by...	Action on detected issue...
Quality of the power supply	A hardware circuit ensures that the device can only be used, if the power supply is in the range specified by the technical data.	If the supply voltage is too low, the device will not start up or it will be set out of service respectively.
Sags of the supply voltage	Short-term sags of the supply voltage are detected and can be bridged in most of the cases by means of the integrated buffer within the power supply hardware. This buffer also allows the termination of ongoing data writing procedures.	The module for the supervision of the system utilization will detect repetitive short-term sags of the supply voltage.
Internal data of the device (memory load, internal resources, ...)	An internal module monitors the system utilization.	The module for the supervision of the system utilization initiates in case of a fatal error a reboot of the device. In case of minor faults the System LED will flash alternating red and green (please refer to the <i>Troubleshooting Guide</i>). The issue will be recorded as a system message.
Battery	The battery is monitored continuously. Notice: The battery serves as buffering of the clock (real time clock). There's no impact on the functionality of the device if the battery breaks down, except for the buffering of the clock while the unit is in de-energized condition.	If the battery is low the System LED will flash alternating red and green (please refer to the <i>Troubleshooting Guide</i>).
Status of the device communication (SCADA)	The projected and activated SCADA module supervises its connection to the master communication system.	You can check if there is active communication with the master system within menu [Operation / Status Display / Scada]. In order to monitor this state you can assign this status onto an LED and/or an output relay. For details on the status of the GOOSE communication please

Self-Supervision within the devices		
Supervision of...	Supervised by...	Action on detected issue...
		refer to chapter  "IEC 61850".

9.1 Device Start (Reboot)

The device reboots in any of the following situations:

- It is connected to the supply voltage,
- the user initiates (intentionally) a restart of the device,
- the device is set back to factory defaults,
- the internal self-supervision of the device detects a fatal error.

Every (re-)start of the MRMV4 appears as a new entry within the Self-Supervision messages,  “Self-Supervision Messages”, for example:

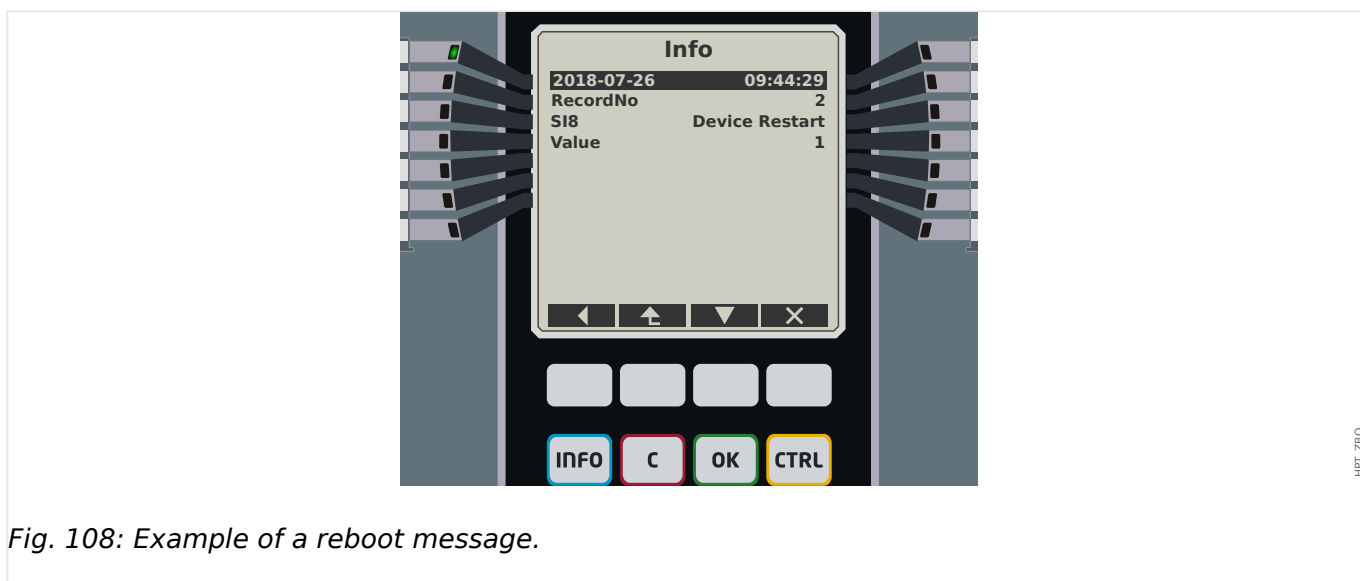

Fig. 108: Example of a reboot message.

The reason for a device start/reboot is shown numerically as “Value”. The value “1” in the example above means a normal start-up. Please see the table below for a full list.

The reason is also logged within the Event Recorder (Event: Sys.Restart).

Device Start-up Codes	
1.	Normal Start-up Start-up after clean disconnection of the supply voltage.
2.	Reboot by the Operator Device reboot triggered by the operator via HMI or <i>Smart view</i> .
3.	Reboot by means of Super Reset Automatic reboot when setting the device back to factory defaults.
4.	-- (obsolete)
5.	-- (obsolete)
6.	Unknown Error Source

Device Start-up Codes	
	Reboot due to unknown error source.
7.	Forced Reboot (initiated by the main processor) The main processor identified invalid conditions or data.
8.	Exceeded Time Limit of the Protection Cycle Unexpected interruption of the Protection Cycle.
9.	Forced Reboot (initiated by the digital signal processor) The digital signal processor identified invalid conditions or data.
10.	Exceeded Time Limit of the Measured Value Processing Unexpected interruption of the cyclic measured value processing.
11.	Sags of the Supply Voltage Reboot after short-term sag or outage of the supply voltage.
12.	Illegal Memory Access Reboot after illegal memory access.

9.2 Self-Supervision Messages

The menu [Operation / Self-Supervision / Messages] gives access to the list of Self-Supervision messages. In particular, it is recommended to check these in case of some problem directly related to the functionality of the MRMV4.

The Self-Supervision collects various security-related messages (e. g. the entry of a false password) and MRMV4-internal status messages, warnings and error messages.

All messages that can potentially appear under [Messages] are described in detail in a separate document, the *“HighPROTEC Troubleshooting Guide”* (HPT-3.6-EN-TSG).

At the HMI (panel) of the MRMV4, there are limitations due to the type of display, so that the list shows only a short entry for each message. After selecting a particular message (with the Softkeys “▲”/Up and “▼”/Down) the Softkey “▶”/Enter takes the user to a screen with all details for this message. There it is also possible to use Softkey “×”/Delete for removing this message plus all older ones.

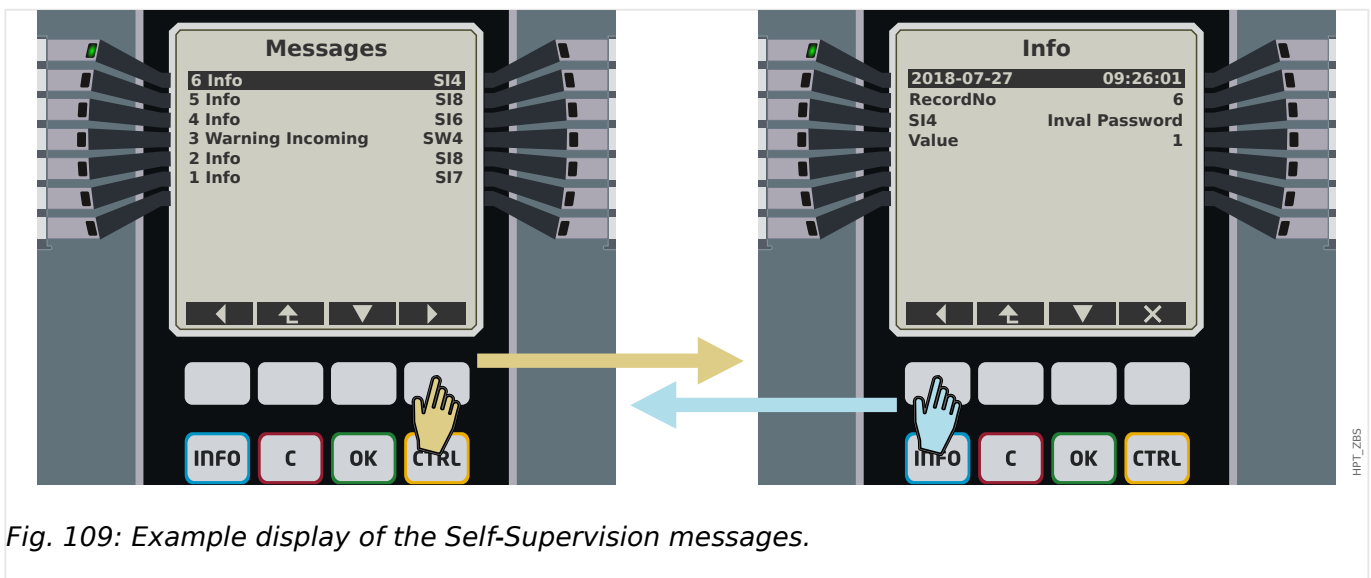





Fig. 109: Example display of the Self-Supervision messages.

All messages are displayed together with an identifier (e. g. **“SI8 Device Restart”**, or **“SI4 Invalid Password”**); this identifier makes it easier to locate detailed information about it in the *Troubleshooting Guide*. The identifier always starts with an **“S”**, next comes either an **“I”** (for “Information”), a **“W”** (for “Warning”), or an **“E”** (for “Error”).

General idea:

- **E** - Errors indicate serious problems. It is advisable to look up the message in the *Troubleshooting Guide*.
- **W** - Warnings should be checked by the user. They might indicate a problem that needs to be solved. On the other hand, depending on the application, it can also be without any effect. Look at the example message **“SW4 Time Sync”** shown below, that indicates an (at least temporary) interrupt of the external time synchronization signal. For most industrial-grade applications, a properly synchronized system time is required, and therefore the user will probably want to check the cause for this message. However, the same message also appears in a situation where the user has intentionally omitted an external clock synchronization.
- **I** - Information messages can be helpful for a thorough analysis of a problem, but in general, such messages have indeed only an informative character and do not affect the operation of the MRMV4.

Checking the Self-Supervision messages using *Smart view* is more convenient (see example figure below) than using the HMI: All messages are listed in one dialog window. There are buttons  in the toolbar of this dialog that allow for restricting the list to particular severity types: It is possible to e. g. hide all “information” messages and show only the types “warning” and “error”.

There is also a delete button  with the same functionality as the “x” on the HMI: It allows for removing the currently selected message plus all older ones.

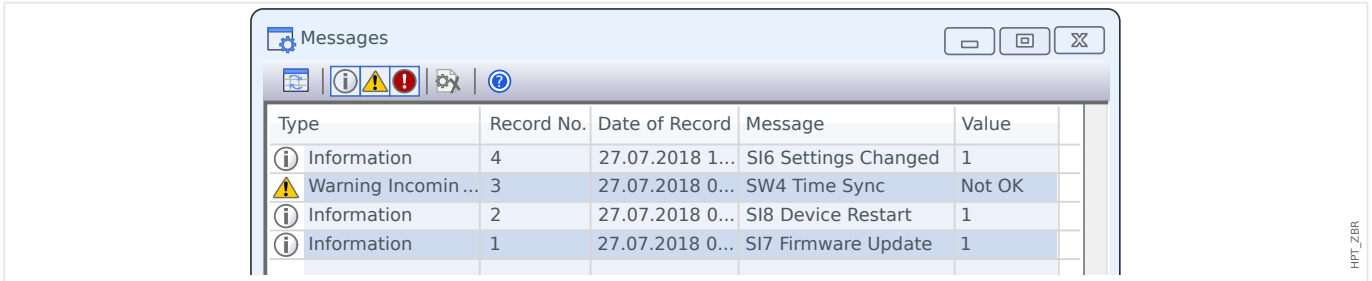

 Note that it is not possible – neither on the HMI nor in *Smart view* – to pick only one particular message for deletion. A “delete” always removes all messages with timestamp until (including) the currently selected one.

9.3 Syslog

It is possible to transfer each new Self-Supervision message ( “Self-Supervision Messages”) to some dedicated server computer. This is done automatically with every new message at the moment when it is issued. This way you can have one central logging system that receives all device messages for all your HighPROTEC devices, so that there is no need to establish new *Smart view* connections to each device only for this purpose.

The transfer uses the so-called **Syslog** communication protocol for the transfer. This is a quite simple standard UDP/IP-based network protocol that transmits text messages of max. 1024 Bytes length to the UDP port 514. (The port number, however, is configurable on the MRMV4.)

The server computer must have a *syslog daemon* running that receives the messages. Of course, the available tools for checking and presenting the messages depend on the setup of this computer.

The Syslog feature of the MRMV4 is inactive by default. If you want to use it you have to activate it first:

- [Device planning] »Syslog . Mode« = “active”

Then the Syslog protocol has to be activated by the following setting:

- [Device Para / Security / Syslog] »Function« = “active”.

Finally one has to specify the IP(v4) address and port number of the server computer so that the MRMV4 knows where to send the messages to:

- [Device Para / Security / Syslog] »IP port number« has to be set to the correct port number.

The default 514 can be simply kept if the server computer listens on the standard port.

- [Device Para / Security / Syslog] »*IP address, part 1*« ... »*IP address, part 4*« — These four parameters specify the IP address of the server computer, i. e. each setting is an integer number from 0 to 255.

9.4 Device Taken out of Service (“Device Stopped”)

The protection device will be taken out of service, if there is an undefined state that cannot be escaped after three reboots.

In this state the system LED will be illuminated red or red flashing. The display will show the message “Device Stopped” followed by a 6-digit error code, e.g. E01487.

There may exist additional error information accessible by the Service Staff. These offer further failure analysis and diagnosis opportunities to the Service Staff.

NOTICE!



In such a case please contact the Woodward Service Staff and provide them the error code.

For further information on trouble shooting please refer to the separately provided *Troubleshooting Guide*.

10 Commissioning

Before starting work on an opened switchboard it is imperative that the complete switchboard is dead and the following 5 safety regulations are always met: ,

DANGER!



Safety precautions:

- Disconnect from the power supply
- Secure against reconnection
- Verify if the equipment is dead
- Connect to ground and short-circuit all phases
- Cover or safeguard all live adjacent parts

DANGER!



The secondary circuit of a current transformer must never be opened during operation. The prevailing high voltages are dangerous to life.

WARNING!



Even when the auxiliary voltage is switched off, it is likely that there are still hazardous voltages at the component connections.

All locally applicable national and international installation and safety regulations for working at electrical power installations must always to be followed (e.g. VDE, EN, DIN, IEC).

WARNING!



Prior to the initial voltage connection, the following must be guaranteed:

- Correct grounding of the device
- All signal circuits must be tested
- All control circuits must be tested
- The transformer wiring must be checked
- Correct rating of the CTs
- Correct burden of the CTs
- The operational conditions must be in line with the Technical Data
- Correct rating and function of the CT fuses;
- Correct wiring of all digital inputs
- Polarity and capacity of the supply voltage
- Correct wiring of the analog inputs and outputs

NOTICE!



The permissible deviations of measuring values and device adjustment are dependent on the technical data/tolerances.

10.1 Commissioning/Protection Test

WARNING!



Putting into operation/Protection test must be carried out by authorized and qualified personnel. Before the device is put into operation the related documentation has to be read and understood.

WARNING!



With any test of the protection functions the following has to be checked:

- Are all signals/messages correctly generated?
- Do all general parameterized blocking functions work properly?
- Do all temporary parameterized (via DI) blocking functions work properly?
- To enable checks on all LEDs and relay functions, these have to be provided with the relevant alarm and tripping functions of the respective protection functions/elements. This has to be tested in practical operation.

WARNING!



Check of all temporary blockings (via digital inputs):

In order to avoid malfunctions, all blockings related to tripping/non-tripping of protection function have to be tested. The test can be very complex and should therefore be performed by the same people who set up the protection concept.

CAUTION!



Check of all general trip blockings:

All general trip blockings have to be tested.

NOTICE!



Prior to the initial operation of the protection device all tripping times and values shown in the adjustment list have to be confirmed by a secondary test

NOTICE!



Any description of functions, parameters, inputs or outputs that does not match the device in hand, can be ignored.

10.2 Putting out of Operation - Plug out the Relay

WARNING!



Warning! Dismounting the relay will lead to a loss of the protection functionality. Ensure that there is a back-up protection. If you are not aware of the consequences of dismounting the device - stop! Don't start.

WARNING!



Inform SCADA before you start.

Switch off the power supply.

Ensure, that the cabinet is dead and that there are no voltages that could lead to personal injury.

Plug-out the terminals at the rear-side of the device. Do not pull any cable - pull on the plugs! If it is stuck use for example a screw driver.

Fasten the cables and terminals in the cabinet by means of cable clips to ensure that no accidental electrical connections are caused.

Hold the device at the front-side while opening the mounting nuts.

Remove the device carefully out of the cabinet.

In case no other device is to be mounted or replaced cover/close the cut-out in the front-door.

Close the cabinet.

10.3 Service and Commissioning Support

Within the service menu various functions support maintenance and commissioning of the device.

10.3.1 General

Within the menu [Service / General], the user can initiate a reboot of the device.



The »System OK« (“Operational”) LED is constantly green when – after the boot phase, [↪ “12 Boot Phase”](#) – the protection functions of the MRMV4 are working. In any other case consult the *Troubleshooting Guide*.

10.3.2 Phase Sequence

Within the menu [Operation / Status Display / Supervision / Phase Sequence], there are signals showing whether the phase sequence calculated by the device is different from the setting under [Field Para / General Settings] »Phase Sequence«. See [↪ “Phase Sequence Supervision”](#) for details.

10.3.3 Forcing the Relay Output Contacts

NOTICE!



See [↪ “Overview of Slots – Assembly Groups”](#) for information on available Relay Output contacts. The parameters, their defaults and setting ranges have to be taken from the Reference Manual.

Principle - General Use

DANGER!



The User **MUST ENSURE** that the relay output contacts operate normally after the maintenance is completed. If the relay output contacts do not operate normally, the protective device **WILL NOT** provide protection.

For commissioning purposes or for maintenance, relay output contacts can be set by force.

Within this mode [Service / Test (Prot inhibit) / Force OR / BO Slot Xx], relay output contacts can be set by force:

- Permanent; or
- via timeout.

If they are set with a timeout, they will only keep their “Force Position” as long as this timer runs. If the timer expires, the relay will operate normally. If they are set as Permanent, they will keep the “Force Position” continuously.

There are two options available:

- Forcing a single relay »Force ORx«; and
- Forcing an entire group of relay output contacts »Force all Outs«.

Forcing an entire group takes precedence over forcing a single relay output contact!

NOTICE!



A relay output contact will NOT follow a force command as long as it is disarmed at the same time.

NOTICE!



A relay output contact will follow a force command:

- If it is not disarmed; and
- If the Direct Command is applied to the relay(s).

Keep in mind, that the forcing of all relay output contacts (of the same assembly group) takes precedence over the force command of a single relay output contact.

10.3.4 Disarming the Relay Output Contacts

NOTICE!



See [↳ “Overview of Slots - Assembly Groups”](#) for information on available Relay Output contacts. The parameters, their defaults and setting ranges have to be taken from the Reference Mnaual.

Principle - General Use

Within this mode [Service / Test (Prot inhibit) / DISARMED / BO Slot Xx][Service/Test Mode/ DISARMED], entire groups of relay output contacts can be disabled. By means of this test mode, contact outputs switching actions of the relay output contacts are prevented. If the relay output contacts are disarmed, maintenance actions can be carried out without the risk of taking entire processes off-line.

DANGER!



The User MUST ENSURE that the relay output contacts are ARMED AGAIN after the maintenance is complete. If they are not armed, the protective device WILL NOT provide protection.

NOTICE!



Zone Interlocking Output and the Supervision Contact cannot be disarmed.

Within this mode [Service / Test (Prot inhibit) / DISARMED] entire groups of relay output contacts can be disarmed:

- Permanent; or
- Via timeout.

If they are set with a timeout, they will only keep their “Disarm Position” as long as this timer runs. If the timer expires, the relay output contacts will operate normally. If they are set Permanent, they will keep the “Disarm State” continuously.

NOTICE!



A relay output contact will NOT be disarmed as long as:

- It's latched (and not yet reset).
- As long as a running t-OFF-delay timer is not yet expired (hold time of a relay output contact).
- The Disarm Control is not set to active.
- The Direct Command is not applied.

NOTICE!



A relay output contact will be disarmed if it's not latched and

- There is no running t-OFF-delay timer (hold time of a relay output contact) and
- The DISARM Control is set to active and
- The Direct Command Disarm is applied.

10.3.5 Forcing RTDs*

* = Availability depends on ordered device.

NOTICE!



The parameters, their defaults, and setting ranges have to be taken from RTD/UTRD section.

Principle - General Use

DANGER!



The User **MUST ENSURE** that the RTDs operate normally after the maintenance is completed. If the RTDs do not operate normally, the protective device **WILL NOT** provide protection.

For commissioning purposes or for maintenance, RTD temperatures can be set by force.

Within this mode [Service / Test (Prot inhibit) / URTD], RTD temperatures can be set by force:

- Permanent; or
- Via timeout.

If they are set with a timeout, they will keep their “Forced Temperature” only as long as this timer runs. If the timer expires, the RTD will operate normally. If they are set as »Permanent«, they will keep the “Forced Temperature” continuously. This menu will show the measured values of the RTDs until the User activates the force mode by calling up the »Function«. As soon as the force mode is activated, the shown values will be frozen as long as this mode is active. Now the User can force RTD values. As soon as the force mode is deactivated, measured values will be shown again.

10.3.6 Forcing Analog Outputs*

* = Availability depends on ordered device.

NOTICE!



The parameters, their defaults, and setting ranges have to be taken from Analog Output section.

Principle - General Use

DANGER!



The User **MUST ENSURE** that the Analog Outputs operate normally after maintenance is completed. Do not use this mode if forced Analog Outputs cause issues in external processes.

For commissioning purposes or for maintenance, Analog Outputs can be set by force.

Within this mode [Service / Test (Prot inhibit) / Analog Outputs], Analog Outputs can be set by force:

- Permanent; or
- Via timeout.

If they are set with a timeout, they will only keep their “Forced Value” as long as this timer runs. If the timer expires, the Analog Output will operate normally. If they are set as »Permanent«, they will keep the “Forced Value” continuously. This menu will show the current value that is assigned onto the Analog Output until the User activates the force mode by calling up the »Function«. As soon as the force mode is activated, the shown values will be frozen as long as this mode is active. Now the User can force Analog Output values. As soon as the force mode is deactivated, measured values will be shown again.

10.3.7 Fault Simulator (Sequencer)*

* = Availability depends on ordered device.

For commissioning support and in order to analyze failures, the protective device offers the option to simulate measuring quantities.

[After setting Device planning] »Mode« = “use”, the simulation menu can be found within the menu branch [Service / Test (Prot inhibit) / Sgen].

The simulation cycle consists of three states:

- Pre-fault;
- Failure;
- Post-fault State (Phase).

In addition to these three states, there is a short “reset stage” of about 100 ms immediately before the Pre-failure state, and another one after the Post-failure state, where all protection functions are deactivated. This is necessary to re-initialize all protection modules and related filters and set them to a healthy new state.

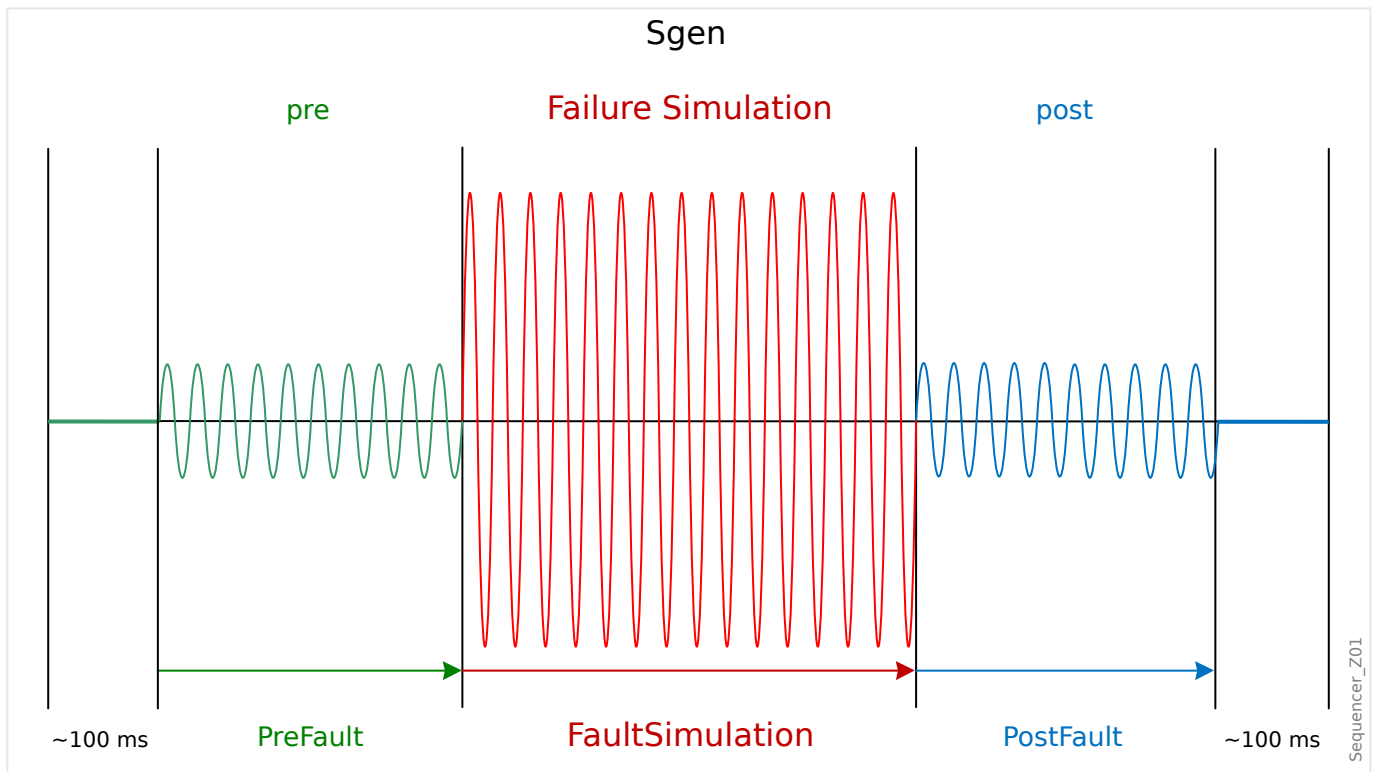

The states are recorded by the Event and Disturbance Recorders as follows:

- **0** - Normal operation (i. e. without fault simulation)
- **1** - Pre-fault
- **2** - Fault
- **3** - Post-fault
- **4** - Reset / initialization phase

Within the menu branch [Service / Test (Prot inhibit) / Sgen / Configuration / Times], the duration of each phase can be set. In addition; the measuring quantities to be simulated can be determined (e. g.: voltages, currents, and the corresponding angles) for each phase (and ground).

NOTICE!



The simulation is terminated immediately, if a phase current exceeds $0.1 \cdot I_n$.
A simulation can be restarted, five seconds after the current has fallen below $0.1 \cdot I_n$.

Moreover, within the menu branch [Service / Test (Prot inhibit) / Sgen / Process] there are two blocking parameters »ExBlo1«, »ExBlo2«. Signals that are assigned to any of these block the Fault Simulator. For example, it can be recommended for security considerations to have the Fault Simulator blocked if the circuit breaker is in closed position.

Furthermore, there is the possibility to assign a signal to the parameter »Ex ForcePost«. Then this signal interrupts the actual state of the Fault Simulator (Pre-fault or Failure) and leads to an immediate transition into the Post-fault state. The typical application for this is a test whether the protective device correctly generates a trip decision, so that it is not necessary to always wait until the regular end of the Failure state. It is possible to assign the trip signal to »Ex ForcePost« so that the Failure state is ended immediately after the trip signal has been correctly generated.

DANGER!



Setting the device into the simulation mode means taking the protective device out of operation for the duration of the simulation. Do not use this feature during operation of the device if the User cannot guarantee that there is a running and properly working backup protection.

NOTICE!



The energy counters are stopped while the failure simulator is running.

NOTICE!



The simulation voltages are always phase to neutral voltages, irrespectively of the mains voltage transformers' connection method (Phase-to-phase / Wye / Open Delta).

NOTICE!



Due to internal dependencies, the frequency of the simulation module is 0.16% greater than the rated one.

Cold Simulation

Simulation without tripping the circuit breaker:

The trip command (»TripCmd«) of all protection functions is blocked. The protection function will possibly trip but not generate a trip command.

- Set [Service / Test (Prot inhibit) / Sgen / Process] »TripCmd Mode« = “No TripCmd”

Hot Simulation

Simulation is authorized to trip the breaker:

- Set [Service / Test (Prot inhibit) / Sgen / Process] »TripCmd Mode« = “With TripCmd”

Start/Stop Options

Manual start, no stop:

Complete run: Pre Failure, Failure, Post Failure.

- Set [Service / Test (Prot inhibit) / Sgen / Process] »Ex ForcePost« = “No assignment”
- Press/Call the Direct Control [Service / Test (Prot inhibit) / Sgen / Process] »Start Simulation«.

Manual start, stop by external signal:

Force Post: As soon as this signal becomes true, the Fault Simulation is forced to switch into the Post Failure mode.

- Set [Service / Test (Prot inhibit) / Sgen / Process] »Ex ForcePost« to the required signal.
- Press/Call the Direct Control [Service / Test (Prot inhibit) / Sgen / Process] »Start Simulation«.

Manual start, manual stop:

As soon as the stop command is given, the Fault Simulation is terminated and the MRMV4 changes back to normal operation.

- Start: as described above.
- Stop: Press/Call the Direct Control [Service / Test (Prot inhibit) / Sgen / Process] »Stop Simulation«.

Start by external signal:

The start of the Fault Simulator is triggered by the assigned external signal (unless it is blocked).

(Moreover, as already said above,  Chapter 10.3.7, the use of the Fault Simulator generally requires that no phase current exceeds $0.1 \cdot I_n$.)

- Set [Service / Test (Prot inhibit) / Sgen / Process] »Ex Start Simulation« to the required signal.

11 Servicing and Maintenance

Within the scope of servicing and maintenance following checks of the MRMV4 hardware have to be conducted:

Output Relays

Every 1–4 years, depending on ambient conditions:

- Check the Output Relays via the test menu branches [Service / Test (Prot inhibit) / Force OR] / [Service / Test (Prot inhibit) / DISARMED], see  “Service and Commissioning Support”)

Digital Inputs

Every 1–4 years, depending on ambient conditions:

- Supply a voltage to the Digital Inputs and check if the appropriate status signal appears.

Current plugs and Current measurements

Every 1–4 years, depending on ambient conditions:

- Supply a test current to the current measurement inputs and check the displayed measured values from the MRMV4.

Voltage plugs and Voltage measurements

Every 1–4 years, depending on ambient conditions:

- Supply a test voltage to the Voltage measurement inputs and check the displayed measured values from the MRMV4.

Analog Outputs

Every 1–4 years, depending on ambient conditions:

- Please check the Analog Outputs via via the test menu branches [Service / Test (Prot inhibit) / Force OR] / [Service / Test (Prot inhibit) / DISARMED], see  “Service and Commissioning Support”)

Battery

In general the battery lasts more than 10 years. Exchange by Woodward.

Notice: The battery serves as buffering of the clock (real-time clock). There's no impact on the functionality of the device if the battery breaks down, except for the buffering of the clock while the unit is in de-energized condition.

- The device checks the battery as part of its Self-Supervision, therefore no dedicated testing activities are required. If the battery is low, the System LED flashes red/green, and an error code is generated (see *Troubleshooting Guide*).

Self-Supervision Contact

Every 1–4 years, depending on ambient conditions:

- Switch off the auxiliary supply of the unit. Then the Self-Supervision Contact must drop out. Switch on the auxiliary supply again.

Mechanical Mounting of the Unit of the Cabinet Door

With each maintenance or yearly:

- Check the torque (1.7 Nm [15 in·lb]) related to the specification of the Installation chapter,  “Dimension Drawings”.

Torque of all cable connections

With each maintenance or yearly:

- Check the torque related to the specification of the Installation chapter ( “MRMV4 - Installation and Wiring”) which describes the hardware modules.

We recommend to execute a protection test after each 4 years period. This period can be extended to 6 years if a function test is executed at least every 3 years.

12 Technical Data

NOTICE!



Use copper conductors only, 75°C.
Conductor size AWG 14 [2.5 mm²].

Climatic and Environmental Data

Storage Temperature:	−30°C to +70°C (−22°F to 158°F)
Operating Temperature:	−20°C to +60°C (−4°F to 140°F)
Permissible Humidity at Ann. Average:	<75% rel. (on 56 days up to 95% rel.)
Permissible Installation Altitude:	<2000 m (6561.67 ft) above sea level If 4000 m (13 123.35 ft) altitude applies, a changed classification of the operating and test voltages may be necessary.

Pollution Degree and Equipment Class

Pollution degree:	2
Equipment class:	1

Degree of Protection EN 60529

HMI front panel with seal	IP54
HMI front panel without seal	IP50
Rear side terminals	IP20

Routine Test

Insulation Test Acc. to IEC60255-5:	All tests to be carried out against ground and other input and output circuits.
Aux. voltage supply, digital inputs, current measuring inputs, signal relay outputs:	2.5 kV (eff) / 50 Hz
Voltage measuring inputs:	3.0 kV (eff) / 50 Hz
All wire-bound communication interfaces:	1.5 kVDC

Housing

Housing B2: height/-width: (8 Pushbottoms / Door Mounting)	183 mm / 212,7 mm
---	-------------------

Housing B2: height/-width: (8 Pushbottoms / 19")	173 mm (4 HE) / 212,7 mm (42 TE)
Housing Depth (Incl. Terminals):	208 mm (8.189 in.)
Material, Housing:	Aluminum extruded section
Material, Front Panel:	Aluminum / foil front
Mounting Position:	Horizontal ($\pm 45^\circ$ around the X-axis must be permitted)
Weight:	approx. 4.7 kg (10.36 lb)

Current and Ground Current Measurement

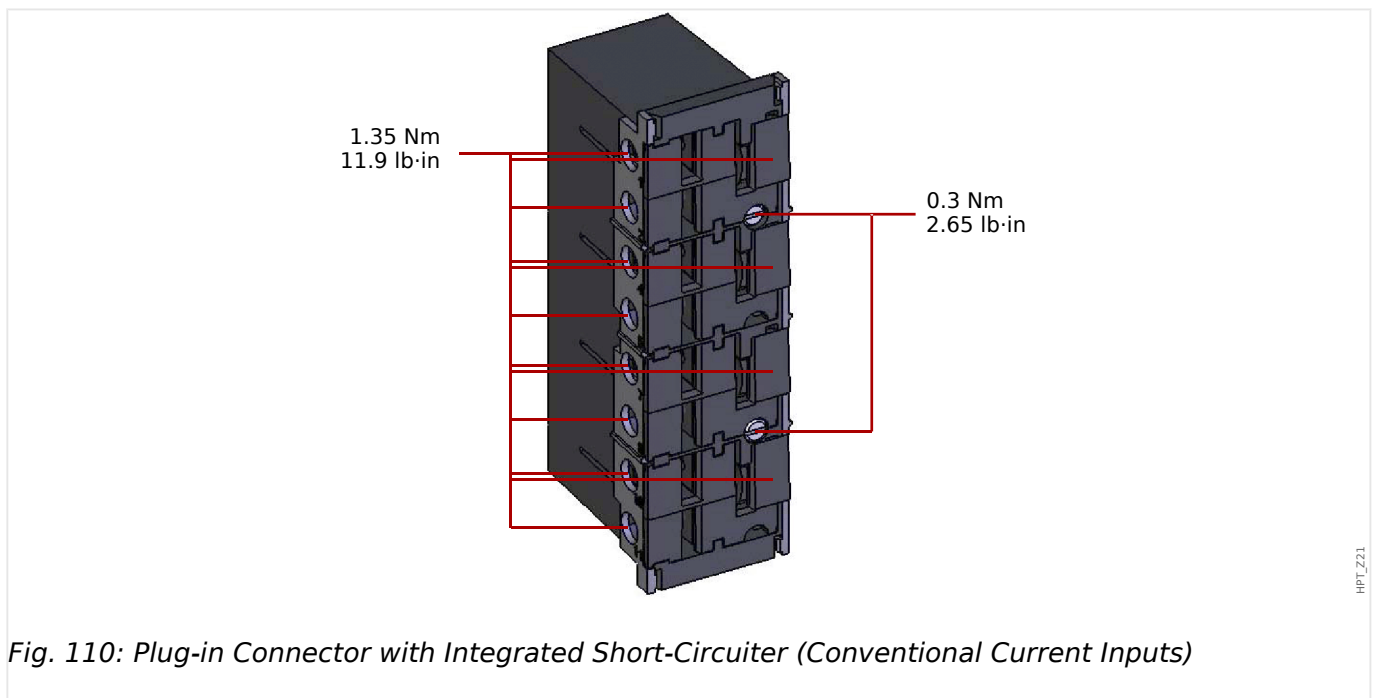

HPT_Z21

Frequency Range:	50 Hz / 60 Hz $\pm 10\%$
Terminals:	Screw-type terminals with integrated short-circuiters (contacts)
Screws	M4, captive type acc. to VDEW
Connection Cross Sections:	<p>1 x or 2 x 2.5 mm² (2 x AWG 14) with wire end ferrule</p> <p>1 x or 2 x 4.0 mm² (2 x AWG 12) with ring cable sleeve or cable sleeve</p> <p>1 x or 2 x 6 mm² (2 x AWG 10) with ring cable sleeve or cable sleeve</p> <p>The current measuring board's terminal blocks may be used as with 2 (double) conductors AWG 10,12,14 otherwise with single conductors only.</p>

Phase and Ground Current Inputs:	
Nominal Currents:	1 A / 5 A
Max. Measuring Range:	Up to 40 x I _n (phase currents) Up to 25 x I _n (ground current standard)
Capacity:	4 x I _n /continuously
Overcurrent Proof:	30 x I _n / 10 s 100 x I _n / 1 s 250 x I _n / 10 ms (1 half-wave)
Power Consumption:	Phase current inputs At I _n = 1 A: S = 25 mVA At I _n = 5 A: S = 90 mVA Ground current input At I _n = 1 A: S = 25 mVA At I _n = 5 A: S = 90 mVA

Sensitive Ground Current Inputs:	
Nominal Currents:	1 A / 5 A
Max. Measuring Range:	Up to 2.5 x I _n
Capacity:	2 x I _n /continuously
Overcurrent Proof:	10 x I _n / 10 s 25 x I _n / 1 s 100 x I _n / 10 ms (1 half-wave)
Power Consumption:	At 1 A: S = 550 mVA At 0.1 A: S = 7 mVA At 5 A: S = 870 mVA At 0.5 A: S = 10 mVA

Voltage and Residual Voltage Measurement (“TU”)

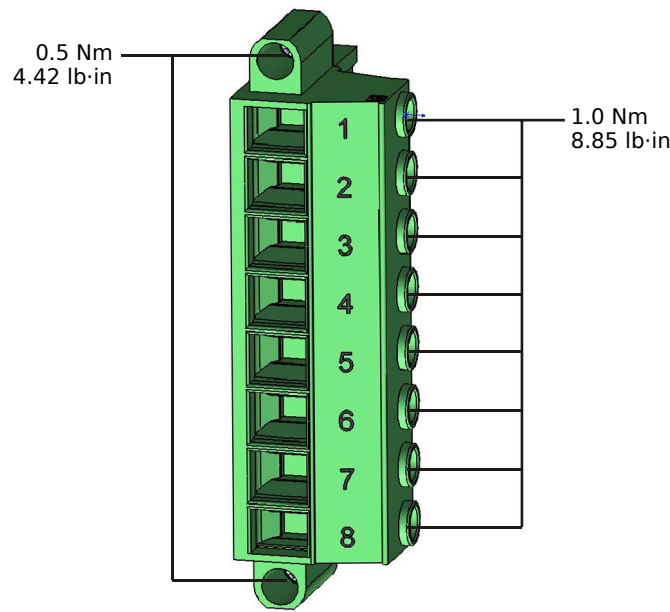

Fig. 111: Voltage measurement terminals of measuring card “TU” (↳ “TU - Voltage Measuring Inputs”).

The following Technical Data are valid for 8-pole (large) voltage measurement terminals.

Nominal voltages:	60 - 520 V (can be configured)
Max. measuring range:	800 VAC
Continuous loading capacity:	800 VAC
Power consumption:	at Vn = 100 V: S = 22 mVA at Vn = 110 V: S = 25 mVA at Vn = 230 V: S = 110 mVA at Vn = 400 V: S = 330 mVA
Frequency range:	50 Hz or 60 Hz ±10%
Terminals:	Screw-type terminals
Connection Cross Sections:	min. 0.5 mm ² (AWG 20) ... max. 6.0 mm ² (AWG 10) with or without wire end ferrule

Frequency Measurement

Nominal frequencies:	50 Hz / 60 Hz
----------------------	---------------

Voltage Supply

Aux. Voltage:	24 ... 270 VDC / 48 ... 230 VAC (-20/+10%) ≈
Buffer Time in Case of Supply Failure:	≥ 50 ms at minimal aux. voltage

	The device will shut down if the buffer time is expired. Note: communication could be interrupted.
Max. Permissible Making Current:	18 A peak value for < 0.25 ms 12 A peak value for < 1 ms
Fuse (built into the wide-range power supply unit):	6.3 A time-lag (This fuse is not to be replaced by the user, but is necessary for safe operation.)

The voltage supply must be protected by an external fuse of:

- 2.5 A time-lag miniature fuse 5 x 20 mm (approx. 1/5 x 0.8 in.) according to IEC 60127
- 3.5 A time-lag miniature fuse 6.3 x 32 mm (approx. 1/4 x 1 ¼ in.) according to UL 248-14

Power Consumption

Power Supply Range	Power consumption in Idle Mode	Max. Power Consumption
24 - 270 VDC:	Approx. 8 W	Approx. 13 W
48 - 230 VAC (for Frequencies of 50-60 Hz):	Approx. 8 W / 16 VA	Approx. 13W / 21 VA

Display

Display type:	LCD with LED background illumination
Resolution - graphics display:	128 x 64 pixel

LEDs

LED type:	Two colored: red / green
Number of LEDs, Housing B2:	15

Front Interface USB

Type:	Mini B
-------	--------

Real Time Clock

Running Reserve of the Real Time Clock:	1 year min.
---	-------------

Analog Outputs

The following technical data only apply to devices, which are equipped with analog outputs. Please refer to the order code of your device.

The mode of each output can be individually selected between current or voltage output. Shielded cable for the analog outputs is recommended. The terminals of the HF shield should be used, when connecting the shield to earth on both sides of the cable is not possible. On one side of the cable the shield has to be directly connected to earth. In case of the use of unshielded twisted pair cables, the length must not exceed 10 m. All analog outputs have a common potential. Each output has an own common terminal.

Current mode	
Range:	0-20 mA
Max. load resistance:	1 kΩ

Voltage mode	
Range:	0-10 V, maximum output current 1 mA
Accuracy	0.5% of the nominal value 20 mA resp. 10 V
Influence of temperature to accuracy	<1%
Test voltage of outputs (one group) against other electrical groups	2.5 kV
Test voltage of outputs (one group) against earth	1.0 kV

Digital Inputs

Max. Input Voltage:	300 VDC / 259 VAC
Input Current:	DC <4 mA AC <16 mA
Reaction Time:	<20 ms
Fallback Time:	
Shorted inputs	<30 ms
Open inputs	<90 ms

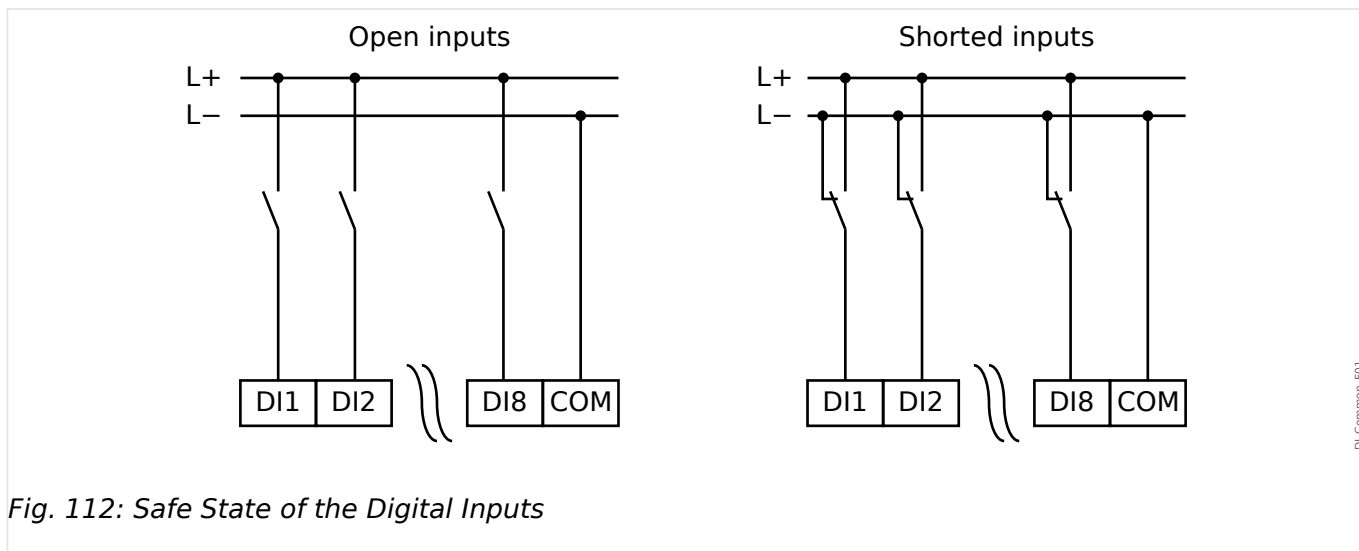

Fig. 112: Safe State of the Digital Inputs

D_Common_F01

Switching Thresholds:	24 VDC, 48 VDC, 60 VDC, 110 VDC, 110 VAC, 230 VDC, 230 VAC
Un = 24 VDC	
Switching Threshold 1 ON:	Min. 19.2 VDC
Switching Threshold 1 OFF:	Max. 9.6 VDC
Un = 48 V / 60VDC	
Switching Threshold 2 ON:	Min. 42.6 VDC
Switching Threshold 2 OFF:	Max. 21.3 VDC
Un = 110 / 120 VAC / DC	
Switching Threshold 3 ON:	Min. 88.0 VDC / 88.0 VAC
Switching Threshold 3 OFF:	Max. 44.0 VDC / 44.0 VAC
Un = 230 / 240 VAC / DC	
Switching Threshold 4 ON:	Min. 184 VDC / 184 VAC
Switching Threshold 4 OFF:	Max. 92 VDC / 92 VAC
Terminals:	Screw-type terminal

Binary Output Relays

Continuous current:	5 A AC/DC
Max. Switch-on current:	25 A AC/DC for 4 s 30 A AC/DC for 0.5 s 48W (VA) at L/R = 40 ms

	30 A / 230 VAC according to ANSI IEEE Std C37.90-2005
	30 A / 250 VDC according to ANSI IEEE Std C37.90-2005
Max. breaking current:	5 A AC up to 240 VAC 4 A AC at 230 V and $\cos \varphi = 0,4$ 5 A DC up to 30 V (resistive) 0.3 A DC at 250 V (resistive) 0.1 A DC at 220 V and L/R = 40 ms
Max. switching voltage:	250 VAC / 250 VDC
Switching capacity:	3000 VA
Operating time: (*)	typ. 7 ms
Reset time: (*)	typ. 3 ms
Contact type:	1 changeover contact or normally open or normally closed
Terminals:	Screw-type terminals

(*) The operating and reset times are the pure hardware-related switching times (coil - making/breaking contact), i. e. without the time that it takes the software to calculate the decisions.

Supervision Contact (SC)

Continuous current:	5 A AC/DC
Max. Switch-on current:	15 A AC/DC for 4 s
Max. breaking current:	5 A AC up to 250 VAC 5 A DC up to 30 V (resistive) 0.25 A DC at 250 V (resistive)
Max. switching voltage:	250 VAC / 250 VDC
Switching capacity:	1250 VA
Contact type:	1 changeover contact
Terminals:	Screw-type terminals

Time Synchronization IRIG-B00X

Nominal input voltage:	5 V
Connection:	Screw-type terminals (twisted pair)

RS485*

*availability depends on device

Connection:	9-pole D-Sub socket (external terminating resistors/in D-Sub) or 6 screw-clamping terminals RM 3.5 mm (138 MIL) (terminating resistors internal)
-------------	---

CAUTION!

In case that the RS485 interface has terminals, the communication cable has to be shielded.

Fiber Optic Module with ST connector*

*availability depends on device

Connector:	ST Port
Compatible Fiber:	50/125 μm , 62.5/125 μm , 100/140 μm and 200 μm HCS
Wavelength	820 nm
Minimum Optical Input Power:	-24.0 dBm
Minimum Optical Output Power:	-19.8 dBm with 50/125 μm fiber -16.0 dBm with 62,5/125 μm fiber -12.5 dBm with 100/145 μm fiber -8.5 dBm with 200 μm HCS fiber
Maximum Link Length:	approx. 2.7 km (depending on link attenuation)

Please note: The transmission speed of the optical interfaces is limited to 3 MBaud for Profibus.

Optical Ethernet Module with LC connector*

*availability depends on device

Connector:	LC Port
Compatible Fiber:	50/125 μm and 62.5/125 μm
Wavelength:	1300 nm
Minimum Optical Input Power:	-30.0 dBm
Minimum Optical Output Power:	-22.5 dBm with 50/125 μm fiber -19.0 dBm with 62,5/125 μm fiber

Maximum Link Length:	approx. 2 km (depending on link attenuation)
----------------------	--

URTD-Interface*

*availability depends on device

Connector:	Versatile Link
Compatible Fiber:	1 mm
Wavelength:	660 nm
Minimum Optical Input Power:	-39.0 dBm

Smart view Connections

The MRMV4 can communicate with the operating software *Smart view* as follows:

- USB connection (using the USB interface at the front of the MRMV4).
- TCP/IP connection (using the Ethernet* interface at the rear side of the MRMV4).

(*availability depends on device)

There can be max. 3 *Smart view* sessions with the same MRMV4 device at the same time.

Self-Supervision Messages

The storage capacity for Self-Supervision messages (see [↳ “Self-Supervision Messages”](#)) is as follows:

- **E** - Errors - up to 500 messages. Each new error beyond this number deletes the oldest error message.
- **W** - Warnings - up to 500 messages. Each new warning beyond this number deletes the oldest warning message.
- **I** - Information messages - up to 500 messages. Each new information message beyond this number deletes the oldest information message.

Boot Phase

After switching on the power supply the protection will be available in approximately 8 seconds. After approximately 58 seconds (depending on the configuration) the boot phase is completed (HMI and Communication initialized).

12.1 Specifications / Tolerances

12.1.1 Specifications of the Real Time Clock

Resolution:	1 ms
Tolerance:	<1 minute / month (+20°C [68°F]) <±1ms if synchronized via IRIG-B

Time Synchronization Tolerances

The different protocols for time synchronisation vary in their accuracy:

Used Protocol	Time drift over one month	Deviation to time generator
Without time synchronization	<1 min (+20°C)	Time drifts
IRIG-B	Dependent on the time drift of the time generator	<±1 ms
SNTP	Dependent on the time drift of the time generator	<±1 ms, if network connection is GOOD (see operation status of SNTP)
IEC60870-5-103	Dependent on the time drift of the time generator	<±1 ms
Modbus TCP	Dependent on the time drift of the time generator	Dependent on the network load
Modbus RTU	Dependent on the time drift of the time generator	<±1 ms
DNP3 TCP	Dependent on the time drift of the time generator	Dependent on the network load
DNP3 UDP	Dependent on the time drift of the time generator	Dependent on the network load
DNP3 RTU	Dependent on the time drift of the time generator	<±1 ms

Note that the availability of the protocols depends on the ordered variant of the MRMV4 (see  "Order Form of the Device").

12.1.2 Specifications of the Measured Value Acquisition

Phase and Ground Current Measuring

Frequency Range:	50 Hz / 60 Hz \pm 10%
Accuracy:	Class 0.5
Amplitude Error if $I < I_n$:	\pm 0.5% of the rated current *3)
Amplitude Error if $I > I_n$:	\pm 0.5% of the measured current *3)
Amplitude Error if $I > 2 I_n$:	\pm 1.0% of the measured current *3)
Harmonics:	Up to 20% 3rd harmonic \pm 2% Up to 20% 5th harmonic \pm 2%
Frequency Influence:	$< \pm$ 2% / Hz in the range of \pm 5 Hz of the configured nominal frequency
Temperature Influence:	$< \pm$ 1% within the range of 0°C to +60°C (+32°F to +140°F)

*3) For earth current sensitive the precision does not depend on the nominal value but is referenced to 100 mA (with $I_n = 1$ A) respectively. 500 mA (with $I_n = 5$ A).

Phase-to-ground and Residual Voltage Measurement

Frequency Range:	50 Hz / 60 Hz \pm 10%
Accuracy for measured values:	Class 0.5
Amplitude Error for $V < V_n$:	\pm 0.5% of the rated voltage or \pm 0.5 V
Amplitude Error for $V > V_n$:	\pm 0.5% of the measured voltage or \pm 0.5 V *2)
Accuracy for calculated values:	Class 1.0
Amplitude Error for $V < V_n$:	\pm 1.0% of the rated voltage or \pm 1 V
Amplitude Error for $V > V_n$:	\pm 1.0% of the calculated voltage or \pm 1 V
Harmonics:	Up to 20% 3 rd harmonic \pm 1% Up to 20% 5 th harmonic \pm 1%
Frequency influence:	$< \pm$ 2% / Hz in the range of \pm 5 Hz of the configured nominal frequency
Temperature influence:	$< \pm$ 1% within the range of 0°C up to +60°C

•
•

Frequency Measurement

Nominal frequency:	50 Hz / 60 Hz
Precision:	$\pm 0.05\%$ of fN within the range of 40 – 70 Hz at voltages >50 V
Voltage dependency:	frequency acquisition from $0.15 \times V_n$

Energy Measurement *)

Energy counter error:	1.5% of the measured energy or 1.5% SN·1h
-----------------------	---

*) Tolerance at $0.8 \dots 1.2 \times V_n$ (with $V_n=100V$) , $|PF|>0.5$, symmetrically fed,
 $SN = 1.73 \cdot VT \text{ rating} \cdot CT \text{ rating}$

Power Measurement *)

S, P, Q:	< $\pm 1\%$ of the measured value or 0.1% SN (for fundamental) < $\pm 2\%$ of the measured value or 0.2% SN (for RMS)
P1, Q1 (pos. sequence):	$\pm 2\%$ of the measured value or 0.2% SN

*) Tolerance at $0.8 \dots 1.2 \times V_n$ (with $V_n=100V$) , $|PF|>0.5$, symmetrically fed,
 $SN = 1.73 \cdot VT \text{ rating} \cdot CT \text{ rating}$

Power Factor Measurement *)

PF:	< ± 0.01 of the measured power factor or 1° $I > 30\% I_n$ and $S > 2\% SN$
-----	---

*) Tolerance at $0.8 \dots 1.2 \times V_n$ (with $V_n=100V$) , $|PF|>0.5$, symmetrically fed,
 $SN = 1.73 \cdot VT \text{ rating} \cdot CT \text{ rating}$

12.1.3 Protection Elements Accuracy

NOTICE!	
	The tripping delay relates to the time between alarm and trip. The accuracy of the operating time relates to the time between fault entry and the time when the protection element is picked-up.

Reference conditions for all Protection Elements: sine wave, at rated frequency, THD < 1%, measuring method: Fundamental

12.1.3.1 Phase Overcurrent Protection

Overcurrent Protection Elements: I[x]	Accuracy
I>	±1.5% of the setting value or ±1% I _n .
Dropout Ratio	97% or 0.5% I _n
t	DEFT ±1% or ±10 ms
Operating Time At testing current ≥ 2 times pickup value	<36 ms
Disengaging Time	<55 ms
tchar	±5% (according to selected curve)
t-reset delay (»Reset Mode«= "delayed")	±1% or ±10 ms

Overcurrent Protection Elements: I[x] with setting »Measuring method«= “I2” (Negative phase sequence current)	Accuracy
I>	±2.0% of the setting value or ±1% I _n .
Dropout Ratio	97% or 0.5% I _n
t	DEFT ±1% or ±10 ms
Operating Time At testing current ≥ 2 times pickup value	<60ms
Disengaging Time	<45 ms

12.1.3.2 Earth (Ground) Overcurrent Protection

Earth Overcurrent Protection Elements: IG[x]	Accuracy *3)
IG>	±1.5% of the setting value or 1% I _n
Dropout Ratio	97% or 0.5% I _n
t	DEFT ±1% or ±10 ms
Operating Time Starting from IE higher than 1.2 x IE>	<45 ms
Disengaging Time	<55 ms
tchar	±5% (according to selected curve)
t-reset delay (»Reset Mode«= "delayed")	±1% or ±10 ms
VG>	±1.5% of the setting value or ±1% V _n .
Dropout Ratio	97% or 0.5% V _n

- *3) For earth current sensitive the precision does not depend on the nominal value but is referenced to 100 mA (with I_n = 1 A) respectively 500 mA (with I_n = 5 A)

12.1.3.3 Thermal Protection

RTD Protection: RTD / URTD	Accuracy
Trip Threshold	$\pm 1^{\circ}\text{C}$ (1.8°F)
Alarm Threshold	$\pm 1^{\circ}\text{C}$ (1.8°F)
t-delay Alarm	DEFT $\pm 1\%$ or ± 10 ms
Reset Hysteresis	-2°C (-3.6°F) of threshold $\pm 1^{\circ}\text{C}$ (1.8°F)

12.1.3.4 Motor Protection

Motor Protection:	Accuracy
Stop Declaration	<50 ms
Time period current must drop below STPC	±1.5% of the setting value or 1% In
Anti Backspin Blocking time to allow for back spin	±1 s
TBS Timer Time between repeated starts.	±1 s
Reset Starts Per Hour Reset starts per hours timer from oldest start event.	±1 minute

Jam-Stall Protection:	Accuracy
Jam[X]	
Pickup	±1.5% of the setting value or 1% In
Dropout Ratio	±97% or 0.5% In
t	DEFT ±1% or ±10 ms
Operating Time Starting from I higher than 1.1 x I>	<35 ms
Disengaging Time	<45 ms

Mechanical Load Shedding:	Accuracy
MLS	
Pickup Threshold	±1.5% of the setting value or 1% In
Pickup Delay	DEFT ±1% or ±10 ms
Dropout Threshold	±1.5% of the setting value or 1% In
Dropout Delay	DEFT ±1% or ±10 ms

Start Delay Timers	Accuracy
Start Delay (common timers)	$\pm 1\%$ or ± 10 ms
Operating Times	
for IOC, GOC, Power, JAM	< 35 ms
for Underload, Undervoltage, Overvoltage, Frequency, Generic 1-5	< 60 ms

Thermal Model	Accuracy
ThR	
Trip Threshold	$\pm 2\%$
Trip Delay	$\pm 1\%$ or ± 10 ms
Alarm Threshold	$\pm 2\%$
Alarm Delay	$\pm 1\%$ or ± 10 ms

12.1.3.5 Current-Related Protection

Current unbalance: I2>[x]	Accuracy *1)
I2>	±2% of the setting value or 1% In
Dropout Ratio	97% or 0.5% In
%(I2/I1)	±1%
t	DEFT ±1% or ±10 ms
Operating Time	<70 ms
Disengaging Time	<50 ms
K	±5% INV
τ-cool	±5% INV

- *1) The negative-sequence current I2 must be $\geq 0.01 \times I_n$, the positive-sequence current I1 must be $\geq 0.1 \times I_n$.

12.1.3.6 Voltage-Related Protection

Voltage Protection: V[x]	Accuracy
Pickup	$\pm 1.5\%$ of the setting value or $1\% V_n$
Dropout Ratio	Adjustable, at least $0.5\% V_n$
t	DEFT $\pm 1\%$ or ± 10 ms
Operating Time Starting from V higher than $1.2 \times$ pickup value for $V >$ or V lower than $0.8 \times$ pickup value for $V <$	< 40 ms typical: 35 ms
Disengaging Time	< 45 ms

Residual Voltage Protection: VG[x]	Accuracy
Pickup	$\pm 1.5\%$ of the setting value or $1\% V_n$
Dropout Ratio	97% or $0.5\% V_n$ for $VG >$ 103% or $0.5\% V_n$ for $VG <$
t	DEFT $\pm 1\%$ or ± 10 ms
Operating Time Starting from V higher than $1.2 \times$ pickup value for $VG >$ or V lower than $0.8 \times$ pickup value for $VG <$	< 40 ms typical: 35 ms
Disengaging Time	< 45 ms

Voltage unbalance: V012[x]	Accuracy *1)
Threshold	$\pm 2\%$ of the setting value or $1\% V_n$
Dropout Ratio	97% or $0.5\% V_n$ for $V1 >$ or $V2 >$ 103% or $0.5\% V_n$ for $V1 <$
$\%(V2/V1)$	$\pm 1\%$
t	DEFT $\pm 1\%$ or ± 10 ms
Operating Time	< 60 ms
Disengaging Time	< 45 ms

- *1) The negative-sequence voltage $V2$ must be $\geq 0.01 \times V_n$, and the positive-sequence voltage $V1$ must be $\geq 0.1 \times V_n$.

12.1.3.7 Frequency Protection

(Over / Under) Frequency Protection: f>, f<	Accuracy *1)
f> / f<	±20 mHz Typically ~5 mHz if the 3 phases are between fN ± 0.2 Hz *3)
Dropout	Default 20 mHz (adjustable in the range 10 mHz ... 100 mHz)
Disengaging Time	<120 ms *2)
Operating Time (for ramps) *4)	<100 ms, typically 65 ms *2)
Operating Time (for steps)	<170 ms, typically 90 ms *2)

- *1) Accuracy is given for rated frequency fN ±10% when all three voltages are applied.
- *2) Accuracy is given for the default setting [Field Para / Frequency] »Stab. window f« = 0.

Note that the Operating and Disengaging times are increased if »Stab. window f« is increased.

- *3) An accuracy of $\leq \pm 10$ mHz can be reached with the setting value »Stab. window f« ≥ 5 , but note that every increase of this setting value worsens (i. e. increases) the Operating and Disengaging times.
- *4) For continuous frequency changes (no phase angle surge nor voltage surges are applied).

When using frequency steps with test equipment, operating time is slightly higher (approx. additional +40 ms) due to extra stabilization.

Rate of Change of Frequency: df/dt	Accuracy *1)
df/dt	$\pm 2.5\%$ or ± 0.025 Hz/s *2) *3)
Dropout	0.070 Hz/s
Operating Time	<300 ms, typically ~ 200 ms *2) <200 ms, using minimum setting values: *3) »Window df/dt« = 2 »Stab. window df/dt« = 2
Disengaging Time	<300 ms, typically ~ 160 ms *2) *3)

- *1) Accuracy is given for rated frequency $f_N \pm 10\%$ when all three voltages are applied.
- *2) Accuracy is given for the default settings [Field Para / Frequency] »Window df/dt« = 4, [Field Para / Frequency] »Stab. window df/dt« = 5.
- *3) The accuracy can be improved by increasing the setting values for »Window df/dt« and »Stab. window df/dt«. Note, however, that this worsens (i. e. increases) the Operating and Disengaging times

Vice versa, decreasing the setting of »Window df/dt« improves (i. e. decreases) the Operating and Disengaging times, but worsens (i. e. increases) the tolerance.

Rate of Change of Frequency: DF/DT	Accuracy
DF	± 20 mHz at f_N
DT	$\pm 1\%$ or ± 10 ms

Vector surge: delta phi	Accuracy
Threshold	$\pm 0.5^\circ$ [1 – 30°] at V_n and f_N
Operating time	<40 ms

12.1.3.8 Power-Related Protection

Power Factor: PF	Accuracy
Trigger-PF	± 0.01 (absolute) or $\pm 1^\circ$
Reset-PF	± 0.01 (absolute) or $\pm 1^\circ$
t	$\pm 1\%$ or ± 10 ms
Operating time »Measuring method« = <ul style="list-style-type: none"> • "Fundamental" • "True RMS" 	*1) <ul style="list-style-type: none"> • <130 ms • <200 ms

*1) The calculation of the Power Factor will be available 300 ms after the required measuring values ($I > 2.5\% I_n$ and $V > 20\% V_n$) have energized the measuring inputs.

Directional Power Protection: PQS[x] with »Mode« = "S>" or "S<"	Accuracy *1)
Threshold	$\pm 3\%$ or $\pm 0.1\%$ SN
Dropout Ratio	<ul style="list-style-type: none"> • 97% or 1 VA for "S>" • 103% or 1 VA for "S<"
t	$\pm 1\%$ or ± 10 ms
Operating Time	75 ms
Disengaging Time	100 ms

Directional Power Protection: PQS[x] with »Mode« = "P>", "P<", "Pr<", "Pr>"	Accuracy *1)
Threshold	±3% or ±0.1% SN
Dropout Ratio	<ul style="list-style-type: none"> • 97% or 1 VA for "P>" and "Pr>" • 103% or 1 VA for "P<" and "Pr<" for setting values ≤ 0.1 SN: <ul style="list-style-type: none"> • 58% or 0.5 VA for "P>" and "Pr>" • 142% or 0.5 VA for "P<" and "Pr<" for setting values ≤ 0.01 SN <ul style="list-style-type: none"> • 58% or 0.2 VA for "P>" and "Pr>" • 142% or 0.2 VA for "P<" and "Pr<"
t	±1% or ±10 ms
Operating Time	75 ms
Disengaging Time	100 ms

Directional Power Protection: PQS[x] with »Mode« = "Q>", "Q<", "Qr<", "Qr>"	Accuracy *1)
Threshold	±3% or ±0.1% SN
Dropout Ratio	<ul style="list-style-type: none"> • 97% or 1 VA for "Q>" and "Qr>" • 103% or 1 VA for "Q<" and "Qr<" for setting values ≤ 0.1 SN: <ul style="list-style-type: none"> • 58% or 0.5 VA for "Q>" and "Qr>" • 142% or 0.5 VA for "Q<" and "Qr<" for setting values ≤ 0.01 SN <ul style="list-style-type: none"> • 58% or 0.2 VA for "Q>" and "Qr>" • 142% or 0.2 VA for "Q<" and "Qr<"
t	±1% or ±10 ms
Operating Time	75 ms
Disengaging Time	100 ms

- *1) Common reference conditions: at $|PF| > 0.5$, symmetrically fed, at f_N and $0.8 - 1.3 \times V_n$ ($V_n = 100 \text{ V}$)

12.1.3.9 Miscellaneous Protection and Supervision

Circuit Breaker Failure Protection: CBF	Accuracy
t-CBF	$\pm 1\%$ or ± 10 ms
I-CBF >	$\pm 1.5\%$ of the setting value or $1\% I_n$
Operating Time Starting from I higher than $1.3 \times I\text{-CBF} >$	<40 ms
Disengaging Time	<40 ms

Trip Circuit Monitoring: TCS	Accuracy
t-TCS	$\pm 1\%$ or ± 10 ms

Current Transformer Supervision: CTS	Accuracy
ΔI	$\pm 2\%$ of the setting value or $1.5\% I_n$
Dropout Ratio	94%
Alarm delay	$\pm 1\%$ or ± 10 ms

Loss of Potential: LOP	Accuracy
t-Alarm	$\pm 1\%$ or ± 10 ms

13 Appendix

13.1 Standards

13.1.1 Approvals

	
	UL File Nr.: E217753 certified regarding UL508 (Industrial Controls)
	CSA File Nr.: 251990 certified regarding CSA-C22.2 No. 14 (Industrial Controls)
	EAC certified by EAC (Eurasian Conformity)
	KESCO 동일성 선언서 (Declaration of Identity)

- Complies with IEEE 1547-2003
- Amended by IEEE 1547a-2014
- Complies with ANSI C37.90-2005
- Complies with “Engineering Recommendation G59 Issue 3 Amendment 4 - July 2018”
- Complies with “Engineering Recommendation G99 Issue 1 Amendment 3 - May 2018”

13.1.2 Design Standards

Generic standard	EN 61000-6-2 , 2005 EN 61000-6-3 , 2006
Product standard	IEC 60255-1; 2009 IEC 60255-26, 2013 IEC 60255-27, 2013 UL 508 (Industrial Control Equipment), 2005 CSA C22.2 No. 14-95 (Industrial Control Equipment),1995 ANSI C37.90, 2005

13.1.3 Electrical Tests

High Voltage Tests

High Frequency Interference Test		
IEC 60255-22-1	Within one circuit	1 kV / 2 s
IEC 60255-26		
IEEE C37.90.1		
IEC 61000-4-18		
	Circuit to ground	2.5 kV / 2 s
class 3	Circuit to circuit	2.5 kV / 2 s

Insulation Voltage Test		
IEC 60255-27	All circuits to other circuits and exposed conductive parts	2.5 kV (eff.) / 50 Hz, 1 min.
IEC 60255-5		
EN 50178		
	Except interfaces	1.5 kV DC, 1 min.
	Voltage measuring input	3 kV (eff.) / 50 Hz, 1 min.

Impulse Voltage Test		
IEC 60255-27		5 kV / 0.5 J, 1.2 / 50 μ s <i>[y.textvar/@name=micro_k]S</i>
IEC 60255-5		

Insulation Resistance Test		
IEC 60255-27	Within one circuit	500 V DC, 5 s
EN 50178		
	Circuit to circuit	500 V DC, 5 s

EMC Immunity Tests

Fast Transient Disturbance Immunity Test (Burst)		
IEC 60255-22-4	Power supply, mains inputs	± 4 kV, 2.5 <i>[y.textvar/@name=kilo_k]Hz</i>
IEC 60255-26		
IEC 61000-4-4	Other in- and outputs	± 2 kV, 5 <i>[y.textvar/@name=kilo_k]Hz</i>

Fast Transient Disturbance Immunity Test (Burst)		
class 4		

Surge Immunity Test (Surge)		
IEC 60255-22-5	Within one circuit	2 kV
IEC 60255-26	Circuit to ground	4 kV
IEC 61000-4-5		
class 4		
class 3	Communication cables to ground	2 kV

Electrical Discharge Immunity Test (ESD)		
IEC 60255-22-2	Air discharge	8 kV
IEC 60255-26	Contact discharge	6 kV
IEC 61000-4-2		
class 3		

Radiated Radio Frequency Electromagnetic Field Immunity Test		
IEC 60255-22-3	26 MHz – 80 MHz	10 V/\$[y.textvar/@name=m_k]
IEC 60255-26	80 MHz – 1 GHz	35 V/\$[y.textvar/@name=m_k]
IEC 61000-4-3	1 GHz – 3 GHz	10 V/\$[y.textvar/@name=m_k]

Immunity to Conducted Disturbances Induced by Radio Frequency Fields		
IEC 61000-4-6	150kHz - 80MHz	10 V
IEC 60255-26		
class 3		

Power Frequency Magnetic Field Immunity Test		
IEC 61000-4-8	continuous	30 A/\$[y.textvar/@name=m_k]
IEC 60255-26	3 sec	300 A/\$[y.textvar/@name=m_k]
class 4		

EMC Emission Tests

Radio Interference Suppression Test

IEC/CISPR 22	150kHz - 30MHz	Limit value class B
IEC 60255-26		

Radio Interference Radiation Test

IEC/CISPR 11	30MHz - 1GHz	Limit value class A
IEC 60255-26		

13.1.4 Environmental Tests

Classification		
IEC 60068-1	Climatic Classification	20/060/56
IEC 60721-3-1	Classification of ambient conditions (Storage)	1K5/1B1/1C1L/1S1/1M2 but min. -30°C (-22°F)
IEC 60721-3-2	Classification of ambient conditions (Transportation)	2K2/2B1/2C1/2S1/2M2 but min. -30°C (-22°F)
IEC 60721-3-3	Classification of ambient conditions (Stationary use at weather protected locations)	3K6/3B1/3C1/3S1/3M2 but min. -20°C (-4°F) / max 60°C (140°F)

Test Ad: Cold		
IEC 60068-2-1	Temperature	-20°C (-4°F)
IEC 60255-27	Test duration	16 h

Test Bd: Dry Heat		
IEC 60068-2-2	Temperature	60°C (140°F)
IEC 60255-27	Relative humidity	<50%
	Test duration	72 h

Test Cab: Damp Heat (Steady State)		
IEC 60068-2-78	Temperature	60°C (140°F)
IEC 60255-27	Relative humidity	95%
	Test duration	56 days

Test Db: Damp Heat (Cyclic)		
IEC 60068-2-30	Temperature	60°C (140°F)
IEC 60255-27	Relative humidity	95%
	Cycles (12 + 12 Hours)	2

Test Nb: Temperature Change		
IEC 60068-2-14	Temperature	60°C / -20°C
	cycle	5
	test duration	1°C / 5 min.

Test BD: Dry Heat Transport and storage test

IEC 60255-27	Temperature	70°C
IEC 60068-2-2	test duration	16 h

Test AB: Cold Transport and storage test

IEC 60255-27	Temperature	−30°C
IEC 60068-2-1	test duration	16 h

13.1.5 Mechanical Tests

Test Fc: Vibration Response Test		
IEC 60068-2-6	(10 Hz - 59 Hz)	0.035 $\$[y.textvar/@name=milli_k]\$$ $\$[y.textvar/@name=m_k]\$$ (0.0014 $\$[y.textvar/@name=inch_k]\$$)
IEC 60255-27	Displacement	
IEC 60255-21-1	(59 Hz - 150 Hz)	0.5 gn
class 1	Acceleration	
	Number of cycles in each axis	1

Test Fc: Vibration Endurance Test		
IEC 60068-2-6	(10 Hz - 150 Hz)	1.0 gn
IEC 60255-21-1	Acceleration	
class 1	Number of cycles in each axis	20

Test Ea: Shock Test		
IEC 60068-2-27	Shock response test	5 gn, 11 ms, 3 impulses in each direction
IEC 60255-27	Shock resistance test	15 gn, 11 ms, 3 impulses in each direction
IEC 60255-21-2		
class 1		

Test Eb: Shock Endurance Test		
IEC 60068-2-29	Shock endurance test	10 gn, 16 ms, 1000 impulses in each direction
IEC 60255-21-2		
class 1		

Test Fe: Earthquake Test		
IEC 60068-3-3	Single axis earthquake vibration test	1 - 9 Hz horizontal: 7.5 $\$[y.textvar/@name=milli_k]\$$ $\$[y.textvar/@name=m_k]\$$ (0.295 $\$[y.textvar/@name=inch_k]\$$)
IEC 60255-27		1 - 9 Hz vertical: 3.5 $\$[y.textvar/@name=milli_k]\$$ $\$[y.textvar/@name=m_k]\$$ (0.137 $\$[y.textvar/@name=inch_k]\$$)
IEC 60255-21-3		1 sweep per axis

Test Fe: Earthquake Test

class 2

9 - 35 Hz horizontal: 2 gn,
9 - 35 Hz vertical : 1 gn,
1 sweep per axis

13.2 IEC 60870-104 Interoperability

This companion standard presents sets of parameters and alternatives from which subsets must be selected to implement particular telecontrol systems. Certain parameter values, such as the choice of “structured” or “unstructured” fields of the INFORMATION OBJECT ADDRESS of ASDUs represent mutually exclusive alternatives. This means that only one value of the defined parameters is admitted per system. Other parameters, such as the listed set of different process information in command and in monitor direction allow the specification of the complete set or subsets, as appropriate for given applications. This clause summarizes the parameters of the previous clauses to facilitate a suitable selection for a specific application. If a system is composed of equipment stemming from different manufacturers, it is necessary that all partners agree on the selected parameters.

The interoperability list is defined as in IEC 60870-5-101 and extended with parameters used in this standard. The text descriptions of parameters which are **not applicable to this companion standard are strike-through and the corresponding check box is marked black.**

NOTE: In addition, the full specification of a system may require individual selection of certain parameters for certain parts of the system, such as the individual selection of scaling factors for individually addressable measured values.

The selected parameters have been marked as follows:

<input type="checkbox"/>	Function or ASDU is not used
[X]	Function or ASDU is used as standardized (default)
[R]	Function or ASDU is used in reverse mode
[B]	Function or ASDU is used in standard and reverse mode

The possible selection (blank, X, R, or B) is specified for each specific clause or parameter.

13.2.1 System or device

(system-specific parameter, indicate definition of a system or a device by marking one of the following with “X”)

<input type="checkbox"/>	System definition
<input type="checkbox"/>	Controlling station definition (Master)
[X]	Controlled station definition (Slave)

13.2.2 Network configuration

(network-specific parameter, all configurations that are used are to be marked “X”)

<input checked="" type="checkbox"/>	Point-to-point	<input checked="" type="checkbox"/>	Multipoint
<input checked="" type="checkbox"/>	Multiple point-to-point	<input checked="" type="checkbox"/>	Multipoint-star

13.2.3 Physical layer

(network-specific parameter, all interfaces and data rates that are used are to be marked "X")

Transmission speed (control direction)

■	100 bit/s	■	2400 bit/s	■	2400 bit/s
■	200 bit/s	■	4800 bit/s	■	4800 bit/s
■	300 bit/s	■	9600 bit/s	■	9600 bit/s
■	600 bit/s			■	19200 bit/s
■	1200 bit/s			■	38400 bit/s
				■	64000 bit/s

Transmission speed (monitor direction)

■	100 bit/s	■	2400 bit/s	■	2400 bit/s
■	200 bit/s	■	4800 bit/s	■	4800 bit/s
■	300 bit/s	■	9600 bit/s	■	9600 bit/s
■	600 bit/s			■	19200 bit/s
■	1200 bit/s			■	38400 bit/s
				■	64000 bit/s

13.2.4 Link layer

(network-specific parameter, all options that are used are to be marked "X". Specify the maximum frame length. If a non-standard assignment of class 2 messages is implemented for unbalanced transmission, indicate the Type ID and COT of all messages assigned to class 2.)

Frame format FT 1.2, single character 1 and the fixed time-out interval are used exclusively in this companion standard.

Link transmission		Address field of the link	
■	Balanced transmission	■	not present (balanced transmission only)
■	Unbalanced transmission	■	One octet
		■	Two octets
		■	Structured
		■	Unstructured

■	Maximum length L (number of octets)
---	-------------------------------------

When using an unbalanced link layer, the following ASDU types are returned in class 2 messages (low priority) with the indicated causes of transmission:

- The standard assignment of ASDUs to class 2 messages is used as follows:

Type identification	Cause of transmission
9, 11, 13, 21	<1>

- Special assignments of ASDUs to class 2 messages are not used.

Note: (In response to a class 2 poll, a controlled station may respond with class 1 data when there is no class 2 data available).

13.2.5 Application layer

Transmission mode for application data

Mode 1 (Least significant octet first), as defined in 4.10 of IEC 60870-5-4, is used exclusively in this companion standard.

Common address of ASDU

(system-specific parameter, all configurations that are used are to be marked "X")

■ One octet	[X]	Two octets
-------------	-----	------------

Information object address

(system-specific parameter, all configurations that are used are to be marked "X")

■ One octet	[X]	Structured
■ Two octets	[X]	Unstructured
[X] Three octets		

Cause of transmission

(system-specific parameter, all configurations that are used are to be marked "X")

■ One octet	[X]	Two octets (with originator address). Originator address is set to zero if not used
-------------	-----	--

Length of APDU

(system-specific parameter, specify the maximum length of the APDU per system)

The maximum length of the APDU is 253 (default). The maximum length may be reduced by the system.

■	Maximum length of APDU per system
---	-----------------------------------

Selection of standard ASDUs

Process information in monitor direction

(station-specific parameter, mark each Type ID "X" if it is only used in the standard direction, "R" if only used in the reverse direction, and "B" if used in both directions).

[X]	<1>	:= Single-point information	M_SP_NA_1
■	<2>	:= Single-point information with time tag	M_SP_TA_1
[X]	<3>	:= Double-point information	M_DP_NA_1
■	<4>	:= Double-point information with time tag	M_DP_TA_1
□	<5>	:= Step position information	M_ST_NA_1
■	<6>	:= Step position information with time tag	M_ST_TA_1
[X]	<7>	:= Bitstring of 32 bit	M_BO_NA_1
■	<8>	:= Bitstring of 32 bit with time tag	M_BO_TA_1
[X]	<9>	:= Measured value, normalized value	M_ME_NA_1
■	<10>	:= Measured value, normalized value with time tag	M_ME_TA_1
[X]	<11>	:= Measured value, scaled value	M_ME_NB_1
■	<12>	:= Measured value, scaled value with time tag	M_ME_TB_1
[X]	<13>	:= Measured value, short floating point value	M_ME_NC_1
■	<14>	:= Measured value, short floating point value with time tag	M_ME_TC_1
[X]	<15>	:= Integrated totals	M_IT_NA_1
■	<16>	:= Integrated totals with time tag	M_IT_TA_1
■	<17>	:= Event of protection equipment with time tag	M_EP_TA_1
■	<18>	:= Packed start events of protection equipment with time tag	M_EP_TB_1
■	<19>	:= Packed output circuit information of protection equipment with time tag	M_EP_TC_1
□	<20>	:= Packed single-point information with status change detection	M_SP_NA_1
□	<21>	:= Measured value, normalized value without quality descriptor	M_ME_ND_1
[X]	<30>	:= Single-point information with time tag CP56Time2a	M_SP_TB_1
[X]	<31>	:= Double-point information with time tag CP56Time2a	M_DP_TB_1
□	<32>	:= Step position information with time tag CP56Time2a	M_ST_TB_1
[X]	<33>	:= Bitstring of 32 bit with time tag CP56Time2a	M_BO_TB_1
[X]	<34>	:= Measured value, normalized value with time tag CP56Time2a	M_ME_TD_1
[X]	<35>	:= Measured value, scaled value with time tag CP56Time2a	M_ME_TE_1
[X]	<36>	:= Measured value, short floating point value with time tag CP56Time2a	M_ME_TF_1

[X]	<37>	:= Integrated totals with time tag CP56Time2a	M_IT_TB_1
<input type="checkbox"/>	<38>	:= Event of protection equipment with time tag CP56Time2a	M_EP_TD_1
<input type="checkbox"/>	<39>	:= Packed start events of protection equipment with time tag CP56Time2a	M_EP_TE_1
<input type="checkbox"/>	<40>	:= Packed output circuit information of protection equipment with time tag CP56Time2a	M_EP_TF_1

Either the ASDUs of the set <2>, <4>, <6>, <8>, <10>, <12>, <14>, <16>, <17>, <18>, <19> or of the set <30> - <40> are used.

Process information in control direction

(station-specific parameter, mark each Type ID "X" if it is only used in the standard direction, "R" if only used in the reverse direction, and "B" if used in both directions).

[X]	<45>	:= Single command	C_SC_NA_1
[X]	<46>	:= Double command	C_DC_NA_1
<input type="checkbox"/>	<47>	:= Regulating step command	C_RC_NA_1
<input type="checkbox"/>	<48>	:= Set point command, normalized value	C_SE_NA_1
<input type="checkbox"/>	<49>	:= Set point command, scaled value	C_SE_NB_1
<input type="checkbox"/>	<50>	:= Set point command, short floating point value	C_SE_NC_1
<input type="checkbox"/>	<51>	:= Bitstring of 32 bit	C_BO_NA_1
<input type="checkbox"/>	<58>	:= Single command with time tag CP56Time2a	C_SC_TA_1
<input type="checkbox"/>	<59>	:= Double command with time tag CP56Time2a	C_DC_TA_1
<input type="checkbox"/>	<60>	:= Regulating step command with time tag CP56Time2a	C_RC_TA_1
<input type="checkbox"/>	<61>	:= Set point command, normalized value with time tag CP56Time2a	C_SE_TA_1
<input type="checkbox"/>	<62>	:= Set point command, scaled value with time tag CP56Time2a	C_SE_TB_1
<input type="checkbox"/>	<63>	:= Set point command, short floating point value with time tag CP56Time2a	C_SE_TC_1
<input type="checkbox"/>	<64>	:= Bitstring of 32 bit with time tag CP56Time2a	C_BO_TA_1

Either the ASDUs of the set <45> – <51> or of the set <58> – <64> are used.

System information in monitor direction

(station-specific parameter, mark "X" if used)

[X]	<70>	:= End of initialization	M_EI_NA_1
-----	------	--------------------------	-----------

System information in control direction

(station-specific parameter, mark each Type ID "X" if it is only used in the standard direction, "R" if only used in the reverse direction, and "B" if used in both directions).

[X]	<100>	:= Interrogation command	C_IC_NA_1
<input type="checkbox"/>	<101>	:= Counter interrogation command	C_CI_NA_1
<input type="checkbox"/>	<102>	:= Read command	C_RD_NA_1
[X]	<103>	:= Clock synchronization command (option)	C_CS_NA_1
■	<104>	:= Test command	C_TS_NA_1
[X]	<105>	:= Reset process command	C_RP_NA_1
■	<106>	:= Delay acquisition command	C_CD_NA_1
<input type="checkbox"/>	<107>	:= Test command with time tag CP56Time2a	C_TS_TA_1

Parameter in control direction

(station-specific parameter, mark each Type ID "X" if it is only used in the standard direction, "R" if only used in the reverse direction, and "B" if used in both directions).

<input type="checkbox"/>	<110>	:= Parameter of measured value, normalized value	P_ME_NA_1
<input type="checkbox"/>	<111>	:= Parameter of measured value, scaled value	P_ME_NB_1
<input type="checkbox"/>	<112>	:= Parameter of measured value, short floating point value	P_ME_NC_1
<input type="checkbox"/>	<113>	:= Parameter activation	P_AC_NA_1

File transfer

(station-specific parameter, mark each Type ID "X" if it is only used in the standard direction, "R" if only used in the reverse direction, and "B" if used in both directions).

<input type="checkbox"/>	<120>	:= File ready	F_FR_NA_1
<input type="checkbox"/>	<121>	:= Section ready	F_SR_NA_1
<input type="checkbox"/>	<122>	:= Call directory, select file, call file, call section	F_SC_NA_1
<input type="checkbox"/>	<123>	:= Last section, last segment	F_LS_NA_1
<input type="checkbox"/>	<124>	:= Ack file, ack section	F_AF_NA_1
<input type="checkbox"/>	<125>	:= Segment	F_SG_NA_1
<input type="checkbox"/>	<126>	:= Directory {blank or X, only available in monitor (standard) direction}	F_DR_TA_1
<input type="checkbox"/>	<127>	:= QueryLog - request of an archive file	F_SC_NB_1

Type identifier and cause of transmission assignments

(station-specific parameters)

▣ Shaded boxes: option not required.

■ Black boxes: option not permitted or not supported in this companion standard

White boxes: functions or ASDU not used.

Mark Type Identification/Cause of transmission combinations:

- “X” if only used in the standard direction;
- “R” if only used in the reverse direction;
- “B” if used in both directions.

Type Identification		Cause of Transmission																		
		1	2	3	4	5	6	7	8	9	10	11	12	13	20 ... 36	37 ... 41	44	45	46	47
<1>	M_SP_NA_1	☐	☐	[X]	☐	☐	☐	☐	☐	☐	☐	☐	☐	[X]	☐	☐	☐	☐	☐	☐
<2>	M_SP_TA_1	☐	☐	■	☐	■	☐	☐	☐	☐	☐	☐	☐	☐	☐	☐	☐	☐	☐	☐
<3>	M_DP_NA_1	☐	☐	[X]	☐	☐	☐	☐	☐	☐	[X]	[X]	☐	[X]	☐	☐	☐	☐	☐	☐
<4>	M_DP_TA_1	☐	☐	■	☐	■	☐	☐	☐	☐	☐	☐	☐	☐	☐	☐	☐	☐	☐	☐
<5>	M_ST_NA_1	☐	☐	☐	☐	☐	☐	☐	☐	☐	☐	☐	☐	☐	☐	☐	☐	☐	☐	☐
<6>	M_ST_TA_1	☐	☐	■	☐	■	☐	☐	☐	☐	☐	☐	☐	☐	☐	☐	☐	☐	☐	☐
<7>	M_BO_NA_1	☐	☐	[X]	☐	☐	☐	☐	☐	☐	☐	☐	☐	[X]	☐	☐	☐	☐	☐	☐
<8>	M_BO_TA_1	☐	☐	■	☐	■	☐	☐	☐	☐	☐	☐	☐	☐	☐	☐	☐	☐	☐	☐
<9>	M_ME_NA_1	[X]	☐	[X]	☐	☐	☐	☐	☐	☐	☐	☐	☐	[X]	☐	☐	☐	☐	☐	☐
<10>	M_ME_TA_1	☐	☐	■	☐	■	☐	☐	☐	☐	☐	☐	☐	☐	☐	☐	☐	☐	☐	☐
<11>	M_ME_NB_1	[X]	☐	[X]	☐	☐	☐	☐	☐	☐	☐	☐	☐	[X]	☐	☐	☐	☐	☐	☐
<12>	M_ME_TB_1	☐	☐	■	☐	■	☐	☐	☐	☐	☐	☐	☐	☐	☐	☐	☐	☐	☐	☐
<13>	M_ME_NC_1	[X]	☐	[X]	☐	☐	☐	☐	☐	☐	☐	☐	☐	[X]	☐	☐	☐	☐	☐	☐
<14>	M_ME_TC_1	☐	☐	■	☐	■	☐	☐	☐	☐	☐	☐	☐	☐	☐	☐	☐	☐	☐	☐
<15>	M_IT_NA_1	☐	☐	[X]	☐	☐	☐	☐	☐	☐	☐	☐	☐	☐	☐	☐	☐	☐	☐	☐
<16>	M_IT_TA_1	☐	☐	■	☐	☐	☐	☐	☐	☐	☐	☐	☐	☐	☐	☐	☐	☐	☐	☐
<17>	M_EP_TA_1	☐	☐	■	☐	☐	☐	☐	☐	☐	☐	☐	☐	☐	☐	☐	☐	☐	☐	☐
<18>	M_EP_TB_1	☐	☐	■	☐	☐	☐	☐	☐	☐	☐	☐	☐	☐	☐	☐	☐	☐	☐	☐
<19>	M_EP_TC_1	☐	☐	■	☐	☐	☐	☐	☐	☐	☐	☐	☐	☐	☐	☐	☐	☐	☐	☐
<20>	M_PS_NA_1	☐	☐	☐	☐	☐	☐	☐	☐	☐	☐	☐	☐	☐	☐	☐	☐	☐	☐	☐
<21>	M_ME_ND_1	☐	☐	☐	☐	☐	☐	☐	☐	☐	☐	☐	☐	☐	☐	☐	☐	☐	☐	☐
<30>	M_SP_TB_1	☐	☐	[X]	☐	☐	☐	☐	☐	☐	☐	☐	☐	☐	☐	☐	☐	☐	☐	☐
<31>	M_DP_TB_1	☐	☐	[X]	☐	☐	☐	☐	☐	☐	☐	☐	☐	☐	☐	☐	☐	☐	☐	☐
<32>	M_ST_TB_1	☐	☐	☐	☐	☐	☐	☐	☐	☐	☐	☐	☐	☐	☐	☐	☐	☐	☐	☐
<33>	M_BO_TB_1	☐	☐	[X]	☐	☐	☐	☐	☐	☐	☐	☐	☐	☐	☐	☐	☐	☐	☐	☐

Type Identification		Cause of Transmission																		
		1	2	3	4	5	6	7	8	9	10	11	12	13	20 ... 36	37 ... 41	44	45	46	47
<34>	M_ME_TD_1	☐	☐	[X]	☐	☐	☐	☐	☐	☐	☐	☐	☐	☐	☐	☐	☐	☐	☐	
<35>	M_ME_TE_1	☐	☐	[X]	☐	☐	☐	☐	☐	☐	☐	☐	☐	☐	☐	☐	☐	☐	☐	
<36>	M_ME_TF_1	☐	☐	[X]	☐	☐	☐	☐	☐	☐	☐	☐	☐	☐	☐	☐	☐	☐	☐	
<37>	M_IT_TB_1	☐	☐	[X]	☐	☐	☐	☐	☐	☐	☐	☐	☐	☐	☐	☐	☐	☐	☐	
<38>	M_EP_TD_1	☐	☐	☐	☐	☐	☐	☐	☐	☐	☐	☐	☐	☐	☐	☐	☐	☐	☐	
<39>	M_EP_TE_1	☐	☐	☐	☐	☐	☐	☐	☐	☐	☐	☐	☐	☐	☐	☐	☐	☐	☐	
<40>	M_EP_TF_1	☐	☐	☐	☐	☐	☐	☐	☐	☐	☐	☐	☐	☐	☐	☐	☐	☐	☐	
<45>	C_SC_NA_1	☐	☐	☐	☐	☐	[X]	[X]	[X]	[X]	[X]	☐	☐	☐	☐	☐	☐	☐	☐	
<46>	C_DC_NA_1	☐	☐	☐	☐	☐	[X]	[X]	[X]	[X]	[X]	☐	☐	☐	☐	☐	☐	☐	☐	
<47>	C_RC_NA_1	☐	☐	☐	☐	☐	☐	☐	☐	☐	☐	☐	☐	☐	☐	☐	☐	☐	☐	
<48>	C_SE_NA_1	☐	☐	☐	☐	☐	☐	☐	☐	☐	☐	☐	☐	☐	☐	☐	☐	☐	☐	
<49>	C_SE_NB_1	☐	☐	☐	☐	☐	☐	☐	☐	☐	☐	☐	☐	☐	☐	☐	☐	☐	☐	
<50>	C_SE_NC_1	☐	☐	☐	☐	☐	☐	☐	☐	☐	☐	☐	☐	☐	☐	☐	☐	☐	☐	
<51>	C_BO_NA_1	☐	☐	☐	☐	☐	☐	☐	☐	☐	☐	☐	☐	☐	☐	☐	☐	☐	☐	
<58>	C_SC_TA_1	☐	☐	☐	☐	☐	☐	☐	☐	☐	☐	☐	☐	☐	☐	☐	☐	☐	☐	
<59>	C_DC_TA_1	☐	☐	☐	☐	☐	☐	☐	☐	☐	☐	☐	☐	☐	☐	☐	☐	☐	☐	
<60>	C_RC_TA_1	☐	☐	☐	☐	☐	☐	☐	☐	☐	☐	☐	☐	☐	☐	☐	☐	☐	☐	
<61>	C_SE_TA_1	☐	☐	☐	☐	☐	☐	☐	☐	☐	☐	☐	☐	☐	☐	☐	☐	☐	☐	
<62>	C_SE_TB_1	☐	☐	☐	☐	☐	☐	☐	☐	☐	☐	☐	☐	☐	☐	☐	☐	☐	☐	
<63>	C_SE_TC_1	☐	☐	☐	☐	☐	☐	☐	☐	☐	☐	☐	☐	☐	☐	☐	☐	☐	☐	
<64>	C_BO_TA_1	☐	☐	☐	☐	☐	☐	☐	☐	☐	☐	☐	☐	☐	☐	☐	☐	☐	☐	
<70>	M_EI_NA_1*	☐	☐	☐	☐	☐	☐	☐	☐	☐	☐	☐	☐	☐	☐	☐	☐	☐	☐	
<100>	C_IC_NA_1	☐	☐	☐	☐	☐	☐	☐	☐	☐	☐	☐	☐	☐	☐	☐	☐	☐	☐	
<101>	C_CI_NA_1	☐	☐	☐	☐	☐	☐	☐	☐	☐	☐	☐	☐	☐	☐	☐	☐	☐	☐	
<102>	C_RD_NA_1	☐	☐	☐	☐	☐	☐	☐	☐	☐	☐	☐	☐	☐	☐	☐	☐	☐	☐	
<103>	C_CS_NA_1	☐	☐	☐	☐	☐	☐	☐	☐	☐	☐	☐	☐	☐	☐	☐	☐	☐	☐	
<104>	C_TS_NA_1	☐	☐	☐	☐	☐	■	■	☐	☐	☐	☐	☐	☐	☐	☐	■	■	■	■
<105>	C_RP_NA_1	☐	☐	☐	☐	☐	[X]	[X]	☐	☐	☐	☐	☐	☐	☐	☐	☐	☐	☐	
<106>	C_CD_NA_1	☐	☐	☐	☐	☐	■	■	☐	☐	☐	☐	☐	☐	☐	☐	■	■	■	■
<107>	C_TS_TA_1	☐	☐	☐	☐	☐	☐	☐	☐	☐	☐	☐	☐	☐	☐	☐	☐	☐	☐	

Type Identification	Cause of Transmission																		
	1	2	3	4	5	6	7	8	9	10	11	12	13	20 ... 36	37 ... 41	44	45	46	47
<110>P_ME_NA_1	<input checked="" type="checkbox"/>	<input checked="" type="checkbox"/>	<input checked="" type="checkbox"/>	<input checked="" type="checkbox"/>	<input checked="" type="checkbox"/>	<input type="checkbox"/>	<input type="checkbox"/>	<input checked="" type="checkbox"/>	<input checked="" type="checkbox"/>	<input checked="" type="checkbox"/>	<input checked="" type="checkbox"/>	<input checked="" type="checkbox"/>	<input checked="" type="checkbox"/>	<input type="checkbox"/>	<input checked="" type="checkbox"/>	<input type="checkbox"/>	<input type="checkbox"/>	<input type="checkbox"/>	<input type="checkbox"/>
<111>P_ME_NB_1	<input checked="" type="checkbox"/>	<input checked="" type="checkbox"/>	<input checked="" type="checkbox"/>	<input checked="" type="checkbox"/>	<input checked="" type="checkbox"/>	<input type="checkbox"/>	<input type="checkbox"/>	<input checked="" type="checkbox"/>	<input checked="" type="checkbox"/>	<input checked="" type="checkbox"/>	<input checked="" type="checkbox"/>	<input checked="" type="checkbox"/>	<input checked="" type="checkbox"/>	<input type="checkbox"/>	<input checked="" type="checkbox"/>	<input type="checkbox"/>	<input type="checkbox"/>	<input type="checkbox"/>	<input type="checkbox"/>
<112>P_ME_NC_1	<input checked="" type="checkbox"/>	<input checked="" type="checkbox"/>	<input checked="" type="checkbox"/>	<input checked="" type="checkbox"/>	<input checked="" type="checkbox"/>	<input type="checkbox"/>	<input type="checkbox"/>	<input checked="" type="checkbox"/>	<input checked="" type="checkbox"/>	<input checked="" type="checkbox"/>	<input checked="" type="checkbox"/>	<input checked="" type="checkbox"/>	<input checked="" type="checkbox"/>	<input type="checkbox"/>	<input checked="" type="checkbox"/>	<input type="checkbox"/>	<input type="checkbox"/>	<input type="checkbox"/>	<input type="checkbox"/>
<113>P_AC_NA_1	<input checked="" type="checkbox"/>	<input checked="" type="checkbox"/>	<input checked="" type="checkbox"/>	<input checked="" type="checkbox"/>	<input checked="" type="checkbox"/>	<input type="checkbox"/>	<input type="checkbox"/>	<input type="checkbox"/>	<input type="checkbox"/>	<input checked="" type="checkbox"/>	<input checked="" type="checkbox"/>	<input checked="" type="checkbox"/>	<input checked="" type="checkbox"/>	<input checked="" type="checkbox"/>	<input checked="" type="checkbox"/>	<input type="checkbox"/>	<input type="checkbox"/>	<input type="checkbox"/>	<input type="checkbox"/>
<120>F_FR_NA_1	<input checked="" type="checkbox"/>	<input checked="" type="checkbox"/>	<input checked="" type="checkbox"/>	<input checked="" type="checkbox"/>	<input checked="" type="checkbox"/>	<input checked="" type="checkbox"/>	<input checked="" type="checkbox"/>	<input checked="" type="checkbox"/>	<input checked="" type="checkbox"/>	<input checked="" type="checkbox"/>	<input checked="" type="checkbox"/>	<input checked="" type="checkbox"/>	<input type="checkbox"/>	<input checked="" type="checkbox"/>	<input checked="" type="checkbox"/>	<input type="checkbox"/>	<input type="checkbox"/>	<input type="checkbox"/>	<input type="checkbox"/>
<121>F_SR_NA_1	<input checked="" type="checkbox"/>	<input checked="" type="checkbox"/>	<input checked="" type="checkbox"/>	<input checked="" type="checkbox"/>	<input checked="" type="checkbox"/>	<input checked="" type="checkbox"/>	<input checked="" type="checkbox"/>	<input checked="" type="checkbox"/>	<input checked="" type="checkbox"/>	<input checked="" type="checkbox"/>	<input checked="" type="checkbox"/>	<input checked="" type="checkbox"/>	<input type="checkbox"/>	<input checked="" type="checkbox"/>	<input checked="" type="checkbox"/>	<input type="checkbox"/>	<input type="checkbox"/>	<input type="checkbox"/>	<input type="checkbox"/>
<122>F_SC_NA_1	<input checked="" type="checkbox"/>	<input checked="" type="checkbox"/>	<input checked="" type="checkbox"/>	<input checked="" type="checkbox"/>	<input type="checkbox"/>	<input checked="" type="checkbox"/>	<input checked="" type="checkbox"/>	<input checked="" type="checkbox"/>	<input checked="" type="checkbox"/>	<input checked="" type="checkbox"/>	<input checked="" type="checkbox"/>	<input checked="" type="checkbox"/>	<input type="checkbox"/>	<input checked="" type="checkbox"/>	<input checked="" type="checkbox"/>	<input type="checkbox"/>	<input type="checkbox"/>	<input type="checkbox"/>	<input type="checkbox"/>
<123>F_LS_NA_1	<input checked="" type="checkbox"/>	<input checked="" type="checkbox"/>	<input checked="" type="checkbox"/>	<input checked="" type="checkbox"/>	<input checked="" type="checkbox"/>	<input checked="" type="checkbox"/>	<input checked="" type="checkbox"/>	<input checked="" type="checkbox"/>	<input checked="" type="checkbox"/>	<input checked="" type="checkbox"/>	<input checked="" type="checkbox"/>	<input checked="" type="checkbox"/>	<input type="checkbox"/>	<input checked="" type="checkbox"/>	<input checked="" type="checkbox"/>	<input type="checkbox"/>	<input type="checkbox"/>	<input type="checkbox"/>	<input type="checkbox"/>
<124>F_AF_NA_1	<input checked="" type="checkbox"/>	<input checked="" type="checkbox"/>	<input checked="" type="checkbox"/>	<input checked="" type="checkbox"/>	<input checked="" type="checkbox"/>	<input checked="" type="checkbox"/>	<input checked="" type="checkbox"/>	<input checked="" type="checkbox"/>	<input checked="" type="checkbox"/>	<input checked="" type="checkbox"/>	<input checked="" type="checkbox"/>	<input checked="" type="checkbox"/>	<input type="checkbox"/>	<input checked="" type="checkbox"/>	<input checked="" type="checkbox"/>	<input type="checkbox"/>	<input type="checkbox"/>	<input type="checkbox"/>	<input type="checkbox"/>
<125>F_SG_NA_1	<input checked="" type="checkbox"/>	<input checked="" type="checkbox"/>	<input checked="" type="checkbox"/>	<input checked="" type="checkbox"/>	<input checked="" type="checkbox"/>	<input checked="" type="checkbox"/>	<input checked="" type="checkbox"/>	<input checked="" type="checkbox"/>	<input checked="" type="checkbox"/>	<input checked="" type="checkbox"/>	<input checked="" type="checkbox"/>	<input checked="" type="checkbox"/>	<input type="checkbox"/>	<input checked="" type="checkbox"/>	<input checked="" type="checkbox"/>	<input type="checkbox"/>	<input type="checkbox"/>	<input type="checkbox"/>	<input type="checkbox"/>
<126>F_DR_TA_1*	<input checked="" type="checkbox"/>	<input checked="" type="checkbox"/>	<input type="checkbox"/>	<input checked="" type="checkbox"/>	<input type="checkbox"/>	<input checked="" type="checkbox"/>	<input checked="" type="checkbox"/>	<input checked="" type="checkbox"/>	<input checked="" type="checkbox"/>	<input checked="" type="checkbox"/>	<input checked="" type="checkbox"/>	<input checked="" type="checkbox"/>	<input checked="" type="checkbox"/>	<input checked="" type="checkbox"/>	<input checked="" type="checkbox"/>	<input checked="" type="checkbox"/>	<input checked="" type="checkbox"/>	<input checked="" type="checkbox"/>	<input checked="" type="checkbox"/>

* Blank or X only

13.2.6 Basic application functions

Station initialization

(station-specific parameter, mark "X" if function is used)

Remote initialization

Cyclic data transmission

(station-specific parameter, mark "X" if function is only used in the standard direction, "R" if only used in the reverse direction, and "B" if used in both directions)

Cyclic data transmission

Read procedure

(station-specific parameter, mark "X" if function is only used in the standard direction, "R" if only used in the reverse direction, and "B" if used in both directions)

Read procedure

Spontaneous transmission

(station-specific parameter, mark "X" if function is only used in the standard direction, "R" if only used in the reverse direction, and "B" if used in both directions)

Spontaneous transmission

Double transmission of information objects with cause of transmission spontaneous

(station-specific parameter, mark each information type “X” where both a Type ID without time and corresponding Type ID with time are issued in response to a single spontaneous change of a monitored object)

The following type identifications may be transmitted in succession caused by a single status change of an information object. The particular information object addresses for which double transmission is enabled are defined in a project-specific list.

<input type="checkbox"/>	Single-point information M_SP_NA_1, M_SP_TA_1, M_SP_TB_1 and M_PS_NA_1
<input type="checkbox"/>	Double-point information M_DP_NA_1, M_DP_TA_1 and M_DP_TB_1
<input type="checkbox"/>	Step position information M_ST_NA_1, M_ST_TA_1 and M_ST_TB_1
<input type="checkbox"/>	Bitstring of 32 bit M_BO_NA_1, M_BO_TA_1 and M_BO_TB_1 (if defined for a specific project)
<input type="checkbox"/>	Measured value, normalized value M_ME_NA_1, M_ME_TA_1, M_ME_ND_1 and M_ME_TD_1
<input type="checkbox"/>	Measured value, scaled value M_ME_NB_1, M_ME_TB_1 and M_ME_TE_1
<input type="checkbox"/>	Measured value, short floating point number M_ME_NC_1, M_ME_TC_1 and M_ME_TF_1

Station interrogation

(station-specific parameter, mark “X” if function is only used in the standard direction, “R” if only used in the reverse direction, and “B” if used in both directions).

[X]	global				
<input type="checkbox"/>	group 1	<input type="checkbox"/>	group 7	<input type="checkbox"/>	group 13
<input type="checkbox"/>	group 2	<input type="checkbox"/>	group 8	<input type="checkbox"/>	group 14
<input type="checkbox"/>	group 3	<input type="checkbox"/>	group 9	<input type="checkbox"/>	group 15
<input type="checkbox"/>	group 4	<input type="checkbox"/>	group 10	<input type="checkbox"/>	group 16
<input type="checkbox"/>	group 5	<input type="checkbox"/>	group 11		Information object addresses assigned to each group must be shown in a separate table.
<input type="checkbox"/>	group 6	<input type="checkbox"/>	group 12		

Clock synchronization

(station-specific parameter, mark “X” if function is only used in the standard direction, “R” if only used in the reverse direction, and “B” if used in both directions).

[X]	Clock synchronization
-----	-----------------------

Command transmission

(object-specific parameter, mark “X” if function is only used in the standard direction, “R” if only used in the reverse direction, and “B” if used in both directions).

[X]	Direct command transmission
<input type="checkbox"/>	Direct set point command transmission
[X]	Select and execute command

<input type="checkbox"/>	Select and execute set point command
[X]	C_SE_ACTTERM used
<input type="checkbox"/>	No additional definition
[X]	Short-pulse duration (duration determined by a system parameter in the outstation)
<input type="checkbox"/>	Long-pulse duration (duration determined by a system parameter in the outstation)
<input type="checkbox"/>	Persistent output
[X]	Supervision of maximum delay in command direction of commands and set point commands

[configurable]	Maximum allowable delay of commands and set point commands
----------------	--

Transmission of integrated totals

(station- or object-specific parameter, mark “X” if function is only used in the standard direction, “R” if only used in the reverse direction, and “B” if used in both directions).

<input type="checkbox"/>	Mode A: Local freeze with spontaneous transmission
<input type="checkbox"/>	Mode B: Local freeze with counter interrogation
<input type="checkbox"/>	Mode C: Freeze and transmit by counter-interrogation commands
<input type="checkbox"/>	Mode D: Freeze by counter-interrogation command, frozen values reported spontaneously
[X]	Counter read
<input type="checkbox"/>	Counter freeze without reset
<input type="checkbox"/>	Counter freeze with reset
<input type="checkbox"/>	Counter reset
<input type="checkbox"/>	General request counter
<input type="checkbox"/>	Request counter group 1
<input type="checkbox"/>	Request counter group 2
<input type="checkbox"/>	Request counter group 3
<input type="checkbox"/>	Request counter group 4

Parameter loading

(object-specific parameter, mark “X” if function is only used in the standard direction, “R” if only used in the reverse direction, and “B” if used in both directions).

<input type="checkbox"/>	Threshold value
<input type="checkbox"/>	Smoothing factor
<input type="checkbox"/>	Low limit for transmission of measured values
<input type="checkbox"/>	High limit for transmission of measured values

Parameter activation

(object-specific parameter, mark "X" if function is only used in the standard direction, "R" if only used in the reverse direction, and "B" if used in both directions).

- Act/deact of persistent cyclic or periodic transmission of the addressed object

Test procedure

(station-specific parameter, mark "X" if function is only used in the standard direction, "R" if only used in the reverse direction, and "B" if used in both directions).

- Test procedure

File transfer

(station-specific parameter, mark "X" if function is used).

File transfer in monitor direction

- Transparent file
- Transmission of disturbance data of protection equipment
- Transmission of sequences of events
- Transmission of sequences of recorded analogue values

File transfer in control direction

- Transparent file

Background scan

(station-specific parameter, mark "X" if function is only used in the standard direction, "R" if only used in the reverse direction, and "B" if used in both directions).

- Background scan

Acquisition of transmission delay

(station-specific parameter, mark "X" if function is only used in the standard direction, "R" if only used in the reverse direction, and "B" if used in both directions).

- Acquisition of transmission delay

Definition of time outs

Parameter	Default value	Remarks	Selected value
t_0	30 s	Time-out of connection establishment	30 s (fixed)
t_1	15 s	Time-out of send or test APDUs	15 s (fixed)
t_2	10 s	Time-out for acknowledges in case of no data messages $t_2 < t_1$	10 s (fixed)

Parameter	Default value	Remarks	Selected value
t ₃	20 s	Time-out for sending test frames in case of a long idle state	20 s (fixed)

Maximum number of outstanding I format APDUs k and latest acknowledge APDUs (w)

Parameter	Default value	Remarks	Selected value
k	12 APDUs	Maximum difference receive sequence number to send state variable	12 (fixed)
w	8 APDUs	Latest acknowledge after receiving w I format APDUs	8 (fixed)

The values for k and w are read-only, i. e. cannot be configured.

Port number

Parameter	Value	Remarks
Port number	2404	Configurable, default value = 2404

RFC 2200 suite

RFC 2200 is an official Internet Standard which describes the state of standardization of protocols used in the Internet as determined by the Internet Architecture Board (IAB). It offers a broad spectrum of actual standards used in the Internet. The suitable selection of documents from RFC 2200 defined in this standard for given projects has to be chosen by the user of this standard.

<input checked="" type="checkbox"/>	Ethernet 802.3
<input type="checkbox"/>	Serial X.21 interface
<input type="checkbox"/>	Other selection from RFC 2200

13.3 Abbreviations, and Acronyms

The following abbreviations and acronyms are used in this manual.

°C	Degrees Celsius
°F	Degrees Fahrenheit
A	Ampere(s), Amp(s)
AC	Alternating current
Ack.	Acknowledge
AND	Logical gate (The output becomes true if all Input signals are true.)
ANSI	American National Standards Institute
avg.	Average
AWG	American wire gauge
BF	Circuit breaker failure
Bkr	Breaker
Blo	Blocking(s)
BO	Binary output relay
BO1	1st binary output relay
BO2	2nd binary output relay
BO3	3rd binary output relay
calc	Calculated
CB	Circuit breaker
CBF	Module Circuit Breaker Failure protection
CD	Compact disk
Char	Curve shape
CLPU	Cold Load Pickup Module
Cmd.	Command
CMN	Common input
COM	Common input
Comm	Communication
Cr.	Counter(s)
CSA	Canadian Standards Association
CT	Control transformer
Ctrl.	Control

CTS	Current Transformer Supervision
CTS	Current transformer supervision
d	Day
D-Sub-Plug	Communication interface
DC	Direct current
DEFT	Definite time characteristic (Tripping time does not depend on the height of the current.)
delta phi	Vector surge
df/dt	Rate-of-frequency-change
DI	Digital Input
Diagn Cr	Diagnosis counter(s)
Diagn.	Diagnosis
DIN	Deutsche Industrie Norm
dir	Directional
EINV	Extremely inverse tripping characteristic
EMC	Electromagnetic compatibility
EN	Europäische Norm
err. / Err.	Error
EVTcon	Parameter determines if the residual voltage is measured or calculated.
Ex	External
Ex Oil Temp	External Oil Temperature
ExBlo	External blocking(s)
ExP	External Protection - Module
ExP	External protection
Ext Sudd Press	Sudden Pressure
Ext Temp Superv	External Temperature Supervision
f	Frequency Protection Module
Fc	Function (Enable or disable functionality = allow or disallow.)
FIFO	First in first out
FIFO Principal	First in first out
fund	Fundamental (ground wave)
gn	Acceleration of the earth in vertical direction (9.81 m/s ²)
GND	Ground

h	Hour
HMI	Human machine interface (Front of the protective relay)
HTL	Manufacturer internal product designation
Hz	Hertz
I	Phase Overcurrent Stage
I	Fault current
I	Current
I-BF	Tripping threshold
I0	Zero current (symmetrical components)
I1	Positive sequence current (symmetrical components)
I2	Negative sequence current (symmetrical components)
I2>	Unbalanced Load-Stage
I2T	Thermal Characteristic
I4T	Thermal Characteristic
IA	Phase A current
IB	Phase B current
IC	Phase C current
IC's	Manufacturer internal product designation
Id	Differential Protection Module
IdG	Restricted Ground Fault Differential Protection Module
IdGH	Restricted Ground Fault Highset Protection Module
IdH	High-Set Differential Protection Module
IEC	International Electrotechnical Commission
IEC61850	IEC61850
IEEE	Institute of Electrical and Electronics Engineers
IG	Earth current protection - Stage
IG	Ground current
IG	Fault current
IGNom	Nominal ground current
IH1	1st harmonic
IH2	Module Inrush
IH2	2nd harmonic
in.	Inch

incl.	Include, including
InEn	Inadvertent Energization
Info.	Information
Interl.	Interlocking
Intertripping	Intertripping
INV	Inverse characteristic (The tripping time will be calculated depending on the height of the current)
IR	Calculated (residual) ground current
IRIG	Input for time synchronization (Clock)
IRIG-B	IRIG-B-Module
IT	Thermal Characteristic
IX	4th measuring input of the current measuring assembly group (either ground or neutral current)
J	Joule
kg	Kilogram
kHz	Kilohertz
kV	Kilovolt(s)
kVdc or kVDC	Kilovolt(s) direct current
I/In	Ratio of current to nominal current.
L1	Phase A
L2	Phase B
L3	Phase C
lb-in	Pound-inch
LED	Light emitting diode
LINV	Long time inverse tripping characteristic
LoE-Z1	Loss of Excitation
LoE-Z2	Loss of Excitation
Logics	Logic
LOP	Loss of Potential
LV	Low voltage
LVRT	Low Voltage Ride Through
m	Meter
mA	Milliampere(s), Milliamp(s)
man.	Manual

max.	Maximum
meas	Measured
min.	Minimum
min.	Minute
MINV	Moderately Inverse Tripping Characteristic
MK	Manufacturer Internal Product Designation Code
mm	Millimeter
MMU	Memory mapping unit
ms	Milli-second(s)
MV	Medium voltage
mVA	Milli volt amperes (Power)
N.C.	Not connected
N.O.	Normal open (Contact)
NINV	Normal inverse tripping characteristic
Nm	Newton-meter
No	Number
Nom.	Nominal
NT	Manufacturer internal product designation code
P	Reverse Active Power
Para.	Parameter
PC	Personal computer
PCB	Printed circuit board
PE	Protected Earth
p.u.	per unit
PF	Power Factor - Module
Ph	Phase
PQS	Power Protection - Module
pri	Primary
PROT or Prot	Protection Module (Master Module)
PS1	Parameter set 1
PS2	Parameter set 2
PS3	Parameter set 3
PS4	Parameter set 4

PSet	Parameter set
PSS	Parameter set switch (Switching from one parameter set to another)
Q	Reverse Reactive Power
Q->&V<	Undervoltage and Reactive Power Direction Protection
R	Reset
rec.	Record
rel	Relative
res	Reset
ResetFct	Reset function
RevData	Review data
RMS	Root mean square
Rst	Reset
RTD	Temperature Protection Module
s	Second(s)
SC	Supervision Contact (Synonyms: Life-Contact, Watchdog, State of Health Contact)
Sca	SCADA
SCADA	Communication module
sec	Second(s)
sec	Secondary
Sgen	Sine wave generator
Sig.	Signal
SNTP	SNTP-Module
SOTF	Switch Onto Fault - Module
StartFct	Start function
Sum	Summation
SW	Software
Sync	Synchrocheck
Sys.	System
t	Tripping delay
t or t.	Time
Tcmd	Trip command
TCP/IP	Communication protocol

TCS	Trip circuit supervision
ThR	Thermal replica module
TI	Manufacturer internal product designation code
TripCmd	Trip command
txt	Text
UL	Underwriters Laboratories
UMZ	DEFT (definite time tripping characteristic)
USB	Universal serial bus
V	Voltage-stage
V	Volts
V/f>	Overexcitation
V012	Symmetrical Components: Supervision of the Positive Phase Sequence or Negative Phase Sequence
Vac / V ac	Volts alternating current
Vdc / V dc	Volts direct current
VDE	Verband Deutscher Elektrotechnik
VDEW	Verband der Elektrizitätswirtschaft
VE	Residual voltage
VG	Residual voltage-Stage
VINV	Very inverse tripping characteristic
VTS	Voltage transformer supervision
W	Watt(s)
WDC	Watch dog contact (supervision contact)
www	World wide web
XCT	4th current measuring input (ground or neutral current)
XInv	Inverse characteristic

13.4 List of ANSI Codes

(This list is essentially based on IEEE Std C37.2-2008.)

ANSI	MRMV4	Functions
14		Underspeed
21		Distance Protection
21P		Phase Distance Protection
24		Overexcitation Protection (Volts per Hertz)
25		Synchronizing or Synchronism-check via 4th measuring channel of voltage measurement card
26		Temperature Protection
27	V	Undervoltage Protection
27(t)		Undervoltage (time dependent) Protection
27A		Undervoltage Protection (Auxiliar) via 4th measuring channel of voltage measurement card
27M		Undervoltage (time dependent) Phase Protection (Main)
27N	VG	Neutral Undervoltage via 4th measuring channel of voltage measurement card
27TN		Third Harmonic Neutral Undervoltage via 4th measuring channel of voltage measurement card
32	P, Q	Directional Power Protection
32F		Forward Power Protection
32R		Reverse Power Protection
37		Undercurrent / Under Power
38		Temperature Protection (optional via Interface/external Box)
40		Loss of Excitation / Loss of Field
46	I2>	Unbalanced Current Protection
46G		Unbalanced Generator Current Protection
47	V012	Unbalanced Voltage Protection
48	MStart	Incomplete Sequence (Start-up time Supervision)
49		Thermal Protection
49M		Thermal Motor Protection
49R		Thermal Rotor Protection
49S		Thermal Stator Protection
50BF	CBF	Breaker Failure

ANSI	MRMV4	Functions
50	I	Overcurrent (instantaneous)
50J	Jam	Jam (locked Rotor)
50P	50P	Phase Overcurrent (instantaneous)
50N/G	IG	Neutral Overcurrent (instantaneous)
50Ns	IG	Sensitive Neutral Overcurrent (instantaneous)
50R	IG	Neutral Overcurrent (instantaneous)
51	I	Overcurrent
51P		Phase Overcurrent
51N/G	IG	Neutral Overcurrent
51Ns	IG	Sensitive Neutral Overcurrent
51LR	MStart	Locked Rotor
51LRS		Locked Rotor Start (during start sequence)
51C	(via adaptive Parameters)	Voltage Controlled Overcurrent
51Q	I	Negative Phase Sequence Overcurrent (multiple trip characteristics)
51V		Voltage Restrained Overcurrent
55	PF	Power Factor Protection
56		Field Application Relay
59	V	Overvoltage Protection
59M		Phase Overvoltage Protection (Main)
59TN	VG	Third Harmonic Neutral Overvoltage via 4th measuring channel of voltage measurement card
59A		Overvoltage Protection via 4th (Auxiliar) measuring channel of voltage measurement card
59N		Neutral Overvoltage Protection
60FL	LOP	Voltage Transformer Supervision
60L	CTS	Current Transformer Supervision
64R		Rotor Earth Fault Protection
64REF		Restricted Ground Fault Protection
66	MStart	Starts per h (Start Inhibit)
67		Directional Overcurrent
67N		Directional Neutral Overcurrent
67Ns	IG	Sensitive Directional Neutral Overcurrent

ANSI	MRMV4	Functions
68		Power Swing Blocking
74TC	TCS	Trip Circuit Supervision
78		Out of Step Tripping
78V	Freq. prot. op. mode "delta phi"	Vector Surge Protection
79		Auto Reclosure
81	f	Frequency Protection
81U		Underfrequency Protection
81O		Overfrequency Protection
81R	df/dt	ROCOF (df/dt)
86		Lock Out
87		Differential Protection (Generator/Transformer/Busbar)
87B		Busbar Differential Protection
87G		Generator Differential Protection
87GN		Generator Ground Differential Protection
87M		Motor Differential Protection
87SV		Open CT Supervision (see also 87 / 87B)
87T		Transformer Differential Protection
87TN		Transformer Ground Differential Protection
CLK	IRIG-B, ...	Clock synchronization (e. g. via IRIG-B)
DDR	Disturbance recorder	Non-fault disturbance recording
DFR	Fault recorder	Digital fault recording
LGC	Logic	Logic, scheme
MET	Measured Values	Substation metering (energy, amps, volts, watts, vars, power factor, demand)
SER	Event recorder	Time-tagged event data
TCM	TCS	Trip circuit monitor / supervision

13.5 Revision History

This chapter lists all changes since version 3.0. If you need a change history for the versions 2.x please contact Woodward.

NOTICE!



In principle, all **3.x** hardware and software versions are compatible with each other. For special questions and more detailed information, please contact Woodward Support.



Up to date documentation?

Please check the web site of Woodward for the latest revision of this Technical Manual and if there is an Errata Sheet with updated information.

13.5.1 Version: 3.6

- Date: 2019-January-31
- Revision: D

Software

The protection functions of the MRMV4 have been adapted to comply with the requirements of the VDE-AR-N-4110:2018.

Frequency Protection Module, Rate-of-frequency-change.

Frequency measurement has been improved with respect to accuracy and stability.

The hysteresis that is used for frequency protection can be modified with the new parameter »*Freq. drop-off*«.

New parameters [Field Para / Frequency] »*Stab. window f*« and »*Stab. window df/dt*« allow for stabilizing the values against momentary fluctuations.

Phase Fault Direction Detection

Bug fix: An error in the direction decision algorithm has been fixed that could lead to false direction decisions for "ACB" systems. ("ABC" phase sequences were not affected.)

»Superv. only«

A new Device Planning parameter »*Superv. only*« has been added to the following protection functions:

- IG[x] - Earth (Ground) Overcurrent protection (see [↳ "Ground \(Earth\) Overcurrent - Functionality"](#))
- VG[x] - Voltage Supervision (see [↳ "4.12 VG, VX Voltage Supervision Functionality"](#))

With the setting »*Superv. only*« = "yes", the functionality of the module is restricted to a supervision function: The alarm and trip decisions still exist as states that be checked at the menu branch [Operation / Status Display] and can be assigned as select options), but these do no longer result in a General Alarm or General Trip, and as a consequence, no trip command is given. (See [↳ "General Alarms and General Trips"](#).)

Security Menu

A lot of enhancements of this HighPROTEC Release refer to the topic IT Security.

There is a new menu branch [Operation / Security / Security States] that collects information about various security-related settings. For example, there are entries telling you whether the connection passwords have been set to some user-specific value, or are still at their factory default. If IT security is a concern for your application, it is recommended to check all these entries during commissioning. (See [↳ "1.4 Security-Related Settings Overview"](#).)

Moreover, there is a Security Logger accessible at the menu path [Operation / Security / Security Logger]. It shows a sub-set of the *self-supervision messages* (see below), restricted to only the security-related messages. (See [↳ "1.4 Security-Related Messages"](#).)

Smart view Access

Another security-related change is that the MRMV4 accepts connections only from recent versions of *Smart view*.

It is possible to define *Smart view* connection passwords: There is a password »*USB connection*« for the connection via the USB interface, and there is another password »*Remote network connection*« for a connection via network. After a connection password has been set, *Smart view* will establish a connection only after the respective password has been entered. (The factory default, however, has blank values set for both connection passwords.)

All connections are now encrypted, and certificates guarantee the correct identity of the communication parties.

(See  »[“Connection Passwords, Smart view Access”](#).)

Passwords

Passwords are now stored in a way such that they “survive” a firmware update. (See  »[“Passwords”](#).)

Time Penalties for False Passwords

If a wrong password is being entered several times, then the MRMV4 blocks any further password entry for an increasing amount of time, until a correct password has been entered. A dedicated message informs the user about this blocking. This behavior refers to all types of passwords (including the connection passwords mentioned above), but it affects only the password entry (i. e. the Softkey ), so that it does not prevent the user from doing some other, “password-free” activities during this blocking time.

See  »[“1.4.2 Time Penalty for Wrong Password Entry”](#)).

Self-Supervision, Syslog

The Recorder for self-supervision messages, that is accessible via the menu branch [Operation / Self-Supervision / Messages], has been enhanced, so that it now also collects various security-related messages (e. g. every entry of a false password) and MRMV4-internal status messages, warnings and error messages.

A Syslog module can be activated, that automatically transmits every new internal (self-supervision) message to some dedicated server-computer. It uses the “Syslog” protocol that is a widely known standard for the transmission of log messages.

See  »[“Self-Supervision Messages”](#)»,  »[“Syslog”](#)».

SCADA »Slave ID«

For all SCADA protocols, the »*Slave ID*« is no longer a setting parameter, but a Direct Command.

Since Direct Commands are never saved as part of an *.HptPara setting file, there is no longer the risk of breaching the uniqueness requirement of Slave IDs by loading one *.HptPara file into several HighPROTEC devices. But of course, this additional safety comes with the disadvantage that while commissioning, the »*Slave ID*« must always be set even if a prepared *.HptPara file is used.

New Communication Protocol IEC 60870-5-104

The communication protocol according to IEC 60870-5-104 is available now.

See [↪](#) “IEC 60870-5-104”.

This protocol can also be used as time synchronization source. (See [↪](#) “Time Synchronization”.)

Configurable Data Points for Modbus and IEC 60870-5-104

The communication protocols Modbus and IEC 60870-5-104 can now be adapted to the application by (re-)mapping the data-points. This helps to smoothly integrate the MRMV4 in an existing substation network. A new tool for Windows operating systems, *SCADAPTER*, is available for mapping the data-points to protocol-internal addresses.

See [↪](#) “Data-Point Mapping Using the SCADAPTER” and the separate *SCADAPTER* documentation.

Communication Protocol IEC 61850

The parameters for the Virtual Inputs and Outputs have been renamed.

The number of available Virtual Inputs and Outputs has been increased (from 32) to 64.

See [↪](#) “IEC 61850”.

Manual Acknowledgment of LEDs

It is now possible to acknowledge (reset) latched LEDs by pressing the »C« key for about 1 second without entering a password. This is due to a new default value for the following parameter: [Device Para / Acknowledge] »Ack via »C« key« = „Ack LEDs w/o passw.“

See [↪](#) “1.5 Manual Acknowledgment (by Pressing the C Key at the Panel)”.

Binary Outputs, LEDs, Trip Manager

The feature for inverting a trigger (input) signal has been modified.

Latching behavior has been modified: Now there are some more conditions that cause a reset of a latched state.

(See [↪](#) “Output Relays Settings”, [↪](#) “LEDs”, [↪](#) “5.2 Trip Manager - Assignment of commands”.)

Technical Manual

The technical documentation has been split into two independent documents:

- The *User Manual* (i. e. this document, MRMV4-3.6-EN-MAN) describes the MRMV4 with its features and applications.

Compared to the previous HighPROTEC Release, all chapters of the User Manual have been thoroughly revised and edited for the sake of a better readability and correctness.

- The *Reference Manual* MRMV4-3.6-EN-REF contains all the parameters, settings, values and binary states. For each entry, there is a table with all properties, e. g. the menu branch, module name, default value and value range, plus a short help text.

- The naming scheme for the technical documents has been changed. In particular, the Release number is part of the document ID now. In principle, all document IDs should follow the naming scheme "`<device(s)>-<version>-<language>-<document type>`". (See also [↪](#) "Comments on the Manual".)

This Technical Manual, for example, was previously (i. e. until Revision 3.4) named DOK-HB-MRMV4-2D. Now it has been renamed to MRMV4-3.6-EN-MAN.

A chapter about CT Requirements has been added, see [↪](#) "CT Requirements".

13.5.2 Version: 3.4

- Date: 2017-October-01
- Revision: C

Hardware

- A metal protecting cap has been added to the LC connectors for the Ethernet / TCP/IP via fiber optics. Since the cap improves the EMC immunity it is recommended to always fasten it carefully after plugging in the LC connectors.
- There is a new communication type “T” available:

RS485 (IEC 60870-5-103, MODBUS RTU, DNP3.0 RTU) + RJ45 Ethernet 100 Mbit/s (IEC 61850, Modbus TCP, DNP3.0 TCP/UDP)

Software

- The device firmware is also available in Romanian language now.
- If the MRMV4 is connected to *Smart view* as of version 4.50 the synchronization of date and time automatically considers that the timezone settings might be different on PC and MRMV4.

Communication

The menu [Device Para / HMI / Security] now makes the following setting parameters available:

- »*Smart view via Eth*« activates or deactivates the access of Smart view via Ethernet.
- »*Smart view via USB*« activates or deactivates the access of Smart view via the USB interface.

(See  »*Connection Passwords, Smart view Access*«.)

IEC 60870-5-103

This communication protocol now supports the blocking of the transmission in Monitor Direction and the test mode. (See  »*IEC60870-5-103*«.)

Modbus

For devices with RS485 *and* Ethernet interfaces (communication types “I” or “T”), the project setting “Modbus RTU/TCP” is available now (via parameter [Device planning] *Scada . Protocol*«). This makes the device communicate via serial line (RTU) and Ethernet (TCP) in parallel. In particular, note that:

- All masters see the same set of states.
- All masters can reset latched states.
- All masters can control the same breaker, make resets and acknowledgments.

Device Para

The Reset dialog, that starts when the »C« key is pressed during a cold start, has been adapted to new security-related requests: Now there is a new setting parameter »*Config*«.

Device Reset« that allows to remove options from the Reset dialog. (See [↪](#) “Reset to Factory Defaults, Reset All Passwords”.)

Overcurrent - I[n], IG[n]

All ANSI and IEC inverse time characteristics have a time limit now according to IEC 60255-151. (See [↪](#) “Characteristics”, [↪](#) “Characteristics”).)

A new inverse time characteristic “RINV” has been added. (See [↪](#) “R Inverse [RINV] - Characteristic”, [↪](#) “R Inverse [RINV] - Characteristic”).)

Undervoltage - V[n]

For the voltage protection running in “undervoltage” mode *→Mode* = “V<” - an undercurrent criterion is available as a new feature.

The basic principle of this “minimum current check”, is that it blocks the undervoltage protection as soon as all phase currents drop below a certain threshold value. The motivation for using this feature is that a situation where all phase currents are “dead” probably indicates an open circuit breaker, and it is probably not desirable that the undervoltage protection reacts to this event. (See [↪](#) “V - Voltage Protection [27,59]”, [↪](#) “4.11 Minimum Current Threshold for Undervoltage Protection”).)

Loss of Potential - LOP

The (internally fixed) undervoltage threshold has been increased from 0.01 Vn to 0.03 Vn (“FNN 2015” - Specification published by the *Forum Netztechnik / Netzbetrieb im VDE*). (See [↪](#) “LOP - Loss of Potential [60]”).)

SelfSupervision

Device-internal messages (in particular error messages) are now accessible under the menu [Operation / Self-Supervision / Messages].

All messages that can potentially appear here are described in a separate document, the “HighPROTEC Troubleshooting Guide” (DOK-HB-TS).

Supervision

The MRMV4 supervises the phase sequence and compares it with the setting that has been made at [Field Para / General Settings] *»Phase Sequence*« (i. e. “ACB” or “ABC”).

Under the menu [Operation / Status Display / Supervision / Phase Sequence], there is a specific signal for each CT and VT, which is set active if the check of the respective CT / VT finds that the actual phase sequence is different from the setting under [Field Para]. (See [↪](#) “Phase Sequence Supervision”).)

LEDs

There is a new automatic acknowledgment mode for all LEDs: The latching of all LEDs is acknowledged (reset) in case of an alarm (from any protection module) or in case of a *General Alarm*, *»Prot . Alarm*«.

The automatic acknowledgment must be activated by setting:

[Device Para / LEDs / LEDs group A / LED 1...n] *»Latched*« = “active, ack. by alarm”

(See [↪](#) “1.5 Manual Acknowledgment (by Pressing the C Key at the Panel)”).)

Manual Acknowledgment

It is possible to acknowledge LEDs, SCADA, binary output relays and / or a pending trip command by pressing the »C« key at the panel.

After assigning the required items to the »Ack via »C« key«, these are acknowledged by simply pressing the »C« key (for ca. 1 second).

If there is the need to be able to acknowledge without entering any password set an empty password for the level »Prot-Lv1«. (See [↳ “1.5 Manual Acknowledgment \(by Pressing the C Key at the Panel\)”](#); for general information about passwords and security-related considerations, see [↳ “Security”](#).)

13.5.3 Version: 3.1

NOTICE!



This version has not been published!

- Date: 2017-March-06

Hardware

No changes.

Software

Reconnection - ReCon[n]

The Reconnection module has been enhanced according to VDE-AR-N 4120.

- The release condition has been made selectable via ReCon . Reconnect. Release Cond (options: V Internal Release, V Ext Release PCC, Both).
- The measuring method has been made selectable via ReCon . Measuring method (options: Fundamental, True RMS, Vavg).

SCADA

Datapoints have been added for the second instance of the Reconnection module.

TCP

Bugfix:

- Some problem with the PPP/TCP communication has been fixed.

13.5.4 Version: 3.0.b

- Date: 2016-February-20
- Revision: B

Hardware

No changes.

Software

The self-monitoring has been improved.

Overcurrent - I[n]

Bugfix:

- An initialization issue has been fixed in the Overcurrent module. In case of MeasureMode I2 and DEFT characteristic, this issue could have caused a false pickup or trip after start-up.

Sys

Bugfix:

- Under special circumstances, an unintended warm restart had been possible.

SCADA / Modbus

Bugfix:

- The Modbus protocol did not read the system time correctly.

Self-Supervision

Bugfix:

- Warnings related to the internal temperature monitoring did not work correctly.

13.5.5 Version: 3.0

- Date: 2015-October-01
- Revision: B

Hardware

- A new front plate in dark gray color replaces the blue housing that had been used for all **2.x** versions.
- The new front plate features a USB interface for the connection with the *Smart view* operating software. (This replaces the serial interface of the **2.x** versions.)
- There is a new communication type “I” available:
RS485 (IEC 60870-5-103, MODBUS RTU, DNP3.0 RTU) + RJ45 Ethernet 100 Mbit/s (Modbus TCP, DNP3.0 TCP/UDP)
- “Conformal coating” is available now as an order option.
- The characters -2 in the typecode signify the major version upgrade from 2.x to 3.x.

Software

The device firmware is also available in Spanish language now.

Various small changes and restructuring have been made to the menu and the display.

Protection

Cause of trips are shown directly on the display.

Voltage-stage - V

The setting precision has been increased to 3 decimal places (0.1% Vn).

Low Voltage Ride Through - LVRT

A second LVRT element has been added.

Loss of Potential - LOP

The Dead Bus Detection has been made configurable.

The breaker assignment is optional. (If no breaker has been assigned then the position is ignored.)

The general IOC blocking has been removed.

The load current threshold LOP . I< can be set with a range 0.5 to 4 In.

Q->&V< / ReCon

The reconnection part has been split off and has become an independent module.

The decoupling functions of the Reconnection module has been extended to all trip commands.

Temperature Protection Module - RTD

The trip command has been made selectable.

Switch Onto Fault - Module - SOTF

The SOTF function has been removed.

SCADA

The DNP3 has been made available (with RTU/TCP/UDP).

New fiber-optic interfaces for SCADA.

Setting procedure (menu structure, default settings) has been modified.

New "SCADA connection status" signal.

Ethernet "TCP Keep Alive" according to RFC 793.

Bugfix:

- After a hardware exception, the IP address might have been lost.

SCADA / IEC 61850

New support of Direct-Control.

Support for LN descriptions via DAI entry in the SCD file.

Handling of InGGIO Ind improved.

Speed of GOOSE messages improved. Potential problem with time-correlated GOOSE messages fixed.

New Logical Nodes for energy counters, LVRT, Exp, TCM, 47.

New LNClass for sensors and monitoring.

Updated reports if angles become zero, and if angles of phasors exceed deadband.

Deadband algorithm improved.

It is now possible to assign IEC 61850 alarm signals to the LEDs of the device.

Counter for the number of active client-server connections added.

Missing modes of directional power fixed.

SCADA / Modbus

"Fast Status Register" added.

Configurable registers added.

Read Fault Recorder and some device-specific information via Modbus.

Stability of Modbus TCP improved.

IEC 60870-5-103

Bugfix:

- Problem with reading disturbances fixed.

SNTP

Start the network after protection is active.

Bugfix:

- SNTP might not have worked correctly in case of an empty battery.
- Default daylight-saving changed to "Sunday".

PC interface / Smart view connection

As of *Smart view* R4.30, it is possible to exchange the single-line for devices that support this.

The user interface supports the improved validation of IEC 61850 SCD files.

Characteristic curves can now be shown graphically.

There is now a Page Editor for creating single lines and device-pages.

Bugfix:

- After an interruption of communication, waveforms could no longer be received from the PC.
- After an interrupted download of the Device Model, file handling could be erroneous.

PC simulation

The LED status has been added to the simulation software.

Trend recorder

Bugfix:

- A memory leak has been fixed.

Analog Output - AnOut

Bugfix:

- After a restart of the device the output could peak to 100% for a short time.

When upgrading from a version 2.x device, the following must be noted with respect to the settings:



- All communication settings have to be re-defined. An automatic conversion is only partly possible.
- The VirtualOutput assignment of IEC 61850 communication has been restructured.

All assignment settings need to be re-defined.

- The reconnection part of Q->&V< has been split off as a new module ReCon. An automatic conversion is not possible.
- The V-Prot mode V<(t) has been abandoned and replaced by the LVRT module.

Index

A

ANSI	
26	340
27	290
27A	297
27U1	320
32	323
37	234, 323
38	340
46	285
47	320, 320
48	199
49	340
50	238
50BF	349
50N/G	264
51	238
51C	238, 259
51LR	231
51N/G	264
51Q	257
51V	238
55	335
59	290
59A	297

59N	297
59U1	320
60	360
60L	357
62BF	349
66	199
78	300
81O/U	300
81R	300
Adaptive Parameter Sets	41
Adaptive Parameters	32
access areas	58
access level password	53
acknowledge	
latched LEDs / output relays / SCADA signals / trip command	63
acknowledgment	57
C	
CBF	349
CT Supervision	357
CTS	357
Circuit breaker failure protection module	349
Counters	32
certificate	54
connection password	53, 54
control	401
cryptographic algorithm	54
cutoff levels (for measured values)	69
D	
D-SUB	80, 133, 134
DNP3	80, 156
Default Passwords	53
Device Stopped	440
Direct Commands	32

E

Earth current protection - Stage	264
ErPara file	32
Ethernet	80, 124, 135
encrypted connection	54
energy unit	68
external OPEN/CLOSE command	370

F

Frequency Protection Module	300
f[x]	300
fiber optic	80, 132, 135

G

Generator Reference System	20
Global Parameters	32

H

HMI	28, 56
-----	--------

I

I2>	285
I2>[x]	257
I<	234
IEC 60870-5-103	80, 128, 163
IEC 60870-5-104	80, 167
IEC 61850	81, 154
IG[x]	264
IT Security	51
I[x]	238
interlockings	371

J

Jam	231
-----	-----

K

keys	
CTRL	401
.....	

L

LC connector	81, 135
--------------	---------

LED Test	67
LED »System«	444
LOP.	360
Load Reference Arrow System	20
Locked Rotor (JAM).	231
Logic.	427
Loss of Potential.	360
M	
MStart	199
Measured Value	32
Modbus.	80, 128, 170
Module Input	32
Motor Start.	199
menu structure.	45
message (self-supervision).	437
motor protection.	11
N	
network access.	54
O	
Order Form (Order Code)	26
P	
PF.	335
PQS[x]	323
Page Editor.	366
Phase Overcurrent Stage	238
Power Factor - Module	335
Power Protection - Module	323
Profibus	80, 153
panel	28, 56
password	56
passwords	
access areas	58
.	
deactivate	57
.	
reset	53, 61
.	
phase angles (calculation)	69
power unit	68

R

RJ45	80, 124
RS485	80, 128
RTD	340
Recorder	407
(Motor) History	407, 425
Disturbance records	407, 409
Event records	407, 419
Fault records	407, 414
Motor Statistics	407, 424
Motor start records	407, 421
Self-Supervision messages	407
Trend records	407, 420
security-related messages	407
Reset Dialog	61
Residual voltage-Stage	296
reboot codes	435
reset latched states (= acknowledge)	63
reset to factory defaults	61
ring-terminal connection	106

S

SC	137
SCADA	401
ST connector	80, 132
Safety-specific settings	51
Security	51
Security Logger	52
Security States	51
Self-Supervision Contact	137
Self-Supervision messages	437
Setting Group Parameters	32
Signals	32
Softkeys	31
Statistical Value	32

Symmetrical Components: Supervision of the Positive Phase Sequence or Negative Phase Sequence.	320
Syslog.	438
System LED.	440
System-LED.	444
scaling of measured values.	68
security-related messages.	437
single-line.	401
single-line diagram.	366
start-up codes.	435
supervision timer (for switchgears).	370
switchgear.	401
switching authority	
local.	401
remote.	401

T

Temperature Protection Module.	340
Trip Manager.	371, 395
Typecode (see Order Form).	26
temperature unit.	69

U

Unbalanced Load-Stage.	257, 285
Underload / Undercurrent.	234

V

V012.	320
VG[x].	296
V[x].	290
Values.	32
Voltage-stage.	290



 Image References	
(11).	396
(14).	186, 232, 235, 254, 282, 287, 293, 296, 302, 305, 306, 308, 314, 320, 324, 335, 338, 344, 352
(14*).	338

(15)	186, 212, 232, 235, 254, 282, 287, 293, 296, 302, 305, 306, 308, 314, 320, 324, 335, 338, 344
(15a)	186, 213, 232, 236, 254, 282, 287, 293, 296, 303, 305, 307, 309, 315, 321, 325, 336, 338, 344
(16b)	254
(17b)	254
(18b)	254
(19)	282
(20)	293
(21)	293
(22)	293
(23)	296
(24b)	254
(25b)	254
(26b)	254
(27)	283
(28)	293
(29)	293
(30)	294
(31)	297
(32)	193
(38a)	361
(38b)	361
(38c)	362
(40)	358
(41)	393

(42)	394
.....
(50)	186, 188
.....
(51)	186, 189
.....
(54)	186, 282, 296
.....
(55)	187, 282, 296
.....
(56)	203
.....
(1)	185
.....
(2)	194
.....
(3)	193
.....
(4G)	198
.....
(4)	196
.....

We appreciate your comments about the content of our publications.

Send comments to: kemp.doc@woodward.com

Please reference publication MRMV4-3.6-EN-MAN

<http://wwdmanuals.com/mrmv4-2>

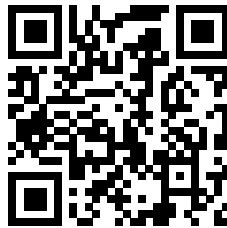

Woodward Kempen GmbH reserves the right to update any portion of this publication at any time. Information provided by Woodward Kempen GmbH is believed to be correct and reliable. However, Woodward Kempen GmbH assumes no responsibility unless otherwise expressly undertaken.



Woodward Kempen GmbH
Krefelder Weg 47 • D-47906 Kempen (Germany)
Postfach 10 07 55 (P.O.Box) • D-47884 Kempen (Germany)
Telephone: : +49 (0) 21 52 145 1

Internet: — www.woodward.com

Sales

Telephone: : +49 (0) 21 52 145 331
Fax: : +49 (0) 21 52 145 354
Email: : SalesPGD_EMEA@woodward.com

Service

Telephone: : +49 (0) 21 52 145 600
Fax: : +49 (0) 21 52 145 455
Email: : SupportPGD_Europe@woodward.com

Woodward has company-owned plants, subsidiaries, and branches, as well as authorized distributors and other authorized service and sales facilities throughout the world.

Complete address / phone / fax / email information for all locations is available on our website.