

MANUAL

High PROTEC | PROTECTION TECHNOLOGY
MADE SIMPLE

MRDT4 | TRANSFORMER DIFFERENTIAL PROTECTION



TRANSFORMER DIFFERENTIAL PROTECTION

DM version: 3.7

English (Original document)

Manual (original)

SEG Electronics GmbH

Krefelder Weg 47 • D-47906 Kempen (Germany)

Postfach 10 07 55 (P.O.Box) • D-47884 Kempen (Germany)

Telephone: +49 (0) 21 52 145 1

Internet: www.SEGelectronics.de

Sales

Telephone: +49 (0) 21 52 145 331

Fax: +49 (0) 21 52 145 354

E-mail: SalesPGD_EMEA@SEGelectronics.de

Service

Telephone: +49 (0) 21 52 145 614

Fax: +49 (0) 21 52 145 354

E-mail: industrial.support@SEGelectronics.de

© 2020 SEG Electronics GmbH. All rights reserved.

Table of Contents

1	MRDT4 - Transformer Differential Protection	12
1.1	Comments on the Manual	14
1.1.1	Important Definitions	18
1.1.2	Symbols and Definitions	23
1.1.2.1	Legend for Wiring Diagrams	24
1.1.2.2	Symbols in Function Diagrams	26
1.2	Information About the Device	29
1.2.1	Order Form of the Device	31
1.2.1.1	Overview of Assembly Groups	33
1.2.1.2	Communication Protocol Codes	34
1.2.2	Navigation - Operation	37
1.2.2.1	Front Panel Parts	38
1.2.2.2	Softkey Symbols	40
1.3	Modules, Settings, Signals and Values	41
1.3.1	Parameter Settings	45
1.3.1.1	Setting Lock	49
1.3.2	Adaptive Parameter Sets	50
1.3.3	Status Display	53
1.3.4	Menu Structure	54
1.3.5	Device Planning	56
1.3.6	Field Parameters	57
1.3.7	Device Parameters	58
1.3.8	Reset Counters, Values and Records	59
1.4	Security	60
1.4.1	Network Security	61
1.4.2	Passwords	62
1.4.3	Connection Passwords, Smart view Access	63
1.4.4	Access Level Passwords	65
1.4.5	Access Levels	67
1.4.6	Reset to Factory Defaults, Reset All Passwords	70
1.5	Acknowledgments	72

1.6	Measuring Values	77
1.7	Statistics	78
1.7.1	Configuration of the Minimum and Maximum Values	78
1.7.2	Configuration of the Average Value Calculation	78
1.7.2.1	Configuration of the Current-Based Average Value Calculation*	78
1.8	Smart view	80
1.9	DataVisualizer	80
2	Hardware	82
2.1	Dimension Drawings	82
2.2	MRDT4 - Installation and Wiring	86
2.2.1	Grounding	86
2.2.2	Overview of Slots - Assembly Groups	87
2.3	Slot X1	88
2.3.1	DI8-X Power Supply and Digital Inputs	89
2.4	Slot X2	93
2.4.1	BO-6 X - Assembly Group with 6 output relays	94
2.5	Slot X3	96
2.5.1	TI - Standard Phase and Ground Current Measuring Input Card	97
2.5.2	TIs - Phase and Sensitive Ground Current Measuring Card	100
2.5.3	Common CT Wiring Configurations	103
2.5.3.1	Connecting the Current Inputs	105
2.5.3.2	CT Requirements	107
2.6	Slot X4	112
2.7	Slot X5	113
2.8	Slot X6	114
2.8.1	DI8 - Assembly Group with 8 Digital Inputs	115
2.9	Slot X100: Ethernet Interface	118
2.9.1	Ethernet - RJ45	119
2.10	Slot X102: Protection Communication	120
2.10.1	Interface for the URTD Module	121
2.11	Slot X103: Data Communication	122
2.11.1	Modbus® RTU / IEC 60870-5-103 via RS485	123

2.11.2	Profibus DP/ Modbus® RTU / IEC 60870-5-103 via Fiber Optic	127
2.11.3	Profibus DP via D-SUB	128
2.11.4	Modbus® RTU / IEC 60870-5-103 via D-SUB	129
2.11.5	Ethernet / TCP/IP via Fiber Optics	130
2.12	Slot X104: IRIG-B00X and Selfsupervision Contact	131
2.12.1	Self-Supervision Contact (SC)/Life-Contact and IRIG-B00X	132
2.13	PC Interface – X120	133
2.14	Input, Output and LED Settings	134
2.14.1	LEDs	134
2.14.2	Configuration of the Digital Inputs	137
2.14.3	Output Relays Settings	140
3	Communication Protocols	143
3.1	General SCADA (Communication) Setting	143
3.2	TCP/IP Settings	144
3.3	Profibus	145
3.4	IEC 61850	146
3.5	DNP3	148
3.5.1	Application Example: Setting a Relay	151
3.5.2	Deadband Settings in DNP3	151
3.6	IEC60870-5-103	156
3.7	Configurable Communication Protocols	159
3.7.1	IEC 60870-5-104	160
3.7.2	Modbus®	164
3.7.3	Data-Point Mapping Using the SCADApter	169
3.8	Time Synchronization	171
3.8.1	SNTP	174
3.8.2	IRIG-B00X	176
4	Protective Elements	178
4.1	Module Prot: General Protection	178
4.1.1	General Alarms and General Trips	180
4.1.2	Blockings	185
4.1.2.1	Blocking the Tripping Command	187

4.1.2.2	Activate, Deactivate or Block a Protection Function Temporarily	188
4.1.2.3	Activate, Deactivate or Block the Phase Current Modules	189
4.1.2.4	Activate, Deactivate or Block the Ground (Earth) Current Modules	190
4.2	Id – Phase Current Differential Protection	192
4.2.1	Tripping Curve	194
4.2.1.1	Setting the Tripping Curve	197
4.2.2	Phasor Compensation	198
4.2.3	CT Mismatch	199
4.2.4	Phase Compensation	200
4.2.5	Zero Sequence Removal	201
4.2.6	Transient Restraining	202
4.2.7	Example on Setting the Differential Function for Transformer Application	205
4.2.8	Connection Groups	206
4.2.9	Automatic Calculations: Amplitudes, Vector Groups, and Zero Sequence Removal	208
4.3	IdH – Unrestrained High-set Differential Current Protection	212
4.4	IdG – Ground Current Differential Protection	213
4.5	IdGH – High Set Restricted Ground Fault Protection	217
4.6	I – Overcurrent Protection	218
4.6.1	Characteristics	219
4.6.1.1	DEFT – Definite Time-Overcurrent	221
4.6.1.2	IEC 60255-151 Curves	222
4.6.1.3	ANSI / IEEE C37.112 Curves	228
4.6.1.4	R Inverse [RINV] - Characteristic	232
4.6.1.5	Thermal Curves	233
4.6.2	Functionality	238
4.6.3	I2> – Negative-Sequence Overcurrent [51Q]	239
4.6.4	Commissioning: Overcurrent Protection, non-directional [50, 51]	240
4.6.5	Commissioning: Negative Sequence Overcurrent	241
4.7	IH2 - Inrush	243
4.7.1	Commissioning: Inrush	244
4.8	IG – Ground (Earth) Overcurrent Protection [50N/G, 51N/G, 67N/G]	245
4.8.1	Characteristics	246

4.8.1.1	DEFT – Definite Time-Overcurrent	249
4.8.1.2	IEC 60255-151 Curves	250
4.8.1.3	ANSI / IEEE C37.112 Curves	256
4.8.1.4	R Inverse [RINV] - Characteristic	260
4.8.1.5	RXIDG	261
4.8.1.6	Thermal Curves	262
4.8.2	Ground (Earth) Overcurrent – Functionality	267
4.8.3	Commissioning: Ground Fault Protection – non-directional [50N/G, 51N/G]	268
4.9	I2> and %I2/I1> – Unbalanced Load [46]	269
4.9.1	Commissioning: Current Unbalance Module	272
4.10	ThR – Thermal Replica [49]	275
4.10.1	Commissioning: Thermal Replica	276
4.11	SOTF - Switch Onto Fault	278
4.11.1	Commissioning: Switch Onto Fault	280
4.12	CLPU - Cold Load Pickup	282
4.12.1	Commissioning of the Cold Load Pickup Module	284
4.13	ExP - External Protection	286
4.13.1	Commissioning: External Protection	286
4.14	Ext Temp Superv – External Temperature Supervision	288
4.14.1	Commissioning: External Temperature Supervision	288
4.15	Ext Oil Temp Protection Module – External Oil Temperature Protection	290
4.15.1	Commissioning: External Protection	290
4.16	Sudden Pressure Protection Module – Sudden Pressure Protection	291
4.16.1	Commissioning: Sudden Pressure Protection	291
4.17	RTD Protection Module [26/38/49]	293
4.18	URTDII Module Interface	298
4.19	Supervision	302
4.19.1	CBF – Circuit Breaker Failure [50BF*/62BF]	302
4.19.1.1	Principle – General Use	302
4.19.1.2	Functionality	305
4.19.1.3	Commissioning Example: Supervision Scheme 50BF	305
4.19.2	TCS - Trip Circuit Supervision [74TC]	307

4.19.2.1	Commissioning: Trip Circuit Supervision [74TC]	308
4.19.3	CTS - Current Transformer Supervision [60L]	310
4.19.3.1	Commissioning: Current Transformer Failure Supervision	311
4.19.4	Phase Sequence Supervision	313
5	Control / Switchgear-Manager	314
5.1	Switchgear Control	315
5.1.1	Settings within the Protection Device	318
5.1.2	Switch	320
5.1.3	Invisible Switch	321
5.1.4	Circuit Breaker	322
5.1.5	Circuit Breaker1	323
5.1.6	Disconnecter (Isolator)	324
5.1.7	Disconnecter-Earthing Combination	325
5.1.8	Earthing Switch	326
5.1.9	Fuse-Load Switch	327
5.1.10	Fuse-Load Switch – Disconnecter	328
5.1.11	Fused-Disconnecter (Isolator)	329
5.1.12	Load Switch	330
5.1.13	Load Switch – Disconnecter	331
5.1.14	Three Position Switch	332
5.1.15	Withdrawable Circuit Breaker	334
5.1.16	Withdrawable Fuse Load Switch	336
5.2	Switchgear Configuration	337
5.3	Switchgear Wear	346
5.4	Control - Example: Switching of a Circuit Breaker	349
6	System Alarms	351
6.1	Demand Management	351
6.2	Min. and Max. Values	353
6.3	THD Protection	353
7	Recorders	354
7.1	Disturbance Recorder	355

7.2	Fault Recorder	360
7.3	Event Recorder	365
7.4	Trend Recorder	366
8	Programmable Logic	367
9	Self-Supervision	373
9.1	Device Start (Reboot)	376
9.2	Self-Supervision Messages	378
9.3	Syslog	379
9.4	Device Taken out of Service (“Device Stopped”)	381
10	Commissioning	382
10.1	Commissioning/Protection Test	383
10.2	Putting out of Operation – Plug out the Relay	384
10.3	Service and Commissioning Support	385
10.3.1	General	385
10.3.2	Phase Sequence	385
10.3.3	Forcing the Relay Output Contacts	385
10.3.4	Disarming the Relay Output Contacts	386
10.3.5	Forcing RTDs*	387
10.3.6	Fault Simulator (Sequencer)*	389
11	Servicing and Maintenance	392
11.1	Routine Functional Tests	392
12	Technical Data	394
12.1	Specifications / Tolerances	403
12.1.1	Specifications of the Real Time Clock	403
12.1.2	Specifications of the Measured Value Acquisition	404
12.1.3	Protection Elements Accuracy	405
12.1.3.1	Phase Overcurrent Protection	405
12.1.3.2	Earth (Ground) Overcurrent Protection	407
12.1.3.3	Phase Differential Protection	408
12.1.3.4	Earth (Ground) Differential Protection	409

12.1.3.5	Thermal Protection	410
12.1.3.6	Current-Related Protection	411
12.1.3.7	Miscellaneous Protection and Supervision	412
13	Appendix	414
13.1	Standards	414
13.1.1	Approvals	414
13.1.2	Design Standards	415
13.1.3	Electrical Tests	416
13.1.4	Environmental Tests	419
13.1.5	Mechanical Tests	421
13.2	IEC 60870-103 Interoperability	423
13.2.1	Physical layer	423
13.2.2	Link layer	423
13.2.3	Application layer	423
13.2.3.1	Common address of ASDU	423
13.2.3.2	Selection of standard information numbers in monitor direction	424
13.2.3.3	Selection of standard information numbers in control direction	425
13.2.3.4	Miscellaneous	426
13.3	IEC 60870-5-104 Interoperability	427
13.3.1	System or device	427
13.3.2	Network configuration	427
13.3.3	Physical layer	428
13.3.4	Link layer	428
13.3.5	Application layer	429
13.3.6	Basic application functions	435
13.4	Abbreviations, and Acronyms	440
13.5	List of ANSI Codes	447
13.6	Revision History	450
13.6.1	Version: 3.0	451
13.6.2	Version: 3.0.b	455
13.6.3	Version: 3.1	456
13.6.4	Version: 3.4	457

13.6.5	Version: 3.6	459
13.6.6	Version: 3.7	462
14	Index	464

1 MRDT4 - Transformer Differential Protection

The various protective functions of the MRDT4 are specifically tailored to the protection of two winding transformers. The device offers in addition to the differential protection various communication and backup protection functions.

Furthermore the MRDT4 can be used for generator differential protection.

The intuitive operating concept with plausibility checks and extensive commissioning functions such as the built-in fault simulator allows a safe and time-optimized maintenance and commissioning. The parameter setting and evaluation software *Smart view* can be used consistently across the entire family of devices.

Functional Overview

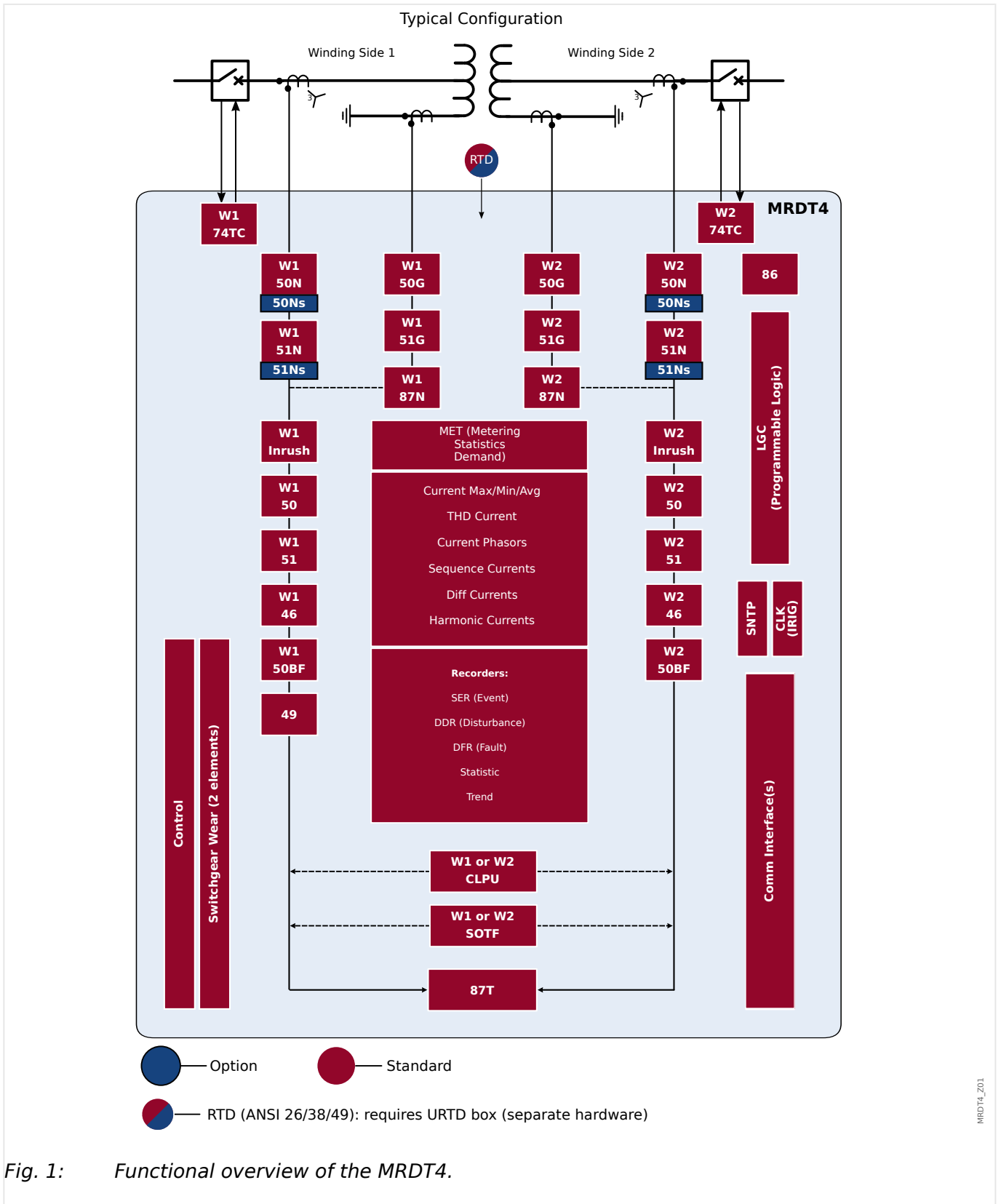

Fig. 1: Functional overview of the MRDT4.

1.1 Comments on the Manual

This manual explains in general the tasks of device planning, parameter setting, installation, commissioning, operation and maintenance of the HighPROTEC devices.

The manual serves as working basis for:

- Engineers in the protection field,
- commissioning engineers,
- people dealing with setting, testing and maintenance of protection and control devices,
- as well as trained personnel for electrical installations and power stations.

All functions concerning the type code will be defined. Should there be a description of any functions, parameters or inputs/outputs which do not apply to the device in use, please ignore that information.

All details and references are explained to the best of our knowledge and are based on our experience and observations.

This manual describes the (optionally) full featured versions of the devices.

All technical information and data included in this manual reflect their state at the time this document was issued. We reserve the right to carry out technical modifications in line with further development without changing this manual and without previous notice. Hence no claim can be brought based on the information and descriptions this manual includes.

Text, graphic and formulae do not always apply to the actual delivery scope. The drawings and graphics are not true to scale. We do not accept any liability for damage and operational failures caused by operating errors or disregarding the directions of this manual.

No part of this manual is allowed to be reproduced or passed on to others in any form, unless *SEG* have approved in writing.

This user manual is part of the delivery scope when purchasing the device. In case the device is passed on (sold) to a third party, the manual has to be handed over as well.

Any repair work carried out on the device requires skilled and competent personnel who need to be well aware especially of the local safety regulations and have the necessary experience for working on electronic protection devices and power installations (provided by evidence).

Information Concerning Liability and Warranty

SEG does not accept any liability for damage resulting from conversions or changes carried out on the device or planning (projecting) work, parameter setting or adjustment changes done by the customer.

The warranty expires after a device has been opened by others than *SEG* specialists.

Warranty and liability conditions stated in *SEG* General Terms and Conditions are not supplemented by the above mentioned explanations.

Structure of This Manual

- Safety first! Make yourself familiar with the most important safety messages used throughout this manual: [↳ “1.1.1 Important Definitions”](#). Moreover, there is general information about the delivery scope ([↳ “1.2 Information About the Device”](#)) and this manual and the conventions and symbols used here ([↳ “1.1.2 Symbols and Definitions”](#)).
- A general overview of the protection functions available with the MRDT4 can be found as a function diagram: [↳ “Functional Overview”](#). Note that the availability of some functions depends on the ordered device type. See [↳ “1.2.1 Order Form of the Device”](#) for the available variants.
- The MRDT4 uses a special modular concept for its settings, measured values and signals. Although this concept of modules and parameters is simple and straightforward it is strongly recommended, especially for beginners, to make oneself familiar with it: [↳ “1.3 Modules, Settings, Signals and Values”](#)
- *Smart view* is the operating program that can be installed on a Windows PC. It can connect to the MRDT4, and it can be used to do configuration work and retrieve data (measuring and statistics values, fault records, etc.) from the MRDT4. A few introductory words are here: [↳ “1.8 Smart view”](#); however, for a detailed description you can consult the full *Smart view* Manual as a separate document.
- The hardware aspects (e. g. dimension diagrams and connection diagrams) can be found here: [↳ “2 Hardware”](#)
- Various Security settings might have to be done, because the MRDT4 is delivered with no access restrictions and a very simple standard password that does not offer any safety at all. Unless you are sure that no special access restrictions are required for your application, it is strictly recommended to check the “Security” chapter: [↳ “1.4 Security”](#)
- A few settings are related to the MRDT4 itself: [↳ “1.3.7 Device Parameters”](#)
- The MRDT4 makes a lot of measured values available and maintains statistics of some more values: [↳ “1.6 Measuring Values”](#) and [↳ “1.7 Statistics”](#) describe what concepts and settings are related to this.
- The various communication protocols that the MRDT4 makes available for communicating with the substation are described in [↳ “3 Communication Protocols”](#).
- The MRDT4 can control a switchgear device. In general, one will probably use it to control a circuit breaker, that is tripped by the protection functions in case of a fault. [↳ “5 Control / Switchgear-Manager”](#) describes the various aspects of the Control functionality.
- The multitude of protection functions is described in sub-chapters within the “Protection Functions” chapter: [↳ “4 Protective Elements”](#). Keep in mind that there is one “master protection” module that governs all protection functions: [↳ “4.1 Module Prot: General Protection”](#). And furthermore, it is not only important to know how to activate a protection module, it is also essential to know about the blocking of a module: [↳ “4.1.2 Blockings”](#)
- Various kinds of events (disturbances, detected faults, etc.) are recorded by the MRDT4, so that you need to know how to access these records: [↳ “7 Recorders”](#)
- The MRDT4 offers programmable logic equations for programming inputs, outputs, blocking of protective functions, and custom logic functions in the relay: [↳ “8 Programmable Logic”](#)

- In addition to the various protection functions, the MRDT4 also features various supervision functions. The main difference is that – contrast to a protection function – a supervision function does not issue any trip signal, but generates an alarm signal under special circumstances. This alarm signal can be used to block protection functions, or it can be assigned to any of the LEDs or some output: [↪ “4.19 Supervision”](#)
- Commissioning aspects for the MRDT4: [↪ “10 Commissioning”](#). But note that protection-specific commissioning descriptions are sub-chapters within the respective chapters for the protection functions.
- Technical data, tolerances, and applicable standards: [↪ “12 Technical Data”](#)
- The last chapter in this document is the Index. There is one speciality with it: Under the initial “☞”, it lists the numbered signals “generated” in logic diagrams (see [↪ “1.1.2 Symbols and Definitions”](#)).

Related Documents

- MRDT4 Reference Manual (MRDT4-3.7-EN-REF): All settings, signals and values available with the MRDT4 are listed here with their respective menu paths, default values and value ranges.
- HighPROTEC Quick Start Guide (HPT-3.7-EN-QSG): A step-by-step introduction to the menu structure, functionality of the buttons and typical activities.
- HighPROTEC Troubleshooting Guide (HPT-3.7-EN-TSG): A description of all device-internal (error or warning) messages that the MRDT4 might issue. (See also [↪ “9.2 Self-Supervision Messages”](#).)

This document should also be consulted whenever the »System OK« (“Operational”) LED is not constantly green after the boot phase ([↪ “Boot Phase”](#)).

- Wiring Diagrams (HPT-3.7-EN-WDG) – [English only]: For each available device variant (ordered by typecode), this document has a related diagram showing (schematically) the rear view of the MRDT4, with all hardware modules fitted and terminal connections.
- Smart view Manual (SMARTV-x.xx-EN-MAN): The Technical Manual of the *Smart view* operating software.
- DataVisualizer Manual (DATVIS-x.xx-EN-MAN): The Technical Manual of the *DataVisualizer* software. This is an application for analyzing disturbance and event records.
- Page Editor Manual (PAGEED-x.xx-EN-MAN): The Technical Manual of the *Page Editor* software. This is an application for creating individual single-line / control pages.
- SCADAPTER Manual (SCADAP-x.xx-EN-MAN): The Technical Manual of the *SCADAPTER* software. This is an application for creating individual data-point mappings for SCADA protocols.
- SCADA reference documents:
 - MRDT4-3.7-EN-DNP3-DeviceProfile — DNP3 Profile – [English only]
 - MRDT4-3.7-EN-Modbus-Datapoints — Modbus Data Point List
 - MRDT4-3.7-EN-Profibus-Datapoints — Profibus Data Point List

- MRDT4-3.7-EN-IEC61850-Mics — IEC 61850 Model Implementation Conformance Statement (MICS) - [English only]
- MRDT4-3.7-EN-IEC61850-Pics — IEC 61850 Protocol Implementation Conformance Statement (PICS) - [English only]
- MRDT4-3.7-EN-IEC61850-Pixit — IEC 61850 Protocol Implementation Extra Information for Testing (PIXIT) - [English only]
- MRDT4-3.7-EN-IEC61850-Tics — IEC 61850 Tissue Implementation Conformance Statement (TICS) - [English only]

1.1.1 Important Definitions

The types of messages shown below serve the safety of life and limb as well as for the appropriate operating life of the device.

DANGER!



DANGER indicates an immediately dangerous situation that will result in death or serious injury if it is not avoided.

WARNING!



WARNING indicates a hazardous situation that can result in death or serious injury if it is not avoided.

CAUTION!



CAUTION indicates a possibly hazardous situation that can result in minor or moderate injuries if it is not avoided.

NOTICE!





NOTICE is used to address practices not related to personal injury.



This symbol indicates useful tips and recommendations as well as information for efficient and trouble-free operation.

Safety Messages Printed on the Housing of the MRDT4

These safety messages are printed on the housing of the MRDT4 as part of the connection diagram:

 <p>Only for use with external galvanic decoupled CT's. See chapter Current Transformers of the manual!</p>	<p>DANGER!</p> <p>The current measuring inputs may exclusively be connected to current measuring transformers (with galvanic separation).</p> <p>See  “2.5.1 TI – Standard Phase and Ground Current Measuring Input Card” for details and more important safety instructions.</p>
--	---

 <p>* Caution Sensitive Current Inputs</p>	<p>WARNING!</p> <p>This variant of the MRDT4 features sensitive inputs for measuring the ground (earth) current. (These are marked by an asterisk “*”.)</p>
---	--

The technical data of the sensitive ground (earth) measuring input are different from the technical data of the phase current measuring inputs. If the rating of the CTs is not right (overrated), then the normal operational conditions may not be recognized.

Please refer to the Technical Data chapter ([↪](#) “12 Technical Data”) and to [↪](#) “2.5.1 TI - Standard Phase and Ground Current Measuring Input Card” for details and more important safety instructions.

Proper Use of the Device and of This Manual

CAUTION!



Do not put the MRDT4 in service until it has been configured and commissioned.

Read the User Manual.

For configuring the required protection functions, read [↪](#) “4.1 Module Prot: General Protection” and the related chapters within [↪](#) “4 Protective Elements”.

For commissioning, read [↪](#) “10 Commissioning” and the “Commissioning” sections within the chapters that are related to the required protection functions.

WARNING!



FOLLOW INSTRUCTIONS

Read this entire manual and all other publications pertaining to the work to be performed before installing, operating, or servicing this equipment. Practice all plant and safety instructions and precautions. Failure to follow instructions can cause personal injury and/or property damage.

WARNING!



PROPER USE

Any unauthorized modifications to or use of this equipment outside its specified mechanical, electrical, or other operating limits may cause personal injury and/or property damage, including damage to the equipment. Any such unauthorized modifications: (1) constitute “misuse” and/or “negligence” within the meaning of the product warranty thereby excluding warranty coverage for any resulting damage, and (2) invalidate product certifications or listings.

The programmable devices subject to this manual are designed for protection and also control of power installations and operational devices that are fed by voltage sources with a fixed frequency, i.e. fixed at 50 or 60 Hertz. They are not intended for use with Variable Frequency Drives. The devices are further designed for installation in low-voltage (LV) compartments of medium voltage (MV) switchgear panels or in decentralized protection panels. The programming and parameterization has to meet all requirements of the protection concept (of the equipment that is to be protected). You must ensure that the device will properly recognize and manage (e. g. switch off the circuit breaker) on the basis of your programming and parameterization all operational conditions (failures). The proper use requires a backup protection by an additional protective device. Before starting any operation and after any modification of the programming (parameterization) test make a documentary proof that your programming and parameterization meets the requirements of your protection concept.

The Self-Supervision Contact (Life-Contact) has to be wired with the substation automation system in order to supervise and monitor the state of health of the programmable protective device. It is very important that an alarm annunciation is driven from the programmable protective device self-supervision contact (Life-Contact) that requires immediate attention when tripped. The alarm indicates that the protective device is no longer protecting the circuit and the system should be serviced.

Typical applications for this product family/device line are for instance:

- Feeder protection
- Mains protection
- Machine protection
- Transformer Protection
- Generator Protection

Any usage beyond these applications the devices are not designed for. This applies also to the use as a partly completed machinery. The manufacturer cannot be held liable for any resulting damage, the user alone bears the risk for this. As to the appropriate use of the device: The technical data and tolerances specified by *SEG* have to be met.

***Out-of-date documentation?***

This publication may have been revised or updated since this copy was produced. To verify that you have the latest revision, please visit the download section of our website.

Please check the web site of SEG for the latest revision of this Technical Manual and if there is an Errata Sheet with updated information.

- Visit the company website and search for the documents you are interested in. (The ID of every document is printed on its cover page.)
- Alternatively, every HighPROTEC device has a QR code printed on it. Scan this code, and you are taken to an online directory that contains all relevant documents in the most recent version.

Important Information**WARNING!**

In line with the customer's requirement the devices are combined in a modular way (in compliance with the order code). The terminal assignment of the device can be found on the top of the device (wiring diagram).

CAUTION!



Electrostatic Discharge Awareness

All electronic equipment is electro static-sensitive, some components more than others. To protect these components from electro static damage, you must take special precautions to minimize or eliminate electrostatic discharges. Follow these precautions when working with or near the control.

1. Before doing maintenance on the electronic control, discharge the static electricity on your body to ground by touching and holding a grounded metal object (pipes, cabinets, equipment, etc.).
2. Avoid the build-up of static electricity on your body by not wearing clothing made of synthetic materials. Wear cotton or cotton-blend materials as much as possible because these do not store static electric charges as much as synthetics.
3. Keep plastic, vinyl, and Styrofoam materials (such as plastic or Styrofoam cups, cup holders, cigarette packages, cellophane wrappers, vinyl books or folders, plastic bottles, and plastic ash trays) away from the control, the modules, and the work area as much as possible.
4. Do not remove any printed circuit board (PCB) from the control cabinet unless absolutely necessary. If you must remove the PCB from the control cabinet, follow these precautions:
 - Verify the safe isolation from supply. All connectors have to be unplugged.
 - Do not touch any part of the PCB except the edges.
 - Do not touch the electrical conductors, the connectors, or the components with conductive devices or with your hands.
 - When replacing a PCB, keep the new PCB in the plastic antistatic protective bag it comes in until you are ready to install it. Immediately after removing the old PCB from the control cabinet, place it in the antistatic protective bag.

SEG reserves the right to update any portion of this publication at any time. Information provided by SEG is believed to be correct and reliable. However, no responsibility is assumed by SEG unless otherwise expressly undertaken.

© 2020 SEG. All Rights Reserved.

1.1.2 Symbols and Definitions

Connection Diagram that is Printed on the Housing

There is a connection (wiring) diagram fixed onto the housing of the MRDT4. This diagram shows all terminals for this particular device variant.

A table of the symbols that can appear in this diagram can be found here: [↳ “1.1.2.1 Legend for Wiring Diagrams”](#)

Load Reference Arrow System

- It is common practice to either use the “Load Reference Arrow System” for loads (consumed energy) or the “Generator Reference System” for generators (generated energy).
- All HighPROTEC protection devices (except generator protection devices) use exclusively the “**Load Reference Arrow System**”. Generator protection devices are working based on the “**Generator Reference System**”.
- This applies to directions and phase angles. The phase angle is defined as the angle between the current phasor and the voltage phasor.
- Current and voltage arrows are to be counted positive in the direction of the arrow.

Typographical Conventions

- »Parameters are indicated by right and left double arrow heads and written in italic.«
- »SIGNALS are indicated by right and left double arrow heads and small caps.«
- [Paths are indicated by brackets.]
- *Software and Device names are written in italic.*
- Module and Instance (Element) names are displayed italic and underlined.
- »Pushbuttons, Modes and Menu entries are indicated by right and left double arrow heads.«
- ①②③ Image References

Numbered Signals in Function Diagrams

The signals labeled by encircled numbers are meant to signify connections between different diagrams. So, if you find such an encircled number somewhere “on the left side” of a diagram you might want to look up in which other diagram this particular signal has been generated.

Therefore all encircled numbers appearing “on the right side” (i. e. as an output signal) of a diagram are listed as part of the Index chapter.

1.1.2.1 Legend for Wiring Diagrams

In this legend designations of various device types are listed, e. g. transformer protection, motor protection, generator protection, etc. Therefore it can occur that not every designation actually appears on the wiring diagram of your device.

FE	Connection of functional earth (see ↳ “2.2.1 Grounding”)
Power Supply	Connection for auxiliary power supply
IL1	Phase current input L1 (in some countries designated as “IA”)
IL2	Phase current input L2 (in some countries designated as “IB”)
IL3	Phase current input L3 (in some countries designated as “IC”)
IG	Earth current input
IL1 W1 ... IL3 W1	Phase current input L1...L3, winding side 1
IL1 W2 ... IL3 W2	Phase current input L1...L3, winding side 2
IG W1, IG W2	Earth current input, winding side 1/2
VL1	Phase-to-neutral voltage L1 (in some countries designated as “VA”)
VL2	Phase-to-neutral voltage L2 (in some countries designated as “VB”)
VL3	Phase-to-neutral voltage L3 (in some countries designated as “VC”)
VL12	Phase-to-phase voltage V12 (in some countries designated as “VAB”)
VL23	Phase-to-phase voltage V23 (in some countries designated as “VBC”)
VL31	Phase-to-phase voltage V31 (in some countries designated as “VCA”)
VX	Fourth voltage measuring input for measuring residual voltage or for Synchro-check
BO	Binary output relay
NO / NC	Contact output, normally open / closed
DI	Digital input
COM	Common connection of digital inputs
Out+, AnOut	Analog output + (0/4...20 mA or 0...10 V)
In–, AnIn	Analog input (0/4...20 mA or 0...10 V)
n.c.	Not connected
DO NOT USE	Do not use
SC	Self-supervision contact
GND	Ground
HF Shield	Connection cable shield
Fiber Optics	Fiber optic connection

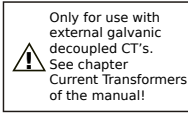

Only for use with external galvanic decoupled CTs. See chapter Current Transformers of the manual.
(See  "2.5.1 TI - Standard Phase and Ground Current Measuring Input Card".)



Caution: Sensitive Current Inputs.
(See  "2.5.2 TIs - Phase and Sensitive Ground Current Measuring Card".)

1.1.2.2 Symbols in Function Diagrams

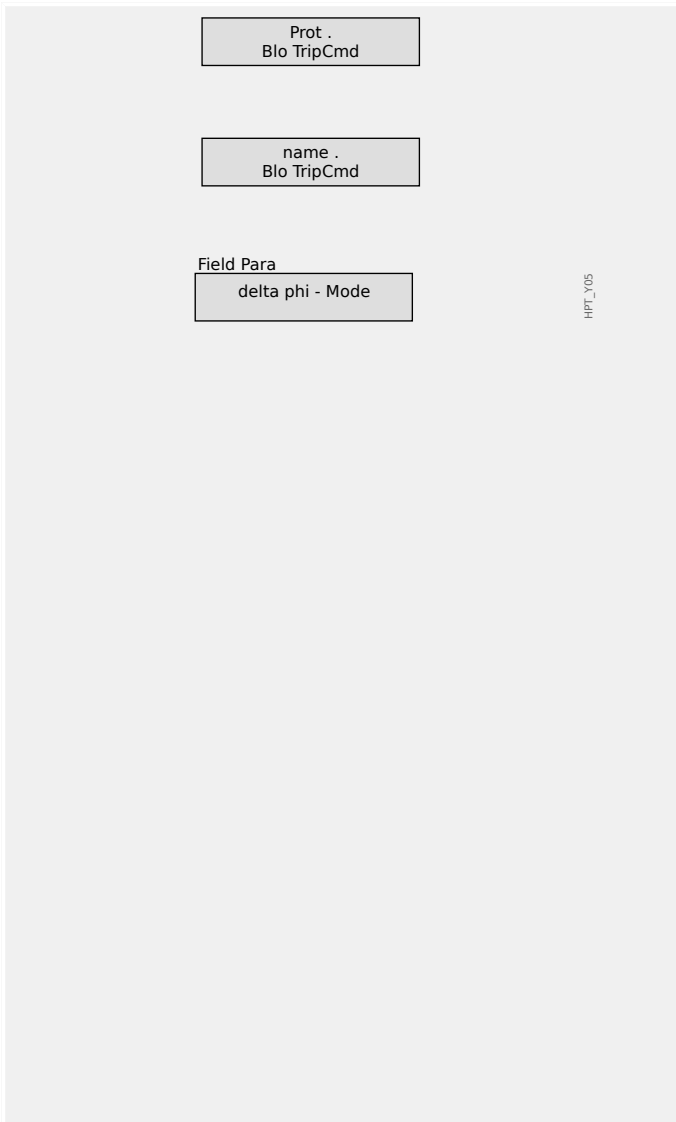

Setting Values

The upper box in the diagram on the left is the usual symbol of a setting value in a function diagram. The setting name is specified by its module and parameter name, separated by a dot “.” one from the other.

Second example: Thanks to the high degree of modularisation in HighPROTEC protection devices, the logic depicted in some function diagrams is often valid for several modules. In these cases, only a symbolic module name, for example: “*name*”, is given. In the heading part of the diagram, the meaning of “*name*” is specified as a list of modules to which the diagram applies.

In rare cases it is necessary to also specify the menu path (or at least the top-level menu item), because it would be too inconvenient to specify this particular setting only based on module name and parameter name. In the third example, the setting »*delta phi - Mode*« is marked as a Field Parameter (i. e. to be found within menu branch [Field Para]).

Another remark: All diagrams in this document show a small label, in this case: “HPT_Y05”. This is the diagram name, i. e. a unique identifier for the diagram. Of course, this is not a setting name, nor any other part of the depicted logic. All function diagrams have an identifier with the characters “_Y”.)

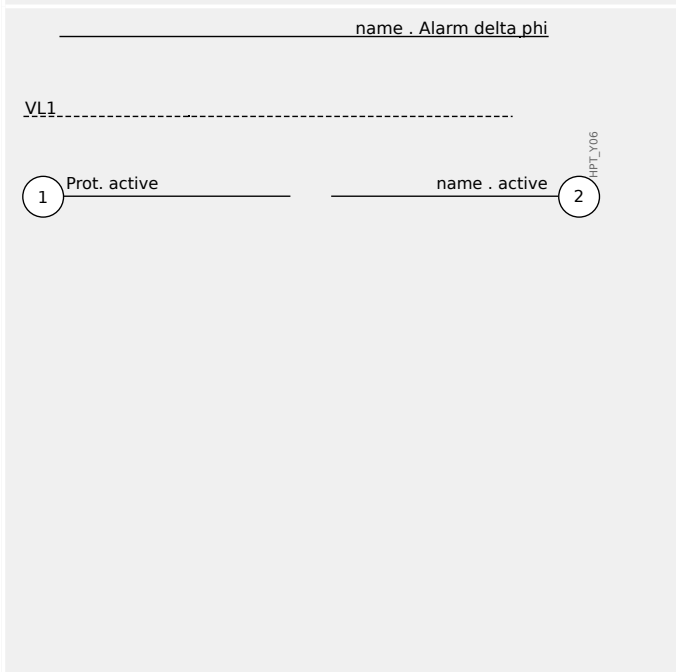

Input and Output Signals

A binary (output) signal is shown on top.

Below the dashed line indicates a measured value (i. e. an analog signal).

Bottom row, left: Numbered input signal; right: numbered output signal: From the technical point of view, there is no difference to “normal” (non-numbered) signals. But these signals appear in several different diagrams, and the numbering helps to identify and locate them across the Technical Manual.

Therefore all encircled numbers appearing “on the right side” (i. e. as an output signal) of a diagram are listed as part of the Index chapter, so that you can look up where a particular signal has been “generated”.

<p>HPT_Y07</p>	<p>If the setting value of parameter »name . VX Source« is set to “measured”, then output 1 is active and output 2 is inactive.</p> <p>If the setting value of parameter »name . VX Source« is set to “calculated”, then output 1 is inactive and output 2 is active.</p>
<p>HPT_Y08</p>	<p>The setting value of parameter »name . ExBlo1« is not a choice from a simple, fixed selection list, but it is another parameter (usually a binary output signal) that is assigned from a parameter list.</p> <p>This means that the setting parameter assumes the value of the assigned parameter. In case of a binary output signal, for example, it means that the parameter »name . ExBlo1« is active whenever the assigned output signal is active.</p> <p>If no signal has been assigned then the output is always inactive (and only the “no assignment” box, which is not connected in this example, would be active).</p>
<p>HPT_Y09</p>	<p>Two types of comparator (“Schmitt triggers”):</p> <p>Top row: If the analog input value (here: the voltage ratio $\%(V2/V1)$) is greater than the specified threshold (here: 0.4) then the output becomes active (=logical “1”).</p> <p>Bottom row: This type has the opposite functionality: If the analog value IL1 is below the threshold (here: the setting value of parameter $I<$) then the output becomes active.</p>
<p>HPT_Y0A</p>	<p>Timer stage: If the input becomes active, then the output becomes active after the time t_{on} (setting value of »t-On Delay«) has elapsed (switch-on delay).</p> <p>If the input becomes inactive again, then the output signal becomes inactive after the other specified duration has elapsed (switch-off delay t_{off}, setting value of »t-Off Delay«).</p>
<p>HPT_YX0</p>	<p>Hold time: This is a pulse which is triggered by the input (and in this case, the pulse duration is settable via parameter).</p>
<p>HPT_YX1</p>	<p>The usual set of logic operators: AND, OR, eXclusive OR (from left to right). The second input of the XOR operator is negated.</p>

1 MRDT4 - Transformer Differential Protection

1.1.2.2 Symbols in Function Diagrams

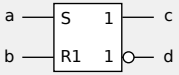
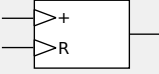
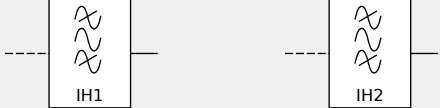
 <table border="1" data-bbox="438 224 590 331"><thead><tr><th>a</th><th>b</th><th>c</th><th>d</th></tr></thead><tbody><tr><td>0</td><td>0</td><td colspan="2">Unchanged</td></tr><tr><td>0</td><td>1</td><td>0</td><td>1</td></tr><tr><td>1</td><td>0</td><td>1</td><td>0</td></tr><tr><td>1</td><td>1</td><td>0</td><td>1</td></tr></tbody></table> <p data-bbox="694 297 710 347">HPT_YX2</p>	a	b	c	d	0	0	Unchanged		0	1	0	1	1	0	1	0	1	1	0	1	RS flip-flop with reset priority.
a	b	c	d																		
0	0	Unchanged																			
0	1	0	1																		
1	0	1	0																		
1	1	0	1																		
 <p data-bbox="694 398 710 448">HPT_YX3</p>	Edge-triggered counter.																				
 <p data-bbox="694 533 710 582">HPT_YX4</p>	Band-pass filter (left: IH1, right: IH2).																				

1.2 Information About the Device

Scope of Delivery



The delivery scope includes:

(1)	The transportation box
(2)	The protective device
(3)	The mounting nuts
(4)	The test report

Please check the consignment for completeness on arrival (delivery note).

Please ascertain whether the type plate, connection diagram, type code and description of the device tally.

If you have any doubts please contact our Service Department (contact address to be found on the reverse of the manual).

Download Area

All technical documentation (User Manual, Reference Manual, etc.) and setup files for the Windows applications (Smart view, DataVisualizer, Page Editor, SCADApt) can be downloaded directly (and without any costs) from \Rightarrow <http://wwdmanuals.com/MRDT4-2>.

This web address is also available as a QR code directly on the housing of the device.

Product DVD

A product DVD with all technical documentation (User Manual, Reference Manual, etc.) and setup files for the Windows applications (Smart view, DataVisualizer, Page Editor, SCADApt) can be ordered separately. This way users who are not connected to the internet can get all files that are required or useful during commissioning.

Storage

The devices must not be stored outdoors. The storing facilities have to be sufficiently ventilated and must be dry (see Technical Data, [↩> “12 Technical Data”](#)).

Battery

The purpose of the battery is to buffer the real-time clock in case of an outage of the protective device's power supply.

Since it is not used for normal operation of the MRDT4, it is not expected under normal conditions that a replacement be necessary during the life-time of the MRDT4. If, however, it happens that the battery needs to be replaced the MRDT4 has to be sent to the manufacturer as a service request.

Removal of the Battery after Life-Time of the MRDT4

The battery has to be soldered out or alternatively the contacts have to be pinched off.

Please see the product safety data sheet of the battery manufacturer for further information (Panasonic, battery type BR2032 - [=> http://panasonic.net/ec/](http://panasonic.net/ec/)). See also [↩> “Waste Disposal”](#) below.

Waste Disposal

This protective device contains a battery, and therefore it is labeled with the following symbol according to the EU Directive 2006/66/EC:

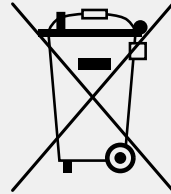

Batteries can be harmful to the environment. Damaged or unusable batteries must be disposed of in a container that is specially reserved for this purpose.

In general, appropriate local guidelines and regulations must be followed when disposing of electrical devices and batteries.

1.2.1 Order Form of the Device

Transformer Differential Protection											
MRDT4						-2	#	#	#	#	#
Housing	Display	Digital Inputs	Binary output relays	Interf. for ext. RTD Box							
B2	LCD, 128 x 64 pixel	8	7	✓			A				
B2	LCD, 128 x 64 pixel	16	13	✓			D				
Hardware variant 2											
Phase Current 5 A/1 A, W1 / W2 Ground Current 5 A/1 A								0			
Phase Current 5 A/1 A; W1: Sensitive Ground Current 5 A/1 A, W2: Ground Current 5 A/1 A								1			
Phase Current 5 A/1 A; W1: Ground Current 5 A/1 A, W2: Sensitive Ground Current 5 A/1 A								2			
Phase Current 5 A/1 A, W1 / W2 Sensitive Ground Current 5 A/1 A								3			
Housing and mounting											
Housing suitable for door mounting									A		
Housing suitable for 19" rack mounting									B		
Communication protocol ^(*)											
Without protocol									A		
Modbus RTU, IEC60870-5-103, DNP3.0 RTU <i>RS485 / terminals</i>									B		
Modbus TCP, DNP3.0 TCP/UDP, IEC60870-5-104 <i>Ethernet 100 MB / RJ45</i>									C		
Profibus-DP <i>optic fiber / ST connector</i>									D		
Profibus-DP <i>RS485 / D-SUB</i>									E		
Modbus RTU, IEC60870-5-103, DNP3.0 RTU <i>optic fiber / ST connector</i>									F		
Modbus RTU, IEC60870-5-103, DNP3.0 RTU <i>RS485 / D-SUB</i>									G		
IEC61850, Modbus TCP, DNP3.0 TCP/UDP, IEC60870-5-104 <i>Ethernet 100MB / RJ45</i>									H		
IEC60870-5-103, Modbus RTU, DNP3.0 RTU <i>RS485 / terminals</i>									I		
Modbus TCP, DNP3.0 TCP/UDP, IEC60870-5-104 <i>Ethernet 100 MB/RJ45</i>											
IEC61850, Modbus TCP, DNP3.0 TCP/UDP, IEC60870-5-104 <i>Optical Ethernet 100MB / LC duplex connector</i>									K		

Transformer Differential Protection											
MRDT4						-2	#	#	#	#	#
Modbus TCP, DNP3.0 TCP/UDP, IEC60870-5-104 <i>Optical Ethernet 100MB / LC duplex connector</i>										L	
IEC60870-5-103, Modbus RTU, DNP3.0 RTU <i>RS485 / terminals</i>										T	
IEC61850, Modbus TCP, DNP3.0 TCP/UDP, IEC60870-5-104 <i>Ethernet 100 MB / RJ45</i>											
Harsh Environment Option											
None											A
Conformal Coating											B
Available menu languages											
English (USA) / German / Spanish / Russian / Polish / Portuguese (BR) / French / Romanian											
Miscellaneous Functions											
Control functions for up to 2 switchgears and logic up to 80 equations.											
IRIG-B interface for time synchronization.											

NOTICE!	
	(*) Within every communication option only one communication protocol is usable.

The **“MRDT4 Wiring Diagrams”** (separate document) show the set of fitted hardware modules for every available typecode.

The **“Communication Protocol Codes”** are an overview (in tabular form) of all communication options, including cross-references to all descriptive chapters in this User Manual.

The parameterizing- and disturbance analyzing software **Smart view** is included in the delivery of HighPROTEC devices.

Smart view can connect to the MRDT4 either via the USB interface at the front or via the Ethernet interface (RJ45, if fitted).

1.2.1.1 Overview of Assembly Groups

The fitted assembly groups are as follows for the main variants:

Typecode	slot X1	slot X2	slot X3	slot X4	slot X5	slot X6
MRDT4-2 A ...	DI-8 X1	OR6	TI / TIs	TI / TIs	—	—
MRDT4-2 D ...	DI-8 X1	OR6			OR6	DI8

slot X3:

- MRDT4-2x**0**..., MRDT4-2x**2**....: TI
- MRDT4-2x**1**, MRDT4-2x**3**.....: TIs

slot X4:

- MRDT4-2x**0**..., MRDT4-2x**1**....: TI
- MRDT4-2x**2**, MRDT4-2x**3**.....: TIs

1.2.1.2 Communication Protocol Codes

The following table lists the “Communication Options” letters from the Order Code (see [↪ “1.2.1 Order Form of the Device”](#)), together with the respective communication interfaces and protocols that are available with this order option.

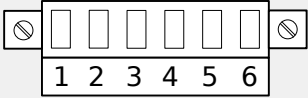
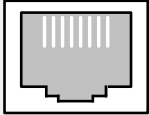
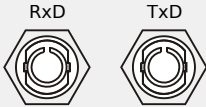
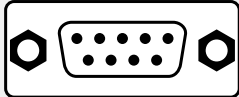
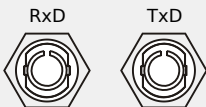
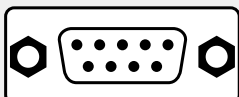
#	Interface	Available Communication Protocols
A	—	Without protocol
B	<p>RS485 / terminals</p> <p>↪ “2.11.1 Modbus® RTU / IEC 60870-5-103 via RS485”</p> 	<p>Modbus RTU, IEC 60870-5-103, DNP3.0 RTU</p> <p>↪ “3.7.2 Modbus®”</p> <p>↪ “3.6 IEC60870-5-103”</p> <p>↪ “3.5 DNP3”</p>
C	<p>Ethernet 100 MB / RJ45</p> <p>↪ “2.9.1 Ethernet – RJ45”</p> 	<p>Modbus TCP, DNP3.0 TCP/UDP, IEC 60870-5-104</p> <p>↪ “3.7.2 Modbus®”</p> <p>↪ “3.5 DNP3”</p> <p>↪ “3.7.1 IEC 60870-5-104”</p>
D	<p>optic fiber / ST connector</p> <p>↪ “2.11.2 Profibus DP/ Modbus® RTU / IEC 60870-5-103 via Fiber Optic”</p> 	<p>Profibus-DP</p> <p>↪ “3.3 Profibus”</p>
E	<p>RS485 / D-SUB</p> <p>↪ “2.11.3 Profibus DP via D-SUB”</p> 	<p>Profibus-DP</p> <p>↪ “3.3 Profibus”</p>
F	<p>optic fiber / ST connector</p> <p>↪ “2.11.2 Profibus DP/ Modbus® RTU / IEC 60870-5-103 via Fiber Optic”</p> 	<p>Modbus RTU, IEC 60870-5-103, DNP3.0 RTU</p> <p>↪ “3.7.2 Modbus®”</p> <p>↪ “3.6 IEC60870-5-103”</p> <p>↪ “3.5 DNP3”</p>
G	<p>RS485 / D-SUB</p> <p>↪ “2.11.4 Modbus® RTU / IEC 60870-5-103 via D-SUB”</p> 	<p>Modbus RTU, IEC 60870-5-103, DNP3.0 RTU</p> <p>↪ “3.7.2 Modbus®”</p> <p>↪ “3.6 IEC60870-5-103”</p> <p>↪ “3.5 DNP3”</p>

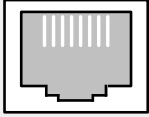
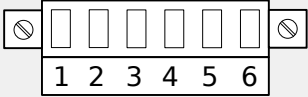
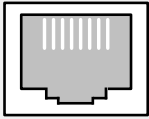
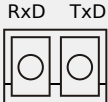
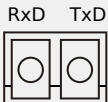
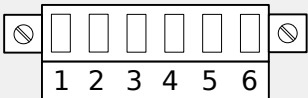
#	Interface	Available Communication Protocols
H	<p>Ethernet 100MB / RJ45</p> <p>↳ “2.9.1 Ethernet – RJ45”</p> 	<p>IEC 61850, Modbus TCP, DNP3.0 TCP/UDP, IEC 60870-5-104</p> <p>↳ “3.4 IEC 61850”</p> <p>↳ “3.7.2 Modbus®”</p> <p>↳ “3.5 DNP3”</p> <p>↳ “3.7.1 IEC 60870-5-104”</p>
I	<p>RS485 / terminals</p> <p>↳ “2.11.1 Modbus® RTU / IEC 60870-5-103 via RS485”</p>  <p>Ethernet 100 MB / RJ45</p> <p>↳ “2.9.1 Ethernet – RJ45”</p> 	<p>IEC 60870-5-103, Modbus RTU, DNP3.0 RTU Modbus TCP, DNP3.0 TCP/UDP, IEC 60870-5-104</p> <p>↳ “3.6 IEC60870-5-103”</p> <p>↳ “3.7.2 Modbus®”</p> <p>↳ “3.5 DNP3”</p> <p>↳ “3.7.1 IEC 60870-5-104”</p>
K	<p>Optical Ethernet 100MB / LC duplex connector</p> <p>↳ “2.11.5 Ethernet / TCP/IP via Fiber Optics”</p> 	<p>IEC 61850, Modbus TCP, DNP3.0 TCP/UDP, IEC 60870-5-104</p> <p>↳ “3.4 IEC 61850”</p> <p>↳ “3.7.2 Modbus®”</p> <p>↳ “3.5 DNP3”</p> <p>↳ “3.7.1 IEC 60870-5-104”</p>
L	<p>Optical Ethernet 100MB / LC duplex connector</p> <p>↳ “2.11.5 Ethernet / TCP/IP via Fiber Optics”</p> 	<p>Modbus TCP, DNP3.0 TCP/UDP, IEC 60870-5-104</p> <p>↳ “3.7.2 Modbus®”</p> <p>↳ “3.5 DNP3”</p> <p>↳ “3.7.1 IEC 60870-5-104”</p>
T	<p>RS485 / terminals</p> <p>↳ “2.11.1 Modbus® RTU / IEC 60870-5-103 via RS485”</p> 	<p>IEC 60870-5-103, Modbus RTU, DNP3.0 RTU IEC 61850, Modbus TCP, DNP3.0 TCP/UDP, IEC 60870-5-104</p> <p>↳ “3.6 IEC60870-5-103”</p> <p>↳ “3.7.2 Modbus®”</p>

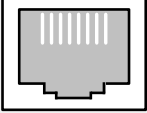
#	Interface	Available Communication Protocols
	<p data-bbox="197 248 512 282"><i>Ethernet 100 MB / RJ45</i></p> <p data-bbox="197 309 571 342">↳ “2.9.1 Ethernet - RJ45”</p> 	<p data-bbox="815 248 1027 282">↳ “3.5 DNP3”</p> <p data-bbox="815 309 1203 342">↳ “3.7.1 IEC 60870-5-104”</p> <p data-bbox="815 369 1090 403">↳ “3.4 IEC 61850”</p>

1.2.2 Navigation - Operation

The following illustration applies to protective devices with "B2" housing and a small display, in particular the MRDT4:

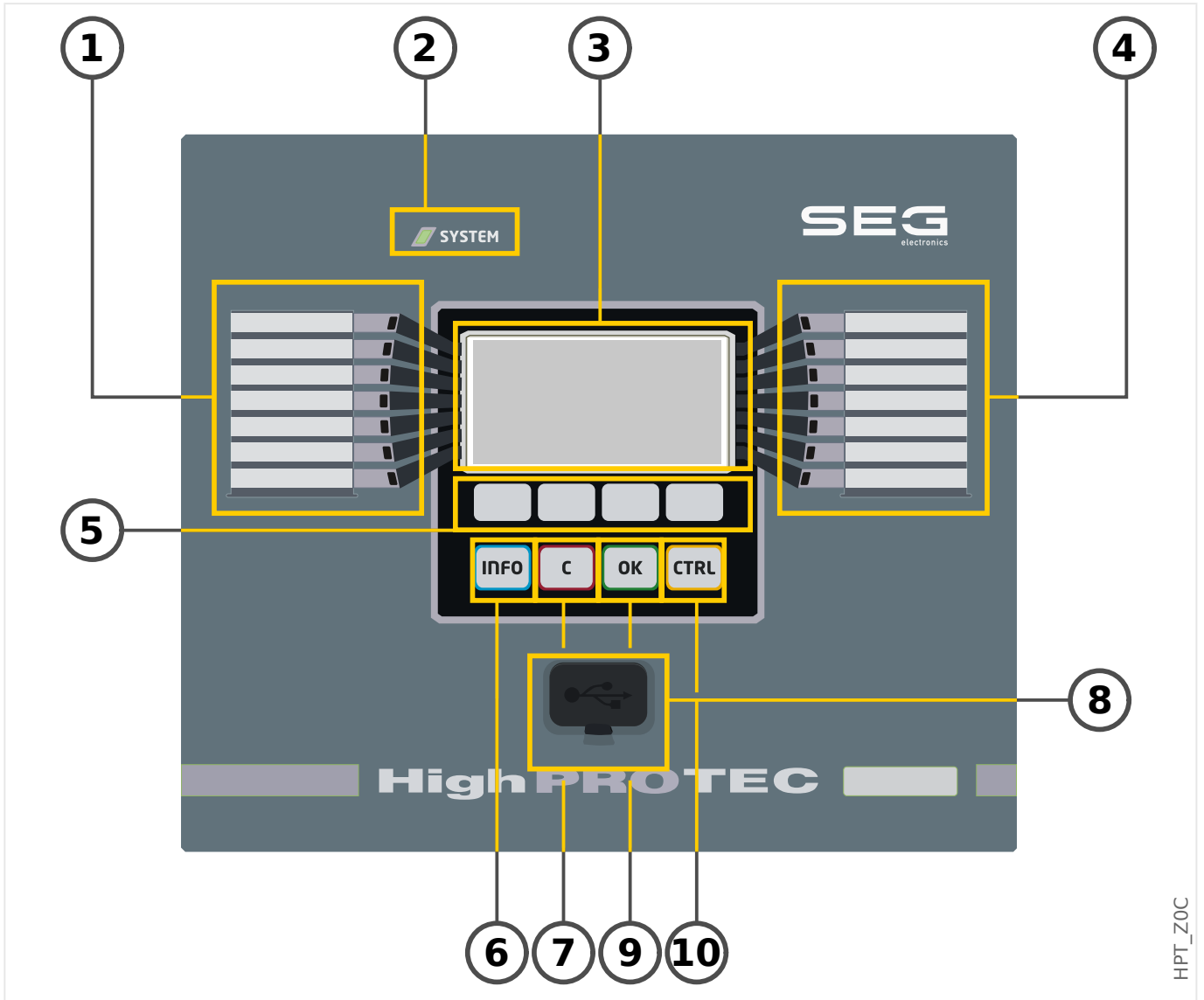

HPT_Z0C

1.2.2.1 Front Panel Parts

(1) Programmable LEDs

Messages inform you about operational conditions, system data or other device particulars. They additionally provide you with information regarding failures and functioning of the device as well as other states of the device and the equipment.

Various signals can be freely allocated to LEDs out of the »assignment list«. (The available signals can be found in the Reference Manual.)

(2) LED »System OK« (“Operational”)

The »System OK« (“Operational”) LED is constantly green when – after the boot phase, [↩➤](#) “Boot Phase” – the protection functions of the MRDT4 are working. In any other case consult the *Troubleshooting Guide*.

(3) Display

Via the display you can check operational data and edit parameters.

(4) Programmable LEDs group B (right)

Messages inform you about operational conditions, system data or other device particulars. They additionally provide you with information regarding failures and functioning of the device as well as other states of the device and the equipment.

Various signals can be freely allocated to LEDs out of the »assignment list«. (The available signals can be found in the Reference Manual.)

(5) Softkeys

The functions of the »SOFTKEYS« are contextual. On the bottom line of the display the present functions are displayed via symbols. See [↩➤](#) “1.2.2.2 Softkey Symbols”

(6) »INFO« Key (Signals/Messages)

The present LED assignment is displayed. The direct select key can be actuated at any time.

In order to leave the LED menu (or submenu) press the softkey “◀” (Left) one (or two) times.

Further information: [↩➤](#) “2.14.1 LEDs”

(7) »C« Key

To abort parameter changes and to acknowledge signals (including LED test). During cold restart: Reset password and / or parameters.

Further information how to abort changes during normal configuration work: [↩➤](#) “1.3.1 Parameter Settings”

Further information how to acknowledge signals: [↩➤](#) “1.5 Acknowledgments”

In particular, manual acknowledgment including LED test: [↩➤](#) “Manual Acknowledgment (by Pressing the C Key at the Panel)”

Reset dialog during a cold restart: [↩➤](#) “1.4.6 Reset to Factory Defaults, Reset All Passwords”

(8) USB Interface (Smart view Connection)

Connection to the PC software *Smart view* can be done via this USB interface.

(9) »OK« Key















When using the »OK« key parameter changes are temporarily stored. If the »OK« key is pressed again, those changes are stored definitely.

(10) »CTRL« Key

Direct Access to the Control Page, see  "Single-Line Diagram".

1.2.2.2 Softkey Symbols

The following symbols are used to label the function of a Softkey:

Softkey	Meaning
	Via Softkey »up« you can scroll upwards. You go to the prior menu point/one parameter up by scrolling upwards.
	Via Softkey »down« you can scroll downwards. You go to the next menu point/one parameter down by scrolling downwards.
	Via Softkey »left« you will go one step back. You can leave the submenu. You go back to the previous page of menu tree.
	Via Softkey »right« you can enter the selected submenu.
	Via Softkey »Top of list« you jump directly to the top of a list.
	Via Softkey »Bottom of list« you jump directly to the end of a list.
	Via Softkey »+« the currently selected digit is incremented. (Continuous pressure: fast repeat).
	Via Softkey »-« the currently selected digit is decremented. (Continuous pressure: fast repeat).
	Via Softkey »left« you select the digit left to the previously selected one.
	Via Softkey »right« you select the digit right to the previously selected one.
	Via the »Wrench« symbol you can change the selected parameter (i. e. enter the parameter setting mode).
	Via the »Key« symbol you are asked for password authorization, then you can change the selected parameter.
	Via Softkey »delete« the selected data is deleted.
	Fast forward scrolling is possible via Softkey »Fast forward«.
	Fast backward scrolling is possible via Softkey »Fast backward«.

1.3 Modules, Settings, Signals and Values

The MRDT4 is a digital protection device that holds various data in its internal memory. Some data is meant to be changed by the user to adapt the functionality to the respective application, other data types are set by the device during run-time and are therefore read-only from the user's perspective.

All settings, device planning and checking the state of signals at run-time can be done:

- Directly at the device; or
- By way of the *Smart view* software application.

Modules

The firmware of the MRDT4 can be thought of being sub-divided in several independent function blocks. Throughout our Technical Documentation, we are talking of “modules” (or sometimes of “functions”). Every protection function, for example, is a module of its own. For HighPROTEC devices, this is a fundamental concept: For example, the functionality of calculating statistical data is a module (named »Statistics«), every communication protocol is a module, the general functionality of controlling switchgear devices is a module (named »Ctrl«), there is even a general protection module (named »Prot«) that interacts with all specific protection modules.



It is important to know that every parameter and every signal and value is always part of exactly one module (even if the module name might not be displayed on the panel for the sake of simplicity).

Modules can interact with each other, either because this is a fixed implemented part of the firmware, or if the user has assigned some signal of a module to a parameter (that becomes a module input this way). An example for a fixed implemented interaction is that the trip signal of any protection module always triggers the trip signal of the general »Prot« module and, vice versa, if the »Prot« trip is blocked, then the trip of all protection functions is blocked.

Some modules exist in several (identical) instances, which can be activated and configured independently. These can be used to have several protection stages. However, there is one fundamental difference to the MRDT4: The functionality of all instances (of a particular module) is always identical (except for the differences that are due to different setting values).

There is the following naming convention: If several instances of a module »Module« exist, then these are named »Module[1]«, »Module[2]«, ... (or, as a short form for descriptions: »Module[x]«).

Types of Settings, Signals and Values

Settings (also called parameters)

- Parameters are data that can be modified by the user, to adapt the functionality of the respective application.

Smart view users can save all settings to a file. This is a file with a filename of the form *.ErPara. It can be (re-)loaded at any later time, and the setting values contained therein can be transferred to some (other) MRDT4 protection device. (For details see the *Smart view* manual.)

(Remark: There are a few exceptions, where a particular setting is always stored within the device and never saved to a *.ErPara file. This is the case if it is not

desirable to directly transfer the setting value from one device to another; the TCP/IP settings are an example for this.)

There are several types of parameters, depending on the type of data they can hold. For the user, it is not necessary to know details, but it can be good to know that there are numerical parameters (e. g. overcurrent thresholds) and parameters which hold one option out of a selection list. These select options can either be fixed values (e. g. the choice of communication protocol), or they can be a signal (so that during run-time, the actual parameter value equals the state of the assigned signal). This case of a signal assignment is what has been mentioned above as a “module input”.

- Some parameter properties depend on the value of particular other parameters. For example, the “device planning” parameters (in the [Device planning] menu) do not only activate or deactivate protection functions but also control the visibility of their related parameters.

Some parameters depend on others not only with respect to visibility, but also default values and/or available value ranges. (For example, the range of some protection parameters depend on the CT ratio.)

- There are parameters that exist only once, named “Global Parameters”.

These are usually within the [Global Prot Para] menu.

- Setting Group Parameters can be found in menu branches [Set 1] ... [Set 4]: These are protection parameters that have a “four-fold” existence: The user can set four values, and each of these is member of a particular “parameter set” (Set 1 to Set 4). At any time only one of these four parameter sets is active, which has the effect that the respective set value is active. (This is always independent of the protection function: It always affects all protection functions at the same time if one switches to another parameter set.)
- By means of Adaptive Parameter Sets you can modify single parameters dynamically during run-time: Setting values are defined to be dependent on the “True/False” value of a particular Boolean signal. It is possible to define up to four Boolean signals for value switching, which means that – together with the base value – such an Adaptive Parameter can have up to five alternative values (per parameter set, which makes a total sum of up to 20 values). Which one gets actively used at a particular moment of time, will then depend on the run-time value of the (up to four) related Boolean parameters.

In contrast to Setting Group Parameters, Adaptive Parameter Sets are “local”, i. e. they are effective only within the protection function where they had been activated.

Note, however, that not all protection functions support Adaptive Parameter Sets.

Since some users are maybe not quite familiar with the concept of Adaptive Parameter Sets there is a dedicated chapter with a more detailed description. See [↳ “1.3.2 Adaptive Parameter Sets”](#).

Direct Commands

- **Direct Commands** are part of the “menu tree”, just like a setting parameter, but they are meant to be executed immediately. Therefore Direct Commands are **NOT** part of a *.HtpPara parameter file.

Typical examples are the Direct Commands for resetting Counters.

On the panel (and on a listing window of Smart view), Direct Commands are marked by a special “push button switch” symbol “⊖”, so that the user can immediately recognize them.

Signals

- *Signals* are run-time states, i. e. depend on the result of a protection function or on the state of a Digital Input.

Signals are part of the “menu tree”. They can all be found in the menu path [Operation / Status Display].

- Some *Signals* represent the state of the installation/equipment (e. g.: position indicators of the breaker).
- Some *Signals* are assessments of the state of the grid and the equipment (e. g.: System OK, Transformer failure detected).
- Some *Signals* represent decisions that are taken by the device (e. g.: Trip Command) based on the parameter settings.
- Many signals can be *assigned* to particular parameters. This means the function of this parameter depends on the run-time state of the signal. For example, every protection function features several blocking parameters. (See also [↪ “4.1.2 Blockings”](#).) If a signal has been assigned to a blocking parameter then the respective protection function gets blocked as soon as the run-time state of the assigned signal becomes “True”.
- In the same way can signals also be assigned to the LEDs of the MRDT4, so that an LED is lit as soon as the assigned signal becomes “True”. (See also [↪ “2.14.1 LEDs”](#).)

Input States (for a module input)

- Input States are special signals and are part of the “menu tree”. For every parameter to which a signal can be assigned, there is a related Input State. At run-time, the Input State reflects the current state of the assigned signal. This way the dependencies in the behavior of a protection function can be traced.

There is the following naming convention: If a parameter to which a signal can be assigned is named »Name«, then the related Input State has the name »Name-I«.

Counters, Values

- *Values* are more or less volatile data that are constantly kept up to date during run-time.
- The most common (and most important) type of *Values* is the set of *Measured Values* (e. g. the current and/or voltage values measured at the CT/VT, frequency values); we are going to use the term *Measured Values* also for values that are derived from measured values by calculation, e. g. the power value calculated from current and voltage). Of course, the set of available *Measured Values* depends on the capabilities of the particular protection device.

See [↪ “1.6 Measuring Values”](#) for information on measured values.

- A *Statistical Value* is a special type of “calculated measured values”, and can be a maximum, minimum or average value; this helps to analyse the development of a measured value in time. For most *Statistical Values*, there is a related Direct Command, which can be used to reset the statistics.

See [↪ “1.7 Statistics”](#) for information on statistics.

- Another important type is the *Counters*. Whereas *Measured Values* are usually floating-point numbers (mostly with a related unit of measurement), do *Counters*

hold a digital, integer number. For most *Counters*, there is a related Direct Command, which can be used to reset the Counter value to 0.

1.3.1 Parameter Settings

Parameter Setting at the HMI

Every parameter belongs to an access area. Editing and changing of a parameter requires a sufficient access authorization. See [↔ “1.4.4 Access Level Passwords”](#) for a detailed description of access areas.

The user can obtain the required access authorizations by unlocking access areas in advance of parameter changes or context-dependent. In the following sections both options will be explained.

Option 1: Direct Authorization for an Access Area

Call up menu [Device Para / Security / Access Level].

Select the required access level respectively navigate to the required access authorization (level). Enter the required password. If the correct password has been entered, the required access authorization will be obtained. In order to do the parameter changes please proceed as follows:

- Move to the parameter you want to change by using the Softkeys. If the parameter is selected, the lower right corner of the display should show a »Wrench« symbol.



This symbol indicates, that the parameter is unlocked and can be edited, because the required access authorization is available. Confirm the Softkey »Wrench«, in order to edit the parameter. Change the parameter.

Now you can:

- save the change you made and have them adopted by the system or:
- change additional parameters and save finally all the altered parameters and have them adopted by the system.

To save parameter changes immediately,

- press the »OK« key for saving changed parameters directly and to have them adopted by the device. Confirm the parameter changes by pressing the »Yes« Softkey or dismiss by pressing »No«.

To change additional parameters and save afterwards,

- move to other parameters and change them

NOTICE!



A star symbol in front of the changed parameters indicates that the modifications have only been saved temporarily, they are not yet finally stored and adopted by the device.

In order to make things easier to follow, especially where complex parameter changes are involved, on every superior/higher-ranking menu level the intended change of the parameter is indicated by the star symbol ("star trace"). This makes it possible to control or follow up from the main menu level at any time where parameter changes have been made and have not been saved finally.

In addition to the star trace to the temporary saved parameter changes, a general parameter changing symbol is faded-in at the left corner of the display, and so it is possible from each point of the menu tree to see that there are temporary (not yet active) parameter changes.

Note that when using *Smart view* for changing parameters, the red star symbol in the menu tree indicates that parameters changes have not yet been saved in a parameter file.

Press the »OK« key to initiate the final storage of all parameter changes. Confirm the parameter changes by pressing the »Yes« softkey or dismiss by pressing Softkey »No«.

NOTICE!



If the display shows a Key Symbol  instead of a Wrench-Symbol, this will indicate, that the required access authorization is not available.

In order to edit this parameter, a password is required, that provides the required authorization.

NOTICE!



Plausibility check: In order to prevent obvious wrong settings the device monitors constantly all temporary saved parameter changes. If the device detects an implausibility, this is indicated by a question mark in front of the respective parameter.

In order to make things easier to follow up, especially where complex parameter changes are involved, on every superior/higher-ranking menu level, above the temporarily saved parameters an invalidity is indicated by the question mark (plausibility trace). This makes it possible to control or follow from the main menu level at any time where implausibilities are intended to be saved.

In addition to the question mark trace to the temporary saved implausible parameter changes a general implausibility symbol/question mark is faded-in at the left corner of the display, and so it is possible to see from each point of the menu tree that implausibilities have been detected by the device.

A star/parameter change indication is always overwritten by the question mark/implausibility symbol.

If a device detects an implausibility, it rejects saving and adopting of the parameters.

Option 2: Context-dependent Access Authorization

Navigate to the parameter, that is to be changed. If the parameter is selected, the lower right corner of the display shows a »Key«-Symbol.



This symbol indicates, that the device is still within the »Read Only-Lv0« level ([↳ "1.4.4 Access Level Passwords"](#)), or that the current level does not provide sufficient access rights to allow editing of this parameter.

Press this Softkey and enter the password that provides access to this parameter. (This page provides also information, which password/access authorization is required to do changes on this parameter.)

Please change the parameter settings.

Now you can:

- save the change you made and have them adopted by the system or:
- change additional parameters and save finally all the altered parameters and have them adopted by the system.

To save parameter changes immediately,

- press the »OK« key for saving changed parameters directly and to have them adopted by the device. Confirm the parameter changes by pressing the »Yes« Softkey or dismiss by pressing »No«.

To change additional parameters and save afterwards,

- move to other parameters and change them

NOTICE!

A star symbol in front of the changed parameters indicates that the modifications have only been saved temporarily, they are not yet finally stored and adopted by the device.

In order to make things easier to follow, especially where complex parameter changes are involved, on every superior/higher-ranking menu level the intended change of the parameter is indicated by the star symbol (star trace). This makes it possible to control or follow up from the main menu level at any time where parameter changes have been made and have not been saved finally.

In addition to the star trace to the temporary saved parameter changes, a general parameter changing symbol is faded-in at the left corner of the display, and so it is possible from each point of the menu tree to see that there are temporary (not yet active) parameter changes.

Note that when using *Smart view* for changing parameters, the red star symbol in the menu tree indicates that parameters changes have not yet been saved in a parameter file.

Press the »OK« key to initiate the final storage of all parameter changes. Confirm the parameter changes by pressing the »Yes« Softkey or dismiss by pressing Softkey »No«.

NOTICE!



Plausibility check: In order to prevent obvious wrong settings the device monitors constantly all temporary saved parameter changes. If the device detects an implausibility, this is indicated by a question mark in front of the respective parameter.

In order to make things easier to follow up, especially where complex parameter changes are involved, on every superior/higher-ranking menu level, above the temporary saved parameters an invalidity is indicated by the question mark (plausibility trace). This makes it possible to control or follow from the main menu level at any time where implausibilities are intended to be saved.

In addition to the question mark trace to the temporary saved implausible parameter changes a general implausibility symbol/question mark is faded-in at the left corner of the display, and so it is possible to see from each point of the menu tree that implausibilities have been detected by the device.

A star/parameter change indication is always overwritten by the question mark/implausibility symbol.

If a device detects an implausibility, it rejects saving and adopting of the parameters.

Setting Groups

The setting parameter [Protection Para / PSet-Switch] »PSet-Switch« allows for the following activities:

- Explicitly activate one of the four setting groups (“PS1” ... “PS4”).
- Assign a signal to each setting group that sets this group to active (setting value “PSS via Inp fct”, and additionally assign the respective signals for the switch-over:

If, for example, a particular signal shall switch to setting group PS2, then this signal has to be assigned to the setting parameter [Protection Para / PSet-Switch] »PS2: *activated by*«.
- Enable SCADA to switch the setting groups (setting value “PSS via Scada”).

Option	Setting Group Switch
<i>Manual Selection</i>	Switch over, if another setting group is chosen manually via parameter »PSet-Switch«.
<i>Via Input Function (e.g. Digital Input)</i>	Switch over if exactly one of the four assigned signals becomes active. Note that the setting group is not changed if more than one activation signal is present at the same time. Example: Signal DI3 is assigned to parameter »PS3: <i>activated by</i> «. DI3 is active “1”. DI4 is assigned to »PS4: <i>activated by</i> «. DI4 is inactive “0”. If it is required to switch from parameter set 3 to parameter set 4 it must be made sure that DI3 becomes inactive first. Then DI4 has to become active.

Option	Setting Group Switch
	Even if DI4 becomes inactive afterwards, parameter set 4 remains active, until there is a new distinct request (e. g. DI3 becomes active and all the other assignments are inactive)
Via SCADA	Switch over if there is a distinct SCADA request.

NOTICE!



Setting group switch: Whenever another setting group gets activated, all memory-related values (e. g. timers) are reset for all protection functions.



Configuration change: Whenever changes are made to the settings of protection parameters (device planning, global parameters or setting group parameters for more than one setting group) all protection functionality is completely deactivated for a short time. This means that all protection modules are inactive for some time, so that they can be restarted with the new settings. This way it is made sure that all protection behavior is consistent with respect to the new settings.

An **exception** from this is a configuration change that is restricted to settings from only one setting group. In this case all protection function are only reset (exactly as for a setting group switch, see above).

Lock During a Switching Operation

As a measure for safety and consistency, it is generally not possible to change any settings while a switching operation is ongoing.

If the user attempts to make any parameter change while the moving timers of a Breaker are running, or while the Aux contacts indicate an ongoing switching operation (see [5.2 Switchgear Configuration](#)), the parameter change is refused, and the message "Please wait\nSystem locked" appears on the display (and a comparable message is shown by *Smart view*).

1.3.1.1 Setting Lock

By means of the Setting Lock, parameter settings can be locked against any changes as long as the assigned signal is true (active). The Setting Lock can be activated via [Field Para / General Settings] »*Setting Lock*«.

Bypass of the Setting Lock

The setting lock can be temporarily canceled in case that it is not possible (or desirable) to change the status of the signal that activates the setting lock.

The Setting Lock can be bypassed by means of the following Direct Control Parameter: [Field Para / General Settings] »*Setting Lock Bypass*«

The protective device will fall back into the Setting Lock as follows:

- Directly after a parameter change has been saved, or
- 10 minutes after the bypass has been activated.

1.3.2 Adaptive Parameter Sets

By means of Adaptive Parameter Sets you can modify dynamically setting values within a protection module.

NOTICE!



Adaptive Parameter Sets are available only for a few protection modules (essentially only the overcurrent protection modules).

From the practical point of view, there is one essential difference to the ordinary parameters sets (see [↳ “Types of Settings, Signals and Values”](#)): Switching to another parameter set affects **all** protection functions at once. This can increase your commissioning and testing efforts considerably if you “only” want to modify the behavior of one particular protection function.

Contrast to this, Adaptive Parameter Sets are “local”, i. e. they are effective only within the protection function where they had been activated. (See below how to do this.)

You can assign a digital signal to any of the parameters [Protection Para / Global Prot Para / I-Prot / “module”] »AdaptSet 1«, ..., »AdaptSet 4«. (“module” means the name of a protection module that features Adaptive Parameter Sets, for example: [I[1]]).

These four assignment parameters are always “Global Parameters” (i. e. within the menu branch [Protection Para / Global Prot Para]). For example, let us make the following assignment: »AdaptSet 1« = “V[1] . Alarm”, see the upper dialog window ① in the diagram below.

With this assignment, the *Smart view* dialog window for the “Setting Group Parameters”, for example the menu branch [Protection Para / Set 1 / I-Prot / I[1]], is getting enhanced by an additional column ②, as shown in the bottom dialog window in the diagram below.

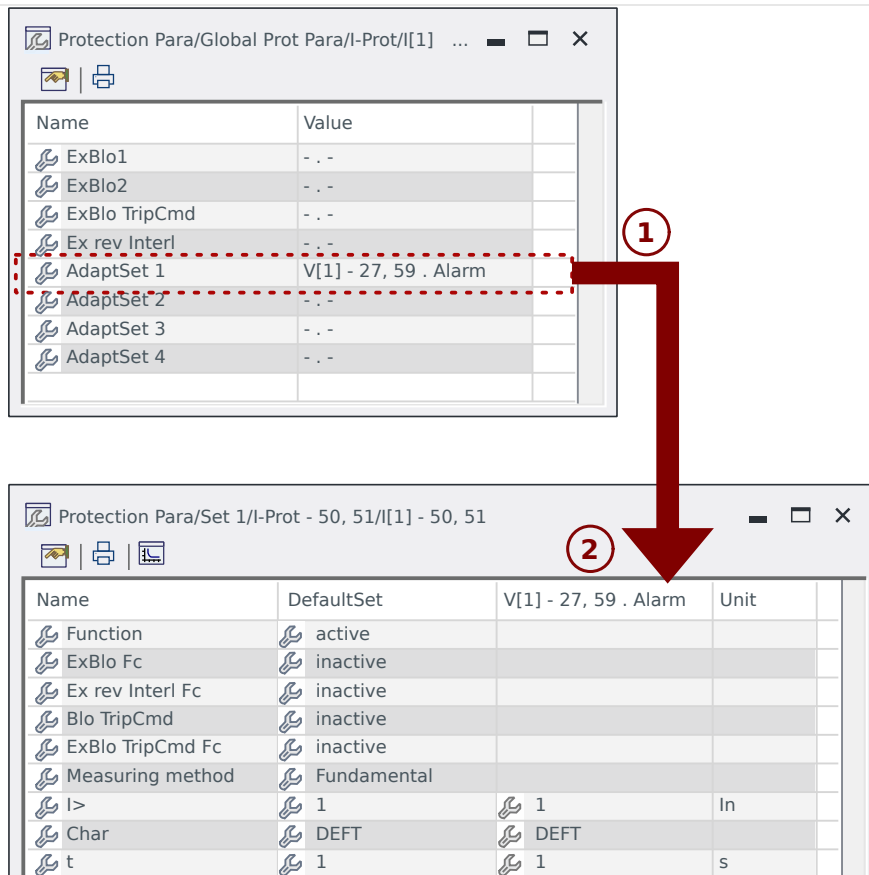

Fig. 2: An assignment to an Adaptive Set parameter adds alternative values to Setting Group parameters.

By this Adaptive Set assignment, most Setting Group Parameters receive an additional, alternative value. At first this new value is identical to the DefaultSet value, but it can be edited the same way. (Double-click it and modify it according to your needs.)

The idea is simple: The protection parameters use the alternative »AdaptSet 1« value as soon as the assigned signal “V[1] . Alarm” becomes true.

Since there are four normal setting groups, and each of these can have up to four Adaptive Sets plus the DefaultSet, this means that parameters supporting Adaptive Sets can have up to 20 different setting values.

NOTICE!



Adaptive Parameters fall back automatically as soon as the assigned signal, that has activated them, has fallen back.

In case several assigned signals are active at a particular moment in time the following holds:

Adaptive Set 1 is dominant to Adaptive Set 2. Adaptive Set 2 is dominant to Adaptive Set 3. Adaptive Set 3 is dominant to Adaptive Set 4.

Application Examples for Adaptive Parameter Sets

- CLPU: cold load pickup
 - Motor start, de-sensibilize current protection

1 MRDT4 – Transformer Differential Protection

1.3.2 Adaptive Parameter Sets

- SOTF: switch on to fault
 - Change the delay time of current protection to a short time

1.3.3 Status Display

In the status display within the »Operation« menu, the present state of all signals can be viewed. This means the User is able to see if the individual signals are active or inactive at that moment. The User can see all signals sorted by protective elements/modules.

State of the Module Input / Signal is...	The State is Shown at the Panel as...
“inactive” / False / »0«	<input type="checkbox"/>
“active” / True / »1«	<input checked="" type="checkbox"/>

1.3.4 Menu Structure

The menu structure offers the following top-level menu entries. You enter a menu branch with Softkey ►. Softkeys ▲ and ▼ let you navigate to the previous or next one.

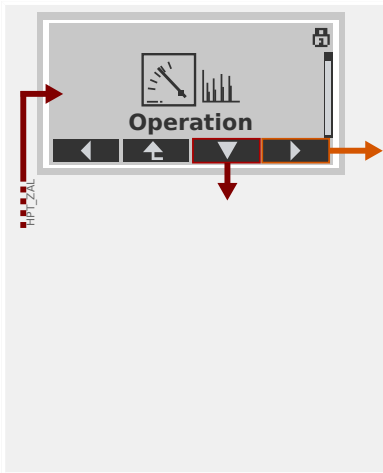
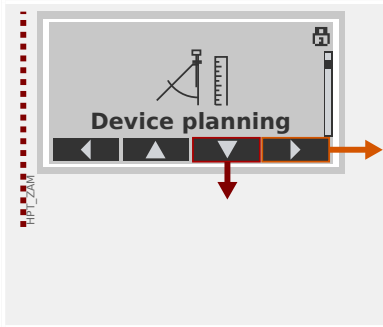
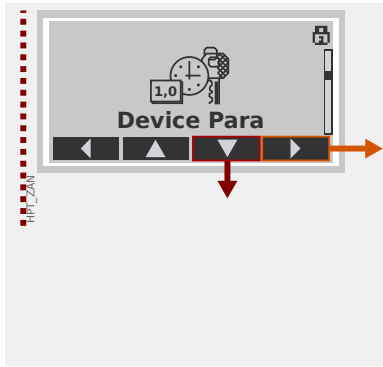
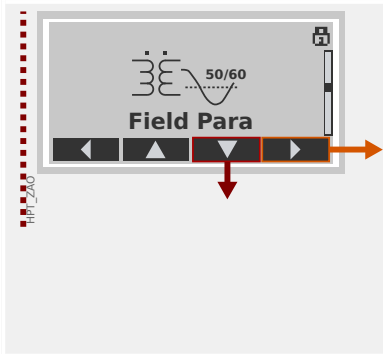
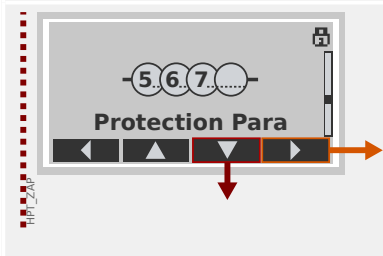
	<p>Operation</p> <p>Here you can find run-time data.</p> <ul style="list-style-type: none"> • Measured Values • Statistics • Status Display • Counter and RevData • Fault recorder, Event recorder, Disturbance recorder • Self-Supervision • Acknowledge, reset
	<p>Device planning</p> <p>This will usually be your first step during commissioning:</p> <p>Activate the elements that you need, deactivate elements that are not needed.</p> <p>Select the protocol for (SCADA) communication with the substation.</p>
	<p>Device Parameters</p> <p>This menu branch features all settings that are directly related to the device, for example:</p> <ul style="list-style-type: none"> • Digital inputs and outputs • LEDs • Settings for the Recorders • Communication settings
	<p>Field settings</p> <p>Usually the second commissioning step: Configure the properties of the field, for example:</p> <ul style="list-style-type: none"> • Nominal frequency, voltage, current • CT and VT ratios • VT connection type (Phase to Ground, Phase to Phase)
	<p>Protection Parameters</p> <p>All protection settings, which are related to a specific protection function, can be found here.</p> <p>For each protection function, the settings are grouped into the following setting types:</p>

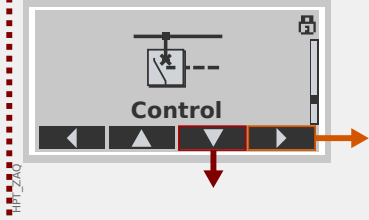
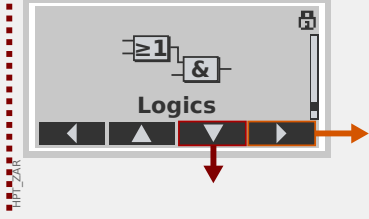
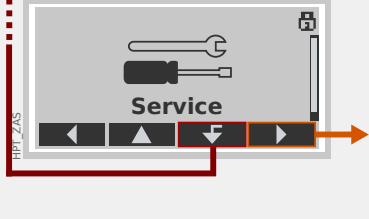
	<ul style="list-style-type: none"> • Global Protection Parameter • Set 1 ... Set 4 • PSet-Switch (Switching Parameter Set)
	<p>Control</p> <p>Settings for switchgear devices.</p> <ul style="list-style-type: none"> • The HighPROTEC devices named “MR...” can control 1 switchgear device. • The HighPROTEC devices named “MC...” can control up to 6 switchgear devices.
	<p>Programmable Logic</p> <ul style="list-style-type: none"> • Up to 80 logic equations • 4 selectable gates • 4 inputs, 4 outputs per equation • timer and memory functions
	<p>Service</p> <p>This menu branch is primarily needed for testing purposes. For example:</p> <ul style="list-style-type: none"> • Force / disarm outputs • Force / disarm analog input and outputs • Use the internal signal/fault generator • Reboot the protection device

1.3.5 Device Planning

“Device Planning” means to change the functional range to a degree that suits the protection task to be fulfilled (i. e.: the device deactivates all functions that are not needed, and shows only the active ones).

There is a top-level menu item [Device planning] that is dedicated to this; it collects a setting parameter for each function which can be set to “-” or to “use”. (In some cases there are additional setting options, for example with devices featuring direction determination).

If the user, for example, activates the voltage protection function, all menu branches related to this function appear in the menu tree. All corresponding events, signals, etc., are activated as well.

WARNING!



It **MUST** be taken into account that Device Planning changes the functionality of the device.

If, for example, the user cancels the directional feature of the overcurrent protections, the device will no longer trip in a directional way but merely in a non-directional way. If the user deactivates a protection function, the device will no longer trip according to the criteria related to this protection function.

The manufacturer does not accept liability for any personal or material damage as a result of incorrect planning.

Contact your SEG Customer Service representative for more information.

WARNING!



Beware of the inadvertent deactivating of protective functions/modules, because all the settings of a deactivated module get lost (i. e. are set back to their respective default values)!

This means: If the user is activating any of these modules again at some later time, all parameters of the re-activated modules need to be reconfigured.

1.3.6 Field Parameters

Within the field parameters you can set all parameters that are relevant for the primary side and the mains operational method like frequency, primary and secondary values.

All field parameters are accessible via the menu branch [Field Para].

See the *Reference Manual* for detailed tables of all settings that are available for the MRDT4.

1.3.7 Device Parameters

Date and Time

In the menu [Device Para / Time] »*Date and Time*« you can set date and time (including a sub-menu for timezone and Daylight-Saving settings).

Version

Within the menu [Device Para / Version] you can obtain information on the software and hardware version.

Display of ANSI-Codes

The display of ANSI codes on the device panel (HMI) can be activated via [Device Para / HMI] »*Display ANSI Device No.*«.

Smart view, however, has its own menu item for controlling the display of ANSI codes, which is independent of the device panel. (See the *Smart view* User Manual.)

1.3.8 Reset Counters, Values and Records

Manual Resets

In menu [Operation / Reset] you can:

- reset counters,
- delete records (e. g. disturbance records) and
- reset special things (like statistics, thermal replica...).

NOTICE!



Descriptions of the available reset commands can be found in a separate document, entitled “MRDT4 Reference Manual”.

1.4 Security

General

CAUTION!



All security settings have to be made by the user of the MRDT4! It is strictly recommended that you adapt the security settings according to the local regulations and requirements at the end of the commissioning procedure.

The MRDT4 is delivered with maximum “open” settings, i. e. all access restrictions are deactivated. This way the commissioning is not complicated unnecessarily. But afterwards, when the MRDT4 is running, it is probably required to restrict the access to some extent. There are in particular the following aspects to consider:

By default, the *Smart view* access to the MRDT4 via the USB interface is permitted (without any password protection), but the the TCP/IP access over the network is deactivated (see [↪ “1.4.3 Connection Passwords, Smart view Access”](#)). However, it is recommended for security reasons to re-adjust these settings after commissioning at the latest.

CAUTION!



For security reasons it is strongly recommended to modify the default passwords (see [↪ “Default Passwords”](#)) according to the security level that is required by your application (see [↪ “Changing Passwords”](#)), for example by defining different, level-specific passwords for the different access areas / levels. This way it is possible to make sure that different user groups get their individual access permissions.

Security-Related Settings Overview

The menu branch [Operation / Security] collects information about various security-related settings, in particular:

- For the connection passwords (see [↪ “Connection Passwords for Smart view Access”](#)) you can see whether these have been set to user-specific values, or are still at their factory default.
- You can see whether Smart view access is permitted (see [↪ “Access via Smart view”](#)).
- You can see which switching authority has been set (see [↪ “Switching Authority”](#)).
- You can see to which extent a reset to factory defaults has been enabled (see [↪ “1.4.6 Reset to Factory Defaults, Reset All Passwords”](#)).

(For a complete list of entries that are shown on this page, check the “Security” chapter in the “MRDT4 Reference Manual”.)

If IT security is a concern for your application, it is recommended to check all these entries during commissioning, but of course without trusting them blindly: If, for example, someone has set the USB connection password simply to “1” then this security page shows the entry »Passw. for USB conn.« = “def. by user”; but the security level of such a password is obviously quite questionable.

Security-Related Messages

There is a special self-supervision recorder, named [Self-Supervision Messages](#). It collects device-internal messages of various types, including security-related events (e. g. if a wrong password has been entered). It is recommended to check these entries from time to time.

A sub-set of these messages, restricted to only the security-related messages, can (also) be accessed at the menu branch [Operation / Security / Security Logger].

1.4.1 Network Security

SCADA Communication

It is to be noted that there are always certain security risks related to the use of SCADA protocols. Detailed information can be found in the technical literature.



Intranet Security

If the Ethernet interface of the MRDT4 is connected to a network it is the responsibility of the user to maintain all necessary means required for the security of the company network. In particular, it must be guaranteed that external access (i. e. out of the internet) to the MRDT4 has been made impossible. Please keep yourself informed about up-to-date technology (firewalls, VPN etc.)!

1.4.2 Passwords

Password Types

There are two different types of passwords:

- **Connection passwords** enable the user to establish a connection with the operating software Smart view. (See  “1.4.3 Connection Passwords, Smart view Access”.)
- **Access level passwords** are required for any changes to the device settings. (See  “1.4.4 Access Level Passwords”.)

Remark: **Connection passwords** have been introduced with HighPROTEC Release **3.6**. The main reason is that as of Release 3.6, all connections between MRDT4 and *Smart view* are fully encrypted, using state-of-the-art cryptographic algorithms. (See also  “Smart view Connections”.)

NOTICE!



The set passwords are stored in a permanent part of the MRDT4 memory so that they “survive” a firmware upgrade. (This is true of both password types.)

Default Passwords

The factory default is for **all** (communication and access level) passwords some standard value that does not provide any security against unauthorized access:

- The connection passwords have an empty text as default (i. e. these are not asked for).
- All access level passwords have the default value »**1234**«.

Time Penalty for Wrong Password Entry

Entering *wrong* passwords (regardless whether connection password or access level password, and regardless whether via HMI or *Smart view*) triggers a “time penalty” stage: The MRDT4 blocks any further password entry for an increasing amount of time, until a correct password has been entered. A dedicated message informs the user about this

blocking. This timer affects only the password entry (i. e. the Softkey  on the HMI), so that it does not prevent the user from doing some other, “password-free” activities during this blocking time.

Password Forgotten

By pressing the »C« key during a cold restart a reset dialog is launched (unless this has been explicitly disabled). It allows for resetting all passwords to the respective default (see  “Default Passwords”).

See  “1.4.6 Reset to Factory Defaults, Reset All Passwords” for details about this General Reset dialog.

1.4.3 Connection Passwords, Smart view Access

Smart view Connections

One of the fundamental requirements of »IT Security« is to make sure that no unauthorized person can eavesdrop on information that is exchanged between an operator and the MRDT4.

Therefore all connections between MRDT4 and *Smart view* are fully encrypted, using state-of-the-art cryptographic algorithms.

SEG provides each installation of *Smart view* (version 4.70 or later) and each individual HighPROTEC device (release 3.6 or later) with cryptographic certificates, which are automatically exchanged when the connection is being established. The certificates are checked by both communication partners (MRDT4 and *Smart view*) to make sure that no other, unauthorized party has hitch-hiked the connection.

The additional security that comes with these cryptographic techniques is available by default, there is nothing that the user has to set up or has to take care of.

Access via Smart view

Another fundamental requirement of »IT Security« is to prevent unauthorized persons from accessing the own systems, including the protective device MRDT4. The MRDT4 offers access via its front panel and via the operating software *Smart view*.

Since the access via front panel is only possible for someone who is located directly in front of the device the risk should normally be rather low, compared to the risk of unauthorized access via *Smart view*, especially if the MRDT4 is part of an Ethernet / TCP/IP network.

- For security reasons, there is the option to deactivate the *Smart view* access via the USB interface; this can be done with the setting parameter [Device Para / Security / Communication] »*Smart view via USB*«. The factory default, however, is that this access type is permitted.
- In the same way, there is also the option to deactivate the *Smart view* access via Ethernet; this can be done with the setting parameter [Device Para / Security / Communication] »*Smart view via Eth*«. The factory default, however, is that this access type is permitted.

NOTICE!



If *Smart view* is used to deactivate the *Smart view* access, then the current session gets automatically terminated.

Connection Passwords for Smart view Access

There are two connection passwords. At the beginning of a new session, *Smart view* prompts the user for a password, and the connection is established only after the password has been correctly entered. (This password prompt is omitted only if an empty value has been defined for the respective password.)

- **USB connection** — The “local connection password” has to be entered for establishing a *Smart view* access via the USB interface. (The default, however, is an empty value.)

- **Remote network connection** — The “remote network connection password” has to be entered for establishing a *Smart view* access via Ethernet. (The default, however, is an empty value, but note that this access type is deactivated by default, see [↩➤ “Access via Smart view”](#).)

The connection passwords can be changed using *Smart view* by accessing the menu branch [Device Para / Security / Password] and making a double-click on the password to be changed.

Note that the two connection passwords are different from the access level passwords (described at [↩➤ “Password Entry at the Panel”](#)) with respect to the following:

- The connection passwords can be entered and be changed only within *Smart view* (not via the HMI of the MRDT4).

(Nevertheless, passwords are permanently stored by the MRDT4, not by *Smart view*. This way every HighPROTEC relay can have some individual connection password, if that is required.)

- Unlike the access level passwords ([↩➤ “Changing Passwords”](#)), the connection passwords are **not** restricted to the digits 1, 2, 3, 4 and are **not** restricted to a maximum length of 8 digits. (The length can be 64 characters and more.) In fact, a connection password can be any sequence of printable Unicode characters, including blanks.

WARNING!



The factory default for all passwords (see [↩➤ “Default Passwords”](#)) does not provide any security.

For security reasons, it is strictly recommended to adapt the default passwords to some individual passwords that meet the local security directives.

Depending on the security policy at your site it is also possible to define a blank value for each password. This has the effect that there is no more password prompt, i. e. the access restriction is lifted. However, we have to declare that from our point of view, this is strongly discouraged – at least for the “network password”.

1.4.4 Access Level Passwords

Access level passwords are required for any changes to the device settings, independent of whether the change is done via *Smart view* or directly at the HMI (panel).

There is a security level – a so-called access level (or access area) – associated with each setting parameter. See [↪ “1.4.5 Access Levels”](#) for a description of the existing access levels.

Whenever you want to change a setting, you have to enter the password for the associated access level. (Afterwards, this access level remains unlocked for some time, so that further changes within this level can be made without re-entering the password.)

Password Entry at the Panel

If one operates the MRDT4 directly at the HMI, then it is possible to use the Softkeys for entering an *access level password*.

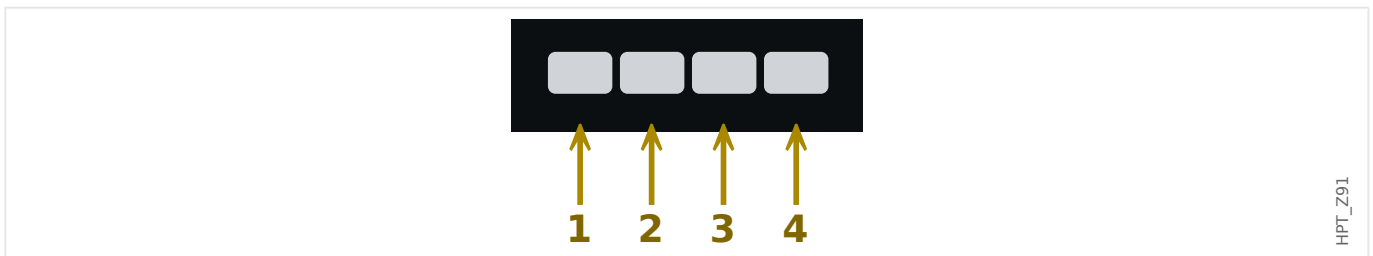

Example: For password (**3244**) press successively:

- Softkey 3
- Softkey 2
- Softkey 4
- Softkey 4

With an active *Smart view* connection, the passwords are requested by *Smart view*, so that they are entered via PC keyboard on request.

Changing Passwords

Access level passwords can be changed in menu [Device Para / Security / Password].

NOTICE!



An *access level password* must have a maximum length of 8 digits, and it must be a user-defined combination of the numerics 1, 2, 3 and 4. All other characters and keys won't be accepted.

Acknowledge without Entering a Password



For general information about acknowledgments see [↪ “1.5 Acknowledgments”](#). Information about access areas / levels can be found at [↪ “1.4.5 Access Levels”](#).

As of HighPROTEC Release 3.6, the LEDs can be acknowledged by pressing the »C« key for approx. 1 second. See [↩➤ “Manual Acknowledgment \(by Pressing the C Key at the Panel\)”](#) for details.

Deactivating Passwords during Commissioning

It is possible optionally to deactivate passwords temporarily during commissioning. It is not allowed to use this feature for other purposes than commissioning. In order to deactivate the password protection replace the existing password with an empty one for the corresponding access areas. All access authorizations (access areas) that are protected by an empty password are unlocked permanently. That means, that all parameters and settings within those areas can be modified anytime.

CAUTION!



You have to ensure that all passwords are activated again after the commissioning. That means, that all access areas have to be protected by sufficiently secure passwords.

SEG will not take over any liability for any personal injuries or damages that are caused by deactivated password protection.

General Considerations

You have to ensure that the access authorizations are protected by secure passwords. These passwords have to be kept as a secret and to be known only by the authorized persons. The default passwords do not provide any security against unauthorized access.

A lock symbol in the upper right corner of the display indicates if there are any access authorizations active at the moment. That means, within the mode “Read Only-Lv0” a closed (locked) lock symbol will be shown in the upper right corner of the display. As soon as there are any access authorizations active (above the “Read Only-Lv0” level), the upper right corner of the display will show an unlocked (open) lock symbol.

During setting parameters the »C« key can be used for canceling the parameter changes. Because of that it is not possible to acknowledge (LEDs, Output Relays...) as long as there are non-saved (cached only) parameters.

The acknowledgment menu cannot be accessed as long as the parameter modifications are not taken over by the device (indicated by a star symbol in the upper left corner).

Existing passwords are persistent (assigned to a device). If an offline created parameter file is transmitted into a device, or if a parameter file is transmitted from one device to another, this will have no impact on existing passwords within the device.

1.4.5 Access Levels

The access levels are designed in form of two hierarchic strands.

The supervisor (administrator) password provides access to all parameters and settings.

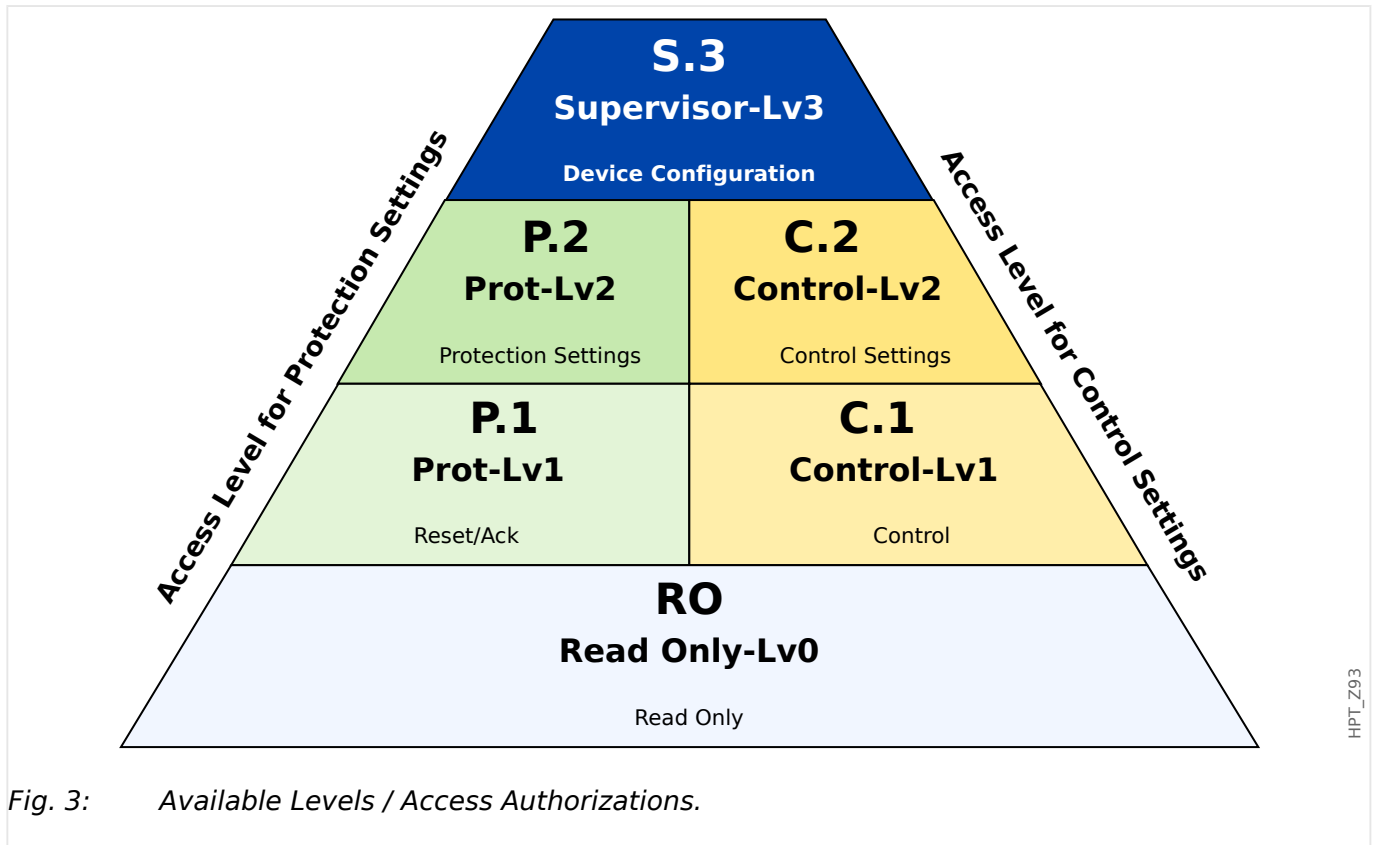







Fig. 3: Available Levels / Access Authorizations.

The following table shows the access areas. Note that each access area requires its own authorization password in order to access it. (However, for a MRDT4 that is reset to factory defaults all these passwords equal the same default password, see [↪ “Reset All Passwords”](#).)

Area Symbol	Access Area	Access to:
	Name of access level (panel / Smart view): Read Only-Lv0 Name of access level in Reference Manual: “RO”	Level 0 provides Read Only access to all settings and parameters of the device. The device will fall back into this level automatically after a configurable period or inactivity
	Password query on panel / Smart view: Prot-Lv1 Name of access level in Reference Manual:	This password provides access to the reset- and acknowledge options. In addition to that, it permits the execution of manual trigger signals.

Area Symbol	Access Area	Access to:
	“P.1”	
	Password query on panel / Smart view: Prot-Lv2 Name of access level in Reference Manual: “P.2”	This password provides access to the reset and acknowledge options. In addition to that it permits changing of protection settings and the configuration of the trip manager.
	Password query on panel / Smart view: Control-Lv1 Name of access level in Reference Manual: “C.1”	This password grants permission for switching operations (switching switchgears)
	Password query on panel / Smart view: Control-Lv2 Name of access level in Reference Manual: “C.2”	This password grants permission for switching operations (switching switchgears). In addition to that it gives access to the switchgear settings (switching authority, interlockings, general settings of switchgears, Breaker wear...).
	Password query on panel / Smart view: Supervisor-Lv3 Name of access level in Reference Manual: “S.3”	This password grants non-restricted access to all parameters and settings of the device (device configuration). This includes also the devices planning, device parameters (e.g. Date and Time), Field Parameters, Service Parameters and Logic Parameters.

NOTICE!	
	If the device was not active within the parameter setting mode for some time (can be set between 20 - 3600 seconds) it changes into »Read Only-Lv0« mode automatically. All unsaved parameter changes get canceled.

Check for unlocked access areas:

The menu [Device Para / Access Level] provides the information, which access areas (authorizations) are currently unlocked. Within this menu it is also possible to enter (unlock) a particular area.

However, the common way during every-day-use of the MRDT4 is not to use this [Access Level] menu, but to simply enter the menu path of a parameter to be changed, then start editing the parameter; at the end, immediately before the change is accepted, the user is asked for the appropriate password, which then unlocks the respective access area.

As soon as there is an unlocked access area (authorization) above »*Read Only-Lv0*«, this will be indicated by an unlocked lock symbol within the upper right corner of the device display.

If you want to explicitly set back (i. e. lock) the access area at the end (instead of waiting for the »*t-max Edit/Access*« timeout) you have to enter the »*Read Only-Lv0*« mode.

Unlock an access area at the panel:

Via the menu [Device Para / Access Level] it is possible to unlock or lock access areas (authorizations). After an access area has been unlocked all parameter changes or activities that are assigned to this (or a lower) level can be made without entering a password once again. However, the access permission is valid only for the panel; any access via *Smart view* has to be unlocked separately.

When no key is pressed for a time that can be specified via the [Device Para / HMI / Security] »*t-max Edit/Access*« setting, the access area is reset automatically to »*Read Only-Lv0*« and all unsaved parameter changes get canceled.

CAUTION!



Do not leave the MRDT4 unsupervised as long as there are still access areas (levels) unlocked (unlocked lock symbol on the display). If the access is no longer needed it is advisable to reset the permissions back to »*Read Only-Lv0*«.

Unlock an access area via *Smart view*:

After an access area (authorizations) has been unlocked by entering the password all parameter changes or activities that are assigned to this (or a lower) level can be made without entering a password once again. However, the access permission is valid only for this instance of *Smart view*; any access via panel or other *Smart view* instances has to be unlocked separately.

When no key is pressed for some (*Smart view*-internal) time the access area is automatically reset.

CAUTION!



Do not leave the MRDT4 unsupervised as long as *Smart view* still keeps some access area unlocked. Lock your PC during your absence, or at least reset the access permissions. This can be done by a double-click on the lock symbol in the status line on the bottom margin of the *Smart view* window (or, alternatively, via the menu [Device / Reset to Parameter "Read Only" Status] .

1.4.6 Reset to Factory Defaults, Reset All Passwords

There is a dedicated Reset dialog that allows for selecting any of the following options:

- **Reset to the factory defaults**, or
- **reset all passwords**.

This Reset dialog is available at the HMI only (i. e. **not** via *Smart view*).

Press the »C« key during a cold start until the Reset dialog appears.

NOTICE!



For technical reasons, this Reset dialog is available **only in English** language (independent of the regional language being used later, after the device has started).

Note furthermore that the dialog might not appear at all because it has been intentionally disabled (see below), or the option to reset all passwords has been disabled.

Reset to Factory Defaults

WARNING!



All parameter settings will be reset. All records will be deleted and statistic values and counters will be reset.

Exception: The operation hours counter is preserved.



1. ▷ From the Reset dialog, select »Reset to factory default«.
 - ▶ There is a confirmation dialog, asking »Reset device to factory defaults and reboot?«
2. ▷ Confirm with »Yes«.
 - ▶ The reset to factory defaults is executed, and the device restarts.

Reset All Passwords

It is possible to remove this option from the Reset dialog for security reasons (see below).



1. ▷ From the Reset dialog, select »Reset all passwords«.
 - ▶ There is a confirmation dialog, asking »Reset all passwords?«
2. ▷ Confirm with »Yes«.
 - ▶ The device starts using the standard passwords (see [↪](#) “Default Passwords”).

WARNING!



The standard passwords (see  "Default Passwords") do not provide any security.

For security reasons, it is strictly recommended to adapt the default passwords to some individual passwords that meet the local security directives.

Security Settings

For security reasons, the Reset dialog can be restricted or removed completely. The setting parameter [Device Para / Security / Miscellaneous] »*Config. Device Reset*« allows for specifying which resetting options shall be available:

- "*Fact.def.*", "*PW rst*": Both options -»Reset to factory default« and »Reset all passwords« - shall be available.
- *Only "Fact.defaults"*: Only the »Reset to factory default« option shall be available.
- *Reset deact.*: The Reset dialog shall be disabled.

CAUTION!



If the password should be lost and the »Reset all passwords« option has been made unavailable then the only chance to recover control is to reset the MRDT4 to factory default. If this option has been deactivated, too, then the MRDT4 has to be sent to SEG as a service request.

1.5 Acknowledgments

The term “acknowledgment” means to reset the latching of a state.

Latching can be configured for the the following types of objects or states:

- LEDs
- Binary output relays
- SCADA signals
- A pending trip command

It is possible to acknowledge an individual object or signal (via a predefined external signal). But it is also possible to acknowledge latched states collectively, e. g. all LEDs at once.

The following acknowledgment types are available:

- **Individual acknowledgment** means to assign an external signal to a parameter that is specific to one individual latching state (e. g. LED number 3 that is located left to the display).

If the assigned signal becomes active, the latching gets acknowledged. (See below, [↩➤ “Individual Acknowledgment of a Latched State”](#)).

- **External acknowledgment** means to assign an external signal to a parameter that is related to several states (e. g. all LEDs).

If the assigned signal becomes active, the related set of states gets acknowledged. (See below, [↩➤ “External Acknowledgment”](#)).

- **Automatic acknowledgment** means that all latched LEDs get acknowledged automatically with a new alarm from any protection function or with a *General Alarm*, »Prot . Alarm«. (This feature is restricted to the LEDs; there is no automatic acknowledgment for binary outputs, SCADA signals or trip commands.)

(See below, [↩➤ “Automatic Acknowledgment”](#)).

- **Collective acknowledgment** means to manually acknowledge the latching of several states all at once.

There are several different Direct Commands available, each of which is related to a specific set of states to be acknowledged (see below, [↩➤ “Collective Acknowledgment \(via Smart view or at the Panel\)”](#)).

- **Manual acknowledgment** is a special way to execute a collective acknowledgment by simply pressing the »C« key at the panel.

The latching of several states are all acknowledged at once this way. (See below, [↩➤ “Manual Acknowledgment \(by Pressing the C Key at the Panel\)”](#)).

NOTICE!

Note that any latched state can be acknowledged only if the signal that initiated the setting is no longer active. This is a general rule that applies to all acknowledgment types.

Another general rule is that with the setting [Device Para / Acknowledge] »Remote Reset« = "inactive", only manual acknowledgments ([↳ "Manual Acknowledgment \(by Pressing the C Key at the Panel\)"](#)) directly at the panel are functional. All other acknowledgement types, including collective acknowledgments using Smart view ([↳ "Collective Acknowledgment \(via Smart view or at the Panel\)"](#)), are silently ignored.

And in any case, the latching of binary outputs is always reset only after the timer »t-Off Delay« has elapsed.

Individual Acknowledgment of a Latched State

[Device Para / LEDs / LEDs group A / LED 1...7] »Ack signal«

[Device Para / LEDs / LEDs group B / LED 1...7] »Ack signal«

✓ Assigned signal acknowledges an individual LED.

[Device Para / Binary Outputs / BO Slot X x / BO y] »Acknowledgement«

✓ Assigned signal acknowledges the binary output "y" at slot "x".

[Control / SG / SG [x] / Trip Manager] »Ack TripCmd«

✓ Assigned signal acknowledges the trip command of switchgear "SG [x]".

Remark: The menu branch does not show the abstract module name »SG [x]«. What you see instead is the switchgear designation that has been assigned via the Control Page (Single-Line diagram), i. e. something like »QA1«. (See [↳ "Single-Line Diagram"](#).)

External Acknowledgment

The external acknowledgment is disabled if the parameter [Device Para / Acknowledge] »Remote Reset« is set to "inactive". This also blocks the acknowledgment via SCADA communication (e. g. Modbus).

[Device Para / Acknowledge] »Ack LED«

✓ Assigned signal acknowledges all LEDs.

[Device Para / Acknowledge] »Ack BO«			
	✓ Assigned signal acknowledges all binary output relays.		

[Device Para / Acknowledge] »Ack Scada«			
		✓ Assigned signal acknowledges latched SCADA signals.	

Automatic Acknowledgment

With an automatic acknowledgment all those LEDs for which this is activated get acknowledged with a protection alarm or with a *General Alarm*, »Prot . Alarm«.

This means that the automatic acknowledgment must be set individually for every LED that shall be acknowledged automatically this way.

[Device Para / LEDs / LEDs group A / LED 1...7] »Latched« = “active, ack. by alarm”			
[Device Para / LEDs / LEDs group B / LED 1...7] »Latched« = “active, ack. by alarm”			
✓ A protection alarm acknowledges every LED with this setting value.			

Collective Acknowledgment (via Smart view or at the Panel)

Remark: As already stated above, the acknowledgment via *Smart view* requires the setting [Device Para / Acknowledge] »Remote Reset« = “active”.

The following Direct Commands are available for acknowledgment:

[Operation / Acknowledge] »SSV . Ack System LED «			
✓ Acknowledge a warning state signaled by the System-LED.			

Remark: The *Troubleshooting Guide* lists all System-LED signals that can potentially occur.

[Operation / Acknowledge] »Sys . Ack LED«			
✓ All LEDs			

[Operation / Acknowledge] »Sys . Ack BO«			
	✓ All binary output relays		

[Operation / Acknowledge] »Sys . Ack Scada«			
		✓ All SCADA signals	

[Operation / Acknowledge] »SG [x] . Ack TripCmd«			
			✓ Acknowledge the trip command of switchgear “SG [x]”.

Remark: The menu branch does not show the abstract module name »SG [x]«. What you see instead is the switchgear designation that has been assigned via the Control Page (Single-Line diagram), i. e. something like »QA1«. (See [↪ “Single-Line Diagram”](#).)

[Operation / Acknowledge] »Sys . Ack BO LED Scd Trips«			
✓ Acknowledge all LEDs,	✓ and all binary output relays,	✓ and all SCADA signals,	✓ and all Trip Commands.

At the panel, the menu [Operation / Acknowledge] can directly be accessed via the »C« key, see below ([↪ “Manual Acknowledgment \(by Pressing the C Key at the Panel\)”](#)).

Manual Acknowledgment (by Pressing the »C« Key at the Panel)

NOTICE!



As long as you are within the parameter setting mode, you cannot acknowledge manually via »C« key (because within the parameter setting mode, this key has a different functionality).

But it is still possible to access the menu [Operation / Acknowledge].

It is possible to acknowledge the System-LED, the assignable LEDs, SCADA, binary output relays and / or a pending trip command by pressing the »C« key at the panel.

There are two acknowledgment methods available with pressing the »C« key:

- **Short keypress:** *With intermediate selection step:* By pressing the »C« key (for a short time) you enter the menu [Operation / Acknowledge]. There you select the items to be acknowledged via the Softkeys (LEDs, SCADA, binary output relays, trip command, or all of these, see [↪ “Collective Acknowledgment \(via Smart view or at the Panel\)”](#)). After this, you press the Softkey with the »Wrench-Symbol«.
- **Long keypress:** *Immediate acknowledge:* Items are acknowledged by simply pressing the »C« key (for ca. 1 second).

Moreover, you can configure which items shall be acknowledged by this “long keypress” feature (see below).

The setting parameter [Device Para / Acknowledge] »Ack via »C« key« decides about which categories shall be acknowledged with a “long keypress” of the »C« key:

- “Nothing” – Only the “short keypress” is functioning, i. e. you always explicitly select the items to be acknowledged.

- “Ack LEDs w/o passw.” - The “long keypress” acknowledges all LEDs, *without* any password entry. (This option is the factory default.)
- “Ack LEDs” - The “long keypress” acknowledges all LEDs (only the password will be asked for, see below).
- “Ack LEDs and relays” - The “long keypress” acknowledges all LEDs and all binary output relays (only the password will be asked for, see below).
- “Ack Everything” - The “long keypress” acknowledges all latched items (only the password will be asked for, see below):
 - All LEDs, and
 - all Relay Outputs, and
 - all latched SCADA signals, and
 - the trip command.



Whenever the LEDs are acknowledged an LED test is also executed: All LEDs flash in red color for a second, then flash in green color for a second.

NOTICE!



For all (manual and collective) acknowledgment types (except “Nothing” and “Ack LEDs w/o passw.”), note that you might be asked to enter the appropriate access-level password.

If there is the need to be able to acknowledge binary output relays, SCADA signals and trip command without entering any password then this is possible by an empty password for the level »Prot-Lv1«. Of course, this can be a potential security risk, so treat this option with care! For general information about passwords and security-related considerations, see [↩➤ “1.4 Security”](#).

1.6 Measuring Values

Read out Measured Values

In menu [Operation / Measured Values] both measured and calculated values can be viewed. The measured values are ordered by »standard values« and »special values« (depending on the type of device).

Display Options

Menu [Device Para / Measurem Display] offers options to change the display of measured values.

Scaling of Measured Values

By means of the parameter [Device Para / Measurem Display / General Settings] »Scaling« the user can determine how measured values are to be displayed within the HMI and *Smart view*:

- Per unit values
- Primary values
- Secondary values

Temperature Unit (applies only for devices with temperature measurement)

By means of the parameter [Device Para / Measurem Display / General Settings] »Temperature Unit« the user can determine how temperatures (of measured values and settings) are displayed within the HMI and *Smart view*:

- ° Celsius
- ° Fahrenheit

Cutoff Level

In order to suppress noise within measured values that are close to zero the user has the option to set cutoff levels. By means of the cutoff levels, measuring quantities that are close to zero will be displayed as zero. These parameters have no impact on recorded values.

Phase Angles

The phase angles of current phasors are determined from the fundamental component and always refer to a particular reference phasor.

The reference phasor is usually the first current measuring input IL1 (slot X3).

If, however, it happens that the amplitude of the reference phasor becomes too small, the next possible measurement channel is used as the reference phasor, i. e. IL2.

If this, too, is not healthy the MRDT4 proceeds with IL3.

By definition the reference phasor has a phase angle of 0°.

1.7 Statistics

In the menu [Operation / Statistics], the min., max. and average values of the measured and calculated measured quantities can be found.

1.7.1 Configuration of the Minimum and Maximum Values

The calculation of the minimum and maximum values is (re-)started with any of the following events:

- When a Reset signal becomes active (Min/Max),
- when the device is restarted
- after a configuration change.

Reset Minimum and Maximum Values (Peak Values/Pointers)

Menu [Device Para / Statistics / Min / Max]

»ResFc Min« – reset all minimum values

»ResFc Max« – reset all maximum values

A reset signal (e. g. a Digital Input) can be assigned to each of these two parameters.

The minimum and maximum values are reset with the rising edge of the corresponding reset signal.

View Minimum Values

Within menu [Operation / Statistics / Min]

View Maximum Values

Within menu [Operation / Statistics / Max]

1.7.2 Configuration of the Average Value Calculation

1.7.2.1 Configuration of the Current-Based Average Value Calculation*

*=Availability depends on the ordered device code.

Configure the Time Period for the Calculation of the Average and Peak Values

[Device Para / Statistics / Demand / Current Demand] »Window I Demand« =

- “sliding”: average calculation based on sliding period.
- “fixed”: average calculation is reset by the end of the period, that means with the next starting period.

Start Options for Current-Based Average Values and Peak Values

[Device Para / Statistics / Demand / Current Demand] »Start I Demand via:« =

- “Duration”: fixed or sliding period. The period duration is settable via »Duration / Demand«.
- “StartFct”: The average values are calculated based on the time period between two rising edges of a signal that has been assigned to parameter »Start / Demand Fc«.

Reset the Current-Based Average Values and Peak Values

Immediate reset via Direct Control:

[Operation / Reset] »ResFc / Demand« – reset all values

It is also possible to assign a reset signal (e. g. a Digital Input) to the parameter [Device Para / Statistics / Demand / Current Demand] »ResFc / Demand«

In this case the values are reset with the rising edge of the reset signal.

View the Current-Based Average Values and Peak Values

Within the menu [Operation / Statistics / Demand]

Trip (Command) Option to Limit the Average Current Demand

Please refer to  “6 System Alarms”.

1.8 Smart view

Smart view is a parameter setting and evaluation software. It has a Technical Manual of its own.

- Menu-controlled parameter setting incl. validity checks
- Offline configuration of all relay types
- Reading and evaluating of statistical data and measuring values
- Setting into operation assistance
- Display of the device status
- Fault analysis via event- and fault and waveform recorder

For a complete MRDT4 configuration it is recommended to use the *Smart view* setting and evaluation software, because it is too cumbersome to make a large amount of settings using the panel of the device.



- > For *Smart view*, a PC with Windows (7, 8.x or 10) operating system is required. Moreover, a connecting cable is required for a direct connection of the MRDT4 with the PC. This cable requires an USB connector of type “Mini B” on the MRDT4 end (see also [↳ “2.13 PC Interface – X120”](#)). Alternatively, it is possible to establish a connection via Ethernet (TCP/IP), if the network permissions allow this and if the MRDT4 has been ordered with an Ethernet interface ([↳ “1.2.1.2 Communication Protocol Codes”](#), [↳ “1.2.1 Order Form of the Device”](#)) and if the necessary TCP/IP-settings (IP address, subnet mask, gateway) have already been made via the panel.

Secured Communication

For security reasons, it is possible to restrict or disable the connection between *Smart view* and the MRDT4. Moreover, a connection is established only after a connection password has been entered. See the Security chapter, [↳ “1.4.3 Connection Passwords, Smart view Access”](#), for details.

1.9 DataVisualizer

DataVisualizer is a waveform and event viewing software. It is installed automatically with *Smart view*. It can also be used as a standard COMTRADE file viewer.

- Open and review downloaded waveforms
- Customize waveform channel layout and views including channel overlapping and zooming
- Analyze sample by sample data points and line up the displayed analog waveform channels along with the recorded internal relay logic.
- Save window setups (snapshots) and print for reporting
- Open industry standard COMTRADE files from other intelligent electronic devices

- Convert downloaded waveform files to COMTRADE file format using “Export” feature

2 Hardware

2.1 Dimension Drawings

Three-Side-View - 19" Variant

NOTICE!



Depending on the connection method of the SCADA system used the needed space (depth) differs. If, for instance, a D-Sub-Plug is used, it has to be added to the depth dimension.

NOTICE!



The three-side-view shown in this section is valid only for 19" devices.

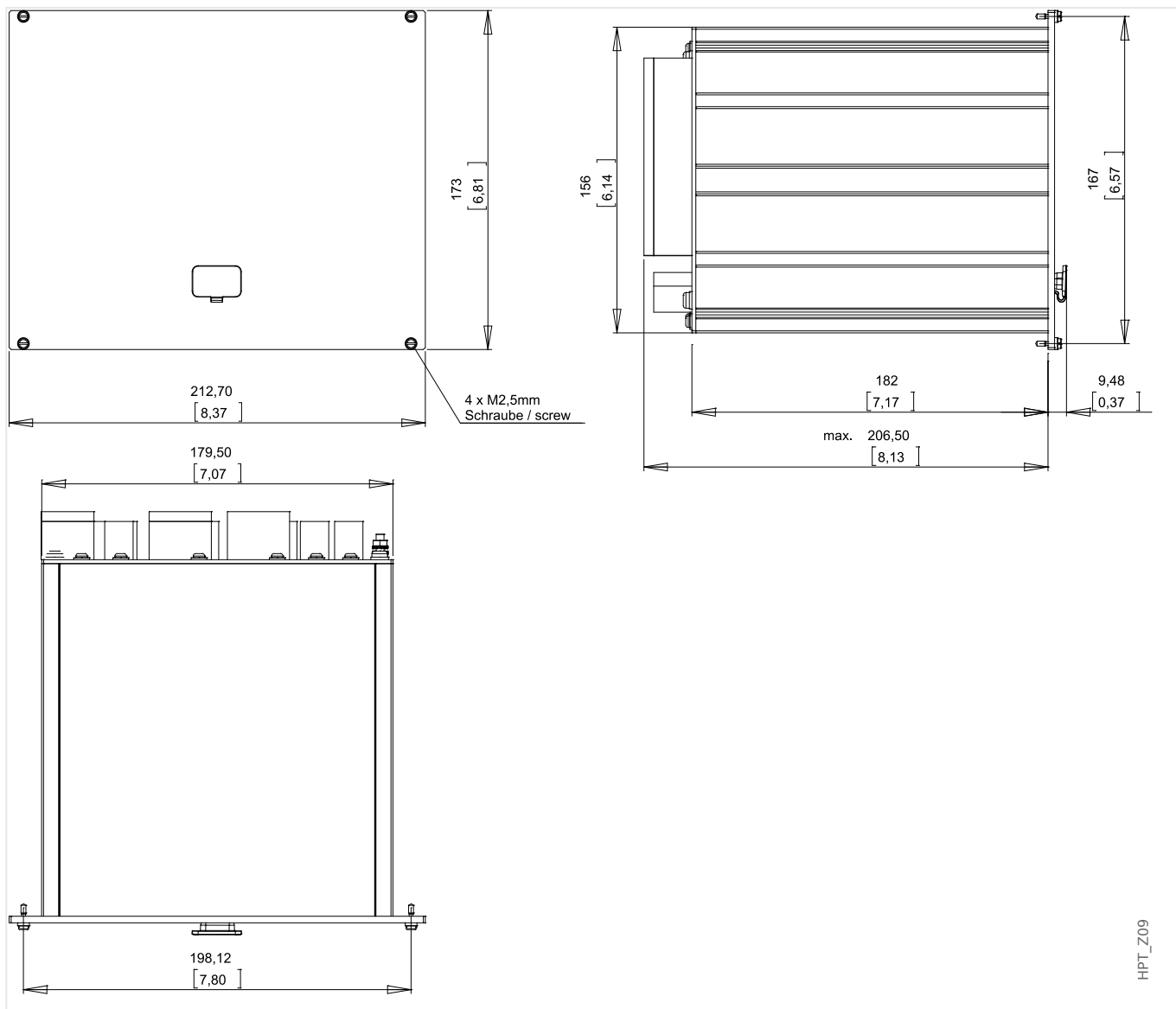

HPT_Z09

Fig. 4: 3-Side-View B2 Housing (19" Devices). (All dimensions in mm, except dimensions in brackets [inch].)

Three-Side-View - Variant for Door Mounting

NOTICE!



Dependent on the connection method of the SCADA system used the needed space (depth) differs. If, for instance, a D-Sub-Plug is used, it has to be added to the depth dimension.

NOTICE!



The installation diagram shown in this section is valid only for devices with 8 pushbuttons at the front side of the HMI. (INFO-, C-, OK-, CTRL-Pushbutton and 4 Softkeys (Pushbuttons)).

2 Hardware

2.1 Dimension Drawings

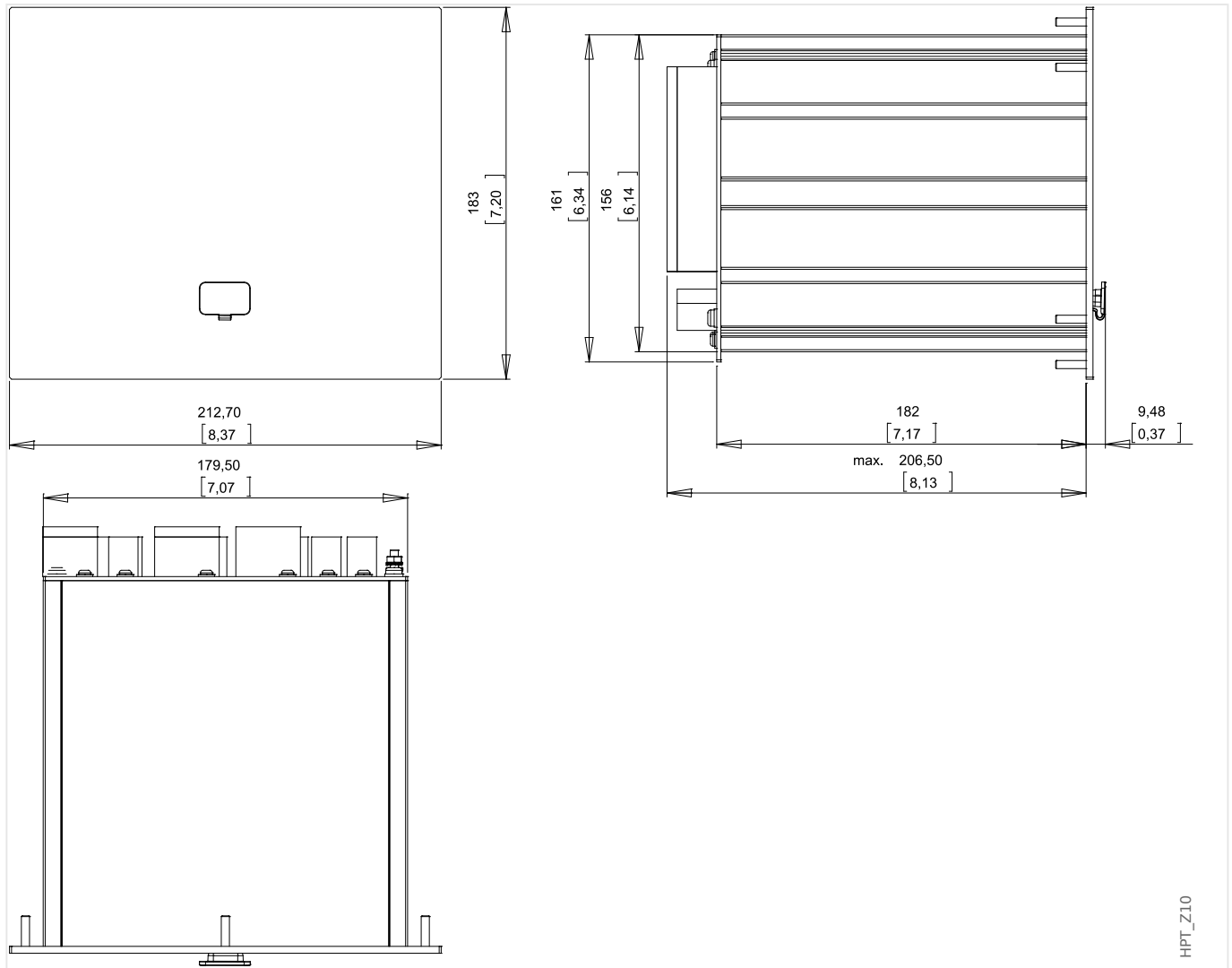

Fig. 5: 3-Side-View B2 Housing (Devices with 8 Softkeys). (All dimensions in mm, except dimensions in brackets [inch].)

Installation Diagram - Cutout for Door Mounting

WARNING!



Even when the auxiliary voltage is switched-off, unsafe voltages might remain at the device connections.

NOTICE!



The installation diagram shown in this section is exclusively valid for devices with 8 pushbuttons at the front side of the HMI. (INFO-, C-, OK-, CTRL-Pushbutton and 4 Softkeys (Pushbuttons)).

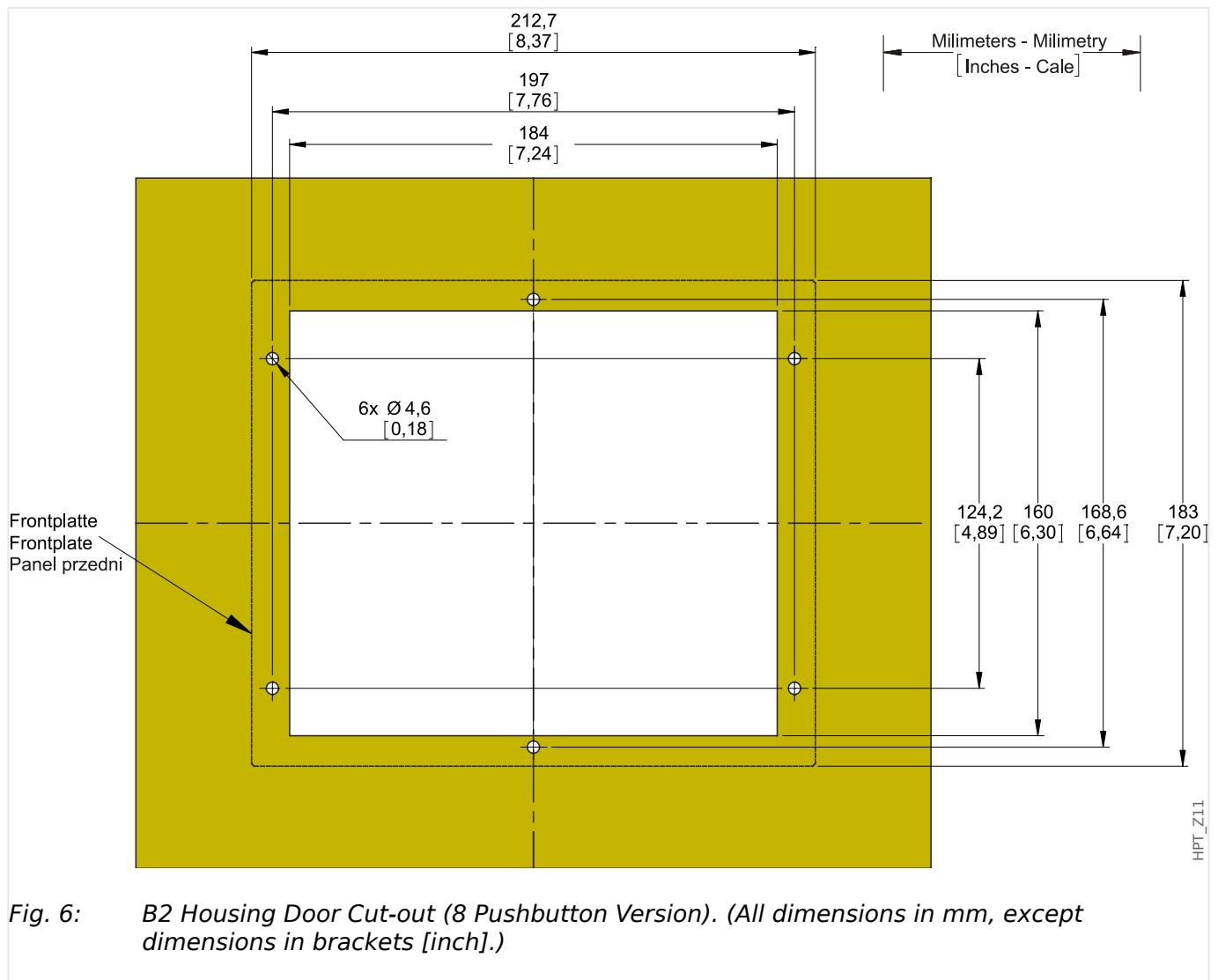

CAUTION!



Be careful. Do not overtighten the mountings nuts of the relay (M4 metric 4 mm). Check the torque by means of a torque wrench (1.7 Nm [15 in-lb]). Over-tightening the mounting nuts could cause personal injury or damage the relay.

2.2 MRDT4 - Installation and Wiring

2.2.1 Grounding

WARNING!



The housing must be carefully grounded. Connect a ground cable (protective earth, 4 to 6 mm² [AWG 11–9], tightening torque 1.7 Nm [15 lb·in]) to the housing, using the screw that is marked with the ground symbol (at the rear side of the device).

Moreover, the power supply card needs a separate ground connection (functional earth, min. 2.5 mm² [\leq AWG 13], tightening torque 0,56 – 0,79 Nm [5–7 lb·in]). See the “Terminal Marking” diagram in Section “DI-4 X – Power Supply and Digital Inputs” to check for the correct terminal.

All grounding connections (i. e. protective and functional earth) must be low-inductance, i. e. as short as possible, and national standards – if applicable – must be followed.

CAUTION!



The devices are very sensitive to electro-static discharges.

2.2.2 Overview of Slots - Assembly Groups

NOTICE!



The set of assembly groups (hardware cards) that the MRDT4 is fitted with depends on the [Order Form](#) of the MRDT4.

In each of the slots an assembly group can be integrated. A tabular overview is in chapter [1.2.1.1 Overview of Assembly Groups](#).

The exact installation place of the individual assembly group can be seen from the connection diagram that is fixed at the top of your device. Moreover, the **“MRDT4 Wiring Diagrams”** (separate document) show the set of fitted hardware cards for every available typecode.

In the following the terminal assignment of the individual assembly-groups are shown.

Front Side

The front side of the MRDT4 equipped with a USB interface, that can be used to establish a connection with the setting software Smart view.

- slot X120

Rear Side

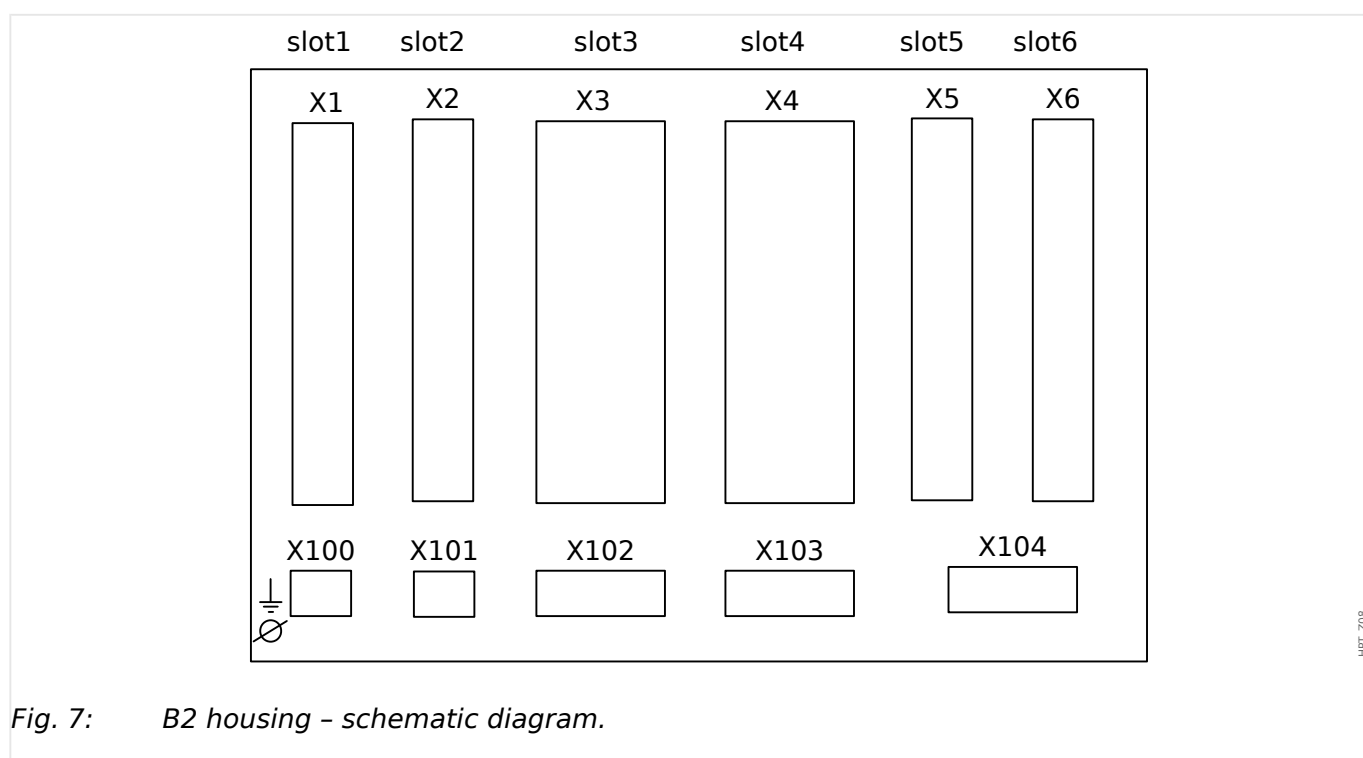

slot X1	slot X2	slot X3	slot X4	slot X5	slot X6
slot X100		slot X102	slot X103	slot X104	

2.3 Slot X1

- Power Supply Card with Digital Inputs

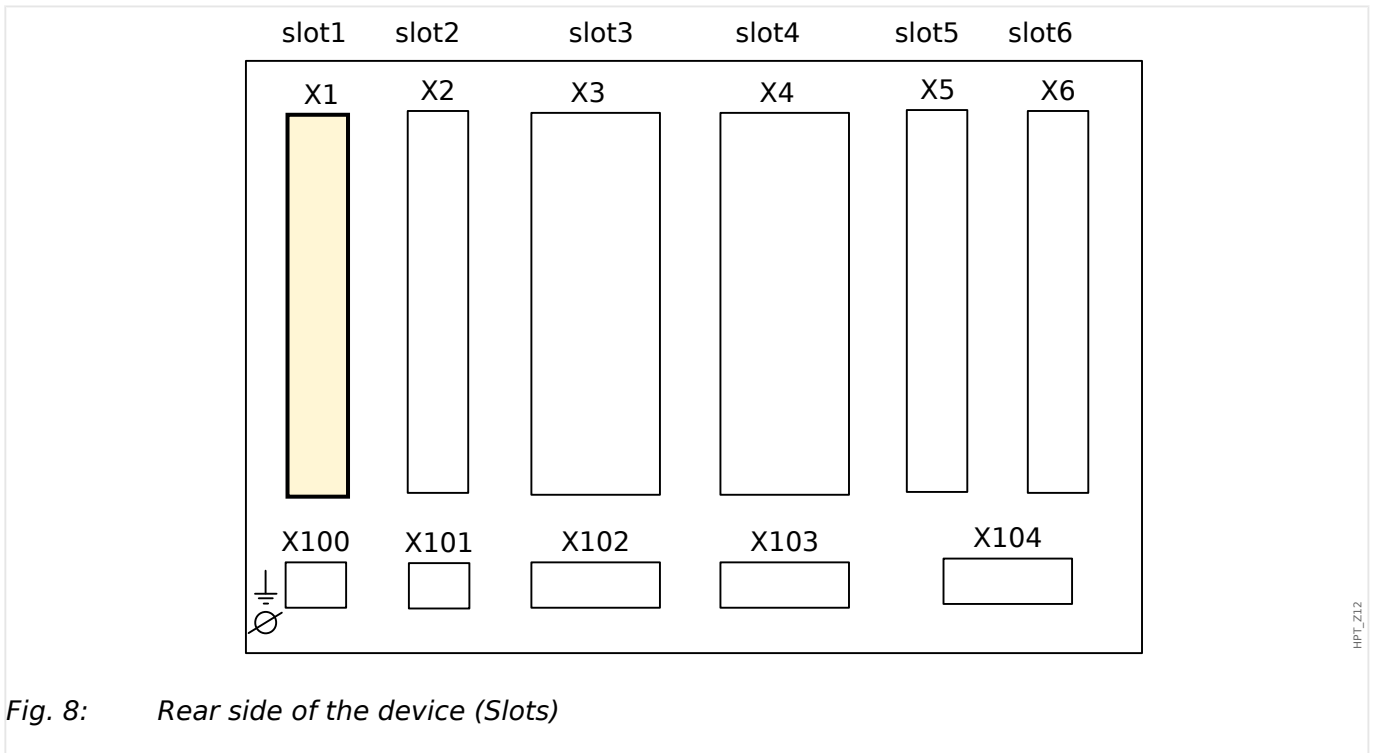

Fig. 8: Rear side of the device (Slots)

The type of power supply card and the number of digital inputs on it used in this slot is dependent on the [ordered device type](#). The different variants have a different scope of functions.

Available assembly groups in this slot:

- **DI-8 X1:** This assembly group comprises a wide-range power supply unit; and two non-grouped digital inputs and 6 digital inputs (grouped).

NOTICE!



The available combinations can be gathered from the [ordering code](#).

2.3.1 DI8-X Power Supply and Digital Inputs

WARNING!



In addition to the grounding of the housing (protective earth, see [2.2.1 Grounding](#)) there must be an additional ground cable connected to the power supply card (functional earth, min. 2.5 mm² [\leq AWG 13], tightening torque 0,56 – 0,79 Nm [5–7 lb•in]).

Connect this ground cable to terminal No. 1, see "[Fig. 9](#)" below.

All grounding connections (i. e. protective and functional earth) must be low-inductance, i. e. as short as possible, and national standards - if applicable - must be followed.

WARNING!



Ensure the correct tightening torques (see diagram).

Connection cross section: min. 0.25 mm² (AWG 23) ... max. 2.5 mm² (AWG 14) with or without wire end ferrule.

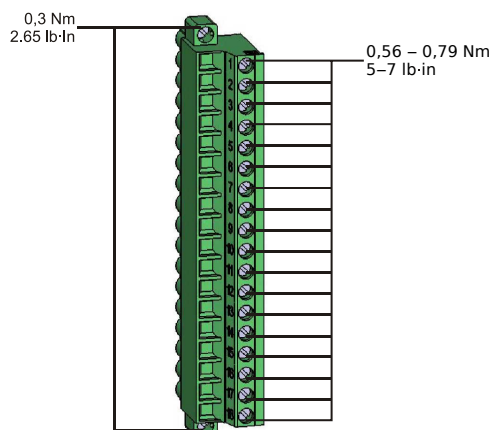

HPT_Z13

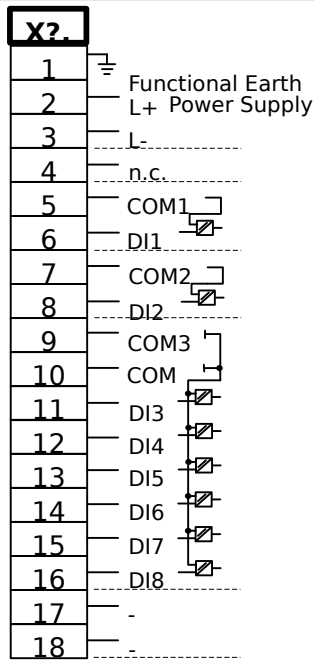

HPF_Z14

Fig. 9: Terminals

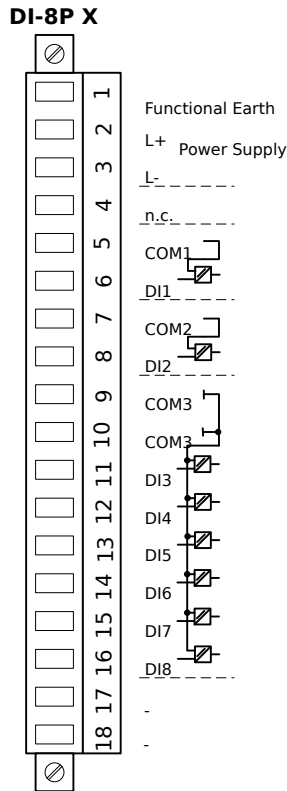

HPF_Z15

Fig. 10: Electro-mechanical assignment

This assembly group comprises:

- a wide-range power supply unit
- 6 digital inputs, grouped

- 2 digital inputs, non-grouped
- Connector for the functional earth (which **must** be connected, see the “Warning” message above)

Auxiliary Voltage Supply

- The aux. voltage inputs (wide-range power supply unit) are non-polarized. The device can be supplied with AC or DC voltage.
- The permissible voltage range is: 24 ... 270 VDC / 48 ... 230 VAC (–20/+10%)
- There is a fuse built into the wide-range power supply unit: 6.3 A time-lag.
(This fuse is not to be replaced by the user, but is necessary for safe operation.)

Moreover, the voltage supply must be protected by an external fuse as follows:

- 2.5 A time-lag miniature fuse 5 x 20 mm (approx. 1/5 x 0.8 in.) according to IEC 60127
- 3.5 A time-lag miniature fuse 6.3 x 32 mm (approx. 1/4 x 1 ¼ in.) according to UL 248-14

Digital Inputs

The module is provided with 8 digital inputs.

The assignment of the digital inputs is described in [↪ “2.14.2 Configuration of the Digital Inputs”](#).

Check the “MRDT4 Reference Manual” (MRDT4-3.7-EN-REF, separate document) for available signal assignments.

CAUTION!



When using DC supply, the negative potential has to be connected to the common terminal (COM1, COM2, COM3 - please see the terminal marking).

CAUTION!



For each digital input group the related voltage input range has to be parameterized. Wrong switching thresholds can result in malfunctions/wrong signal transfer times.

The digital inputs are provided with different switching thresholds (settable via parameter [Device Para / Digital Inputs / DI Slot Xx / Group y] »*Nom voltage*«). For each group the following switching thresholds can be defined:

- “24 VDC”
- “48 VDC”
- “60 VDC”
- “110 VDC”

2 Hardware

2.3.1 DI8-X Power Supply and Digital Inputs

- “230 VDC”
- “110 VAC”
- “230 VAC”

If a voltage >80% of the set switching threshold is applied at the digital input, the state change is recognized (physically “1”). If the voltage is below 40% of the set switching threshold, the device detects physically “0”.

2.4 Slot X2

- Relay Output Card

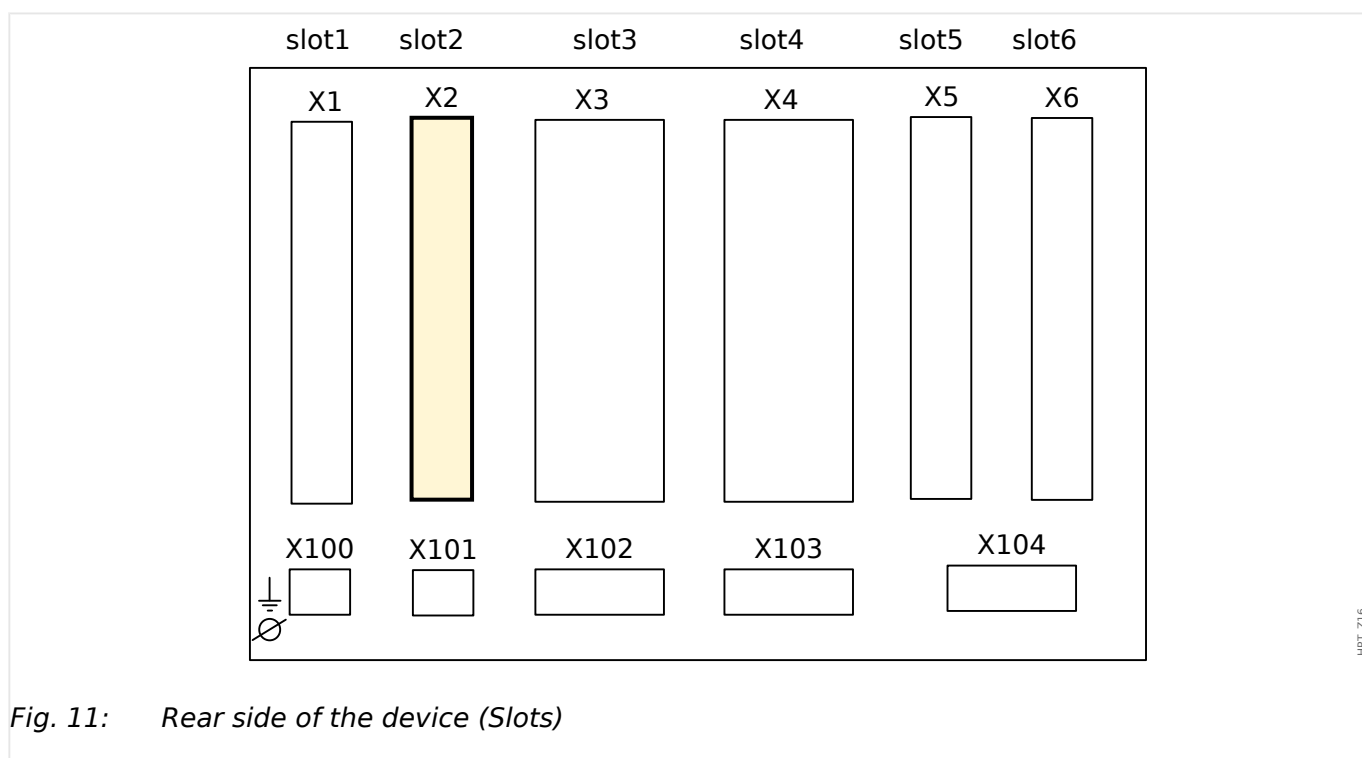

The type of card in this slot is dependent on the [ordered device type](#). The different variants have a different scope of functions.

Available assembly groups in this slot:

- **OR6:** Assembly Group with 6 output relays.

All output relays are Changeover (Form C) contacts.

NOTICE!



The available combinations can be gathered from the [ordering code](#).

2.4.1 BO-6 X - Assembly Group with 6 output relays

WARNING!

 Ensure the correct tightening torques (see diagram).
Connection cross section: min. 0.25 mm² (AWG 23) ... max. 2.5 mm² (AWG 14) with or without wire end ferrule.

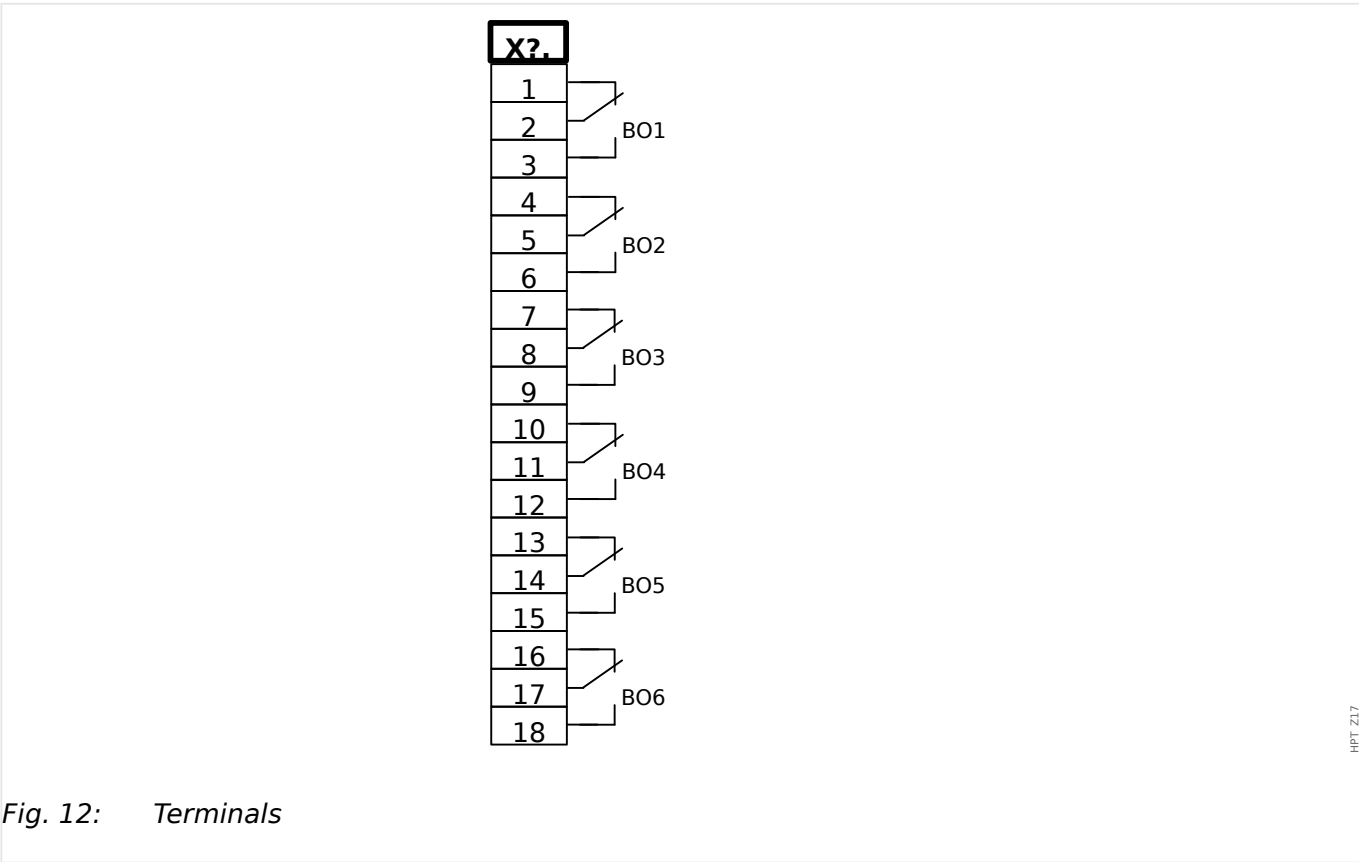
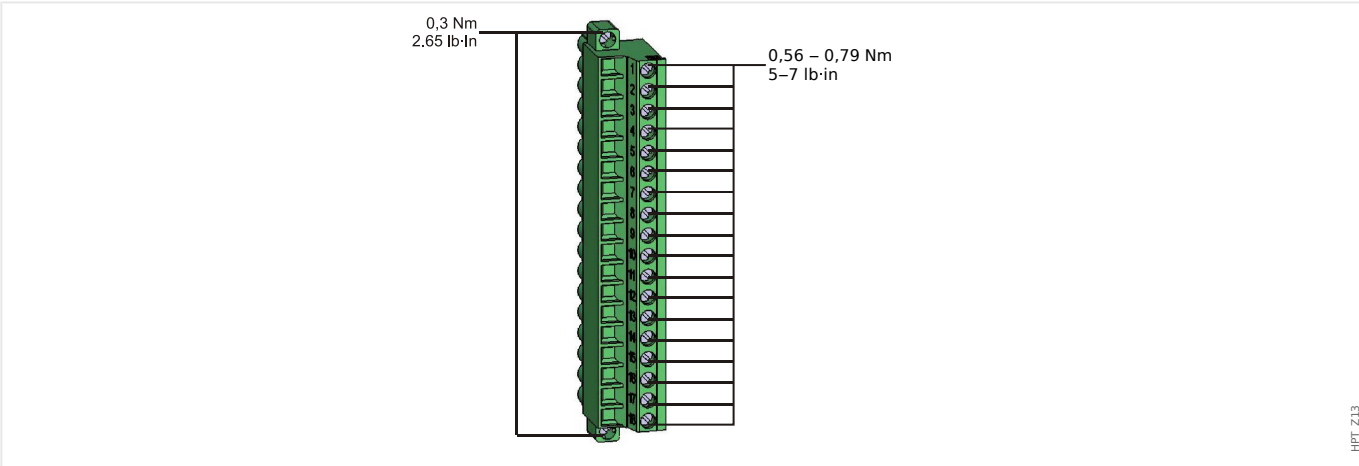

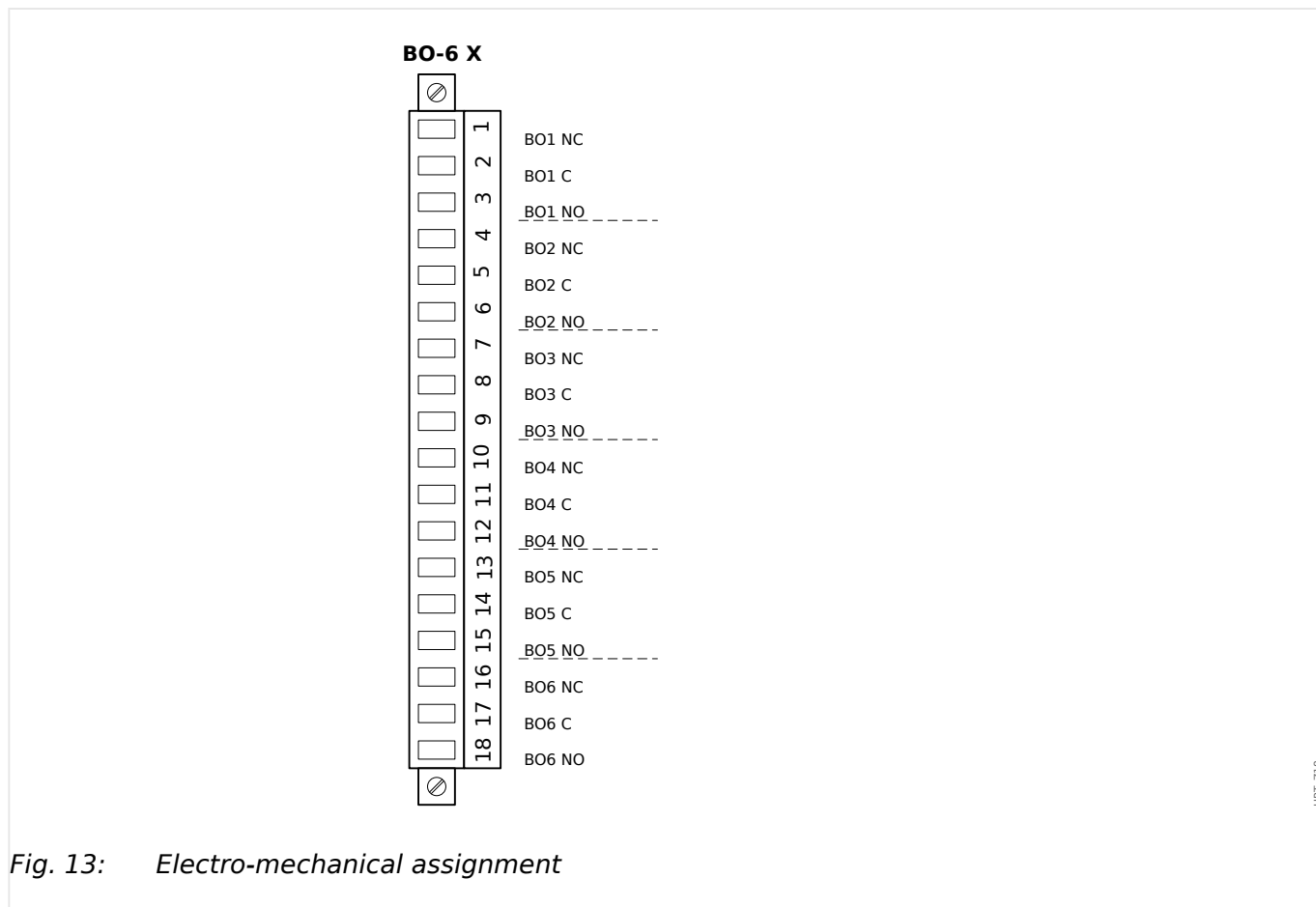

Binary Output Relays

The Output Relays are potential-free contacts. The assignment of the Output Relays is described in [2.14.3 Output Relays Settings](#). Check the “MRDT4 Reference Manual” (MRDT4-3.7-EN-REF, separate document) for a list of signals that can be assigned.

CAUTION!



Please carefully consider the current carrying capacity of the Output Relays. Please refer to the Technical Data ([12 Technical Data](#)).

2.5 Slot X3

- CT - Current Transformer Measuring Inputs for the Winding Side W1

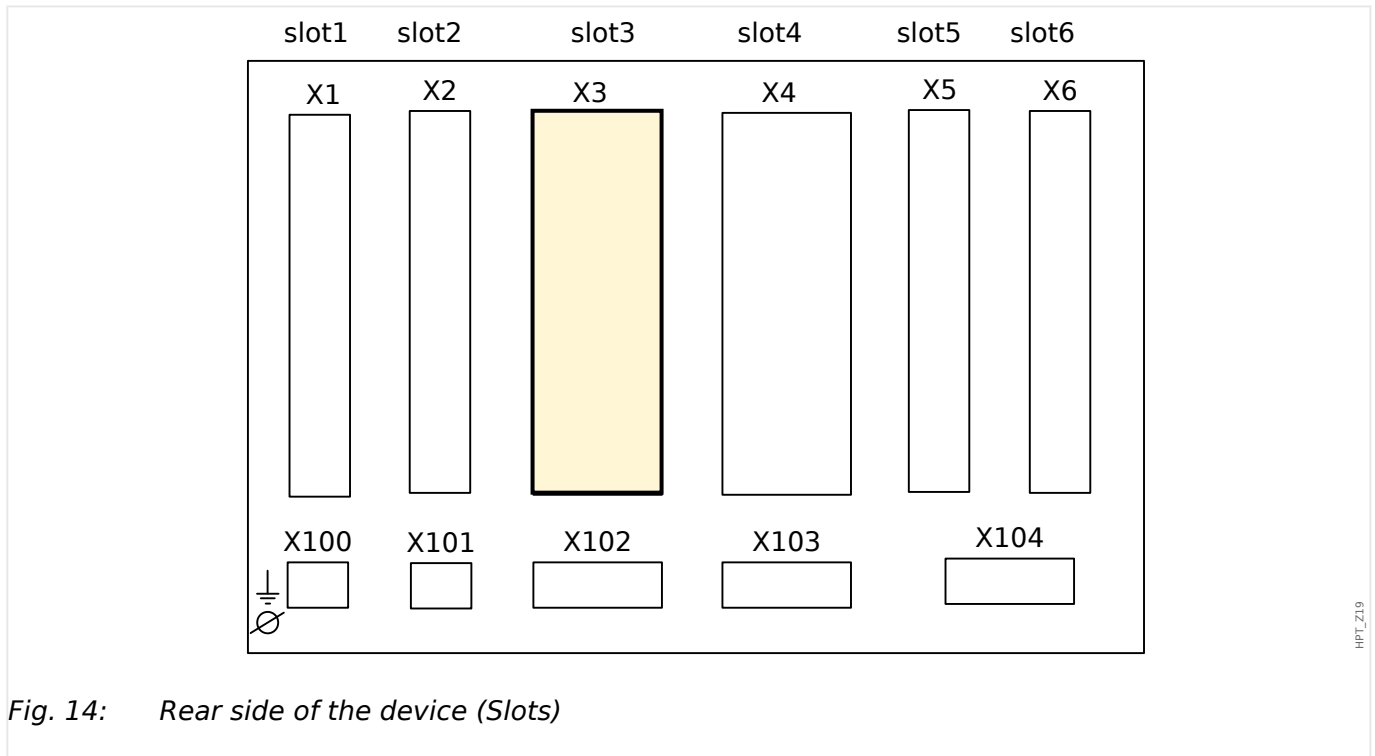

This slot contains the current transformer measuring inputs for the W1 side. Depending on the order code, this might be a standard current measuring card or a sensitive ground current measuring card.

Available assembly groups in this slot:

- **Tl**: Phase and Ground Current Measuring Input Card, standard sensitivity.
- **Tls**: Phase and Ground Current Measuring Input Card with sensitive ground current inputs. The technical data of the sensitive ground measuring input are different from the technical data of the phase current measuring inputs. Please refer to the Technical Data chapter ([↪](#) “12 Technical Data”).

2.5.1 TI - Standard Phase and Ground Current Measuring Input Card

This measuring card is provided with 4 current measuring inputs: three for measuring the phase currents and one for measuring of the earth current. Each of the current measuring inputs has a measuring input for 1 A and 5 A.

The input for earth current measuring either can be connected to a cable-type current transformer or alternatively it is possible to connect the summation current path of the phase current transformer to this input (Holmgreen connection).

DANGER!



Current transformers have to be earthed on their secondary side.

DANGER!



Interrupting the secondary circuits of current transformers causes hazardous voltages.

The secondary side of the current transformers have to be short circuited before the current circuit to the device is opened.

DANGER!



The current measuring inputs may exclusively be connected to current measuring transformers (with galvanic separation).

WARNING!



- Do not interchange the inputs (1 A/5 A)
- Make sure the transformation ratios and the power of the CTs are correctly rated. If the rating of the CTs is not right (overrated), then the normal operational conditions may not be recognized. The pickup value of the measuring unit amounts approx. 3% of the rated current of the device. Also the CTs need a current greater than approx 3% of the rated current to ensure sufficient accuracy. Example: For a 600 A CT (primary current) any currents below 18 A cannot be detected any more.
- Overloading can result in destruction of the measuring inputs or faulty signals. Overloading means that in case of a short-circuit the current-carrying capacity of the measuring inputs could be exceeded.

WARNING!



Use a torque limiting spanner to ensure the correct tightening torques:

- Two screws for the terminal block:
 - Torque: 0.3 Nm (2.65 lb·in)
- Screws for the CT connection:
 - recommended torque: 1.35 Nm (11.9 lb·in)
 - maximum allowed torque: 2.0 Nm (17.7 lb·in)

CT connection cross-section:

- 1 x or 2 x 2.5 mm² (2 x AWG 14) with wire end ferrule, or:
- 1 x or 2 x 4.0 mm² (2 x AWG 12) with ring cable sleeve or cable sleeve, or:
- 1 x or 2 x 6 mm² (2 x AWG 10) with ring cable sleeve or cable sleeve.

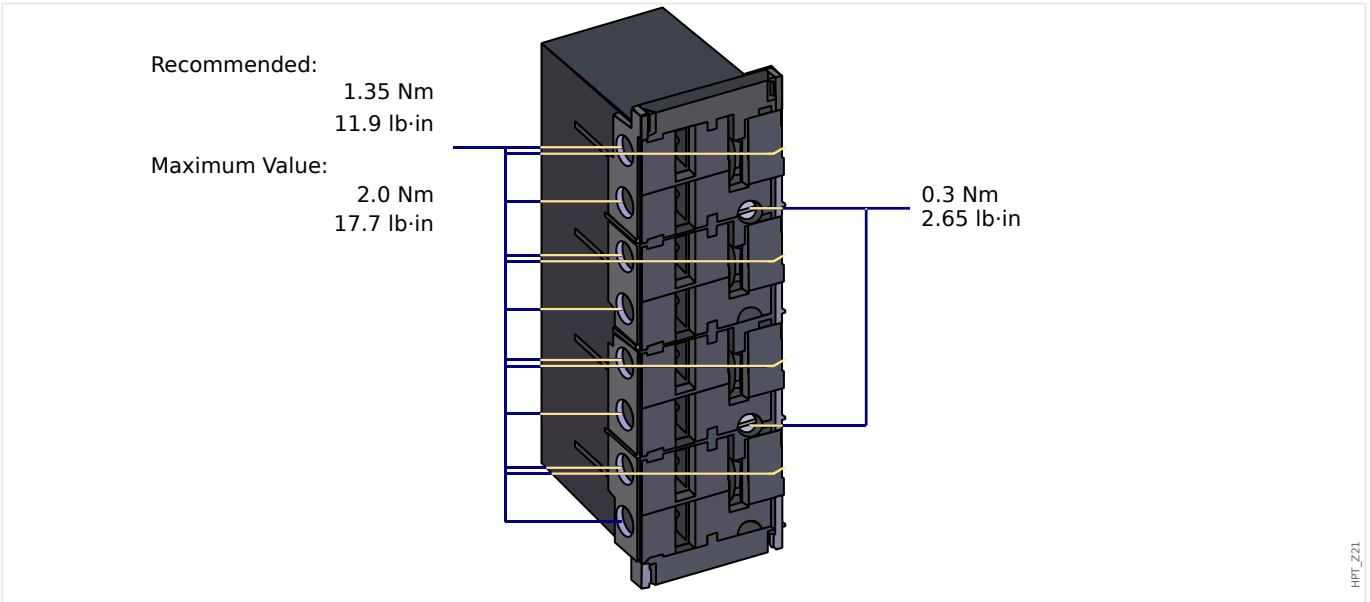

HPT_Z21

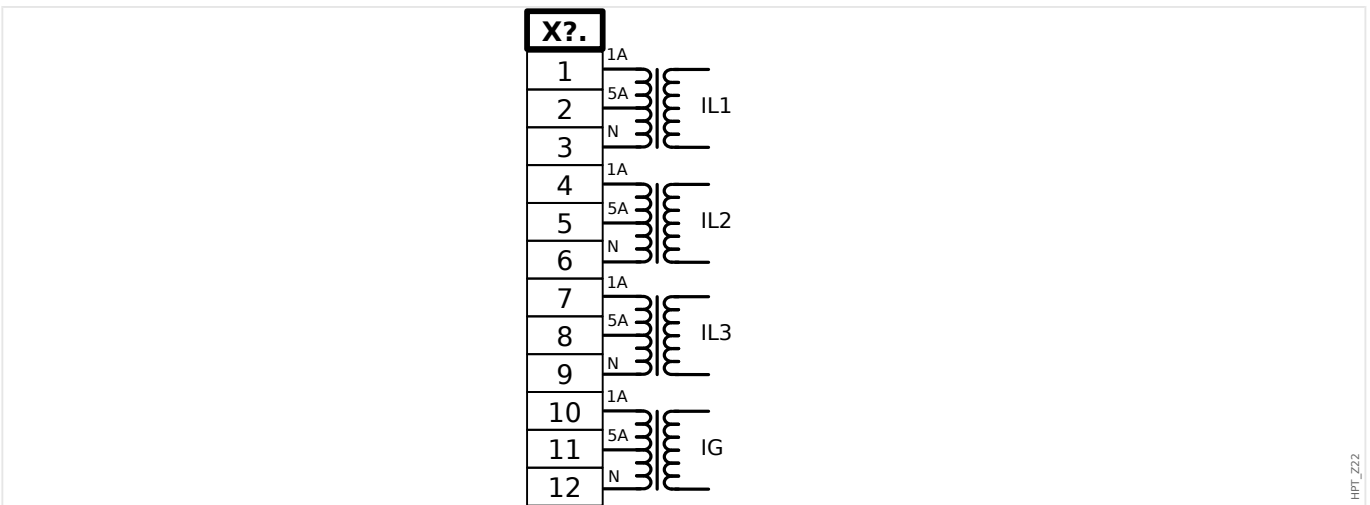

HPT_Z22

Fig. 15: TI – Terminal Marking

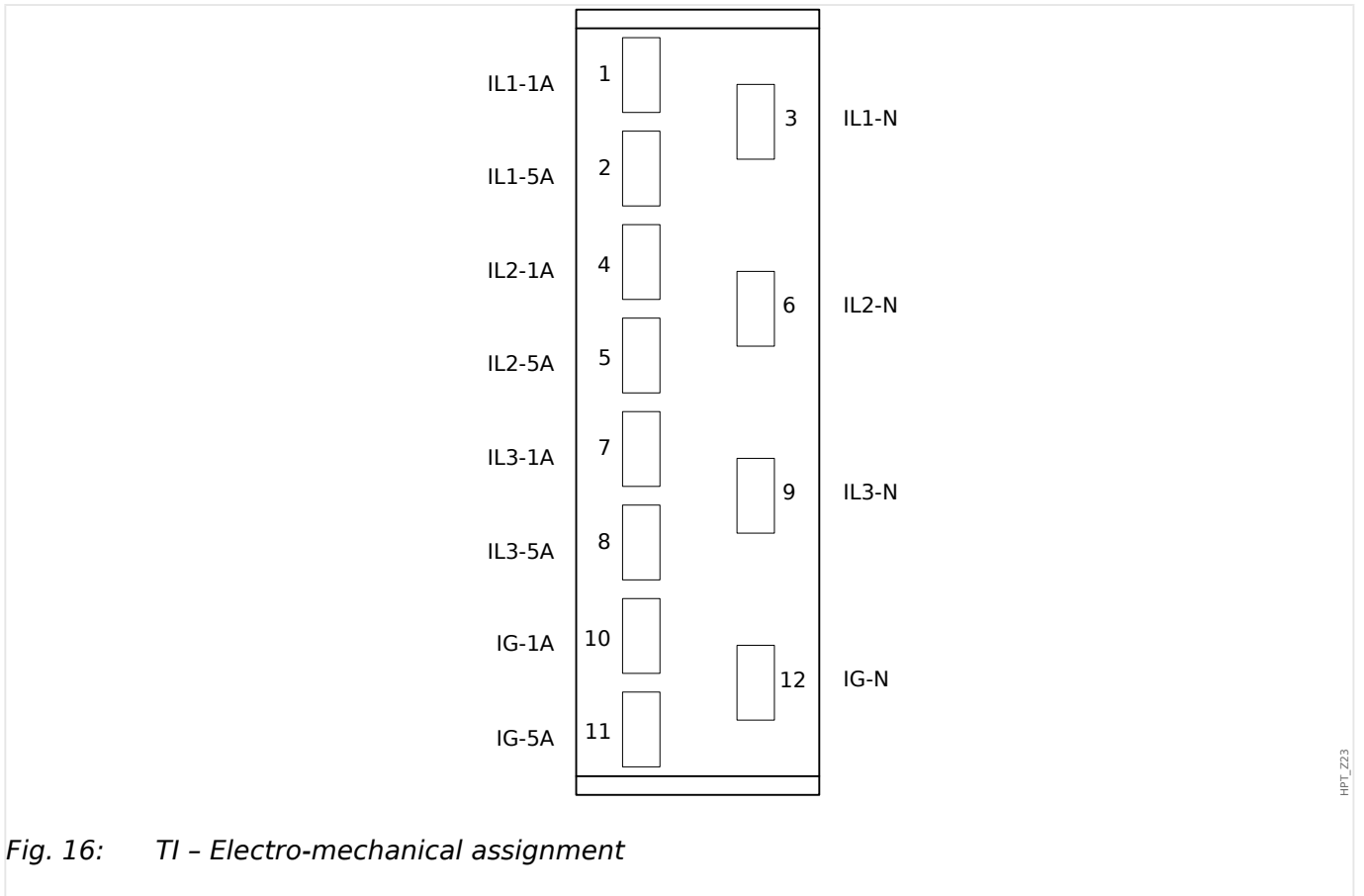

HPT_Z23

2.5.2 TIs - Phase and Sensitive Ground Current Measuring Card

The sensitive ground current measuring card “TIs” is provided with 4 current measuring inputs: three for measuring the phase currents and one for measuring of the earth current.

The technical data of the sensitive ground measuring input are different from the technical data of the phase current measuring inputs. Please refer to the Technical Data chapter ([↩️](#) “12 Technical Data”).

The input for earth current measuring either can be connected to a cable-type current transformer or alternatively it is possible to connect the summation current path of the phase current transformer to this input (Holmgreen connection).

DANGER!



Current transformers have to be earthed on their secondary side.

DANGER!



Interrupting the secondary circuits of current transformers causes hazardous voltages.

The secondary side of the current transformers have to be short circuited before the current circuit to the device is opened.

DANGER!



The current measuring inputs may exclusively be connected to current measuring transformers (with galvanic separation).

WARNING!



- Do not interchange the inputs (1 A/5 A)
- Make sure the transformation ratios and the power of the CTs are correctly rated. If the rating of the CTs is not right (overrated), then the normal operational conditions may not be recognized. The pickup value of the measuring unit amounts approx. 3% of the rated current of the device. Also the CTs need a current greater than approx 3% of the rated current to ensure sufficient accuracy. Example: For a 600 A CT (primary current) any currents below 18 A cannot be detected any more.
- Overloading can result in destruction of the measuring inputs or faulty signals. Overloading means that in case of a short-circuit the current-carrying capacity of the measuring inputs could be exceeded.

WARNING!



Use a torque limiting spanner to ensure the correct tightening torques:

- Two screws for the terminal block:
 - Torque: 0.3 Nm (2.65 lb·in)
- Screws for the CT connection:
 - recommended torque: 1.35 Nm (11.9 lb·in)
 - maximum allowed torque: 2.0 Nm (17.7 lb·in)

CT connection cross-section:

- 1 x or 2 x 2.5 mm² (2 x AWG 14) with wire end ferrule, or:
- 1 x or 2 x 4.0 mm² (2 x AWG 12) with ring cable sleeve or cable sleeve, or:
- 1 x or 2 x 6 mm² (2 x AWG 10) with ring cable sleeve or cable sleeve.

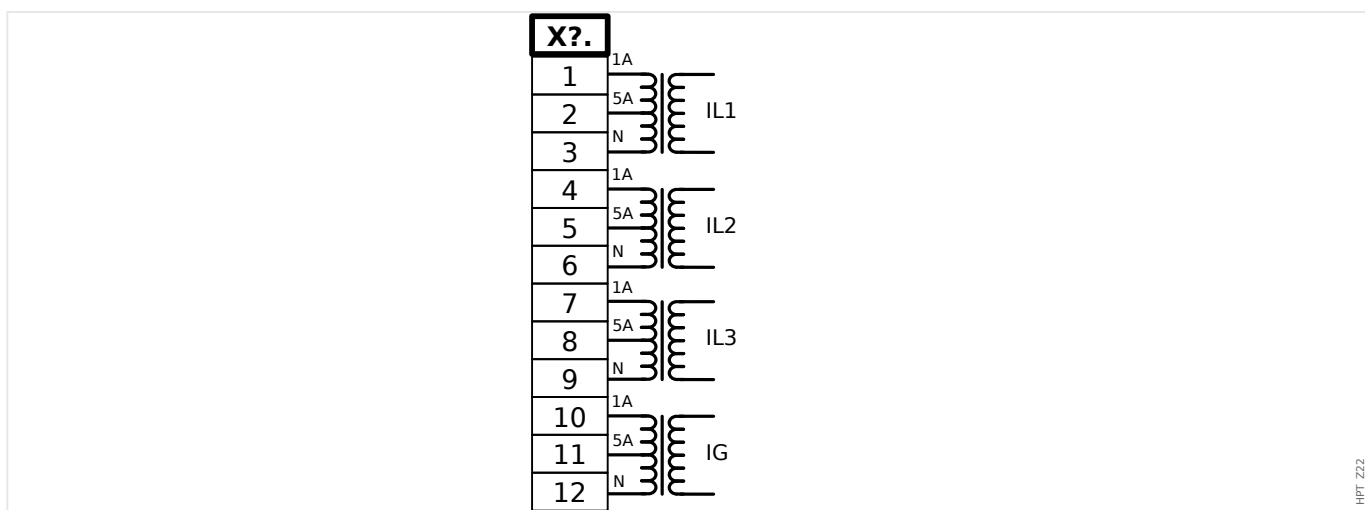
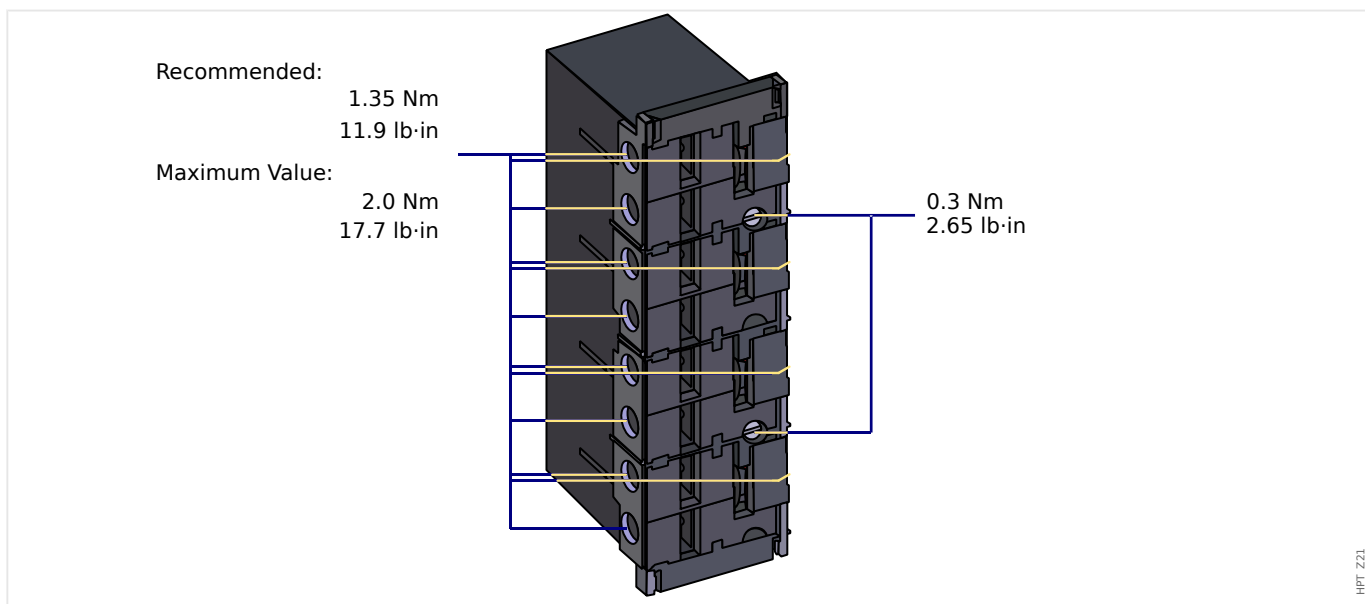
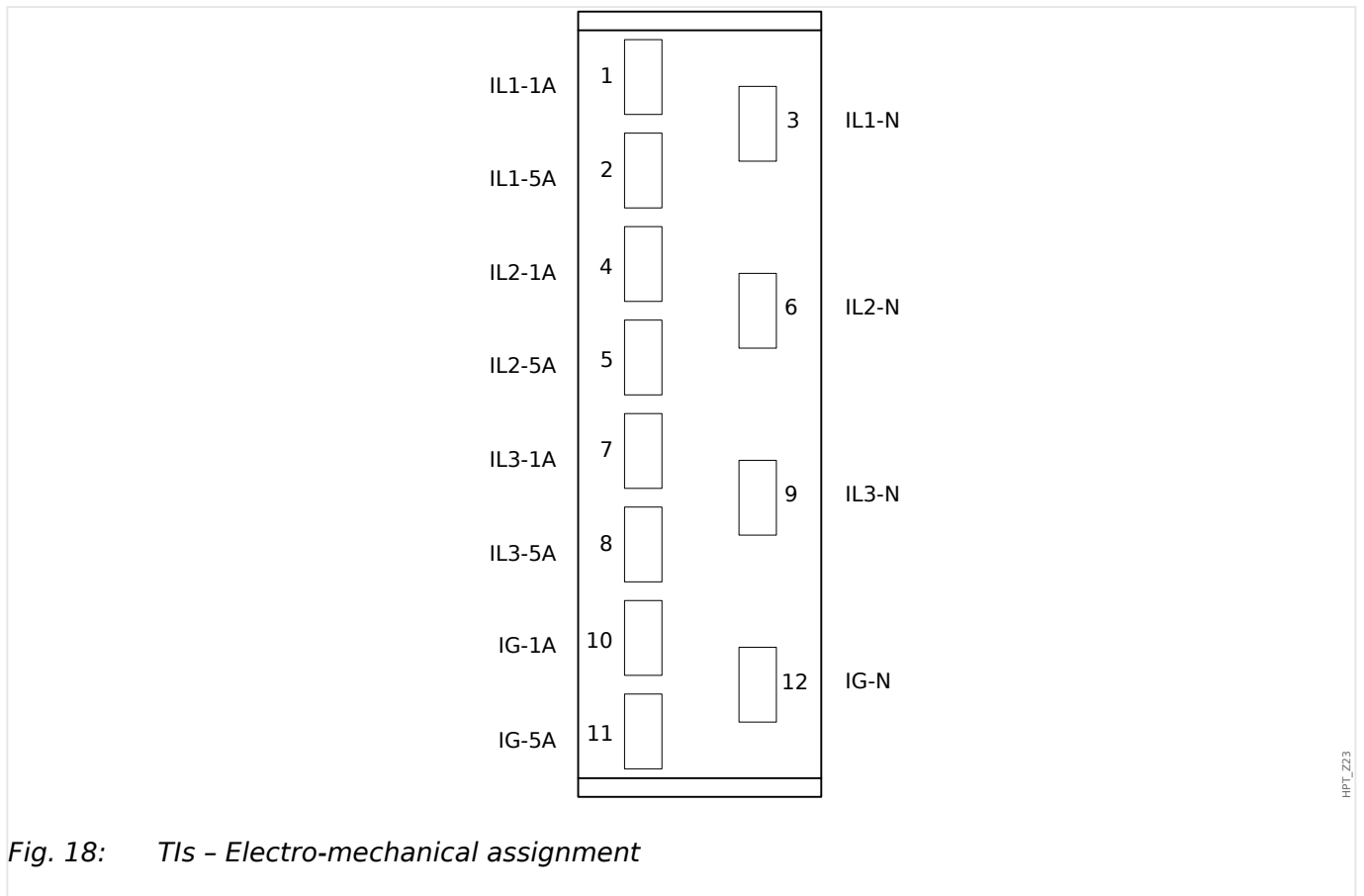

Fig. 17: TIs - Terminals

2 Hardware

2.5.2 TIs - Phase and Sensitive Ground Current Measuring Card



HPT_Z23

2.5.3 Common CT Wiring Configurations

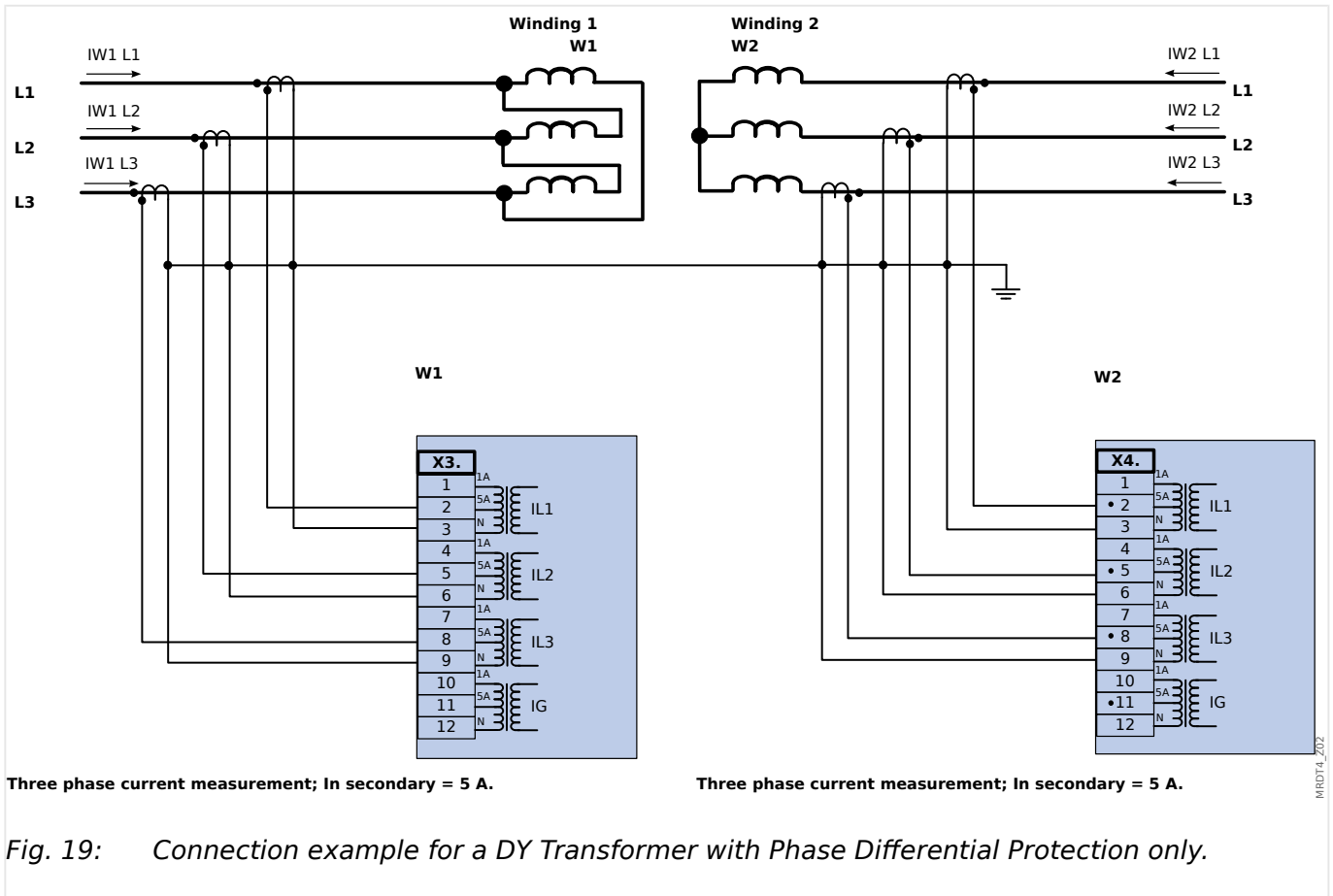

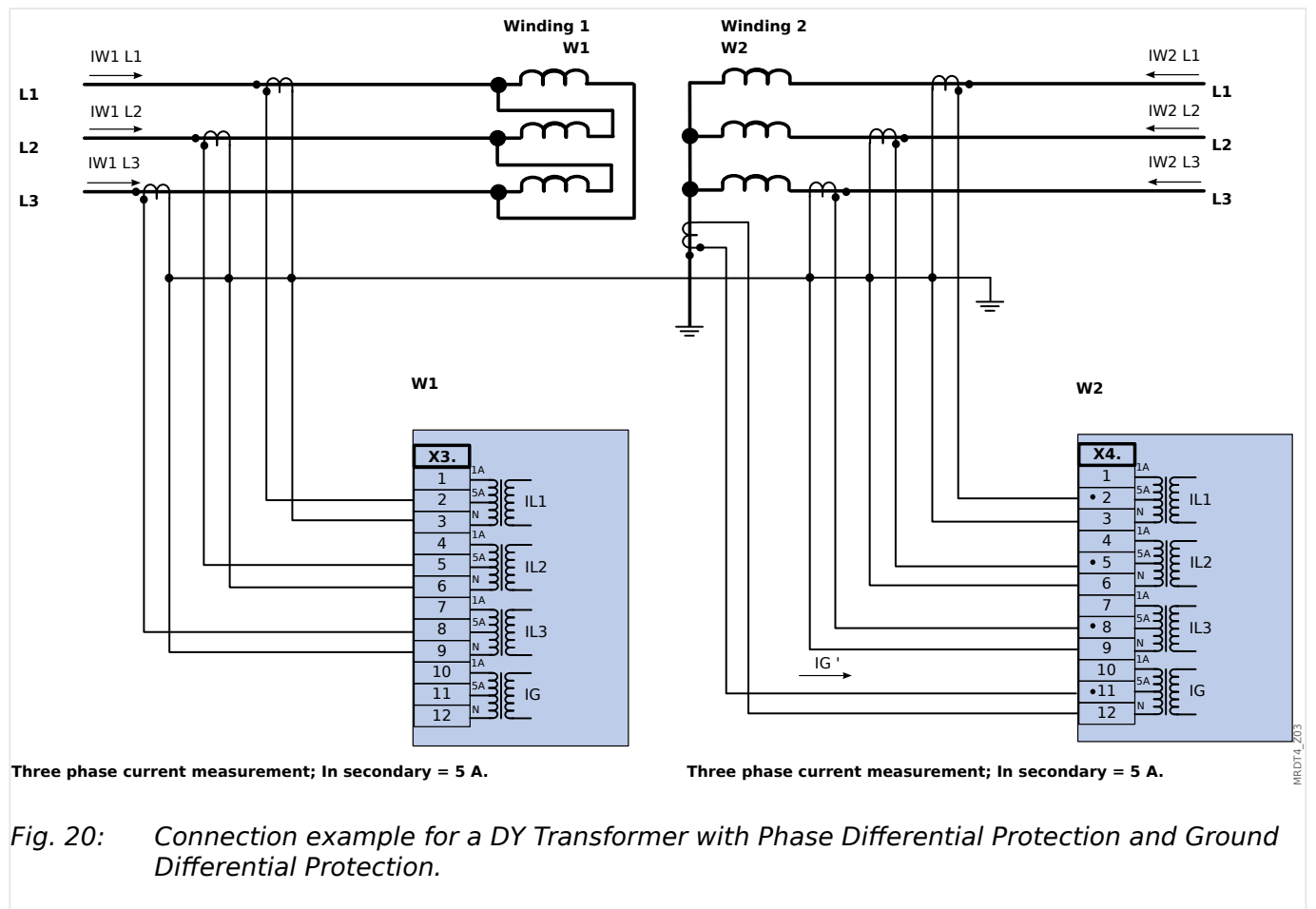

2.5.3.1 Connecting the Current Inputs

The Phase and Ground Current Measuring Input Card supports both pin-terminal connections and ring-terminal connections.

CAUTION!



You have to follow national standards and directives. It might be that not all connection types are permissible in your country.

WARNING!



Use a torque limiting spanner to ensure the correct tightening torques:

- Two screws for the terminal block:
 - Torque: 0.3 Nm (2.65 lb·in)
- Screws for the CT connection:
 - recommended torque: 1.35 Nm (11.9 lb·in)
 - maximum allowed torque: 2.0 Nm (17.7 lb·in)

CT connection cross-section:

- 1 x or 2 x 2.5 mm² (2 x AWG 14) with wire end ferrule, or:
- 1 x or 2 x 4.0 mm² (2 x AWG 12) with ring cable sleeve or cable sleeve, or:
- 1 x or 2 x 6 mm² (2 x AWG 10) with ring cable sleeve or cable sleeve.

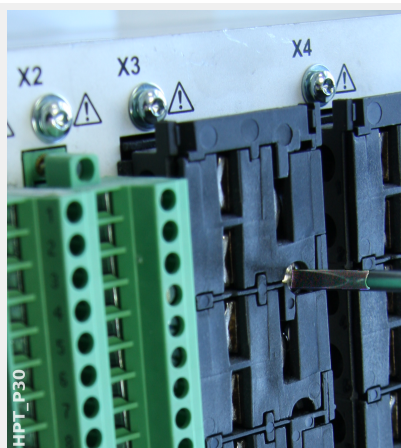

For either connection type, the first step is to remove the terminals from the device by opening the screws.

Remark: This removable part is a shorting block.

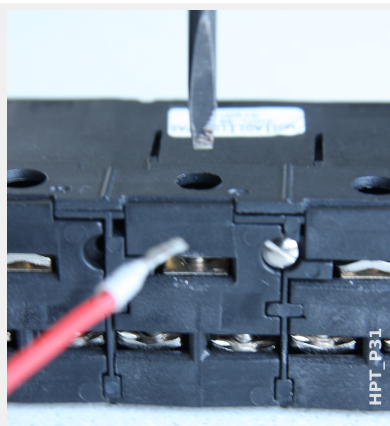

For the pin-terminal connection type, insert the cables and fasten them by the screws that are located at the side of the input card.

Attention should be paid to the tightening torque, [↪ Fig. .](#)

2 Hardware

2.5.3.1 Connecting the Current Inputs

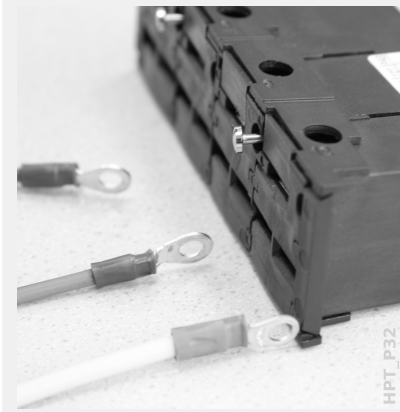

For the ring-terminal connection type, there is one intermediate step to be done.



Move the slider aside, so that the screws and metal contact become fully accessible.

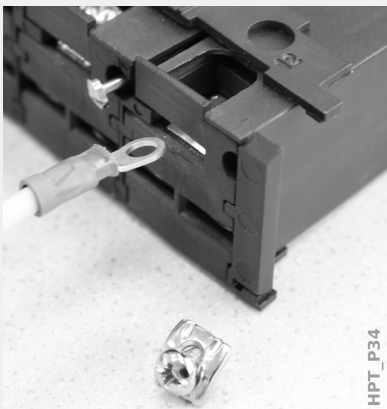

Every terminal consists of a screw with a non-losable metal contact. Screw (plus contact) can be unscrewed completely.

After removing screw and contact you can insert the ring. Then re-insert screw plus contact so that the screw goes through the ring. Tighten the screw.

Attention should be paid to the tightening torque, [↪ Fig. .](#)

Finally move the slider back into its “closed” position.

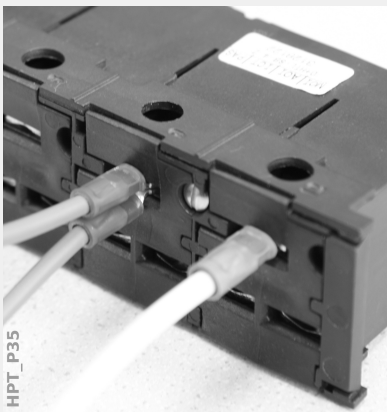

Remark: As long as the cable cross-sections are within the limits given in the Technical Data chapter ([↪ “12 Technical Data”, ↪ Table](#)) it is also possible to insert two rings into one terminal, as shown here. This is useful for setting up the neutral point connection.

2.5.3.2 CT Requirements

WARNING!



In addition to the considerations in this chapter and the requirements mentioned, all applicable national and international standards and regulations have to be followed.

Symbols

The following table gives an overview of the symbols that are used in the CT requirement section.

K_{SSC}	Rated symmetrical short-circuit current factor
K_{td}	Transient dimensioning factor considering DC component of fault current
K	Total dimensioning factor
$I_{psc,max}$	Primary maximum symmetrical short circuit current
I_{pr}	Primary rated current of the CT
I_{sr}	Secondary rated current of the CT
R_{ct}	Secondary internal wiring resistance of the CT
R_b	Rated resistive burden
R'_b	Connected resistive burden of the CT
$S_{nom,ct}$	Nominal apparent power of the CT
ALF	Accuracy limit factor
ALF'	Effective Accuracy limit factor considering connected burden
E_k	Rated knee point e.m.f.
V_s	Secondary terminal voltage
$V_{s,t,max}$	Maximum secondary terminal voltage

When dimensioning current transformers, transient effects like the DC-component of short circuit currents have to be considered. For this purpose the CT requirements are split into a symmetrical short-circuit current and a transient DC current part.

The calculation is started with K_{SSC} for the maximum symmetrical short-circuit current at the primary side of the current transformer.

$$K_{SSC} = \frac{I_{psc,max}}{I_{pr}}$$

The value $I_{psc,max}$ as well as the transient dimensioning factor K_{td} depend on the main active protection function. These can be determined according to the following data:

Overcurrent Protection

K_{td}	1
K_{SSC}	According to the equation above, and ≥ 20
$I_{psc,max}$	Maximum threshold setting of $I_{>}$

Differential Protection

K_{td}	<ul style="list-style-type: none"> • Line: 2 • Generator: 4 • Transformer: 4
K_{SSC}	According to the equation above
$I_{psc,max}$	Maximum primary symmetrical short circuit current for an external fault

For most CT classes it is necessary to make sure that the requirements in the following table are fulfilled. For this the total dimensioning factor is needed:

$$K = K_{SSC} \cdot K_{td}$$

CT class	Requirement
P, PR	$K \leq ALF'$, with: $ALF' = ALF \cdot \frac{R_{ct} + R_b}{R_{ct} + R'_b}$
PX, PXR	$E_k \geq \frac{K}{1.2} \cdot I_{sr} \cdot (R_{ct} + R'_b)$
IEEE / ANSI C-class	$V_s \geq K \cdot I_{sr} \cdot (R_{ct} + R'_b)$ Order CTs with the next higher voltage rating than V_s .
TPX, TPY, TPZ	Order CTs with the determined minimum of K_{SSC} and K_{td} .

Remanence is not considered at this time. Nevertheless it can lead to problems, especially for external faults when using differential protection. To consider remanence the dimensioning factor has to be chosen higher and/or anti remanence class CTs like PR, TPY and PXR can be used.

The requirements for distance protection apply to the fault cases 3 and 4 in IEC 60255-121 (2014). Nevertheless only fault case 3 has to be considered by the user for the calculation of the CT requirements according to this guide.

If the fault current rises over time the CT may be under-dimensioned for the corresponding protection functions. When planning a new installation it makes sense to use CTs with a higher total dimensioning factor than necessary to add some backup reserves for the future.

Example: Overcurrent Protection

Current Transformer:	$I_{pr} = 500 \text{ A}$ $I_{sr} = 1 \text{ A}$ $R_{ct} = 1.5 \Omega$
Overcurrent setting:	$I_{>} = 25 I_n = 25 \cdot 500 \text{ A} = 12500 \text{ A}$
Rated resistive burden:	$R_b = S_{nom,ct} / I_{sr}^2 = 5 \text{ VA} / (1 \text{ A})^2 = 5 \Omega$
Connected burden:	$R'_b = 2.5 \Omega$

Start by calculating K_{SSC} with the setting threshold for the maximum symmetrical short-circuit current:

$$K_{SSC} = \frac{I_{psc,max}}{I_{pr}} = \frac{25 \cdot 500 \text{ A}}{500 \text{ A}} = 25$$

This fulfills the additional condition for overcurrent protection $K_{SSC} \geq 20$, and $K_{td} = 1$ (see requirements table above, [↪ Table](#)).

The total dimensioning factor is calculated from this:

$$K = K_{SSC} \cdot K_{td} = 25 \cdot 1 = 25$$

These data are already sufficient to select a TPX class CT.

For a P class CT, however, additional calculations are necessary. We are going to check for a 5P20 5 VA whether it fits the protection application:

$$ALF = 20$$

$$R_b = 5 \Omega$$

$$ALF' = ALF \cdot \frac{R_{ct} + R_b}{R_{ct} + R'_b} = 20 \cdot \frac{1.5 \Omega + 5 \Omega}{1.5 \Omega + 2.5 \Omega} = 32.5 \geq K = 25$$

The selected CT is sufficient for the given application.

Example: Differential Protection

Current Transformer:	$I_{pr} = 250 \text{ A}$ $I_{sr} = 1 \text{ A}$ $R_{ct} = 0.5 \Omega$
Connected burden:	$R'_{CTA,b} = 0.5 \Omega$ $R'_{CTB,b} = 1.3 \Omega$
Maximum possible symmetrical short-circuit current for an external fault:	$I_{psc,max} = 800 \text{ A}$

First determine K_{SSC} with the maximum possible symmetrical short-circuit current for an external fault:

$$K_{SSC} = \frac{I_{psc,max}}{I_{pr}} = \frac{800 \text{ A}}{250 \text{ A}} = 3.2$$

Look up the transient dimensioning factor K_{td} in the table above (↳ “Differential Protection”); for example for generator / motor differential protection:

$$K_{td} = 3$$

Then the total dimensioning factor is:

$$K = K_{SSC} \cdot K_{td} = 3.2 \cdot 3 = 9.6$$

Therefore the choice is as follows: CTA = 5PR10 1 VA, and for CTB = 5PR10 2.5 VA

Now the accuracy limit factors have to be adapted to the connected burden:

$$ALF_{CTA} = 10, ALF_{CTB} = 10$$

$$ALF'_{CTA} = ALF_{CTA} \cdot \frac{R_{ct} + R_{CTA,b}}{R_{ct} + R'_{CTA,b}} = 10 \cdot \frac{0.5 \Omega + 1 \Omega}{0.5 \Omega + 0.5 \Omega} = 15 \geq K = 9.6$$

$$ALF'_{CTB} = ALF_{CTB} \cdot \frac{R_{ct} + R_{CTB,b}}{R_{ct} + R'_{CTB,b}} = 10 \cdot \frac{0.5 \Omega + 2.5 \Omega}{0.5 \Omega + 1.3 \Omega} = 16.67 \geq K = 9.6$$

The adapted accuracy limit factors ALF' of CTA and CTB are above the total dimensioning factor, which means the CTs can be used for the given application.

Example: Transformer Protection

Transformer:	Yy0 Two windings 3-phase
Power rating:	$S_T = 25 \text{ MVA}$
Rated voltage HV-side:	$V_{TH} = 110 \text{ kV}$
Rated voltage LV-side:	$V_{TL} = 20 \text{ kV}$

Maximum possible symmetrical short circuit currents for an external fault:

HV side:	$I_{HV,psc} = 1.5 \text{ kA}$
LV-side:	$I_{LV,psc} = 8.25 \text{ kA}$

HV side current transformer:	$I_{HV,pr} = 240 \text{ A}$ $I_{HV,sr} = 1 \text{ A}$ $R_{HV,ct} = 0.5 \Omega$
------------------------------	--

	$R_{HV,b} = 5 \Omega$
Connected burden:	$R'_{HV,b} = 1 \Omega$
LV side current transformer:	$I_{LV,pr} = 1200 \text{ A}$ $I_{LV,sr} = 1 \text{ A}$ $R_{LV,ct} = 0.9 \Omega$ $R_{LV,b} = 5 \Omega$
Connected burden:	$R'_{LV,b} = 2 \Omega$

First we determine K_{SSC} and K_{td} :

$$K_{HV,SSC} = \frac{I_{HV,pSC}}{I_{HV,pr}} = \frac{1500 \text{ A}}{240 \text{ A}} = 6.25$$

$$K_{HV,td} = 4$$

$$K_{LV,SSC} = \frac{I_{LV,pSC}}{I_{LV,pr}} = \frac{8250 \text{ A}}{1200 \text{ A}} = 6.88$$

$$K_{LV,td} = 4$$

The total dimensioning factor is calculated from this:

$$K_{HV} = K_{HV,SSC} \cdot K_{HV,td} = 6.25 \cdot 4 = 25$$

$$K_{LV} = K_{LV,SSC} \cdot K_{LV,td} = 6.88 \cdot 4 = 27.5$$

Now a **5PR20 5 VA** CT is selected for the LV side, and a **5PR10 5 VA** CT for the HV side.

The accuracy limit factor has to be adapted to the connected burden first:

$$ALF_{HV} = 10$$

$$ALF_{LV} = 20$$

$$ALF'_{HV} = ALF_{HV} \cdot \frac{R_{HV,ct} + R_{HV,b}}{R_{HV,ct} + R'_{HV,b}} = 10 \cdot \frac{0.5 \Omega + 5 \Omega}{0.5 \Omega + 1.0 \Omega} = 36.67 \geq K_{HV} = 25$$

$$ALF'_{LV} = ALF_{LV} \cdot \frac{R_{LV,ct} + R_{LV,b}}{R_{LV,ct} + R'_{LV,b}} = 20 \cdot \frac{0.9 \Omega + 5 \Omega}{0.9 \Omega + 2.0 \Omega} = 40.69 \geq K_{LV} = 27.5$$

So, the selected CTs are sufficient for the given application.

2.6 Slot X4

- CT - Current Transformer Measuring Inputs for the Winding Side W2

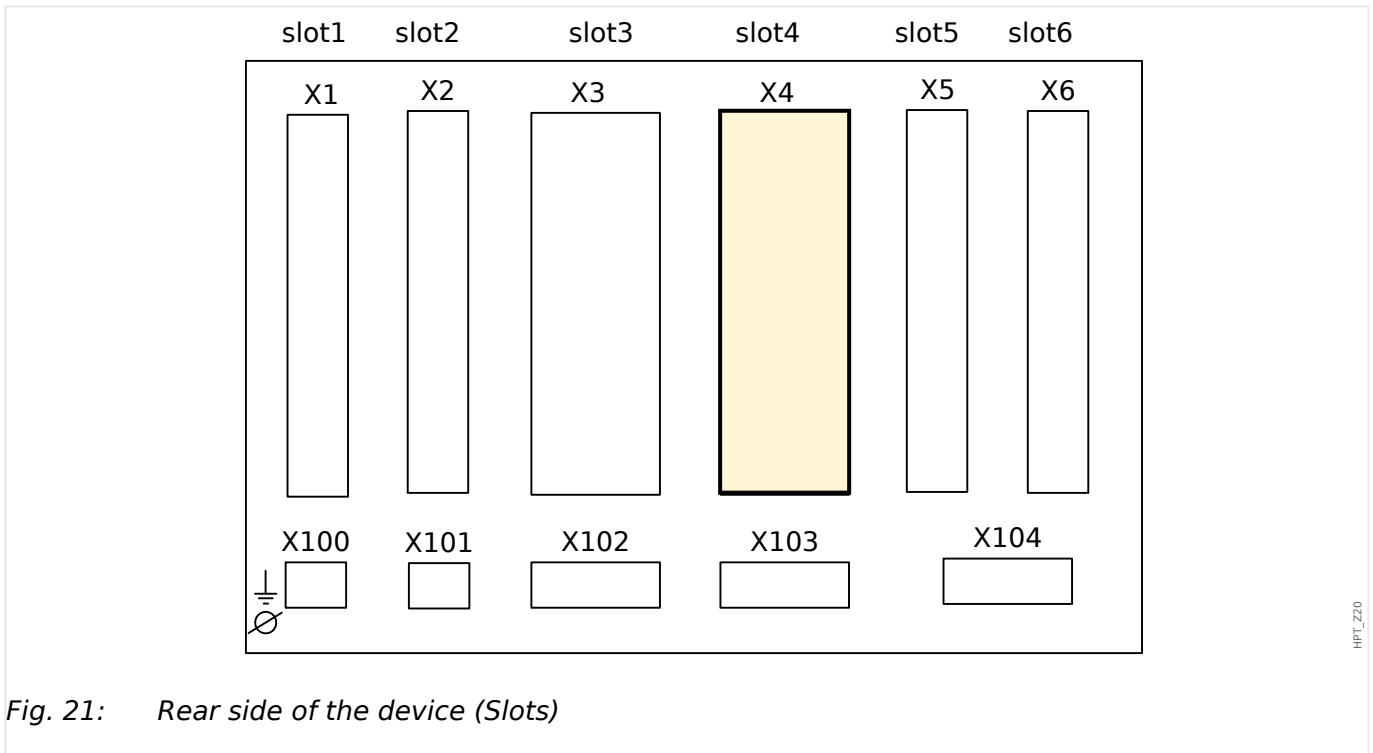

This slot contains the current transformer measuring inputs for the W2 side.

The type of card in this slot is dependent on the [ordered device type](#). The different variants have a different scope of functions.

Available assembly groups in this slot:

- **Ti**: Standard ground current measuring card.
- **Ti**: Sensitive Ground current measuring card. The technical data of the sensitive ground measuring input are different from the technical data of the phase current measuring inputs. Please refer to the Technical Data chapter ([↪ "12 Technical Data"](#)).

NOTICE!



The available combinations can be gathered from the [ordering code](#).

2.7 Slot X5

- Relay Output Card

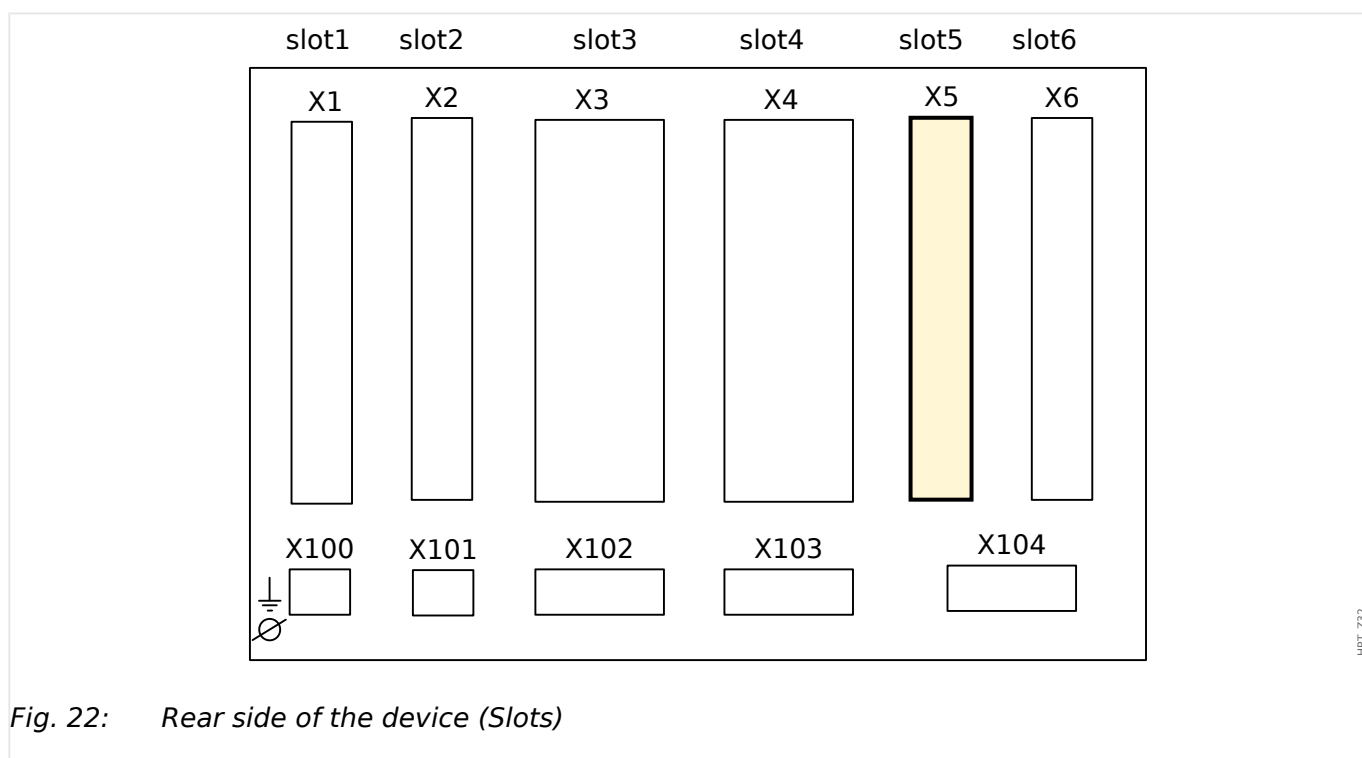

The type of card in this slot is dependent on the [ordered device type](#). The different variants have a different scope of functions.

Available assembly groups in this slot:

- **OR6:** Assembly Group with 6 output relays.

All output relays are Changeover (Form C) contacts.

NOTICE!



The available combinations can be gathered from the [ordering code](#).

2.8 Slot X6

- Digital Inputs

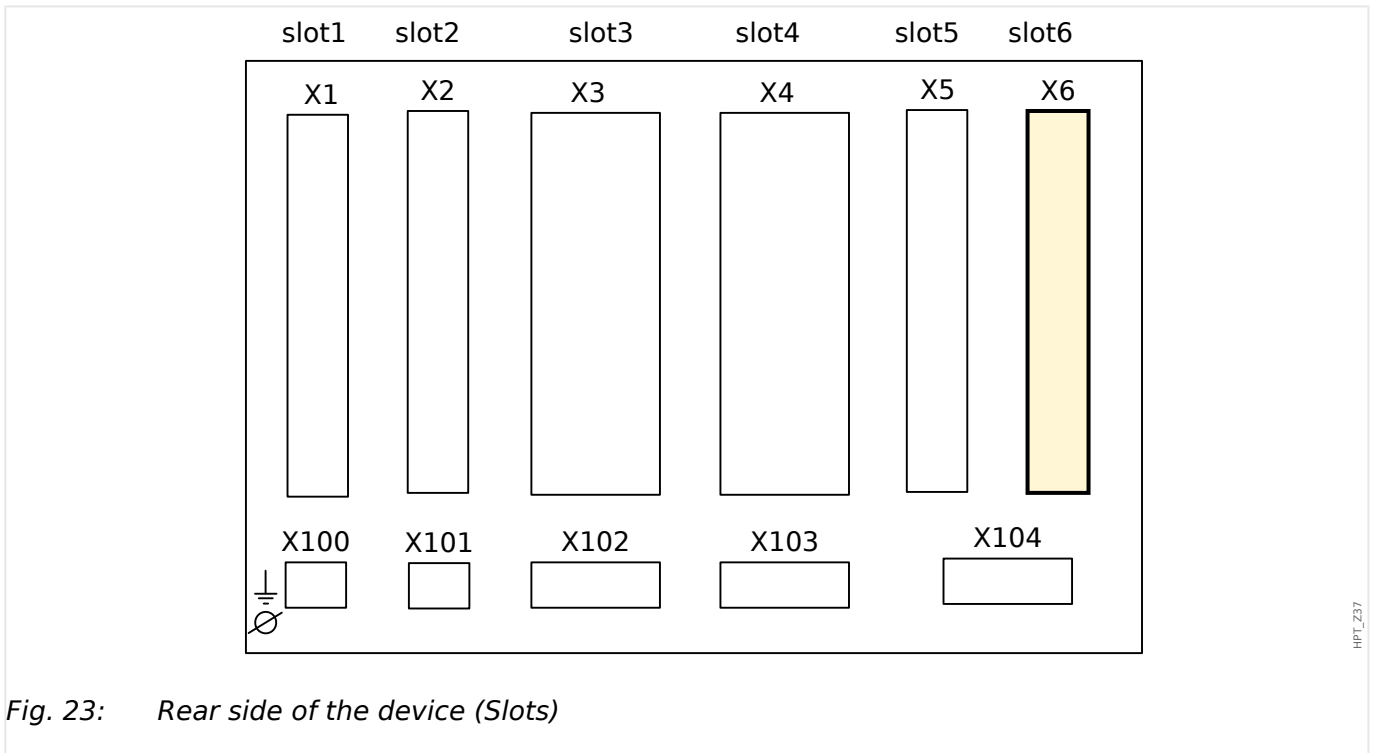

The type of card in this slot is dependent on the [ordered device type](#). The different variants have a different scope of functions.

Available assembly groups in this slot:

- **DI8:** Assembly Group with 8 Digital Inputs
- **OR6:** Assembly Group with 6 output relays.

All output relays are Changeover (Form C) contacts.

NOTICE!



The available combinations can be gathered from the [ordering code](#).

2.8.1 DI8 - Assembly Group with 8 Digital Inputs

WARNING!



Ensure the correct tightening torques (see diagram).

Connection cross section: min. 0.25 mm² (AWG 23) ... max. 2.5 mm² (AWG 14) with or without wire end ferrule.

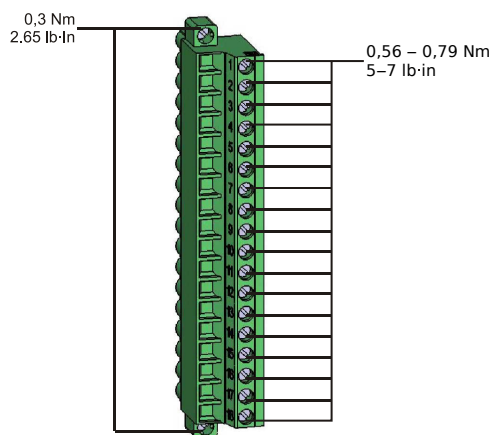

HPT_Z13

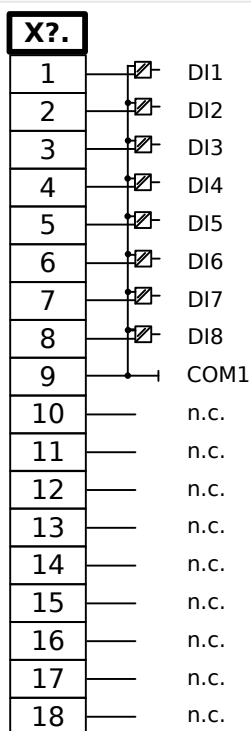

HPT_Z2A

Fig. 24: Terminals.

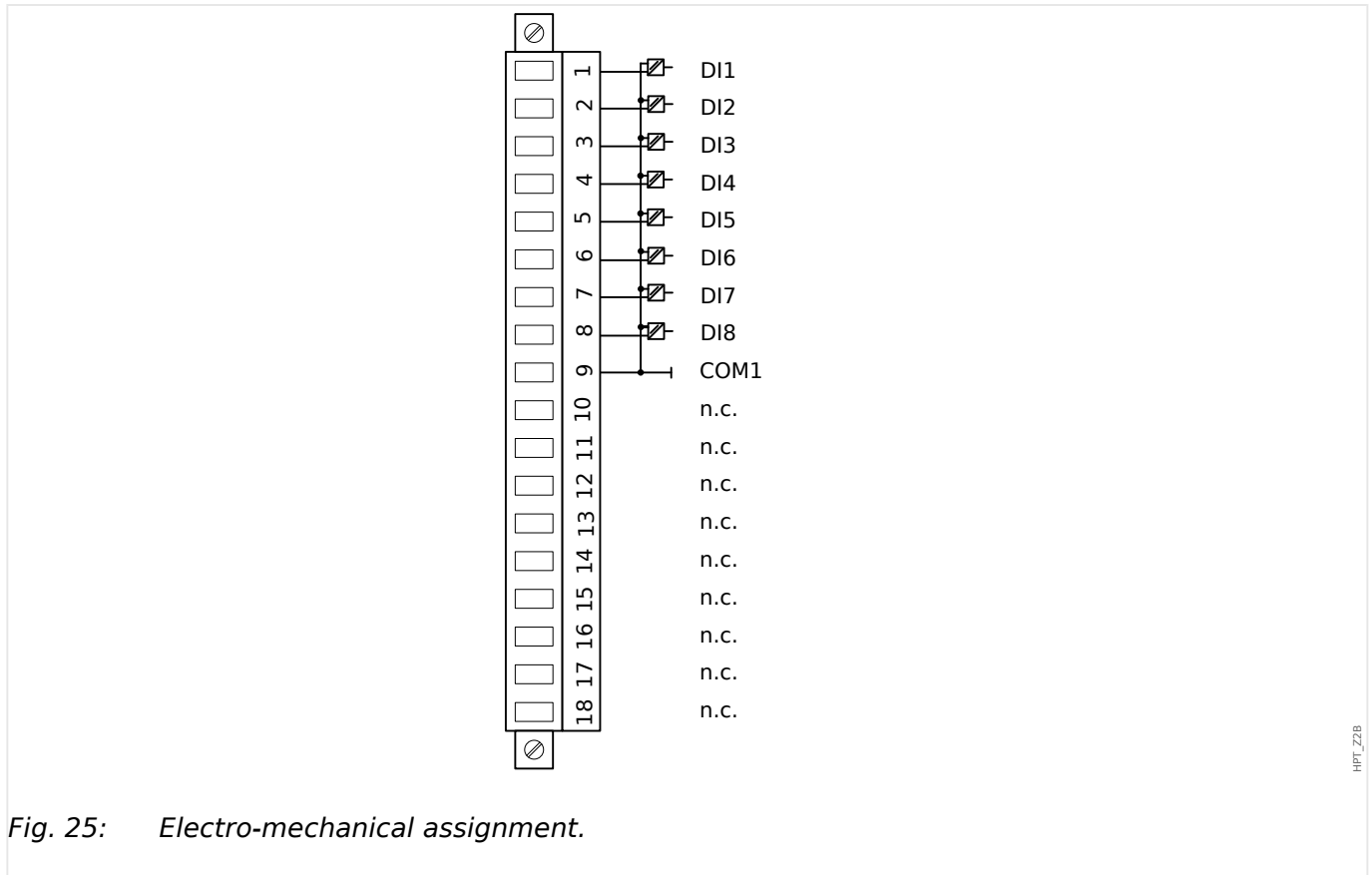

Fig. 25: Electro-mechanical assignment.

Digital Inputs

The module is provided with 8 grouped digital inputs.

The assignment of the digital inputs is described in [“2.14.2 Configuration of the Digital Inputs”](#).

Check the “MRDT4 Reference Manual” (MRDT4-3.7-EN-REF, separate document) for available signal assignments.

CAUTION!



When using DC supply, the negative potential has to be connected to the common terminal (COM1, COM2, COM3 - please see the terminal marking).

CAUTION!



For each digital input group the related voltage input range has to be parameterized. Wrong switching thresholds can result in malfunctions/wrong signal transfer times.

The digital inputs are provided with different switching thresholds (settable via parameter [Device Para / Digital Inputs / DI Slot Xx / Group y] »Nom voltage«). For each group the following switching thresholds can be defined:

- “24 VDC”
- “48 VDC”

- "60 VDC"
- "110 VDC"
- "230 VDC"
- "110 VAC"
- "230 VAC"

If a voltage >80% of the set switching threshold is applied at the digital input, the state change is recognized (physically "1"). If the voltage is below 40% of the set switching threshold, the device detects physically "0".

2.9 Slot X100: Ethernet Interface

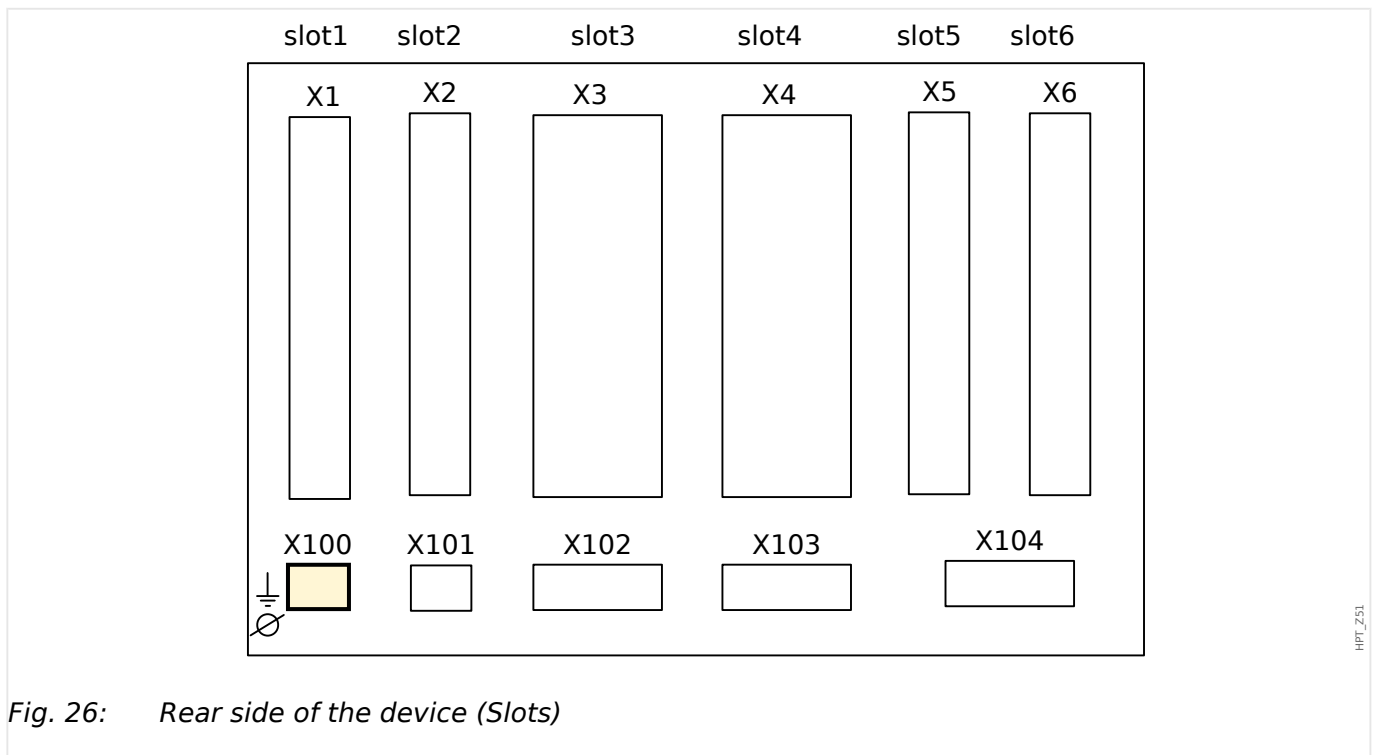

Fig. 26: Rear side of the device (Slots)

An Ethernet interface may be available depending on the [ordered device type](#).

NOTICE!



The available combinations can be gathered from the [ordering code](#).

2.9.1 Ethernet - RJ45

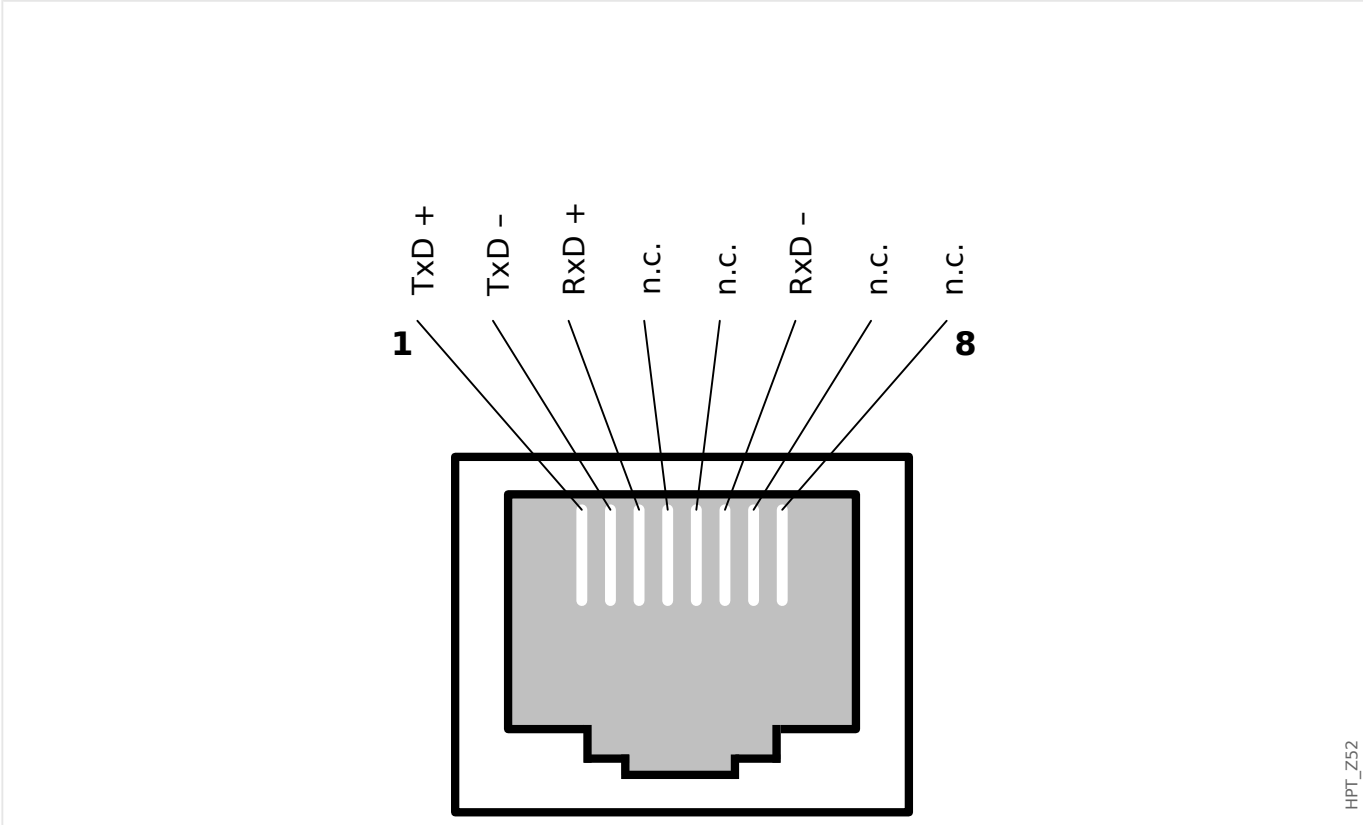

2.10 Slot X102: Protection Communication

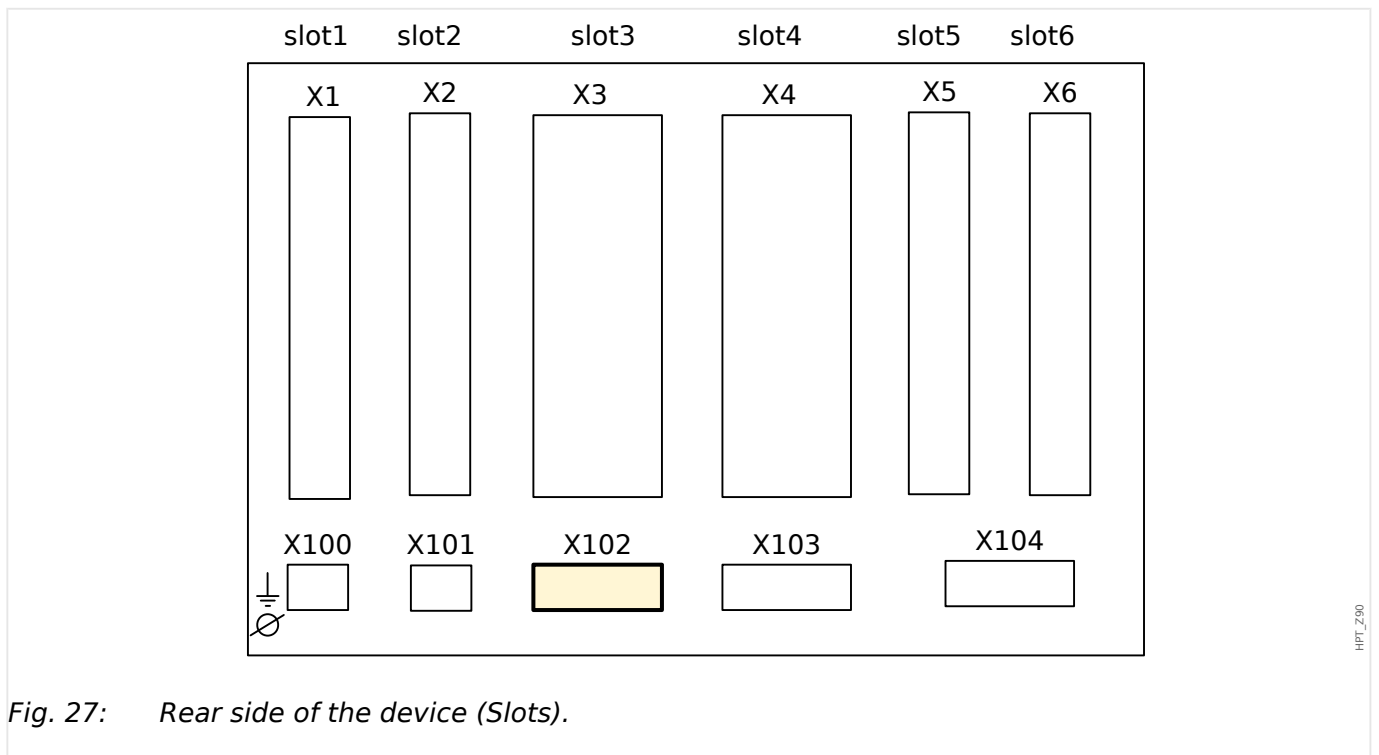

Fig. 27: Rear side of the device (Slots).

The Protection Communication interface is available in slot **X102**.

Available assembly groups in this slot:

- Fiber optics interface for the »ProtCom« (Protection Communication) module.

2.10.1 Interface for the URTD Module

The Universal Resistance-Temperature Detector (URTD) module has to be connected to the protective device at the special fiber optic interface (1 optical slave).

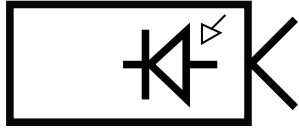

E_F45

Fig. 28: Interface for the External URTD Module - Terminal Marking



E_F46

Fig. 29: Interface External URTD Module - Terminal Marking

2.11 Slot X103: Data Communication

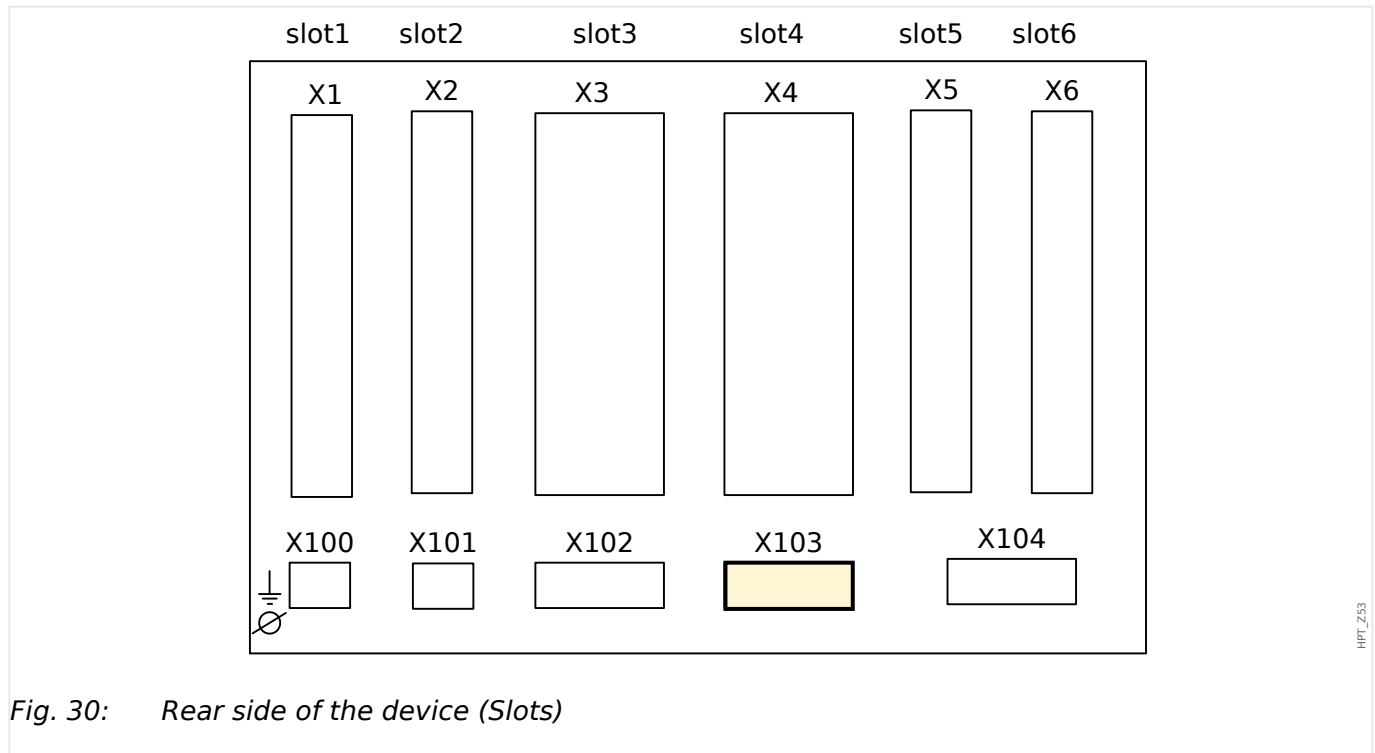

The data communication interface in the **X103** slot is dependent on the [ordered device type](#). The scope of functions is dependent on the type of data communication interface.

Available assembly groups in this slot:

- [RS485 terminals](#) for Modbus, DNP and IEC
- [Fiber Optics interface](#) for Profibus, Modbus, DNP and IEC
- [D-SUB interface](#) for Modbus, DNP and IEC
- [D-SUB interface](#) for Profibus
- [Fiber Optics interface](#) for Ethernet

NOTICE!



The available combinations can be gathered from the [ordering code](#).

2.11.1 Modbus® RTU / IEC 60870-5-103 via RS485

WARNING!



Ensure the correct tightening torques.

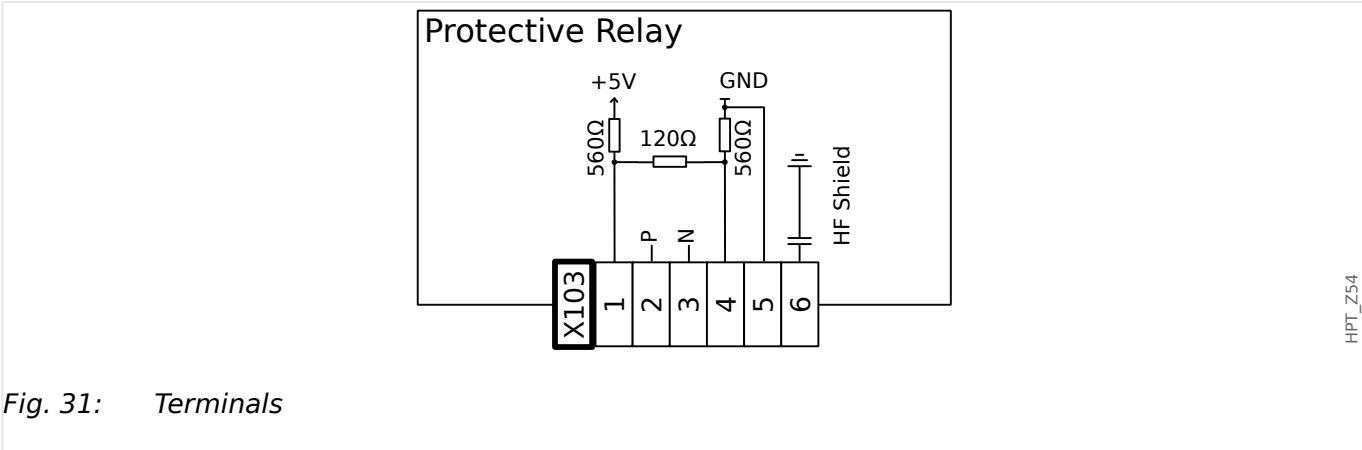
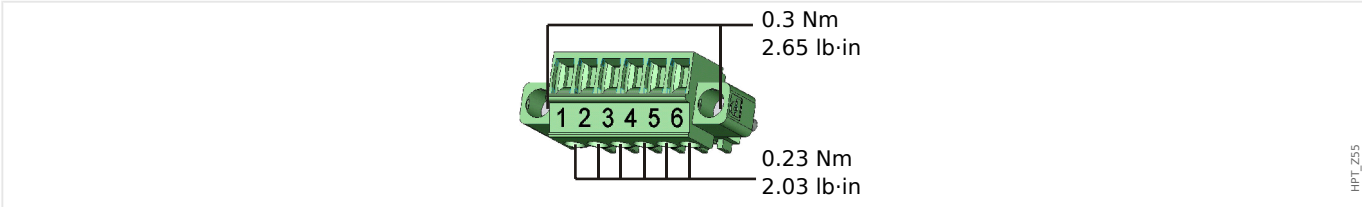

Fig. 31: Terminals

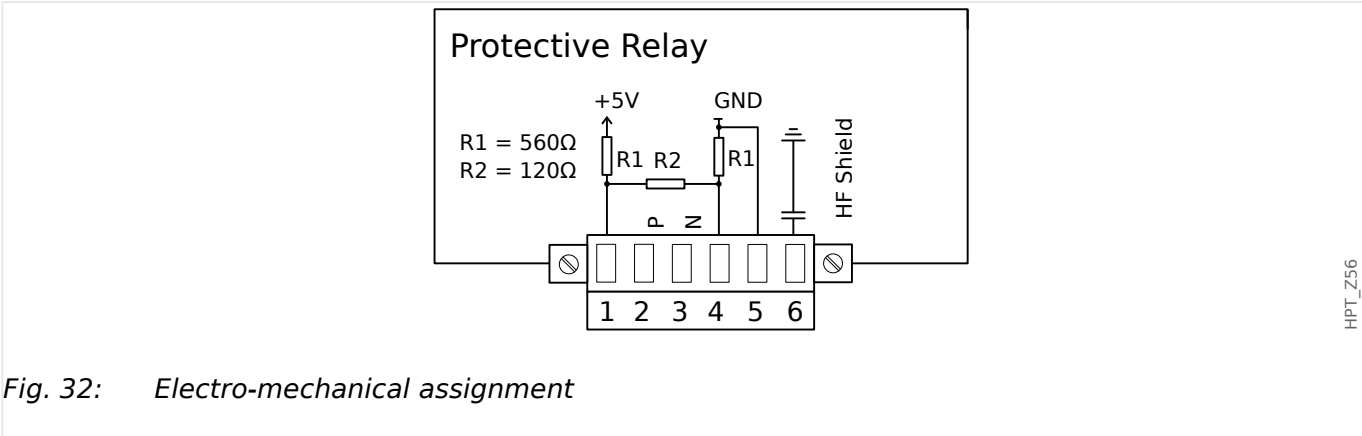



Fig. 32: Electro-mechanical assignment

NOTICE!



The Modbus® / IEC 60870-5-103 connection cable must be shielded. The shielding has to be fixed at the screw beneath the interface at the rear side of the device.

The communication is halfduplex.

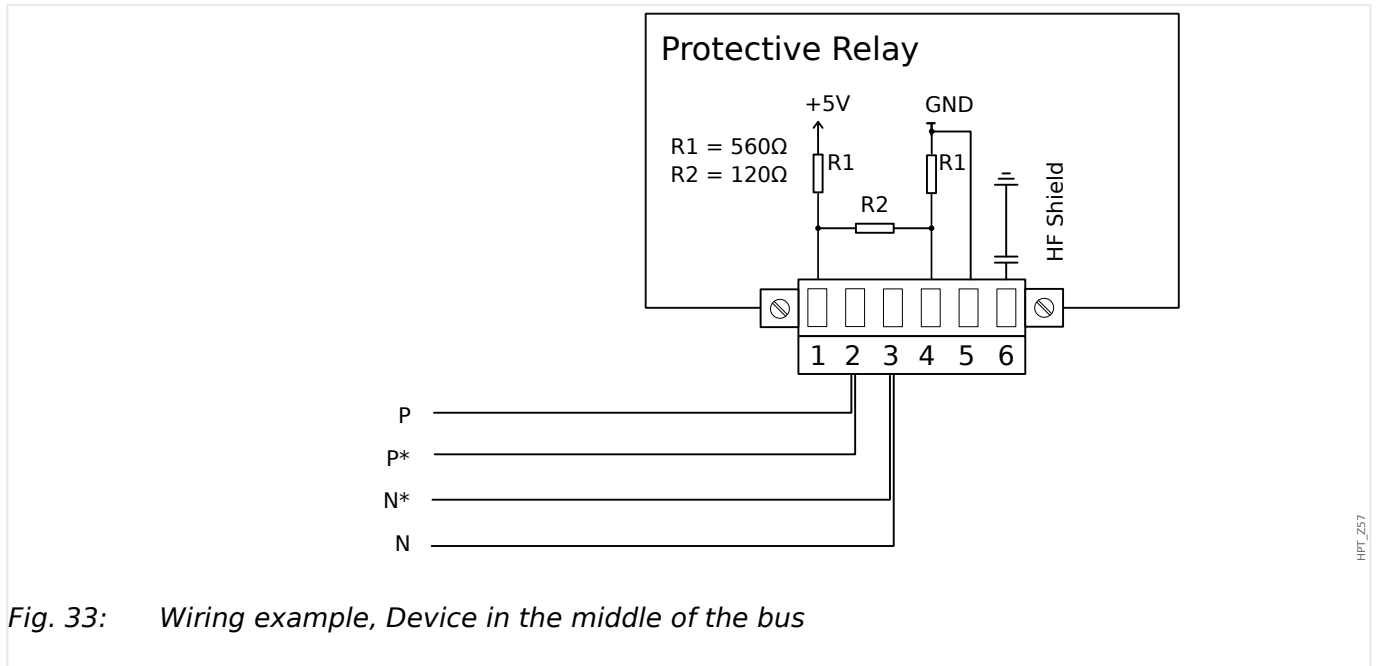

HPT_Z57

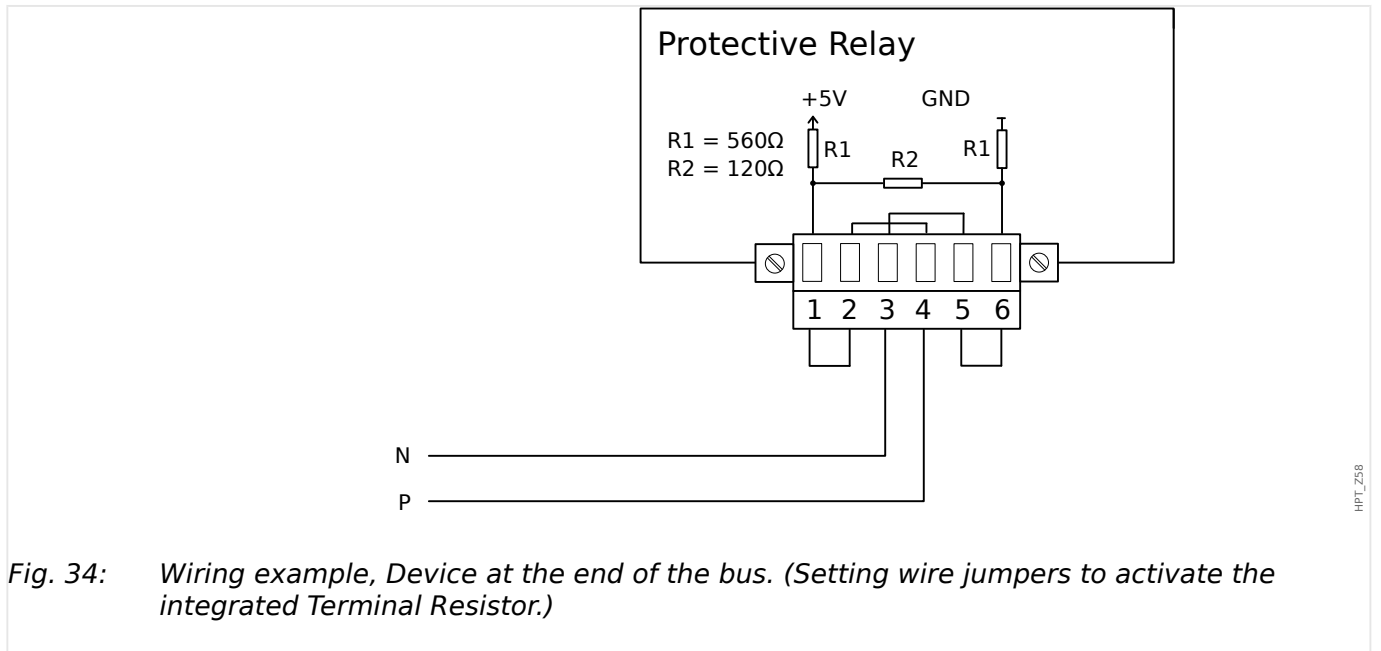

HPT_Z58

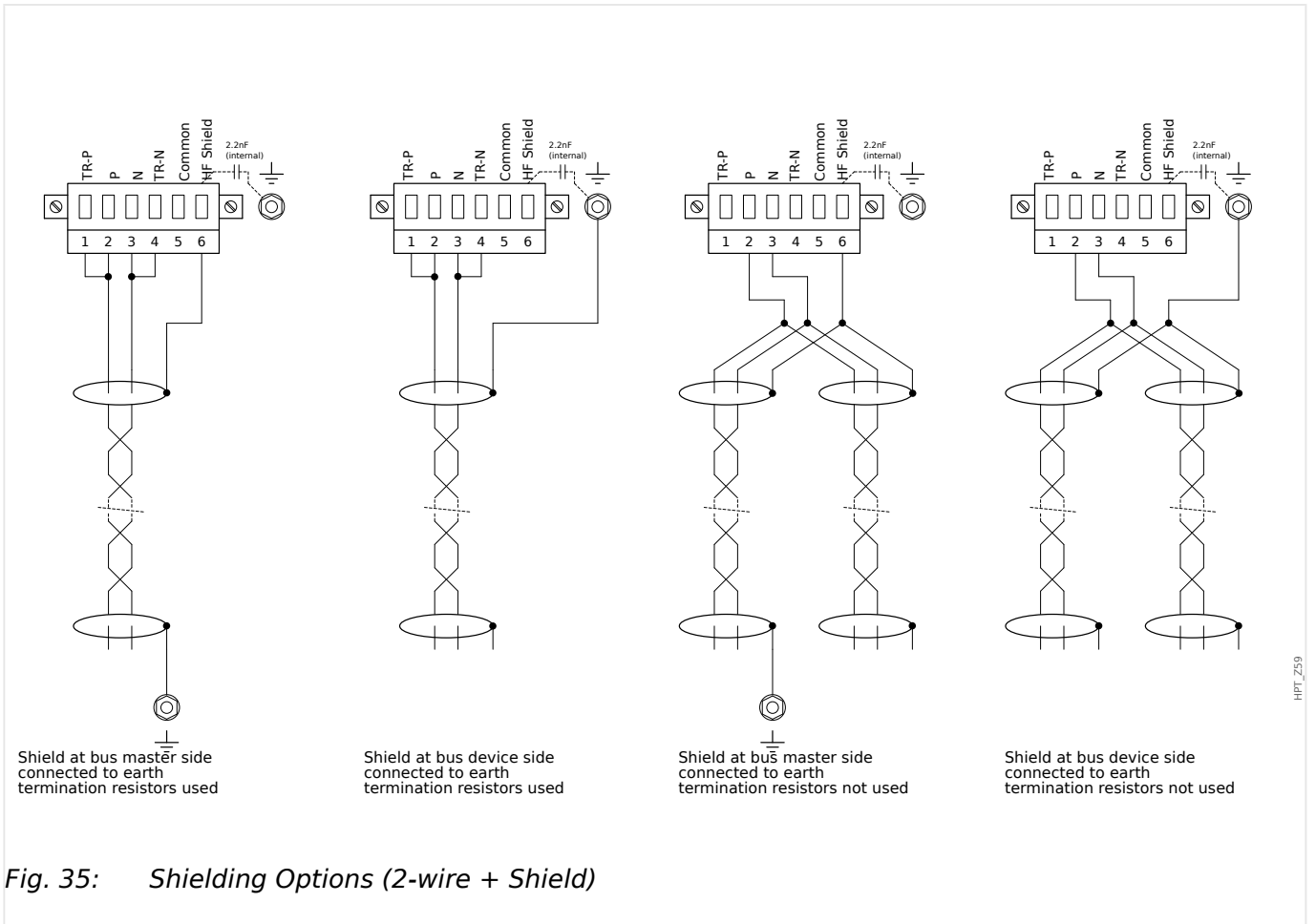
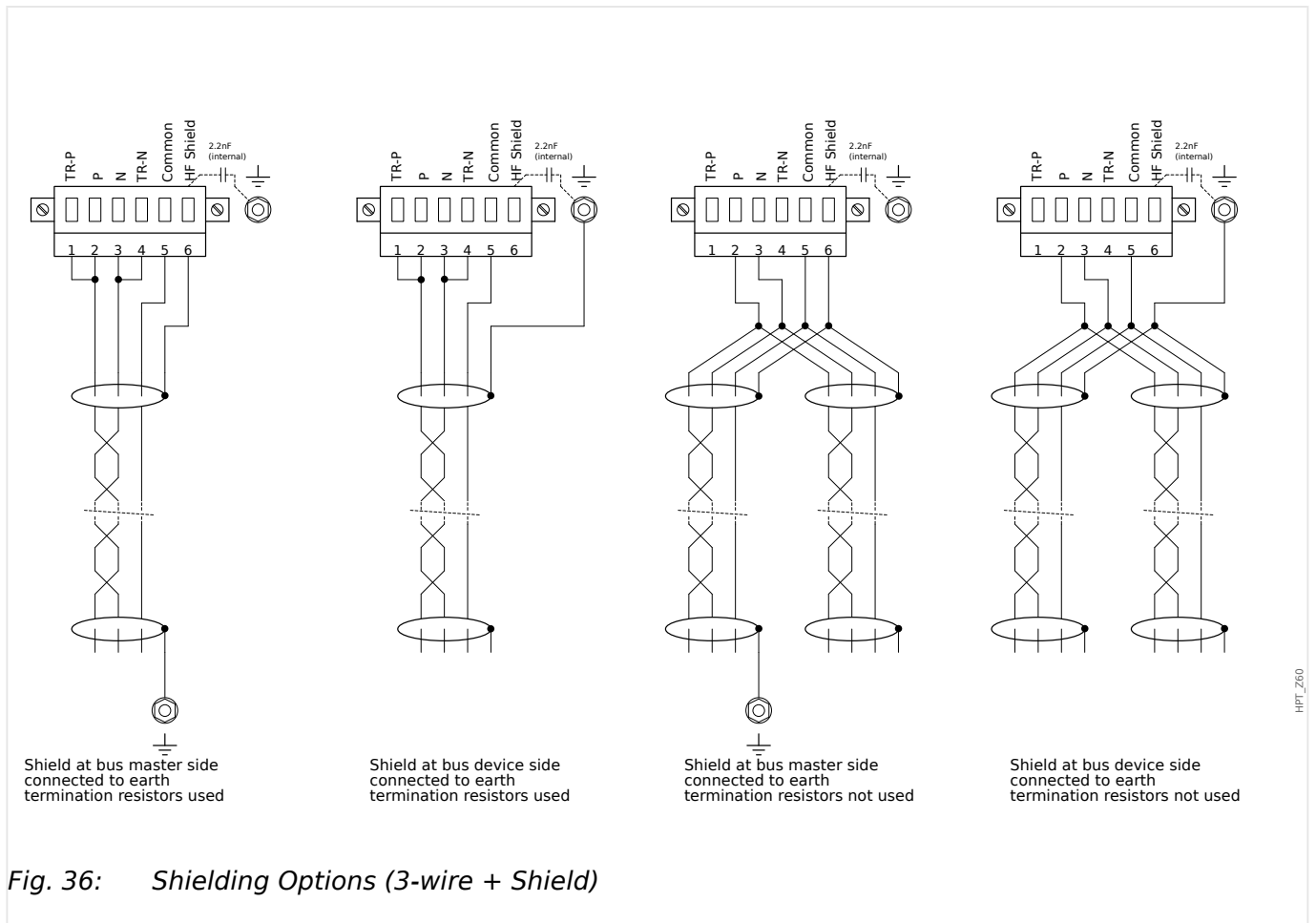

Fig. 35: Shielding Options (2-wire + Shield)

2 Hardware

2.11.1 Modbus® RTU / IEC 60870-5-103 via RS485



2.11.2 Profibus DP/ Modbus® RTU / IEC 60870-5-103 via Fiber Optic

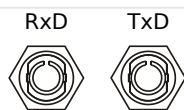

HPT_Z61

Fig. 37: Fiber Optic – FO, ST connector

WARNING!



Do not look directly into the light beam that is emitted from the fiber optics connector!

Serious injury of the eyes can be consequence of ignoring this warning.

2.11.3 Profibus DP via D-SUB

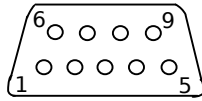

HPT_262

D-SUB assignment - bushing

- 1: Earthing/shielding
- 3: RxD TxD - P: High-Level
- 4: RTS-signal
- 5: DGND: Ground, neg. Potential of aux voltage supply
- 6: VP: pos. Potential of the aux voltage supply
- 8: RxD TxD - N: Low-Level

NOTICE!



The connection cable must be shielded. The shielding has to be fixed at the screw which is marked with the ground symbol at the back side of the device.

2.11.4 Modbus® RTU / IEC 60870-5-103 via D-SUB

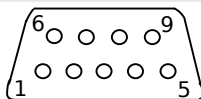

HPT_262

D-SUB assignment - bushing

- 1: Earthing/shielding
- 3: RxD TxD - P: High-Level
- 4: RTS-signal
- 5: DGND: Ground, neg. Potential of aux voltage supply
- 6: VP: pos. Potential of the aux voltage supply
- 8: RxD TxD - N: Low-Level

NOTICE!



The connection cable must be shielded.

2.11.5 Ethernet / TCP/IP via Fiber Optics

RxD TxD



HPT_Z63

Fig. 38: Fiber Optics – FO, LC duplex connector.

CAUTION!



After plugging in the LC connector, fasten the metal protecting cap.

The tightening torque for the screw is 0.3 Nm [2.65 lb·in].

WARNING!



Do not look directly into the light beam that is emitted from the fiber optics connector!

Serious injury of the eyes can be consequence of ignoring this warning.

2.12 Slot X104: IRIG-B00X and Selfsupervision Contact

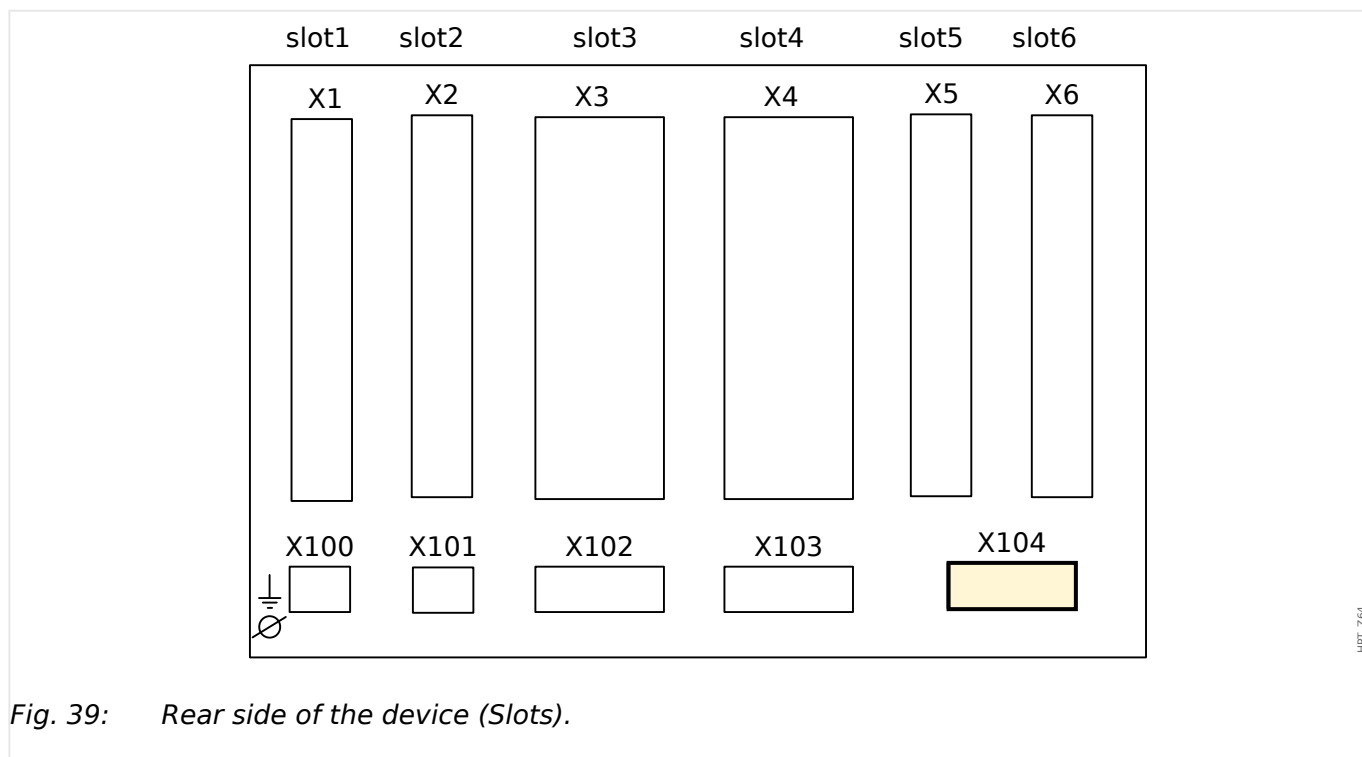

Fig. 39: Rear side of the device (Slots).

This slot comprises the IRIG-B00X and the Selfsupervision Contact.

Available assembly groups in this slot:

- IRIG-B00X, incl. Selfsupervision Contact

2.12.1 Self-Supervision Contact (SC)/Life-Contact and IRIG-B00X

WARNING!



Ensure the correct tightening torques.

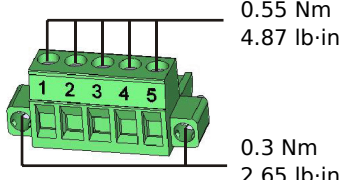

0.55 Nm
4.87 lb·in

0.3 Nm
2.65 lb·in

HPT_Z67

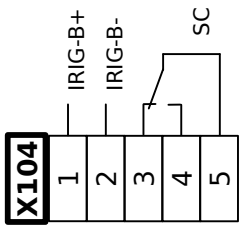

X104

1 IRIG-B+
2 IRIG-B-
3 SC
4 SC
5 SC

HPT_Z65

Fig. 40: Terminals

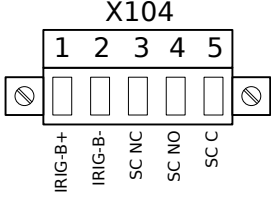

X104

1	2	3	4	5
IRIG-B+	IRIG-B-	SC NC	SC NO	SC C

HPT_Z66

Fig. 41: Electro-mechanical assignment

Self-Supervision Contact

The Self-Supervision Contact contact (“SC”) cannot be configured. It is a changeover (Form “C”) contact that picks up when the device is free from internal faults. While the device is booting up, the “SC” relay remains dropped-off (unenergized). As soon as the system is properly started (and protection is active), it picks up and the assigned LED is activated accordingly (please refer to the Self Supervision chapter, [“9 Self-Supervision”](#)).

2.13 PC Interface - X120

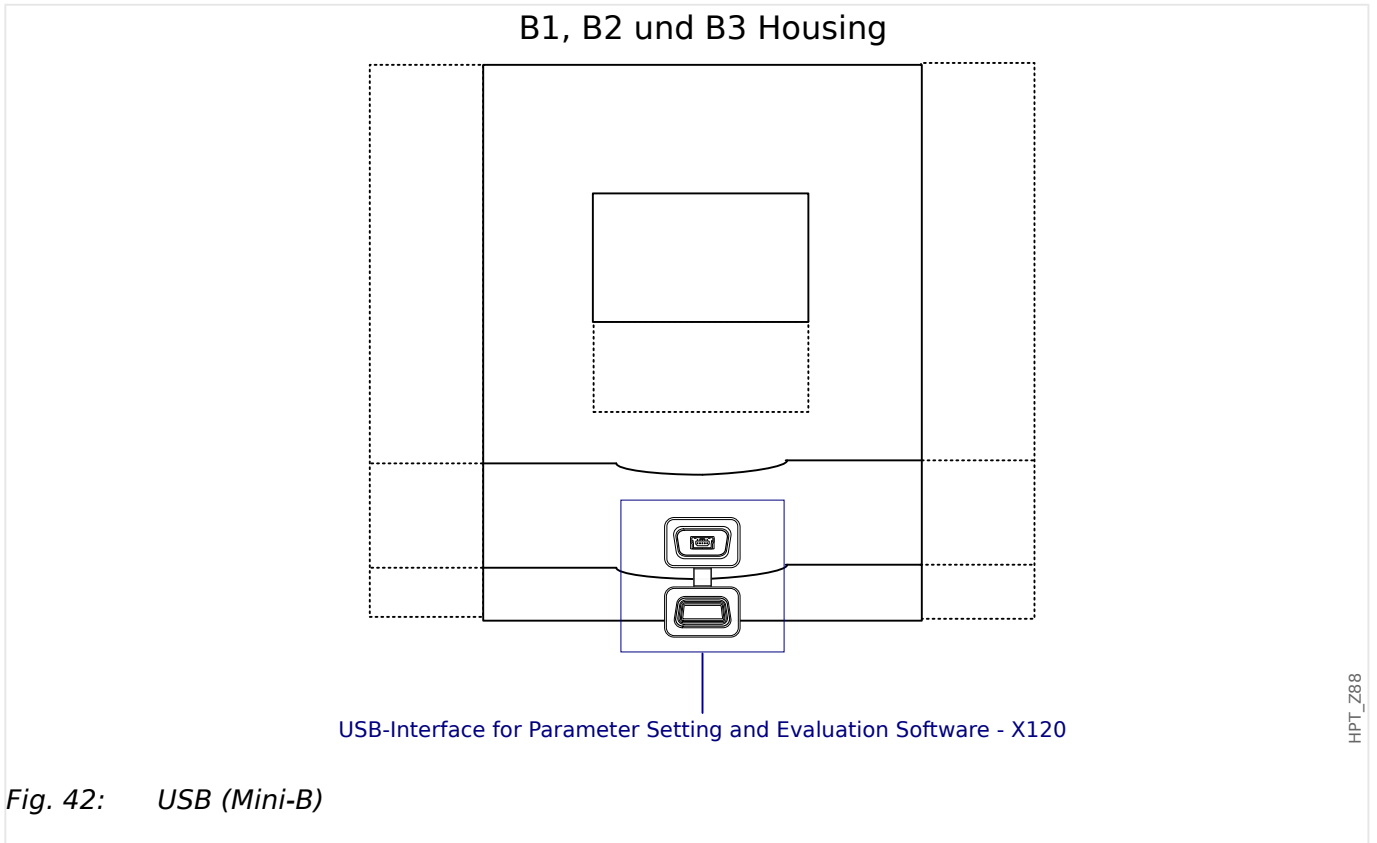

Fig. 42: USB (Mini-B)

2.14 Input, Output and LED Settings

2.14.1 LEDs

LED Configuration

The LEDs can be configured within the menu branches [Device Para / LEDs / LEDs group A] (LED column left to the display) and [Device Para / LEDs / LEDs group B] (LED column right to the display).

CAUTION!



Attention must be paid to ensure that there are no overlapping functions due to double or multiple LED assignment of colors and flashing codes.

NOTICE!



This chapter contains information on the LEDs that are placed on the left-hand side of the display (Group A).

If your device is also equipped with LEDs on the right-hand side of the display (Group B), the information given in this chapter is valid in the same way, and the only difference between "Group A" and "Group B" is within the menu paths.

Apart from the LED for System OK (that has a fixed function), each LED can be configured via the following parameters:

- »Assigned signals«: The parameters [Device Para / LEDs / LED x] »Assignment 1« to »Assignment 5« can be used to assign up to 5 trigger signals to "LED number x".
- »Inverting«: The parameters »Inverting 1« to »Inverting 5«, if set to "active", can be used to invert the respective trigger signal.

Note that for a **non-assigned** trigger signal (i. e. »Inverting n« = "-") the inverting is ineffective, so that the trigger signal is always simply treated as a binary "0" (False/inactive).

- »Latching/self holding function«: With the setting »Latched« = "active", the state that is set by the trigger signals is permanently stored. (See section "Latching" below,  "Latching".)
- If »Latched« = "inactive", the LED always adopts the state of the assigned signals.
- »Ack signal«: This setting is available only if »Latched« = "active". It assigns a signal that will reset the latching of the LED. (This, however, is effective only if all assigned trigger signals have dropped out.)
- »LED active color«: The LED lights up in this color if at least one of the assigned trigger signals is active. Available setting values are: "-" (No assignment), "green", "red", "red flash", "green flash".
- »LED inactive color«: The LED lights up in this color when none of the allocated functions is active. (The available settings are the same as for the active color above.)

»INFO« **Push-Button**

Via the »INFO« button it is always possible to display the current status of the assigned trigger signals.

Main LED overview:

If the »INFO« key is pressed once, the »main overview of the left LEDs« is displayed (for the LEDs on the left-hand side).

If the »INFO« key is pressed a second time, the »main overview of the LEDs on the right-hand side« are displayed (if available).

Pressing the softkey “◀” »left« (or the »INFO« key a third time) takes the user back to the previous screen, i. e. you leave the main LED overview.

For each LED, only the first assignment is shown (or “-.-” if there is none).

In addition, the available softkeys are shown periodically for a short time.

If there is more than one signal assigned to an LED, this is indicated by 3 dots at the right margin: “...” – The complete list of assignments can then be seen on the »multiple assignment page«.

LED multiple assignment page:

On the main overview page use the softkeys “▲” (Up) or “▼” (Down) to select an LED.

Then you can enter the »LED multiple assignment page« for the selected LED by pressing “▶” (Enter) Softkey.

This page shows all assignments for this LED, and an arrow symbol points leftwards, to the selected LED.

A (ticked “☑” / unticked “☐”) checkbox next to each assigned signal indicates whether or not the signal is currently active.

Via the softkeys “▲” (Up) or “▼” (Down) you can select the next / previous LED.

Pressing the softkey “◀” (Left) takes the user back to the previous screen, i. e. you will return to the main LED overview.

Latching

If an LED is configured as »Latched« = “active”, it will keep its state – regardless whatever may happen – until it is acknowledged (see “Acknowledgment Options” below).

A latched LED gets reset only in any of the following cases and only after all assigned trigger signals have dropped out:

- It is acknowledged (either by the user at the HMI, or via SCADA), see below.
- It is reset (acknowledged) by the signal that has been assigned to the parameter »Ack signal«.
- It is re-configured to »Latched« = “inactive”.
- If no trigger signal at all is assigned, i. e. **all** »Assignment *n*« have been set to “-”.

Note that a latched LED does **not** get reset in case of a restart of the MRDT4: After a (warm or cold) restart, every latched LED will return to its individual (previously assumed) state.

Acknowledgment Options

Resetting a latched LED will always require an acknowledgment. (For a detailed description, see [↪](#) “1.5 Acknowledgments”.)

LEDs can be acknowledged by:

- Via the push-button »C« at the operating panel, see [↪](#) “Manual Acknowledgment (by Pressing the C Key at the Panel)”.
- The LED can be acknowledged by the signal that has been assigned to the parameter »Ack signal«.
- All latched LEDs can be acknowledged at once by the signal that has been assigned to the parameter [Device Para / Acknowledge] »Ack LED«.
- All LEDs can be acknowledged at once via Communication (SCADA).
- All LEDs can be acknowledged at once automatically in case of an alarm from a protection function.

Remark: The two options, that allow for resetting all LEDs at once via signal or SCADA, are available only if [Device Para / Acknowledge] »Remote Reset« = “active”.

The last option, that allows for resetting all LEDs at once in case of a protection alarm, must be activated by setting: [Device Para / LEDs / LEDs group A / LED 1...n] »Latched« = “active, ack. by alarm”.

See also [↪](#) “1.5 Acknowledgments” for more information.

NOTICE!



The Product-CD that is delivered with the device contains a PDF-Template in order to create and print out self adhesive films for LED assignment texts (front foil) by means of a laser printer. Recommendation: (AVERY Zweckform Art. Nr. 3482)

Functionality

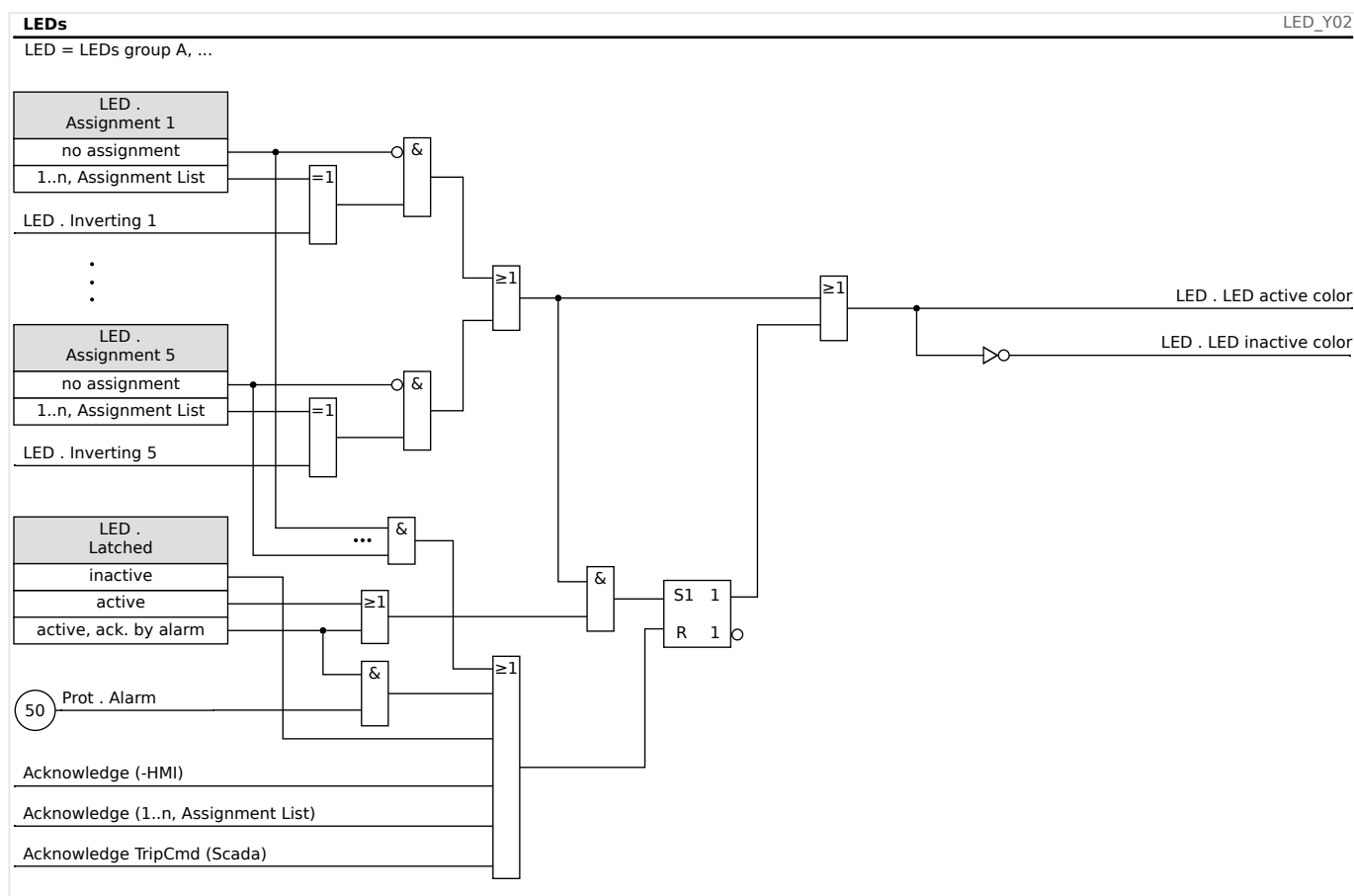

The »System OK« LED

This LED flashes green while the device is booting. After booting is complete, the LED for System OK lights up in green, signaling that the protection (function) is »activated«. Please refer to [9 Self-Supervision](#) and to the external document *Troubleshooting Guide* to find out further information on blink codes of the System OK LED.

The »System OK« LED cannot be configured.

2.14.2 Configuration of the Digital Inputs

The State of the Digital Inputs can be checked within the menu: [Operation / Status Display / name of the assembly group (e. g. "DI-8 X")]

The Digital Inputs can be configured within the menu: [Device Para / Digital Inputs / name of the assembly group (e. g. "DI-8 X") / Group X]

Set the following parameters for each of the groups of digital inputs:

- »Nom voltage« — the nominal voltage of the digital inputs.
- »Debouncing time 1...n« — A state change will only be adopted by the digital input after the debouncing time has expired.
- »Inverting 1...n« — Optional inverting of the input signal.

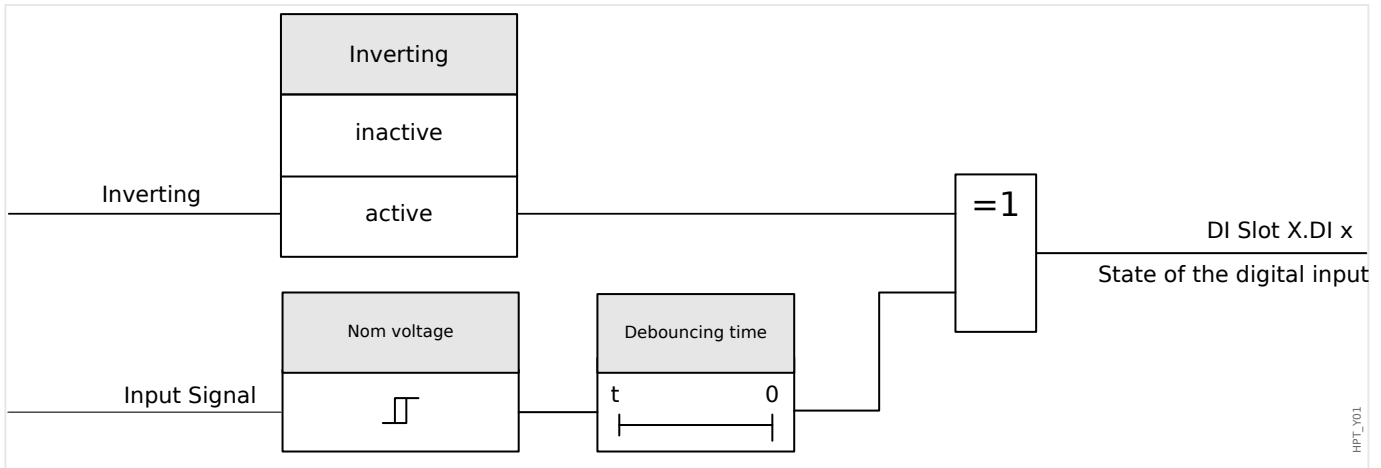

HPT_Y01

CAUTION!

! The debouncing time will be started each time the state of the input signal alternates.

CAUTION!

! In addition to the debouncing time that can be set via software, there is always a hardware debouncing time (approx 12 ms) that cannot be turned of.

There are two options available in order to determine where a Digital Input should be assigned to.

Assignment of Digital Inputs

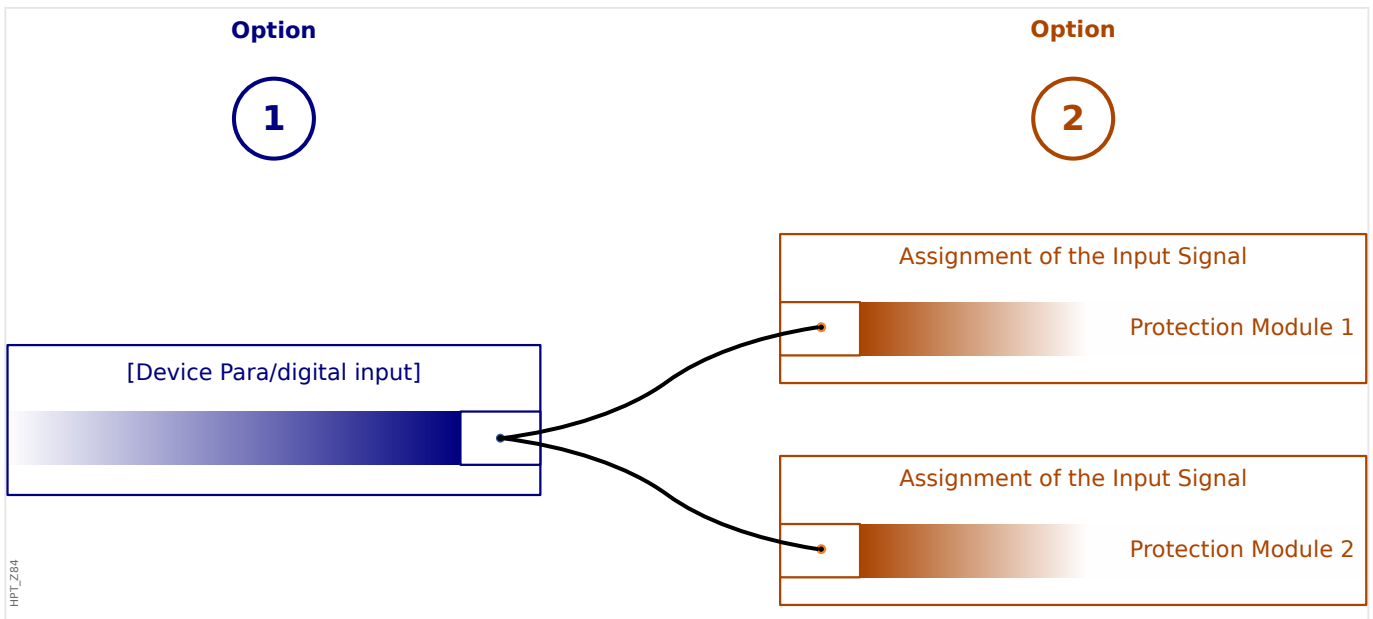

HPT_Z84

Option 1: Assigning a Digital Input onto one or mutiple modules.

Adding an assignment:

Within menu [Device Para / Digital Inputs], Digital Inputs can be assigned onto one or multiple targets.

Call up the Digital Input (Arrow right on the DI). Click on the Softkey »Parameter Setting/Wrench«. Click on »Add« and assign a target. Assign where required additional targets.

Deleting an assignment:

Select as described above a Digital Input that should be edited at the HMI.

Call up the assignments of the Digital Input (Arrow-right on the DI) and select the assignment that should be removed/deleted (Please note, this has to be marked with the cursor). The assignment can now be deleted at the HMI by means of the Softkey »Parameter setting« and selection of »remove«. Confirm the parameter setting update.

Option 2: Connecting a Module Input with a Digital Input

Call a module. Within this module assign a Digital Input onto a module input.

Example: A protection module should be blocked depending on the state of a Digital Input. For this assign onto the blocking input within the Global Parameters the Digital Input (e. g. »ExBlo1«).

Checking the Assignments of a Digital Input

In order to check the targets that a Digital Input is assigned to please proceed as follows:

Call up menu [Device Para / Digital Inputs].

Navigate to the Digital Input that should be checked.

At the HMI:

A multiple assignment, that means if a Digital Input is used more than once (if it is assigned to multiple targets), this will be indicated by an ellipsis "..." next to a Digital Input. Call up this Digital Input by Softkey »Arrow right« in order to see the list of targets of this Digital Input.

2.14.3 Output Relays Settings

The State of the Relay Outputs can be checked within the menu: [Operation / Status Display / Name of the assembly group (e. g. BO-3 X)]

The Relay Outputs can be configured within the menu: [Device Para / Binary Outputs / Name of the assembly group (e. g. BO-3 X)]

The conditions of module outputs and signals/protective functions (such as reverse interlocking) can be passed by means of alarm relays. The alarm relays are potential-free contacts (which can be used as opening or closing contact). Each alarm relay can be assigned up to 7 functions out of the »assignment list«.

Set the following parameters for each of the binary output relays:

- »Assigned signals«: The parameters »Assignment 1« to »Assignment 7« can be used to assign up to 7 trigger signals (OR-connected).
- »Inverting«: The parameters »Inverting 1« to »Inverting 7«, if set to "active", can be used to invert the respective trigger signal.

Note that for a **non-assigned** trigger signal (i. e. »Assignment n« = "-") the inverting is ineffective, so that the trigger signal is always simply treated as a binary "0" (False/inactive).

- With the setting »Inverting« = "active", the (collective) state of the binary output relay can be inverted (open or closed circuit current principle).

Note that if **no signals at all** have been assigned (i. e. **all** »Assignment n« = "-") this inverting is ineffective, so that the (collective) state is always simply treated as a binary "0" (False/inactive).

- By the »Operating Mode« it can be determined whether the relay output works in working current or closed-circuit principle.
- With the setting »Latched« = "inactive", the relay contact continuously adopts the state of the assigned signals.
- With the setting »Latched« = "active", the state of the relay contact is stored permanently. (See also the "Latching" section below,  "Latching".)
- »Acknowledgement«: This setting is available only if »Latched« = "active". It assigns a signal that will reset the latching of the relay contact. (This, however, is effective only if all assigned trigger signals have dropped out.)

The relay contact can only be acknowledged after all signals that had initiated the setting of the relay have dropped out, and after the minimum retention time »t-Off Delay« has elapsed.

- »t-hold«: At signal changes, the minimal latching time ensures that the relay will be maintained picked-up or released for at least this period.

NOTICE!



The System OK alarm relay (SC) (watchdog) cannot be configured.

Latching

If a binary output is configured as »Latched« = "active", it will keep its state - regardless whatever may happen - until it is acknowledged (see "Acknowledgment Options" below).

A latched binary output gets reset only in any of the following cases and only after all assigned trigger signals have dropped out:

- It is acknowledged (either by the user at the HMI, or via SCADA), see below.
- It is reset (acknowledged) by the signal that has been assigned to the parameter »Acknowledgement«.
- It is re-configured to »Latched« = "inactive".
- If no trigger signal at all is assigned, i. e. **all** »Assignment n« have been set to "-".

Note that a latched binary output does **not** get reset in case of a restart of the MRDT4: After a (warm or cold) restart, every latched output will return to its individual (previously assumed) state.

Acknowledgment Options

Resetting a binary output in a latched position will always require an acknowledgment. (For a detailed description, see [↳ "1.5 Acknowledgments"](#).)

Binary output relays can be acknowledged:

- Via the push-button »C« at the operating panel.
- The relay output contact can be acknowledged by the signal that has been assigned to the parameter »Acknowledgement«.
- All binary output relays can be acknowledged at once by the signal that has been assigned to the parameter [Device Para / Acknowledge] »Ack BO«.
- All output relays can be acknowledged at once via SCADA.

Remark: The last two options, that allow for resetting all outputs at once, are available only if [Device Para / Acknowledge] »Remote Reset« = "active".

WARNING!



Relay output contacts can be set by force or disarmed (for commissioning support. Please refer to the following chapters: [↳ "10.3.4 Disarming the Relay Output Contacts"](#), [↳ "10.3.3 Forcing the Relay Output Contacts"](#)).

Functionality

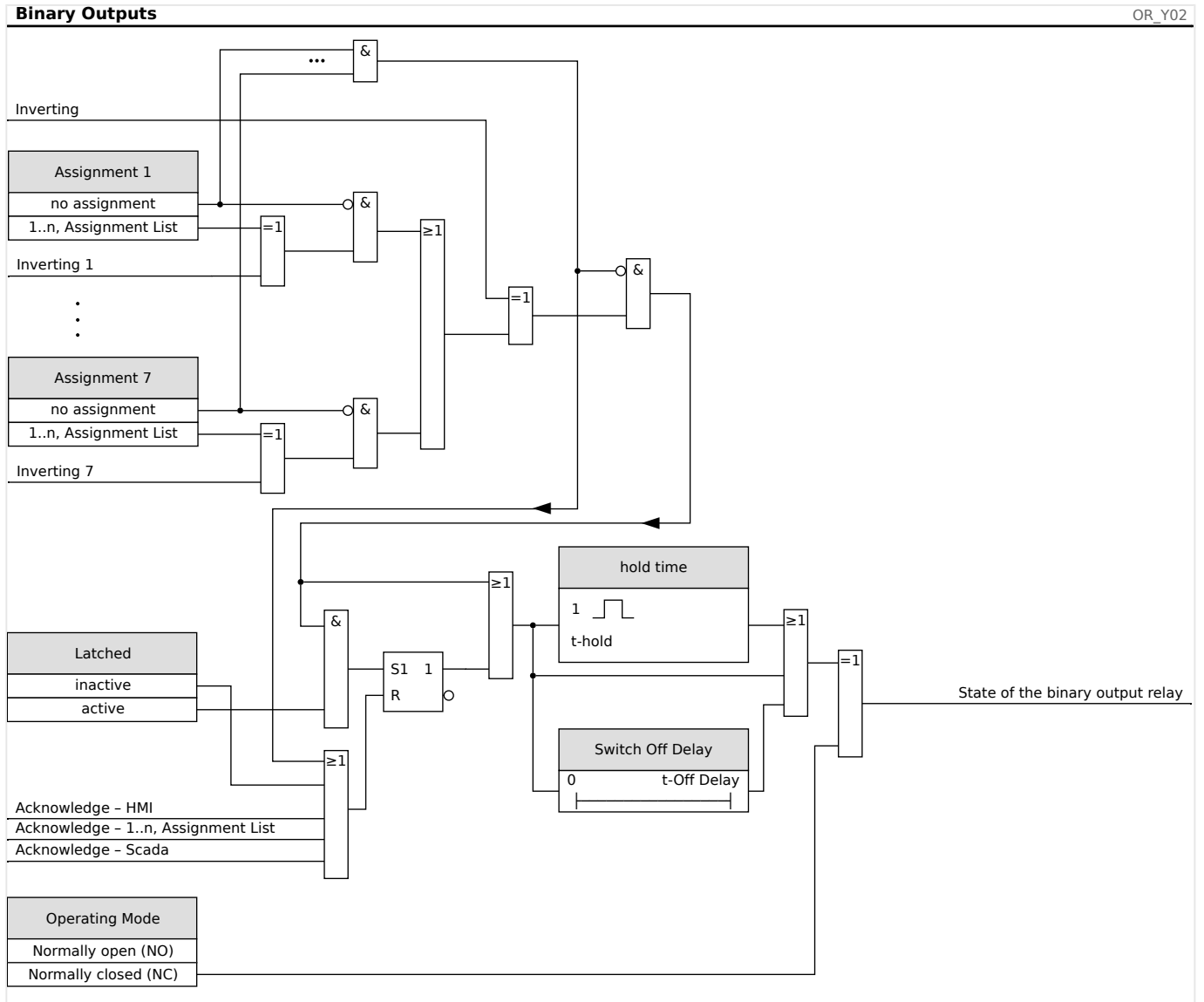

System Contact

The System OK alarm relay (SC) is the devices »life contact«. Its installation location depends on the housing type. Please refer to the wiring diagram of the device (WDC-contact).

The System-OK relay (SC) cannot be parameterized. The system contact is an operating current contact that picks-up, when the device is free from internal faults. While the device is booting up, the System OK relay (SC) remains dropped-off. As soon as the system was duly started up, the relay picks up and the assigned LED is activated accordingly (please refer to [“9 Self-Supervision”](#)).

3 Communication Protocols

3.1 General SCADA (Communication) Setting

The set of available SCADA protocols depends on the ordered hardware variant (see [↩➤](#) “1.2.1 Order Form of the Device”, [↩➤](#) “1.2.1.2 Communication Protocol Codes”).

You have to define which one of the available SCADA protocols the MRDT4 shall use. This is done by setting [Device planning] »*Protocol*« to the required communication protocol.

After this, you have to make some more settings related to the selected protocol.

3.2 TCP/IP Settings

NOTICE!



Establishing a connection via TCP/IP to the device is only possible if your device is equipped with an Ethernet Interface (RJ45).

Contact your IT administrator in order to establish the network connection.

Within menu [Device Para / TCP/IP / TCP/IP config] the TCP/IP settings have to be set.

The following settings have to be made:

- »TCP/IP« - This can be set to “active”. (The default is “inactive” so that the protocol is not used.)

NOTICE!



The other TCP/IP settings - see below - can only be set after »TCP/IP« has been set to “active”.

- »IP address« - the IPv4 address of the MRDT4.
- »Subnet mask« - the subnet mask that defines the IP address range of your local network.
- »Default gateway« - the default gateway: This address is contacted for all connections to IP addresses outside your local network (i. e. for IP addresses not matching the range of the subnet mask).

The first-time setting of the TCP/IP Parameters can be done at the panel (HMI) or via Smart view with USB connection.

Moreover, there are some special settings in the menu branch [Device Para / TCP/IP / Advanced Settings], see the Reference Manual. Only in very rare situations will it be necessary to modify their default values.

3.3 Profibus

Configuration of the Devices

After selecting Profibus as the SCADA protocol (via setting [Device planning] »*Protocol*« = "Profibus"), enter the menu branch [Device Para / Profibus] ; there you have to set the following communication parameter:

- »*Slave ID*«, to allow clear identification of the device This is a number from 2 to 125, which must be unique among all Profibus devices in the network.

In addition to that the Master has to be provided with the GSD-file. The GSD-file can be taken from the Product-CD.

Some more (Profibus-related) parameters that might be interesting are listed in the Reference Manual.

Hardware Connection

- The hardware connection to the control system depends on the ordered hardware variant (see [↳ "1.2.1 Order Form of the Device"](#), [↳ "1.2.1.2 Communication Protocol Codes"](#)): At the rear side of the MRDT4, there is either an RS485 (D-SUB) interface or an optic fiber (ST connector) interface available for the Profibus connection.
- Connect bus and MRDT4.
- Up to 123 Slaves can be connected.
- In case of a D-SUB interface, terminate the Bus by means of an Terminate Resistor.

Error Handling

Information on physical communication errors (e. g. the detected baud rate) can be obtained from the Event Recorder (see [↳ "7.3 Event Recorder"](#)) or the status display (menu branch [Operation / Status Display]).

Error Handling - D-SUB Status LED

The Profibus D-SUB interface at the rear side of the device is equipped with a status LED.

- Baud Search — red flashing
- Baud Found — green flashing
- Data Exchange — green
- Profibus protocol not selected at [Device planning] »*SCADA . Protocol*« — red

3.4 IEC 61850

Introduction

To understand the functioning and mode of operation of a substation in an IEC 61850 automation environment, it is useful to compare the commissioning steps with those of a conventional substation in a Modbus TCP environment.

In a conventional substation the individual IEDs (Intelligent Electronic Devices) communicate in vertically direction with the higher level control center via SCADA. The horizontal communication is exclusively realized by wiring output relays (OR) and digital inputs (DI) among each other.

In an IEC 61850 environment communication between the IEDs takes place digitally (via Ethernet) by a service called GOOSE (Generic Object Oriented Substation Event). By means of this service information about events is submitted between each IED. Therefore each IED has to know about the functional capability of all other connected IEDs.

Each IEC 61850 capable device includes a description of its own functionality and communications skills (IED Capability Description, *.ICD).

By means of a Substation Configuration Tool to describe the structure of the substation, assignment of the devices to the primary technique, etc. a virtual wiring of the IEDs among each other and with other switch gear of the substation can be done. A description of the substation configuration will be generated in form of an *.SCD file. At last this file has to be submitted to each device. Now the IEDs are able to communicate closed among each other, react to interlockings and operate switch gear.

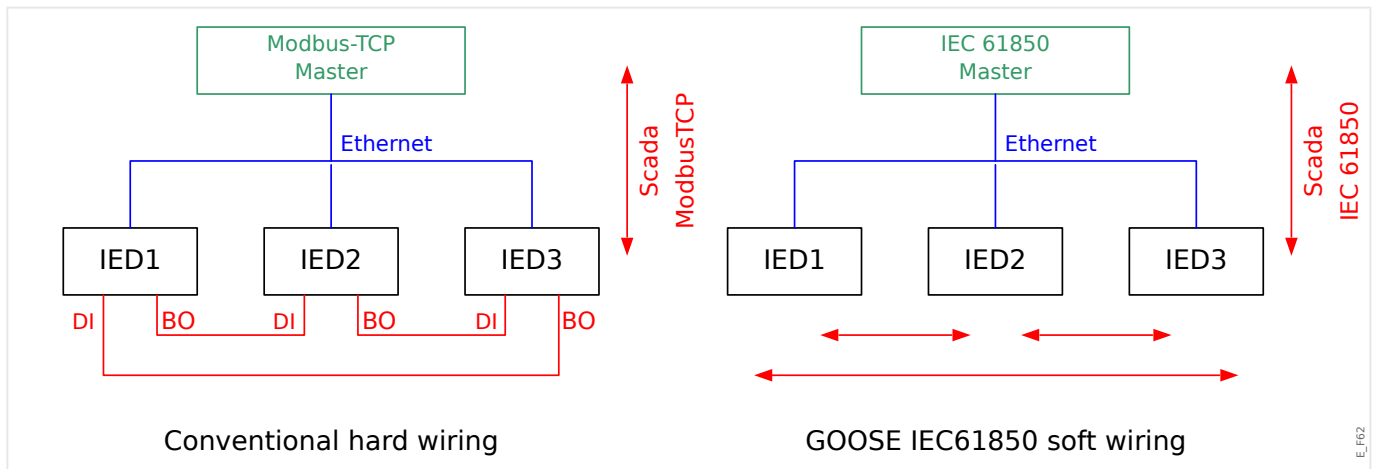

Commissioning steps for a conventional substation with modbus TCP environment:

- Parameter setting of the IEDs;
- Ethernet installation;
- TCP/IP settings for the IEDs;
- Wiring according to wiring scheme.

Commissioning steps for a substation with IEC 61850 environment:

- Parameter setting of the IEDs
- Ethernet installation
- TCP/IP settings for the IEDs

IEC 61850 configuration (software wiring):

- Exporting an ICD file from each device
- Configuration of the substation (generating an SCD file)
- Transmit SCD file to each device.

Generation / Export of a device specific ICD file

Please refer to chapter "IEC 61850" of the *Smart view* Manual.

Generation / Export of an SCD file

Please refer to chapter "IEC 61850" of the *Smart view* Manual.

Substation Configuration, Generation of .SCD file (Station Configuration Description)

The substation configuration, i. e. connection of all logical nodes of protection and control devices, as well as switch gear usually is done with a „Substation Configuration Tool“. Therefore the ICD files of all connected IEDs in the IEC 61850 environment have to be available. The result of the station wide "software wiring" can be exported in the form of an SCD file (Station Configuration Description).

Suitable Substation Configuration Tools (SCT) are available from the following companies:

- H&S, Hard- & Software Technologie GmbH & Co. KG, Dortmund (Germany) (⇒ www.hstech.de).
- Applied Systems Engineering Inc. (⇒ www.ase-systems.com)
- Kalki Communication Technologies Limited (⇒ www.kalkitech.com)

Import of the .SCD file into the device

Please refer to chapter "IEC 61850" of the *Smart view* Manual.

IEC 61850 Virtual Outputs

Additionally to the standardized logical node status information up to 64 free configurable status values can be assigned to 64 Virtual Outputs. This can be done in the menu [Device Para / IEC 61850 / Virt.Outp. 1...4].

IEC 61850 - Virtual Inputs

If there is an INPUT defined in the SCD file the status of the input can be checked at [Operation / Status Display / IEC 61850 / Virt.Inp. 1...4] »GOSINGGIO[1...4].Ind1...32.stVal«. For every status bit there is a corresponding Quality bit at [Operation / Status Display / IEC 61850 / Virt.Inp. 1...4] »GOSINGGIO[1...4].Ind1...32.q«.

GOOSE Status

The status of the GOOSE connection can be checked at [Operation / Status Display / IEC 61850 / State] »All Goose Subscriber active«. This signal summarizes the Quality of all Virtual Inputs (see above).

3.5 DNP3

DNP (Distributed Network Protocol) is for data and information exchange between SCADA (Master) and IEDs (Intelligent Electronic Devices). The DNP protocol has been developed in first releases for serial communication. Due to further development of the DNP protocol, it offers now also TCP and UDP communication options via Ethernet.

DNP Device Planning

Depending on the hardware of the protective device up to three DNP communication options are available within the Device Planning.

Enter the [Device planning] device planning menu and select the appropriate SCADA Protocol, depending on the device code.

- DNP3 RTU (via serial Port)
- DNP3 TCP (via Ethernet)
- DNP3 UDP (via Ethernet)

DNP Protocol General Settings

NOTICE!



Please note that unsolicited reporting is not available for serial communication, if more than one slave is connected to the serial communication (collisions). Do not use in these cases unsolicited reporting for DNP RTU.

Unsolicited reporting is available also for serial communication, if each slave is connected via a separated connection to the Master-System. That means, the master is equipped with a separate serial interface for each slave (multi serial cards).

Enter the menu [Device Para / DNP3 / Communication].

The Communication (General Settings) Settings have to be set according to the needs of the SCADA (Master) – System.

Self Addressing is available for DNP-TCP. That means that the Master and Slave id are auto-detected.

NOTICE!



Some Output signals (that are for a short time active only) have to be acknowledged separately (e. g. Trip signals) by the Communication System.

Point Mapping

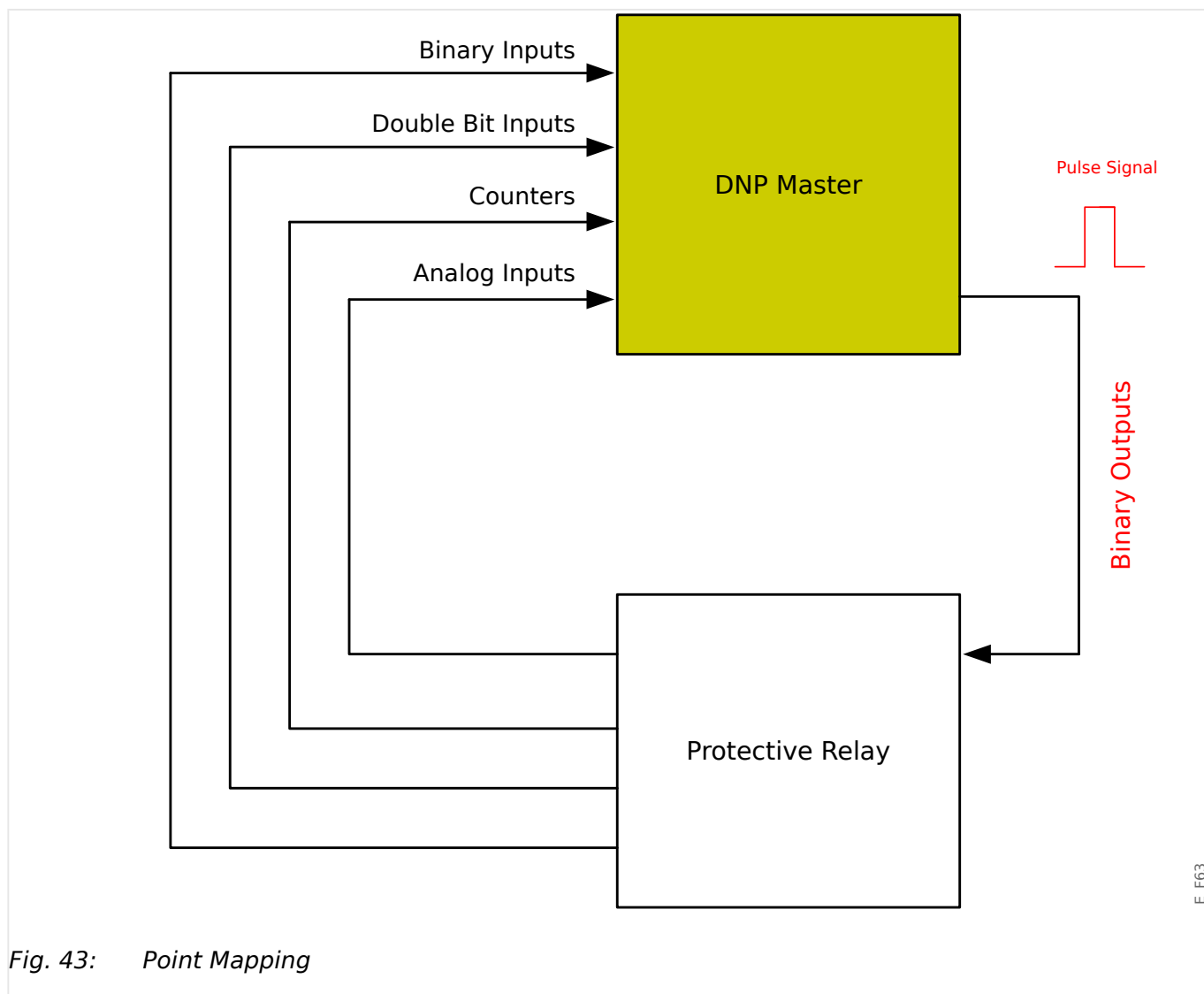

Fig. 43: Point Mapping

NOTICE!



Please take into account that the designations of inputs and outputs are set from the Masters perspective. This way of choosing the designations is due to a definition in the DNP standard. That means for example that Binary Inputs that can be set within the Device Parameters of the DNP protocol are the “Binary Inputs” of the Master.

Enter the menu [Device Para / DNP3 / Point map]. Once the general settings of the DNP protocol are done, the point mapping is to be done as a next step.

- Binary Inputs (States to be sent to the master):

Assign the required status signal (e. g. »Prot . Trip« to an available parameter [Device Para / DNP3 / Point map / Binary Inputs] »BinaryInput 0...63«.

- Double Bit Inputs (Breaker states to be sent to the master)

Assign the required signal (e. g. the breaker position »SG[1] . Pos« to an available parameter [Device Para / DNP3 / Point map / Double Bit Inputs] »DoubleBitInput 0...5«.

- Counters (Counters to be sent to the master)

Assign the required counter (e. g. the number of operating hours »Sys . Operating hours Cr« to an available parameter [Device Para / DNP3 / Point map / BinaryCounter] »*DoubleBitInput 0...7*«.

- Analog Inputs (e. g. measured values to be sent to the master). Please take into account that floating values have to be transmitted as integers. That means they have to be scaled (multiplied) with a scaling factor in order to bring them into the integer format.

Assign the required value (e. g. the phase current »CT . IL1« to an available parameter [Device Para / DNP3 / Point map / Analog Input] »*Analog value 0...31*«.

Then define the scaling for this parameter at [Device Para / DNP3 / Point map / Analog Input] »*Scale Factor 0...31*«.

Finally set the Deadband value for this parameter at [Device Para / DNP3 / Point map / Analog Input] »*Dead Band 0...31*«. This defines the value change for this data object (in percent of the maximum value) that will cause the protection device to re-send the changed value, and it is always a percentage of the *maximum* value. See also the examples given at [↳ “3.5.2 Deadband Settings in DNP3”](#).

Use Binary outputs in order to control e. g. LEDs or Relays within the protective device (via Logic).

Please try to avoid gaps that will slow down the performance of the DNP communication. That means do not leave unused inputs / outputs in between used inputs / outputs (e. g. do not use Binary Output 1 and 3 when 2 is unused).

3.5.1 Application Example: Setting a Relay

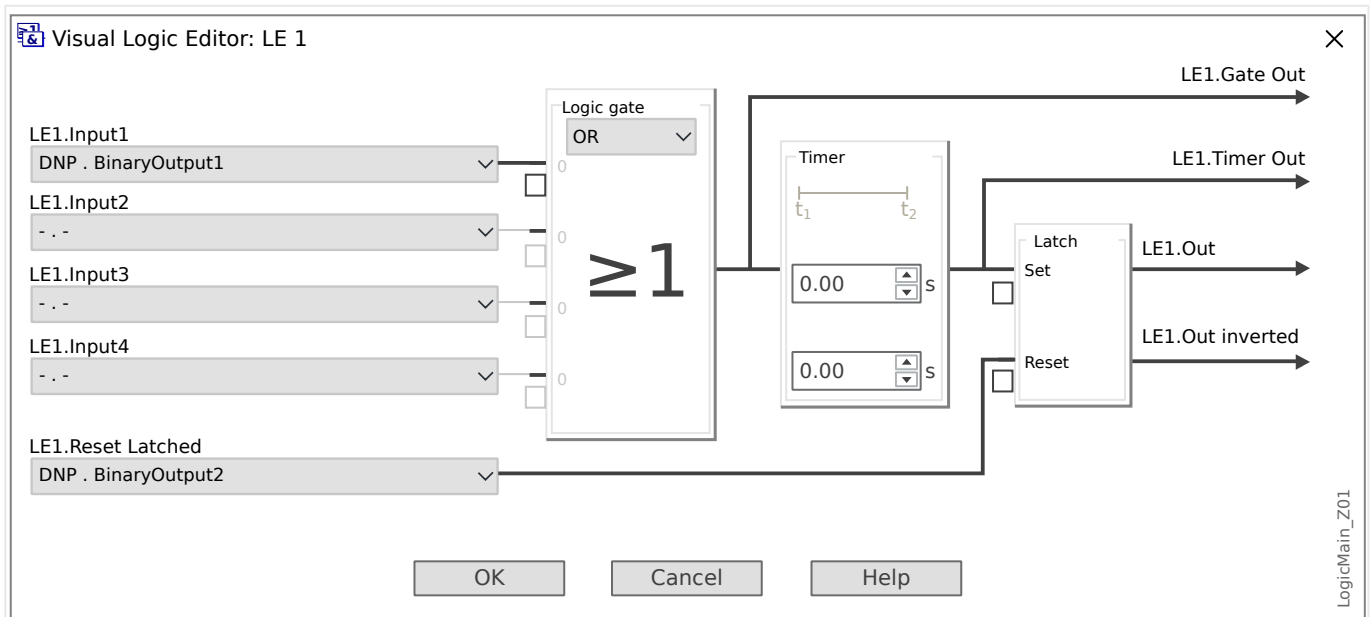

Fig. 44: Setting example from Smart view, to make a steady state signal from a DNP output signal.

Binary Output signals of the DNP cannot directly be used in order to switch relays because the DNP Binary Outputs are pulse signals (by DNP definition, not steady state). Steady states can be created by means of Logic functions and their Latching feature, see settings example above. The Logic Output signal can be assigned onto the Relay Input.

3.5.2 Deadband Settings in DNP3

The Deadband setting [Device Para / DNP3 / Point map / Analog Input] »*Dead Band 0... 31*« specifies for a measured (or statistical) value, for which change the updated value is transmitted again. The Deadband must always be specified in percent of the *maximum* value.

Examples for Deadband Settings

The Deadband setting shall be detailed by some examples.



Voltage (via “TU” Voltage Measuring Card)

- The voltage transformer card “TU” covers the voltage range 0 – 800 V. (See the “Technical Data” chapter in the manual.) In other words, the **maximum** value is **800 V**.
- The **rated** value (secondary) is **100 V**.
- Therefore the conversion factor from the percentage of the rated voltage to the *Deadband setting* is:
 $q = 100 \text{ V} / 800 \text{ V} = \mathbf{0.125}$
- For example, a deadband value of **10%**, given as a percentage of the *rated* voltage, is required.
- Then the Deadband setting value must be as follows:
 $10\% \cdot q = 0.0125 = \mathbf{1.25\%}$



Currents (1 A CT)

- The 1 A current transformers cover the range 0 – 40 A.
- The **rated** current (secondary) is **1 A**.
- Therefore the conversion factor from the percentage of the rated current to the *Deadband setting* is:
 $q = 1 \text{ A} / 40 \text{ A} = \mathbf{0.025}$
- For example, a deadband value of **10%**, given as a percentage of the *rated* current, is required.
- Then the Deadband setting value must be as follows:
 $10\% \cdot q = 0.0025 = \mathbf{0.25\%}$



Currents (5 A CT)

- The 5 A current transformers cover the range 0 – 200 A.
- The **rated** current (secondary) is **5 A**.
- Therefore the conversion factor from the percentage of the rated current to the *Deadband setting* is:
 $q = 5 \text{ A} / 200 \text{ A} = \mathbf{0.025}$
- For example, a deadband value of **10%**, given as a percentage of the *rated* current, is required.
- Then the Deadband setting value must be as follows:
 $10\% \cdot q = 0.0025 = \mathbf{0.25\%}$

✱

Earth (Ground) Current (1 A CT)

- The standard current transformer card “TI” covers the range 0 - 25 A.
- The **rated** current (secondary) is **1 A**.
- Therefore the conversion factor from the percentage of the rated current to the *Deadband setting* is:
 $q = 1 \text{ A} / 25 \text{ A} = \mathbf{0.04}$
- For example, a deadband value of **10%**, given as a percentage of the *rated* current, is required.
- Then the Deadband setting value must be as follows:
 $10\% \cdot q = 0.004 = \mathbf{0.4\%}$

✱

Sensitive Earth (Ground) Current (1 A CT)

- The sensitive current transformer card “TIs” covers the range 0 - 2.5 A.
- The **rated** current (secondary) is **1 A**.
- Therefore the conversion factor from the percentage of the rated current to the *Deadband setting* is:
 $q = 1 \text{ A} / 2.5 \text{ A} = \mathbf{0.4}$
- For example, a deadband value of **1%**, given as a percentage of the *rated* current, is required.
- Then the Deadband setting value must be as follows:
 $1\% \cdot q = 0.004 = \mathbf{0.4\%}$

✱

Power (1 A CT and “TU” Voltage Measuring Card)

- The value range is 0 - 32000 VA.
- The **rated** power (secondary) is based on the rated voltage and the rated current (secondary): $100 \text{ V} \cdot 1 \text{ A} \cdot \sqrt{3} = \mathbf{173.21 \text{ VA}}$.
- Therefore the conversion factor from the percentage of the rated power to the *Deadband setting* is:
 $q = 173.21 \text{ VA} / 32000 \text{ VA} = \mathbf{0.00541}$
- For example, a deadband value of **10%**, given as a percentage of the *rated* power, is required.
- Then the Deadband setting value must be as follows:
 $10\% \cdot q = 0.000541 = \mathbf{0.0541\%}$

✳

Power (5 A CT and “TU” Voltage Measuring Card)

- The value range is 0 – 160000 VA.
- The **rated** power (secondary) is based on the rated voltage and the rated current (secondary): $100\text{ V} \cdot 5\text{ A} \cdot \sqrt{3} = \mathbf{866.05\text{ VA}}$.
- Therefore the conversion factor from the percentage of the rated power to the *Deadband setting* is:
 $q = 866.05\text{ VA} / 160000\text{ VA} = \mathbf{0.00541}$
- For example, a deadband value of **10%**, given as a percentage of the *rated* power, is required.
- Then the Deadband setting value must be as follows:
 $10\% \cdot q = 0.000541 = \mathbf{0.0541\%}$

✳

Frequency (50 Hz Network)

- The value range is 40 – 70 Hz.
- The **rated** frequency is: **50 Hz**.
- Therefore the conversion factor from the percentage of the rated frequency to the *Deadband setting* is:
 $q = 50\text{ Hz} / 70\text{ Hz} = \mathbf{0.714}$
- For example, a deadband value of **0.1%**, given as a percentage of the *rated* frequency, is required.
- Then the Deadband setting value must be as follows:
 $0.1\% \cdot q = 0.000714 = \mathbf{0.0714\%}$

✳

Frequency (60 Hz Network)

- The value range is 40 – 70 Hz (i. e. the same as for 50 Hz).
- The **rated** frequency is: **60 Hz**.
- Therefore the conversion factor from the percentage of the rated frequency to the *Deadband setting* is:
 $q = 60\text{ Hz} / 70\text{ Hz} = \mathbf{0.857}$
- For example, a deadband value of **0.1%**, given as a percentage of the *rated* frequency, is required.
- Then the Deadband setting value must be as follows:
 $0.1\% \cdot q = 0.000857 = \mathbf{0.0857\%}$

※ **cos(ψ)**

This value is special because there is no rated value.

- The maximum value is 1.0.
- For example, a deadband value of **0.01** is required. (It makes not much sense to talk of percentages here.)
- Then the Deadband setting value must be as follows:
 $0.01 / 1.0 = \mathbf{1\%}$.

※ **ψ**

- All angle values are given in degree units, i. e. the maximum value is 360°.
- For example, a deadband value of **1°** is required. (It makes no sense to talk of percentages here.)
- Then the Deadband setting value must be as follows:
 $1^\circ / 360^\circ = \mathbf{0.278\%}$

3.6 IEC60870-5-103

In order to use the IEC60870-5-103 protocol it has to be assigned to the X103 Interface within the Device Planning. The device will reboot after setting this parameter.

Moreover, the IEC103 protocol has to be activated by setting [Device Para / IEC103] »*Function*« to “active”.

NOTICE!



The parameter X103 is only available if the device is at the rear side equipped with an interface like RS485 or Fiber Optic.

NOTICE!



If the device is equipped with an Fiber Optic Interface, the Optical Rest Position has to be set within the Device Parameters .

The time-controlled IEC60870-5-103 protocol is based on the Master-Slave working principle. This means that the substation control and protection system sends an enquiry or instruction to a certain device (slave address) which will then be answered or carried out accordingly.

The device meets the compatibility mode 2. Compatibility mode 3 is not supported.

The following IEC60870-5-103-functions will be supported:

- Initialization (Reset)
- Time Synchronization
- Reading out of time stamped, instantaneous signals
- General Queries
- Cyclic Signals
- General Commands
- Transmission of Disturbance Data

Initialization

The communication has to be reset by a Reset Command each time that the device is turned on or that communication parameters have been changed. The “Reset CU” Command resets. The relay acts on both Reset Commands (Reset CU or Reset FCB).

The relay acts on the reset command by an identification signal ASDU 5 (Application Service Data Unit), as a reason (Cause Of Transmission, COT) for the transmission of the answer either a “Reset CU” or a “Reset FCB” will be sent depending on the type of the reset command. This information can be part of the data section of the ASDU-signal.

Name of the Manufacturer

The section for the identification of the software contains three digits of the device code for the identification of the device type. Beside the upper mentioned identification number the device generates a communication start event.

Time Synchronization

Time and date of the relay can be set by means of the time synchronization function of the IEC60870-5-103 protocol. If the time synchronization signal is send out with a confirmation request, the device will answer with a confirmation signal.

Spontaneous Events

The events that are generated by the device will be forwarded to the master with numbers for standard function types / standard information. The data point list comprises all events that can be generated by the device.

Cyclic Measurement

The device generates on a cyclic base measured values by means of ASDU 9. They can be read out via a class 2 query. Please take into account that the measured values will be send out as multiples (1.2 or 2.4 times the rated value). How to set 1.2 or 2.4 as multiplier for a value can be taken from the data point list.

The parameter "Transm priv meas val" defines if additional measurement values should be transmitted in the private part. Public and private measured values are transmitted by ASDU9. That means that either a "private" or a "public" ASDU9 will be transmitted. If this parameter is set, the ASDU9 will contain additional measured values that are an enhancement of the standard. The "private" ASDU9 is send with a fixed function type and information number that does not depend the type of device. Please refer to the data point list.

Commands

The data point list comprises a list of the supported commands. Any command will be responded by the device with a positive or negative confirmation. If the command is executable, the execution with the corresponding reason for the transmission (COT) will be lead in at first, and subsequently the execution will be confirmed with COT1 within a ASDU9.

Disturbance Recording

The disturbances recorded by the device can be read out by means described in standard IEC60870-5-103. The device is in compliance with the VDEW-Control System by transmission of an ASDU 23 without disturbance records at the beginning of an GI-Cycle.

A disturbance record contains the following information:

- Analog Measured Values, IL1, IL2, IL3, IN, Voltages VL1, VL2, VL3, VEN;
- Binary States, transmitted as marks, e.g. Alarms and Trips.
- The Transmission ratio will not be supported. The transmission ratio is included in the "Multiplier".

Blocking the Transmission Direction

The relay supports the function to block the transmission in monitor direction. There are two ways to activate this blocking:

- Manual activation via Direct Control parameter »Activate Block MD«

- External activation, by assigning a signal to the setting parameter »*Ex activate Block MD*«

Test Mode

The relay supports the test mode (Cause of Transmission 7). There are two ways to activate the test mode:

- Manual activation via Direct Control parameter »*Activate test mode*«
- External activation, by assigning a signal to the setting parameter »*Ex activate test mode*«

3.7 Configurable Communication Protocols

Some of the SCADA protocols supported by the MRDT4 have an option to adapt the mapping of data objects to the protocol-internal addresses to one's own needs. This can be done using a separate PC software tool, *SCADApter*.

The protocols supporting such a re-mapping are currently as follows:

- IEC 60870-5-103, [↪ “3.6 IEC60870-5-103”](#) — The default mapping is available as IEC103_Default_IU.HptSMap.
- IEC 60870-5-104, [↪ “3.7.1 IEC 60870-5-104”](#) — The default mapping is available as IEC104_Default_IU.HptSMap.
- Modbus, [↪ “3.7.2 Modbus®”](#)
- Profibus, [↪ “3.3 Profibus”](#) — An example mapping is available as Profibus_Default_IU.HptSMap.

These *.HptSMap files can be downloaded from the web address that is accessible via the QR code that is printed on the device housing. Moreover, they are featured on the product DVD. (However, note that the product DVD has to be ordered separately.)

For detailed information about these communication protocols, see the *SCADApter* documentation and the respective protocol-specific chapters. The transfer of a new mapping to the MRDT4 is also described in [↪ “3.7.3 Data-Point Mapping Using the SCADApter”](#).

3.7.1 IEC 60870-5-104

The IEC 60870-5-104 protocol is a standardized communication protocol. It is available with HighPROTEC devices that are equipped with an Ethernet interface.

Although there is a standard mapping of data-points that comes with the MRDT4 it is expected that most users want to adapt the mapping to their own needs. This can be done using a separate PC software tool, *SCADApter*.

NOTICE!



The IEC104 protocol is only available if the device is equipped with an Ethernet interface (either RJ45 or fiber optic with LC duplex connector) at the rear side.

NOTICE!



See [↪](#) “13.3 IEC 60870-5-104 Interoperability” for the standard compatibility and implementation chapter.

Setup

At first the IEC104 protocol has to be selected as the SCADA protocol to be used:

Set [Device planning] »*Protocol*« to “IEC104”

Define the Common Address of the ASDU, so that the device can be uniquely identified:
[Device Para / IEC104 / General Settings] »*Common address*«.

(This setting is a Direct Command and therefore never saved as part of a parameter setting (*.HptPara) file, therefore it must be explicitly specified!)

Then the IEC104 protocol has to be activated by setting [Device Para / IEC104 / General Settings] »*Function*« to “active”.

Note that some settings in the menu branch [Device Para / IEC104 / Advanced] are intentionally implemented as “read-only” parameters, so that the network administrator can check the values, but a modification is not possible.

The setting [Device Para / IEC104 / Advanced] »*Update time*«, however, can be set to some time in the range 1 s ... 60 s: In case of cyclic transmission of measured values this setting defines the cycle duration (i. e. the time after that updated values are transmitted).

Whether a measured value is part of a cyclic transmission or not is an individual property of the data-point. For a user-defined data-point mapping, this property is settable. (See the documentation of the *SCADApter* for details.)

Information Object Address

The *SCADApter* configuration tool allows for creating and editing a mapping table that assigns data objects to their respective Information Object Address (“IOA”).

The IOA consists of three bytes according to the IEC104 companion standard. The *SCADApter* allows to set each byte separately, so that the user can assign each data object to an IOA according to the application-specific needs.

Data-Point Mapping of Measurement Values

In the *SCADA*pter configuration tool, there is a setting »Deadband« for each measured (or statistical) value. It defines the value change that will cause the updated value to be transmitted again.

Cyclic transmission is defined for a measured value by setting the Deadband percentage for this measured value to zero.

A non-zero Deadband percentage always refers to the *maximum* value of the respective measured value, see the examples in the *SCADA*pter documentation.

For each measurement value, one out of three different presentation modes can be selected in accordance with the IEC104 companion standard:

- »Short float« — The value is a floating-point number.
- »Scaled« — The value has a fixed number of decimal digits; the scaling is settable.
- »Normalized« — The value is relative to the nominal value.

Energy Counters

All energy values are always handled as data objects of type »Integrated total«.

Fault Counters

All fault counters are handled as data objects of type »Bitstring«.

Binary States

For all binary output states, one out of two different presentation modes can be selected in accordance with the IEC104 companion standard:

- Single-point — Single-point information (M_SP_TB_1),
- Double-point — Double-point information (M_DP_TB_1),
- Bitstring — Bitstring of 32 bit (M_BO_TB_1).

IEC Commands

The IEC104 protocol features 16 commands that are freely configurable. The commands can be used for various purposes, e. g. for acknowledging LEDs, output relays and latched trip commands, or for operating a switchgear.

Using an IEC104 command involves essentially a 2-step-configuration:

One step involves defining the protocol-related properties of the respective command using the *SCADA*pter configuration tool.

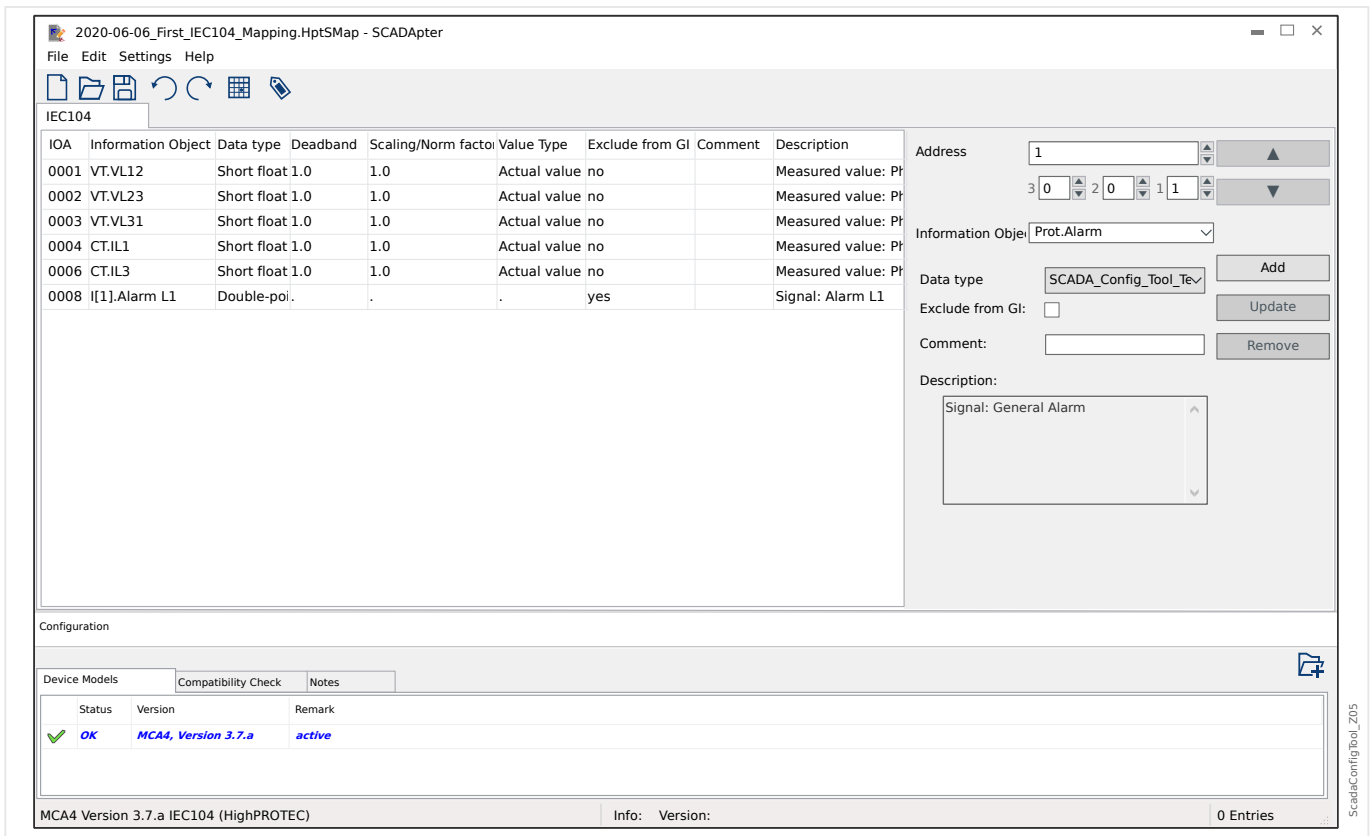

The other step involves a setting on the MRDT4: The commands are available as setting values(!) that can be assigned to the appropriate parameter.

If, for example, IEC104 command 2 shall acknowledge (reset the latching of) LED 1 of the MRDT4 then you have to make the following setting:

[Device Para / LEDs / LEDs group A / LED 1] »Assignment 1« = "IEC104 . Scada Cmd 2"

If, for example, the command shall *operate* output relay number 1 on slot X2:

[Device Para / Binary Outputs / BO Slot X2 / BO 1] »Assignment 1« = "IEC104 . Scada Cmd 2"

If, for example, the command shall *acknowledge* (reset the latching of) output relay number 1 on slot X2:

[Device Para / Binary Outputs / BO Slot X2 / BO 1] »Acknowledgement« = "IEC104 . Scada Cmd 2"

If, for example, the command shall *operate* (switch off) the switchgear SG[1]:

[Control / SG / SG[1] / Ex ON/OFF Cmd] »SCmd OFF« = "IEC104 . Scada Cmd 2"

For switchgear control, there are various more settings to be checked, of course. In particular, it is necessary that [Control / General Settings] »Switching Authority« is set to either "Remote" or to "Local and Remote". See ["5 Control / Switchgear-Manager"](#) for details.

Anwendungsbeispiel - Setzen eines Ausgangsrelais

The concept of using the Programmable Logic to set up a steady state is identical to the description for the DNP3 protocol: ["3.5.1 Application Example: Setting a Relay"](#)

Activate a User-Defined Data-Point Mapping

For information about how to create a mapping file and download or upload it to the MRDT4, see the *SCADApter* documentation and [↪ “3.7.3 Data-Point Mapping Using the SCADApter”](#). (Since the data-point mapping is a general feature that is usable for several communication protocols in the same way, it is described separately.)

3.7.2 Modbus®

Modbus® Protocol Configuration

The Modbus® communication protocol is available with HighPROTEC devices that are equipped with either a serial interface (“Modbus RTU”) or an Ethernet interface (“Modbus TCP”).

The standard protocol definition (mapping of data-points) that comes with the MRDT4 is sufficient for most applications, so that only a few settings have to be made (see below).

Only in the special case that the internal mapping of data-points needs to be adapted to an existing substation communication you can define an individual mapping using a separate PC software tool, *SCADApter*.

The time-controlled Modbus® protocol is based on the Master-Slave working principle. This means that the substation control and protection system sends an enquiry or instruction to a certain device (slave address) which will then be answered or carried out accordingly. If the enquiry/instruction cannot be answered/carried out (e. g. because of an invalid slave address), a failure message is returned to the master.

NOTICE!



Some signals (that are for a short time active only) have to be acknowledged separately (e.g. Trip signals) by the Communication System.

The Master (substation control and protection system) can query information from the device, such as:

- Type of unit version
- Measuring values/Statistical measured values
- Switch operating position
- State of device
- Time and date
- State of the device’s digital inputs
- Protection-/State alarms

The Master (control system) can give commands/instructions to the device, such as:

- Control of switchgear (where applicable depending on the applied device version)
- Change-over of parameter set
- Reset and acknowledgment of alarms/signals
- Adjustment of date and time
- Control of alarm relays

For detailed information on data point lists and error handling, please refer to the Modbus® documentation.

To allow configuration of the devices for Modbus® connection, some default values of the control system must be available.

Setup

At first the Modbus protocol has to be selected as the SCADA protocol to be used:

Set [Device planning] »*Protocol*«

- = “Modbus RTU” — use the Modbus® protocol over a serial connection
- = “Modbus TCP” — use the Modbus® protocol over Ethernet (TCP/IP)
- = “Modbus TCP/RTU” — use both Ethernet (TCP/IP) and serial interfaces for Modbus messages

Then continue with the settings described below for Modbus RTU or Modbus TCP, depending on your type of use.

Modbus RTU

Part 1: Configuration of the Devices

Enter the menu [Device Para / Modbus / Communication / RTU] and set the following communication parameters there:

- »*Slave ID*« — the Slave-address, required to allow clear identification of the device.
- »*Baud rate*« — the Baud rate that the serial interface shall use.

Also, select below indicated RS485 interface-related parameters from there, such as:

- Number of data bits
- One of the following supported communication variants: Number of data bits, even, odd, parity or no parity, number of stop bits.
- »*t-timeout*«: communication errors are only identified after expiry of a supervision time »*t-timeout*«.
- Response time (defining the period within which an enquiry from the master has to be answered).

Part 2: Hardware Connection

- For hardware connection to the control system, there is an RS485 interface at the rear side of the device (RS485, fiber optic or terminals).
- Connect bus and device (wiring).

Error Handling - Hardware Errors

Information on physical communication errors, such as:

- Baudrate Error
- Parity Error ...

can be obtained from the event recorder.

Error Handling - Errors on protocol level

If, for example, an invalid memory address is enquired, error codes will be returned by the device that need to be interpreted.

Modbus TCP

NOTICE!



Establishing a connection via TCP/IP to the device is only possible if your device is equipped with an Ethernet Interface (RJ45).

Contact your IT administrator in order to establish the network connection.

Part 1: Setting the TCP/IP Parameters

Call up [Device Para / TCP/IP / TCP/IP config] at the HMI (panel) and set the following parameters:

- TCP/IP address
- Subnet mask
- Gateway

Part 2: Configuration of the Devices

Call up »Device parameter/Modbus« and set the following communication parameters:

- Setting a Unit Identifier is only necessary if a TCP network should be coupled to a RTU network.
- If a different port than the default port 502 should be used please proceed as follows:
 - Choose “Private” within the TCP-Port-Configuration.
 - Set the port-number.
- Set the maximum accepted time of “no communication”. If this time has expired – without any communication, the device concludes a failure within the master system or communication.
- Allow or disallow the blocking of SCADA commands.

Part 3: Hardware Connection

- There is a RJ45 interface at the rear side of the device for the hardware connection to the control system.
- Establish the connection to the device by means of a proper Ethernet cable.

SCADApter

The *SCADApter* is a PC tool of its own, therefore the details of its used are described in the *SCADApter* manual.

If you want to download a previous user-defined mapping from the MRDT4 so that you can use it as a template for further adaptations, then this is possible using *Smart view*. This is also true of the transfer of the edited mappings to the MRDT4. See [↩️ “3.7.3 Data-Point Mapping Using the SCADApter”](#).

Then start the *SCADA*pter. After selecting either [File / New] or [File / Open] you have to select a device model and the communication protocol (which is “Modbus” in this case). After this, you can see six tabs, “FC1” ... “FC6”. Each of these tabs features a table that holds the mapped data-objects.

FC

- The “Function Code” number decides about the type of data-objects that it can hold:
 - FC1, FC2 hold states (but no measurement values).
 - FC3, FC4 can hold all types except commands.
 - FC5, FC6 are for commands.
 - FC16 is for special multi-word messages (essentially for time-synchronization).

Please see the Modbus specification for details!

Address, Bit position

- This is the Modbus address to which the data-object shall be mapped.
- The bit position appears only where it makes sense to select it (in particular with binary states of 1 bit length).

Information Object, Description, Comment

- The data-object that shall be mapped, and some description text. The type of information that the data-object represents must be supported by the MRDT4, and therefore the selection list reads the supported entities from the device model file.
- The comment is some user-defined text without any technical functionality. It can be used for archiving some background information of the mapping.

Format, Bit size, Latched

- Select the format of the data-object:
 - “Int16” — Integer number with 16 bit length
 - “Int32” — Integer number with 32 bit length
 - “Uint32” — Unsigned (i.e. non-negative) integer number with 32 bit length
 - “Float” — Number in floating point representation (according to IEEE 754)
- The bit size is automatically set according to the format of the data-object.
- The “Latched” checkbox decides whether the Modbus information shall be latched (until an explicit acknowledgment).

Factor, Scaling

- Specify the factor and the scaling of the data (if these input fields are visible). The scaling can be as follows:
 - “Primary” — Scaling of the information object to primary value
 - “Secondary” — Scaling of the information object to secondary value
 - “Relative” — Scaling of the information object relative to nominal value

For information about how to upload the edited mapping to the MRDT4, see the *SCADApter* documentation and [↗ “3.7.3 Data-Point Mapping Using the SCADApter”](#). (Since the data-point mapping is a general feature that is usable for several communication protocols in the same way, it is described separately.)

3.7.3 Data-Point Mapping Using the SCADAPTER

Software Tools

The setup procedure for a user-defined data-point mapping always works the same way for all SCADA protocols that support user-defined mappings. A mapping of data objects is always based on a separate file of file-type (extension) *.HptSMap. This file is edited with a separate PC tool, *SCADAPTER*, and *Smart view* is used to download the currently active user mapping from the protection device (for further editing), or to upload and activate the edited new *.HptSMap mapping file.

NOTICE!



The factory default mapping cannot be downloaded for further editing.

Specify the Data-Point Mapping

The setting parameter [Device Para / protocol-name / Config. Data Obj.] »Type of SCADA mapping« can be set to either “Standard” or to “User-defined”.

- “Standard” means that the protection device uses the factory-default as data-point mapping (even if a user-defined mapping has already been uploaded to the MRDT4).
- “User-defined” means that the protection device uses the user-defined data-point mapping. (If no valid mapping file has been uploaded then the device reports this by setting the output value [Device Para / protocol-name / Advanced] »Update time« = “Error 1/2”.)

Transfer the Data-Point Mapping

If there is already a user-defined data-point mapping on the protection device, it is possible to download it and use it for further editing. (The factory default cannot be downloaded.)

Depending on the value of »Type of SCADA mapping«, the active mapping is either the factory default or a previously uploaded valid mapping file.

Both the download of a mapping file or a (later) upload of an edited mapping file has to be done via *Smart view*, to which the protection device has to be connected.

After the *Smart view* connection has been established and all device data has been retrieved, double-click the menu item [Device Para / protocol-name / Config. Data Obj.].

A dialog window is opened that features a »SCADA Configuration Transfer« button. (See **(1)** in the example figure below.)

Clicking on this button opens another dialog, »SCADA Point Mapping Configuration«. There are two buttons there, **(2)** and **(a)** in the figure below.

Button **(a)** performs the download: The protection devices sends its user-defined SCADA protocol mapping to the »SCADA Point Mapping Configuration«, then a »Save as« file-dialog appears, that allows the user to create a new *.HptSMap file from these protocol definitions. (This download is not possible for the (factory default) standard mapping.)

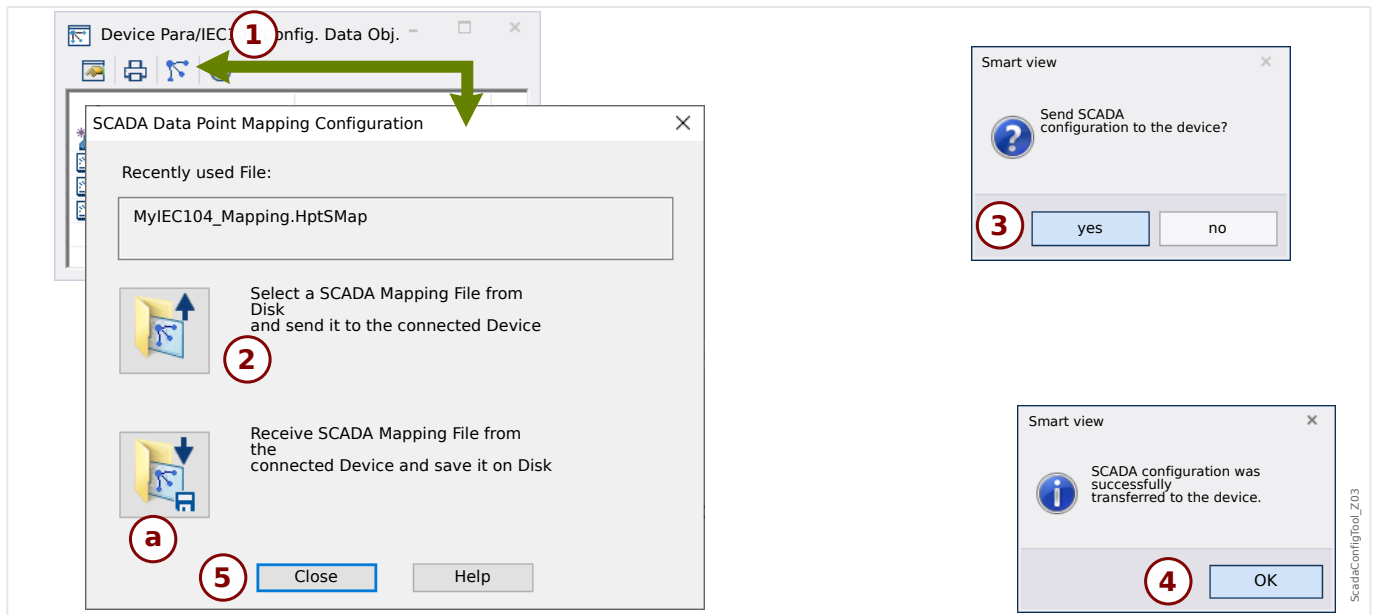

Fig. 45: Example of using Smart view to transfer the *.HptSMap to the protection device.

Button **(2)**, »Select a SCADA Mapping File from Disk and send it to the connected Device.«, starts the upload of an edited mapping file. After clicking this button a file-select dialog opens.

Then navigate to the *.HptSMap file that keeps the required SCADA definitions and click »Open«.

Smart view opens and checks the *.HptSMap file. If it is compatible with the connected protection device a dialog asks the user whether the protocol definitions shall be transferred to the protection device [**(3)** in the diagram].

After clicking »yes« (and entering the password for the access level »Supervisor-Lv3«) the data is transferred, and the user is informed about the success **(4)**.

The user may now click »Close« **(5)** in the »SCADA Point Mapping Configuration« dialog, to return to the Smart view main window.

Finally the user-specific mapping must be activated by the setting [Device Para / protocol-name / Config. Data Obj.] »Type of SCADA mapping« = "User-defined".

Do not forget to transfer all (or all changed) settings (from Smart view) to the protection device. Moreover, it is recommended to have the "Automatic Refresh" active within Smart view, so that all entries within the [Config. Data Obj.] dialog get updated properly.

3.8 Time Synchronization

The device gives the user the ability to synchronize the device with a central time generator. This provides the following advantages:

- The time does not drift from the reference time. A continuously accumulating deviation of the reference time thereby will be balanced. Also refer to the Specifications (Tolerances Real Time Clock) section.
- All time synchronized devices operate with the same time. Therefore, logged events of the individual devices can be compared exactly and be evaluated (single events of the event recorder, waveform records).

The device's time can be synchronized via the following protocols:

- IRIG-B
- SNTP
- Communication protocol Modbus (RTU or TCP)
- Communication protocol IEC 60870-5-103
- Communication protocol IEC 60870-5-104
- Communication protocol DNP3

These protocols use different hardware interfaces and are different in accuracy. For further information, see [↪ “12.1 Specifications / Tolerances”](#).

Without time synchronization

This is possible, but not recommended for industry-standard applications.

IRIG-B

Hardware Interface	Recommended Application
IRIG-B Terminal	Recommended, if interface available.

SNTP

Hardware Interface	Recommended Application
RJ45 (Ethernet)	Recommended alternative to IRIG-B, especially when using IEC 61850 or Modbus TCP.

Modbus RTU

Hardware Interface	Recommended Application
RS485, D-SUB or Fiber Optic	Recommended when using Modbus RTU communication protocol and when no IRIG-B real time clock is available.

Modbus TCP

Hardware Interface	Recommended Application
RJ45 (Ethernet)	Limited recommendation when Modbus TCP communication protocol is used and when no IRIG-B real time clock or an SNTP server is available.

IEC 60870-5-103

Hardware Interface	Recommended Application
RS485, D-SUB or Fiber Optic	Recommended when using the IEC 60870-5-103 communication protocol and no IRIG-B real time clock is available.

IEC 60870-5-104

Hardware Interface	Recommended Application
RJ45 (Ethernet)	Recommended when using the IEC 60870-5-104 communication protocol and no IRIG-B real time clock is available.

DNP3

Hardware Interface	Recommended Application
RS485 or RJ45 (Ethernet)	Limited recommendation when using the DNP3 communication protocol and no IRIG-B real time clock or an SNTP server is available

Accuracy of Time Synchronization

The accuracy of the device's synchronized system time depends on several factors:

- Accuracy of the connected time generator;
- Synchronization protocol that is used; and
- If Modbus TCP, SNTP, IEC 60870-5-104 or DNP3 TCP/UDP is used: Network load and data package transmission times

NOTICE!	
	Please consider the accuracy of the used time generator. Deviations of the time generator's time cause the same deviations on the device's system time.

Selection of Timezone and Synchronization Protocol

The protection relay masters both UTC and local time. This means that the device can be synchronized with UTC time while using local time for user display.

Time Synchronization with UTC time (recommended):

Time synchronization is usually done using UTC time. This means for example that an IRIG-B time generator is sending UTC time information to the protection relay. This is the recommended use case, since here a continuous time synchronization can be ensured. There are no “leaps in time” through change of Daylight Saving Time.

To achieve that the device shows the current local time, the timezone and the change to Daylight Saving Time (i. e. the change between summer- and wintertime) can be configured.

Please carry out the following setting steps in the menu branch [Device Para / Time / Timezone]:

- Set the parameter »Time Zones« to your local timezone.
- Then configure the switching of daylight saving time.

Then, in the menu branch [Device Para / Time / TimeSync / TimeSync]:

- Set the parameter »TimeSync« to the used time synchronization protocol (e.g. “IRIG-B”).
- Set the parameters of the synchronization protocol (refer to the according chapter).

Time Synchronization with local time:

Should the time synchronization however be done using local time, then please leave the timezone to “UTC+0 London” and do not use switching of daylight saving time.

NOTICE!

The synchronization of the relay's system time is exclusively done by the synchronization protocol selected in the menu [Device Para / Time / TimeSync / TimeSync].

Without Time Synchronization:

To achieve that the device shows the current local time, the timezone and the change to Daylight Saving Time can be configured.

Please carry out the following setting steps:

- In the menu branch [Device Para / Time / TimeSync / TimeSync], set the parameter »TimeSync« to “-”.
- Then, in the menu branch [Device Para / Time / Timezone], set the parameter »Time Zones« to your local timezone.
- Then configure the switching of daylight saving time.
- Set date and time at [Device Para / Time] »Date and Time«.

3.8.1 SNTP

NOTICE!

! Important pre-condition: The device needs to have access to an SNTP server via the connected network. This server preferably should be installed locally.

Principle - General Use

SNTP is a standard protocol for time synchronisation via a network. For this at least one SNTP server has to be available within the network. The device can be configured for one or two SNTP servers.

The protection relay's system time will be synchronised with the connected SNTP server 1-4 times per minute. In turn the SNTP server synchronises its time via NTP with other NTP servers. This is the normal case. Alternatively it can synchronise its time via GPS, radio controlled clock or the like.

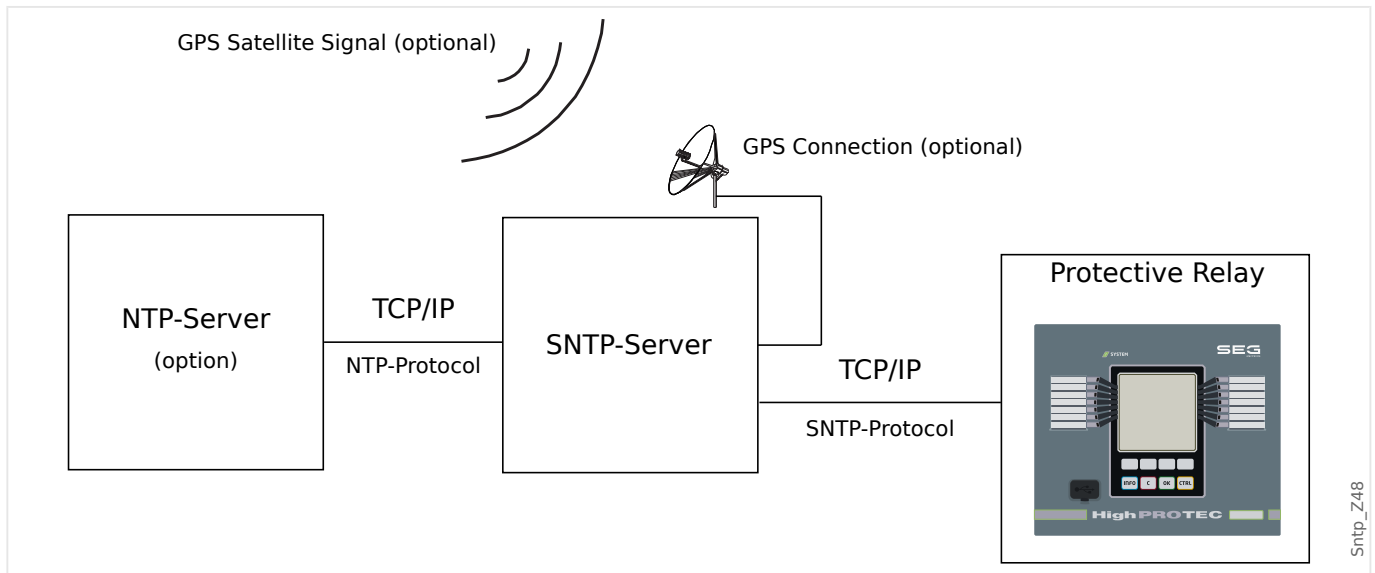

Accuracy

The accuracy of the used SNTP server and the excellence of its reference clock influences the accuracy of the protection relay's clock. Further information about accuracy: [↪](#) "12.1 Specifications / Tolerances"

For further information about accuracy refer to the chapter "Specifications".

With each transmitted time information, the SNTP server also sends information about its accuracy:

- Stratum: The stratum indicates over how many interacting NTP-Servers the used SNTP server is connected to an atomic or radio controlled clock.
- Precision: This indicates the accuracy of the system time provided by the SNTP server.

Additionally the performance of the connected network (traffic and data package transmission times) has an influence on the accuracy of the time synchronisation.

Recommended is a locally installed SNTP server with an accuracy of $\leq 200 \mu\text{sec}$. If this cannot be realised, the connected server's excellence can be checked in the menu [Operation / Status Display / TimeSync / SNTP]:

- The server quality gives information about the accuracy of the used server. The quality should be GOOD or SUFFICIENT. A server with BAD quality should not be used, because this could cause fluctuations in time synchronisation.
- The network quality gives information about the network's load and data package transmission time. The quality should be GOOD or SUFFICIENT. A network with BAD quality should not be used, because this could cause fluctuations in time synchronisation.

Using two SNTP Servers

When configuring two SNTP servers, the device always synchronizes to server 1 by default.

If server 1 fails, the device automatically switches to server 2.

When (after a failure) server 1 recovers, the device switches back to server 1.

SNTP Commissioning

Activate the SNTP time synchronization by means of the [Device Para / Time / TimeSync] menu:

- Set the parameter »TimeSync« to "SNTP".
- Set the IP address of the first server in the SNTP menu.
- Set the IP address of the second server, if available.
- Set all configured servers to "active".

3.8.2 IRIG-B00X

NOTICE!

! Requirement: An IRIG-B00X time code generator is needed. IRIG-B004 and higher will support/transmit the “year information”.

! If you are using an IRIG time code that does not support the “year information” (IRIG-B000, IRIG-B001, IRIG-B002, IRIG-B003), you have to set the “year” manually within the device. In these cases the correct year information is a precondition for a properly working IRIG-B.

Principle - General Use

The IRIG-B standard is the most used standard to synchronize the time of protection devices in medium voltage applications.

The protection device supports IRIG-B according to the IRIG STANDARD 200-04.

This means that all time synchronization formats IRIG-B00X (IRIG-B000 / B001 / B002 / B003 / B004 / B005 / B006 / B007) are supported. It is recommended to use IRIG-B004 and higher which also transmits the “year information”.

The system time of the protection device is being synchronized with the connected IRIG-B code generator once a second. The accuracy of the used IRIG-B code generator can be increased by connecting a GPS-receiver to it.

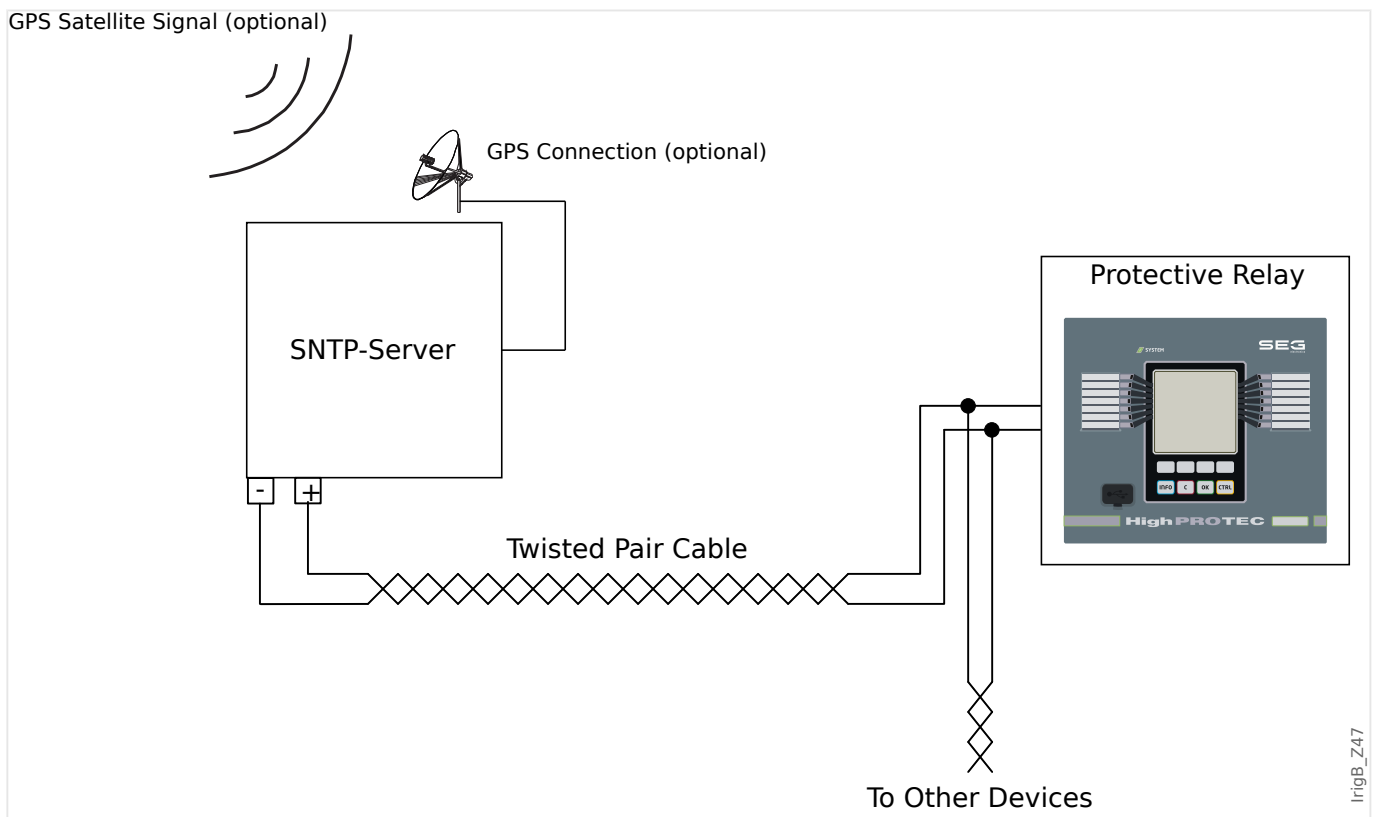

The location of the IRIG-B interface depends to the device type. Please refer to the wiring diagram supplied with the protective device.

IRIG-B Commissioning

Activate the IRIG-B synchronization within the menu [Device Para / Time / TimeSync]:

- Select »IRIG-B« in the time synchronization menu.
- Set the time synchronization in the [IRIG-B] menu to “active”.
- Select the IRIG-B type (choose B000 through B007).

Fault Analysis

If the device does not receive any IRIG-B time code for more than 60 s, the IRIG-B status switches from »active« to »inactive« and there is created an entry within the Event Recorder.

Check the IRIG-B functionality through the menu [Operation / Status Display / TimeSync / IRIG-B]:

Should the IRIG-B status not be reported as being “active”, please proceed as follows:

- To begin with check the IRIG-B wiring.
- Check, if the correct IRIG-B00X type is configured.

IRIG-B Control Commands

In addition to the date and time information, the IRIG-B code offers the option to transmit up to 18 control commands that can be processed by the protective device. They have to be set and issued by the IRIG-B code generator.

The MRDT4 offers up to 18 IRIG-B assignment options for those control commands in order to carry out the assigned action. As soon as a control command is transmitted the state of the corresponding signal »IRIG-B . Control Signal1« ... »IRIG-B . Control Signal18« becomes true.

These signals are available for assignment to some parameter, so that the functionality of this parameter is being triggered as soon as the control command is transmitted.

NOTICE!



IRIG-B control commands are not recorded by Event and Disturbance Recorders.

If it is required to have a control signal recorded, the best way is to use a Logic (1 gate) equation, because the Programmable Logic always gets recorded.

4 Protective Elements

4.1 Module Prot: General Protection

The module »Module General Protection« (»Prot«) serves as outer frame for all other protection modules, i. e. they are all enclosed by this module.

WARNING!



If in the »Prot« module the parameter [Protection Para / Global Prot Para / Prot] »Function« is set on "inactive" or in case the module is blocked, then **no** protective function of the MRDT4 is effective.

Blocking all Protective Elements Permanently

In order to permanently deactivate the entire protection navigate to the menu [Protection Para / Global Prot Para / Prot]:

- Set the parameter »Function« = "inactive".

Blocking all Protective Elements Temporarily

In order to allow the temporary blocking of the entire protection navigate to the menu [Protection Para / Global Prot Para / Prot]:

- Set the parameter »ExBlo Fc« = "active".
- Assign a blocking signal to »ExBlo1«.
- Optionally make assign a blocking signal to »ExBlo2«.

If any of the assigned signals becomes true, then the entire protection is blocked (as long as any of these signals stays true).

Blocking all Trip Commands Permanently

In order to permanently block all trip commands navigate to the menu [Protection Para / Global Prot Para / Prot]:

- Set the parameter »Blo TripCmd« = "active".

Blocking all Trip Commands Temporarily

In order to allow the temporary blocking of all trip commands navigate to the menu [Protection Para / Global Prot Para / Prot]:

- Set the parameter »ExBlo TripCmd Fc« = "active".
- Assign a blocking signal to »ExBlo TripCmd«.

If the assigned signal becomes true, then all trip commands are blocked (as long as this signal stays true).

Availability of the Protection Function

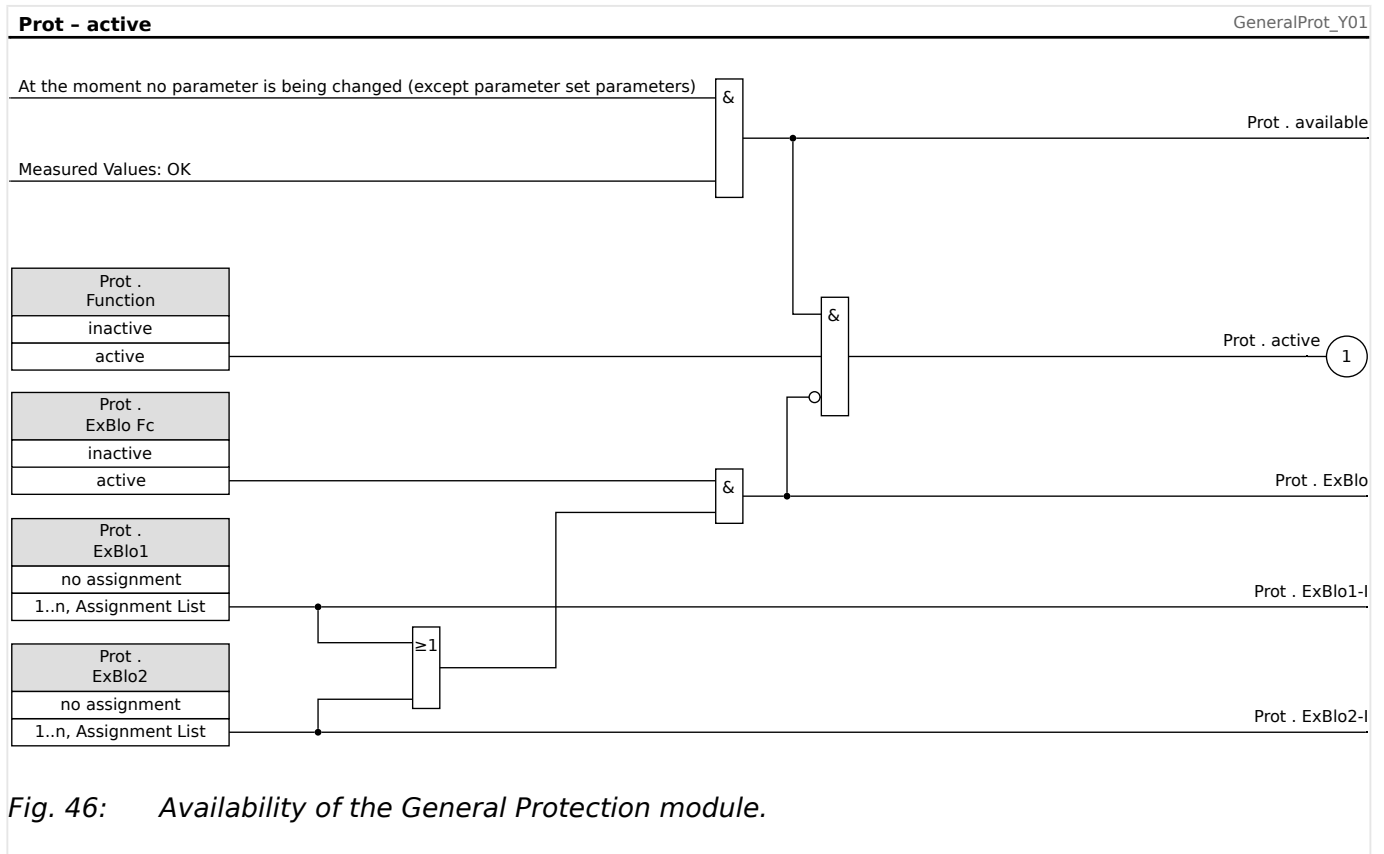

4.1.1 General Alarms and General Trips

Each protective element generates its own alarm and trip signals. In general, all alarms and trip decision are passed on to the master module »Prot«, with one important exception:



If a protective element features a setting »*Superv. only*« (in the menu branch [Device planning]) then the alarms and trip decisions of this protective element are passed on to »Prot« only with the setting »*Superv. only*« = “no”.

If »*Superv. only*« = “yes” then the module works as a supervision element: Alarms and trip decisions are kept as element-specific states (i. e. these states can be checked at the menu branch [Operation / Status Display] and can be assigned as select options), but the module does not have a trip command, and the alarm/trip decisions do not result in a General Alarm or General Trip.

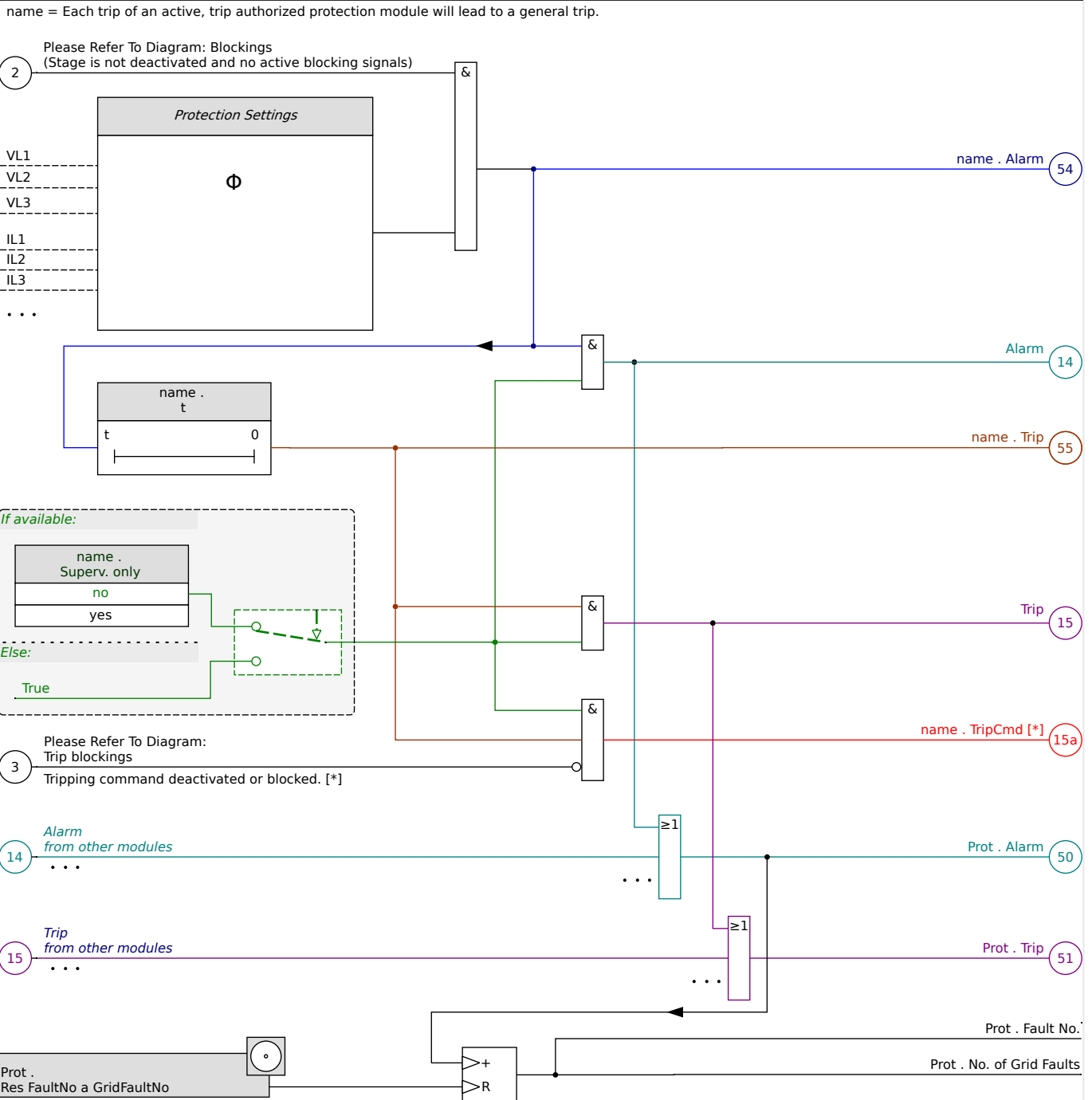

Fig. 47: Rough sketch of the functionality of any HighPROTEC protective element.

[*] The trip command and its blockings exist only if there is no setting »Superv. only« = "yes"

This diagram shows the basic idea behind a protective element. (Nevertheless, keep in mind that device-specific or protection-specific deviations are possible: Some devices do not feature voltage measurement, other do not feature current measurement, for some protection elements other timers and/or phase-specific algorithms are required, etc. So, for the exact functionality of a protection module please consult the respective chapter.)

Alarm

- If a protection module, named »name«, detects a fault it issues an alarm signal: »name . Alarm« - “(54)” in the diagram.
 - Unless there is a setting »name . Superv. only« = “yes” the alarm signal gets passed on - “(14)” in the diagram - to the master module »Prot« module and triggers a *General Alarm*: »Prot . Alarm« - “(50)” in the diagram.
 - Since also other protection elements can trigger a *General Alarm* one can say that the *General Alarm* is a collective signal OR-ed from all protection-specific alarms.

Trip

- If the fault criterion is still detected after a protection-specific timer stage »name . t« has elapsed then the module issues a trip signal: »name . Trip« - “(55)” in the diagram.
 - Unless there is a setting »name . Superv. only« = “yes” the trip signal gets passed on - “(15)” in the diagram - to the master module »Prot« module and triggers a *General Trip*: »Prot . Trip« - “(51)” in the diagram.
 - Since also other protection elements can trigger a *General Trip* one can say that the *General Trip* is a collective signal OR-ed from all protection-specific trips.

Trip Command (and its blocking exist only if there is no setting »Superv. only« = “yes”)

- If there is a *General Trip* the protection module issues a *trip command*: »name . TripCmd« - “(15a)” in the diagram, if the module's trip command is not blocked (see [↳ “4.1.2 Blockings”](#)).

Since also other protection elements can trigger a trip command, the MRDT4 offers a so-called *Trip Manager* for every circuit breaker, which allows for assigning trip commands to it (see [↳ “Trip Manager - Assignment of commands”](#)).

Phase-Selective Signals

In addition to the *General Alarm* and *General Trip* signals, the »Prot« module also features the respective phase-specific signals. These, too, can be triggered by any protection module »name« if it is able to detect 1p faults and unless there is a setting »name . Superv. only« = “yes”.

Examples: »Prot . Alarm L1« is a collective signal (OR-connected) for all alarms issued by any of the protective elements concerning phase L1.

»Prot . Trip L1« is a collective signal (OR-connected) for all trips issued by any of the protective elements concerning phase L1.

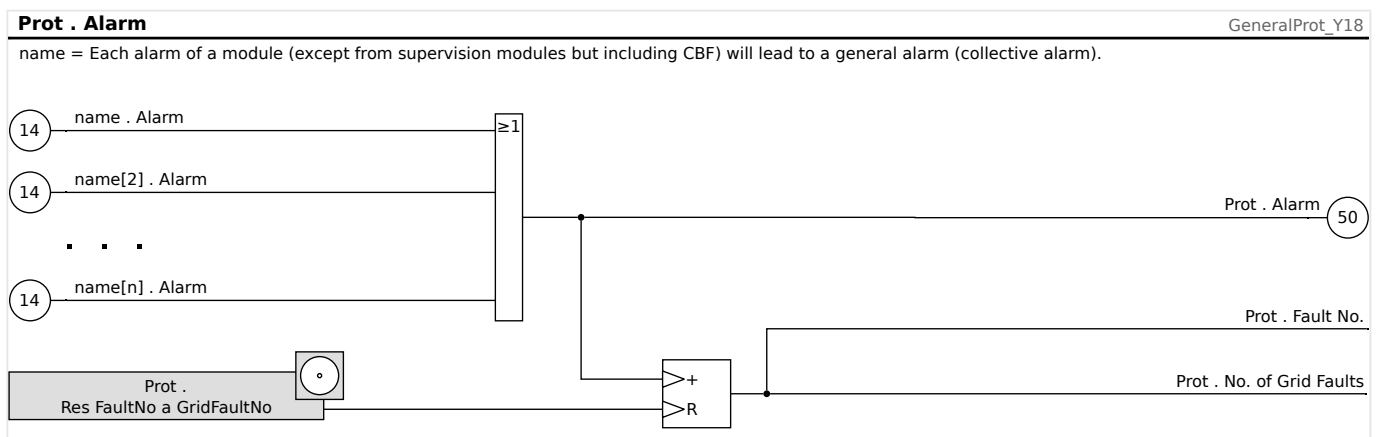

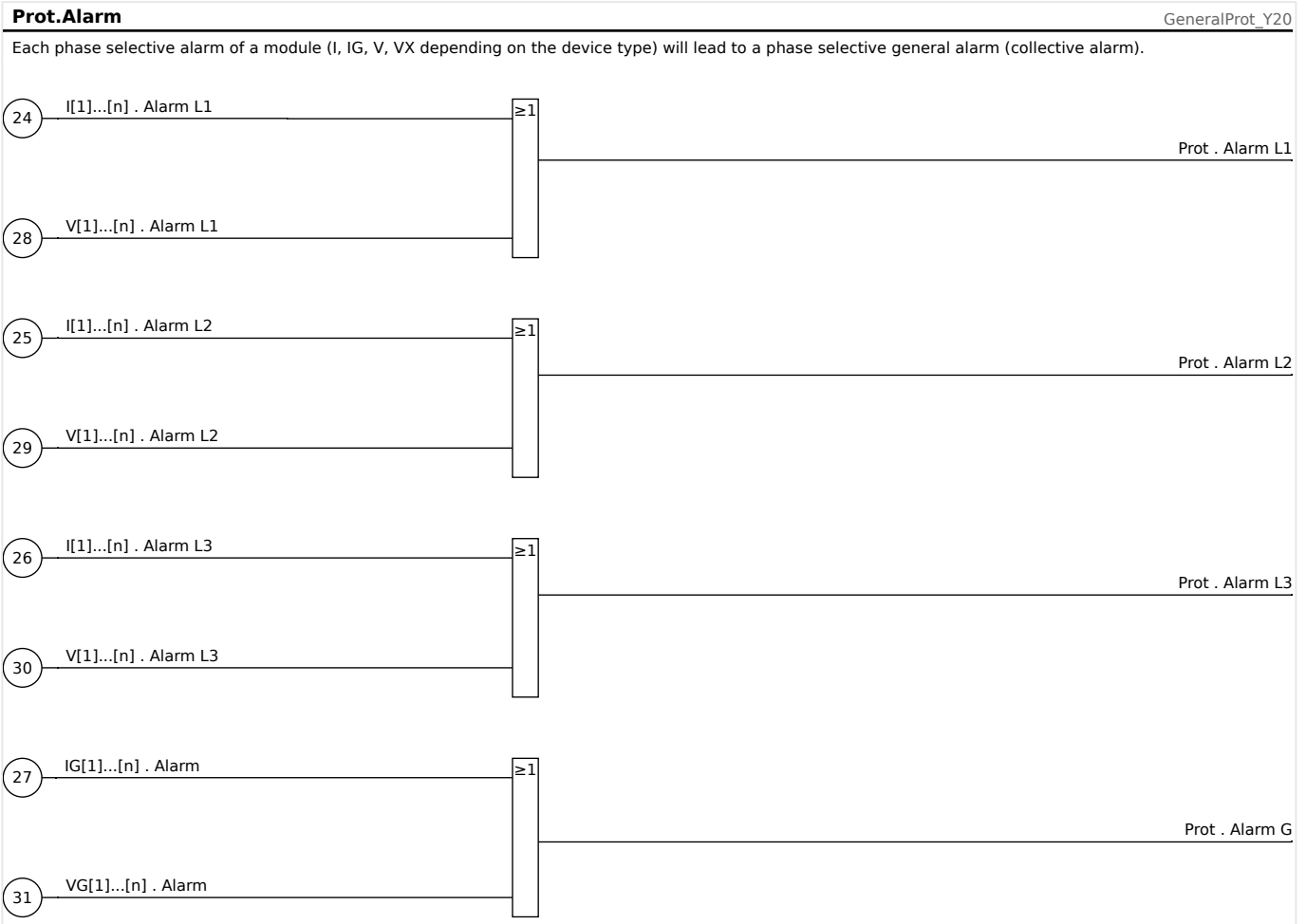
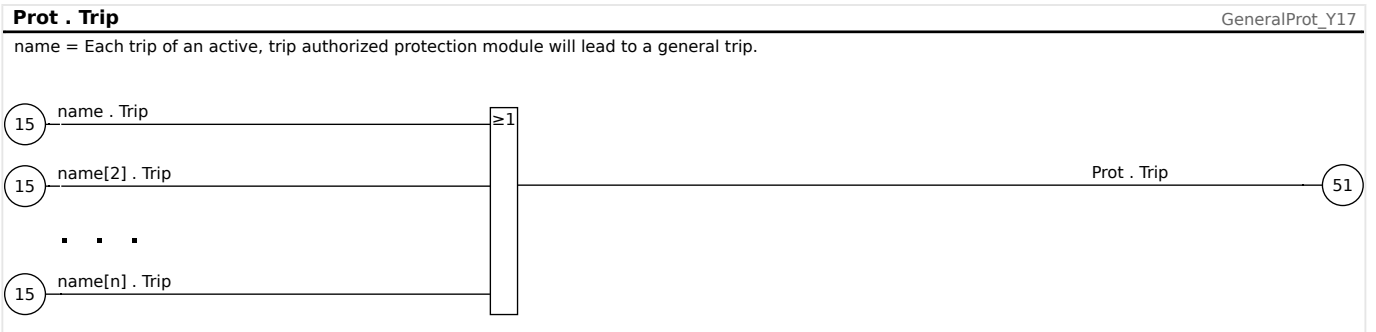

4 Protective Elements

4.1.1 General Alarms and General Trips

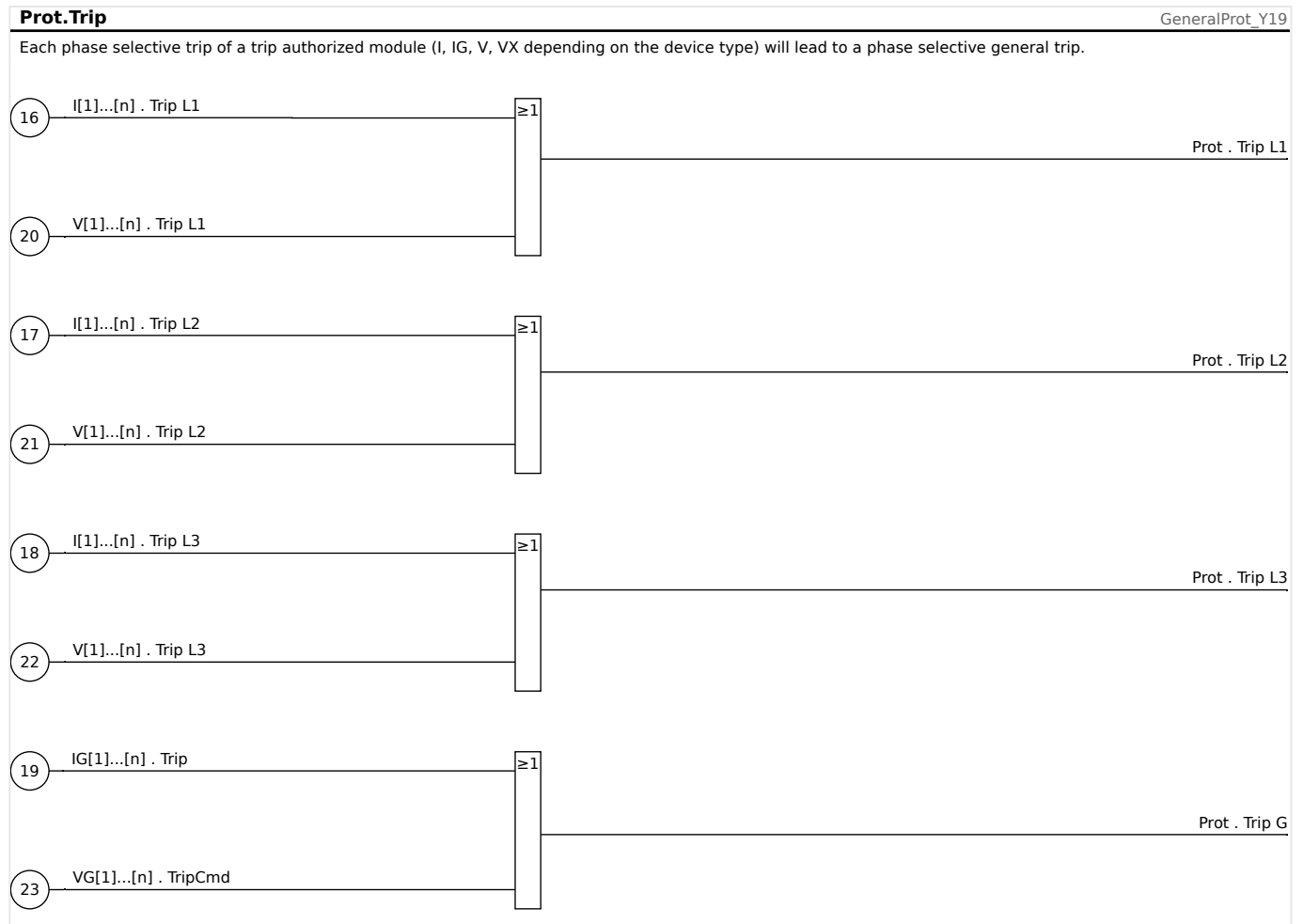

4.1.2 Blockings

The device provides a function for temporary and permanent blocking of the complete protection functionality or of single protection stages.

WARNING!



Make absolutely sure that no illogical or even life-threatening blockings are allocated.

Make sure that you do not carelessly deactivate protection functions which have to be available according to the protection concept.

Permanent Blocking

Switching ON or OFF the complete protection functionality:

In module »Prot« the complete protection of the device can be switched on or off. Set the parameter [Protection Para / Global Prot Para / Prot] »Function« to “active” or “inactive” in module »Prot«.

WARNING!



Only if in module »Prot« the parameter »Function« = “active”, the protection is activated; i. e. with »Function« = “inactive”, no protection function is operating. Then the device cannot protect any components.

Switching modules ON or OFF:

Each of the modules can be switched on or off (permanently). This is achieved when the parameter »Function« is set to “active” or “inactive” in the respective module.

Activating or deactivating the tripping command of a protection stage permanently:

In each of the protection stages the tripping command to the CB can be permanently blocked. For this purpose the parameter »Blo TripCmd« has to be set to “active”.

Temporary Blocking

To block the complete protection of the device temporarily by a signal:

In module »Prot« the complete protection of the device can be blocked temporarily by a signal. On condition that a module-external blocking is permitted »ExBlo Fc« = “active”. In addition to this, a related blocking signal from the »assignment list« must have been assigned. For the time the allocated blocking signal is active, the module is blocked.

WARNING!



If the module »Prot« is blocked the complete protection function does not work. As long as the blocking signal is active, the device does not protect any components.

To block a complete protection module temporarily by an active assignment:

- In order to establish a temporary blocking of a protection module the parameter »ExBlo Fc« of the module has to be set to “active”. This gives the permission: »This module can be blocked«.

- Within the general protection parameters a signal has to be assigned to »ExBlo1« or »ExBlo2«. The blocking only becomes active when the assigned signal is active.

To block the tripping command of a protection stage temporarily by an active assignment.

The tripping command of any of the protection modules can be blocked from external. In this case, external does not only mean from outside the device, but also from outside the module. Not only real external signals are permitted to be used as blocking signals, as for example, the state of a digital input, but you can also choose any other signal from the »assignment list«.

- In order to establish a temporary blockage of a protection stage, the parameter »ExBlo TripCmd Fc« of the module has to be set to "active". This gives the permission: »The tripping command of this stage can be blocked«.
- Within the general protection parameters, a signal has to be chosen additionally and assigned to the parameter »ExBlo TripCmd« from the »assignment list«. If the selected signal is activated, the temporary blockage becomes effective.

4.1.2.1 Blocking the Tripping Command

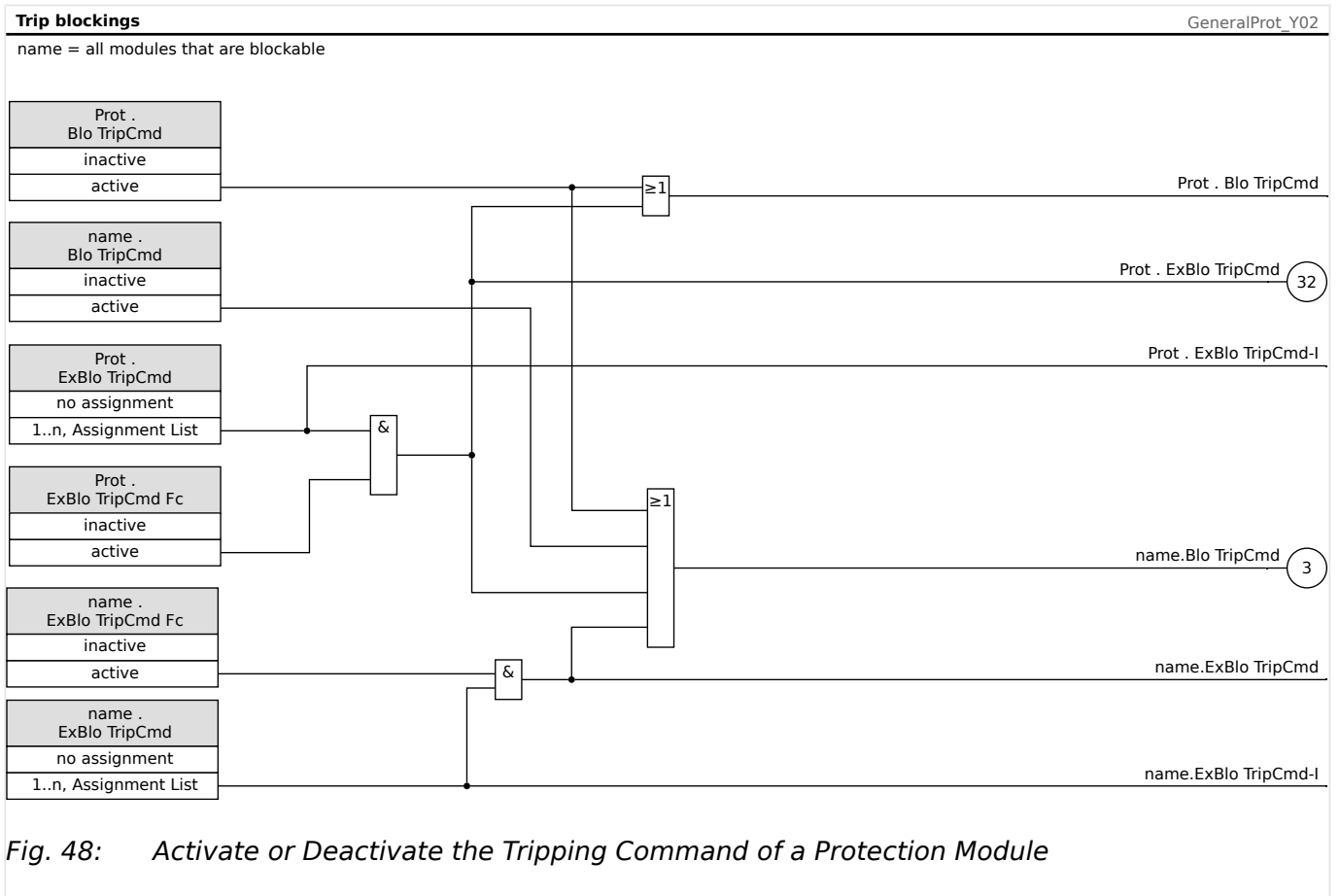

4.1.2.2 Activate, Deactivate or Block a Protection Function Temporarily

The following diagram applies to all protective elements except those for which a module-specific diagram follows underneath:

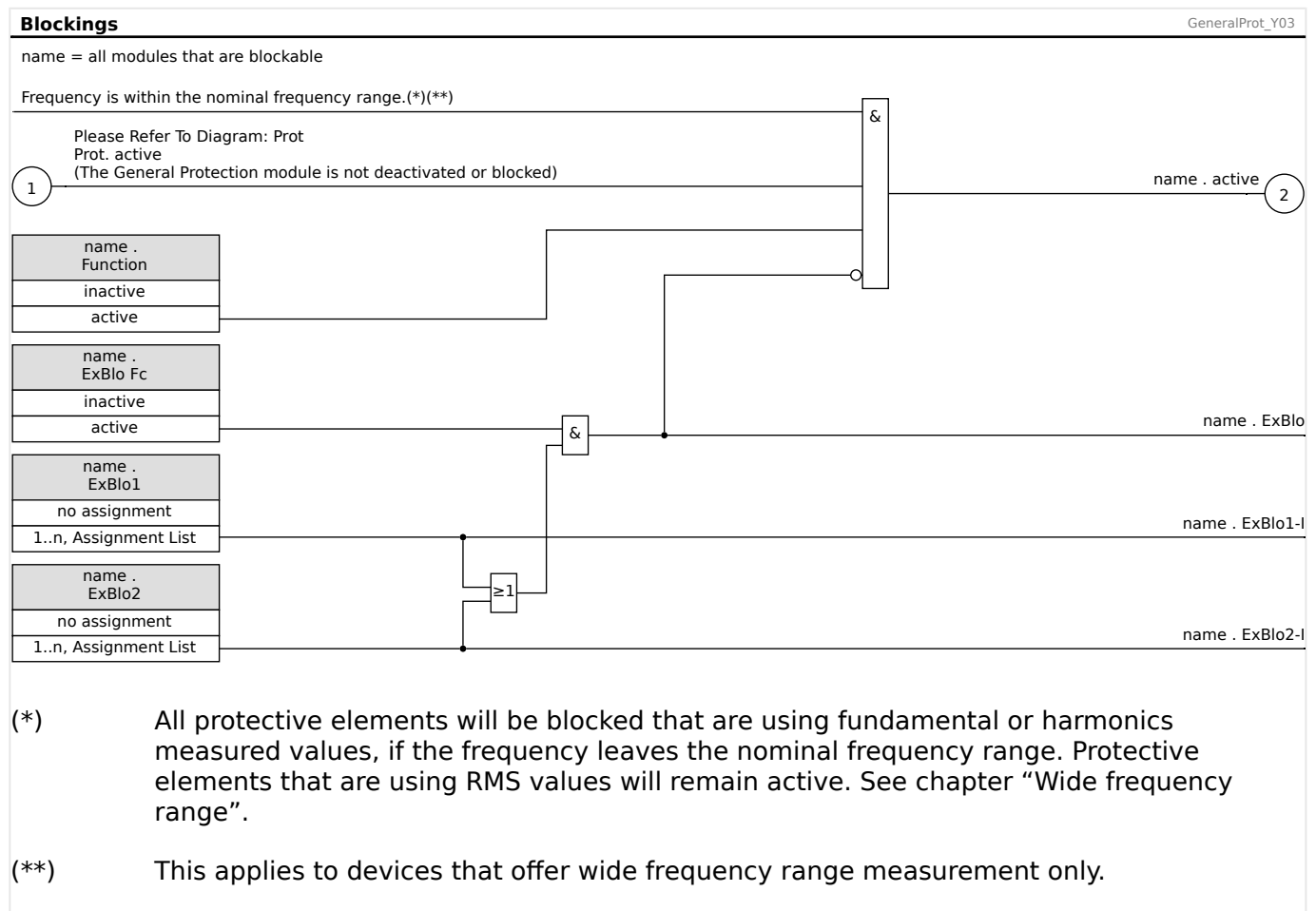

4.1.2.3 Activate, Deactivate or Block the Phase Current Modules

Current protective functions cannot only be blocked permanently (»Function« = "inactive") or temporarily by any blocking signal from the »assignment list«, but also by »reverse Interlocking«.

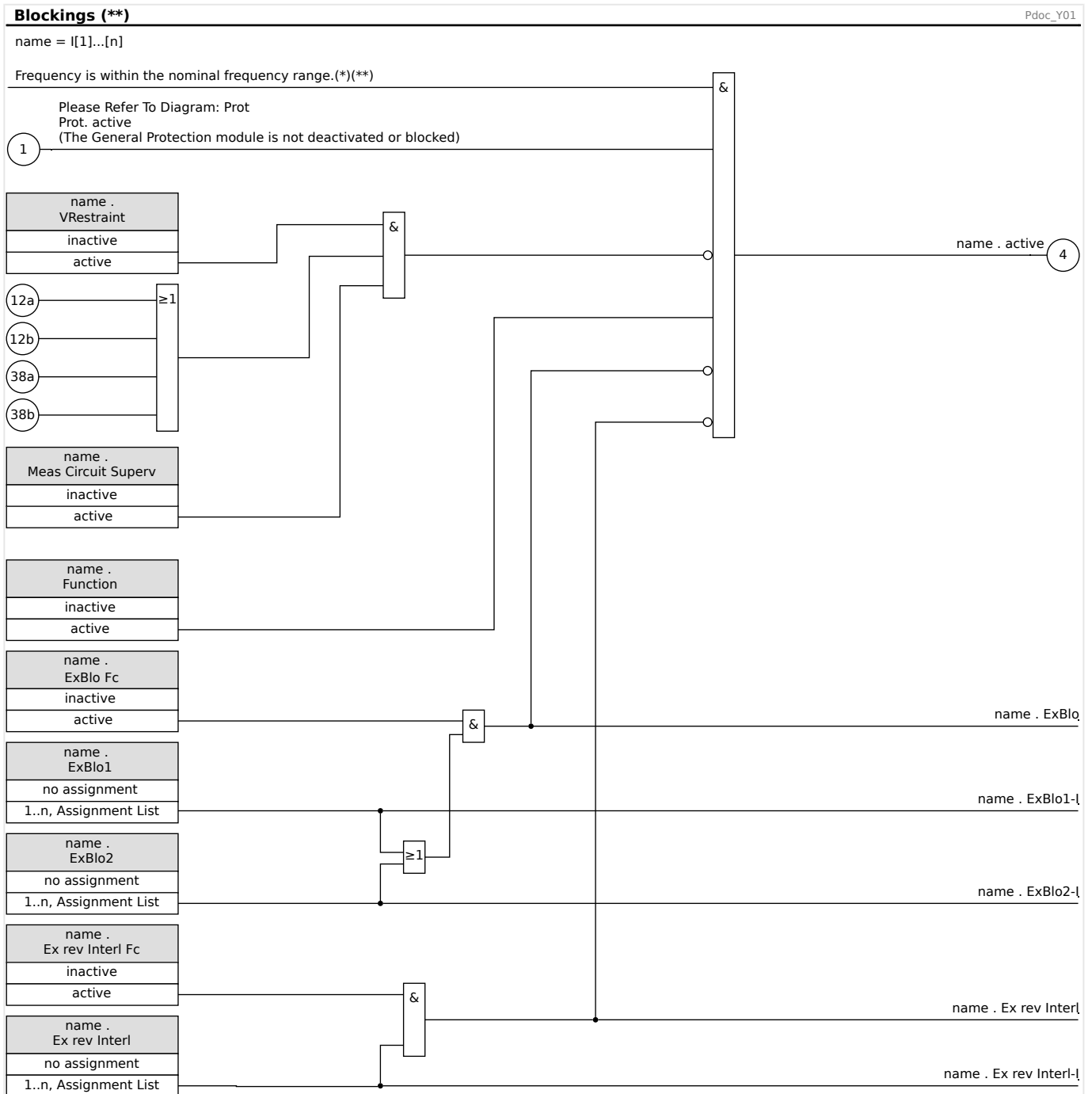

(*) All protective elements will be blocked that are using fundamental or harmonics measured values, if the frequency leaves the nominal frequency range. Protective elements that are using RMS values will remain active. See chapter "Wide frequency range".

(**) This applies to devices that offer wide frequency range measurement only.

4.1.2.4 Activate, Deactivate or Block the Ground (Earth) Current Modules

Ground (earth) current protective functions cannot only be blocked permanently (»*Function*« = “inactive”) or temporarily by any blocking signal from the »assignment list«, but also by »reverse Interlocking«.

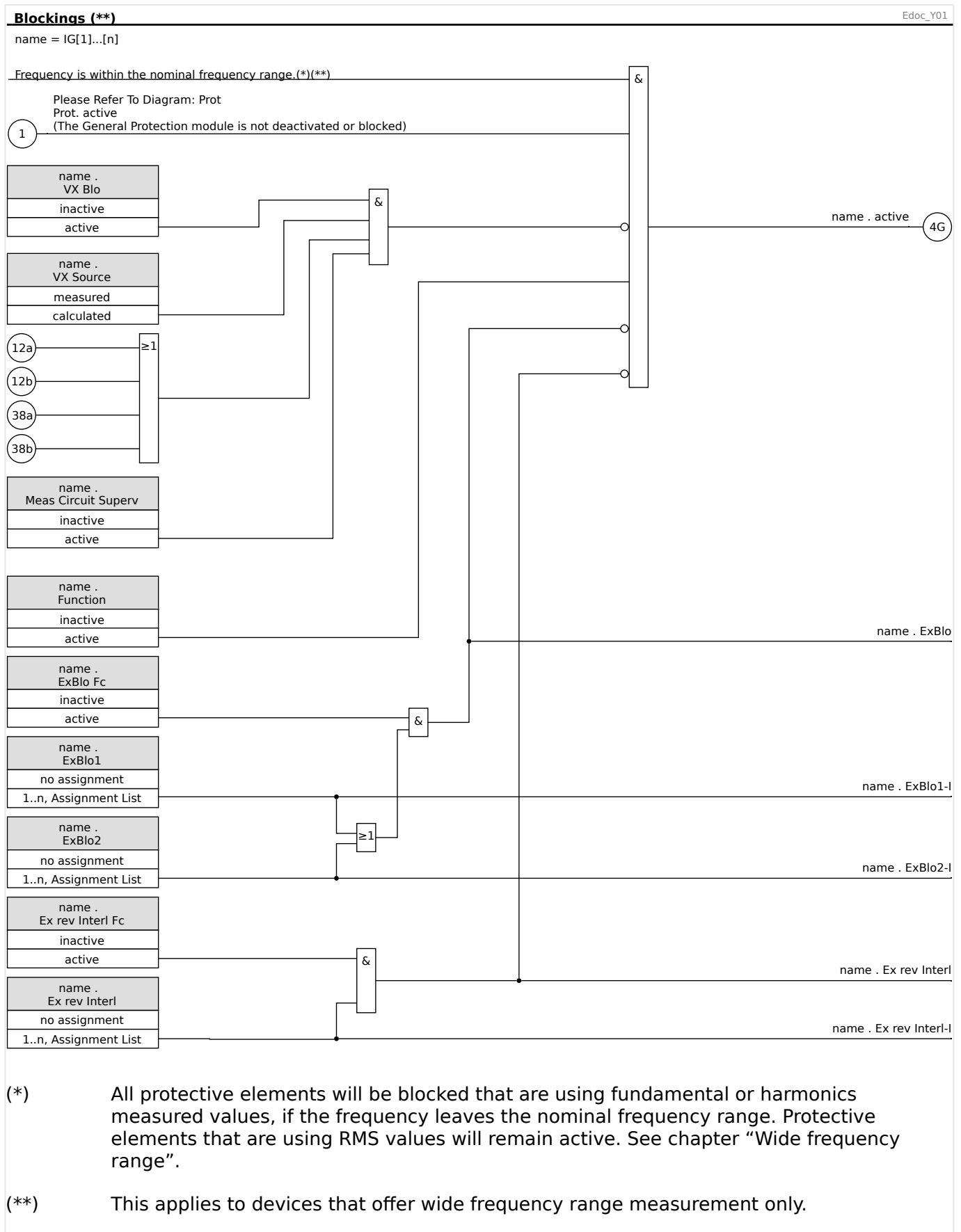

4.2 Id - Phase Current Differential Protection

The Phase Current Differential Protection module »Id« covers the following ANSI protection functions:

- ANSI 87T

Description

The protective device provides restrained phase differential protection function with User-configurable multiple slope percentage restrained characteristic that allows to compensate both the static error and the dynamic error. The static error accounts for transformer static magnetizing current and current measurement circuit calibration errors. The dynamic error may be caused by Tap Changing (OLTC) and by CT saturation caused by heavy fault currents.

In addition, the static tripping characteristic can be modified temporarily at the User's choice to prevent some nuisance tripping from the harmonic inrush during energization, over-excitation, or deep CT saturation. The harmonic inrush is evaluated through 2nd, 4th harmonics transient is monitored through the CT saturation detector. The 5th harmonic can appear due to over-excitation.

Base (Reference) Current

The base (reference current) is calculated as:

$$I_b = I_{b,W1} = \frac{S_N}{\sqrt{3} \cdot V_{LL,W1}} = \frac{\text{Rated Power}_{Transformer}}{\sqrt{3} \cdot \text{Rated Voltage}_{Transformer}}$$

Direction Definitions

The direction convention adopted here is as shown in the "ANSI 87TP" diagram below:  Fig. 49.

Transformer Phase Differential Protection - Application 87T

For this application, the phase differential protection will detect phase faults within the transformer windings. The differential zone is between the current transformers (CT) installed at both sides of the transformer.

The reference side for the phase differential protection is winding side 1 (W1).

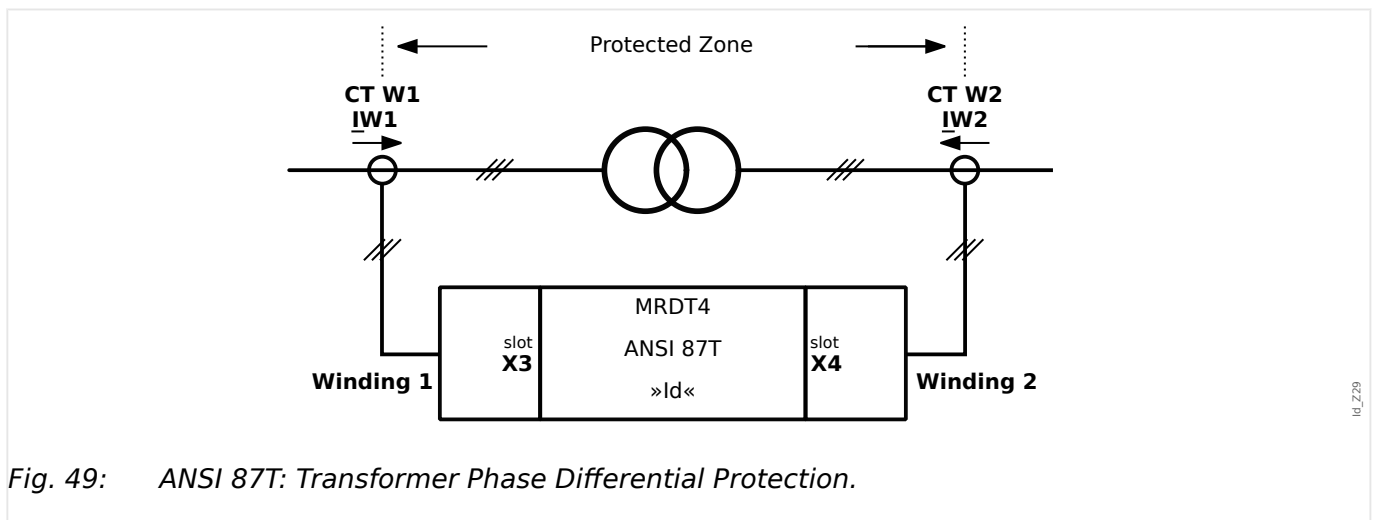

Fig. 49: ANSI 87T: Transformer Phase Differential Protection.

Required Settings:

Note 1: “CT W1” must be connected to the device current input X3 (W1) and “CT W2” side must be connected to device current terminal X4 (W2).

Set the Field Parameters of the Transformer⁽¹⁾ within the menu branch [Field Para / Transformer].

Set the Differential Protection Parameters within the menu branch [Protection Para / Set x / Diff-Prot].

Symbols

These symbols are used in the following description of the tripping principles of phase differential protection:

Symbol	Explanation
S_N	Rated Power of the Protected Object (e. g. Generator or Transformer).
V_{LL}	Rated Voltage of the Protected Object (e. g. Generator).
$V_{LL,W1}$	Rated Voltage of the Transformer on the W1 side (high-voltage, HV).
$V_{LL,W2}$	Rated Voltage of the Transformer on the W2 side (low-voltage, LV).
$CT_{prim,W1}$	Primary Rated current of the Current Transformer on Transformer side W1.
$CT_{sec,W1}$	Secondary Rated current of the Current Transformer on Transformer side W1.
$CT_{prim,W2}$	Primary Rated current of the Current Transformer on Transformer side W2.
$CT_{sec,W2}$	Secondary Rated current of the Current Transformer on Transformer side W2.
I_b	Base current (depending on the applied context. In general, this is the Rated Current of the Protected Object, e. g. Generator or Transformer).
$I_{b,W1}$	Base current or Rated Current of the Transformer winding on side W1.
$I_{b,W2}$	Base current or Rated Current of the Transformer winding on side W2.
$I_{pri,W1}$	Uncompensated primary current phasors on the corresponding side.
$I_{pri,W2}$	
\underline{I}_{W1}	Uncompensated secondary current phasors on the corresponding winding side (W1 or W2).
\underline{I}_{W2}	

4.2.1 Tripping Curve

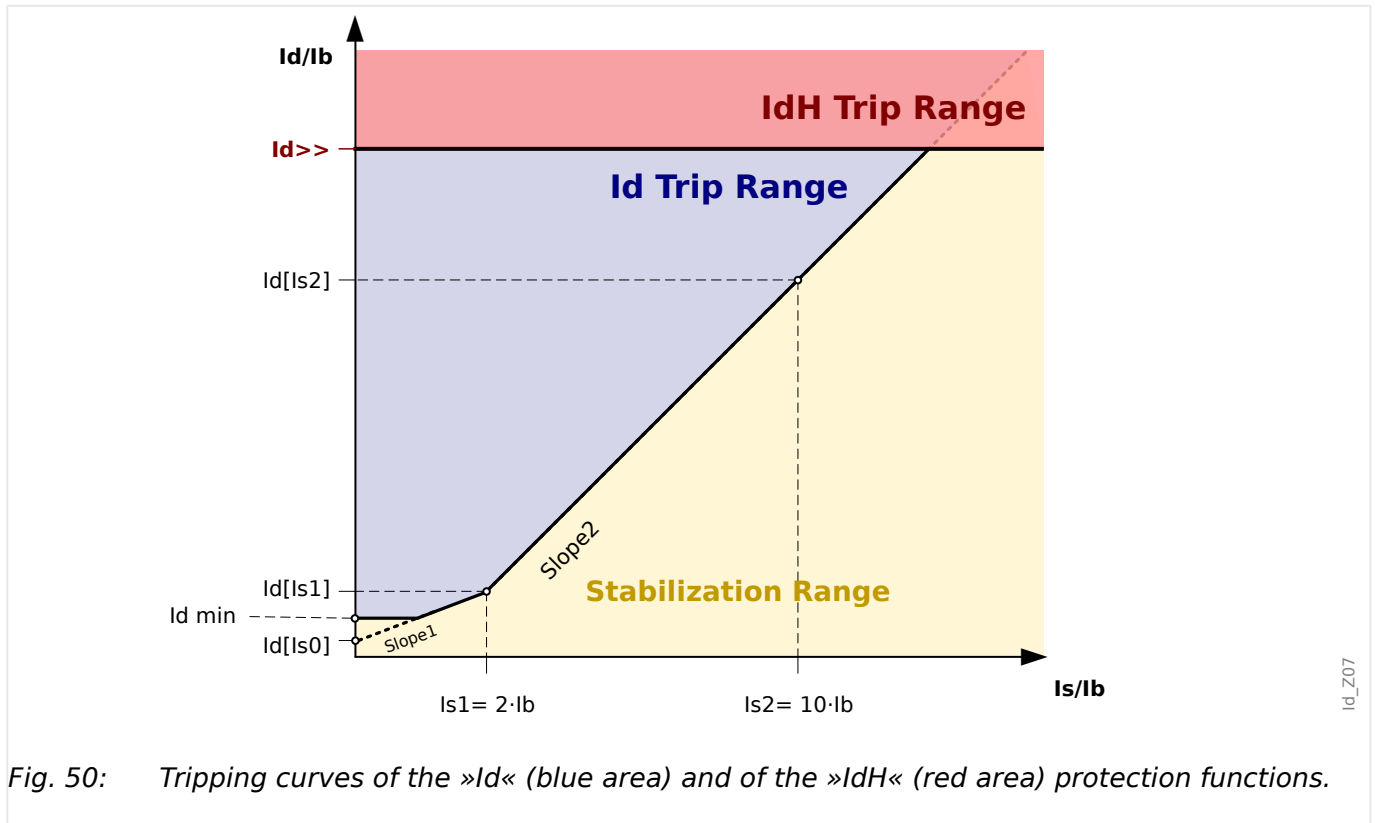



Fig. 50: Tripping curves of the »Id« (blue area) and of the »IdH« (red area) protection functions.

In this tripping curve, the symbols are as follows:

<p>Blue area shown in Fig. 50:</p>	<p>Trip range of the »Id« protection function.</p> <p>(This is the phase current differential protection, described throughout this chapter).</p>
<p>Red area shown in Fig. 50:</p>	<p>Trip range of the »IdH« protection function.</p> <p>This is the unrestrained high-set differential current protection, described in "4.3 IdH - Unrestrained High-set Differential Current Protection". This protection function operates independently of the »Id« function (and has to be configured separately), but for the sake of completeness, the diagram above shows both trip ranges.</p> <p>For the related setting threshold $I_d \gg$, see "4.3 IdH - Unrestrained High-set Differential Current Protection".</p> <p>This means the MRDT4 has a general starting as soon as the value pair of differential current I_d and restraining current I_s lies in the blue or in the red area.</p>
<p>$I_d = I_w1 + I_w2$</p>	<p>Fundamental differential current.</p>
<p>$I_s = 0.5 \cdot I_w1 - I_w2$</p>	<p>Fundamental restraining current.</p> <p>It is also called the through-current for normal load and external faults.</p>

$I_{d0} \equiv I_d(I_{s0})$	<p>Starting point of the static tripping characteristic at $I_{s0}=0$.</p> <p>The setting parameter is: [Protection Para / Set 1...4 / Diff-Prot / Id] »<i>Id(Is0)</i>«</p>
$I_{d,min} \equiv I_{d,min}$	<p>Minimum differential current, scaled to the base current I_b.</p> <p>The setting parameter is: [Protection Para / Set 1...4 / Diff-Prot / Id] »<i>Id min</i>«</p> <p>For a given setting value, the related value on the I_s axis is:</p> $I_{s0,0} = \frac{I_{d,min} - I_{d0}}{K_1}$
I_{s1}	<p>Break-point of the static tripping characteristic.</p> <p>The setting parameter is: [Protection Para / Set 1...4 / Diff-Prot / Id] »<i>Is1</i>«</p>
$I_{d1} \equiv I_d(I_{s1})$	<p>Break-point of the static tripping characteristic at I_{s1}.</p> <p>The setting parameter is: [Protection Para / Set 1...4 / Diff-Prot / Id] »<i>Id(Is1)</i>«</p>
I_{s2}	<p>Break-point of the static tripping characteristic.</p> <p>The setting parameter is: [Protection Para / Set 1...4 / Diff-Prot / Id] »<i>Is2</i>«</p>
$I_{d2} \equiv I_d(I_{s2})$	<p>Value of the static tripping characteristic at I_{s2}.</p> <p>The setting parameter is: [Protection Para / Set 1...4 / Diff-Prot / Id] »<i>Id(Is2)</i>«</p>
K_1, K_2	<p>Slope factors for two slope sections on the operating curve, respectively.</p> <p>These can be calculated out of the given setting values, as follows:</p> $K_1 = \frac{I_{d1} - I_{d0}}{I_{s1}}$ <p>and</p> $K_2 = \frac{I_{d2} - I_{d1}}{I_{s2} - I_{s1}}$
$d(H,m)$	<p>Temporary restraining current (see  Fig. 51), which is a configurable multiple of the base current I_b.</p>
I''_{w1}, I''_{w2}	<p>Corresponding compensated secondary current phasors, that are scaled from the uncompensated primary phase current phasors $I_{pri,W1}$ and $I_{pri,W2}$ flowing into the protected object.</p>

So, the restrained percentage phase differential protection tripping characteristic can be expressed mathematically as the combination of three tripping areas:

- For $I_s < I_{s,min} = I_{s1} \cdot (I_{d,min} - I_{d0}) / (I_{d1} - I_{d0})$:

$$I_d \geq I_{d,min} + d(H, m)$$

- For $I_{s,min} \leq I_s < I_{s1}$:

$$I_d \geq I_{d0} + \frac{(I_{d1} - I_{d0}) \cdot I_s}{I_{s1}} + d(H, m)$$

- For $I_s \geq I_{s1}$:

$$I_d \geq I_{d1} + \frac{(I_{d2} - I_{d1}) \cdot (I_s - I_{s1})}{I_{s2} - I_{s1}} + d(H, m)$$

Under normal conditions, the differential current should be below $I_{d,min}$. When an internal fault occurs, the differential current will raise above the restraining current to trip.

4.2.1.1 Setting the Tripping Curve

$I_{d,min}$ is the minimum differential current multiple scaled to the base current to get the restrained phase differential protection to trip, which should be set based on the static error (no load error, transformer magnetizing current, and measurement circuit noise).

K_1 and K_2 are the restraining slopes that will be determined with the settings $I_d(I_{s0})$, $I_d(I_{s1})$, and $I_d(I_{s2})$ as follows:

$$K_1 = \frac{|I_d(I_{s1}) - I_d(I_{s0})|}{I_{s1}}$$

$$K_2 = \frac{|I_d(I_{s2}) - I_d(I_{s1})|}{(I_{s2} - I_{s1})}$$

All current settings are expressed as multiples of the base current (I_b). The base current is calculated internally from the power rating and voltage ratings of the protected object under the field parameter menu.

NOTICE!



For setting the tripping characteristics of the 87 Transformer Phase Differential Protection, the base current $I_b = I_{b,W1}$ must be used.

The values of $I_d(I_{s0})$, $I_d(I_{s1})$, and $I_d(I_{s2})$ are set according to the following procedures:

- Use $I_d(I_{s0})$ as a minimum differential current to trip (starting point of the tripping characteristic is at $I_{s0} = 0$);
- Select the slope K_1 (typically 50%);
- Calculate the value $I_d(I_{s1})$ using $I_d(I_{s0})$ and K_1 :

$$I_d(I_{s1}) = I_d(I_{s0}) + I_{s1} \cdot K_1$$

- Select the slope K_2 (typically 100%);
- Calculate the value $I_d(I_{s2})$ using $I_d(I_{s1})$ and K_2 :

$$I_d(I_{s2}) = I_d(I_{s1}) + (I_{s2} - I_{s1}) \cdot K_2$$

4.2.2 Phasor Compensation

Please note: This section applies only if a transformer is part of the protected differential zone.

NOTICE!	
	The reference side for the phasor compensation is the current measuring card W1.

The phase current phasor compensations are performed automatically and involve amplitude and phase adjustments based on the field parameters.

NOTICE!	
	The compensated secondary current phasor on the side W2, with side W1 as reference winding, can be expressed as follows:

$\underline{I}'_{W2} = \frac{V_{LL,W2}}{V_{LL,W1}(1 + \text{Tap changer})} \cdot \frac{CT_{\text{prim},W2}}{CT_{\text{prim},W1}} \cdot \underline{I}_{W2}$	Magnitude compensation.
$\underline{I}''_{W2} = T_{\text{Phase Shift}(n)} \cdot \underline{I}'_{W2}$	Angle compensation, where $T_{\text{Phase Shift}(n)}$ is a complex factor due to transformer vector group setting.

4.2.3 CT Mismatch

Please note: This section applies only if a transformer is part of the protected differential zone.

NOTICE!



None of the Amplitudes Matching factors must exceed a value of 10.

$$k_{CT1} = \frac{CT_{prim,W1}}{Ib_{W1}} \leq 10$$

and

$$k_{CT2} = \frac{CT_{prim,W2}}{Ib_{W2}} \leq 10$$

The ratio between the maximum and second largest amplitudes matching factors must not exceed a value of 3.

4.2.4 Phase Compensation

Please note: This section applies only if a transformer is part of the protected differential zone.

The MRDT4 calculates the phase compensation with side W1 as reference winding. The vector group depends on the direction of observation.

The setting parameter [Field Para / Transformer] »Phase Shift« specifies the angle (as a factor of 30°) by which the W2 side is lagging the W1 side.

Transformer Type Plate

The specifications printed on the type plate of the transformer (vector group, connection type, e. g. Yd7) always refer to the primary winding side.

Since for HighPROTEC devices the W1 side is designed to correspond to the HV side, it is recommended for the MRDT4 to connect the CTs of the HV side with the terminals at slot X3, and the LV CTs with X4. (See also [↳ “4.2.7 Example on Setting the Differential Function for Transformer Application”](#).)

The set phase sequence [Field Para / General Settings] »Phase Sequence« is handled internally for the phase compensation, so that there is no need to take care of it for the connection group specification.

4.2.5 Zero Sequence Removal

Please note: This section applies only if a transformer is part of the protected differential zone.

Zero sequence currents must be removed to prevent the phase differential protection from tripping on external ground faults. For ground faults, the zero sequence current exits only on the transformer winding side whose neutral is grounded, but not on the ungrounded winding side. The differential current due to different groundings on two winding sides results in maloperation of phase differential function if it is not compensated (removed) before. The protective device does not require the zero sequence currents to be removed externally and they will be automatically removed internally according to the field parameters »W1 Connection/Grounding« and »W2 Connection/Grounding«.

$$I_{W1}''' = I_{W1} - I_{0,W1}$$

$$I_{W2}''' = I_{W2} - I_{0,W2}$$

4.2.6 Transient Restraining

Temporarily Restraining

The protective device also offers the temporary restraining feature for further securing phase percentage restrained differential protection against harmonics and other transients such as CT saturation. The temporary restraining, whenever effective, adds a constant $d(H,m)$ to the fundamental restraining.

Graphically, the static tripping curve is temporarily raised by $d(H,m)$ which reduces sensitivity of the differential function.

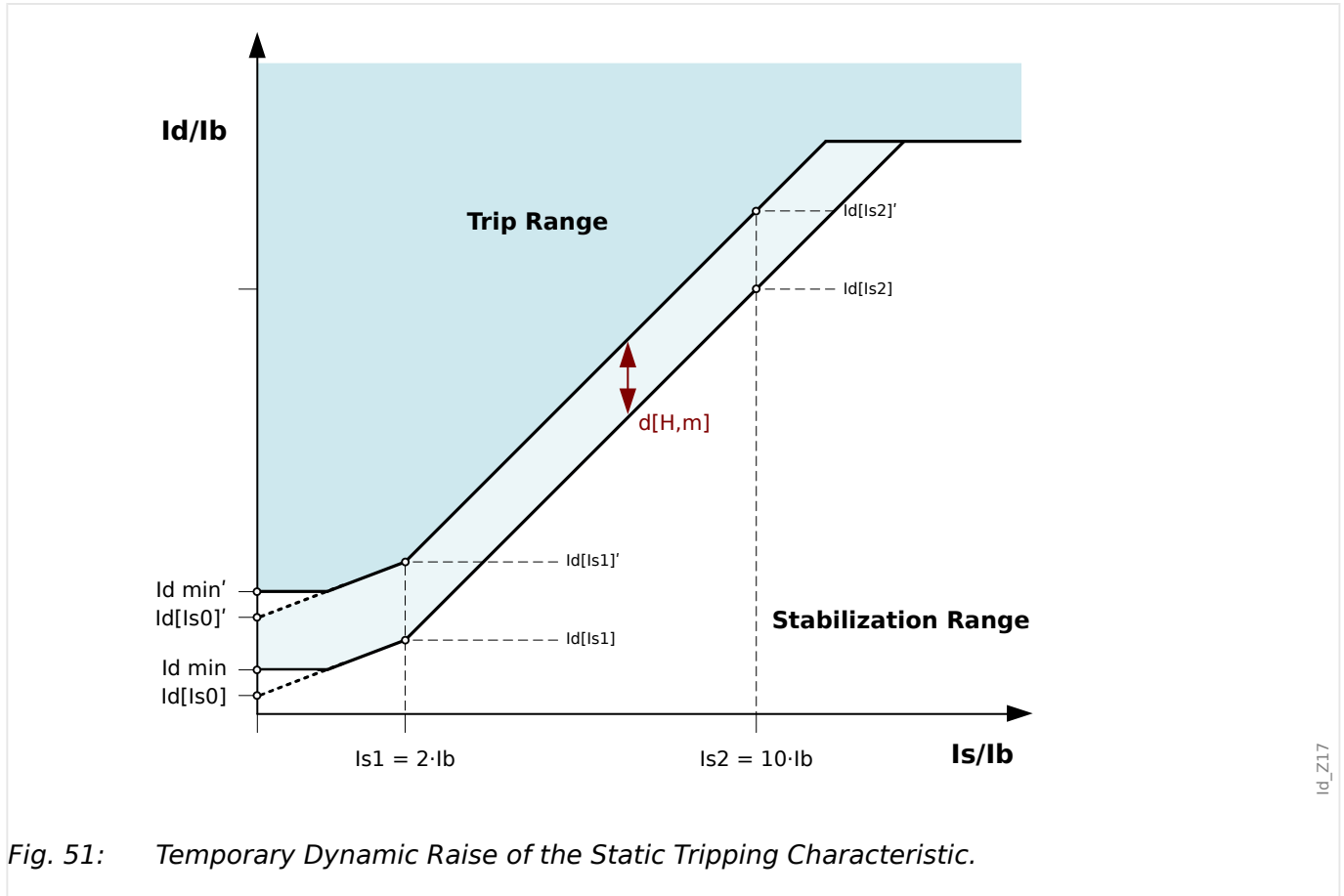

Fig. 51: Temporary Dynamic Raise of the Static Tripping Characteristic.

The transient behavior can be evoked by:

- Directly energizing the transformer (inrush effect);
- Sympathetic inrush current sharing due to adjacent transformer energization;
- Saturation of the CT.

Temporarily restraining can be triggered by:

- The 2nd harmonic trigger [Protection Para / Set 1...4 / Diff-Prot / Id] »Stab H2« is "active" and the percentage of the 2nd harmonic exceeds its threshold.
- The 4th harmonic trigger [Protection Para / Set 1...4 / Diff-Prot / Id] »Stab H4« is "active" and the percentage of the 4th harmonic exceeds its threshold.
- The 5th harmonic trigger [Protection Para / Set 1...4 / Diff-Prot / Id] »Stab H5« is "active" and the percentage of the 5th harmonic exceeds its threshold; or:

- The CT saturation trigger [Protection Para / Set 1...4 / Diff-Prot / Id] »CT Satur. Stab.« is “active” and there is an external fault with CT saturation.

By means of the parameter [Protection Para / Set 1...4 / Diff-Prot / Id] »Crossbl«, the user can specify if a harmonic signal or CT saturation within one phase temporarily causes restraining within this phase only or a cross block (3 phases).

Monitoring of the Harmonics

The amount of the temporary restraining is configured as multiple of the base current I_b . The 2nd, 4th, and 5th harmonics percentage relative to fundamental can trigger the temporary restraining. For each harmonic trigger function to be effective, it must be enabled and the percentage of the harmonic over fundamental must exceed its threshold.

Moreover, for the 2nd and 5th harmonics trigger functions, they can be configured independently as having different trigger levels for transient (»H2 Tra«, »H5 Tra«) and stationary (»H2 Sta«, »H5 Sta«) harmonics. The transient restraining is effective for a specified »t-Trans« beginning with energization, which should be set according to the time duration expected for inrush (IH2) currents. For example, this can vary from around 1 second up to nearly 30 seconds for special applications like auto-transformer banks.

The stationary harmonic restraining remains active after »t-Trans« has elapsed, as long as one of the stationary harmonic thresholds (»H2 Sta«, »H4 Sta«, »H5 Sta«) is exceeded.

Monitoring of the CT Saturation (CT Saturation Stabilization)

Besides the harmonic temporary restraining triggers, the protective device offers another trigger function – the CT saturation stabilization. After initiation of CT saturation there is a small time frame where CT transmits the signal without saturation losses after each zero crossing of the current. In this time-frame it can be checked if an external or an internal fault is active. For an external fault the stabilizing current rises after zero-crossing where the differential current stays at zero. During an internal fault both values rise after zero-crossing.

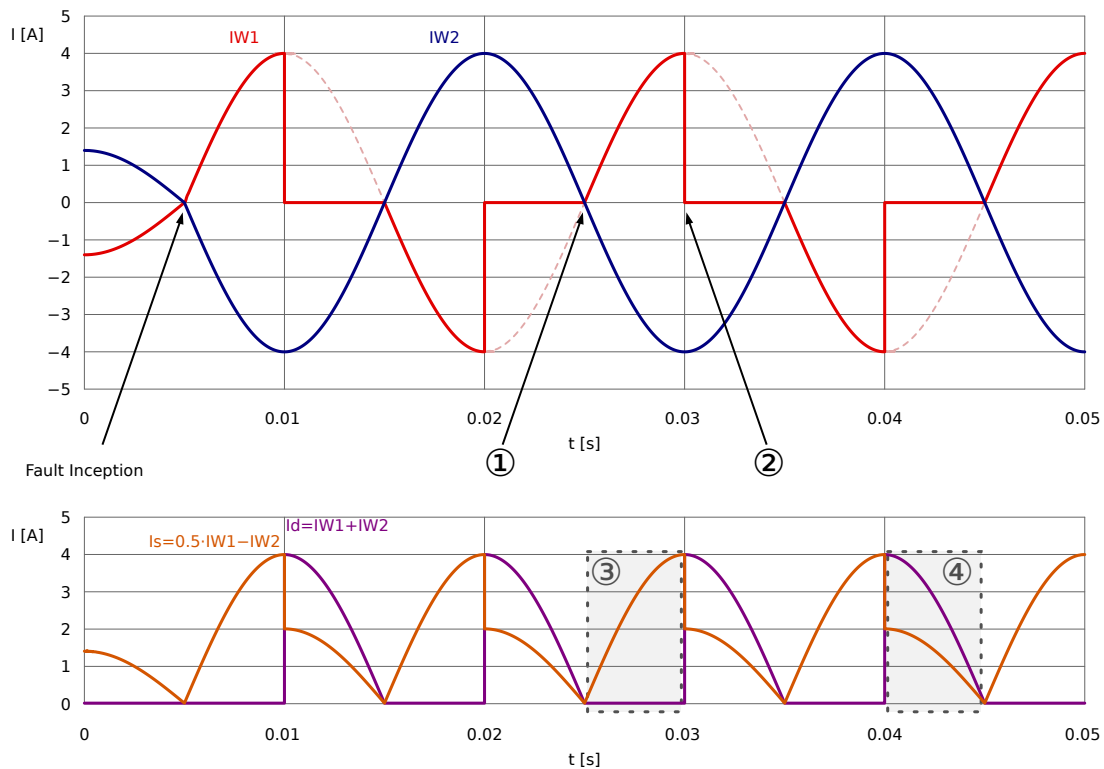

Fig. 52: Characteristic of I_d and I_s with saturation at the W1 CT side for an external fault.

- (1) Start of time-frame without saturation
- (2) Start of saturation
- (3) No saturation after zero-crossing: $I_s > 0$, $I_d \approx 0$
- (4) Saturation inception: $I_d > I_s$

The stabilizing function evaluates for each zero-crossing event if an external fault is detected and the temporary restraining has to be triggered, or continued if already active. The restraining is removed if an internal fault is detected. This is the case when both I_d and I_s rise after two zero-crossing events in a row.

The restraining is never triggered during an internal fault and therefore does not delay tripping in this case. But if an external fault evolves to an internal fault and if the restraining has already been triggered the tripping of the differential protection may be delayed for about 1...2 cycles.

»CT Sat. Stab. tBlock« adjusts the maximum stabilization duration time. The timer is started when the temporary restraining is triggered from the stabilization function. After expiring the stabilizing is removed independent of detected external faults. The setting value for this timer should be - among other dependencies - coordinated with the maximum fault clearing time for an external fault.

Once the stabilization is removed the next stabilization event cannot be triggered for one second.

4.2.7 Example on Setting the Differential Function for Transformer Application

Setting the differential module will be described here with focus on the differential functionality. The protective device asks for nearly all type-plate data of the transformer to allow for optimal adjustment of the differential function without the need of an auxiliary transformer and other tools like CT tapping (especially that known from non-digital relays in the past).

This results in the fact that the relay takes automatically these numeric values into account:

- CT ratio and its deviation from full load amperage at each winding of the transformer;
- Transformer ratio with respect to amplitude and transformer vector-group; and
- Ratio change by tap changer displacement.

All this is compensated internally for by numeric means.

[Field Para / Transformer] »SN«: Nominal, rated capacity of the transformer – basis for calculating the full load amperage of the transformer.

Example: »SN« = 78 MVA

[Field Para / Transformer] »Rated W1 (HV)«: Rated voltage of the transformer regarding winding 1.

Example: »Rated W1 (HV)« = 118 kV

[Field Para / Transformer] »Rated W2 (LV)«: Rated voltage of the transformer regarding winding 2.

Example: »Rated W1 (HV)« = 14.4 kV

By means of these three settings, the following full load amperage I_b is calculated, which is defined as the full load amperage for the maximum allowed apparent power of the transformer. There is one full load amperage for each winding, but differential protection results are always displayed in relation to I_b of the winding 1.

Example:

$$I_b = I_{b_{W1}} = \frac{78000000 \text{ VA}}{\sqrt{3} \cdot 118000 \text{ V}} = 381 \text{ A}$$

I_b = Full load current (FLA related to the W1 side, which is – in this example – the transformer primary side)

4.2.8 Connection Groups

[Field Para / Transformer] »W1 <i>Connection/Grounding</i> «	Allowed Settings: <ul style="list-style-type: none"> • “Y” – Star (connection group winding on primary side) • “D” – Delta (connection group winding on primary side) • “Z” – Zig-Zag (connection group winding on primary side) • “YN” – Star grounded (connection group winding on primary side) • “ZN” – Zig-Zag with ground connection (connection group winding on primary side)
---	--

This is the setting for the connection scheme of the winding W1 and its grounding condition.

[Field Para / Transformer] »W2 <i>Connection/Grounding</i> «	Allowed Settings: <ul style="list-style-type: none"> • “y” – Star (connection group winding on secondary side) • “d” – Delta (connection group winding on secondary side) • “z” – Zig-Zag (connection group winding on secondary side) • “yn” – Star grounded (connection group winding on secondary side) • “zn” – Zig-Zag with ground connection (connection group winding on secondary side)
---	--

This is the setting for the connection scheme of the winding W2 and its grounding condition.

The combination of »W1 *Connection/Grounding*« and »W2 *Connection/Grounding*« allows for all possible physical connection schemes of stepup transformers.

“YN” or “ZN” means that the neutral of the transformer is connected to ground on the W1 side.

“yn” or “zn” means that the neutral of the transformer is connected to ground on the W2 side.

[Field Para / Transformer] »Phase <i>Shift</i> «	Allowed Settings: 0, ..., 11
---	------------------------------

The phase shift is set in multiples of 30° and defines the angle by which the voltage on the W2 side lags the voltage on the W1 side.

Please refer to the Phase Compensation section for a number of typical, preferred transformer types.

For (Y, y, Z, z) connections, the neutral can be connected to ground or not connected to ground. In general, there is a distinction between odd (1, 3, 5, ..., 11) and even (0, 2, 4,

...,10) connection numbers. Together with the connection scheme (y, d, or z) and the treatment of the neutral of the transformer, the following definitions are taken.

- The three-phase symmetrical system I1 is rotated counter-clockwise when transferring from winding 1 to winding 2 (applies for ABC phase sequence).
- The three-phase symmetrical system I2 is rotated clockwise when transferring from winding 1 to winding 2 (applies for ABC phase sequence).
- The connection of the transformer to a negative rotating system (ACB) is taken into account according to the parameter.
- The transformation of the zero sequence system I0 depends on the connection of the windings:
 - Only (Y, y, Z, z) - connections provide for an external available neutral point;
 - Only when this neutral point is connected to ground (this is indicated by an appended "n" in the winding group setting (example Dyn)), and at least another ground connection is available on the grid to which the winding is connected (a zero sequence - respectively ground current can flow); and
 - Only when both windings of the transformer allow for ground current flowing, the zero sequence current can be transformed from one side of the transformer to the other without any phase shift.
- Odd connection groups are created by Dy, Yd, Yz, Zy schemes.
- Even connection groups are created by Yy, Zd, Dz, Dd.
- The primary values of winding 1 are reference values when displaying or evaluating relative values.

The transformer ratio can be modified by a tap changer.

[Field Para / Transformer] »Tap
changer«

Allowed Settings: -15%, ..., 15%

The tap changer changes the transformer voltage ratio k_{Tap} .

$$k_{Tap} = \frac{V_{LL,W1} (1 + TapChanger)}{V_{LL,W2}}$$

Principally, the following calculations need to be executed before calculating differential values and restraining values of the transformer differential protection:

- Rotating the measured values of winding 2 to the reference winding 1, counter-clockwise with an angle of rotation number $(0...11) \times 30$ degrees.
- Adjustment of measured values for winding 2 with respect to CT ratio mismatch.
- Adjustment of measured values for winding 2 with respect to winding connection (y, d, z).
- Adjustment of measured values for winding 1 and winding 2 according to neutral connection and ground treatment (zero sequence current elimination).

4.2.9 Automatic Calculations: Amplitudes, Vector Groups, and Zero Sequence Removal

The calculations performed can be done by matrix calculations. Three steps have to be completed.

- **1.** Adjust the amplitude according to all transformation ratios (Stepup transformer and CTs).
- **2.** Adjust the vector group angle by rotating the three-phase system accordingly.
- **3.** Remove the zero sequence current where necessary (this being valid for winding 1 and winding 2).

Re. **1.**: Amplitude Adjustment:

$$\underline{I}'_{W2} = \underline{I}_{W2} \cdot k_r \cdot k_r = \frac{CT_{prim,W2}}{I_{b,W2}} \cdot \frac{I_{b,W1}}{CT_{prim,W1}} = \frac{CT_{prim,W2}}{CT_{prim,W1}} \cdot \frac{V_{LL,W2}}{V_{LL,W1} (1 + \text{Tap changer})}$$

Re. **2.**: Vector Group Adjustment:

The vector group adjustment is calculated using the following formulas and transformation matrices:

$$\underline{I}''_{W2} = [T_{\text{Phase Shift}}] \cdot \underline{I}'_{W2} \cdot [T_{\text{Phase Shift}}] \rightarrow [T_{0,1,2...11}]$$

Even Connection Groups	Odd Connection Groups
$T_0 = \begin{bmatrix} 1 & 0 & 0 \\ 0 & 1 & 0 \\ 0 & 0 & 1 \end{bmatrix}$	$T_1 = \frac{1}{\sqrt{3}} \cdot \begin{bmatrix} 1 & -1 & 0 \\ 0 & 1 & -1 \\ -1 & 0 & 1 \end{bmatrix}$
$T_2 = \begin{bmatrix} 0 & -1 & 0 \\ 0 & 0 & -1 \\ -1 & 0 & 0 \end{bmatrix}$	$T_3 = \frac{1}{\sqrt{3}} \cdot \begin{bmatrix} 0 & -1 & 1 \\ 1 & 0 & -1 \\ -1 & 1 & 0 \end{bmatrix}$
$T_4 = \begin{bmatrix} 0 & 0 & 1 \\ 1 & 0 & 0 \\ 0 & 1 & 0 \end{bmatrix}$	$T_5 = \frac{1}{\sqrt{3}} \cdot \begin{bmatrix} -1 & 0 & 1 \\ 1 & -1 & 0 \\ 0 & 1 & -1 \end{bmatrix}$
$T_6 = \begin{bmatrix} -1 & 0 & 0 \\ 0 & -1 & 0 \\ 0 & 0 & -1 \end{bmatrix}$	$T_7 = \frac{1}{\sqrt{3}} \cdot \begin{bmatrix} -1 & 1 & 0 \\ 0 & -1 & 1 \\ 1 & 0 & -1 \end{bmatrix}$
$T_8 = \begin{bmatrix} 0 & 1 & 0 \\ 0 & 0 & 1 \\ 1 & 0 & 0 \end{bmatrix}$	$T_9 = \frac{1}{\sqrt{3}} \cdot \begin{bmatrix} 0 & 1 & -1 \\ -1 & 0 & 1 \\ 1 & -1 & 0 \end{bmatrix}$
$T_{10} = \begin{bmatrix} 0 & 0 & -1 \\ -1 & 0 & 0 \\ 0 & -1 & 0 \end{bmatrix}$	$T_{11} = \frac{1}{\sqrt{3}} \cdot \begin{bmatrix} 1 & 0 & -1 \\ -1 & 1 & 0 \\ 0 & -1 & 1 \end{bmatrix}$

Table 1: Vector group adjustments

Re. **3.**: Zero sequence removal (elimination of the ground current if this can only flow through one winding at the external asymmetrical faults and will not be transformed to the other winding).

Zero sequence removal is calculated for the W1 side, if the »W1 Connection/ Grounding« value is set to YN or ZN.

A zero sequence current can only flow:

- If the neutral is connected to ground on the W1 side; and
- The grid on the W1 side is grounded as well.

$$I_{W1}''' = I_{W1}'' - I_{0,W1}$$

For the W2 side: Zero sequence removal is calculated for the W2 side, if the »W2 Connection/Grounding« value is set to yn or zn.

A zero sequence current can only flow:

- If the vector group is odd;
- If the neutral is connected to ground on the W2 side; and
- The grid on the W2 side is grounded as well

$$I_{W2}''' = I_{W2}'' - I_{0,W2}''$$

After setting the values for the percentage restrained characteristic curve, the settings for harmonic and transient restraining have to be defined. Both the harmonic and transient restraining settings depend on many parameters:

- Transformer type;
- Transformer material;
- Operational parameter of the grid; and
- Time of energizing relative to the sinusoidal phase.

Therefore it is very difficult to give “one for all” settings in this area and to find a compromise between making a differential relay extremely fast and extremely reliable in its trip decisions.

Application Hints

Beginning with the static characteristic curve, typical slopes of 50% and 100% for both sections are recommended. They will be obtained by the settings [Protection Para / Set x / Diff-Prot / Id] »Id(Is0)«, »Id(Is1)«, »Id(Is2)«.

In case of harmonic or transient restraint, the curve will be added by a static offset $d(H,m)$.

To be able to withstand magnetizing inrush currents of typical values, the setting [Protection Para / Set x / Diff-Prot / Id] »d(H,m)« = 8 is recommended.

In case that harmonic restraint threshold is reached, this value will be added to the characteristic curve.

It is important to estimate the necessary harmonic threshold to obtain stability against magnetizing inrush and over-excitation. The harmonics seen under different operational conditions like magnetizing inrush and CT saturation depend on many different parameters.

Magnetizing inrush:

As soon as transformers are added to a circuit high inrush currents are possible due to magnetic remanence. These currents have a high 2nd harmonic component (and often also some amount of the 4th harmonic). An important dependency for the amount of the inrush current is the exact switching time, and the maximum value usually occurs with a

zero crossing of the voltage. The inrush current flows on one side only and is therefore measured as a differential current, which makes a temporary restraining of the differential protection necessary.

It is generally recommended to set the harmonic restraint as active. This is done (for each harmonic separately) by setting the respective parameter [Protection Para / Set x / Diff-Prot / Id] »Stab H2«, »Stab H4«, »Stab H5« to "active".

To operate very stably under stationary circumstances, it can be distinguished between a stationary value of harmonic thresholds and a transient harmonic threshold directly after energizing.

The so-called transient time period »*t-Trans*« directly after energizing strongly depends on the above mentioned influencing parameter. Time spans from nearly zero to more than 15 seconds are known for special auto-transformer banks. A typical setting of 2 s is recommended for commonly used transformers.

This transient period is always started if both the differential and the restraining current are below 5% of the base current I_b . The following values are recommended for typical cases:

- »H2 Sta« = 30 %
- »H2 Tra« = 15 %
- »H4 Sta« = 30 %

Over-excitation:

In case of an over-excitation of the transformer the magnetization current increases, which causes saturation effects. These are characterized by a high amount of the 5th harmonic. Since this magnetization current is measured as a differential current, a temporary restraining of the differential protection is necessary. This restraining can be triggered by the amount of the 5th harmonic.

- »H5 Sta« = 30 %
- »H5 Tra« = 15 %

All harmonic-generating events can occur to a different degree in one, two, or all three phases. That is why there is a choice provided to restrain only those phases with harmonic content or restrain all three phases. Restraining all three phases should be preferred only if the knowledge of the grid and modes of operation require this.

- »Crossbl« = "active": Phase-overlapping stabilisation of the differential protection function.
- »Crossbl« = "inactive": Phase-selective stabilisation of the differential protection function.

The CT saturation stabilization feature monitors and compares the differential and stabilizing current after each zero crossing event to discriminate between internal and external faults. If CT saturation is expected under fault currents activating this feature gives an additional stabilization to prevent false trips.

If the saturation is caused by an external fault, the tripping curve is raised by $d(H,m)$. For internal faults, there is no raising/stabilizing of the tripping curve.

- »CT Satur. Stab.« = "active"

- »*CT Sat. Stab. tBlock*« = 0.3s (example)

4.3 IdH - Unrestrained High-set Differential Current Protection

Irrespective of the set static tripping characteristic and restraining factors $d[H,m]$, a pickup value for a max. differential current I_dH can be adjusted and results in undelayed tripping when exceeded. This protection step is referred to as high-set differential step I_dH and only trips on faults within the protection zone.

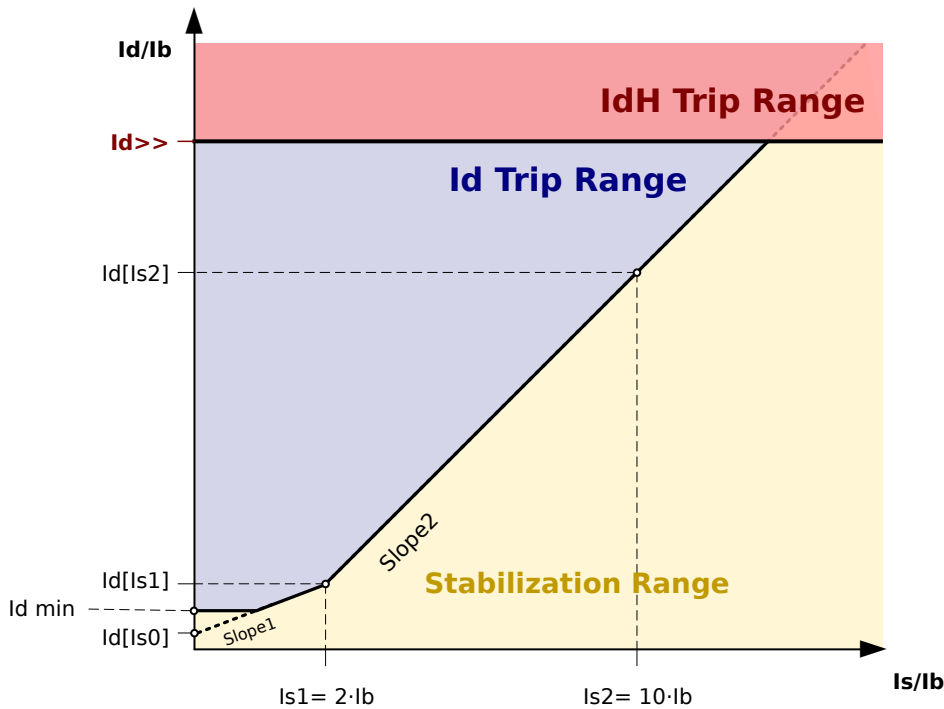

Idhigh_Z01

Fig. 53: Unrestrained High-set Differential Protection Step I_dH .

$I_d >>$ Highset Differential Current Protection/Unstabilized high-phase fault: Pickup value of the differential current based on the rated current I_b of the protection object.

The diagram above shows the following tripping curves and trip ranges:

<p>Blue area shown in Fig. 53:</p>	<p>Trip range of the »I_d« protection function.</p> <p>(This is the phase current differential protection, described in “4.2.1 Tripping Curve”, where also all the related settings are described.)</p>
<p>Red area shown in Fig. 53:</p>	<p>Trip range of the »I_dH« protection function.</p> <p>This is the unrestrained high-set differential current protection, that operates independently of the »I_d« function.</p> <p>The pickup threshold $I_d >>$ is set (in units of I_b) at [Protection Para / Set 1...4 / Diff-Prot / I_dH] »$I_d >>$«.</p> <p>This means the MRDT4 has a general starting as soon as the value pair of differential current I_d and restraining current I_s lies either in the blue or in the red area.</p>

4.4 IdG – Ground Current Differential Protection

The Ground Current Differential Protection module »IdG« covers the following ANSI protection functions:

- ANSI 64REF

The ground differential protective element can be used to provide:

- Sensitive detection of internal ground faults on the wye-side windings of transformers.
- Sensitive ground fault detection for solidly or low-impedance grounded generators.

Description

This protection principle is based on a restricted ground fault scheme that only can be used in systems with an earthed neutral. The ground differential current is the vector sum of the measured earth current and the calculated zero sequence current from three measured phase currents. Similarly to the phase restrained differential protection, the ground restraining current is the vector difference of the measured earth current and the calculated zero sequence current from three measured phase currents. The trip characteristic is very much similar to the phase restrained differential protection and it does not have the temporary restraining.

WARNING!



The trip commands generated by the protective function restricted ground fault »IdG« have to be assigned within the Breaker Manager.

NOTICE!



Please be aware that the protective function Restricted Ground Fault »IdG« solely can be applied to the winding end which builds the earthed neutral point.

Protection Principle

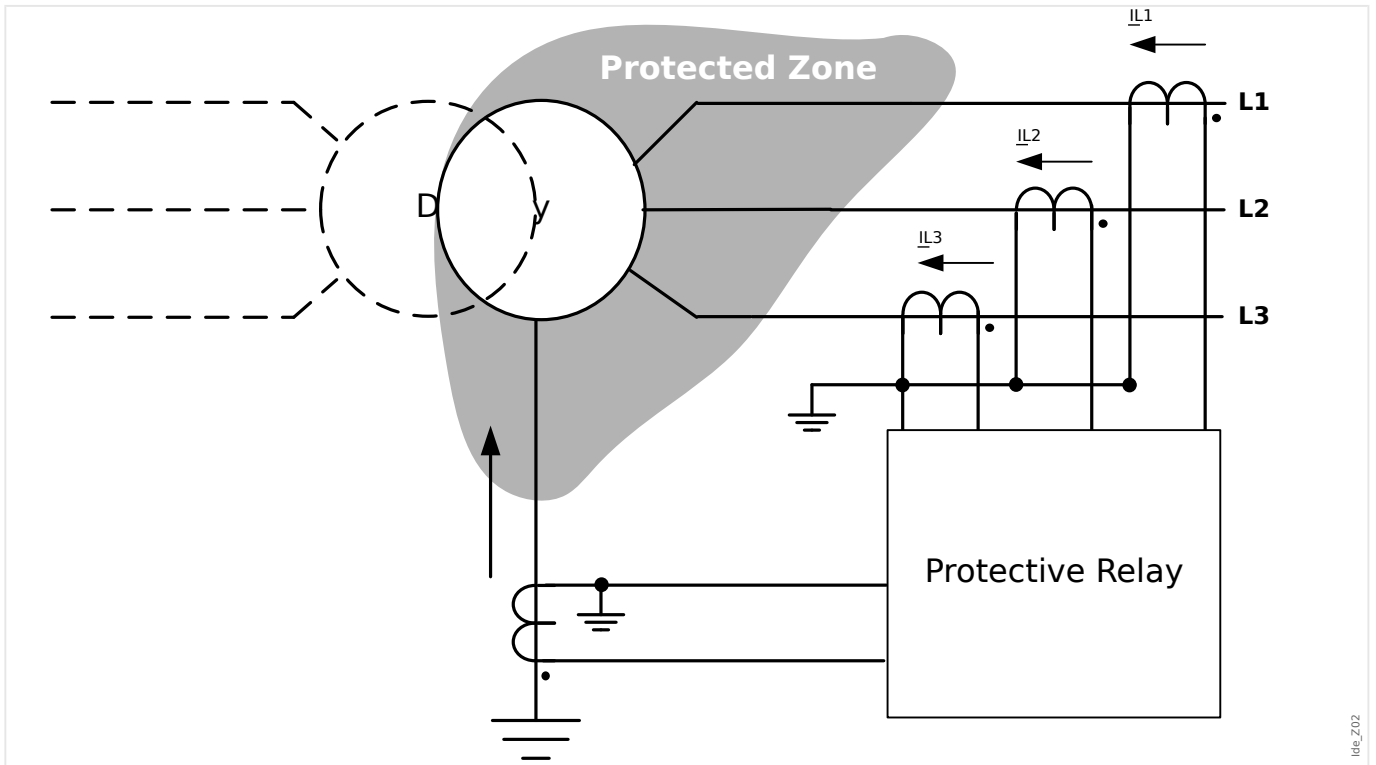
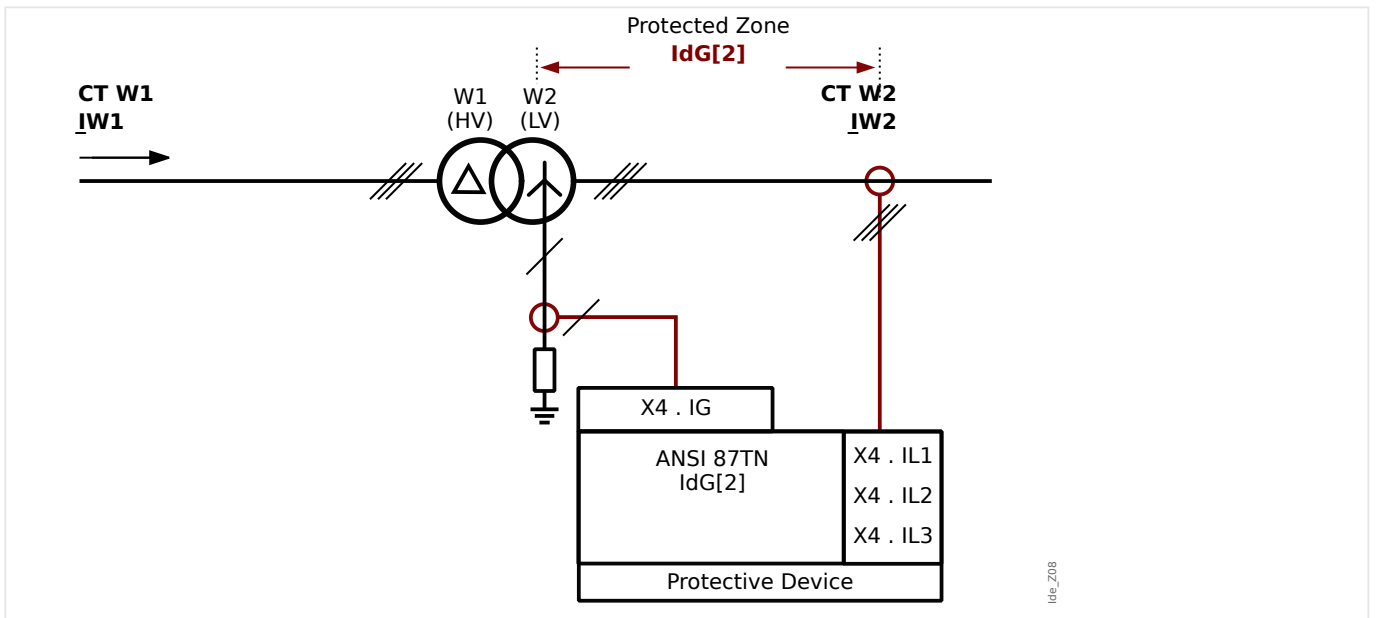

Fig. 54: Protection principle of Ground Current Differential Protection connected on wye-side winding of a transformer.

Application Example (D-y-Transformer) - ANSI 87TN



Proper Use:

To be used if the start-point side of a transformer should be protected against ground differential faults within the transformer.

Required type of current transformers and current transformer locations:

- Phase current transformers at the mains site of the transformer.
- Ground current transformer at the neutral site of the transformer.

Name of the Element that is to be used: IdG[2]

Wiring of the current transformers

- Phase current transformers to be connected to: X4 . IL1, X4 . IL2, X4 . IL3
- Ring core or ground current transformer to be connected to X4 . IG

Calculated Reference Current:

$$I_b = I_{b,W2} = \frac{S_N}{\sqrt{3} * V_{LL,W2}}$$

$$= \frac{\text{RatedPower}_{Transformer}}{\sqrt{3} * \text{RatedVoltage}(W2)_{Transformer} (Ph - Ph)}$$

Required Settings:

Activate the Protective Element: [Device planning] »IdG[2] . Mode« = “use”

Set the Field Parameters of the Transformer within the menu branch [Field Para / Transformer].

Set the Differential Protection Parameters within the menu branch [Protection Para / Set x / Diff-Prot].

Application Example (Y-y-Transformer) - ANSI 87TN

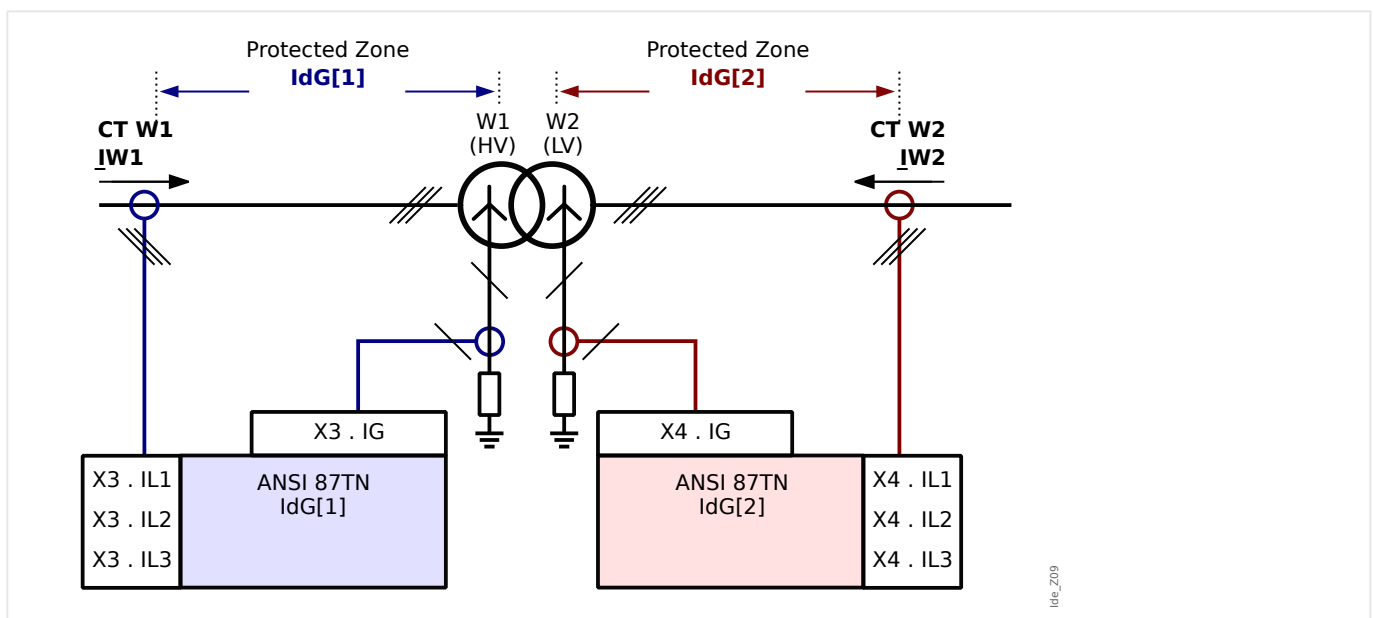

Proper Use:

To be used if the start-point sides of a Y-y-transformer should be protected against ground differential faults within the transformer on both winding sides.

Required type of current transformers on both sides and current transformer locations

- Phase current transformers at the mains site of the transformer.

- Ground current transformer at the neutral site of the transformer.

Name of the Element that is to be used:

- IdG[1] on winding side W1,
- IdG[2] on winding side W2.

Wiring of the current transformers

- Phase current transformers on winding side W1 to be connected to: X3 . IL1, X3 . IL2, X3 . IL3
- Ring core or ground current transformer on winding side W1 to be connected to X3 . IG
- Phase current transformers on winding side W2 to be connected to: X4 . IL1, X4 . IL2, X4 . IL3
- Ring core or ground current transformer on winding side W2 to be connected to X4 . IG

Calculated Reference Current Winding Side W1:

$$I_b = I_{b,W1} = \frac{S_N}{\sqrt{3} * V_{LL,W1}}$$

$$= \frac{RatedPower_{Transformer}}{\sqrt{3} * RatedVoltage_{Transformer} (Ph - Ph)}$$

Calculated Reference Current Winding Side W2:

$$I_b = I_{b,W2} = \frac{S_N}{\sqrt{3} * V_{LL,W2}}$$

$$= \frac{RatedPower_{Transformer}}{\sqrt{3} * RatedVoltage_{Transformer} (Ph - Ph)}$$

Required Settings:

Activate the Protective Element:

- [Device planning] »IdG[1] . Mode« = “use”
- [Device planning] »IdG[2] . Mode« = “use”

Set the Field Parameters of the Transformer within the menu branch [Field Para / Transformer].

Set the Differential Protection Parameters within the menu branch [Protection Para / Set x / Diff-Prot].

4.5 IdGH - High Set Restricted Ground Fault Protection

Similar to the unrestrained phase differential protection, unrestrained ground differential protection functions are provided for a high ground differential current.

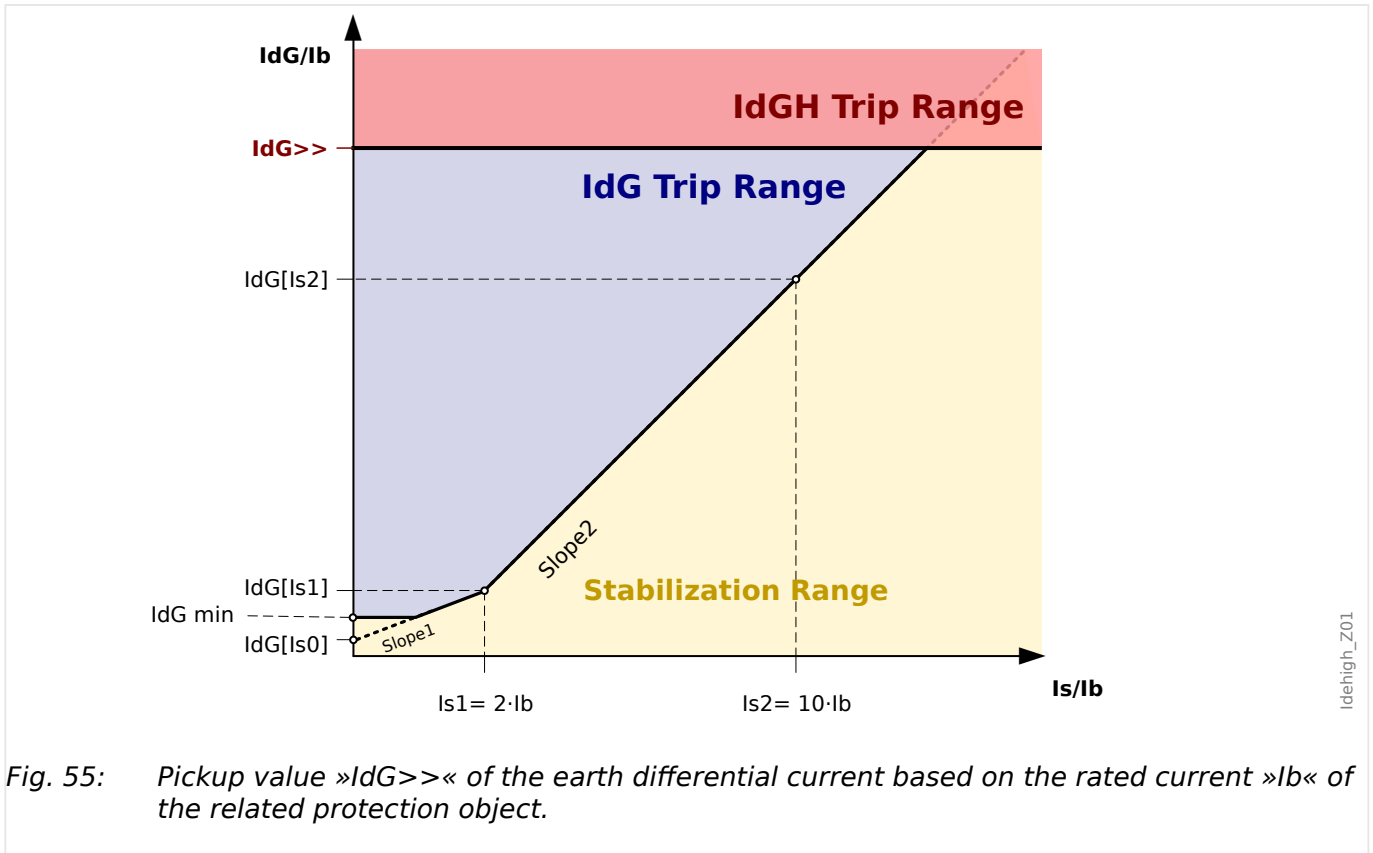







Fig. 55: Pickup value $\gg I_{dG} \gg$ of the earth differential current based on the rated current $\gg I_b$ of the related protection object.

The diagram above shows the following tripping curves and trip ranges:

<p>Blue area shown in Fig. 55:</p>	<p>Trip range of the $\gg I_{dG}$ protection function. (This is the ground current differential protection, described in "4.4 IdG - Ground Current Differential Protection".)</p>
<p>Red area shown in Fig. 55:</p>	<p>Trip range of the $\gg I_{dGH}$ protection function. This is the high set restricted ground fault protection, that operates independently of the $\gg I_{dG}$ function. The pickup threshold $I_{dG} \gg$ is set (in units of I_b) at [Protection Para / Set 1...4 / Diff-Prot / IdGH] $\gg I_{dG} \gg$. This means the MRDT4 has a general starting as soon as the value pair of ground differential current I_{dG} and restraining current I_s lies either in the blue or in the red area.</p>

4.6 I - Overcurrent Protection

The Phase Overcurrent module »I« covers the following ANSI protection functions:

- ANSI 50 —  “ANSI 50, 51 - Definite / Inverse Time Overcurrent Protection, Non-Directional”,  “4.6.1 Characteristics”
- ANSI 51 —  “ANSI 50, 51 - Definite / Inverse Time Overcurrent Protection, Non-Directional”,  “4.6.1 Characteristics”
- ANSI 51Q —  “ANSI 51Q - Negative Phase Sequence Overcurrent Protection”,  “4.6.3 I2> - Negative-Sequence Overcurrent [51Q]”

WARNING!



If you are using inrush blockings the tripping delay of the current protection functions must be at least 30 ms or more in order to prevent faulty trippings.

NOTICE!



All overcurrent protective elements are identically structured.

NOTICE!



This module offers Adaptive Parameter Sets.

Parameters can be modified within parameter sets dynamically by means of Adaptive Parameter Sets. Please refer to  “1.3.2 Adaptive Parameter Sets”.

ANSI 50, 51 - Definite / Inverse Time Overcurrent Protection, Non-Directional

This application option is set via the [Device planning] menu:

- [Device planning] »Mode« = “non directional”

No directional information is taken into account if the current protective element is planned as “non directional”.

Options:

- [Protection Para / Set 1...4 / I-Prot / I[x]] »Measuring method« =
 - Fundamental
 - True RMS
 - I2

ANSI 51Q - Negative Phase Sequence Overcurrent Protection

This application option is activated as follows:

- [Protection Para / Set 1...4 / I-Prot / I[x]] »Measuring method« = "I2"

Measuring Method

For each protection element it can be defined via setting »Measuring method«, whether the measurement is done on basis of the "Fundamental" or if "True RMS" measurement is used.

Alternatively the »Measuring method« can be set to "I2". In this case the negative phase sequence current will be measured. This is to detect unbalanced faults.

4.6.1 Characteristics

For each element the following characteristics are available:

- **DEFT** - *Definite Time-Overcurrent*
- **IEC 60255-151 Curves:**
 - **NINV** - *IEC Normal Inverse* (IEC 60255-151)
 - **VINV** - *IEC Very Inverse* (IEC 60255-151)
 - **LINV** - *IEC Long Time Inverse* (IEC 60255-151)
 - **EINV** - *IEC Extremely Inverse* (IEC 60255-151)
- **ANSI / IEEE C37.112 Curves:**
 - **MINV** - *ANSI Moderately Inverse* (IEEE C37.112)
 - **VINV** - *ANSI Very Inverse* (IEEE C37.112)
 - **EINV** - *ANSI Extremely Inverse* (IEEE C37.112)
- **RINV** - *R Inverse*
- **Thermal Curves:**
 - **Therm Flat** - *Thermal Flat*
 - **IT**
 - **I2T**
 - **I4T**

Explanation for All Characteristics

- **I**: Fault current
- **I>**: If the pickup value is exceeded, the module/element starts to time out to trip.
Setting: [Protection Para / Set 1...4 / I-Prot / I[x]] »I>«
- **t** for »Char« = "**DEFT**":
 -
 - Trip delay for $I > I>$, settable via [Protection Para / Set 1...4 / I-Prot / I[x]] »t«.

-

The reset delay for $I < I_{set}$ always equals 0 (“instantaneous”).

- t_{reset} for all characteristics except “DEFT”:
 - The trip delay for $I > I_{set}$ is calculated based on the selected characteristics.
 - The reset delay for $I < I_{set}$ is settable via »Reset Mode«, available options: “instantaneous”, “definite time” or “inverse time”.
 - With option »Reset Mode« = “instantaneous”: Instantaneous reset: when the current drops below the pickup setting, the TOC time resets to zero within 2 cycles.
 - With option »Reset Mode« = “definite time”: The reset delay is settable at »t-reset delay«.
 - With option »Reset Mode« = “inverse time”: The reset delay is calculated based on the selected characteristics.
- t_{char} (for all characteristics except “DEFT”):
 - Time multiplier/tripping characteristic factor. The setting range depends on the selected tripping curve.
 - Setting via [Protection Para / Set 1...4 / I-Prot / I[x]] »tchar«

For all characteristics except the [Thermal Curves](#), there is a minimum trip delay t_{min} , that is dependent on a I_{max} . The effective trip delay does never fall below t_{min} , independent of the actual value of I .

- I_{max} is the smallest value out of these:
 - $20 \cdot I_{set}$
 - $40 \cdot I_n$
- t_{min} is the trip delay at I_{max} for the respective characteristic.

4.6.1.1 DEFT - Definite Time-Overcurrent

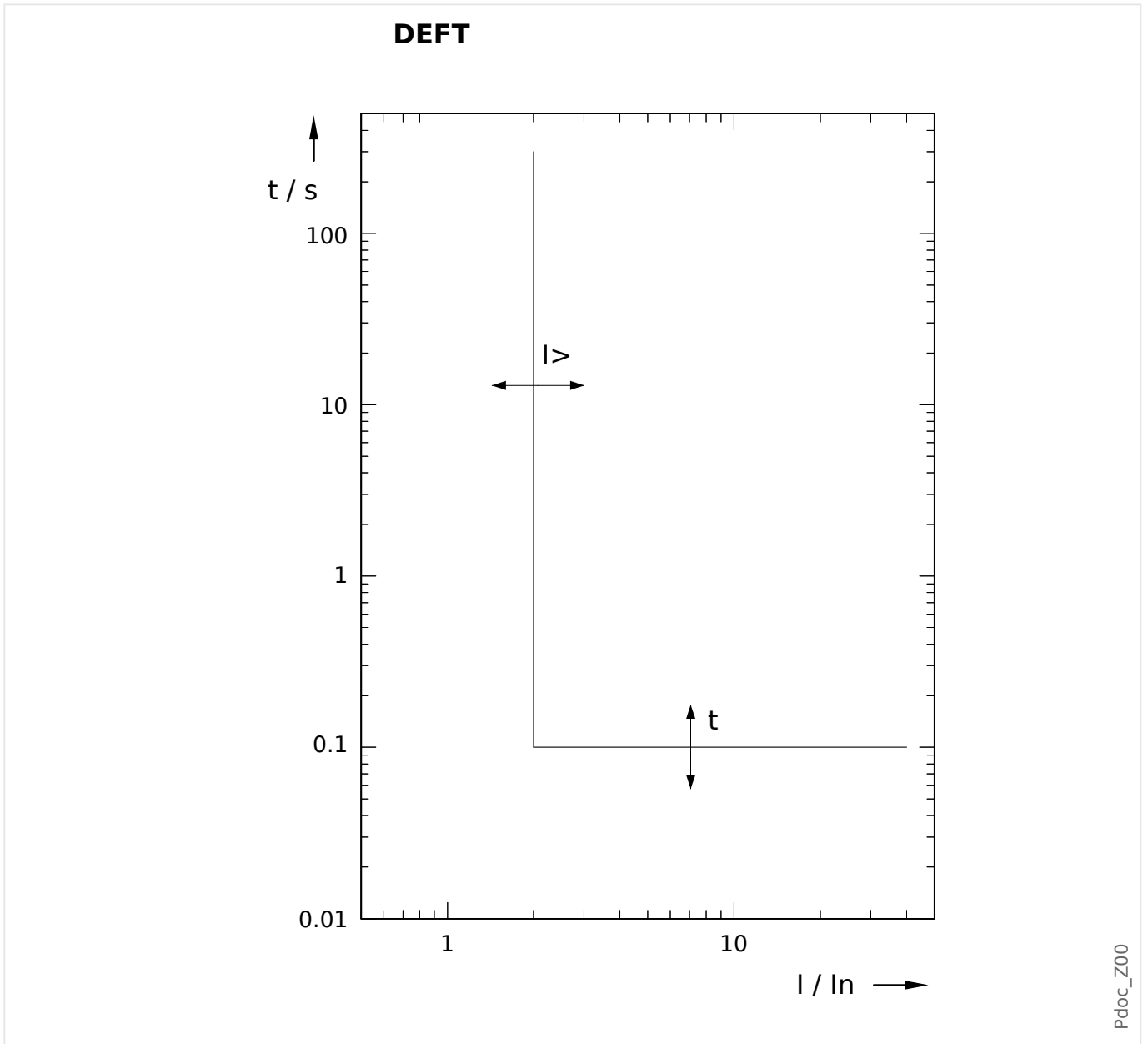

Trip delay for $I > I_{>}$, settable via [Protection Para / Set 1...4 / I-Prot / I[x]] »t«.

The reset delay for $I < I_{>}$ always equals 0 (“instantaneous”).

4.6.1.2 IEC 60255-151 Curves

4.6.1.2.1 Normal Inverse (IEC 60255-151)

»Char« = IEC NINV

Reset Delay

Various reset modes are available: Resetting via characteristic, delayed and instantaneous. See [↳ “Explanation for All Characteristics”](#) for details.

For »Reset Mode« = “inverse time”, with $I < I_{>}$, the reset delay is defined by this equation:

$$t = \frac{0.14}{1 - \left(\frac{I}{I_{>}}\right)^2} \cdot t_{char}$$

Trip Delay

If $I > < I < I_{max}$, the trip delay is defined by this equation:

$$t = \frac{0.14}{\left(\frac{I}{I_{>}}\right)^{0.02} - 1} \cdot t_{char}$$

For $I > I_{max}$, the trip delay t is kept constant at $t = t_{min}$.

See [↳ “Explanation for All Characteristics”](#) for details about I_{max} and t_{min} .

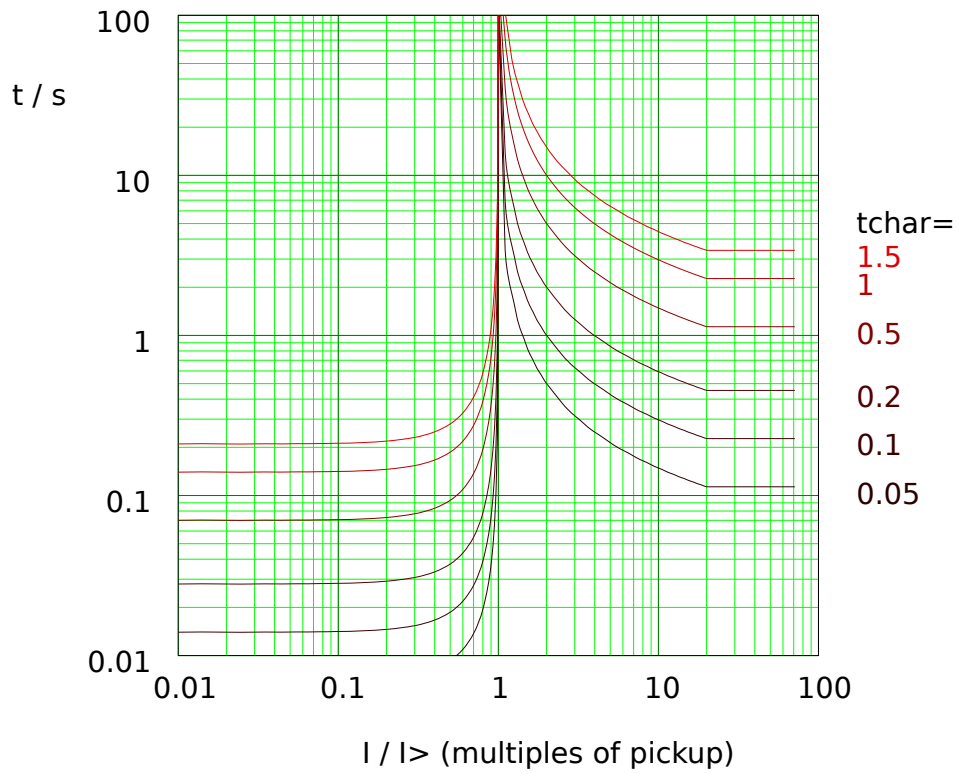

Pdoc_Z01

Fig. 56: NINV: reset delay (left half, $I < I >$) and trip delay (right half, $I > I >$), example for $I_{max} = 20 \cdot I >$.

4.6.1.2.2 Very Inverse [VINV] (IEC 60255-151)

»Char« = IEC VINV

Reset Delay

Various reset modes are available: Resetting via characteristic, delayed and instantaneous. See [↪ “Explanation for All Characteristics”](#) for details.

For »Reset Mode« = “inverse time”, with $I < I>$, the reset delay is defined by this equation:

$$t = \frac{13.5}{1 - \left(\frac{I}{I>}\right)^2} \cdot t_{char}$$

Trip Delay

If $I> < I < I_{max}$, the trip delay is defined by this equation:

$$t = \frac{13.5}{\frac{I}{I>} - 1} \cdot t_{char}$$

For $I > I_{max}$, the trip delay t is kept constant at $t = t_{min}$.

See [↪ “Explanation for All Characteristics”](#) for details about I_{max} and t_{min} .

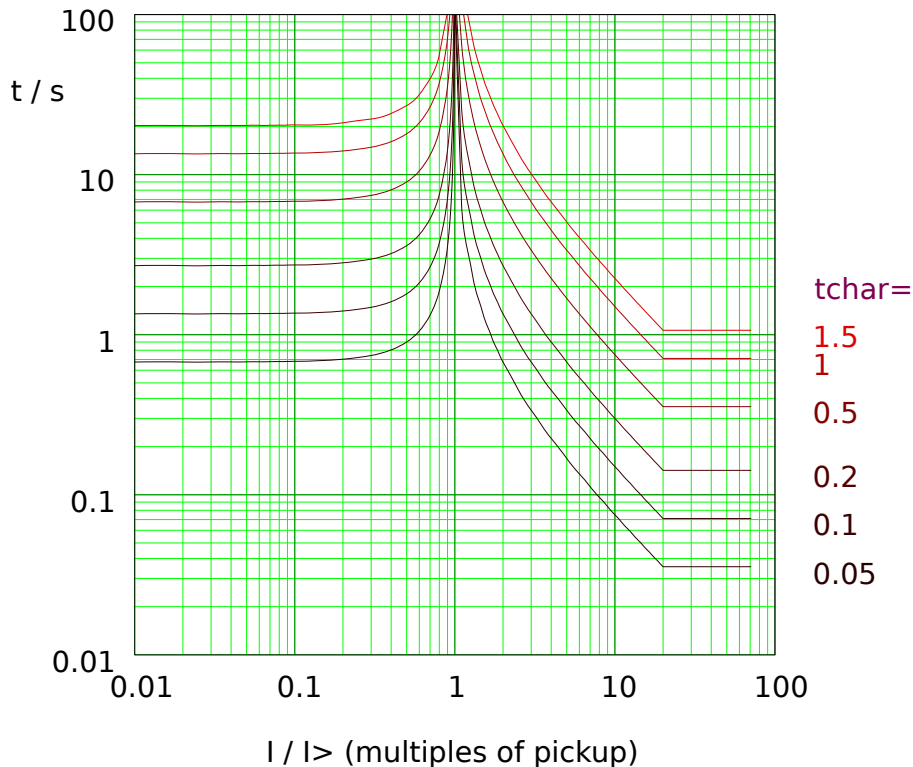

Fig. 57: VINV: reset delay (left half, $I < I>$) and trip delay (right half, $I > I>$), example for $I_{max} = 20 \cdot I>$.

4.6.1.2.3 Extremely Inverse - Characteristic (IEC 60255-151)

»Char« = IEC EINV

Reset Delay

Various reset modes are available: Resetting via characteristic, delayed and instantaneous. See [↳ “Explanation for All Characteristics”](#) for details.

For »Reset Mode« = “inverse time”, with $I < I_{>}$, the reset delay is defined by this equation:

$$t = \frac{80}{1 - \left(\frac{I}{I_{>}}\right)^2} \cdot t_{char}$$

Trip Delay

If $I > < I < I_{max}$, the trip delay is defined by this equation:

$$t = \frac{80}{\left(\frac{I}{I_{>}}\right)^2 - 1} \cdot t_{char}$$

For $I > I_{max}$, the trip delay t is kept constant at $t = t_{min}$.

See [↳ “Explanation for All Characteristics”](#) for details about I_{max} and t_{min} .

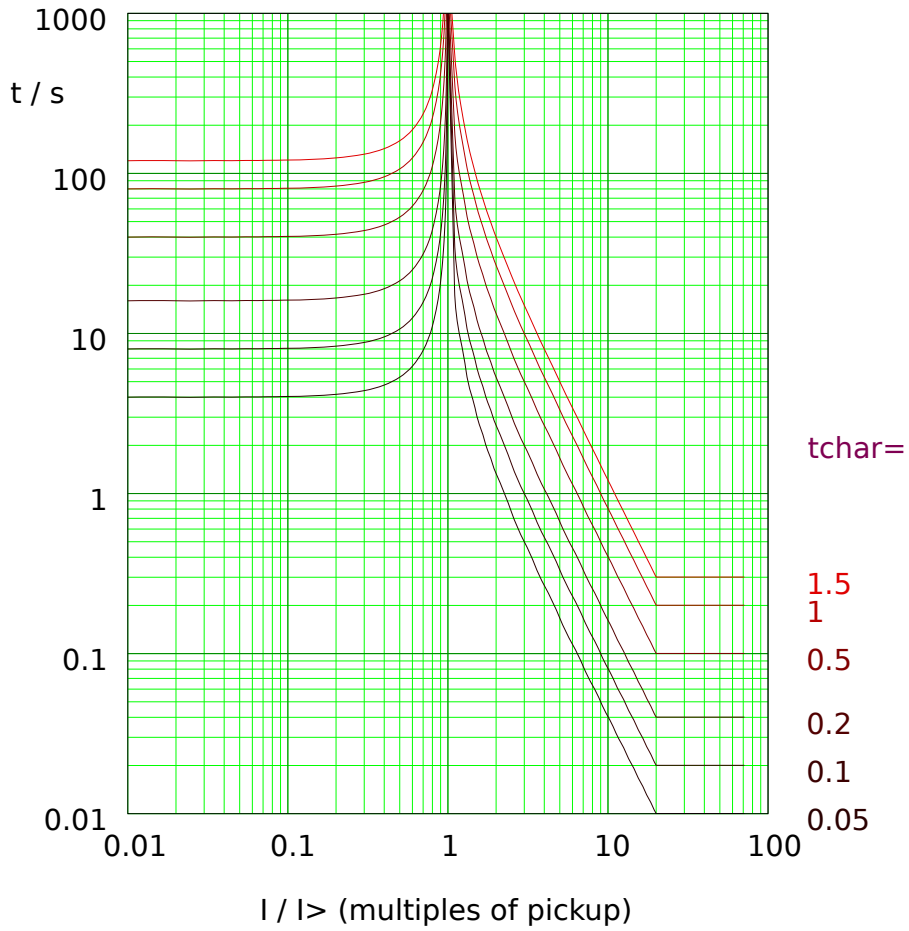

Fig. 58: EINV: reset delay (left half, $I < I_p$) and trip delay (right half, $I > I_p$), example for $I_{max} = 20 \cdot I_p$.

4.6.1.2.4 Long Time Inverse - Characteristic [LINV] (IEC 60255-151)

»Char« = IEC LINV

Reset Delay

Various reset modes are available: Resetting via characteristic, delayed and instantaneous. See [↪ “Explanation for All Characteristics”](#) for details.

For »Reset Mode« = “inverse time”, with $I < I>$, the reset delay is defined by this equation:

$$t = \frac{120}{1 - \left(\frac{I}{I>}\right)^2} \cdot tchar$$

Trip Delay

If $I > < I < I_{max}$, the trip delay is defined by this equation:

$$t = \frac{120}{\frac{I}{I>} - 1} \cdot tchar$$

For $I > I_{max}$, the trip delay t is kept constant at $t = t_{min}$.

See [↪ “Explanation for All Characteristics”](#) for details about I_{max} and t_{min} .

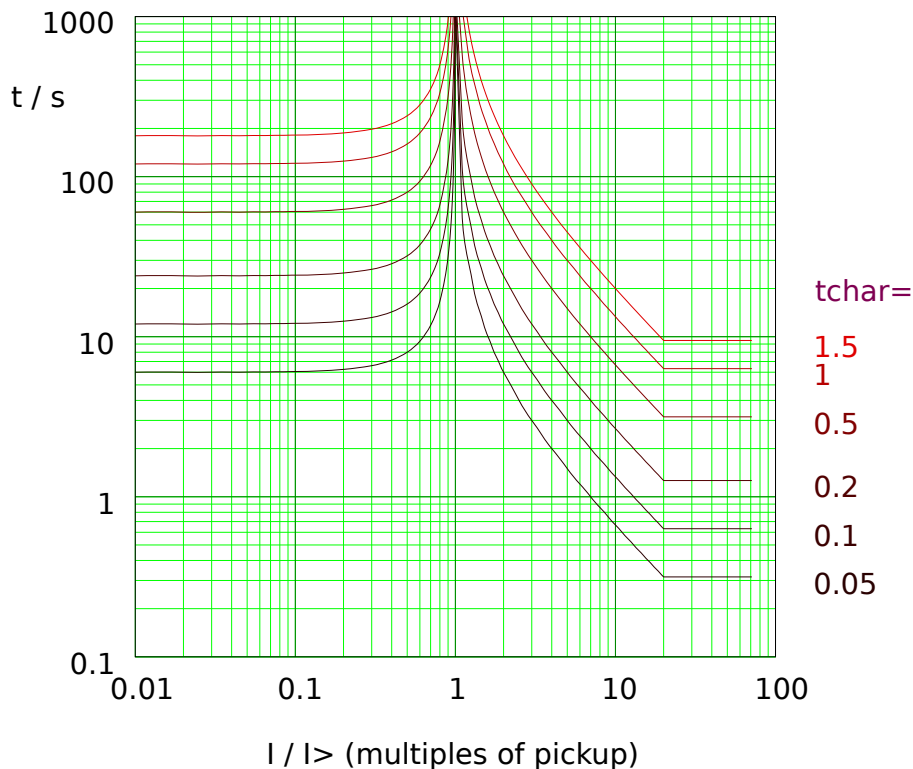

Fig. 59: LINV: reset delay (left half, $I < I>$) and trip delay (right half, $I > I>$), example for $I_{max} = 20 \cdot I>$.

Pdoc_Z03

4.6.1.3 ANSI / IEEE C37.112 Curves

4.6.1.3.1 Moderately Inverse [MINV] - Characteristic (IEEE C37.112)

»Char« = ANSI MINV

Reset Delay

Various reset modes are available: Resetting via characteristic, delayed and instantaneous. See [↳ “Explanation for All Characteristics”](#) for details.

For »Reset Mode« = “inverse time”, with $I < I_{>}$, the reset delay is defined by this equation:

$$t = \frac{4.85}{1 - \left(\frac{I}{I_{>}}\right)^2} \cdot t_{char}$$

Trip Delay

If $I_{>} < I < I_{max}$, the trip delay is defined by this equation:

$$t = \left(\frac{0.0515}{\left(\frac{I}{I_{>}}\right)^{0.02} - 1} + 0.1140 \right) \cdot t_{char}$$

For $I > I_{max}$, the trip delay t is kept constant at $t = t_{min}$.

See [↳ “Explanation for All Characteristics”](#) for details about I_{max} and t_{min} .

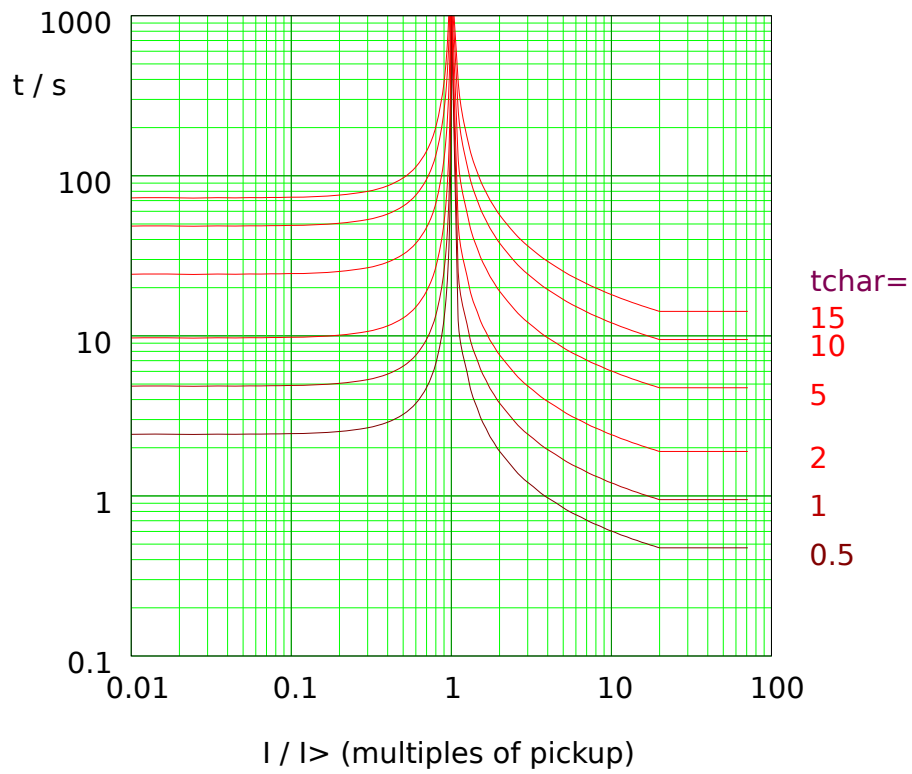

Fig. 60: MINV: reset delay (left half, $I < I_{pickup}$) and trip delay (right half, $I > I_{pickup}$), example for $I_{max} = 20 \cdot I_{pickup}$.

4.6.1.3.2 Very Inverse [VINV] (IEEE C37.112)

»Char« = ANSI VINV

Reset Delay

Various reset modes are available: Resetting via characteristic, delayed and instantaneous. See [↪ “Explanation for All Characteristics”](#) for details.

For »Reset Mode« = “inverse time”, with $I < I>$, the reset delay is defined by this equation:

$$t = \frac{21.6}{1 - \left(\frac{I}{I>}\right)^2} \cdot tchar$$

Trip Delay

If $I> < I < I_{max}$, the trip delay is defined by this equation:

$$t = \left(\frac{19.61}{\left(\frac{I}{I>}\right)^2 - 1} + 0.491 \right) \cdot tchar$$

For $I > I_{max}$, the trip delay t is kept constant at $t = t_{min}$.

See [↪ “Explanation for All Characteristics”](#) for details about I_{max} and t_{min} .

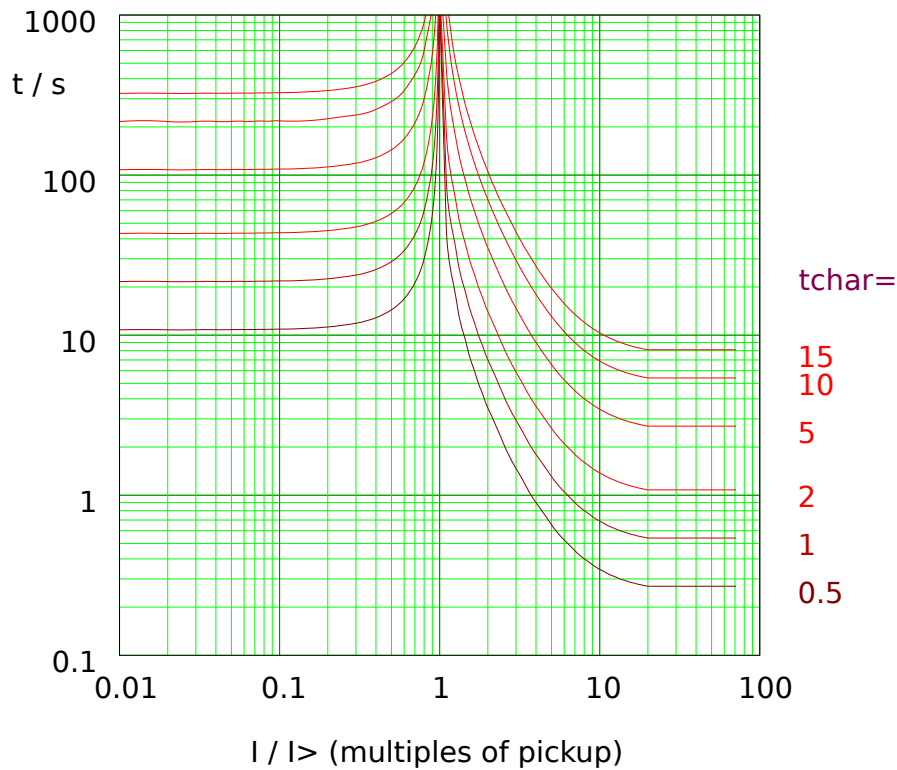

Fig. 61: VINV: reset delay (left half, $I < I>$) and trip delay (right half, $I > I>$), example for $I_{max} = 20 \cdot I>$.

4.6.1.3.3 Extremely Inverse - Characteristic (IEEE C37.112)

»Char« = ANSI EINV

Reset Delay

Various reset modes are available: Resetting via characteristic, delayed and instantaneous. See [↳ “Explanation for All Characteristics”](#) for details.

For »Reset Mode« = “inverse time”, with $I < I>$, the reset delay is defined by this equation:

$$t = \frac{29.1}{1 - \left(\frac{I}{I>}\right)^2} \cdot tchar$$

Trip Delay

If $I > < I < I_{max}$, the trip delay is defined by this equation:

$$t = \left(\frac{28.2}{\left(\frac{I}{I>}\right)^2 - 1} + 0.1217 \right) \cdot tchar$$

For $I > I_{max}$, the trip delay t is kept constant at $t = t_{min}$.

See [↳ “Explanation for All Characteristics”](#) for details about I_{max} and t_{min} .

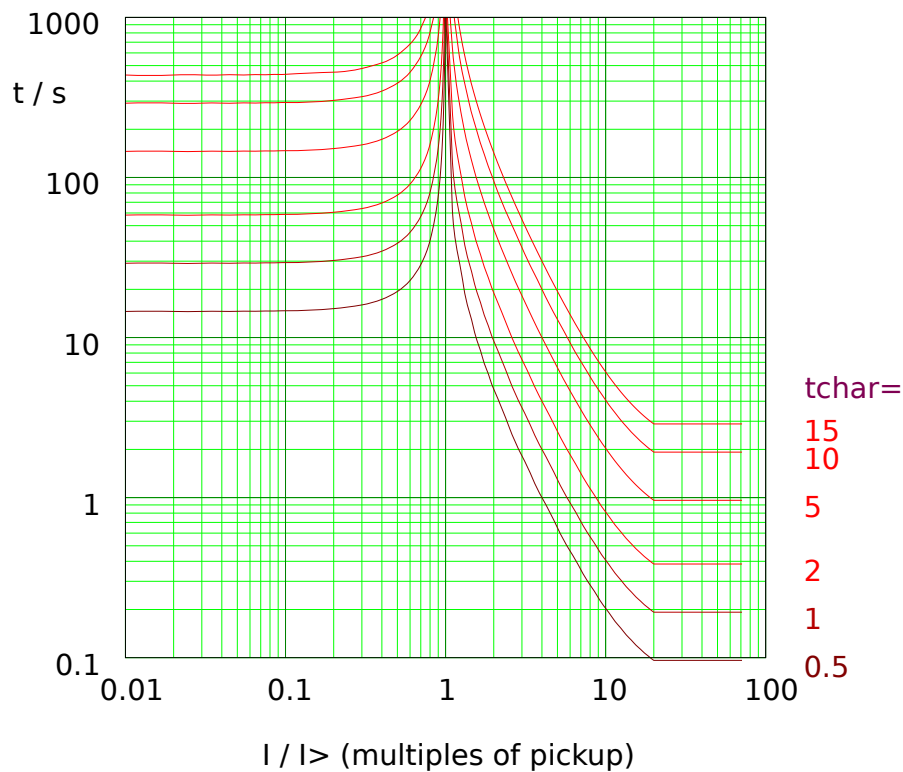

Fig. 62: EINV: reset delay (left half, $I < I>$) and trip delay (right half, $I > I>$), example for $I_{max} = 20 \cdot I>$.

Pdoc_Z07

4.6.1.4 R Inverse [RINV] - Characteristic

»Char« = RINV

Reset Delay

Various reset modes are available: Resetting via characteristic, delayed and instantaneous. See [»Explanation for All Characteristics«](#) for details.

For »Reset Mode« = "inverse time", with $I < I>$, the reset delay is defined by this equation:

$$t = \frac{1.0}{1 - \left(\frac{I}{I>}\right)^2} \cdot tchar$$

Trip Delay

If $I> < I < I_{max}$, the trip delay is defined by this equation:

$$t = \frac{1.0}{0.339 - \frac{0.236}{\left(\frac{I}{I>}\right)}} \cdot tchar$$

For $I > I_{max}$, the trip delay t is kept constant at $t = t_{min}$.

See [»Explanation for All Characteristics«](#) for details about I_{max} and t_{min} .

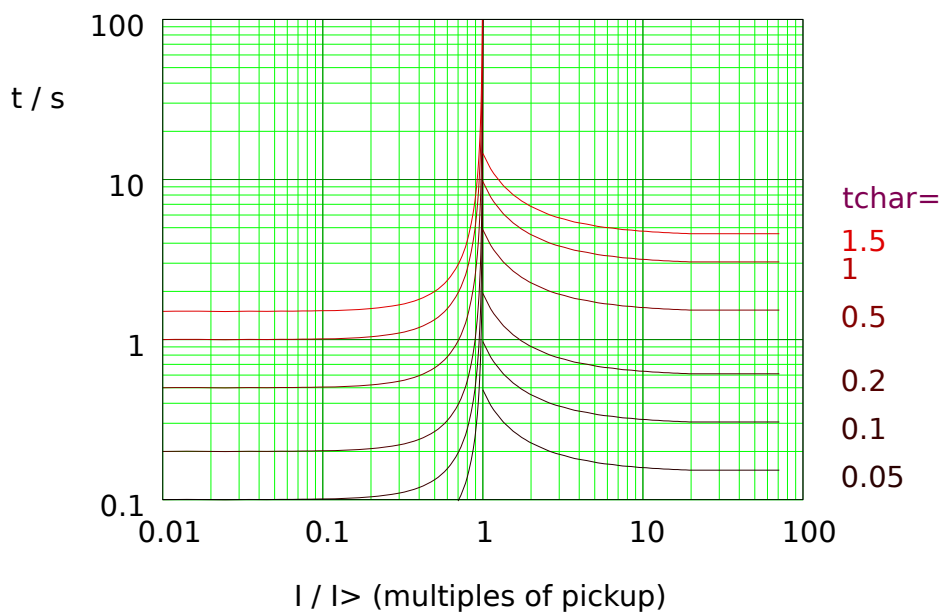

Fig. 63: RINV: reset delay (left half, $I < I>$) and trip delay (right half, $I > I>$), example for $I_{max} = 20 \cdot I>$.

Pdoc_Z1.2

4.6.1.5 Thermal Curves

Thermal Tripping Times

The thermal tripping times include **Therm Flat**, **IT**, **I2T**, and **I4T**. They are defined by the following equation:

$$t = \frac{5 \cdot tchar \cdot K^M}{\left(\frac{I}{In}\right)^M}$$

t	Trip time [in seconds].
tchar	Time multiplier setting [in seconds].
K	= 3 for phase current , = 1 for ground/earth current .
M	Slope: = 0 for Therm Flat , = 1 for IT , = 2 for I2T , = 4 for I4T .
In	Nominal current, either 1 A or 5 A, depending on the setting [Field Para / CT] »CT sec«.
I	Measured current. The dynamic range of the phase overcurrent starts above the pickup threshold and ends at $40 \cdot In$, and the lowest possible setting value for the pickup threshold is $0.02 \cdot In$.

Thermal Reset Delay

The thermal reset delay is independent of the measured current values, as long as these are below the pickup threshold. They are defined by the following equation:

$$t = 5 \cdot tchar \cdot K^2 = 45 \cdot tchar$$

t	Reset time [in seconds].
tchar	Time multiplier setting [same value as for trip delay].
K	[same as for trip delay above].

4.6.1.5.1 Therm Flat [TF] - Characteristic

»Char« = Therm Flat

Reset Delay

Various reset modes are available: Resetting via characteristic, delayed and instantaneous. See [↳ “Explanation for All Characteristics”](#) for details.

For »Reset Mode« = “inverse time”, with $I < I_n$, the reset delay is defined by this equation:

$$t = (5 \cdot 3^2) \cdot t_{char} = 45 \cdot t_{char}$$

Trip Delay

If $I > I_n$, the trip delay is defined by this equation:

$$t = (5 \cdot 3^0) \cdot t_{char} = 5 \cdot t_{char}$$

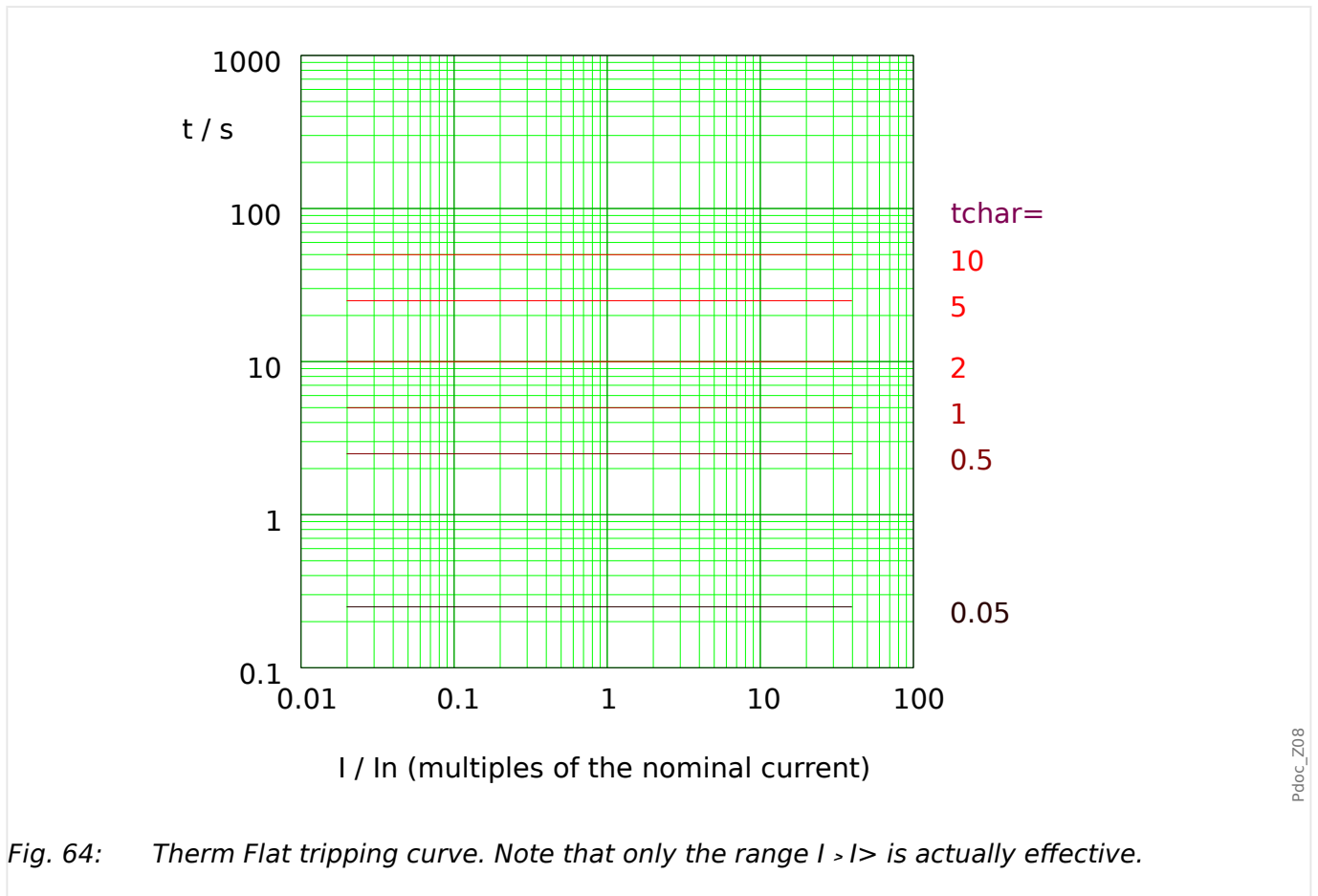

Pdoc_Z08

Fig. 64: Therm Flat tripping curve. Note that only the range $I > I_n$ is actually effective.

4.6.1.5.2 IT - Characteristic

»Char« = IT

Reset Delay

Various reset modes are available: Resetting via characteristic, delayed and instantaneous. See [↳ “Explanation for All Characteristics”](#) for details.

For »Reset Mode« = “inverse time”, with $I < I_n$, the reset delay is defined by this equation:

$$t = (5 \cdot 3^2) \cdot t_{char} = 45 \cdot t_{char}$$

Trip Delay

If $I > I_n$, the trip delay is defined by this equation:

$$t = \frac{5 \cdot 3^1}{\left(\frac{I}{I_n}\right)^1} \cdot t_{char} = \frac{15 \cdot I_n}{I} \cdot t_{char}$$

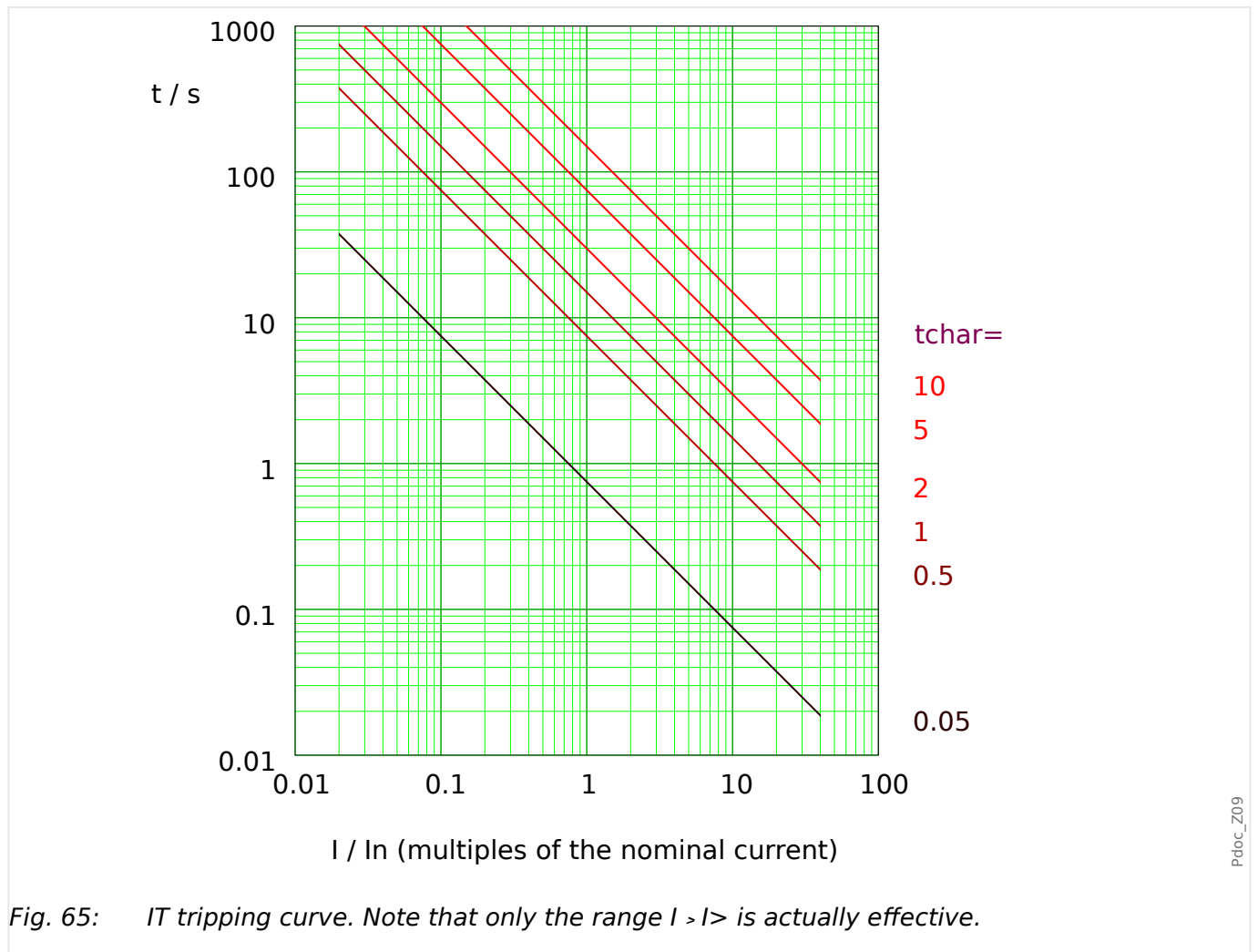

Fig. 65: IT tripping curve. Note that only the range $I > I_n$ is actually effective.

4.6.1.5.3 I2T - Characteristic

»Char« = I2T

Reset Delay

Various reset modes are available: Resetting via characteristic, delayed and instantaneous. See [↩️ “Explanation for All Characteristics”](#) for details.

For »Reset Mode« = “inverse time”, with $I < I_n$, the reset delay is defined by this equation:

$$t = (5 \cdot 3^2) \cdot t_{char} = 45 \cdot t_{char}$$

Trip Delay

If $I > I_n$, the trip delay is defined by this equation:

$$t = \frac{5 \cdot 3^2}{\left(\frac{I}{I_n}\right)^2} \cdot t_{char} = \frac{45}{\left(\frac{I}{I_n}\right)^2} \cdot t_{char}$$

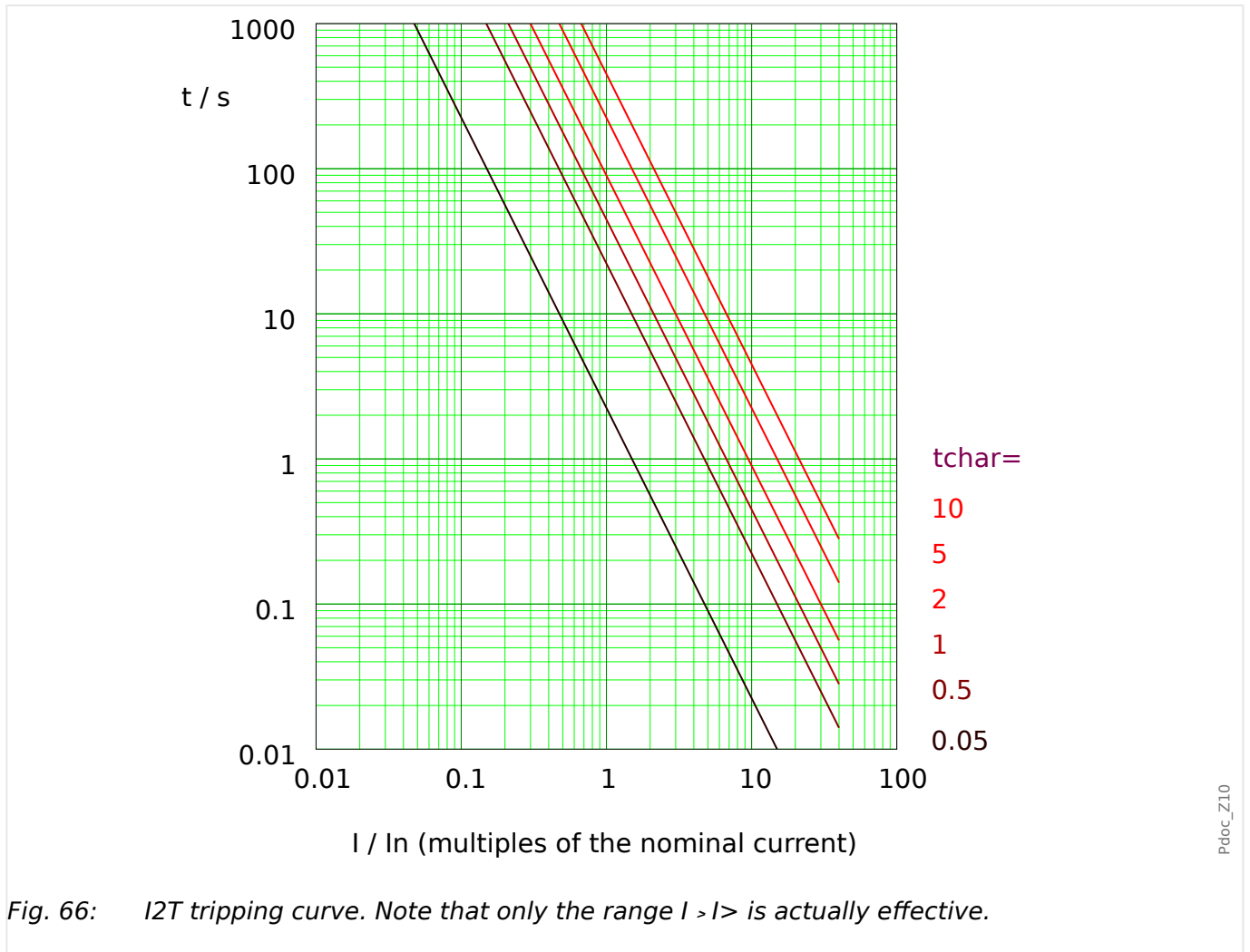

Fig. 66: I2T tripping curve. Note that only the range $I > I_n$ is actually effective.

4.6.1.5.4 I4T - Characteristic

»Char« = I4T

Reset Delay

Various reset modes are available: Resetting via characteristic, delayed and instantaneous. See [↩️»Explanation for All Characteristics«](#) for details.

For »Reset Mode« = "inverse time", with $I < I_n$, the reset delay is defined by this equation:

$$t = (5 \cdot 3^2) \cdot t_{char} = 45 \cdot t_{char}$$

Trip Delay

If $I > I_n$, the trip delay is defined by this equation:

$$t = \frac{5 \cdot 3^4}{\left(\frac{I}{I_n}\right)^4} \cdot t_{char} = \frac{405}{\left(\frac{I}{I_n}\right)^4} \cdot t_{char}$$

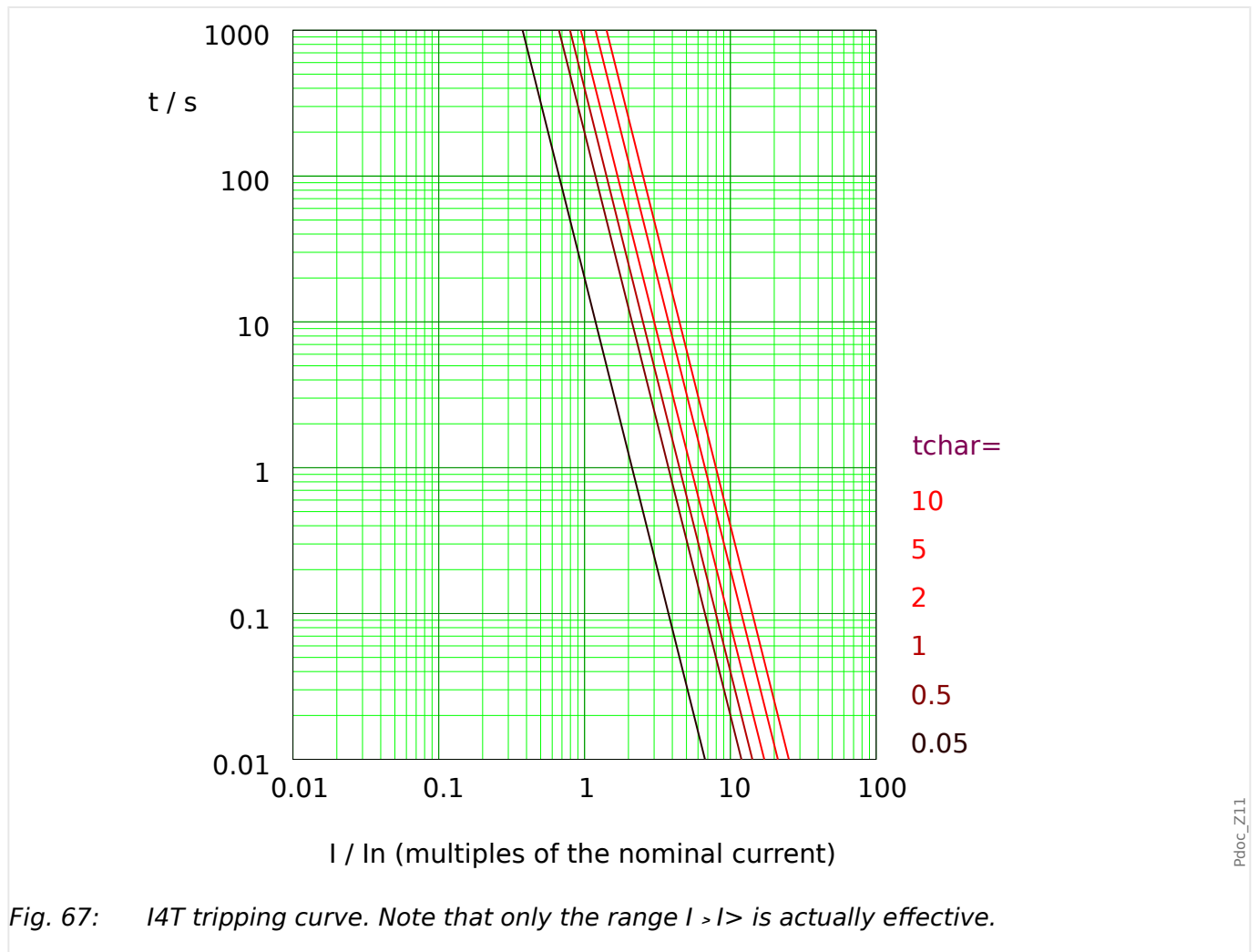
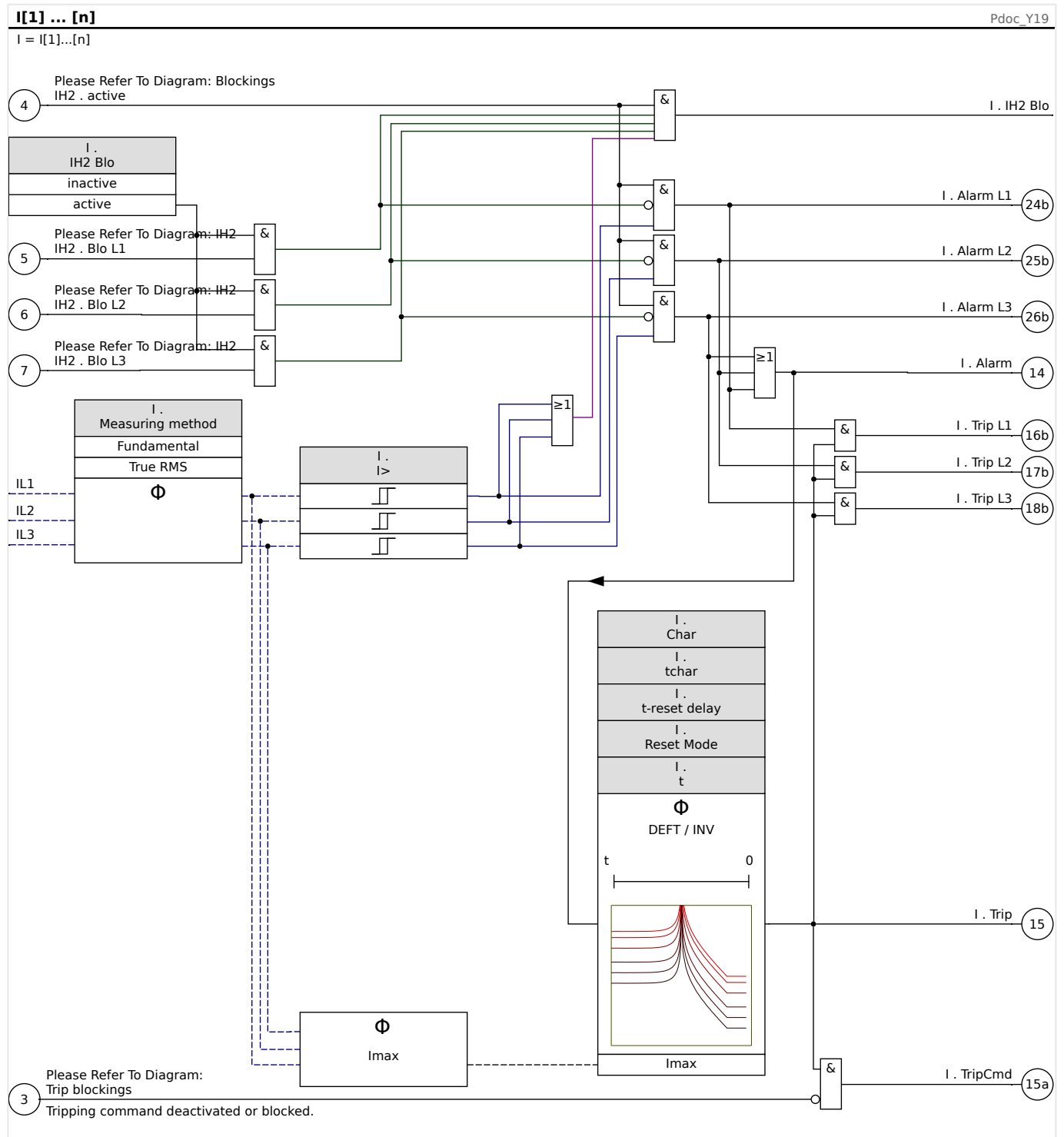

Fig. 67: I4T tripping curve. Note that only the range $I > I_n$ is actually effective.

4.6.2 Functionality



4.6.3 I2> - Negative-Sequence Overcurrent [51Q]

For activating this function, the parameter [Protection Para / Set n / I-Prot / I[x]] »*Measuring method*« has to be set to "I2" in the parameter set of the corresponding overcurrent element I[x].

The negative-sequence overcurrent protection function (I2>) is to be seen as an equivalent to the phase overcurrent protection with the exception that it uses negative-sequence current (I2>) as measured quantities instead of the three phase currents used by phase overcurrent protection function. The negative-sequence current used by I2> is derived from the following well-known symmetrical component transformation:

$$I_2 = \frac{1}{3}(I_{L1} + a^2 I_{L2} + a I_{L3})$$

The pickup set value of a I2> protection function should be set in accordance of the negative-sequence current occurrence in the protected object.

Besides that, the negative-sequence overcurrent protection function (I2>) uses the same setting parameters as the phase overcurrent protection function, like trip and reset characteristics from both IEC/ANSI standards, time multiplier, etc.

The negative-sequence overcurrent protection function (I2>) can be used for line, generator, transformer and motor protection to protect the system from unbalanced faults. Because the I2> protection function operates on the negative-sequence current component which is normally absent during load conditions, the I2> can, therefore, be set more sensitive than the phase overcurrent protection functions. On the other hand, coordination of negative-sequence overcurrent protection function in a radial system does not mean automatically very long fault clearing time for the furthest upstream protection devices, because the tripping time of concerned negative-sequence overcurrent protection function needs only be coordinate with the next downstream device with the negative-sequence overcurrent protection function. This makes the I2> in many cases as an advantageous protection concept in addition to the phase overcurrent protection function.

WARNING!



If you are using inrush blockings, the tripping delay of the current protection functions must be at least 30 ms or more in order to prevent faulty trippings.

NOTICE!



At the moment of breaker closure, negative-sequence current might be the result of transients.

4 Protective Elements

4.6.4 Commissioning: Overcurrent Protection, non-directional [50, 51]

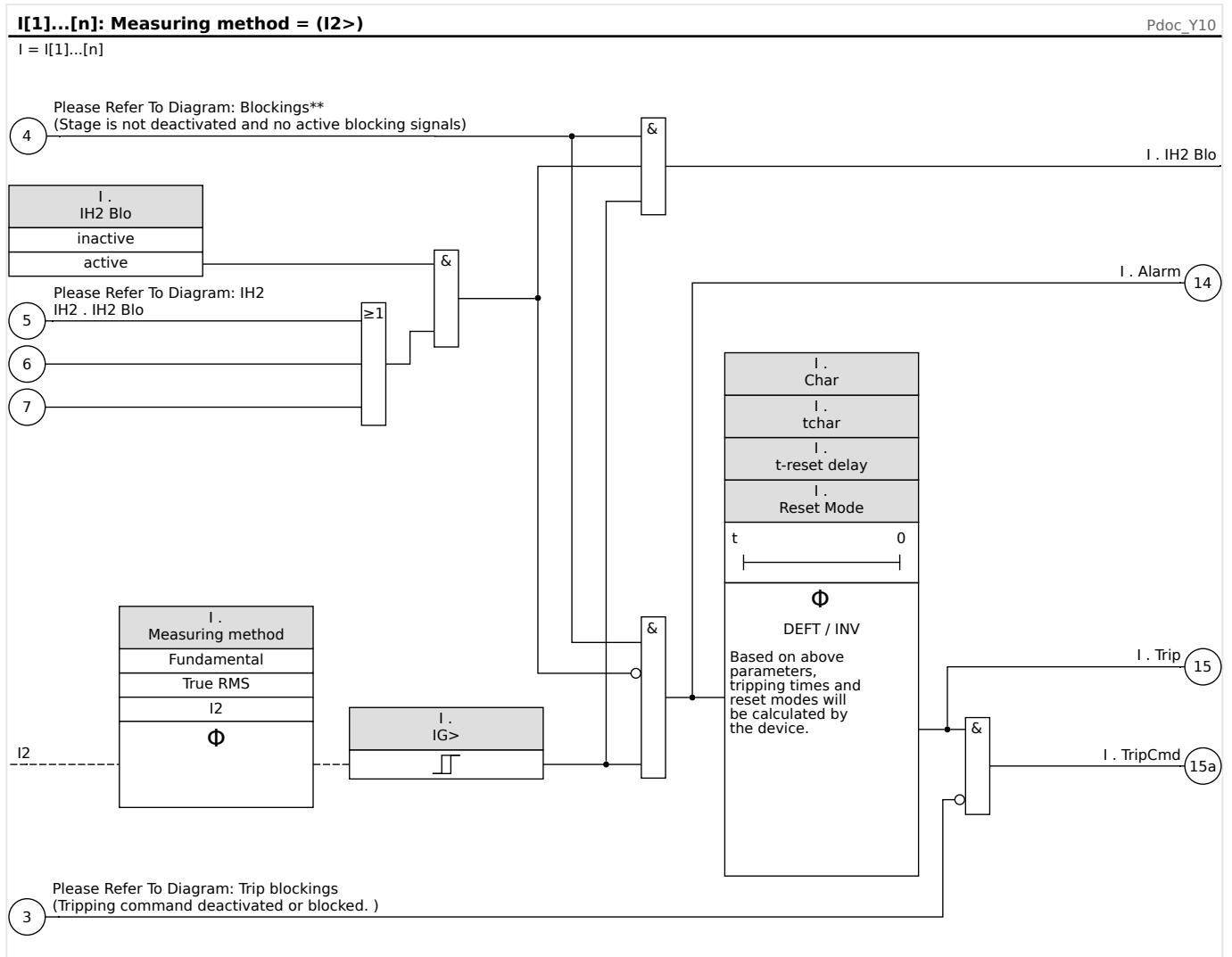

4.6.4 Commissioning: Overcurrent Protection, non-directional [50, 51]

Object to be tested

- Signals to be measured for each current protection element, the threshold values, total tripping time (recommended), or alternatively tripping delays and the fallback ratios; each time 3 x single-phase and 1 x three-phase.

NOTICE!



Especially in Holmgreen connections, wiring errors can easily happen, and these are then detected safely. Measuring the total tripping time can ensure that the secondary wiring is o.k. (from the terminal on, up to the trip coil of the CB).

NOTICE!

It is recommended to measure the total tripping time instead of the tripping delay. The tripping delay should be specified by the customer. The total tripping time is measured at the position signalling contact of the CB (not at the relay output!).

Total tripping time = tripping delay (please refer to the tolerances of the protection stages) + CB operating time (about 50 ms)

Please take the CB operating times from the technical data specified in the relevant documentation provided by the CB manufacturer.

Necessary means

- Current source
- May be: ampere meters
- Timer

*Procedure**Testing the threshold values (3 x single-phase and 1 x three-phase)*

Each time feed a current which is about 3-5% above the threshold value for activation/tripping. Then check the threshold values.

Testing the total tripping delay (recommendation)

Measure the total tripping times at the auxiliary contacts of the CB (CB tripping).

Testing the tripping delay (measuring at the relay output)

Measure the tripping times at the relay output.

Testing the fallback ratio

Reduce the current to 97% below the trip value and check the fallback ratio.

Successful test result

The measured total tripping delays or individual tripping delays, threshold values and fallback ratios correspond with those values, specified in the adjustment list. Permissible deviations/tolerances can be found under Technical Data.

4.6.5 Commissioning: Negative Sequence Overcurrent*Object to be tested*

Signals to be measured for each current protection function: the threshold values, total tripping time (recommended), or alternatively tripping delays and the dropout ratios.

NOTICE!



It is recommended to measure the total tripping time instead of the tripping time. The tripping delay should be specified by the customer. The total tripping time is measured at the position signalling contacts of the CBs (not at the relay output!).

Total tripping time: = tripping delay (please refer to the tolerances of the protection stages) + CB operating time (about 50 ms)

Please take the CB switching times from the technical data, specified in the relevant documentation, provided by the CB manufacturer.

Necessary means:

- Current source
- Current meters
- Timer

Procedure:

Testing the threshold values

In order to get a negative-sequence current, please change the phase sequence at the terminals of the current source (in case of ABC sequence to ACB - in case of a ACB sequence to ABC).

For each test performed, feed a current that is about 3-5% above the threshold value for activation/tripping. Then check the threshold values.

Testing the total tripping delay (recommendation)

Measure the total tripping times at the auxiliary contacts of the breakers (breaker tripping).

Testing the tripping delay (measuring at the relay output contact)

Measure the tripping times at the relay output contact.

Testing the dropout ratio

Reduce the current to 97% below the trip value and check the dropout ratio.

Successful test result

The measured total tripping delays or individual tripping delays, threshold values, and dropout ratios correspond with those values specified in the adjustment list. Permissible deviations/tolerances can be found under Technical Data.

4.7 IH2 - Inrush

The inrush module can prevent false trips caused by switching actions of saturated inductive loads. The ratio of the 2nd harmonic to the 1st harmonic is taken into account.

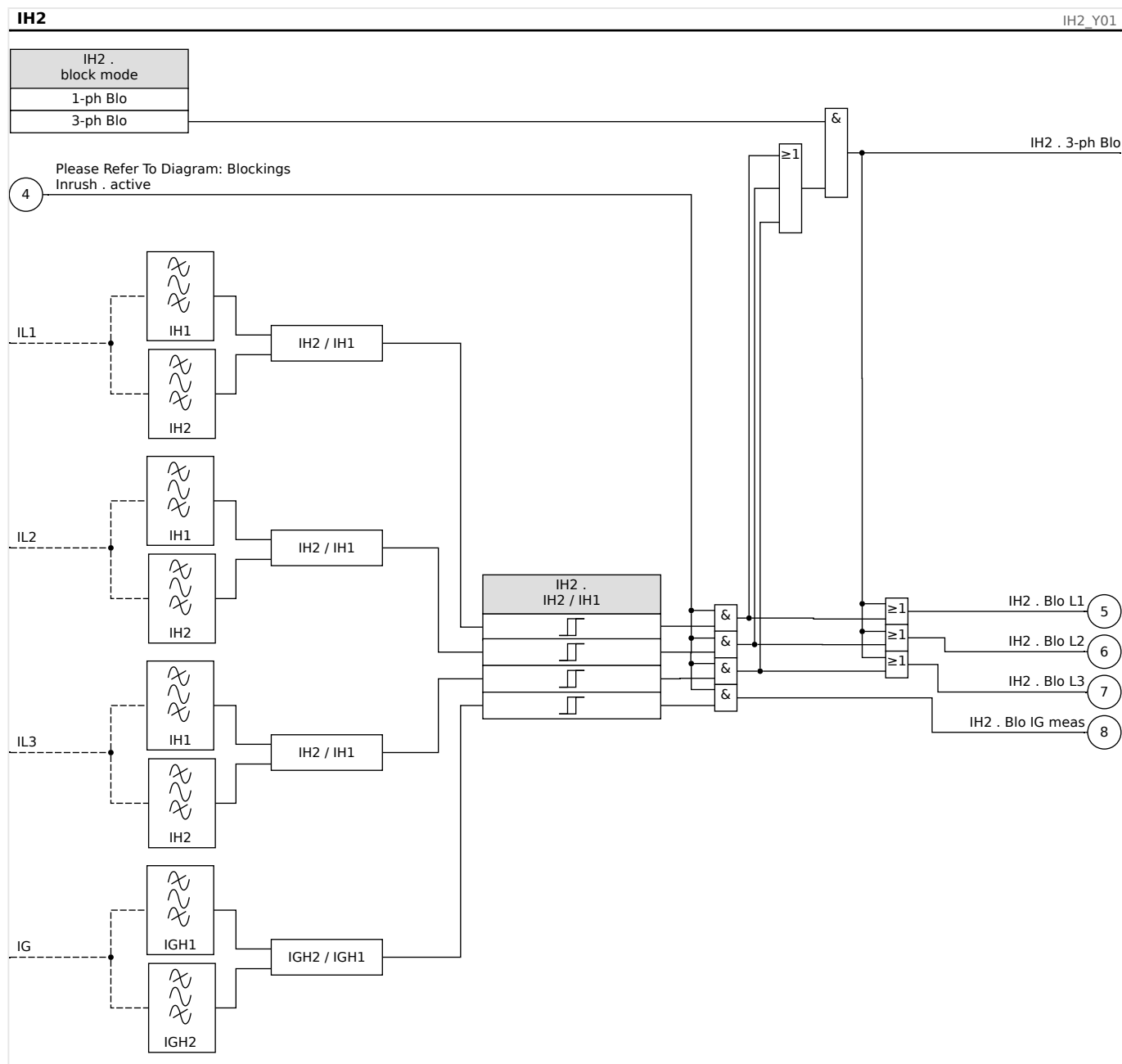

NOTICE!



Do not use the Inrush element in combination with undelayed/instantaneous overcurrent protection (in order to prevent faulty tripping).

4.7.1 Commissioning: Inrush

The test procedure is dependent on the parameterized inrush-blocking-mode:

- [Protection Para / Set x / I-Prot / IH2] »*block mode*« = “1-ph Blo”:

For this mode, the test has to be carried out first for each individual phase and then for all three phases together.

- [Protection Para / Set x / I-Prot / IH2] »*block mode*« = “3-ph Blo”:

For this mode, the test is a three-phase one.

Object to be tested:

Test of inrush blocking.

Necessary means:

- three-phase current source with adjustable frequency
- three-phase current source (for the first harmonic)

Procedure (dependent on the parameterized blocking mode):

- Feed the current to the secondary side with nominal frequency.
- Feed abruptly current to the secondary side with double nominal frequency. The amplitude must exceed the preset ratio/threshold »*IH2 / IH1*«.
- Ascertain that the corresponding Inrush blocking signal is generated now: »*IH2 . Blo L1*«, »*IH2 . Blo L2*«, »*IH2 . Blo L3*«, or »*IH2 . 3-ph Blo*«

Successful test results:

The corresponding Inrush blocking signal is generated and the event recorder indicates the blocking of the current protection stage.

4.8 IG - Ground (Earth) Overcurrent Protection [50N/G, 51N/G, 67N/G]

The Ground Fault (Earth Overcurrent) module »IG« covers the following ANSI protection functions:

- ANSI 50N/G
- ANSI 51N/G

WARNING!



If you are using inrush blockings the tripping delay of the ground (earth) current protection functions must be at least 30 ms or more in order to prevent faulty trippings.

NOTICE!



All ground (earth) current elements are identically structured.

NOTICE!



This module offers Adaptive Parameter Sets.

Parameters can be modified within parameter sets dynamically by means of Adaptive Parameter Sets. Please see [↪ “1.3.2 Adaptive Parameter Sets”](#).

ANSI 50N/G - Ground (Earth) Overcurrent Protection, Non-Directional

This application option is set via the [Device planning] menu:

- [Device planning] »Mode« = “non directional”

No directional information is taken into account if the current protective element is planned as “non directional”.

Options:

- [Protection Para / Set 1...4 / I-Prot / IG[x]] »Measuring method« =
 - Fundamental
 - True RMS

ANSI 51N/G - Ground (Earth) Short-Circuit Protection, Non-Directional

This application option is set via the [Device planning] menu:

- [Device planning] »Mode« = “non directional”

No directional information is taken into account if the current protective element is planned as “non directional”.

Options:

- [Protection Para / Set 1...4 / I-Prot / IG[x]] »Measuring method« =
 - Fundamental
 - True RMS

Measuring Method

For each protection element it can be defined via setting »Measuring method«, whether the measurement is done on basis of the “Fundamental” or if “True RMS” measurement is used.

IG Source / VG Source

The parameters »IG Source« and »VX Source« determine whether the earth current and the residual voltage are “measured” or “calculated”.

4.8.1 Characteristics

For each element the parameter [Protection Para / Set 1...4 / I-Prot / IG[x]] »Char« selects any of the following characteristics:

- DEFT – *Definite Time-Overcurrent*
- IEC 60255-151 Curves:
 - NINV – *IEC Normal Inverse* (IEC 60255-151)
 - VINV – *IEC Very Inverse* (IEC 60255-151)
 - LINV – *IEC Long Time Inverse* (IEC 60255-151)
 - EINV – *IEC Extremely Inverse* (IEC 60255-151)
- ANSI / IEEE C37.112 Curves:
 - MINV – *ANSI Moderately Inverse* (IEEE C37.112)
 - VINV – *ANSI Very Inverse* (IEEE C37.112)
 - EINV – *ANSI Extremely Inverse* (IEEE C37.112)
- RINV – *R Inverse*
- RXIDG
- Thermal Curves:
 - Therm Flat – *Thermal Flat*
 - IT
 - I2T
 - I4T

Explanation for All Characteristics

- reset IG: Fault current
- IG>: If the pickup value is exceeded, the module/element starts to time out to trip.
Setting: [Protection Para / Set 1...4 / I-Prot / IG[x]] »IG>«
- t for »Char« = “DEFT”:
 -
 - Trip delay for IG > IG>, settable via [Protection Para / Set 1...4 / I-Prot / IG[x]] »t«.
 -

The reset delay for IG < IG> always equals 0 (“instantaneous”).
- t for »Char« = “RXIDG”:
 - The trip delay for IG > IG> is calculated based on the selected characteristics.
 - The reset delay for IG < IG> is settable via »Reset Mode«, available options: “instantaneous” or “definite time”.
 - For »Reset Mode« = “definite time” is the reset delay settable at »t-reset delay«.
- t for all characteristics except “DEFT” and “RXIDG”:
 - The trip delay for IG > IG> is calculated based on the selected characteristics.
 - The reset delay for IG < IG> is settable via »Reset Mode«, available options: “instantaneous”, “definite time” or “inverse time”.
 - With option »Reset Mode« = “instantaneous”: Instantaneous reset: when the current drops below the pickup setting, the TOC time resets to zero within 2 cycles.
 - With option »Reset Mode« = “definite time”: The reset delay is settable at »t-reset delay«.
 - With option »Reset Mode« = “inverse time”: The reset delay is calculated based on the selected characteristics.
- tchar (for all characteristics except “DEFT”):
 - Time multiplier/tripping characteristic factor. The setting range depends on the selected tripping curve.
 - Setting via [Protection Para / Set 1...4 / I-Prot / IG[x]] »tchar«

For all characteristics except the **Thermal Curves**, there is a minimum trip delay t_{min} , that is dependent on a $I_{G,max}$. The effective trip delay does never fall below t_{min} , independent of the actual value of IG.

- $I_{G,max}$ is the smallest value out of these:
 - $20 \cdot IG>$,
 - $40 \cdot IG_{nom}$, if calculated ground/earth current *IG calc* is used,

- $25 \cdot I_{Gnom}$, if measured ground/earth current $I_{G\ meas}$ is used,
- $2.5 \cdot I_{Gnom}$, if sensitive measured ground/earth current is used.
- t_{min} is the trip delay at $I_{G,max}$ for the respective characteristic.
 - Exception: For »Char« = "RXIDG", t_{min} is independent of $I_{G,max}$, but has the fixed value $t_{min} = 0.02\ s$

4.8.1.1 DEFT - Definite Time-Overcurrent

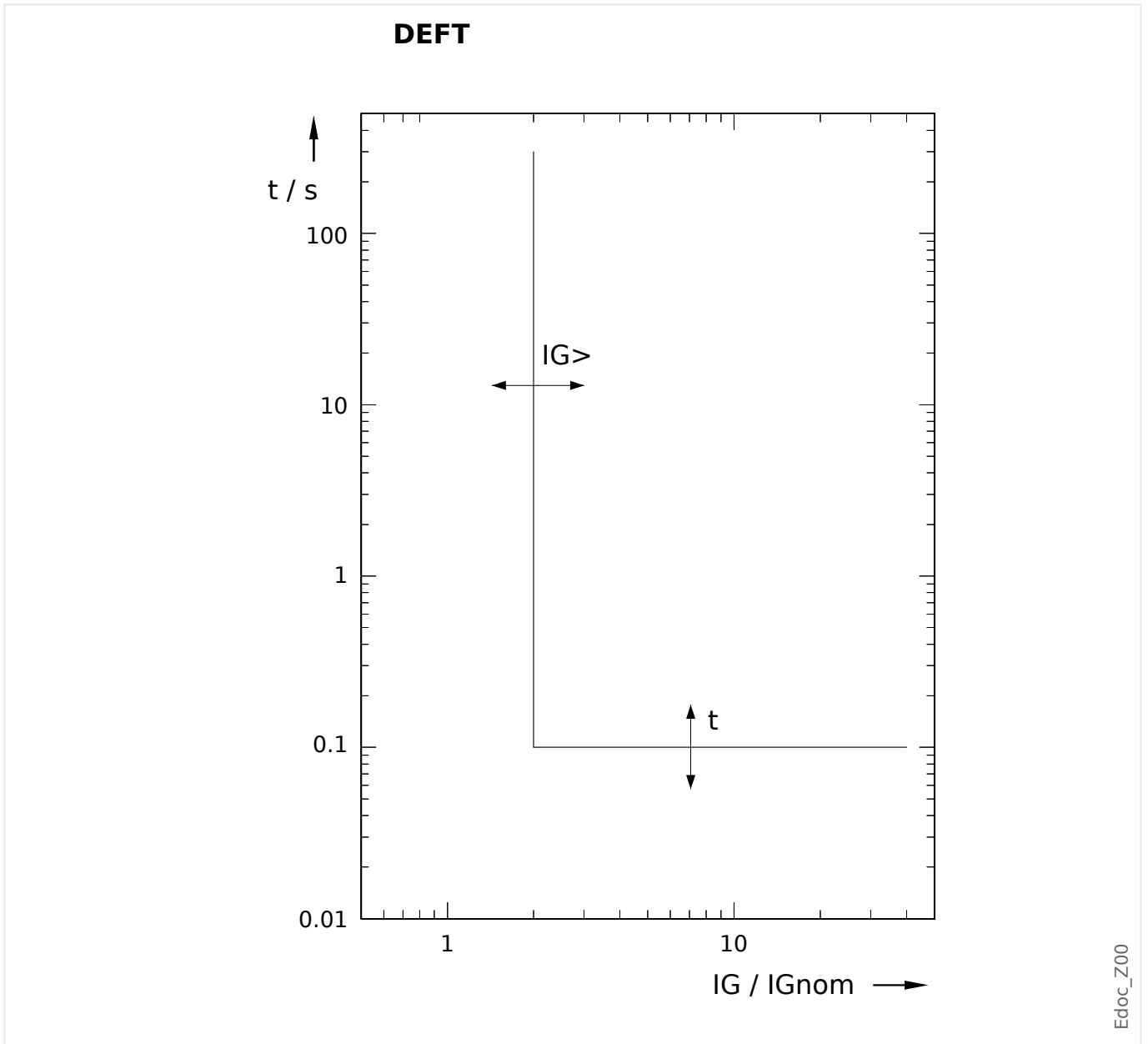

Trip delay for $I_G > I_G >$, settable via [Protection Para / Set 1...4 / I-Prot / $I_G[x]$] »t«.

The reset delay for $I_G < I_G >$ always equals 0 ("instantaneous").

4.8.1.2 IEC 60255-151 Curves

4.8.1.2.1 IEC Normal Inverse (IEC 60255-151)

»Char« = IEC NINV

Reset Delay

Various reset modes are available: Resetting via characteristic, delayed and instantaneous. See [↳ “Explanation for All Characteristics”](#) for details.

For »Reset Mode« = “inverse time”, with $I_G < I_{G>}$, the reset delay is defined by this equation:

$$t = \frac{0.14}{1 - \left(\frac{I_G}{I_{G>}}\right)^2} \cdot t_{char}$$

Trip Delay

If $I_G > I_{G>} < I_{G,max}$, the trip delay is defined by this equation:

$$t = \frac{0.14}{\left(\frac{I_G}{I_{G>}}\right)^{0.02} - 1} \cdot t_{char}$$

For $I_G > I_{G,max}$, the trip delay t is kept constant at $t = t_{min}$.

See [↳ “Explanation for All Characteristics”](#) for details about $I_{G,max}$ and t_{min} .

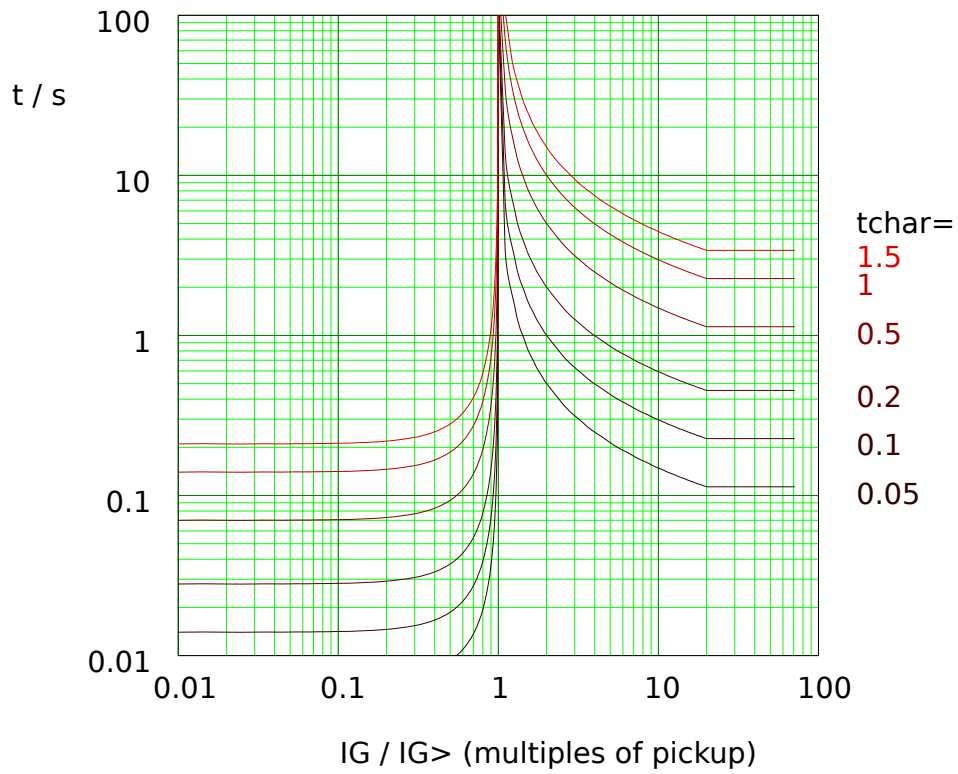

Edoc_Z01

Fig. 68: NINV: reset delay (left half, $I_G < I_{G>}$) and trip delay (right half, $I_G > I_{G>}$), example for $I_{G,max} = 20 \cdot I_{G>}$.

4.8.1.2.2 IEC Very Inverse [VINV] (IEC 60255-151)

»Char« = IEC VINV

Reset Delay

Various reset modes are available: Resetting via characteristic, delayed and instantaneous. See [↳ “Explanation for All Characteristics”](#) for details.

For »Reset Mode« = “inverse time”, with $I_G < I_{G>}$, the reset delay is defined by this equation:

$$t = \frac{13.5}{1 - \left(\frac{I_G}{I_{G>}}\right)^2} \cdot t_{char}$$

Trip Delay

If $I_G < I_{G,max}$, the trip delay is defined by this equation:

$$t = \frac{13.5}{\frac{I_G}{I_{G>}} - 1} \cdot t_{char}$$

For $I_G > I_{G,max}$, the trip delay t is kept constant at $t = t_{min}$.

See [↳ “Explanation for All Characteristics”](#) for details about $I_{G,max}$ and t_{min} .

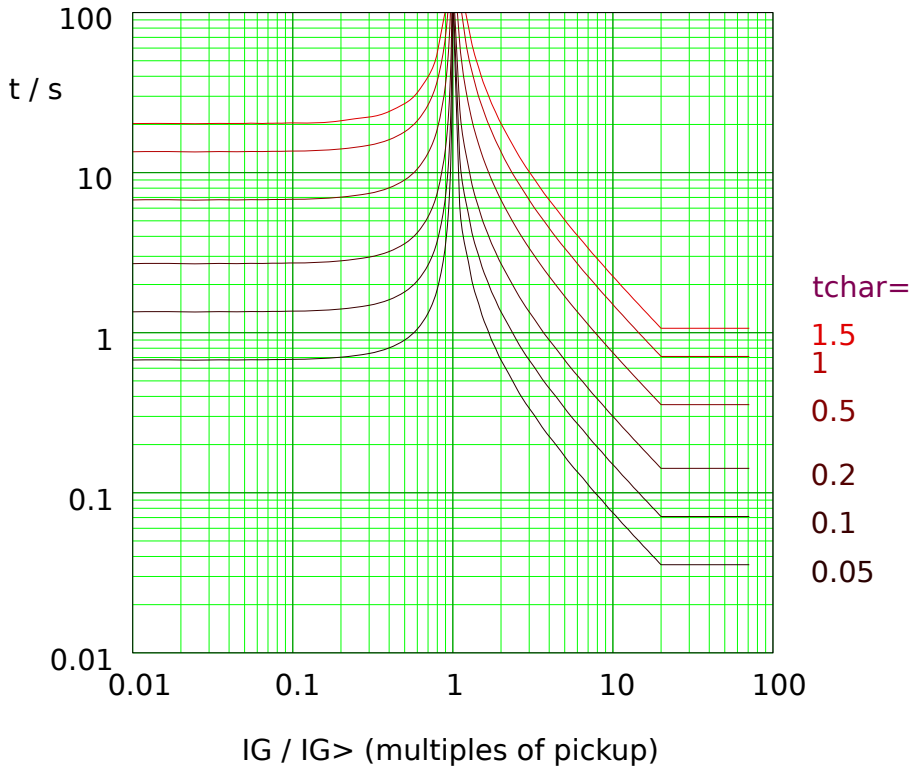

Fig. 69: VINV: reset delay (left half, $I_G < I_{G>}$) and trip delay (right half, $I_G > I_{G>}$), example for $I_{G,max} = 20 \cdot I_{G>}$.

4.8.1.2.3 IEC Extremely Inverse - Characteristic (IEC 60255-151)

»Char« = IEC EINV

Reset Delay

Various reset modes are available: Resetting via characteristic, delayed and instantaneous. See [↳ “Explanation for All Characteristics”](#) for details.

For »Reset Mode« = “inverse time”, with $I_G < I_{G>}$, the reset delay is defined by this equation:

$$t = \frac{80}{1 - \left(\frac{I_G}{I_{G>}}\right)^2} \cdot t_{char}$$

Trip Delay

If $I_G < I_{G>} < I_{G,max}$, the trip delay is defined by this equation:

$$t = \frac{80}{\left(\frac{I_G}{I_{G>}}\right)^2 - 1} \cdot t_{char}$$

For $I_G > I_{G,max}$, the trip delay t is kept constant at $t = t_{min}$.

See [↳ “Explanation for All Characteristics”](#) for details about $I_{G,max}$ and t_{min} .

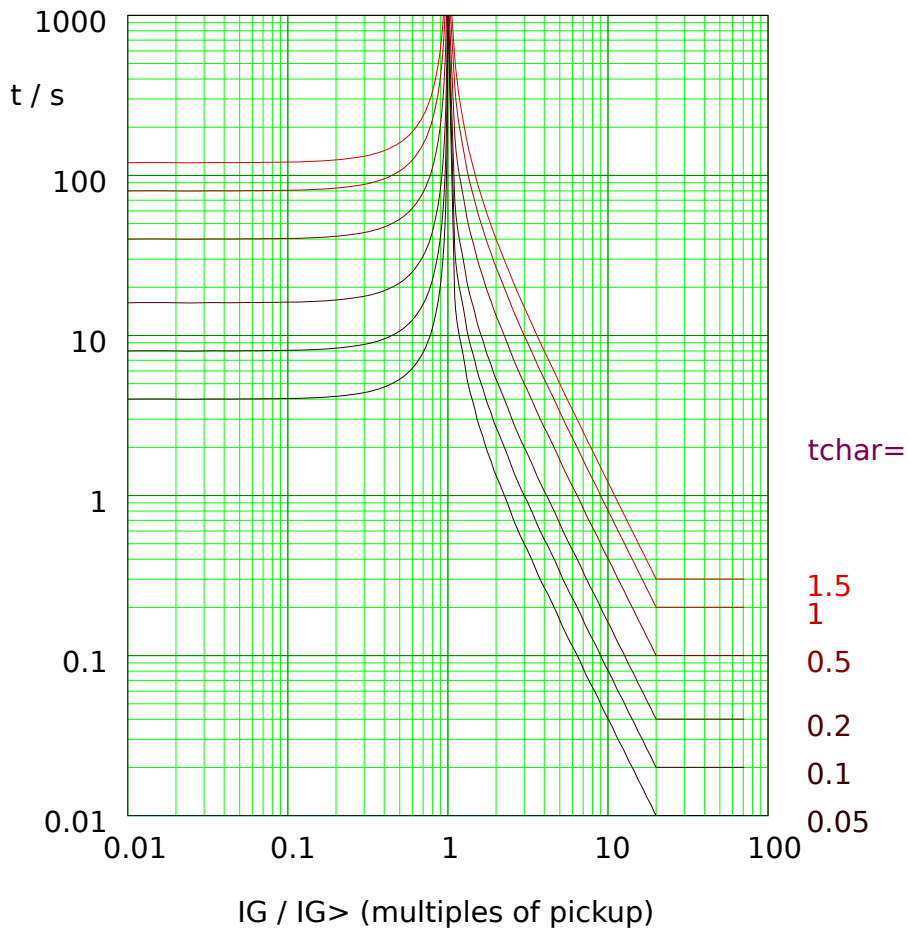

Fig. 70: EINV: reset delay (left half, $I_G < I_{G>}$) and trip delay (right half, $I_G > I_{G>}$), example for $I_{G,max} = 20 \cdot I_{G>}$.

4.8.1.2.4 IEC Long Time Inverse - Characteristic [LINV] (IEC 60255-151)

»Char« = IEC LINV

Reset Delay

Various reset modes are available: Resetting via characteristic, delayed and instantaneous. See [↪ “Explanation for All Characteristics”](#) for details.

For »Reset Mode« = “inverse time”, with $I_G < I_{G>}$, the reset delay is defined by this equation:

$$t = \frac{120}{1 - \left(\frac{I_G}{I_{G>}}\right)^2} \cdot t_{char}$$

Trip Delay

If $I_G < I_{G,max}$, the trip delay is defined by this equation:

$$t = \frac{120}{\frac{I_G}{I_{G>}} - 1} \cdot t_{char}$$

For $I_G > I_{G,max}$, the trip delay t is kept constant at $t = t_{min}$.

See [↪ “Explanation for All Characteristics”](#) for details about $I_{G,max}$ and t_{min} .

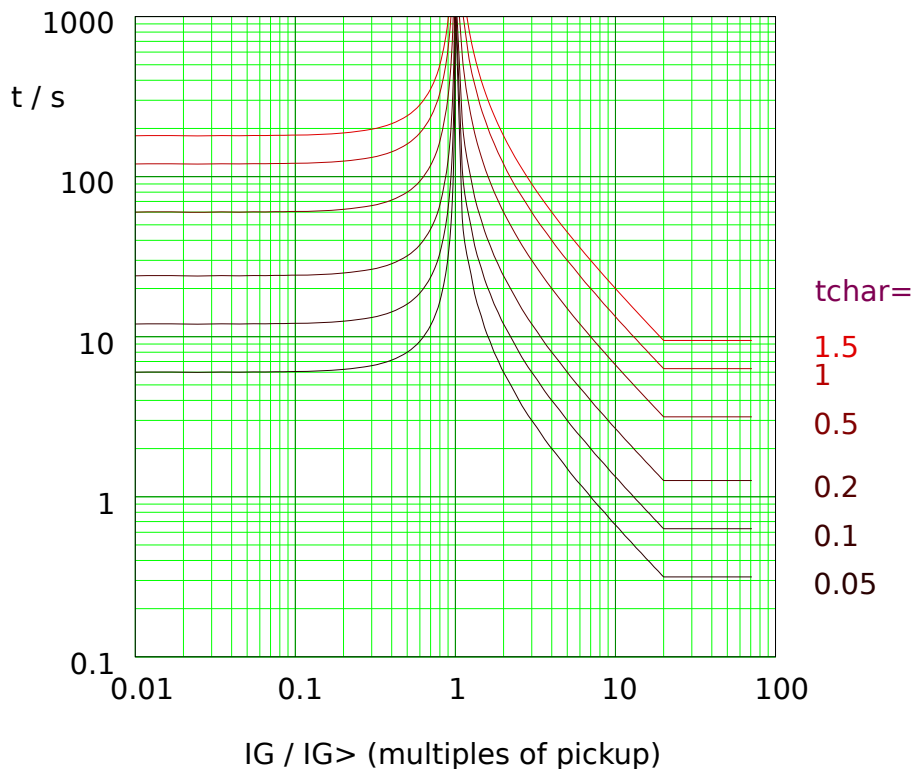

Fig. 71: LINV: reset delay (left half, $I_G < I_{G>}$) and trip delay (right half, $I_G > I_{G>}$), example for $I_{G,max} = 20 \cdot I_{G>}$.

Edoc_Z03

4.8.1.3 ANSI / IEEE C37.112 Curves

4.8.1.3.1 Moderately Inverse [MINV] - Characteristic (IEEE C37.112)

»Char« = ANSI MINV

Reset Delay

Various reset modes are available: Resetting via characteristic, delayed and instantaneous. See [↳ “Explanation for All Characteristics”](#) for details.

For »Reset Mode« = “inverse time”, with $I_G < I_{G>}$, the reset delay is defined by this equation:

$$t = \frac{4.85}{1 - \left(\frac{I_G}{I_{G>}}\right)^2} \cdot t_{char}$$

Trip Delay

If $I_G < I_{G>} < I_{G,max}$, the trip delay is defined by this equation:

$$t = \left(\frac{0.0515}{\left(\frac{I_G}{I_{G>}}\right)^{0.02} - 1} + 0.1140 \right) \cdot t_{char}$$

For $I_G > I_{G,max}$, the trip delay t is kept constant at $t = t_{min}$.

See [↳ “Explanation for All Characteristics”](#) for details about $I_{G,max}$ and t_{min} .

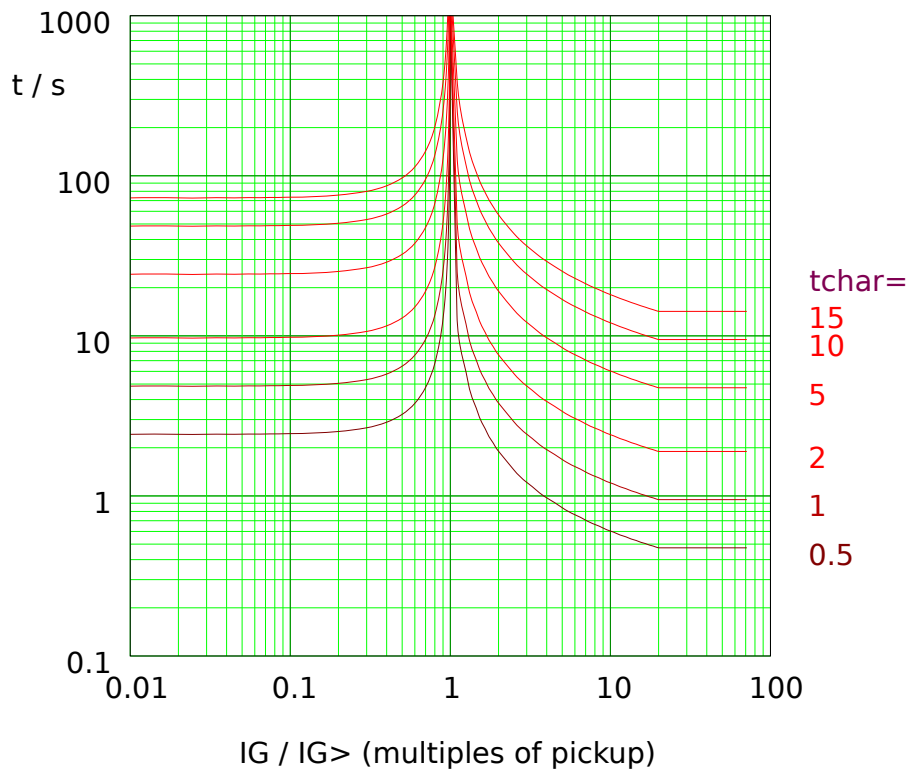

Edoc_Z05

Fig. 72: MINV: reset delay (left half, $I_G < I_{G>}$) and trip delay (right half, $I_G > I_{G>}$), example for $I_{G,max} = 20 \cdot I_{G>}$.

4.8.1.3.2 Very Inverse [VINV] (IEEE C37.112)

»Char« = ANSI VINV

Reset Delay

Various reset modes are available: Resetting via characteristic, delayed and instantaneous. See [↳ “Explanation for All Characteristics”](#) for details.

For »Reset Mode« = “inverse time”, with $I_G < I_{G>}$, the reset delay is defined by this equation:

$$t = \frac{21.6}{1 - \left(\frac{I_G}{I_{G>}}\right)^2} \cdot t_{char}$$

Trip Delay

If $I_G > I_{G,max}$, the trip delay is defined by this equation:

$$t = \left(\frac{19.61}{\left(\frac{I_G}{I_{G>}}\right)^2 - 1} + 0.491 \right) \cdot t_{char}$$

For $I_G > I_{G,max}$, the trip delay t is kept constant at $t = t_{min}$.

See [↳ “Explanation for All Characteristics”](#) for details about $I_{G,max}$ and t_{min} .

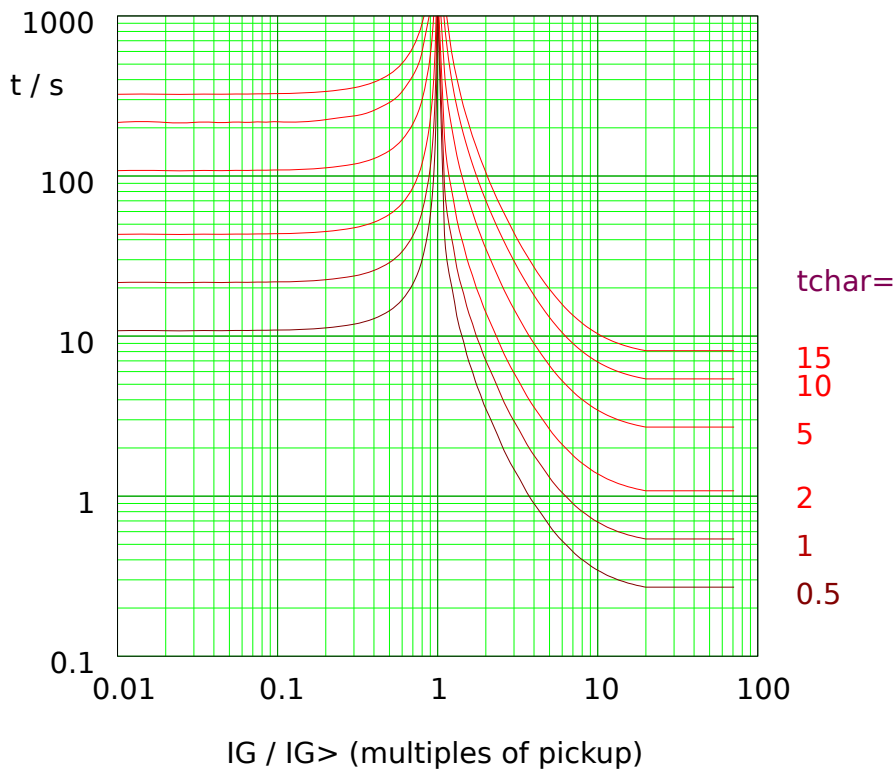

Fig. 73: VINV: reset delay (left half, $I_G < I_{G>}$) and trip delay (right half, $I_G > I_{G>}$), example for $I_{G,max} = 20 \cdot I_{G>}$.

Edoc_Z06

4.8.1.3.3 Extremely Inverse - Characteristic (IEEE C37.112)

»Char« = ANSI EINV

Reset Delay

Various reset modes are available: Resetting via characteristic, delayed and instantaneous. See [↳](#) “Explanation for All Characteristics” for details.

For »Reset Mode« = “inverse time”, with $I_G < I_{G>}$, the reset delay is defined by this equation:

$$t = \frac{29.1}{1 - \left(\frac{I_G}{I_{G>}}\right)^2} \cdot t_{char}$$

Trip Delay

If $I_{G>} < I_G < I_{G,max}$, the trip delay is defined by this equation:

$$t = \left(\frac{28.2}{\left(\frac{I_G}{I_{G>}}\right)^2 - 1} + 0.1217 \right) \cdot t_{char}$$

For $I_G > I_{G,max}$, the trip delay t is kept constant at $t = t_{min}$.

See [↳](#) “Explanation for All Characteristics” for details about $I_{G,max}$ and t_{min} .

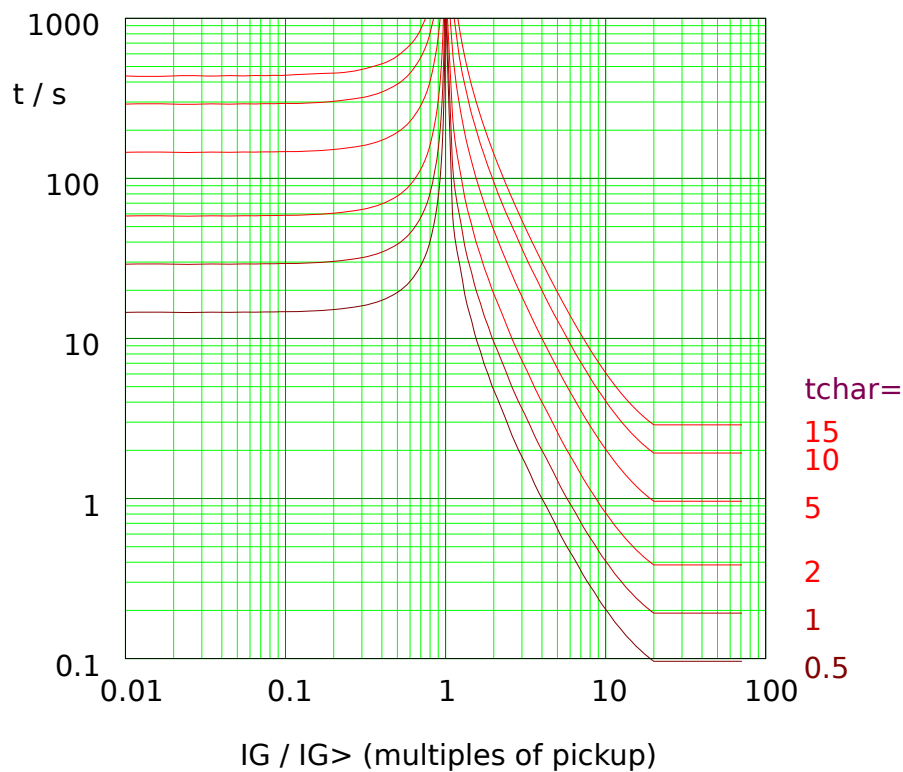

Fig. 74: EINV: reset delay (left half, $I_G < I_{G>}$) and trip delay (right half, $I_G > I_{G>}$), example for $I_{G,max} = 20 \cdot I_{G>}$.

4.8.1.4 R Inverse [RINV] - Characteristic

»Char« = RINV

Reset Delay

Various reset modes are available: Resetting via characteristic, delayed and instantaneous. See [↳ “Explanation for All Characteristics”](#) for details.

For »Reset Mode« = “inverse time”, with $I_G < I_{G>}$, the reset delay is defined by this equation:

$$t = \frac{1.0}{1 - \left(\frac{I_G}{I_{G>}}\right)^2} \cdot t_{char}$$

Trip Delay

If $I_{G>} < I_G < I_{G,max}$, the trip delay is defined by this equation:

$$t = \frac{1.0}{0.339 - \frac{0.236}{\left(\frac{I_G}{I_{G>}}\right)}} \cdot t_{char}$$

For $I_G > I_{G,max}$, the trip delay t is kept constant at $t = t_{min}$.

See [↳ “Explanation for All Characteristics”](#) for details about $I_{G,max}$ and t_{min} .

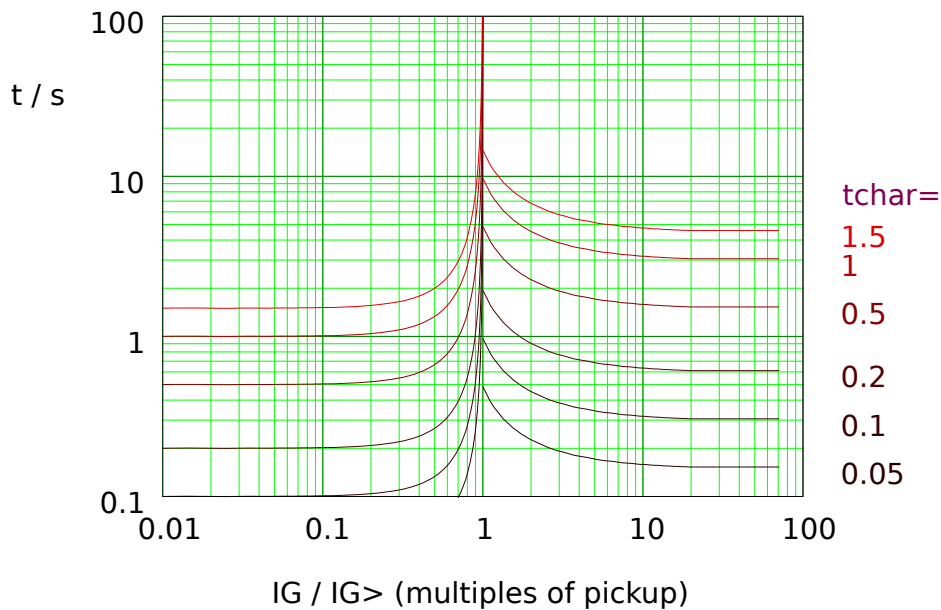

Fig. 75: RINV: reset delay (left half, $I_G < I_{G>}$) and trip delay (right half, $I_G > I_{G>}$), example for $I_{G,max} = 20 \cdot I_{G>}$.

Edoc_Z12

4.8.1.5 RXIDG

»Char« = RXIDG

NOTICE!



The reset modes “instantaneous” or “definite time” are available. For this characteristic, there is no reset mode with dynamic reset delay. See [“Explanation for All Characteristics”](#) for details.

Trip Delay

If $I_G > I_{G>}$, the trip delay is defined by this equation, but only under the condition that the resulting trip delay holds $t > t_{min}$ with $t_{min} = 0.02$ s:

$$t = 5.8 - 1.35 \cdot \ln\left(\frac{I_G}{I_{G>} \cdot t_{char}}\right)$$

In other words, the trip delay t is always at least $t_{min} = 0.02$ s.

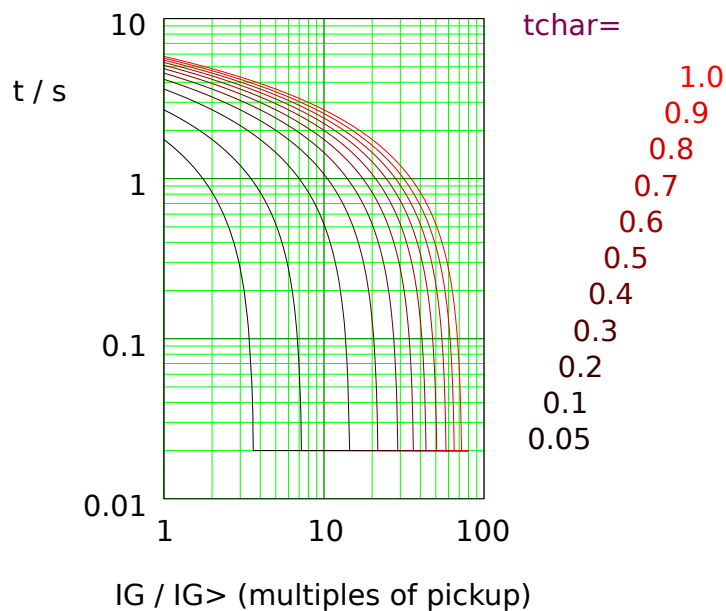

Fig. 76: RXIDG: trip delay, $I_G > I_{G>}$.

Edoc_Z13

4.8.1.6 Thermal Curves

Thermal Tripping Times

The thermal tripping times include **Therm Flat**, **IT**, **I2T**, and **I4T**. They are defined by the following equation:

$$t = \frac{5 \cdot t_{char} \cdot K^M}{\left(\frac{IG}{IG_{nom}}\right)^M}$$

t	Trip time [in seconds].
tchar	Time multiplier setting [in seconds].
K	= 3 for phase current , = 1 for ground/earth current .
M	Slope: = 0 for Therm Flat , = 1 for IT , = 2 for I2T , = 4 for I4T .
IGnom	Nominal current, either 1 A or 5 A, depending on the setting [Field Para / CT] »ECT sec«.
IG	Measured current. For calculated ground/earth current (51R protection), the dynamic range of the earth/ground overcurrent starts above the pickup threshold and ends at $40 \cdot IG_{nom}$, and the lowest possible setting value for the pickup threshold is $0.02 \cdot IG_{nom}$. For measured ground/earth current (51G protection), the dynamic range of the earth/ground overcurrent starts above the pickup threshold and ends at $25 \cdot IG_{nom}$, and the lowest possible setting value for the pickup threshold is $0.02 \cdot IG_{nom}$. For sensitive measurement of the ground/earth current, the dynamic range of the earth/ground overcurrent starts above the pickup threshold and ends at $2.5 \cdot IG_{nom}$, and the lowest possible setting value for the pickup threshold is $0.002 \cdot IG_{nom}$.

Thermal Reset Delay

The thermal reset delay is independent of the measured current values, as long as these are below the pickup threshold. They are defined by the following equation:

$$t = 5 \cdot t_{char} \cdot K^2$$

t	Reset time [in seconds].
tchar	Time multiplier setting [same value as for trip delay].
K	[same as for trip delay above].

4.8.1.6.1 Therm Flat [TF] - Characteristic

»Char« = Therm Flat

Reset Delay

Various reset modes are available: Resetting via characteristic, delayed and instantaneous. See [↳ “Explanation for All Characteristics”](#) for details.

For »Reset Mode« = “inverse time”, with $I_G < I_G>$, the reset delay is defined by this equation:

$$t = (5 \cdot 1^2) \cdot t_{char} = 5 \cdot t_{char}$$

Trip Delay

If $I_G > I_G>$, the trip delay is defined by this equation:

$$t = (5 \cdot 1^0) \cdot t_{char} = 5 \cdot t_{char}$$

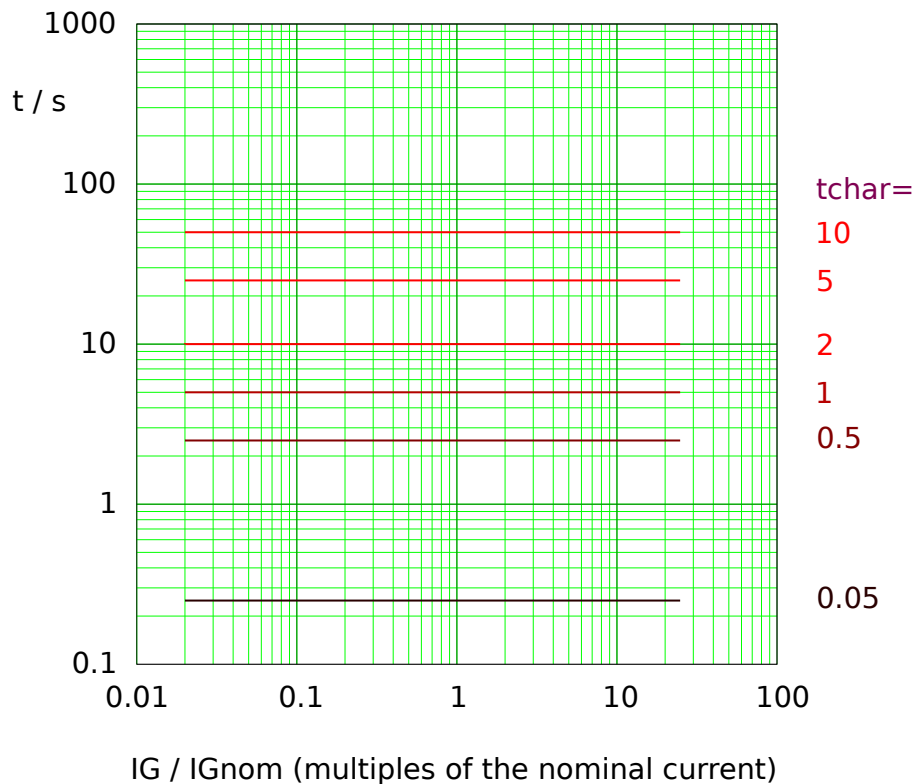

Fig. 77: Therm Flat tripping curve, example diagram for measured (non-sensitive) earth/ground current (51G). Note that only the range $I_G > I_G>$ is actually effective.

Edoc_Z08

4.8.1.6.2 IT - Characteristic

»Char« = IT

Reset Delay

Various reset modes are available: Resetting via characteristic, delayed and instantaneous. See [↳ “Explanation for All Characteristics”](#) for details.

For »Reset Mode« = “inverse time”, with $I_G < I_G>$, the reset delay is defined by this equation:

$$t = (5 \cdot 1^2) \cdot t_{char} = 5 \cdot t_{char}$$

Trip Delay

If $I_G > I_G>$, the trip delay is defined by this equation:

$$t = \frac{5 \cdot 1^1}{\left(\frac{I_G}{I_{Gnom}}\right)^1} \cdot t_{char} = \frac{5 \cdot I_{Gnom}}{I_G} \cdot t_{char}$$

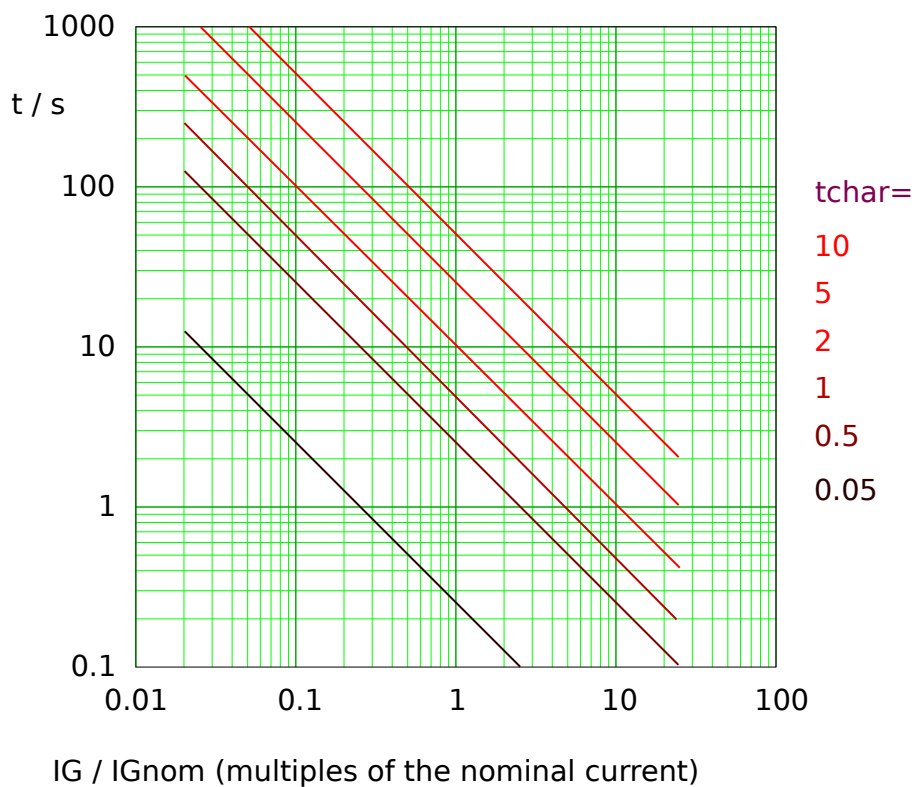

Fig. 78: IT tripping curve, example diagram for measured (non-sensitive) earth/ground current ($5I_G$). Note that only the range $I_G > I_G>$ is actually effective.

Edoc_Z09

4.8.1.6.3 I2T - Characteristic

»Char« = I2T

Reset Delay

Various reset modes are available: Resetting via characteristic, delayed and instantaneous. See [↳ “Explanation for All Characteristics”](#) for details.

For »Reset Mode« = “inverse time”, with $I_G < I_G>$, the reset delay is defined by this equation:

$$t = (5 \cdot 1^2) \cdot t_{char} = 5 \cdot t_{char}$$

Trip Delay

If $I_G > I_G>$, the trip delay is defined by this equation:

$$t = \frac{5 \cdot 1^2}{\left(\frac{I_G}{I_{Gnom}}\right)^2} \cdot t_{char} = \frac{5}{\left(\frac{I_G}{I_{Gnom}}\right)^2} \cdot t_{char}$$

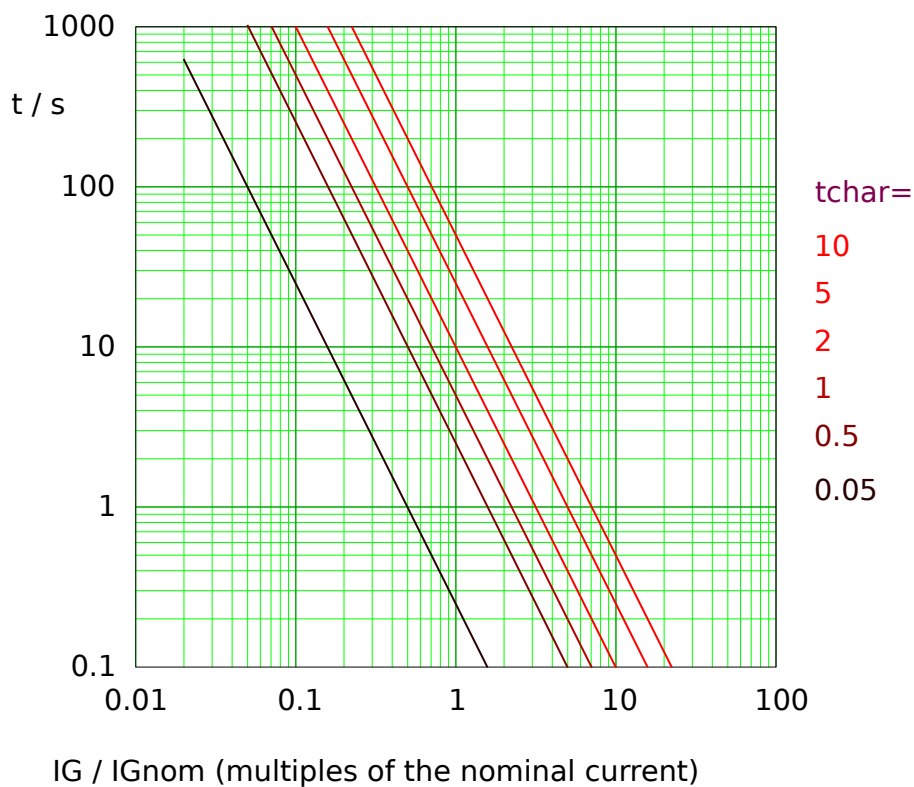

Fig. 79: I2T tripping curve, example diagram for measured (non-sensitive) earth/ground current (51G). Note that only the range $I_G > I_G>$ is actually effective.

4.8.1.6.4 I4T - Characteristic

»Char« = I4T

Reset Delay

Various reset modes are available: Resetting via characteristic, delayed and instantaneous. See [«Explanation for All Characteristics»](#) for details.

For »Reset Mode« = "inverse time", with $I_G < I_G>$, the reset delay is defined by this equation:

$$t = (5 \cdot 1^2) \cdot t_{char} = 5 \cdot t_{char}$$

Trip Delay

If $I_G > I_G>$, the trip delay is defined by this equation:

$$t = \frac{5 \cdot 1^4}{\left(\frac{I_G}{I_{Gnom}}\right)^4} \cdot t_{char} = \frac{5}{\left(\frac{I_G}{I_{Gnom}}\right)^4} \cdot t_{char}$$

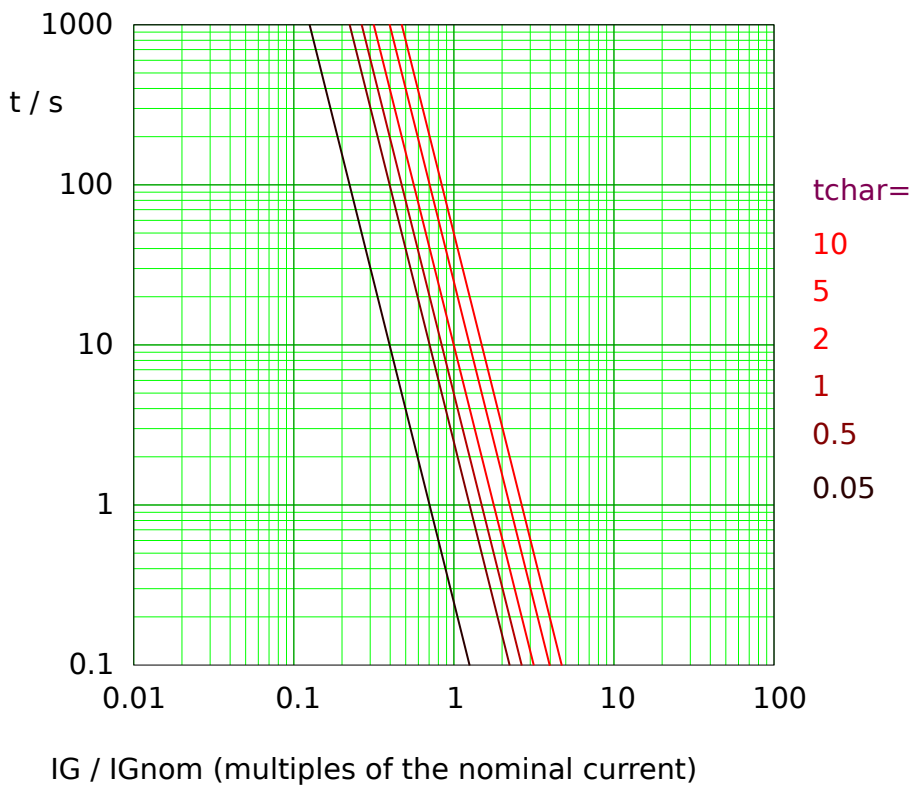

Fig. 80: I4T tripping curve, example diagram for measured (non-sensitive) earth/ground current (51G). Note that only the range $I_G > I_G>$ is actually effective.

Edoc_Z111

4.8.2 Ground (Earth) Overcurrent - Functionality

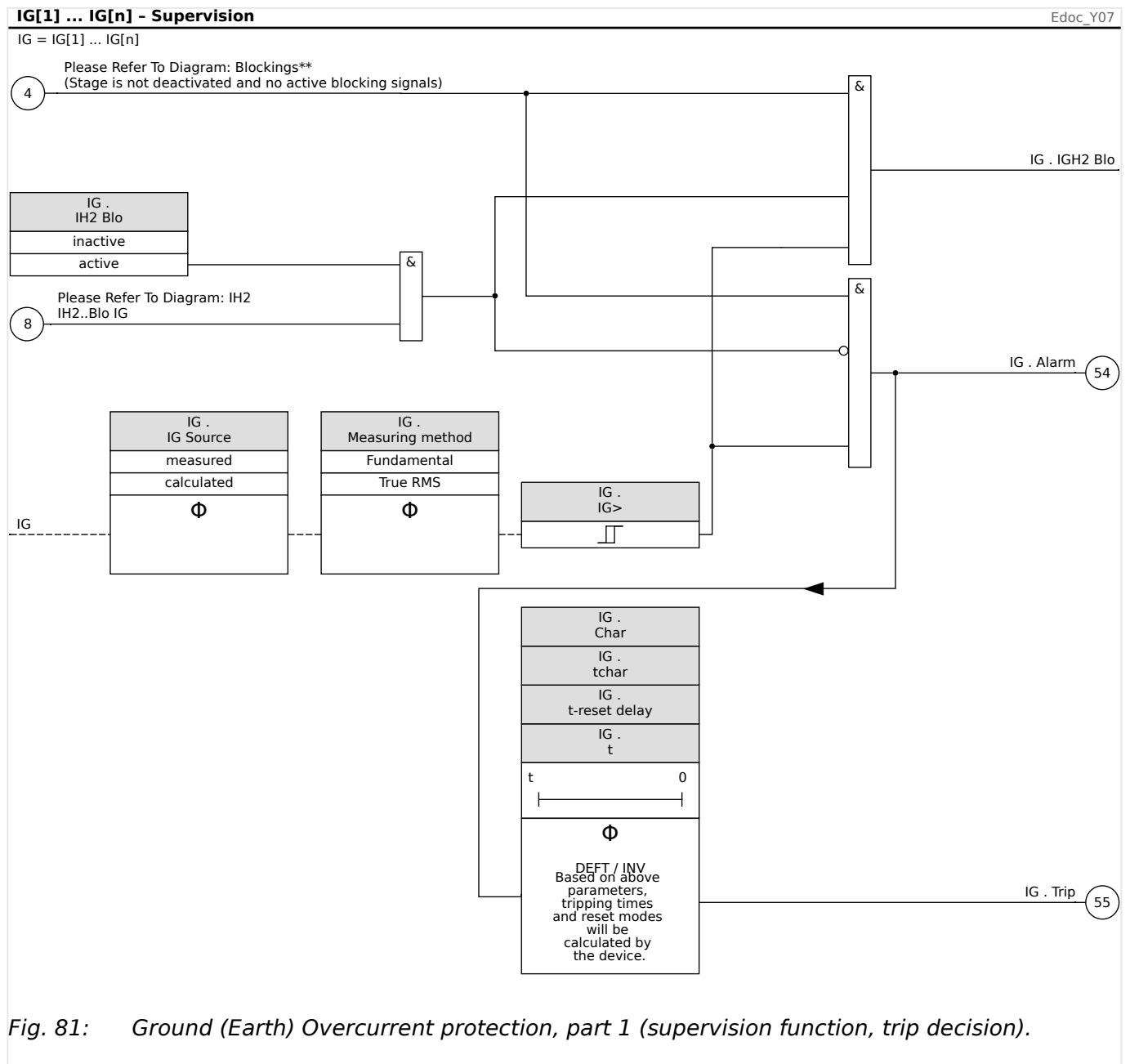
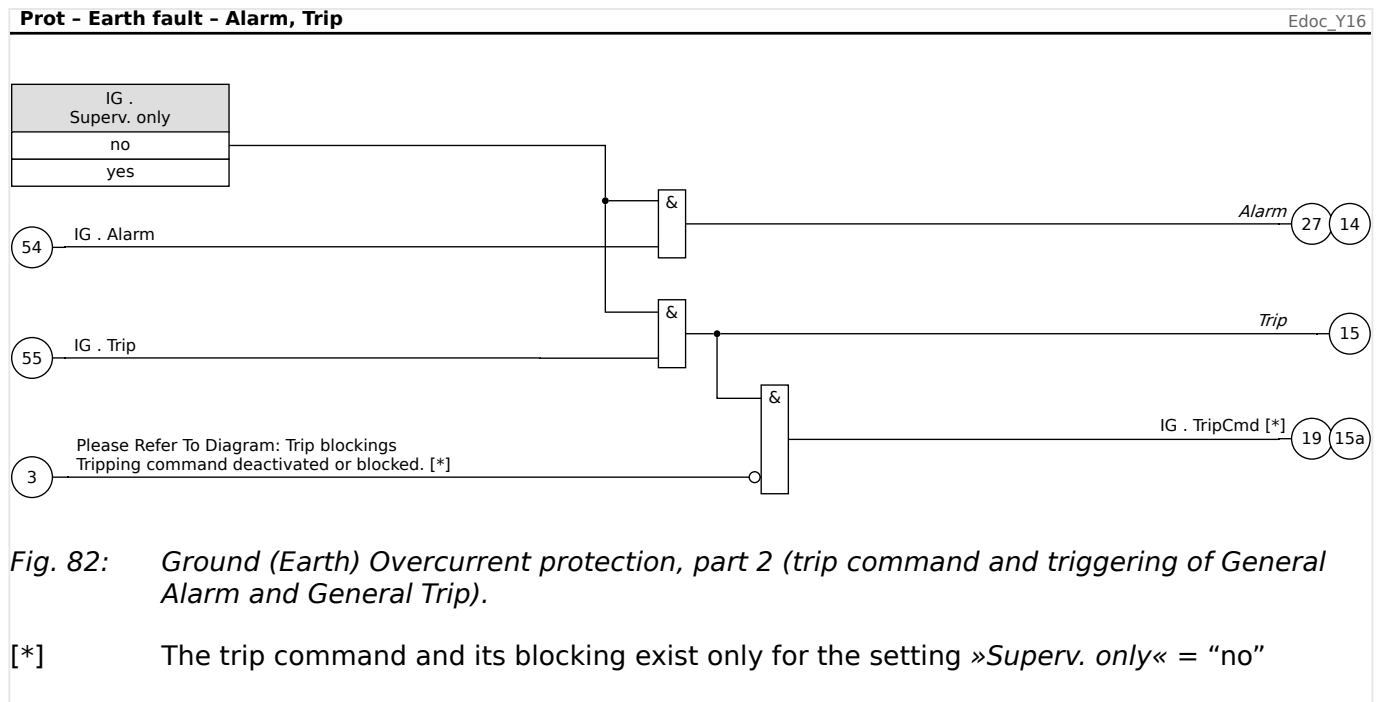

Fig. 81: Ground (Earth) Overcurrent protection, part 1 (supervision function, trip decision).



4.8.3 Commissioning: Ground Fault Protection - non-directional [50N/G, 51N/G]

Please test the non-directional ground (earth) overcurrent analog to the non-directional phase overcurrent protection, see [↳ “4.6.4 Commissioning: Overcurrent Protection, non-directional \[50, 51\]”](#).

4.9 I2> and %I2/I1> - Unbalanced Load [46]

The »I2>« Current Unbalance module works similar to the »V012« Voltage Unbalance module. The positive and negative sequence currents are calculated from the 3-phase currents. The threshold setting (either »I2>« or »I2/FLA«) defines a minimum operating current magnitude of I2 for the ANSI 46 function to operate, which insures that the relay has a solid basis for initiating a current unbalance trip. The »%(I2/I1)« (option) setting is the unbalance trip pickup setting. It is defined by the ratio of negative sequence current to positive sequence current »%(I2/I1)«. (Of course, the determination of positive and negative sequence currents takes into account the phase sequence setting at [Field Para] »Phase Sequence«.)

(Remark: "FLA" = Ib: Full Load Amperes.)

NOTICE!



All »I2>« Current Unbalance modules are identically structured.

The condition for a trip of this module is that the negative sequence current I2 is above the set threshold **and** - if configured - the percentage current unbalance is above the setting »%(I2/I1)«. The module initiates a trip if this condition is fulfilled for a specific tripping delay time.

The setting [Protection Para / Global Prot Para / I-Prot / I2>[x]] »CurrentBase« decides about the threshold value:

- If »CurrentBase« = "Device Rating": The permitted continuous unbalanced load current is [Protection Para / Set 1...4 / I-Prot / I2>[x]] »I2>«, and it is specified in units of In.
- If »CurrentBase« = "Protected Object Rating": The permitted continuous unbalanced load current is [Protection Para / Set 1...4 / I-Prot / I2>[x]] »I2/FLA«, and it is specified in units of Ib.

For the tripping delay time, there are two characteristics available as configuring options:

- If »Char« = "DEFT": The tripping delay is a setting value, which is available as the parameter »t«.
- If »Char« = "INV": The tripping delay is calculated by the MRDT4.

The principle of the definite time characteristic (DEFT) is as follows: The module trips if for the tripping delay time »t« the negative sequence current I2 is above the set threshold **and** (if configured) the percentage current unbalance is above the setting »%(I2/I1)«.

The principle of the inverse time characteristic (INV) is as follows: The protective device permanently calculates the heat (thermal) energy θ of the object to be protected. This happens all the time, independent of any alarm or tripping decisions. The module trips if for the tripping delay time t_{trip} - which is dependent on θ - **all** the following conditions are fulfilled:

- The negative sequence current I2 is above the set threshold (»I2>« or »I2/FLA«), **and**
- the percentage current unbalance is above the setting »%(I2/I1)« (if configured) **and**

- the calculated thermal energy θ exceeds a maximum value θ_{max} , which is calculated based on the setting »K« for the thermal load capability.

For $\theta = 0$ the tripping delay time is calculated as follows:

- If »CurrentBase« = “Device Rating”:

$$t_{Trip} = \frac{K \cdot I_n^2}{I_2^2 - I_{2>}^2}$$

- If »CurrentBase« = “Protected Object Rating”:

$$t_{Trip} = \frac{K \cdot I_b^2}{I_2^2 - I_{2/FLA}^2}$$

where:

t_{Trip}	= tripping delay in seconds.
K	= thermal load capability of the object while running with 100% unbalanced load current. This is an intrinsic property of the object that is to be protected, and therefore it must be specified as a setting value (Setting Group parameter »K«). It should be possible to obtain this value from the data sheet of the generator.
I_n	= nominal current, in case of »CurrentBase« = “Device Rating”
I_b	= nominal current, in case of »CurrentBase« = “Protected Object Rating”
I_2	= unbalanced load current I2 (calculated from measured current values)
$I_{2>}$	= Setting value »I2>«, in case of »CurrentBase« = “Device Rating”
$I_{2/FLA}$	= Setting value »I2/FLA«, in case of »CurrentBase« = “Protected Object Rating”

In case of a still present residual heat, $\theta > 0$, the tripping delay t_{trip} is reduced accordingly, so that an earlier tripping occurs.

As long as the unbalanced load current I_2 is **greater** than the threshold »I2>« it is assumed that the object is *heating up*. During this phase, the heat (thermal) energy is calculated by an integration of the current value I_2 :

$$\theta(t) = \theta_{0,cool} + f \cdot \int | I_2 |^2 dt$$

$\theta(t)$	= actual value of the thermal energy.
$\theta_{0,cool}$	= initial value at the beginning of the heating phase, i. e. the thermal energy at the end of the last cooling-down phase (or = 0, if the last cooling-down phase has ended, see below, or if there has not been any cooling-down phase yet).
f	= scaling factor.

As long as the unbalanced load current I_2 is **less** than the threshold (»I2>« or »I2/FLA«) it is assumed that the object is *cooling down*.

During this phase, the heat (thermal) energy is calculated based on a cooling-down constant. This constant is another intrinsic property of the object that is to be protected, and therefore it must be specified as a setting value (Setting Group parameter » τ -cool«):

$$\theta(t) = \theta_{0,heat} \cdot e^{-\frac{t}{\tau_{cool}}}$$

$\theta(t)$	= actual value of the thermal energy,
$\theta_{0,heat}$	= initial value at the beginning of the cooling-down phase, i. e. the thermal energy at the end of the last heating-up phase
τ_{cool}	= object property, setting value » τ -cool«.

The cooling-down phase always continues as long as I_2 is below the threshold, i. e. $\theta(t)$ is calculated continuously. (Only after $\theta(t)$ has dropped below $0.01 \cdot \theta_{max}$ the calculation ends and θ gets reset to 0, i. e. a subsequent heating-up phase will start with initial value $\theta_{0,cool} = 0$.)

NOTICE!



The heat (thermal) energy is an auxiliary value that is calculated and maintained internally, i. e. it can neither be displayed at the HMI nor be retrieved via any communication protocol.

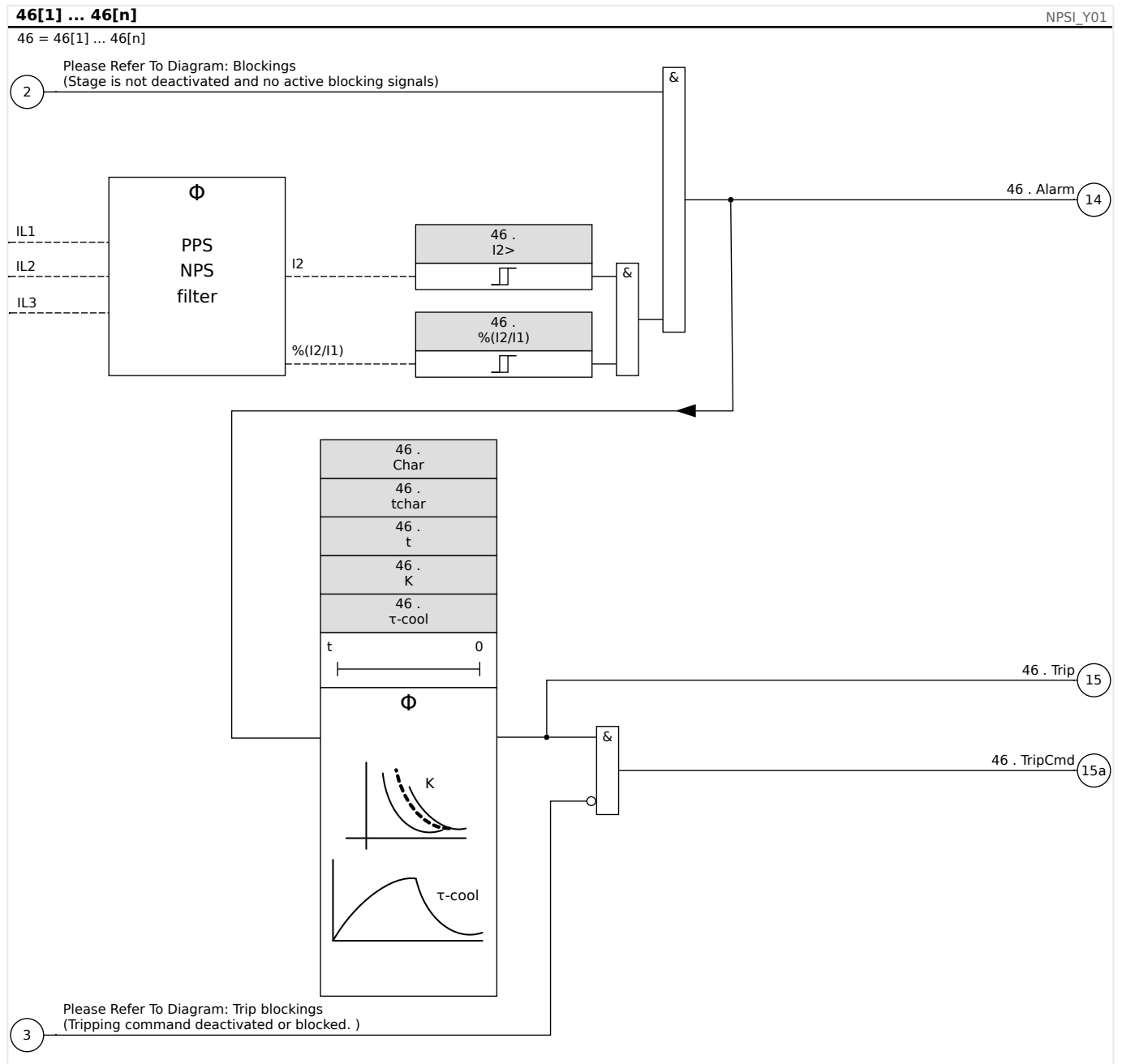

4.9.1 Commissioning: Current Unbalance Module

Object to be tested:

Test of the unbalanced load protection function.

Necessary means:

- Three-phase current source with adjustable current unbalance; and
- Timer.

Procedure:

Check the phase sequence:

- Ensure that the phase sequence is the same as that set in the field parameters.

- Feed-in a three-phase nominal current.
- Change to the »Measuring Values« menu.
- Check the measuring value for the unbalanced current »I2«. The measuring value displayed for »I2« should be zero (within the physical measuring accuracy).

NOTICE!



If the displayed magnitude for I2 is the same as that for the symmetrical nominal currents fed to the relay, it implies that the phase sequence of the currents seen by the relay is reversed.

- Now turn-off phase L1.
- Again check the measuring value of the unbalanced current »I2« in the »Measuring Values« menu. The measuring value of the asymmetrical current »I2« should now be 33%.
- Turn-on phase L1, but turn-off phase L2.
- Once again check the measuring value of the asymmetrical current I2 in the »Measuring Values« menu. The measuring value of the asymmetrical current »I2« should be again 33%.
- Turn-on phase L2, but turn-off phase L3.
- Again check the measuring value of asymmetrical current »I2« in the »Measuring Values« menu. The measuring value of the asymmetrical current »I2« should still be 33%.

Testing the trip delay:

- Apply a symmetrical three-phase current system (nominal currents).
- Switch off IL1 (the threshold value »Threshold« for »I2« must be below 33%).
- Measure the tripping time.

The present current unbalance »I2« corresponds with 1/3 of the existing phase current displayed.

Testing the threshold values

- Configure minimum »%I2/I1« setting (2%) and an arbitrary threshold value »Threshold« (I2).
- For testing the threshold value, a current has to be fed to phase A which is lower than three times the adjusted threshold value »Threshold« (I2).
- Feeding only phase A results in »%I2/I1 = 100%«, so the first condition »%I2/I1 >= 2%« is always fulfilled.
- Now increase the phase L1 current until the relay is activated.

Testing the dropout ratio of the threshold values

Having tripped the relay in the previous test, now decrease the phase A current. The dropout ratio must not be higher than 0.97 times the threshold value.

Testing I_2/I_1

- Configure minimum threshold value »Threshold« (I_2) ($0.01 \times I_n$) and set » I_2/I_1 « greater or equal to 10%.
- Apply a symmetrical three-phase current system (nominal currents). The measuring value of » I_2/I_1 « should be 0%.
- Now increase the phase L1 current. With this configuration, the threshold value »Threshold« (I_2) should be reached before the measuring value of » I_2/I_1 « reaches the set » I_2/I_1 « ratio threshold.
- Continue increasing the phase 1 current until the relay is activated.

Testing the dropout ratio of I_2/I_1

Having tripped the relay in the previous test, now decrease the phase L1 current. The dropout of » I_2/I_1 « has to be 1% below the » I_2/I_1 « setting.

Successful test result:

The measured trip delays, threshold values, and dropout ratios are within the permitted deviations/tolerances, specified under Technical Data.

4.10 ThR - Thermal Replica [49]

The maximal permissible thermal loading capacity, and consequently the tripping delay of a component, depends on the amount of the flowing current at a specific time, the »previously existing load (current)« as well as on a constant specified by the component.

A complete thermal replica function is implemented in the device as Homogeneous-Body Replica of the equipment to be protected and by taking the previously existing load into account. The protection function is of one step design, provided with a warning limit.

For this the device calculates the thermal load of the equipment by using the existing measured values and the parameter settings. When knowing the thermal constants, the temperature of the equipment can be established (simulated).

The thermal state is reset in any of the following cases:

- a (warm or cold) restart of the MRDT4;
- a change of the configuration (i. e. changed settings / parameters);
- a change of the active parameter set.

Tripping Time

The general tripping times of the overload protection can be gathered from the following equation:

$$t = \tau\text{-warm} \cdot \ln\left(\frac{I^2 - I_p^2}{I^2 - (K \cdot I_b)^2}\right)$$

Legend:

- t = tripping delay
- $\tau\text{-warm}$ = warming-up time constant
- $\tau\text{-cool}$ = cooling time constant
- I_b = base current: maximum permissible thermal continuous current
- K = overload factor: The maximum thermal limit is defined as $K \cdot I_b$, the product of the overload factor and the base current.
- I = measured current (in units of In)
- I_p = preload current

Functionality

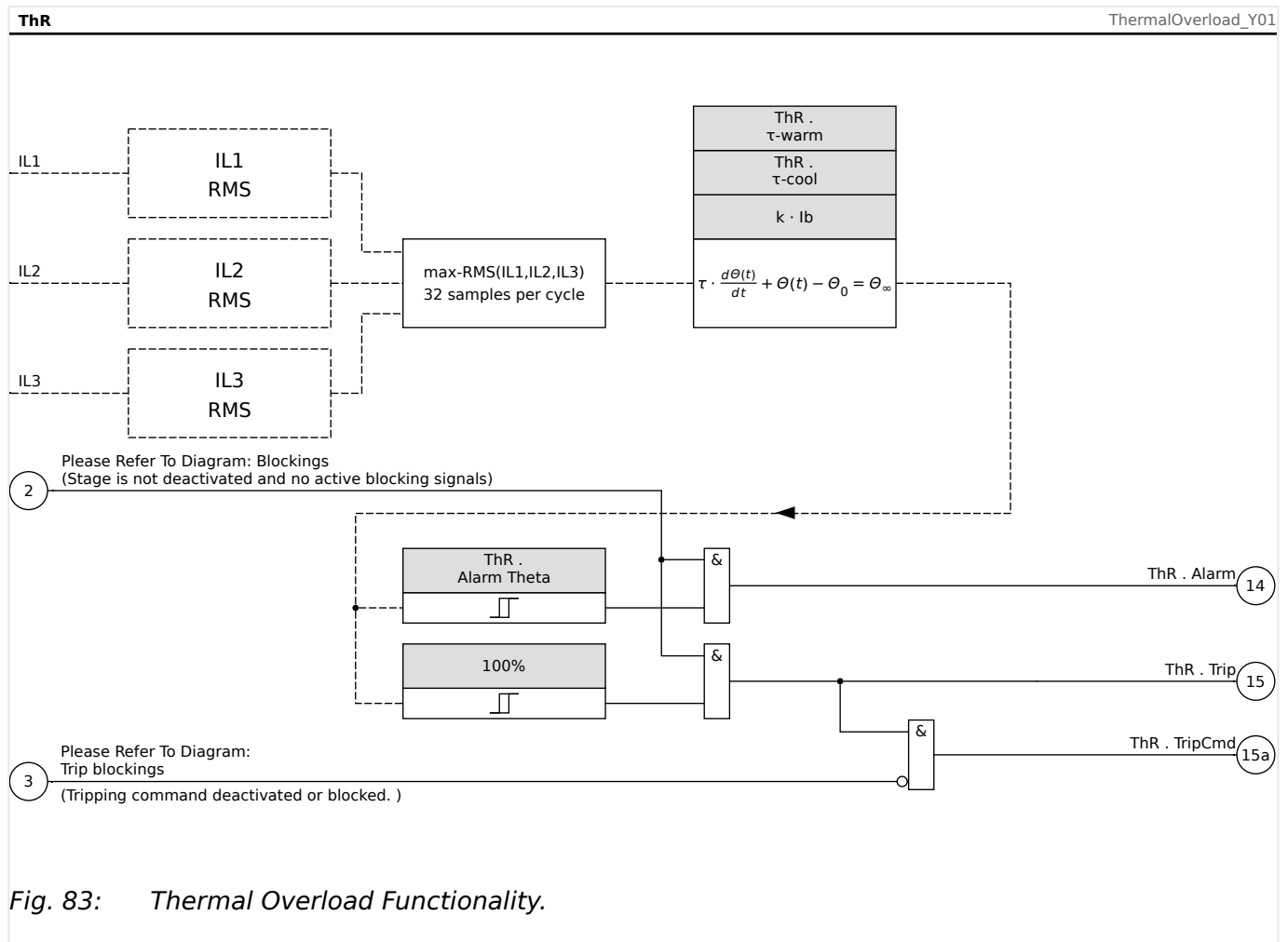

Fig. 83: Thermal Overload Functionality.

4.10.1 Commissioning: Thermal Replica

Object to be tested

Protective function: ThR

Necessary means

- Three-phase current source
- Timer

Procedure

Calculate the tripping time for the current to be constantly impressed by using the formula for the thermal image (see [↩](#) [➡](#) [↪](#)).

NOTICE!



The parameter of the temperature rise of the component » τ_w « has to be known to guarantee an optimal protection.

Testing the threshold values

Apply the current you have based your mathematical calculation on.

*Testing the trip delay***NOTICE!**

The thermal capacity should be zero before the test is started. See [Operation / Measured Values / ThR] »Thermal Cap Used«.

For testing the trip delay, a timer is to be connected to the contact of the associated trip relay.

Apply the current you have based your mathematical calculation on. The timer is started as soon as the current is applied and it is stopped when the relay trips.

Successful test result

The calculated tripping time and the fallback ratio comply with the measured values. For permissible deviations/tolerances, please see Technical Data.

4.11 SOTF - Switch Onto Fault

In case a faulty line is energized (e. g. when an earthing switch is in closed position), an instantaneous trip is required. The »SOTF« module is provided to generate a permissive signal for other protection functions such as overcurrents to accelerate their trips (via adaptive parameters, see [↳ “1.3.2 Adaptive Parameter Sets”](#)).

The SOTF condition is recognized according to the user’s operation mode. The following options are available for the setting [Protection Para / Global Prot Para / SOTF] »Mode«:

- »Mode« = “CB Pos” - The breaker state;
- »Mode« = “I<” - No current flowing;
- »Mode« = “CB Pos And I<” - Breaker state **and** no current flowing;
- »Mode« = “CB manual ON” - Breaker switched on manually;
- »Mode« = “Ext SOTF” - An external trigger.

The »SOTF« module requires that a switchgear (circuit breaker) is assigned to the parameter [Protection Para / Global Prot Para / SOTF] »Assigned SG«. Only those switchgears are permissible that feature measuring transformers providing measuring data to the MRDT4.

This module issues a signal only, it is not armed and does not issue a trip command.

In order to influence the trip settings of the overcurrent protection in case of switching onto a fault, the user has to assign the signal »SOTF . enabled« onto an Adaptive Parameter Set. (Please refer to [↳ “1.3.2 Adaptive Parameter Sets”](#) for a general description). Within the Adaptive Parameter Set, the user has to modify the trip characteristic of the overcurrent protection according to the user's needs.

Example: Undelayed Tripping of Overcurrent Element »I[1]«

Let us assume that all settings for the phase overcurrent element »I[1]« have been done. (See [↳ “4.6 I - Overcurrent Protection”](#) for a detailed description.) Then, as a second step, we want to set the tripping delay »I[1] . t« from the default value 1.00 s to 0 s as soon as the SOTF condition is recognized. The following steps are an example to achieve this:

- There are 4 Adaptive Sets. If, for instance, we select Adaptive Set 1, then we start with the following setting:

[Protection Para / Global Prot Para / I-Prot / I[1]] »AdaptSet 1« = “SOTF . enabled”.

- Then assign the “AdaptSet 1” value to the tripping delay:

[Protection Para / Set 1...4 / I-Prot / I[1]] »AdaptSet 1« [AdaptSet 1] = 0.00 s

When entering the menu branch [Protection Para / Set 1...4 / I-Prot / I[1]] on the panel, you should be able to see the following pages:

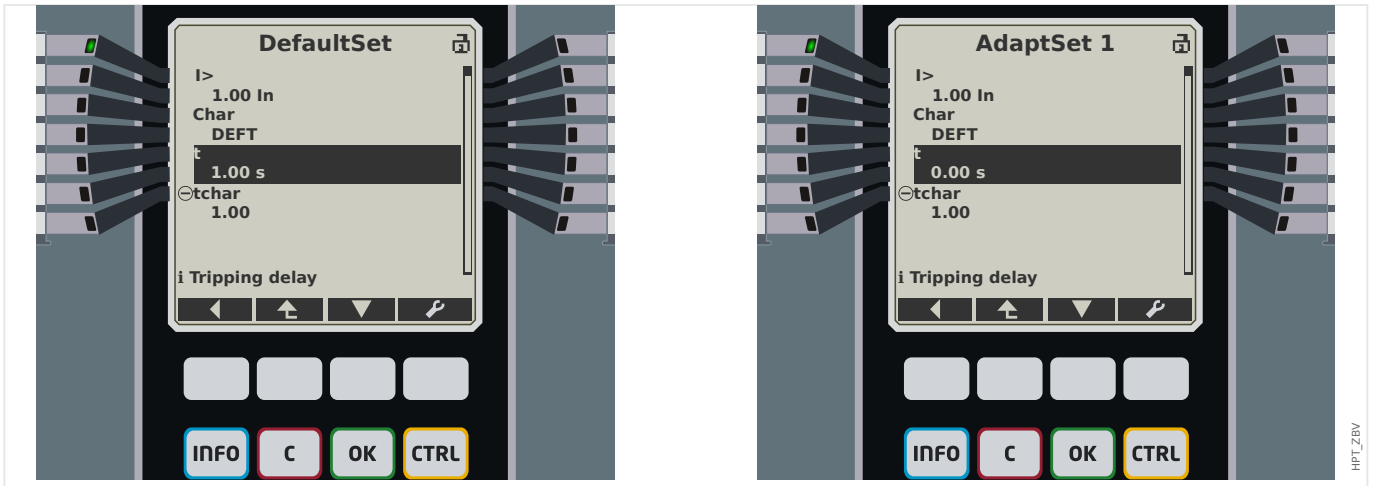

In Smart view, the same example settings should look like this:

1

Name	Value
ExBlo1	- . -
ExBlo2	- . -
ExBlo TripCmd	- . -
Ex rev Interl	- . -
AdaptSet 1	SOTF . enabled
AdaptSet 2	- . -
AdaptSet 3	- . -
AdaptSet 4	- . -

2

Name	DefaultSet	V[... 27, 59 . Alarm	Unit
Function	active		
ExBlo Fc	inactive		
Ex rev Interl Fc	inactive		
Blo TripCmd	inactive		
ExBlo TripCmd Fc	inactive		
Measuring method	Fundamental		
I>	1		In
Char	DEFT	DEFT	
t	1	0	s

Functionality of the »SOTF« Module

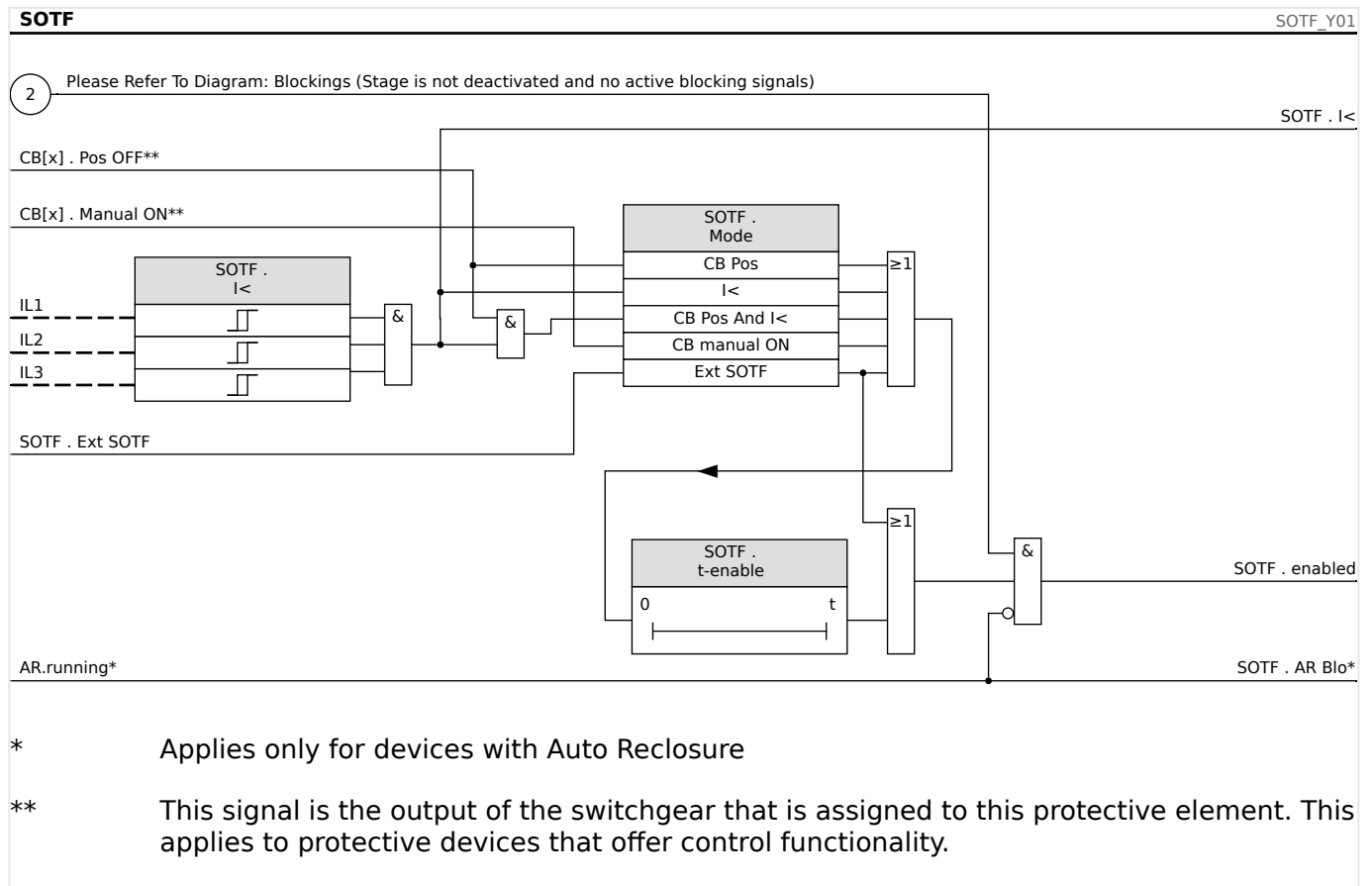

4.11.1 Commissioning: Switch Onto Fault

Object to be tested

Testing the module Switch Onto Fault according to the parameterized operating mode:

- The breaker state (CB Pos);
- No current flowing (I<);
- Breaker state and no current flowing(CB Pos and I<);
- Breaker switched on manually (CB manually On); and/or
- An external trigger (Ex SOTF).

Necessary means:

- Three-phase current source (If the Enable-Mode depends on current);
- Ampere meters (May be needed if the Enable-Mode depends on current); and
- Timer.

Test Example for Mode CB manual ON

NOTICE!

Mode I<: In order to test the effectiveness: Initially do not feed any current. Start the timer and feed with an abrupt change current that is distinctly greater than the I<-threshold to the measuring inputs of the relay.

Mode I< and Bkr state: Simultaneous switch on the breaker manually and feed with an abrupt change current that is distinctly greater than the I<-threshold.

Mode Bkr state: The breaker has to be in the OFF Position. The signal „SOTF.enabled“=0 is untrue. If the breaker is switched on, the signal „SOTF.enabled“=1 becomes true as long as the timer t-enabled is running.

- The Circuit Breaker has to be in the OFF Position. There must be no load current.
- The Status Display of the device shows the signal »SOTF . enabled« = 1.

Testing

- Switch the Circuit Breaker manually ON and start the timer at the same time.
- After the hold time t-enable is expired the state of the signal has to change to »SOTF . enabled« = 0.
- Write down the measured time.

Successful test result

The measured total tripping delays or individual tripping delays, threshold values and fallback ratios correspond with those values, specified in the adjustment list. Permissible deviations/tolerances can be found under Technical Data.

4.12 CLPU - Cold Load Pickup

When the electric load is freshly started or restarted after a prolonged outage, the load current tends to have a temporary surge that could be several times the normal load current in magnitude due to motor starting. This phenomena is called cold load inrush. If the overcurrent pickup threshold is set according to the maximum possible load inrush, the overcurrent protection may be insensitive to some faults, thus making whole protection systems coordination difficult or even impossible. On the other hand, the overcurrent protection could trip on load inrush if it is set based on the fault current studies. The CLPU module is provided to generate a temporary blocking/desensitizing signal to prevent overcurrent protections from unwanted tripping. The cold load pickup function detects a warm-to-cold load transition according to the four selectable cold load detection modes:

- CB POS (Breaker state);
- I< (Undercurrent);
- CB POS AND I< (Breaker state and undercurrent); and
- CB POS OR I< (Breaker state OR undercurrent).

After a warm-to-cold load transition has been detected, a specified load-off timer will be started. This User-settable load-off timer is used in some cases to make sure that the load is really "cold" enough. After the load-off timer times out, the CLPU function issues an "enable" signal »CLPU.enabled« that can be used to block some sensitive protection elements like instantaneous overcurrent elements, current unbalance, or power protection elements at User's choice. Using this enable signal, some time inverse overcurrent elements may also be desensitized at the User's choice by means of activating adaptive settings of the corresponding overcurrent elements.

When a cold load condition is finished (a cold-to-warm load condition is detected) due to, for example, breaker closing or load current injection, a load inrush detector will be initiated that supervises the coming and going of the load inrush current process. A load inrush is detected if the coming load current exceeds a User-specified inrush current threshold. This load inrush is considered as finished if the load current is decreased to 90% of the inrush current threshold. After the inrush current is diminished, a settle timer starts. The cold load pickup enable signal can only be reset after the settle timer times out. Another max-Block timer, which is started parallel with the load inrush detector after a cold load condition is finished, may also terminate the CLPU enable signal if a load inrush condition is prolonged abnormally.

The cold load pickup function can be blocked manually by external or internal signal at the User's choice. For the devices with Auto-Reclosing function, the CLPU function will be blocked automatically if auto-reclosure is initiated (AR is running).

CAUTION!



This module issues a signal only (it is not armed).

In order to influence the tripping settings of the overcurrent protection, the User has to assign the signal "CLPU.enabled" to an adaptive parameter set. Please refer to the Parameter / Adaptive Parameter Sets section. Within the adaptive parameter set, the User has to modify the tripping characteristic of the overcurrent protection according to the needs.

NOTICE!



Please be aware of the meaning of the two delay timers.

t load Off (Pickup Delay): After this time expires, the load is no longer diversified.

t Max Block (Release Delay): After the starting condition is fulfilled (e.g.: breaker switched on manually), the "CLPU.enabled" signal will be issued for this time. That means for the duration of this time, the tripping thresholds of the overcurrent protection can be desensitized by means of adaptive parameters (please refer to the Parameters section). This timer will be stopped if the current falls below 0.9 times of the threshold of the load inrush detector and remains below 0.9 times of the threshold for the duration of the settle time.

NOTICE!



This Notice applies to protective devices that offer control functionality only! This protective element requires, that a switchgear (circuit breaker) is assigned to it. It is allowed only to assign switchgears (circuit breaker) to this protective element, whose measuring transformers provide measuring data to the protective device.

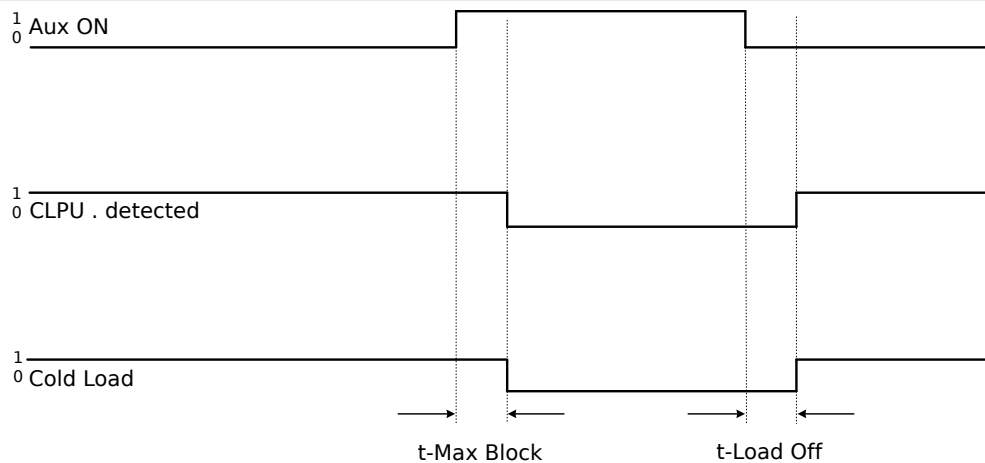

DCLP_Y02

Fig. 84: Example Mode: Breaker Position.

4 Protective Elements

4.12.1 Commissioning of the Cold Load Pickup Module

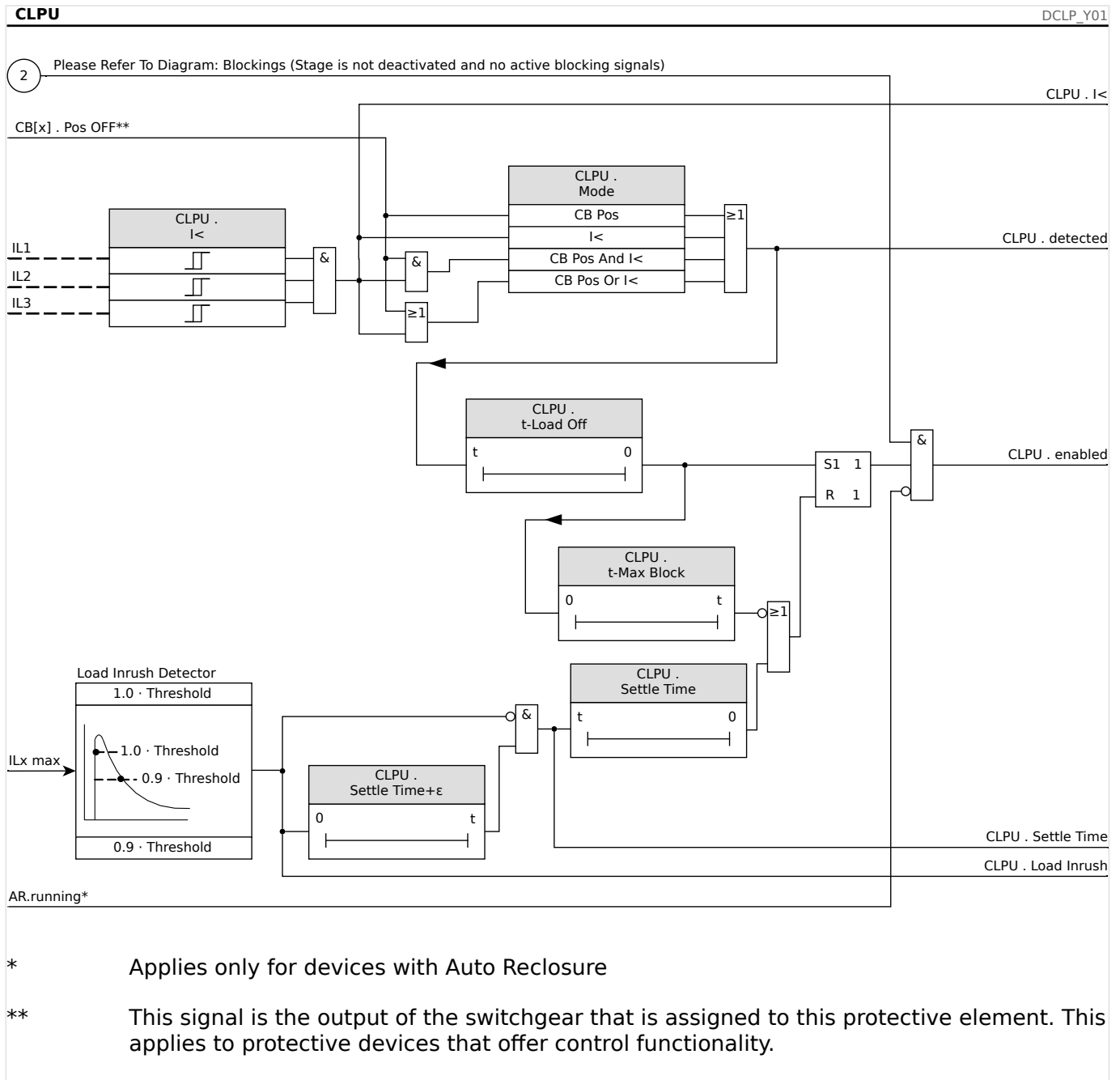

4.12.1 Commissioning of the Cold Load Pickup Module

Object to be tested:

Testing the Cold Load Pickup module according to the configured operating mode:

- I< (No current);
- Bkr state (Breaker position);
- I< (No Current) and Bkr state (Breaker position); and
- I< (No Current) or Bkr state (Breaker position).

Necessary means:

- Three-phase current source (if the Enable Mode depends on current);

- Ampere meters (may be needed if the Enable Mode depends on current); and
- Timer.

Test Example for Mode Bkr State (Breaker Position)

NOTICE!



Mode I<: In order to test the tripping delay, start the timer and feed with an abrupt change current that is distinctly less than the I<-threshold. Measure the tripping delay. In order to measure the drop-out ratio, feed a current with an abrupt change that is distinctly above the I<-threshold.

Mode I< and Bkr state: Combine the abrupt change (switching the current ON and OFF) with the manual switching ON and OFF of the breaker.

Mode I< or Bkr state: Initially carry out the test with an abrupt changing current that is switched ON and OFF (above and below the I<-threshold). Measure the tripping times. Finally, carry out the test by manually switching the breaker ON and OFF.

- The breaker has to be in the OFF position. There must not be any load current.
- The Status Display of the device shows the signal "CLPU.Enabled"=1.
- The Status Display of the device shows the signal "CLPU.I<"=1.
- *Testing the tripping delay and the resetting ratio:*
- Switch the breaker manually ON and simultaneously start the timer.
- After the the »t Max Block (Release Delay)« timer has expired, the signal "CPLU.Enabled "=0 has to become untrue.
- Write down the measured time.
- Manually switch the breaker OFF and simultaneously start the timer.
- After the »t load Off« timer has expired, the signal "CPLU.Enabled "=1 has to become true.
- Write down the measured time.

Successful test result:

The measured total tripping delays or individual tripping delays, threshold values, and drop-out ratios correspond with those values specified in the adjustment list. Permissible deviations/tolerances can be found in the Technical Data section.

4.13 ExP - External Protection

NOTICE!



All 4 stages of the external protection ExP[1] ... ExP[4] are identically structured.

By using the module External Protection the following can be incorporated into the device function: trip commands, alarms and blockades of external protection facilities. Devices which are not provided with a communication interface can be connected to the control system as well.

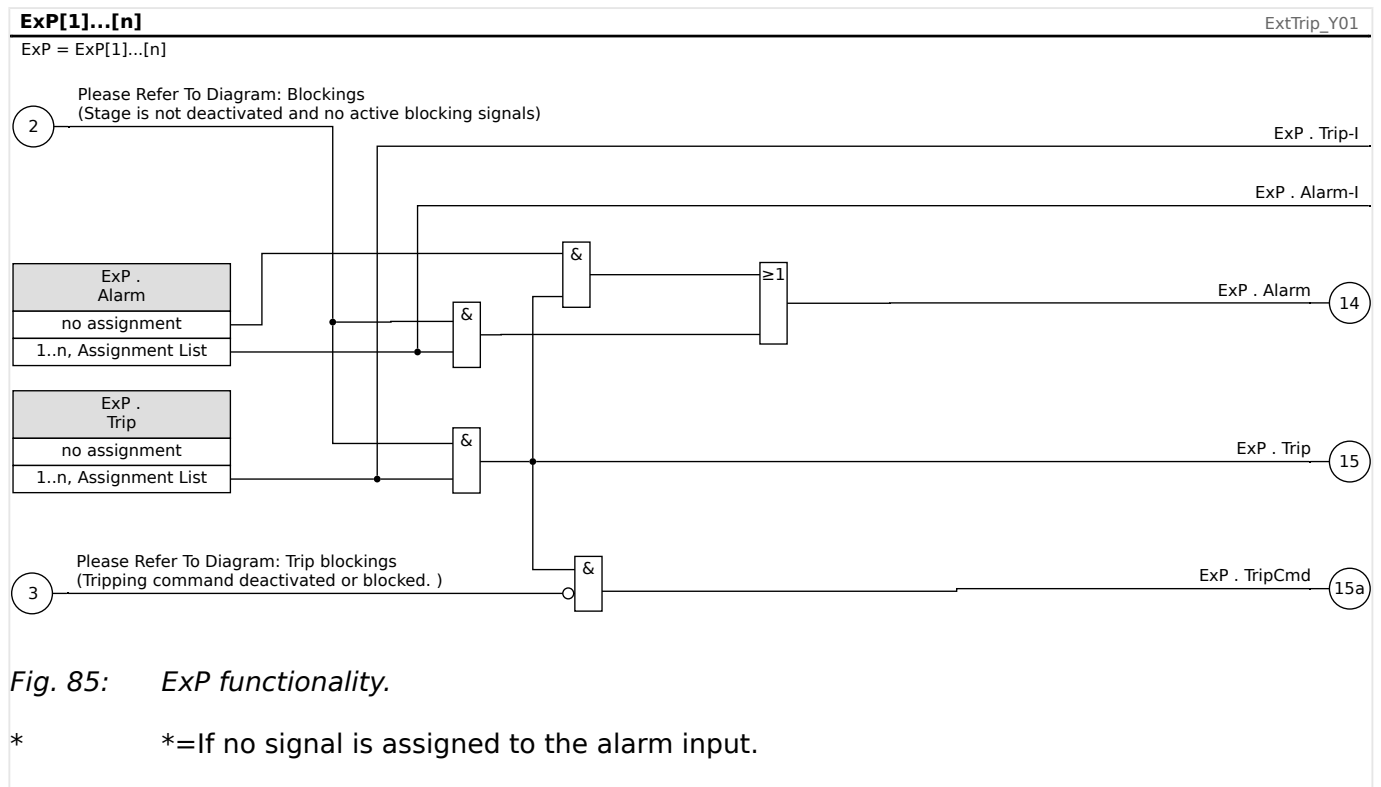

4.13.1 Commissioning: External Protection

Object to be tested:

Test of the External Protection Module.

Necessary means:

Dependent on the application.

Procedure:

Simulate the functionality of the External Protection (pickup, trip, and blockings) by (de-)energizing the digital inputs:

After module activation via [Device planning] »Mode« = "use", assign an available Digital Input to the Global Parameters for pickup and trip, for example:

- [Protection Para / Global Prot Para / ExP / Exp[n]] »Alarm« = "DI Slot X1 . DI 1"

- [Protection Para / Global Prot Para / ExP / ExP[n]] »Trip« = “DI Slot X1 . DI 2”

The same for the blocking parameters, for example:

- [Protection Para / Global Prot Para / ExP / ExP[n]] »ExBlo1« = “DI Slot X1 . DI 3”

Successful test result:

All external pickups, external trips, and external blockings are correctly recognized and processed by the MRDT4. Check also the respective entries in the [Event recorder](#).

4.14 Ext Temp Superv - External Temperature Supervision

NOTICE!

! All elements of the external protection Ext Temp Superv are identically structured.

By using the »Ext Temp Superv« module, the following can be incorporated into the device function: trip commands, alarms (pickups), and blockages of digital external temperature protection.

Since the »Ext Temp Superv« module is functionally identical to the »Exp« module, it is the user's responsibility to select the proper assignments for the settings Alarm (Pickup) and Trip for reflecting the purpose of this module.

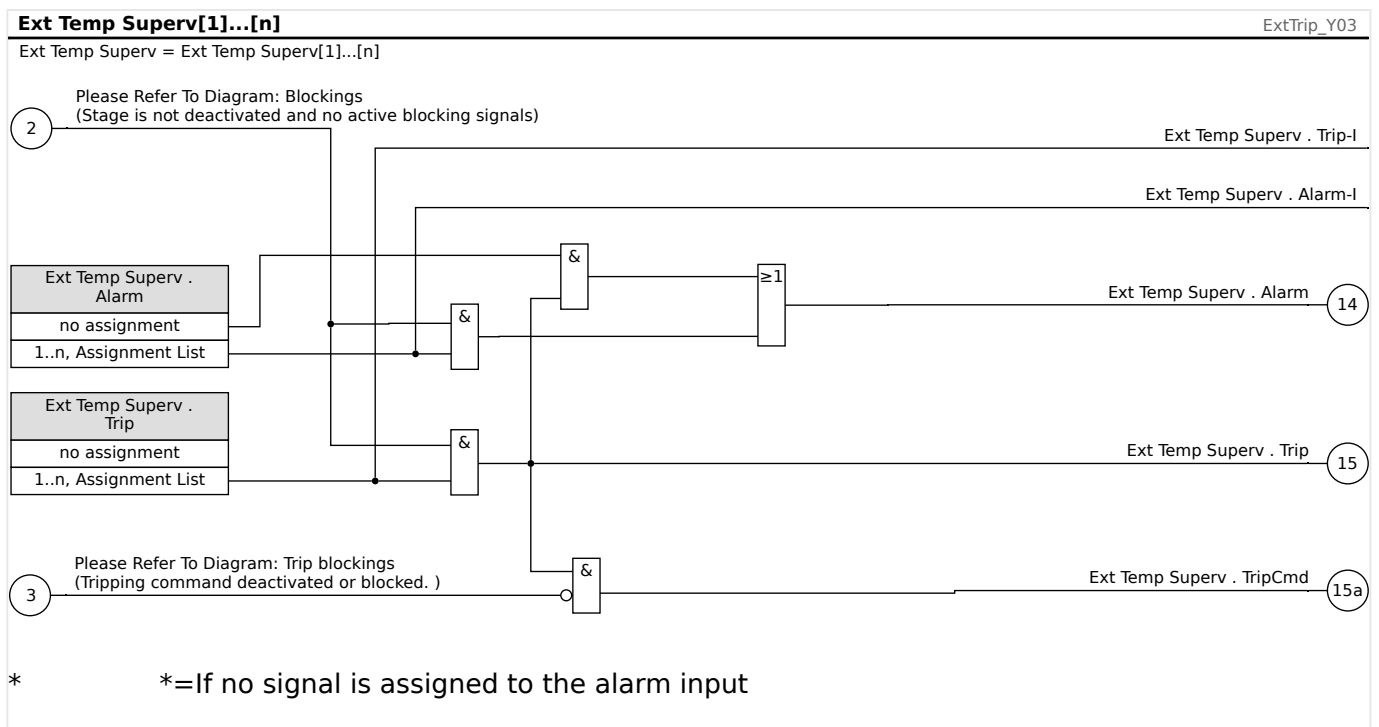

4.14.1 Commissioning: External Temperature Supervision

Object to be tested:

Test of the External Temperature Supervision module.

Necessary means:

Dependent on the application.

Procedure:

Simulate the functionality of the External Temperature Supervision (pickup, trip, blockings) by (de-)energizing of the digital inputs.

Successful test result:

All external pickups, external trips, and external blockings are correctly recognized and processed by the device.

4.15 Ext Oil Temp Protection Module - External Oil Temperature Protection

By using the »Ext Oil Temp« module, the following can be incorporated into the device function: trip commands, alarms (pickups), and blockages of digital external temperature facilities.

Since the »Ext Oil Temp« module is functionally identical to the »Exp« module, it is the user’s responsibility to select the proper assignments for the settings Alarm (Pickup) and Trip for reflecting the purpose of this module.

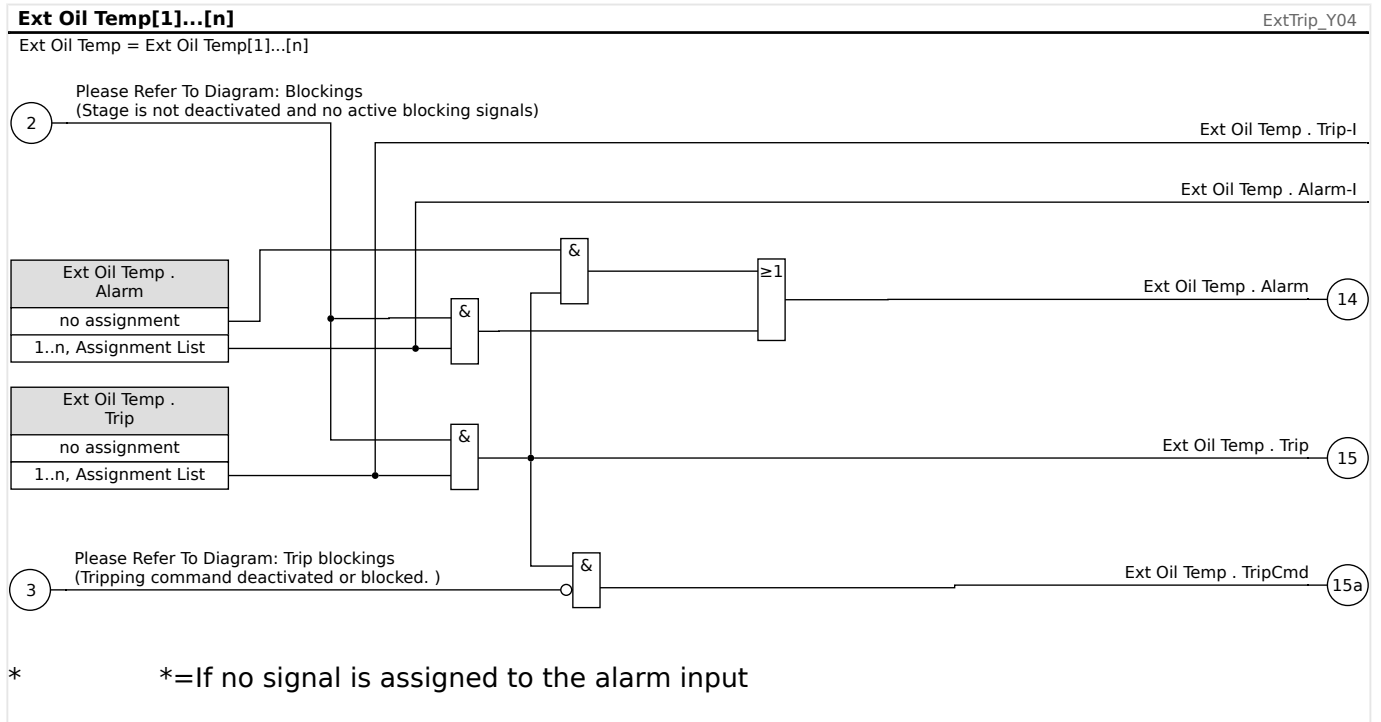

4.15.1 Commissioning: External Protection

Object to be tested:

Test of the External Oil Temperature Protection module.

Necessary means:

Dependent on the application.

Procedure:

Simulate the functionality of the External Oil Temperature Protection (pickup, trip, blockings) by (de-)energizing of the digital inputs.

Successful test result:

All external pickups, external trips, and external blockings are correctly recognized and processed by the device.

4.16 Sudden Pressure Protection Module – Sudden Pressure Protection

Principle - General Use

Most large size transformers (5000 KVA or above) are recommended to be equipped with a sudden pressure relay (Buchholz) that detects rapid change in oil or gas pressure within the tank as result of internal arcing. The sudden pressure relay can detect internal faults such as turn to turn faults that other protection functions such as differential and overcurrents may not be sensitive enough to sense. The sudden pressure relay is usually equipped with output contacts that can be directly used for tripping and alarming, but it does not have recording and communication capabilities built in.

The module »Ext Sudd Press« is provided in the protective device to take the output signals from the conventional sudden pressure relay and to form more secure and intelligent transformer protections. Through this module, the events of sudden pressure relay operations can be recorded and communicated to the control center (SCADA).

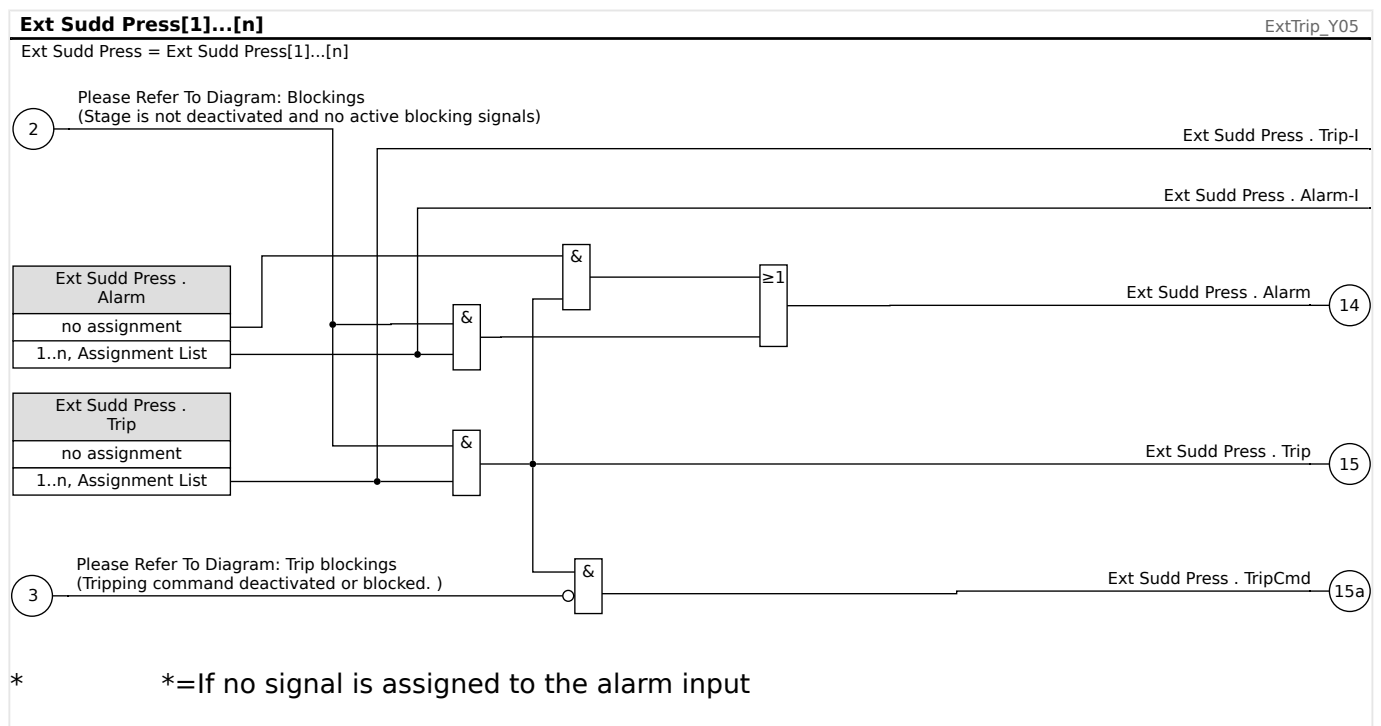

4.16.1 Commissioning: Sudden Pressure Protection

Object to be tested:

Test of the Sudden Pressure Protection module.

Necessary means:

Dependent on the application.

Procedure:

Simulate the functionality of the Sudden Protection Relay.

Successful test result:

4 Protective Elements

4.16.1 Commissioning: Sudden Pressure Protection

All external pickups, external trips, and external blockings are correctly recognized and processed by the device.

4.17 RTD Protection Module [26/38/49]

General - Principle Use

NOTICE!



The Resistance-based Temperature Detector (RTD) Protection Module uses temperature data that are provided by a Universal Resistance-based Temperature Detector (URTD) module (please refer to [↳ “4.18 URTDII Module Interface”](#)).

NOTICE!



If voting trip is required, please map the output used for tripping purposes: »RTD . Trip Group 1« or »RTD . Trip Group 2«.

The protective device provides tripping and alarming functions based on the direct temperature measurements read from the URTD device that has 11 temperature sensor channels. Each channel features a trip function without an intended delay and one alarm function with a delay.

- The “trip” function has only a threshold setting.
- Each individual »Alarm Function« will have a threshold setting range, and can be individually enabled or disabled. Since the temperature cannot change instantaneously (which is a way that temperature differs from current), the “delay” is essentially built in to the function due to the fact that the temperature will take some time to increase from room temperature to the “trip threshold” level.
- The dropout ratio for both trip and alarm is 0.99.
- The temperature rise is limited by the RTD driver.
- The entire function can be turned off or on, or individual channels can be turned off or on.

Channel Groups

The RTD channels are grouped:

- The channels W1 L1 ... W2 L3 belong to the group “Winding Temperature”:
 - Settings can be made in menu branch [Protection Para / Set 1 ... 4 / Temp-Prot / RTD / W1L1 ... W2L3]
 - Status values can be found in menu branches [Operation / Status Display / Temp-Prot / RTD / W1L1 ... W2L3] and [Operation / Status Display / Temp-Prot / RTD / Windg W1 Group ... Windg W2 Group]
 - Measured temperature values can be found in menu branch [Operation / Measured Values / URTD]
- The channels Amb1 ... Amb2 belong to the group “Ambient Temperature”:
 - Settings can be made in menu branches [Protection Para / Set 1 ... 4 / Temp-Prot / RTD / Amb 1 ... 2] and [Protection Para / Set 1 ... 4 / Temp-Prot / RTD / Amb Group]

- Status values can be found in menu branches [Operation / Status Display / Temp-Prot / RTD / Amb 1 ... 2] and [Operation / Status Display / Temp-Prot / RTD / Amb Group]
- Measured temperature values can be found in menu branch [Operation / Measured Values / URTD]
- The channels Aux1 ... Aux4 belong to the group “Auxiliary Temperature”:
 - Settings can be made in menu branches [Protection Para / Set 1 ... 4 / Temp-Prot / RTD / Aux 1 ... 4] and [Protection Para / Set 1 ... 4 / Temp-Prot / RTD / Aux Group]
 - Status values can be found in menu branches [Operation / Status Display / Temp-Prot / RTD / Aux 1 ... 4] and [Operation / Status Display / Temp-Prot / RTD / Aux Group]
 - Measured temperature values can be found in menu branch [Operation / Measured Values / URTD]

Within each group, always the hottest RTD is used.

Voting

Additionally, RTD voting schemes are available and user-programmable. The Voting feature must be activated and configured within the following menu, [Protection Para / Set n / Temp-Prot / RTD / Voting x]. Here, the setting »*Function*« has to be set to “active”.

Once activated, the number of channels that will be used by the voting feature is selected. This is set by way of the parameter »*Voting x*«. This parameter defines how many of the selected channels must be over its threshold level in order to get a voting trip. Each individual channel must be selected or deselected by setting to either “yes” or “no”. When selecting “yes”, the channel will be used in the voting process. Note that in order to be selected, each channel must also be active and the RTD module itself has to be active.

If for example, »*Voting x*« is set to “3”, and all channels are set to “yes”, and if any three of the selected channels exceed their individual threshold settings, a Vote trip will occur.

Please note that the voting trip will be issued as a RTD trip only, if the parameter »*TripCmd Selection*« is set to “Voting Trip” within the Global Protection Parameters of the RTD module. The Trip has to be assigned then within the trip manager to the Breaker.

Alarm, Timeout Alarm and Trip Principle for each RTD Sensor

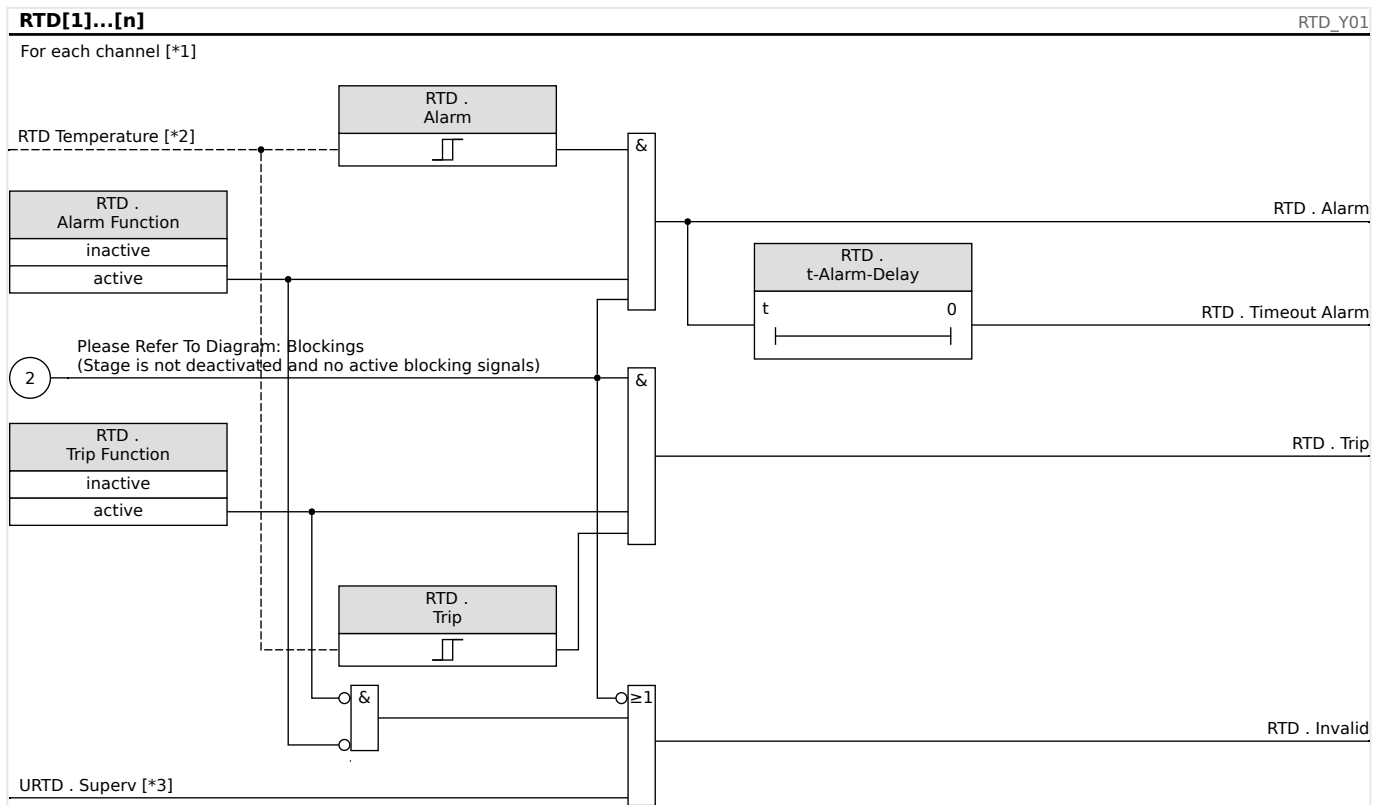

Fig. 86: The general working principle (delayed alarm, undelayed trip).

[*1] RTD channels or the following groups: W1L1, W1L2, W1L3, W2L1, W2L2, W2L3, Amb1, Amb2, Aux1, Aux2, Aux3

[*2] Within a group, always the hottest measured temperature is used.

[*3] The supervision checks all RTDs that belong to a group.

The diagram shows the general working principle (delayed alarm, undelayed trip) of each of the RTD sensors. Note that some text-labels had to be simplified, to make the diagram valid for each group. Please consult the Reference Manual for exact listings of available parameters and signals.

Collective Alarm, Timeout Alarm and Trip Signals

The RTD sensors are assigned to four groups (depending on the ordered device). These four groups are OR-connected to the "AnyGroup". The AnyGroup generates an alarm, an timeout alarm and a trip signal if any of the sensors mounted into this issues the corresponding signal.

4 Protective Elements

4.17 RTD Protection Module [26/38/49]

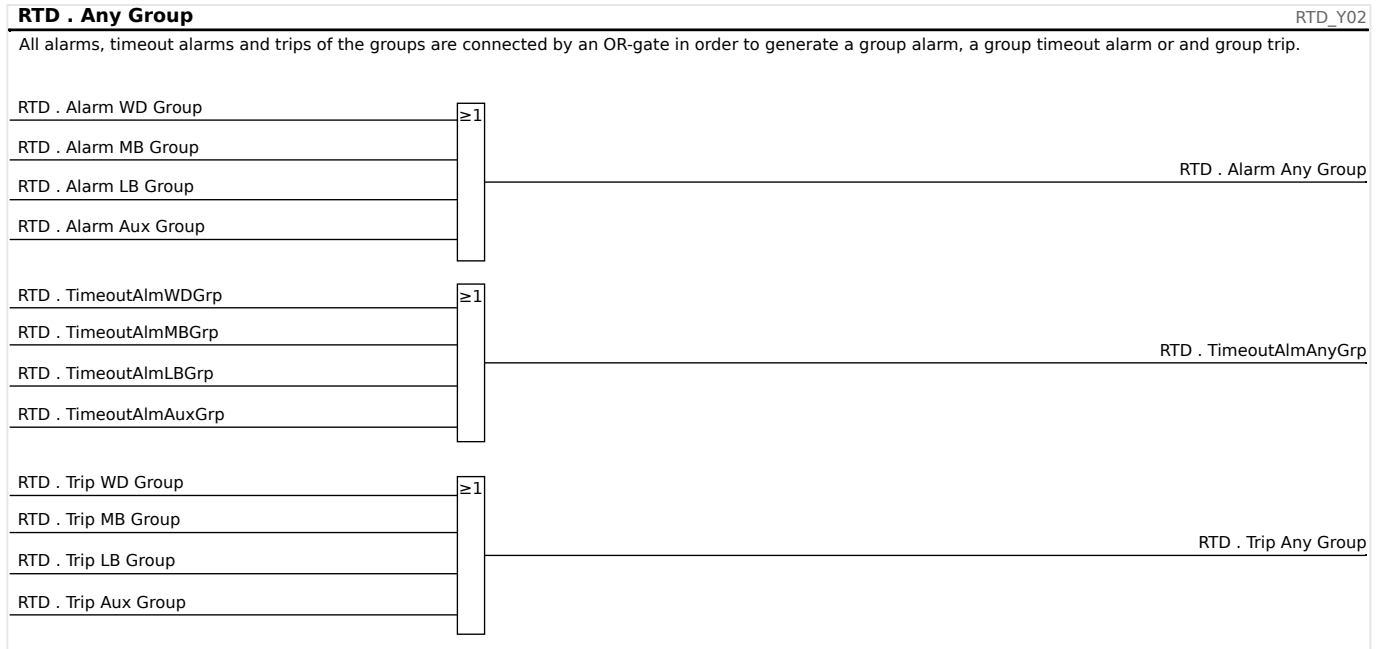

Trips of the Voting Groups

In order to use voting groups the user has to determine the sensors that should belong to a voting group and how many of them have to trip in order to generate a voting trip of the corresponding group.

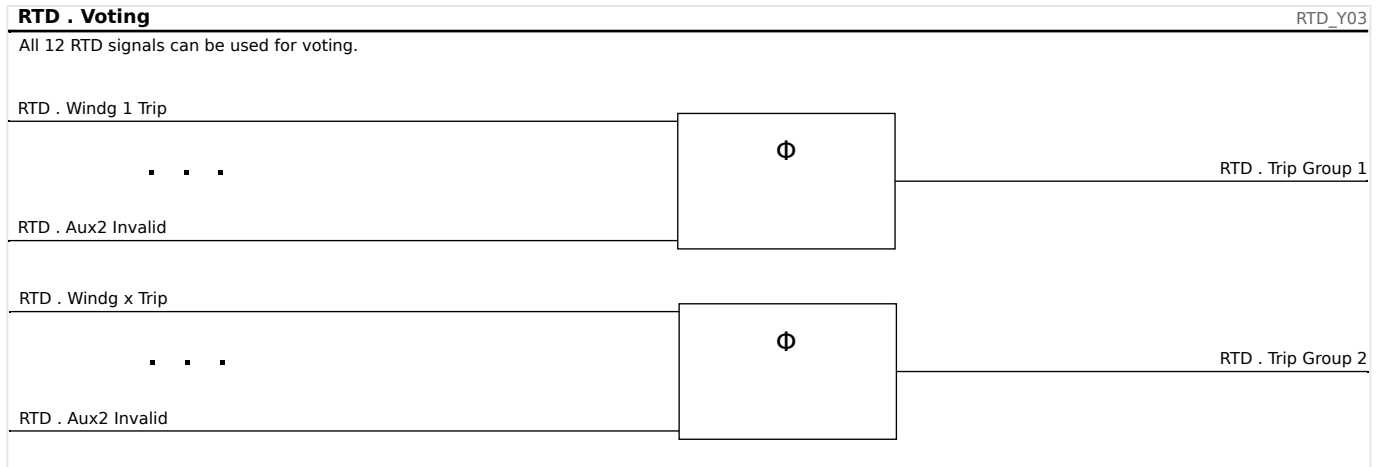

Collective Timeout Alarm Signal

All RTD sensor timeout alarms and all group timeouts are OR-connected.

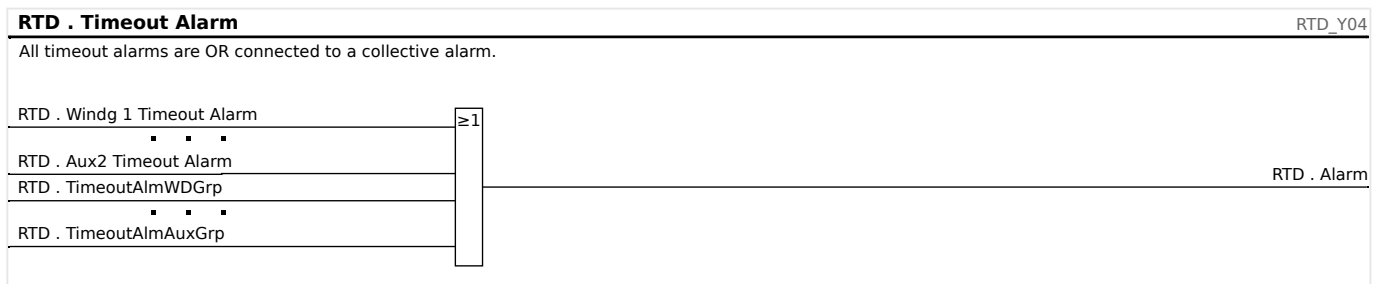

Collective Trip Signal

By means of the trip command selection »TripCmdSelection« the user determines if the RTD element should use for the final trip signal the OR-connected default RTD trips or if the RTD element should use the OR-connected voting trips.

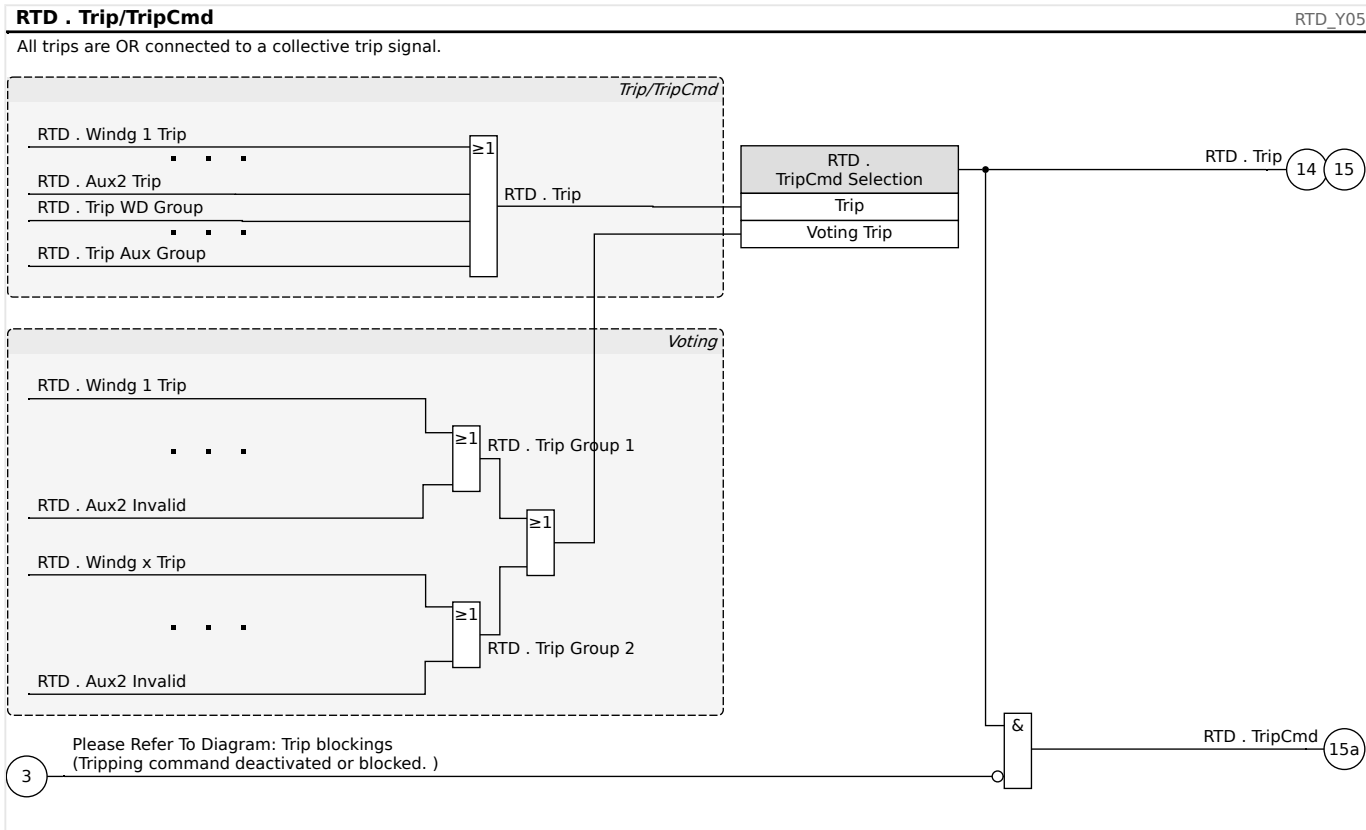

CAUTION!



Caution: A Block Trip Command blocks the trips of all RTDs.

4.18 URTDII Module Interface

Principle - General Use

The optional Universal Resistance-based Temperature Detector II (URTDII) Module provides temperature data to the protective device up to 12 RTDs embedded in the motor, generator, transformer, or cable connector and driven equipment. The temperature data will be shown as measured values and statistics in the Operating Data menu. In addition, each channel will be monitored. The measured data provided by the URTDII Module can also be used for temperature protection (please refer to the Temperature Protection section).

The URTDII conveys multiplexed temperature data back to the relay via a single optical fiber. The URTDII may be mounted remotely from the protective device. The fiber optic connector is located on the **X102** terminal of the protective device.

Consider the benefit of mounting the URTDII module away from the protective device and as close to the protected equipment as possible. The big bundle of RTD wires to the protected equipment becomes much shorter. The URTDII may be placed up to 400 ft (121.9 m) from the protective device with the optical fiber connection. Note that the URTDII will require a power supply connection at its remote location.

Connect a suitable source to the power terminals J10A-1 and J10A-2 on the URTDII module. Connect any of the Shield terminals to a non-current-carrying safety ground. It is recommended to have a ground connection on both sides of the unit.

Style	Power Supply
URTDII-01	48 – 240 VAC 48 – 250 VDC
URTDII-02	24 – 48 VDC

URTDII Module Fiber Optic Connection to the Protective Device

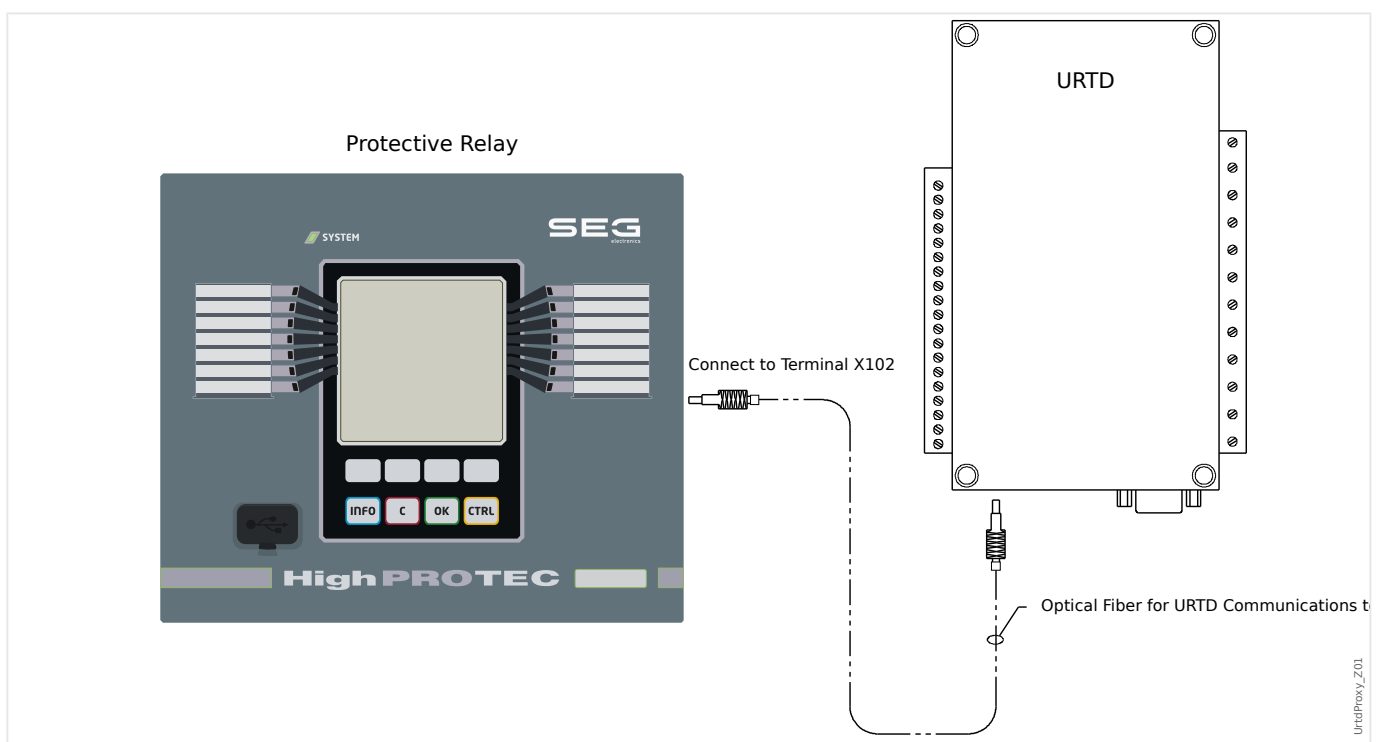

The figure above shows the fiber optic connections between the URTDII Module and the protective device. The protective device supports the optical fiber connection.

Preassembled plastic optical fibers with connectors can be ordered from any distributor of optical fiber products. In addition, these same distributors offer long rolls of cable with connectors that can be installed in the field. Some distributors will make custom lengths to order.

NOTICE!



Surplus length of a pre-cut fiber does not cause a problems. Simply coil and tie the excess fiber at a convenient point. Avoid high tie pressure. Bending radius of the fiber should be greater than 2 in. (50.8 mm).

The fiber termination at the URTDII simply snaps into or out of the connector. To connect the fiber termination at the protective device, push the plug of the fiber optic onto the device interface then turn it until it “snaps”.

CAUTION!



The protective device as well as the URTDII have various power supply options. Make certain that the power supply is acceptable for both units before connecting the same power supply to both devices.

NOTICE!



Consult the URTDII Module Instruction Leaflet for complete instructions.

Wiring RTDs to the URTDII Module

RTD Channel (avail. signals see Reference Manual)	URTDII Con- nection Name	Terminals	Temperature Monitoring Point
W1L1	Group I, RTD1	J2-20, J2-21	RTD Temperature of Transformer Winding 1, Phase L1.
W1L2	Group I, RTD2	J2-16, J2-17	RTD Temperature of Transformer Winding 1, Phase L2.
W1L3	Group I, RTD3	J2-13, J2-14	RTD Temperature of Transformer Winding 1, Phase L3.
W2L1	Group I, RTD4	J2-9, J2-10	RTD Temperature of Transformer Winding 2, Phase L1.
W2L2	Group I, RTD5	J2-6, J2-7	RTD Temperature of Transformer Winding 2, Phase L2.
W2L3	Group I, RTD6	J2-2, J2-3	RTD Temperature of Transformer Winding 2, Phase L3.

RTD Channel (avail. signals see Reference Manual)	URTDII Con- nection Name	Terminals	Temperature Monitoring Point
Amb1	Group II, RTD7	J10B-19, J10B-20	Transformer Ambient RTD Temperature (1).
Amb2	Group II, RTD8	J10B-15, J10B-16	Transformer Ambient RTD Temperature (2).
Aux1	Group III, RTD9	J10B-12, J10B-13	User Defined RTD Temperature.
Aux2	Group III, RTD10	J10B-8, J10B-9	User Defined RTD Temperature.
Aux3	Group IV, RTD11	J10B-5, J10B-6	User Defined RTD Temperature.
Aux4	Group IV, RTD12	J10B-1, J10B-2	User Defined RTD Temperature.

Three URTD terminals are provided for each RTD input.

The three terminals for any unused RTD input channel should be wired together. For example, if MW5 and MW6 are unused, MW5 terminals J2-15, J2-16, and J2-17 should be wired together and MW6 terminals J2-19, J2-20, J2-21 should be separately wired together.

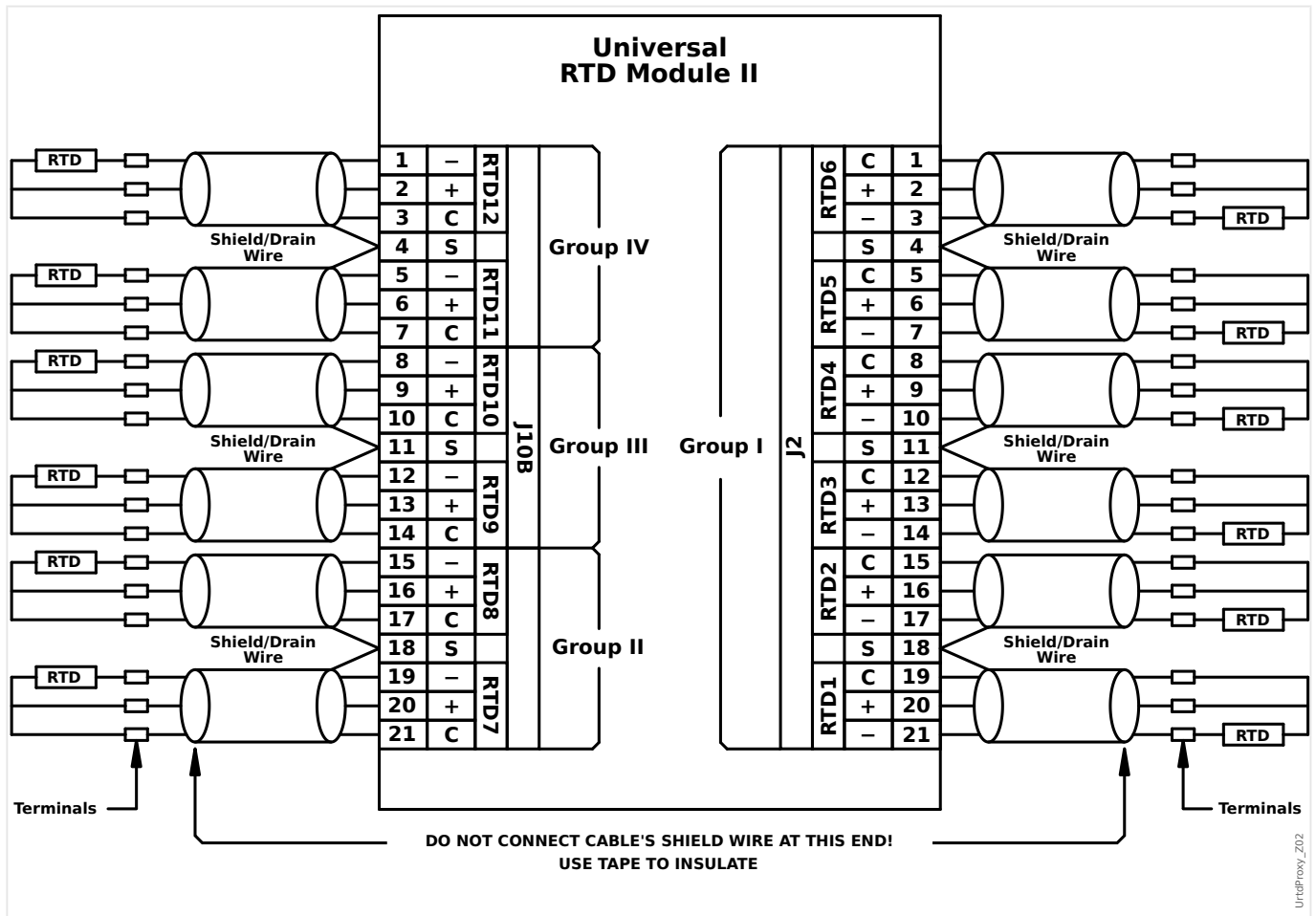

See the figure above for wiring of RTDs to the URTD inputs. Use three-conductor shielded cable. Note the connection rules in the figure. When making connections to a two-lead

RTD, connect two of the cable conductors to one of the RTD leads as shown. Make this connection as close to the protected object as possible. Connect the third cable conductor to the remaining RTD lead.

Connect the shield / drain wire to the Shield terminal as shown in the figure. The RTD cable shield should be connected only at the URTD end, and insulated at the RTD end. The RTD's themselves must not be grounded at the object to be protected.

Remember to set the URTDII module DIP switches according to the types of RTDs in each of the channels.

4.19 Supervision

4.19.1 CBF - Circuit Breaker Failure [50BF*/62BF]

* = only available in protective relays that offer current measurement.

4.19.1.1 Principle - General Use

The »CBF« module is used to provide backup protection in the event that a breaker fails to operate properly during fault clearing. This signal is to be used to trip the upstream breaker (e.g. infeed of a busbar) either via an output relay or via Communication (SCADA).

Depending on the ordered device type there are different/multiple schemes available to detect a breaker failure.

Supervision Schemes

The setting [Protection Para / Global Prot Para / Supervision / CBF] »Scheme« allows to select a supervision method that shall be used to detect a Breaker Failure. The following options are available:

- “50BF” — A supervision timer is started as soon as the »CBF« module is triggered by a trip signal. A Breaker Failure is detected and a signal is issued if the measured current does not fall below a set threshold within the set time.

This threshold can be set at [Protection Para / Set 1...4 / Supervision / CBF] »I-CBF >«.

- “CB Pos” — A supervision timer is started as soon as the »CBF« module is triggered by a trip signal. A Breaker Failure is detected and a signal is issued if the evaluation of the position indicators of the Breaker does not indicate that the breaker has successfully opened within the set time.

This scheme is recommended if Breaker Failures have to be detected while there is no or not much load flow (small currents). This might be the case if overvoltage or overfrequency is detected for a generator application that is running in stand-by.

- “50BF and CB Pos” — A supervision timer is started as soon as the »CBF« module is triggered by a trip signal. A Breaker Failure is detected and a signal is issued if the measured current does not fall below a set threshold and if simultaneously the evaluation of the position indicators of the Breaker does not indicate that the breaker successfully opened within the set time.

This scheme is recommended if Breaker Failures have to be double-checked. This scheme issues a trip command to the upstream breaker even if position indicators indicate misleadingly (faulty) that the breaker has been opened or if the current measurement indicates misleadingly (faulty) that the breaker is now in the open position.

Start/Trigger of the CBF Timer

The setting [Protection Para / Set 1...4 / Supervision / CBF] »t-CBF« defines a supervision time: The timer is started once the CBF module is triggered. Even if the trigger signal drops again, this timer continues. If the timer elapses (before it gets stopped by the breaker having successfully opened), the »CBF« module issues a trip. This trip signal is to be used to trip the upstream breaker (backup).

NOTICE!



In order to prevent a faulty activation of the »CBF« Module, the supervision time »t-CBF« must be greater than the sum of:

- Operating time of the protective relay
- + The close-open time of the breaker (please refer to the technical data of the manufacturer of the breaker);
- + Drop off time (current- or position indicators)
- + Security margin.

Stop the CBF Timer

The »t-CBF« timer is stopped if the opening of the breaker is detected. Depending on the supervision scheme (↳ “Supervision Schemes”) the timer is stopped if the current falls below the current threshold or if the position signals indicate the open position of the breaker or a combination of both. The »CBF« module remains in the state rejected until the trigger signal drops (falls back).

States

The »CBF« module switches into the rejected state if the circuit breaker failure triggers are still active while the open position of the breaker has been detected successfully.

The »CBF« module switches back into the Stand-by if the trigger signals drop (fall back).

Locking (Latching)

A locking signal will be issued simultaneously with the CBF-Signal (Trip). The locking signal is permanent. This signal has to be acknowledged at the HMI.

This signal can be used to block the breaker against a switching on attempt.

Triggers

The setting [Protection Para / Global Prot Para / Supervision / CBF] »Trigger« allows to select a trigger mode. In addition to that, there are three assignable trigger inputs available that might trigger the »CBF« module even if they are not assigned within the breaker manager onto the breaker that is to be monitored.

These additional trigger inputs can be set at [Protection Para / Global Prot Para / Supervision / CBF] »Trigger1« ... »Trigger3«.

The following options are available for »Trigger«:

- “All Trips” — All trip signals that are assigned to the breaker (within the trip manager, ↳ “Trip Manager – Assignment of commands”) start the »CBF« module.
- “External Trips” — All external trips that are assigned to the breaker (within the trip manager, ↳ “Trip Manager – Assignment of commands”) start the »CBF« module.

You can find all external trips in the Reference Manual (MRDT4-3.7-EN-REF), Chapter “Selection Lists”, as a table entitled “External Trips”.

- “Current Trips” — All current trips that are assigned to the breaker (within the trip manager, ↳ “Trip Manager – Assignment of commands”) start the »CBF« module.

4 Protective Elements

4.19.1.1 Principle - General Use

You can find all current trips in the Reference Manual (MRDT4-3.7-EN-REF), Chapter “Selection Lists”, as a table entitled “Current Trips”.

- “- . -” — No assignment, the user intends to use one of the three additional assignable trigger inputs.

4.19.1.2 Functionality

Breaker Failure Protection for devices that offer current measurement

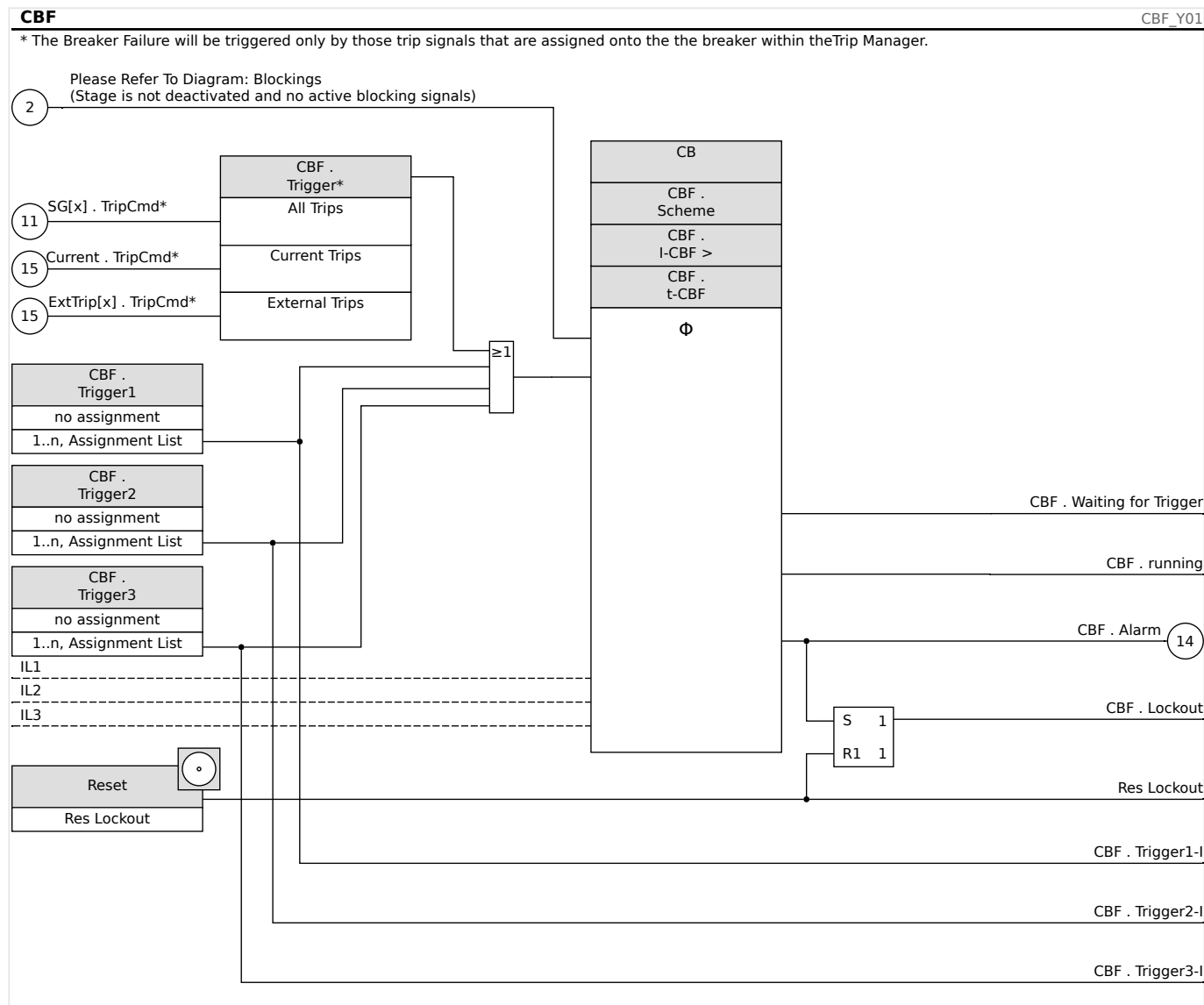

4.19.1.3 Commissioning Example: Supervision Scheme 50BF

Object to Be Tested:

Test of the breaker failure protection (Supervision Scheme 50BF).

Necessary Means:

- Current source;
- Ammeter; and
- Timer.

NOTICE!



When testing, the applied test current must always be higher than the tripping threshold »I-CBF«. If the test current falls below the threshold while the breaker is in the "Off" position, no pickup will be generated.

Procedure (Single-Phase):

For testing the tripping time of the CBF protection, a test current has to be higher than the threshold value of one of the current protection modules that are assigned to trigger the CBF protection. The CBF trip delay can be measured from the time when one of the triggering inputs becomes active to the time when the CBF protection trip is asserted.

To avoid wiring errors, checked to make sure the breaker in the upstream system switches off.

The time, measured by the timer, should be in line with the specified tolerances.

Successful Test Result:

The actual times measured comply with the setpoint times. The breaker in the higher-level section switches off.

WARNING!



Re-connect the control cable to the breaker!

4.19.2 TCS - Trip Circuit Supervision [74TC]

The trip circuit monitoring is used for monitoring if the trip circuit is ready for operations. The monitoring can be fulfilled in two ways. The first assumes only »Aux On (52a)« is used in the trip circuit. The second assumes that, in addition to »Aux On (52a), »Aux Off(52b)« is also used for the circuit monitoring.

With »Aux On (52a), only in the trip circuit, the monitoring is only effective when the breaker is closed while if both »Aux On (52a), and »Aux Off(52b)« are used, the trip circuit will be monitored all time as long as the control power is on.

Note that the digital inputs used for this purpose must be configured properly based on the trip circuit control voltage. If the trip circuit is detected broken, an alarm will be issued with a specified delay, which must be longer than the time when a trip contact is closed to the time when the breaker status is clearly recognized by the relay.

NOTICE!



In Slot 1 has 2 digital inputs, each of which has a separate root (contact separation) for the trip circuit supervision.

NOTICE!



This Notice applies to protective devices that offer control functionality only! This protective element requires, that a switchgear (circuit breaker is assigned to it.

In this case, the trip circuit supply voltage serves also as supply voltage for the digital inputs and so the supply voltage failure of a trip circuit can be detected directly.

In order to identify a conductor failure in the trip circuit on the supply line or in the trip coil, the off-coil has to be looped-in to the supervision circuit.

The time delay is to be set in a way that switching actions cannot cause false trips in this module.

4 Protective Elements

4.19.2.1 Commissioning: Trip Circuit Supervision [74TC]

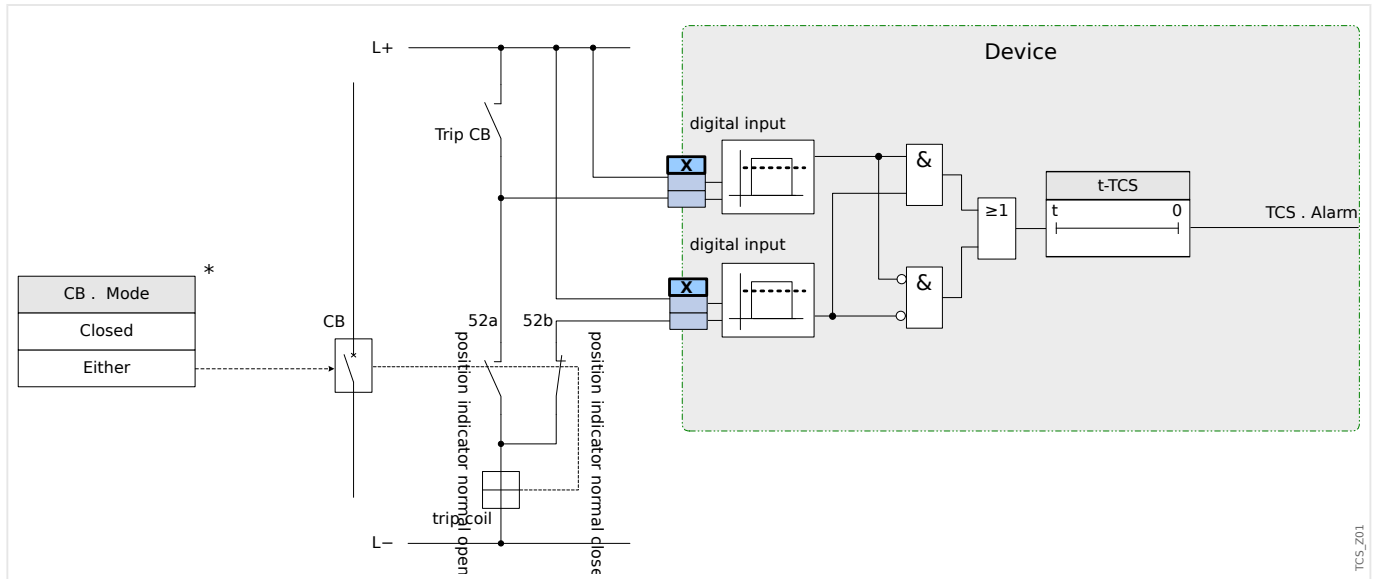

Fig. 87: Connection example: Trip circuit supervision with two CB auxiliary contacts »Aux ON« (52a) and »Aux OFF« (52b).

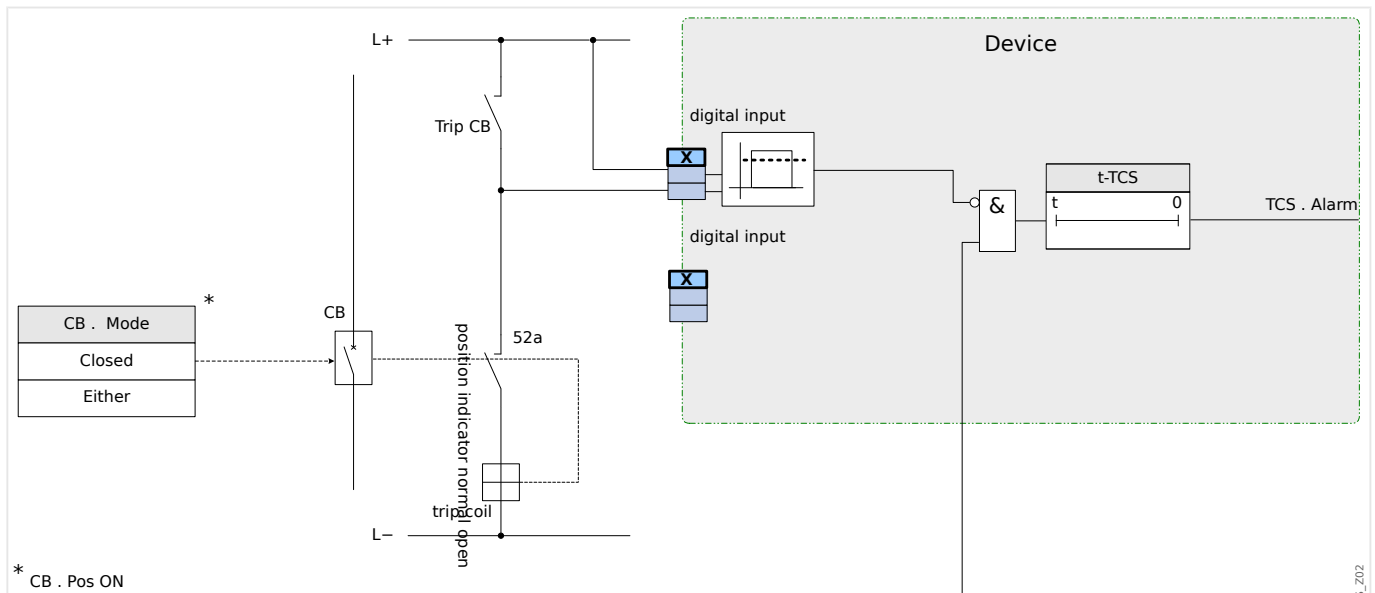

Fig. 88: Connection example: Trip circuit supervision with only one CB auxiliary contact »Aux ON« (52a).

4.19.2.1 Commissioning: Trip Circuit Supervision [74TC]

NOTICE!



For CBs that trip by means of little energy (e. g. via an optocoupler), it has to be ensured that the current applied by the digital inputs will not cause false tripping of the CB.

Object to be tested

Test of the trip circuit supervision.

Procedure, part 1

Simulate failure of the control voltage in the power circuits.

Successful test result, part 1

After expiry of »t-TCS« the trip circuit supervision TCS of the device should signal an alarm.

Procedure, part 2

Simulate a broken cable in the CB control circuit.

Successful test result, part 2

After expiry of »t-TCS« the trip circuit supervision TCS of the device should signal an alarm.

4.19.3 CTS - Current Transformer Supervision [60L]

Wire breaks and failures within measuring circuits cause current transformer failures.

The module »CTS« can detect a failure of the CT if the calculated earth current does not match the measured one. If an adjustable threshold value (Difference of measured and calculated earth current) is exceeded, a CT failure can be assumed. This is signaled through a message/alarm.

The precondition is that the conductor currents are measured by the device and the earth current, for instance, by a ring core type current transformer.

The measuring principles of the circuit supervision are based on comparing the measured and the calculated residual currents:

In an ideal case these are:

$$(\vec{I}_{L1} + \vec{I}_{L2} + \vec{I}_{L3}) + KI * \vec{I}_G = 3 * I_0 + KI * \vec{I}_G = 0$$

KI represents a correction factor which takes the different transformation ratio of the phase- and earth current transformers into account. The device automatically calculates this factor from the rated field parameters, i.e. the relation between the rated primary and secondary current values of the phase- and earth current transformers.

For compensating the current proportional ratio error of the measuring circuits, the dynamic correction factor Kd can be used. As a function of the measured max. current this factor is considering the linear rising measuring error.

The limiting value of the CT supervision is calculated as follows:

DI = deviation I (rated value)

Kd = correction factor

I_{max} = current maximum

Limiting value = DI + Kd x I_{max}

Precondition for identifying an error

$$3 * \vec{I}_0 + KI * \vec{I}_G \geq \Delta I + Kd * I_{max}$$

The evaluation method of the circuit supervision by using factor Kd can be graphically represented as follows:

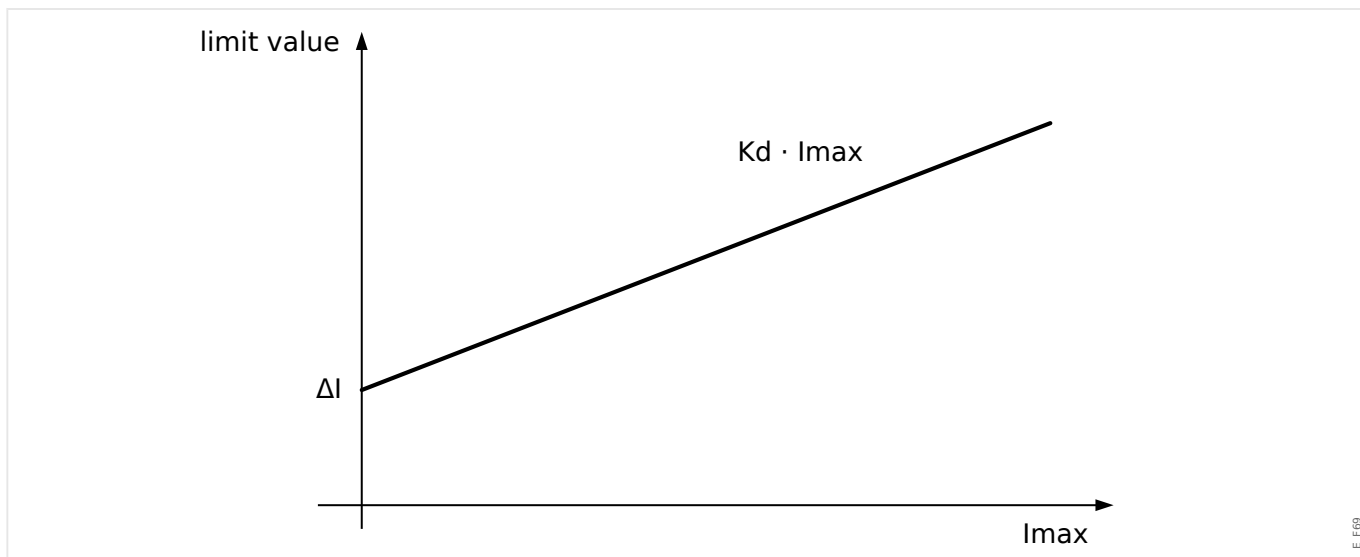

E_F69

CAUTION!

! If the current is measured in two phases only (for instant only IL1/IL3) or if there is no separate earth current measuring (e.g. normally via a cable-type CT), the supervision function should be deactivated.

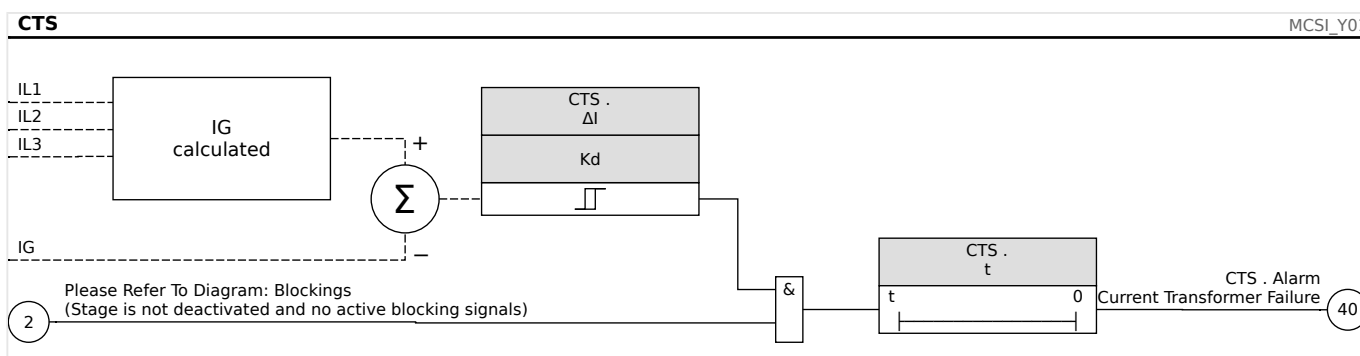

4.19.3.1 Commissioning: Current Transformer Failure Supervision

NOTICE!

! Precondition:

- Measurement of all three phase currents (are applied to the measuring inputs of the device); and:
- The earth current is detected via a cable-type transformer (not in Holmgreen connection).

Object to be tested

Check of the CT supervision (by comparing the calculated with the measured earth current).

Necessary means

- Three-phase current source

Procedure, part 1

- Set the limiting value of the CTS to » $\Delta I = 0.1 \cdot I_n$ «.
- Feed a three-phase, symmetrical current system (approx. nominal current) to the secondary side.
- Disconnect the current of one phase from one of the measuring inputs (the symmetrical feeding at secondary side has to be maintained).
- Make sure that the signal »CTS.Alarm« is generated now.

Successful test result, part 1

- The signal »CTS.Alarm« is generated.

Procedure, part 2

- Feed a three-phase, symmetrical current system (approx. nominal current) to the secondary side.
- Feed a current that is higher than the threshold value for the measuring circuit supervision to the earth current measuring input.
- Ascertain that the signal »CTS.Alarm« is generated now.

Successful test result, part 2

The signal »CTS.Alarm« is generated.

4.19.4 Phase Sequence Supervision

The MRDT4 calculates the phase sequence at each measuring input (based on positive-sequence and negative-sequence components). The calculated phase sequence (i. e. „ACB“ or „ABC“) is permanently compared with the setting that has been made at [Field Para / General Settings] »Phase Sequence«.

The menu [Operation / Status Display / Supervision / Phase Sequence] contains a specific (warning) signal for each CT and VT. If the check of a CT / VT finds that the actual phase sequence is different from the setting under [Field Para] then the respective signal becomes true (active).

In general, the phase sequence supervision is useful during commissioning of the MRDT4 because it helps making sure that the »Phase Sequence« setting under [Field Para] is correct.

WARNING!



The supervision requires minimum values for the current (in case of a CT), or for the voltage (in case of a VT, respectively), otherwise the phase sequence cannot be reliably determined.

- For a VT: The minimum voltage is $0.1 \cdot V_n$.
- For a CT: The minimum current is $0.1 \cdot I_n$.

5 Control / Switchgear-Manager

WARNING!



Misconfiguration of switchgear could result in death or serious injury. This e. g. is the case when opening a disconnecter under load or when switching a ground connector to live parts of a system.

Beside protection functions, protective relays more and more will take care about controlling switchgear, like breakers, load break switches, disconnectors and ground connectors.

A correct configuration of all switchgear is an indispensable precondition for the proper functioning of the protective device. This also is the case, when the switchgear are not controlled, but supervised only.

Single-Line Diagram

The single-line diagram includes the graphical description of the breaker and its designation (name) as well as its features (short-circuit proof or not ...). For displaying in the device's software, the switchgears' designations (e. g. **QA1**, **QA2**, instead of some abstract module name »SG[x]«) are taken from the single-line diagram (configuration file).

Beside switching properties a configuration file also includes a single line-diagram. Switching properties and single-line diagram are coupled via the the configuration file. Since the single-line diagram is independent of the device type, a new/other single line diagram can be imported into the configuration file.

NOTICE!



Whenever a configuration file is loaded into a protection device, a single line diagram will be always loaded at the same time.

This means, whenever a configuration file is transferred from one to another device, a suitable single-line diagram has to be loaded by means of the [Device planning] menu.

The user can create and modify Single Lines (pages) by means of the *Page Editor*. The Single Lines (Control Pages) have to be loaded into the protective device by means of *Smart view*. For details on the creation, modification and upload of Single Lines (Control Pages) please refer to the *Page Editor* manual (or contact the technical support). The *Page Editor* manual can be simply accessed via the *Page Editor*'s help menu.

5.1 Switchgear Control

Representation of a Switchgear in the Page Editor

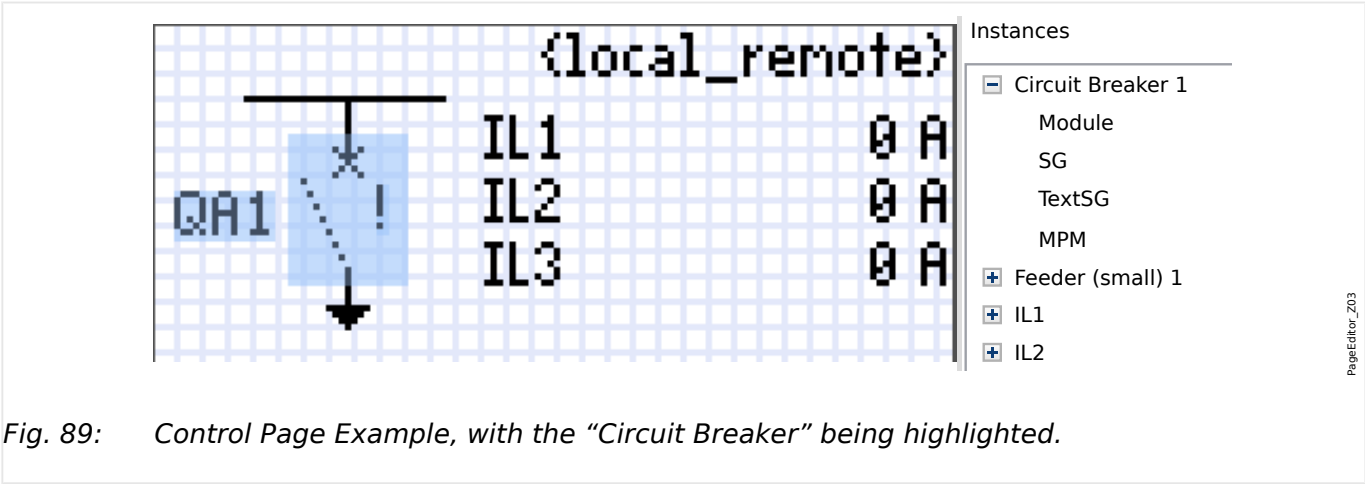

Fig. 89: Control Page Example, with the “Circuit Breaker” being highlighted.

Although a switchgear always appears using a fixed representation in the Page Editor, with an exclamation mark “!” being placed aside, this symbol features several representations: one for the closed switchgear, one for the open switchgear, one for the intermediate and faulty positions.

Once the single-line has been transferred to the protection device the switchgear is shown using the representation according to the configured position indication.

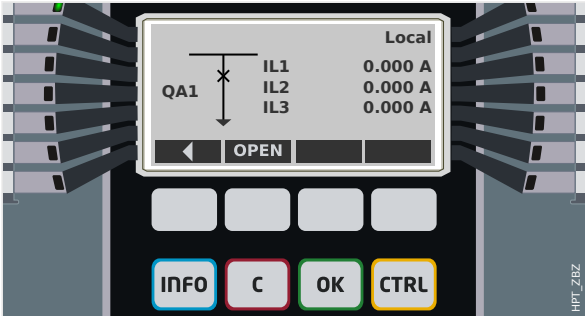

Fig. 90: Control Page Example, with the “Circuit Breaker” in closed position.

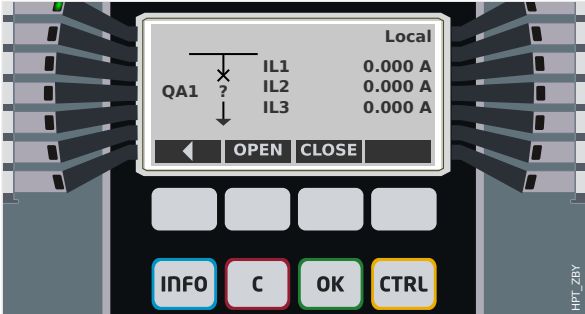

Fig. 91: Control Page Example, with the “Circuit Breaker” in faulty (or implausible) position.

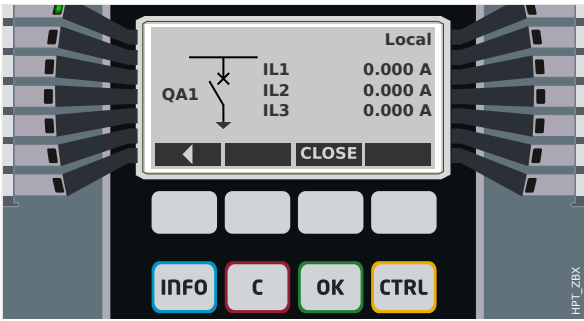

Fig. 92: Control Page Example, with the “Circuit Breaker” in open position.

Switchgear with the Property “Break Capability”

For each switchgear you can define in the *Page Editor* the “**Break Capability**” property. If this is set then you declare that the switchgear is a circuit breaker, that is capable to switch off the phase currents in case of a protection trip.

Therefore the MRDT4 makes the *Trip Manager* available only for switchgears with “Break Capability”. (For details about the Trip Manager, see [↳ “Trip Manager - Assignment of commands”](#).)

NOTICE!



HighPROTEC devices require that the first switching device, »SG[1]«, must have the “**Break Capability**” property set, because this is the switchgear to which a protection trip command is routed by default.

A Control Page without “Break Capability” for »SG[1]« will not pass the compatibility check in the *Page Editor*.

“Controlled” Switchgear

For each switchgear you can define in the *Page Editor* the “**Controlled**” property. If this is set then it shall be possible for the protection device to execute manual switching commands for the switchgear.

If this property is not set, but the “Break Capability” is set, then the switchgear can still be used for **protection** trip commands. However, it will not be available for manual switching operations.

If neither “Break Capability” nor “Controlled” is set then the switchgear is only monitored, i.e. the status / position is available, but it is not meant to be actively used by the protection device.

Changing the Order of the Switchgear in the Page Editor

This chapter is only relevant for devices with more than one switching device.

In general, the configured switching devices are presented by their user-defined names. This applies also to their representation on the HMI of the protective device and the dialogs within *Smart view*.

An exception to this representation are the switching device names in the SCADA protocols. SCADA protocols do not know the user-defined names of the switching devices, they are addressed via the number of the switchgear.

Therefore the *Page Editor* allows for changing the assignment to a particular switchgear number: Select the menu item [Configuration / Switching Device Order...] (keyboard-shortcut: »F6«). This opens a dialog window where all configured switchgear devices are listed with their respective number. After selecting any of these, buttons »Up« and »Down« can be used to modify the order.

NOTICE!



Due to application requirements the switching device number 1 should have enabled Break Capabilities. Other switching devices, if available, may be of arbitrary type.

The assignment of a switching device number to a type is checked by *Smart view*: A warning is displayed if the exchange of the user-defined Control Page changes the switching device type of any switching device number. This warning can be confirmed if the modification of the switching device type has been done by intention.

5.1.1 Settings within the Protection Device

Assignment of Position Indications (Digital Inputs)

Settings in the device menu [Control / SG / SG[x] / Pos Indicators Wiring]:

- »Aux ON« — The CB is in ON-position if the state of the assigned signal is true (52a).

Exception: For the [Earthing Switch part of the “Three Position Switch”](#), this is called: »Aux GROUND« — The switchgear is in Earth-position if the state of the assigned signal is true.
- »Aux OFF« — The CB is in OFF-position if the state of the assigned signal is true (52b).

Exception: For the [“Disconnecter-Earthing Combination”](#), this is called: »Aux GROUND« — The switchgear is in Earth-position if the state of the assigned signal is true.
- »Ready« — Circuit breaker is ready for operation if the state of the assigned signal is true. This digital input can be used by some protective elements (if they are available within the device) like Auto Reclosure (AR), e.g. as a trigger signal.
- »Removed« — The withdrawable circuit breaker is Removed

Setting of Supervision Timers

Settings in the device menu [Control / SG / SG[x] / General Settings]:

- »t-Move ON« — Time to move to the ON Position
- »t-Move OFF« — Time to move to the OFF Position

Assignment of Commands to Output Relays

Only available if the switchgear has been set “**Controlled**” in the *Page Editor* (see [““Controlled” Switchgear”](#)).

Settings in the device menu [Device Para / Binary Outputs / BO Slot Xx / BO y]:

- »Assignment 1« ... »Assignment 7« — for example for switchgear number 1 settable to “SG[1] . ON Cmd” / “SG[1] . OFF Cmd”

For details, see [“5 Control / Switchgear-Manager”](#).

Optional: External OPEN/CLOSE Command

Only available if the switchgear has been set “**Controlled**” in the *Page Editor* (see [““Controlled” Switchgear”](#)).

Settings in the device menu [Control / SG / SG[x] / Ex ON/OFF Cmd]:

- »SCmd ON« — Switching ON Command, e.g. the state of the Logics or the state of the digital input
- »SCmd OFF« — Switching OFF Command, e.g. the state of the Logics or the state of the digital input

For details, see [“Ex CLOSE / OPEN”](#).

Interlockings

Only available if the switchgear has been set “**Controlled**” in the *Page Editor* (see [↩➤](#) ““Controlled” Switchgear”).

Settings in the device menu [Control / SG / SG[x] / Interlockings]:

- »*Interl ON1*« ... »*Interl ON3*« — Interlocking of the ON command (i. e. close commands are rejected if the assigned signal is true).
- »*Interl OFF1*« ... »*Interl OFF3*« — Interlocking of the OFF command (i. e. open commands are rejected if the assigned signal is true).

For details, see [↩➤](#) “Interlockings”.

Trip Manager (Assignment of Trip Commands)

Only available if the property “**Break Capability**” has been set for this switchgear in the *Page Editor*.

Settings in the device menu [Control / SG / SG[x] / Trip Manager]:

- »*Off Cmd1*« ... — Off Command to the Circuit Breaker if the state of the assigned signal becomes true.
- »*t-TripCmd*« — Minimum hold time of the OFF-command (circuit breaker, load break switch)
- »*Latched*« — Defines whether the Trip Command is latched.
- »*Ack TripCmd*« — Acknowledgment of the Trip Command



For details, see [↩➤](#) “Switchgear with the Property “Break Capability”” and [↩➤](#) “Trip Manager - Assignment of commands”.

Optional: Switchgear Wear

See [↩➤](#) “5.3 Switchgear Wear”.

5.1.2 Switch

Generic switching device.

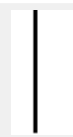
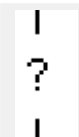
[Operation / Status Display / Control / SG[x]] »Pos«			
= 0 (Pos Indeterm)	= 1 (Pos OFF)	= 2 (Pos ON)	= 3 (Pos Disturb)
			

Assignment of Position Indications (Digital Inputs)

See [↪](#) “Assignment of Position Indications (Digital Inputs)”. These settings are available in the device menu:

[Control / SG / SG[x] / Pos Indicatr Wirng]			
»Aux ON«	»Aux OFF«	»Ready«	»Removed«
✓	✓	✓	✓

5.1.3 Invisible Switch

Switching device which is not visible on the single-line diagram, but available in the protection device.

(Since it is not existing on the single-line, it cannot be selected via the HMI (panel), and therefore cannot be operated manually.)

[Operation / Status Display / Control / SG[x]] »Pos«			
= 0 (Pos Indeterm)	= 1 (Pos OFF)	= 2 (Pos ON)	= 3 (Pos Disturb)
(Invisible)			





Assignment of Position Indications (Digital Inputs)

See  "Assignment of Position Indications (Digital Inputs)". These settings are available in the device menu:

[Control / SG / SG[x] / Pos Indicatrs Wirng]			
»Aux ON«	»Aux OFF«	»Ready«	»Removed«
✓	✓	✓	✓

5.1.4 Circuit Breaker

Switching device, capable of making, carrying and breaking currents under normal conditions and also making, carrying for a specified duration and breaking currents under specified abnormal conditions (e.g. short circuit).

[Operation / Status Display / Control / SG[x]] »Pos«			
= 0 (Pos Indeterm)	= 1 (Pos OFF)	= 2 (Pos ON)	= 3 (Pos Disturb)
			





Assignment of Position Indications (Digital Inputs)

See [↪](#) “Assignment of Position Indications (Digital Inputs)”. These settings are available in the device menu:

[Control / SG / SG[x] / Pos Indicatrs Wirng]			
»Aux ON«	»Aux OFF«	»Ready«	»Removed«
✓	✓	✓	✓

5.1.5 Circuit Breaker1

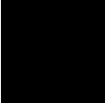
Switching device, capable of making, carrying and breaking currents under normal conditions and also making, carrying for a specified duration and breaking currents under specified abnormal conditions (e.g. short circuit).

[Operation / Status Display / Control / SG[x]] »Pos«			
= 0 (Pos Indeterm)	= 1 (Pos OFF)	= 2 (Pos ON)	= 3 (Pos Disturb)
			



Assignment of Position Indications (Digital Inputs)

See [↪](#) “Assignment of Position Indications (Digital Inputs)”. These settings are available in the device menu:

[Control / SG / SG[x] / Pos Indicatrs Wirng]			
»Aux ON«	»Aux OFF«	»Ready«	»Removed«
✓	✓	✓	✓

5.1.6 Disconnecter (Isolator)

Switching device which provides, in the open position, an isolating distance.

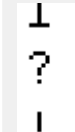
[Operation / Status Display / Control / SG[x]] »Pos«			
= 0 (Pos Indeterm)	= 1 (Pos OFF)	= 2 (Pos ON)	= 3 (Pos Disturb)
			



Assignment of Position Indications (Digital Inputs)

See [↪](#) “Assignment of Position Indications (Digital Inputs)”. These settings are available in the device menu:

[Control / SG / SG[x] / Pos Indicatr Wirng]			
»Aux ON«	»Aux OFF«	»Ready«	»Removed«
✓	✓	—	—

5.1.7 Disconnecter-Earthing Combination

A switch which combines a disconnecter and an earthing switch. This switch has two positions (connected - earthed).

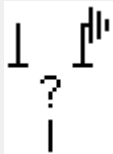
[Operation / Status Display / Control / SG[x]] »Pos«			
= 0 (Pos Indeterm)	= 1 (Pos OFF)	= 2 (Pos ON)	= 3 (Pos Disturb)
			





Assignment of Position Indications (Digital Inputs)

See [↪](#) "Assignment of Position Indications (Digital Inputs)". These settings are available in the device menu:

[Control / SG / SG[x] / Pos Indicatr's Wirng]			
»Aux ON«	»Aux GROUND«	»Ready«	»Removed«
✓	✓	—	—

5.1.8 Earthing Switch

Earthing Switch with short-circuit making capacity.

[Operation / Status Display / Control / SG[x]] »Pos«			
= 0 (Pos Indeterm)	= 1 (Pos OFF)	= 2 (Pos ON)	= 3 (Pos Disturb)
			





Assignment of Position Indications (Digital Inputs)

See [↪](#) “Assignment of Position Indications (Digital Inputs)”. These settings are available in the device menu:

[Control / SG / SG[x] / Pos Indicatrs Wirng]			
»Aux ON«	»Aux OFF«	»Ready«	»Removed«
✓	✓	—	—

5.1.9 Fuse-Load Switch

Switching device capable of making, carrying and breaking normal currents, in which a fuse-link forms the moving contact.

[Operation / Status Display / Control / SG[x]] »Pos«			
= 0 (Pos Indeterm)	= 1 (Pos OFF)	= 2 (Pos ON)	= 3 (Pos Disturb)
			

Assignment of Position Indications (Digital Inputs)

See [↪](#) “Assignment of Position Indications (Digital Inputs)”. These settings are available in the device menu:

[Control / SG / SG[x] / Pos Indicatrns Wirng]			
»Aux ON«	»Aux OFF«	»Ready«	»Removed«
✓	✓	✓	✓

5.1.10 Fuse-Load Switch - Disconnecter

Switching device capable of making, carrying and breaking normal currents.

Satisfies in the open position the isolating requirements for a disconnecter, in which a fuse-link forms the moving contact.

[Operation / Status Display / Control / SG[x]] »Pos«			
= 0 (Pos Indeterm)	= 1 (Pos OFF)	= 2 (Pos ON)	= 3 (Pos Disturb)





Assignment of Position Indications (Digital Inputs)

See [↪](#) "Assignment of Position Indications (Digital Inputs)". These settings are available in the device menu:

[Control / SG / SG[x] / Pos Indicatr's Wirng]			
»Aux ON«	»Aux OFF«	»Ready«	»Removed«
✓	✓	✓	✓

5.1.11 Fused-Disconnecter (Isolator)

Switching device which provides, in the open position, an isolating distance, in which a fuse-link forms the moving contact.

[Operation / Status Display / Control / SG[x]] »Pos«			
= 0 (Pos Indeterm)	= 1 (Pos OFF)	= 2 (Pos ON)	= 3 (Pos Disturb)
			





Assignment of Position Indications (Digital Inputs)

See [↪](#) “Assignment of Position Indications (Digital Inputs)”. These settings are available in the device menu:

[Control / SG / SG[x] / Pos Indicatrs Wirng]			
»Aux ON«	»Aux OFF«	»Ready«	»Removed«
✓	✓	—	—

5.1.12 Load Switch

Switching device capable of making, carrying and breaking normal currents.

[Operation / Status Display / Control / SG[x]] »Pos«			
= 0 (Pos Indeterm)	= 1 (Pos OFF)	= 2 (Pos ON)	= 3 (Pos Disturb)
			

Assignment of Position Indications (Digital Inputs)





See [↪](#) “Assignment of Position Indications (Digital Inputs)”. These settings are available in the device menu:

[Control / SG / SG[x] / Pos Indicatr Wirng]			
»Aux ON«	»Aux OFF«	»Ready«	»Removed«
✓	✓	✓	✓

5.1.13 Load Switch - Disconnecter

Switching device capable of making, carrying and breaking normal currents.

Satisfies in the open position the isolating requirements for a disconnecter.

[Operation / Status Display / Control / SG[x]] »Pos«			
= 0 (Pos Indeterm)	= 1 (Pos OFF)	= 2 (Pos ON)	= 3 (Pos Disturb)
			





Assignment of Position Indications (Digital Inputs)

See [↪](#) "Assignment of Position Indications (Digital Inputs)". These settings are available in the device menu:

[Control / SG / SG[x] / Pos Indicatrs Wirng]			
»Aux ON«	»Aux OFF«	»Ready«	»Removed«
✓	✓	✓	✓

5.1.14 Three Position Switch

A switch which combines a disconnecter and an earthing switch. This switch has three positions (connected - disconnected - earthed) and is intrinsically safe against maloperation.

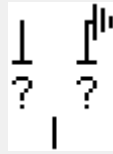
[Operation / Status Display / Control / ...]				
[... / SG[1]] »Pos« = 0 (Pos Indeterm)	[... / SG[1]] »Pos« = 2 (Pos ON)	[... / SG[1]] »Pos« = 1 (Pos OFF)	[... / SG[1]] »Pos« = 1 (Pos OFF)	[... / SG[1]] »Pos« = 3 (Pos Disturb)
[SG[2]] »Pos« = 0 (Pos Indeterm)	[SG[2]] »Pos« = 1 (Pos OFF)	[SG[2]] »Pos« = 1 (Pos OFF)	[SG[2]] »Pos« = 2 (Pos GROUND)	[SG[2]] »Pos« = 3 (Pos Disturb)
				

The “Three Position Switch” is composed of two switchgears. One switchgear corresponds to the disconnecter of the “Three Position Switch”, and the second switchgear corresponds to the earthing switch.

The separation into two switchgears makes switching from the »Pos ON«-position via the »Pos OFF«-position into the »Pos GROUND«-position available.

From security aspects there are two clear switch positions »Isolating« and »Earth«. Thanks to this separation, individual supervision and switching timers for the earthing and isolating part can be set. In addition to that individual interlockings and device names (designations) can be set for the earthing and the isolating part.

NOTICE!

!

The Command Execution Supervision will issue the following message in case of a switching attempt from the earthing position (directly) into the isolator position and vice versa:

- [Operation / Status Display / Control / SG[x]] »CES SwitchDir«

The “Pos GROUND” position of the “Three Position Switch” is shown as “CB POS OFF” within the SCADA documentation (register maps)

Assignment of Position Indications (Digital Inputs)

See [↪](#) “Assignment of Position Indications (Digital Inputs)”. These settings are available in the device menu:

Disconnecter, e. g. »SG[1]«:			
[Control / SG / SG[1] / Pos Indicatrns Wirng]			
»Aux ON«	»Aux OFF«	»Ready«	»Removed«
✓	✓	✓	✓

Earthing Switch, e. g. »SG[2]«:

[Control / SG / SG[2] / Pos Indicatrns Wirng]

»Aux GROUND«	»Aux OFF«	»Ready«	»Removed«
✓	✓	—	—

5.1.15 Withdrawable Circuit Breaker

Truck mounted (“Draw-Out”) circuit breaker.

[Operation / Status Display / Control / SG[x]]				
»Pos« (*) (*) the same value for both switchgears - see also remark below.				»Removed«
= 0 (Pos Indeterm)	= 1 (Pos OFF)	= 2 (Pos ON)	= 3 (Pos Disturb)	= 1

(*) Remark: The table above does not list all combinations of positions that are technically possible for the two switchgears, but only some typical “end positions” are shown as examples.

The “Withdrawable Circuit Breaker” is composed of two switchgears. One switchgear corresponds to the circuit breaker, and the second switchgear corresponds to the movable truck.

There is no fixed connection between the circuit breaker and the truck. An interlocking has to be set by the user because it is not allowed to withdraw the circuit breaker as long as it is in the closed position. The circuit breaker can be switched in the withdrawn and in the non-withdrawn position. The signals of the control circuit (low voltage) plug have to be wired and configured within the protective device. The control (supervision) is set to »Removed« when the control circuit plug is removed. The circuit breaker is set into the »Pos OFF«-position as long as the »Removed«-signal is active.

NOTICE!

It is not possible to manipulate the position signals of a withdrawn (removed) circuit breaker.

Assignment of Position Indications (Digital Inputs)

See [↪](#) “Assignment of Position Indications (Digital Inputs)”. These settings are available in the device menu:

Circuit Breaker, e. g. »SG[1]«:			
[Control / SG / SG[1] / Pos Indicatr Wirng]			
»Aux ON«	»Aux OFF«	»Ready«	»Removed«
✓	✓	✓	✓





Movable Truck, e. g. »SG[2]«:

[Control / SG / SG[2] / Pos Indicatrns Wirng]

»Aux ON«	»Aux OFF«	»Ready«	»Removed«
✓	✓	—	—

5.1.16 Withdrawable Fuse Load Switch

Truck mounted fuse load switch.

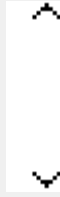
[Operation / Status Display / Control / SG[x]]				
»Pos« (*) (* the same value for both switchgears - see also remark below.)				»Removed«
= 0 (Pos Indeterm)	= 1 (Pos OFF)	= 2 (Pos ON)	= 3 (Pos Disturb)	= 1
				

(*) Remark: The table above does not list all combinations of positions that are technically possible for the two switchgears, but only some typical “end positions” are shown as examples.

The “Withdrawable Fuse Load Switch” is composed of two switchgears. One switchgear corresponds to the fuse load switch, and the second switchgear corresponds to the movable truck.

There is no fixed connection between the fuse load switch and the truck. An interlocking has to be set by the user because it is not allowed to withdraw the fuse load switch as long as it is in the closed position. The circuit breaker can be switched in the withdrawn and in the non-withdrawn position. The signals of the control circuit (low voltage) plug have to be wired and configured within the protective device. The control (supervision) is set to »Removed« when the control circuit plug is removed. The circuit breaker is set into the »Pos OFF«-position as long as the »Removed«-signal is active.

NOTICE!



It is not possible to manipulate the position signals of a withdrawn (removed) fuse load switch.

Assignment of Position Indications (Digital Inputs)

See [↪ “Assignment of Position Indications \(Digital Inputs\)”](#). These settings are available in the device menu:

Fuse Load Switch, e. g. »SG[1]«:			
[Control / SG / SG[1] / Pos Indicatrns Wirng]			
»Aux ON«	»Aux OFF«	»Ready«	»Removed«
✓	✓	✓	✓

Movable Truck, e. g. »SG[2]«:

[Control / SG / SG[2] / Pos Indicatrns Wirng]

»Aux ON«	»Aux OFF«	»Ready«	»Removed«
✓	✓	—	—

5.2 Switchgear Configuration

Wiring

At first the switchgear positioning indicators have to be connected to the digital inputs of the protection device.

One of the position indicators' contact (either the »Aux CLOSE« or the »Aux OPEN«) **must** be connected necessarily. However, it is recommended to connect both position indicators.

Thereafter the command outputs (relay outputs) have to be connected with the switchgear.

NOTICE!



Please observe the following option: In the general settings of a breaker, the CLOSE/ OPEN commands of a protection element can be issued to the same output relays, where the other control commands are issued.

If the commands are issued to different output relays the amount of wiring increases.

Setting of Supervision / Moving Times

In the menu [Control / SG / SG[x] / General Settings] the moving times »*t-Move ON*« and »*t-Move OFF*« of each individual switchgear have to be set.

Dependent on the type of switchgear it can be necessary to set further parameters, like the dwell time »*t-Dwell*«.

NOTICE!



The setting values of the timers »*t-Move ON*« and »*t-Move OFF*« are both monitoring **and** moving times, i. e. these are not only used for deciding about intermediate or faulty positions. In fact, it is important to be aware that also the maximum duration of the switching signal, that is issued to the switchgear, equals these values.

This means: Duration of »ON Cmd« equals »*t-Move ON*« at maximum, being limited by the indication of the switch's new position.

In the same way: Duration of »OFF Cmd« equals »*t-Move OFF*« at maximum, being limited by the indication of the switch's new position.

Assignment of Position Indications

The position indication is needed by the device to get (evaluate) the information about the current status /position of the breaker. The switchgear position indications are shown

in the devices display. Each position change of a switchgear results in a change of the corresponding switchgear symbol.

NOTICE!



It is recommended for the detection of a switchgear's position to always use both positioning indicators! If only one contact is used, no intermediate or disturbed positions can be detected.

A (reduced) transition supervision (time between issue of the command and position feedback indication of the switchgear) is also possible by one Aux contact.

In the menu [Control / SG / SG[x]] the assignments for the position indications have to be set.

*Detection of switchgear position with two Aux contacts - **Aux CLOSE and Aux OPEN (recommended!)***

For detection of their positions switchgear are provided with Aux contacts (Aux CLOSE and Aux OPEN). It is recommended to use both contacts to detect intermediate and disturbed positions too.

The protection device continuously supervises the status of the inputs »Aux ON-I« and »Aux OFF-I«.

These signals are validated based on the supervision timers »*t-Move ON*« and »*t-Move OFF*« validation functions. As a result, the switchgear position will be detected by the following signals:

- »Pos ON«
- »Pos OFF«
- »Pos Indeterm«
- »Pos Disturb«
- »Pos« (Signal: Circuit Breaker Position (0 = Indeterminate, 1 = OFF, 2 = ON, 3 = Disturbed))

Supervision of the CLOSE command

When a CLOSE command is initiated, the »*t-Move ON*« timer is started. While the timer is running, the »Pos Indeterm« state is true. If the command is executed and properly fed back from the switchgear before the timer has elapsed, »Pos ON« becomes true. Otherwise, if the timer has expired without receiving the expected new position indication, »Pos Disturb« becomes true.

Supervision of the OPEN command

When a CLOSE command is initiated, the »*t-Move OFF*« timer is started. While the timer is running, the »Pos Indeterm« state is true. If the command is executed and properly fed back from the switchgear before the timer has elapsed, »Pos OFF« becomes true. Otherwise, if the timer has expired without receiving the expected new position indication, »Pos Disturb« becomes true.

The following table shows how switchgear positions are validated:

States of the Digital Inputs		Validated Breaker Positions				
Aux ON-I	Aux OFF-I	Pos ON	Pos OFF	Pos Indeterm	Pos Disturb	Pos
0	0	0	0	1 (while a Moving timer is running)	0 (while a Moving timer is running)	0 Pos Indeterm
1	1	0	0	1 (while a Moving timer is running)	0 (while a Moving timer is running)	0 Pos Indeterm
0	1	0	1	0	0	1 Pos OFF
1	0	1	0	0	0	2 Pos ON
0	0	0	0	0 (Moving timer elapsed)	1 (Moving timer elapsed)	3 Pos Disturb
1	1	0	0	0 (Moving timer elapsed)	1 (Moving timer elapsed)	3 Pos Disturb

*Single Position Indication **Aux CLOSE or Aux OPEN***

If the single pole indication is used, the »SI SingleContactInd« becomes true.

The moving time supervision works only in one direction. If the Aux OPEN signal is connected to the device, only the "OPEN command" can be supervised and if the Aux CLOSE signal is connected to the device, only the "CLOSE command" can be supervised.

*Single Position Indication - **Aux CLOSE***

If only the Aux CLOSE signal is used for the Status Indication of a "CLOSE command", the switch command will also start the moving time, the position indication indicates an »Pos Indeterm« position during this time interval. When the switchgear reaches the end position indicated by the signals »Pos ON« and »CES succesf« before the timer has elapsed the signal »Pos Indeterm« disappears.

If the moving time elapsed before the switchgear has reached the end position, the switching operation was not successful and the Position Indication changes to »Pos

Disturb« and the signal »Pos Indeterm« disappears. After the moving time has elapsed, the timer »t-Dwell« is started (if set). During this time interval the Position Indication also indicates an »Pos Indeterm« state. When the »t-Dwell« has elapsed the Position Indication changes to »Pos ON«.

The following table shows how breaker positions are validated based on **Aux CLOSE**:

States of the Digital Inputs		Validated Breaker Positions				
Aux ON-I	Aux OFF-I	Pos ON	Pos OFF	Pos Indeterm	Pos Disturb	Pos
0	Not wired	0	0	1 (while »t-Move ON« is running)	0 (while »t-Move ON« is running)	0 Pos Indeterm
0	Not wired	0	1	0	0	1 Pos OFF
1	Not wired	1	0	0	0	2 Pos ON

If there is no digital input assigned to the »Aux CLOSE« contact, the position indication »Pos« has the value 3 (disturbed).

Single Position Indication - Aux OPEN

If only the Aux OPEN signal is used for the monitoring of the "OPEN command", the switch command will start the moving timer. The Position Indication will indicate an »Pos Indeterm« position. When the switchgear reaches its end position before the moving timer elapses, the »Pos OFF« and »CES succesf« signals are issued. At the same time the signal »Pos Indeterm« disappears.

If the moving time has elapsed before the switchgear has reached the OPEN position, the switching operation was not successful and the Position Indication changes to »Pos Disturb« and the signal »Pos Indeterm« disappears.

After the moving time has elapsed, the timer »t-Dwell« is started (if set). During this time interval the Position Indication »Pos Indeterm« is indicated. After the dwell time »t-Dwell« has elapsed, the OPEN position of the switchgear is indicated by the »Pos OFF« signal.

The following table shows how breaker positions are validated based on **Aux OPEN**:

States of the Digital Inputs		Validated Breaker Positions				
Aux ON-I	Aux OFF-I	Pos ON	Pos OFF	Pos Indeterm	Pos Disturb	Pos
Not wired	0	0	0	1 (while »t-Move ON« is running)	0 (while »t-Move ON« is running)	0 Pos Indeterm

States of the Digital Inputs		Validated Breaker Positions				
Aux ON-I	Aux OFF-I	Pos ON	Pos OFF	Pos Indeterm	Pos Disturb	Pos
				OFF« is running)	OFF« is running)	
Not wired	1	0	1	0	0	1 Pos OFF
Not wired	0	1	0	0	0	2 Pos ON

If there is no digital input assigned to the »Aux OPEN« contact, the position indication »Pos« has the value 3 (disturbed).

Interlockings

To avoid faulty operations, interlockings have to be provided. This can be realized mechanically or electrically.

For a controllable switchgear up to three interlockings can be assigned in both switching directions (CLOSE/OPEN). These interlockings prevent switching in the corresponding direction.

The protection OPEN command and the reclosing command of the Automatic Reclosure (AR module, availability depends on the ordered device type) are always executed without interlockings. If a protection OPEN command **must not** be issued, it must be blocked separately.

Further interlockings can be configured by means of the Logic module.

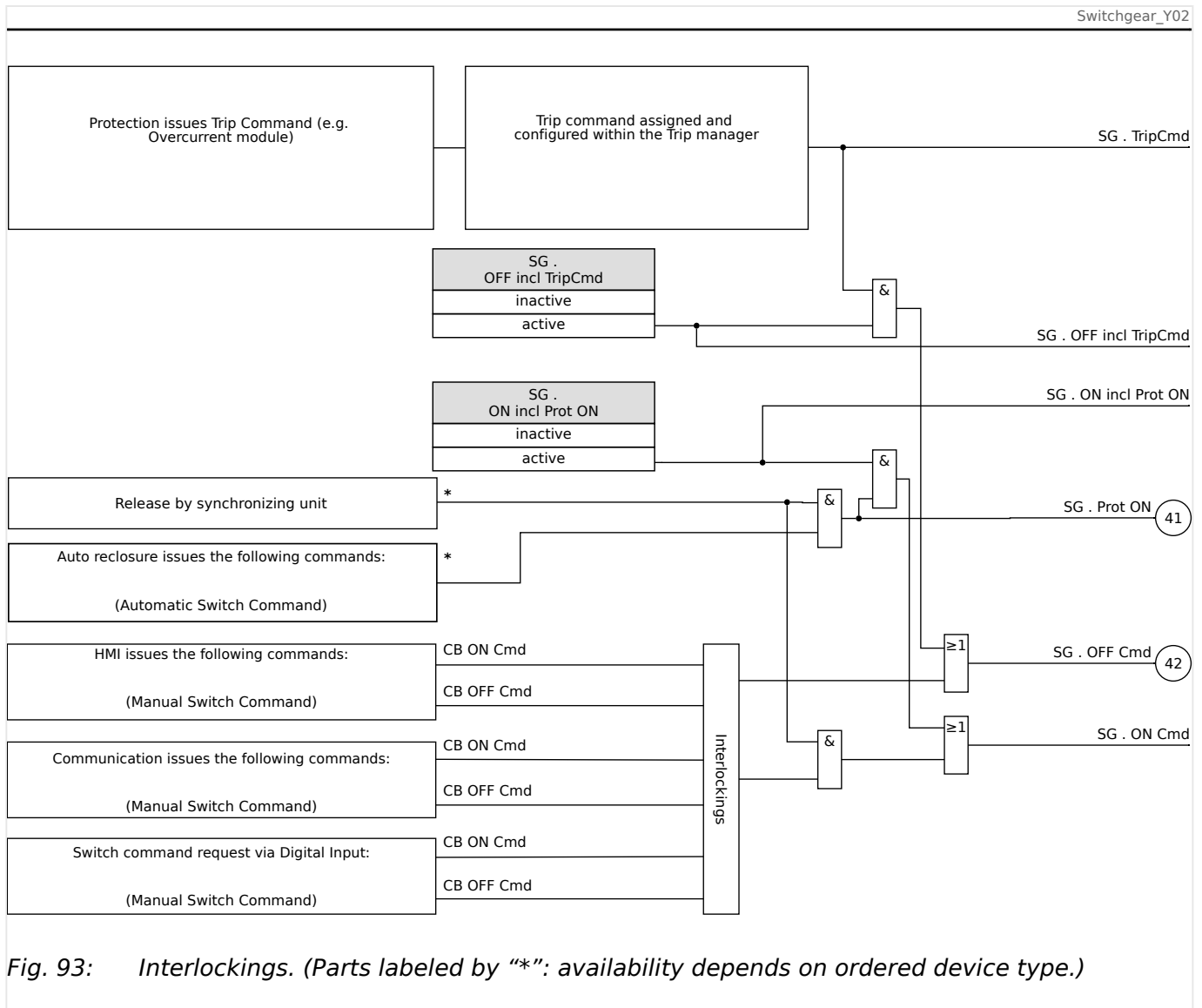

Trip Manager - Assignment of commands

The trip commands of the protection elements have to be assigned to those switchgear, that are make/break capable (Breaker). For every make/break capable switchgear a Trip Manager is provided.

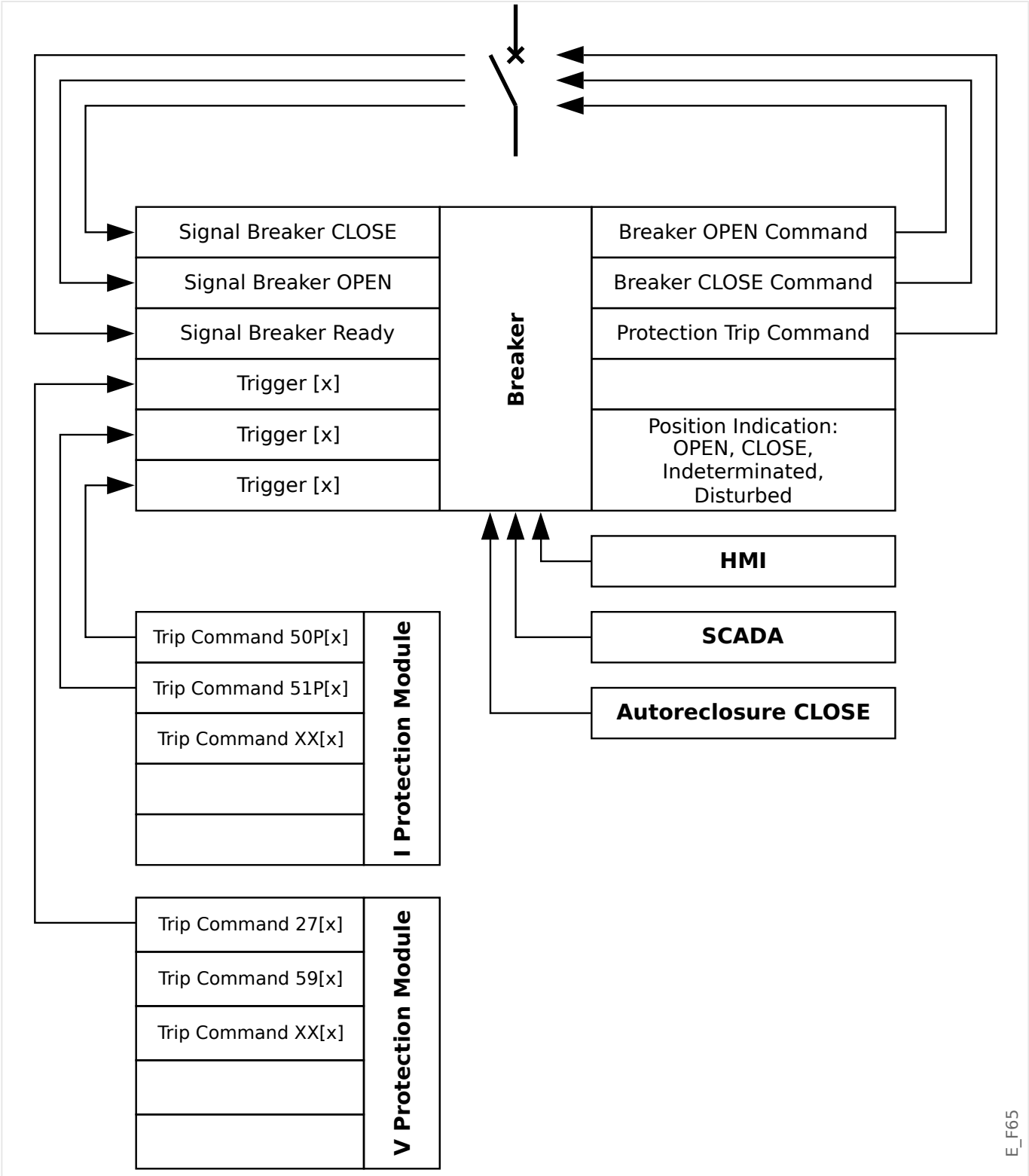

E_F65

In the menu [Control / Qxx / Trip Manager] (where “Qxx” corresponds to the designation of the switchgear, as it is defined in the single-line diagram), there are setting parameters »Off Cmd n«, to which you can assign the protection trip commands. In this so-called Trip Manger, all these assigned protection trip commands are combined by an “OR” logic, which then cause a switchgear trip command to be issued.

Only the switchgear trip command, that is issued by the Trip Manager, is actually sent to the switchgear. This means, that only tripping commands which are assigned in the Trip Manager lead to an operation of the switchgear.

In addition to that, the user can set the minimum hold time of the trip command within this module and define whether the trip command is latched or not (see also section „Latching“ below, [↪](#) “Latching”).

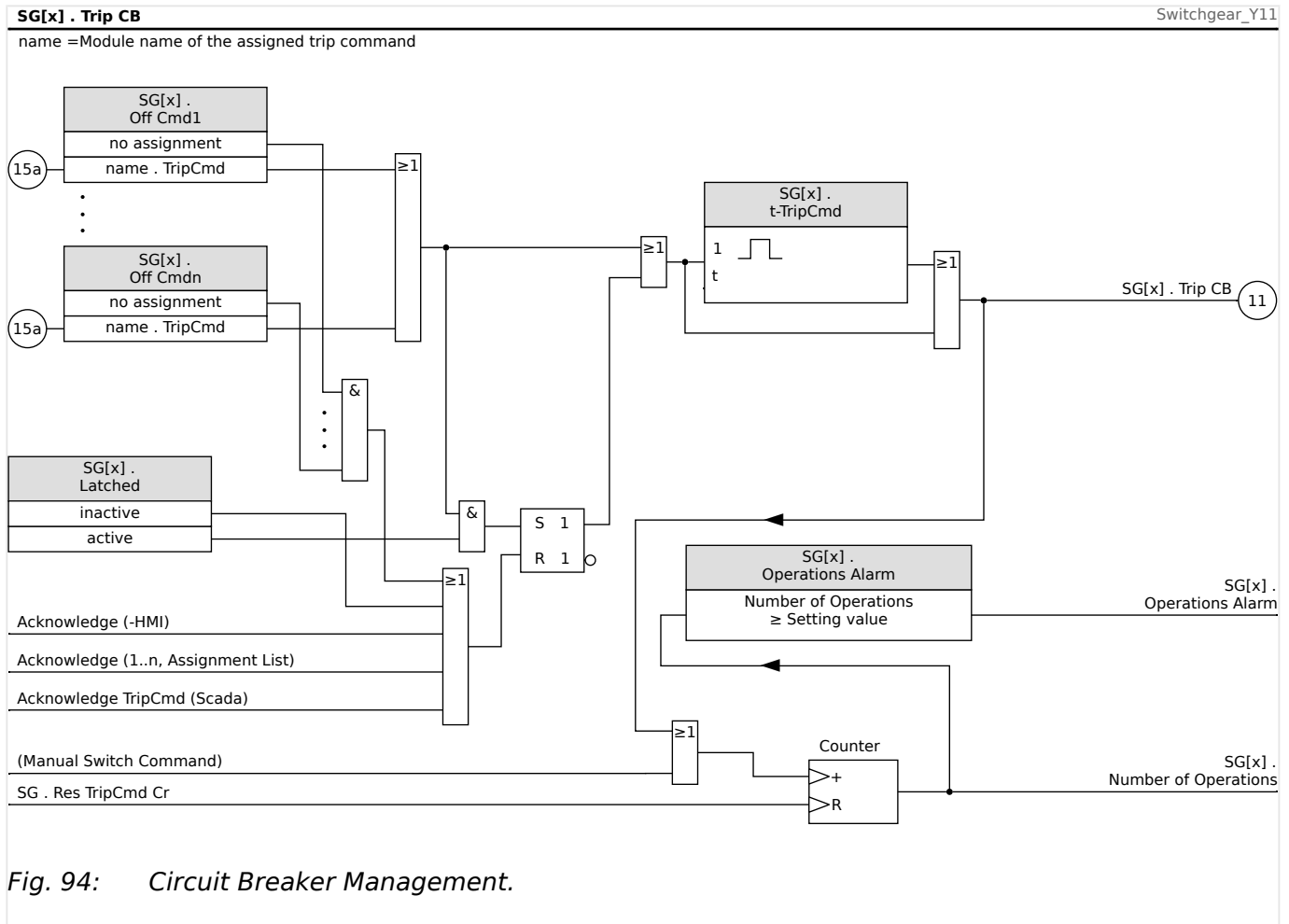

Fig. 94: Circuit Breaker Management.

Note that in the diagram above, “SG[x]” represents “switchgear number x”; however, the exact designation is defined in the single-line file, see also [↪](#) “Single-Line Diagram”.

Latching

If a tripping command is configured as »Latched« = “active”, it will stay active until it is acknowledged (see “Acknowledgment” chapter, [↪](#) “1.5 Acknowledgments”).

A latched tripping command gets reset only in any of the following cases and only after all assigned trip commands of the protection elements have dropped out:

- It is acknowledged (either by the user at the HMI, or via SCADA), see [↪](#) “1.5 Acknowledgments”.
- It is reset (acknowledged) by the signal that has been assigned to the parameter »Ack TripCmd«.
- It is re-configured to »Latched« = “inactive”.
- If no protection trip command at all is assigned, i. e. **all** »Off Cmd n« have been set to “-”.

Ex CLOSE / OPEN

If it is required that the switchgear be opened or closed by an external signal, the user can assign one signal that triggers the CLOSE and one signal that triggers the OPEN command (e. g. digital inputs or output signals of the Logics).

The external CLOSE signal can be assigned to [Control / SG / SG[x] / Ex ON/OFF Cmd] »SCmd ON«.

The external OPEN signal can be assigned to [Control / SG / SG[x] / Ex ON/OFF Cmd] »SCmd OFF«.

An OPEN command has priority. CLOSE commands are slope-oriented, OPEN commands are level-oriented.

Switching via SCADA

Switching via SCADA commands is possible if [Control / General Settings] »Switching Authority« is set to either "Remote" or to "Local and Remote". (See also [↳ "Switching Authority"](#).)

For the example of switching via the IEC 60870-5-104 protocol, see [↳ "IEC Commands"](#). The principle is essentially the same for other protocols that support SCADA commands.

Switching Authority

The Switching Authority defines the types of switching commands that are allowed to be executed. It does not have any influence on trippings triggered by protection functions.

For the setting of the Switching Authority [Control / General Settings] »Switching Authority«, the following choices are possible:

- "None": Switching operations are blocked. (Note that protection tripping are still possible.)
- "Local": Switching operations only via push buttons at the panel.
- "Remote": Switching operations via SCADA, digital inputs, or internal signals.
- "Local and Remote": Switching operations via push buttons, SCADA, digital inputs, or internal signals.

Non-Interlocked Switching

For test purposes, during commissioning and temporarily operations, interlockings can be disabled.

WARNING!



Non-interlocked switching can lead to serious injuries or death!

For non-interlocked switching the setting [Control / General Settings] »Res NonIL« provides the following options:

- "single Operation": Non-interlocked switching for one single command
- "permanent": Permanent

- “timeout”: Non interlocked switching for a certain time

The set time for non-interlocked switching is set at the parameter »*Timeout NonIL*« and applies also for the “single Operation” mode.

Non-interlocked switching can also be activated by assigning a signal to »*Timeout NonIL*«.

Manual Manipulation of the Switchgear Position

In case of faulty position indication contacts (Aux contacts) or broken wires, the position indication resulted from the assigned signals can be manipulated (overwritten) manually, to keep the ability to switch the affected switchgear.

This is available at [Control / SG / SG[x] / General Settings] »*Manipulate Position*«.

A manipulated switchgear position is indicated on the display by an exclamation mark “!” besides the switchgear symbol.

WARNING!



Manipulation of the Switchgear Position can lead to serious injuries or death!

Double Operation Locking

All control commands to any switchgear in a bay have to be processed sequentially. During a running control command no other command will be handled.

Switch Direction Control

Switching commands are validated before execution. When the switchgear is already in the desired position, the switch command will not be issued again. (An opened circuit breaker cannot be opened again.) This also applies for switching command at the HMI or via SCADA.

Anti-Pumping

By pressing the CLOSE command Softkey only a single switching CLOSE impulse is sent, regardless how long the Softkey is pressed. The switchgear executes the close command only once.

5.3 Switchgear Wear

Switchgear Wear Features

The MRDT4 maintains various statistical values related to each switchgear.

- The number of switching operations is available at [Operation / Count and RevData / Control / SG[x]] »*TripCmd Cr*«.

At [Control / SG[x] / SG Wear] »*Operations Alarm*«, the user can set a limit for the maximum number of switching operations. If this limit is exceeded a related alarm signal is set at [Operation / Status Display / Control / SG[x]] »*Operations Alarm*«.

- The sum of the accumulated interrupted currents is available at [Operation / Count and RevData / Control / SG[x]] »*Sum trip IL1*«, ..., »*Sum trip IL3*«.

At [Control / SG[x] / SG Wear] »Isum Intr Alarm«, the user can set a threshold for the maximum allowed sum of interrupt currents. If this threshold is exceeded a related alarm signal is set at [Operation / Status Display / Control / SG[x]] »Isum Intr trip«, plus the respective phase-selective signals »Isum Intr trip: lxx«.

- The MRDT4 continuously maintains the “open capacity” at [Operation / Count and RevData / Control / SG[x]] »CB OPEN capacity« (as a percentage value). If it reaches 100% maintenance of the switchgear is mandatory.
- The signal [Operation / Status Display / Control / SG[x]] »SGwear Slow SG« reports that the switchgear has become slower. (See also [↳ “Slow Switchgear Alarm”](#).) This might indicate a malfunction at an early stage.
- The user can define a switchgear-specific wear curve, see below ([↳ “Switchgear Wear Curve”](#)). Based on this curve the MRDT4 sets an alarm signal at [Operation / Status Display / Control / SG[x]] »WearLevel Alarm«.
- The MRDT4 maintains the frequency of CLOSE/OPEN cycles: At [Control / SG[x] / SG Wear] »Isum Intr ph Alm«, the user can set a threshold for the maximum allowed sum of interrupt currents per hour. If this threshold is exceeded a related alarm signal is set at [Operation / Status Display / Control / SG[x]] »Isum Intr ph Alm«. By means of this alarm, excessive switchgear operations can be detected at an early stage.

Slow Switchgear Alarm

An increase of the close or opening time of the switchgear is an indication for the maintenance need. If the measured time exceeds the time »t-Move OFF« or »t-Move ON«, the signal [Operation / Status Display / Control / SG[x]] »SGwear Slow SG« is activated.

Switchgear Wear Curve

In order to keep the switchgear in good working condition, the switchgear needs to be monitored. The switchgear health (operation life) depends above all on:

- The number of CLOSE/OPEN cycles.
- The amplitudes of the interrupting currents.
- The frequency that the switchgear operates (Operations per hour).

The user has to maintain the switchgear accordingly to the maintenance schedule that is to be provided by the manufacturer (switchgear operation statistics). By means of up to ten points that the user can replicate the switchgear wear curve within menu [Control / SG / SG[x] / SG Wear]. Each point has two settings: the interrupt current in kilo amperes and the allowed operation counts. No matter how many points are used, the operation counts the last point as zero. The protective relay will interpolate the allowed operations based on the switchgear wear curve. When the interrupted current is greater than the interrupt current at the last point, the protective relay will assume zero operation counts.

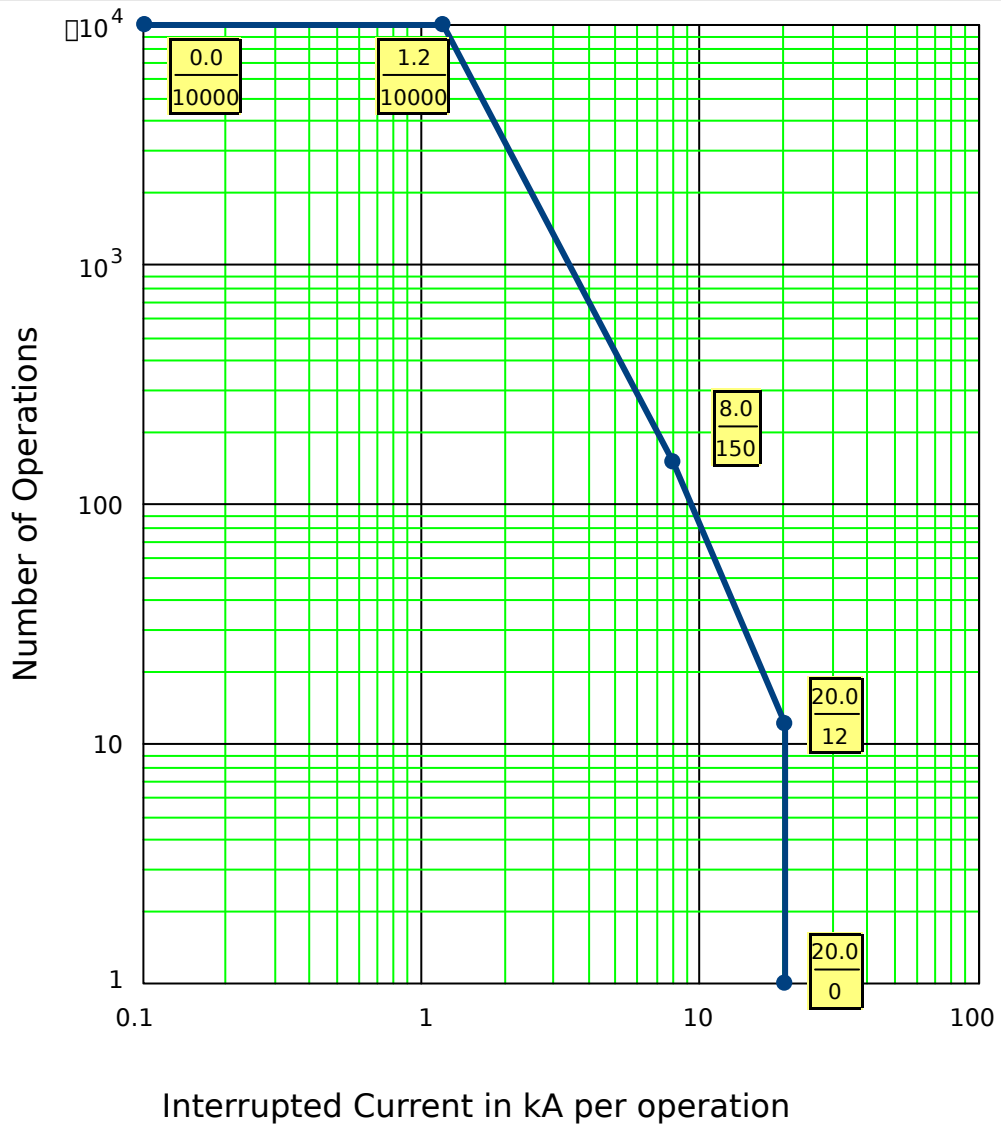

E_F67

Fig. 95: Breaker Maintenance Curve for a typical 25kV Circuit Breaker

5.4 Control - Example: Switching of a Circuit Breaker

The following example shows how to switch a circuit breaker via the HMI at the device.

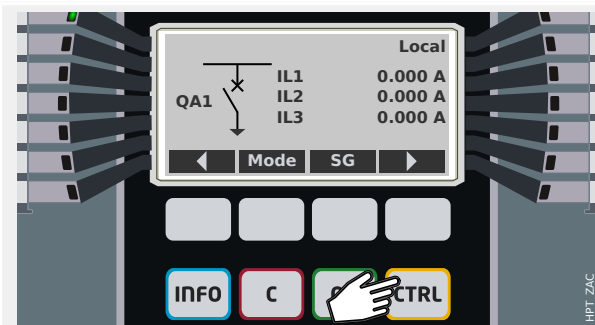

By pressing the »CTRL« key you enter a screen showing the single line, and you have direct access to related measuring values and control functions.

Remark: The switchgear name »QA1« is only an example; the available set of switchgear devices and their designations are dependent on your particular application.

A switching operation can be executed if the switching authority (which is displayed in the top right corner) is set to either "Local" or "Local and Remote".

Remark: Note that this single line screen as well as the two Softkeys "General Settings" and "SG" are also accessible via the main menu:

- The menu path [Control / Control Page] gives access to this single line page.
- The menu path [Control / General Settings] accesses the same menu branch as the Softkey "Mode".
- The menu path [Control / SG] accesses the same menu branch as the Softkey "SG".

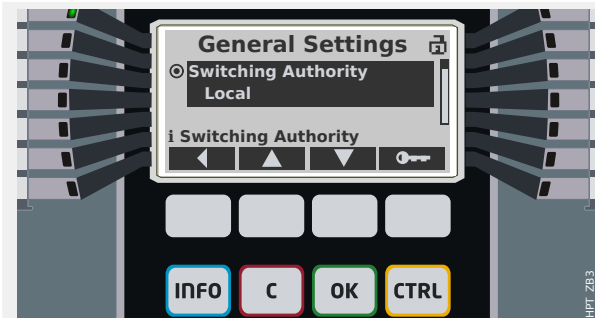

The Softkey "Mode" takes you to the menu branch [Control / General Settings].

There you can do several switchgear-related settings, in particular (re-)define the switching authority.

For the »Switching Authority« setting the following options are available:

- "None": No control function.
- "Local": Control only via the buttons at the panel (HMI).
- "Remote": Control only via SCADA, digital inputs or internal signals.
- "Local and Remote": Control via HMI buttons, SCADA, digital inputs, or internal signals.

As already said, the setting has to be either "Local" or "Local and Remote" for this example.



The Softkey “SG” takes you to a screen that lists all connected switchgear devices.

(For HighPROTEC devices of type »MC...«, up to 6 switchgear devices are supported. A device of type »MR...« can control one switchgear device.)

After selecting a switchgear device, the Softkey “►” (Enter) takes you to the menu that is dedicated to the selected switchgear device. There you can make various settings, e. g. control times, position indicators, external ON/OFF commands, interlockings.

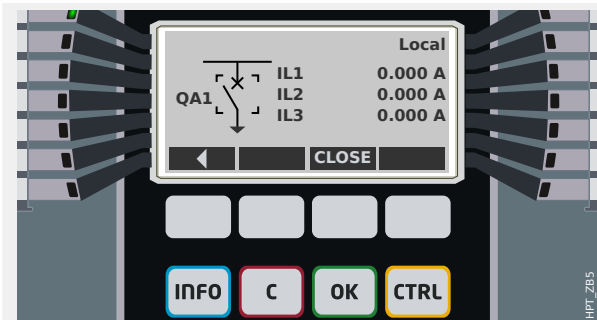

The Softkey “►” (Enter) takes you to an enhanced single line (after you have entered the password for access level “Control-Lv1”). The switchgear device is highlighted by small markers (and in case of several implemented switchgear devices, the Softkey “Select” is visible, which allows you to select another one).

If the switching authority permits local switching there are Softkeys “OPEN” and “CLOSE” which allow for executing a switching operation. (Note that usually, i. e. with correct position status indication from the switchgear device, only one of these two Softkeys is visible: If, for instance, a particular switchgear device is already open, only the “CLOSE” is visible.)

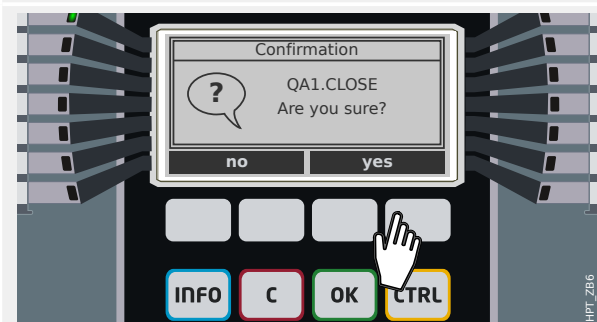

After pressing the “CLOSE” Softkey you get a confirmation dialog, which prevents unintended switching operations.

After pressing “yes” the switching operation is actually executed.

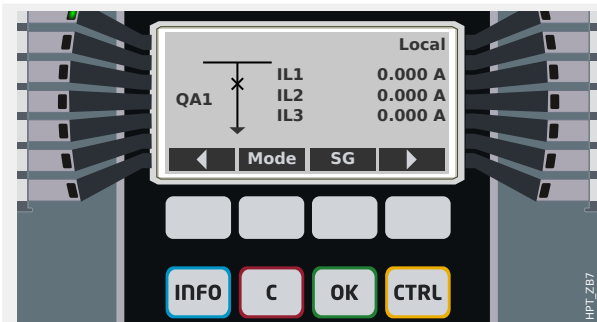

The new position of the switchgear device is shown on the display (as soon as it has been reached according to the feedback of the position indication, or after the configured switching time has elapsed).

Moreover, the functionality of the Softkeys changes so that the new permitted switching operations are available.

6 System Alarms

After activation (via [Device planning] »SysA . Mode« = “use”) the user can configure within the System Alarms menu [SysA]:

- General Settings (activate/inactivate the Demand Management, optional assign a signal, that will block the Demand Management);
- Average Values (↳ “6.1 Demand Management”)
 - Demand Management (Current),
- Maximum (Peak) Values (↳ “6.2 Min. and Max. Values”)
- Total Harmonic Distortion (THD Protection).

Please note that all thresholds are to be set as primary values.

6.1 Demand Management

Demand Management

Demand is the average of system current or power over a time interval (window). Demand management supports the user to keep energy demand below target values bound by contract (with the energy supplier). If the contractual target values are exceeded, extra charges are to be paid to the energy supplier.

Therefore, demand management helps the user detect and avoid averaged peak loads that are taken into account for the billing. In order to reduce the demand charge respective to demand rate, peak loads, if possible, should be diversified. That means, if possible, avoiding large loads at the same time. In order to assist the user in analyzing the demand, demand management might inform the user by an alarm. The user might also use demand alarms and assign them on relays in order to perform load shedding (where applicable).

Demand management comprises:

- Current Demand.

Within the menu [Operation / Statistics / Demand], the actual average (demand) values can be seen. (See also ↳ “1.7 Statistics”.)

Configuring the Demand

Configuring the demand is a two step procedure. Proceed as follows.

Step1: Configure the general settings within the [Device Para / Statistics / Demand] menu:

- Set the trigger source to »Duration«.
- Select a time base for the »window«.
- Determine if the window is »fixed« or »sliding«.
- If applicable assign a reset signal.

The interval time (window) can be set to fixed or sliding.

Example for a fixed window: If the range is set for 15 minutes, the protective device calculates the average current or power over the past 15 minutes and updates the value every 15 minutes.

Example for a sliding window: If the sliding window is selected and the interval is set to 15 minutes, the protective device calculates and updates the average current or power continuously, for the past 15 minutes (the newest measuring value replaces the oldest measuring value continuously).

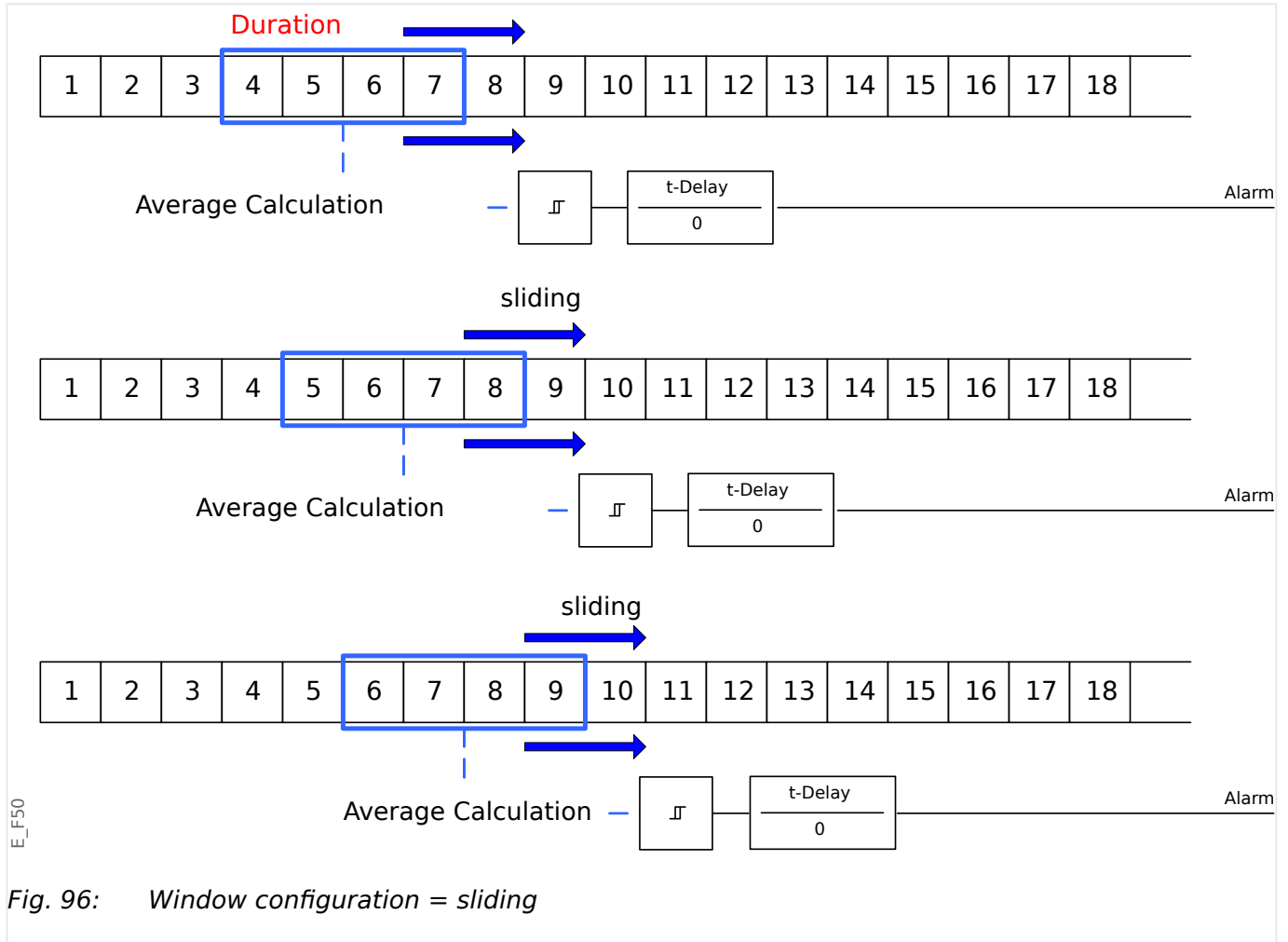

Fig. 96: Window configuration = sliding

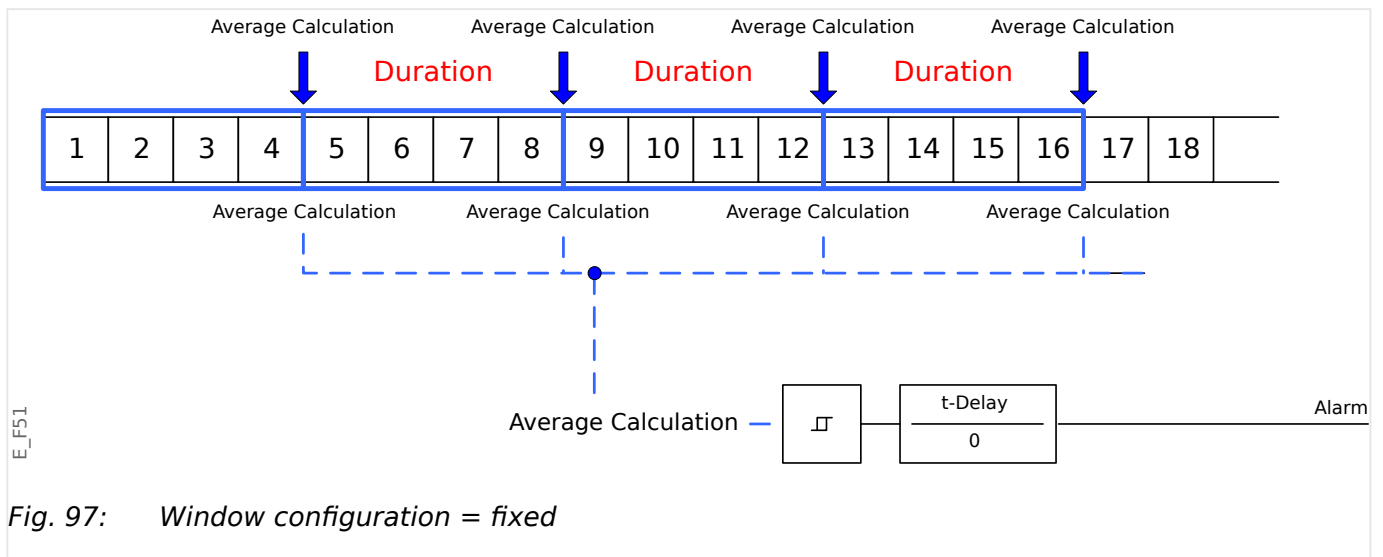

Fig. 97: Window configuration = fixed

Step 2:

- In addition, the Demand specific settings have to be configured in the [SysA] menu.
- Determine if the demand should generate an alarm or if it should run in the silent mode (»Alarm« = “active” or “inactive”).
- Set the threshold (»Threshold«).
- Where applicable, set a delay time (»t-Delay«) for the alarm.

6.2 Min. and Max. Values

The protective device saves the peak demand values for current and power. The quantities represent the largest demand value since the demand values were last reset. Peak demands for current and system power are date and time stamped.

Within the [Device Para / Statistics / Demand] menu, the current Demand and Peak demand values can be seen.

Min. and Max. Values

Within [Operation] menu the minimum (min.) and maximum (max.) values can be seen. (See also  “1.7 Statistics”.)

Minimum values since last reset: The minimum values are continuously compared to the last minimum value for that measuring value. If the new value is less than the last minimum, the value is updated. Within the [Device Para / Statistics] menu, a reset signal can be assigned.

Maximum values since last reset: The maximum values are continuously compared to the last maximum value for that measuring value. If the new value is greater than the last maximum, the value is updated. Within the [Device Para / Statistics] menu, a reset signal can be assigned.

6.3 THD Protection

In order to supervise power quality, the protective device can monitor the voltage (phase-to-phase) and current THDs.

Within the [SysA / THD] menu:

- Determine if an alarm is to be issued or not (»Alarm« = “active” or “inactive”);
- Set the threshold (»Threshold«); and
- Where applicable, set a delay time for the alarm (»t-Delay«).

7 Recorders

The MRDT4 features several Recorders that collect log messages of particular types (in some non-volatile memory):

- The [Self-Supervision Messages](#) (↪ “9.2 Self-Supervision Messages”) collects device-internal messages of various types. These can be, for example, security-related events (e. g. if a wrong password has been entered), or Troubleshooting messages that are directly related to the functionality of the device.

The entries can be accessed at the menu branch [Operation / Self-Supervision / Messages].

- The [Disturbance Recorder](#) (↪ “7.1 Disturbance Recorder”) adds a new entry with each new disturbance event (that is configured as a trigger signal).

The entries can be accessed at the menu branch [Operation / Recorders / Disturb rec].

Moreover, a double-click on any entry within the Disturbance Recorder window in Smart view enables the user to save the data of this entry in an *.HptDr file that can be opened in the *DataVisualizer* PC software for graphical analysis.

- The [Fault Recorder](#) (↪ “7.2 Fault Recorder”) collects information about faults (e. g. Trip Causes).

The entries can be accessed at the menu branch [Operation / Recorders / Fault rec].

- The [Event Recorder](#) (↪ “7.3 Event Recorder”) collects status changes of binary states and counters of the various MRDT4 modules, so that the user can get an overview of what has happened recently.

The entries can be accessed at the menu branch [Operation / Recorders / Event rec].

- The [Trend Recorder](#) (↪ “7.4 Trend Recorder”) records analog measurement values over time.

A summary (timestamp, number of entries) can be accessed at the menu branch [Operation / Recorders / Trend rec].

Moreover, a double-click on this summary within the Trend Recorder window in Smart view enables the user to save all data in an *.HptTr file that can be opened in the *DataVisualizer* PC software for graphical analysis.

7.1 Disturbance Recorder

- Disturbance records can be downloaded (read out) by means of the parameter setting and evaluation software *Smart view*.
- The disturbance records can be viewed and analyzed within the *DataVisualizer*. (This is a tool that is always installed along with *Smart view*).
- Disturbance records can be converted into the COMTRADE file format by means of the *DataVisualizer*.

The disturbance recorder works with 32 samples per cycle. The disturbance recorder can be triggered by any of eight configurable start signals. The disturbance record contains the measuring values including pre-trigger-time. By means of *Smart view / DataVisualizer* the oscillographic curves of the analog (current, voltage) and digital channels/traces can be shown and evaluated in a graphical form. The disturbance recorder has a storage capacity of 120 s. The disturbance recorder is able to record up to 15 s (adjustable) per record. The amount of records depends on the size of each record.

Read Out Disturbance Records

Within the menu [Operation / Recorders / Disturb rec] you can see the accumulated disturbance records.

NOTICE!



Within the Menu [Operation / Recorders / Man Trigger] you can trigger the disturbance recorder manually.

Deleting Disturbance Records at the Panel

Within the menu [Operation / Recorders / Disturb rec] you can:

- Delete disturbance records.
- Choose via »SOFTKEY« »up« and »SOFTKEY« »down« the disturbance record that is to be deleted.
- Call up the detailed view of the disturbance record via »SOFTKEY« »right«.
- Confirm by pressing »SOFTKEY« »delete«
- Enter your password followed by pressing the key »OK«
- Choose whether only the current of whether all disturbance records should be deleted.
- Confirm by pressing »SOFTKEY« »OK«

Configuring the Disturbance Recorder

The disturbance recorder can be configured in the menu [Device Para / Recorders / Disturb rec].

Configure the max. recording time of a disturbance event. This can be set via the parameter »Max file size«, the maximum value is 15 s (including pre-trigger and post-trigger time). The pre-trigger and post-trigger times of the disturbance recorder are set

(via parameters »Pre-trigger time« and »Post-trigger time«) in percent of the »Max file size« value.

To trigger the disturbance recorder, up to 8 signals can be selected. The trigger signals are OR-linked. If a disturbance record has been written, a new disturbance record cannot be triggered until all trigger signals that have triggered the previous disturbance record are gone.

NOTICE!



If tT is the duration of the trigger signal and $tMax = \text{»Max file size«}$, $tPre = (\text{»Pre-trigger time«} \cdot tMax)$, $tPost = (\text{»Post-trigger time«} \cdot tMax)$, then the resulting durations are as follows:

- The actual pre-trigger timer always equals $tPre$
- The disturbance event is recorded for the time tEv , which is: $tEv = \min(tT, (tMax - tPre))$
- The actual post-trigger timer $tRest$ is: $tRest = \min(tPost, (tMax - tPre - tEv))$

Obviously, it can happen that - depending on the actual duration of the trigger signal and the setting $tPre$ - that $tEv < tT$, i. e. that the disturbance event does not get recorded completely. The only way to mitigate this risk (besides setting a smaller value for $tPre$) is to configure a larger value for $tMax$. This, however, has the consequence that a smaller number of events can be held in memory.

In the same way it can happen that no more post-trigger time is left (i. e. $tRest = 0$). Note that the recording always gets stopped after the configured time $tMax = \text{»Max file size«}$ has elapsed.

Moreover, decide about the behavior of the disturbance recorder in case the storage capacity has been used up: Do you want it to automatically overwrite the oldest recordings (»Auto overwriting« = "active"), or do you want it to stop making any further recordings (»Auto overwriting« = "inactive") until the memory has been cleared manually.

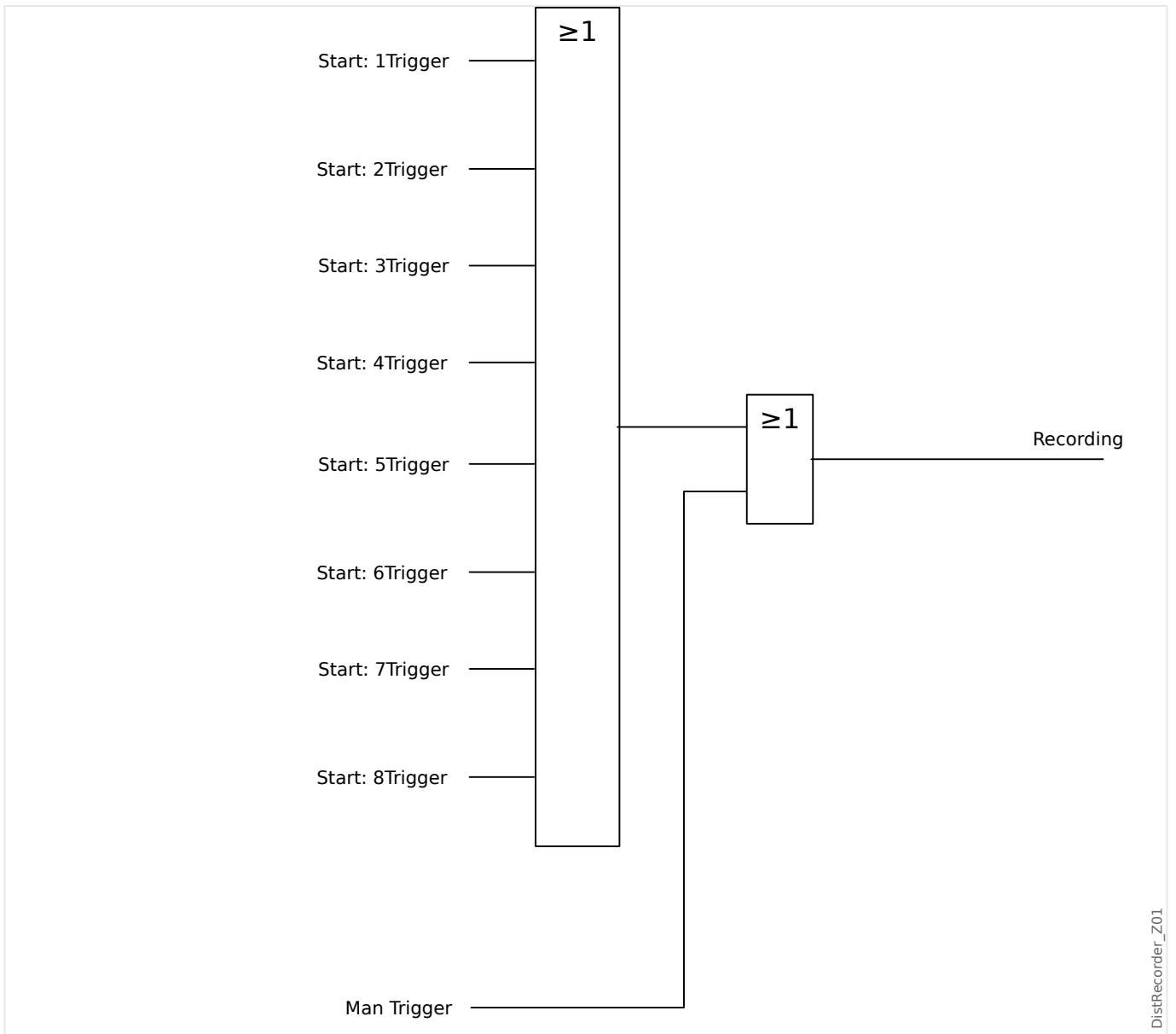

Start 1 = Prot.Alarm
 Start 2 = --
 Start 3 = --
 Start 4 = --
 Start 5 = --
 Start 6 = --
 Start 7 = --
 Start 8 = --
 Auto overwriting = active
 Post-trigger time = 25%
 Pre-trigger time = 15%
 Max file size = 2s

t-rec = Max file size

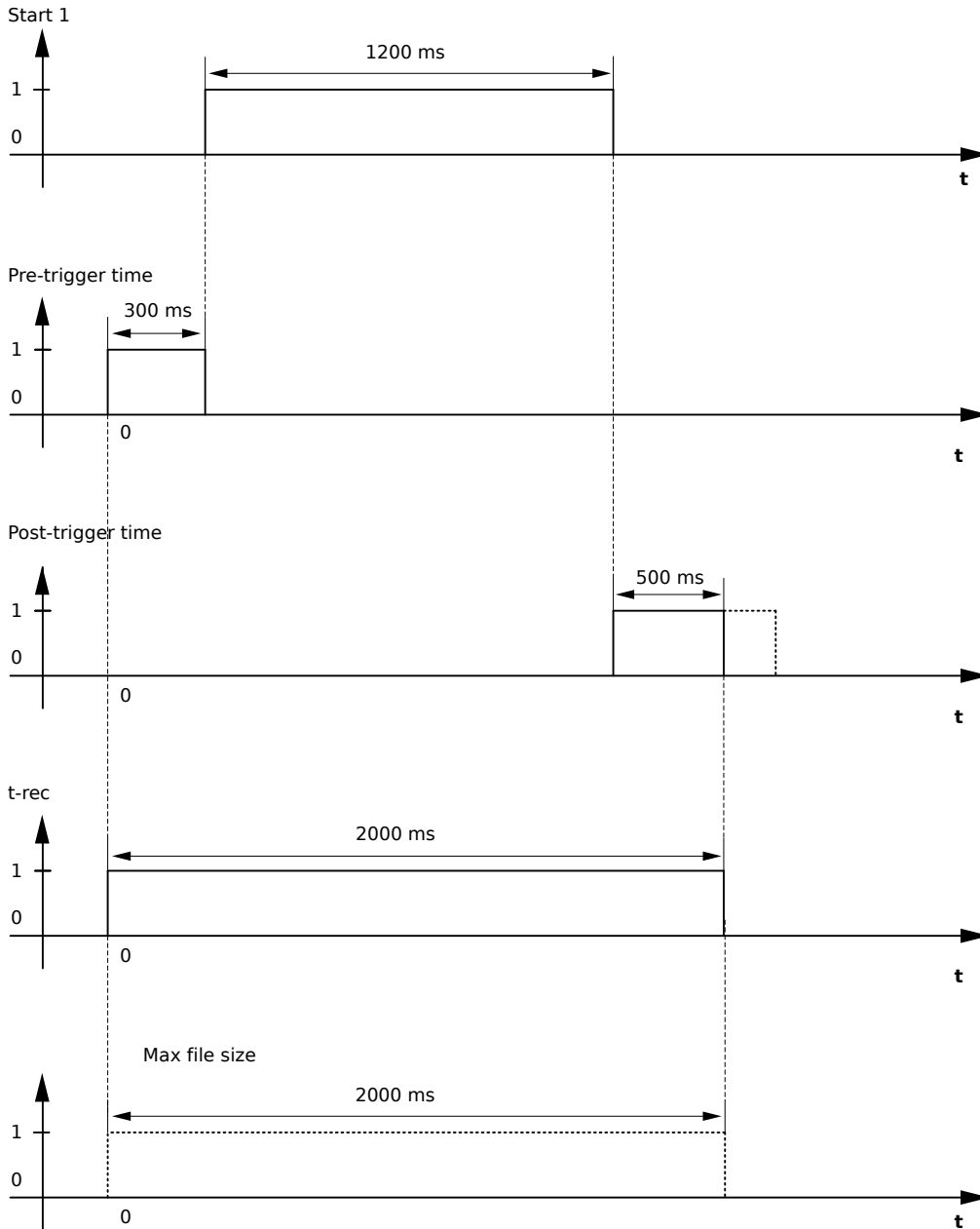

DistRecorder_Z02

Fig. 98: Example Disturbance Recorder Timing Chart I

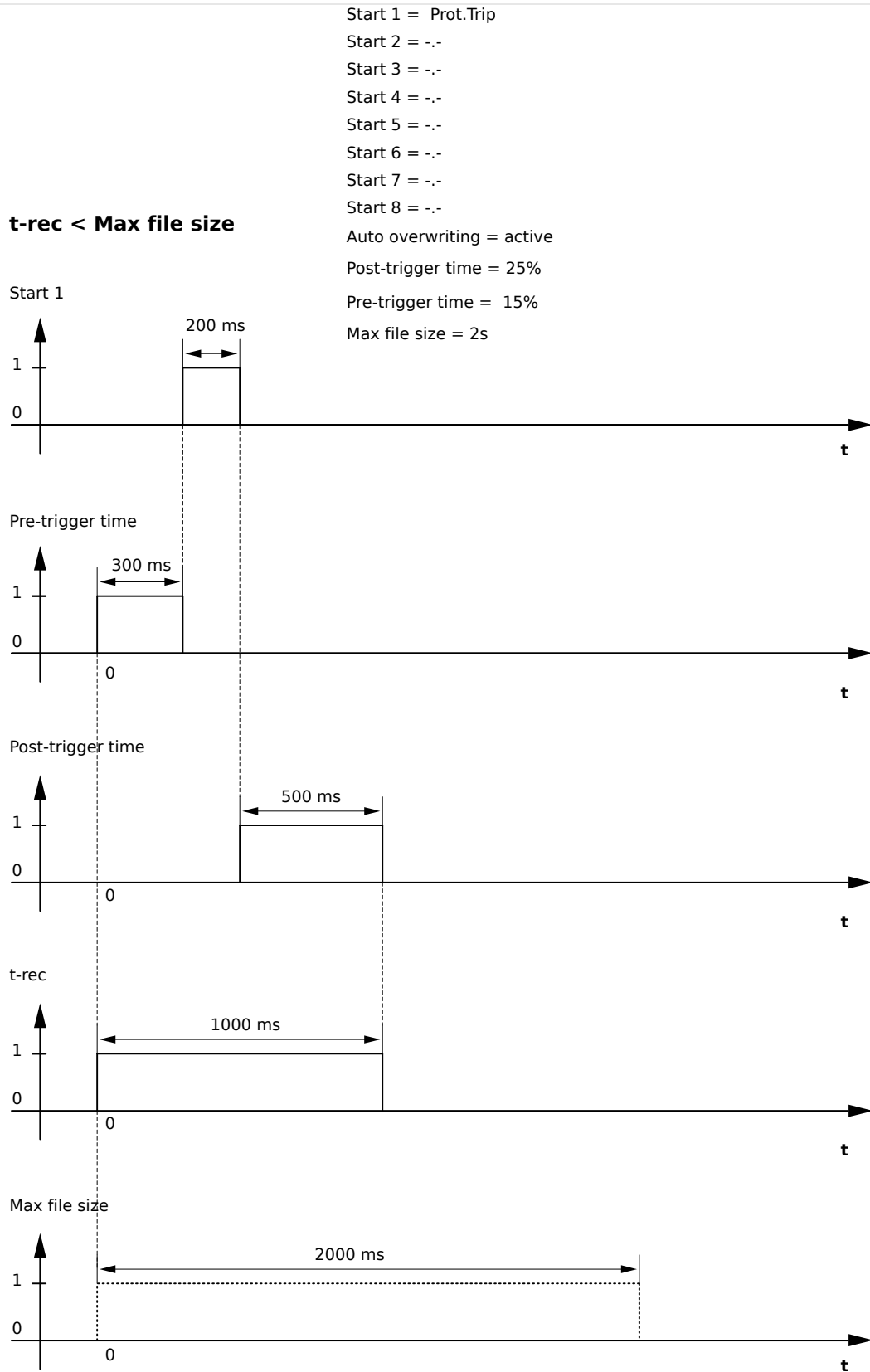

DistRecorder_Z03

Fig. 99: Example Disturbance Recorder Timing Chart II

7.2 Fault Recorder

Purpose of the Fault Recorder

The *Fault Recorder* provides compressed information about faults (e.g. Trip Causes). The compressed information can be read also at the HMI. This might be helpful for fast fault analysis. After a fault, a pop-up window will be sent onto the display in order to draw the user`s attention to the fault. The *Fault Recorder* will provide information on the causes of the fault. A detailed fault analysis (in oscillographic form) can be done by means of the Disturbance Recorder. The reference between the Fault Records and the corresponding Disturbance Records are the »Fault Number« and the »Grid Fault Number«.

Times and Durations

Time to Trip:	Time between <i>First Alarm</i> (»Prot . Alarm«) and <i>First Trip</i> (»Prot . Trip«) decision.
Fault Duration:	Time period from the rising edge of the General Pickup (»Prot . Alarm«) signal up to the falling edge of the General Pickup Signal. Please note that General Pickup is an or-connection (disjunction) of all Pickup signals. General Trip (»Prot . Trip«) is an OR-connection of all Trips.

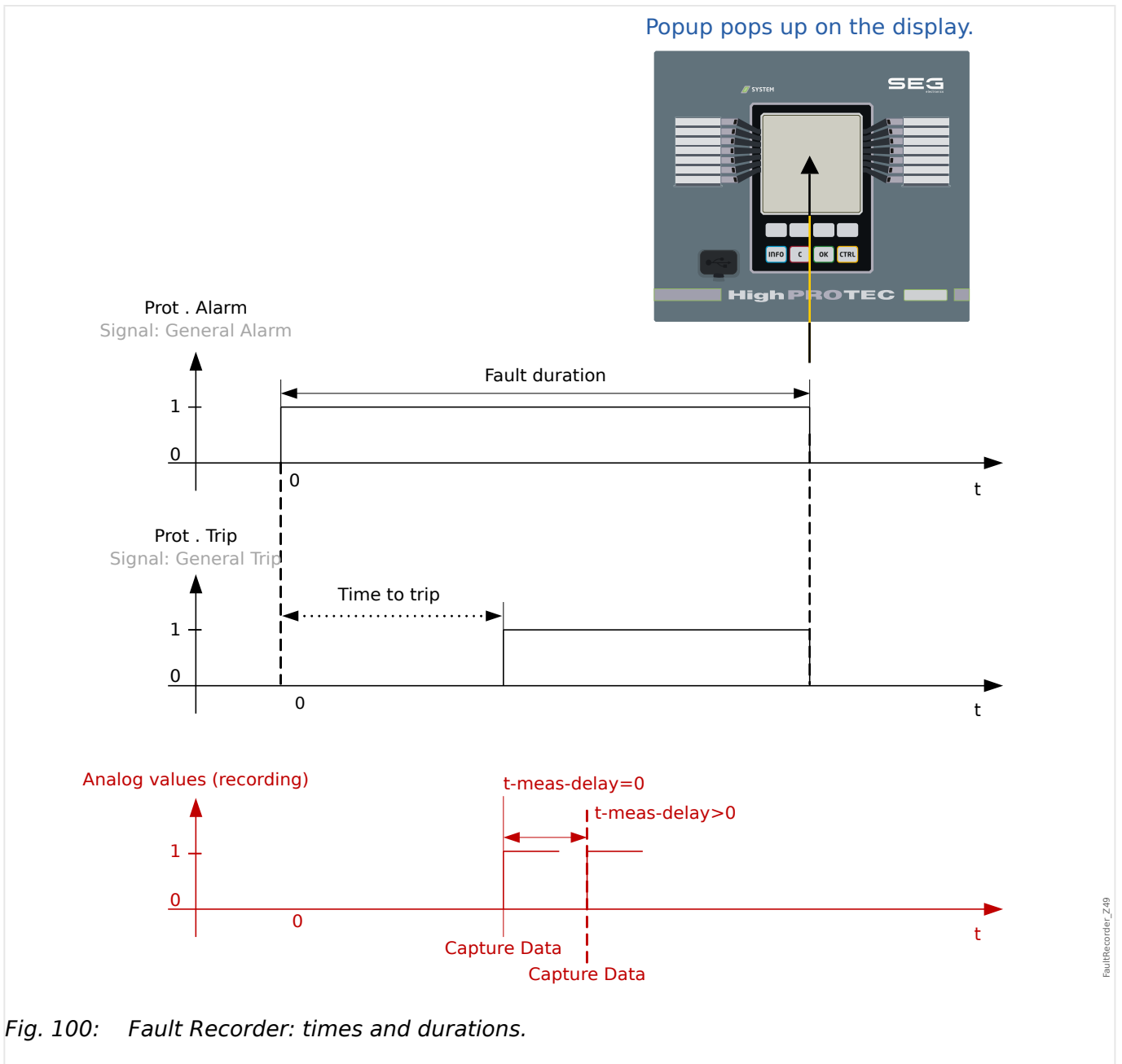

Behaviour of the Fault Recorder

Who triggers the Fault Recorder?

The *Fault Recorder* will be triggered by the rising edge of the »Prot. Alarm« (General Pickup) signal. Please note that »Prot. Alarm« (General Pickup) is an or-connection of all Pickup signals. The first Pickup will trigger the Fault recorder.

At which point of time will the fault measurements be captured?

The fault measurements will be captured (written) when the trip decision is taken. The point in time, when the measurements are captured (after a trip) can be delayed optionally by the parameter [Device Para / Recorders / Fault rec /] »Fault rec . t-meas-delay«. This might be reasonable in order to achieve more reliable measuring values (e.g. in order to avoid measuring disturbances caused by significant DC-components).

Modes

If it is required that a fault record be written even if a general alarm has not lead to a trip, the parameter [Device Para / Recorders / Fault rec /] »Fault rec . Record-Mode« has to be set to "Alarms and Trips".

Set parameter »Record-Mode« to "Trips only" if an Alarm that is not followed by a trip decision shall not lead to a trip.

When does the overlay (pop-up) appears on the display of the HMI?

A pop-up appears on the HMI display when the General Pickup (»Prot . Alarm«) disappears.

NOTICE!



No time to trip will be shown if the pickup signal that triggers the fault recorder is issued by another protection module than the trip signal. This might happen if more than one protection module is involved into a fault.

NOTICE!



Please note: The parameter settings (thresholds, etc.) that are shown in a fault record are not part of the fault record itself. They are always read out from the current device setting. If it may be the case that the parameter settings shown in a fault record were updated, they are indicated with an asterisk symbol within the fault record.

To prevent this please proceed as follows:

Save any fault record that should be archived to your local network/hard disk before doing any parameter change. Delete all the fault records in your fault recorder afterwards.

Memory

The last stored fault record is saved (fail-safe) within the *Fault Recorder* (the others are saved within a memory that depends on the auxiliary power of the protective relay). If there is no more memory free, the oldest record will be overwritten (FIFO). Up to 20 records can be stored.

How to close the overlay/pop-up?

By using Softkey »OK«.

How to find out fast, if a fault has lead to a trip or not?

Within the overview menu of the fault recorder, faults that have led to a trip are indicated by a flash "⚡" icon (on the right-hand side).

Which fault record pops up?

The newest fault.

Content of a Fault Record

A fault record comprises information about:

Part 1: Common Information (independent of protection function)

Date and Time	Date and Time of the Fault
---------------	----------------------------

Part 1: Common Information (independent of protection function)	
Fault No.	This counter will be incremented with each fault (»Prot . Alarm«)
No. of Grid Faults	This counter will also be incremented with each »Prot . Alarm« with exception of the AR (this applies only to devices that offer auto reclosing).
Act Set	The active parameter set
Fault duration	Time period from the rising edge of the General Pickup (»Prot . Alarm«) signal up to the falling edge of the General Pickup Signal. Please note that General Pickup is an or-connection (disjunction) of all Pickup signals. General Trip (»Prot . Trip«) is an OR-connection of all Trips.
Time to trip	The time between pickup and trip. Please note: No time to trip will be shown if the first pickup and the first trip are issued by different protection modules.
Pickup	Name of the module that picked up first.
Trip	Name of the module that tripped first.
Active AdaptSet	In case that adaptive sets are used, the number of the active set will be displayed.

Part 2: Information specific to the protection function that detected the fault	
e. g. Fault type	<p>The bits of information given in this part depend on the protection module.</p> <p>For example, in case of phase-selective protection functions, there is also data about the single phases.</p>

Part 3: Information depending on the protection device	
Measured Values	<p>Various measuring values at the time of tripping (or delayed depending on parameter setting) will be displayed.</p> <p>The set of data depends on the measuring values that are available with the particular device.</p>

How to Navigate Within the Fault Recorder

Navigation within the Fault recorder	Softkey
Back to overview.	◀
Next (upper) item within this fault record.	▲
Previous fault record.	▶▶
Next (lower) item within this fault record.	▼

How to Read Out the Fault Recorder at the Panel

In order to read out a fault record there are two options available:

- Option 1: A Fault has popped up on the HMI (because a trip or pickup has occurred).
- Option 2: Call up the Fault recorder menu manually.

Option 1 (in case a fault record pops up on the display (overlay)):

- Analyze the fault record by using Softkeys “▲” and “▼”.
- Or close the Pop-up by using the Softkey OK.

Option 2:

- Enter the menu branch [Operation / Recorders / Fault rec].
- Select a fault record.
- Analyze the fault record by using Softkeys “▲” and “▼”.

7.3 Event Recorder

The event recorder can register up to 300 events and the last (minimum) 50 saved events are recorded fail-safe. The following information is provided for any of the events:

Events are logged as follows:

Record No.	Sequential Number
Fault No.	Number of the ongoing fault. This counter is incremented by each General Pickup (»Prot . Alarm«).
No. of grid faults	A grid fault No. can have several Fault Nos. This counter is incremented by each General Pickup. (Exception AR: This applies only to devices that offer auto-reclosing).
Date of Record	Time stamp
Module Name	What has changed?
State	Changed Value

There are three different classes of events:

- **Alternation of binary states are shown as:**
 - 0->1 if the signal changes physically from »0« to »1«.
 - 1->0 if the signal changes physically from »1« to »0«.
- **Counters increment is shown as:**
 - Old Counter state -> New Counter state (e.g. 3->4)
- **Alternation of multiple states are shown as:**
 - Old state -> New state (e.g. 0->2)

Read the Event Recorder

- Enter the menu branch [Operation / Recorders / Event rec].
- Select an event.

7.4 Trend Recorder

Read the Trend Recorder

The Trend Recorder saves measured data in their time development.

- Enter the menu branch [Operation / Recorders / Trend rec].
- On the panel you can see a summary (timestamp, number of entries).

Due to the technical restrictions of the LCD display it is not possible to see any details of the recorded data.

- Via Smart view, however, you can make a double-click on the entry with the summary. This allows you to download the analog data from the MRDT4 and save it to a file (with the filename extension *.HptTr).

Afterwards the *.HptTr file can be opened with the DataVisualizer. Please see the DataVisualizer manual for a detailed description.

Configuring the Trend Recorder

The Trend Recorder can be configured within [Device Para / Recorders / Trend rec] menu.

The time interval defines the distance between two measuring points.

Up to ten values can be selected for recording.

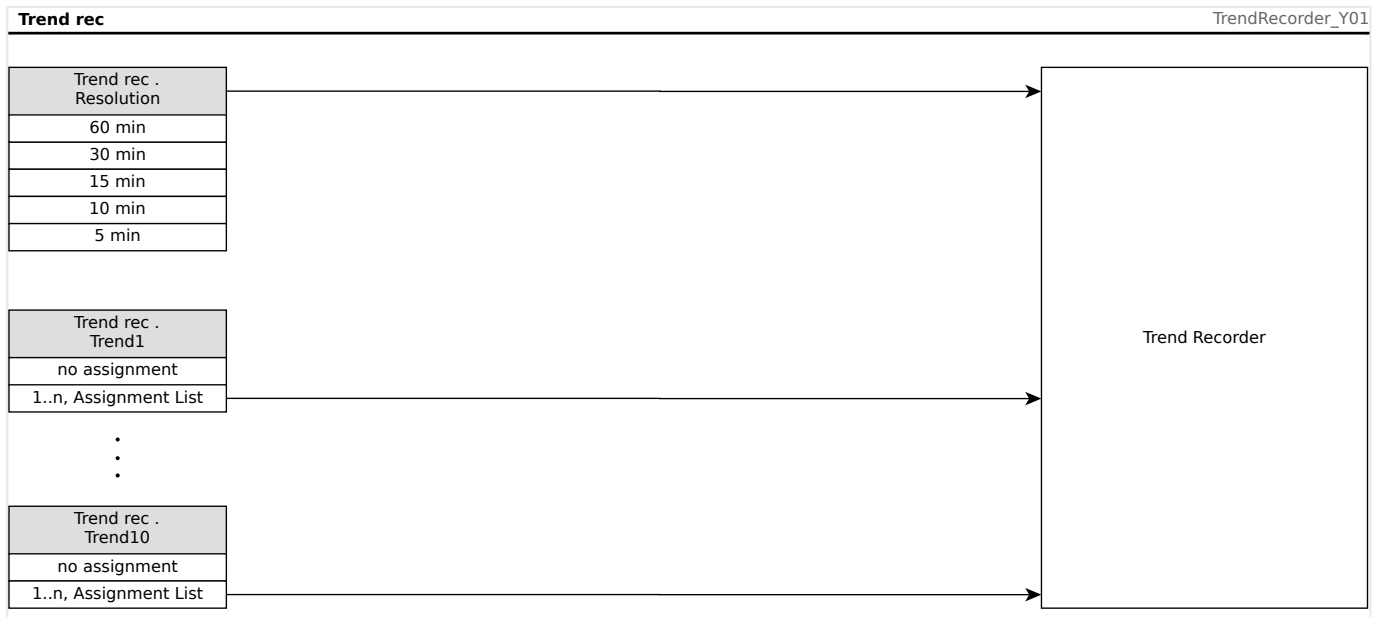

8 Programmable Logic

General Description

The MRDT4 includes programmable Logic Equations for programming output relays, blocking of protective functions and custom logic functions in the relay.

The logic provides control of the output relays based on the state of the inputs that can be chosen from the assignment list (protective function pickups, protective function states, breaker states, system alarms and module inputs - see [“1.3 Modules, Settings, Signals and Values”](#)).

The user can cascade logic equations, i. e. use the output signals of a logic equation as inputs of other equations.

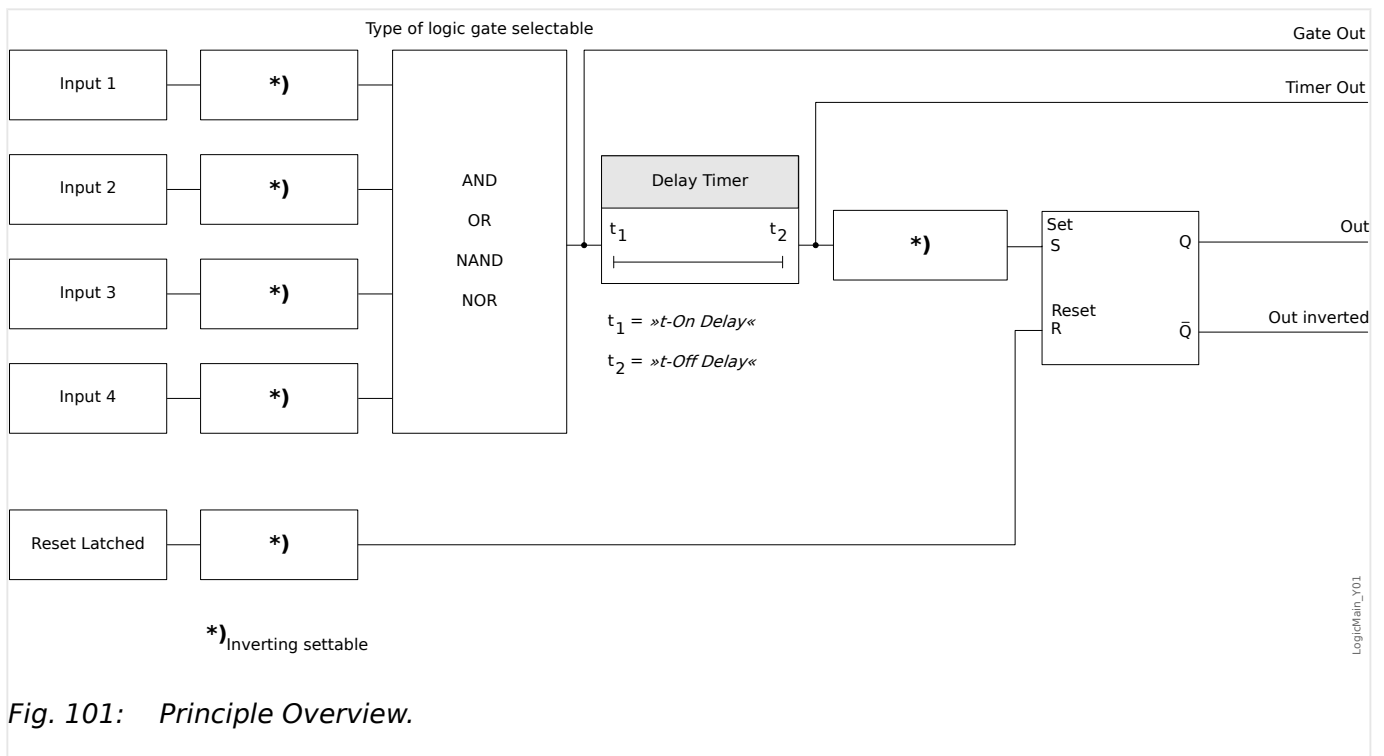

Fig. 101: Principle Overview.

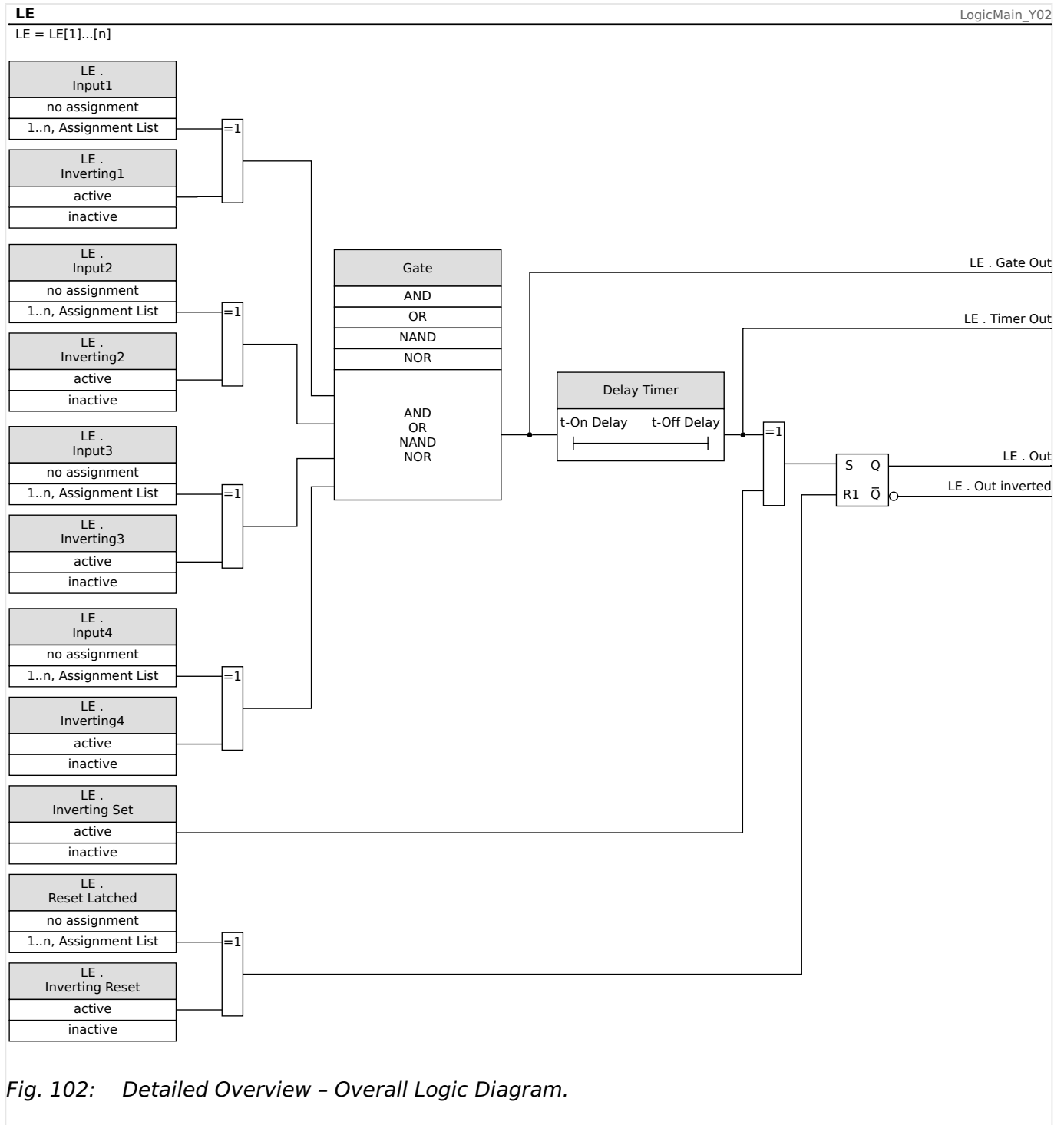

Fig. 102: Detailed Overview - Overall Logic Diagram.

Available Gates (Operators)

Within the Logic Equation, the following Gates can be used:

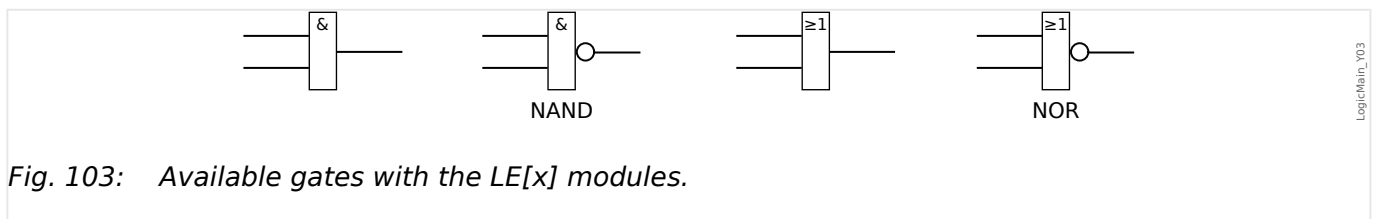

Fig. 103: Available gates with the LE[x] modules.

Input Signals

The user can assign up to 4 Input signals (from the assignment list) to the inputs of the gate.

As an option, each of the 4 input signals can be inverted (negated)

Timer Gate (On Delay and Off Delay)

The output of the gate can be delayed. The user has the option to set an On and an Off delay.

Latching

The logic equations issues two signals. An unlatched and a latched signal. The latched output is also available as an inverted output.

In order to reset the latched signal the user has to assign a reset signal from the assignment list. The reset signal can also optionally be inverted. The latching works based on reset priority. That means, the reset input is dominant.

Cascading Logical Outputs

The MRDT4 evaluates output states of the Logic Equations starting from Logic Equation 1 up to the Logic Equation with the highest number. This evaluation (device) cycle will be continuously repeated.



For time-critical processes this ascending evaluation order can be of interest, whenever the output of some logic equation (i. e. its evaluation result) is used as the input of some other logic equation. From a technical point of view, such a “cascading” of logic equations can be in ascending or descending sequence.

- **Ascending** sequence means that some output is fed into the input of a logic equation with **higher** number. For instance, diagram  Fig. 104 below shows an example where the result of Logic Equation LE1 is used as an input of Logic Equation LE2.

(Here: »LE2 . Input 1« = »LE1 . Out«)

- **Descending** sequence means that some output is fed into the input of a logic equation with **lower** number. For instance, diagram  Fig. 105 shows an example where the result of Logic Equation LE3 is used as an input of Logic Equation LE2.

(Here: »LE2 . Input 4« = »LE3 . Out«)

Both ascending and descending sequences may be used and combined one with the other, with no immediate difference. However, due to the evaluation of all equations in ascending order the actual run-time values that are fed in at the input of an equation will have a different “age”, as is shown in  Fig. 104 and  Fig. 105 below.

Cascading Logic Equations in an ascending sequence

Cascading in an ascending sequence means that the user uses the output signal of “Logic Equation **k**” as input of “Logic Equation **n**” with **k < n**.

Since the output states of all logic equations are evaluated in ascending order the output state of “Logic Equation **k**” (i. e. the input of “Logic Equation **n**”) and the output state of “Logic Equation **n**” are evaluated and updated within the same process cycle.

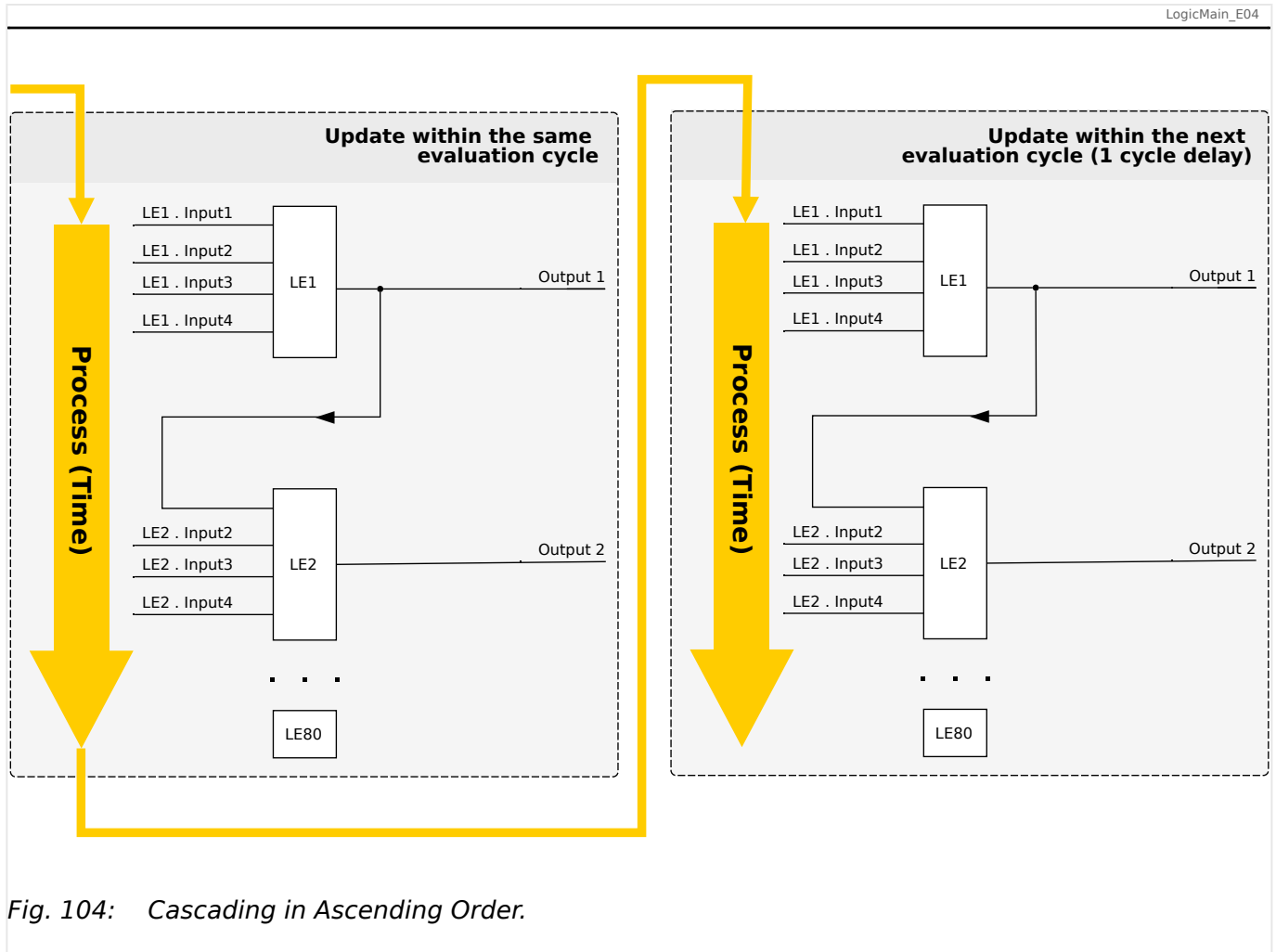

Fig. 104: Cascading in Ascending Order.

Cascading Logic Equations in a descending sequence

Cascading in a descending sequence means that the user uses the output signal of “Logic Equation **n**” as input of “Logic Equation **k**” with **n > k**.

But since the output states of all logic equations are evaluated in *ascending* order the evaluation of “Logic Equation **k**” uses the resulting output state of “Logic Equation **n**” of the previous process cycle.

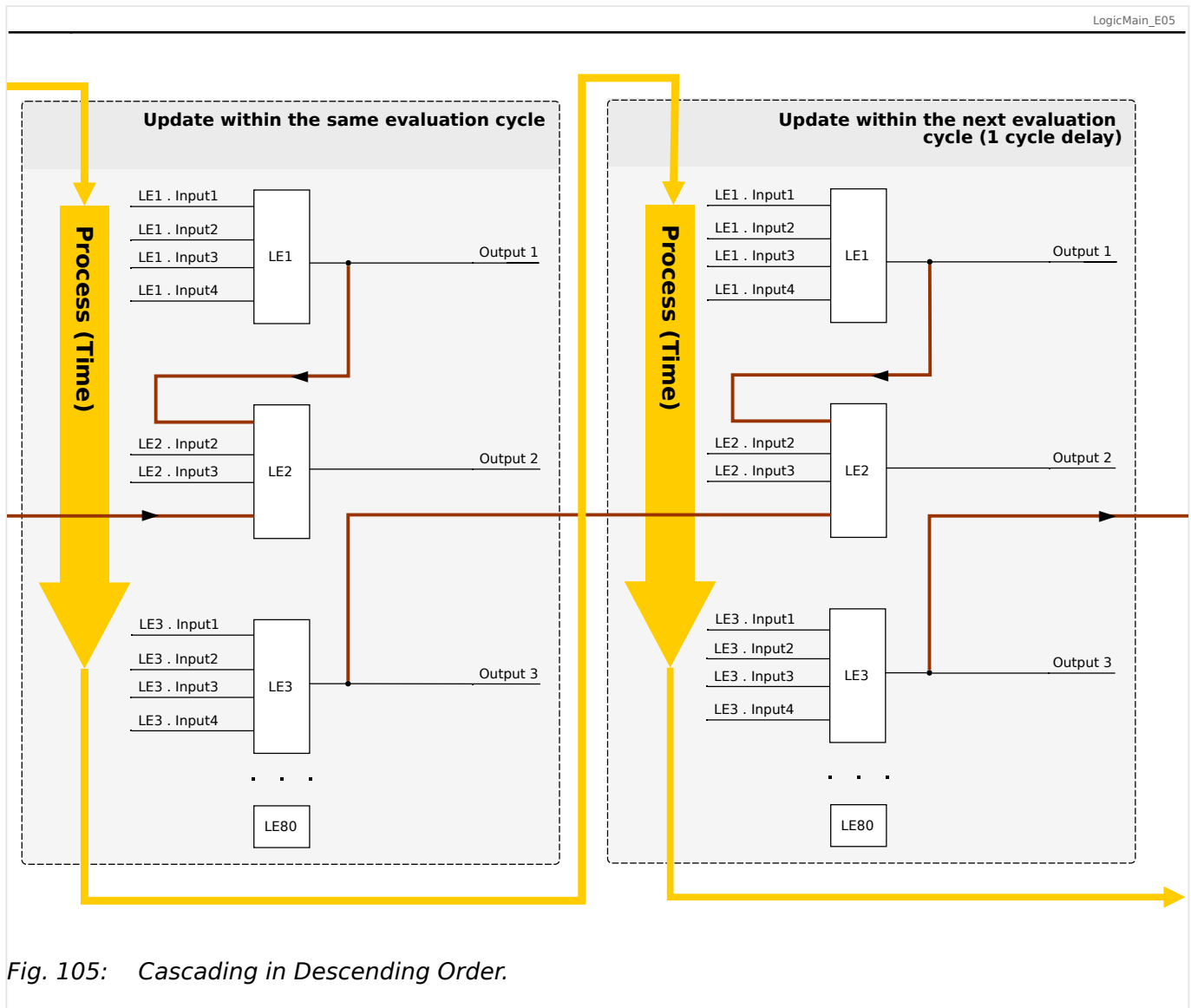

Fig. 105: Cascading in Descending Order.

In the example shown in [Fig. 105](#) above, “Logic Equation 2” uses the output states of two other equations, “Logic Equation 1” and “Logic Equation 3”. The result of “Logic Equation 1” is used in ascending order and has therefore been evaluated within the same process cycle. The result of “Logic Equation 3” is used in descending order and has therefore been evaluated in the previous process cycle.

Programmable Logic at the Panel

WARNING!



Improper use of Logic Equations might result in personal injury or damage the electrical equipment.

Do not use Logic Equations unless you can ensure the safe functionality.

How to configure a Logic Equation?

- Call up menu [Logics / LE x]:
- Set the Input Signals (where necessary, invert them).

- If required, configure the timers (»*LEx.t-On Delay*« and »*LEx.t-Off Delay*«).
- If the latched output signal is used assign a reset signal to the reset input.
- In case that Logic Equations should be cascaded the user has to be aware of timing delays (cycles) in case of descending sequences. (See [↪](#) “[Cascading Logical Outputs](#)”.)
- Within the »status display« (menu path [Operation / Status Display]), the user can check the status of the logical inputs and outputs of the Logic Equation.

9 Self-Supervision

The protection devices apply various check routines during normal operation and during the start-up phase to supervise themselves for faulty operation.

Self-Supervision within the devices		
Supervision of...	Supervised by...	Action on detected issue...
Start phase	The duration (permitted time) of the boot phase is monitored.	The device will be rebooted. ⇒ The device will be taken out of service after three unsuccessful start attempts.
Supervision of the duration of a protection cycle (Software cycle)	The maximum permitted time for a protection cycle is monitored by a timing analysis.	The self-supervision contact will be deenergized if the permitted time for a protection cycle is exceeded (first threshold). The protection device will be rebooted, if the protection cycle exceeds the second threshold.
Monitoring of the communication between Main and Digital Signal Processor (DSP)	The cyclic measured value processing of the DSP is monitored by the main processor.	The device will be rebooted, if a failure is detected. The self-supervision contact will be de-energized.
Analog-Digital-Converter	The DSP does a plausibility check on the digitalized data.	Protection will be blocked, if a failure is detected, in order to prevent faulty tripping.
Supervision of data consistency after an outage of the power supply (e.g. outage of the power supply while changing the parameter settings).	An internal logic detects fragmentary saved data after an outage of the power supply.	If the new data is incomplete or corrupt, it will be deleted during the reboot phase of the device. The device will continue to work with the last valid data set.
Data consistency in general	Generation of check-sums.	The device will be taken out of service in case that inconsistent data is detected that is not caused by an outage of the power supply (fatal internal error).
Parameter Setting (Device)	Protecting the parameter setting by plausibility checks.	Implausibilities within the parameter configuration can be detected by means of plausibility checks. Detected implausibilities are highlighted by a question mark symbol. Please refer to chapter

Self-Supervision within the devices		
Supervision of...	Supervised by...	Action on detected issue...
		parameter setting for detailed information.
Quality of the power supply	A hardware circuit ensures that the device can only be used, if the power supply is in the range specified by the technical data.	If the supply voltage is too low, the device will not start up or it will be set out of service respectively.
Sags of the supply voltage	Short-term sags of the supply voltage are detected and can be bridged in most of the cases by means of the integrated buffer within the power supply hardware. This buffer also allows the termination of ongoing data writing procedures.	The module for the supervision of the system utilization will detect repetitive short-term sags of the supply voltage.
Internal data of the device (memory load, internal resources, ...)	An internal module monitors the system utilization.	The module for the supervision of the system utilization initiates in case of a fatal error a reboot of the device. In case of minor faults the System LED will flash alternating red and green (please refer to the <i>Troubleshooting Guide</i>). The issue will be recorded as a system message.
Battery	The battery is monitored continuously. Notice: The battery serves as buffering of the clock (real time clock). There's no impact on the functionality of the device if the battery breaks down, except for the buffering of the clock while the unit is in de-energized condition.	If the battery is low the System LED will flash alternating red and green (please refer to the <i>Troubleshooting Guide</i>).
Status of the device communication (SCADA)	The projected and activated SCADA module supervises its connection to the master communication system.	You can check if there is active communication with the master system within menu [Operation / Status Display / Scada]. In order to monitor this state you can assign this status onto an LED and/or an output relay. For details on the status of the GOOSE communication please

Self-Supervision within the devices		
Supervision of...	Supervised by...	Action on detected issue...
		refer to chapter ↪ “3.4 IEC 61850”.

9.1 Device Start (Reboot)

The device reboots in any of the following situations:

- It is connected to the supply voltage,
- the user initiates (intentionally) a restart of the device,
- the device is set back to factory defaults,
- the internal self-supervision of the device detects a fatal error.

Every (re-)start of the MRDT4 appears as a new entry within the Self-Supervision messages, [↪ “9.2 Self-Supervision Messages”](#), for example:

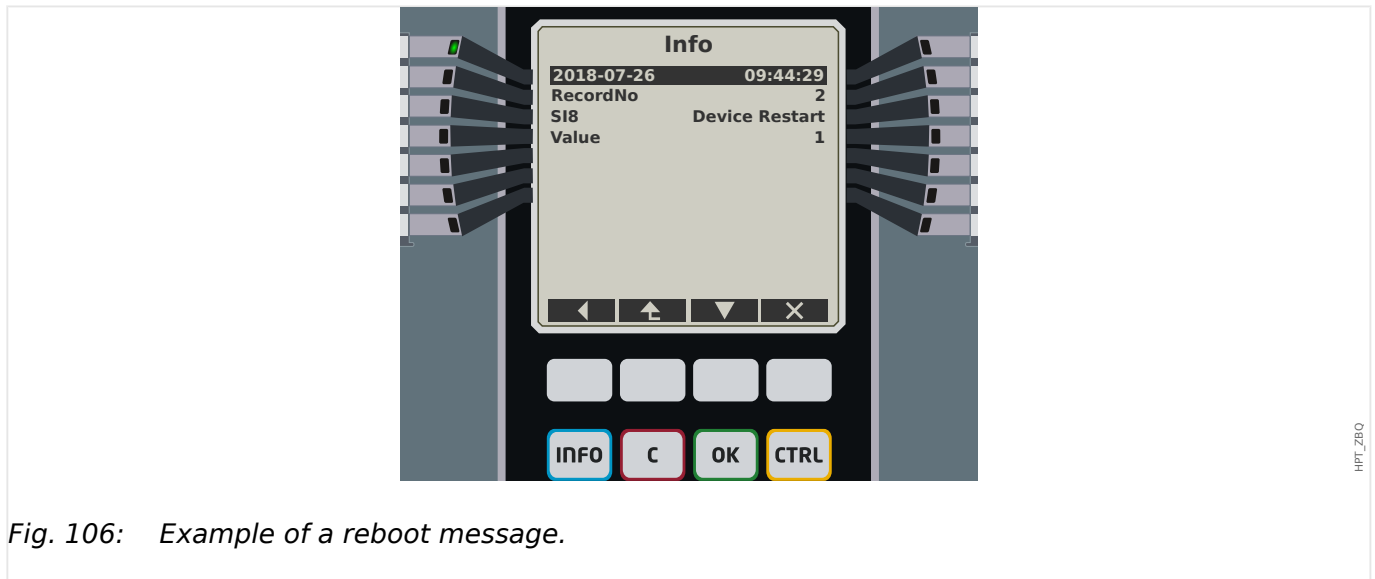

Fig. 106: Example of a reboot message.

The reason for a device start/reboot is shown numerically as “Value”. The value “1” in the example above means a normal start-up. Please see the table below for a full list.

The reason is also logged within the Event Recorder (Event: Sys.Restart).

Device Start-up Codes	
1.	Normal Start-up Start-up after clean disconnection of the supply voltage.
2.	Reboot by the Operator Device reboot triggered by the operator via HMI or <i>Smart view</i> .
3.	Reboot by means of Super Reset Automatic reboot when setting the device back to factory defaults.
4.	-- (obsolete)
5.	-- (obsolete)
6.	Unknown Error Source

Device Start-up Codes	
	Reboot due to unknown error source.
7.	Forced Reboot (initiated by the main processor) The main processor identified invalid conditions or data.
8.	Exceeded Time Limit of the Protection Cycle Unexpected interruption of the Protection Cycle.
9.	Forced Reboot (initiated by the digital signal processor) The digital signal processor identified invalid conditions or data.
10.	Exceeded Time Limit of the Measured Value Processing Unexpected interruption of the cyclic measured value processing.
11.	Sags of the Supply Voltage Reboot after short-term sag or outage of the supply voltage.
12.	Illegal Memory Access Reboot after illegal memory access.

9.2 Self-Supervision Messages

The menu [Operation / Self-Supervision / Messages] gives access to the list of Self-Supervision messages. In particular, it is recommended to check these in case of some problem directly related to the functionality of the MRDT4.

The Self-Supervision collects various security-related messages (e. g. the entry of a false password) and MRDT4-internal status messages, warnings and error messages.

All messages that can potentially appear under [Messages] are described in detail in a separate document, the “HighPROTEC Troubleshooting Guide” (HPT-3.7-EN-TSG).

At the HMI (panel) of the MRDT4, there are limitations due to the type of display, so that the list shows only a short entry for each message. After selecting a particular message (with the Softkeys “▲”/Up and “▼”/Down) the Softkey “▶”/Enter takes the user to a screen with all details for this message. There it is also possible to use Softkey “×”/Delete for removing this message plus all older ones.

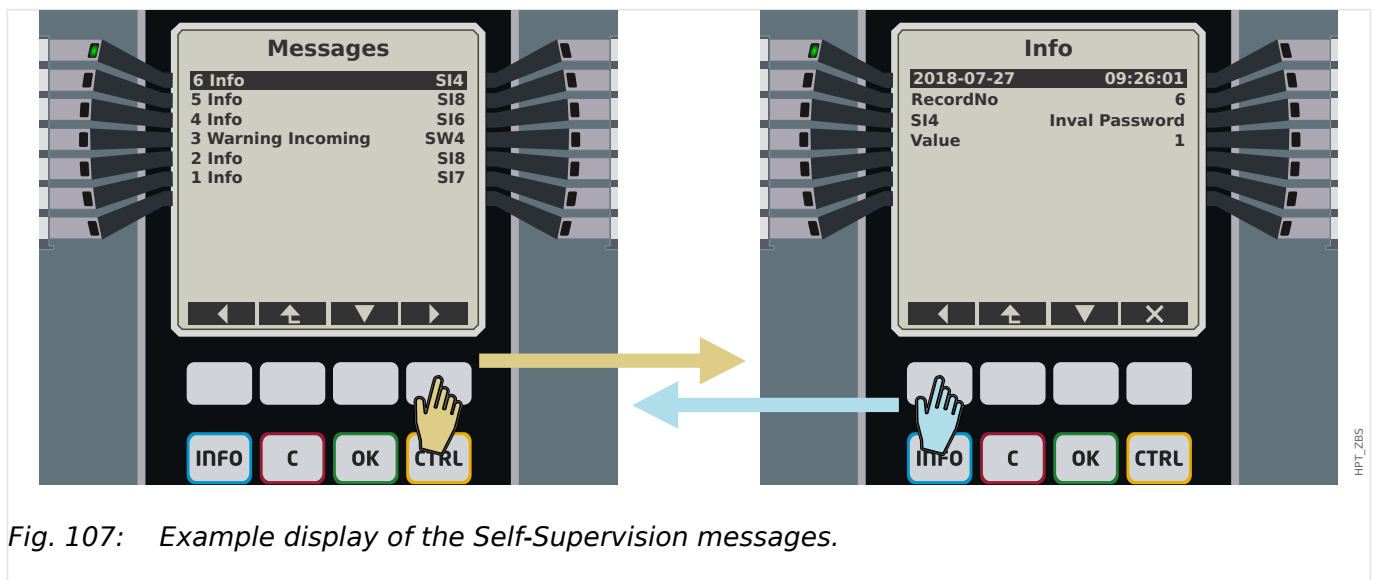



Fig. 107: Example display of the Self-Supervision messages.

All messages are displayed together with an identifier (e. g. “**SI8** Device Restart”, or “**SI4** Invalid Password”); this identifier makes it easier to locate detailed information about it in the *Troubleshooting Guide*. The identifier always starts with an “**S**”, next comes either an “**I**” (for “Information”), a “**W**” (for “Warning”), or an “**E**” (for “Error”).





General idea:

- **E** - Errors indicate serious problems. It is advisable to look up the message in the *Troubleshooting Guide*.
- **W** - Warnings should be checked by the user. They might indicate a problem that needs to be solved. On the other hand, depending on the application, it can also be without any effect. Look at the example message “**SW4** Time Sync” shown below, that indicates an (at least temporary) interrupt of the external time synchronization signal. For most industrial-grade applications, a properly synchronized system time is required, and therefore the user will probably want to check the cause for this message. However, the same message also appears in a situation where the user has intentionally omitted an external clock synchronization.
- **I** - Information messages can be helpful for a thorough analysis of a problem, but in general, such messages have indeed only an informative character and do not affect the operation of the MRDT4.

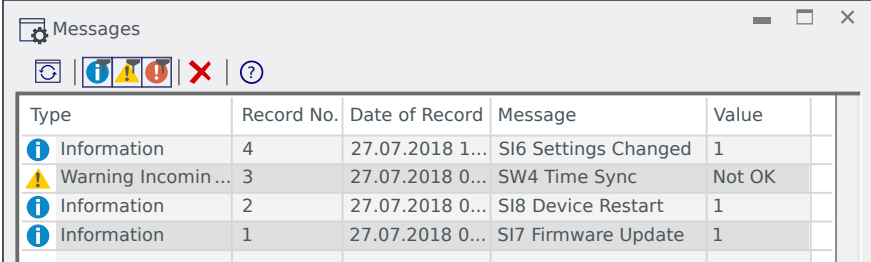
Checking the Self-Supervision messages using *Smart view* is more convenient (see example figure below) than using the HMI: All messages are listed in one dialog window. There are buttons  in the toolbar of this dialog that allow for restricting the list to particular severity types: It is possible to e. g. hide all “information” messages and show only the types “warning” and “error”.

There is also a delete button  with the same functionality as the “x” on the HMI: It allows for removing the currently selected message plus all older ones.



Type	Record No.	Date of Record	Message	Value
 Information	4	27.07.2018 1...	SI6 Settings Changed	1
 Warning Incomin ...	3	27.07.2018 0...	SW4 Time Sync	Not OK
 Information	2	27.07.2018 0...	SI8 Device Restart	1
 Information	1	27.07.2018 0...	SI7 Firmware Update	1

HPT_ZBR



Note that it is not possible – neither on the HMI nor in *Smart view* – to pick only one particular message for deletion. A “delete” always removes all messages with timestamp until (including) the currently selected one.

9.3 Syslog

It is possible to transfer each new Self-Supervision message ([↪ “9.2 Self-Supervision Messages”](#)) to some dedicated server computer. This is done automatically with every new message at the moment when it is issued. This way you can have one central logging system that receives all device messages for all your HighPROTEC devices, so that there is no need to establish new *Smart view* connections to each device only for this purpose.

The transfer uses the so-called **Syslog** communication protocol for the transfer. This is a quite simple standard UDP/IP-based network protocol that transmits text messages of max. 1024 Bytes length to the UDP port 514. (The port number, however, is configurable on the MRDT4.)

The server computer must have a *syslog daemon* running that receives the messages. Of course, the available tools for checking and presenting the messages depend on the setup of this computer.

The Syslog feature of the MRDT4 is inactive by default. If you want to use it you have to activate it first:

- [Device planning] »Syslog . Mode« = “active”

Then the Syslog protocol has to be activated by the following setting:

- [Device Para / Security / Syslog] »Function« = “active”.

Finally one has to specify the IP(v4) address and port number of the server computer so that the MRDT4 knows where to send the messages to:

- [Device Para / Security / Syslog] »IP port number« has to be set to the correct port number.

The default 514 can be simply kept if the server computer listens on the standard port.

- [Device Para / Security / Syslog] »*IP address, part 1*« ... »*IP address, part 4*« — These four parameters specify the IP address of the server computer, i. e. each setting is an integer number from 0 to 255.

9.4 Device Taken out of Service (“Device Stopped”)

The protection device will be taken out of service, if there is an undefined state that cannot be escaped after three reboots.

In this state the system LED will be illuminated red or red flashing. The display will show the message “Device Stopped” followed by a 6-digit error code, e.g. E01487.

There may exist additional error information accessible by the Service Staff. These offer further failure analysis and diagnosis opportunities to the Service Staff.

NOTICE!



In such a case please contact the SEG Service Staff and provide them the error code.

For further information on trouble shooting please refer to the separately provided *Troubleshooting Guide*.

10 Commissioning

Before starting work on an opened switchboard it is imperative that the complete switchboard is dead and the following 5 safety regulations are always met: ,

DANGER!



Safety precautions:

- Disconnect from the power supply
- Secure against reconnection
- Verify if the equipment is dead
- Connect to ground and short-circuit all phases
- Cover or safeguard all live adjacent parts

DANGER!



The secondary circuit of a current transformer must never be opened during operation. The prevailing high voltages are dangerous to life.

WARNING!



Even when the auxiliary voltage is switched off, it is likely that there are still hazardous voltages at the component connections.

All locally applicable national and international installation and safety regulations for working at electrical power installations must always to be followed (e.g. VDE, EN, DIN, IEC).

WARNING!



Prior to the initial voltage connection, the following must be guaranteed:

- Correct grounding of the device
- All signal circuits must be tested
- All control circuits must be tested
- The transformer wiring must be checked
- Correct rating of the CTs
- Correct burden of the CTs
- The operational conditions must be in line with the Technical Data
- Correct rating and function of the CT fuses;
- Correct wiring of all digital inputs
- Polarity and capacity of the supply voltage
- Correct wiring of the analog inputs and outputs

NOTICE!



The permissible deviations of measuring values and device adjustment are dependent on the technical data/tolerances.

10.1 Commissioning/Protection Test

WARNING!



Putting into operation/Protection test must be carried out by authorized and qualified personnel. Before the device is put into operation the related documentation has to be read and understood.

WARNING!



With any test of the protection functions the following has to be checked:

- Are all signals/messages correctly generated?
- Do all general parameterized blocking functions work properly?
- Do all temporary parameterized (via DI) blocking functions work properly?
- To enable checks on all LEDs and relay functions, these have to be provided with the relevant alarm and tripping functions of the respective protection functions/elements. This has to be tested in practical operation.

WARNING!



Check of all temporary blockings (via digital inputs):

In order to avoid malfunctions, all blockings related to tripping/non-tripping of protection function have to be tested. The test can be very complex and should therefore be performed by the same people who set up the protection concept.

CAUTION!



Check of all general trip blockings:

All general trip blockings have to be tested.

NOTICE!



Prior to the initial operation of the protection device all tripping times and values shown in the adjustment list have to be confirmed by a secondary test

NOTICE!



Any description of functions, parameters, inputs or outputs that does not match the device in hand, can be ignored.

CAUTION!



In most countries, there are specific national regulations and standards about functional and protection tests that must be carried out on a regular basis.

These must be followed in addition to the routine functional tests described in [↪ “11.1 Routine Functional Tests”](#).

10.2 Putting out of Operation - Plug out the Relay

WARNING!



Warning! Dismounting the relay will lead to a loss of the protection functionality. Ensure that there is a back-up protection. If you are not aware of the consequences of dismantling the device - stop! Don't start.

WARNING!



Inform SCADA before you start.

Switch off the power supply.

Ensure, that the cabinet is dead and that there are no voltages that could lead to personal injury.

Plug-out the terminals at the rear-side of the device. Do not pull any cable - pull on the plugs! If it is stuck use for example a screw driver.

Fasten the cables and terminals in the cabinet by means of cable clips to ensure that no accidental electrical connections are caused.

Hold the device at the front-side while opening the mounting nuts.

Remove the device carefully out of the cabinet.

In case no other device is to be mounted or replaced cover/close the cut-out in the front-door.

Close the cabinet.

10.3 Service and Commissioning Support

Within the service menu various functions support maintenance and commissioning of the device.

10.3.1 General

Within the menu [Service / General], the user can initiate a reboot of the device.



The »System OK« (“Operational”) LED is constantly green when – after the boot phase, [↪](#) “Boot Phase” – the protection functions of the MRDT4 are working. In any other case consult the *Troubleshooting Guide*.

10.3.2 Phase Sequence

Within the menu [Operation / Status Display / Supervision / Phase Sequence], there are signals showing whether the phase sequence calculated by the device is different from the setting under [Field Para / General Settings] »Phase Sequence«. See [↪](#) “4.19.4 Phase Sequence Supervision” for details.

10.3.3 Forcing the Relay Output Contacts

NOTICE!



See [↪](#) “2.2.2 Overview of Slots – Assembly Groups” for information on available Relay Output contacts. The parameters, their defaults and setting ranges have to be taken from the Reference Mnaual.

Principle - General Use

DANGER!



The User MUST ENSURE that the relay output contacts operate normally after the maintenance is completed. If the relay output contacts do not operate normally, the protective device WILL NOT provide protection.

For commissioning purposes or for maintenance, relay output contacts can be set by force.

Within this mode [Service / Test (Prot inhibit) / Force OR / BO Slot Xx], relay output contacts can be set by force:

- Permanent; or
- via timeout.

If they are set with a timeout, they will only keep their “Force Position” as long as this timer runs. If the timer expires, the relay will operate normally. If they are set as Permanent, they will keep the “Force Position” continuously.

There are two options available:

- Forcing a single relay »Force ORx«; and
- Forcing an entire group of relay output contacts »Force all Outs«.

Forcing an entire group takes precedence over forcing a single relay output contact!

NOTICE!



A relay output contact will NOT follow a force command as long as it is disarmed at the same time.

NOTICE!



A relay output contact will follow a force command:

- If it is not disarmed; and
- If the Direct Command is applied to the relay(s).

Keep in mind, that the forcing of all relay output contacts (of the same assembly group) takes precedence over the force command of a single relay output contact.

10.3.4 Disarming the Relay Output Contacts

NOTICE!



See [↳ “2.2.2 Overview of Slots - Assembly Groups”](#) for information on available Relay Output contacts. The parameters, their defaults and setting ranges have to be taken from the Reference Mnaual.

Principle - General Use

Within this mode [Service / Test (Prot inhibit) / DISARMED / BO Slot Xx][Service/Test Mode/ DISARMED], entire groups of relay output contacts can be disabled. By means of this test mode, contact outputs switching actions of the relay output contacts are prevented. If the relay output contacts are disarmed, maintenance actions can be carried out without the risk of taking entire processes off-line.

DANGER!



The User MUST ENSURE that the relay output contacts are ARMED AGAIN after the maintenance is complete. If they are not armed, the protective device WILL NOT provide protection.

NOTICE!



Zone Interlocking Output and the Supervision Contact cannot be disarmed.

Within this mode [Service / Test (Prot inhibit) / DISARMED] entire groups of relay output contacts can be disarmed:

- Permanent; or
- Via timeout.

If they are set with a timeout, they will only keep their “Disarm Position” as long as this timer runs. If the timer expires, the relay output contacts will operate normally. If they are set Permanent, they will keep the “Disarm State” continuously.

NOTICE!



A relay output contact will NOT be disarmed as long as:

- It's latched (and not yet reset).
- As long as a running t-OFF-delay timer is not yet expired (hold time of a relay output contact).
- The Disarm Control is not set to active.
- The Direct Command is not applied.

NOTICE!



A relay output contact will be disarmed if it's not latched and

- There is no running t-OFF-delay timer (hold time of a relay output contact) and
- The DISARM Control is set to active and
- The Direct Command Disarm is applied.

10.3.5 Forcing RTDs*

* = Availability depends on ordered device.

NOTICE!



The parameters, their defaults, and setting ranges have to be taken from RTD/UTRD section.

Principle - General Use

DANGER!



The User MUST ENSURE that the RTDs operate normally after the maintenance is completed. If the RTDs do not operate normally, the protective device WILL NOT provide protection.

For commissioning purposes or for maintenance, RTD temperatures can be set by force.

Within this mode [Service / Test (Prot inhibit) / URTD], RTD temperatures can be set by force:

- Permanent; or
- Via timeout.

If they are set with a timeout, they will keep their “Forced Temperature” only as long as this timer runs. If the timer expires, the RTD will operate normally. If they are set as »Permanent«, they will keep the “Forced Temperature” continuously. This menu will show the measured values of the RTDs until the User activates the force mode by calling up the »Function«. As soon as the force mode is activated, the shown values will be frozen as long as this mode is active. Now the User can force RTD values. As soon as the force mode is deactivated, measured values will be shown again.

10.3.6 Fault Simulator (Sequencer)*

* = Availability depends on ordered device.

For commissioning support and in order to analyze failures, the protective device offers the option to simulate measuring quantities.

[After setting Device planning] »Mode« = “use”, the simulation menu can be found within the menu branch [Service / Test (Prot inhibit) / Sgen].

The simulation cycle consists of three sequences:

- Pre-fault;
- Failure;
- Post-fault sequence.

In addition to these three sequences, there is a short “reset sequence” of about 100 ms immediately before the Pre-failure sequence, and another one after the Post-failure sequence, where all protection functions are deactivated. This is necessary to re-initialize all protection modules and related filters and set them to a healthy new state.

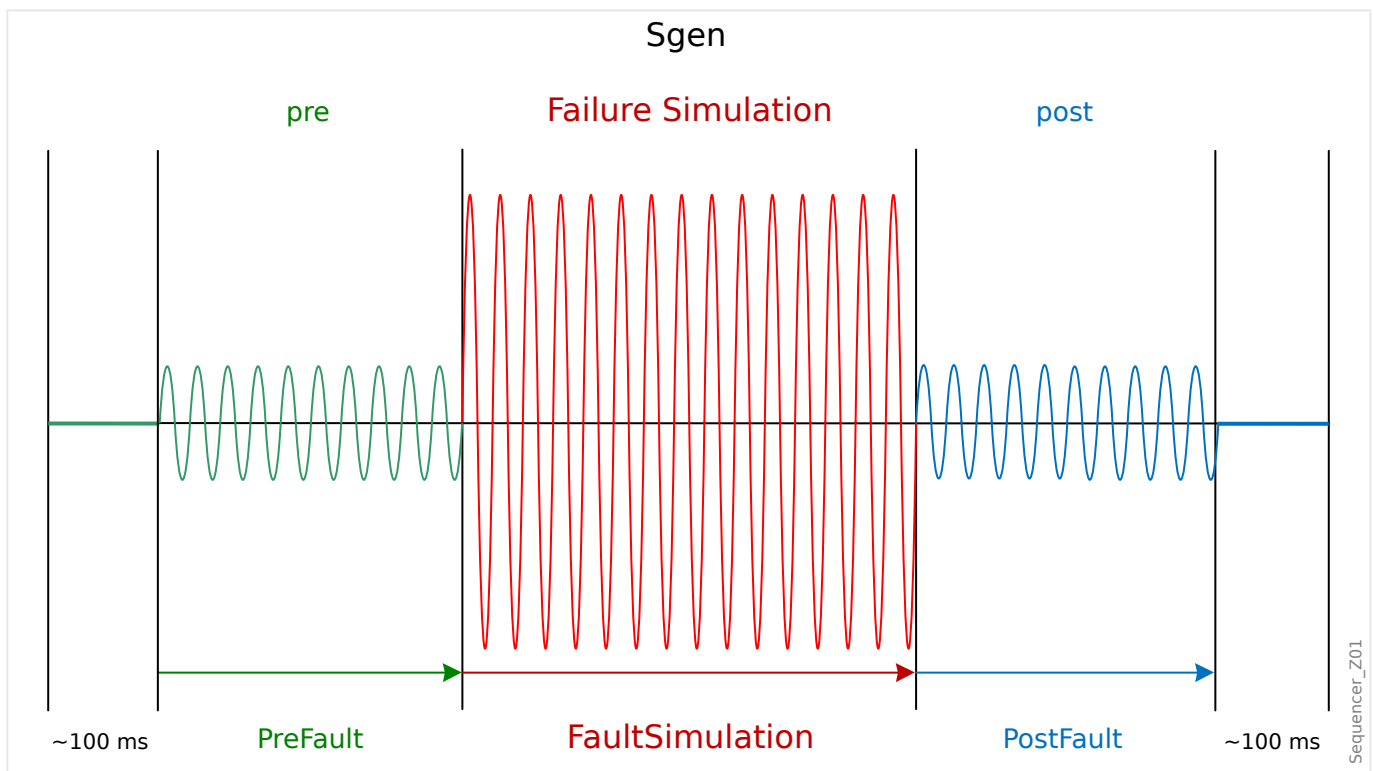

The states are recorded by the Event and Disturbance Recorders as follows:

- **0** - Normal operation (i. e. without fault simulation)
- **1** - Pre-fault
- **2** - Fault
- **3** - Post-fault
- **4** - Reset / initialization phase

Within the menu branch [Service / Test (Prot inhibit) / Sgen / Configuration / Times], the duration of each sequence can be set. In addition, the measuring quantities to be simulated can be determined (e. g.: voltages, currents, and the corresponding angles) for each phase (and ground).

NOTICE!



The simulation is terminated immediately, if a phase current exceeds $0.1 \cdot I_n$.
A simulation can be restarted, five seconds after the current has fallen below $0.1 \cdot I_n$.

Moreover, within the menu branch [Service / Test (Prot inhibit) / Sgen / Process] there are two blocking parameters »ExBlo1«, »ExBlo2«. Signals that are assigned to any of these block the Fault Simulator. For example, it can be recommended for security considerations to have the Fault Simulator blocked if the circuit breaker is in closed position.

Furthermore, there is the possibility to assign a signal to the parameter »Ex ForcePost«. Then this signal interrupts the actual sequence of the Fault Simulator (Pre-fault or Failure) and leads to an immediate transition into the Post-fault sequence. The typical application for this is a test whether the protective device correctly generates a trip decision, so that it is not necessary to always wait until the regular end of the Failure sequence. It is possible to assign the trip signal to »Ex ForcePost« so that the Failure sequence is ended immediately after the trip signal has been correctly generated.

DANGER!



Setting the device into the simulation mode means taking the protective device out of operation for the duration of the simulation. Do not use this feature during operation of the device if the User cannot guarantee that there is a running and properly working backup protection.

NOTICE!



The energy counters are stopped while the failure simulator is running.

NOTICE!



The simulation voltages are always phase to neutral voltages, irrespectively of the mains voltage transformers' connection method (Phase-to-phase / Wye / Open Delta).

NOTICE!



Due to internal dependencies, the frequency of the simulation module is 0.16% greater than the rated one.

Cold Simulation

Simulation without tripping the circuit breaker:

The trip command (»TripCmd«) of all protection functions is blocked. The protection function will possibly trip but not generate a trip command.

- Set [Service / Test (Prot inhibit) / Sgen / Process] »TripCmd Mode« = “No TripCmd”

Hot Simulation

Simulation is authorized to trip the breaker:

- Set [Service / Test (Prot inhibit) / Sgen / Process] »TripCmd Mode« = “With TripCmd”

Start/Stop Options

Manual start, no stop:

Complete run: Pre Failure, Failure, Post Failure.

- Set [Service / Test (Prot inhibit) / Sgen / Process] »Ex ForcePost« = “No assignment”
- Press/Call the Direct Control [Service / Test (Prot inhibit) / Sgen / Process] »Start Simulation«.

Manual start, stop by external signal:

Force Post: As soon as this signal becomes true, the Fault Simulation is forced to switch into the Post Failure mode.

- Set [Service / Test (Prot inhibit) / Sgen / Process] »Ex ForcePost« to the required signal.
- Press/Call the Direct Control [Service / Test (Prot inhibit) / Sgen / Process] »Start Simulation«.

Manual start, manual stop:

As soon as the stop command is given, the Fault Simulation is terminated and the MRDT4 changes back to normal operation.

- Start: as described above.
- Stop: Press/Call the Direct Control [Service / Test (Prot inhibit) / Sgen / Process] »Stop Simulation«.

Start by external signal:

The start of the Fault Simulator is triggered by the assigned external signal (unless it is blocked).

(Moreover, as already said above, [↪ Chapter 10.3.6](#), the use of the Fault Simulator generally requires that no phase current exceeds $0.1 \cdot I_n$.)

- Set [Service / Test (Prot inhibit) / Sgen / Process] »Ex Start Simulation« to the required signal.

11 Servicing and Maintenance

CAUTION!



In most countries, there are specific national regulations and standards about functional and protection tests that must be carried out on a regular basis.

These must be followed in addition to the routine functional tests described in [↪ “11.1 Routine Functional Tests”](#).

11.1 Routine Functional Tests

Within the scope of servicing and maintenance following checks of the MRDT4 hardware have to be conducted:

Output Relays

Every 1–4 years, depending on ambient conditions:

- Check the Output Relays via the test menu branches [Service / Test (Prot inhibit) / Force OR] / [Service / Test (Prot inhibit) / DISARMED], see [↪ “10.3 Service and Commissioning Support”](#))

Digital Inputs

Every 1–4 years, depending on ambient conditions:

- Supply a voltage to the Digital Inputs and check if the appropriate status signal appears.

Current plugs and Current measurements

Every 1–4 years, depending on ambient conditions:

- Supply a test current to the current measurement inputs and check the displayed measured values from the MRDT4.

Communication

Every 1–4 years, for devices with established SCADA communication:

- Check whether the SCADA connection to the substation is still active and functional.

Battery

In general the battery lasts more than 10 years. Exchange by SEG.

Notice: The battery serves as buffering of the clock (real-time clock). There's no impact on the functionality of the device if the battery breaks down, except for the buffering of the clock while the unit is in de-energized condition.

- The device checks the battery as part of its Self-Supervision, therefore no dedicated testing activities are required. If the battery is low, the System LED flashes red/green, and an error code is generated (see *Troubleshooting Guide*).

Self-Supervision Contact

Every 1–4 years, depending on ambient conditions:

- Switch off the auxiliary supply of the unit. Then the Self-Supervision Contact must drop out. Switch on the auxiliary supply again.

Mechanical Mounting of the Unit of the Cabinet Door

With each maintenance or yearly:

- Check the torque (1.7 Nm [15 in·lb]) related to the specification of the Installation chapter, [↪ “2.1 Dimension Drawings”](#).

Terminals, Torque of all Cable Connections

With each maintenance or yearly:

- Visual inspection of all connections and terminals.
- Check the torque related to the specification of the Installation chapter ([↪ “2.2 MRDT4 - Installation and Wiring”](#)) which describes the hardware modules.

Protection Test

- We recommend to execute a protection test after each 4 years period. This period can be extended to 6 years if a function test is executed at least every 3 years.

12 Technical Data

NOTICE!



Use copper conductors only, 75°C.
Conductor size AWG 14 [2.5 mm²].

Climatic and Environmental Data

Storage Temperature:	−30°C to +70°C (−22°F to 158°F)
Operating Temperature:	−20°C to +60°C (−4°F to 140°F)
Permissible Humidity at Ann. Average:	<75% rel. (on 56 days up to 95% rel.)
Permissible Installation Altitude:	<2000 m (6561.67 ft) above sea level If 4000 m (13 123.35 ft) altitude applies, a changed classification of the operating and test voltages may be necessary.

Pollution Degree and Equipment Class

Pollution degree:	2
Equipment class:	1

Degree of Protection EN 60529

HMI front panel with seal	IP54
HMI front panel without seal	IP50
Rear side terminals	IP20

Routine Test

Insulation Test Acc. to IEC60255-5:	All tests to be carried out against ground and other input and output circuits.
Aux. voltage supply, digital inputs, current measuring inputs, signal relay outputs:	2.5 kV (eff) / 50 Hz
Voltage measuring inputs:	3.0 kV (eff) / 50 Hz
All wire-bound communication interfaces:	1.5 kVDC

Housing

Housing B2: height/-width: (8 Pushbottoms / Door Mounting)	183 mm / 212,7 mm
---	-------------------

Housing B2: height/-width: (8 Pushbottoms / 19")	173 mm (4 HE) / 212,7 mm (42 TE)
Housing Depth (Incl. Terminals):	208 mm (8.189 in.)
Material, Housing:	Aluminum extruded section
Material, Front Panel:	Aluminum / foil front
Mounting Position:	Horizontal ($\pm 45^\circ$ around the X-axis must be permitted)
Weight:	approx. 4.7 kg (10.36 lb)

Current and Ground Current Measurement

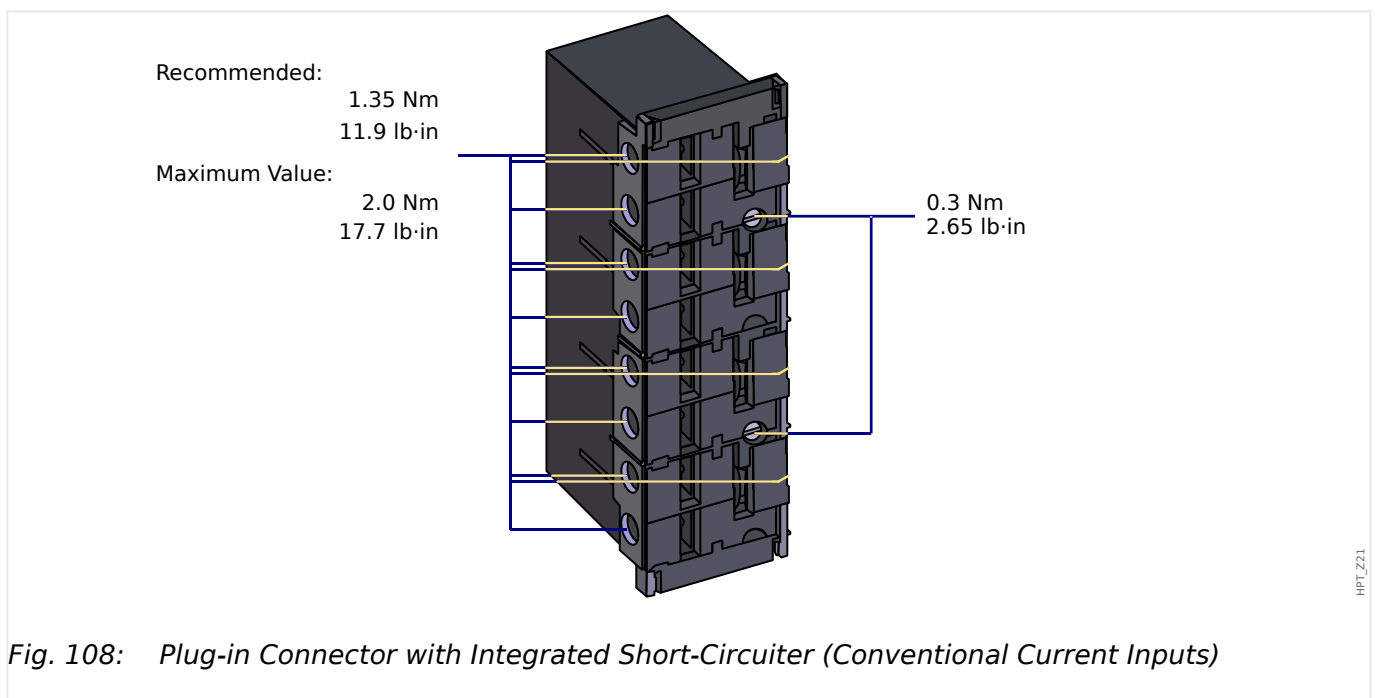

Fig. 108: Plug-in Connector with Integrated Short-Circuiter (Conventional Current Inputs)

Frequency Range:	50 Hz / 60 Hz $\pm 10\%$
Terminals:	Screw-type terminals with integrated short-circuiters (contacts)
Screws	M4, captive type acc. to VDEW
Connection Cross Sections:	<p>1 x or 2 x 2.5 mm² (2 x AWG 14) with wire end ferrule</p> <p>1 x or 2 x 4.0 mm² (2 x AWG 12) with ring cable sleeve or cable sleeve</p> <p>1 x or 2 x 6 mm² (2 x AWG 10) with ring cable sleeve or cable sleeve</p> <p>The current measuring board's terminal blocks may be used as with 2 (double) conductors</p>

	AWG 10,12,14 otherwise with single conductors only.
--	---

Phase and Ground Current Inputs:	
Nominal Currents:	1 A / 5 A
Max. Measuring Range:	Up to 40 x I _n (phase currents) Up to 25 x I _n (ground current standard)
Capacity:	4 x I _n /continuously
Overcurrent Proof:	30 x I _n / 10 s 100 x I _n / 1 s 250 x I _n / 10 ms (1 half-wave)
Power Consumption:	Phase current inputs: At I _n = 1 A: S ≤ 25 mVA At I _n = 5 A: S ≤ 0.1 VA Ground current input: At I _n = 1 A: S ≤ 25 mVA At I _n = 5 A: S ≤ 0.1 VA

Sensitive Ground Current Inputs:	
Nominal Currents:	1 A / 5 A
Max. Measuring Range:	Up to 2.5 x I _n
Capacity:	2 x I _n /continuously
Overcurrent Proof:	10 x I _n / 10 s 25 x I _n / 1 s 100 x I _n / 10 ms (1 half-wave)
Power Consumption:	At 1 A: S = 550 mVA At 0.1 A: S = 7 mVA At 5 A: S = 870 mVA At 0.5 A: S = 10 mVA

Frequency Measurement

Nominal frequencies:	50 Hz / 60 Hz
----------------------	---------------

Voltage Supply

Aux. Voltage:	24 ... 270 VDC / 48 ... 230 VAC (–20/+10%) ≈
Buffer Time in Case of Supply Failure:	≥ 50 ms at minimal aux. voltage The device will shut down if the buffer time is expired. Note: communication could be interrupted.
Max. Permissible Making Current:	18 A peak value for < 0.25 ms 12 A peak value for < 1 ms
Fuse (built into the wide-range power supply unit):	6.3 A time-lag (This fuse is not to be replaced by the user, but is necessary for safe operation.)

The voltage supply must be protected by an external fuse of:

- 2.5 A time-lag miniature fuse 5 x 20 mm (approx. 1/5 x 0.8 in.) according to IEC 60127
- 3.5 A time-lag miniature fuse 6.3 x 32 mm (approx. 1/4 x 1 ¼ in.) according to UL 248-14

Power Consumption

Power Supply Range	Power consumption in Idle Mode	Max. Power Consumption
24 - 270 VDC:	Approx. 8 W	Approx. 13 W
48 - 230 VAC (for Frequencies of 50-60 Hz):	Approx. 8 W / 16 VA	Approx. 13W / 21 VA

Display

Display type:	LCD with LED background illumination
Resolution - graphics display:	128 x 64 pixel

LEDs

LED type:	Two colored: red / green
Number of LEDs, Housing B2:	15

Front Interface USB

Type:	Mini B
-------	--------

Real Time Clock

Running Reserve of the Real Time Clock:	1 year min.
---	-------------

Digital Inputs

Max. Input Voltage:	300 VDC / 259 VAC
Input Current:	DC <4 mA AC <16 mA
Reaction Time:	<20 ms
Fallback Time:	
Shorted inputs	<30 ms
Open inputs	<90 ms

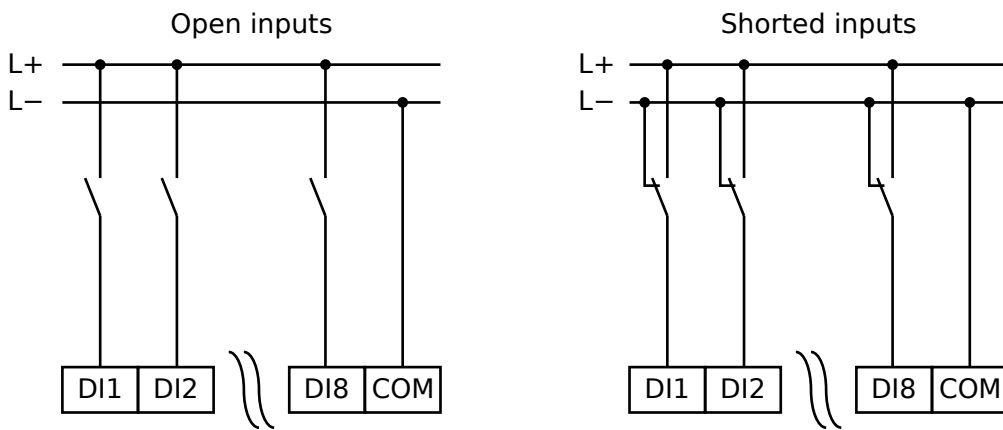

Fig. 109: Safe State of the Digital Inputs

Switching Thresholds:	24 VDC, 48 VDC, 60 VDC, 110 VDC, 110 VAC, 230 VDC, 230 VAC
Un = 24 VDC	
Switching Threshold 1 ON:	Min. 19.2 VDC
Switching Threshold 1 OFF:	Max. 9.6 VDC
Un = 48 V / 60VDC	
Switching Threshold 2 ON:	Min. 42.6 VDC
Switching Threshold 2 OFF:	Max. 21.3 VDC
Un = 110 / 120 VAC / DC	
Switching Threshold 3 ON:	Min. 88.0 VDC / 88.0 VAC

Switching Threshold 3 OFF:	Max. 44.0 VDC / 44.0 VAC
Un = 230 / 240 VAC / DC	
Switching Threshold 4 ON:	Min. 184 VDC / 184 VAC
Switching Threshold 4 OFF:	Max. 92 VDC / 92 VAC
Terminals:	Screw-type terminal

Binary Output Relays

Continuous current:	5 A AC/DC
Max. Switch-on current:	25 A AC/DC for 4 s 30 A AC/DC for 0.5 s 1000 W (VA) at L/R = 40 ms 30 A / 230 VAC according to ANSI IEEE Std C37.90-2005 30 A / 250 VDC according to ANSI IEEE Std C37.90-2005
Max. breaking current:	5 A AC up to 240 VAC 4 A AC at 230 V and $\cos \varphi = 0,4$ 5 A DC up to 30 V (resistive) 0.3 A DC at 250 V (resistive) 0.1 A DC at 220 V and L/R = 40 ms
Max. switching voltage:	250 VAC / 250 VDC
Switching capacity:	3000 VA
Operating time: (*)	typ. 7 ms
Reset time: (*)	typ. 3 ms
Contact type:	1 changeover contact or normally open or normally closed
Terminals:	Screw-type terminals

(*) The operating and reset times are the pure hardware-related switching times (coil - making/breaking contact), i. e. without the time that it takes the software to calculate the decisions.

Supervision Contact (SC)

Continuous current:	5 A AC/DC
Max. Switch-on current:	15 A AC/DC for 4 s

Max. breaking current:	5 A AC up to 250 VAC 5 A DC up to 30 V (resistive) 0.25 A DC at 250 V (resistive)
Max. switching voltage:	250 VAC / 250 VDC
Switching capacity:	1250 VA
Contact type:	1 changeover contact
Terminals:	Screw-type terminals

Time Synchronization IRIG-B00X

Nominal input voltage:	5 V
Connection:	Screw-type terminals (twisted pair)

RS485*

*availability depends on device

Connection:	9-pole D-Sub socket (external terminating resistors/in D-Sub) or 6 screw-clamping terminals RM 3.5 mm (138 MIL) (terminating resistors internal)
-------------	---

CAUTION!	
	In case that the RS485 interface has terminals, the communication cable has to be shielded.

Fiber Optic Module with ST connector*

*availability depends on device

Connector:	ST Port
Compatible Fiber:	50/125 µm, 62.5/125 µm, 100/140 µm and 200 µm HCS
Wavelength	820 nm
Minimum Optical Input Power:	-24.0 dBm
Minimum Optical Output Power:	-19.8 dBm with 50/125 µm fiber -16.0 dBm with 62,5/125 µm fiber -12.5 dBm with 100/145 µm fiber -8.5 dBm with 200 µm HCS fiber

Maximum Link Length:	approx. 2.7 km (depending on link attenuation)
----------------------	--

Please note: The transmission speed of the optical interfaces is limited to 3 MBaud for Profibus.

Optical Ethernet Module with LC connector*

*availability depends on device

Connector:	LC Port
Compatible Fiber:	50/125 μm and 62.5/125 μm
Wavelength:	1300 nm
Minimum Optical Input Power:	-30.0 dBm
Minimum Optical Output Power:	-22.5 dBm with 50/125 μm fiber -19.0 dBm with 62,5/125 μm fiber
Maximum Link Length:	approx. 2 km (depending on link attenuation)

URTD-Interface*

*availability depends on device

Connector:	Versatile Link
Compatible Fiber:	1 mm
Wavelength:	660 nm
Minimum Optical Input Power:	-39.0 dBm

Smart view Connections

The MRDT4 can communicate with the operating software *Smart view* as follows:

- USB connection (using the USB interface at the front of the MRDT4).
- TCP/IP connection (using the Ethernet* interface at the rear side of the MRDT4).

(*availability depends on device)

There can be max. 3 *Smart view* sessions with the same MRDT4 device at the same time.

Self-Supervision Messages

The storage capacity for Self-Supervision messages (see [↪ "9.2 Self-Supervision Messages"](#)) is as follows:

- **E** - Errors - up to 500 messages. Each new error beyond this number deletes the oldest error message.
- **W** - Warnings - up to 500 messages. Each new warning beyond this number deletes the oldest warning message.

- **I** - Information messages - up to 500 messages. Each new information message beyond this number deletes the oldest information message.

Boot Phase

After switching on the power supply the protection will be available in approximately 7 seconds. After approximately 39 seconds (depending on the configuration) the boot phase is completed (HMI and Communication initialized).

12.1 Specifications / Tolerances

12.1.1 Specifications of the Real Time Clock

Resolution:	1 ms
Tolerance:	<1 minute / month (+20°C [68°F]) <±1ms if synchronized via IRIG-B

Time Synchronization Tolerances

The different protocols for time synchronisation vary in their accuracy:

Used Protocol	Time drift over one month	Deviation to time generator
Without time synchronization	<1 min (+20°C)	Time drifts
IRIG-B	Dependent on the time drift of the time generator	<±1 ms
SNTP	Dependent on the time drift of the time generator	<±1 ms, if network connection is GOOD (see operation status of SNTP)
IEC60870-5-103	Dependent on the time drift of the time generator	<±1 ms
Modbus TCP	Dependent on the time drift of the time generator	Dependent on the network load
Modbus RTU	Dependent on the time drift of the time generator	<±1 ms
DNP3 TCP	Dependent on the time drift of the time generator	Dependent on the network load
DNP3 UDP	Dependent on the time drift of the time generator	Dependent on the network load
DNP3 RTU	Dependent on the time drift of the time generator	<±1 ms

Note that the availability of the protocols depends on the ordered variant of the MRDT4 (see [↪](#) “1.2.1 Order Form of the Device”).

12.1.2 Specifications of the Measured Value Acquisition

Phase and Ground Current Measuring

Frequency Range:	50 Hz / 60 Hz \pm 10%
Accuracy:	Class 0.5
Amplitude Error if $I < I_n$:	$\pm 0.5\%$ of the rated current *3)
Amplitude Error if $I > I_n$:	$\pm 0.5\%$ of the measured current *3)
Amplitude Error if $I > 2 I_n$:	$\pm 1.0\%$ of the measured current *3)
Harmonics:	Up to 20% 3rd harmonic $\pm 2\%$ Up to 20% 5th harmonic $\pm 2\%$
Frequency Influence:	$< \pm 2\%$ / Hz in the range of ± 5 Hz of the configured nominal frequency
Temperature Influence:	$< \pm 1\%$ within the range of 0°C to +60°C (+32°F to +140°F)

*3) For earth current sensitive the precision does not depend on the nominal value but is referenced to 100 mA (with $I_n = 1$ A) respectively. 500 mA (with $I_n = 5$ A).

12.1.3 Protection Elements Accuracy

NOTICE!



The tripping delay relates to the time between alarm and trip. The accuracy of the operating time relates to the time between fault entry and the time when the protection element is picked-up.

Reference conditions for all Protection Elements: sine wave, at rated frequency, THD < 1%, measuring method: Fundamental

12.1.3.1 Phase Overcurrent Protection

Overcurrent Protection Elements: I[x]	Accuracy
Threshold value »I>«	±1.5% of the setting value or ±1% I _n .
Dropout Ratio	97% or 0.5% I _n
Definite time (»Char« = "DEFT"):	
Tripping delay »t«	±1% or ±10 ms
Operate time (for »t« = 0 ms) At testing current ≥ 2 times pickup value	<36 ms
Characteristic curve:	
Start time (pickup time) At testing current ≥ 2 times threshold value	<36 ms
Tripping delay t(I, I>, tchar) For testing current in the range 2 ... 20 times threshold value	±5% (according to the selected curve, see ↳ "4.6.1 Characteristics")
Operate time	= Start time + Tripping delay
Disengaging Time	<55 ms
t-reset delay (»Reset Mode« = "definite time")	±1% or ±10 ms

Overcurrent Protection Elements: I[x] with setting »Measuring method« = “I2” (Negative phase sequence current)	Accuracy
Threshold value »I>«	±2.0% of the setting value or ±1% I _n .
Dropout Ratio	97% or 0.5% I _n
Definite time (»Char« = “DEFT”):	
Tripping delay »t«	±1% or ±10 ms
Operate time (for »t« = 0 ms) At testing current ≥ 2 times pickup value	<60 ms
Disengaging Time	<45 ms

12.1.3.2 Earth (Ground) Overcurrent Protection

Earth Overcurrent Protection Elements: IG[x]	Accuracy *3)
Threshold value »IG>«	±1.5% of the setting value or ±1% In.
Dropout Ratio	97% or 0.5% In
Definite time (»Char« = "DEFT"):	
Tripping delay »t«	±1% or ±10 ms
Operate time (for »t« = 0 ms) At testing current ≥ 2 times pickup value	<45 ms
Characteristic curve:	
Start time (pickup time) At testing current ≥ 2 times threshold value	<45 ms
Tripping delay t(IG, IG>, tchar) For testing current in the range 2 ... 20 times threshold value	±5% (according to the selected curve, see ↳ "4.8.1 Characteristics")
Operate time	= Start time + Tripping delay
Disengaging Time	<55 ms
t-reset delay (»Reset Mode«= "definite time")	±1% or ±10 ms

- *3) For earth current sensitive the precision does not depend on the nominal value but is referenced to 100 mA (with In = 1 A) respectively 500 mA (with In = 5 A)

12.1.3.3 Phase Differential Protection

Phase Differential Protection: Id	Accuracy
Id>	±5% of the setting value or 2% In
Dropout Ratio	Adjustable, at least 1% In
Operating Time	
Id > 2 x pickup (step from zero to 200% pickup of 87-Char)	<40 ms
Typical trip time	30 ms
Shortest trip time	18 ms

Unrestrained Phase Differential Protection: IdH	Accuracy
Id>>	±5% of the setting value or 2% In
Dropout Ratio	90% or 1% In
Operating Time	
Id > 1.1 x pickup	<30 ms
Typical trip time	19 ms
Shortest trip time	13 ms

12.1.3.4 Earth (Ground) Differential Protection

Ground Differential Protection: IdG	Accuracy
IdG>	±3% of the setting value or 2% In
Dropout Ratio	95% or 1% In
Operating Time	
IdG > 2 x pickup (step from zero to 200% pickup of 87G-Char)	<40 ms
Typical trip time	30 ms
Shortest trip time	18 ms

Unrestrained Ground Differential Protection: IdGH	Accuracy
IdG>>	±3% of the setting value or 2% In
Dropout Ratio	90% or 1% In
Operating Time	
IdG > 1.1 x pickup	<30 ms
Typical trip time	19 ms
Shortest trip time	13 ms

12.1.3.5 Thermal Protection

RTD Protection: RTD / URTD	Accuracy
Trip Threshold	±1°C (1.8°F)
Alarm Threshold	±1°C (1.8°F)
t-delay Alarm	DEFT ±1% or ±10 ms
Reset Hysteresis	-2°C (-3.6°F) of threshold ±1°C (1.8°F)

Thermal Replica: ThR	Accuracy *1)
K·Ib	±5% of the setting value or 1% In
Tripping Delay (according to the equation in  "Tripping Time") in cold state (i. e. no previous heat)	±5% of the calculated value or ±1 s
Dropout Ratio	97%

*1) Accuracy applies for the following setting ranges:

- $K \cdot Ib \geq 0.1 \text{ In}$
- $\tau\text{-warm} \leq 30000 \text{ s}$
- $\tau\text{-cool} \leq 30000 \text{ s}$

12.1.3.6 Current-Related Protection

Inrush Supervision: IH2	Accuracy
IH2 / IH1	$\pm 1\% I_n$
Dropout Ratio	5% IH2 or 1% I_n
Operating Time	$< 30 \text{ ms}^{*1)}$

- ^{*1)} Inrush supervision is possible if the fundamental Harmonic (IH1) $> 0.1 I_n$ and 2nd Harmonic (IH2) $> 0.01 I_n$.

Current unbalance: I2>[x]	Accuracy ^{*1)}
I2>	$\pm 2\%$ of the setting value or $1\% I_n$
Dropout Ratio	97% or $0.5\% I_n$
$\%(I2/I1)$	$\pm 1\%$
t	DEFT $\pm 1\%$ or $\pm 10 \text{ ms}$
Operating Time	$< 70 \text{ ms}$
Disengaging Time	$< 50 \text{ ms}$
K	$\pm 5\% \text{ INV}$
$\tau\text{-cool}$	$\pm 5\% \text{ INV}$

- ^{*1)} The negative-sequence current I2 must be $\geq 0.01 \times I_n$, the positive-sequence current I1 must be $\geq 0.1 \times I_n$.

12.1.3.7 Miscellaneous Protection and Supervision

Switch onto Fault: SOTF	Accuracy
Operating time	<35 ms
I<	±1.5% of the setting value or 1% I _n
t-enable	±1% or ±20 ms

Cold Load Pickup: CLPU	Accuracy
Threshold	±1.5% of the setting value or 1% I _n
Operating time	<35 ms
I<	±1.5% of the setting value or 1% I _n
t-Load Off	±1% or ±15 ms
t-Max Block	±1% or ±15 ms
Settle Time	±1% or ±15 ms

Circuit Breaker Failure Protection: CBF	Accuracy
t-CBF	±1% or ±10 ms
I-CBF >	±1.5% of the setting value or 1% I _n
Operating Time	<40 ms
Starting from I higher than 1.3 x I-CBF >	
Disengaging Time	<40 ms

Trip Circuit Monitoring: TCS	Accuracy
t-TCS	±1% or ±10 ms

Current Transformer Supervision: CTS	Accuracy
ΔI	$\pm 2\%$ of the setting value or $1.5\% I_n$
Dropout Ratio	94%
Alarm delay	$\pm 1\%$ or ± 10 ms

13 Appendix

13.1 Standards

13.1.1 Approvals

	
	UL File Nr.: E217753 certified regarding UL508 (Industrial Controls)
	CSA File Nr.: 251990 certified regarding CSA-C22.2 No. 14 (Industrial Controls)
	EAC certified by EAC (Eurasian Conformity)
	KEMA Laboratories — Type tested and certified in accordance with the complete type test requirements of IEC 60255-1:2009.
	KESCO 동일성 선언서 (Declaration of Identity).

- Complies with IEEE 1547-2003
- Amended by IEEE 1547a-2014
- Complies with ANSI C37.90-2005

13.1.2 Design Standards

Generic standard	EN 61000-6-2 , 2005 EN 61000-6-3 , 2006
Product standard	IEC 60255-1; 2009 IEC 60255-26, 2013 IEC 60255-27, 2013 UL 508 (Industrial Control Equipment), 2005 CSA C22.2 No. 14-95 (Industrial Control Equipment),1995 ANSI C37.90, 2005

13.1.3 Electrical Tests

High Voltage Tests

High Frequency Interference Test		
IEC 60255-22-1	Within one circuit	1 kV / 2 s
IEC 60255-26		
IEEE C37.90.1		
IEC 61000-4-18		
	Circuit to ground	2.5 kV / 2 s
class 3	Circuit to circuit	2.5 kV / 2 s

Insulation Voltage Test		
IEC 60255-27	All circuits to other circuits and exposed conductive parts	2.5 kV (eff.) / 50Hz, 1 min.
IEC 60255-5		
EN 50178		
	Except interfaces	1.5 kV DC, 1 min.
	Voltage measuring input	3 kV (eff.)/50 Hz, 1 min.

Impulse Voltage Test		
IEC 60255-27		5 kV / 0.5J, 1.2 / 50 μ s
IEC 60255-5		

Insulation Resistance Test		
IEC 60255-27	Within one circuit	500V DC , 5s
EN 50178		
	Circuit to circuit	500V DC , 5s

EMC Immunity Tests

Fast Transient Disturbance Immunity Test (Burst)		
IEC 60255-22-4	Power supply, mains inputs	\pm 4 kV, 2.5 kHz
IEC 60255-26	Other in- and outputs	\pm 2 kV, 5 kHz
IEC 61000-4-4		

Fast Transient Disturbance Immunity Test (Burst)

class 4		
---------	--	--

Surge Immunity Test (Surge)

IEC 60255-22-5	Within one circuit	2 kV
IEC 60255-26	Circuit to ground	4 kV
IEC 61000-4-5		
class 4		
class 3	Communication cables to ground	2 kV

Electrical Discharge Immunity Test (ESD)

IEC 60255-22-2	Air discharge	8 kV
IEC 60255-26	Contact discharge	6 kV
IEC 61000-4-2		
class 3		

Radiated Radio Frequency Electromagnetic Field Immunity Test

IEC 60255-22-3	26 MHz – 80 MHz	10 V/m
IEC 60255-26	80 MHz – 1 GHz	35 V/m
IEC 61000-4-3	1 GHz – 3 GHz	10 V/m

Immunity to Conducted Disturbances Induced by Radio Frequency Fields

IEC 61000-4-6	150kHz - 80MHz	10 V
IEC 60255-26		
class 3		

Power Frequency Magnetic Field Immunity Test

IEC 61000-4-8	continuous	30 A/m
IEC 60255-26	3 sec	300 A/m
class 4		

EMC Emission Tests**Radio Interference Suppression Test**

IEC/CISPR 22	150kHz - 30MHz	Limit value class B
IEC 60255-26		

Radio Interference Radiation Test

IEC/CISPR 11	30MHz - 1GHz	Limit value class A
IEC 60255-26		

13.1.4 Environmental Tests

Classification		
IEC 60068-1	Climatic Classification	20/060/56
IEC 60721-3-1	Classification of ambient conditions (Storage)	1K5/1B1/1C1L/1S1/1M2 but min. -30°C (-22°F)
IEC 60721-3-2	Classification of ambient conditions (Transportation)	2K2/2B1/2C1/2S1/2M2 but min. -30°C (-22°F)
IEC 60721-3-3	Classification of ambient conditions (Stationary use at weather protected locations)	3K6/3B1/3C1/3S1/3M2 but min. -20°C (-4°F) / max 60°C (140°F)

Test Ad: Cold		
IEC 60068-2-1	Temperature	-20°C (-4°F)
IEC 60255-27	Test duration	16 h

Test Bd: Dry Heat		
IEC 60068-2-2	Temperature	60°C (140°F)
IEC 60255-27	Relative humidity	<50%
	Test duration	72 h

Test Cab: Damp Heat (Steady State)		
IEC 60068-2-78	Temperature	60°C (140°F)
IEC 60255-27	Relative humidity	95%
	Test duration	56 days

Test Db: Damp Heat (Cyclic)		
IEC 60068-2-30	Temperature	60°C (140°F)
IEC 60255-27	Relative humidity	95%
	Cycles (12 + 12-hour)	2

Test Nb: Temperature Change		
IEC 60068-2-14	Temperature	60°C/-20°C
	cycle	5
	test duration	1°C / 5min

Test BD: Dry Heat Transport and storage test

IEC 60255-27	Temperature	70°C
IEC 60068-2-2	test duration	16 h

Test AB: Cold Transport and storage test

IEC 60255-27	Temperature	−30°C
IEC 60068-2-1	test duration	16 h

13.1.5 Mechanical Tests

Test Fc: Vibration Response Test		
IEC 60068-2-6	(10 Hz - 59 Hz)	0.035 mm (0.0014 in.)
IEC 60255-27	Displacement	
IEC 60255-21-1	(59Hz - 150Hz)	0.5 gn
class 1	Acceleration	
	Number of cycles in each axis	1

Test Fc: Vibration Endurance Test		
IEC 60068-2-6	(10 Hz - 150 Hz)	1.0 gn
IEC 60255-21-1	Acceleration	
class 1	Number of cycles in each axis	20

Test Ea: Shock Test		
IEC 60068-2-27	Shock response test	5 gn, 11 ms, 3 impulses in each direction
IEC 60255-27	Shock resistance test	15 gn, 11 ms, 3 impulses in each direction
IEC 60255-21-2		
class 1		

Test Eb: Shock Endurance Test		
IEC 60068-2-29	Shock endurance test	10 gn, 16 ms, 1000 impulses in each direction
IEC 60255-21-2		
class 1		

Test Fe: Earthquake Test		
IEC 60068-3-3	Single axis earthquake vibration test	1 - 9 Hz horizontal: 7.5 mm (0.295 in.)
IEC 60255-27		1 - 9 Hz vertical: 3.5 mm (0.137 in.)
IEC 60255-21-3		1 sweep per axis
class 2		9 - 35 Hz horizontal: 2 gn, 9 - 35 Hz vertical : 1 gn,

Test Fe: Earthquake Test

1 sweep per axis

13.2 IEC 60870-103 Interoperability

The selected parameters have been marked as follows:

<input type="checkbox"/>	Function or ASDU is not used
<input checked="" type="checkbox"/>	Function or ASDU is used as standardized (default)

The possible selection (blank “” / X “”) is specified for each specific clause or parameter.

13.2.1 Physical layer

Electrical interface

<input checked="" type="checkbox"/>	EIA RS-485	<input checked="" type="checkbox"/>	Number of loads for one equipment: 32
-------------------------------------	------------	-------------------------------------	---------------------------------------

Optical interface

<input checked="" type="checkbox"/>	Glass fiber	<input type="checkbox"/>	F-SMA type connector
<input checked="" type="checkbox"/>	Plastic fiber	<input checked="" type="checkbox"/>	BFOC/2,5 type connector

Transmission speed:

<input checked="" type="checkbox"/>	9600 bit/s	<input checked="" type="checkbox"/>	19200 bit/s
		<input checked="" type="checkbox"/>	38400 bit/s

13.2.2 Link layer

There are no choices for the link layer.

13.2.3 Application layer

Transmission mode for application data Mode 1 (least significant octet first) as defined in 4.10 of IEC 60870-5-4.

13.2.3.1 Common address of ASDU

<input checked="" type="checkbox"/>	One common address of ADSU (identical with station address)	<input type="checkbox"/>	More than one common address of ASDU
-------------------------------------	---	--------------------------	--------------------------------------

13.2.3.2 Selection of standard information numbers in monitor direction

System functions in monitor direction:

<input checked="" type="checkbox"/>	INF = 0 — End of general interrogation	<input checked="" type="checkbox"/>	INF = 0 — Time synchronization
<input checked="" type="checkbox"/>	INF = 2 — Reset FCB	<input checked="" type="checkbox"/>	INF = 3 — Reset CU
<input checked="" type="checkbox"/>	INF = 4 — Start/Restart	<input checked="" type="checkbox"/>	INF = 5 — Power on

Measurands in monitor direction:

<input type="checkbox"/>	INF = 144 — Measurand I	<input type="checkbox"/>	INF = 145 — Measurands I, V
<input type="checkbox"/>	INF = 146 — Measurands I, V, P, Q	<input type="checkbox"/>	INF = 147 — Measurands I_N , V_{EN}
<input checked="" type="checkbox"/>	INF = 148 — Measurands $I_{L1,2,3}$, $V_{L1,2,3}$, P, Q, f		

Generic functions in monitor direction:

<input type="checkbox"/>	INF = 240 — Read headings of all defined groups	<input type="checkbox"/>	INF = 241 — Read values of all entries of one group
<input type="checkbox"/>	INF = 243 — Read directory of a single entry	<input type="checkbox"/>	INF = 244 — Read value of a single entry
<input type="checkbox"/>	INF = 245 — End of general interrogation of generic data	<input type="checkbox"/>	INF = 249 — Write entry with confirmation
<input type="checkbox"/>	INF = 250 — Write entry with execution	<input type="checkbox"/>	INF = 251 — Write entry aborted

13.2.3.3 Selection of standard information numbers in control direction

System functions in control direction:

<input checked="" type="checkbox"/>	INF = 0 — Initiation of general interrogation	<input checked="" type="checkbox"/>	INF = 0 — Time synchronization
-------------------------------------	---	-------------------------------------	--------------------------------

Generic commands in control direction:

<input checked="" type="checkbox"/>	INF = 16 — Auto-recloser on/off	<input checked="" type="checkbox"/>	INF = 17 — Teleprotection on/off
<input checked="" type="checkbox"/>	INF = 18 — Protection on/off	<input checked="" type="checkbox"/>	INF = 19 — LED reset
<input checked="" type="checkbox"/>	INF = 20 — Blocking of Monitor Direction	<input checked="" type="checkbox"/>	INF = 21 — Test mode
<input checked="" type="checkbox"/>	INF = 23 — Activate characteristic 1	<input checked="" type="checkbox"/>	INF = 24 — Activate characteristic 2
<input checked="" type="checkbox"/>	INF = 25 — Activate characteristic 3	<input checked="" type="checkbox"/>	INF = 26 — Activate characteristic 4

Generic functions in control direction:

<input type="checkbox"/>	INF = 240 — Read headings of all defined groups	<input type="checkbox"/>	INF = 241 — Read values of all entries of one group
<input type="checkbox"/>	INF = 243 — Read directory of a single entry	<input type="checkbox"/>	INF = 244 — Read value of a single entry
<input type="checkbox"/>	INF = 245 — End of general interrogation of generic data	<input type="checkbox"/>	INF = 248 — Write entry
<input type="checkbox"/>	INF = 249 — Write entry with confirmation	<input type="checkbox"/>	INF = 250 — Write entry with execution
<input type="checkbox"/>	INF = 251 — Write entry abort		

Basic application functions:

<input checked="" type="checkbox"/>	Test mode	<input checked="" type="checkbox"/>	Blocking of monitor direction
<input checked="" type="checkbox"/>	Disturbance data	<input type="checkbox"/>	Generic services
<input checked="" type="checkbox"/>	Private data		

13.2.3.4 Miscellaneous

Measurand	max. value = rated value ×	
	1.2	2.4
Current L ₁	<input type="checkbox"/>	<input checked="" type="checkbox"/>
Current L ₂	<input type="checkbox"/>	<input checked="" type="checkbox"/>
Current L ₃	<input type="checkbox"/>	<input checked="" type="checkbox"/>
Voltage L ₁ -E	<input type="checkbox"/>	<input checked="" type="checkbox"/>
Voltage L ₂ -E	<input type="checkbox"/>	<input checked="" type="checkbox"/>
Voltage L ₃ -E	<input type="checkbox"/>	<input checked="" type="checkbox"/>
Voltage L ₁ -L ₂	<input type="checkbox"/>	<input checked="" type="checkbox"/>
Active power P	<input type="checkbox"/>	<input checked="" type="checkbox"/>
Reactive power Y	<input type="checkbox"/>	<input checked="" type="checkbox"/>
Frequency f	<input checked="" type="checkbox"/>	<input type="checkbox"/>

13.3 IEC 60870-5-104 Interoperability

This companion standard presents sets of parameters and alternatives from which subsets must be selected to implement particular telecontrol systems. Certain parameter values, such as the choice of “structured” or “unstructured” fields of the INFORMATION OBJECT ADDRESS of ASDUs represent mutually exclusive alternatives. This means that only one value of the defined parameters is admitted per system. Other parameters, such as the listed set of different process information in command and in monitor direction allow the specification of the complete set or subsets, as appropriate for given applications. This clause summarizes the parameters of the previous clauses to facilitate a suitable selection for a specific application. If a system is composed of equipment stemming from different manufacturers, it is necessary that all partners agree on the selected parameters.

The interoperability list is defined as in IEC 60870-5-101 and extended with parameters used in this standard. The text descriptions of parameters which are **not applicable to this companion standard are strike-through and the corresponding check box is marked black**.

NOTE: In addition, the full specification of a system may require individual selection of certain parameters for certain parts of the system, such as the individual selection of scaling factors for individually addressable measured values.

The selected parameters have been marked as follows:

<input type="checkbox"/>	Function or ASDU is not used
[X]	Function or ASDU is used as standardized (default)
[R]	Function or ASDU is used in reverse mode
[B]	Function or ASDU is used in standard and reverse mode

The possible selection (blank, X, R, or B) is specified for each specific clause or parameter.

13.3.1 System or device

(system-specific parameter, indicate definition of a system or a device by marking one of the following with “X”)

<input type="checkbox"/>	System definition
<input type="checkbox"/>	Controlling station definition (Master)
[X]	Controlled station definition (Slave)

13.3.2 Network configuration

(network-specific parameter, all configurations that are used are to be marked “X”)

<input checked="" type="checkbox"/>	Point-to-point	<input checked="" type="checkbox"/>	Multipoint
<input checked="" type="checkbox"/>	Multiple point-to-point	<input checked="" type="checkbox"/>	Multipoint-star

13.3.3 Physical layer

(network-specific parameter, all interfaces and data rates that are used are to be marked "X")

Transmission speed (control direction)

■	100 bit/s	■	2400 bit/s	■	2400 bit/s
■	200 bit/s	■	4800 bit/s	■	4800 bit/s
■	300 bit/s	■	9600 bit/s	■	9600 bit/s
■	600 bit/s			■	19200 bit/s
■	1200 bit/s			■	38400 bit/s
				■	64000 bit/s

Transmission speed (monitor direction)

■	100 bit/s	■	2400 bit/s	■	2400 bit/s
■	200 bit/s	■	4800 bit/s	■	4800 bit/s
■	300 bit/s	■	9600 bit/s	■	9600 bit/s
■	600 bit/s			■	19200 bit/s
■	1200 bit/s			■	38400 bit/s
				■	64000 bit/s

13.3.4 Link layer

(network-specific parameter, all options that are used are to be marked "X". Specify the maximum frame length. If a non-standard assignment of class 2 messages is implemented for unbalanced transmission, indicate the Type ID and COT of all messages assigned to class 2.)

Frame format FT 1.2, single character 1 and the fixed time-out interval are used exclusively in this companion standard.

Link transmission		Address field of the link	
■	Balanced transmission	■	not present (balanced transmission only)
■	Unbalanced transmission	■	One octet
		■	Two octets
		■	Structured
		■	Unstructured

■	Maximum length L (number of octets)
---	-------------------------------------

When using an unbalanced link layer, the following ASDU types are returned in class 2 messages (low priority) with the indicated causes of transmission:

- The standard assignment of ASDUs to class 2 messages is used as follows:

Type identification	Cause of transmission
9, 11, 13, 21	<1>

- Special assignments of ASDUs to class 2 messages are not used.

Note: (In response to a class 2 poll, a controlled station may respond with class 1 data when there is no class 2 data available).

13.3.5 Application layer

Transmission mode for application data

Mode 1 (Least significant octet first), as defined in 4.10 of IEC 60870-5-4, is used exclusively in this companion standard.

Common address of ASDU

(system-specific parameter, all configurations that are used are to be marked "X")

■ One octet	[X]	Two octets
-------------	-----	------------

Information object address

(system-specific parameter, all configurations that are used are to be marked "X")

■ One octet	[X]	Structured
■ Two octets	[X]	Unstructured
[X] Three octets		

Cause of transmission

(system-specific parameter, all configurations that are used are to be marked "X")

■ One octet	[X]	Two octets (with originator address). Originator address is set to zero if not used
-------------	-----	--

Length of APDU

(system-specific parameter, specify the maximum length of the APDU per system)

The maximum length of the APDU is 253 (default). The maximum length may be reduced by the system.

■	Maximum length of APDU per system
---	-----------------------------------

Selection of standard ASDUs

Process information in monitor direction

(station-specific parameter, mark each Type ID “X” if it is only used in the standard direction, “R” if only used in the reverse direction, and “B” if used in both directions).

[X]	<1>	:= Single-point information	M_SP_NA_1
■	<2>	:= Single-point information with time tag	M_SP_TA_1
[X]	<3>	:= Double-point information	M_DP_NA_1
■	<4>	:= Double-point information with time tag	M_DP_TA_1
□	<5>	:= Step position information	M_ST_NA_1
■	<6>	:= Step position information with time tag	M_ST_TA_1
[X]	<7>	:= Bitstring of 32 bit	M_BO_NA_1
■	<8>	:= Bitstring of 32 bit with time tag	M_BO_TA_1
[X]	<9>	:= Measured value, normalized value	M_ME_NA_1
■	<10>	:= Measured value, normalized value with time tag	M_ME_TA_1
[X]	<11>	:= Measured value, scaled value	M_ME_NB_1
■	<12>	:= Measured value, scaled value with time tag	M_ME_TB_1
[X]	<13>	:= Measured value, short floating point value	M_ME_NC_1
■	<14>	:= Measured value, short floating point value with time tag	M_ME_TC_1
[X]	<15>	:= Integrated totals	M_IT_NA_1
■	<16>	:= Integrated totals with time tag	M_IT_TA_1
■	<17>	:= Event of protection equipment with time tag	M_EP_TA_1
■	<18>	:= Packed start events of protection equipment with time tag	M_EP_TB_1
■	<19>	:= Packed output circuit information of protection equipment with time tag	M_EP_TC_1
□	<20>	:= Packed single-point information with status change detection	M_SP_NA_1
□	<21>	:= Measured value, normalized value without quality descriptor	M_ME_ND_1
[X]	<30>	:= Single-point information with time tag CP56Time2a	M_SP_TB_1
[X]	<31>	:= Double-point information with time tag CP56Time2a	M_DP_TB_1
□	<32>	:= Step position information with time tag CP56Time2a	M_ST_TB_1
[X]	<33>	:= Bitstring of 32 bit with time tag CP56Time2a	M_BO_TB_1
[X]	<34>	:= Measured value, normalized value with time tag CP56Time2a	M_ME_TD_1
[X]	<35>	:= Measured value, scaled value with time tag CP56Time2a	M_ME_TE_1
[X]	<36>	:= Measured value, short floating point value with time tag CP56Time2a	M_ME_TF_1

[X]	<37>	:= Integrated totals with time tag CP56Time2a	M_IT_TB_1
<input type="checkbox"/>	<38>	:= Event of protection equipment with time tag CP56Time2a	M_EP_TD_1
<input type="checkbox"/>	<39>	:= Packed start events of protection equipment with time tag CP56Time2a	M_EP_TE_1
<input type="checkbox"/>	<40>	:= Packed output circuit information of protection equipment with time tag CP56Time2a	M_EP_TF_1

Either the ASDUs of the set <2>, <4>, <6>, <8>, <10>, <12>, <14>, <16>, <17>, <18>, <19> or of the set <30> - <40> are used.

Process information in control direction

(station-specific parameter, mark each Type ID "X" if it is only used in the standard direction, "R" if only used in the reverse direction, and "B" if used in both directions).

[X]	<45>	:= Single command	C_SC_NA_1
[X]	<46>	:= Double command	C_DC_NA_1
<input type="checkbox"/>	<47>	:= Regulating step command	C_RC_NA_1
<input type="checkbox"/>	<48>	:= Set point command, normalized value	C_SE_NA_1
<input type="checkbox"/>	<49>	:= Set point command, scaled value	C_SE_NB_1
<input type="checkbox"/>	<50>	:= Set point command, short floating point value	C_SE_NC_1
<input type="checkbox"/>	<51>	:= Bitstring of 32 bit	C_BO_NA_1
<input type="checkbox"/>	<58>	:= Single command with time tag CP56Time2a	C_SC_TA_1
<input type="checkbox"/>	<59>	:= Double command with time tag CP56Time2a	C_DC_TA_1
<input type="checkbox"/>	<60>	:= Regulating step command with time tag CP56Time2a	C_RC_TA_1
<input type="checkbox"/>	<61>	:= Set point command, normalized value with time tag CP56Time2a	C_SE_TA_1
<input type="checkbox"/>	<62>	:= Set point command, scaled value with time tag CP56Time2a	C_SE_TB_1
<input type="checkbox"/>	<63>	:= Set point command, short floating point value with time tag CP56Time2a	C_SE_TC_1
<input type="checkbox"/>	<64>	:= Bitstring of 32 bit with time tag CP56Time2a	C_BO_TA_1

Either the ASDUs of the set <45> - <51> or of the set <58> - <64> are used.

System information in monitor direction

(station-specific parameter, mark "X" if used)

[X]	<70>	:= End of initialization	M_EI_NA_1
-----	------	--------------------------	-----------

System information in control direction

(station-specific parameter, mark each Type ID "X" if it is only used in the standard direction, "R" if only used in the reverse direction, and "B" if used in both directions).

[X]	<100>	:= Interrogation command	C_IC_NA_1
<input type="checkbox"/>	<101>	:= Counter interrogation command	C_CI_NA_1
<input type="checkbox"/>	<102>	:= Read command	C_RD_NA_1
[X]	<103>	:= Clock synchronization command (option)	C_CS_NA_1
■	<104>	:= Test command	C_TS_NA_1
[X]	<105>	:= Reset process command	C_RP_NA_1
■	<106>	:= Delay acquisition command	C_CD_NA_1
<input type="checkbox"/>	<107>	:= Test command with time tag CP56Time2a	C_TS_TA_1

Parameter in control direction

(station-specific parameter, mark each Type ID "X" if it is only used in the standard direction, "R" if only used in the reverse direction, and "B" if used in both directions).

<input type="checkbox"/>	<110>	:= Parameter of measured value, normalized value	P_ME_NA_1
<input type="checkbox"/>	<111>	:= Parameter of measured value, scaled value	P_ME_NB_1
<input type="checkbox"/>	<112>	:= Parameter of measured value, short floating point value	P_ME_NC_1
<input type="checkbox"/>	<113>	:= Parameter activation	P_AC_NA_1

File transfer

(station-specific parameter, mark each Type ID "X" if it is only used in the standard direction, "R" if only used in the reverse direction, and "B" if used in both directions).

<input type="checkbox"/>	<120>	:= File ready	F_FR_NA_1
<input type="checkbox"/>	<121>	:= Section ready	F_SR_NA_1
<input type="checkbox"/>	<122>	:= Call directory, select file, call file, call section	F_SC_NA_1
<input type="checkbox"/>	<123>	:= Last section, last segment	F_LS_NA_1
<input type="checkbox"/>	<124>	:= Ack file, ack section	F_AF_NA_1
<input type="checkbox"/>	<125>	:= Segment	F_SG_NA_1
<input type="checkbox"/>	<126>	:= Directory {blank or X, only available in monitor (standard) direction}	F_DR_TA_1
<input type="checkbox"/>	<127>	:= QueryLog - request of an archive file	F_SC_NB_1

Type identifier and cause of transmission assignments

(station-specific parameters)

▣ Shaded boxes: option not required.

■ Black boxes: option not permitted or not supported in this companion standard

White boxes: functions or ASDU not used.

Mark Type Identification/Cause of transmission combinations:

- “X” if only used in the standard direction;
- “R” if only used in the reverse direction;
- “B” if used in both directions.

Type Identification		Cause of Transmission																		
		1	2	3	4	5	6	7	8	9	10	11	12	13	20 ... 36	37 ... 41	44	45	46	47
<1>	M_SP_NA_1	☐	☐	[X]	☐	☐	☐	☐	☐	☐	☐	☐	☐	[X]	☐	☐	☐	☐	☐	☐
<2>	M_SP_TA_1	☐	☐	■	☐	■	☐	☐	☐	☐	☐	☐	☐	☐	☐	☐	☐	☐	☐	☐
<3>	M_DP_NA_1	☐	☐	[X]	☐	☐	☐	☐	☐	☐	[X]	[X]	☐	[X]	☐	☐	☐	☐	☐	☐
<4>	M_DP_TA_1	☐	☐	■	☐	■	☐	☐	☐	☐	☐	☐	☐	☐	☐	☐	☐	☐	☐	☐
<5>	M_ST_NA_1	☐	☐	☐	☐	☐	☐	☐	☐	☐	☐	☐	☐	☐	☐	☐	☐	☐	☐	☐
<6>	M_ST_TA_1	☐	☐	■	☐	■	☐	☐	☐	☐	☐	☐	☐	☐	☐	☐	☐	☐	☐	☐
<7>	M_BO_NA_1	☐	☐	[X]	☐	☐	☐	☐	☐	☐	☐	☐	☐	[X]	☐	☐	☐	☐	☐	☐
<8>	M_BO_TA_1	☐	☐	■	☐	■	☐	☐	☐	☐	☐	☐	☐	☐	☐	☐	☐	☐	☐	☐
<9>	M_ME_NA_1	[X]	☐	[X]	☐	☐	☐	☐	☐	☐	☐	☐	☐	[X]	☐	☐	☐	☐	☐	☐
<10>	M_ME_TA_1	☐	☐	■	☐	■	☐	☐	☐	☐	☐	☐	☐	☐	☐	☐	☐	☐	☐	☐
<11>	M_ME_NB_1	[X]	☐	[X]	☐	☐	☐	☐	☐	☐	☐	☐	☐	[X]	☐	☐	☐	☐	☐	☐
<12>	M_ME_TB_1	☐	☐	■	☐	■	☐	☐	☐	☐	☐	☐	☐	☐	☐	☐	☐	☐	☐	☐
<13>	M_ME_NC_1	[X]	☐	[X]	☐	☐	☐	☐	☐	☐	☐	☐	☐	[X]	☐	☐	☐	☐	☐	☐
<14>	M_ME_TC_1	☐	☐	■	☐	■	☐	☐	☐	☐	☐	☐	☐	☐	☐	☐	☐	☐	☐	☐
<15>	M_IT_NA_1	☐	☐	[X]	☐	☐	☐	☐	☐	☐	☐	☐	☐	☐	☐	☐	☐	☐	☐	☐
<16>	M_IT_TA_1	☐	☐	■	☐	☐	☐	☐	☐	☐	☐	☐	☐	☐	☐	☐	☐	☐	☐	☐
<17>	M_EP_TA_1	☐	☐	■	☐	☐	☐	☐	☐	☐	☐	☐	☐	☐	☐	☐	☐	☐	☐	☐
<18>	M_EP_TB_1	☐	☐	■	☐	☐	☐	☐	☐	☐	☐	☐	☐	☐	☐	☐	☐	☐	☐	☐
<19>	M_EP_TC_1	☐	☐	■	☐	☐	☐	☐	☐	☐	☐	☐	☐	☐	☐	☐	☐	☐	☐	☐
<20>	M_PS_NA_1	☐	☐	☐	☐	☐	☐	☐	☐	☐	☐	☐	☐	☐	☐	☐	☐	☐	☐	☐
<21>	M_ME_ND_1	☐	☐	☐	☐	☐	☐	☐	☐	☐	☐	☐	☐	☐	☐	☐	☐	☐	☐	☐
<30>	M_SP_TB_1	☐	☐	[X]	☐	☐	☐	☐	☐	☐	☐	☐	☐	☐	☐	☐	☐	☐	☐	☐
<31>	M_DP_TB_1	☐	☐	[X]	☐	☐	☐	☐	☐	☐	☐	☐	☐	☐	☐	☐	☐	☐	☐	☐
<32>	M_ST_TB_1	☐	☐	☐	☐	☐	☐	☐	☐	☐	☐	☐	☐	☐	☐	☐	☐	☐	☐	☐
<33>	M_BO_TB_1	☐	☐	[X]	☐	☐	☐	☐	☐	☐	☐	☐	☐	☐	☐	☐	☐	☐	☐	☐

Type Identification		Cause of Transmission																		
		1	2	3	4	5	6	7	8	9	10	11	12	13	20 ... 36	37 ... 41	44	45	46	47
<34>	M_ME_TD_1	☐	☐	[X]	☐	☐	☐	☐	☐	☐	☐	☐	☐	☐	☐	☐	☐	☐	☐	
<35>	M_ME_TE_1	☐	☐	[X]	☐	☐	☐	☐	☐	☐	☐	☐	☐	☐	☐	☐	☐	☐	☐	
<36>	M_ME_TF_1	☐	☐	[X]	☐	☐	☐	☐	☐	☐	☐	☐	☐	☐	☐	☐	☐	☐	☐	
<37>	M_IT_TB_1	☐	☐	[X]	☐	☐	☐	☐	☐	☐	☐	☐	☐	☐	☐	☐	☐	☐	☐	
<38>	M_EP_TD_1	☐	☐	☐	☐	☐	☐	☐	☐	☐	☐	☐	☐	☐	☐	☐	☐	☐	☐	
<39>	M_EP_TE_1	☐	☐	☐	☐	☐	☐	☐	☐	☐	☐	☐	☐	☐	☐	☐	☐	☐	☐	
<40>	M_EP_TF_1	☐	☐	☐	☐	☐	☐	☐	☐	☐	☐	☐	☐	☐	☐	☐	☐	☐	☐	
<45>	C_SC_NA_1	☐	☐	☐	☐	☐	[X]	[X]	[X]	[X]	[X]	☐	☐	☐	☐	☐	☐	☐	☐	
<46>	C_DC_NA_1	☐	☐	☐	☐	☐	[X]	[X]	[X]	[X]	[X]	☐	☐	☐	☐	☐	☐	☐	☐	
<47>	C_RC_NA_1	☐	☐	☐	☐	☐	☐	☐	☐	☐	☐	☐	☐	☐	☐	☐	☐	☐	☐	
<48>	C_SE_NA_1	☐	☐	☐	☐	☐	☐	☐	☐	☐	☐	☐	☐	☐	☐	☐	☐	☐	☐	
<49>	C_SE_NB_1	☐	☐	☐	☐	☐	☐	☐	☐	☐	☐	☐	☐	☐	☐	☐	☐	☐	☐	
<50>	C_SE_NC_1	☐	☐	☐	☐	☐	☐	☐	☐	☐	☐	☐	☐	☐	☐	☐	☐	☐	☐	
<51>	C_BO_NA_1	☐	☐	☐	☐	☐	☐	☐	☐	☐	☐	☐	☐	☐	☐	☐	☐	☐	☐	
<58>	C_SC_TA_1	☐	☐	☐	☐	☐	☐	☐	☐	☐	☐	☐	☐	☐	☐	☐	☐	☐	☐	
<59>	C_DC_TA_1	☐	☐	☐	☐	☐	☐	☐	☐	☐	☐	☐	☐	☐	☐	☐	☐	☐	☐	
<60>	C_RC_TA_1	☐	☐	☐	☐	☐	☐	☐	☐	☐	☐	☐	☐	☐	☐	☐	☐	☐	☐	
<61>	C_SE_TA_1	☐	☐	☐	☐	☐	☐	☐	☐	☐	☐	☐	☐	☐	☐	☐	☐	☐	☐	
<62>	C_SE_TB_1	☐	☐	☐	☐	☐	☐	☐	☐	☐	☐	☐	☐	☐	☐	☐	☐	☐	☐	
<63>	C_SE_TC_1	☐	☐	☐	☐	☐	☐	☐	☐	☐	☐	☐	☐	☐	☐	☐	☐	☐	☐	
<64>	C_BO_TA_1	☐	☐	☐	☐	☐	☐	☐	☐	☐	☐	☐	☐	☐	☐	☐	☐	☐	☐	
<70>	M_EI_NA_1*	☐	☐	☐	☐	☐	☐	☐	☐	☐	☐	☐	☐	☐	☐	☐	☐	☐	☐	
<100>	C_IC_NA_1	☐	☐	☐	☐	☐	☐	☐	☐	☐	☐	☐	☐	☐	☐	☐	☐	☐	☐	
<101>	C_CI_NA_1	☐	☐	☐	☐	☐	☐	☐	☐	☐	☐	☐	☐	☐	☐	☐	☐	☐	☐	
<102>	C_RD_NA_1	☐	☐	☐	☐	☐	☐	☐	☐	☐	☐	☐	☐	☐	☐	☐	☐	☐	☐	
<103>	C_CS_NA_1	☐	☐	☐	☐	☐	☐	☐	☐	☐	☐	☐	☐	☐	☐	☐	☐	☐	☐	
<104>	C_TS_NA_1	☐	☐	☐	☐	☐	■	■	☐	☐	☐	☐	☐	☐	☐	☐	■	■	■	■
<105>	C_RP_NA_1	☐	☐	☐	☐	☐	[X]	[X]	☐	☐	☐	☐	☐	☐	☐	☐	☐	☐	☐	
<106>	C_CD_NA_1	☐	☐	☐	☐	☐	■	■	☐	☐	☐	☐	☐	☐	☐	☐	■	■	■	■

Type Identification	Cause of Transmission																		
	1	2	3	4	5	6	7	8	9	10	11	12	13	20 ... 36	37 ... 41	44	45	46	47
<107>C_TS_TA_1	<input checked="" type="checkbox"/>	<input checked="" type="checkbox"/>	<input checked="" type="checkbox"/>	<input checked="" type="checkbox"/>	<input checked="" type="checkbox"/>	<input type="checkbox"/>	<input type="checkbox"/>	<input checked="" type="checkbox"/>	<input checked="" type="checkbox"/>	<input checked="" type="checkbox"/>	<input checked="" type="checkbox"/>	<input checked="" type="checkbox"/>	<input checked="" type="checkbox"/>	<input checked="" type="checkbox"/>	<input checked="" type="checkbox"/>	<input type="checkbox"/>	<input type="checkbox"/>	<input type="checkbox"/>	<input type="checkbox"/>
<110>P_ME_NA_1	<input checked="" type="checkbox"/>	<input checked="" type="checkbox"/>	<input checked="" type="checkbox"/>	<input checked="" type="checkbox"/>	<input checked="" type="checkbox"/>	<input type="checkbox"/>	<input type="checkbox"/>	<input checked="" type="checkbox"/>	<input checked="" type="checkbox"/>	<input checked="" type="checkbox"/>	<input checked="" type="checkbox"/>	<input checked="" type="checkbox"/>	<input checked="" type="checkbox"/>	<input type="checkbox"/>	<input checked="" type="checkbox"/>	<input type="checkbox"/>	<input type="checkbox"/>	<input type="checkbox"/>	<input type="checkbox"/>
<111>P_ME_NB_1	<input checked="" type="checkbox"/>	<input checked="" type="checkbox"/>	<input checked="" type="checkbox"/>	<input checked="" type="checkbox"/>	<input checked="" type="checkbox"/>	<input type="checkbox"/>	<input type="checkbox"/>	<input checked="" type="checkbox"/>	<input checked="" type="checkbox"/>	<input checked="" type="checkbox"/>	<input checked="" type="checkbox"/>	<input checked="" type="checkbox"/>	<input checked="" type="checkbox"/>	<input type="checkbox"/>	<input checked="" type="checkbox"/>	<input type="checkbox"/>	<input type="checkbox"/>	<input type="checkbox"/>	<input type="checkbox"/>
<112>P_ME_NC_1	<input checked="" type="checkbox"/>	<input checked="" type="checkbox"/>	<input checked="" type="checkbox"/>	<input checked="" type="checkbox"/>	<input checked="" type="checkbox"/>	<input type="checkbox"/>	<input type="checkbox"/>	<input checked="" type="checkbox"/>	<input checked="" type="checkbox"/>	<input checked="" type="checkbox"/>	<input checked="" type="checkbox"/>	<input checked="" type="checkbox"/>	<input checked="" type="checkbox"/>	<input type="checkbox"/>	<input checked="" type="checkbox"/>	<input type="checkbox"/>	<input type="checkbox"/>	<input type="checkbox"/>	<input type="checkbox"/>
<113>P_AC_NA_1	<input checked="" type="checkbox"/>	<input checked="" type="checkbox"/>	<input checked="" type="checkbox"/>	<input checked="" type="checkbox"/>	<input checked="" type="checkbox"/>	<input type="checkbox"/>	<input type="checkbox"/>	<input type="checkbox"/>	<input type="checkbox"/>	<input checked="" type="checkbox"/>	<input checked="" type="checkbox"/>	<input checked="" type="checkbox"/>	<input checked="" type="checkbox"/>	<input checked="" type="checkbox"/>	<input checked="" type="checkbox"/>	<input type="checkbox"/>	<input type="checkbox"/>	<input type="checkbox"/>	<input type="checkbox"/>
<120>F_FR_NA_1	<input checked="" type="checkbox"/>	<input checked="" type="checkbox"/>	<input checked="" type="checkbox"/>	<input checked="" type="checkbox"/>	<input checked="" type="checkbox"/>	<input checked="" type="checkbox"/>	<input checked="" type="checkbox"/>	<input checked="" type="checkbox"/>	<input checked="" type="checkbox"/>	<input checked="" type="checkbox"/>	<input checked="" type="checkbox"/>	<input checked="" type="checkbox"/>	<input type="checkbox"/>	<input checked="" type="checkbox"/>	<input checked="" type="checkbox"/>	<input type="checkbox"/>	<input type="checkbox"/>	<input type="checkbox"/>	<input type="checkbox"/>
<121>F_SR_NA_1	<input checked="" type="checkbox"/>	<input checked="" type="checkbox"/>	<input checked="" type="checkbox"/>	<input checked="" type="checkbox"/>	<input checked="" type="checkbox"/>	<input checked="" type="checkbox"/>	<input checked="" type="checkbox"/>	<input checked="" type="checkbox"/>	<input checked="" type="checkbox"/>	<input checked="" type="checkbox"/>	<input checked="" type="checkbox"/>	<input checked="" type="checkbox"/>	<input type="checkbox"/>	<input checked="" type="checkbox"/>	<input checked="" type="checkbox"/>	<input type="checkbox"/>	<input type="checkbox"/>	<input type="checkbox"/>	<input type="checkbox"/>
<122>F_SC_NA_1	<input checked="" type="checkbox"/>	<input checked="" type="checkbox"/>	<input checked="" type="checkbox"/>	<input checked="" type="checkbox"/>	<input type="checkbox"/>	<input checked="" type="checkbox"/>	<input checked="" type="checkbox"/>	<input checked="" type="checkbox"/>	<input checked="" type="checkbox"/>	<input checked="" type="checkbox"/>	<input checked="" type="checkbox"/>	<input checked="" type="checkbox"/>	<input type="checkbox"/>	<input checked="" type="checkbox"/>	<input checked="" type="checkbox"/>	<input type="checkbox"/>	<input type="checkbox"/>	<input type="checkbox"/>	<input type="checkbox"/>
<123>F_LS_NA_1	<input checked="" type="checkbox"/>	<input checked="" type="checkbox"/>	<input checked="" type="checkbox"/>	<input checked="" type="checkbox"/>	<input checked="" type="checkbox"/>	<input checked="" type="checkbox"/>	<input checked="" type="checkbox"/>	<input checked="" type="checkbox"/>	<input checked="" type="checkbox"/>	<input checked="" type="checkbox"/>	<input checked="" type="checkbox"/>	<input checked="" type="checkbox"/>	<input type="checkbox"/>	<input checked="" type="checkbox"/>	<input checked="" type="checkbox"/>	<input type="checkbox"/>	<input type="checkbox"/>	<input type="checkbox"/>	<input type="checkbox"/>
<124>F_AF_NA_1	<input checked="" type="checkbox"/>	<input checked="" type="checkbox"/>	<input checked="" type="checkbox"/>	<input checked="" type="checkbox"/>	<input checked="" type="checkbox"/>	<input checked="" type="checkbox"/>	<input checked="" type="checkbox"/>	<input checked="" type="checkbox"/>	<input checked="" type="checkbox"/>	<input checked="" type="checkbox"/>	<input checked="" type="checkbox"/>	<input checked="" type="checkbox"/>	<input type="checkbox"/>	<input checked="" type="checkbox"/>	<input checked="" type="checkbox"/>	<input type="checkbox"/>	<input type="checkbox"/>	<input type="checkbox"/>	<input type="checkbox"/>
<125>F_SG_NA_1	<input checked="" type="checkbox"/>	<input checked="" type="checkbox"/>	<input checked="" type="checkbox"/>	<input checked="" type="checkbox"/>	<input checked="" type="checkbox"/>	<input checked="" type="checkbox"/>	<input checked="" type="checkbox"/>	<input checked="" type="checkbox"/>	<input checked="" type="checkbox"/>	<input checked="" type="checkbox"/>	<input checked="" type="checkbox"/>	<input checked="" type="checkbox"/>	<input type="checkbox"/>	<input checked="" type="checkbox"/>	<input checked="" type="checkbox"/>	<input type="checkbox"/>	<input type="checkbox"/>	<input type="checkbox"/>	<input type="checkbox"/>
<126>F_DR_TA_1*	<input checked="" type="checkbox"/>	<input checked="" type="checkbox"/>	<input type="checkbox"/>	<input checked="" type="checkbox"/>	<input type="checkbox"/>	<input checked="" type="checkbox"/>	<input checked="" type="checkbox"/>	<input checked="" type="checkbox"/>	<input checked="" type="checkbox"/>	<input checked="" type="checkbox"/>	<input checked="" type="checkbox"/>	<input checked="" type="checkbox"/>	<input checked="" type="checkbox"/>	<input checked="" type="checkbox"/>	<input checked="" type="checkbox"/>	<input checked="" type="checkbox"/>	<input checked="" type="checkbox"/>	<input checked="" type="checkbox"/>	<input checked="" type="checkbox"/>

* Blank or X only

13.3.6 Basic application functions

Station initialization

(station-specific parameter, mark "X" if function is used)

Remote initialization

Cyclic data transmission

(station-specific parameter, mark "X" if function is only used in the standard direction, "R" if only used in the reverse direction, and "B" if used in both directions)

Cyclic data transmission

Read procedure

(station-specific parameter, mark "X" if function is only used in the standard direction, "R" if only used in the reverse direction, and "B" if used in both directions)

Read procedure

Spontaneous transmission

(station-specific parameter, mark "X" if function is only used in the standard direction, "R" if only used in the reverse direction, and "B" if used in both directions)

[X] Spontaneous transmission

Double transmission of information objects with cause of transmission spontaneous

(station-specific parameter, mark each information type “X” where both a Type ID without time and corresponding Type ID with time are issued in response to a single spontaneous change of a monitored object)

The following type identifications may be transmitted in succession caused by a single status change of an information object. The particular information object addresses for which double transmission is enabled are defined in a project-specific list.

- Single-point information M_SP_NA_1, M_SP_TA_1, M_SP_TB_1 and M_PS_NA_1
- Double-point information M_DP_NA_1, M_DP_TA_1 and M_DP_TB_1
- Step position information M_ST_NA_1, M_ST_TA_1 and M_ST_TB_1
- Bitstring of 32 bit M_BO_NA_1, M_BO_TA_1 and M_BO_TB_1 (if defined for a specific project)
- Measured value, normalized value M_ME_NA_1, M_ME_TA_1, M_ME_ND_1 and M_ME_TD_1
- Measured value, scaled value M_ME_NB_1, M_ME_TB_1 and M_ME_TE_1
- Measured value, short floating point number M_ME_NC_1, M_ME_TC_1 and M_ME_TF_1

Station interrogation

(station-specific parameter, mark “X” if function is only used in the standard direction, “R” if only used in the reverse direction, and “B” if used in both directions).

[X]	global		
<input type="checkbox"/>	group 1	<input type="checkbox"/>	group 7
<input type="checkbox"/>	group 2	<input type="checkbox"/>	group 8
<input type="checkbox"/>	group 3	<input type="checkbox"/>	group 9
<input type="checkbox"/>	group 4	<input type="checkbox"/>	group 10
<input type="checkbox"/>	group 5	<input type="checkbox"/>	group 11
<input type="checkbox"/>	group 6	<input type="checkbox"/>	group 12
			Information object addresses assigned to each group must be shown in a separate table.

Clock synchronization

(station-specific parameter, mark “X” if function is only used in the standard direction, “R” if only used in the reverse direction, and “B” if used in both directions).

[X] Clock synchronization

Command transmission

(object-specific parameter, mark “X” if function is only used in the standard direction, “R” if only used in the reverse direction, and “B” if used in both directions).

[X] Direct command transmission

<input type="checkbox"/>	Direct set point command transmission
[X]	Select and execute command
<input type="checkbox"/>	Select and execute set point command
[X]	C_SE_ACTTERM used
<input type="checkbox"/>	No additional definition
[X]	Short-pulse duration (duration determined by a system parameter in the outstation)
<input type="checkbox"/>	Long-pulse duration (duration determined by a system parameter in the outstation)
<input type="checkbox"/>	Persistent output
[X]	Supervision of maximum delay in command direction of commands and set point commands

[configurable]	Maximum allowable delay of commands and set point commands
----------------	--

Transmission of integrated totals

(station- or object-specific parameter, mark "X" if function is only used in the standard direction, "R" if only used in the reverse direction, and "B" if used in both directions).

<input type="checkbox"/>	Mode A: Local freeze with spontaneous transmission
<input type="checkbox"/>	Mode B: Local freeze with counter interrogation
<input type="checkbox"/>	Mode C: Freeze and transmit by counter-interrogation commands
<input type="checkbox"/>	Mode D: Freeze by counter-interrogation command, frozen values reported spontaneously
[X]	Counter read
<input type="checkbox"/>	Counter freeze without reset
<input type="checkbox"/>	Counter freeze with reset
<input type="checkbox"/>	Counter reset
<input type="checkbox"/>	General request counter
<input type="checkbox"/>	Request counter group 1
<input type="checkbox"/>	Request counter group 2
<input type="checkbox"/>	Request counter group 3
<input type="checkbox"/>	Request counter group 4

Parameter loading

(object-specific parameter, mark "X" if function is only used in the standard direction, "R" if only used in the reverse direction, and "B" if used in both directions).

<input type="checkbox"/>	Threshold value
<input type="checkbox"/>	Smoothing factor
<input type="checkbox"/>	Low limit for transmission of measured values

- High limit for transmission of measured values

Parameter activation

(object-specific parameter, mark “X” if function is only used in the standard direction, “R” if only used in the reverse direction, and “B” if used in both directions).

- Act/deact of persistent cyclic or periodic transmission of the addressed object

Test procedure

(station-specific parameter, mark “X” if function is only used in the standard direction, “R” if only used in the reverse direction, and “B” if used in both directions).

- Test procedure

File transfer

(station-specific parameter, mark “X” if function is used).

File transfer in monitor direction

- Transparent file
- Transmission of disturbance data of protection equipment
- Transmission of sequences of events
- Transmission of sequences of recorded analogue values

File transfer in control direction

- Transparent file

Background scan

(station-specific parameter, mark “X” if function is only used in the standard direction, “R” if only used in the reverse direction, and “B” if used in both directions).

- Background scan

Acquisition of transmission delay

(station-specific parameter, mark “X” if function is only used in the standard direction, “R” if only used in the reverse direction, and “B” if used in both directions).

- Acquisition of transmission delay

Definition of time outs

Parameter	Default value	Remarks	Selected value
t ₀	30 s	Time-out of connection establishment	30 s (fixed)
t ₁	15 s	Time-out of send or test APDUs	15 s (fixed)

Parameter	Default value	Remarks	Selected value
t_2	10 s	Time-out for acknowledges in case of no data messages $t_2 < t_1$	10 s (fixed)
t_3	20 s	Time-out for sending test frames in case of a long idle state	20 s (fixed)

Maximum number of outstanding I format APDUs k and latest acknowledge APDUs (w)

Parameter	Default value	Remarks	Selected value
k	12 APDUs	Maximum difference receive sequence number to send state variable	12 (fixed)
w	8 APDUs	Latest acknowledge after receiving w I format APDUs	8 (fixed)

The values for k and w are read-only, i. e. cannot be configured.

Port number

Parameter	Value	Remarks
Port number	2404	Configurable, default value = 2404

RFC 2200 suite

RFC 2200 is an official Internet Standard which describes the state of standardization of protocols used in the Internet as determined by the Internet Architecture Board (IAB). It offers a broad spectrum of actual standards used in the Internet. The suitable selection of documents from RFC 2200 defined in this standard for given projects has to be chosen by the user of this standard.

<input checked="" type="checkbox"/>	Ethernet 802.3
<input type="checkbox"/>	Serial X.21 interface
<input type="checkbox"/>	Other selection from RFC 2200

13.4 Abbreviations, and Acronyms

The following abbreviations and acronyms are used in this manual.

°C	Degrees Celsius
°F	Degrees Fahrenheit
A	Ampere(s), Amp(s)
AC	Alternating current
Ack.	Acknowledge
AND	Logical gate (The output becomes true if all Input signals are true.)
ANSI	American National Standards Institute
avg.	Average
AWG	American wire gauge
BF	Circuit breaker failure
Bkr	Breaker
Blo	Blocking(s)
BO	Binary output relay
BO1	1st binary output relay
BO2	2nd binary output relay
BO3	3rd binary output relay
calc	Calculated
CB	Circuit breaker
CBF	Module Circuit Breaker Failure protection
CD	Compact disk
Char	Curve shape
CLPU	Cold Load Pickup Module
Cmd.	Command
CMN	Common input
COM	Common input
Comm	Communication
Cr.	Counter(s)
CSA	Canadian Standards Association
CT	Control transformer
Ctrl.	Control

CTS	Current Transformer Supervision
CTS	Current transformer supervision
d	Day
D-Sub-Plug	Communication interface
DC	Direct current
DEFT	Definite time characteristic (Tripping time does not depend on the height of the current.)
delta phi	Vector surge
df/dt	Rate-of-frequency-change
DI	Digital Input
Diagn Cr	Diagnosis counter(s)
Diagn.	Diagnosis
DIN	Deutsche Industrie Norm
dir	Directional
EINV	Extremely inverse tripping characteristic
EMC	Electromagnetic compatibility
EN	Europäische Norm
err. / Err.	Error
EVTcon	Parameter determines if the residual voltage is measured or calculated.
Ex	External
Ex Oil Temp	External Oil Temperature
ExBlo	External blocking(s)
ExP	External Protection - Module
ExP	External protection
Ext Sudd Press	Sudden Pressure
Ext Temp Superv	External Temperature Supervision
f	Frequency Protection Module
Fc	Function (Enable or disable functionality = allow or disallow.)
FIFO	First in first out
FIFO Principal	First in first out
fund	Fundamental (ground wave)
gn	Acceleration of the earth in vertical direction (9.81 m/s ²)
GND	Ground

h	Hour
HMI	Human machine interface (Front of the protective relay)
HTL	Manufacturer internal product designation
Hz	Hertz
I	Phase Overcurrent Stage
I	Fault current
I	Current
I-BF	Tripping threshold
I0	Zero current (symmetrical components)
I1	Positive sequence current (symmetrical components)
I2	Negative sequence current (symmetrical components)
I2>	Unbalanced Load-Stage
I2T	Thermal Characteristic
I4T	Thermal Characteristic
IA	Phase A current
IB	Phase B current
IC	Phase C current
IC's	Manufacturer internal product designation
Id	Differential Protection Module
IdG	Restricted Ground Fault Differential Protection Module
IdGH	Restricted Ground Fault Highset Protection Module
IdH	High-Set Differential Protection Module
IEC	International Electrotechnical Commission
IEC61850	IEC61850
IEEE	Institute of Electrical and Electronics Engineers
IG	Earth current protection - Stage
IG	Ground current
IG	Fault current
IGNom	Nominal ground current
IH1	1st harmonic
IH2	Module Inrush
IH2	2nd harmonic
in.	Inch

incl.	Include, including
InEn	Inadvertent Energization
Info.	Information
Interl.	Interlocking
Intertripping	Intertripping
INV	Inverse characteristic (The tripping time will be calculated depending on the height of the current)
IR	Calculated (residual) ground current
IRIG	Input for time synchronization (Clock)
IRIG-B	IRIG-B-Module
IT	Thermal Characteristic
IX	4th measuring input of the current measuring assembly group (either ground or neutral current)
J	Joule
kg	Kilogram
kHz	Kilohertz
kV	Kilovolt(s)
kVdc or kVDC	Kilovolt(s) direct current
I/In	Ratio of current to nominal current.
L1	Phase A
L2	Phase B
L3	Phase C
lb-in	Pound-inch
LED	Light emitting diode
LINV	Long time inverse tripping characteristic
LoE-Z1	Loss of Excitation
LoE-Z2	Loss of Excitation
Logics	Logic
LOP	Loss of Potential
LV	Low voltage
LVRT	Low Voltage Ride Through
m	Meter
mA	Milliampere(s), Milliamp(s)
man.	Manual

max.	Maximum
meas	Measured
min.	Minimum
min.	Minute
MINV	Moderately Inverse Tripping Characteristic
MK	Manufacturer Internal Product Designation Code
mm	Millimeter
MMU	Memory mapping unit
ms	Milli-second(s)
MV	Medium voltage
mVA	Milli volt amperes (Power)
N.C.	Not connected
N.O.	Normal open (Contact)
NINV	Normal inverse tripping characteristic
Nm	Newton-meter
No	Number
Nom.	Nominal
NT	Manufacturer internal product designation code
P	Reverse Active Power
Para.	Parameter
PC	Personal computer
PCB	Printed circuit board
PE	Protected Earth
p.u.	per unit
PF	Power Factor - Module
Ph	Phase
PQS	Power Protection - Module
pri	Primary
PROT or Prot	Protection Module (Master Module)
PS1	Parameter set 1
PS2	Parameter set 2
PS3	Parameter set 3
PS4	Parameter set 4

PSet	Parameter set
PSS	Parameter set switch (Switching from one parameter set to another)
Q	Reverse Reactive Power
Q->&V<	Undervoltage and Reactive Power Direction Protection
R	Reset
rec.	Record
rel	Relative
res	Reset
ResetFct	Reset function
RevData	Review data
RMS	Root mean square
Rst	Reset
RTD	Temperature Protection Module
s	Second(s)
SC	Supervision Contact (Synonyms: Life-Contact, Watchdog, State of Health Contact)
Sca	SCADA
SCADA	Communication module
sec	Second(s)
sec	Secondary
Sgen	Sine wave generator
Sig.	Signal
SNTP	SNTP-Module
SOTF	Switch Onto Fault - Module
StartFct	Start function
Sum	Summation
SW	Software
Sync	Synchrocheck
Sys.	System
t	Tripping delay
t or t.	Time
Tcmd	Trip command
TCP/IP	Communication protocol

TCS	Trip circuit supervision
ThR	Thermal replica module
TI	Manufacturer internal product designation code
TripCmd	Trip command
txt	Text
UL	Underwriters Laboratories
UMZ	DEFT (definite time tripping characteristic)
USB	Universal serial bus
V	Voltage-stage
V	Volts
V/f>	Overexcitation
V012	Symmetrical Components: Supervision of the Positive Phase Sequence or Negative Phase Sequence
Vac / V ac	Volts alternating current
Vdc / V dc	Volts direct current
VDE	Verband Deutscher Elektrotechnik
VDEW	Verband der Elektrizitätswirtschaft
VE	Residual voltage
VG	Residual voltage-Stage
VINV	Very inverse tripping characteristic
VTS	Voltage transformer supervision
W	Watt(s)
WDC	Watch dog contact (supervision contact)
www	World wide web
XCT	4th current measuring input (ground or neutral current)
XInv	Inverse characteristic

13.5 List of ANSI Codes

(This list is essentially based on IEEE Std C37.2-2008.)

IEEE C37.2 / ANSI	MRDT4	Functions
14		Underspeed
21		Distance Protection
21P		Phase Distance Protection
24		Overexcitation Protection (Volts per Hertz)
25		Synchronizing or Synchronism-check via 4th measuring channel of voltage measurement card
26		Temperature Protection
27		Undervoltage Protection
27(t)		Undervoltage (time dependent) Protection
27A		Undervoltage Protection (Auxiliar) via 4th measuring channel of voltage measurement card
27M		Undervoltage (time dependent) Phase Protection (Main)
27N		Neutral Undervoltage via 4th measuring channel of voltage measurement card
27TN		Third Harmonic Neutral Undervoltage via 4th measuring channel of voltage measurement card
32		Directional Power Protection
32F		Forward Power Protection
32R		Reverse Power Protection
37		Undercurrent / Under Power
38		Temperature Protection (optional via Interface/external Box)
40		Loss of Excitation / Loss of Field
46	I2>	Unbalanced Current Protection
46G		Unbalanced Generator Current Protection
47		Unbalanced Voltage Protection
48		Incomplete Sequence (Start-up time Supervision)
49	ThR	Thermal Protection
49M		Thermal Motor Protection
49R		Thermal Rotor Protection
49S		Thermal Stator Protection

IEEE C37.2 / ANSI	MRDT4	Functions
50BF	CBF	Breaker Failure
50	I	Instantaneous / Definite Time Overcurrent
50J		Jam (locked Rotor)
50P	50P	Instantaneous / Definite Time Overcurrent for the phase currents
50N/G	IG	Instantaneous / Definite Time Overcurrent for the ground element
50Ns	IG	Instantaneous / Definite Time Overcurrent for the ground element, sensitive measuring input
51	I	Inverse Time Overcurrent
51P		Inverse Time Overcurrent for the phase currents
51N/G	IG	Inverse Time Overcurrent for the ground element
51Ns	IG	Inverse Time Overcurrent for the ground element, sensitive measuring input
51LR		Locked Rotor
51LRS		Locked Rotor Start (during start sequence)
51C		Voltage Controlled Overcurrent
51Q	I	Negative Phase Sequence Overcurrent (multiple trip characteristics)
51V		Voltage Restrained Overcurrent
55		Power Factor Protection
56		Field Application Relay
59		Overvoltage Protection
59M		Phase Overvoltage Protection (Main)
59TN		Third Harmonic Neutral Overvoltage via 4th measuring channel of voltage measurement card
59A		Overvoltage Protection via 4th (Auxiliary) measuring channel of voltage measurement card
59N		Neutral Overvoltage Protection
60FL		Voltage Transformer Supervision
60L	CTS	Current Transformer Supervision
64R		Rotor Earth Fault Protection
64REF	IdG	Restricted Ground Fault Protection
66		Starts per h (Start Inhibit)

IEEE C37.2 / ANSI	MRDT4	Functions
67		Directional Overcurrent Protection
67N		Directional Overcurrent Protection for the ground element
67Ns		Directional Overcurrent Protection for the ground element, sensitive measuring input
68		Power Swing Blocking
74TC	TCS	Trip Circuit Supervision
78		Out of Step Tripping
78V		Vector Surge Protection
79		Auto Reclosure
81		Frequency Protection
81U		Underfrequency Protection
81O		Overfrequency Protection
81R		ROCOF (df/dt)
86		Lock Out
87	Id	Differential Protection (Generator/Transformer/Busbar)
87B		Busbar Differential Protection
87G	Id	Generator Differential Protection
87GN	IdG	Generator Ground Differential Protection
87M		Motor Differential Protection
87SV		Open CT Supervision (see also 87 / 87B)
87T	Id	Transformer Differential Protection
87TN	IdG	Transformer Ground Differential Protection
CLK	IRIG-B, ...	Clock synchronization (e. g. via IRIG-B)
DDR	Disturbance recorder	Non-fault disturbance recording
DFR	Fault recorder	Digital fault recording
LGC	Logic	Logic, scheme
MET	Measured Values	Substation metering (energy, amps, volts, watts, vars, power factor, demand)
SER	Event recorder	Time-tagged event data
TCM	TCS	Trip circuit monitor / supervision

13.6 Revision History

This chapter lists all changes since version 3.0. If you need a change history for the versions 2.x please contact SEG.

NOTICE!



In principle, all **3.x** hardware and software versions are compatible with each other. For special questions and more detailed information, please contact SEG Support.



Up to date documentation?

Please check the web site of SEG for the latest revision of this Technical Manual and if there is an Errata Sheet with updated information.

13.6.1 Version: 3.0

- Date: 2015-October-01
- Revision: C

Hardware

- A new front plate in dark gray color replaces the blue housing that had been used for all **2.x** versions.
- The new front plate features a USB interface for the connection with the *Smart view* operating software. (This replaces the serial interface of the **2.x** versions.)
- There is a new communication type “I” available:
RS485 (IEC 60870-5-103, MODBUS RTU, DNP3.0 RTU) + RJ45 Ethernet 100 Mbit/s (Modbus TCP, DNP3.0 TCP/UDP)
- “Conformal coating” is available now as an order option.
- The characters -2 in the typecode signify the major version upgrade from 2.x to 3.x.

Software

The device firmware is also available in Spanish language now.

Various small changes and restructuring have been made to the menu and the display.

Protection

Cause of trips are shown directly on the display.

Low Voltage Ride Through - LVRT

A second LVRT element has been added.

Loss of Potential - LOP

The Dead Bus Detection has been made configurable.

The breaker assignment is optional. (If no breaker has been assigned then the position is ignored.)

The general IOC blocking has been removed.

The load current threshold LOP . I< can be set with a range 0.5 to 4 In.

Q->&V< / ReCon

The reconnection part has been split off and has become an independent module.

The decoupling functions of the Reconnection module has been extended to all trip commands.

Temperature Protection Module - RTD

The trip command has been made selectable.

Differential Protection Module - Id

The setting precision has been increased.

Restricted Ground Fault Differential Protection Module - IdG, IdGH

The alarm signals have been enhanced.

SCADA

The DNP3 has been made available (with RTU/TCP/UDP).

New fiber-optic interfaces for SCADA.

Setting procedure (menu structure, default settings) has been modified.

New "SCADA connection status" signal.

Ethernet "TCP Keep Alive" according to RFC 793.

Bugfix:

- After a hardware exception, the IP address might have been lost.

SCADA / IEC 61850

New support of Direct-Control.

Support for LN descriptions via DAI entry in the SCD file.

Handling of InGGIO Ind improved.

Speed of GOOSE messages improved. Potential problem with time-correlated GOOSE messages fixed.

New Logical Nodes for energy counters, LVRT, Exp, TCM, 47.

New LNClass for sensors and monitoring.

Updated reports if angles become zero, and if angles of phasors exceed deadband.

Deadband algorithm improved.

It is now possible to assign IEC 61850 alarm signals to the LEDs of the device.

Counter for the number of active client-server connections added.

Missing modes of directional power fixed.

SCADA / Modbus

"Fast Status Register" added.

Configurable registers added.

Read Fault Recorder and some device-specific information via Modbus.

Stability of Modbus TCP improved.

IEC 60870-5-103

Bugfix:

- Problem with reading disturbances fixed.

SNTP

Start the network after protection is active.

Bugfix:

- SNTP might not have worked correctly in case of an empty battery.
- Default daylight-saving changed to "Sunday".

PC interface / Smart view connection

As of *Smart view* R4.30, it is possible to exchange the single-line for devices that support this.

The user interface supports the improved validation of IEC 61850 SCD files.

Characteristic curves can now be shown graphically.

There is now a Page Editor for creating single lines and device-pages.

Bugfix:

- After an interruption of communication, waveforms could no longer be received from the PC.
- After an interrupted download of the Device Model, file handling could be erroneous.

PC simulation

The LED status has been added to the simulation software.

Trend recorder

Bugfix:

- A memory leak has been fixed.

Analog Output - AnOut

Bugfix:

- After a restart of the device the output could peak to 100% for a short time.

When upgrading from a version 2.x device, the following must be noted with respect to the settings:



- All communication settings have to be re-defined. An automatic conversion is only partly possible.
- The VirtualOutput assignment of IEC 61850 communication has been restructured.

All assignment settings need to be re-defined.

- The reconnection part of Q->&V< has been split off as a new module ReCon. An automatic conversion is not possible.
- The V-Prot mode V<(t) has been abandoned and replaced by the LVRT module.

13.6.2 Version: 3.0.b

- Date: 2016-February-20
- Revision: C

Hardware

No changes.

Software

The self-monitoring has been improved.

Overcurrent - I[n]

Bugfix:

- An initialization issue has been fixed in the Overcurrent module. In case of MeasureMode I2 and DEFT characteristic, this issue could have caused a false pickup or trip after start-up.

Sys

Bugfix:

- Under special circumstances, an unintended warm restart had been possible.

SCADA / Modbus

Bugfix:

- The Modbus protocol did not read the system time correctly.

Self-Supervision

Bugfix:

- Warnings related to the internal temperature monitoring did not work correctly.

13.6.3 Version: 3.1

NOTICE!



This version has not been published!

- Date: 2017-March-06

Hardware

No changes.

Software

Reconnection - ReCon[n]

The Reconnection module has been enhanced according to VDE-AR-N 4120.

- The release condition has been made selectable via ReCon . Reconnect. Release Cond (options: V Internal Release, V Ext Release PCC, Both).
- The measuring method has been made selectable via ReCon . Measuring method (options: Fundamental, True RMS, Vavg).

SCADA

Datapoints have been added for the second instance of the Reconnection module.

TCP

Bugfix:

- Some problem with the PPP/TCP communication has been fixed.

13.6.4 Version: 3.4

- Date: 2017-October-01
- Revision: D

Hardware

- A metal protecting cap has been added to the LC connectors for the Ethernet / TCP/IP via fiber optics. Since the cap improves the EMC immunity it is recommended to always fasten it carefully after plugging in the LC connectors.
- There is a new communication type “T” available:

RS485 (IEC 60870-5-103, MODBUS RTU, DNP3.0 RTU) + RJ45 Ethernet 100 Mbit/s (IEC 61850, Modbus TCP, DNP3.0 TCP/UDP)

Software

- The device firmware is also available in Romanian language now.
- If the MRDT4 is connected to *Smart view* as of version 4.50 the synchronization of date and time automatically considers that the timezone settings might be different on PC and MRDT4.

Communication

The menu [Device Para / HMI / Security] now makes the following setting parameters available:

- »*Smart view via Eth*« activates or deactivates the access of Smart view via Ethernet.
- »*Smart view via USB*« activates or deactivates the access of Smart view via the USB interface.

(See  “1.4.3 Connection Passwords, Smart view Access”.)

IEC 60870-5-103

This communication protocol now supports the blocking of the transmission in Monitor Direction and the test mode. (See  “3.6 IEC60870-5-103”.)

Modbus

For devices with RS485 *and* Ethernet interfaces (communication types “I” or “T”), the project setting “Modbus RTU/TCP” is available now (via parameter [Device planning] *Scada . Protocol*«). This makes the device communicate via serial line (RTU) and Ethernet (TCP) in parallel. In particular, note that:

- All masters see the same set of states.
- All masters can reset latched states.
- All masters can control the same breaker, make resets and acknowledgments.

Device Para

The Reset dialog, that starts when the »C« key is pressed during a cold start, has been adapted to new security-related requests: Now there is a new setting parameter »*Config*».

Device Reset« that allows to remove options from the Reset dialog. (See [↪](#) “1.4.6 Reset to Factory Defaults, Reset All Passwords”).)

Overcurrent - I[n], IG[n]

All ANSI and IEC inverse time characteristics have a time limit now according to IEC 60255-151. (See [↪](#) “4.6.1 Characteristics”, [↪](#) “4.8.1 Characteristics”).)

A new inverse time characteristic “RINV” has been added. (See [↪](#) “4.6.1.4 R Inverse [RINV] - Characteristic”, [↪](#) “4.8.1.4 R Inverse [RINV] - Characteristic”).)

Thermal replica module - ThR

The setting range of the overload factor »K« has been extended (from 0.80–1.20) to 0.80–1.50 (IEC 60255-149).

SelfSupervision

Device-internal messages (in particular error messages) are now accessible under the menu [Operation / Self-Supervision / Messages].

All messages that can potentially appear here are described in a separate document, the “HighPROTEC Troubleshooting Guide” (DOK-HB-TS).

Supervision

The MRDT4 supervises the phase sequence and compares it with the setting that has been made at [Field Para / General Settings] »Phase Sequence« (i. e. “ACB” or “ABC”).

Under the menu [Operation / Status Display / Supervision / Phase Sequence], there is a specific signal for each CT and VT, which is set active if the check of the respective CT / VT finds that the actual phase sequence is different from the setting under [Field Para]. (See [↪](#) “4.19.4 Phase Sequence Supervision”).)

LEDs

There is a new automatic acknowledgment mode for all LEDs: The latching of all LEDs is acknowledged (reset) in case of an alarm (from any protection module) or in case of a *General Alarm*, »Prot . Alarm«.

The automatic acknowledgment must be activated by setting:

[Device Para / LEDs / LEDs group A / LED 1...n] »Latched« = “active, ack. by alarm”

(See [↪](#) “Manual Acknowledgment (by Pressing the C Key at the Panel)”).)

Manual Acknowledgment

It is possible to acknowledge LEDs, SCADA, binary output relays and / or a pending trip command by pressing the »C« key at the panel.

After assigning the required items to the »Ack via »C« key«, these are acknowledged by simply pressing the »C« key (for ca. 1 second).

If there is the need to be able to acknowledge without entering any password set an empty password for the level »Prot-Lvl1«. (See [↪](#) “Manual Acknowledgment (by Pressing the C Key at the Panel)”; for general information about passwords and security-related considerations, see [↪](#) “1.4 Security”).)

13.6.5 Version: 3.6

- Date: 2019-January-31

Software

The protection functions of the MRDT4 have been adapted to comply with the requirements of the VDE-AR-N-4110:2018.

Phase Fault Direction Detection

Bug fix: An error in the direction decision algorithm has been fixed that could lead to false direction decisions for "ACB" systems. ("ABC" phase sequences were not affected.)

»Superv. only«

A new Device Planning parameter »Superv. only« has been added to the following protection functions:

- IG[x] - Earth (Ground) Overcurrent protection (see [↳ "4.8.2 Ground \(Earth\) Overcurrent - Functionality"](#))

With the setting »Superv. only« = "yes", the functionality of the module is restricted to a supervision function: The alarm and trip decisions still exist as states that be checked at the menu branch [Operation / Status Display] and can be assigned as select options), but these do no longer result in a General Alarm or General Trip, and as a consequence, no trip command is given. (See [↳ "4.1.1 General Alarms and General Trips"](#).)

Security Menu

A lot of enhancements of this HighPROTEC Release refer to the topic IT Security.

There is a new menu branch [Operation / Security / Security States] that collects information about various security-related settings. For example, there are entries telling you whether the connection passwords have been set to some user-specific value, or are still at their factory default. If IT security is a concern for your application, it is recommended to check all these entries during commissioning. (See [↳ "Security-Related Settings Overview"](#).)

Moreover, there is a Security Logger accessible at the menu path [Operation / Security / Security Logger]. It shows a sub-set of the *self-supervision messages* (see below), restricted to only the security-related messages. (See [↳ "Security-Related Messages"](#).)

Smart view Access

Another security-related change is that the MRDT4 accepts connections only from recent versions of *Smart view*.

It is possible to define *Smart view* connection passwords: There is a password »USB connection« for the connection via the USB interface, and there is another password »Remote network connection« for a connection via network. After a connection password has been set, *Smart view* will establish a connection only after the respective password has been entered. (The factory default, however, has blank values set for both connection passwords.)

All connections are now encrypted, and certificates guarantee the correct identity of the communication parties.

(See [↳ "1.4.3 Connection Passwords, Smart view Access"](#).)

Passwords

Passwords are now stored in a way such that they “survive” a firmware update. (See [“1.4.2 Passwords”](#).)

Time Penalties for False Passwords

If a wrong password is being entered several times, then the MRDT4 blocks any further password entry for an increasing amount of time, until a correct password has been entered. A dedicated message informs the user about this blocking. This behavior refers to all types of passwords (including the connection passwords mentioned above), but it affects only the password entry, so that it does not prevent the user from doing some other, “password-free” activities during this blocking time.

See [“Time Penalty for Wrong Password Entry”](#).

Self-Supervision, Syslog

The Recorder for self-supervision messages, that is accessible via the menu branch [Operation / Self-Supervision / Messages], has been enhanced, so that it now also collects various security-related messages (e. g. every entry of a false password) and MRDT4-internal status messages, warnings and error messages.

A Syslog module can be activated, that automatically transmits every new internal (self-supervision) message to some dedicated server-computer. It uses the “Syslog” protocol that is a widely known standard for the transmission of log messages.

See [“9.2 Self-Supervision Messages”](#), [“9.3 Syslog”](#).

SCADA »Slave ID«

For all SCADA protocols, the »Slave ID« is no longer a setting parameter, but a Direct Command.

Since Direct Commands are never saved as part of an *.HptPara setting file, there is no longer the risk of breaching the uniqueness requirement of Slave IDs by loading one *.HptPara file into several HighPROTEC devices. But of course, this additional safety comes with the disadvantage that while commissioning, the »Slave ID« must always be set even if a prepared *.HptPara file is used.

New Communication Protocol IEC 60870-5-104

The communication protocol according to IEC 60870-5-104 is available now.

See [“3.7.1 IEC 60870-5-104”](#).

This protocol can also be used as time synchronization source. (See [“3.8 Time Synchronization”](#).)

Configurable Data Points for Modbus and IEC 60870-5-104

The communication protocols Modbus and IEC 60870-5-104 can now be adapted to the application by (re-)mapping the data-points. This helps to smoothly integrate the MRDT4 in an existing substation network. A new tool for Windows operating systems, *SCADApter*, is available for mapping the data-points to protocol-internal addresses.

See [“3.7.3 Data-Point Mapping Using the SCADApter”](#) and the separate *SCADApter* documentation.

Communication Protocol IEC 61850

The parameters for the Virtual Inputs and Outputs have been renamed.

The number of available Virtual Inputs and Outputs has been increased (from 32) to 64.

See [↪](#) “3.4 IEC 61850”.

Manual Acknowledgment of LEDs

It is now possible to acknowledge (reset) latched LEDs by pressing the »C« key for about 1 second without entering a password. This is due to a new default value for the following parameter: [Device Para / Acknowledge] »Ack via »C« key« = „Ack LEDs w/o passw.“

See [↪](#) “Manual Acknowledgment (by Pressing the C Key at the Panel)”.

Binary Outputs, LEDs, Trip Manager

The feature for inverting a trigger (input) signal has been modified.

Latching behavior has been modified: Now there are some more conditions that cause a reset of a latched state.

(See [↪](#) “2.14.3 Output Relays Settings”, [↪](#) “2.14.1 LEDs”, [↪](#) “Trip Manager - Assignment of commands”.)

Differential Protection Module - Id

The CT saturation trigger of temporary restraining has been improved in accuracy. This involves a replacement of the previous settings »CT Satur Monit«, CT Satur Sensitv by new parameters »CT Satur. Stab.«, Id.

(See [↪](#) “Monitoring of the CT Saturation (CT Saturation Stabilization)”.)

Technical Manual

The technical documentation has been split into two independent documents:

- The *User Manual* (i. e. this document, MRDT4-3.7-EN-MAN) describes the MRDT4 with its features and applications.

Compared to the previous HighPROTEC Release, all chapters of the User Manual have been thoroughly revised and edited for the sake of a better readability and correctness.

- The *Reference Manual* MRDT4-3.7-EN-REF contains all the parameters, settings, values and binary states. For each entry, there is a table with all properties, e. g. the menu branch, module name, default value and value range, plus a short help text.
- The naming scheme for the technical documents has been changed. In particular, the Release number is part of the document ID now. In principle, all document IDs should follow the naming scheme
”<device(s)>-<version>-<language>-<document type>”. (See also [↪](#) “1.1 Comments on the Manual”.)

This Technical Manual, for example, was previously (i. e. until Revision 3.4) named DOK-HB-MRDT4-2D. Now it has been renamed to MRDT4-3.7-EN-MAN.

A chapter about CT Requirements has been added, see [↪](#) “2.5.3.2 CT Requirements”.

13.6.6 Version: 3.7

- Date: 2020-April-30

Scope of Delivery

Due to environmental and efficiency considerations, the product DVD is no longer part of the standard delivery of HighPROTEC devices.

Our experience shows that most users prefer to directly download all technical documentation (User Manual, Reference Manual, etc.) and setup files for the Windows applications (Smart view, DataVisualizer, Page Editor, SCADApter) from the web address [⇒ http://wwdmanuals.com/MRDT4-2](http://wwdmanuals.com/MRDT4-2). Note that this URL is also available as a QR code directly on the housing of the device.

If the product DVD is still required, for example for users who are not connected to the internet, it can be ordered separately.

(See also [↪](#) “Scope of Delivery”.)

Hardware

HighPROTEC devices with a large (128 x 128 pixel) display will be delivered with a display from another manufacturer. This display is feature-compatible in any respect with the previous one, except that it requires a firmware with an adapted display driver.

Software

A new display driver has been added, that is compatible with the new hardware.

- This means that this Release features all drivers for all HighPROTEC hardware (including previous devices), so that it is also possible to upgrade previous HighPROTEC hardware (except old 2.x Releases, i. e. devices with RS232 serial interface).

Some setting names and help texts have been revised to improve the clarity and use some common uniform terminology.

In particular, the following be mentioned:

- For the setting parameters »I . Reset Mode« and »IG . Reset Mode«, the option that is related to the inverse-time characteristics has been renamed from “calculated” to “inverse time”.

Differential Protection Module - Id

The CT Saturation Stabilization function (for the phase differential protection) has been improved with respect to external faults with CT saturation.

(See [↪](#) “Monitoring of the CT Saturation (CT Saturation Stabilization)”.)

IEC 60870-5-103

Disturbance records have been added to the SCADApter.

Profibus, IEC 60870-5-103

The communication protocols Profibus and IEC 60870-5-103 can now be adapted to the application by (re-)mapping the data-points. This helps to smoothly integrate the MRDT4 in an existing substation network.

The Windows tool *SCADApter* has been enhanced correspondingly, so that mapping the data-points to protocol-internal addresses can be carried out for these protocols (in addition to the SCADA protocols Modbus and IEC 60870-5-104, that have already been configurable as of Release 3.6).

As a consequence of this, the document entitled “**IEC 60870-5-103 Data Point List**” is no longer maintained:

- The declaration of IEC 60870-5-103 Interoperability that had been part of that document, is now available as a new chapter within the Appendix of this User Manual. See [↪](#) “13.2 IEC 60870-103 Interoperability”.
- Since the Data Point List can be configured using *SCADApter*, the default set of data points is available as a file `IEC103_Default_IU.HptSMap` for direct use within *SCADApter*, instead of a chapter within “IEC 60870-5-103 Data Point List”.

This file can be downloaded directly (and without any costs) from [⇒ http://wwdmanuals.com/MRDT4-2](http://wwdmanuals.com/MRDT4-2), or it can be found on the product DVD. (The DVD, however, must be ordered separately, see “Scope of Delivery” above.)

- In the same way, data point mapping files `IEC104_Default_IU.HptSMap` and `Profibus_Default_IU.HptSMap` are available, too, as starting templates for the SCADA protocols IEC 60870-5-104 and Profibus, respectively.

See [↪](#) “3.7.3 Data-Point Mapping Using the *SCADApter*” and the separate *SCADApter* documentation for general information about configurable SCADA protocols.

IEC 60870-5-103

Disturbance records have been added to the *SCADApter*.

The »Slave ID« is no longer a setting parameter, but a Direct Command, so that it is not saved as part of an *.HptPara setting file.

Energy values are now available with Type 41. (This way the transmission of energy values is now compatible with the behavior of System Line devices.)

Profibus

Measurement values can now be configured as Big Endian values in *SCADApter*.

Smart view, DataVisualizer, Page Editor, SCADApter

These administrative and control applications for the Windows operating system have been redesigned. The new look is modern, straight-forward and fits well to the standard design concepts of Windows 10.

SCADA Documentation

The *SCADA documents* have been adapted to the layout and style of the *User Manual* (i. e. this document).

Index

A

ANSI	
26	293
38	293
46	269
49	275, 293
50	218
50BF	302
50N/G	245
51	218
51N/G	245
51Q	218, 239
60L	310
62BF	302
64REF	213
ANSI EINV (earth/ground overcurrent characteristic)	259
ANSI EINV (phase overcurrent characteristic)	231
ANSI MINV (earth/ground overcurrent characteristic)	256
ANSI MINV (phase overcurrent characteristic)	228
ANSI VINV (earth/ground overcurrent characteristic)	258
ANSI VINV (phase overcurrent characteristic)	230
Adaptive Parameter Sets	50
Adaptive Parameters	41
access areas	67
access level password	62
acknowledge	
latched LEDs / output relays / SCADA signals / trip command	72

acknowledgment	66
B	
Bypass the Setting Lock	49
C	
CBF	302
CT Supervision	310
CTS	310
Circuit breaker failure protection module	302
Counters	41
certificate	63
characteristics (earth/ground overcurrent)	246
characteristics (phase overcurrent)	219
connection password	62, 63
control	349
cryptographic algorithm	63
cutoff levels (for measured values)	77
D	
D-SUB	34, 128, 129
DEFT (earth/ground overcurrent characteristic)	249
DEFT (phase overcurrent characteristic)	221
DNP3	34, 148
Default Passwords	62
Device Stopped	381
Differential Protection Module	192
Direct Commands	41
Display of the LED configuration	135
demand values	
system current	351

E

Earth current protection - Stage	245
ErPara file	41
Ethernet	34, 119, 130
Ext Sudd Press	291
encrypted connection	63
external OPEN/CLOSE command	318

F

fiber optic	34, 127, 130
-------------------	--------------

G

Generator Reference System	23
Global Parameters	41

H

HMI	37, 65
-----------	--------

I

I2>	269
I2>[x]	239
I2T (earth/ground overcurrent characteristic)	265
I2T (phase overcurrent characteristic)	236
I4T (earth/ground overcurrent characteristic)	266
I4T (phase overcurrent characteristic)	237
IEC EINV (earth/ground overcurrent characteristic)	253
IEC EINV (phase overcurrent characteristic)	225
IEC LINV (earth/ground overcurrent characteristic)	255
IEC LINV (phase overcurrent characteristic)	227

IEC NINV (earth/ground overcurrent characteristic)	250
IEC NINV (phase overcurrent characteristic)	222
IEC VINV (earth/ground overcurrent characteristic)	252
IEC VINV (phase overcurrent characteristic)	224
IEC 60870-5-103	34, 123, 156
IEC 60870-5-104	34, 160
IEC 61850	35, 146
IG[x]	245
IH2	243
INFO key	135
IT (earth/ground overcurrent characteristic)	264
IT (phase overcurrent characteristic)	235
IT Security	60
I[x]	218
Id	192
IdG	213
interlockings	319
K	
keys	
CTRL	349
L	
LC connector	35, 130
LED Test	76
LED »System«	385
LEDs	
Latching	135
System OK LED	137
acknowledge/reset latching	136

configuration	134
configuration info	135
Load Reference Arrow System	23
Logic	367
Cascading Logic Equations	369
Cascading Logic Equations in ascending sequence	369
Cascading Logic Equations in descending sequence	370
M	
Measured Value	41
Modbus	34, 123, 164
Module Input	41
Module Inrush	243
menu structure	54
message (self-supervision)	378
minimum / maximum values	353
N	
network access	63
O	
Order Form (Order Code)	31
P	
Page Editor	314
Phase Overcurrent Stage	218
Please wait\nSystem locked	49
Profibus	34, 145
panel	37, 65
password	65
passwords	
access areas	67

deactivate	66
reset	62, 70
peak demand values	353
phase angles (calculation)	77

R

RINV (earth/ground overcurrent characteristic)	260
RINV (phase overcurrent characteristic)	232
RJ45	34, 119
RS485	34, 123
RTD	293
RXIDG (earth/ground overcurrent characteristic)	261
Recorder	354
(Motor) History	354
Disturbance records	354, 355
Event records	354, 365
Fault records	354, 360
Motor Statistics	354
Motor start records	354
Self-Supervision messages	354
Trend records	354, 366
security-related messages	354
Reset Dialog	70
Restricted Ground Fault Differential Protection Module	213
reboot codes	376
reset delay (earth/ground overcurrent)	247
reset delay (phase overcurrent)	220
reset latched states (= acknowledge)	72
reset to factory defaults	70
ring-terminal connection	105

S

SC	132
SCADA	349
SOTF	278
ST connector	34, 127
Safety-specific settings	60
Security	60
Security Logger	61
Security States	60
Self-Supervision Contact	132
Self-Supervision messages	378
Setting Group Parameters	41
Setting Lock	49
Signals	41
Softkeys	40
Statistical Value	41
Sudden Pressure	291
Switch Onto Fault - Module	278
Syslog	379
System LED	381
System-LED	385
scaling of measured values	77
security-related messages	378
single-line	349
single-line diagram	314
start-up codes	376
supervision timer (for switchgears)	318
switchgear	349
switching authority	
local	349
remote	349

T

THD (Total Harmonic Distortion)	353
Temperature Protection Module	293
ThR	275
Therm Flat (phase overcurrent characteristic)	234, 263
Thermal replica module	275
Trip Manager	319, 343
Typecode (see Order Form)	31
temperature unit	77
transformer differential protection	13
trip delay (earth/ground overcurrent)	
trip delay (phase overcurrent)	

U

Unbalanced Load-Stage	239, 269
-----------------------------	----------

V

Values	41
--------------	----

⚙

⚙ Image References

(11)	344
(14)	180, 238, 267, 271, 275, 286, 288, . 290, 291, 297, 305
(14*)	286, 288, 290, 291
(15)	180, 238, 267, 271, 275, 286, 288, . 290, 291, 297
(15a)	180, 238, 267, 272, 276, 286, 288, . 290, 291, 297
(16b)	238
(17b)	238
(18b)	238
(19)	267

(24b) 238

(25b) 238

(26b) 238

(27) 268

(32) 187

(40) 311

(41) 341

(42) 342

(50) 180, 182

(51) 180, 183

(54) 180, 267

(55) 181, 267

(1) 179

(2) 188

(3) 187

(4G) 191

(4) 189

(5) 243

(6) 243

(7) 243

(8) 243

docs.SEGelectronics.de/mrdt4-2

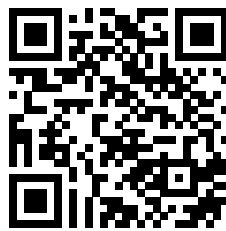

SEG Electronics GmbH reserves the right to update any portion of this publication at any time. Information provided by SEG Electronics GmbH is believed to be correct and reliable. However, SEG Electronics GmbH assumes no responsibility unless otherwise expressly undertaken.



SEG Electronics GmbH
Krefelder Weg 47 • D-47906 Kempen (Germany)
Postfach 10 07 55 (P.O.Box) • D-47884 Kempen (Germany)
Telephone: +49 (0) 21 52 145 1

Internet: www.SEGelectronics.de

Sales
Telephone: +49 (0) 21 52 145 331
Fax: +49 (0) 21 52 145 354

Service
Telephone: +49 (0) 21 52 145 614
Fax: +49 (0) 21 52 145 354

SEG Electronics has company-owned plants, subsidiaries, and branches, as well as authorized distributors and other authorized service and sales facilities throughout the world.

Complete address / phone / fax / email information for all locations is available on our website.