

WIRING DIAGRAMS

High **PROTEC** | PROTECTION TECHNOLOGY
MADE SIMPLE

MCDGV4 | Generator Protection

Version: 3.10

Original document

English

This document does not replace the Technical Manual.

MCDGV4-2A0AAA

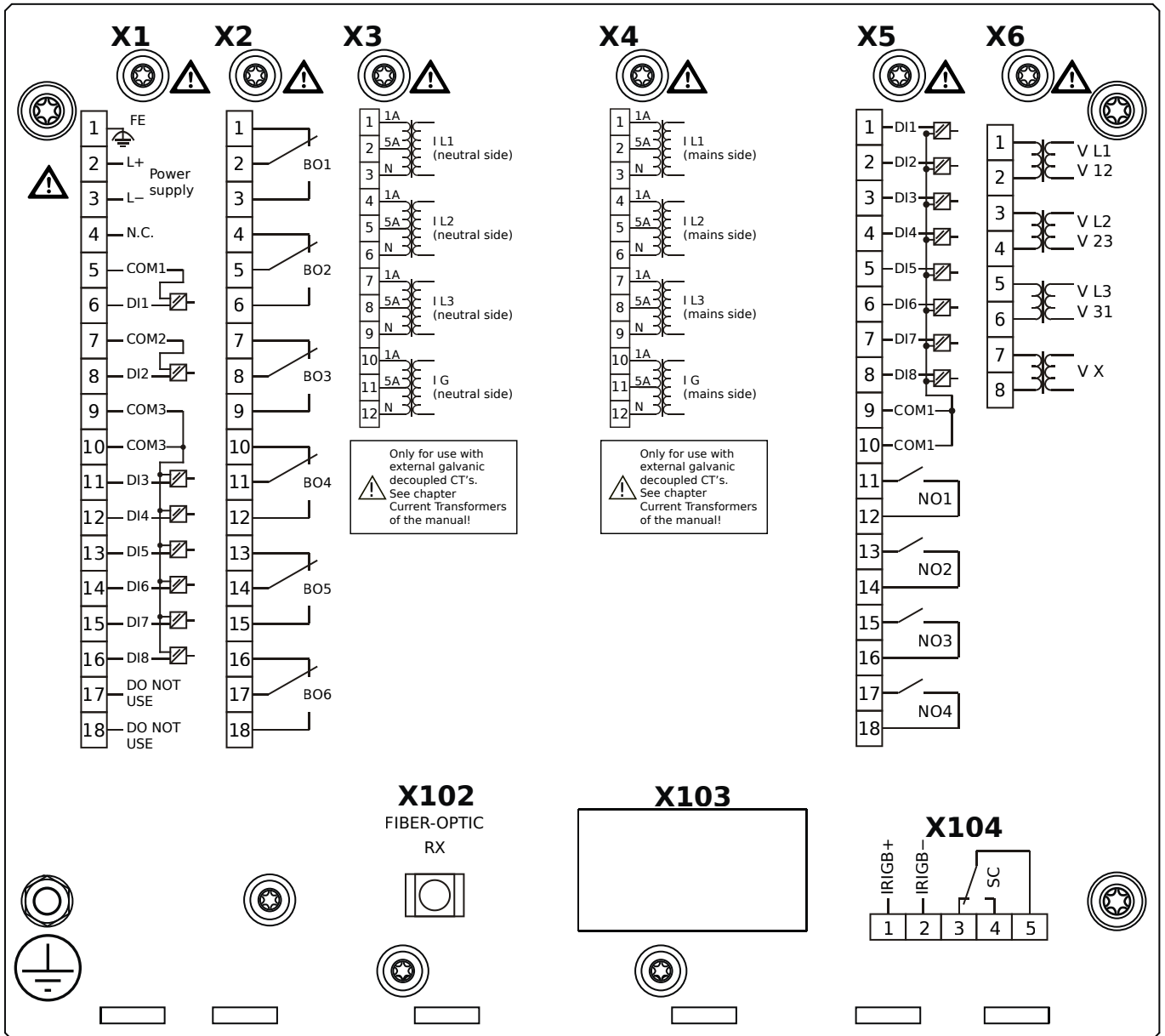

Housing B2, large display, door mounting

- X1** – DI8-X1: Wide-range power supply unit, incl. 2 non-grouped digital inputs and 6 grouped digital inputs
- X2** – OR6: Assembly Group with 6 Output Relays (Changeover / Form C)
- X3** – TI: Standard current measuring card (for the neutral side of the differential protection)
- X4** – TI: Standard current measuring card (for the mains side of the differential protection)
- X5** – DI8-OR4: Assembly Group with 8 Digital Inputs and 4 Output Relays (NO / Form A)
- X6** – TU: Card with 4 voltage transformer measuring inputs (0 ... 800 VAC, under UL: 0 ... 600 VAC)
- X102** – Universal Resistance-Temperature Detector (URTD) input, Fiber optics interface, Versatile Link
- X104** – IRIG-B00X, incl. System Contact (Supervision Contact)

MCDGV4-2A0AAB

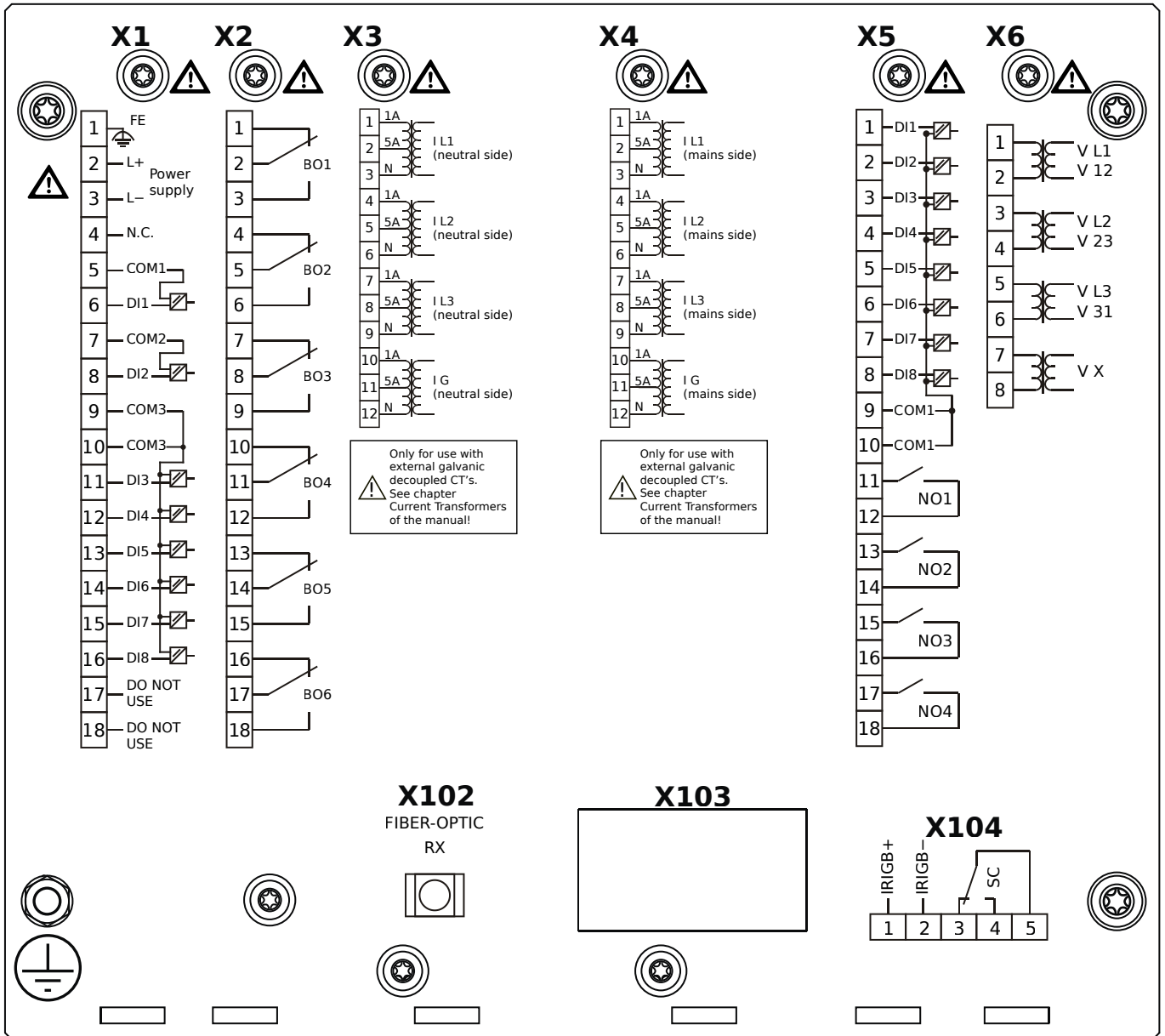

Housing B2, large display, door mounting

- + Conformal Coating (for installations in harsh environment)

- X1** – DI8-X1: Wide-range power supply unit, incl. 2 non-grouped digital inputs and 6 grouped digital inputs
- X2** – OR6: Assembly Group with 6 Output Relays (Changeover / Form C)
- X3** – TI: Standard current measuring card (for the neutral side of the differential protection)
- X4** – TI: Standard current measuring card (for the mains side of the differential protection)
- X5** – DI8-OR4: Assembly Group with 8 Digital Inputs and 4 Output Relays (NO / Form A)
- X6** – TU: Card with 4 voltage transformer measuring inputs (0 ... 800 VAC, under UL: 0 ... 600 VAC)
- X102** – Universal Resistance-Temperature Detector (URTD) input, Fiber optics interface, Versatile Link
- X104** – IRIG-B00X, incl. System Contact (Supervision Contact)

MCDGV4-2A0ABA

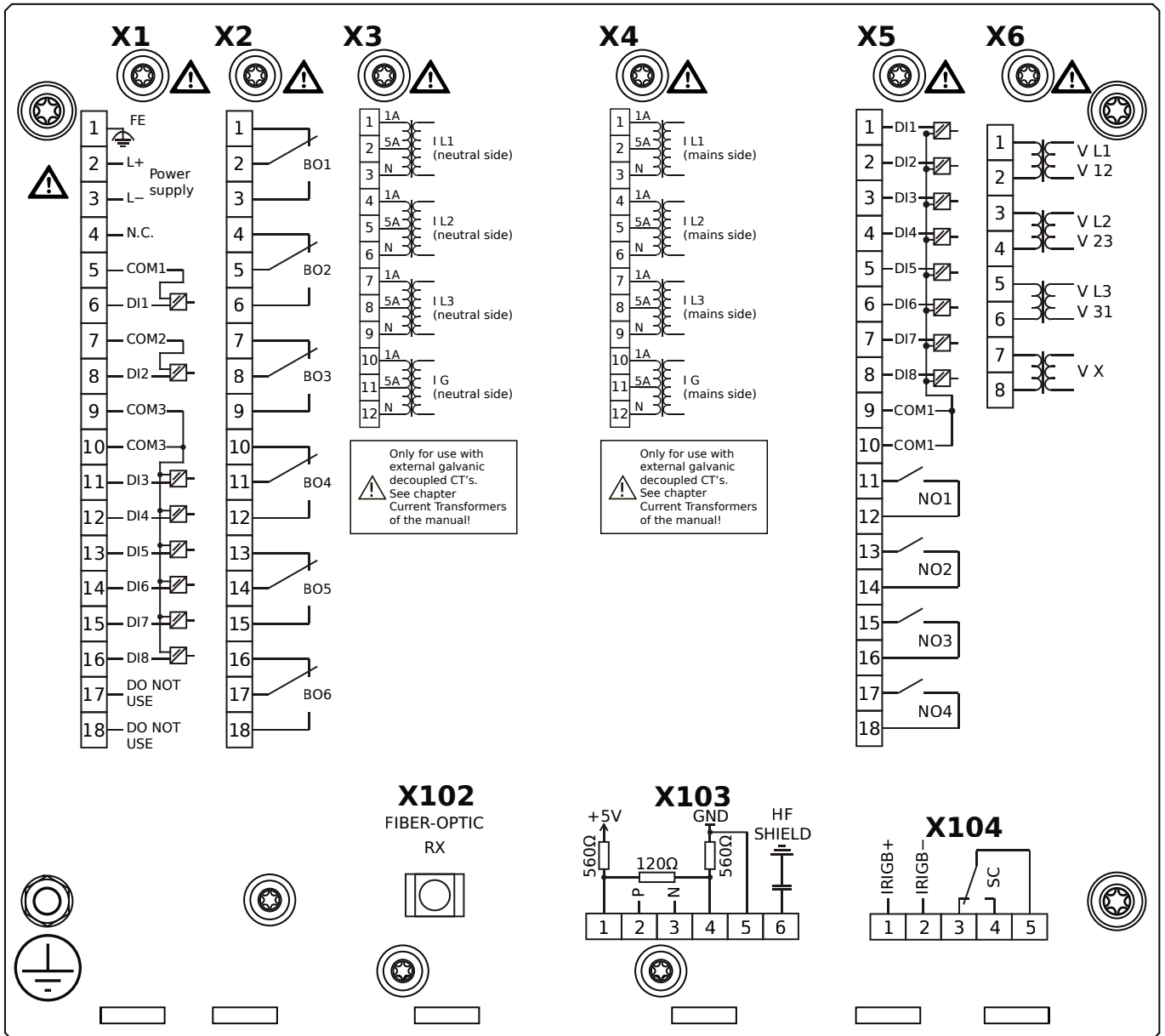

Housing B2, large display, door mounting

- X1** – DI8-X1: Wide-range power supply unit, incl. 2 non-grouped digital inputs and 6 grouped digital inputs
- X2** – OR6: Assembly Group with 6 Output Relays (Changeover / Form C)
- X3** – TI: Standard current measuring card (for the neutral side of the differential protection)
- X4** – TI: Standard current measuring card (for the mains side of the differential protection)
- X5** – DI8-OR4: Assembly Group with 8 Digital Inputs and 4 Output Relays (NO / Form A)
- X6** – TU: Card with 4 voltage transformer measuring inputs (0 ... 800 VAC, under UL: 0 ... 600 VAC)
- X102** – Universal Resistance-Temperature Detector (URTD) input, Fiber optics interface, Versatile Link
- X103** – Modbus RTU / IEC 60870-5-103 / DNP3.0 RTU, RS485, Terminals
- X104** – IRIG-B00X, incl. System Contact (Supervision Contact)

MCDGV4-2A0ABB

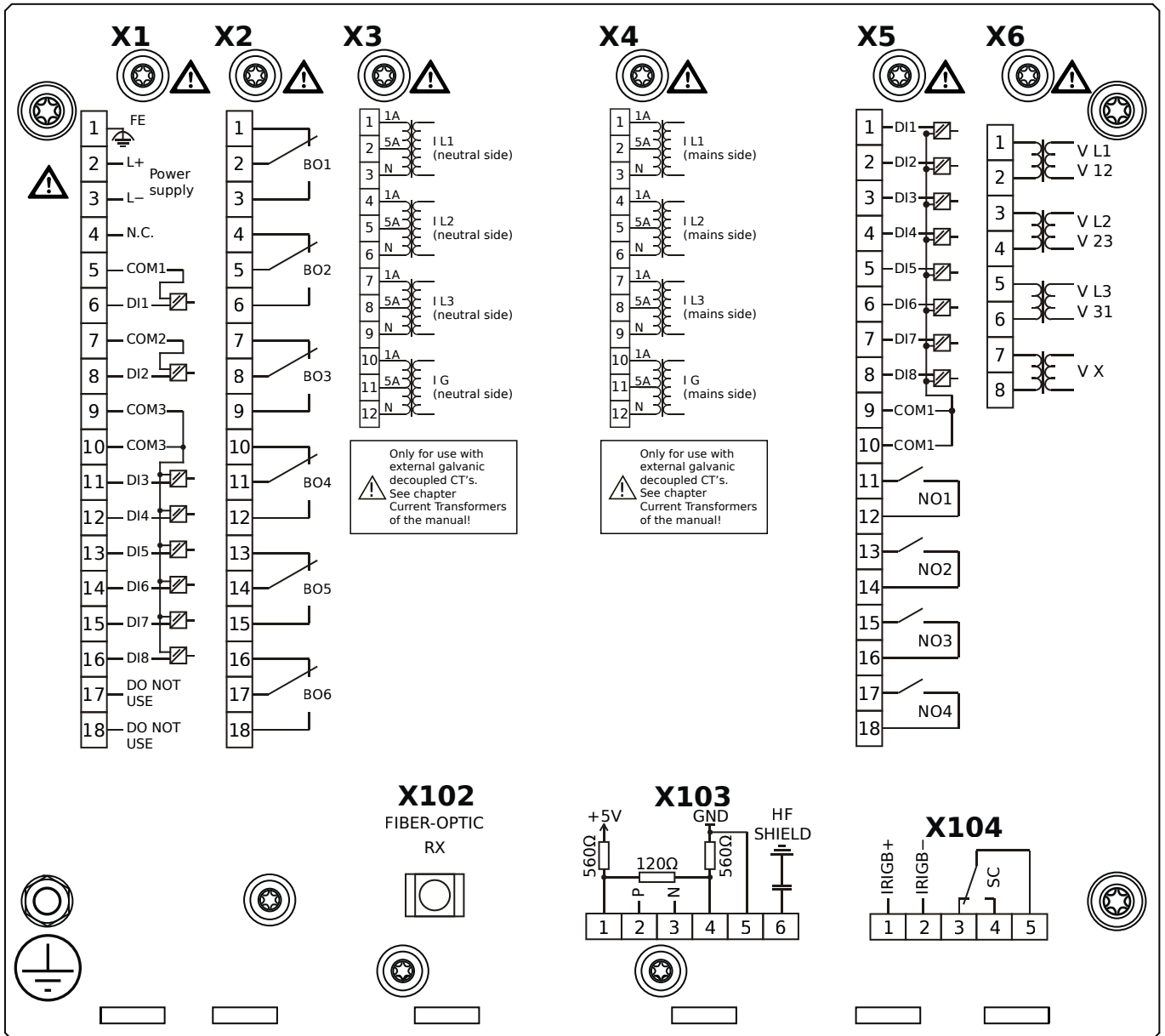

Housing B2, large display, door mounting

+ Conformal Coating (for installations in harsh environment)

- X1** – DI8-X1: Wide-range power supply unit, incl. 2 non-grouped digital inputs and 6 grouped digital inputs
- X2** – OR6: Assembly Group with 6 Output Relays (Changeover / Form C)
- X3** – TI: Standard current measuring card (for the neutral side of the differential protection)
- X4** – TI: Standard current measuring card (for the mains side of the differential protection)
- X5** – DI8-OR4: Assembly Group with 8 Digital Inputs and 4 Output Relays (NO / Form A)
- X6** – TU: Card with 4 voltage transformer measuring inputs (0 ... 800 VAC, under UL: 0 ... 600 VAC)
- X102** – Universal Resistance-Temperature Detector (URTD) input, Fiber optics interface, Versatile Link
- X103** – Modbus RTU / IEC 60870-5-103 / DNP3.0 RTU, RS485, Terminals
- X104** – IRIG-B00X, incl. System Contact (Supervision Contact)

MCDGV4-2A0ACA

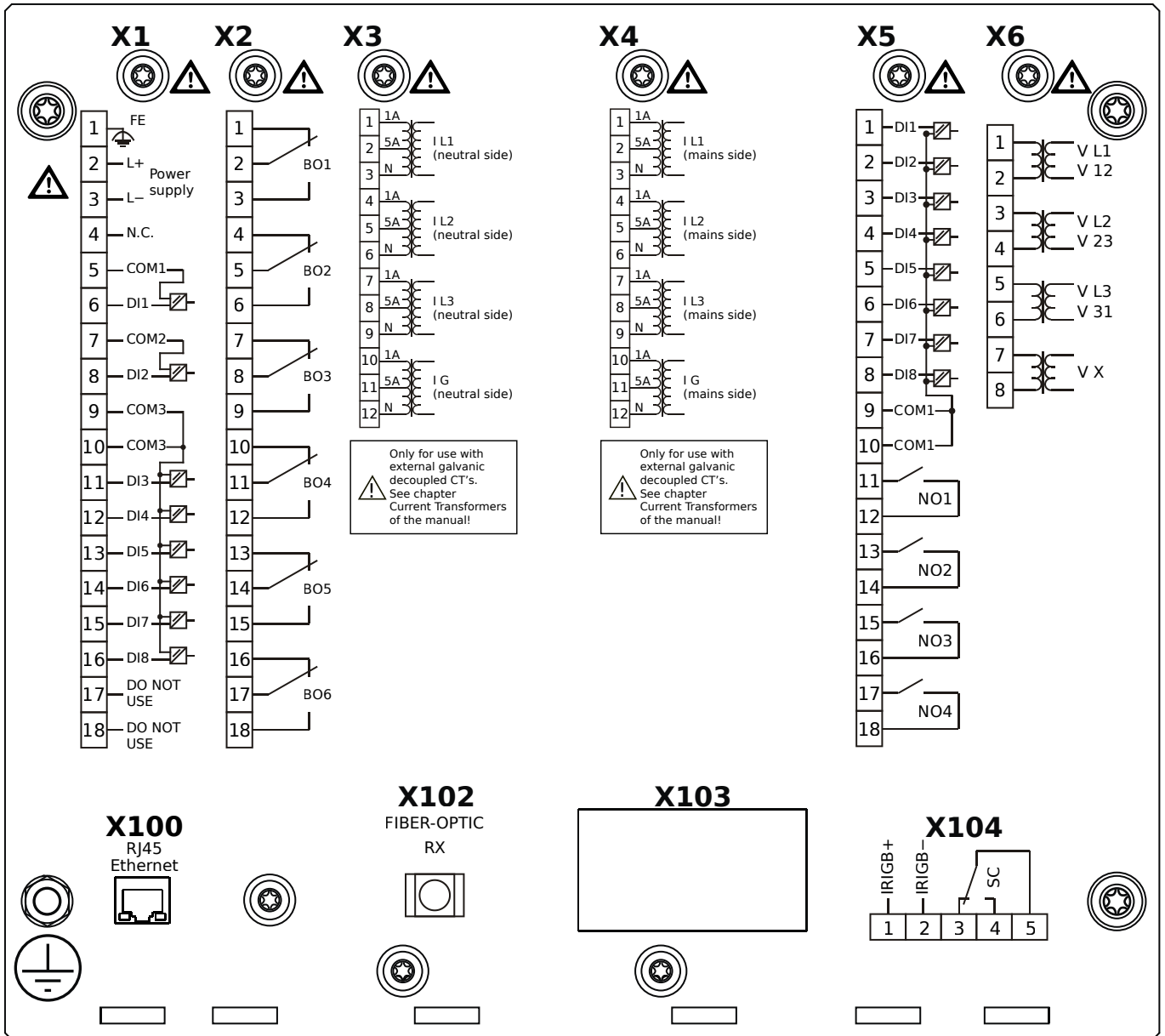

Housing B2, large display, door mounting

- X1** – DI8-X1: Wide-range power supply unit, incl. 2 non-grouped digital inputs and 6 grouped digital inputs
- X2** – OR6: Assembly Group with 6 Output Relays (Changeover / Form C)
- X3** – TI: Standard current measuring card (for the neutral side of the differential protection)
- X4** – TI: Standard current measuring card (for the mains side of the differential protection)
- X5** – DI8-OR4: Assembly Group with 8 Digital Inputs and 4 Output Relays (NO / Form A)
- X6** – TU: Card with 4 voltage transformer measuring inputs (0 ... 800 VAC, under UL: 0 ... 600 VAC)
- X100** – Modbus TCP / DNP3.0 TCP/UDP, Ethernet interface, 100 Mbit/s, RJ45 (BASE100-FX)
- X102** – Universal Resistance-Temperature Detector (URTD) input, Fiber optics interface, Versatile Link
- X104** – IRIG-B00X, incl. System Contact (Supervision Contact)

MCDGV4-2A0ACB

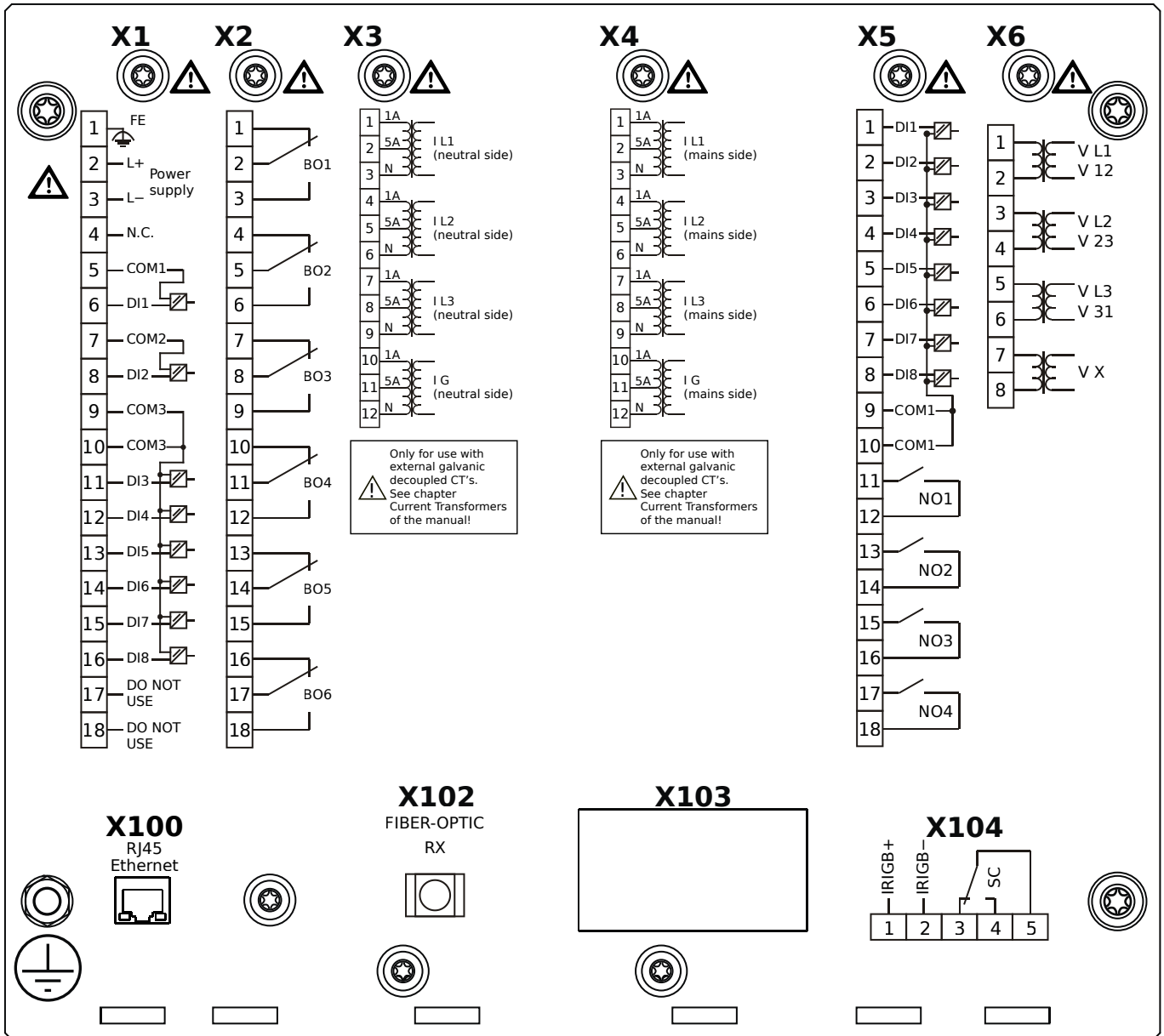

Housing B2, large display, door mounting

+ Conformal Coating (for installations in harsh environment)

- X1** – DI8-X1: Wide-range power supply unit, incl. 2 non-grouped digital inputs and 6 grouped digital inputs
- X2** – OR6: Assembly Group with 6 Output Relays (Changeover / Form C)
- X3** – TI: Standard current measuring card (for the neutral side of the differential protection)
- X4** – TI: Standard current measuring card (for the mains side of the differential protection)
- X5** – DI8-OR4: Assembly Group with 8 Digital Inputs and 4 Output Relays (NO / Form A)
- X6** – TU: Card with 4 voltage transformer measuring inputs (0 ... 800 VAC, under UL: 0 ... 600 VAC)
- X100** – Modbus TCP / DNP3.0 TCP/UDP, Ethernet interface, 100 Mbit/s, RJ45 (BASE100-FX)
- X102** – Universal Resistance-Temperature Detector (URTD) input, Fiber optics interface, Versatile Link
- X104** – IRIG-B00X, incl. System Contact (Supervision Contact)

MCDGV4-2A0ADA

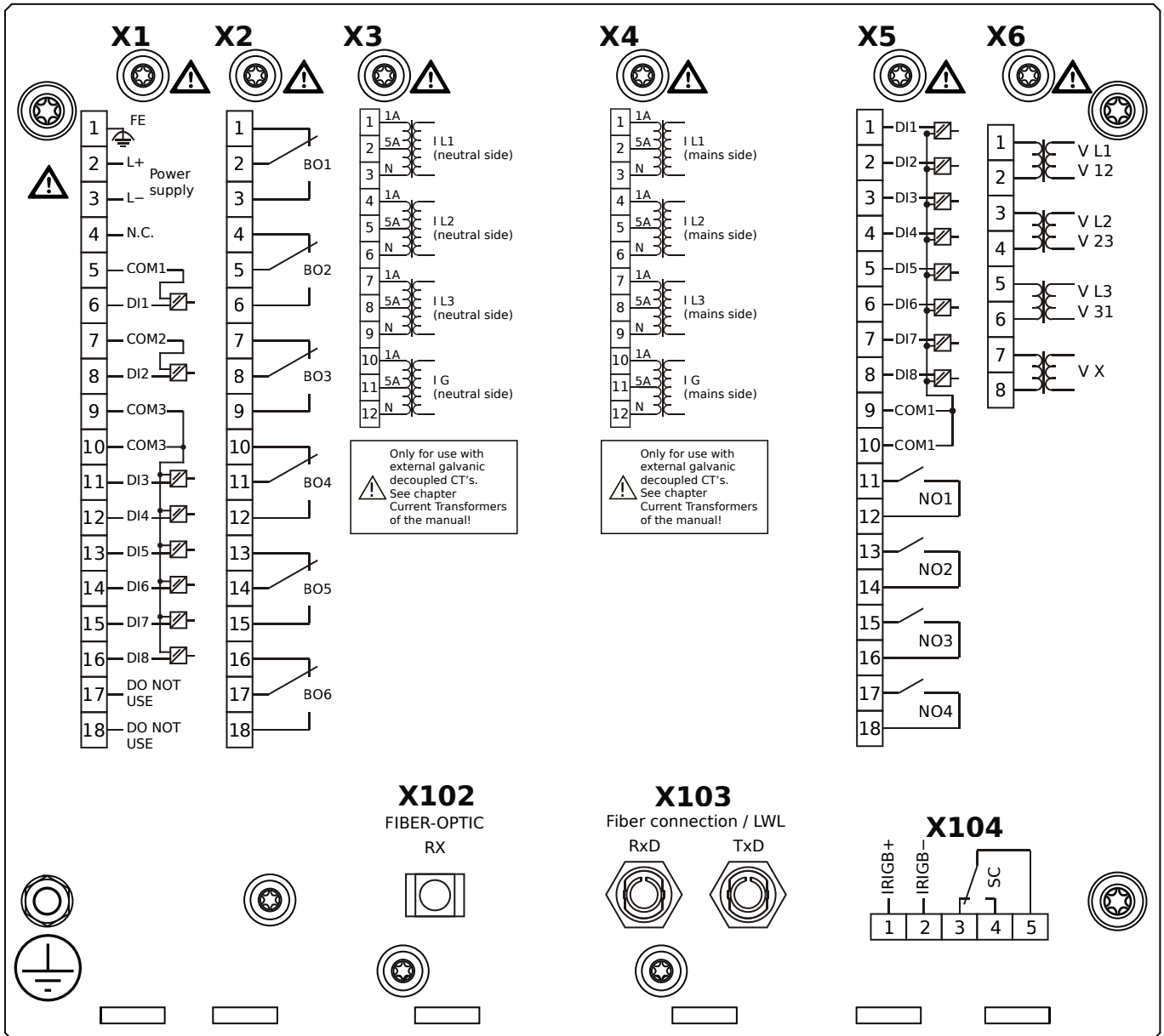

Housing B2, large display, door mounting

- X1** – DI8-X1: Wide-range power supply unit, incl. 2 non-grouped digital inputs and 6 grouped digital inputs
- X2** – OR6: Assembly Group with 6 Output Relays (Changeover / Form C)
- X3** – TI: Standard current measuring card (for the neutral side of the differential protection)
- X4** – TI: Standard current measuring card (for the mains side of the differential protection)
- X5** – DI8-OR4: Assembly Group with 8 Digital Inputs and 4 Output Relays (NO / Form A)
- X6** – TU: Card with 4 voltage transformer measuring inputs (0 ... 800 VAC, under UL: 0 ... 600 VAC)
- X102** – Universal Resistance-Temperature Detector (URTD) input, Fiber optics interface, Versatile Link
- X103** – Profibus-DP, Fiber optics interface, ST Connector
- X104** – IRIG-B00X, incl. System Contact (Supervision Contact)

MCDGV4-2A0ADB

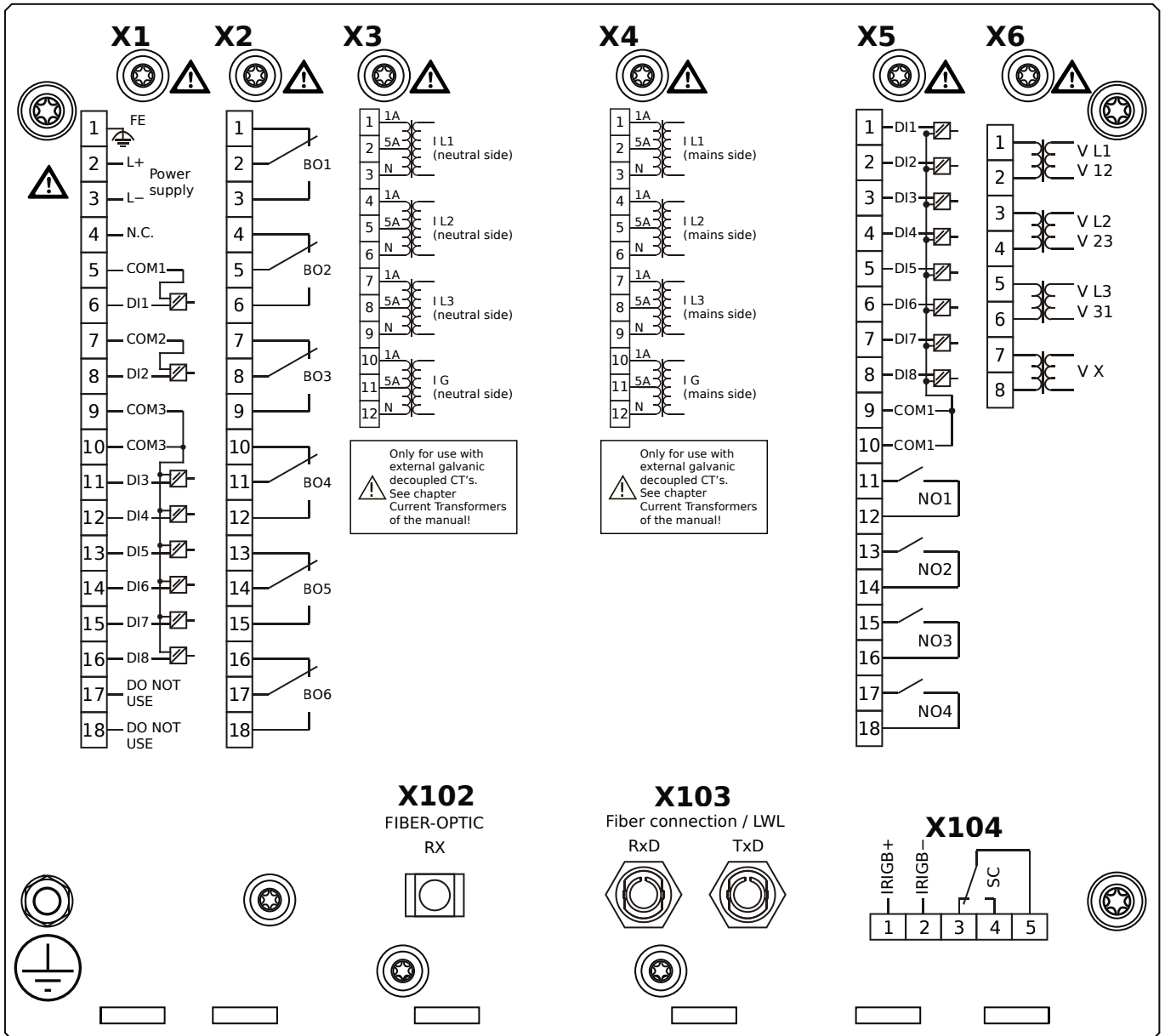

Housing B2, large display, door mounting

- + Conformal Coating (for installations in harsh environment)

- X1** – DI8-X1: Wide-range power supply unit, incl. 2 non-grouped digital inputs and 6 grouped digital inputs
- X2** – OR6: Assembly Group with 6 Output Relays (Changeover / Form C)
- X3** – TI: Standard current measuring card (for the neutral side of the differential protection)
- X4** – TI: Standard current measuring card (for the mains side of the differential protection)
- X5** – DI8-OR4: Assembly Group with 8 Digital Inputs and 4 Output Relays (NO / Form A)
- X6** – TU: Card with 4 voltage transformer measuring inputs (0 ... 800 VAC, under UL: 0 ... 600 VAC)
- X102** – Universal Resistance-Temperature Detector (URTD) input, Fiber optics interface, Versatile Link
- X103** – Profibus-DP, Fiber optics interface, ST Connector
- X104** – IRIG-B00X, incl. System Contact (Supervision Contact)

MCDGV4-2A0AEA

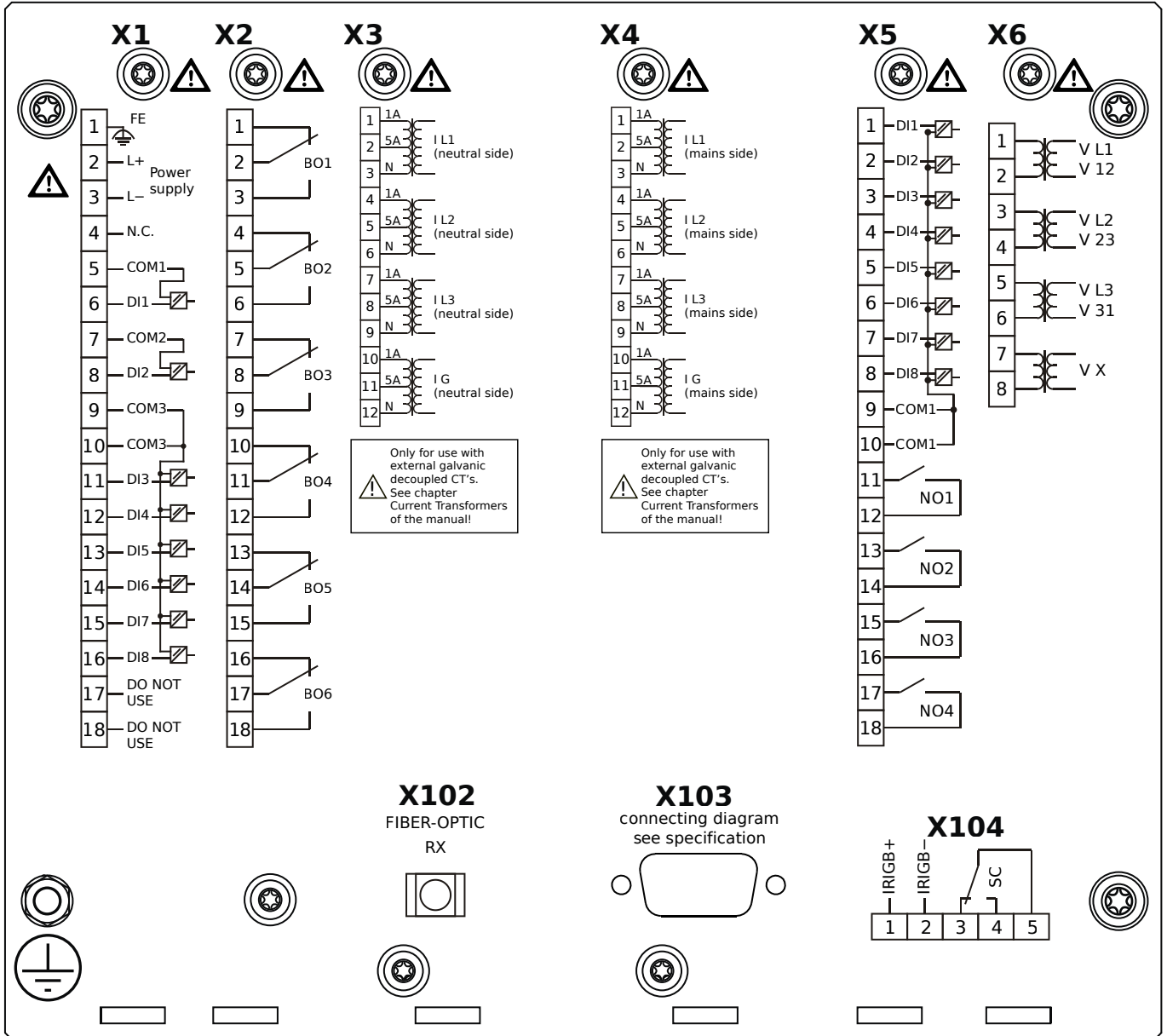

Housing B2, large display, door mounting

- X1** – DI8-X1: Wide-range power supply unit, incl. 2 non-grouped digital inputs and 6 grouped digital inputs
- X2** – OR6: Assembly Group with 6 Output Relays (Changeover / Form C)
- X3** – TI: Standard current measuring card (for the neutral side of the differential protection)
- X4** – TI: Standard current measuring card (for the mains side of the differential protection)
- X5** – DI8-OR4: Assembly Group with 8 Digital Inputs and 4 Output Relays (NO / Form A)
- X6** – TU: Card with 4 voltage transformer measuring inputs (0 ... 800 VAC, under UL: 0 ... 600 VAC)
- X102** – Universal Resistance-Temperature Detector (URTD) input, Fiber optics interface, Versatile Link
- X103** – Profibus-DP, RS485, D-SUB
- X104** – IRIG-B00X, incl. System Contact (Supervision Contact)

MCDGV4-2A0AEB

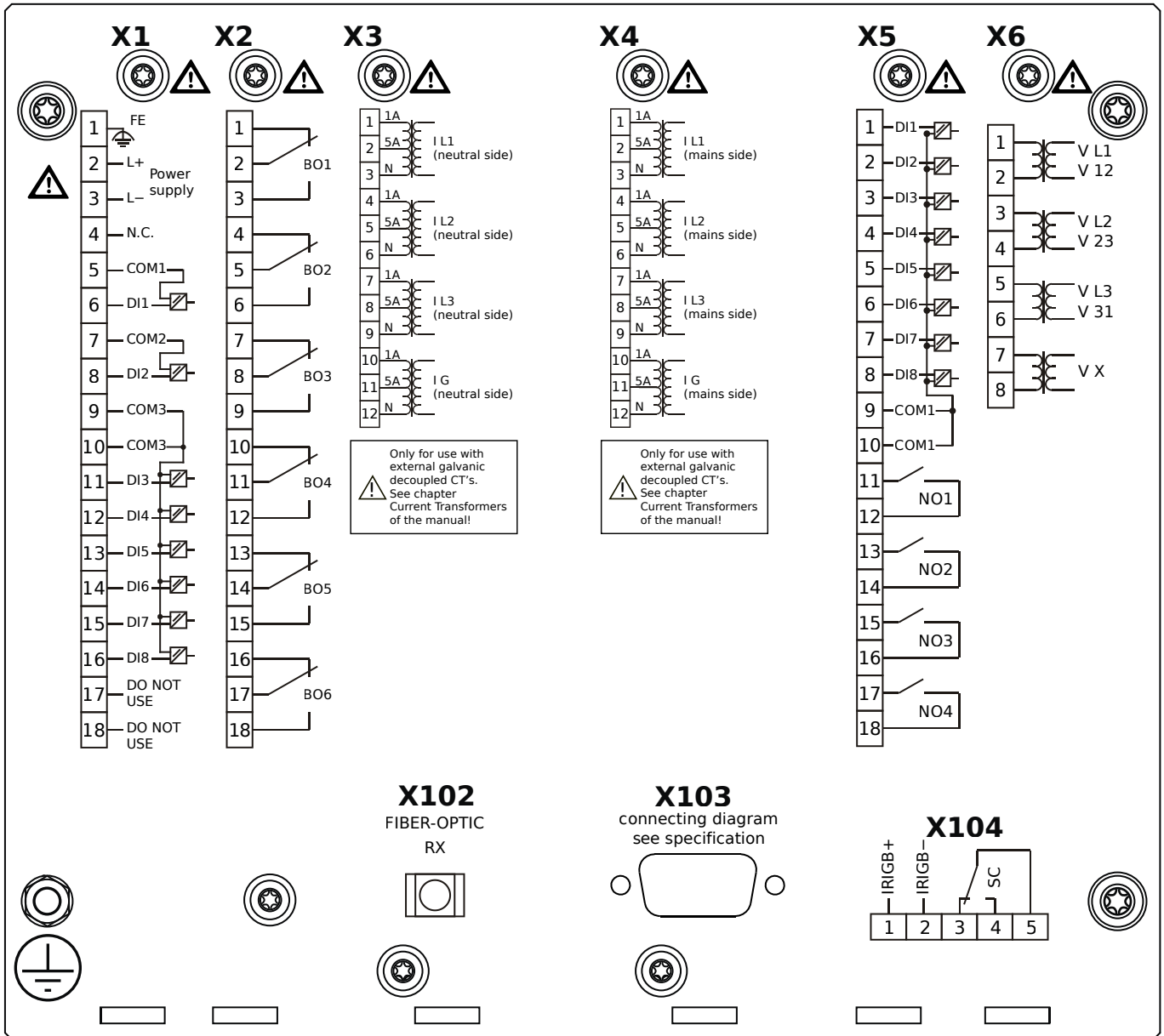

Housing B2, large display, door mounting

- + Conformal Coating (for installations in harsh environment)

- X1** – DI8-X1: Wide-range power supply unit, incl. 2 non-grouped digital inputs and 6 grouped digital inputs
- X2** – OR6: Assembly Group with 6 Output Relays (Changeover / Form C)
- X3** – TI: Standard current measuring card (for the neutral side of the differential protection)
- X4** – TI: Standard current measuring card (for the mains side of the differential protection)
- X5** – DI8-OR4: Assembly Group with 8 Digital Inputs and 4 Output Relays (NO / Form A)
- X6** – TU: Card with 4 voltage transformer measuring inputs (0 ... 800 VAC, under UL: 0 ... 600 VAC)
- X102** – Universal Resistance-Temperature Detector (URTD) input, Fiber optics interface, Versatile Link
- X103** – Profibus-DP, RS485, D-SUB
- X104** – IRIG-B00X, incl. System Contact (Supervision Contact)

MCDGV4-2A0AFA

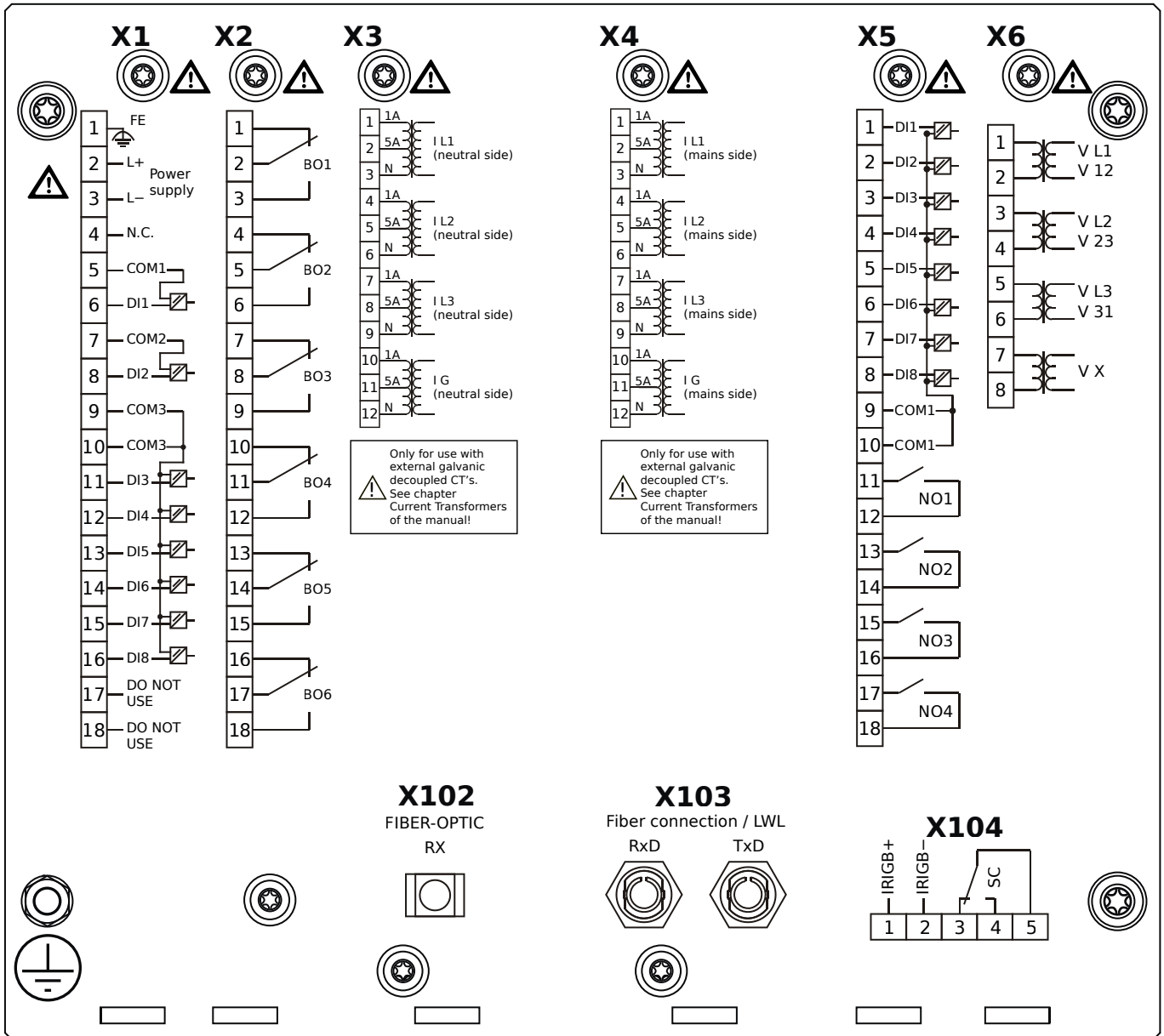

Housing B2, large display, door mounting

- X1** – DI8-X1: Wide-range power supply unit, incl. 2 non-grouped digital inputs and 6 grouped digital inputs
- X2** – OR6: Assembly Group with 6 Output Relays (Changeover / Form C)
- X3** – TI: Standard current measuring card (for the neutral side of the differential protection)
- X4** – TI: Standard current measuring card (for the mains side of the differential protection)
- X5** – DI8-OR4: Assembly Group with 8 Digital Inputs and 4 Output Relays (NO / Form A)
- X6** – TU: Card with 4 voltage transformer measuring inputs (0 ... 800 VAC, under UL: 0 ... 600 VAC)
- X102** – Universal Resistance-Temperature Detector (URTD) input, Fiber optics interface, Versatile Link
- X103** – Modbus RTU / IEC 60870-5-103 / DNP3.0 RTU, Fiber optics interface, ST Connector
- X104** – IRIG-B00X, incl. System Contact (Supervision Contact)

MCDGV4-2A0AFB

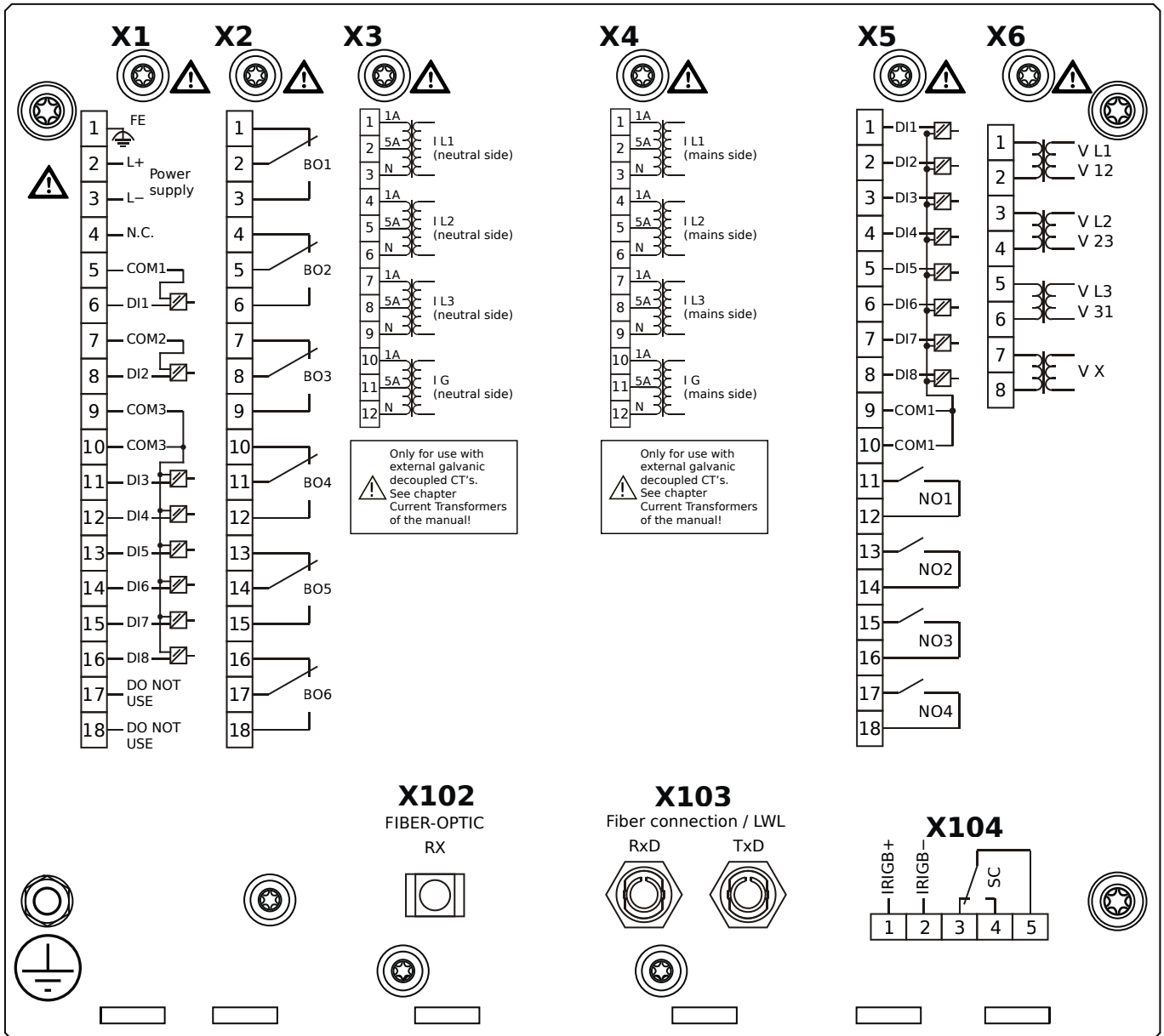

Housing B2, large display, door mounting

+ Conformal Coating (for installations in harsh environment)

- X1** – DI8-X1: Wide-range power supply unit, incl. 2 non-grouped digital inputs and 6 grouped digital inputs
- X2** – OR6: Assembly Group with 6 Output Relays (Changeover / Form C)
- X3** – TI: Standard current measuring card (for the neutral side of the differential protection)
- X4** – TI: Standard current measuring card (for the mains side of the differential protection)
- X5** – DI8-OR4: Assembly Group with 8 Digital Inputs and 4 Output Relays (NO / Form A)
- X6** – TU: Card with 4 voltage transformer measuring inputs (0 ... 800 VAC, under UL: 0 ... 600 VAC)
- X102** – Universal Resistance-Temperature Detector (URTD) input, Fiber optics interface, Versatile Link
- X103** – Modbus RTU / IEC 60870-5-103 / DNP3.0 RTU, Fiber optics interface, ST Connector
- X104** – IRIG-B00X, incl. System Contact (Supervision Contact)

MCDGV4-2A0AGA

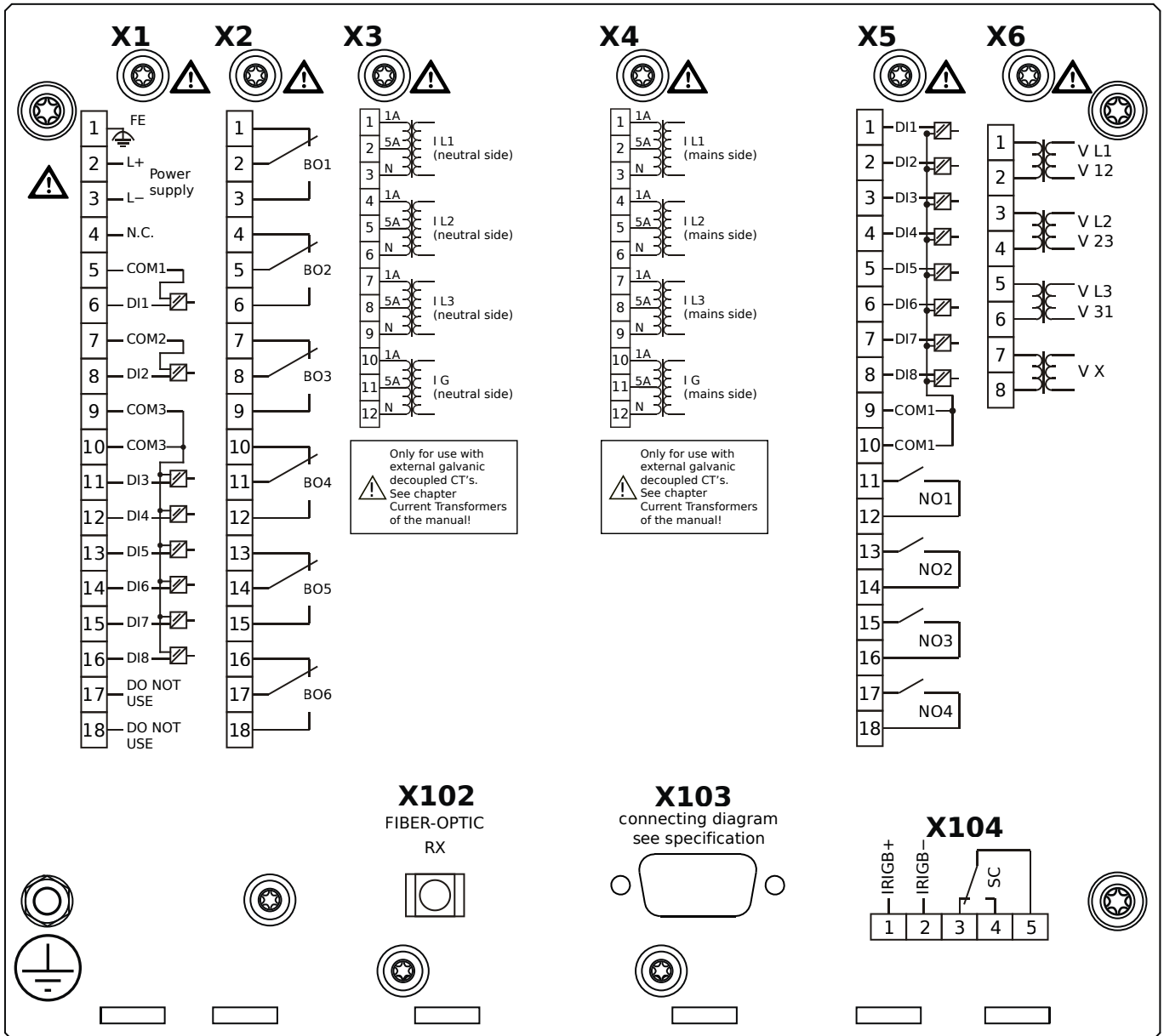

Housing B2, large display, door mounting

- X1** – DI8-X1: Wide-range power supply unit, incl. 2 non-grouped digital inputs and 6 grouped digital inputs
- X2** – OR6: Assembly Group with 6 Output Relays (Changeover / Form C)
- X3** – TI: Standard current measuring card (for the neutral side of the differential protection)
- X4** – TI: Standard current measuring card (for the mains side of the differential protection)
- X5** – DI8-OR4: Assembly Group with 8 Digital Inputs and 4 Output Relays (NO / Form A)
- X6** – TU: Card with 4 voltage transformer measuring inputs (0 ... 800 VAC, under UL: 0 ... 600 VAC)
- X102** – Universal Resistance-Temperature Detector (URTD) input, Fiber optics interface, Versatile Link
- X103** – Modbus RTU / IEC 60870-5-103 / DNP3.0 RTU, RS485, D-SUB
- X104** – IRIG-B00X, incl. System Contact (Supervision Contact)

MCDGV4-2A0AGB

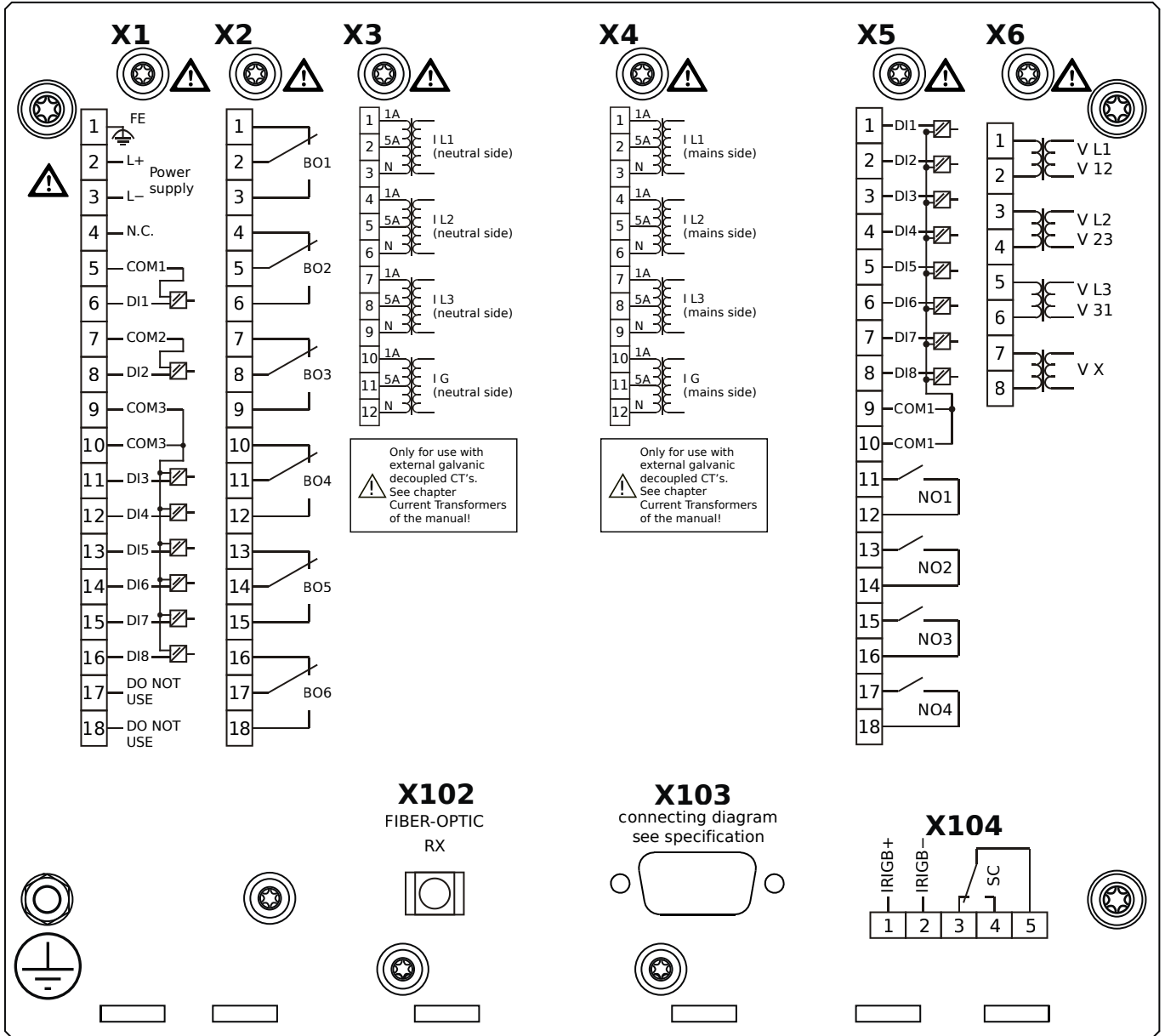

Housing B2, large display, door mounting

+ Conformal Coating (for installations in harsh environment)

- X1** – DI8-X1: Wide-range power supply unit, incl. 2 non-grouped digital inputs and 6 grouped digital inputs
- X2** – OR6: Assembly Group with 6 Output Relays (Changeover / Form C)
- X3** – TI: Standard current measuring card (for the neutral side of the differential protection)
- X4** – TI: Standard current measuring card (for the mains side of the differential protection)
- X5** – DI8-OR4: Assembly Group with 8 Digital Inputs and 4 Output Relays (NO / Form A)
- X6** – TU: Card with 4 voltage transformer measuring inputs (0 ... 800 VAC, under UL: 0 ... 600 VAC)
- X102** – Universal Resistance-Temperature Detector (URTD) input, Fiber optics interface, Versatile Link
- X103** – Modbus RTU / IEC 60870-5-103 / DNP3.0 RTU, RS485, D-SUB
- X104** – IRIG-B00X, incl. System Contact (Supervision Contact)

MCDGV4-2A0AHA

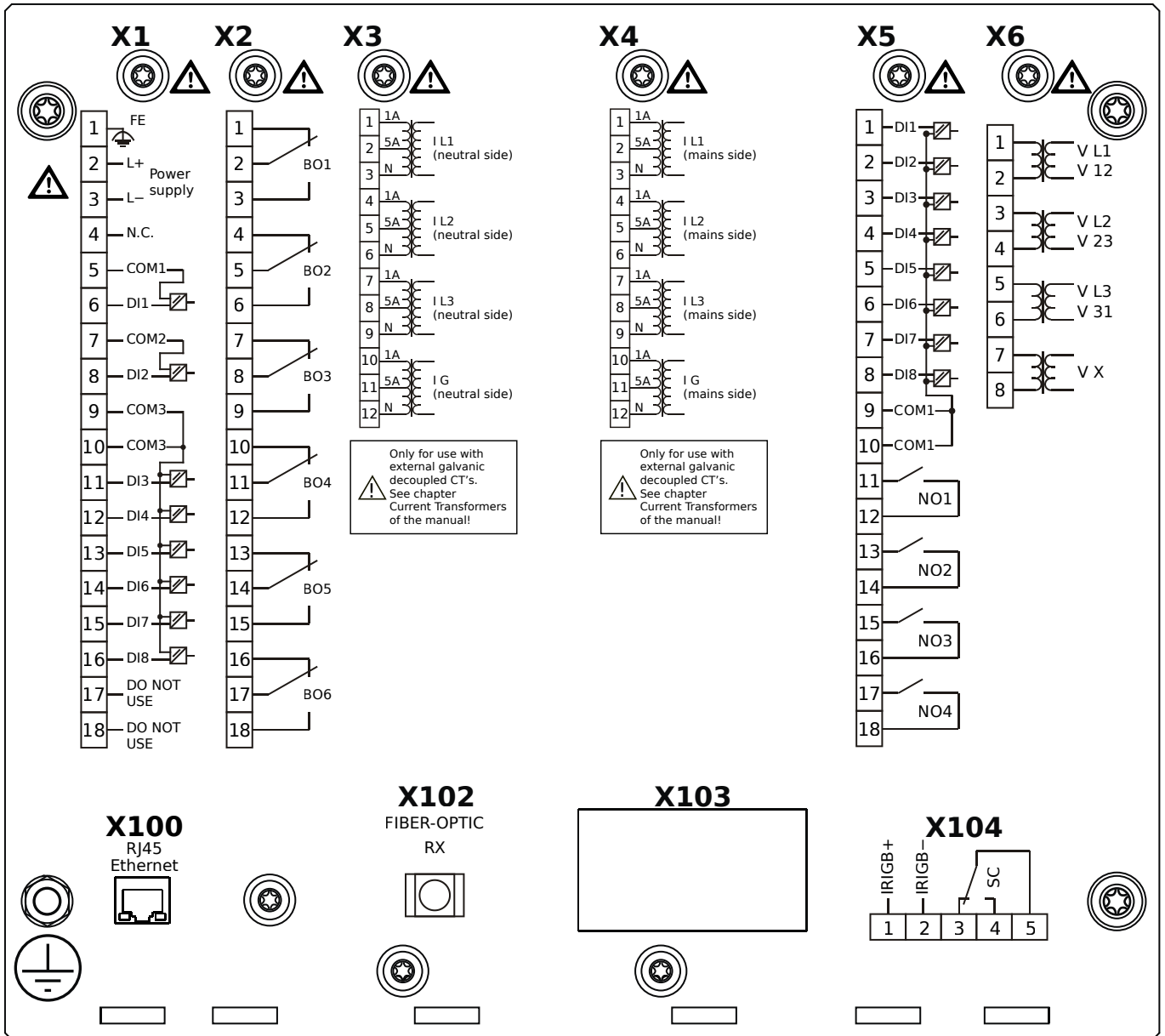

Housing B2, large display, door mounting

- X1** – DI8-X1: Wide-range power supply unit, incl. 2 non-grouped digital inputs and 6 grouped digital inputs
- X2** – OR6: Assembly Group with 6 Output Relays (Changeover / Form C)
- X3** – TI: Standard current measuring card (for the neutral side of the differential protection)
- X4** – TI: Standard current measuring card (for the mains side of the differential protection)
- X5** – DI8-OR4: Assembly Group with 8 Digital Inputs and 4 Output Relays (NO / Form A)
- X6** – TU: Card with 4 voltage transformer measuring inputs (0 ... 800 VAC, under UL: 0 ... 600 VAC)
- X100** – IEC 61850 / Modbus TCP / DNP3.0 TCP/UDP, Ethernet interface, 100 Mbit/s, RJ45 (BASE100-FX)
- X102** – Universal Resistance-Temperature Detector (URTD) input, Fiber optics interface, Versatile Link
- X104** – IRIG-B00X, incl. System Contact (Supervision Contact)

MCDGV4-2A0AHB

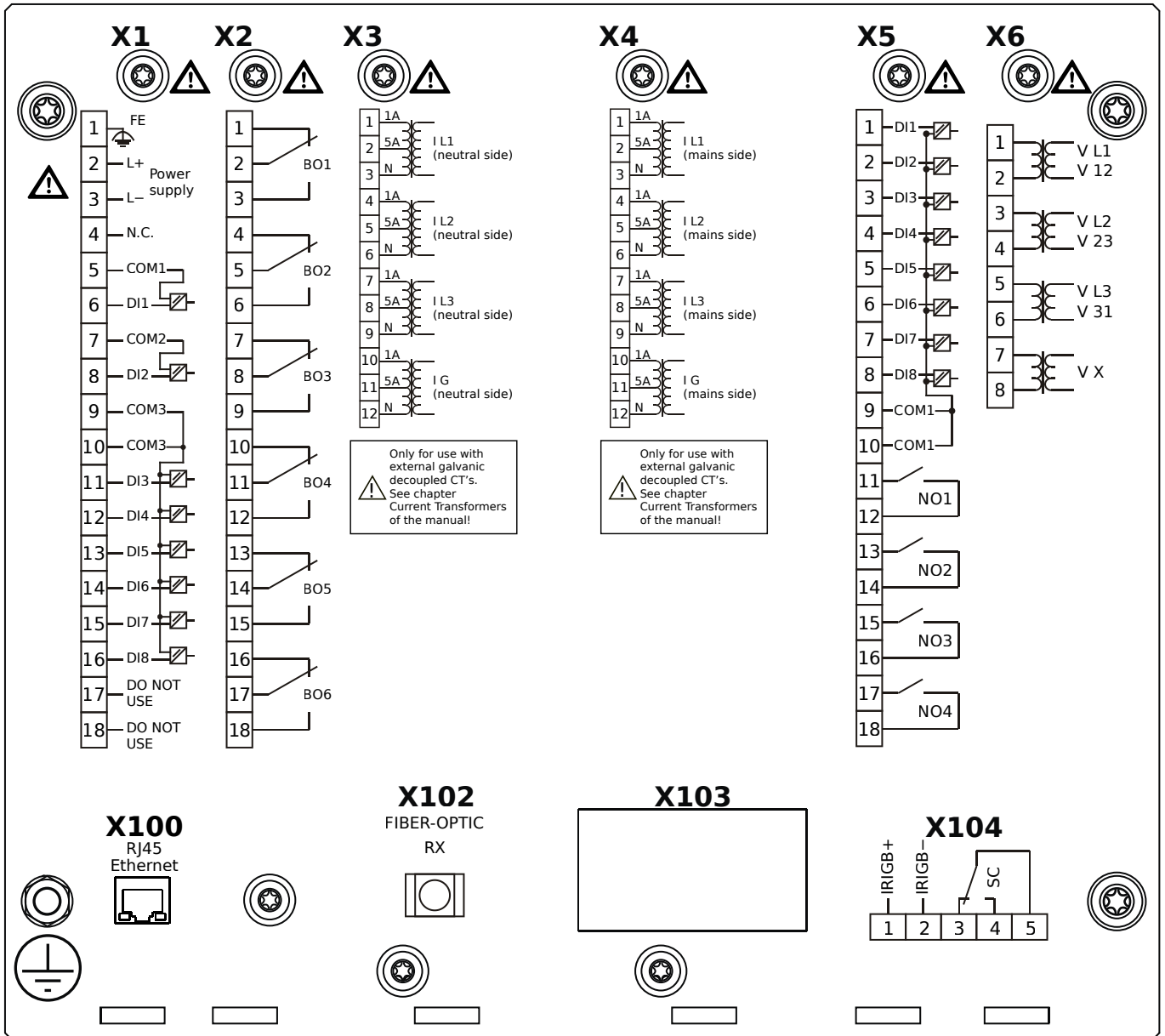

Housing B2, large display, door mounting

- + Conformal Coating (for installations in harsh environment)

- X1** – DI8-X1: Wide-range power supply unit, incl. 2 non-grouped digital inputs and 6 grouped digital inputs
- X2** – OR6: Assembly Group with 6 Output Relays (Changeover / Form C)
- X3** – TI: Standard current measuring card (for the neutral side of the differential protection)
- X4** – TI: Standard current measuring card (for the mains side of the differential protection)
- X5** – DI8-OR4: Assembly Group with 8 Digital Inputs and 4 Output Relays (NO / Form A)
- X6** – TU: Card with 4 voltage transformer measuring inputs (0 ... 800 VAC, under UL: 0 ... 600 VAC)
- X100** – IEC 61850 / Modbus TCP / DNP3.0 TCP/UDP, Ethernet interface, 100 Mbit/s, RJ45 (BASE100-FX)
- X102** – Universal Resistance-Temperature Detector (URTD) input, Fiber optics interface, Versatile Link
- X104** – IRIG-B00X, incl. System Contact (Supervision Contact)

MCDGV4-2A0AIA

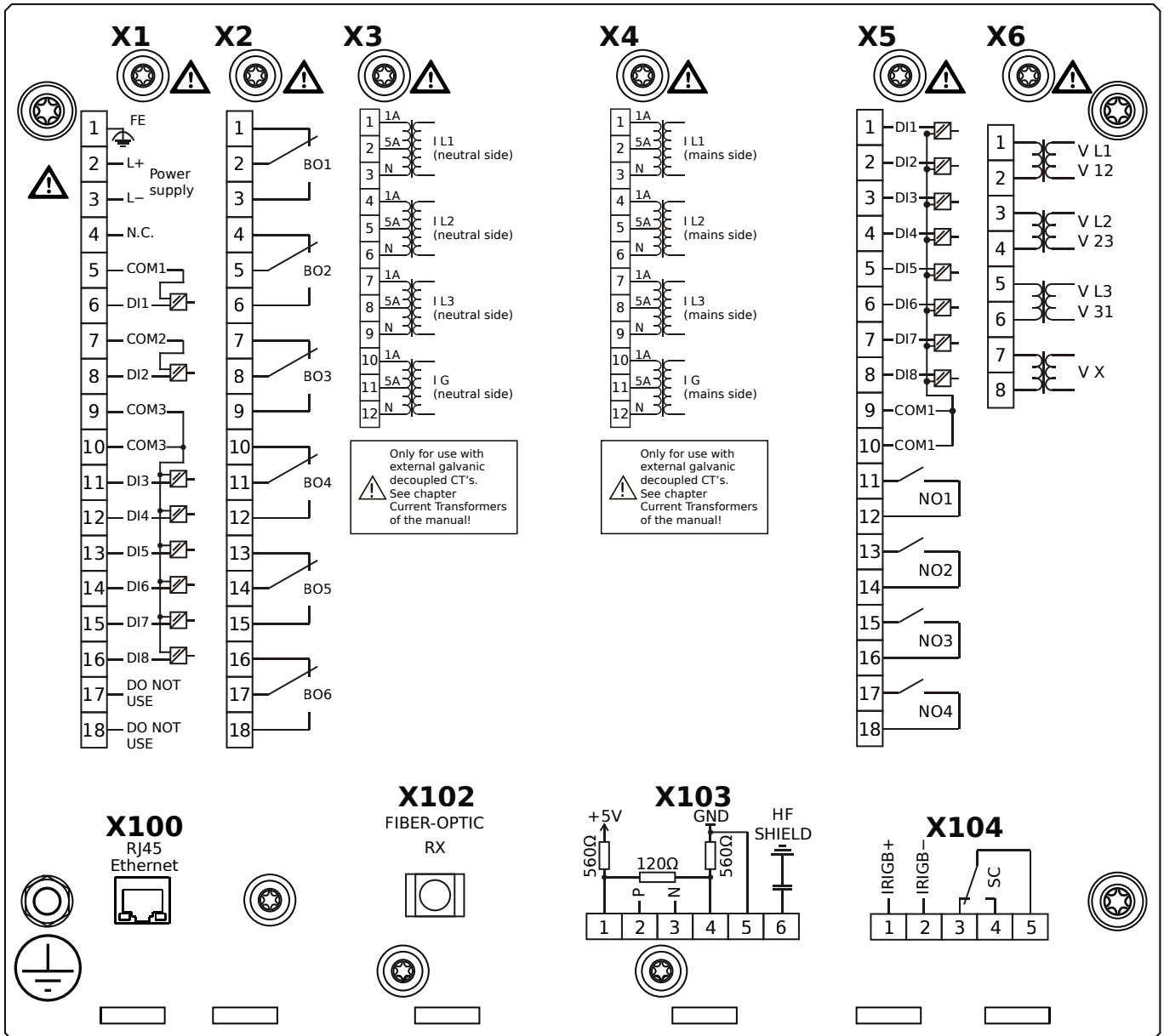

Housing B2, large display, door mounting

- X1** – DI8-X1: Wide-range power supply unit, incl. 2 non-grouped digital inputs and 6 grouped digital inputs
- X2** – OR6: Assembly Group with 6 Output Relays (Changeover / Form C)
- X3** – TI: Standard current measuring card (for the neutral side of the differential protection)
- X4** – TI: Standard current measuring card (for the mains side of the differential protection)
- X5** – DI8-OR4: Assembly Group with 8 Digital Inputs and 4 Output Relays (NO / Form A)
- X6** – TU: Card with 4 voltage transformer measuring inputs (0 ... 800 VAC, under UL: 0 ... 600 VAC)
- X100** – Modbus TCP / DNP3.0 TCP/UDP, Ethernet interface, 100 Mbit/s, RJ45 (BASE100-FX)
- X102** – Universal Resistance-Temperature Detector (URTD) input, Fiber optics interface, Versatile Link
- X103** – IEC 60870-5-103 / Modbus RTU / DNP3.0 RTU, RS485, Terminals
- X104** – IRIG-B00X, incl. System Contact (Supervision Contact)

MCDGV4-2A0AIB

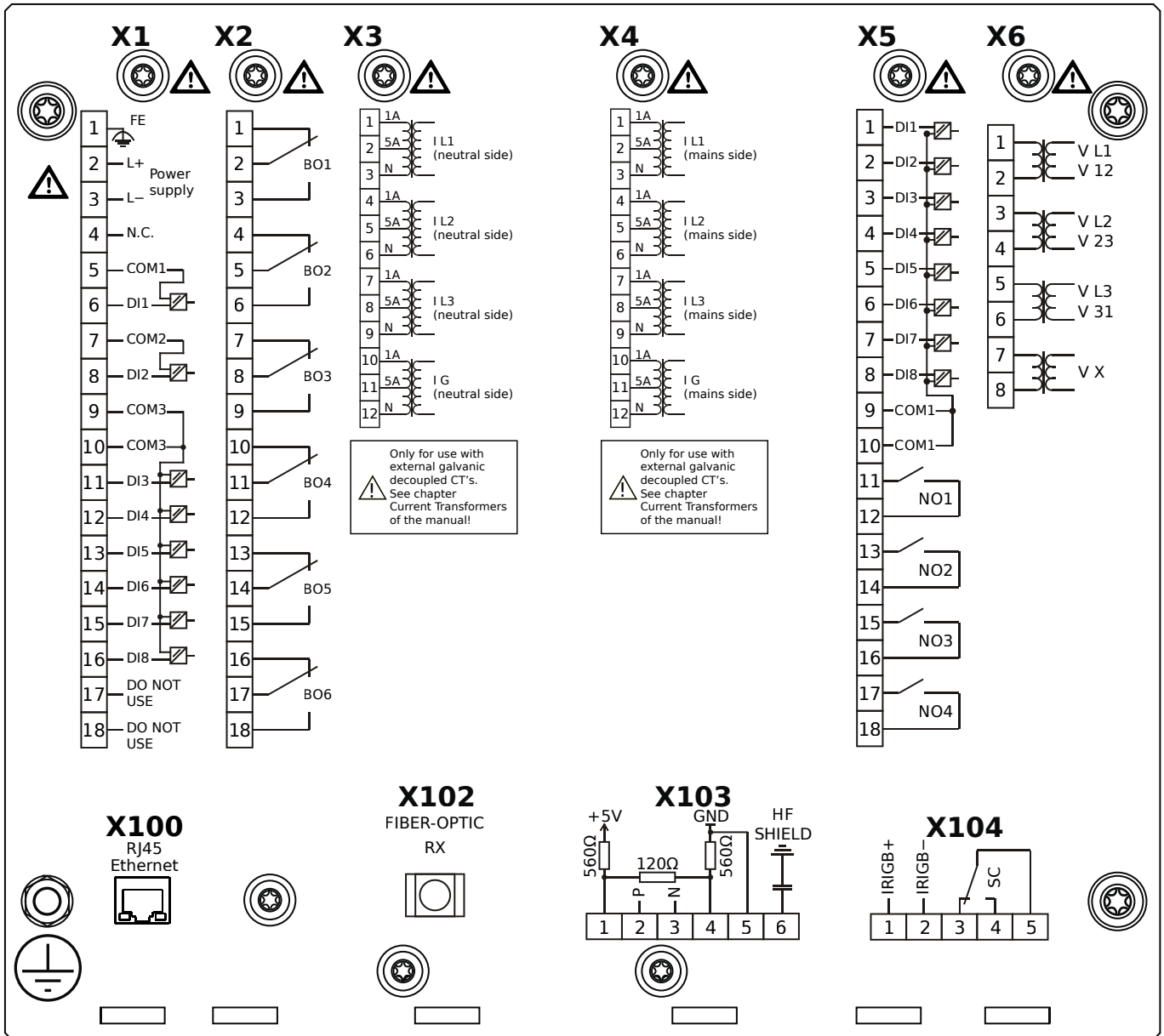

Housing B2, large display, door mounting

+ Conformal Coating (for installations in harsh environment)

- X1** – DI8-X1: Wide-range power supply unit, incl. 2 non-grouped digital inputs and 6 grouped digital inputs
- X2** – OR6: Assembly Group with 6 Output Relays (Changeover / Form C)
- X3** – TI: Standard current measuring card (for the neutral side of the differential protection)
- X4** – TI: Standard current measuring card (for the mains side of the differential protection)
- X5** – DI8-OR4: Assembly Group with 8 Digital Inputs and 4 Output Relays (NO / Form A)
- X6** – TU: Card with 4 voltage transformer measuring inputs (0 ... 800 VAC, under UL: 0 ... 600 VAC)
- X100** – Modbus TCP / DNP3.0 TCP/UDP, Ethernet interface, 100 Mbit/s, RJ45 (BASE100-FX)
- X102** – Universal Resistance-Temperature Detector (URTD) input, Fiber optics interface, Versatile Link
- X103** – IEC 60870-5-103 / Modbus RTU / DNP3.0 RTU, RS485, Terminals
- X104** – IRIG-B00X, incl. System Contact (Supervision Contact)

MCDGV4-2A0AKA

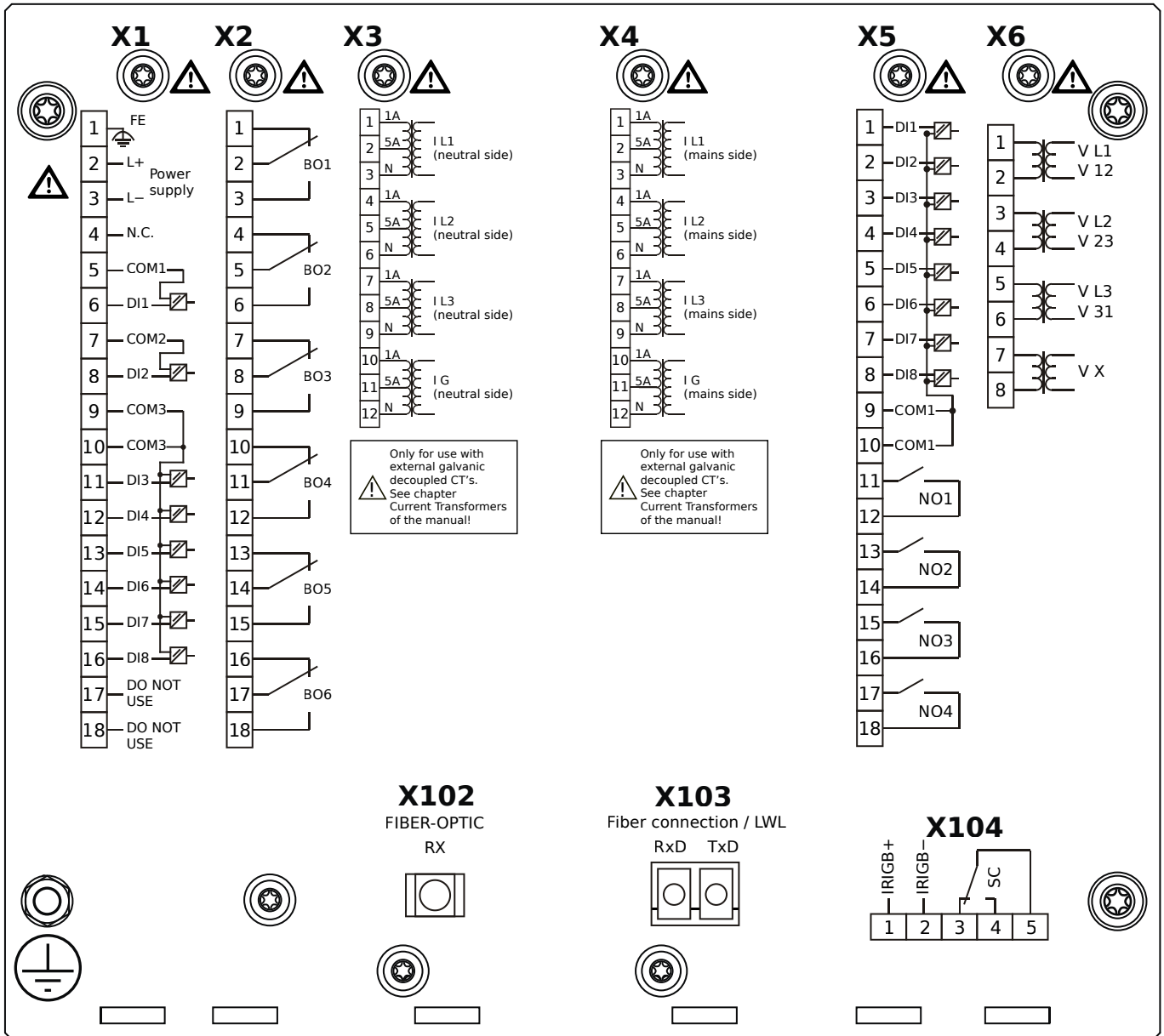

Housing B2, large display, door mounting

- X1** – DI8-X1: Wide-range power supply unit, incl. 2 non-grouped digital inputs and 6 grouped digital inputs
- X2** – OR6: Assembly Group with 6 Output Relays (Changeover / Form C)
- X3** – TI: Standard current measuring card (for the neutral side of the differential protection)
- X4** – TI: Standard current measuring card (for the mains side of the differential protection)
- X5** – DI8-OR4: Assembly Group with 8 Digital Inputs and 4 Output Relays (NO / Form A)
- X6** – TU: Card with 4 voltage transformer measuring inputs (0 ... 800 VAC, under UL: 0 ... 600 VAC)
- X102** – Universal Resistance-Temperature Detector (URTD) input, Fiber optics interface, Versatile Link
- X103** – IEC 61850 / Modbus TCP / DNP3.0 TCP/UDP, Fiber optics interface, LC Connector
- X104** – IRIG-B00X, incl. System Contact (Supervision Contact)

MCDGV4-2A0AKB

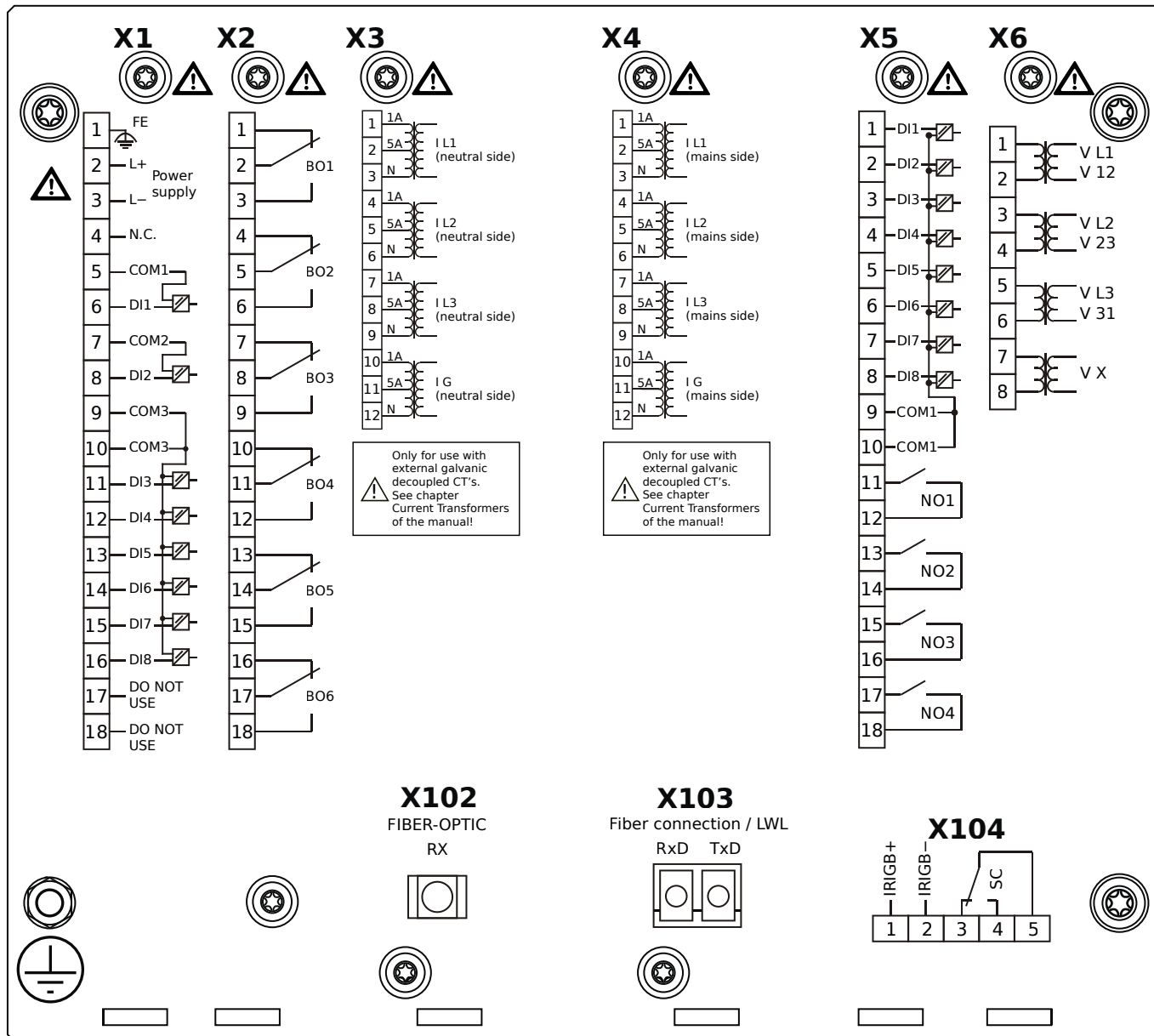

Housing B2, large display, door mounting

- + Conformal Coating (for installations in harsh environment)

- X1** – DI8-X1: Wide-range power supply unit, incl. 2 non-grouped digital inputs and 6 grouped digital inputs
- X2** – OR6: Assembly Group with 6 Output Relays (Changeover / Form C)
- X3** – TI: Standard current measuring card (for the neutral side of the differential protection)
- X4** – TI: Standard current measuring card (for the mains side of the differential protection)
- X5** – DI8-OR4: Assembly Group with 8 Digital Inputs and 4 Output Relays (NO / Form A)
- X6** – TU: Card with 4 voltage transformer measuring inputs (0 ... 800 VAC, under UL: 0 ... 600 VAC)
- X102** – Universal Resistance-Temperature Detector (URTD) input, Fiber optics interface, Versatile Link
- X103** – IEC 61850 / Modbus TCP / DNP3.0 TCP/UDP, Fiber optics interface, LC Connector
- X104** – IRIG-B00X, incl. System Contact (Supervision Contact)

MCDGV4-2A0ALA

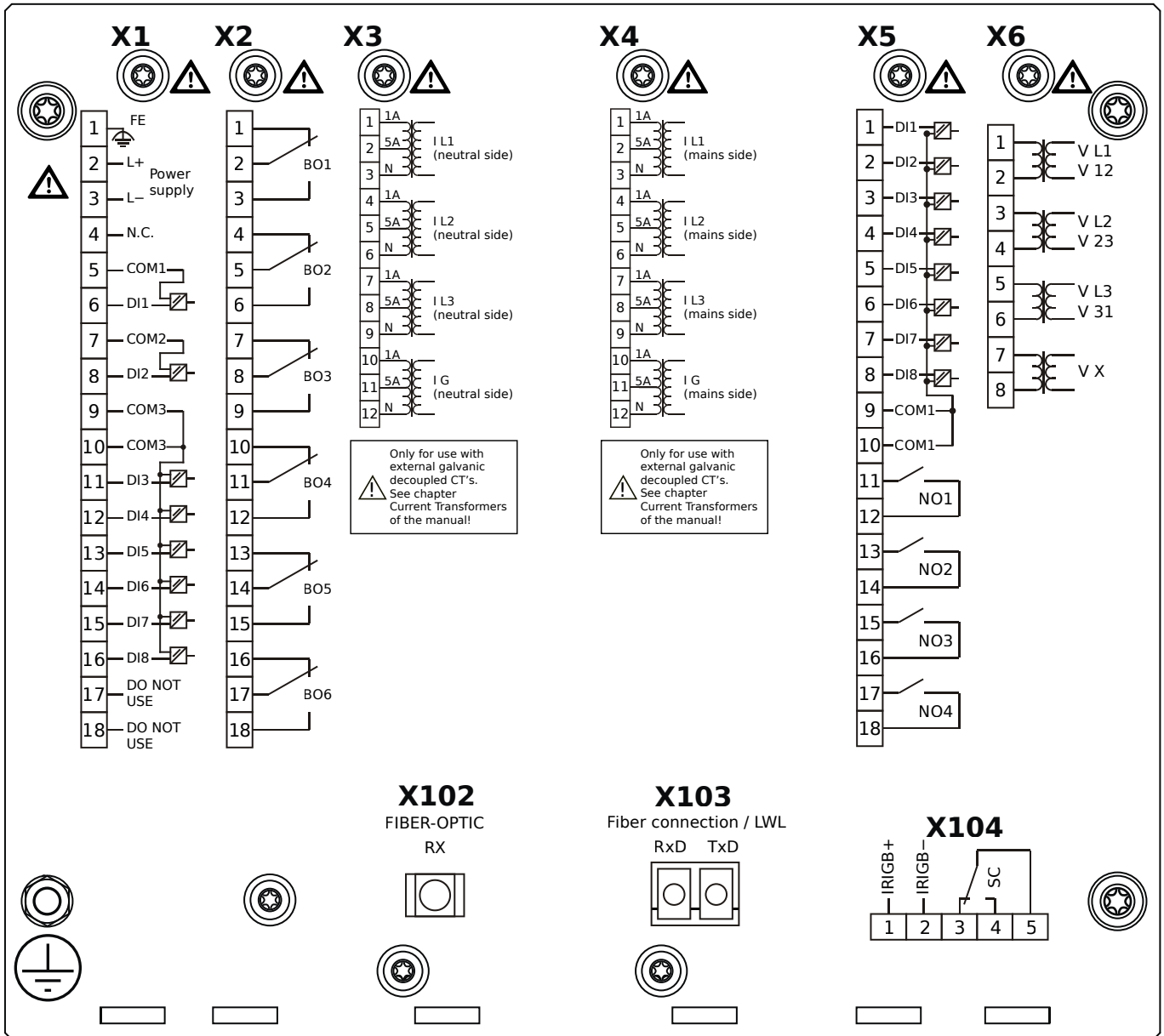

Housing B2, large display, door mounting

- X1** – DI8-X1: Wide-range power supply unit, incl. 2 non-grouped digital inputs and 6 grouped digital inputs
- X2** – OR6: Assembly Group with 6 Output Relays (Changeover / Form C)
- X3** – TI: Standard current measuring card (for the neutral side of the differential protection)
- X4** – TI: Standard current measuring card (for the mains side of the differential protection)
- X5** – DI8-OR4: Assembly Group with 8 Digital Inputs and 4 Output Relays (NO / Form A)
- X6** – TU: Card with 4 voltage transformer measuring inputs (0 ... 800 VAC, under UL: 0 ... 600 VAC)
- X102** – Universal Resistance-Temperature Detector (URTD) input, Fiber optics interface, Versatile Link
- X103** – Modbus TCP / DNP3.0 TCP/UDP, Fiber optics interface, LC Connector
- X104** – IRIG-B00X, incl. System Contact (Supervision Contact)

MCDGV4-2A0ALB

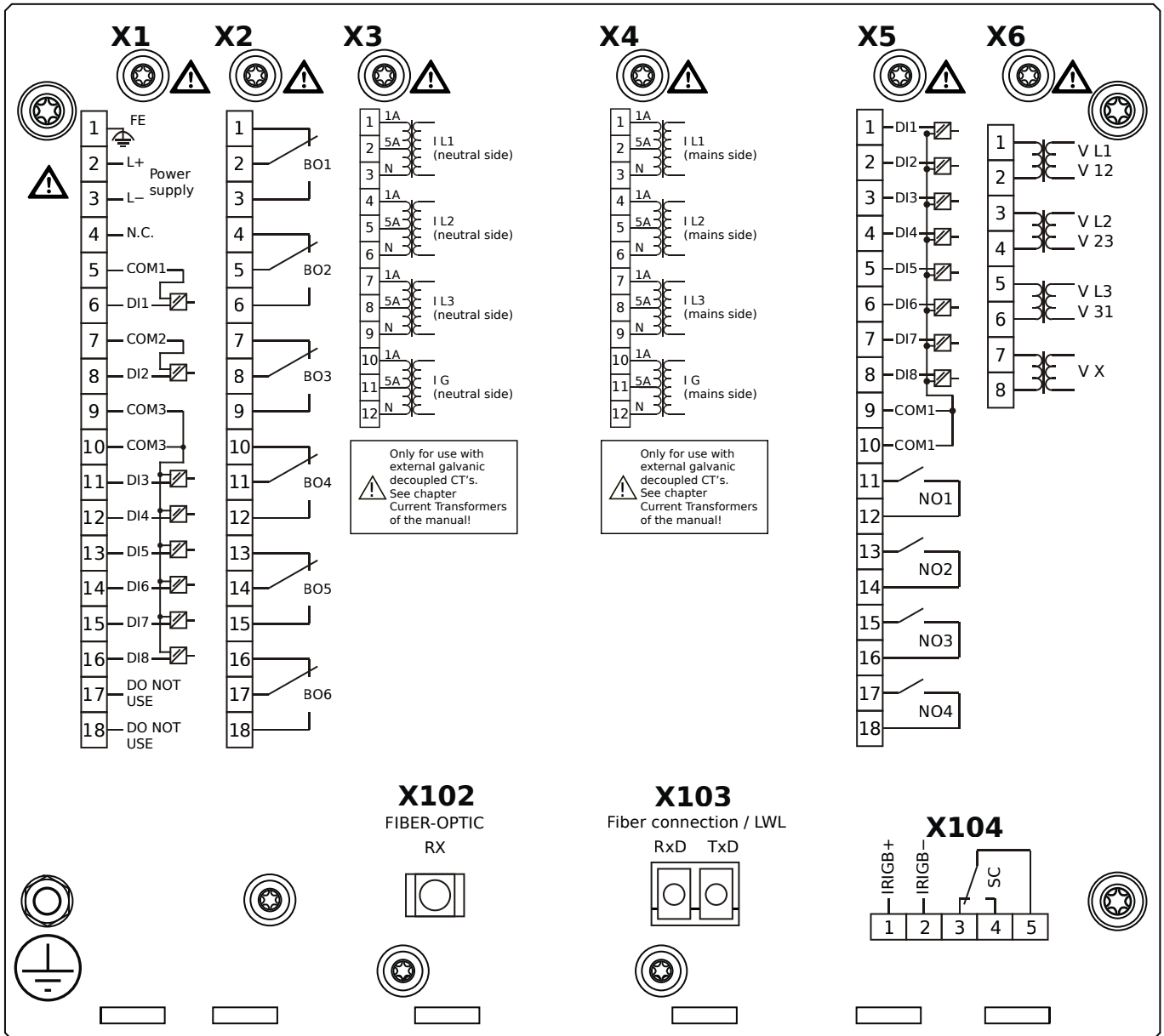

Housing B2, large display, door mounting

- + Conformal Coating (for installations in harsh environment)

- X1** – DI8-X1: Wide-range power supply unit, incl. 2 non-grouped digital inputs and 6 grouped digital inputs
- X2** – OR6: Assembly Group with 6 Output Relays (Changeover / Form C)
- X3** – TI: Standard current measuring card (for the neutral side of the differential protection)
- X4** – TI: Standard current measuring card (for the mains side of the differential protection)
- X5** – DI8-OR4: Assembly Group with 8 Digital Inputs and 4 Output Relays (NO / Form A)
- X6** – TU: Card with 4 voltage transformer measuring inputs (0 ... 800 VAC, under UL: 0 ... 600 VAC)
- X102** – Universal Resistance-Temperature Detector (URTD) input, Fiber optics interface, Versatile Link
- X103** – Modbus TCP / DNP3.0 TCP/UDP, Fiber optics interface, LC Connector
- X104** – IRIG-B00X, incl. System Contact (Supervision Contact)

MCDGV4-2A0ATA

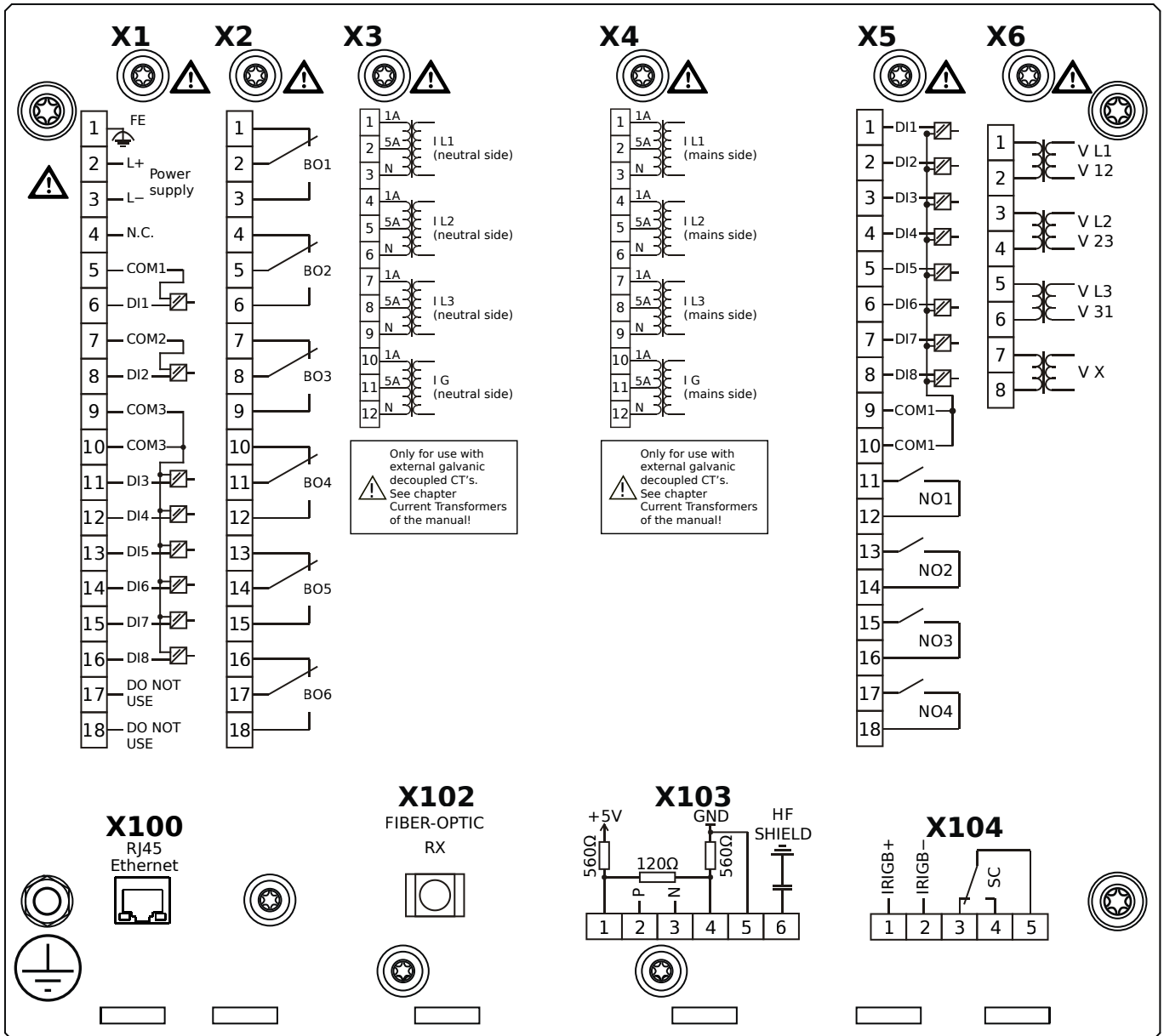

Housing B2, large display, door mounting

- X1** – DI8-X1: Wide-range power supply unit, incl. 2 non-grouped digital inputs and 6 grouped digital inputs
- X2** – OR6: Assembly Group with 6 Output Relays (Changeover / Form C)
- X3** – TI: Standard current measuring card (for the neutral side of the differential protection)
- X4** – TI: Standard current measuring card (for the mains side of the differential protection)
- X5** – DI8-OR4: Assembly Group with 8 Digital Inputs and 4 Output Relays (NO / Form A)
- X6** – TU: Card with 4 voltage transformer measuring inputs (0 ... 800 VAC, under UL: 0 ... 600 VAC)
- X100** – IEC 61850 / Modbus TCP / DNP3.0 TCP/UDP, Ethernet interface, 100 Mbit/s, RJ45 (BASE100-FX)
- X102** – Universal Resistance-Temperature Detector (URTD) input, Fiber optics interface, Versatile Link
- X103** – IEC 60870-5-103 / Modbus RTU / DNP3.0 RTU, RS485, Terminals
- X104** – IRIG-B00X, incl. System Contact (Supervision Contact)

MCDGV4-2A0ATB

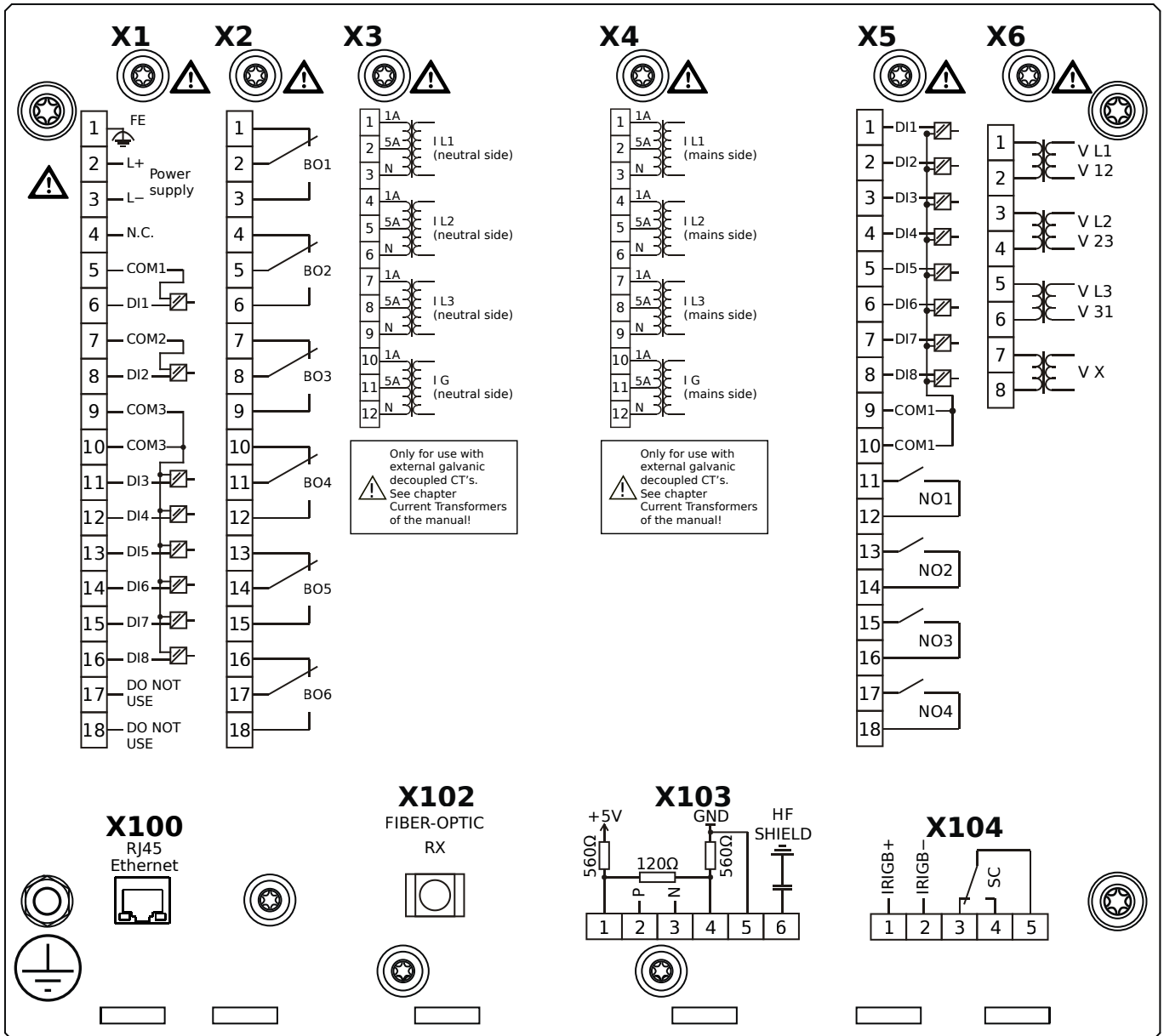

Housing B2, large display, door mounting

+ Conformal Coating (for installations in harsh environment)

- X1** – DI8-X1: Wide-range power supply unit, incl. 2 non-grouped digital inputs and 6 grouped digital inputs
- X2** – OR6: Assembly Group with 6 Output Relays (Changeover / Form C)
- X3** – TI: Standard current measuring card (for the neutral side of the differential protection)
- X4** – TI: Standard current measuring card (for the mains side of the differential protection)
- X5** – DI8-OR4: Assembly Group with 8 Digital Inputs and 4 Output Relays (NO / Form A)
- X6** – TU: Card with 4 voltage transformer measuring inputs (0 ... 800 VAC, under UL: 0 ... 600 VAC)
- X100** – IEC 61850 / Modbus TCP / DNP3.0 TCP/UDP, Ethernet interface, 100 Mbit/s, RJ45 (BASE100-FX)
- X102** – Universal Resistance-Temperature Detector (URTD) input, Fiber optics interface, Versatile Link
- X103** – IEC 60870-5-103 / Modbus RTU / DNP3.0 RTU, RS485, Terminals
- X104** – IRIG-B00X, incl. System Contact (Supervision Contact)

MCDGV4-2A0BAA

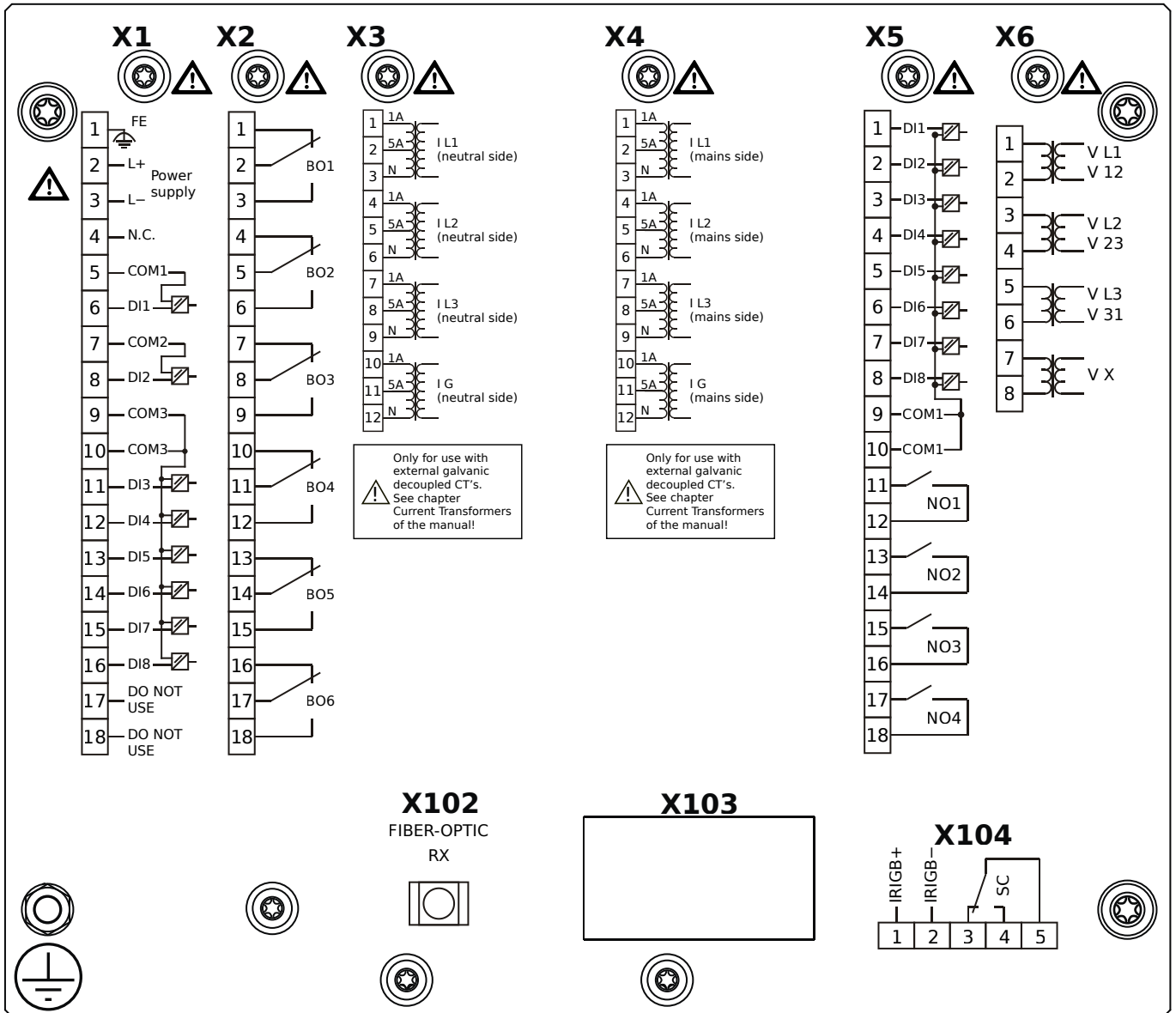

Housing B2, large display, 19" rack mounting

- X1** – DI8-X1: Wide-range power supply unit, incl. 2 non-grouped digital inputs and 6 grouped digital inputs
- X2** – OR6: Assembly Group with 6 Output Relays (Changeover / Form C)
- X3** – TI: Standard current measuring card (for the neutral side of the differential protection)
- X4** – TI: Standard current measuring card (for the mains side of the differential protection)
- X5** – DI8-OR4: Assembly Group with 8 Digital Inputs and 4 Output Relays (NO / Form A)
- X6** – TU: Card with 4 voltage transformer measuring inputs (0 ... 800 VAC, under UL: 0 ... 600 VAC)
- X102** – Universal Resistance-Temperature Detector (URTD) input, Fiber optics interface, Versatile Link
- X104** – IRIG-B00X, incl. System Contact (Supervision Contact)

MCDGV4-2A0BAB

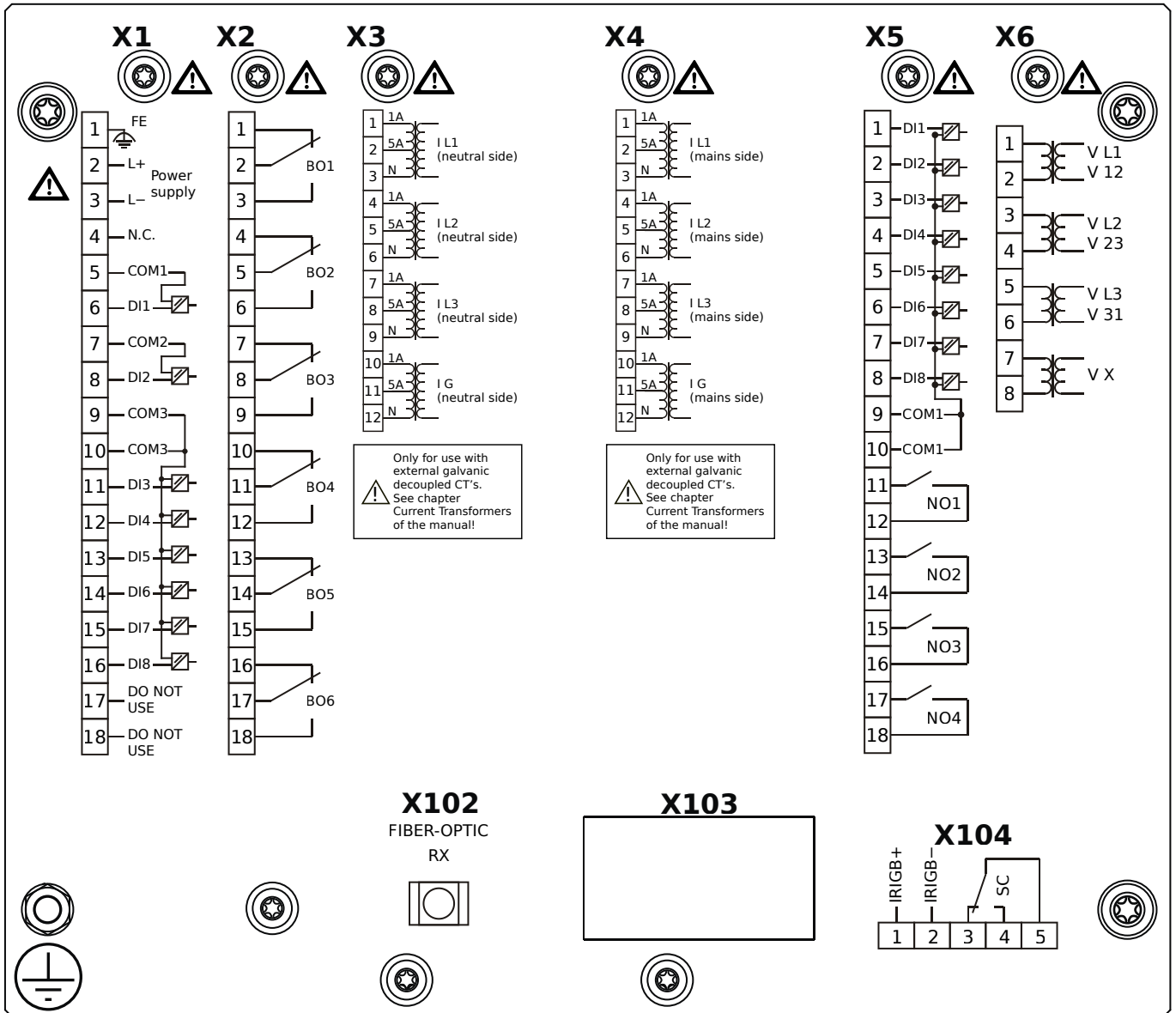

Housing B2, large display, 19" rack mounting

- + Conformal Coating (for installations in harsh environment)

- X1** – DI8-X1: Wide-range power supply unit, incl. 2 non-grouped digital inputs and 6 grouped digital inputs
- X2** – OR6: Assembly Group with 6 Output Relays (Changeover / Form C)
- X3** – TI: Standard current measuring card (for the neutral side of the differential protection)
- X4** – TI: Standard current measuring card (for the mains side of the differential protection)
- X5** – DI8-OR4: Assembly Group with 8 Digital Inputs and 4 Output Relays (NO / Form A)
- X6** – TU: Card with 4 voltage transformer measuring inputs (0 ... 800 VAC, under UL: 0 ... 600 VAC)
- X102** – Universal Resistance-Temperature Detector (URTD) input, Fiber optics interface, Versatile Link
- X104** – IRIG-B00X, incl. System Contact (Supervision Contact)

MCDGV4-2A0BBA

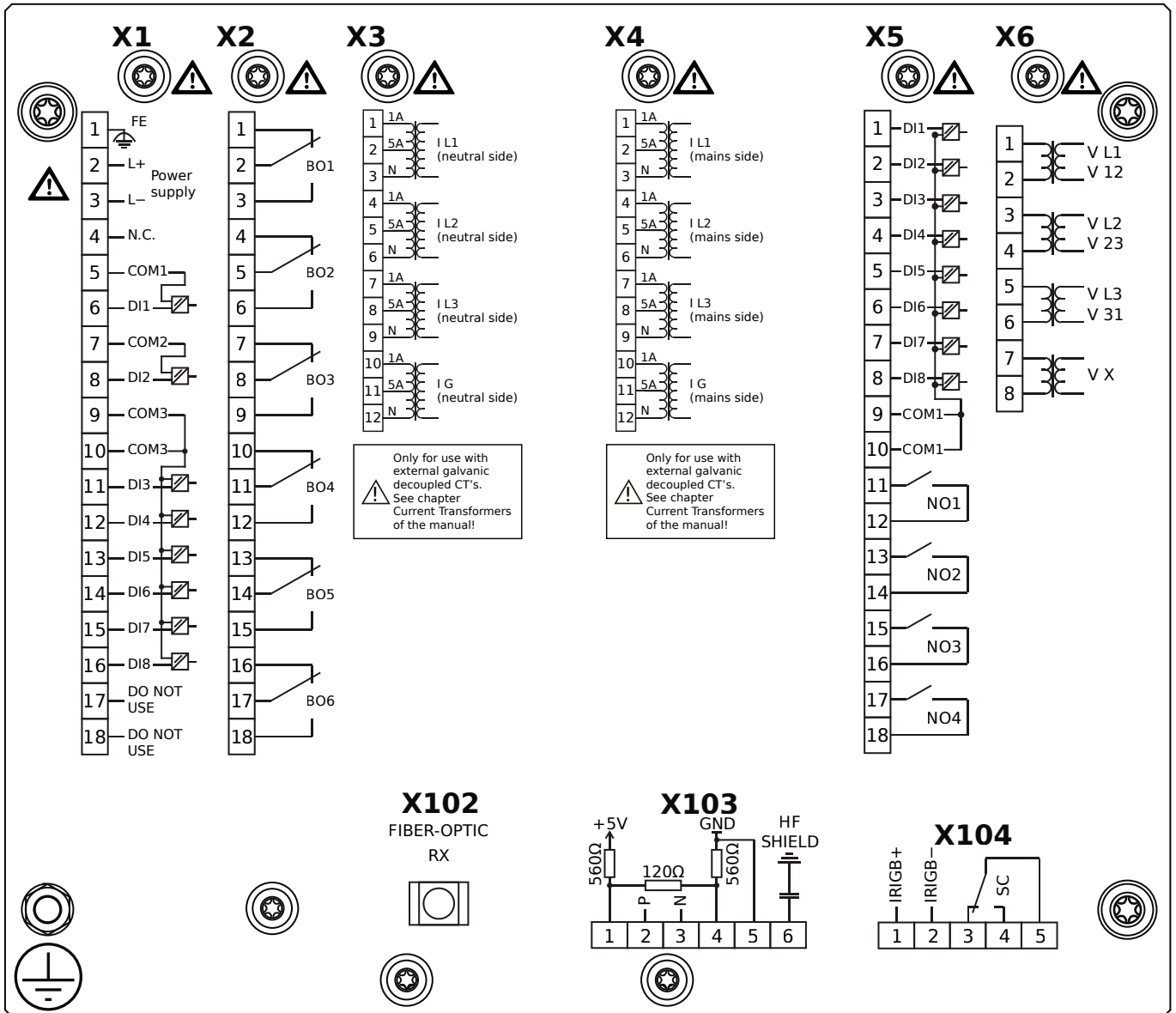

Housing B2, large display, 19" rack mounting

- X1** – DI8-X1: Wide-range power supply unit, incl. 2 non-grouped digital inputs and 6 grouped digital inputs
- X2** – OR6: Assembly Group with 6 Output Relays (Changeover / Form C)
- X3** – TI: Standard current measuring card (for the neutral side of the differential protection)
- X4** – TI: Standard current measuring card (for the mains side of the differential protection)
- X5** – DI8-OR4: Assembly Group with 8 Digital Inputs and 4 Output Relays (NO / Form A)
- X6** – TU: Card with 4 voltage transformer measuring inputs (0 ... 800 VAC, under UL: 0 ... 600 VAC)
- X102** – Universal Resistance-Temperature Detector (URTD) input, Fiber optics interface, Versatile Link
- X103** – Modbus RTU / IEC 60870-5-103 / DNP3.0 RTU, RS485, Terminals
- X104** – IRIG-B00X, incl. System Contact (Supervision Contact)

MCDGV4-2A0BBB

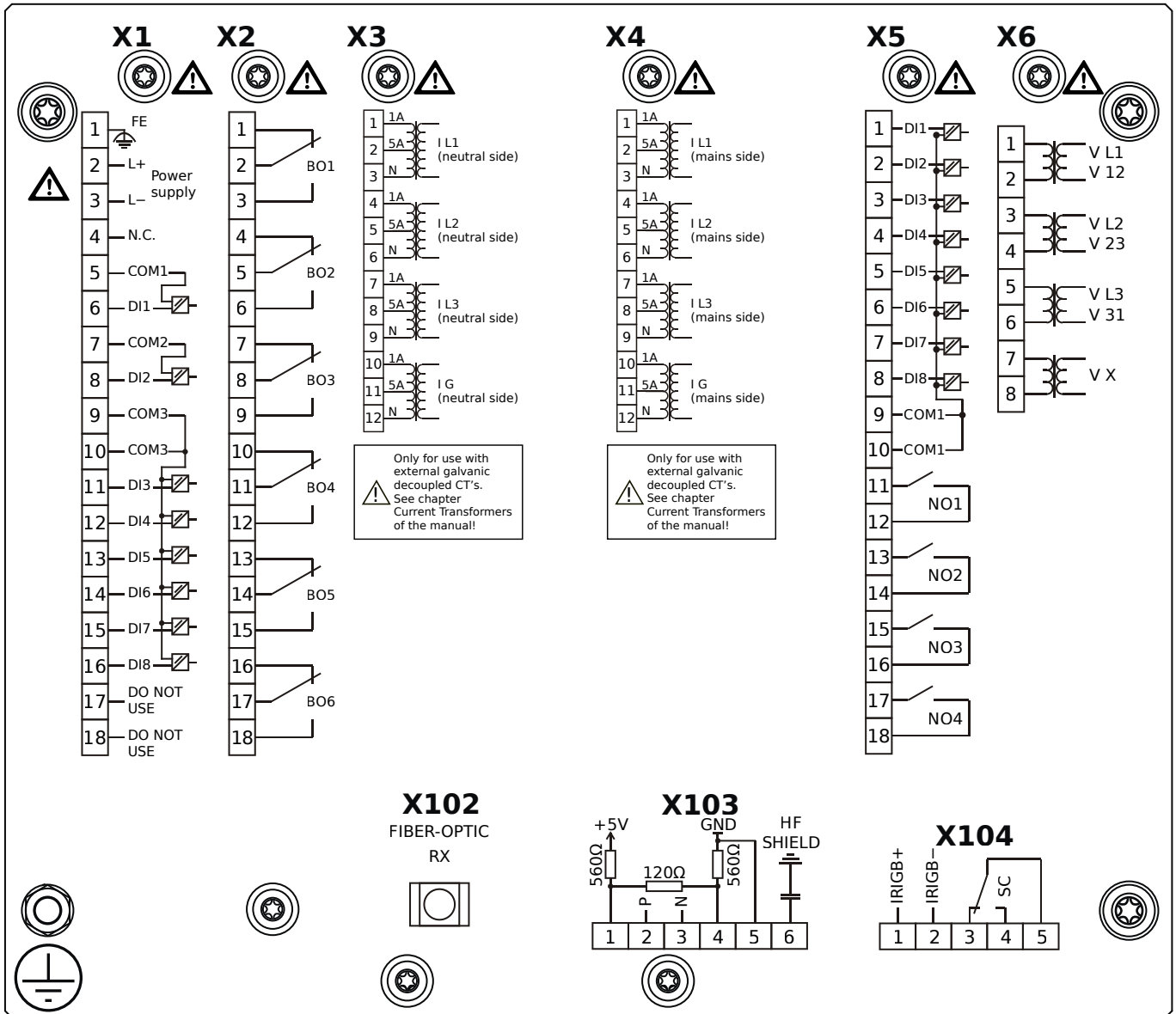

Housing B2, large display, 19" rack mounting

+ Conformal Coating (for installations in harsh environment)

- X1** – DI8-X1: Wide-range power supply unit, incl. 2 non-grouped digital inputs and 6 grouped digital inputs
- X2** – OR6: Assembly Group with 6 Output Relays (Changeover / Form C)
- X3** – TI: Standard current measuring card (for the neutral side of the differential protection)
- X4** – TI: Standard current measuring card (for the mains side of the differential protection)
- X5** – DI8-OR4: Assembly Group with 8 Digital Inputs and 4 Output Relays (NO / Form A)
- X6** – TU: Card with 4 voltage transformer measuring inputs (0 ... 800 VAC, under UL: 0 ... 600 VAC)
- X102** – Universal Resistance-Temperature Detector (URTD) input, Fiber optics interface, Versatile Link
- X103** – Modbus RTU / IEC 60870-5-103 / DNP3.0 RTU, RS485, Terminals
- X104** – IRIG-B00X, incl. System Contact (Supervision Contact)

MCDGV4-2A0BCA

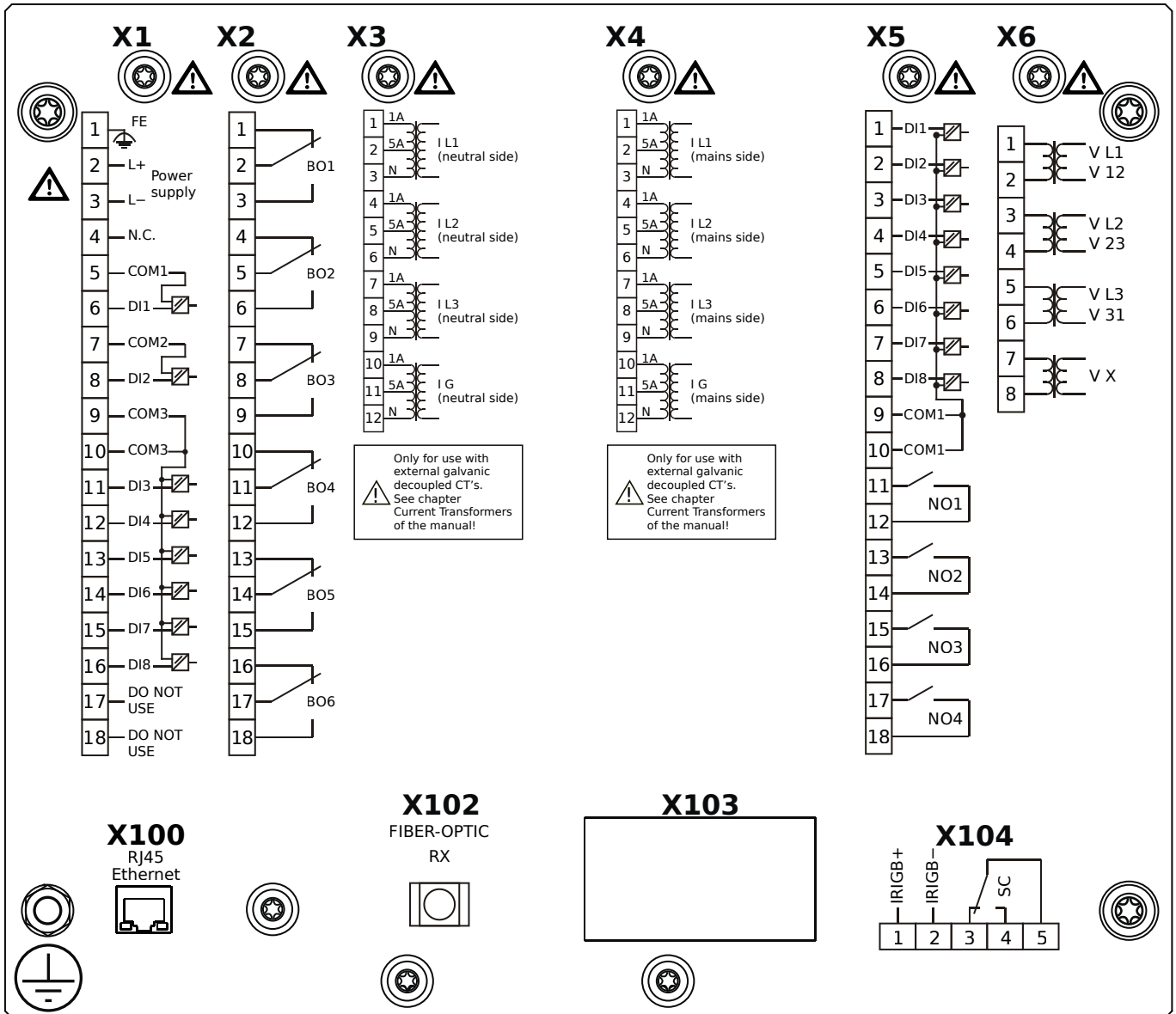

Housing B2, large display, 19" rack mounting

- X1** – DI8-X1: Wide-range power supply unit, incl. 2 non-grouped digital inputs and 6 grouped digital inputs
- X2** – OR6: Assembly Group with 6 Output Relays (Changeover / Form C)
- X3** – TI: Standard current measuring card (for the neutral side of the differential protection)
- X4** – TI: Standard current measuring card (for the mains side of the differential protection)
- X5** – DI8-OR4: Assembly Group with 8 Digital Inputs and 4 Output Relays (NO / Form A)
- X6** – TU: Card with 4 voltage transformer measuring inputs (0 ... 800 VAC, under UL: 0 ... 600 VAC)
- X100** – Modbus TCP / DNP3.0 TCP/UDP, Ethernet interface, 100 Mbit/s, RJ45 (BASE100-FX)
- X102** – Universal Resistance-Temperature Detector (URTD) input, Fiber optics interface, Versatile Link
- X104** – IRIG-B00X, incl. System Contact (Supervision Contact)

MCDGV4-2A0BCB

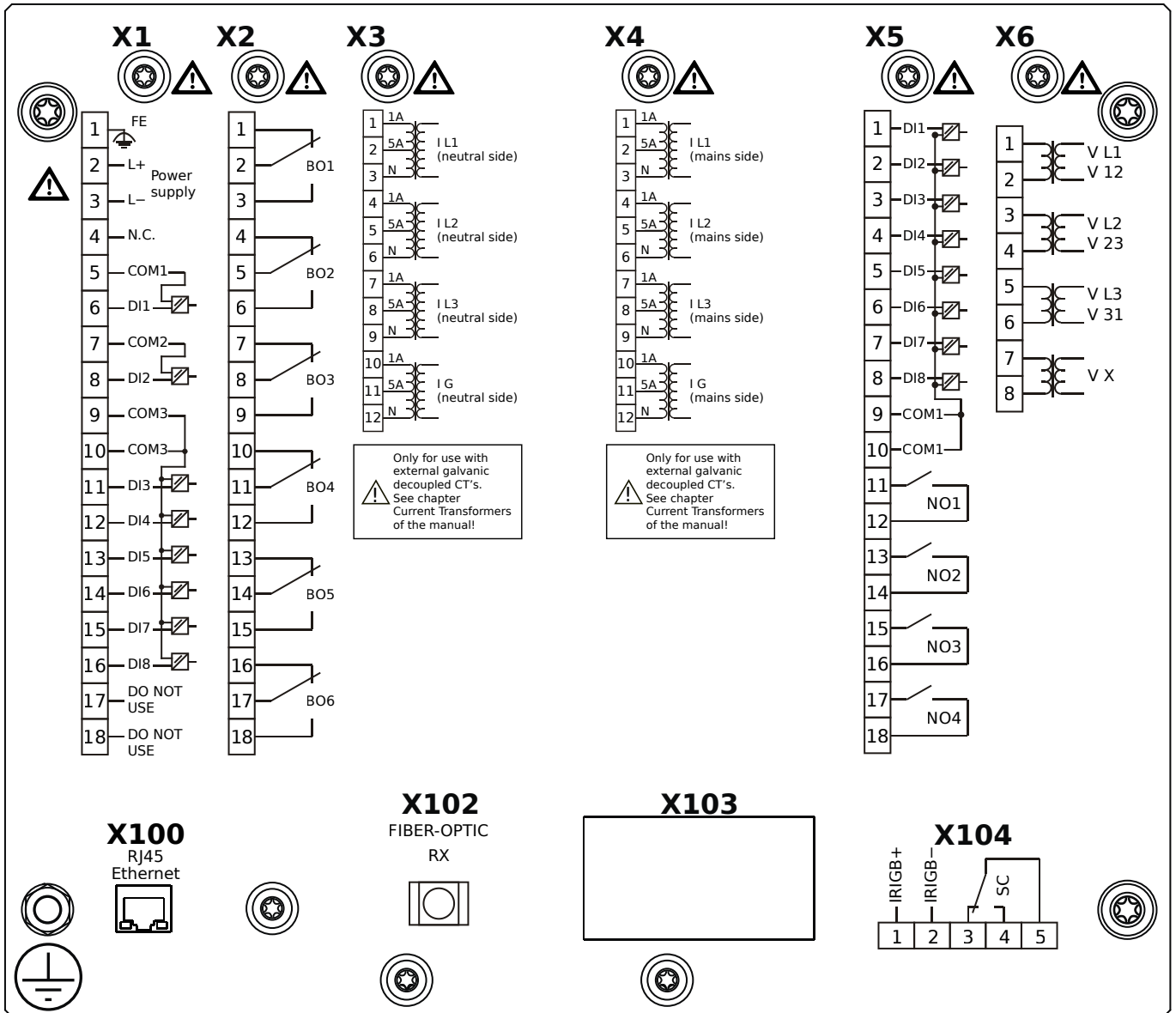

Housing B2, large display, 19" rack mounting

+ Conformal Coating (for installations in harsh environment)

- X1** – DI8-X1: Wide-range power supply unit, incl. 2 non-grouped digital inputs and 6 grouped digital inputs
- X2** – OR6: Assembly Group with 6 Output Relays (Changeover / Form C)
- X3** – TI: Standard current measuring card (for the neutral side of the differential protection)
- X4** – TI: Standard current measuring card (for the mains side of the differential protection)
- X5** – DI8-OR4: Assembly Group with 8 Digital Inputs and 4 Output Relays (NO / Form A)
- X6** – TU: Card with 4 voltage transformer measuring inputs (0 ... 800 VAC, under UL: 0 ... 600 VAC)
- X100** – Modbus TCP / DNP3.0 TCP/UDP, Ethernet interface, 100 Mbit/s, RJ45 (BASE100-FX)
- X102** – Universal Resistance-Temperature Detector (URTD) input, Fiber optics interface, Versatile Link
- X104** – IRIG-B00X, incl. System Contact (Supervision Contact)

MCDGV4-2A0BDA

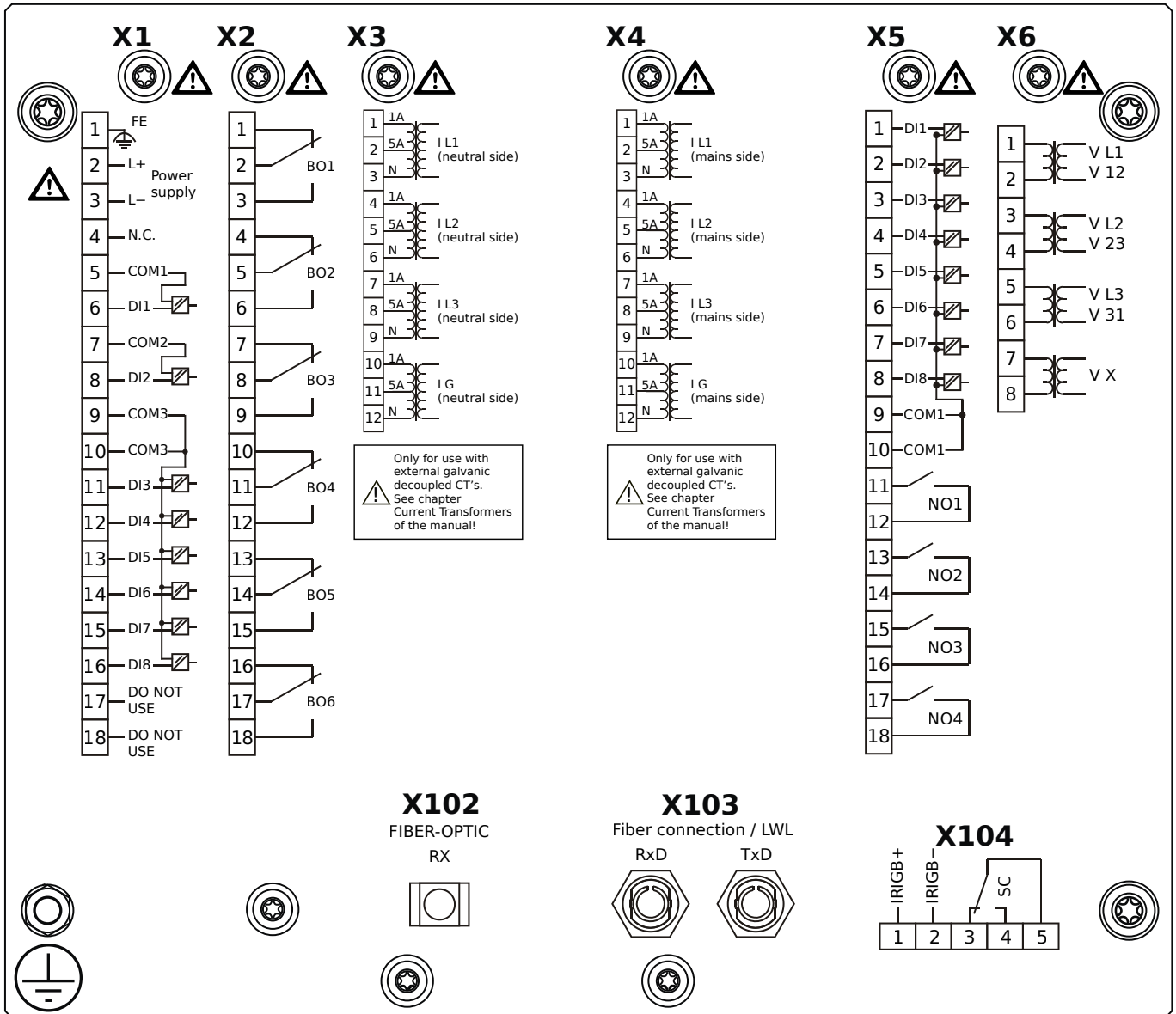

Housing B2, large display, 19" rack mounting

- X1** – DI8-X1: Wide-range power supply unit, incl. 2 non-grouped digital inputs and 6 grouped digital inputs
- X2** – OR6: Assembly Group with 6 Output Relays (Changeover / Form C)
- X3** – TI: Standard current measuring card (for the neutral side of the differential protection)
- X4** – TI: Standard current measuring card (for the mains side of the differential protection)
- X5** – DI8-OR4: Assembly Group with 8 Digital Inputs and 4 Output Relays (NO / Form A)
- X6** – TU: Card with 4 voltage transformer measuring inputs (0 ... 800 VAC, under UL: 0 ... 600 VAC)
- X102** – Universal Resistance-Temperature Detector (URTD) input, Fiber optics interface, Versatile Link
- X103** – Profibus-DP, Fiber optics interface, ST Connector
- X104** – IRIG-B00X, incl. System Contact (Supervision Contact)

MCDGV4-2A0BDB

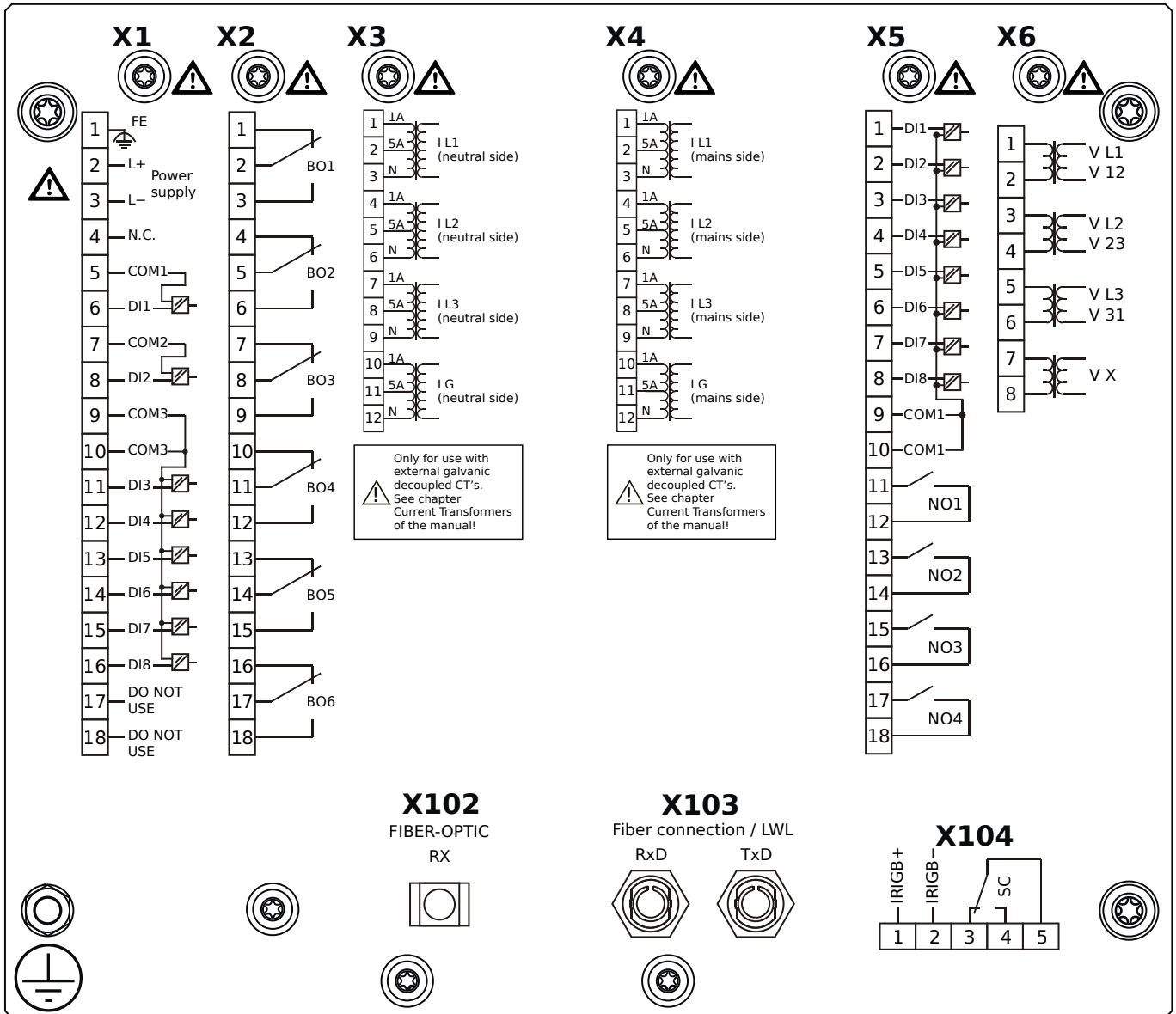

Housing B2, large display, 19" rack mounting

- + Conformal Coating (for installations in harsh environment)

- X1** – DI8-X1: Wide-range power supply unit, incl. 2 non-grouped digital inputs and 6 grouped digital inputs
- X2** – OR6: Assembly Group with 6 Output Relays (Changeover / Form C)
- X3** – TI: Standard current measuring card (for the neutral side of the differential protection)
- X4** – TI: Standard current measuring card (for the mains side of the differential protection)
- X5** – DI8-OR4: Assembly Group with 8 Digital Inputs and 4 Output Relays (NO / Form A)
- X6** – TU: Card with 4 voltage transformer measuring inputs (0 ... 800 VAC, under UL: 0 ... 600 VAC)
- X102** – Universal Resistance-Temperature Detector (URTD) input, Fiber optics interface, Versatile Link
- X103** – Profibus-DP, Fiber optics interface, ST Connector
- X104** – IRIG-B00X, incl. System Contact (Supervision Contact)

MCDGV4-2A0BEA

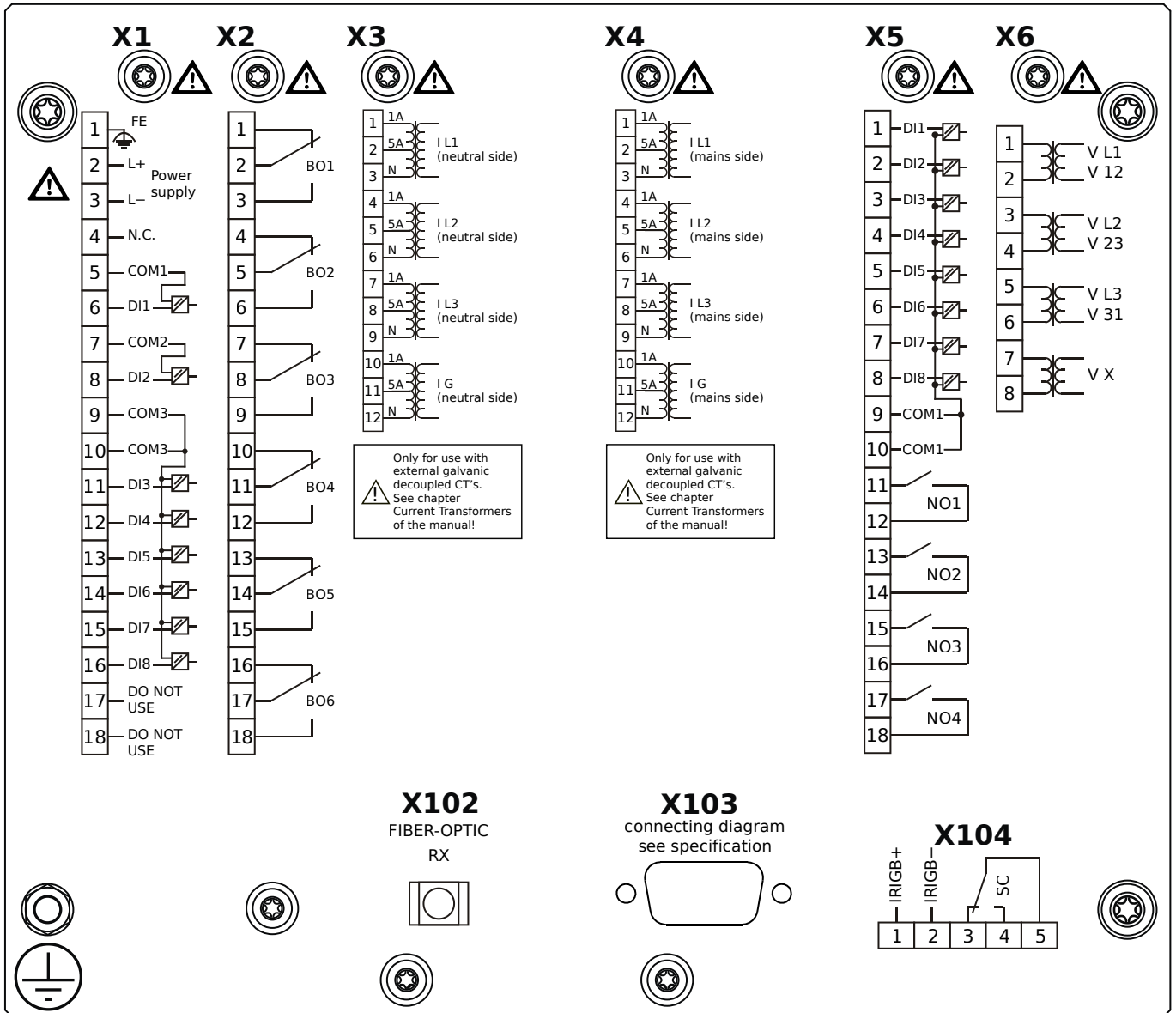

Housing B2, large display, 19" rack mounting

- X1** – DI8-X1: Wide-range power supply unit, incl. 2 non-grouped digital inputs and 6 grouped digital inputs
- X2** – OR6: Assembly Group with 6 Output Relays (Changeover / Form C)
- X3** – TI: Standard current measuring card (for the neutral side of the differential protection)
- X4** – TI: Standard current measuring card (for the mains side of the differential protection)
- X5** – DI8-OR4: Assembly Group with 8 Digital Inputs and 4 Output Relays (NO / Form A)
- X6** – TU: Card with 4 voltage transformer measuring inputs (0 ... 800 VAC, under UL: 0 ... 600 VAC)
- X102** – Universal Resistance-Temperature Detector (URTD) input, Fiber optics interface, Versatile Link
- X103** – Profibus-DP, RS485, D-SUB
- X104** – IRIG-B00X, incl. System Contact (Supervision Contact)

MCDGV4-2A0BEB

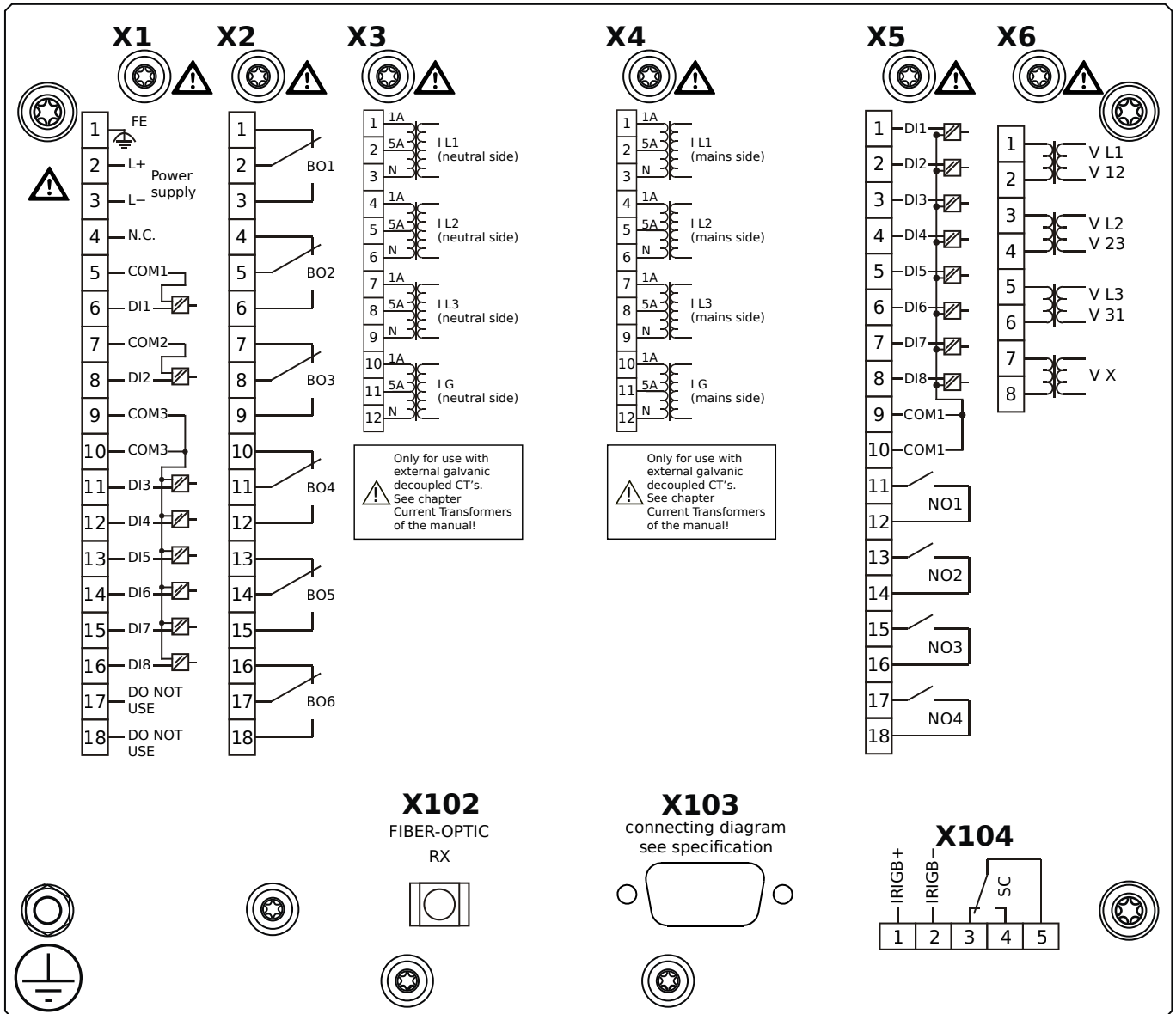

Housing B2, large display, 19" rack mounting

+ Conformal Coating (for installations in harsh environment)

- X1** – DI8-X1: Wide-range power supply unit, incl. 2 non-grouped digital inputs and 6 grouped digital inputs
- X2** – OR6: Assembly Group with 6 Output Relays (Changeover / Form C)
- X3** – TI: Standard current measuring card (for the neutral side of the differential protection)
- X4** – TI: Standard current measuring card (for the mains side of the differential protection)
- X5** – DI8-OR4: Assembly Group with 8 Digital Inputs and 4 Output Relays (NO / Form A)
- X6** – TU: Card with 4 voltage transformer measuring inputs (0 ... 800 VAC, under UL: 0 ... 600 VAC)
- X102** – Universal Resistance-Temperature Detector (URTD) input, Fiber optics interface, Versatile Link
- X103** – Profibus-DP, RS485, D-SUB
- X104** – IRIG-B00X, incl. System Contact (Supervision Contact)

MCDGV4-2A0BFA

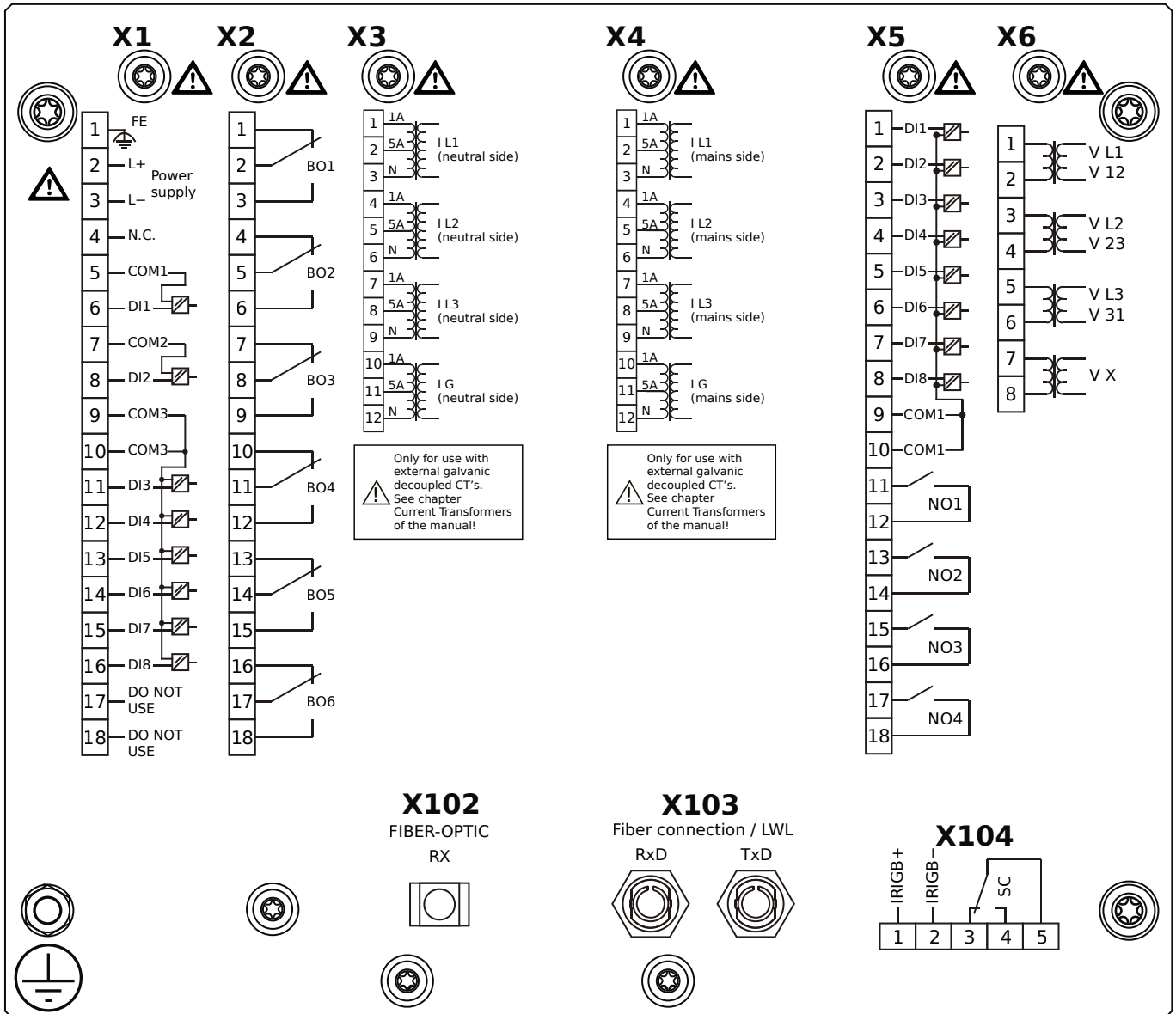

Housing B2, large display, 19" rack mounting

- X1** – DI8-X1: Wide-range power supply unit, incl. 2 non-grouped digital inputs and 6 grouped digital inputs
- X2** – OR6: Assembly Group with 6 Output Relays (Changeover / Form C)
- X3** – TI: Standard current measuring card (for the neutral side of the differential protection)
- X4** – TI: Standard current measuring card (for the mains side of the differential protection)
- X5** – DI8-OR4: Assembly Group with 8 Digital Inputs and 4 Output Relays (NO / Form A)
- X6** – TU: Card with 4 voltage transformer measuring inputs (0 ... 800 VAC, under UL: 0 ... 600 VAC)
- X102** – Universal Resistance-Temperature Detector (URTD) input, Fiber optics interface, Versatile Link
- X103** – Modbus RTU / IEC 60870-5-103 / DNP3.0 RTU, Fiber optics interface, ST Connector
- X104** – IRIG-B00X, incl. System Contact (Supervision Contact)

MCDGV4-2A0BFB

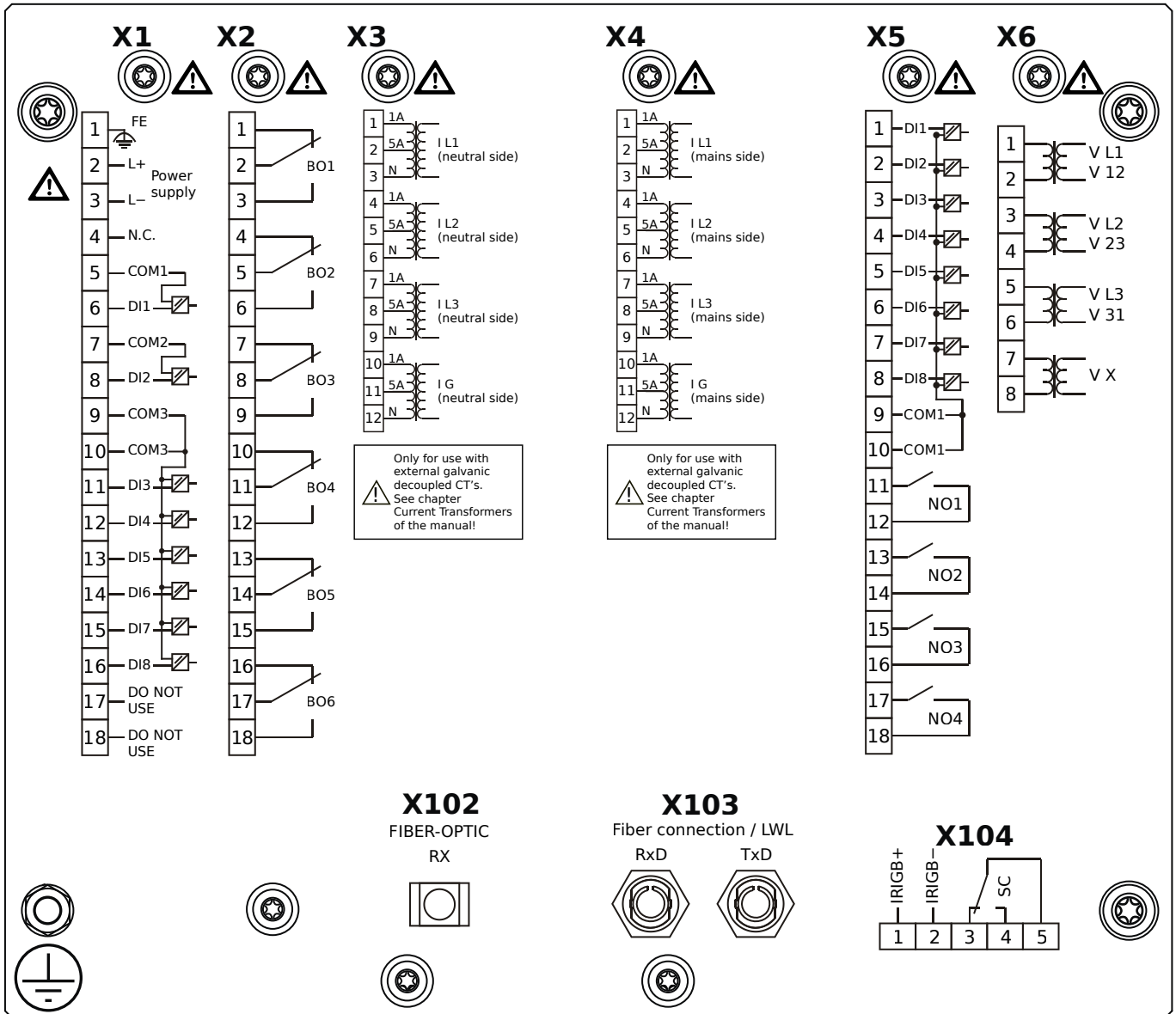

Housing B2, large display, 19" rack mounting

+ Conformal Coating (for installations in harsh environment)

- X1** – DI8-X1: Wide-range power supply unit, incl. 2 non-grouped digital inputs and 6 grouped digital inputs
- X2** – OR6: Assembly Group with 6 Output Relays (Changeover / Form C)
- X3** – TI: Standard current measuring card (for the neutral side of the differential protection)
- X4** – TI: Standard current measuring card (for the mains side of the differential protection)
- X5** – DI8-OR4: Assembly Group with 8 Digital Inputs and 4 Output Relays (NO / Form A)
- X6** – TU: Card with 4 voltage transformer measuring inputs (0 ... 800 VAC, under UL: 0 ... 600 VAC)
- X102** – Universal Resistance-Temperature Detector (URTD) input, Fiber optics interface, Versatile Link
- X103** – Modbus RTU / IEC 60870-5-103 / DNP3.0 RTU, Fiber optics interface, ST Connector
- X104** – IRIG-B00X, incl. System Contact (Supervision Contact)

MCDGV4-2A0BGA

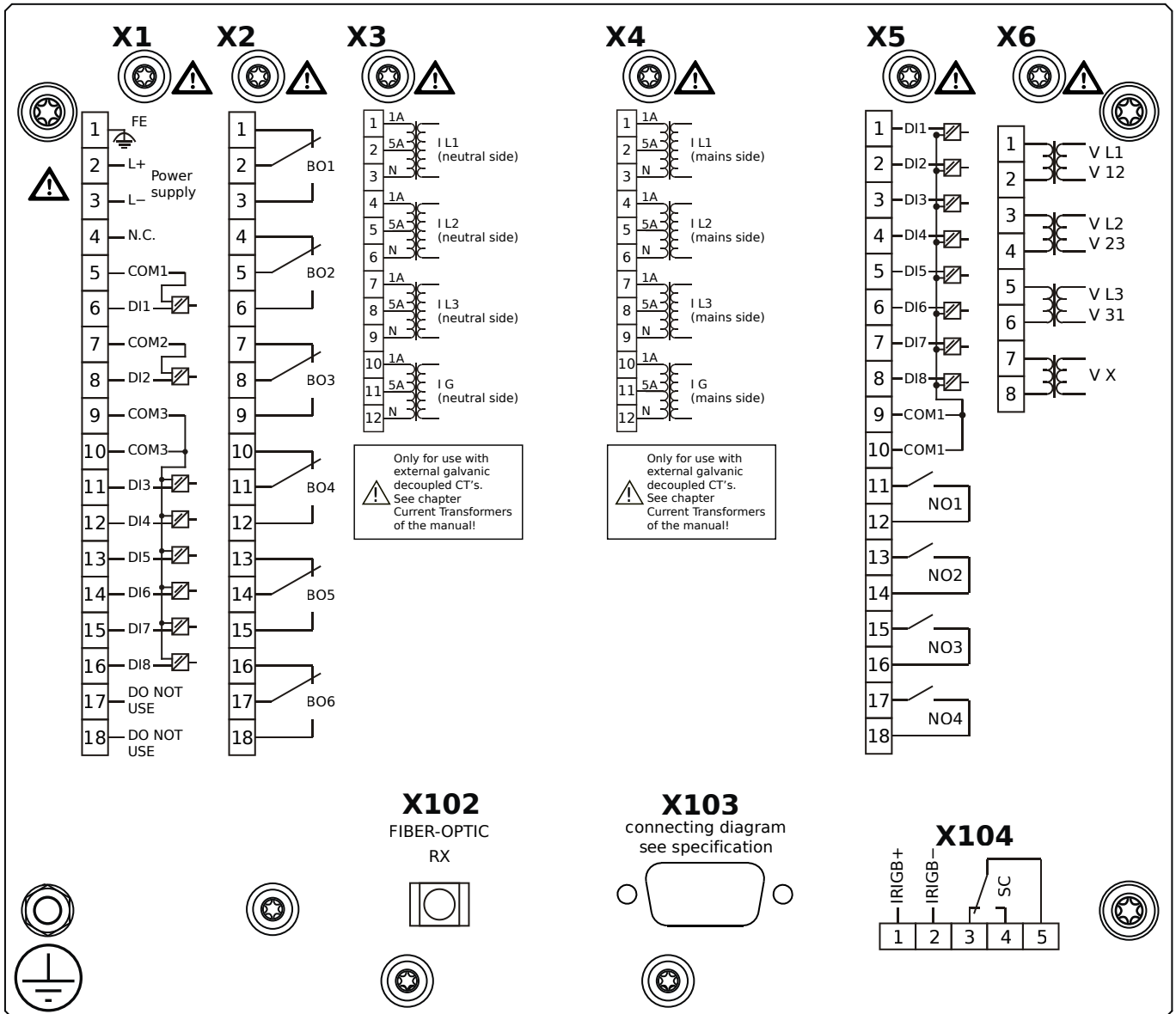

Housing B2, large display, 19" rack mounting

- X1** – DI8-X1: Wide-range power supply unit, incl. 2 non-grouped digital inputs and 6 grouped digital inputs
- X2** – OR6: Assembly Group with 6 Output Relays (Changeover / Form C)
- X3** – TI: Standard current measuring card (for the neutral side of the differential protection)
- X4** – TI: Standard current measuring card (for the mains side of the differential protection)
- X5** – DI8-OR4: Assembly Group with 8 Digital Inputs and 4 Output Relays (NO / Form A)
- X6** – TU: Card with 4 voltage transformer measuring inputs (0 ... 800 VAC, under UL: 0 ... 600 VAC)
- X102** – Universal Resistance-Temperature Detector (URTD) input, Fiber optics interface, Versatile Link
- X103** – Modbus RTU / IEC 60870-5-103 / DNP3.0 RTU, RS485, D-SUB
- X104** – IRIG-B00X, incl. System Contact (Supervision Contact)

MCDGV4-2A0BGB

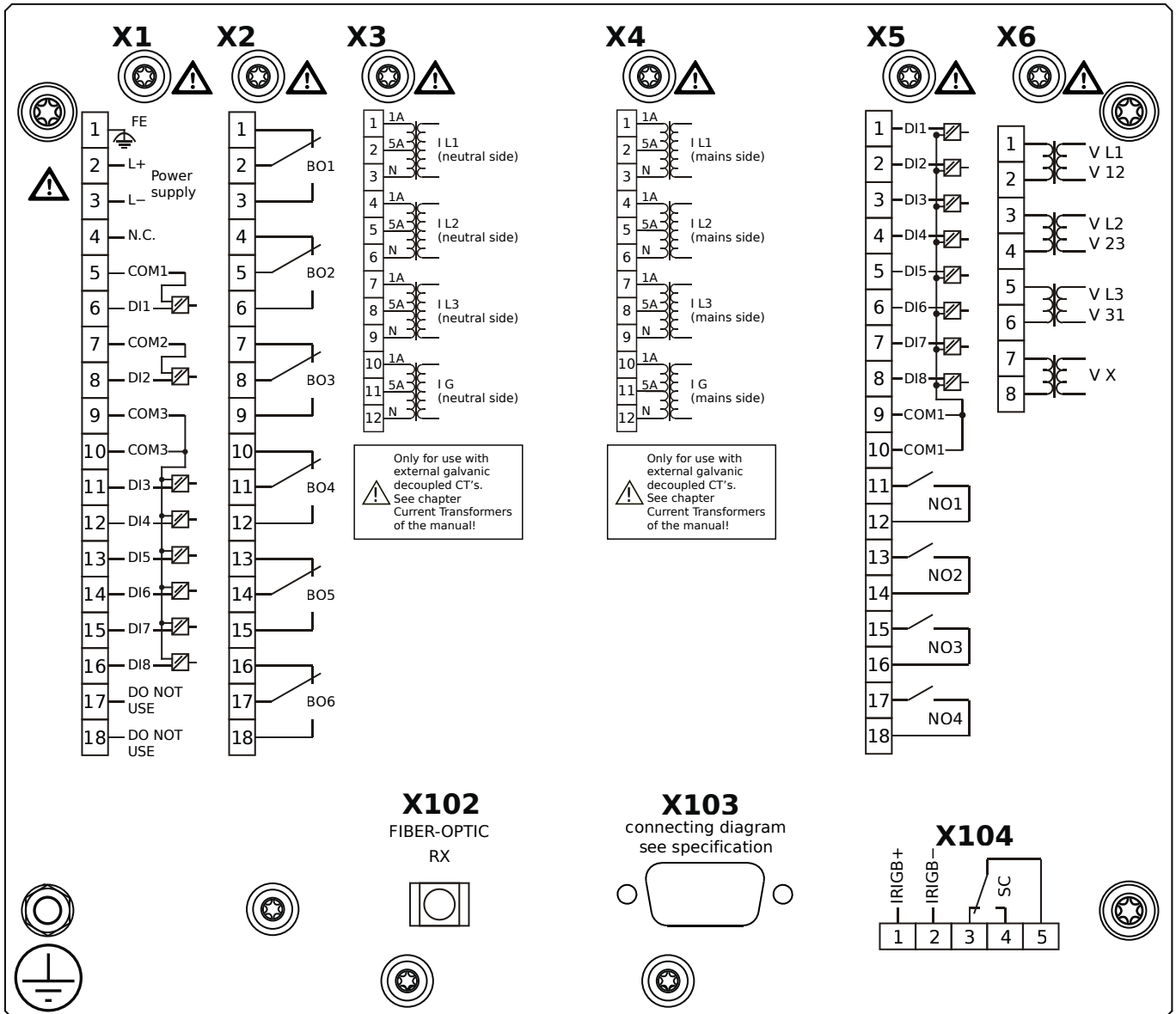

Housing B2, large display, 19" rack mounting

+ Conformal Coating (for installations in harsh environment)

- X1** – DI8-X1: Wide-range power supply unit, incl. 2 non-grouped digital inputs and 6 grouped digital inputs
- X2** – OR6: Assembly Group with 6 Output Relays (Changeover / Form C)
- X3** – TI: Standard current measuring card (for the neutral side of the differential protection)
- X4** – TI: Standard current measuring card (for the mains side of the differential protection)
- X5** – DI8-OR4: Assembly Group with 8 Digital Inputs and 4 Output Relays (NO / Form A)
- X6** – TU: Card with 4 voltage transformer measuring inputs (0 ... 800 VAC, under UL: 0 ... 600 VAC)
- X102** – Universal Resistance-Temperature Detector (URTD) input, Fiber optics interface, Versatile Link
- X103** – Modbus RTU / IEC 60870-5-103 / DNP3.0 RTU, RS485, D-SUB
- X104** – IRIG-B00X, incl. System Contact (Supervision Contact)

MCDGV4-2A0BHA

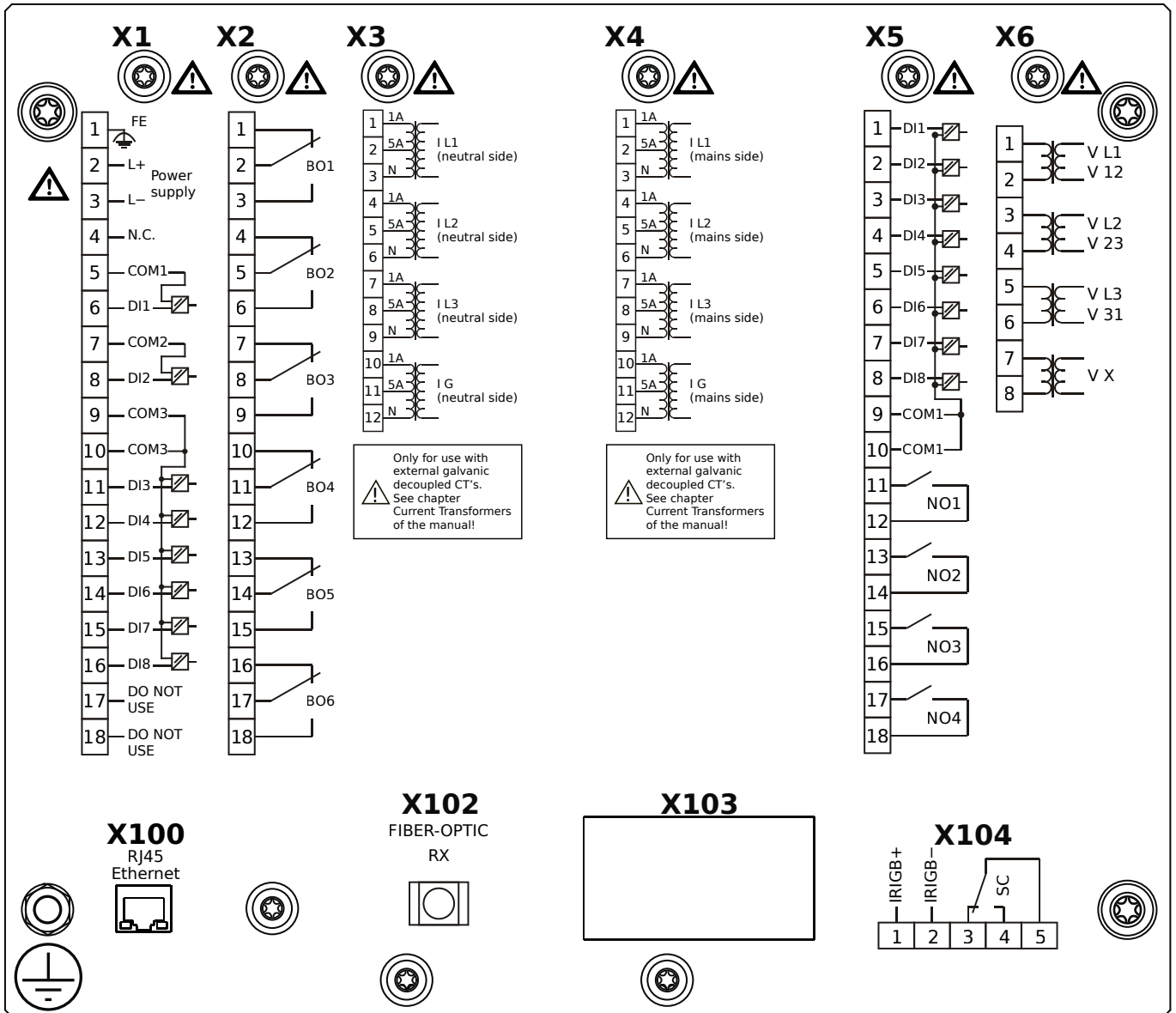

Housing B2, large display, 19" rack mounting

- X1** – DI8-X1: Wide-range power supply unit, incl. 2 non-grouped digital inputs and 6 grouped digital inputs
- X2** – OR6: Assembly Group with 6 Output Relays (Changeover / Form C)
- X3** – TI: Standard current measuring card (for the neutral side of the differential protection)
- X4** – TI: Standard current measuring card (for the mains side of the differential protection)
- X5** – DI8-OR4: Assembly Group with 8 Digital Inputs and 4 Output Relays (NO / Form A)
- X6** – TU: Card with 4 voltage transformer measuring inputs (0 ... 800 VAC, under UL: 0 ... 600 VAC)
- X100** – IEC 61850 / Modbus TCP / DNP3.0 TCP/UDP, Ethernet interface, 100 Mbit/s, RJ45 (BASE100-FX)
- X102** – Universal Resistance-Temperature Detector (URTD) input, Fiber optics interface, Versatile Link
- X104** – IRIG-B00X, incl. System Contact (Supervision Contact)

MCDGV4-2A0BHB

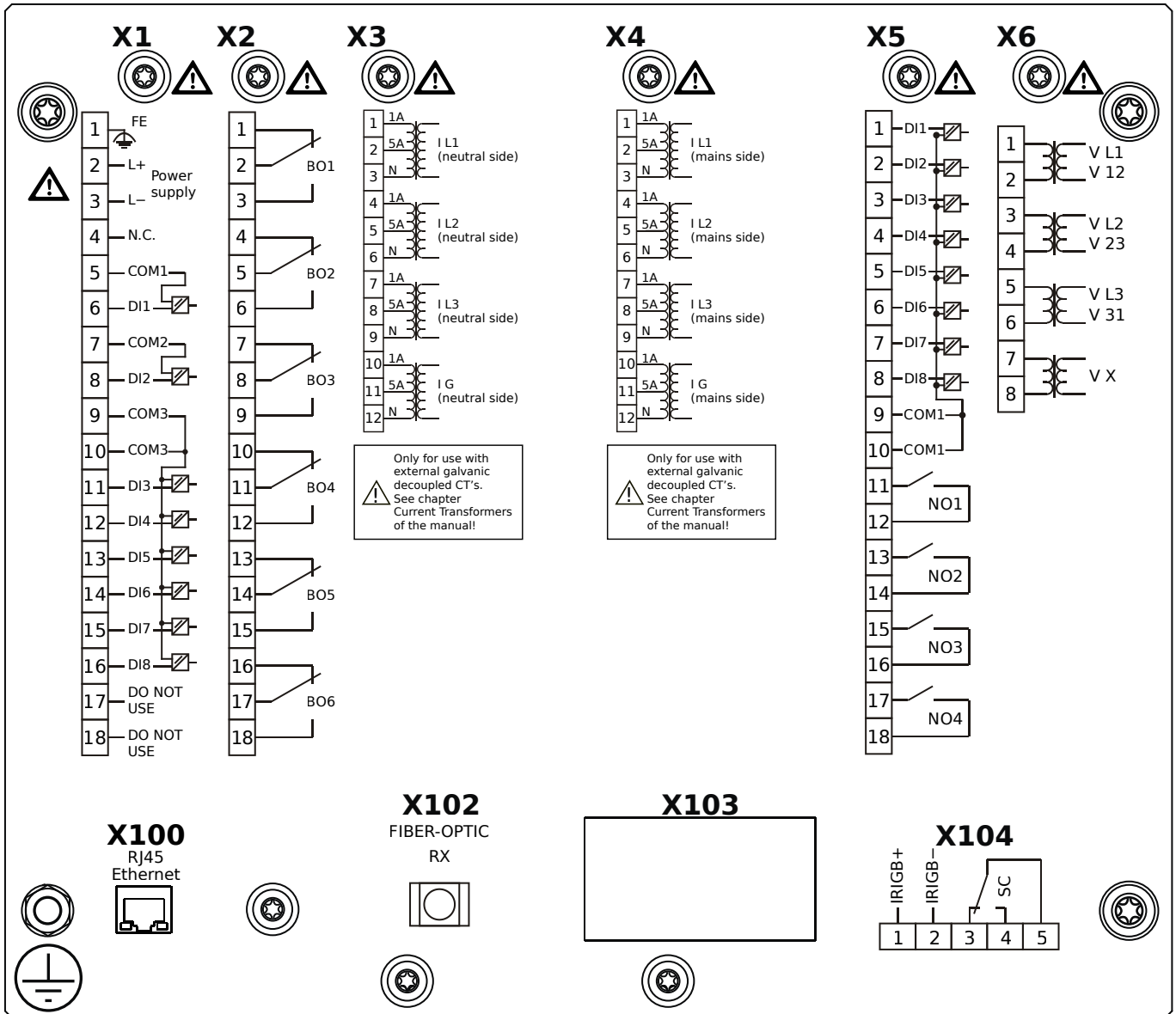

Housing B2, large display, 19" rack mounting

+ Conformal Coating (for installations in harsh environment)

- X1** – DI8-X1: Wide-range power supply unit, incl. 2 non-grouped digital inputs and 6 grouped digital inputs
- X2** – OR6: Assembly Group with 6 Output Relays (Changeover / Form C)
- X3** – TI: Standard current measuring card (for the neutral side of the differential protection)
- X4** – TI: Standard current measuring card (for the mains side of the differential protection)
- X5** – DI8-OR4: Assembly Group with 8 Digital Inputs and 4 Output Relays (NO / Form A)
- X6** – TU: Card with 4 voltage transformer measuring inputs (0 ... 800 VAC, under UL: 0 ... 600 VAC)
- X100** – IEC 61850 / Modbus TCP / DNP3.0 TCP/UDP, Ethernet interface, 100 Mbit/s, RJ45 (BASE100-FX)
- X102** – Universal Resistance-Temperature Detector (URTD) input, Fiber optics interface, Versatile Link
- X104** – IRIG-B00X, incl. System Contact (Supervision Contact)

MCDGV4-2A0BIA

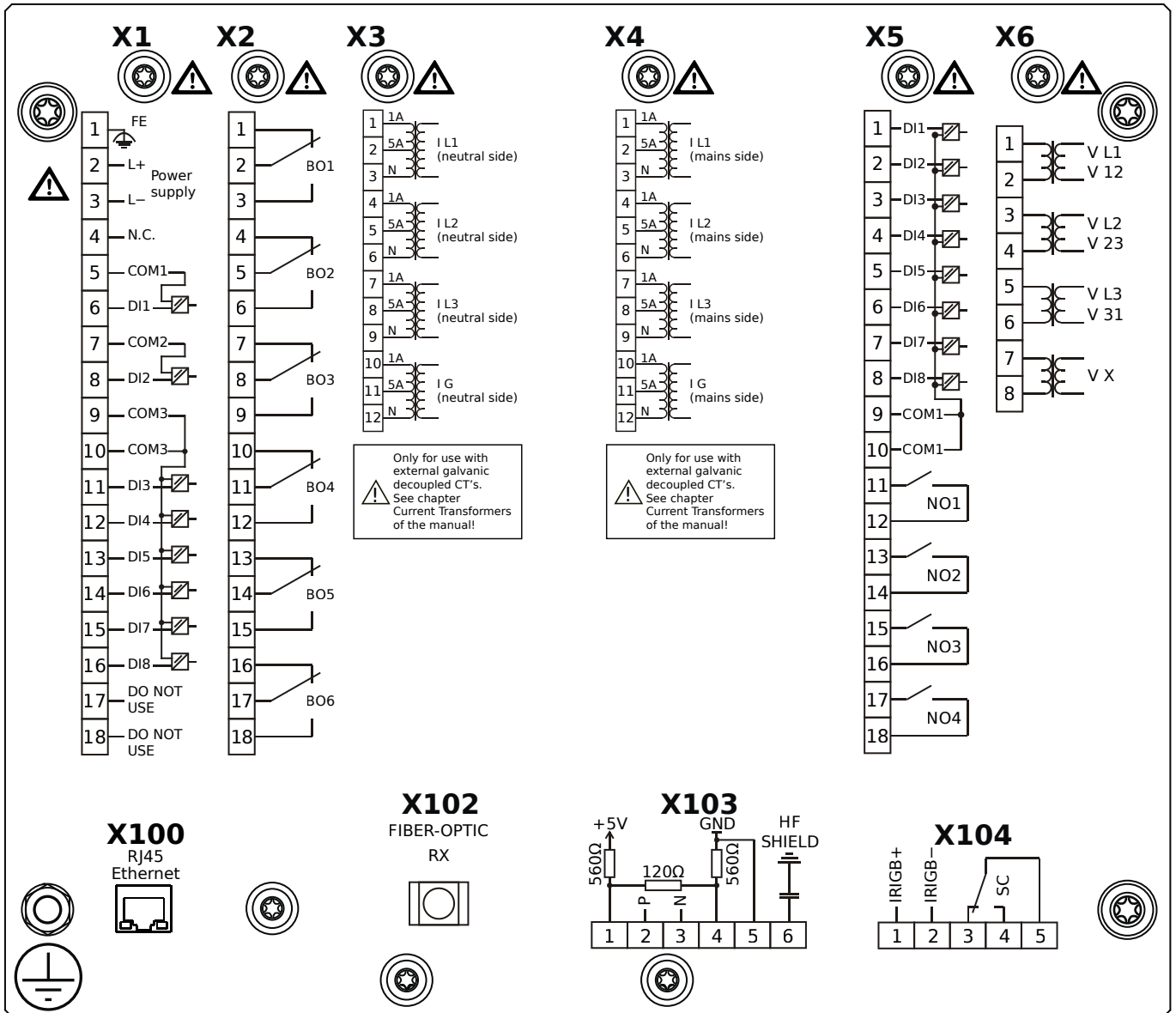

Housing B2, large display, 19" rack mounting

- X1** – DI8-X1: Wide-range power supply unit, incl. 2 non-grouped digital inputs and 6 grouped digital inputs
- X2** – OR6: Assembly Group with 6 Output Relays (Changeover / Form C)
- X3** – TI: Standard current measuring card (for the neutral side of the differential protection)
- X4** – TI: Standard current measuring card (for the mains side of the differential protection)
- X5** – DI8-OR4: Assembly Group with 8 Digital Inputs and 4 Output Relays (NO / Form A)
- X6** – TU: Card with 4 voltage transformer measuring inputs (0 ... 800 VAC, under UL: 0 ... 600 VAC)
- X100** – Modbus TCP / DNP3.0 TCP/UDP, Ethernet interface, 100 Mbit/s, RJ45 (BASE100-FX)
- X102** – Universal Resistance-Temperature Detector (URTD) input, Fiber optics interface, Versatile Link
- X103** – IEC 60870-5-103 / Modbus RTU / DNP3.0 RTU, RS485, Terminals
- X104** – IRIG-B00X, incl. System Contact (Supervision Contact)

MCDGV4-2A0BIB

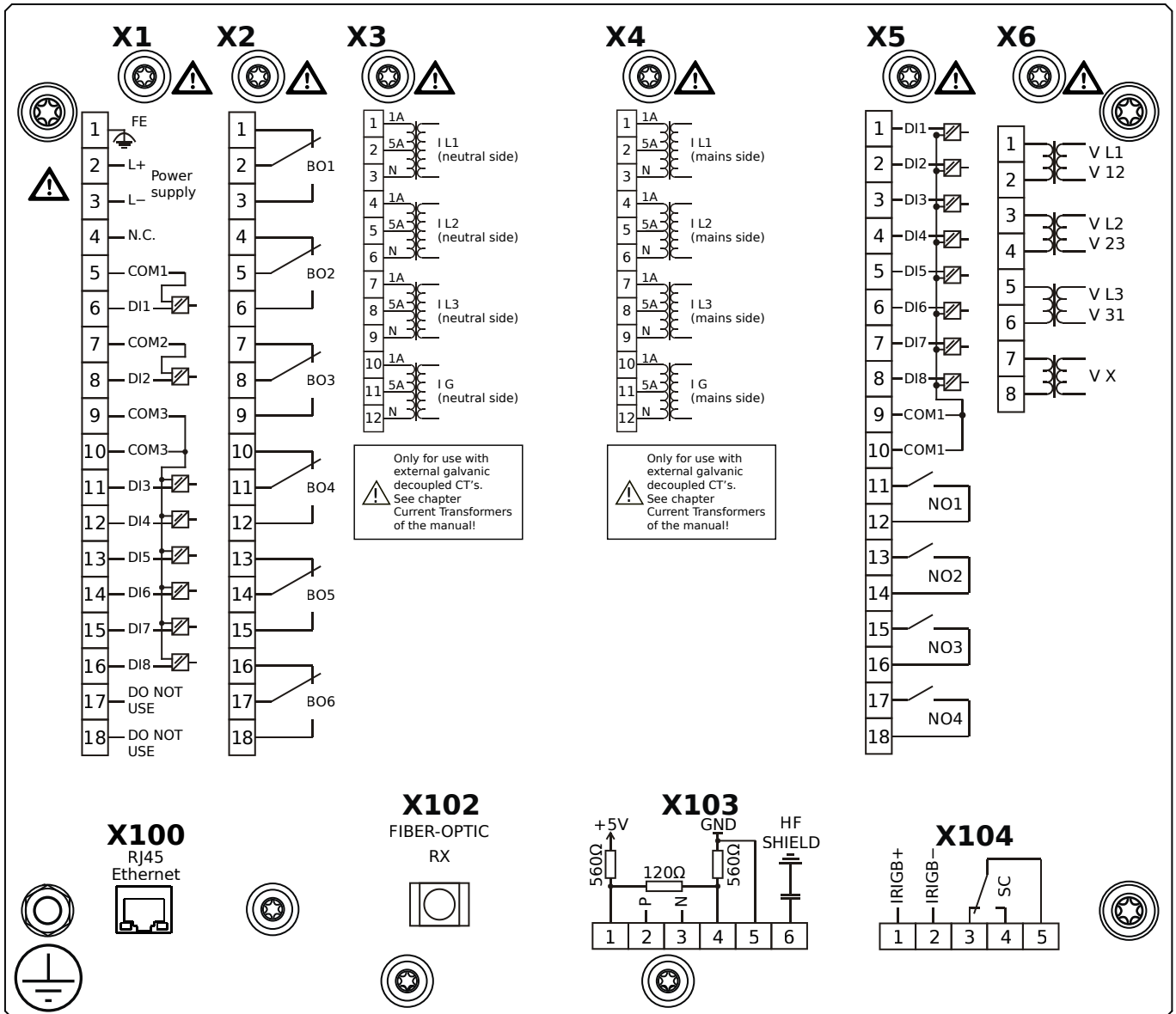

Housing B2, large display, 19" rack mounting

+ Conformal Coating (for installations in harsh environment)

- X1** – DI8-X1: Wide-range power supply unit, incl. 2 non-grouped digital inputs and 6 grouped digital inputs
- X2** – OR6: Assembly Group with 6 Output Relays (Changeover / Form C)
- X3** – TI: Standard current measuring card (for the neutral side of the differential protection)
- X4** – TI: Standard current measuring card (for the mains side of the differential protection)
- X5** – DI8-OR4: Assembly Group with 8 Digital Inputs and 4 Output Relays (NO / Form A)
- X6** – TU: Card with 4 voltage transformer measuring inputs (0 ... 800 VAC, under UL: 0 ... 600 VAC)
- X100** – Modbus TCP / DNP3.0 TCP/UDP, Ethernet interface, 100 Mbit/s, RJ45 (BASE100-FX)
- X102** – Universal Resistance-Temperature Detector (URTD) input, Fiber optics interface, Versatile Link
- X103** – IEC 60870-5-103 / Modbus RTU / DNP3.0 RTU, RS485, Terminals
- X104** – IRIG-B00X, incl. System Contact (Supervision Contact)

MCDGV4-2A0BKA

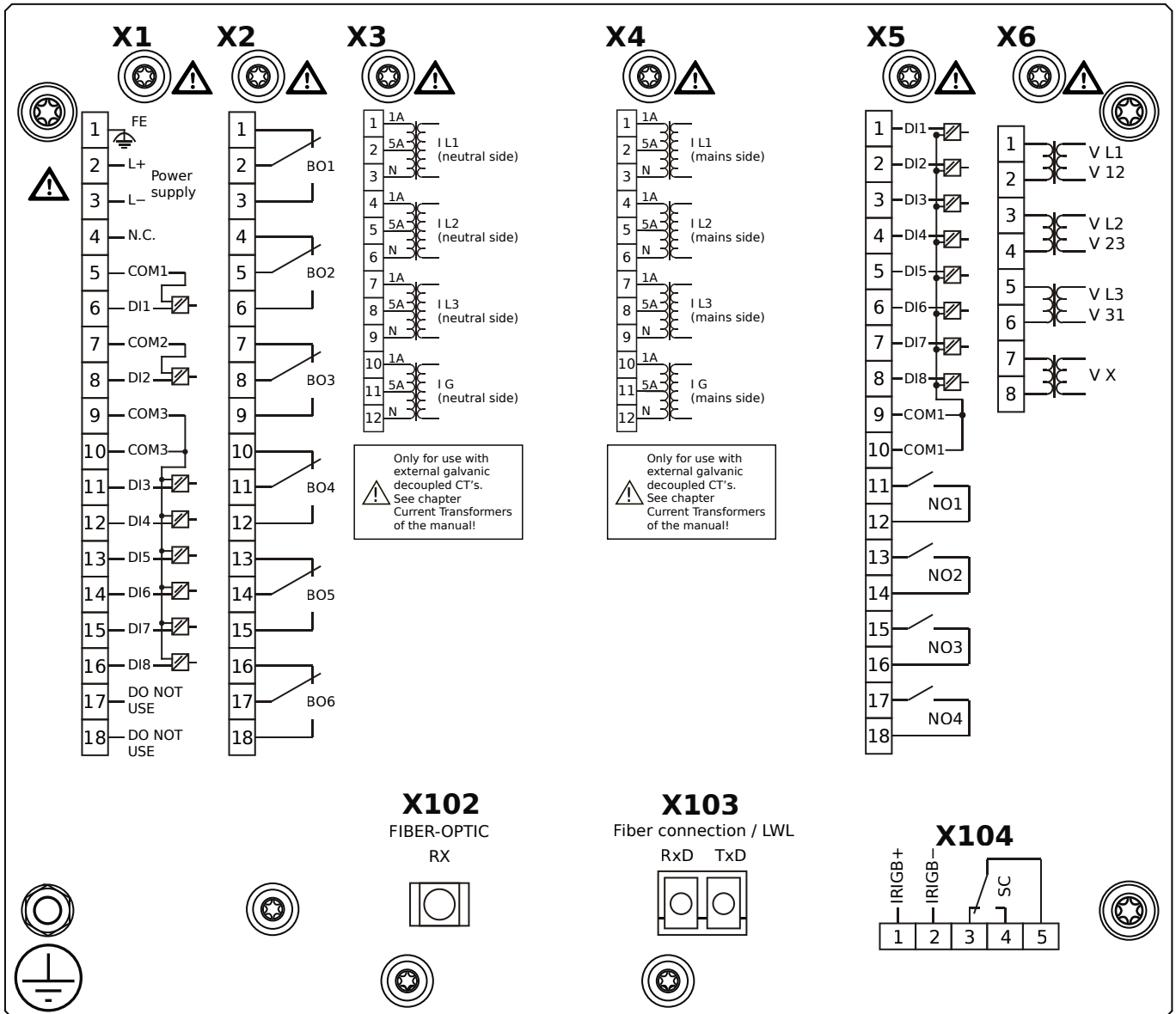

Housing B2, large display, 19" rack mounting

- X1** – DI8-X1: Wide-range power supply unit, incl. 2 non-grouped digital inputs and 6 grouped digital inputs
- X2** – OR6: Assembly Group with 6 Output Relays (Changeover / Form C)
- X3** – TI: Standard current measuring card (for the neutral side of the differential protection)
- X4** – TI: Standard current measuring card (for the mains side of the differential protection)
- X5** – DI8-OR4: Assembly Group with 8 Digital Inputs and 4 Output Relays (NO / Form A)
- X6** – TU: Card with 4 voltage transformer measuring inputs (0 ... 800 VAC, under UL: 0 ... 600 VAC)
- X102** – Universal Resistance-Temperature Detector (URTD) input, Fiber optics interface, Versatile Link
- X103** – IEC 61850 / Modbus TCP / DNP3.0 TCP/UDP, Fiber optics interface, LC Connector
- X104** – IRIG-B00X, incl. System Contact (Supervision Contact)

MCDGV4-2A0BKB

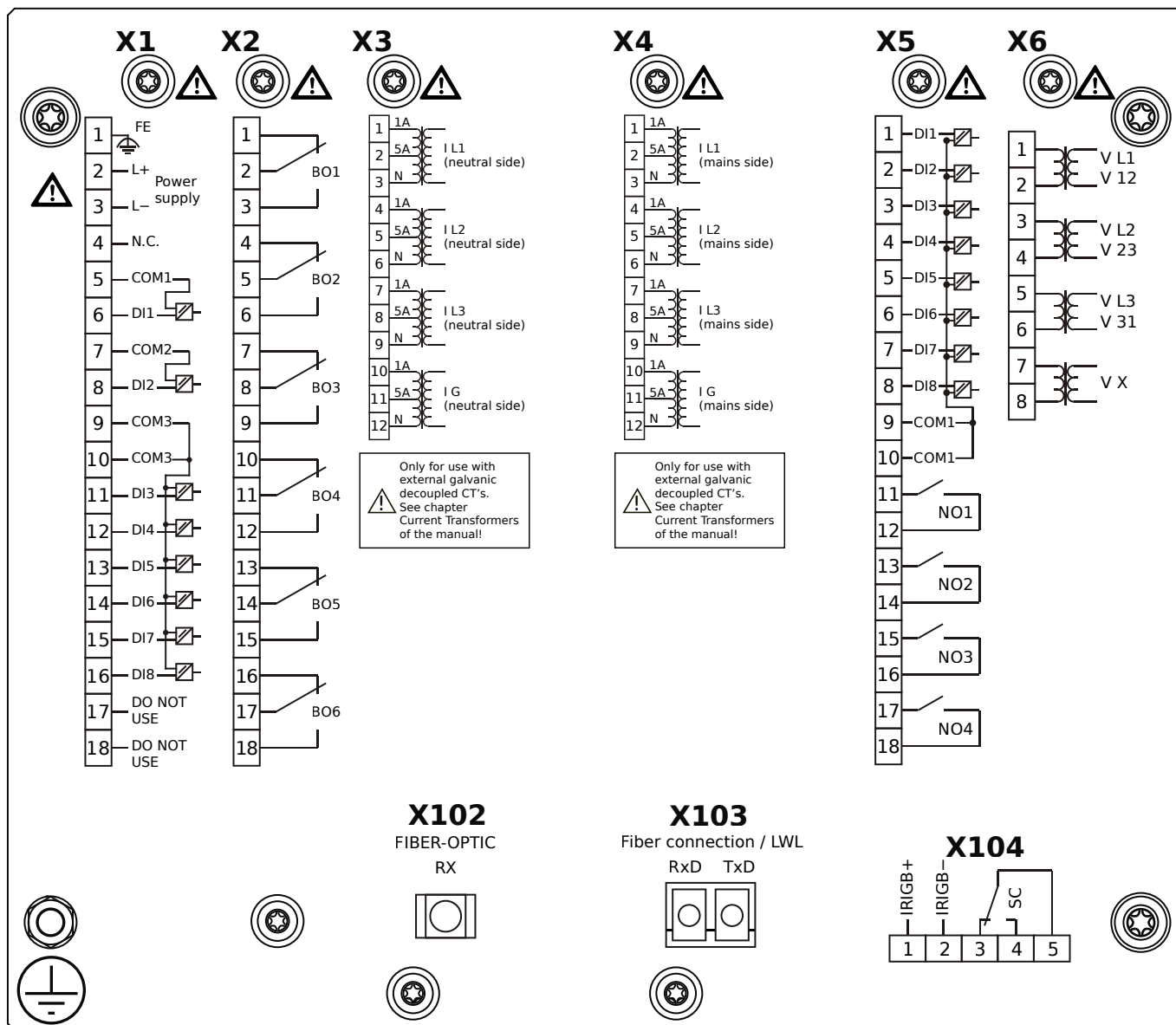

Housing B2, large display, 19" rack mounting

- + Conformal Coating (for installations in harsh environment)

- X1** – DI8-X1: Wide-range power supply unit, incl. 2 non-grouped digital inputs and 6 grouped digital inputs
- X2** – OR6: Assembly Group with 6 Output Relays (Changeover / Form C)
- X3** – TI: Standard current measuring card (for the neutral side of the differential protection)
- X4** – TI: Standard current measuring card (for the mains side of the differential protection)
- X5** – DI8-OR4: Assembly Group with 8 Digital Inputs and 4 Output Relays (NO / Form A)
- X6** – TU: Card with 4 voltage transformer measuring inputs (0 ... 800 VAC, under UL: 0 ... 600 VAC)
- X102** – Universal Resistance-Temperature Detector (URTD) input, Fiber optics interface, Versatile Link
- X103** – IEC 61850 / Modbus TCP / DNP3.0 TCP/UDP, Fiber optics interface, LC Connector
- X104** – IRIG-B00X, incl. System Contact (Supervision Contact)

MCDGV4-2A0BLA

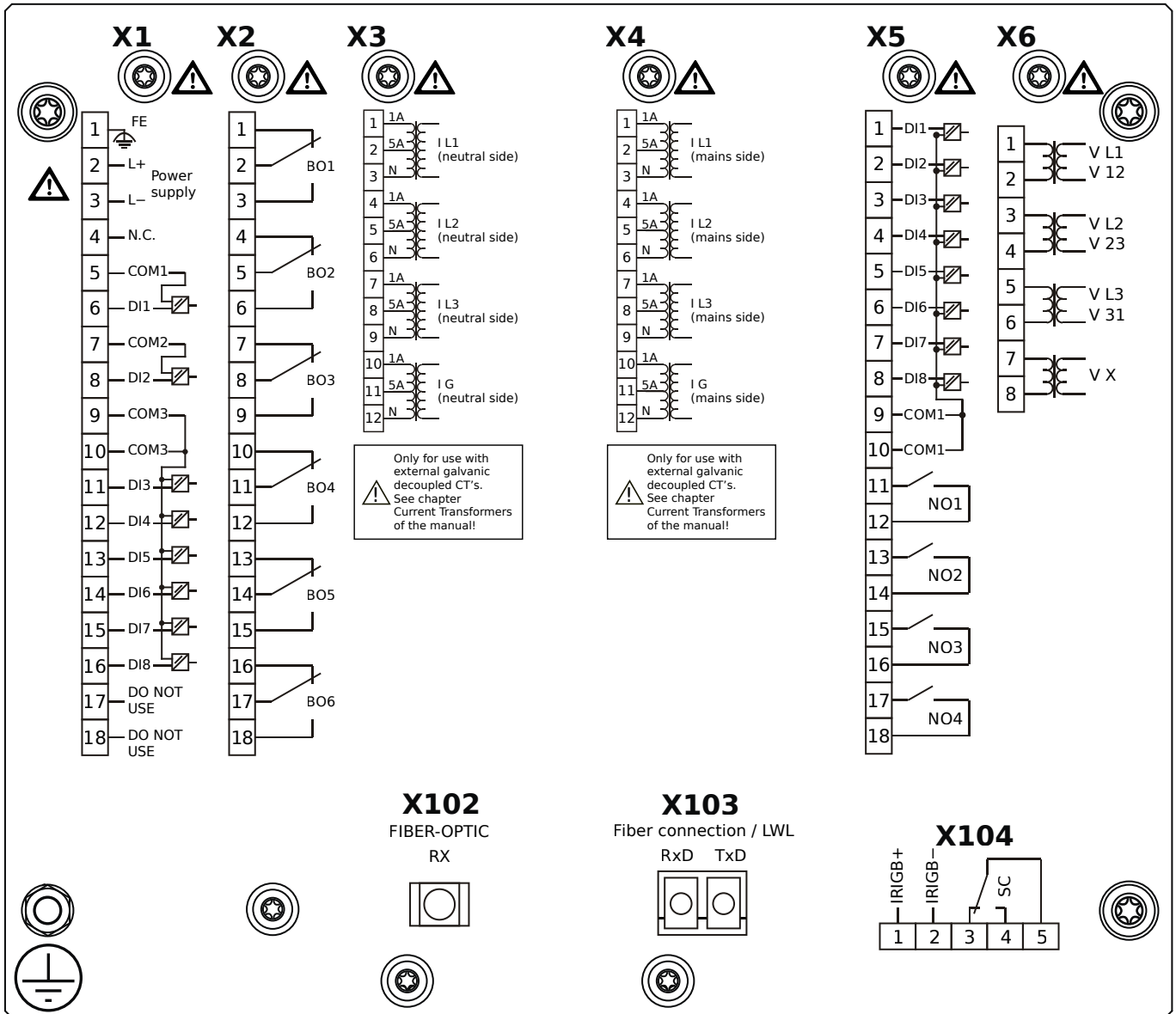

Housing B2, large display, 19" rack mounting

- X1** – DI8-X1: Wide-range power supply unit, incl. 2 non-grouped digital inputs and 6 grouped digital inputs
- X2** – OR6: Assembly Group with 6 Output Relays (Changeover / Form C)
- X3** – TI: Standard current measuring card (for the neutral side of the differential protection)
- X4** – TI: Standard current measuring card (for the mains side of the differential protection)
- X5** – DI8-OR4: Assembly Group with 8 Digital Inputs and 4 Output Relays (NO / Form A)
- X6** – TU: Card with 4 voltage transformer measuring inputs (0 ... 800 VAC, under UL: 0 ... 600 VAC)
- X102** – Universal Resistance-Temperature Detector (URTD) input, Fiber optics interface, Versatile Link
- X103** – Modbus TCP / DNP3.0 TCP/UDP, Fiber optics interface, LC Connector
- X104** – IRIG-B00X, incl. System Contact (Supervision Contact)

MCDGV4-2A0BLB

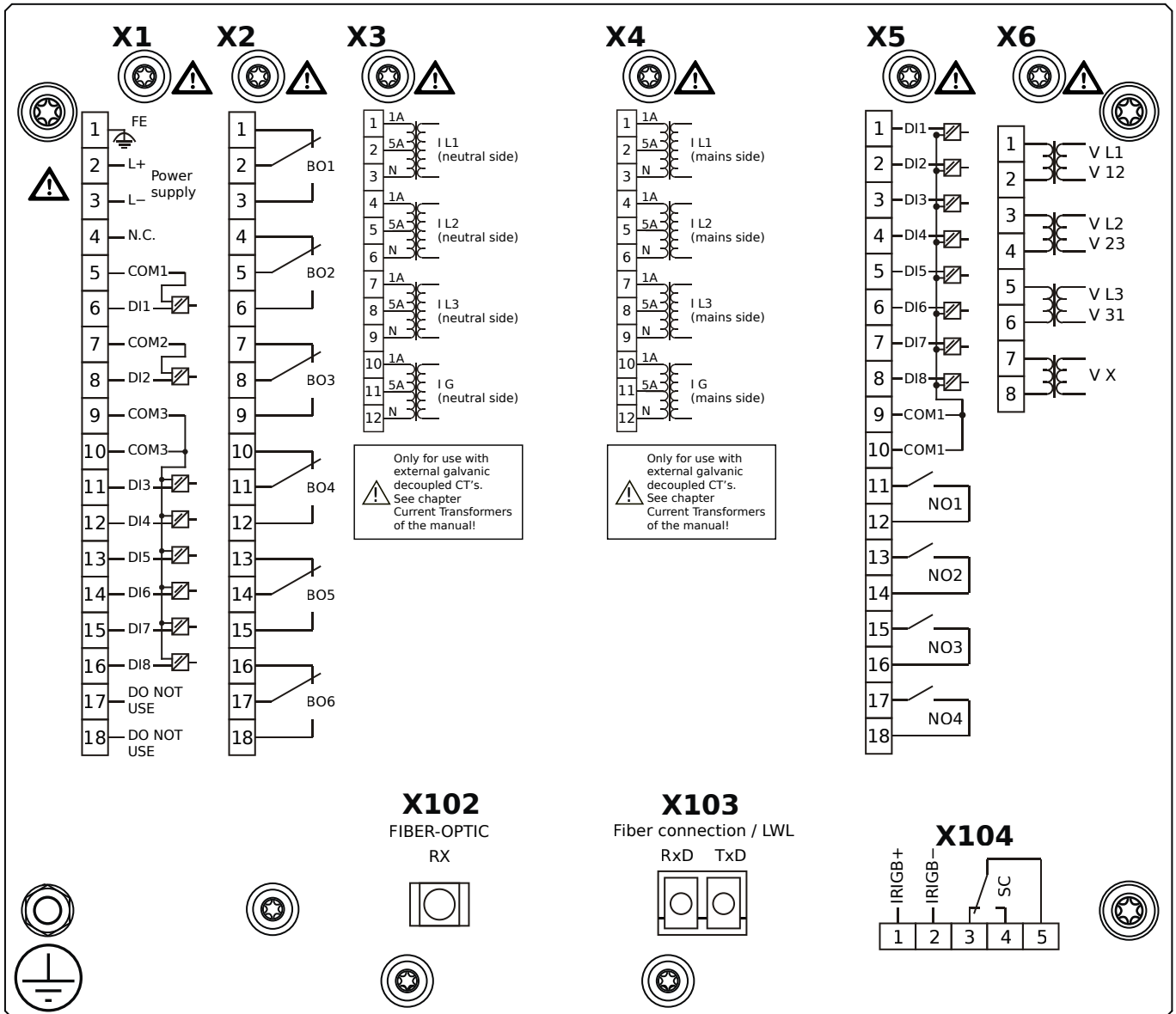

Housing B2, large display, 19" rack mounting

+ Conformal Coating (for installations in harsh environment)

- X1** – DI8-X1: Wide-range power supply unit, incl. 2 non-grouped digital inputs and 6 grouped digital inputs
- X2** – OR6: Assembly Group with 6 Output Relays (Changeover / Form C)
- X3** – TI: Standard current measuring card (for the neutral side of the differential protection)
- X4** – TI: Standard current measuring card (for the mains side of the differential protection)
- X5** – DI8-OR4: Assembly Group with 8 Digital Inputs and 4 Output Relays (NO / Form A)
- X6** – TU: Card with 4 voltage transformer measuring inputs (0 ... 800 VAC, under UL: 0 ... 600 VAC)
- X102** – Universal Resistance-Temperature Detector (URTD) input, Fiber optics interface, Versatile Link
- X103** – Modbus TCP / DNP3.0 TCP/UDP, Fiber optics interface, LC Connector
- X104** – IRIG-B00X, incl. System Contact (Supervision Contact)

MCDGV4-2A0BTA

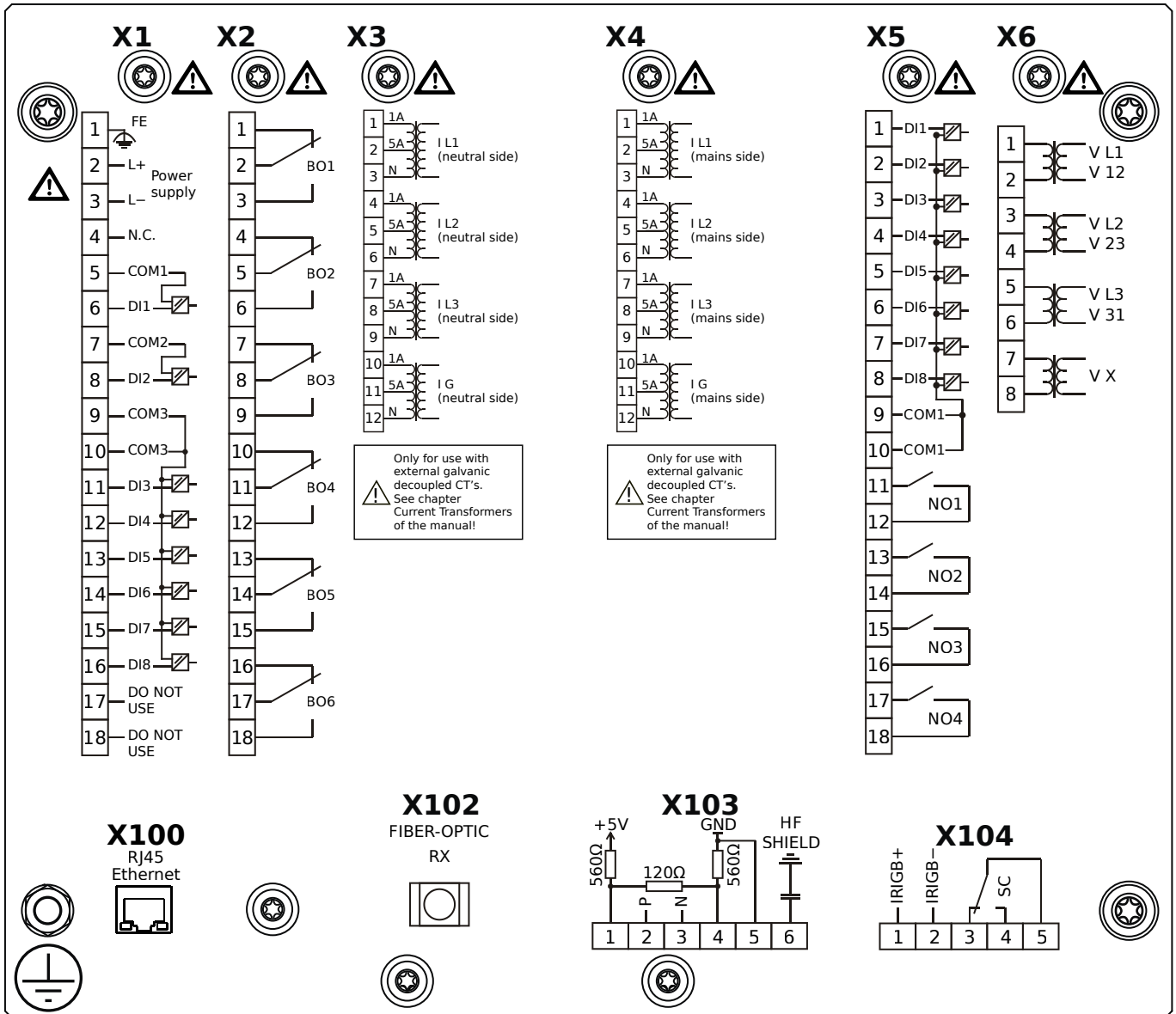

Housing B2, large display, 19" rack mounting

- X1** – DI8-X1: Wide-range power supply unit, incl. 2 non-grouped digital inputs and 6 grouped digital inputs
- X2** – OR6: Assembly Group with 6 Output Relays (Changeover / Form C)
- X3** – TI: Standard current measuring card (for the neutral side of the differential protection)
- X4** – TI: Standard current measuring card (for the mains side of the differential protection)
- X5** – DI8-OR4: Assembly Group with 8 Digital Inputs and 4 Output Relays (NO / Form A)
- X6** – TU: Card with 4 voltage transformer measuring inputs (0 ... 800 VAC, under UL: 0 ... 600 VAC)
- X100** – IEC 61850 / Modbus TCP / DNP3.0 TCP/UDP, Ethernet interface, 100 Mbit/s, RJ45 (BASE100-FX)
- X102** – Universal Resistance-Temperature Detector (URTD) input, Fiber optics interface, Versatile Link
- X103** – IEC 60870-5-103 / Modbus RTU / DNP3.0 RTU, RS485, Terminals
- X104** – IRIG-B00X, incl. System Contact (Supervision Contact)

MCDGV4-2A0BTB

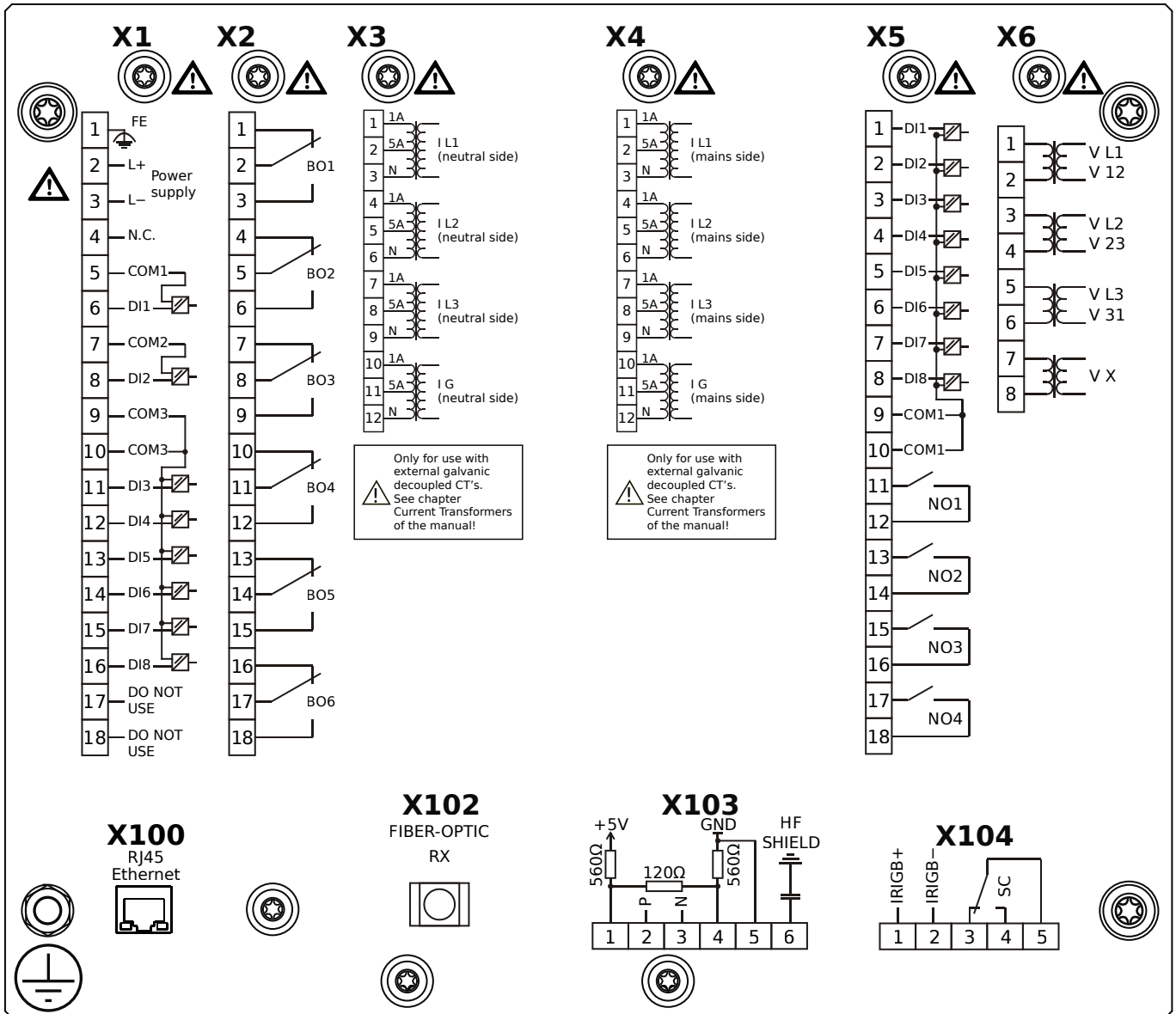

Housing B2, large display, 19" rack mounting

+ Conformal Coating (for installations in harsh environment)

- X1** – DI8-X1: Wide-range power supply unit, incl. 2 non-grouped digital inputs and 6 grouped digital inputs
- X2** – OR6: Assembly Group with 6 Output Relays (Changeover / Form C)
- X3** – TI: Standard current measuring card (for the neutral side of the differential protection)
- X4** – TI: Standard current measuring card (for the mains side of the differential protection)
- X5** – DI8-OR4: Assembly Group with 8 Digital Inputs and 4 Output Relays (NO / Form A)
- X6** – TU: Card with 4 voltage transformer measuring inputs (0 ... 800 VAC, under UL: 0 ... 600 VAC)
- X100** – IEC 61850 / Modbus TCP / DNP3.0 TCP/UDP, Ethernet interface, 100 Mbit/s, RJ45 (BASE100-FX)
- X102** – Universal Resistance-Temperature Detector (URTD) input, Fiber optics interface, Versatile Link
- X103** – IEC 60870-5-103 / Modbus RTU / DNP3.0 RTU, RS485, Terminals
- X104** – IRIG-B00X, incl. System Contact (Supervision Contact)

MCDGV4-2A1AAA

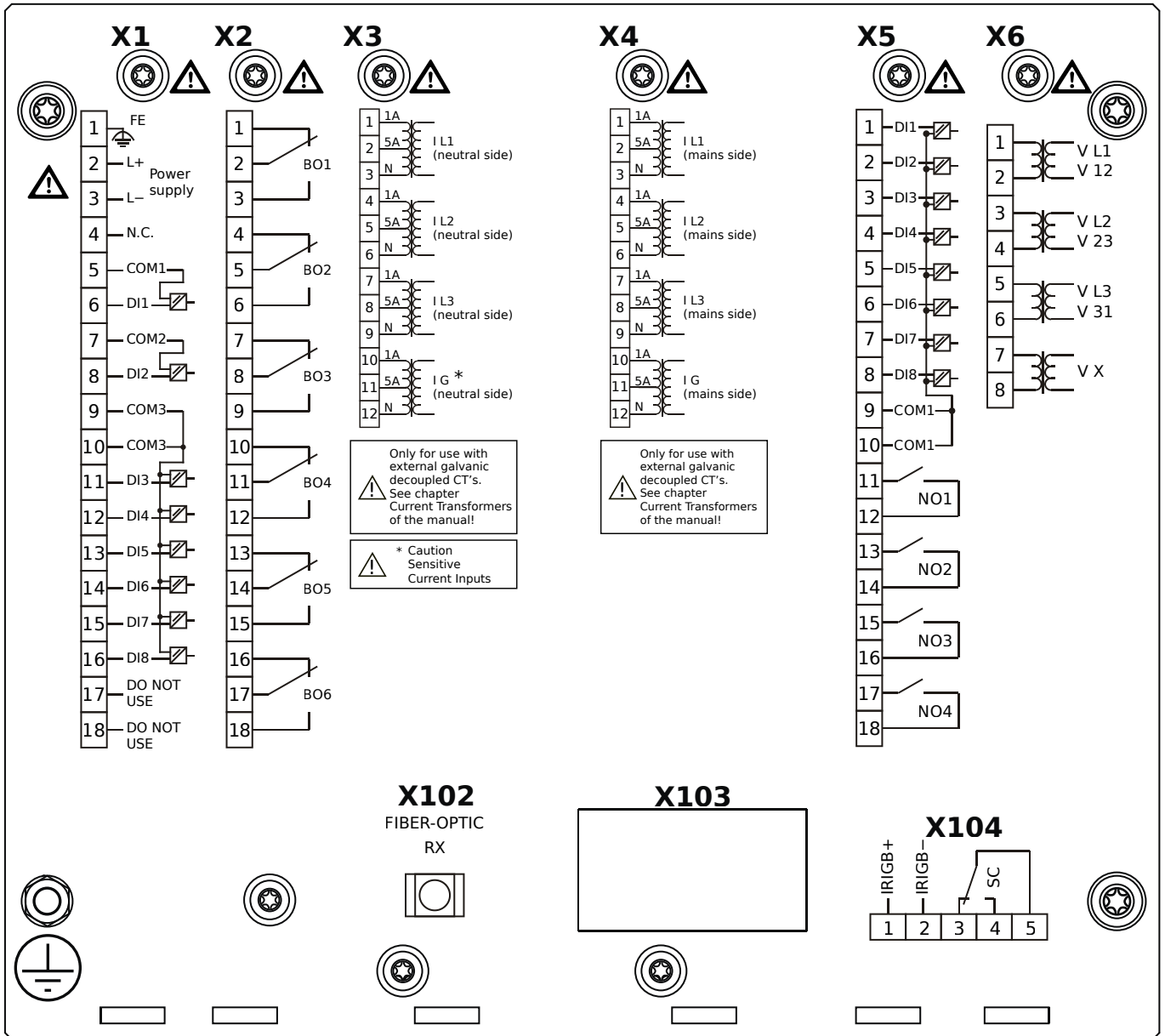

Housing B2, large display, door mounting

- X1** – DI8-X1: Wide-range power supply unit, incl. 2 non-grouped digital inputs and 6 grouped digital inputs
- X2** – OR6: Assembly Group with 6 Output Relays (Changeover / Form C)
- X3** – TI: Standard phase current measuring card and sensitive ground current measuring (neutral side of the diff. prot.)
- X4** – TI: Standard current measuring card (for the mains side of the differential protection)
- X5** – DI8-OR4: Assembly Group with 8 Digital Inputs and 4 Output Relays (NO / Form A)
- X6** – TU: Card with 4 voltage transformer measuring inputs (0 ... 800 VAC, under UL: 0 ... 600 VAC)
- X102** – Universal Resistance-Temperature Detector (URTD) input, Fiber optics interface, Versatile Link
- X104** – IRIG-B00X, incl. System Contact (Supervision Contact)

MCDGV4-2A1AAB

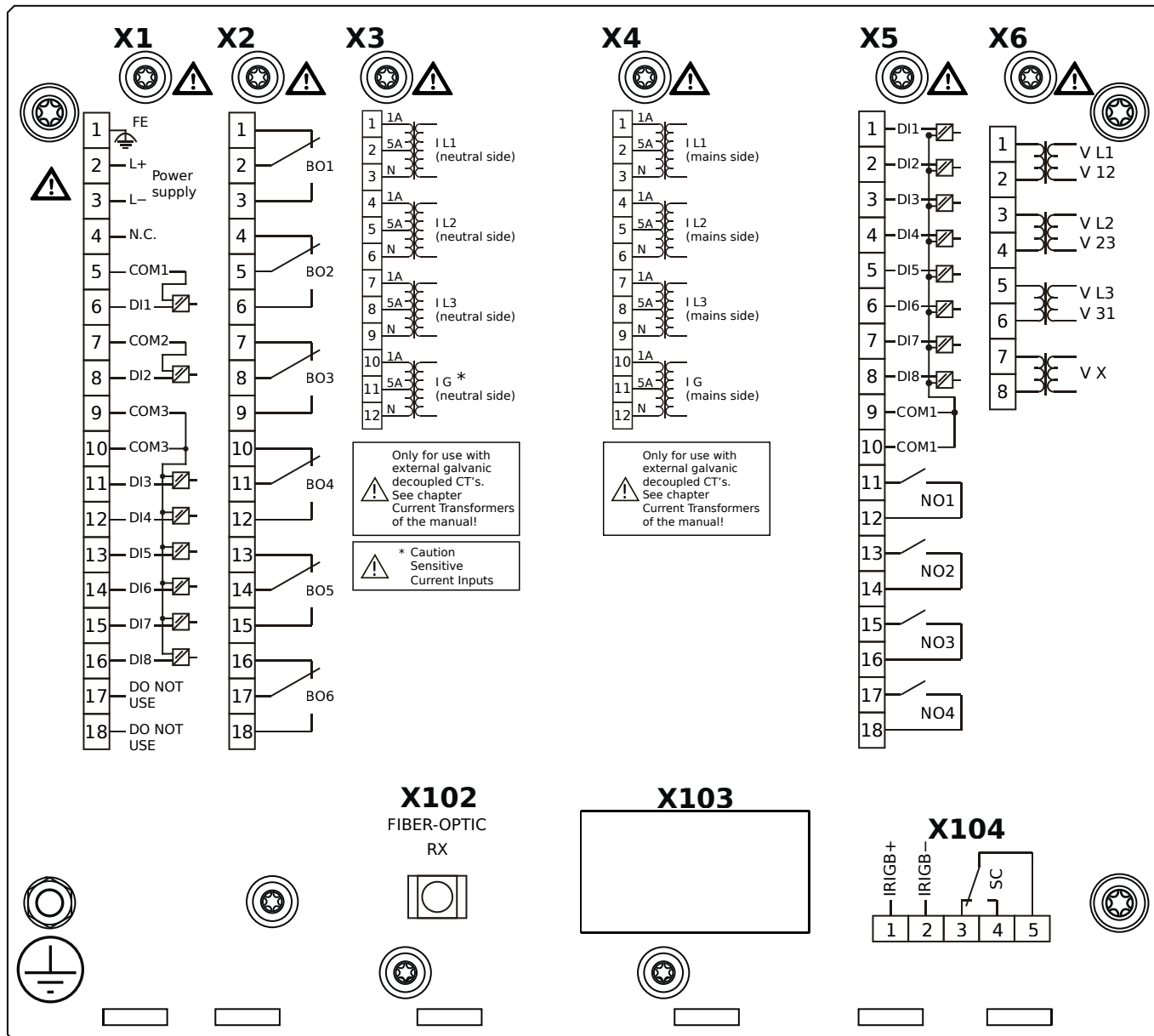

Housing B2, large display, door mounting

+ Conformal Coating (for installations in harsh environment)

- X1** – DI8-X1: Wide-range power supply unit, incl. 2 non-grouped digital inputs and 6 grouped digital inputs
- X2** – OR6: Assembly Group with 6 Output Relays (Changeover / Form C)
- X3** – TIs: Standard phase current measuring card and sensitive ground current measuring (neutral side of the diff. prot.)
- X4** – TI: Standard current measuring card (for the mains side of the differential protection)
- X5** – DI8-OR4: Assembly Group with 8 Digital Inputs and 4 Output Relays (NO / Form A)
- X6** – TU: Card with 4 voltage transformer measuring inputs (0 ... 800 VAC, under UL: 0 ... 600 VAC)
- X102** – Universal Resistance-Temperature Detector (URTD) input, Fiber optics interface, Versatile Link
- X104** – IRIG-B00X, incl. System Contact (Supervision Contact)

MCDGV4-2A1ABA

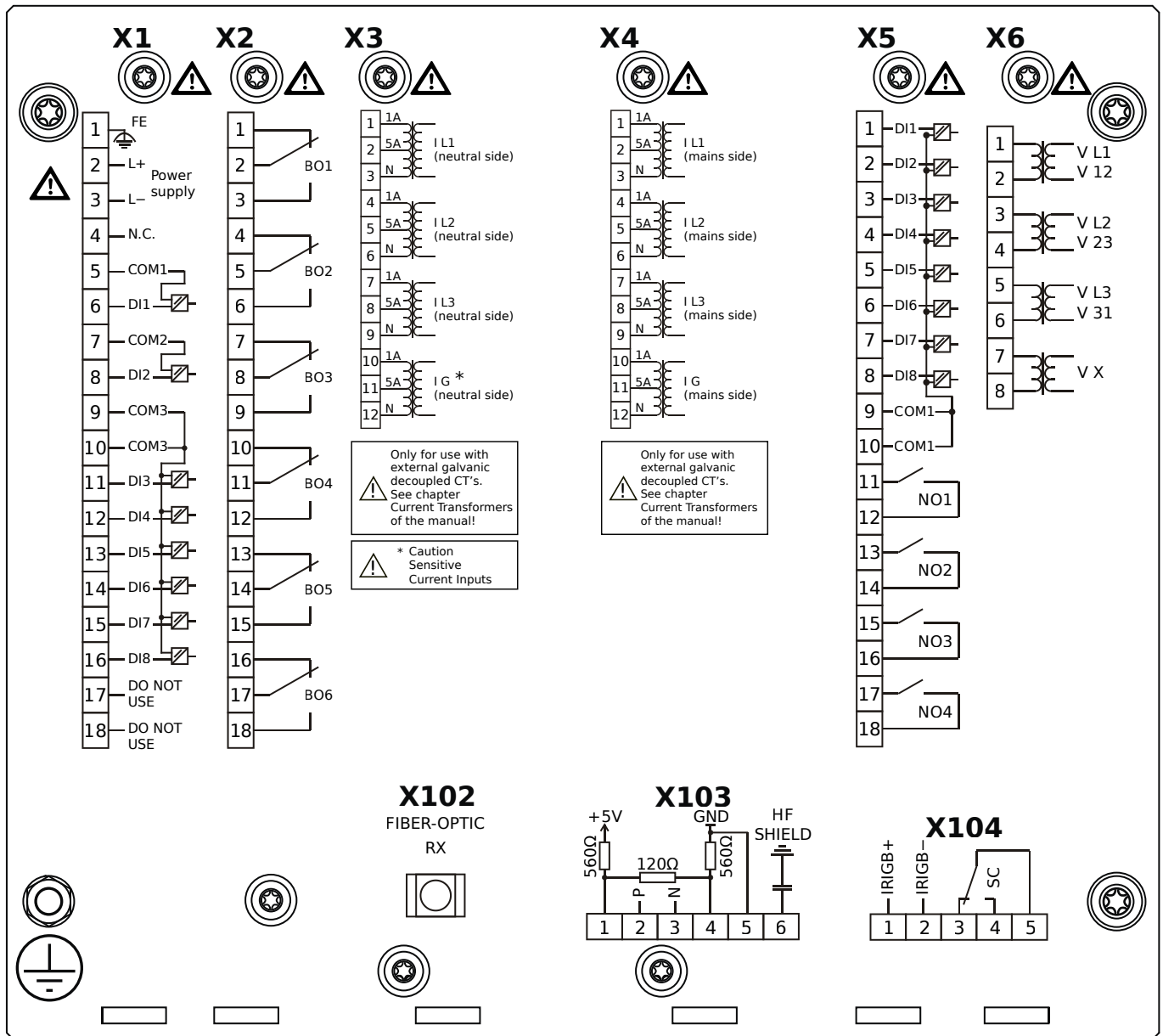

Housing B2, large display, door mounting

- X1** – DI8-X1: Wide-range power supply unit, incl. 2 non-grouped digital inputs and 6 grouped digital inputs
- X2** – OR6: Assembly Group with 6 Output Relays (Changeover / Form C)
- X3** – TIs: Standard phase current measuring card and sensitive ground current measuring (neutral side of the diff. prot.)
- X4** – TI: Standard current measuring card (for the mains side of the differential protection)
- X5** – DI8-OR4: Assembly Group with 8 Digital Inputs and 4 Output Relays (NO / Form A)
- X6** – TU: Card with 4 voltage transformer measuring inputs (0 ... 800 VAC, under UL: 0 ... 600 VAC)
- X102** – Universal Resistance-Temperature Detector (URTD) input, Fiber optics interface, Versatile Link
- X103** – Modbus RTU / IEC 60870-5-103 / DNP3.0 RTU, RS485, Terminals
- X104** – IRIG-B00X, incl. System Contact (Supervision Contact)

MCDGV4-2A1ABB

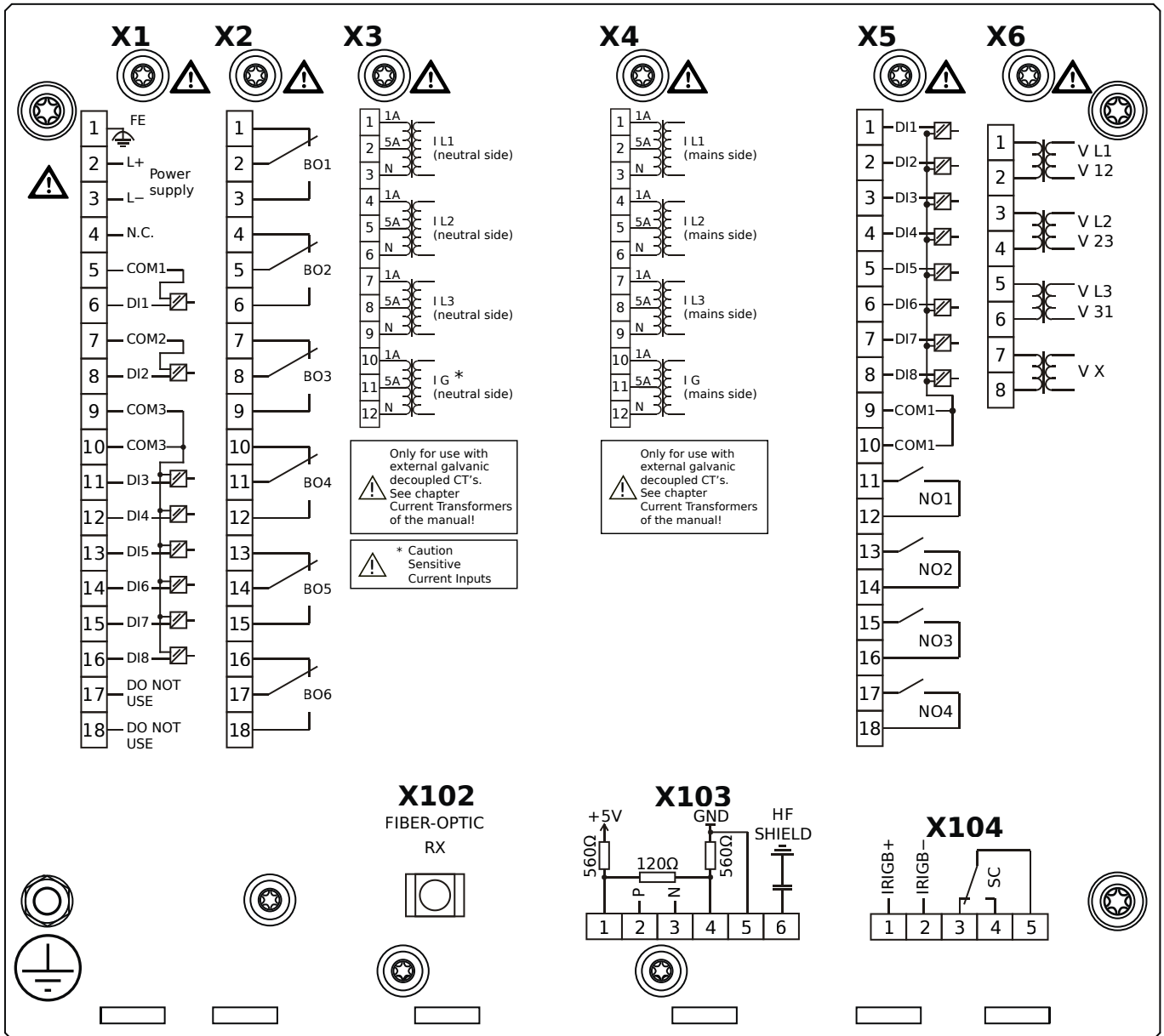

Housing B2, large display, door mounting

+ Conformal Coating (for installations in harsh environment)

- X1** – DI8-X1: Wide-range power supply unit, incl. 2 non-grouped digital inputs and 6 grouped digital inputs
- X2** – OR6: Assembly Group with 6 Output Relays (Changeover / Form C)
- X3** – TIs: Standard phase current measuring card and sensitive ground current measuring (neutral side of the diff. prot.)
- X4** – TI: Standard current measuring card (for the mains side of the differential protection)
- X5** – DI8-OR4: Assembly Group with 8 Digital Inputs and 4 Output Relays (NO / Form A)
- X6** – TU: Card with 4 voltage transformer measuring inputs (0 ... 800 VAC, under UL: 0 ... 600 VAC)
- X102** – Universal Resistance-Temperature Detector (URTD) input, Fiber optics interface, Versatile Link
- X103** – Modbus RTU / IEC 60870-5-103 / DNP3.0 RTU, RS485, Terminals
- X104** – IRIG-B00X, incl. System Contact (Supervision Contact)

MCDGV4-2A1ACA

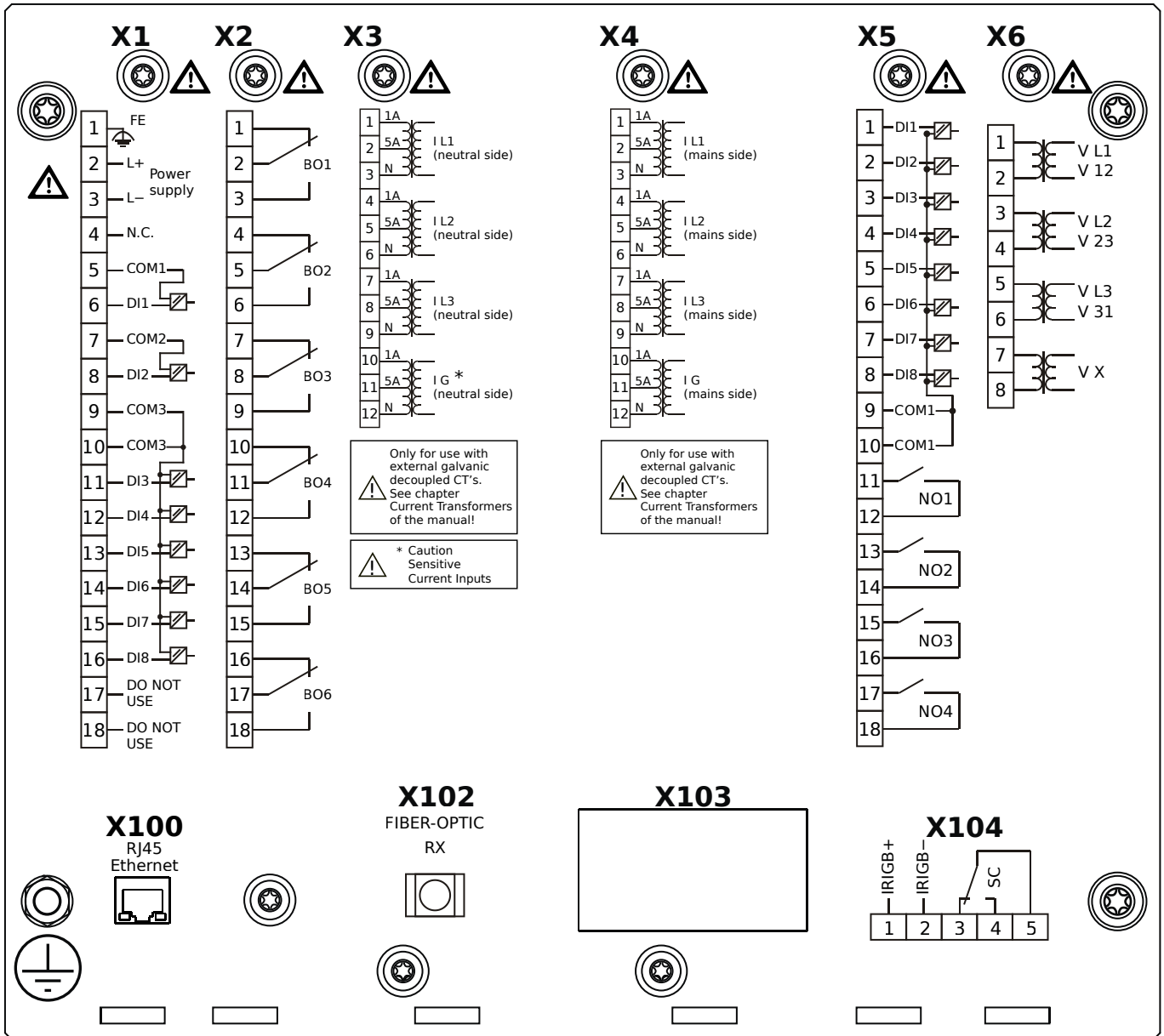

Housing B2, large display, door mounting

- X1** – DI8-X1: Wide-range power supply unit, incl. 2 non-grouped digital inputs and 6 grouped digital inputs
- X2** – OR6: Assembly Group with 6 Output Relays (Changeover / Form C)
- X3** – TI: Standard phase current measuring card and sensitive ground current measuring (neutral side of the diff. prot.)
- X4** – TI: Standard current measuring card (for the mains side of the differential protection)
- X5** – DI8-OR4: Assembly Group with 8 Digital Inputs and 4 Output Relays (NO / Form A)
- X6** – TU: Card with 4 voltage transformer measuring inputs (0 ... 800 VAC, under UL: 0 ... 600 VAC)
- X100** – Modbus TCP / DNP3.0 TCP/UDP, Ethernet interface, 100 Mbit/s, RJ45 (BASE100-FX)
- X102** – Universal Resistance-Temperature Detector (URTD) input, Fiber optics interface, Versatile Link
- X104** – IRIG-B00X, incl. System Contact (Supervision Contact)

MCDGV4-2A1ACB

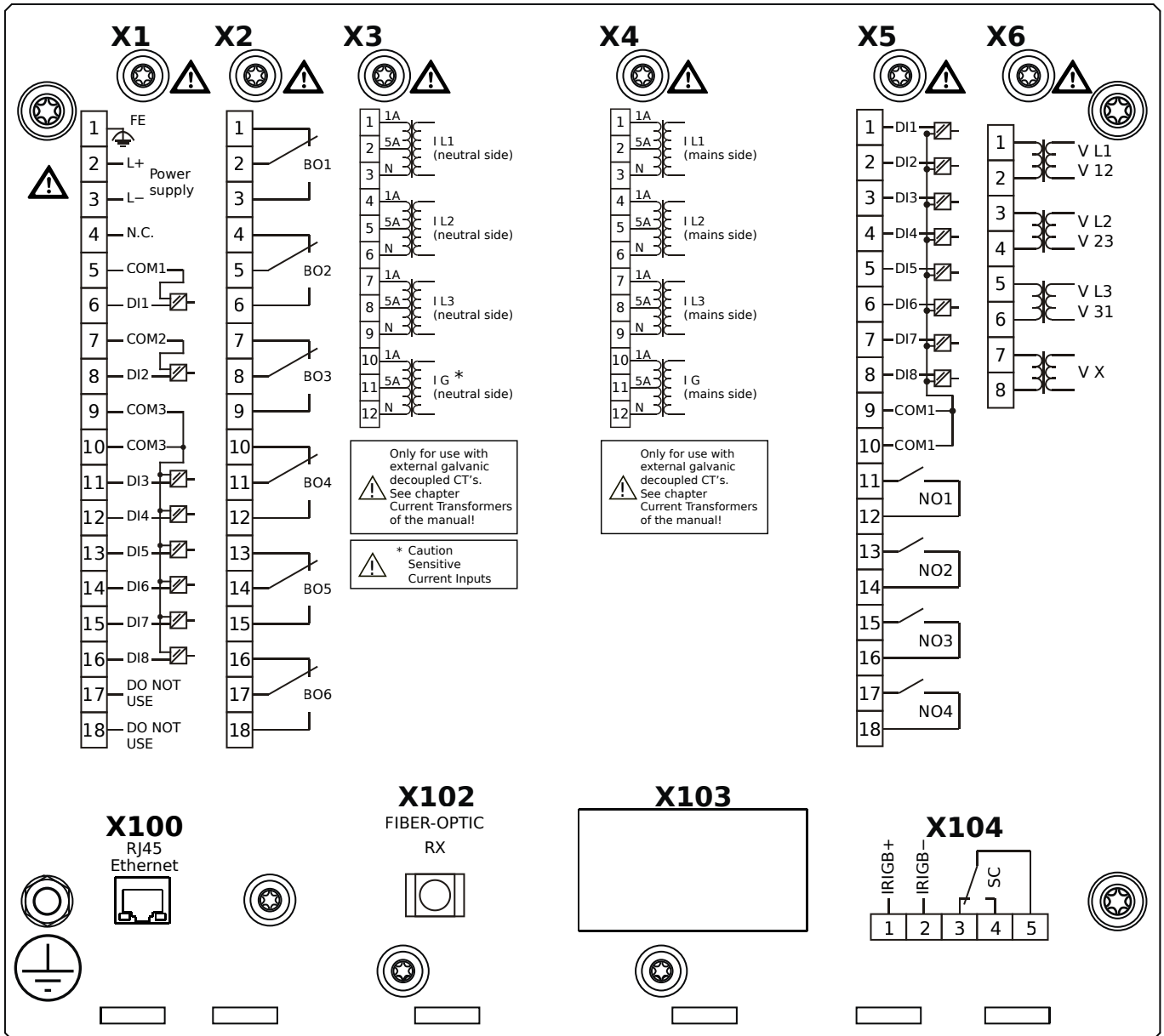

Housing B2, large display, door mounting

+ Conformal Coating (for installations in harsh environment)

- X1** – DI8-X1: Wide-range power supply unit, incl. 2 non-grouped digital inputs and 6 grouped digital inputs
- X2** – OR6: Assembly Group with 6 Output Relays (Changeover / Form C)
- X3** – TIs: Standard phase current measuring card and sensitive ground current measuring (neutral side of the diff. prot.)
- X4** – TI: Standard current measuring card (for the mains side of the differential protection)
- X5** – DI8-OR4: Assembly Group with 8 Digital Inputs and 4 Output Relays (NO / Form A)
- X6** – TU: Card with 4 voltage transformer measuring inputs (0 ... 800 VAC, under UL: 0 ... 600 VAC)
- X100** – Modbus TCP / DNP3.0 TCP/UDP, Ethernet interface, 100 Mbit/s, RJ45 (BASE100-FX)
- X102** – Universal Resistance-Temperature Detector (URTD) input, Fiber optics interface, Versatile Link
- X104** – IRIG-B00X, incl. System Contact (Supervision Contact)

MCDGV4-2A1ADA

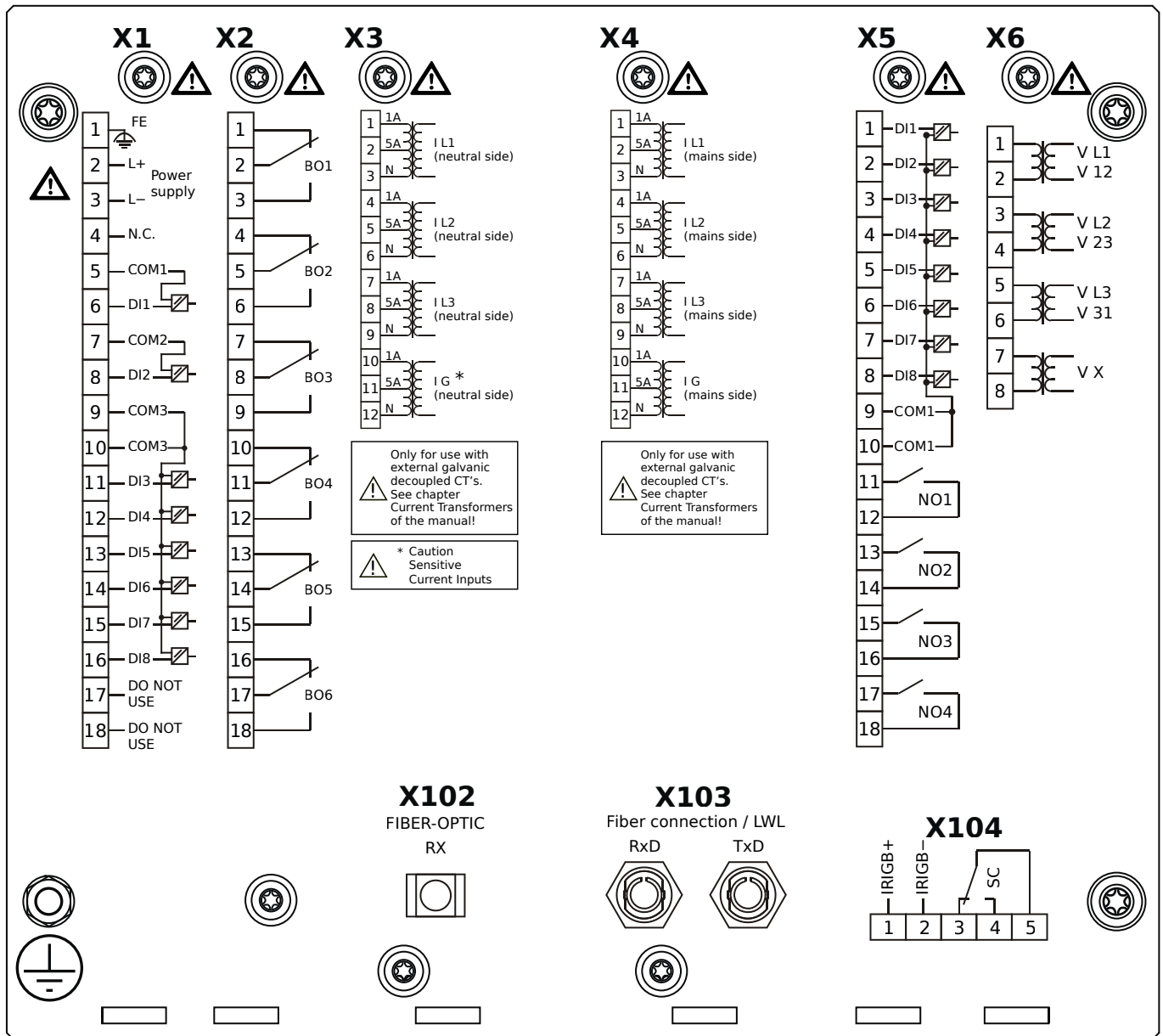

Housing B2, large display, door mounting

- X1** – DI8-X1: Wide-range power supply unit, incl. 2 non-grouped digital inputs and 6 grouped digital inputs
- X2** – OR6: Assembly Group with 6 Output Relays (Changeover / Form C)
- X3** – TIs: Standard phase current measuring card and sensitive ground current measuring (neutral side of the diff. prot.)
- X4** – TI: Standard current measuring card (for the mains side of the differential protection)
- X5** – DI8-OR4: Assembly Group with 8 Digital Inputs and 4 Output Relays (NO / Form A)
- X6** – TU: Card with 4 voltage transformer measuring inputs (0 ... 800 VAC, under UL: 0 ... 600 VAC)
- X102** – Universal Resistance-Temperature Detector (URTD) input, Fiber optics interface, Versatile Link
- X103** – Profibus-DP, Fiber optics interface, ST Connector
- X104** – IRIG-B00X, incl. System Contact (Supervision Contact)

MCDGV4-2A1ADB

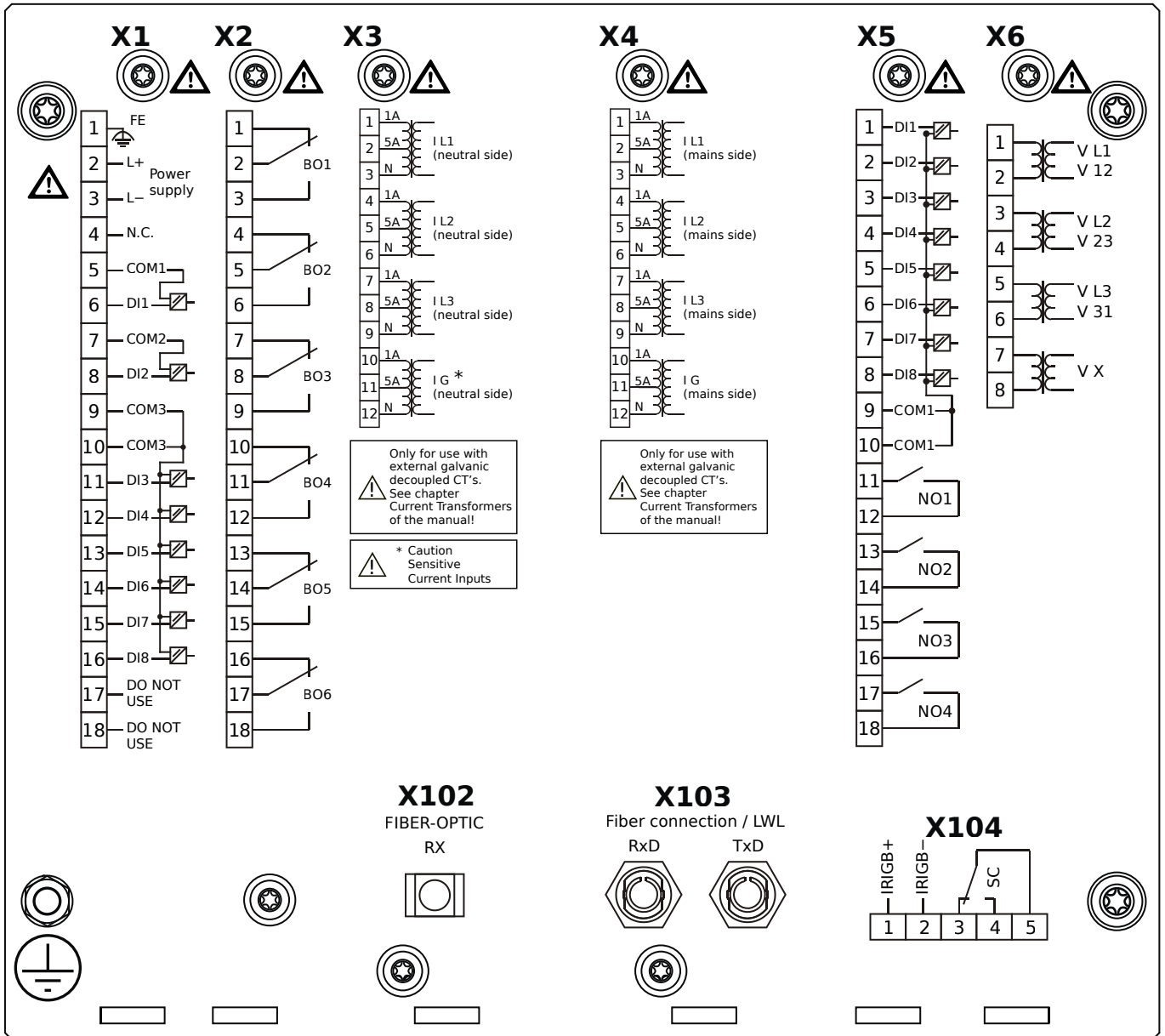

Housing B2, large display, door mounting

+ Conformal Coating (for installations in harsh environment)

- X1** – DI8-X1: Wide-range power supply unit, incl. 2 non-grouped digital inputs and 6 grouped digital inputs
- X2** – OR6: Assembly Group with 6 Output Relays (Changeover / Form C)
- X3** – TIs: Standard phase current measuring card and sensitive ground current measuring (neutral side of the diff. prot.)
- X4** – TI: Standard current measuring card (for the mains side of the differential protection)
- X5** – DI8-OR4: Assembly Group with 8 Digital Inputs and 4 Output Relays (NO / Form A)
- X6** – TU: Card with 4 voltage transformer measuring inputs (0 ... 800 VAC, under UL: 0 ... 600 VAC)
- X102** – Universal Resistance-Temperature Detector (URTD) input, Fiber optics interface, Versatile Link
- X103** – Profibus-DP, Fiber optics interface, ST Connector
- X104** – IRIG-B00X, incl. System Contact (Supervision Contact)

MCDGV4-2A1AEA

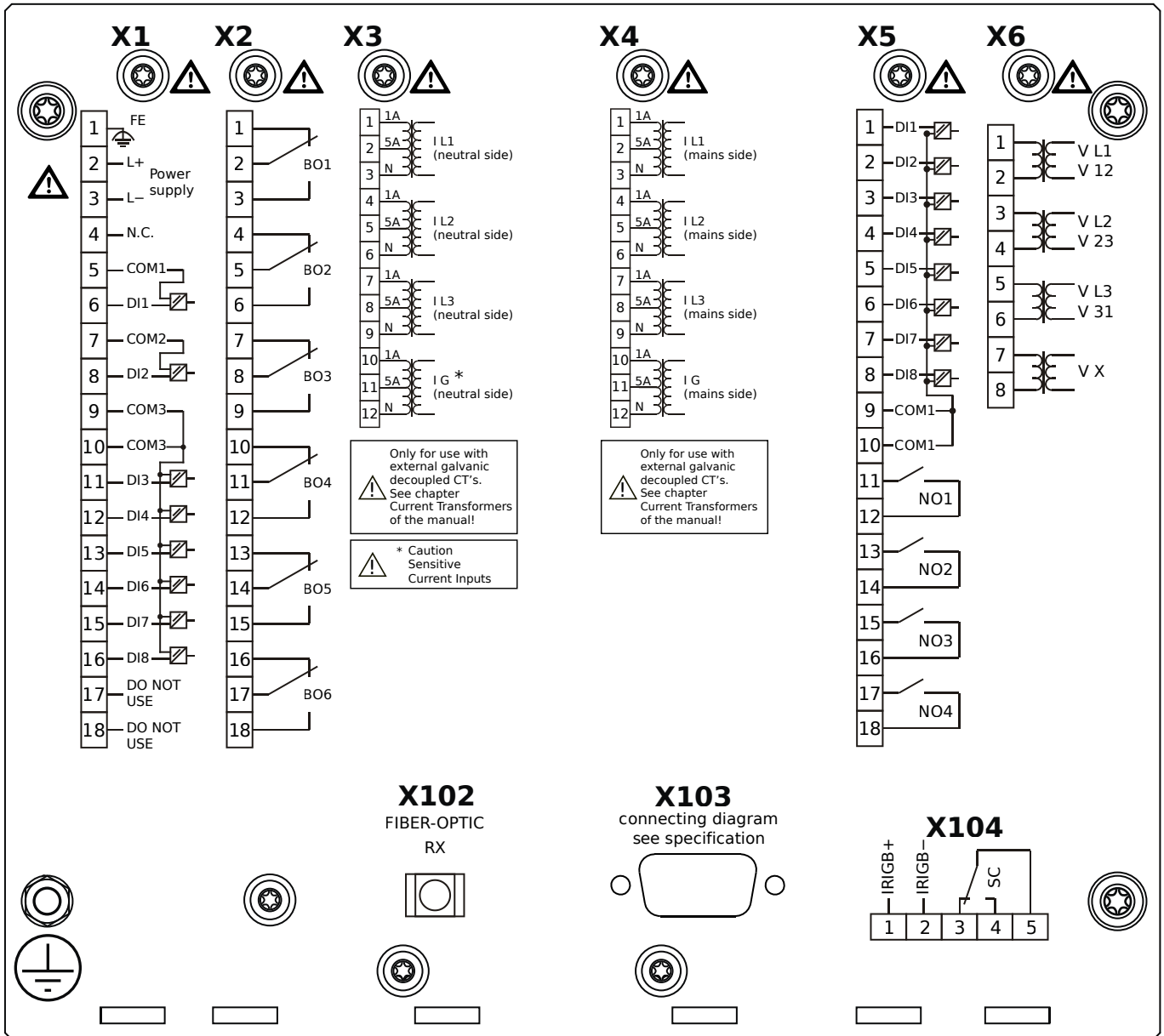

Housing B2, large display, door mounting

- X1** – DI8-X1: Wide-range power supply unit, incl. 2 non-grouped digital inputs and 6 grouped digital inputs
- X2** – OR6: Assembly Group with 6 Output Relays (Changeover / Form C)
- X3** – TIs: Standard phase current measuring card and sensitive ground current measuring (neutral side of the diff. prot.)
- X4** – TI: Standard current measuring card (for the mains side of the differential protection)
- X5** – DI8-OR4: Assembly Group with 8 Digital Inputs and 4 Output Relays (NO / Form A)
- X6** – TU: Card with 4 voltage transformer measuring inputs (0 ... 800 VAC, under UL: 0 ... 600 VAC)
- X102** – Universal Resistance-Temperature Detector (URTD) input, Fiber optics interface, Versatile Link
- X103** – Profibus-DP, RS485, D-SUB
- X104** – IRIG-B00X, incl. System Contact (Supervision Contact)

MCDGV4-2A1AEB

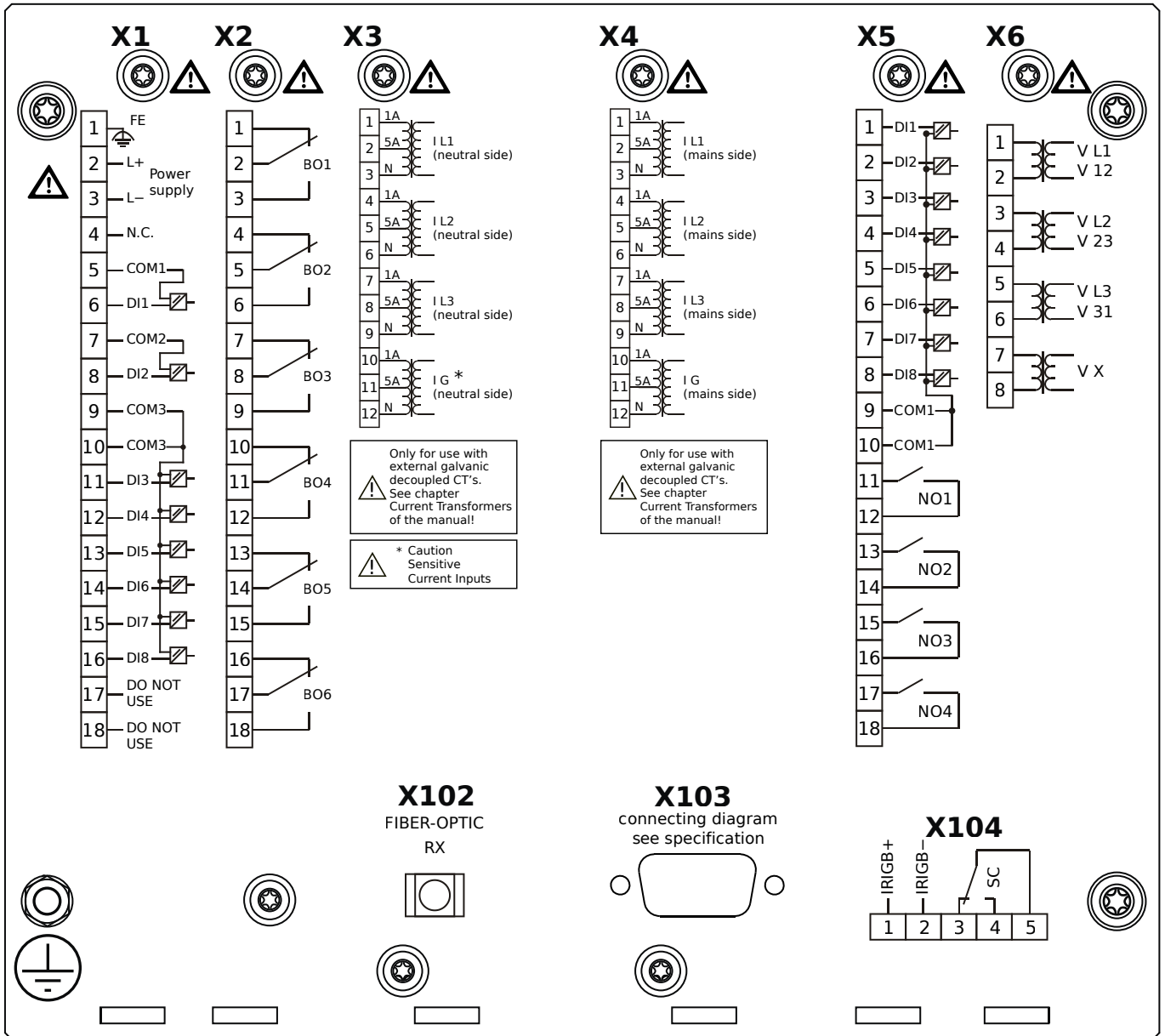

Housing B2, large display, door mounting

+ Conformal Coating (for installations in harsh environment)

- X1** – DI8-X1: Wide-range power supply unit, incl. 2 non-grouped digital inputs and 6 grouped digital inputs
- X2** – OR6: Assembly Group with 6 Output Relays (Changeover / Form C)
- X3** – TIs: Standard phase current measuring card and sensitive ground current measuring (neutral side of the diff. prot.)
- X4** – TI: Standard current measuring card (for the mains side of the differential protection)
- X5** – DI8-OR4: Assembly Group with 8 Digital Inputs and 4 Output Relays (NO / Form A)
- X6** – TU: Card with 4 voltage transformer measuring inputs (0 ... 800 VAC, under UL: 0 ... 600 VAC)
- X102** – Universal Resistance-Temperature Detector (URTD) input, Fiber optics interface, Versatile Link
- X103** – Profibus-DP, RS485, D-SUB
- X104** – IRIG-B00X, incl. System Contact (Supervision Contact)

MCDGV4-2A1AFA

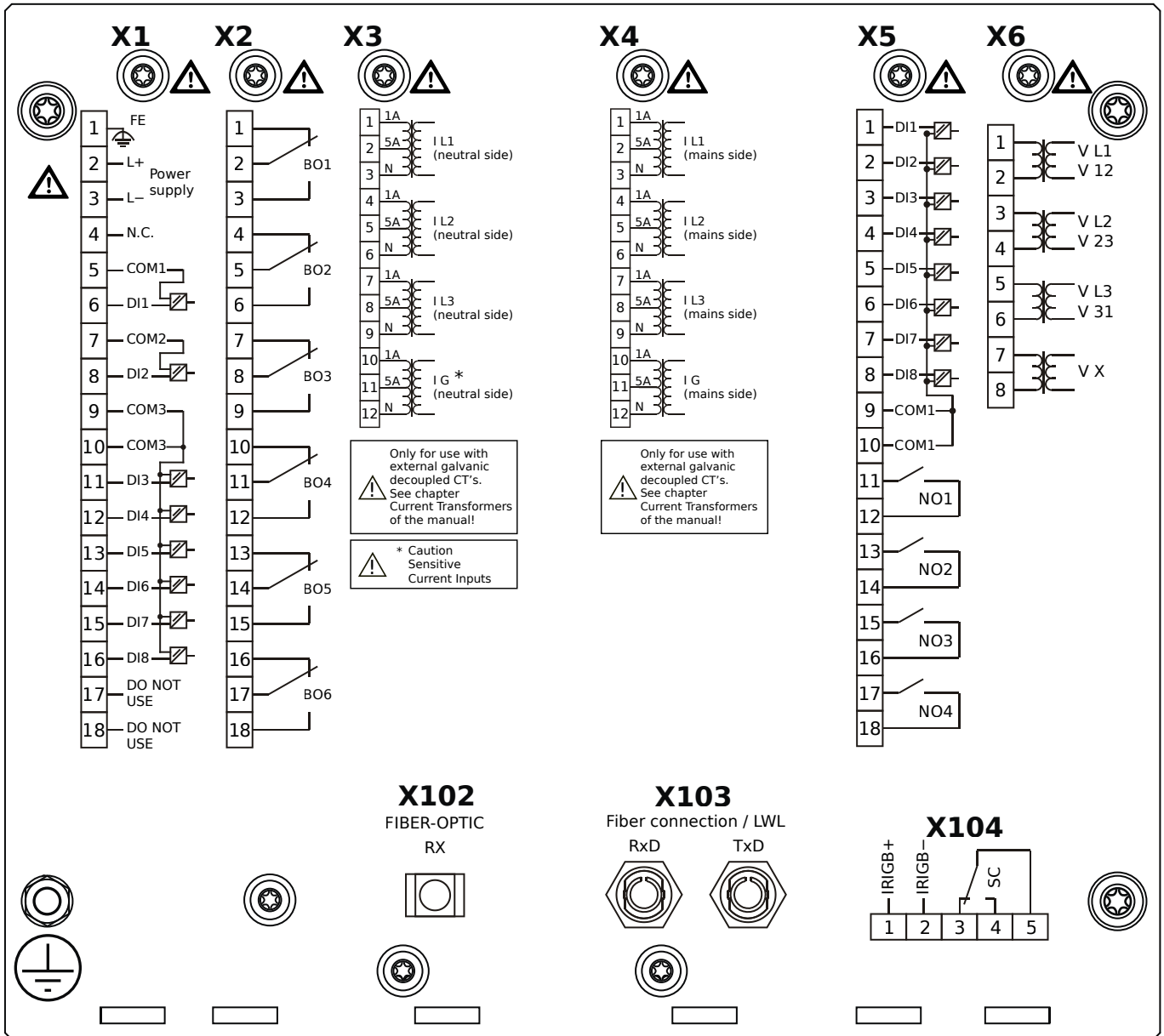

Housing B2, large display, door mounting

- X1** – DI8-X1: Wide-range power supply unit, incl. 2 non-grouped digital inputs and 6 grouped digital inputs
- X2** – OR6: Assembly Group with 6 Output Relays (Changeover / Form C)
- X3** – TI: Standard phase current measuring card and sensitive ground current measuring (neutral side of the diff. prot.)
- X4** – TI: Standard current measuring card (for the mains side of the differential protection)
- X5** – DI8-OR4: Assembly Group with 8 Digital Inputs and 4 Output Relays (NO / Form A)
- X6** – TU: Card with 4 voltage transformer measuring inputs (0 ... 800 VAC, under UL: 0 ... 600 VAC)
- X102** – Universal Resistance-Temperature Detector (URTD) input, Fiber optics interface, Versatile Link
- X103** – Modbus RTU / IEC 60870-5-103 / DNP3.0 RTU, Fiber optics interface, ST Connector
- X104** – IRIG-B00X, incl. System Contact (Supervision Contact)

MCDGV4-2A1AFB

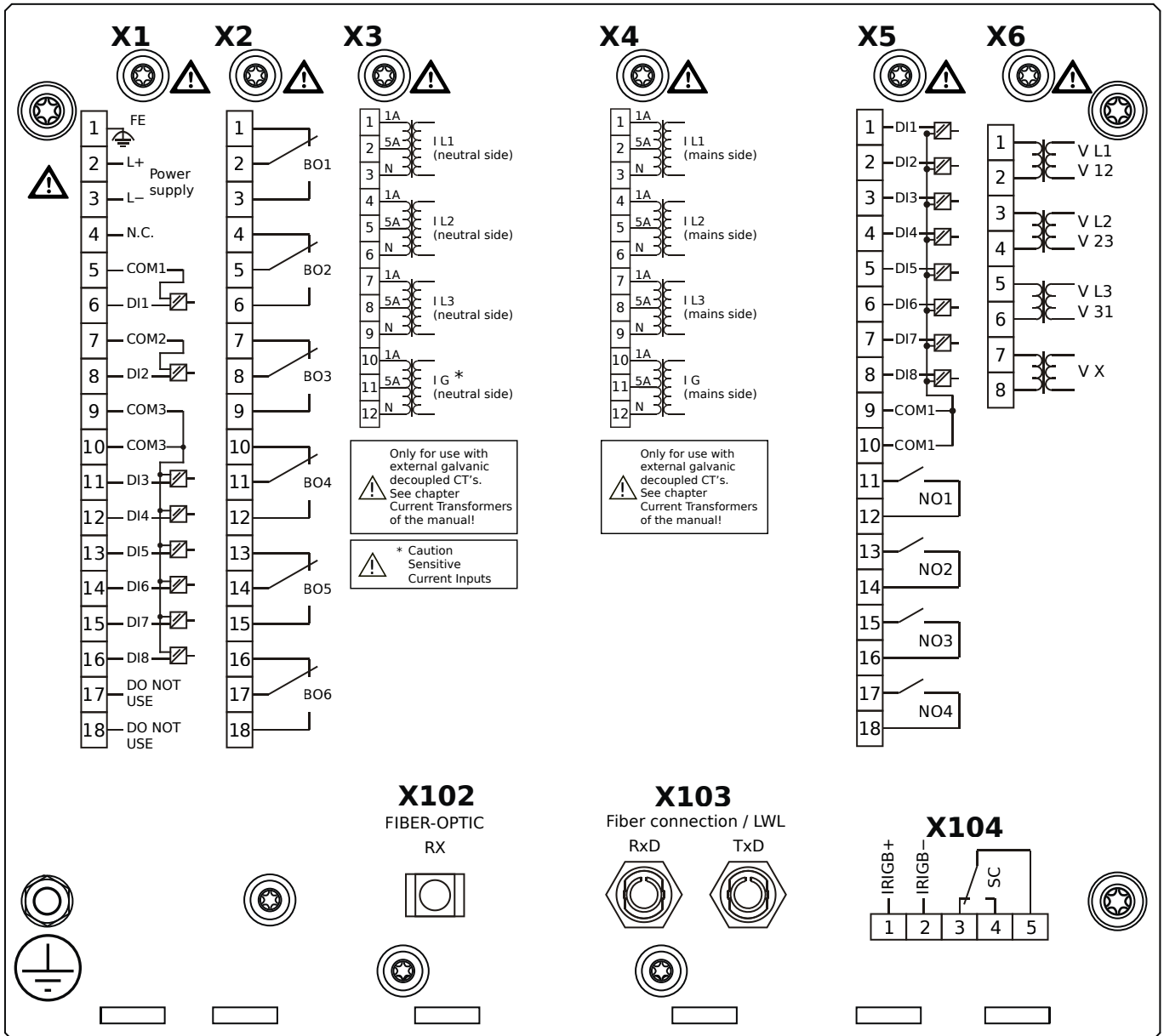

Housing B2, large display, door mounting

+ Conformal Coating (for installations in harsh environment)

- X1** – DI8-X1: Wide-range power supply unit, incl. 2 non-grouped digital inputs and 6 grouped digital inputs
- X2** – OR6: Assembly Group with 6 Output Relays (Changeover / Form C)
- X3** – TIs: Standard phase current measuring card and sensitive ground current measuring (neutral side of the diff. prot.)
- X4** – TI: Standard current measuring card (for the mains side of the differential protection)
- X5** – DI8-OR4: Assembly Group with 8 Digital Inputs and 4 Output Relays (NO / Form A)
- X6** – TU: Card with 4 voltage transformer measuring inputs (0 ... 800 VAC, under UL: 0 ... 600 VAC)
- X102** – Universal Resistance-Temperature Detector (URTD) input, Fiber optics interface, Versatile Link
- X103** – Modbus RTU / IEC 60870-5-103 / DNP3.0 RTU, Fiber optics interface, ST Connector
- X104** – IRIG-B00X, incl. System Contact (Supervision Contact)

MCDGV4-2A1AGA

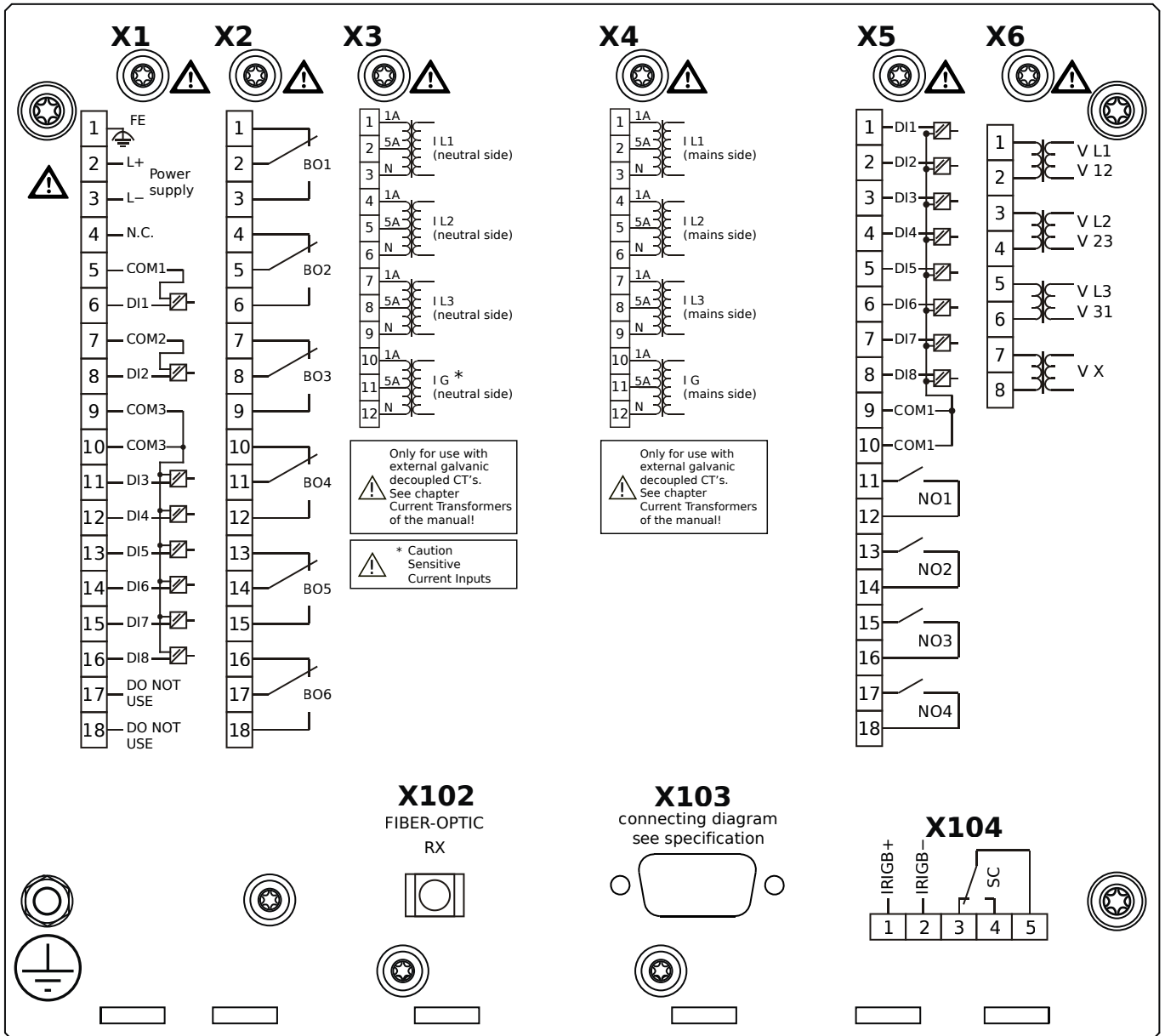

Housing B2, large display, door mounting

- X1** – DI8-X1: Wide-range power supply unit, incl. 2 non-grouped digital inputs and 6 grouped digital inputs
- X2** – OR6: Assembly Group with 6 Output Relays (Changeover / Form C)
- X3** – TIs: Standard phase current measuring card and sensitive ground current measuring (neutral side of the diff. prot.)
- X4** – TI: Standard current measuring card (for the mains side of the differential protection)
- X5** – DI8-OR4: Assembly Group with 8 Digital Inputs and 4 Output Relays (NO / Form A)
- X6** – TU: Card with 4 voltage transformer measuring inputs (0 ... 800 VAC, under UL: 0 ... 600 VAC)
- X102** – Universal Resistance-Temperature Detector (URTD) input, Fiber optics interface, Versatile Link
- X103** – Modbus RTU / IEC 60870-5-103 / DNP3.0 RTU, RS485, D-SUB
- X104** – IRIG-B00X, incl. System Contact (Supervision Contact)

MCDGV4-2A1AGB

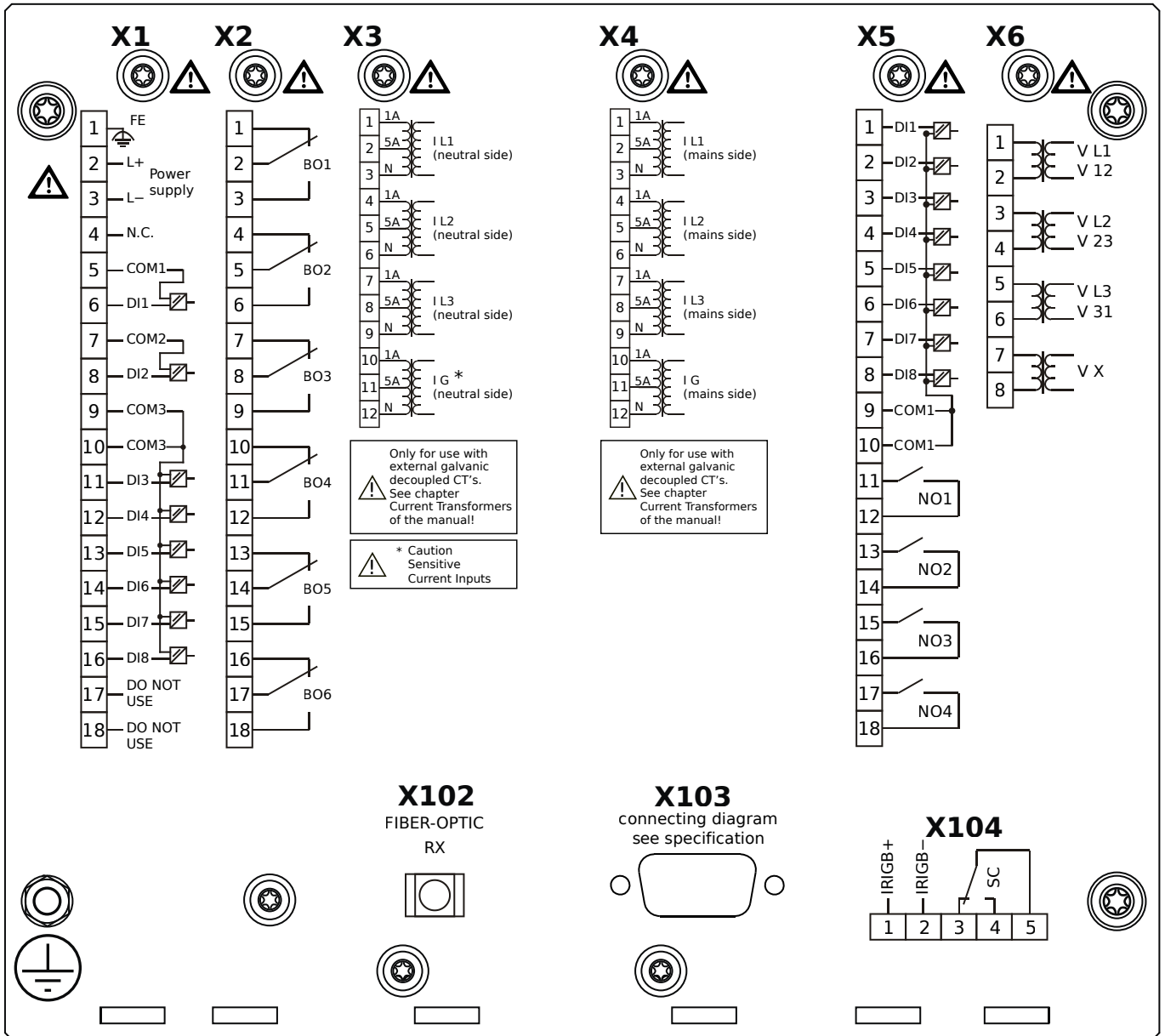

Housing B2, large display, door mounting

+ Conformal Coating (for installations in harsh environment)

- X1** – DI8-X1: Wide-range power supply unit, incl. 2 non-grouped digital inputs and 6 grouped digital inputs
- X2** – OR6: Assembly Group with 6 Output Relays (Changeover / Form C)
- X3** – TIs: Standard phase current measuring card and sensitive ground current measuring (neutral side of the diff. prot.)
- X4** – TI: Standard current measuring card (for the mains side of the differential protection)
- X5** – DI8-OR4: Assembly Group with 8 Digital Inputs and 4 Output Relays (NO / Form A)
- X6** – TU: Card with 4 voltage transformer measuring inputs (0 ... 800 VAC, under UL: 0 ... 600 VAC)
- X102** – Universal Resistance-Temperature Detector (URTD) input, Fiber optics interface, Versatile Link
- X103** – Modbus RTU / IEC 60870-5-103 / DNP3.0 RTU, RS485, D-SUB
- X104** – IRIG-B00X, incl. System Contact (Supervision Contact)

MCDGV4-2A1AHA

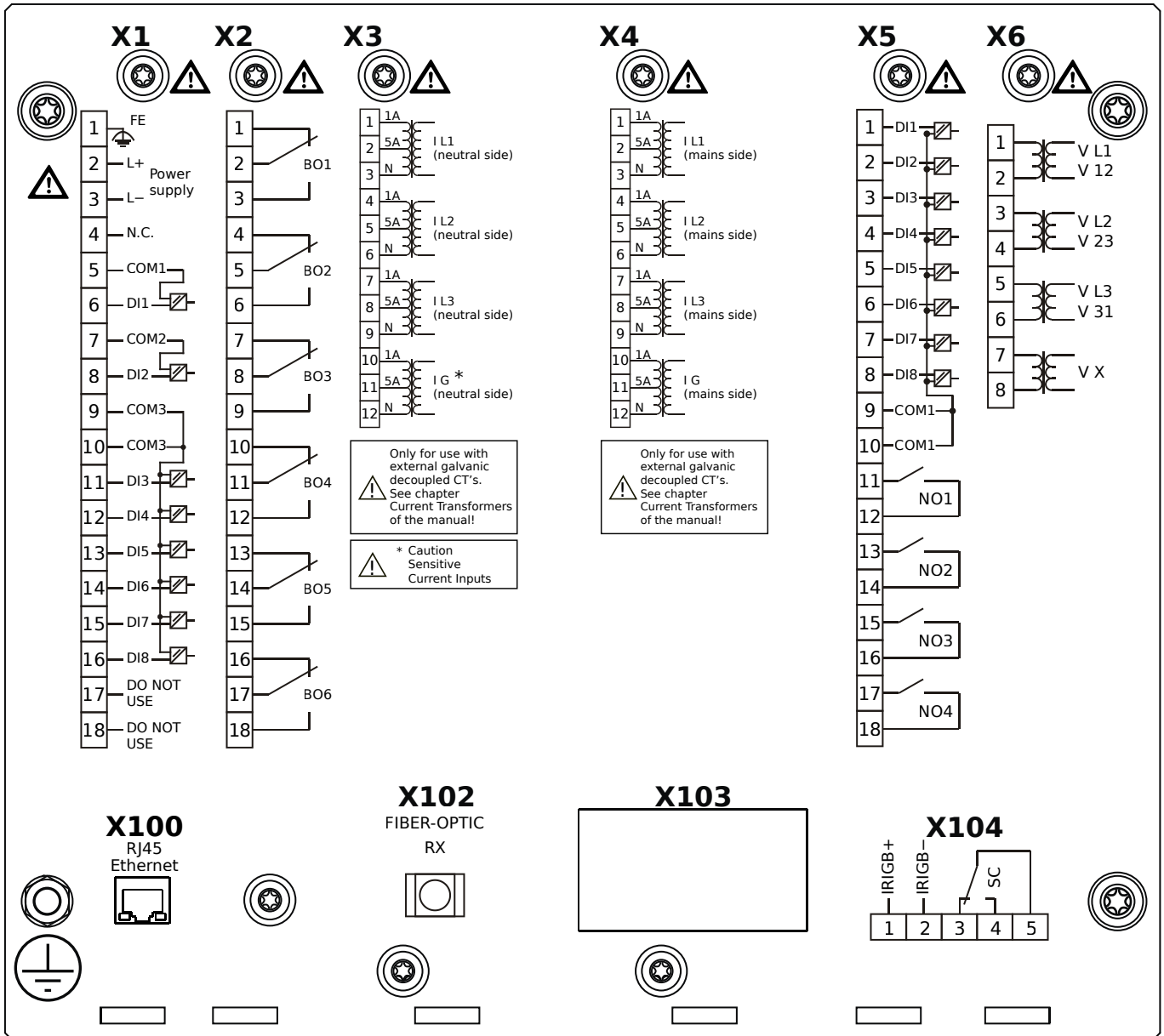

Housing B2, large display, door mounting

- X1** – DI8-X1: Wide-range power supply unit, incl. 2 non-grouped digital inputs and 6 grouped digital inputs
- X2** – OR6: Assembly Group with 6 Output Relays (Changeover / Form C)
- X3** – TIs: Standard phase current measuring card and sensitive ground current measuring (neutral side of the diff. prot.)
- X4** – TI: Standard current measuring card (for the mains side of the differential protection)
- X5** – DI8-OR4: Assembly Group with 8 Digital Inputs and 4 Output Relays (NO / Form A)
- X6** – TU: Card with 4 voltage transformer measuring inputs (0 ... 800 VAC, under UL: 0 ... 600 VAC)
- X100** – IEC 61850 / Modbus TCP / DNP3.0 TCP/UDP, Ethernet interface, 100 Mbit/s, RJ45 (BASE100-FX)
- X102** – Universal Resistance-Temperature Detector (URTD) input, Fiber optics interface, Versatile Link
- X104** – IRIG-B00X, incl. System Contact (Supervision Contact)

MCDGV4-2A1AHB

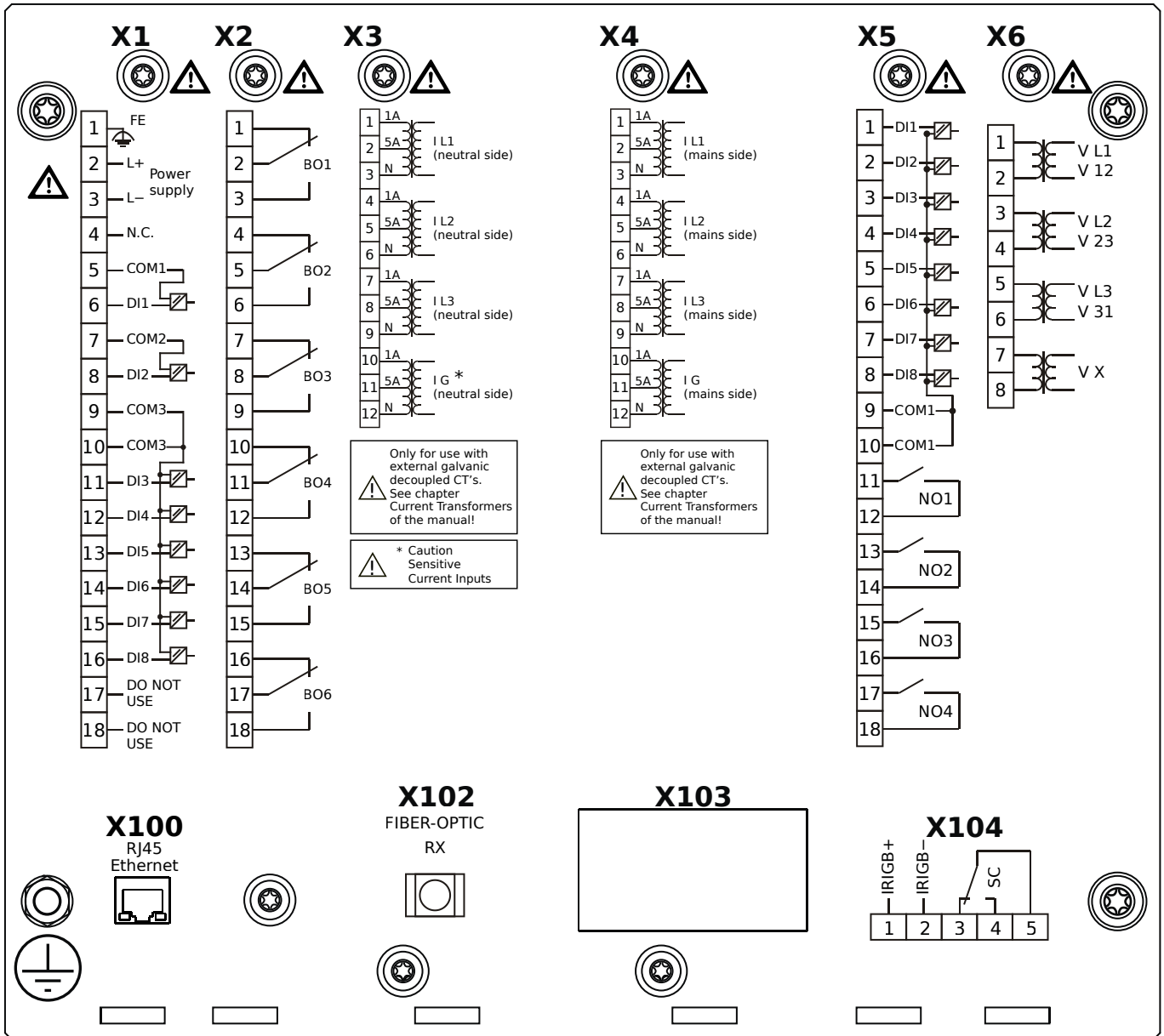

Housing B2, large display, door mounting

+ Conformal Coating (for installations in harsh environment)

- X1** – DI8-X1: Wide-range power supply unit, incl. 2 non-grouped digital inputs and 6 grouped digital inputs
- X2** – OR6: Assembly Group with 6 Output Relays (Changeover / Form C)
- X3** – TIs: Standard phase current measuring card and sensitive ground current measuring (neutral side of the diff. prot.)
- X4** – TI: Standard current measuring card (for the mains side of the differential protection)
- X5** – DI8-OR4: Assembly Group with 8 Digital Inputs and 4 Output Relays (NO / Form A)
- X6** – TU: Card with 4 voltage transformer measuring inputs (0 ... 800 VAC, under UL: 0 ... 600 VAC)
- X100** – IEC 61850 / Modbus TCP / DNP3.0 TCP/UDP, Ethernet interface, 100 Mbit/s, RJ45 (BASE100-FX)
- X102** – Universal Resistance-Temperature Detector (URTD) input, Fiber optics interface, Versatile Link
- X104** – IRIG-B00X, incl. System Contact (Supervision Contact)

MCDGV4-2A1AIA

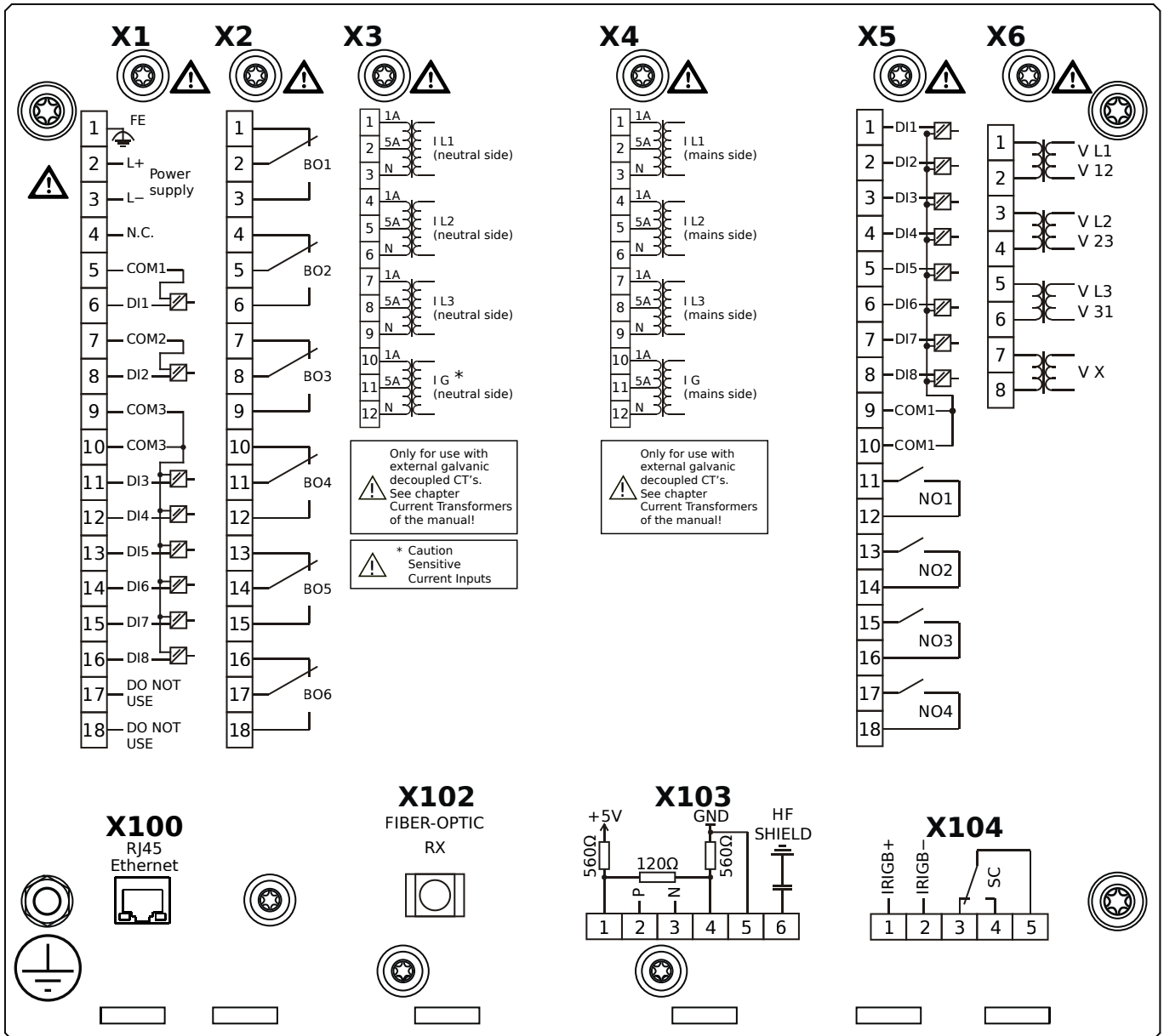

Housing B2, large display, door mounting

- X1** – DI8-X1: Wide-range power supply unit, incl. 2 non-grouped digital inputs and 6 grouped digital inputs
- X2** – OR6: Assembly Group with 6 Output Relays (Changeover / Form C)
- X3** – TI: Standard phase current measuring card and sensitive ground current measuring (neutral side of the diff. prot.)
- X4** – TI: Standard current measuring card (for the mains side of the differential protection)
- X5** – DI8-OR4: Assembly Group with 8 Digital Inputs and 4 Output Relays (NO / Form A)
- X6** – TU: Card with 4 voltage transformer measuring inputs (0 ... 800 VAC, under UL: 0 ... 600 VAC)
- X100** – Modbus TCP / DNP3.0 TCP/UDP, Ethernet interface, 100 Mbit/s, RJ45 (BASE100-FX)
- X102** – Universal Resistance-Temperature Detector (URTD) input, Fiber optics interface, Versatile Link
- X103** – IEC 60870-5-103 / Modbus RTU / DNP3.0 RTU, RS485, Terminals
- X104** – IRIG-B00X, incl. System Contact (Supervision Contact)

MCDGV4-2A1AIB

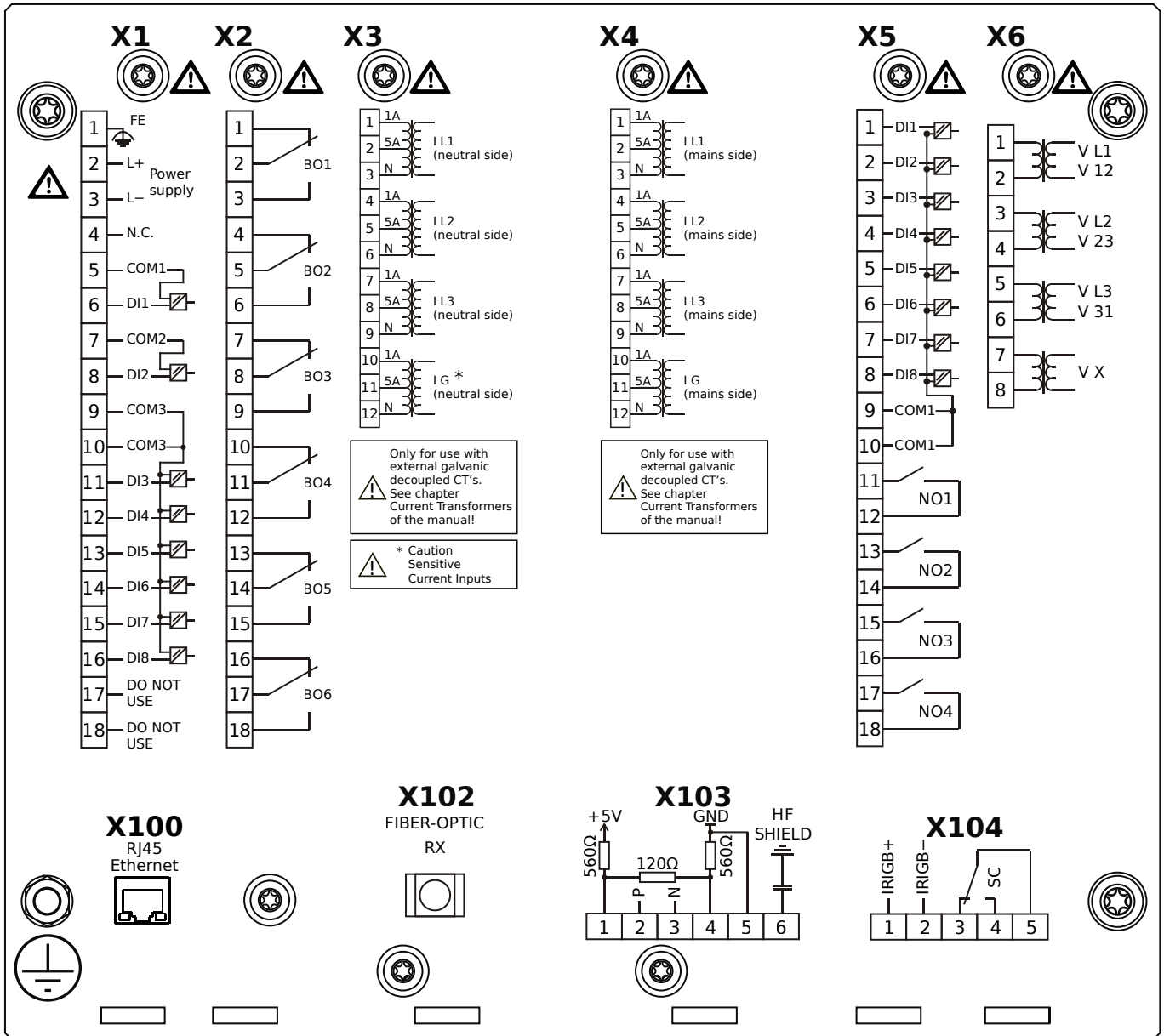

Housing B2, large display, door mounting

+ Conformal Coating (for installations in harsh environment)

- X1** – DI8-X1: Wide-range power supply unit, incl. 2 non-grouped digital inputs and 6 grouped digital inputs
- X2** – OR6: Assembly Group with 6 Output Relays (Changeover / Form C)
- X3** – TIs: Standard phase current measuring card and sensitive ground current measuring (neutral side of the diff. prot.)
- X4** – TI: Standard current measuring card (for the mains side of the differential protection)
- X5** – DI8-OR4: Assembly Group with 8 Digital Inputs and 4 Output Relays (NO / Form A)
- X6** – TU: Card with 4 voltage transformer measuring inputs (0 ... 800 VAC, under UL: 0 ... 600 VAC)
- X100** – Modbus TCP / DNP3.0 TCP/UDP, Ethernet interface, 100 Mbit/s, RJ45 (BASE100-FX)
- X102** – Universal Resistance-Temperature Detector (URTD) input, Fiber optics interface, Versatile Link
- X103** – IEC 60870-5-103 / Modbus RTU / DNP3.0 RTU, RS485, Terminals
- X104** – IRIG-B00X, incl. System Contact (Supervision Contact)

MCDGV4-2A1AKA

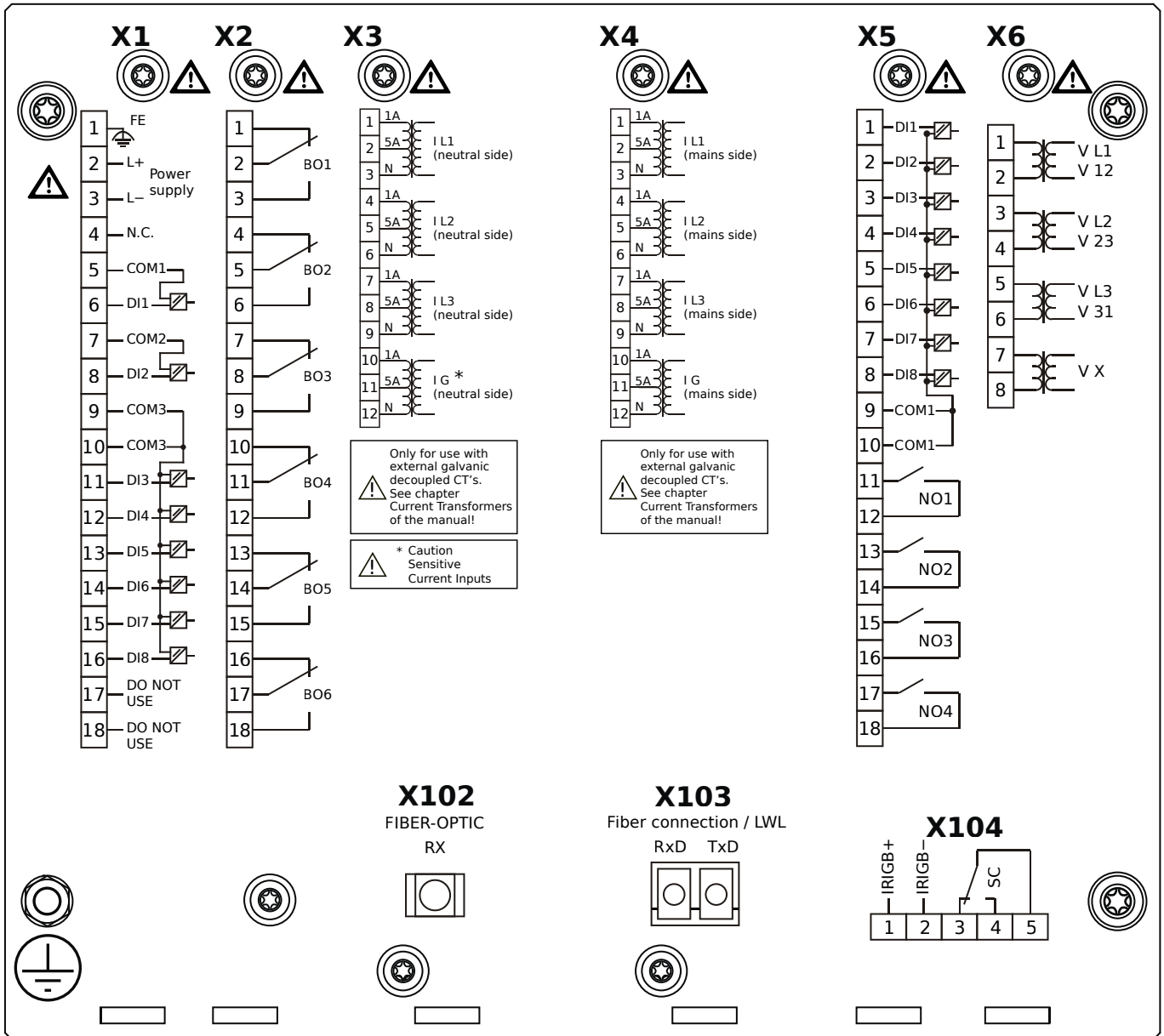

Housing B2, large display, door mounting

- X1** – DI8-X1: Wide-range power supply unit, incl. 2 non-grouped digital inputs and 6 grouped digital inputs
- X2** – OR6: Assembly Group with 6 Output Relays (Changeover / Form C)
- X3** – TIs: Standard phase current measuring card and sensitive ground current measuring (neutral side of the diff. prot.)
- X4** – TI: Standard current measuring card (for the mains side of the differential protection)
- X5** – DI8-OR4: Assembly Group with 8 Digital Inputs and 4 Output Relays (NO / Form A)
- X6** – TU: Card with 4 voltage transformer measuring inputs (0 ... 800 VAC, under UL: 0 ... 600 VAC)
- X102** – Universal Resistance-Temperature Detector (URTD) input, Fiber optics interface, Versatile Link
- X103** – IEC 61850 / Modbus TCP / DNP3.0 TCP/UDP, Fiber optics interface, LC Connector
- X104** – IRIG-B00X, incl. System Contact (Supervision Contact)

MCDGV4-2A1AKB

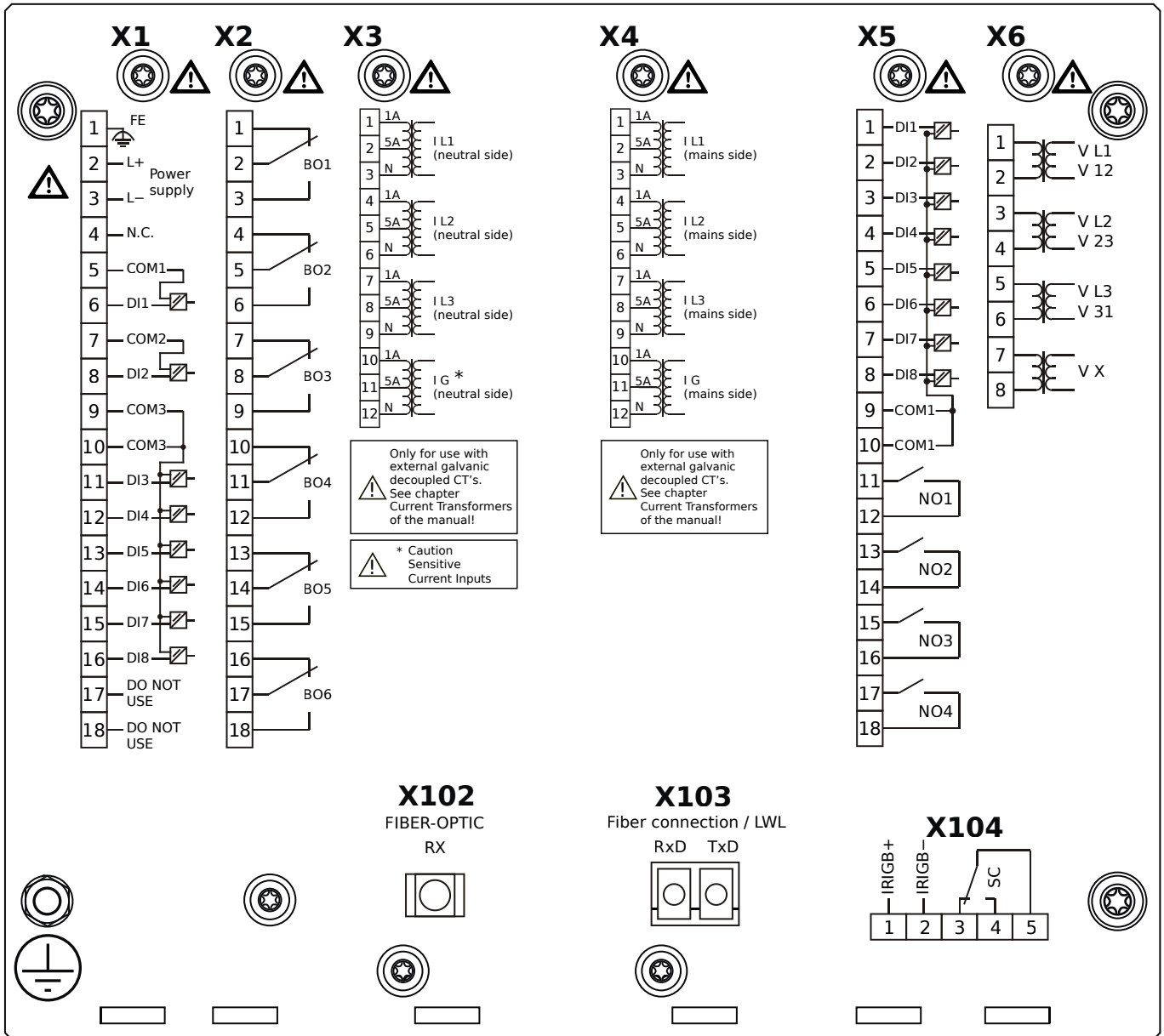

Housing B2, large display, door mounting

+ Conformal Coating (for installations in harsh environment)

- X1** – DI8-X1: Wide-range power supply unit, incl. 2 non-grouped digital inputs and 6 grouped digital inputs
- X2** – OR6: Assembly Group with 6 Output Relays (Changeover / Form C)
- X3** – TIs: Standard phase current measuring card and sensitive ground current measuring (neutral side of the diff. prot.)
- X4** – TI: Standard current measuring card (for the mains side of the differential protection)
- X5** – DI8-OR4: Assembly Group with 8 Digital Inputs and 4 Output Relays (NO / Form A)
- X6** – TU: Card with 4 voltage transformer measuring inputs (0 ... 800 VAC, under UL: 0 ... 600 VAC)
- X102** – Universal Resistance-Temperature Detector (URTD) input, Fiber optics interface, Versatile Link
- X103** – IEC 61850 / Modbus TCP / DNP3.0 TCP/UDP, Fiber optics interface, LC Connector
- X104** – IRIG-B00X, incl. System Contact (Supervision Contact)

MCDGV4-2A1ALA

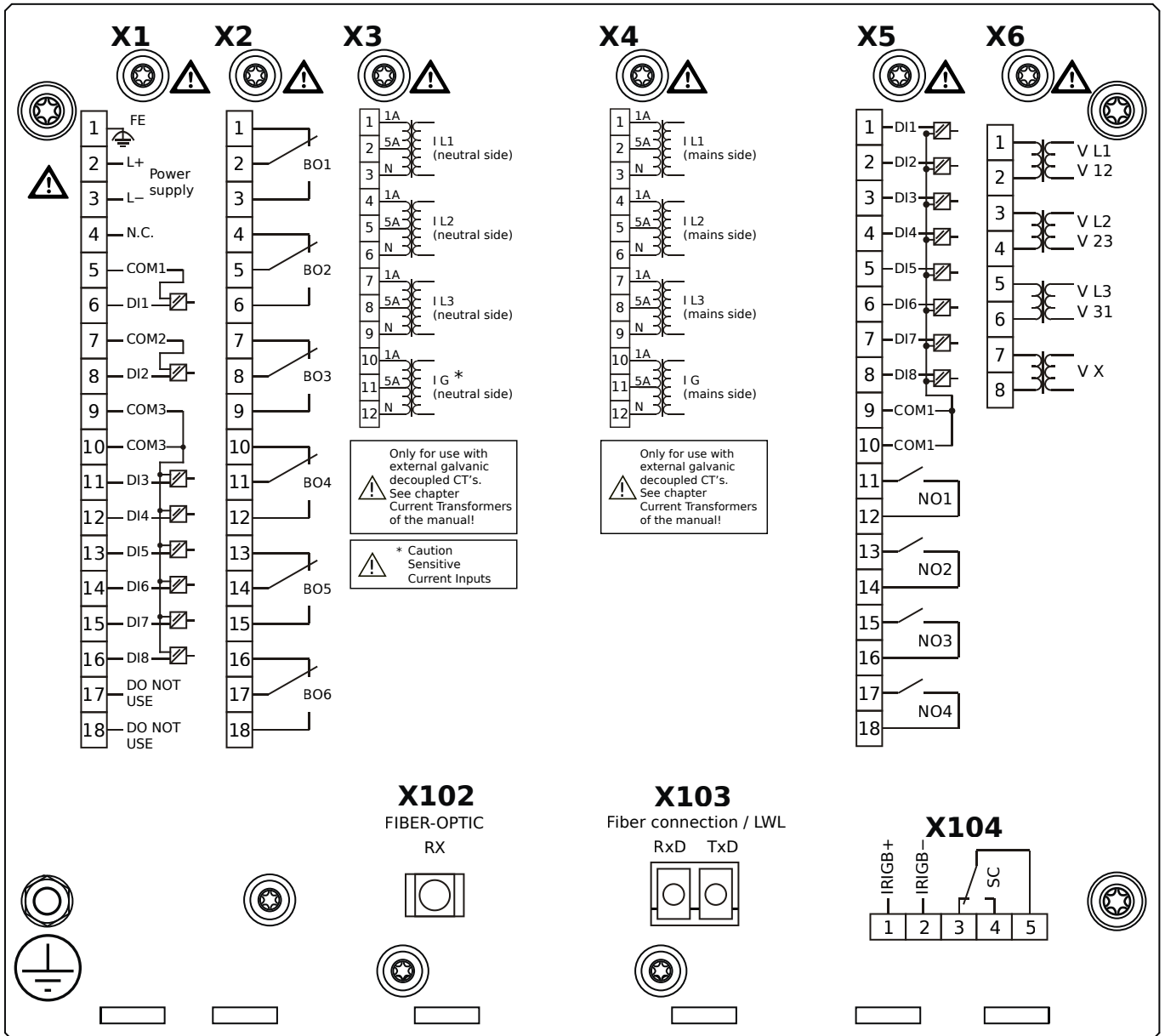

Housing B2, large display, door mounting

- X1** – DI8-X1: Wide-range power supply unit, incl. 2 non-grouped digital inputs and 6 grouped digital inputs
- X2** – OR6: Assembly Group with 6 Output Relays (Changeover / Form C)
- X3** – TIs: Standard phase current measuring card and sensitive ground current measuring (neutral side of the diff. prot.)
- X4** – TI: Standard current measuring card (for the mains side of the differential protection)
- X5** – DI8-OR4: Assembly Group with 8 Digital Inputs and 4 Output Relays (NO / Form A)
- X6** – TU: Card with 4 voltage transformer measuring inputs (0 ... 800 VAC, under UL: 0 ... 600 VAC)
- X102** – Universal Resistance-Temperature Detector (URTD) input, Fiber optics interface, Versatile Link
- X103** – Modbus TCP / DNP3.0 TCP/UDP, Fiber optics interface, LC Connector
- X104** – IRIG-B00X, incl. System Contact (Supervision Contact)

MCDGV4-2A1ALB

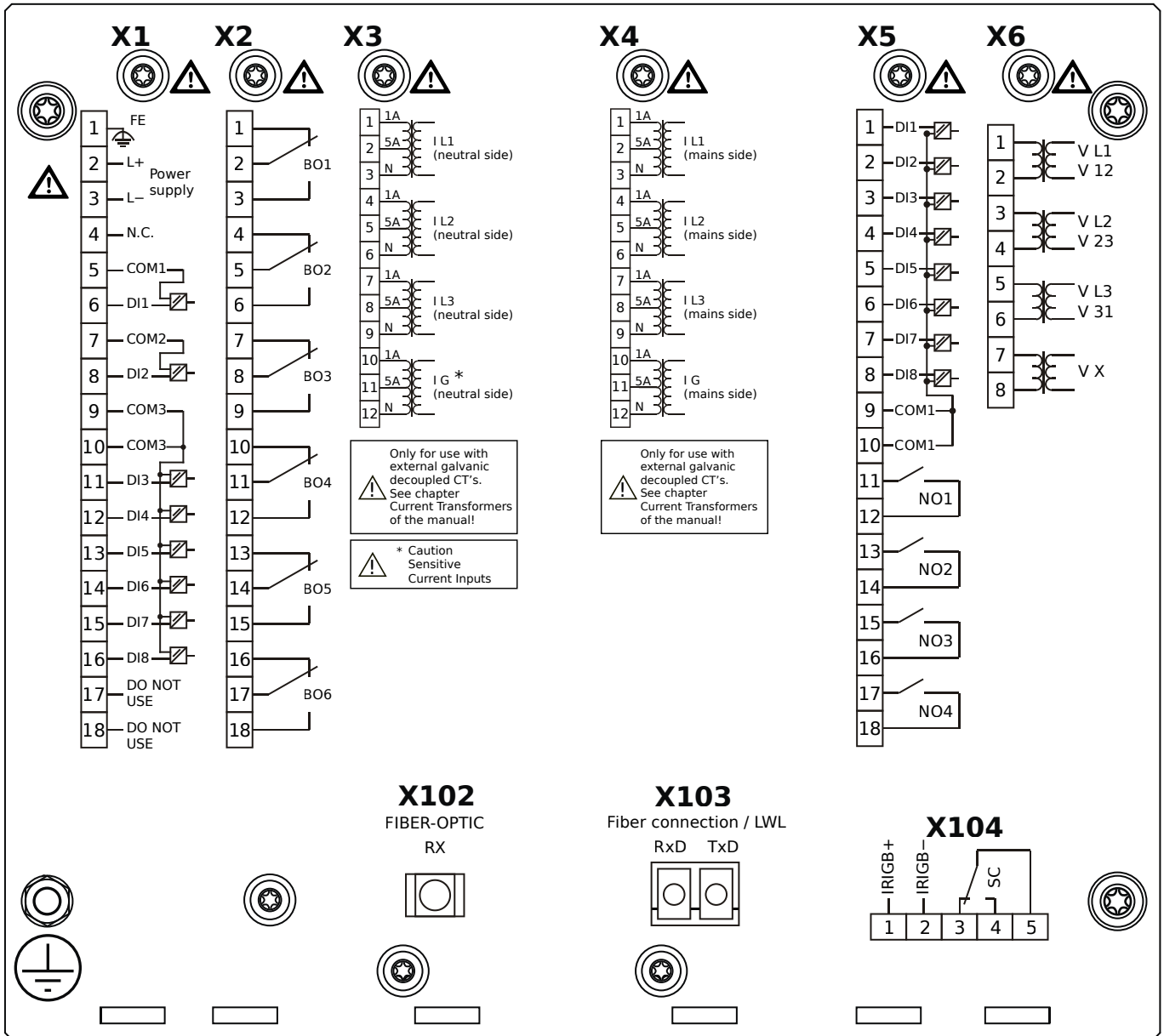

Housing B2, large display, door mounting

+ Conformal Coating (for installations in harsh environment)

- X1** – DI8-X1: Wide-range power supply unit, incl. 2 non-grouped digital inputs and 6 grouped digital inputs
- X2** – OR6: Assembly Group with 6 Output Relays (Changeover / Form C)
- X3** – TIs: Standard phase current measuring card and sensitive ground current measuring (neutral side of the diff. prot.)
- X4** – TI: Standard current measuring card (for the mains side of the differential protection)
- X5** – DI8-OR4: Assembly Group with 8 Digital Inputs and 4 Output Relays (NO / Form A)
- X6** – TU: Card with 4 voltage transformer measuring inputs (0 ... 800 VAC, under UL: 0 ... 600 VAC)
- X102** – Universal Resistance-Temperature Detector (URTD) input, Fiber optics interface, Versatile Link
- X103** – Modbus TCP / DNP3.0 TCP/UDP, Fiber optics interface, LC Connector
- X104** – IRIG-B00X, incl. System Contact (Supervision Contact)

MCDGV4-2A1ATA

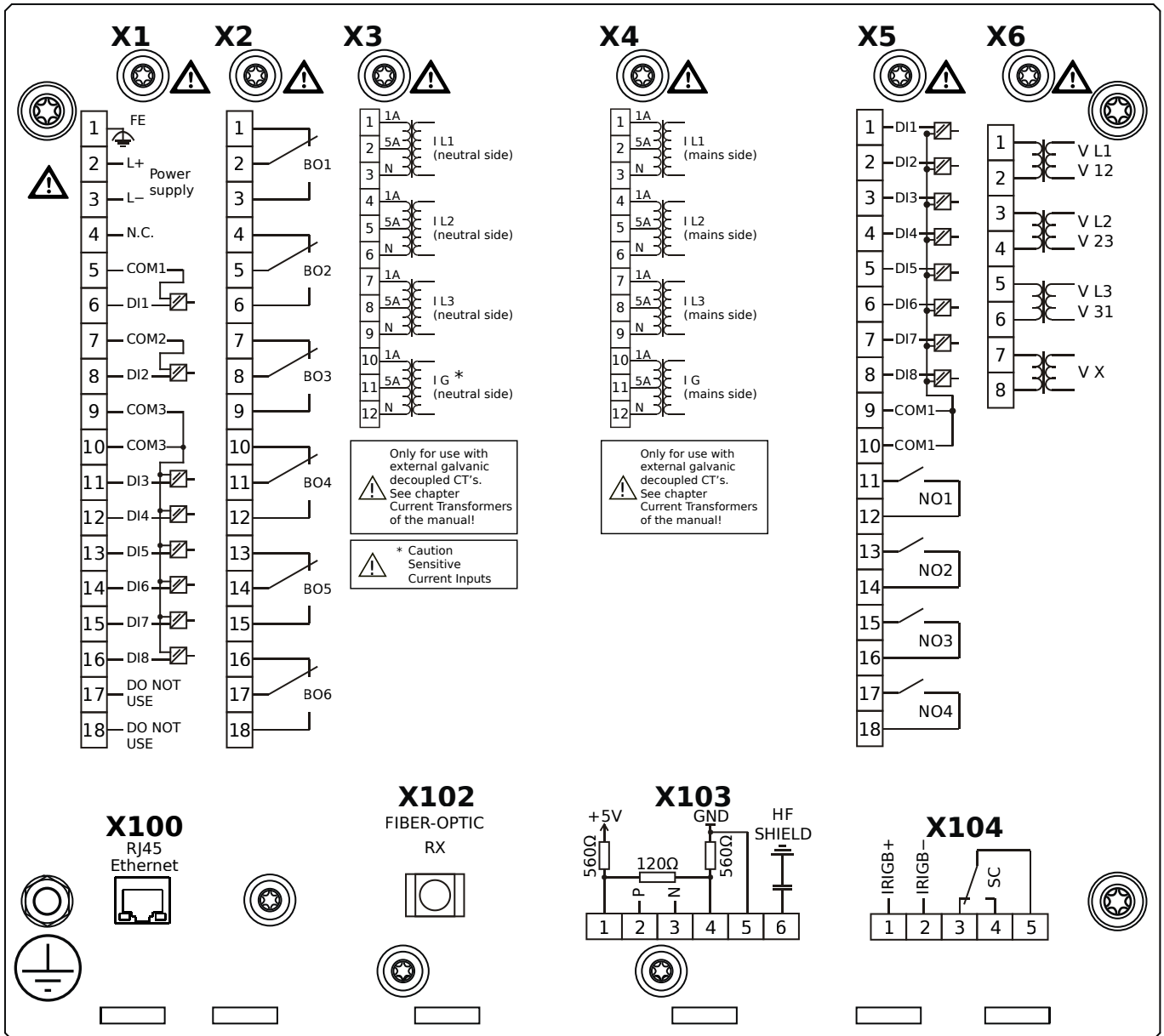

Housing B2, large display, door mounting

- X1** – DI8-X1: Wide-range power supply unit, incl. 2 non-grouped digital inputs and 6 grouped digital inputs
- X2** – OR6: Assembly Group with 6 Output Relays (Changeover / Form C)
- X3** – TIs: Standard phase current measuring card and sensitive ground current measuring (neutral side of the diff. prot.)
- X4** – TI: Standard current measuring card (for the mains side of the differential protection)
- X5** – DI8-OR4: Assembly Group with 8 Digital Inputs and 4 Output Relays (NO / Form A)
- X6** – TU: Card with 4 voltage transformer measuring inputs (0 ... 800 VAC, under UL: 0 ... 600 VAC)
- X100** – IEC 61850 / Modbus TCP / DNP3.0 TCP/UDP, Ethernet interface, 100 Mbit/s, RJ45 (BASE100-FX)
- X102** – Universal Resistance-Temperature Detector (URTD) input, Fiber optics interface, Versatile Link
- X103** – IEC 60870-5-103 / Modbus RTU / DNP3.0 RTU, RS485, Terminals
- X104** – IRIG-B00X, incl. System Contact (Supervision Contact)

MCDGV4-2A1ATB

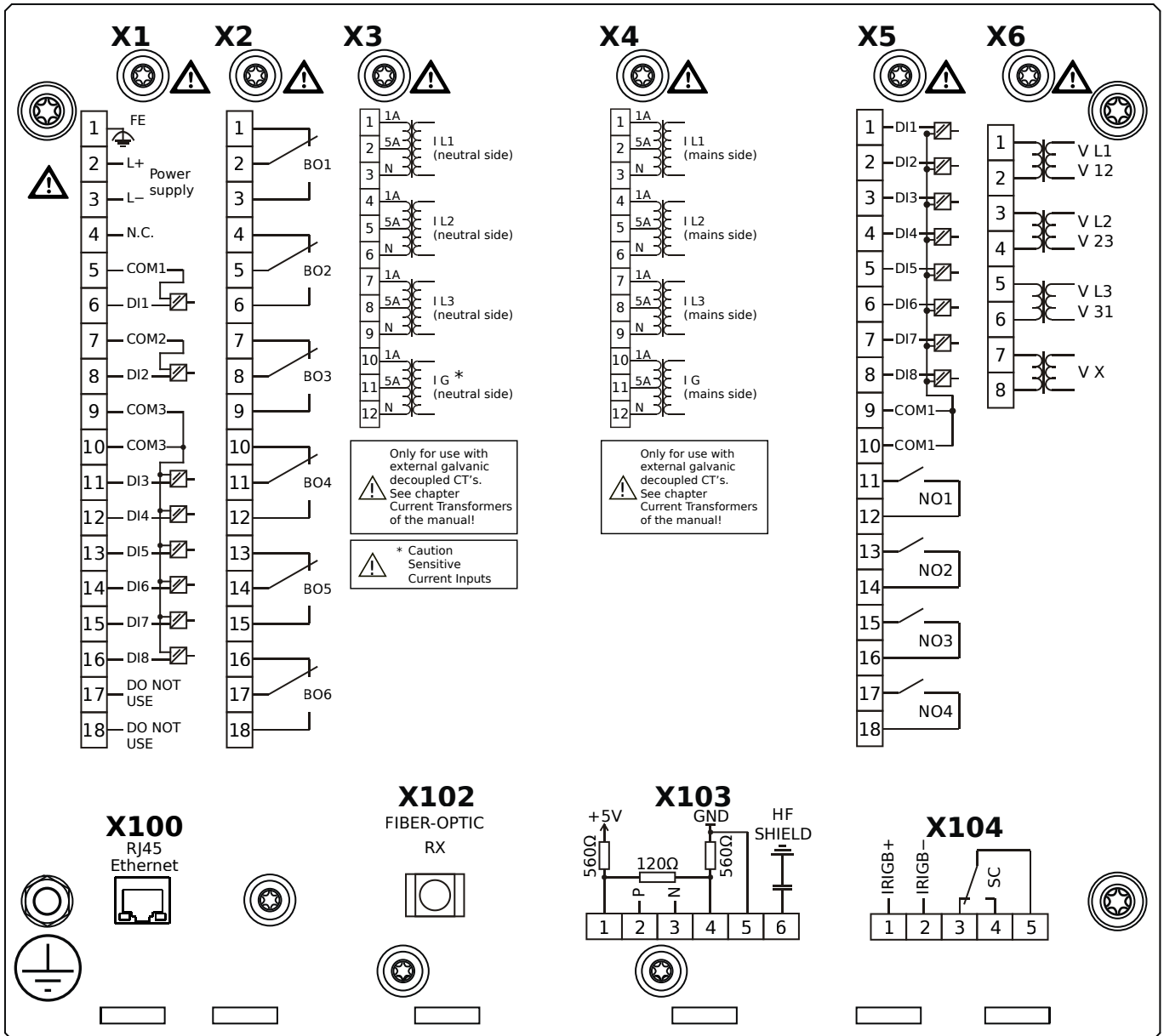

Housing B2, large display, door mounting

+ Conformal Coating (for installations in harsh environment)

- X1** – DI8-X1: Wide-range power supply unit, incl. 2 non-grouped digital inputs and 6 grouped digital inputs
- X2** – OR6: Assembly Group with 6 Output Relays (Changeover / Form C)
- X3** – TIs: Standard phase current measuring card and sensitive ground current measuring (neutral side of the diff. prot.)
- X4** – TI: Standard current measuring card (for the mains side of the differential protection)
- X5** – DI8-OR4: Assembly Group with 8 Digital Inputs and 4 Output Relays (NO / Form A)
- X6** – TU: Card with 4 voltage transformer measuring inputs (0 ... 800 VAC, under UL: 0 ... 600 VAC)
- X100** – IEC 61850 / Modbus TCP / DNP3.0 TCP/UDP, Ethernet interface, 100 Mbit/s, RJ45 (BASE100-FX)
- X102** – Universal Resistance-Temperature Detector (URTD) input, Fiber optics interface, Versatile Link
- X103** – IEC 60870-5-103 / Modbus RTU / DNP3.0 RTU, RS485, Terminals
- X104** – IRIG-B00X, incl. System Contact (Supervision Contact)

MCDGV4-2A1BAA

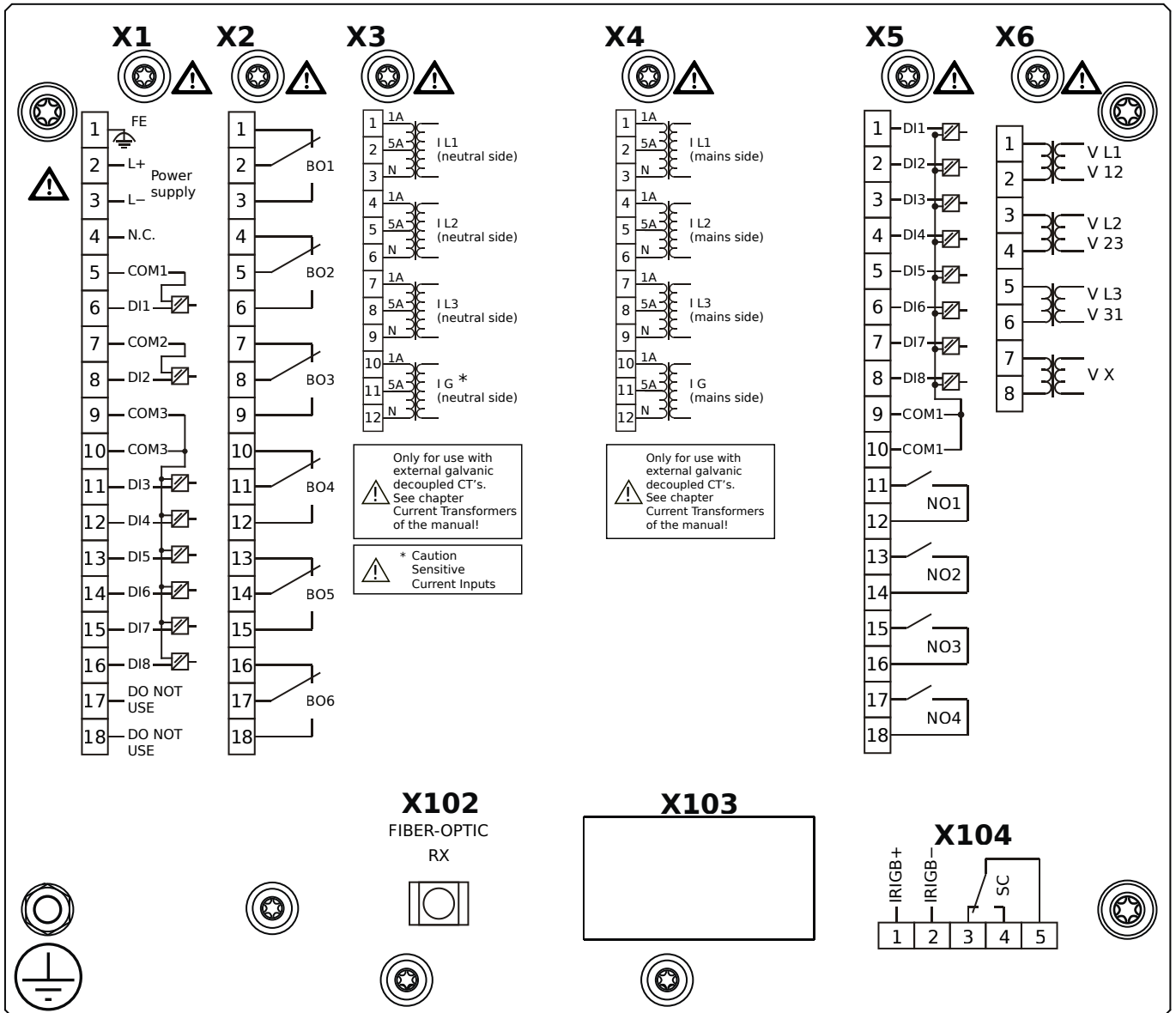

Housing B2, large display, 19" rack mounting

- X1** – DI8-X1: Wide-range power supply unit, incl. 2 non-grouped digital inputs and 6 grouped digital inputs
- X2** – OR6: Assembly Group with 6 Output Relays (Changeover / Form C)
- X3** – TIs: Standard phase current measuring card and sensitive ground current measuring (neutral side of the diff. prot.)
- X4** – TI: Standard current measuring card (for the mains side of the differential protection)
- X5** – DI8-OR4: Assembly Group with 8 Digital Inputs and 4 Output Relays (NO / Form A)
- X6** – TU: Card with 4 voltage transformer measuring inputs (0 ... 800 VAC, under UL: 0 ... 600 VAC)
- X102** – Universal Resistance-Temperature Detector (URTD) input, Fiber optics interface, Versatile Link
- X104** – IRIG-B00X, incl. System Contact (Supervision Contact)

MCDGV4-2A1BAB

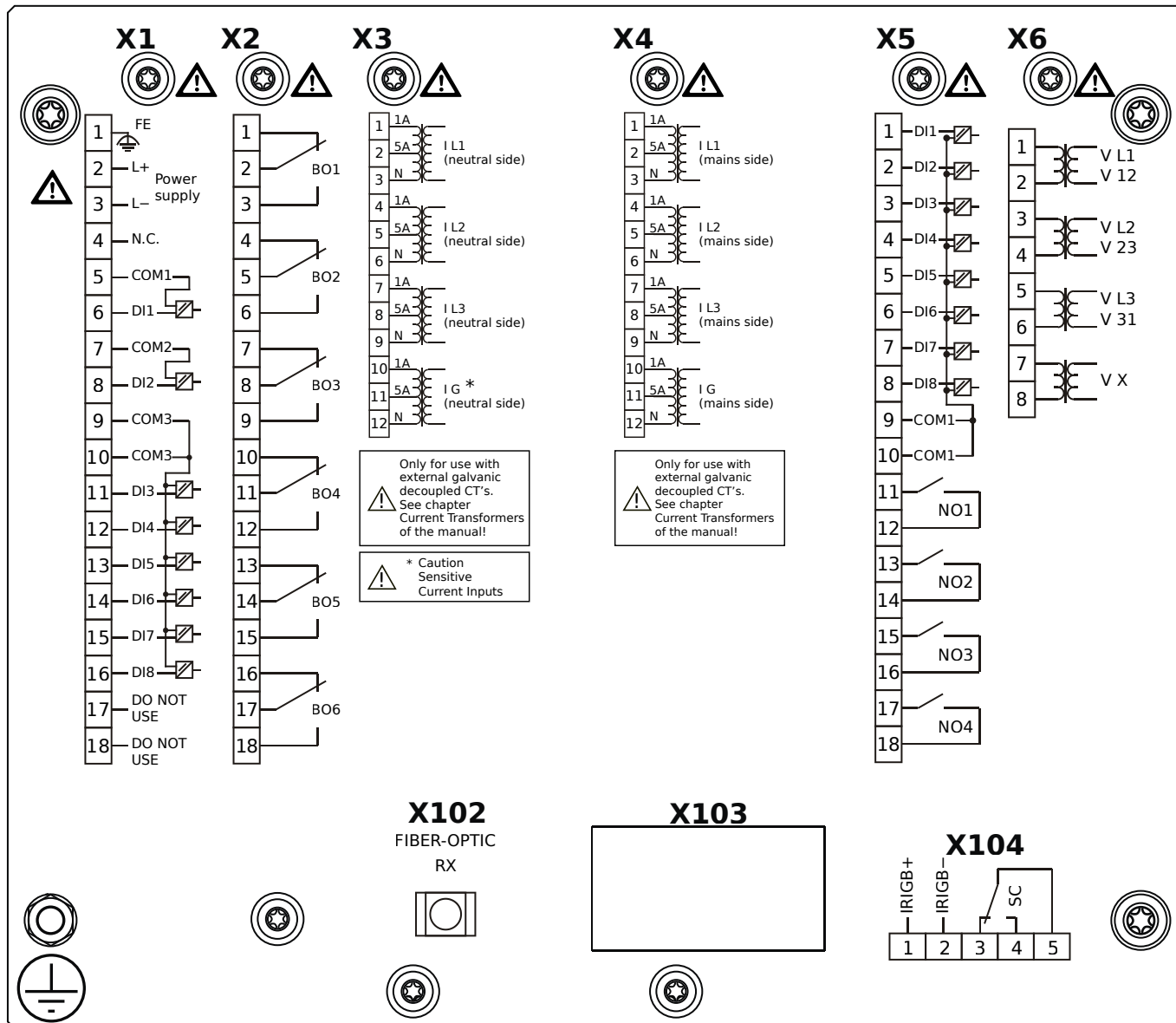

Housing B2, large display, 19" rack mounting

+ Conformal Coating (for installations in harsh environment)

- X1** – DI8-X1: Wide-range power supply unit, incl. 2 non-grouped digital inputs and 6 grouped digital inputs
- X2** – OR6: Assembly Group with 6 Output Relays (Changeover / Form C)
- X3** – TIs: Standard phase current measuring card and sensitive ground current measuring (neutral side of the diff. prot.)
- X4** – TI: Standard current measuring card (for the mains side of the differential protection)
- X5** – DI8-OR4: Assembly Group with 8 Digital Inputs and 4 Output Relays (NO / Form A)
- X6** – TU: Card with 4 voltage transformer measuring inputs (0 ... 800 VAC, under UL: 0 ... 600 VAC)
- X102** – Universal Resistance-Temperature Detector (URTD) input, Fiber optics interface, Versatile Link
- X104** – IRIG-B00X, incl. System Contact (Supervision Contact)

MCDGV4-2A1BBA

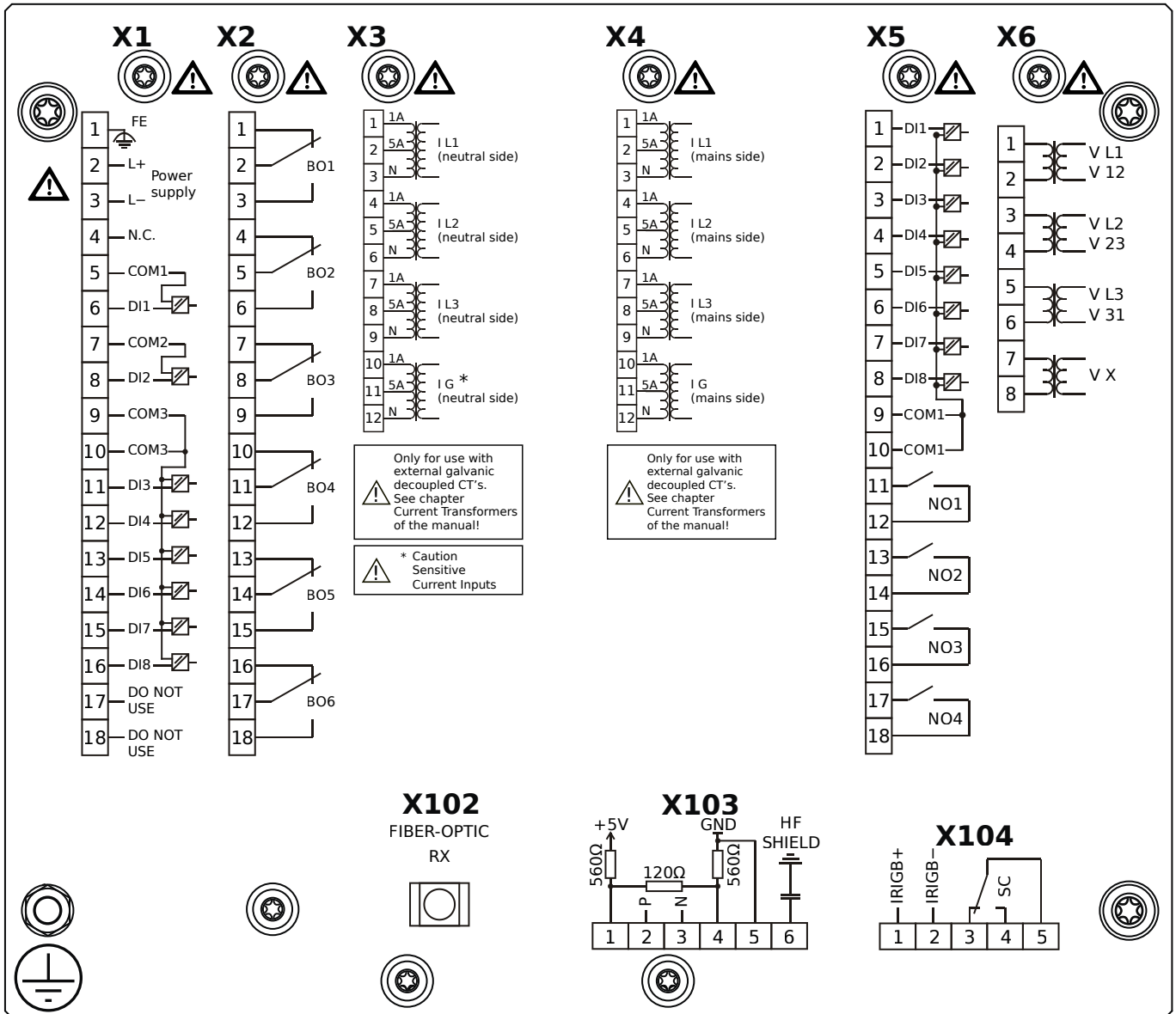

Housing B2, large display, 19" rack mounting

- X1** – DI8-X1: Wide-range power supply unit, incl. 2 non-grouped digital inputs and 6 grouped digital inputs
- X2** – OR6: Assembly Group with 6 Output Relays (Changeover / Form C)
- X3** – TIs: Standard phase current measuring card and sensitive ground current measuring (neutral side of the diff. prot.)
- X4** – TI: Standard current measuring card (for the mains side of the differential protection)
- X5** – DI8-OR4: Assembly Group with 8 Digital Inputs and 4 Output Relays (NO / Form A)
- X6** – TU: Card with 4 voltage transformer measuring inputs (0 ... 800 VAC, under UL: 0 ... 600 VAC)
- X102** – Universal Resistance-Temperature Detector (URTD) input, Fiber optics interface, Versatile Link
- X103** – Modbus RTU / IEC 60870-5-103 / DNP3.0 RTU, RS485, Terminals
- X104** – IRIG-B00X, incl. System Contact (Supervision Contact)

MCDGV4-2A1BBB

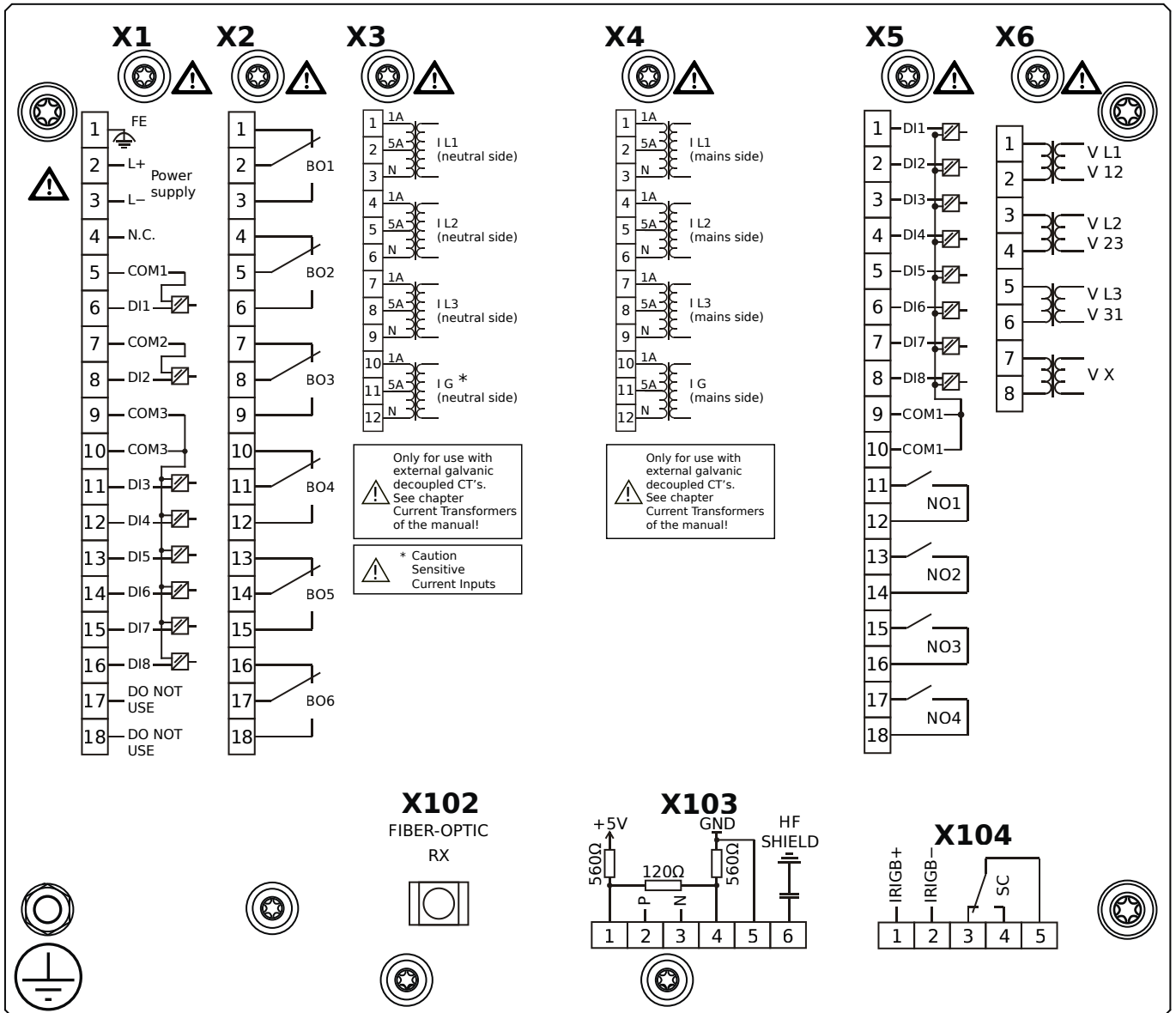

Housing B2, large display, 19" rack mounting

+ Conformal Coating (for installations in harsh environment)

- X1** – DI8-X1: Wide-range power supply unit, incl. 2 non-grouped digital inputs and 6 grouped digital inputs
- X2** – OR6: Assembly Group with 6 Output Relays (Changeover / Form C)
- X3** – TIs: Standard phase current measuring card and sensitive ground current measuring (neutral side of the diff. prot.)
- X4** – TI: Standard current measuring card (for the mains side of the differential protection)
- X5** – DI8-OR4: Assembly Group with 8 Digital Inputs and 4 Output Relays (NO / Form A)
- X6** – TU: Card with 4 voltage transformer measuring inputs (0 ... 800 VAC, under UL: 0 ... 600 VAC)
- X102** – Universal Resistance-Temperature Detector (URTD) input, Fiber optics interface, Versatile Link
- X103** – Modbus RTU / IEC 60870-5-103 / DNP3.0 RTU, RS485, Terminals
- X104** – IRIG-B00X, incl. System Contact (Supervision Contact)

MCDGV4-2A1BCA

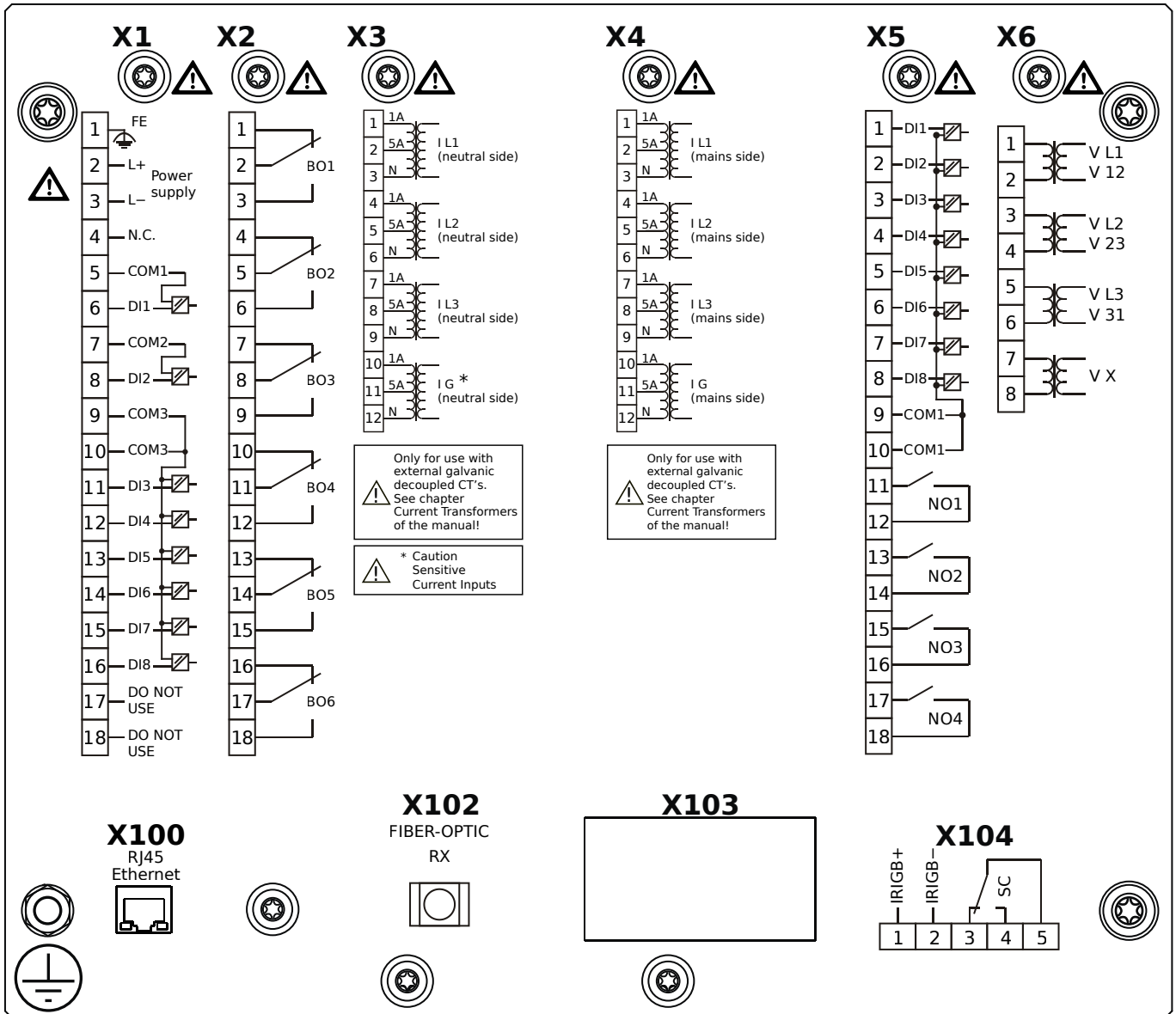

Housing B2, large display, 19" rack mounting

- X1** – DI8-X1: Wide-range power supply unit, incl. 2 non-grouped digital inputs and 6 grouped digital inputs
- X2** – OR6: Assembly Group with 6 Output Relays (Changeover / Form C)
- X3** – TI: Standard phase current measuring card and sensitive ground current measuring (neutral side of the diff. prot.)
- X4** – TI: Standard current measuring card (for the mains side of the differential protection)
- X5** – DI8-OR4: Assembly Group with 8 Digital Inputs and 4 Output Relays (NO / Form A)
- X6** – TU: Card with 4 voltage transformer measuring inputs (0 ... 800 VAC, under UL: 0 ... 600 VAC)
- X100** – Modbus TCP / DNP3.0 TCP/UDP, Ethernet interface, 100 Mbit/s, RJ45 (BASE100-FX)
- X102** – Universal Resistance-Temperature Detector (URTD) input, Fiber optics interface, Versatile Link
- X104** – IRIG-B00X, incl. System Contact (Supervision Contact)

MCDGV4-2A1BCB

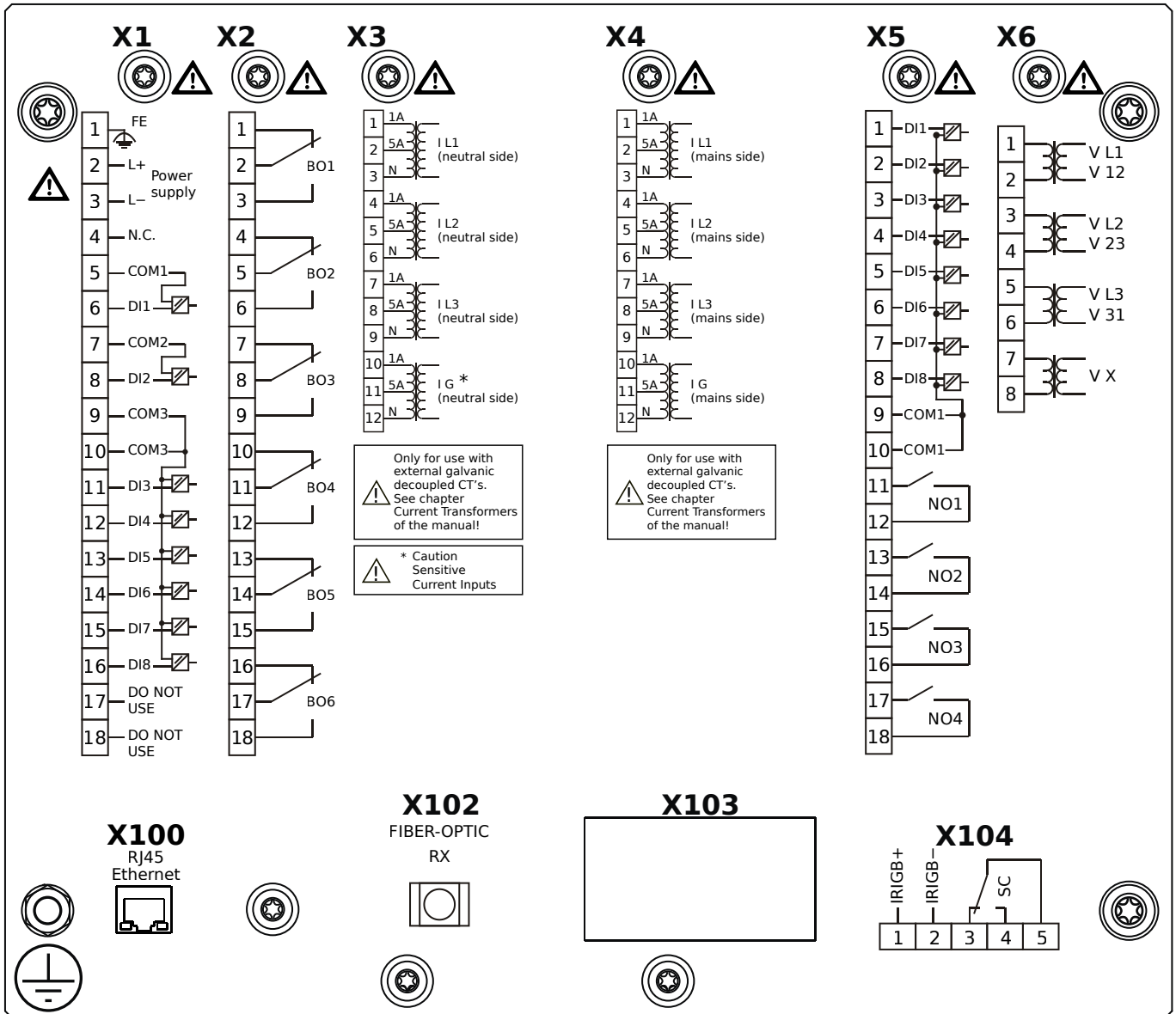

Housing B2, large display, 19" rack mounting

+ Conformal Coating (for installations in harsh environment)

- X1** – DI8-X1: Wide-range power supply unit, incl. 2 non-grouped digital inputs and 6 grouped digital inputs
- X2** – OR6: Assembly Group with 6 Output Relays (Changeover / Form C)
- X3** – TIs: Standard phase current measuring card and sensitive ground current measuring (neutral side of the diff. prot.)
- X4** – TI: Standard current measuring card (for the mains side of the differential protection)
- X5** – DI8-OR4: Assembly Group with 8 Digital Inputs and 4 Output Relays (NO / Form A)
- X6** – TU: Card with 4 voltage transformer measuring inputs (0 ... 800 VAC, under UL: 0 ... 600 VAC)
- X100** – Modbus TCP / DNP3.0 TCP/UDP, Ethernet interface, 100 Mbit/s, RJ45 (BASE100-FX)
- X102** – Universal Resistance-Temperature Detector (URTD) input, Fiber optics interface, Versatile Link
- X104** – IRIG-B00X, incl. System Contact (Supervision Contact)

MCDGV4-2A1BDA

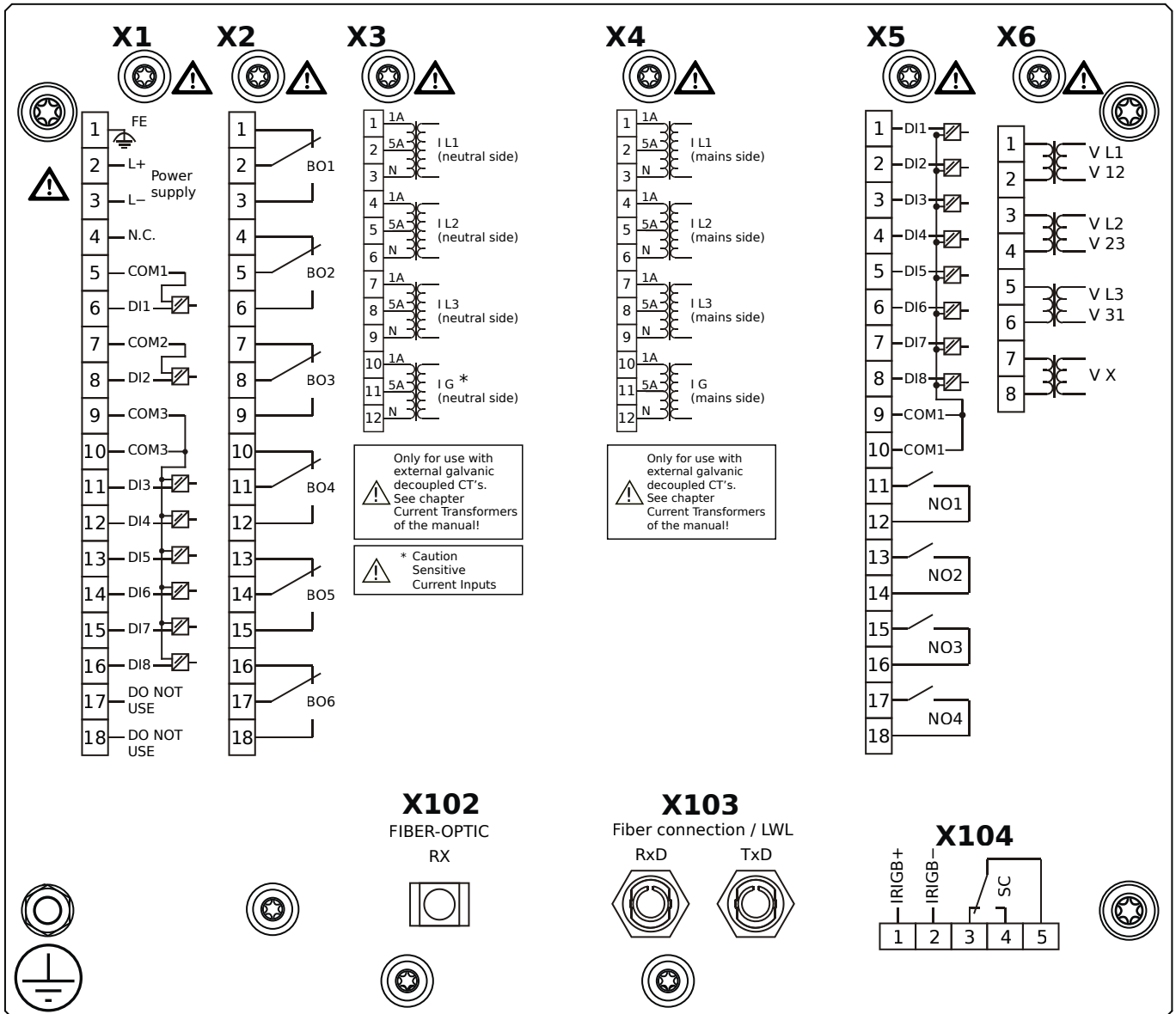

Housing B2, large display, 19" rack mounting

- X1** – DI8-X1: Wide-range power supply unit, incl. 2 non-grouped digital inputs and 6 grouped digital inputs
- X2** – OR6: Assembly Group with 6 Output Relays (Changeover / Form C)
- X3** – TIs: Standard phase current measuring card and sensitive ground current measuring (neutral side of the diff. prot.)
- X4** – TI: Standard current measuring card (for the mains side of the differential protection)
- X5** – DI8-OR4: Assembly Group with 8 Digital Inputs and 4 Output Relays (NO / Form A)
- X6** – TU: Card with 4 voltage transformer measuring inputs (0 ... 800 VAC, under UL: 0 ... 600 VAC)
- X102** – Universal Resistance-Temperature Detector (URTD) input, Fiber optics interface, Versatile Link
- X103** – Profibus-DP, Fiber optics interface, ST Connector
- X104** – IRIG-B00X, incl. System Contact (Supervision Contact)

MCDGV4-2A1BDB

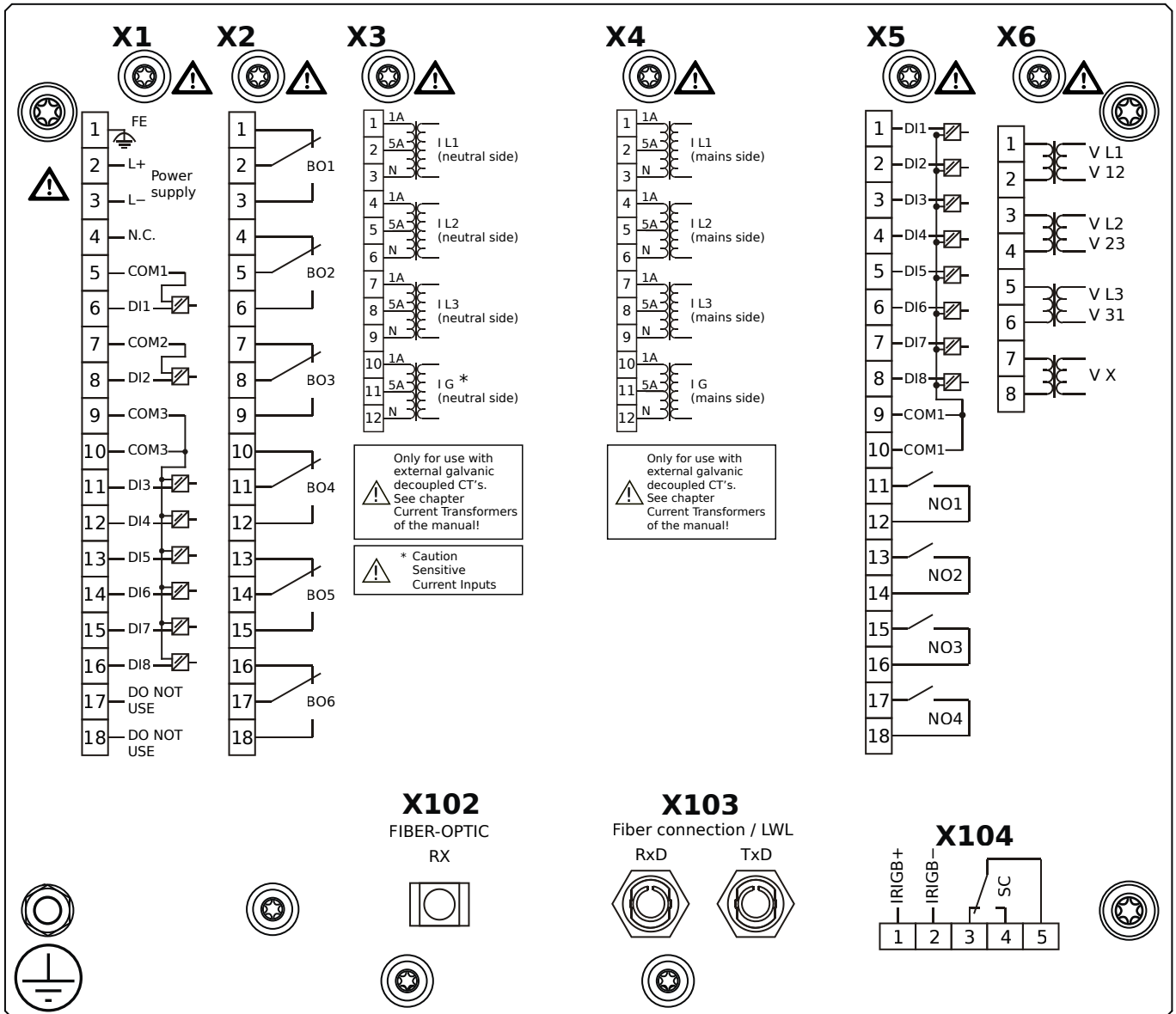

Housing B2, large display, 19" rack mounting

+ Conformal Coating (for installations in harsh environment)

- X1** – DI8-X1: Wide-range power supply unit, incl. 2 non-grouped digital inputs and 6 grouped digital inputs
- X2** – OR6: Assembly Group with 6 Output Relays (Changeover / Form C)
- X3** – TIs: Standard phase current measuring card and sensitive ground current measuring (neutral side of the diff. prot.)
- X4** – TI: Standard current measuring card (for the mains side of the differential protection)
- X5** – DI8-OR4: Assembly Group with 8 Digital Inputs and 4 Output Relays (NO / Form A)
- X6** – TU: Card with 4 voltage transformer measuring inputs (0 ... 800 VAC, under UL: 0 ... 600 VAC)
- X102** – Universal Resistance-Temperature Detector (URTD) input, Fiber optics interface, Versatile Link
- X103** – Profibus-DP, Fiber optics interface, ST Connector
- X104** – IRIG-B00X, incl. System Contact (Supervision Contact)

MCDGV4-2A1BEA

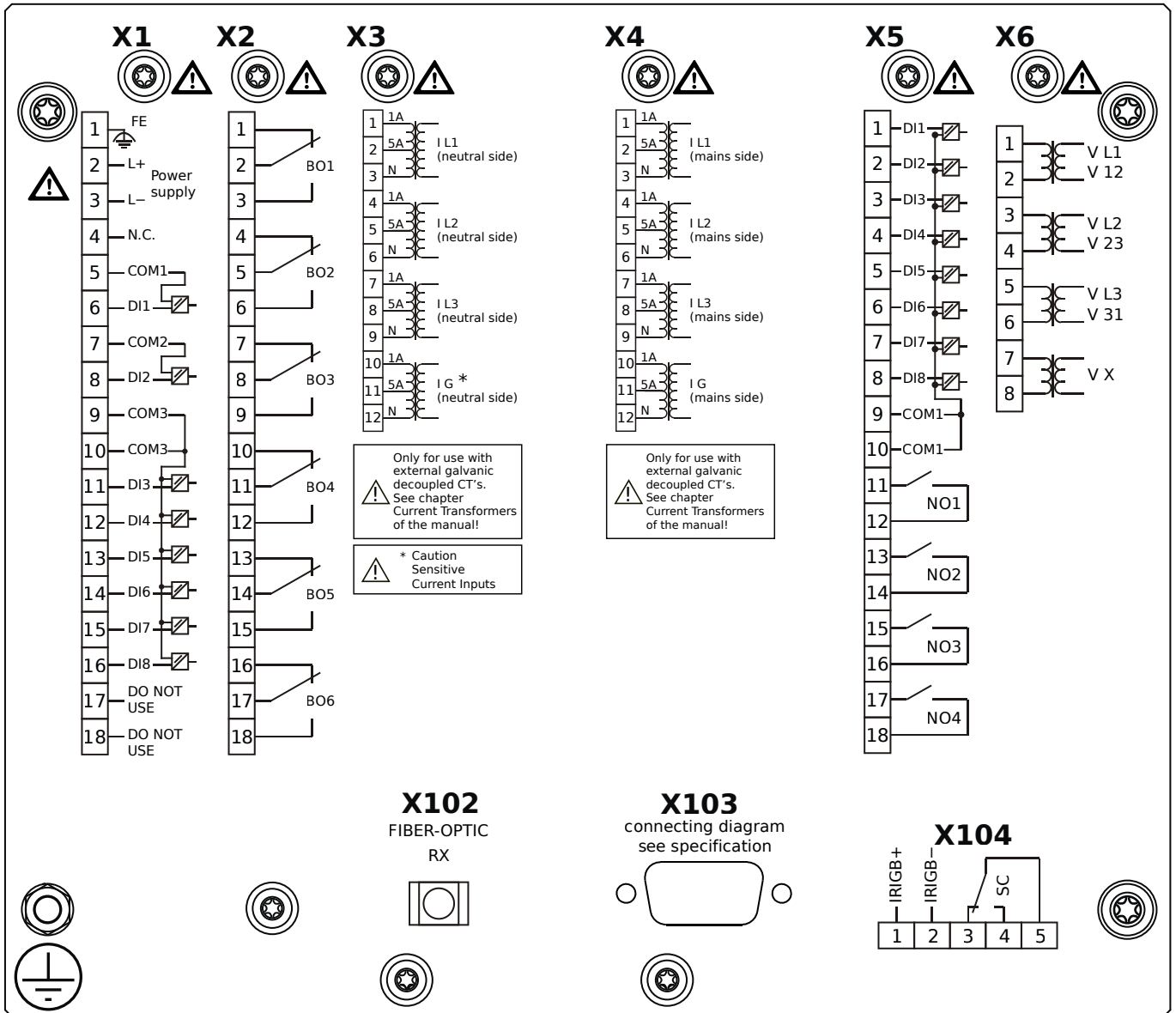

Housing B2, large display, 19" rack mounting

- X1** – DI8-X1: Wide-range power supply unit, incl. 2 non-grouped digital inputs and 6 grouped digital inputs
- X2** – OR6: Assembly Group with 6 Output Relays (Changeover / Form C)
- X3** – TIs: Standard phase current measuring card and sensitive ground current measuring (neutral side of the diff. prot.)
- X4** – TI: Standard current measuring card (for the mains side of the differential protection)
- X5** – DI8-OR4: Assembly Group with 8 Digital Inputs and 4 Output Relays (NO / Form A)
- X6** – TU: Card with 4 voltage transformer measuring inputs (0 ... 800 VAC, under UL: 0 ... 600 VAC)
- X102** – Universal Resistance-Temperature Detector (URTD) input, Fiber optics interface, Versatile Link
- X103** – Profibus-DP, RS485, D-SUB
- X104** – IRIG-B00X, incl. System Contact (Supervision Contact)

MCDGV4-2A1BEB

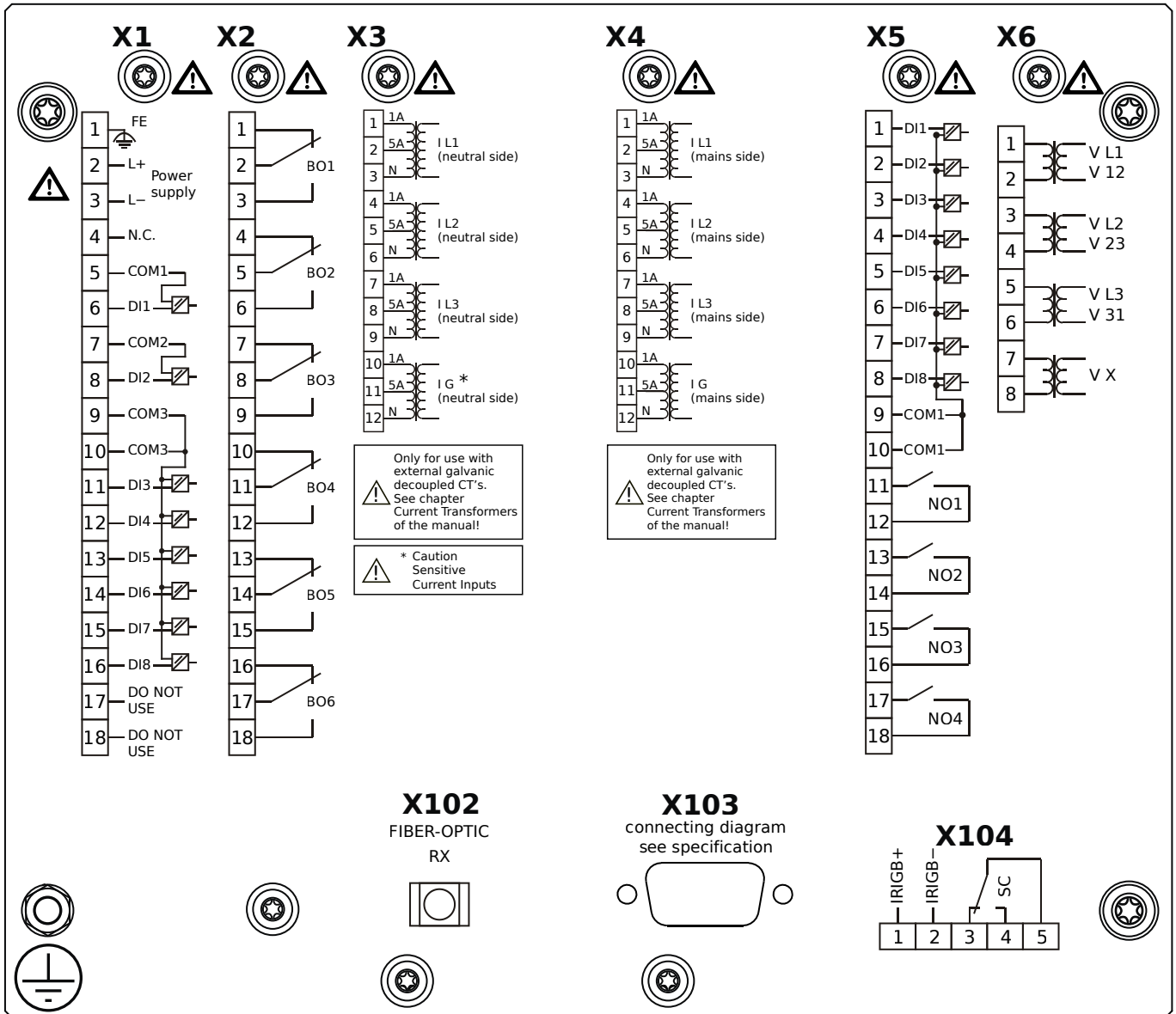

Housing B2, large display, 19" rack mounting

+ Conformal Coating (for installations in harsh environment)

- X1** – DI8-X1: Wide-range power supply unit, incl. 2 non-grouped digital inputs and 6 grouped digital inputs
- X2** – OR6: Assembly Group with 6 Output Relays (Changeover / Form C)
- X3** – TIs: Standard phase current measuring card and sensitive ground current measuring (neutral side of the diff. prot.)
- X4** – TI: Standard current measuring card (for the mains side of the differential protection)
- X5** – DI8-OR4: Assembly Group with 8 Digital Inputs and 4 Output Relays (NO / Form A)
- X6** – TU: Card with 4 voltage transformer measuring inputs (0 ... 800 VAC, under UL: 0 ... 600 VAC)
- X102** – Universal Resistance-Temperature Detector (URTD) input, Fiber optics interface, Versatile Link
- X103** – Profibus-DP, RS485, D-SUB
- X104** – IRIG-B00X, incl. System Contact (Supervision Contact)

MCDGV4-2A1BFA

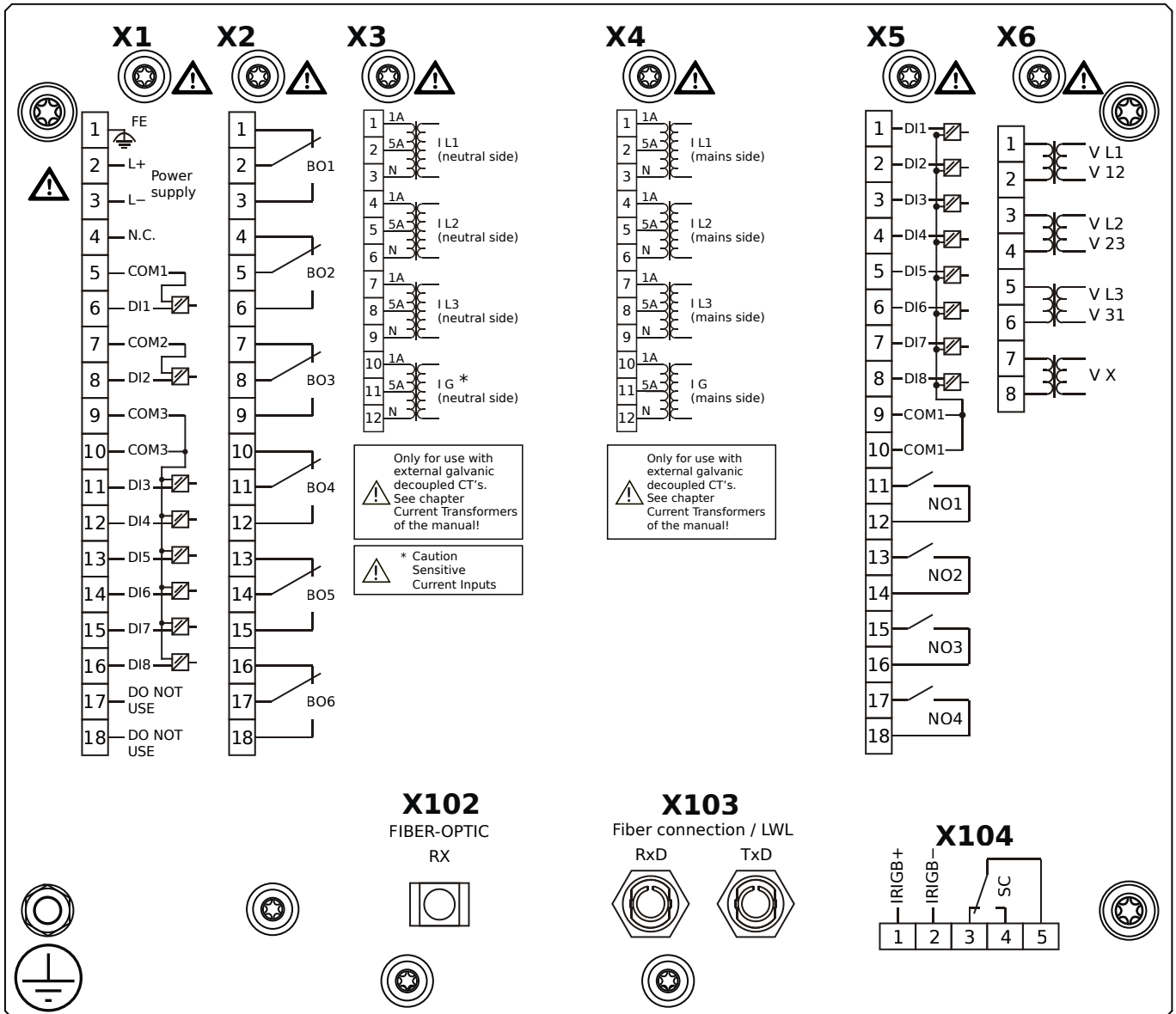

Housing B2, large display, 19" rack mounting

- X1** – DI8-X1: Wide-range power supply unit, incl. 2 non-grouped digital inputs and 6 grouped digital inputs
- X2** – OR6: Assembly Group with 6 Output Relays (Changeover / Form C)
- X3** – TIs: Standard phase current measuring card and sensitive ground current measuring (neutral side of the diff. prot.)
- X4** – TI: Standard current measuring card (for the mains side of the differential protection)
- X5** – DI8-OR4: Assembly Group with 8 Digital Inputs and 4 Output Relays (NO / Form A)
- X6** – TU: Card with 4 voltage transformer measuring inputs (0 ... 800 VAC, under UL: 0 ... 600 VAC)
- X102** – Universal Resistance-Temperature Detector (URTD) input, Fiber optics interface, Versatile Link
- X103** – Modbus RTU / IEC 60870-5-103 / DNP3.0 RTU, Fiber optics interface, ST Connector
- X104** – IRIG-B00X, incl. System Contact (Supervision Contact)

MCDGV4-2A1BFB

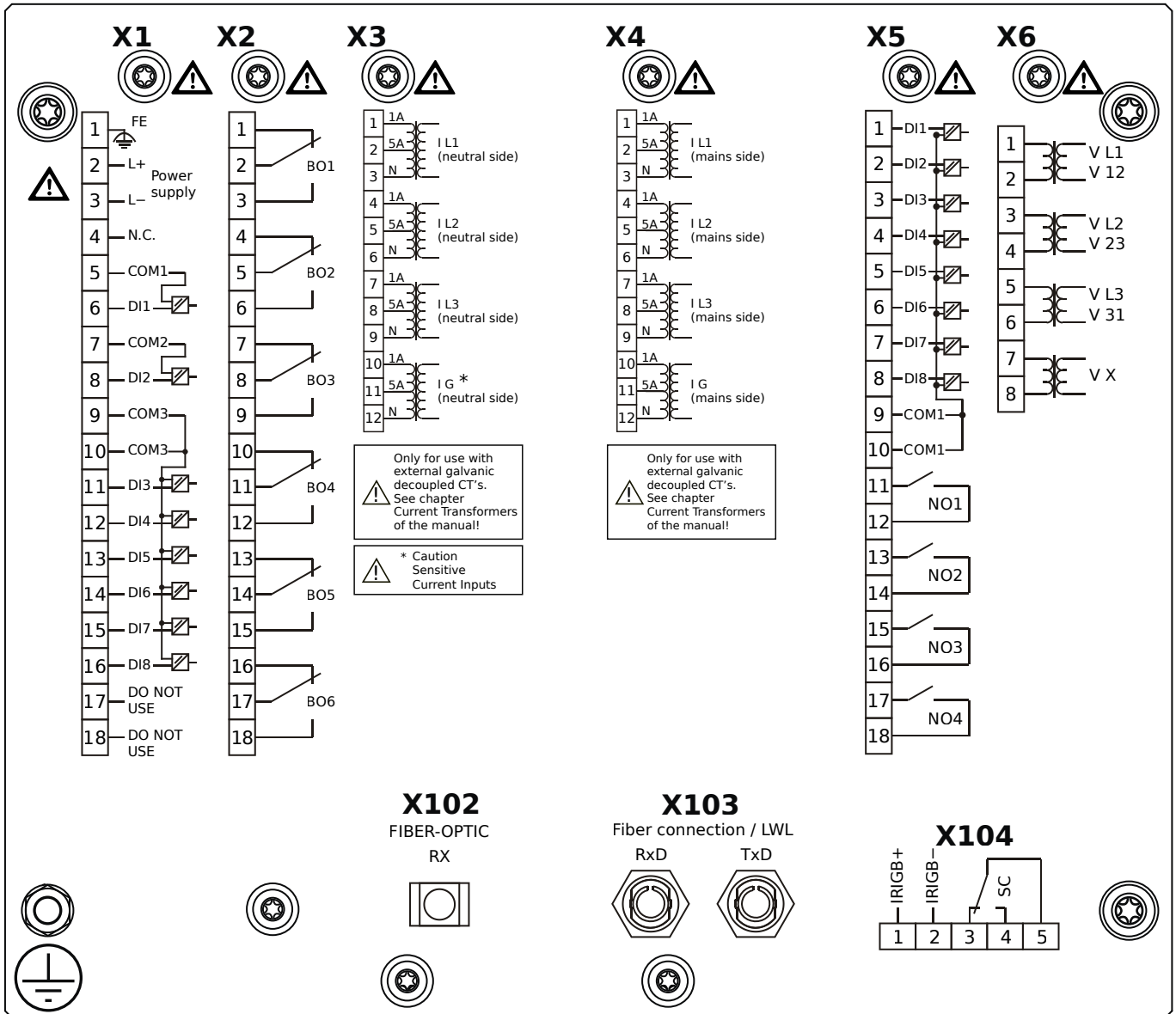

Housing B2, large display, 19" rack mounting

+ Conformal Coating (for installations in harsh environment)

- X1** – DI8-X1: Wide-range power supply unit, incl. 2 non-grouped digital inputs and 6 grouped digital inputs
- X2** – OR6: Assembly Group with 6 Output Relays (Changeover / Form C)
- X3** – TIs: Standard phase current measuring card and sensitive ground current measuring (neutral side of the diff. prot.)
- X4** – TI: Standard current measuring card (for the mains side of the differential protection)
- X5** – DI8-OR4: Assembly Group with 8 Digital Inputs and 4 Output Relays (NO / Form A)
- X6** – TU: Card with 4 voltage transformer measuring inputs (0 ... 800 VAC, under UL: 0 ... 600 VAC)
- X102** – Universal Resistance-Temperature Detector (URTD) input, Fiber optics interface, Versatile Link
- X103** – Modbus RTU / IEC 60870-5-103 / DNP3.0 RTU, Fiber optics interface, ST Connector
- X104** – IRIG-B00X, incl. System Contact (Supervision Contact)

MCDGV4-2A1BGA

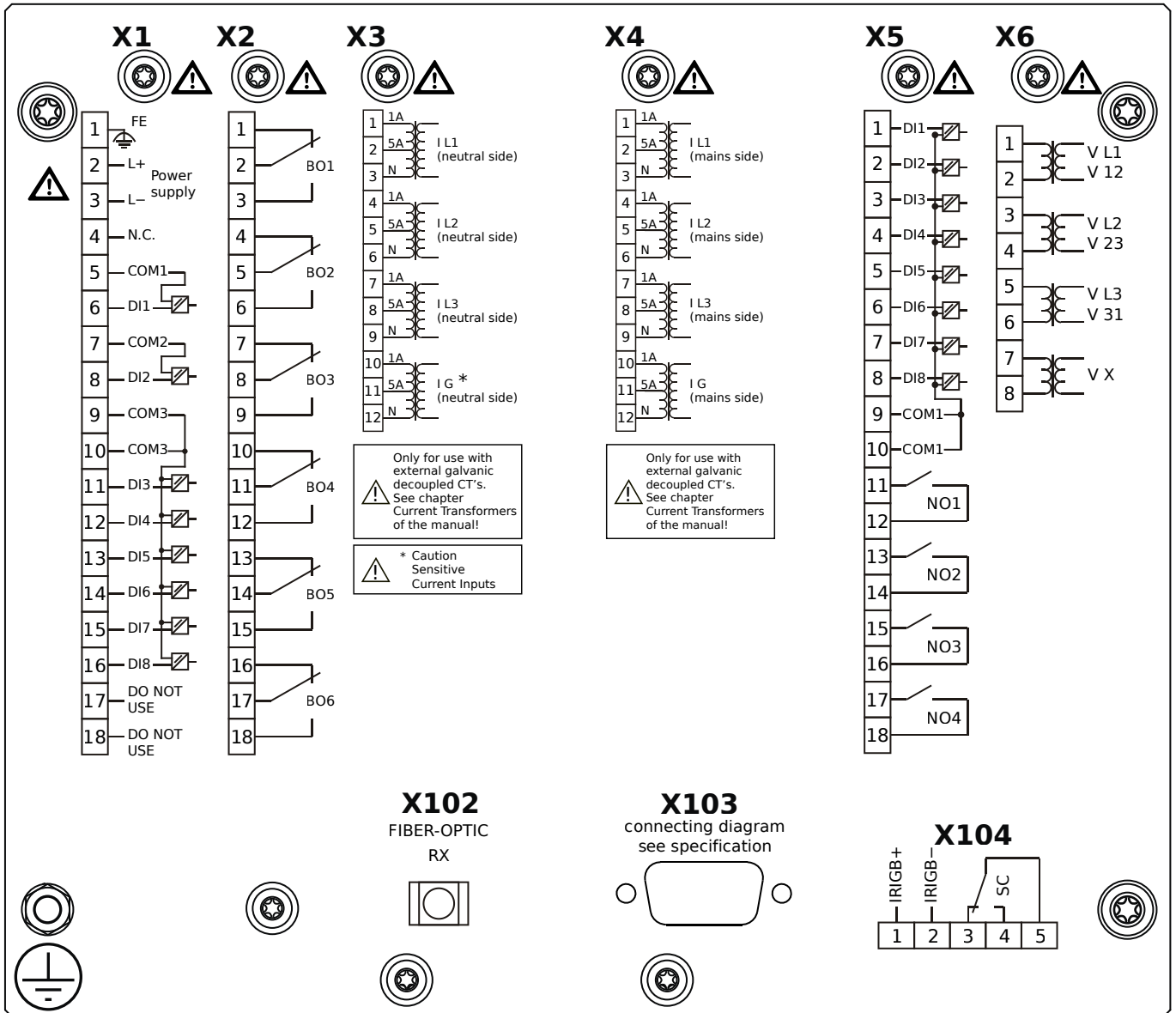

Housing B2, large display, 19" rack mounting

- X1** – DI8-X1: Wide-range power supply unit, incl. 2 non-grouped digital inputs and 6 grouped digital inputs
- X2** – OR6: Assembly Group with 6 Output Relays (Changeover / Form C)
- X3** – TIs: Standard phase current measuring card and sensitive ground current measuring (neutral side of the diff. prot.)
- X4** – TI: Standard current measuring card (for the mains side of the differential protection)
- X5** – DI8-OR4: Assembly Group with 8 Digital Inputs and 4 Output Relays (NO / Form A)
- X6** – TU: Card with 4 voltage transformer measuring inputs (0 ... 800 VAC, under UL: 0 ... 600 VAC)
- X102** – Universal Resistance-Temperature Detector (URTD) input, Fiber optics interface, Versatile Link
- X103** – Modbus RTU / IEC 60870-5-103 / DNP3.0 RTU, RS485, D-SUB
- X104** – IRIG-B00X, incl. System Contact (Supervision Contact)

MCDGV4-2A1BGB

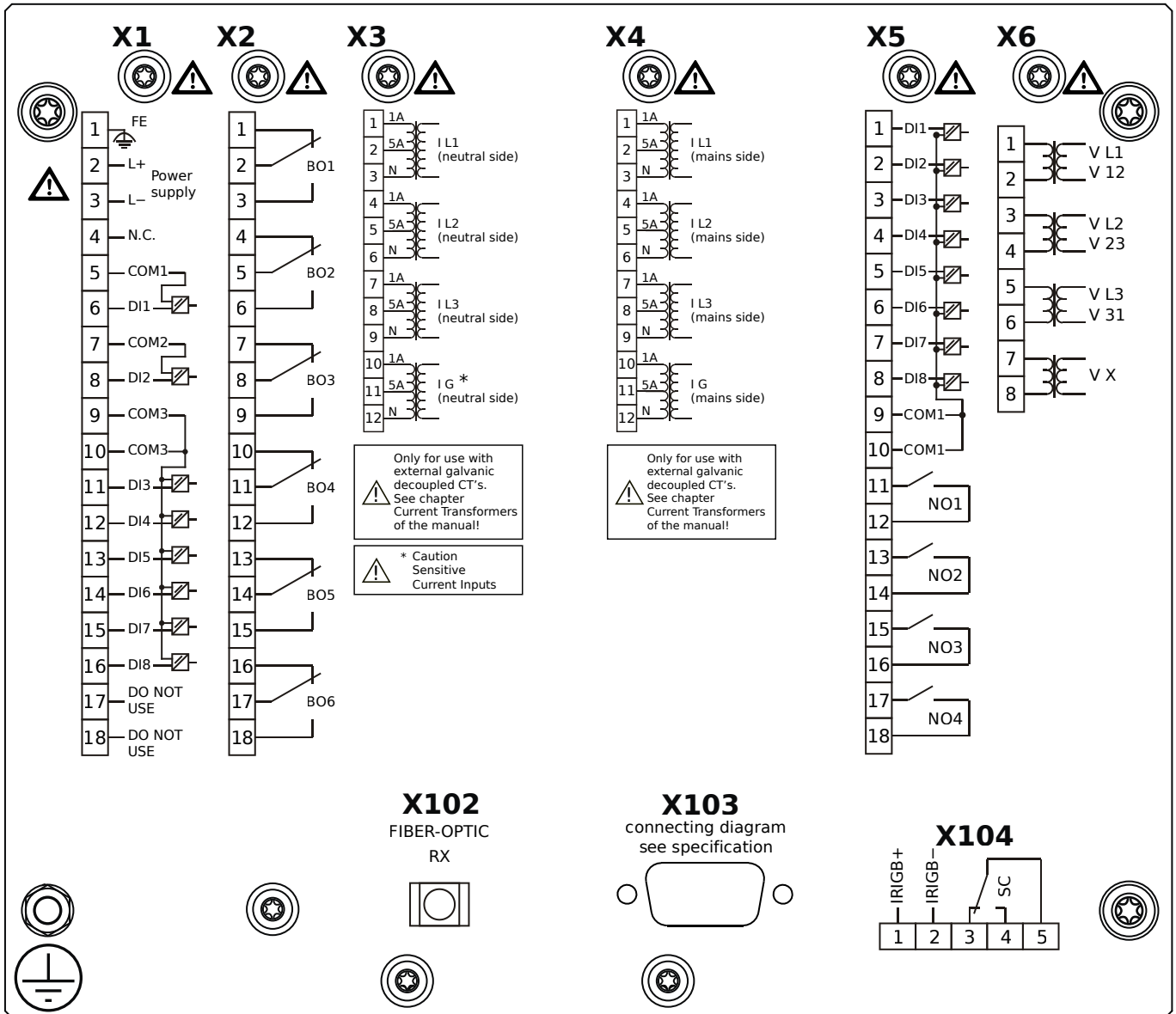

Housing B2, large display, 19" rack mounting

+ Conformal Coating (for installations in harsh environment)

- X1** – DI8-X1: Wide-range power supply unit, incl. 2 non-grouped digital inputs and 6 grouped digital inputs
- X2** – OR6: Assembly Group with 6 Output Relays (Changeover / Form C)
- X3** – TIs: Standard phase current measuring card and sensitive ground current measuring (neutral side of the diff. prot.)
- X4** – TI: Standard current measuring card (for the mains side of the differential protection)
- X5** – DI8-OR4: Assembly Group with 8 Digital Inputs and 4 Output Relays (NO / Form A)
- X6** – TU: Card with 4 voltage transformer measuring inputs (0 ... 800 VAC, under UL: 0 ... 600 VAC)
- X102** – Universal Resistance-Temperature Detector (URTD) input, Fiber optics interface, Versatile Link
- X103** – Modbus RTU / IEC 60870-5-103 / DNP3.0 RTU, RS485, D-SUB
- X104** – IRIG-B00X, incl. System Contact (Supervision Contact)

MCDGV4-2A1BHA

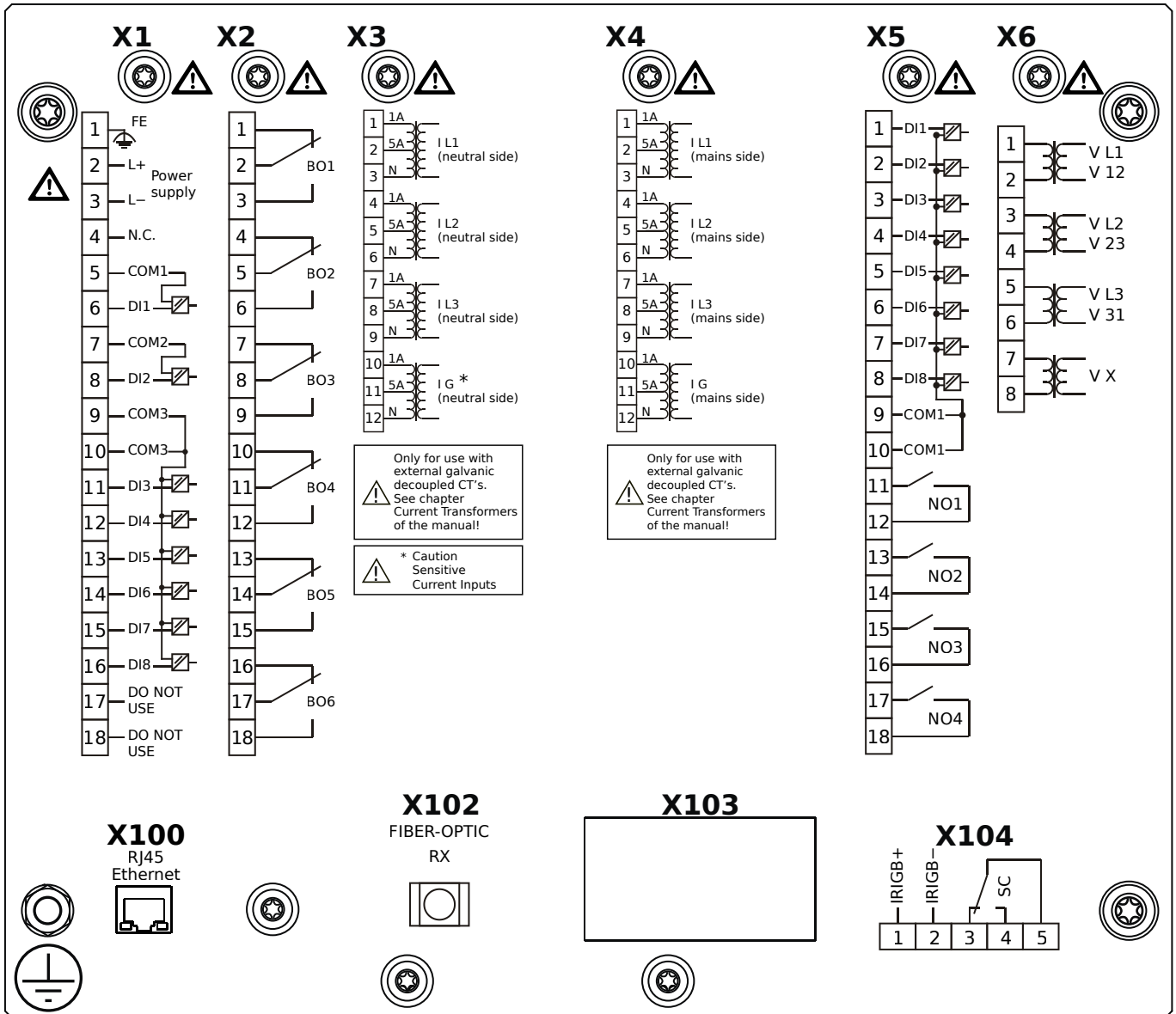

Housing B2, large display, 19" rack mounting

- X1** – DI8-X1: Wide-range power supply unit, incl. 2 non-grouped digital inputs and 6 grouped digital inputs
- X2** – OR6: Assembly Group with 6 Output Relays (Changeover / Form C)
- X3** – TIs: Standard phase current measuring card and sensitive ground current measuring (neutral side of the diff. prot.)
- X4** – TI: Standard current measuring card (for the mains side of the differential protection)
- X5** – DI8-OR4: Assembly Group with 8 Digital Inputs and 4 Output Relays (NO / Form A)
- X6** – TU: Card with 4 voltage transformer measuring inputs (0 ... 800 VAC, under UL: 0 ... 600 VAC)
- X100** – IEC 61850 / Modbus TCP / DNP3.0 TCP/UDP, Ethernet interface, 100 Mbit/s, RJ45 (BASE100-FX)
- X102** – Universal Resistance-Temperature Detector (URTD) input, Fiber optics interface, Versatile Link
- X104** – IRIG-B00X, incl. System Contact (Supervision Contact)

MCDGV4-2A1BHB

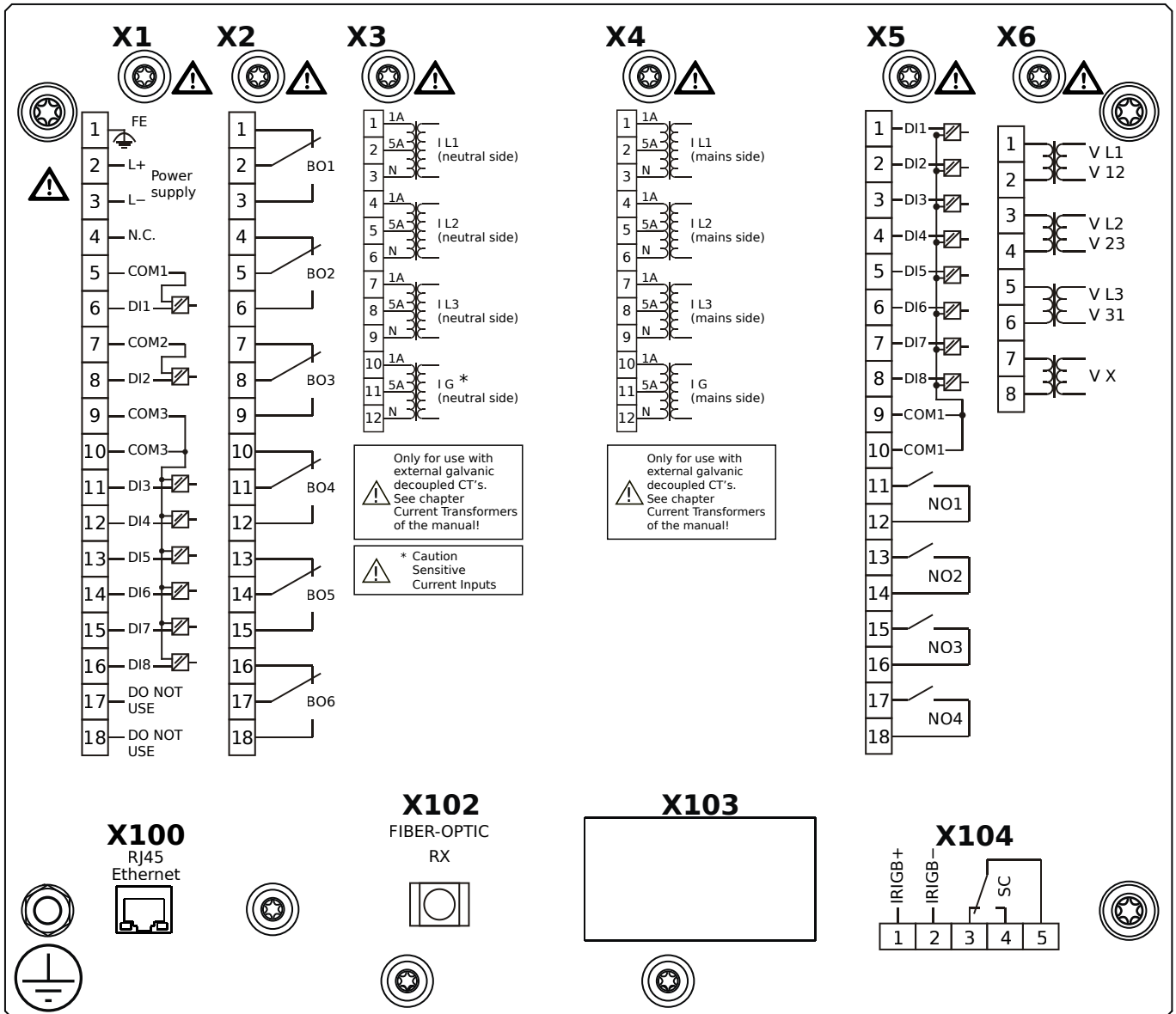

Housing B2, large display, 19" rack mounting

+ Conformal Coating (for installations in harsh environment)

- X1** – DI8-X1: Wide-range power supply unit, incl. 2 non-grouped digital inputs and 6 grouped digital inputs
- X2** – OR6: Assembly Group with 6 Output Relays (Changeover / Form C)
- X3** – TIs: Standard phase current measuring card and sensitive ground current measuring (neutral side of the diff. prot.)
- X4** – TI: Standard current measuring card (for the mains side of the differential protection)
- X5** – DI8-OR4: Assembly Group with 8 Digital Inputs and 4 Output Relays (NO / Form A)
- X6** – TU: Card with 4 voltage transformer measuring inputs (0 ... 800 VAC, under UL: 0 ... 600 VAC)
- X100** – IEC 61850 / Modbus TCP / DNP3.0 TCP/UDP, Ethernet interface, 100 Mbit/s, RJ45 (BASE100-FX)
- X102** – Universal Resistance-Temperature Detector (URTD) input, Fiber optics interface, Versatile Link
- X104** – IRIG-B00X, incl. System Contact (Supervision Contact)

MCDGV4-2A1BIA

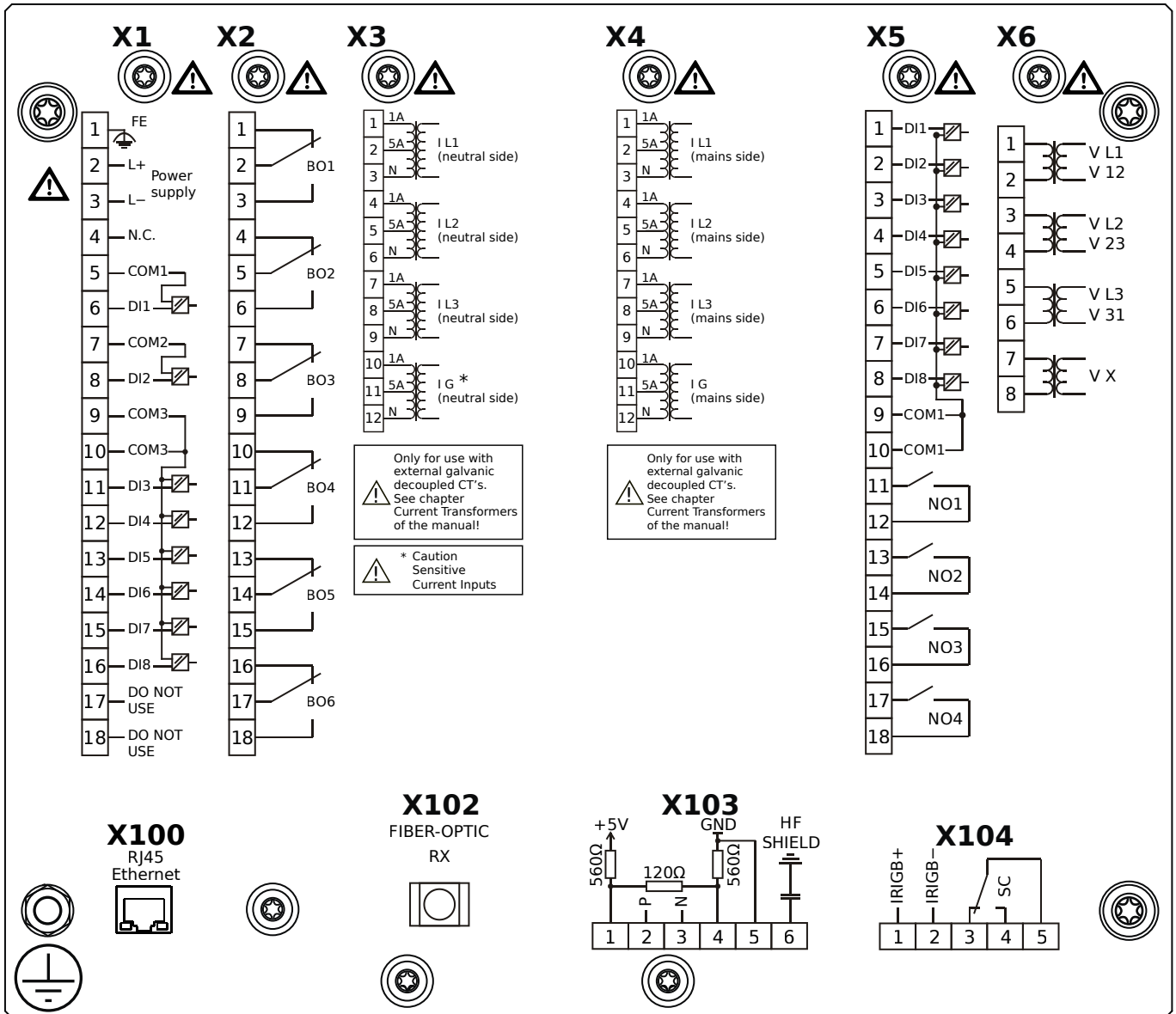

Housing B2, large display, 19" rack mounting

- X1** – DI8-X1: Wide-range power supply unit, incl. 2 non-grouped digital inputs and 6 grouped digital inputs
- X2** – OR6: Assembly Group with 6 Output Relays (Changeover / Form C)
- X3** – TI: Standard phase current measuring card and sensitive ground current measuring (neutral side of the diff. prot.)
- X4** – TI: Standard current measuring card (for the mains side of the differential protection)
- X5** – DI8-OR4: Assembly Group with 8 Digital Inputs and 4 Output Relays (NO / Form A)
- X6** – TU: Card with 4 voltage transformer measuring inputs (0 ... 800 VAC, under UL: 0 ... 600 VAC)
- X100** – Modbus TCP / DNP3.0 TCP/UDP, Ethernet interface, 100 Mbit/s, RJ45 (BASE100-FX)
- X102** – Universal Resistance-Temperature Detector (URTD) input, Fiber optics interface, Versatile Link
- X103** – IEC 60870-5-103 / Modbus RTU / DNP3.0 RTU, RS485, Terminals
- X104** – IRIG-B00X, incl. System Contact (Supervision Contact)

MCDGV4-2A1BIB

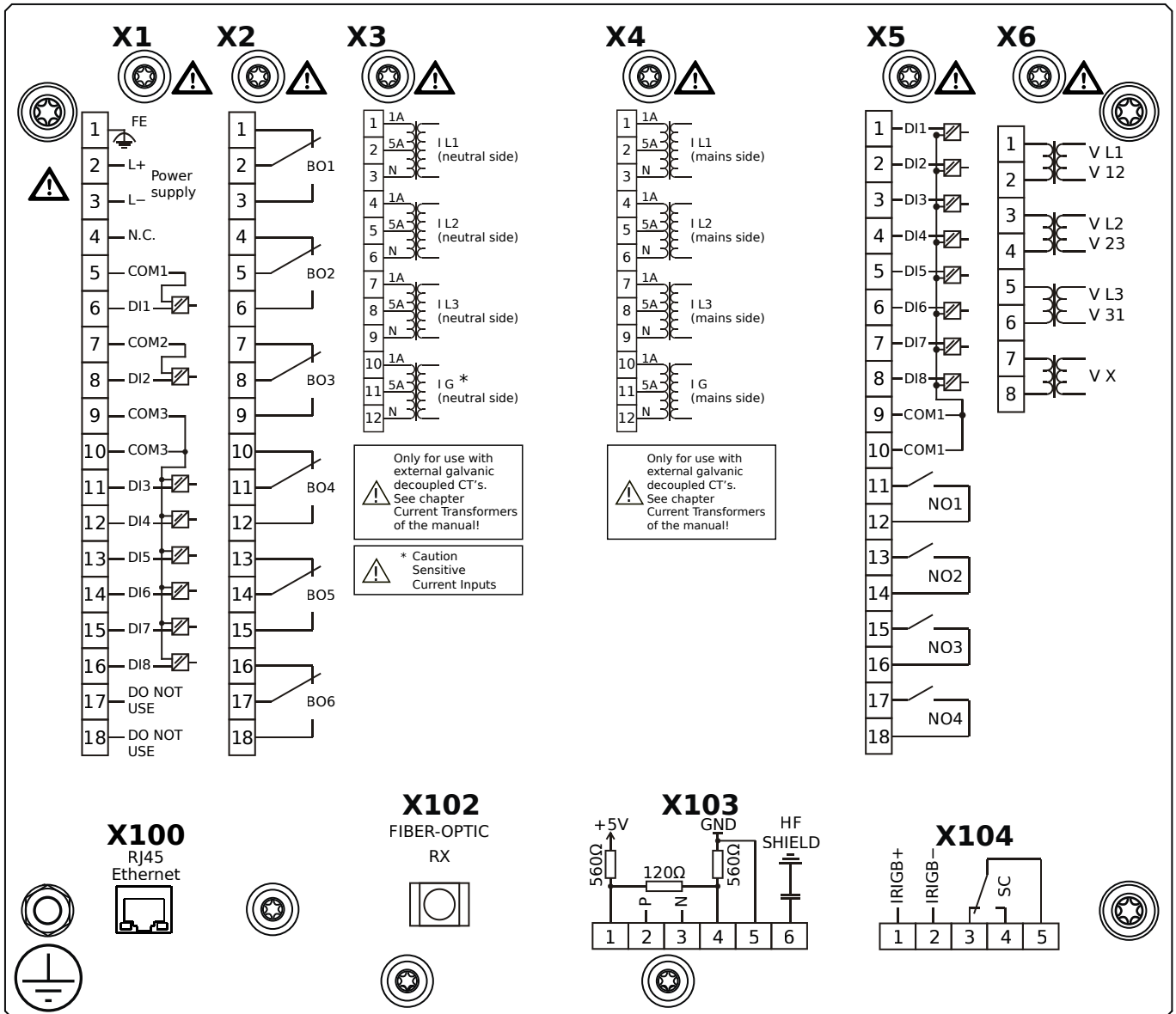

Housing B2, large display, 19" rack mounting

+ Conformal Coating (for installations in harsh environment)

- X1** – DI8-X1: Wide-range power supply unit, incl. 2 non-grouped digital inputs and 6 grouped digital inputs
- X2** – OR6: Assembly Group with 6 Output Relays (Changeover / Form C)
- X3** – TIs: Standard phase current measuring card and sensitive ground current measuring (neutral side of the diff. prot.)
- X4** – TI: Standard current measuring card (for the mains side of the differential protection)
- X5** – DI8-OR4: Assembly Group with 8 Digital Inputs and 4 Output Relays (NO / Form A)
- X6** – TU: Card with 4 voltage transformer measuring inputs (0 ... 800 VAC, under UL: 0 ... 600 VAC)
- X100** – Modbus TCP / DNP3.0 TCP/UDP, Ethernet interface, 100 Mbit/s, RJ45 (BASE100-FX)
- X102** – Universal Resistance-Temperature Detector (URTD) input, Fiber optics interface, Versatile Link
- X103** – IEC 60870-5-103 / Modbus RTU / DNP3.0 RTU, RS485, Terminals
- X104** – IRIG-B00X, incl. System Contact (Supervision Contact)

MCDGV4-2A1BKA

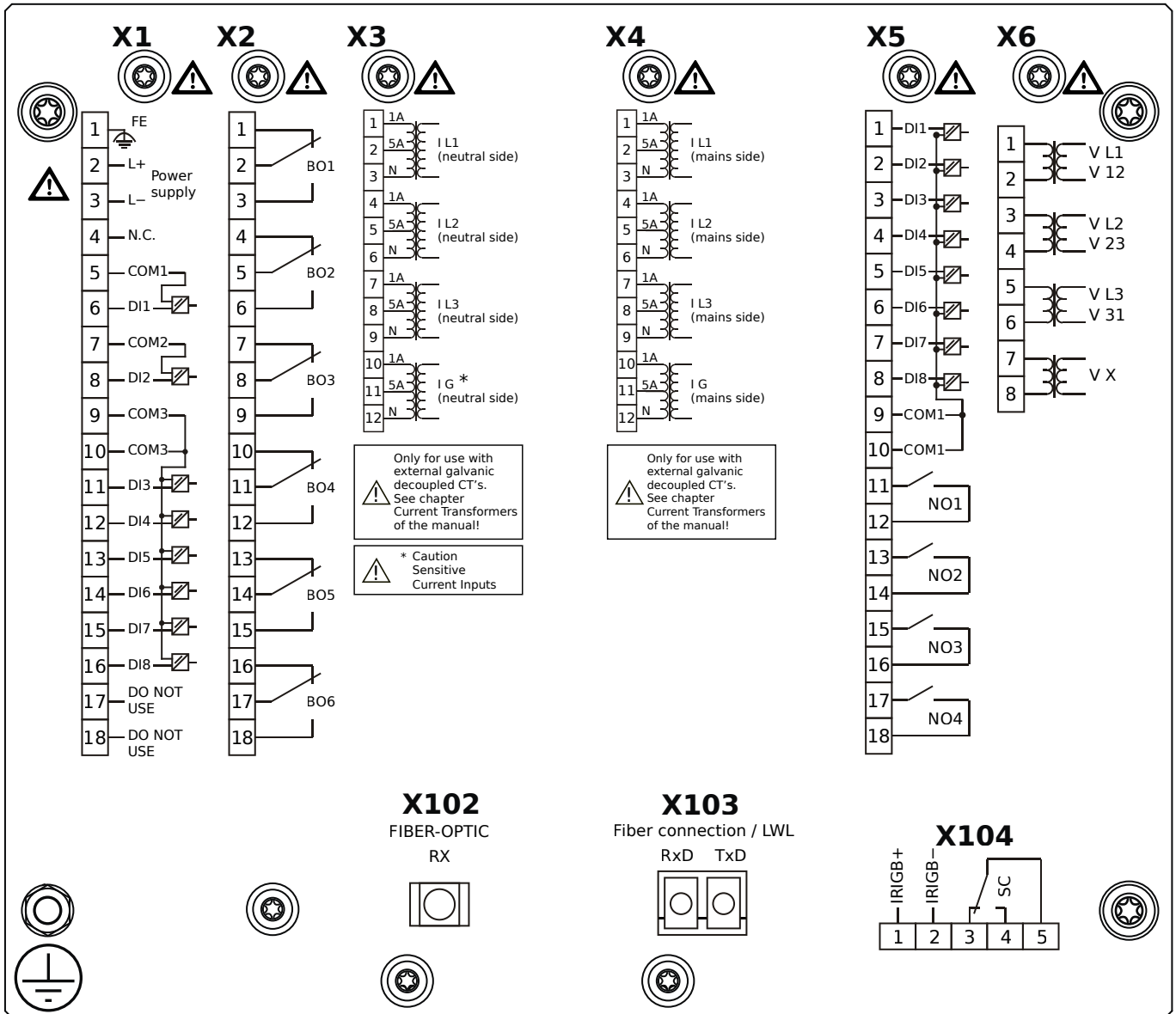

Housing B2, large display, 19" rack mounting

- X1** – DI8-X1: Wide-range power supply unit, incl. 2 non-grouped digital inputs and 6 grouped digital inputs
- X2** – OR6: Assembly Group with 6 Output Relays (Changeover / Form C)
- X3** – TIs: Standard phase current measuring card and sensitive ground current measuring (neutral side of the diff. prot.)
- X4** – TI: Standard current measuring card (for the mains side of the differential protection)
- X5** – DI8-OR4: Assembly Group with 8 Digital Inputs and 4 Output Relays (NO / Form A)
- X6** – TU: Card with 4 voltage transformer measuring inputs (0 ... 800 VAC, under UL: 0 ... 600 VAC)
- X102** – Universal Resistance-Temperature Detector (URTD) input, Fiber optics interface, Versatile Link
- X103** – IEC 61850 / Modbus TCP / DNP3.0 TCP/UDP, Fiber optics interface, LC Connector
- X104** – IRIG-B00X, incl. System Contact (Supervision Contact)

MCDGV4-2A1BKB

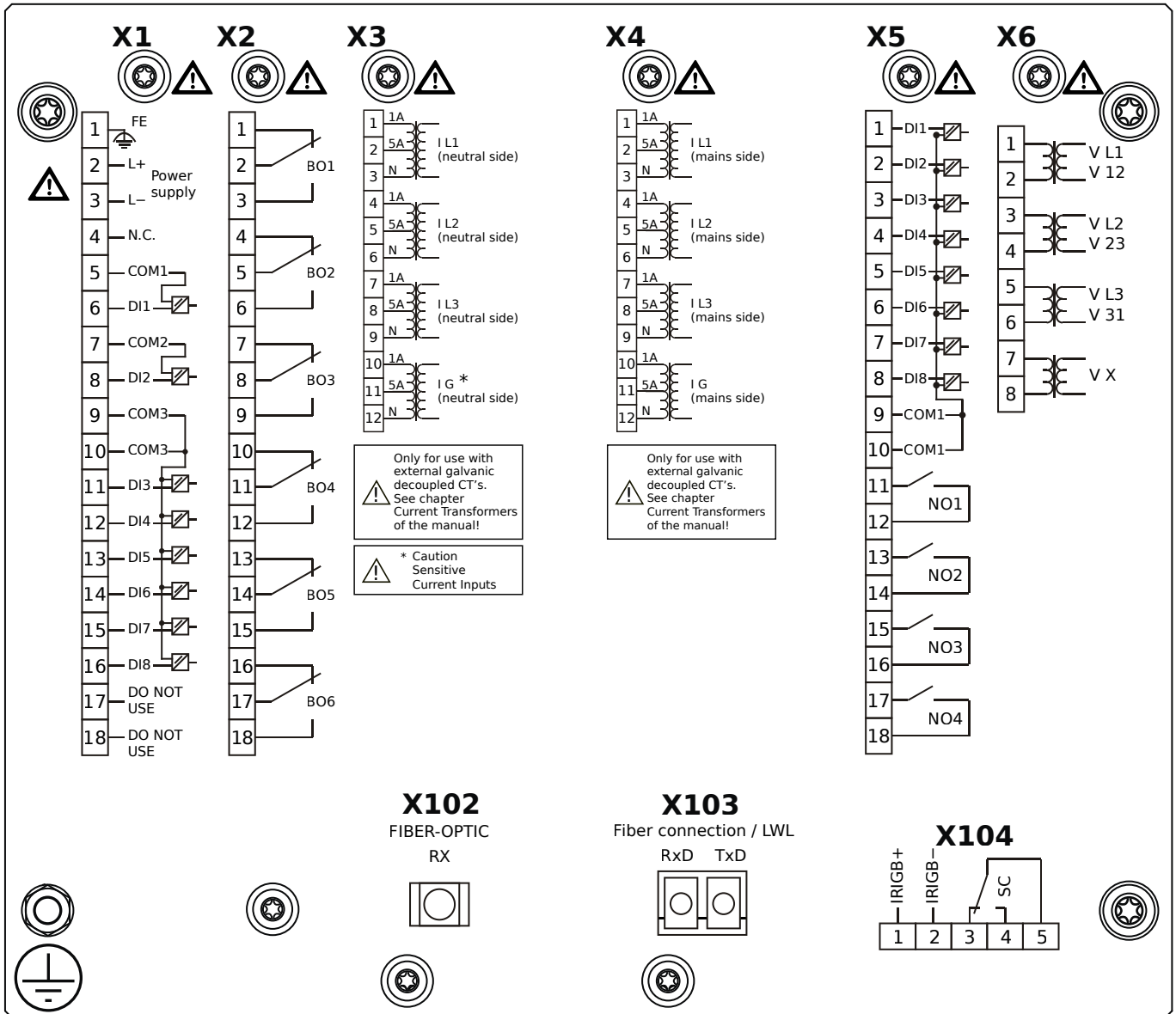

Housing B2, large display, 19" rack mounting

+ Conformal Coating (for installations in harsh environment)

- X1** – DI8-X1: Wide-range power supply unit, incl. 2 non-grouped digital inputs and 6 grouped digital inputs
- X2** – OR6: Assembly Group with 6 Output Relays (Changeover / Form C)
- X3** – TIs: Standard phase current measuring card and sensitive ground current measuring (neutral side of the diff. prot.)
- X4** – TI: Standard current measuring card (for the mains side of the differential protection)
- X5** – DI8-OR4: Assembly Group with 8 Digital Inputs and 4 Output Relays (NO / Form A)
- X6** – TU: Card with 4 voltage transformer measuring inputs (0 ... 800 VAC, under UL: 0 ... 600 VAC)
- X102** – Universal Resistance-Temperature Detector (URTD) input, Fiber optics interface, Versatile Link
- X103** – IEC 61850 / Modbus TCP / DNP3.0 TCP/UDP, Fiber optics interface, LC Connector
- X104** – IRIG-B00X, incl. System Contact (Supervision Contact)

MCDGV4-2A1BLA

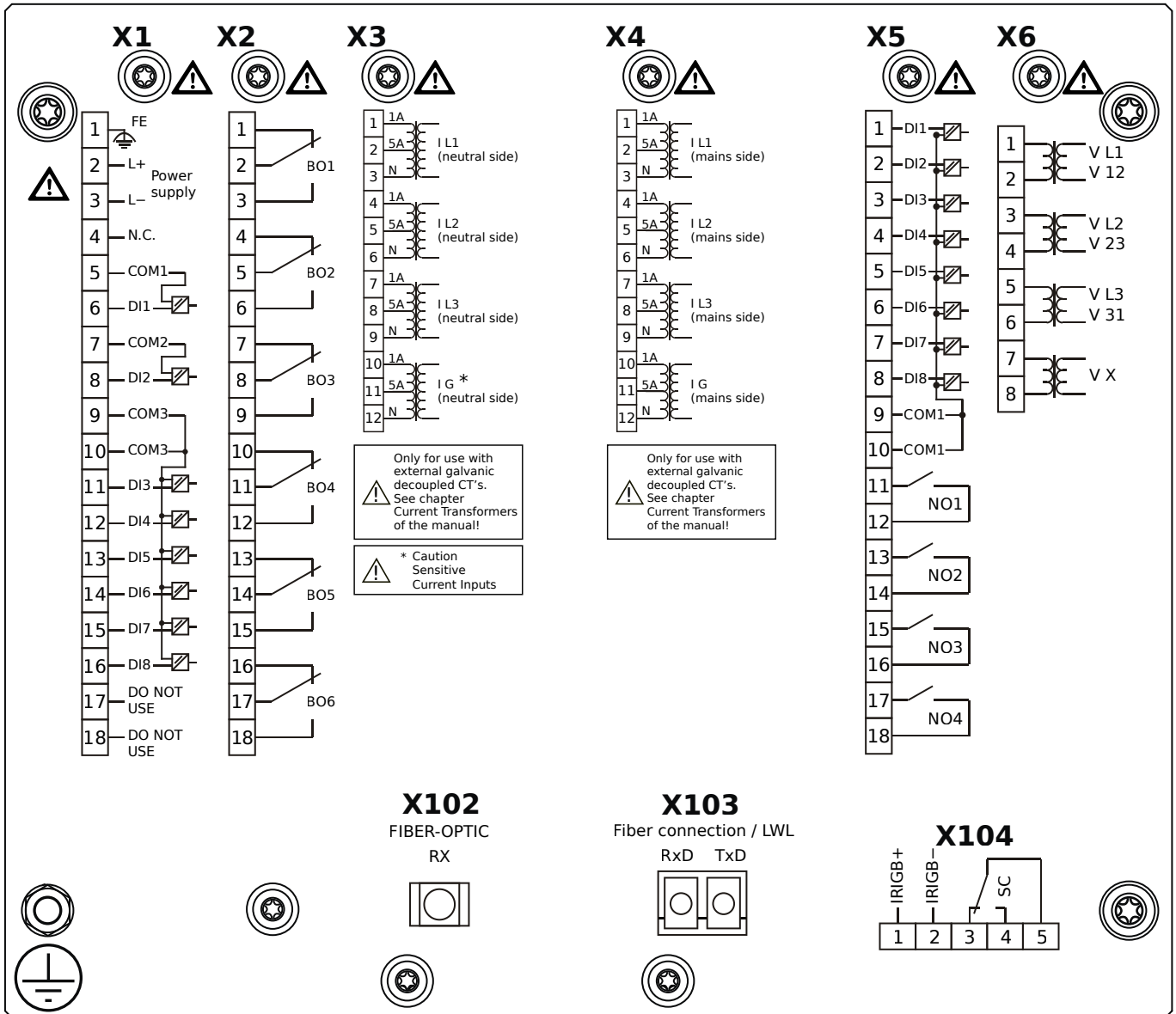

Housing B2, large display, 19" rack mounting

- X1** – DI8-X1: Wide-range power supply unit, incl. 2 non-grouped digital inputs and 6 grouped digital inputs
- X2** – OR6: Assembly Group with 6 Output Relays (Changeover / Form C)
- X3** – TIs: Standard phase current measuring card and sensitive ground current measuring (neutral side of the diff. prot.)
- X4** – TI: Standard current measuring card (for the mains side of the differential protection)
- X5** – DI8-OR4: Assembly Group with 8 Digital Inputs and 4 Output Relays (NO / Form A)
- X6** – TU: Card with 4 voltage transformer measuring inputs (0 ... 800 VAC, under UL: 0 ... 600 VAC)
- X102** – Universal Resistance-Temperature Detector (URTD) input, Fiber optics interface, Versatile Link
- X103** – Modbus TCP / DNP3.0 TCP/UDP, Fiber optics interface, LC Connector
- X104** – IRIG-B00X, incl. System Contact (Supervision Contact)

MCDGV4-2A1BLB

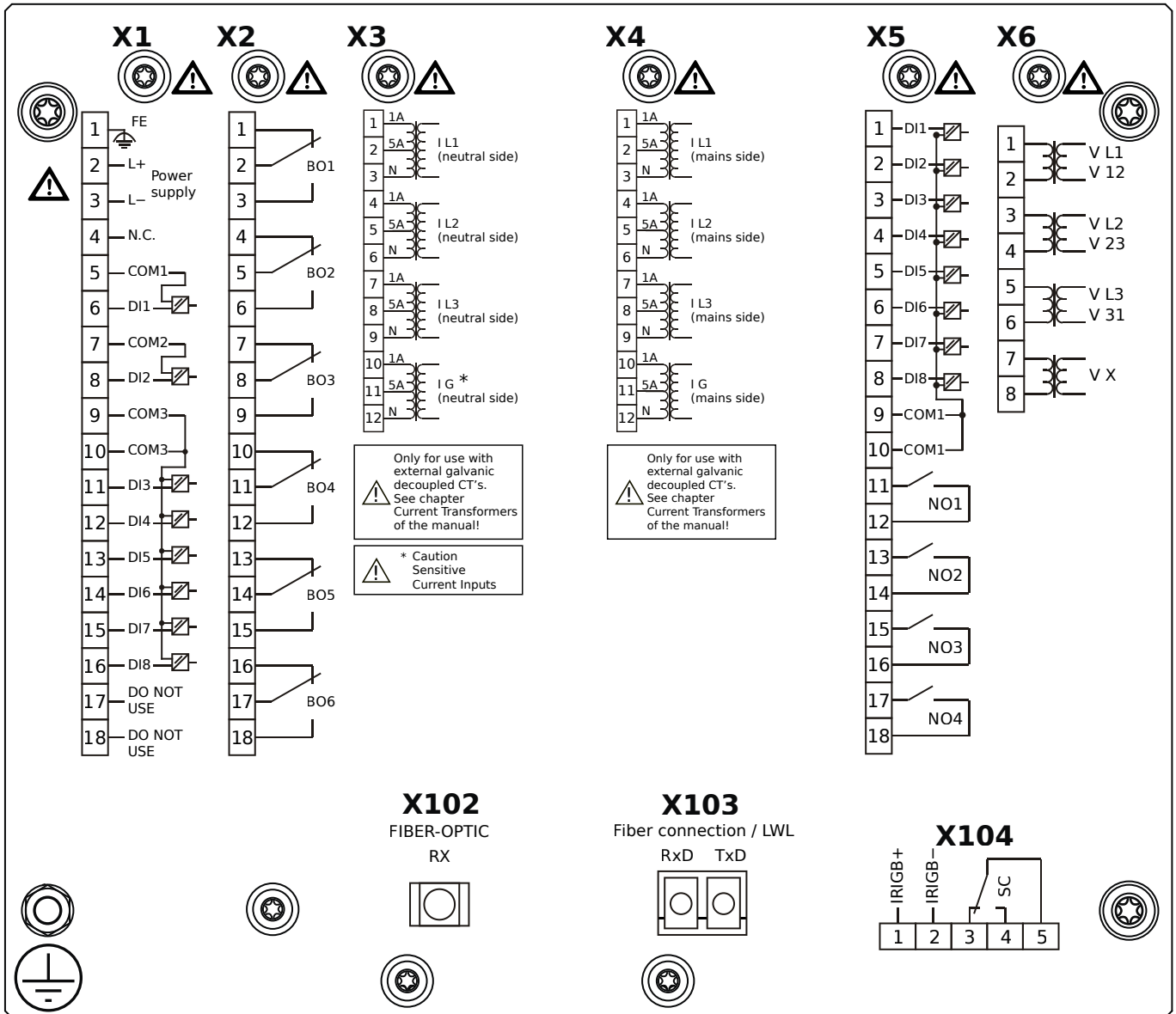

Housing B2, large display, 19" rack mounting

+ Conformal Coating (for installations in harsh environment)

- X1** – DI8-X1: Wide-range power supply unit, incl. 2 non-grouped digital inputs and 6 grouped digital inputs
- X2** – OR6: Assembly Group with 6 Output Relays (Changeover / Form C)
- X3** – TIs: Standard phase current measuring card and sensitive ground current measuring (neutral side of the diff. prot.)
- X4** – TI: Standard current measuring card (for the mains side of the differential protection)
- X5** – DI8-OR4: Assembly Group with 8 Digital Inputs and 4 Output Relays (NO / Form A)
- X6** – TU: Card with 4 voltage transformer measuring inputs (0 ... 800 VAC, under UL: 0 ... 600 VAC)
- X102** – Universal Resistance-Temperature Detector (URTD) input, Fiber optics interface, Versatile Link
- X103** – Modbus TCP / DNP3.0 TCP/UDP, Fiber optics interface, LC Connector
- X104** – IRIG-B00X, incl. System Contact (Supervision Contact)

MCDGV4-2A1BTA

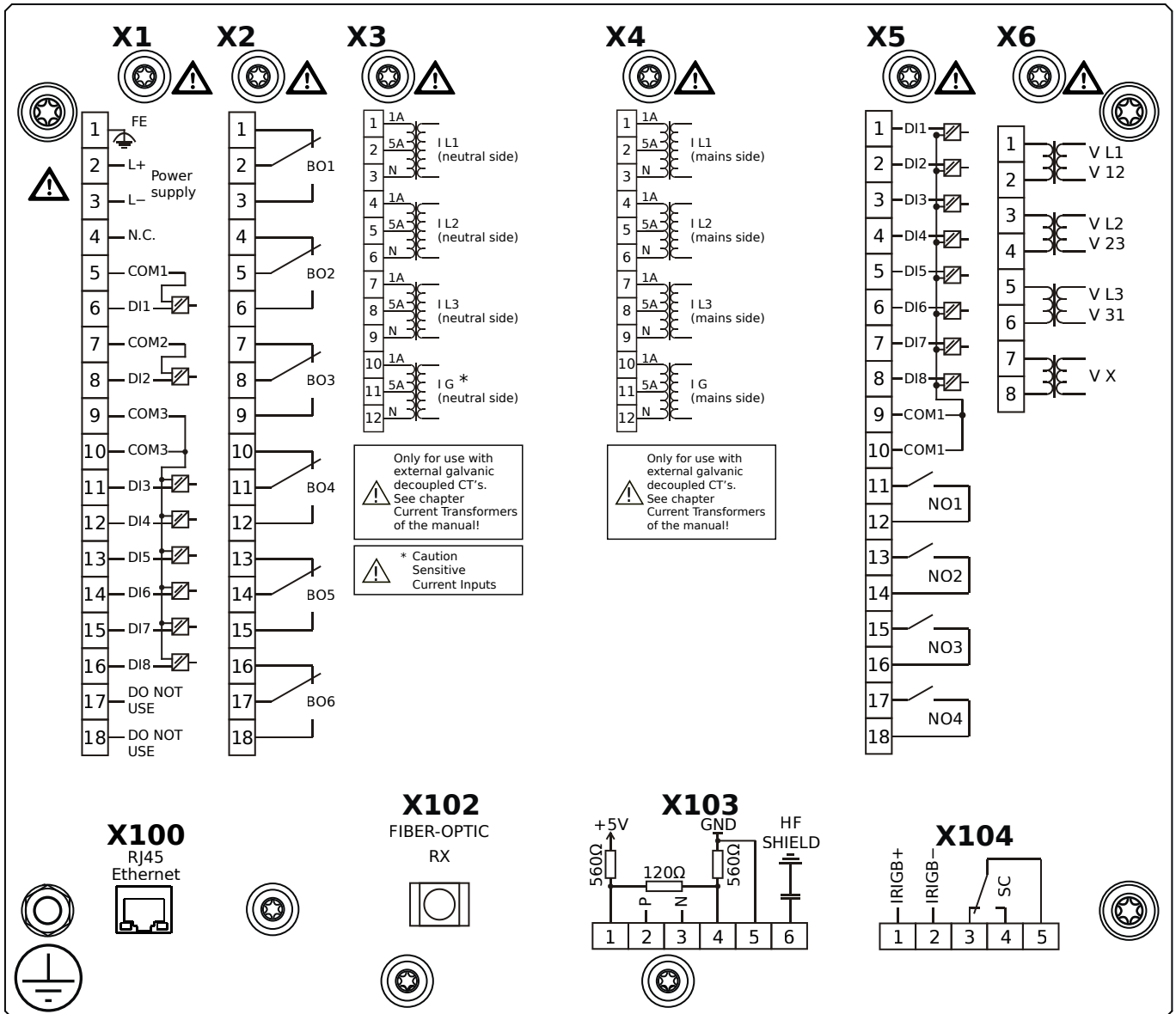

Housing B2, large display, 19" rack mounting

- X1** – DI8-X1: Wide-range power supply unit, incl. 2 non-grouped digital inputs and 6 grouped digital inputs
- X2** – OR6: Assembly Group with 6 Output Relays (Changeover / Form C)
- X3** – TIs: Standard phase current measuring card and sensitive ground current measuring (neutral side of the diff. prot.)
- X4** – TI: Standard current measuring card (for the mains side of the differential protection)
- X5** – DI8-OR4: Assembly Group with 8 Digital Inputs and 4 Output Relays (NO / Form A)
- X6** – TU: Card with 4 voltage transformer measuring inputs (0 ... 800 VAC, under UL: 0 ... 600 VAC)
- X100** – IEC 61850 / Modbus TCP / DNP3.0 TCP/UDP, Ethernet interface, 100 Mbit/s, RJ45 (BASE100-FX)
- X102** – Universal Resistance-Temperature Detector (URTD) input, Fiber optics interface, Versatile Link
- X103** – IEC 60870-5-103 / Modbus RTU / DNP3.0 RTU, RS485, Terminals
- X104** – I/RGB-B00X, incl. System Contact (Supervision Contact)

MCDGV4-2A1BTB

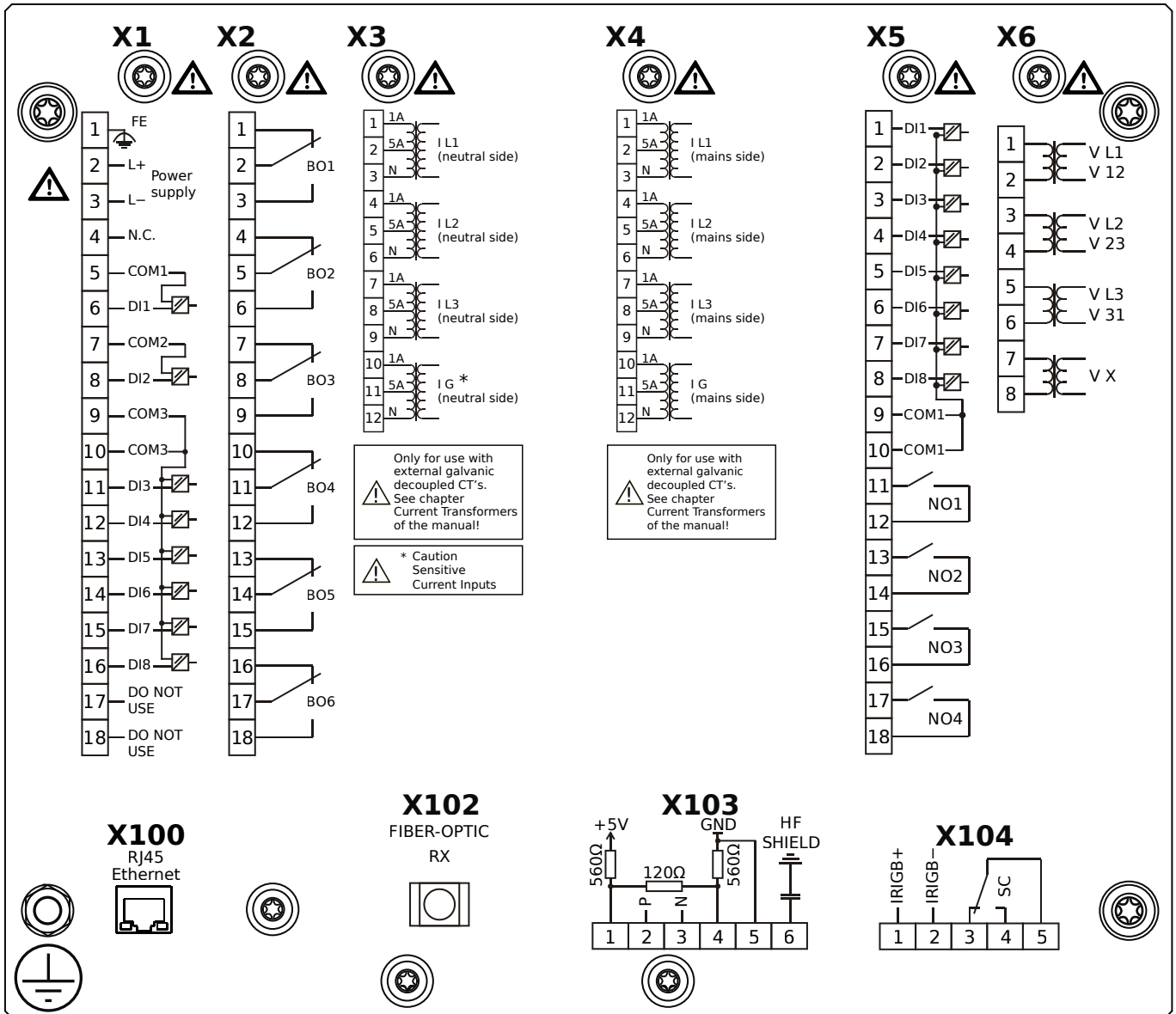

Housing B2, large display, 19" rack mounting

+ Conformal Coating (for installations in harsh environment)

- X1** – DI8-X1: Wide-range power supply unit, incl. 2 non-grouped digital inputs and 6 grouped digital inputs
- X2** – OR6: Assembly Group with 6 Output Relays (Changeover / Form C)
- X3** – TIs: Standard phase current measuring card and sensitive ground current measuring (neutral side of the diff. prot.)
- X4** – TI: Standard current measuring card (for the mains side of the differential protection)
- X5** – DI8-OR4: Assembly Group with 8 Digital Inputs and 4 Output Relays (NO / Form A)
- X6** – TU: Card with 4 voltage transformer measuring inputs (0 ... 800 VAC, under UL: 0 ... 600 VAC)
- X100** – IEC 61850 / Modbus TCP / DNP3.0 TCP/UDP, Ethernet interface, 100 Mbit/s, RJ45 (BASE100-FX)
- X102** – Universal Resistance-Temperature Detector (URTD) input, Fiber optics interface, Versatile Link
- X103** – IEC 60870-5-103 / Modbus RTU / DNP3.0 RTU, RS485, Terminals
- X104** – IRIG-B00X, incl. System Contact (Supervision Contact)

MCDGV4-2B0AAA

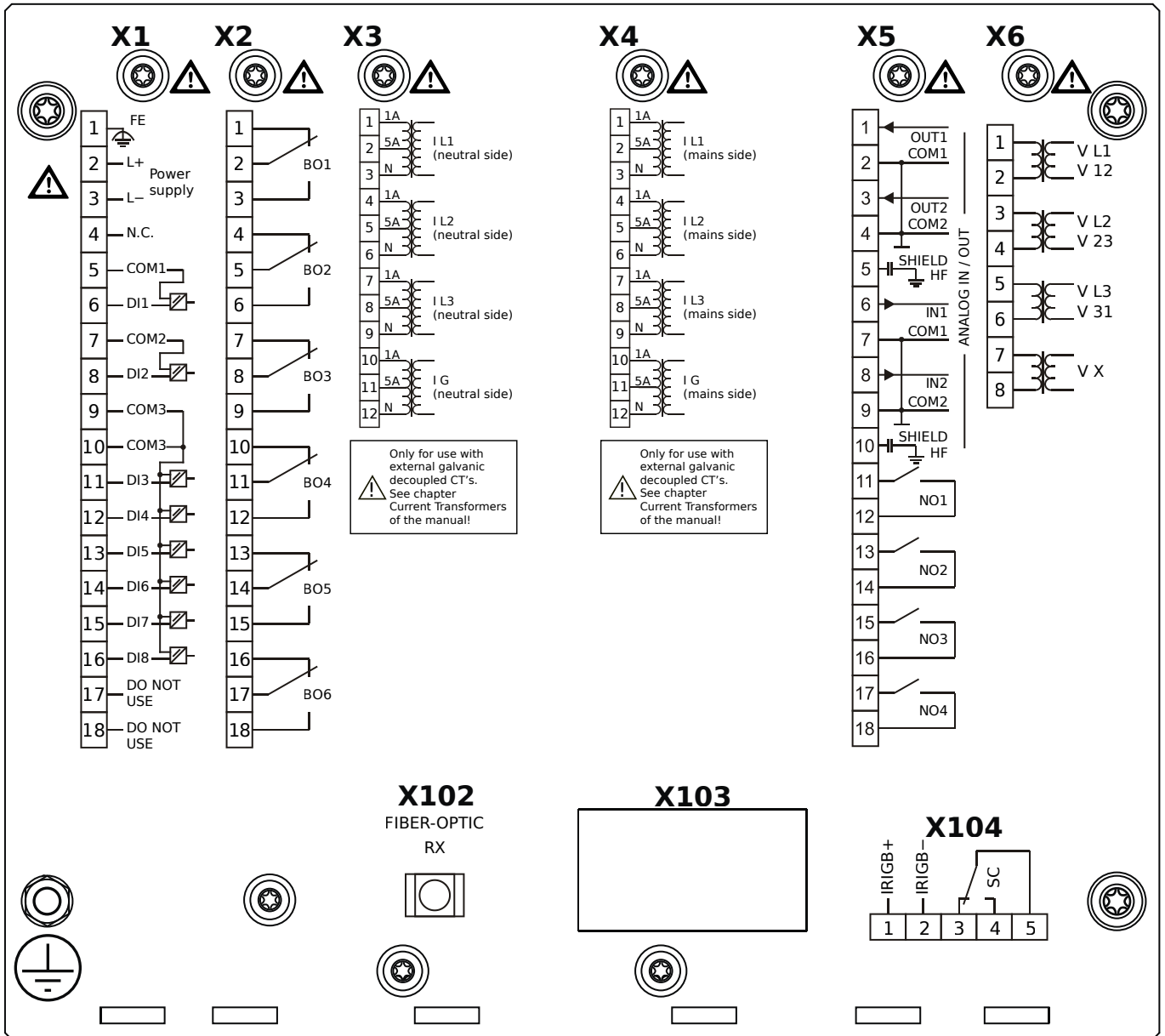

Housing B2, large display, door mounting

- X1** – DI8-X1: Wide-range power supply unit, incl. 2 non-grouped digital inputs and 6 grouped digital inputs
- X2** – OR6: Assembly Group with 6 Output Relays (Changeover / Form C)
- X3** – TI: Standard current measuring card (for the neutral side of the differential protection)
- X4** – TI: Standard current measuring card (for the mains side of the differential protection)
- X5** – AnIO2-OR4: Assembly Group with 2 Analog Inputs, 2 Analog Outputs and 4 Output Relays
- X6** – TU: Card with 4 voltage transformer measuring inputs (0 ... 800 VAC, under UL: 0 ... 600 VAC)
- X102** – Universal Resistance-Temperature Detector (URTD) input, Fiber optics interface, Versatile Link
- X104** – IRIG-B00X, incl. System Contact (Supervision Contact)

MCDGV4-2B0AAB

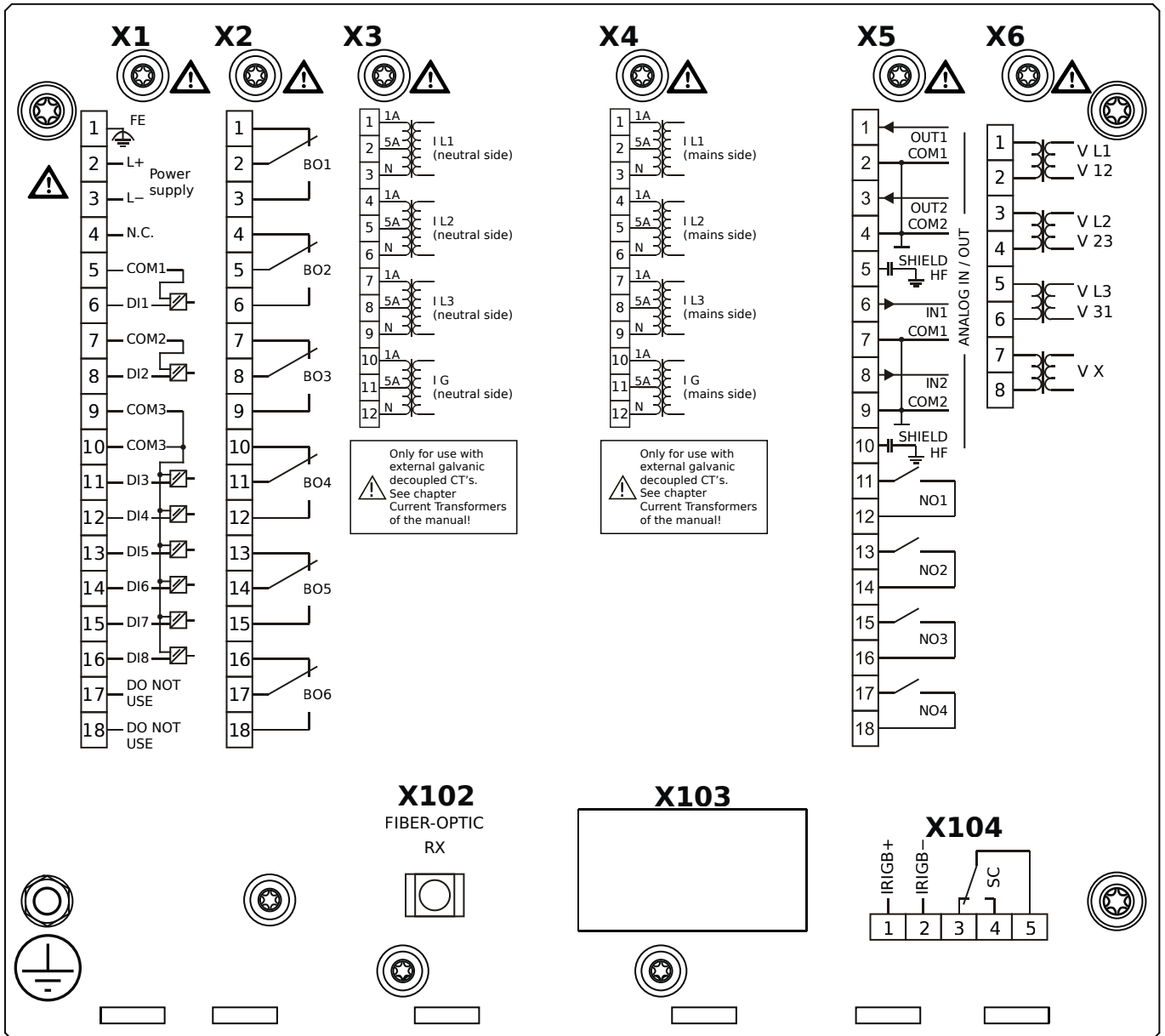

Housing B2, large display, door mounting

- + Conformal Coating (for installations in harsh environment)

- X1** – DI8-X1: Wide-range power supply unit, incl. 2 non-grouped digital inputs and 6 grouped digital inputs
- X2** – OR6: Assembly Group with 6 Output Relays (Changeover / Form C)
- X3** – TI: Standard current measuring card (for the neutral side of the differential protection)
- X4** – TI: Standard current measuring card (for the mains side of the differential protection)
- X5** – AnIO2-OR4: Assembly Group with 2 Analog Inputs, 2 Analog Outputs and 4 Output Relays
- X6** – TU: Card with 4 voltage transformer measuring inputs (0 ... 800 VAC, under UL: 0 ... 600 VAC)
- X102** – Universal Resistance-Temperature Detector (URTD) input, Fiber optics interface, Versatile Link
- X104** – IRIG-B00X, incl. System Contact (Supervision Contact)

MCDGV4-2B0ABA

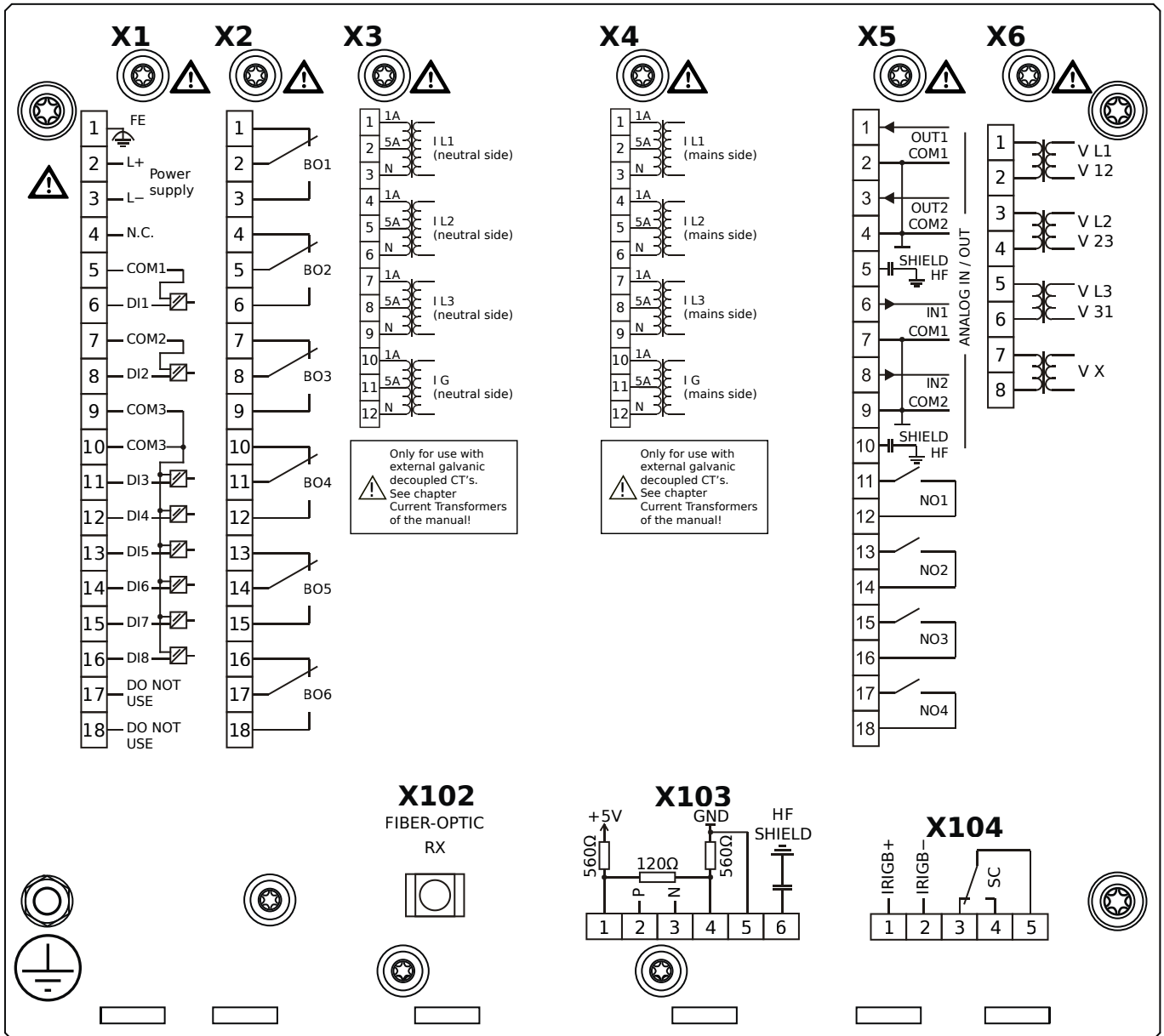

Housing B2, large display, door mounting

- X1** – DI8-X1: Wide-range power supply unit, incl. 2 non-grouped digital inputs and 6 grouped digital inputs
- X2** – OR6: Assembly Group with 6 Output Relays (Changeover / Form C)
- X3** – TI: Standard current measuring card (for the neutral side of the differential protection)
- X4** – TI: Standard current measuring card (for the mains side of the differential protection)
- X5** – AnIO2-OR4: Assembly Group with 2 Analog Inputs, 2 Analog Outputs and 4 Output Relays
- X6** – TU: Card with 4 voltage transformer measuring inputs (0 ... 800 VAC, under UL: 0 ... 600 VAC)
- X102** – Universal Resistance-Temperature Detector (URTD) input, Fiber optics interface, Versatile Link
- X103** – Modbus RTU / IEC 60870-5-103 / DNP3.0 RTU, RS485, Terminals
- X104** – IRIG-B00X, incl. System Contact (Supervision Contact)

MCDGV4-2B0ABB

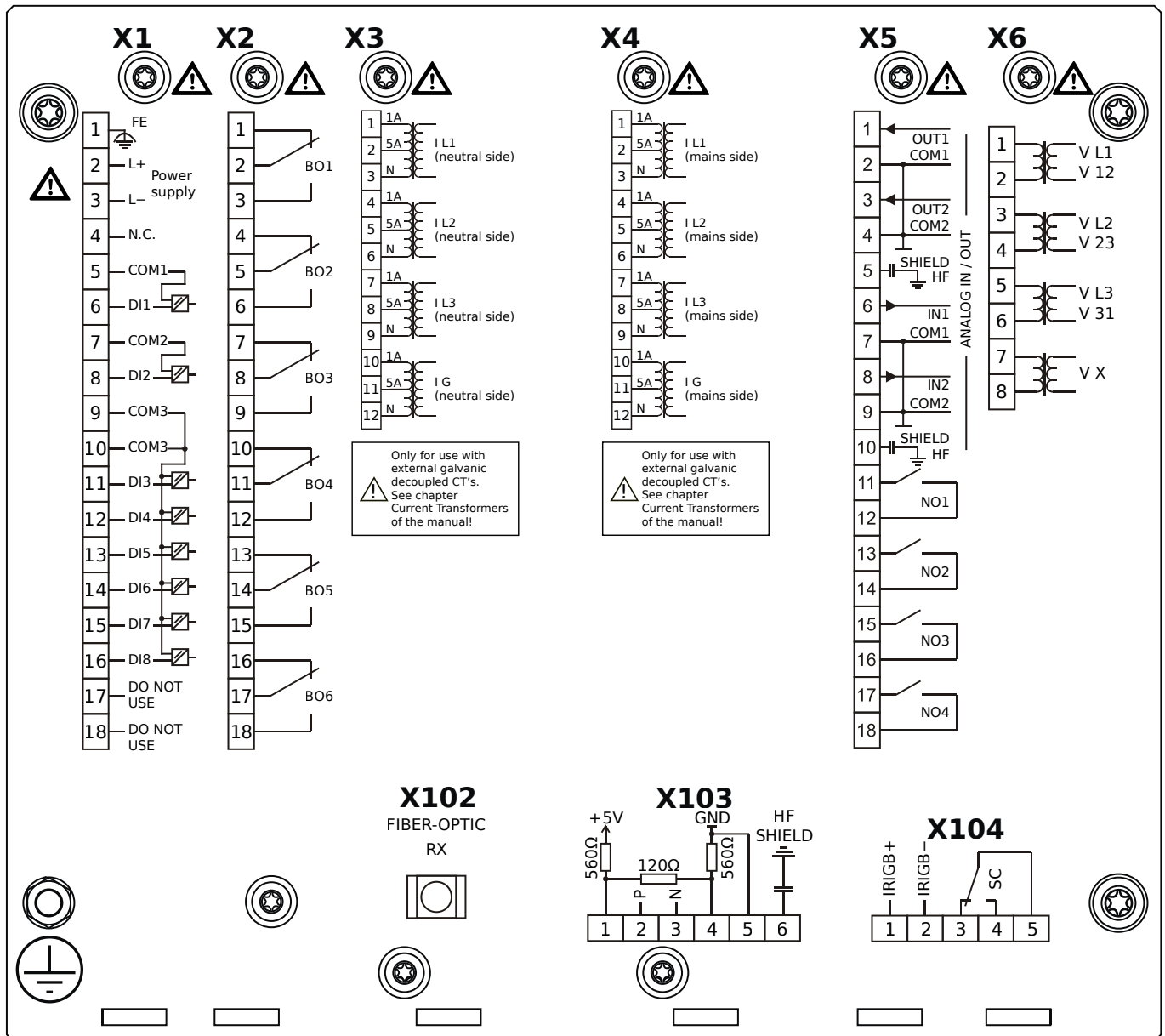

Housing B2, large display, door mounting

+ Conformal Coating (for installations in harsh environment)

- X1** – DI8-X1: Wide-range power supply unit, incl. 2 non-grouped digital inputs and 6 grouped digital inputs
- X2** – OR6: Assembly Group with 6 Output Relays (Changeover / Form C)
- X3** – TI: Standard current measuring card (for the neutral side of the differential protection)
- X4** – TI: Standard current measuring card (for the mains side of the differential protection)
- X5** – AnIO2-OR4: Assembly Group with 2 Analog Inputs, 2 Analog Outputs and 4 Output Relays
- X6** – TU: Card with 4 voltage transformer measuring inputs (0 ... 800 VAC, under UL: 0 ... 600 VAC)
- X102** – Universal Resistance-Temperature Detector (URTD) input, Fiber optics interface, Versatile Link
- X103** – Modbus RTU / IEC 60870-5-103 / DNP3.0 RTU, RS485, Terminals
- X104** – IRIG-B00X, incl. System Contact (Supervision Contact)

MCDGV4-2B0ACA

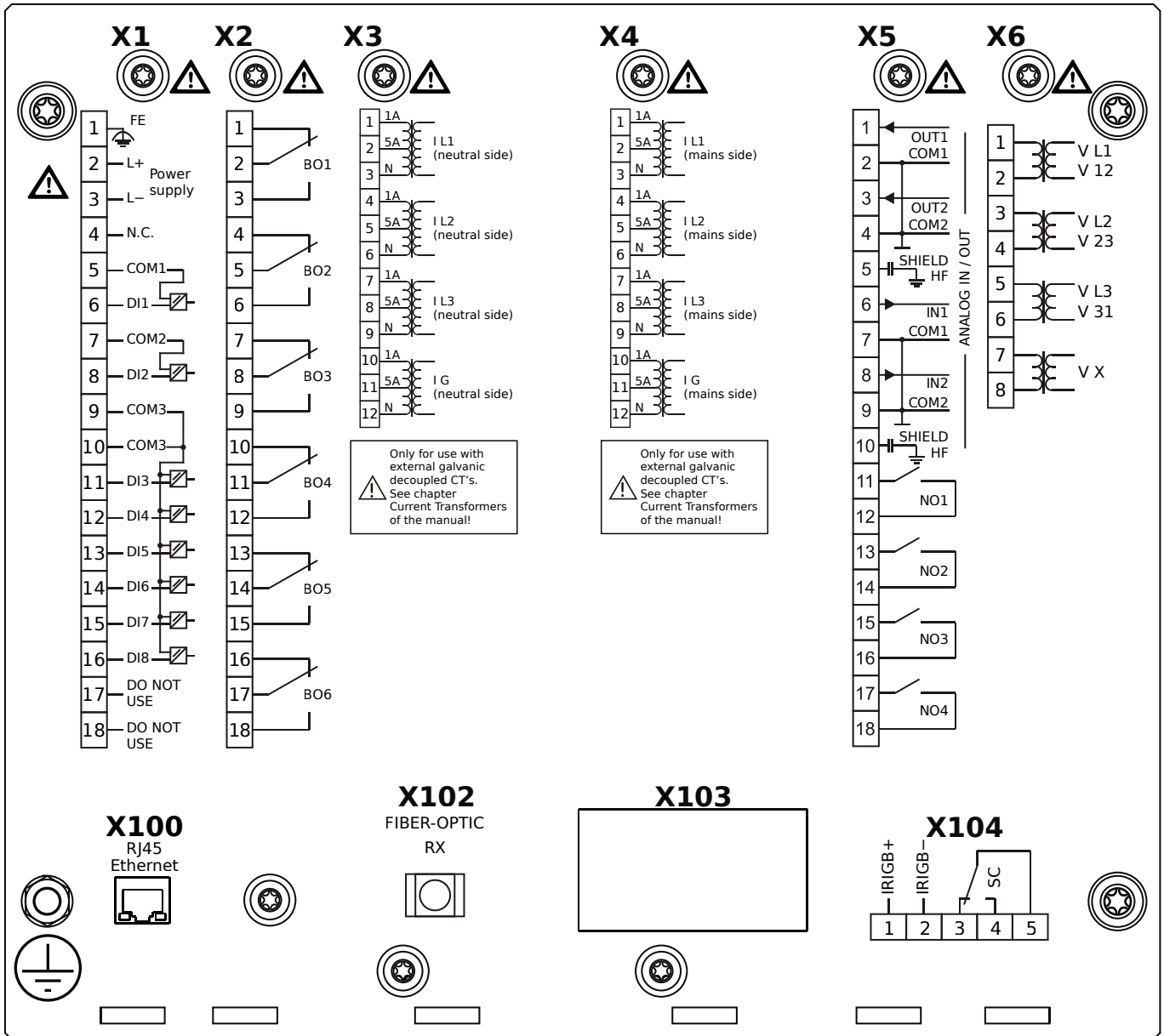

Housing B2, large display, door mounting

- X1** – DI8-X1: Wide-range power supply unit, incl. 2 non-grouped digital inputs and 6 grouped digital inputs
- X2** – OR6: Assembly Group with 6 Output Relays (Changeover / Form C)
- X3** – TI: Standard current measuring card (for the neutral side of the differential protection)
- X4** – TI: Standard current measuring card (for the mains side of the differential protection)
- X5** – AnIO2-OR4: Assembly Group with 2 Analog Inputs, 2 Analog Outputs and 4 Output Relays
- X6** – TU: Card with 4 voltage transformer measuring inputs (0 ... 800 VAC, under UL: 0 ... 600 VAC)
- X100** – Modbus TCP / DNP3.0 TCP/UDP, Ethernet interface, 100 Mbit/s, RJ45 (BASE100-FX)
- X102** – Universal Resistance-Temperature Detector (URTD) input, Fiber optics interface, Versatile Link
- X104** – IRIG-B00X, incl. System Contact (Supervision Contact)

MCDGV4-2B0ACB

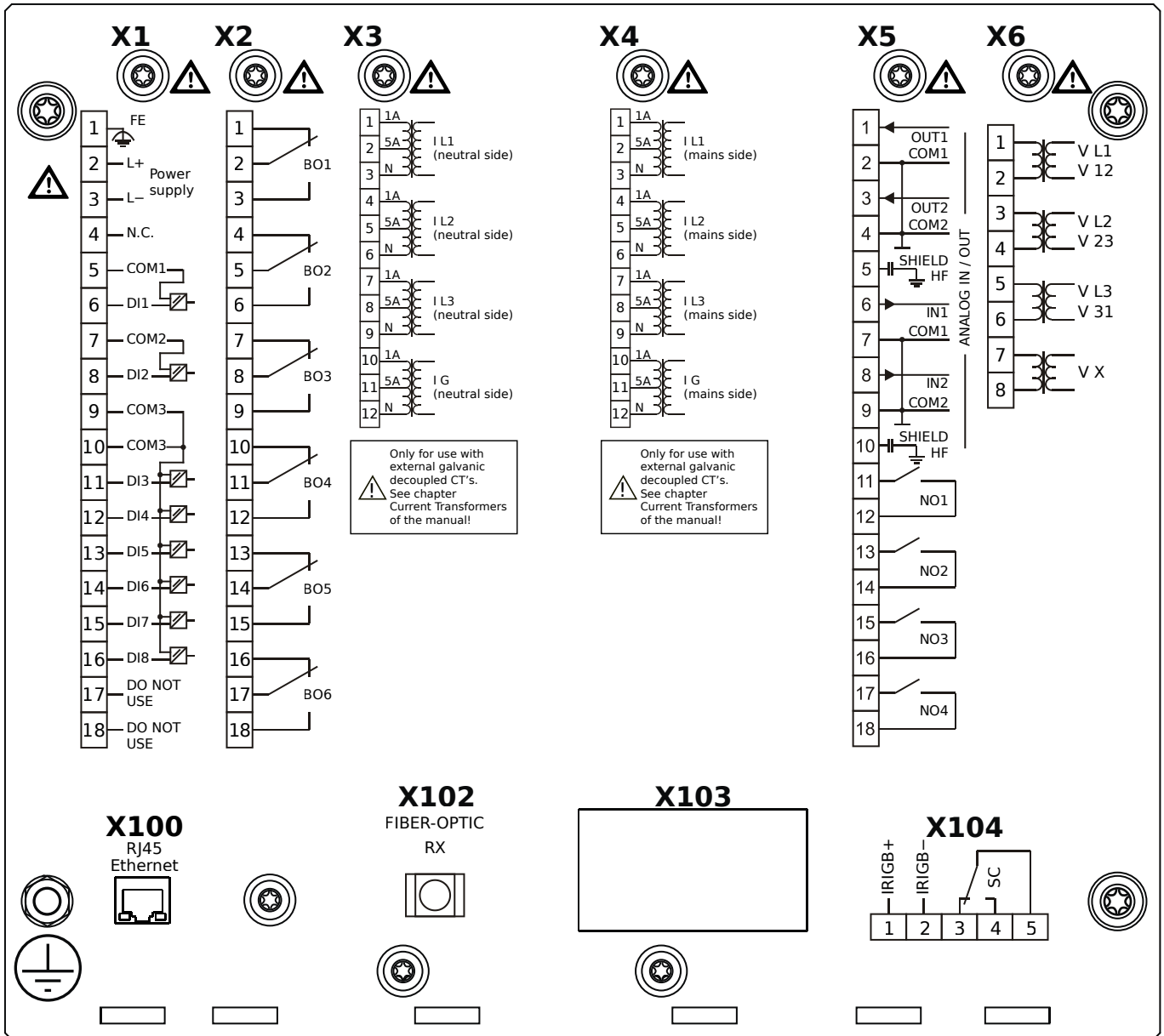

Housing B2, large display, door mounting

+ Conformal Coating (for installations in harsh environment)

- X1** – DI8-X1: Wide-range power supply unit, incl. 2 non-grouped digital inputs and 6 grouped digital inputs
- X2** – OR6: Assembly Group with 6 Output Relays (Changeover / Form C)
- X3** – TI: Standard current measuring card (for the neutral side of the differential protection)
- X4** – TI: Standard current measuring card (for the mains side of the differential protection)
- X5** – AnIO2-OR4: Assembly Group with 2 Analog Inputs, 2 Analog Outputs and 4 Output Relays
- X6** – TU: Card with 4 voltage transformer measuring inputs (0 ... 800 VAC, under UL: 0 ... 600 VAC)
- X100** – Modbus TCP / DNP3.0 TCP/UDP, Ethernet interface, 100 Mbit/s, RJ45 (BASE100-FX)
- X102** – Universal Resistance-Temperature Detector (URTD) input, Fiber optics interface, Versatile Link
- X104** – IRIG-B00X, incl. System Contact (Supervision Contact)

MCDGV4-2B0ADA

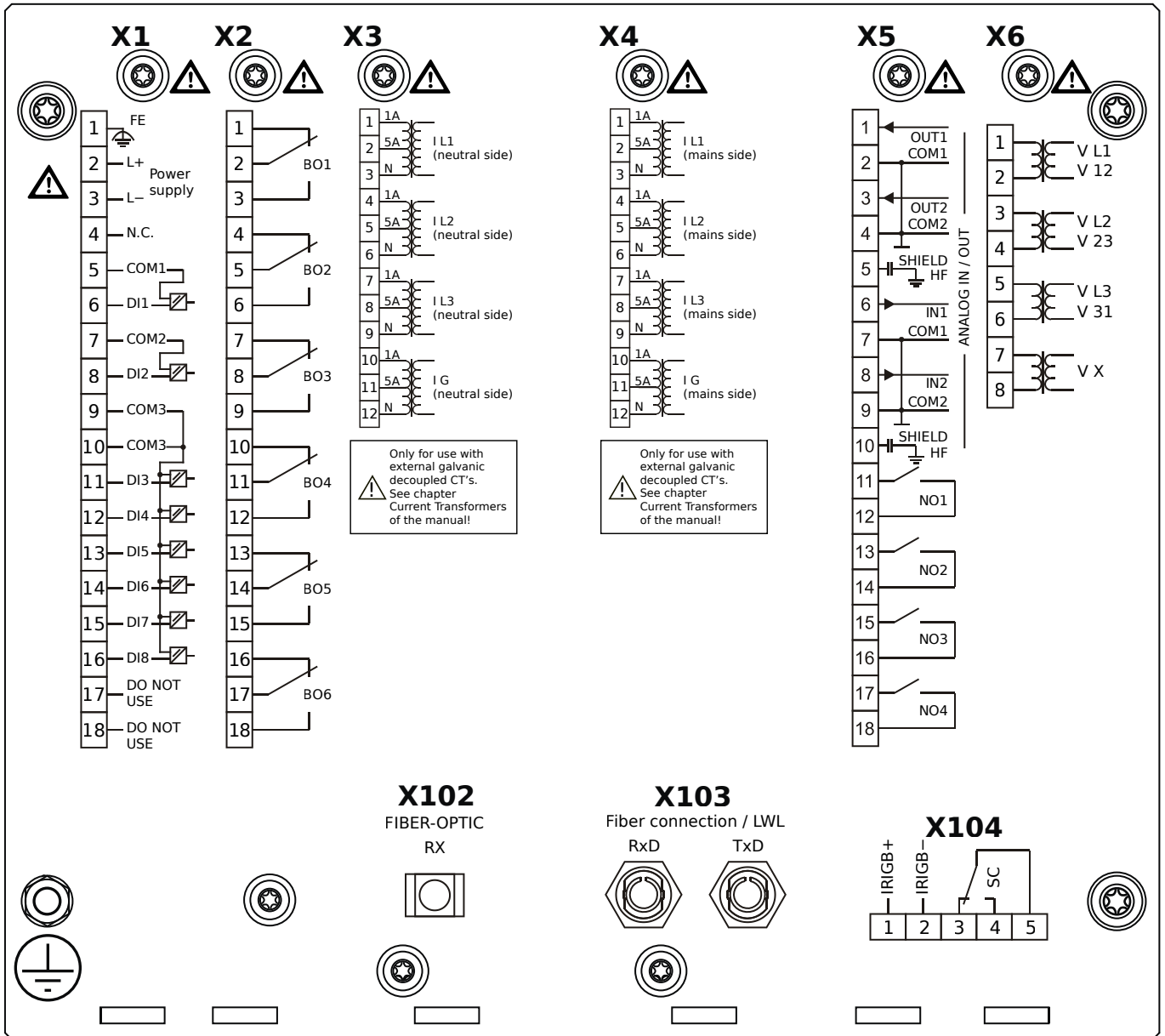

Housing B2, large display, door mounting

- X1** – DI8-X1: Wide-range power supply unit, incl. 2 non-grouped digital inputs and 6 grouped digital inputs
- X2** – OR6: Assembly Group with 6 Output Relays (Changeover / Form C)
- X3** – TI: Standard current measuring card (for the neutral side of the differential protection)
- X4** – TI: Standard current measuring card (for the mains side of the differential protection)
- X5** – AnIO2-OR4: Assembly Group with 2 Analog Inputs, 2 Analog Outputs and 4 Output Relays
- X6** – TU: Card with 4 voltage transformer measuring inputs (0 ... 800 VAC, under UL: 0 ... 600 VAC)
- X102** – Universal Resistance-Temperature Detector (URTD) input, Fiber optics interface, Versatile Link
- X103** – Profibus-DP, Fiber optics interface, ST Connector
- X104** – IRIG-B00X, incl. System Contact (Supervision Contact)

MCDGV4-2B0ADB

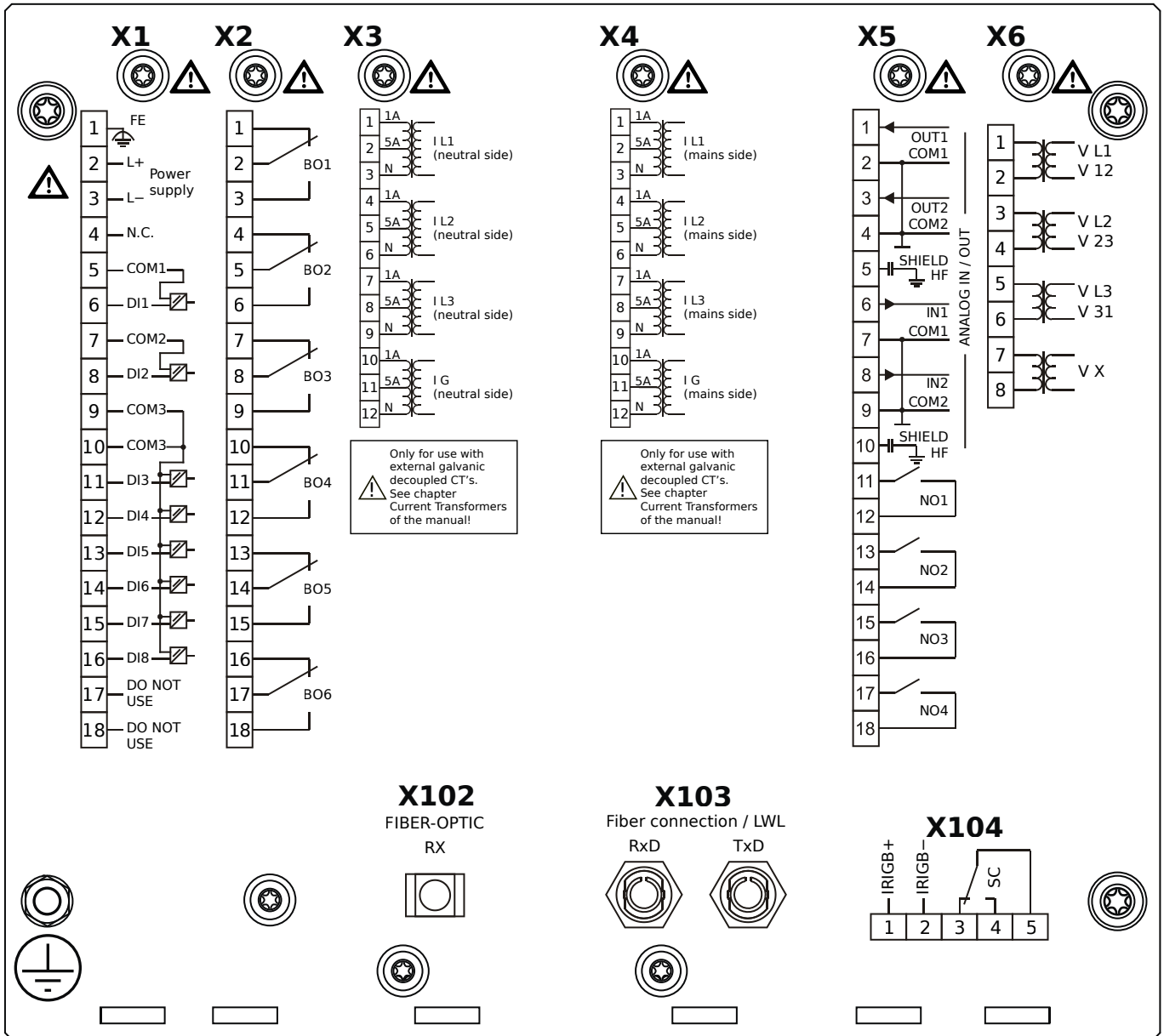

Housing B2, large display, door mounting

- + Conformal Coating (for installations in harsh environment)

- X1** – DI8-X1: Wide-range power supply unit, incl. 2 non-grouped digital inputs and 6 grouped digital inputs
- X2** – OR6: Assembly Group with 6 Output Relays (Changeover / Form C)
- X3** – TI: Standard current measuring card (for the neutral side of the differential protection)
- X4** – TI: Standard current measuring card (for the mains side of the differential protection)
- X5** – AnIO2-OR4: Assembly Group with 2 Analog Inputs, 2 Analog Outputs and 4 Output Relays
- X6** – TU: Card with 4 voltage transformer measuring inputs (0 ... 800 VAC, under UL: 0 ... 600 VAC)
- X102** – Universal Resistance-Temperature Detector (URTD) input, Fiber optics interface, Versatile Link
- X103** – Profibus-DP, Fiber optics interface, ST Connector
- X104** – IRIG-B00X, incl. System Contact (Supervision Contact)

MCDGV4-2B0AEA

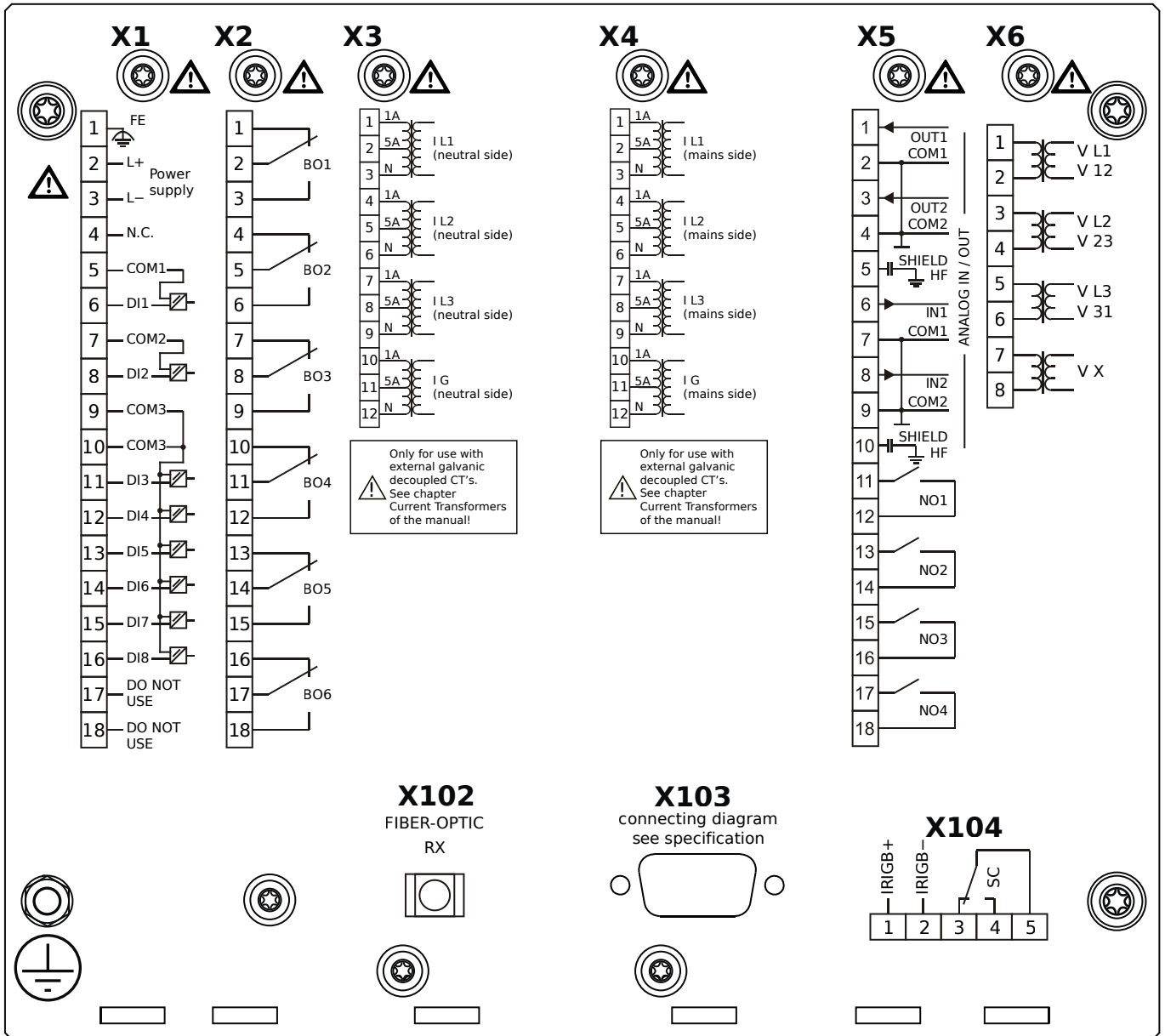

Housing B2, large display, door mounting

- X1** – DI8-X1: Wide-range power supply unit, incl. 2 non-grouped digital inputs and 6 grouped digital inputs
- X2** – OR6: Assembly Group with 6 Output Relays (Changeover / Form C)
- X3** – TI: Standard current measuring card (for the neutral side of the differential protection)
- X4** – TI: Standard current measuring card (for the mains side of the differential protection)
- X5** – AnIO2-OR4: Assembly Group with 2 Analog Inputs, 2 Analog Outputs and 4 Output Relays
- X6** – TU: Card with 4 voltage transformer measuring inputs (0 ... 800 VAC, under UL: 0 ... 600 VAC)
- X102** – Universal Resistance-Temperature Detector (URTD) input, Fiber optics interface, Versatile Link
- X103** – Profibus-DP, RS485, D-SUB
- X104** – IRIG-B00X, incl. System Contact (Supervision Contact)

MCDGV4-2B0AEB

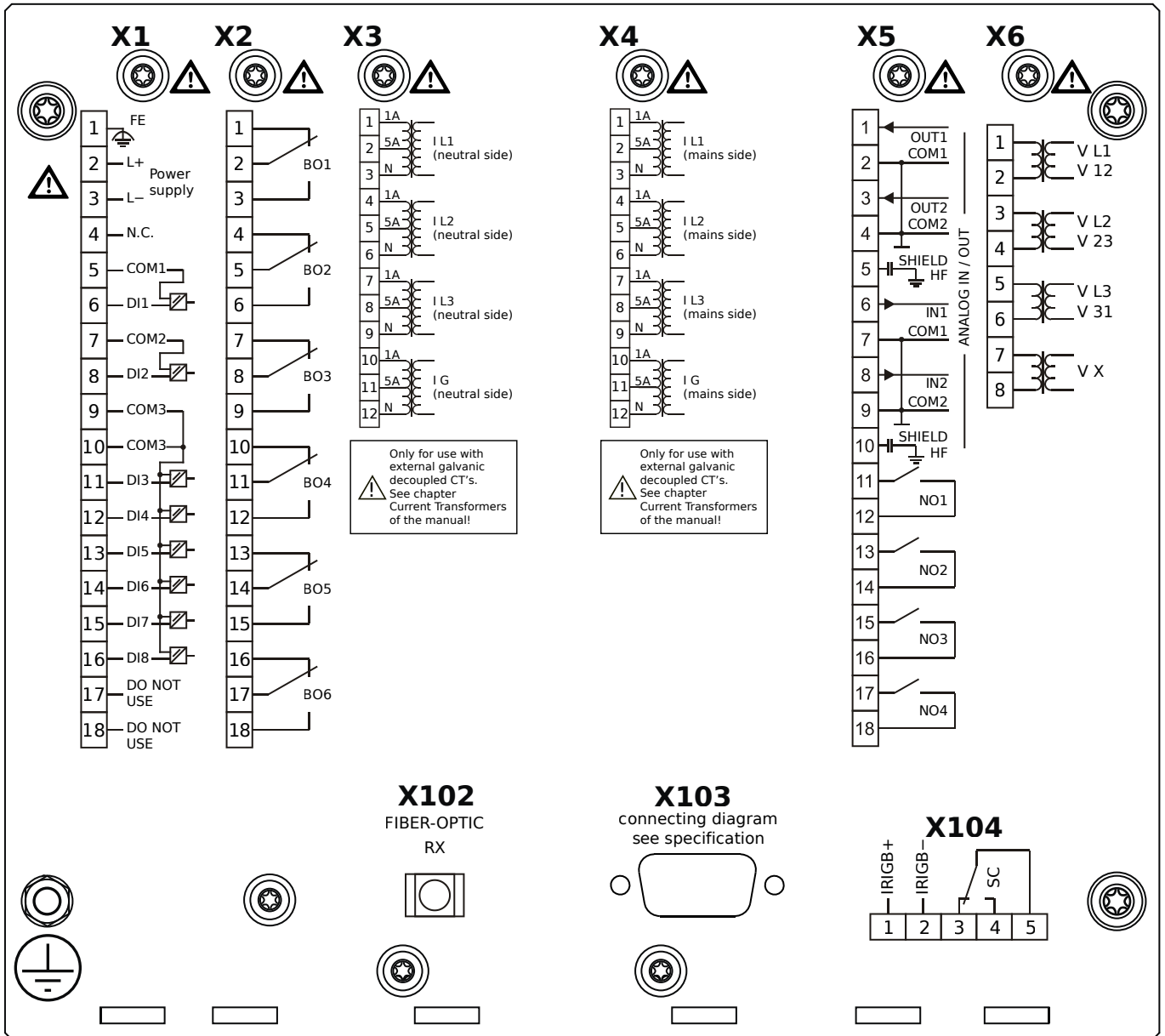

Housing B2, large display, door mounting

- + Conformal Coating (for installations in harsh environment)

- X1** – DI8-X1: Wide-range power supply unit, incl. 2 non-grouped digital inputs and 6 grouped digital inputs
- X2** – OR6: Assembly Group with 6 Output Relays (Changeover / Form C)
- X3** – TI: Standard current measuring card (for the neutral side of the differential protection)
- X4** – TI: Standard current measuring card (for the mains side of the differential protection)
- X5** – AnIO2-OR4: Assembly Group with 2 Analog Inputs, 2 Analog Outputs and 4 Output Relays
- X6** – TU: Card with 4 voltage transformer measuring inputs (0 ... 800 VAC, under UL: 0 ... 600 VAC)
- X102** – Universal Resistance-Temperature Detector (URTD) input, Fiber optics interface, Versatile Link
- X103** – Profibus-DP, RS485, D-SUB
- X104** – IRIG-B00X, incl. System Contact (Supervision Contact)

MCDGV4-2B0AFA

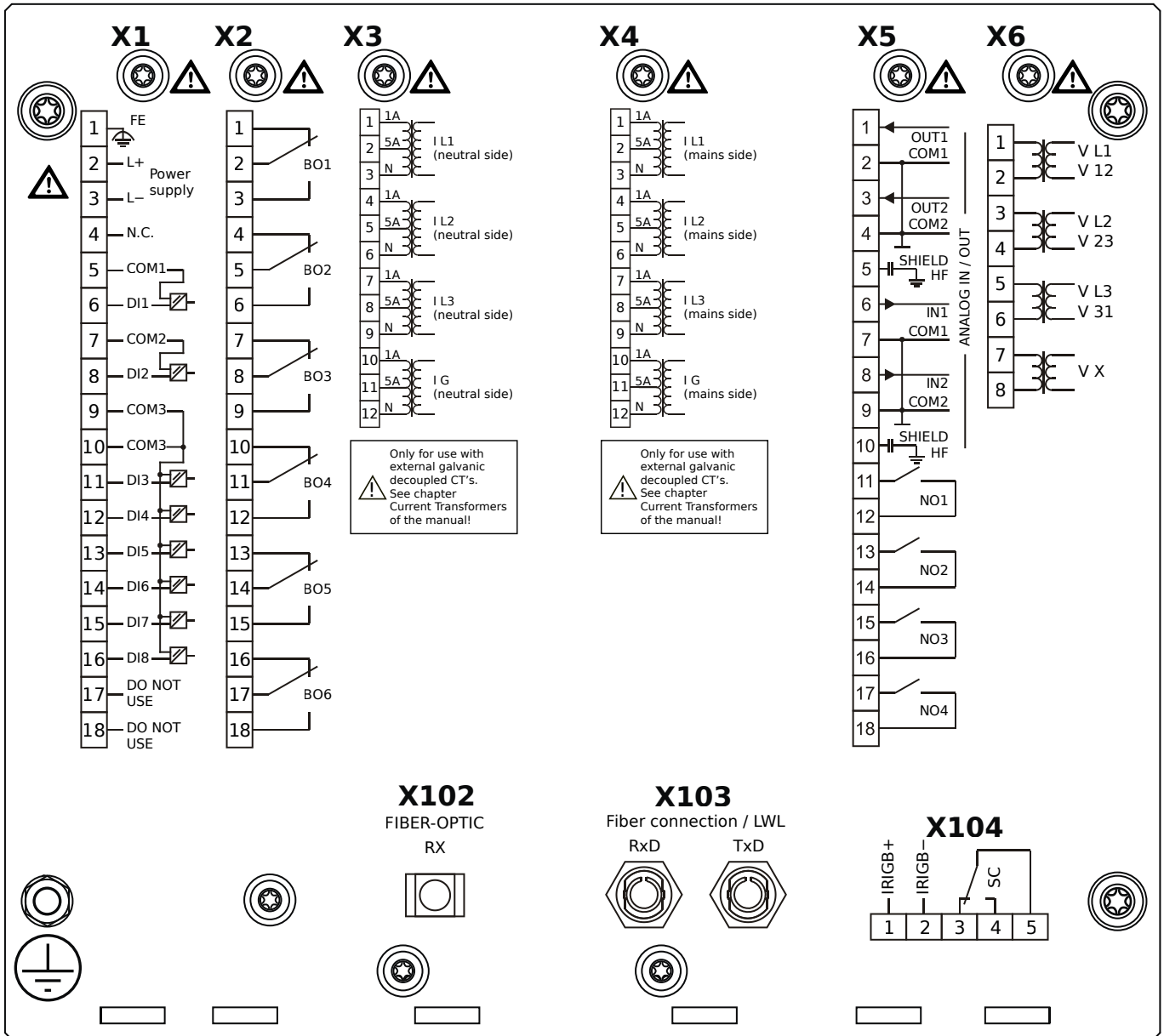

Housing B2, large display, door mounting

- X1** – DI8-X1: Wide-range power supply unit, incl. 2 non-grouped digital inputs and 6 grouped digital inputs
- X2** – OR6: Assembly Group with 6 Output Relays (Changeover / Form C)
- X3** – TI: Standard current measuring card (for the neutral side of the differential protection)
- X4** – TI: Standard current measuring card (for the mains side of the differential protection)
- X5** – AnIO2-OR4: Assembly Group with 2 Analog Inputs, 2 Analog Outputs and 4 Output Relays
- X6** – TU: Card with 4 voltage transformer measuring inputs (0 ... 800 VAC, under UL: 0 ... 600 VAC)
- X102** – Universal Resistance-Temperature Detector (URTD) input, Fiber optics interface, Versatile Link
- X103** – Modbus RTU / IEC 60870-5-103 / DNP3.0 RTU, Fiber optics interface, ST Connector
- X104** – IRIG-B00X, incl. System Contact (Supervision Contact)

MCDGV4-2B0AFB

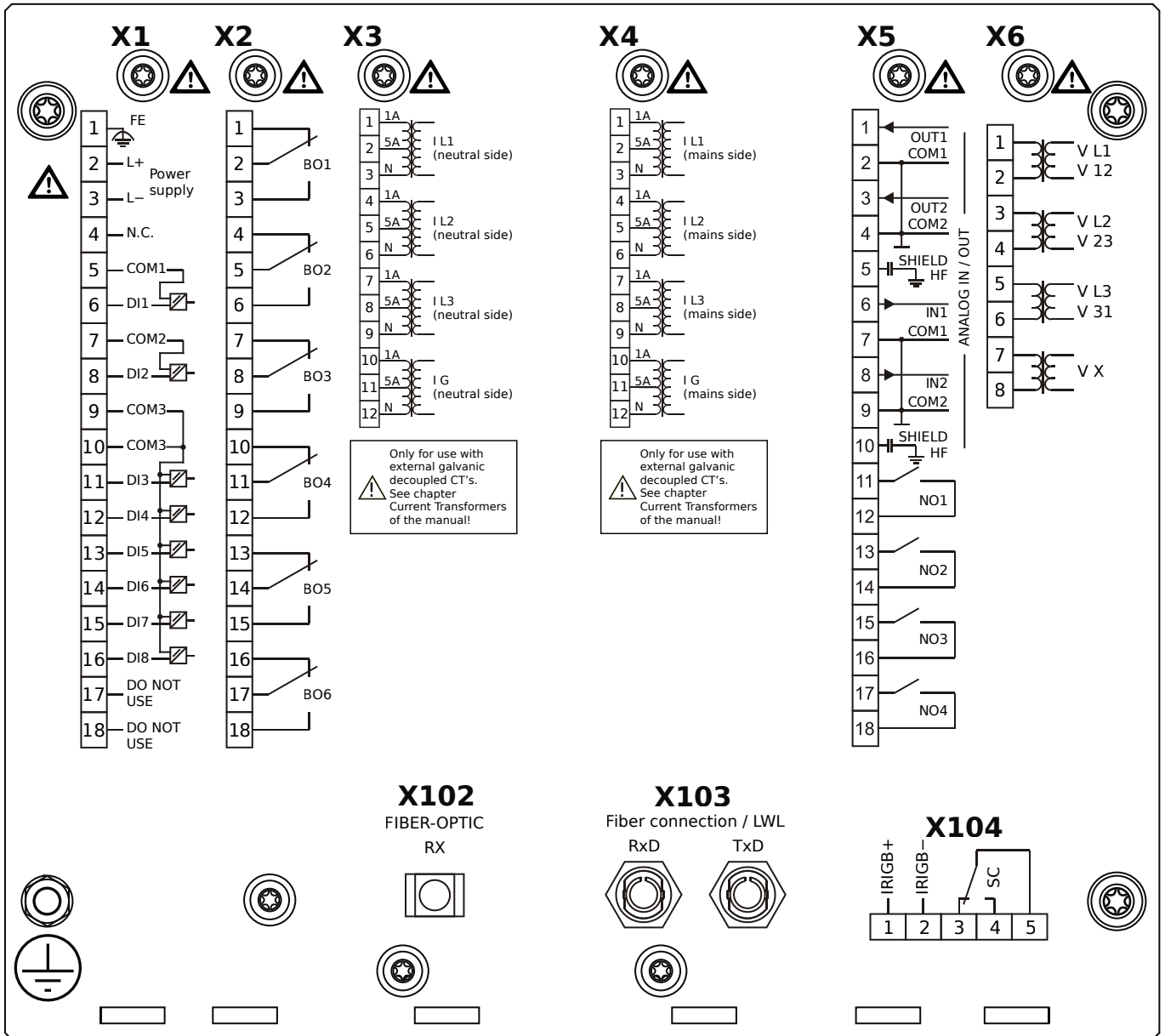

Housing B2, large display, door mounting

+ Conformal Coating (for installations in harsh environment)

- X1** – DI8-X1: Wide-range power supply unit, incl. 2 non-grouped digital inputs and 6 grouped digital inputs
- X2** – OR6: Assembly Group with 6 Output Relays (Changeover / Form C)
- X3** – TI: Standard current measuring card (for the neutral side of the differential protection)
- X4** – TI: Standard current measuring card (for the mains side of the differential protection)
- X5** – AnIO2-OR4: Assembly Group with 2 Analog Inputs, 2 Analog Outputs and 4 Output Relays
- X6** – TU: Card with 4 voltage transformer measuring inputs (0 ... 800 VAC, under UL: 0 ... 600 VAC)
- X102** – Universal Resistance-Temperature Detector (URTD) input, Fiber optics interface, Versatile Link
- X103** – Modbus RTU / IEC 60870-5-103 / DNP3.0 RTU, Fiber optics interface, ST Connector
- X104** – IRIG-B00X, incl. System Contact (Supervision Contact)

MCDGV4-2B0AGA

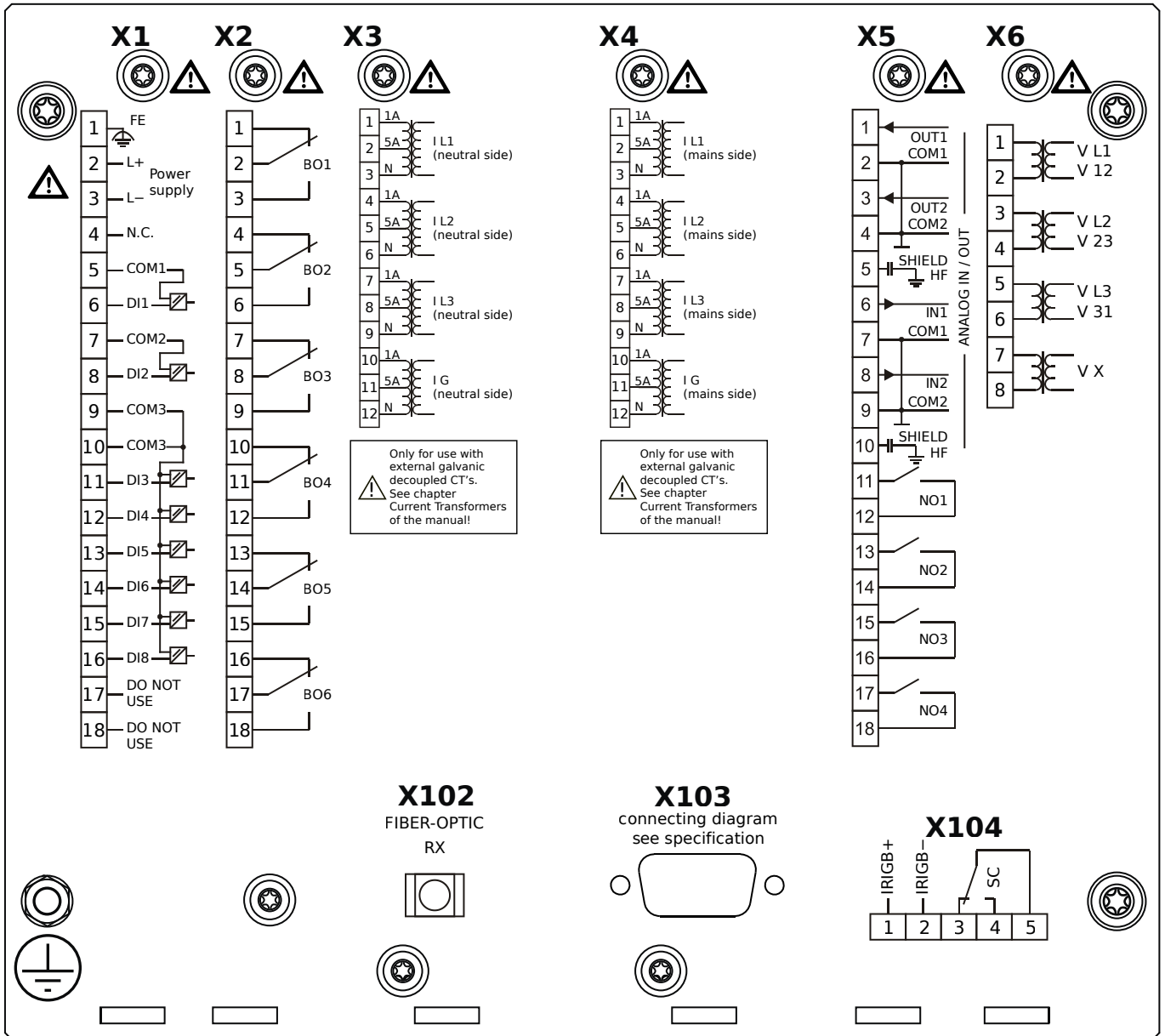

Housing B2, large display, door mounting

- X1** – DI8-X1: Wide-range power supply unit, incl. 2 non-grouped digital inputs and 6 grouped digital inputs
- X2** – OR6: Assembly Group with 6 Output Relays (Changeover / Form C)
- X3** – TI: Standard current measuring card (for the neutral side of the differential protection)
- X4** – TI: Standard current measuring card (for the mains side of the differential protection)
- X5** – AnIO2-OR4: Assembly Group with 2 Analog Inputs, 2 Analog Outputs and 4 Output Relays
- X6** – TU: Card with 4 voltage transformer measuring inputs (0 ... 800 VAC, under UL: 0 ... 600 VAC)
- X102** – Universal Resistance-Temperature Detector (URTD) input, Fiber optics interface, Versatile Link
- X103** – Modbus RTU / IEC 60870-5-103 / DNP3.0 RTU, RS485, D-SUB
- X104** – IRIG-B00X, incl. System Contact (Supervision Contact)

MCDGV4-2B0AGB

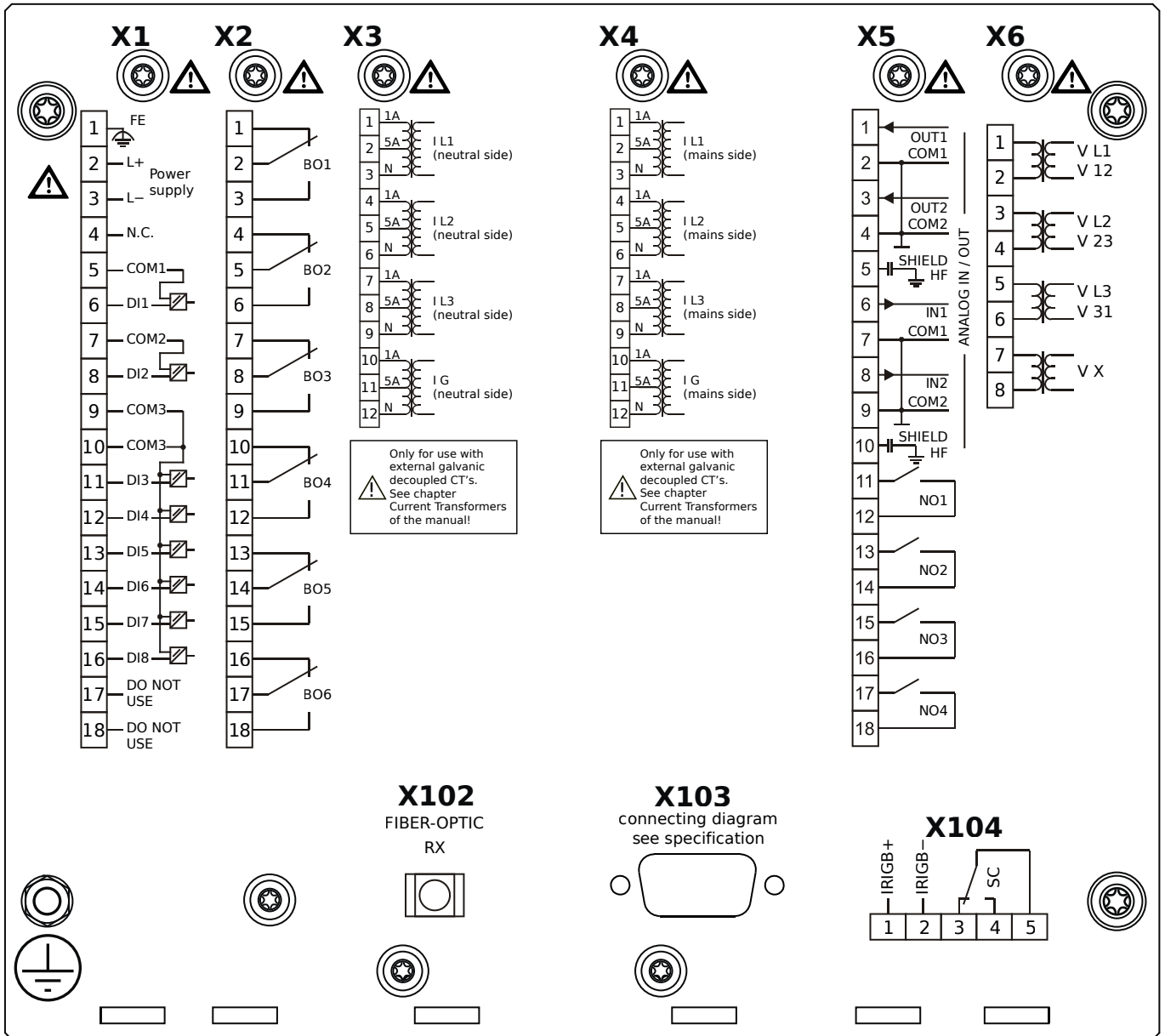

Housing B2, large display, door mounting

+ Conformal Coating (for installations in harsh environment)

- X1** – DI8-X1: Wide-range power supply unit, incl. 2 non-grouped digital inputs and 6 grouped digital inputs
- X2** – OR6: Assembly Group with 6 Output Relays (Changeover / Form C)
- X3** – TI: Standard current measuring card (for the neutral side of the differential protection)
- X4** – TI: Standard current measuring card (for the mains side of the differential protection)
- X5** – AnIO2-OR4: Assembly Group with 2 Analog Inputs, 2 Analog Outputs and 4 Output Relays
- X6** – TU: Card with 4 voltage transformer measuring inputs (0 ... 800 VAC, under UL: 0 ... 600 VAC)
- X102** – Universal Resistance-Temperature Detector (URTD) input, Fiber optics interface, Versatile Link
- X103** – Modbus RTU / IEC 60870-5-103 / DNP3.0 RTU, RS485, D-SUB
- X104** – IRIG-B00X, incl. System Contact (Supervision Contact)

MCDGV4-2B0AHA

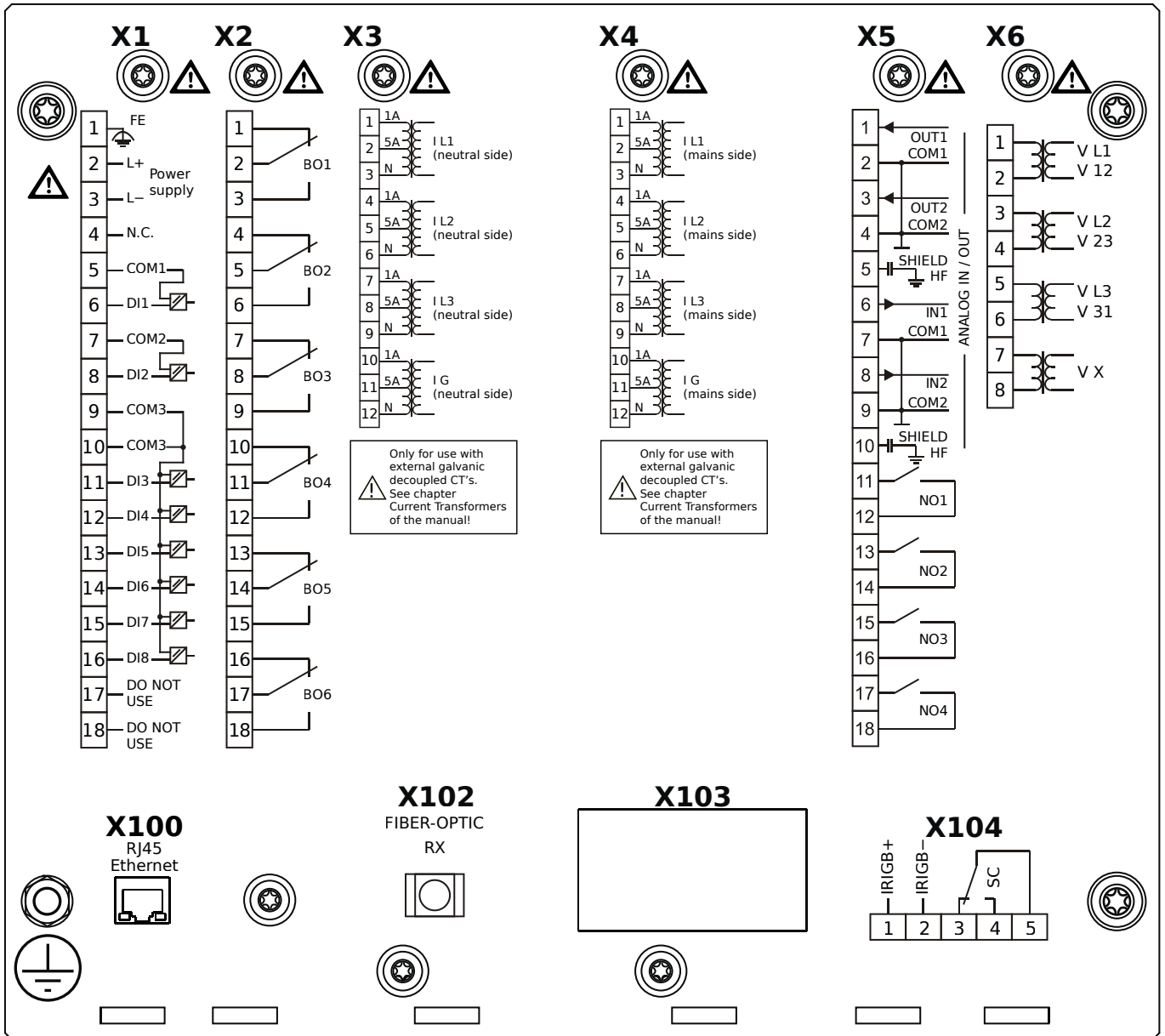

Housing B2, large display, door mounting

- X1** – DI8-X1: Wide-range power supply unit, incl. 2 non-grouped digital inputs and 6 grouped digital inputs
- X2** – OR6: Assembly Group with 6 Output Relays (Changeover / Form C)
- X3** – TI: Standard current measuring card (for the neutral side of the differential protection)
- X4** – TI: Standard current measuring card (for the mains side of the differential protection)
- X5** – AnIO2-OR4: Assembly Group with 2 Analog Inputs, 2 Analog Outputs and 4 Output Relays
- X6** – TU: Card with 4 voltage transformer measuring inputs (0 ... 800 VAC, under UL: 0 ... 600 VAC)
- X100** – IEC 61850 / Modbus TCP / DNP3.0 TCP/UDP, Ethernet interface, 100 Mbit/s, RJ45 (BASE100-FX)
- X102** – Universal Resistance-Temperature Detector (URTD) input, Fiber optics interface, Versatile Link
- X104** – IRIG-B00X, incl. System Contact (Supervision Contact)

MCDGV4-2B0AHB

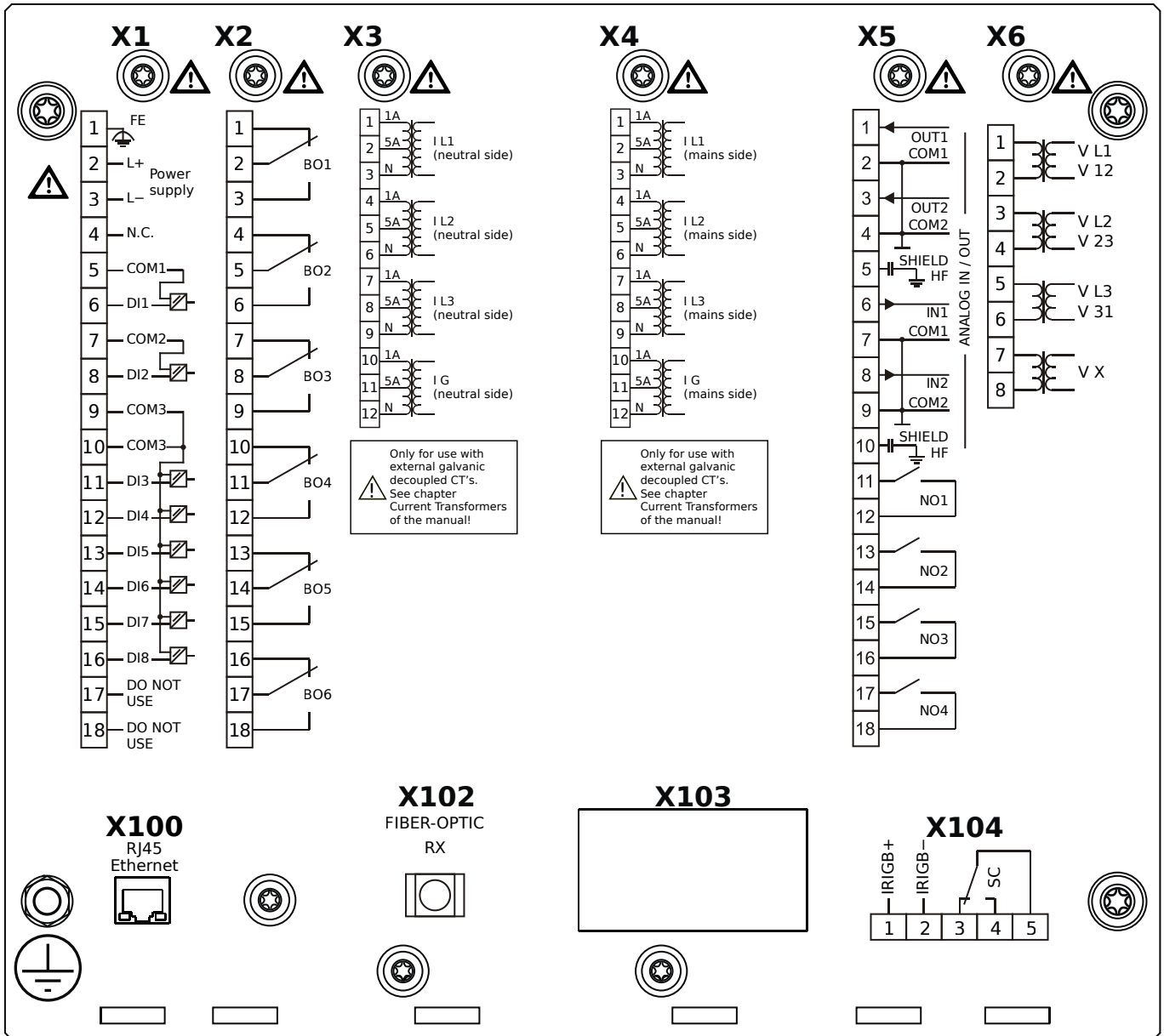

Housing B2, large display, door mounting

- + Conformal Coating (for installations in harsh environment)

- X1** – DI8-X1: Wide-range power supply unit, incl. 2 non-grouped digital inputs and 6 grouped digital inputs
- X2** – OR6: Assembly Group with 6 Output Relays (Changeover / Form C)
- X3** – TI: Standard current measuring card (for the neutral side of the differential protection)
- X4** – TI: Standard current measuring card (for the mains side of the differential protection)
- X5** – AnIO2-OR4: Assembly Group with 2 Analog Inputs, 2 Analog Outputs and 4 Output Relays
- X6** – TU: Card with 4 voltage transformer measuring inputs (0 ... 800 VAC, under UL: 0 ... 600 VAC)
- X100** – IEC 61850 / Modbus TCP / DNP3.0 TCP/UDP, Ethernet interface, 100 Mbit/s, RJ45 (BASE100-FX)
- X102** – Universal Resistance-Temperature Detector (URTD) input, Fiber optics interface, Versatile Link
- X104** – IRIG-B00X, incl. System Contact (Supervision Contact)

MCDGV4-2B0AIA

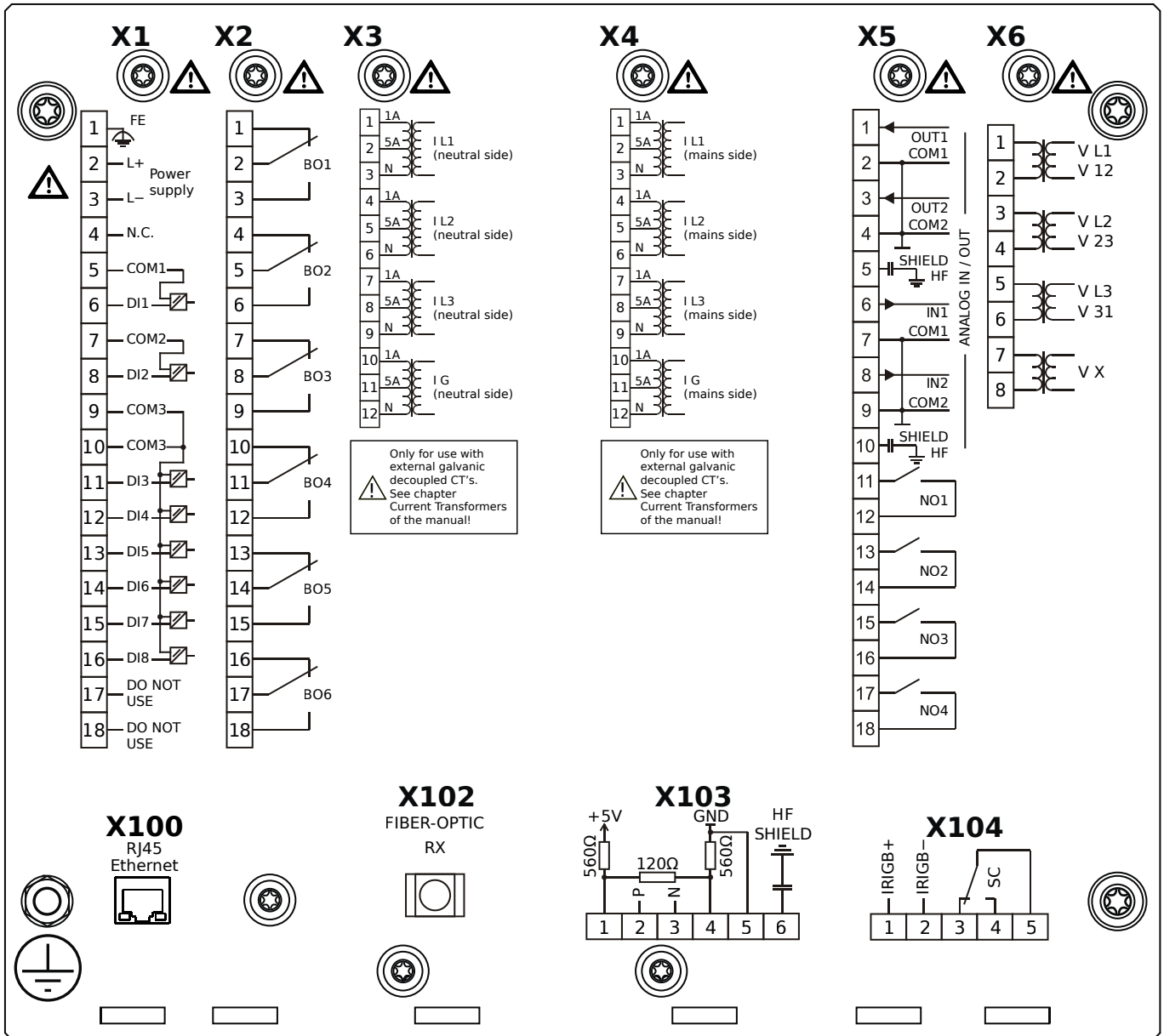

Housing B2, large display, door mounting

- X1** – DI8-X1: Wide-range power supply unit, incl. 2 non-grouped digital inputs and 6 grouped digital inputs
- X2** – OR6: Assembly Group with 6 Output Relays (Changeover / Form C)
- X3** – TI: Standard current measuring card (for the neutral side of the differential protection)
- X4** – TI: Standard current measuring card (for the mains side of the differential protection)
- X5** – AnIO2-OR4: Assembly Group with 2 Analog Inputs, 2 Analog Outputs and 4 Output Relays
- X6** – TU: Card with 4 voltage transformer measuring inputs (0 ... 800 VAC, under UL: 0 ... 600 VAC)
- X100** – Modbus TCP / DNP3.0 TCP/UDP, Ethernet interface, 100 Mbit/s, RJ45 (BASE100-FX)
- X102** – Universal Resistance-Temperature Detector (URTD) input, Fiber optics interface, Versatile Link
- X103** – IEC 60870-5-103 / Modbus RTU / DNP3.0 RTU, RS485, Terminals
- X104** – IRIG-B00X, incl. System Contact (Supervision Contact)

MCDGV4-2B0AIB

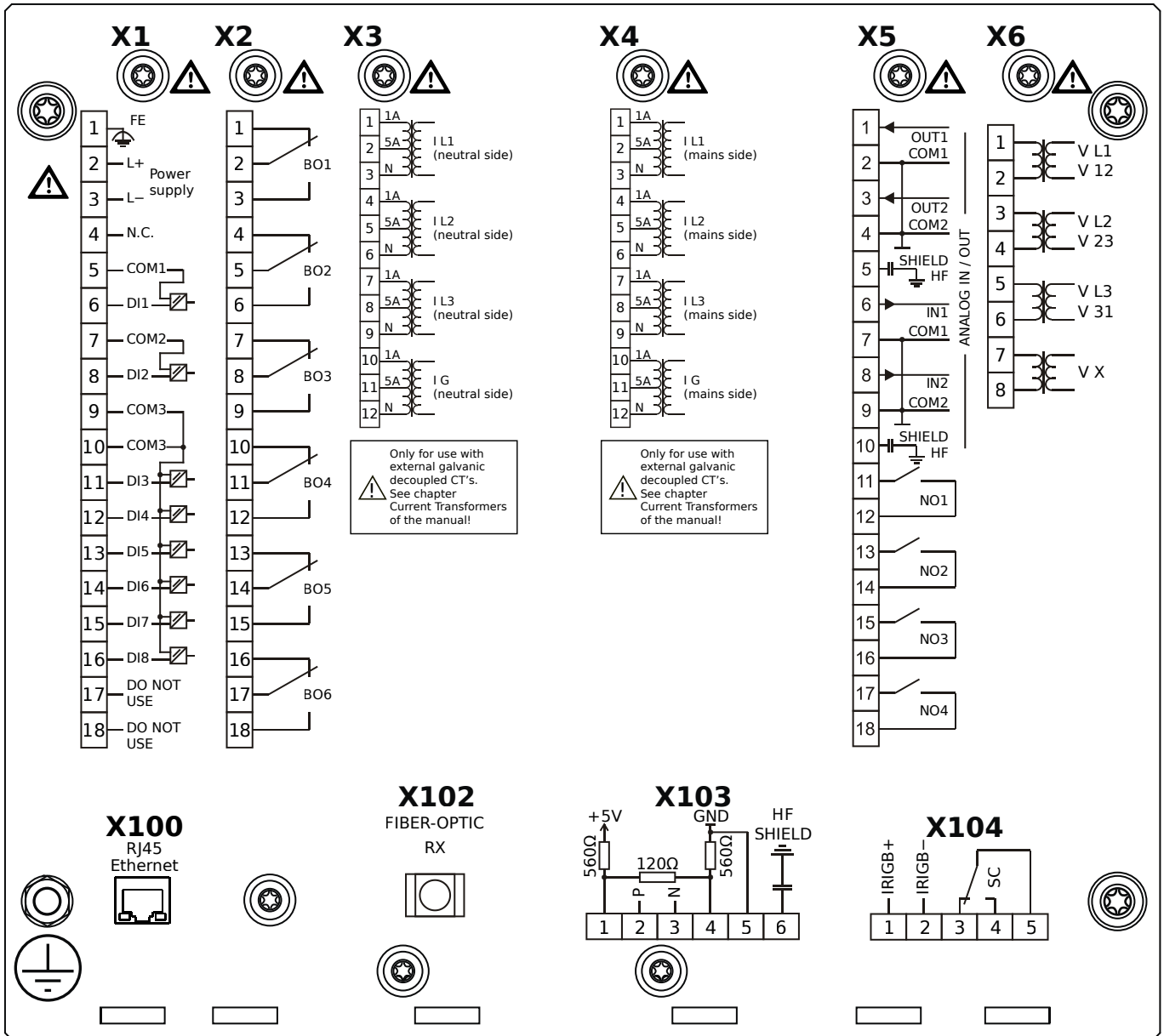

Housing B2, large display, door mounting

- + Conformal Coating (for installations in harsh environment)

- X1** – DI8-X1: Wide-range power supply unit, incl. 2 non-grouped digital inputs and 6 grouped digital inputs
- X2** – OR6: Assembly Group with 6 Output Relays (Changeover / Form C)
- X3** – TI: Standard current measuring card (for the neutral side of the differential protection)
- X4** – TI: Standard current measuring card (for the mains side of the differential protection)
- X5** – AnIO2-OR4: Assembly Group with 2 Analog Inputs, 2 Analog Outputs and 4 Output Relays
- X6** – TU: Card with 4 voltage transformer measuring inputs (0 ... 800 VAC, under UL: 0 ... 600 VAC)
- X100** – Modbus TCP / DNP3.0 TCP/UDP, Ethernet interface, 100 Mbit/s, RJ45 (BASE100-FX)
- X102** – Universal Resistance-Temperature Detector (URTD) input, Fiber optics interface, Versatile Link
- X103** – IEC 60870-5-103 / Modbus RTU / DNP3.0 RTU, RS485, Terminals
- X104** – IRIG-B00X, incl. System Contact (Supervision Contact)

MCDGV4-2B0AKA

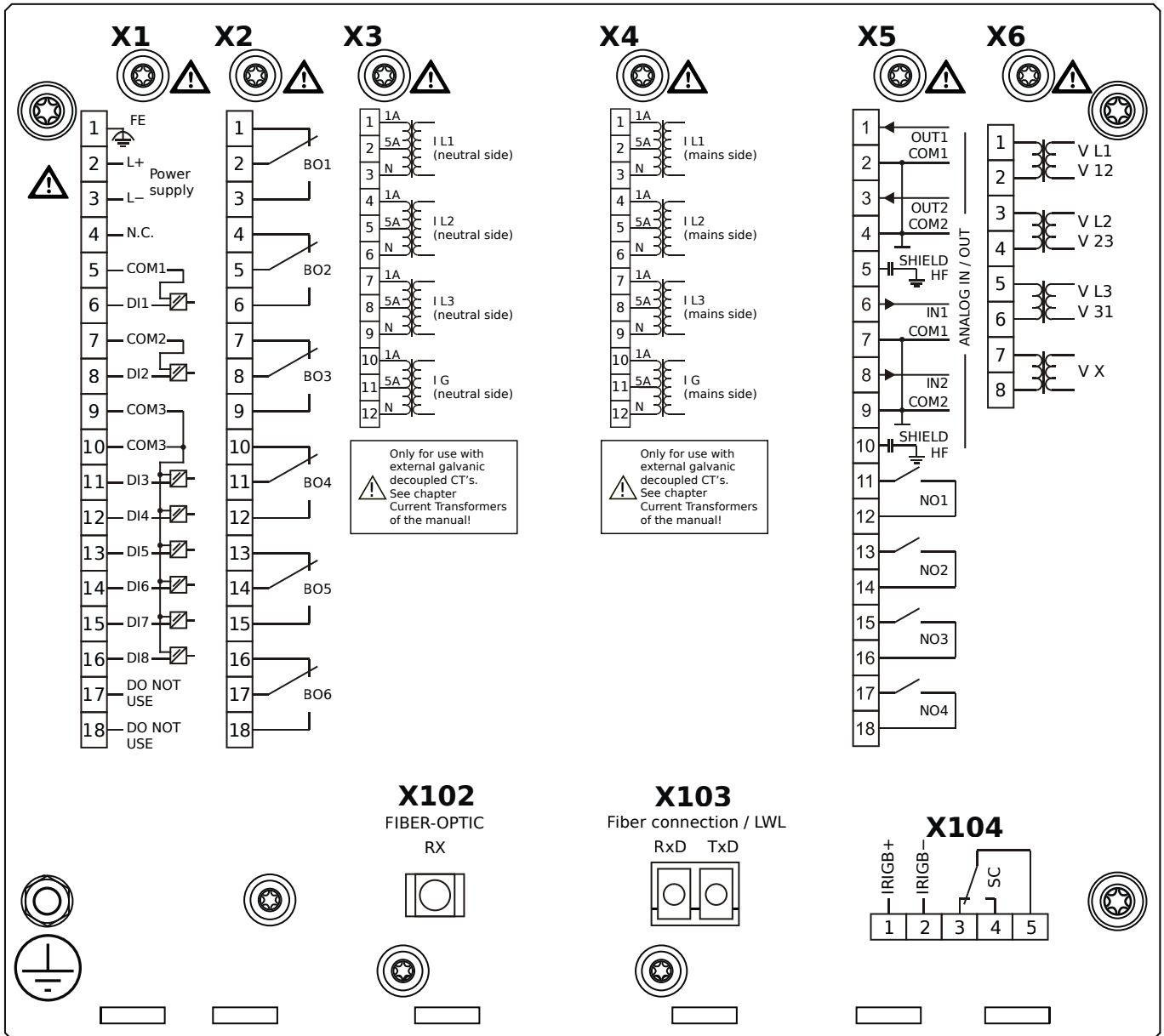

Housing B2, large display, door mounting

- X1** – DI8-X1: Wide-range power supply unit, incl. 2 non-grouped digital inputs and 6 grouped digital inputs
- X2** – OR6: Assembly Group with 6 Output Relays (Changeover / Form C)
- X3** – TI: Standard current measuring card (for the neutral side of the differential protection)
- X4** – TI: Standard current measuring card (for the mains side of the differential protection)
- X5** – AnIO2-OR4: Assembly Group with 2 Analog Inputs, 2 Analog Outputs and 4 Output Relays
- X6** – TU: Card with 4 voltage transformer measuring inputs (0 ... 800 VAC, under UL: 0 ... 600 VAC)
- X102** – Universal Resistance-Temperature Detector (URTD) input, Fiber optics interface, Versatile Link
- X103** – IEC 61850 / Modbus TCP / DNP3.0 TCP/UDP, Fiber optics interface, LC Connector
- X104** – IRIG-B00X, incl. System Contact (Supervision Contact)

MCDGV4-2B0AKB

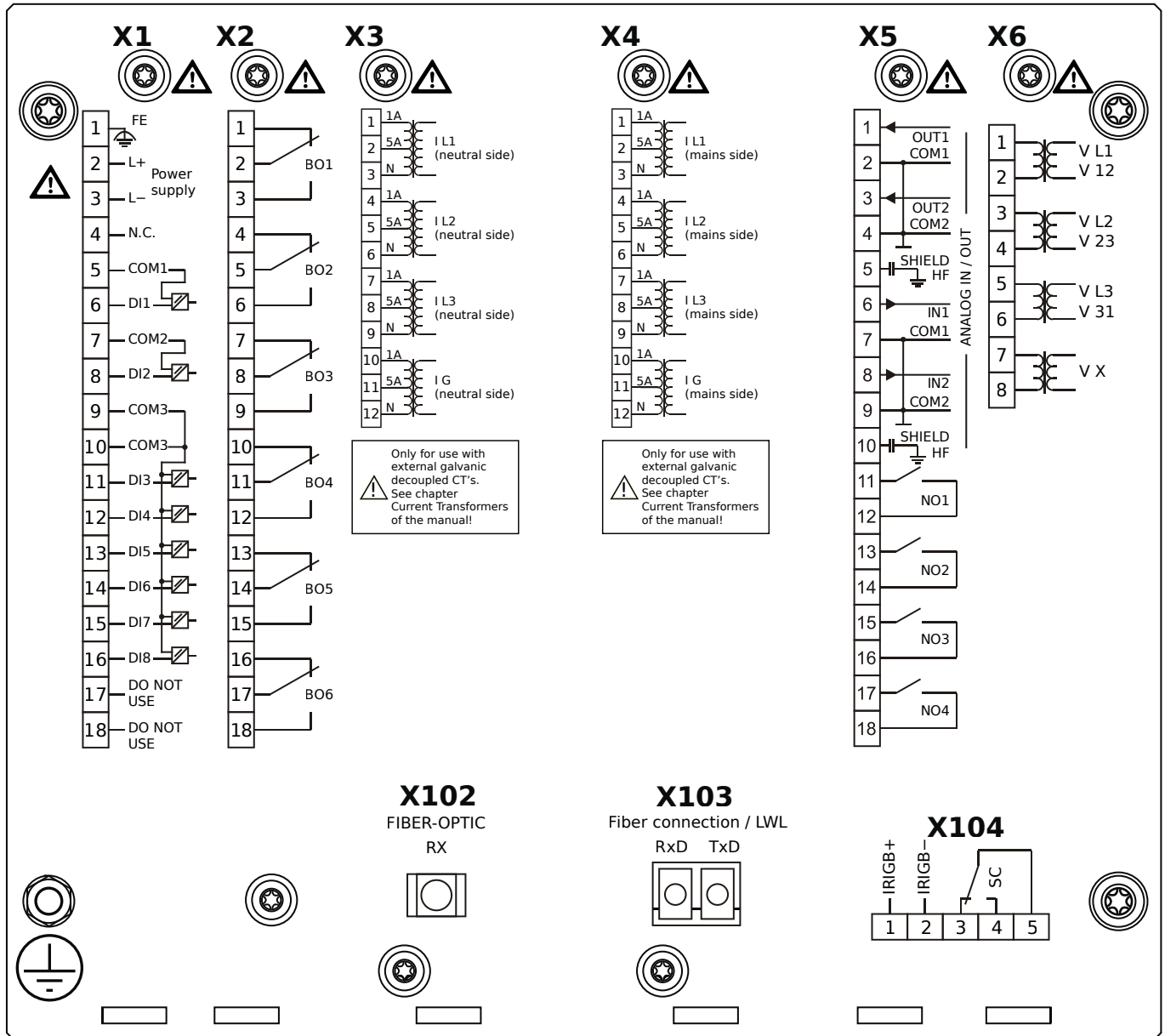

Housing B2, large display, door mounting

- + Conformal Coating (for installations in harsh environment)

- X1** – DI8-X1: Wide-range power supply unit, incl. 2 non-grouped digital inputs and 6 grouped digital inputs
- X2** – OR6: Assembly Group with 6 Output Relays (Changeover / Form C)
- X3** – TI: Standard current measuring card (for the neutral side of the differential protection)
- X4** – TI: Standard current measuring card (for the mains side of the differential protection)
- X5** – AnIO2-OR4: Assembly Group with 2 Analog Inputs, 2 Analog Outputs and 4 Output Relays
- X6** – TU: Card with 4 voltage transformer measuring inputs (0 ... 800 VAC, under UL: 0 ... 600 VAC)
- X102** – Universal Resistance-Temperature Detector (URTD) input, Fiber optics interface, Versatile Link
- X103** – IEC 61850 / Modbus TCP / DNP3.0 TCP/UDP, Fiber optics interface, LC Connector
- X104** – IRIG-B00X, incl. System Contact (Supervision Contact)

MCDGV4-2B0ALA

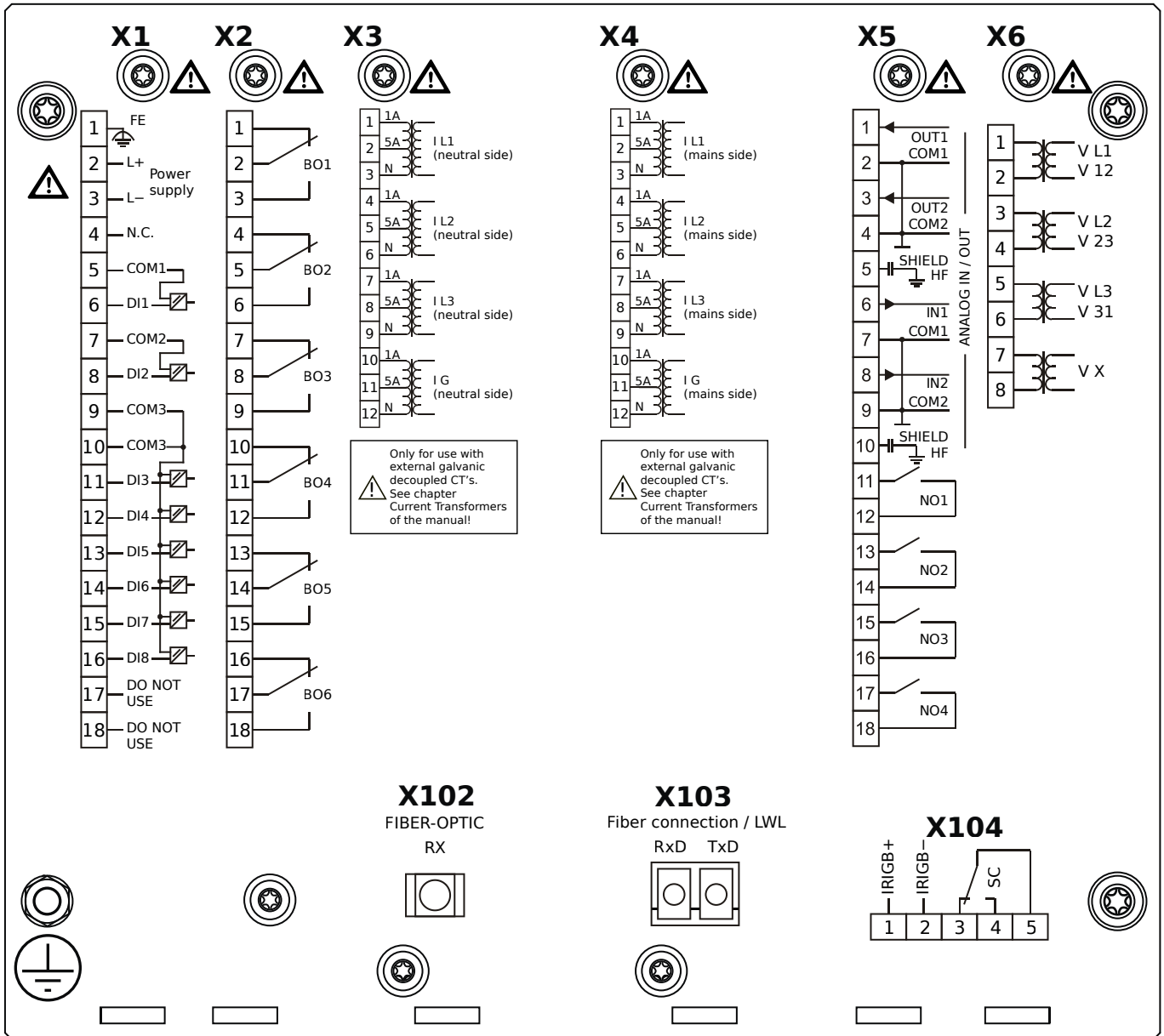

Housing B2, large display, door mounting

- X1** – DI8-X1: Wide-range power supply unit, incl. 2 non-grouped digital inputs and 6 grouped digital inputs
- X2** – OR6: Assembly Group with 6 Output Relays (Changeover / Form C)
- X3** – TI: Standard current measuring card (for the neutral side of the differential protection)
- X4** – TI: Standard current measuring card (for the mains side of the differential protection)
- X5** – AnIO2-OR4: Assembly Group with 2 Analog Inputs, 2 Analog Outputs and 4 Output Relays
- X6** – TU: Card with 4 voltage transformer measuring inputs (0 ... 800 VAC, under UL: 0 ... 600 VAC)
- X102** – Universal Resistance-Temperature Detector (URTD) input, Fiber optics interface, Versatile Link
- X103** – Modbus TCP / DNP3.0 TCP/UDP, Fiber optics interface, LC Connector
- X104** – IRIG-B00X, incl. System Contact (Supervision Contact)

MCDGV4-2B0ALB

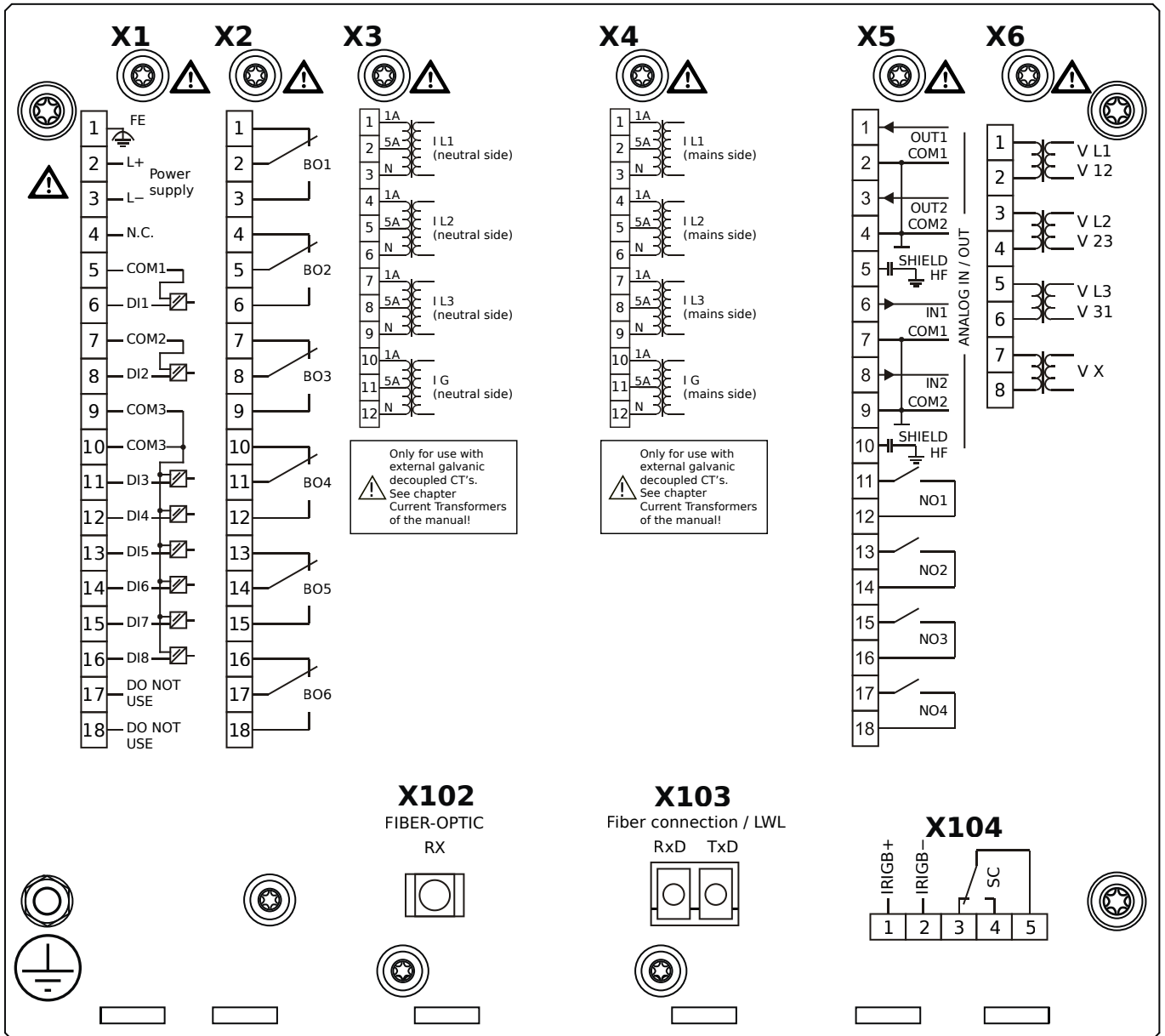

Housing B2, large display, door mounting

- + Conformal Coating (for installations in harsh environment)

- X1** – DI8-X1: Wide-range power supply unit, incl. 2 non-grouped digital inputs and 6 grouped digital inputs
- X2** – OR6: Assembly Group with 6 Output Relays (Changeover / Form C)
- X3** – TI: Standard current measuring card (for the neutral side of the differential protection)
- X4** – TI: Standard current measuring card (for the mains side of the differential protection)
- X5** – AnIO2-OR4: Assembly Group with 2 Analog Inputs, 2 Analog Outputs and 4 Output Relays
- X6** – TU: Card with 4 voltage transformer measuring inputs (0 ... 800 VAC, under UL: 0 ... 600 VAC)
- X102** – Universal Resistance-Temperature Detector (URTD) input, Fiber optics interface, Versatile Link
- X103** – Modbus TCP / DNP3.0 TCP/UDP, Fiber optics interface, LC Connector
- X104** – IRIG-B00X, incl. System Contact (Supervision Contact)

MCDGV4-2B0ATA

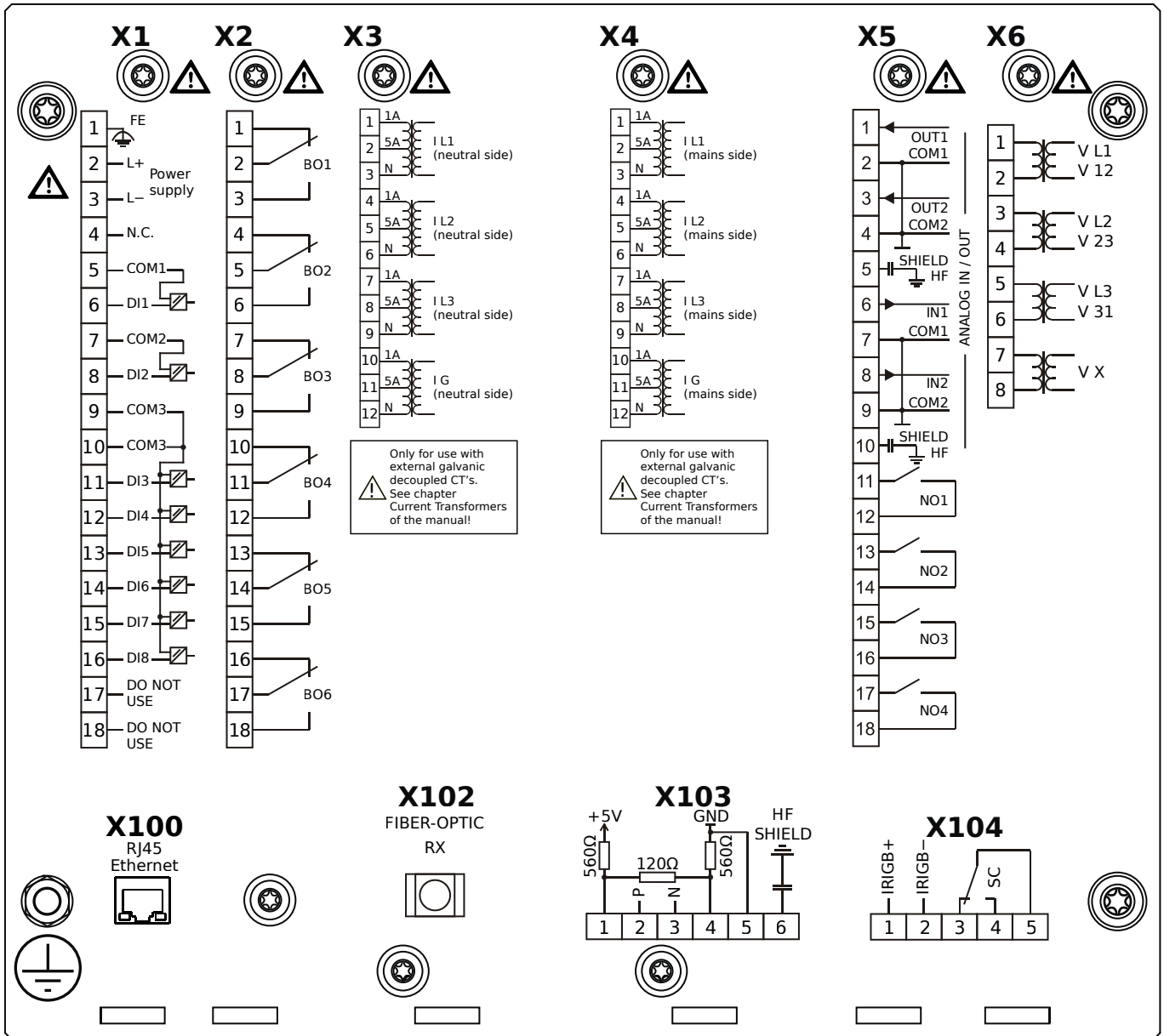

Housing B2, large display, door mounting

- X1** – DI8-X1: Wide-range power supply unit, incl. 2 non-grouped digital inputs and 6 grouped digital inputs
- X2** – OR6: Assembly Group with 6 Output Relays (Changeover / Form C)
- X3** – TI: Standard current measuring card (for the neutral side of the differential protection)
- X4** – TI: Standard current measuring card (for the mains side of the differential protection)
- X5** – AnIO2-OR4: Assembly Group with 2 Analog Inputs, 2 Analog Outputs and 4 Output Relays
- X6** – TU: Card with 4 voltage transformer measuring inputs (0 ... 800 VAC, under UL: 0 ... 600 VAC)
- X100** – IEC 61850 / Modbus TCP / DNP3.0 TCP/UDP, Ethernet interface, 100 Mbit/s, RJ45 (BASE100-FX)
- X102** – Universal Resistance-Temperature Detector (URTD) input, Fiber optics interface, Versatile Link
- X103** – IEC 60870-5-103 / Modbus RTU / DNP3.0 RTU, RS485, Terminals
- X104** – IRIG-B00X, incl. System Contact (Supervision Contact)

MCDGV4-2B0ATB

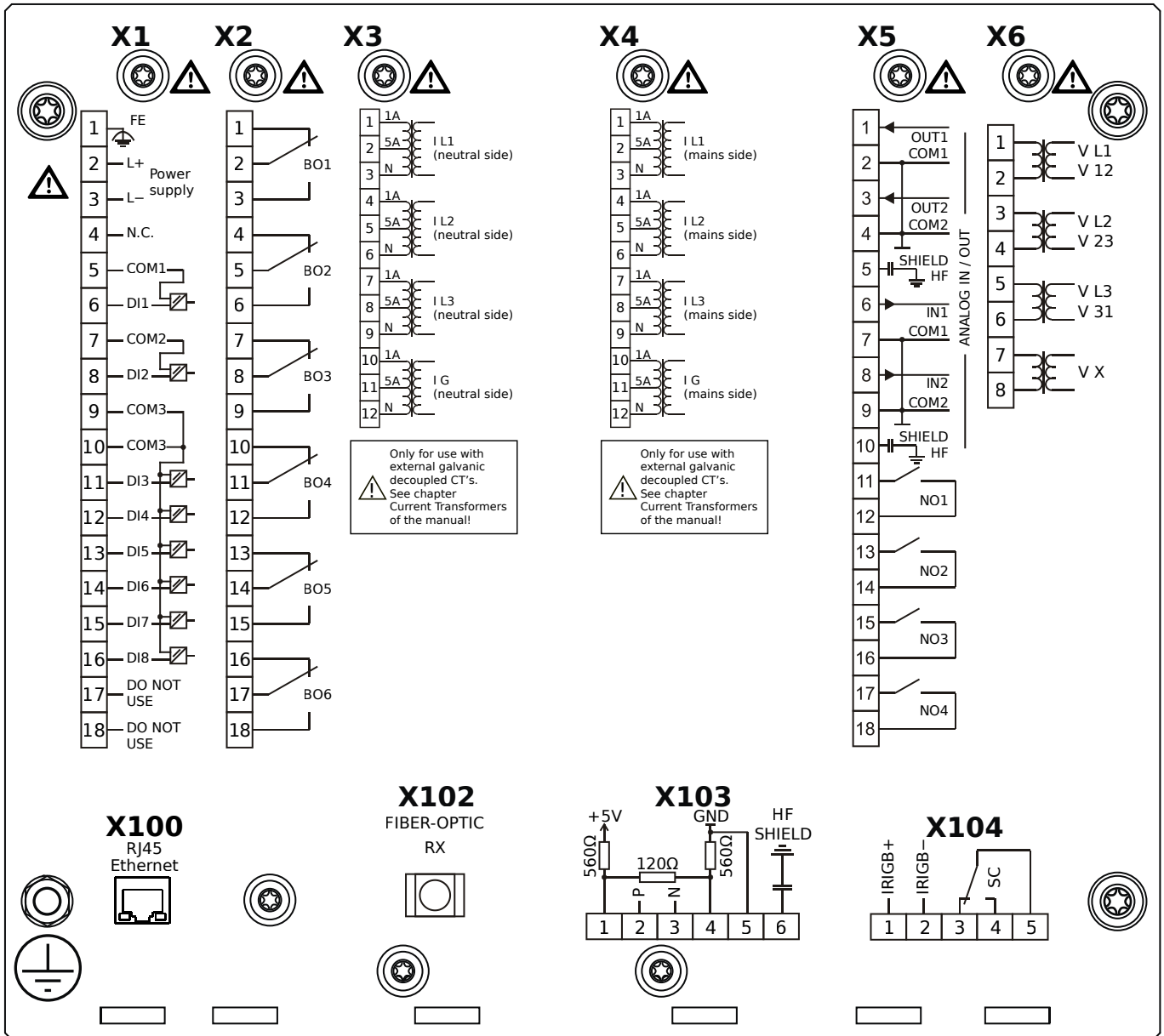

Housing B2, large display, door mounting

+ Conformal Coating (for installations in harsh environment)

- X1** – DI8-X1: Wide-range power supply unit, incl. 2 non-grouped digital inputs and 6 grouped digital inputs
- X2** – OR6: Assembly Group with 6 Output Relays (Changeover / Form C)
- X3** – TI: Standard current measuring card (for the neutral side of the differential protection)
- X4** – TI: Standard current measuring card (for the mains side of the differential protection)
- X5** – AnIO2-OR4: Assembly Group with 2 Analog Inputs, 2 Analog Outputs and 4 Output Relays
- X6** – TU: Card with 4 voltage transformer measuring inputs (0 ... 800 VAC, under UL: 0 ... 600 VAC)
- X100** – IEC 61850 / Modbus TCP / DNP3.0 TCP/UDP, Ethernet interface, 100 Mbit/s, RJ45 (BASE100-FX)
- X102** – Universal Resistance-Temperature Detector (URTD) input, Fiber optics interface, Versatile Link
- X103** – IEC 60870-5-103 / Modbus RTU / DNP3.0 RTU, RS485, Terminals
- X104** – IRIG-B00X, incl. System Contact (Supervision Contact)

MCDGV4-2B0BAA

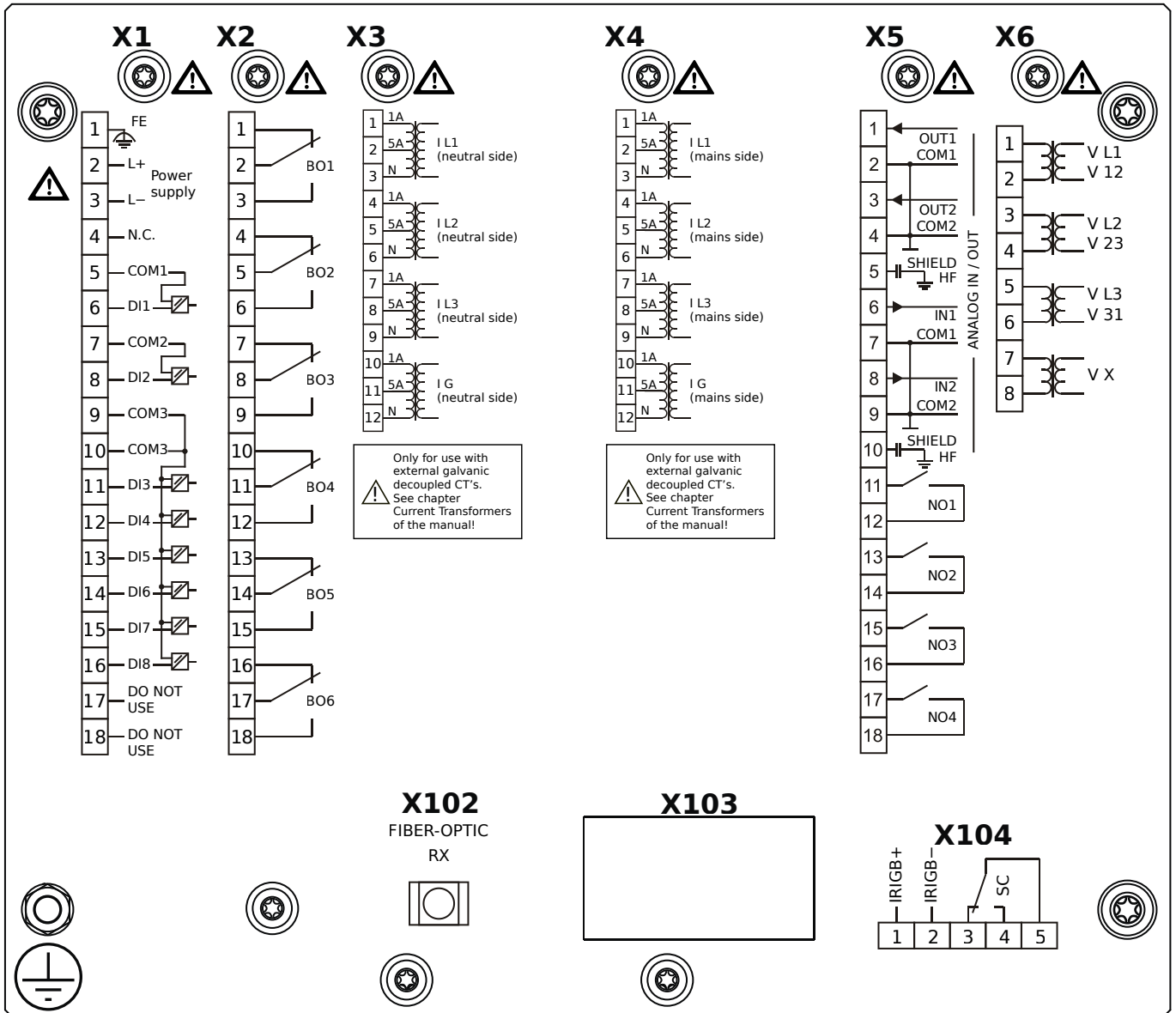

Housing B2, large display, 19" rack mounting

- X1** – DI8-X1: Wide-range power supply unit, incl. 2 non-grouped digital inputs and 6 grouped digital inputs
- X2** – OR6: Assembly Group with 6 Output Relays (Changeover / Form C)
- X3** – TI: Standard current measuring card (for the neutral side of the differential protection)
- X4** – TI: Standard current measuring card (for the mains side of the differential protection)
- X5** – AnIO2-OR4: Assembly Group with 2 Analog Inputs, 2 Analog Outputs and 4 Output Relays
- X6** – TU: Card with 4 voltage transformer measuring inputs (0 ... 800 VAC, under UL: 0 ... 600 VAC)
- X102** – Universal Resistance-Temperature Detector (URTD) input, Fiber optics interface, Versatile Link
- X104** – IRIG-B00X, incl. System Contact (Supervision Contact)

MCDGV4-2B0BAB

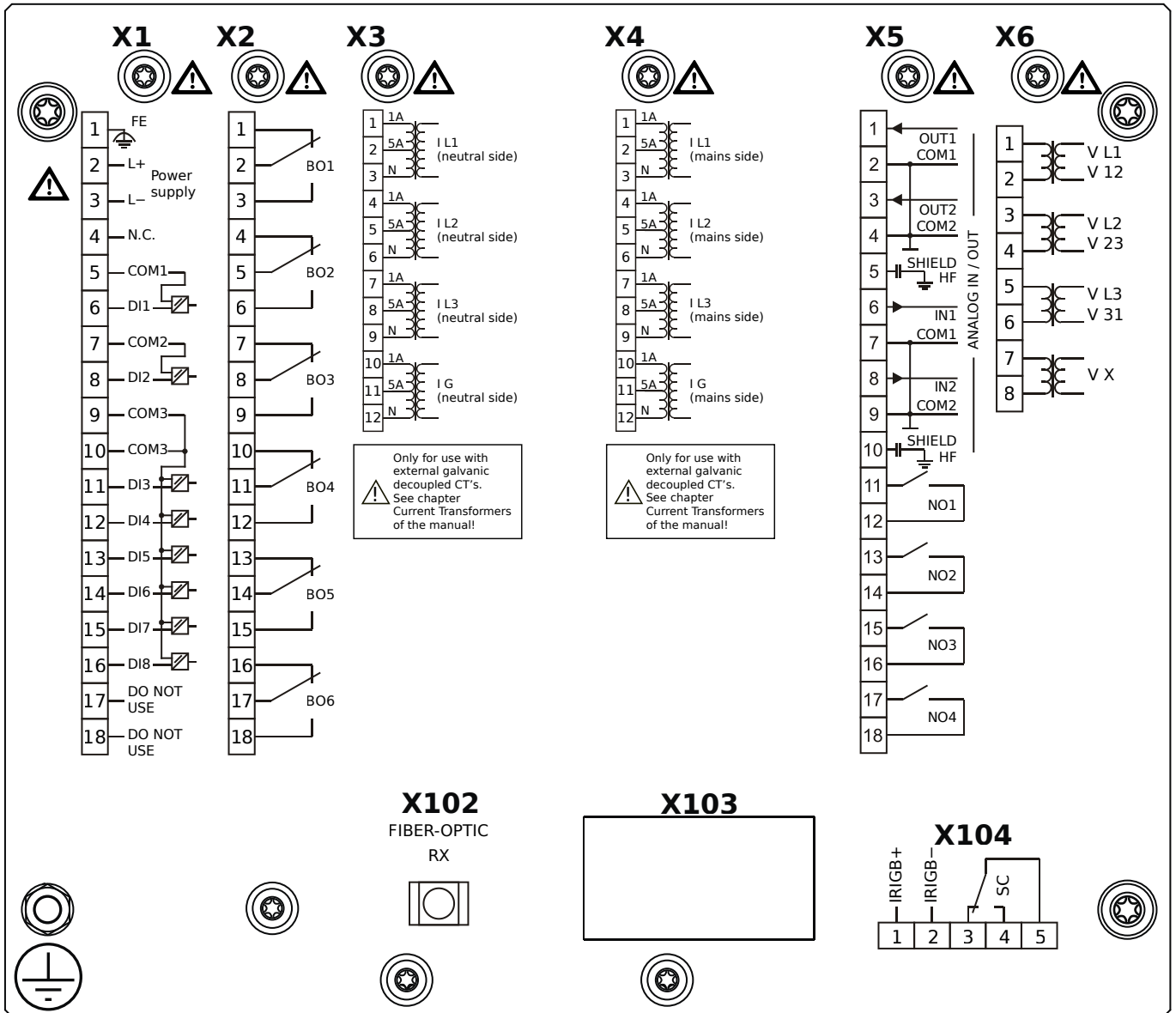

Housing B2, large display, 19" rack mounting

- + Conformal Coating (for installations in harsh environment)

- X1** – DI8-X1: Wide-range power supply unit, incl. 2 non-grouped digital inputs and 6 grouped digital inputs
- X2** – OR6: Assembly Group with 6 Output Relays (Changeover / Form C)
- X3** – TI: Standard current measuring card (for the neutral side of the differential protection)
- X4** – TI: Standard current measuring card (for the mains side of the differential protection)
- X5** – AnIO2-OR4: Assembly Group with 2 Analog Inputs, 2 Analog Outputs and 4 Output Relays
- X6** – TU: Card with 4 voltage transformer measuring inputs (0 ... 800 VAC, under UL: 0 ... 600 VAC)
- X102** – Universal Resistance-Temperature Detector (URTD) input, Fiber optics interface, Versatile Link
- X104** – IRIG-B00X, incl. System Contact (Supervision Contact)

MCDGV4-2B0BBA

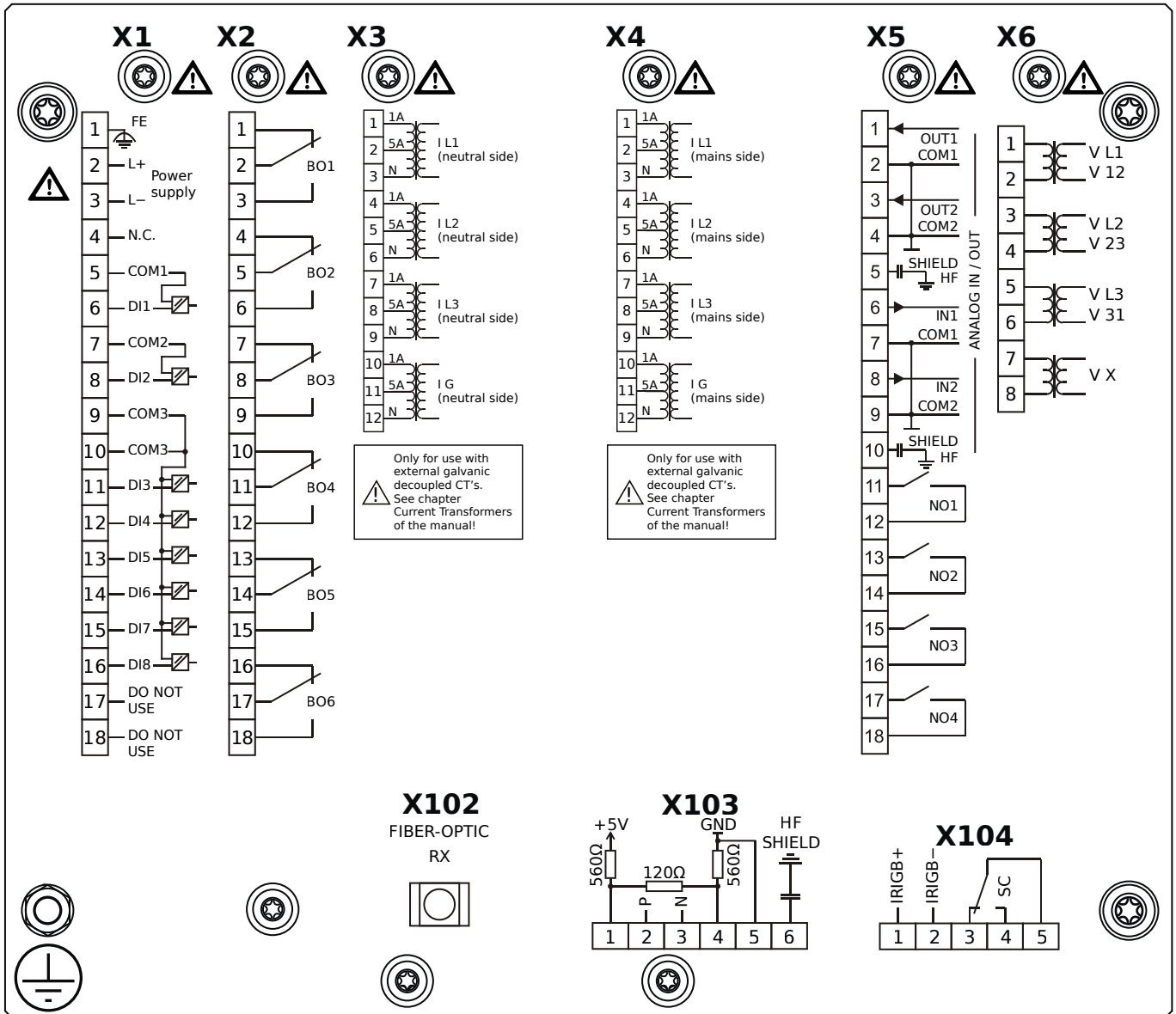

Housing B2, large display, 19" rack mounting

- X1** – DI8-X1: Wide-range power supply unit, incl. 2 non-grouped digital inputs and 6 grouped digital inputs
- X2** – OR6: Assembly Group with 6 Output Relays (Changeover / Form C)
- X3** – TI: Standard current measuring card (for the neutral side of the differential protection)
- X4** – TI: Standard current measuring card (for the mains side of the differential protection)
- X5** – AnIO2-OR4: Assembly Group with 2 Analog Inputs, 2 Analog Outputs and 4 Output Relays
- X6** – TU: Card with 4 voltage transformer measuring inputs (0 ... 800 VAC, under UL: 0 ... 600 VAC)
- X102** – Universal Resistance-Temperature Detector (URTD) input, Fiber optics interface, Versatile Link
- X103** – Modbus RTU / IEC 60870-5-103 / DNP3.0 RTU, RS485, Terminals
- X104** – IRIG-B00X, incl. System Contact (Supervision Contact)

MCDGV4-2B0BBB

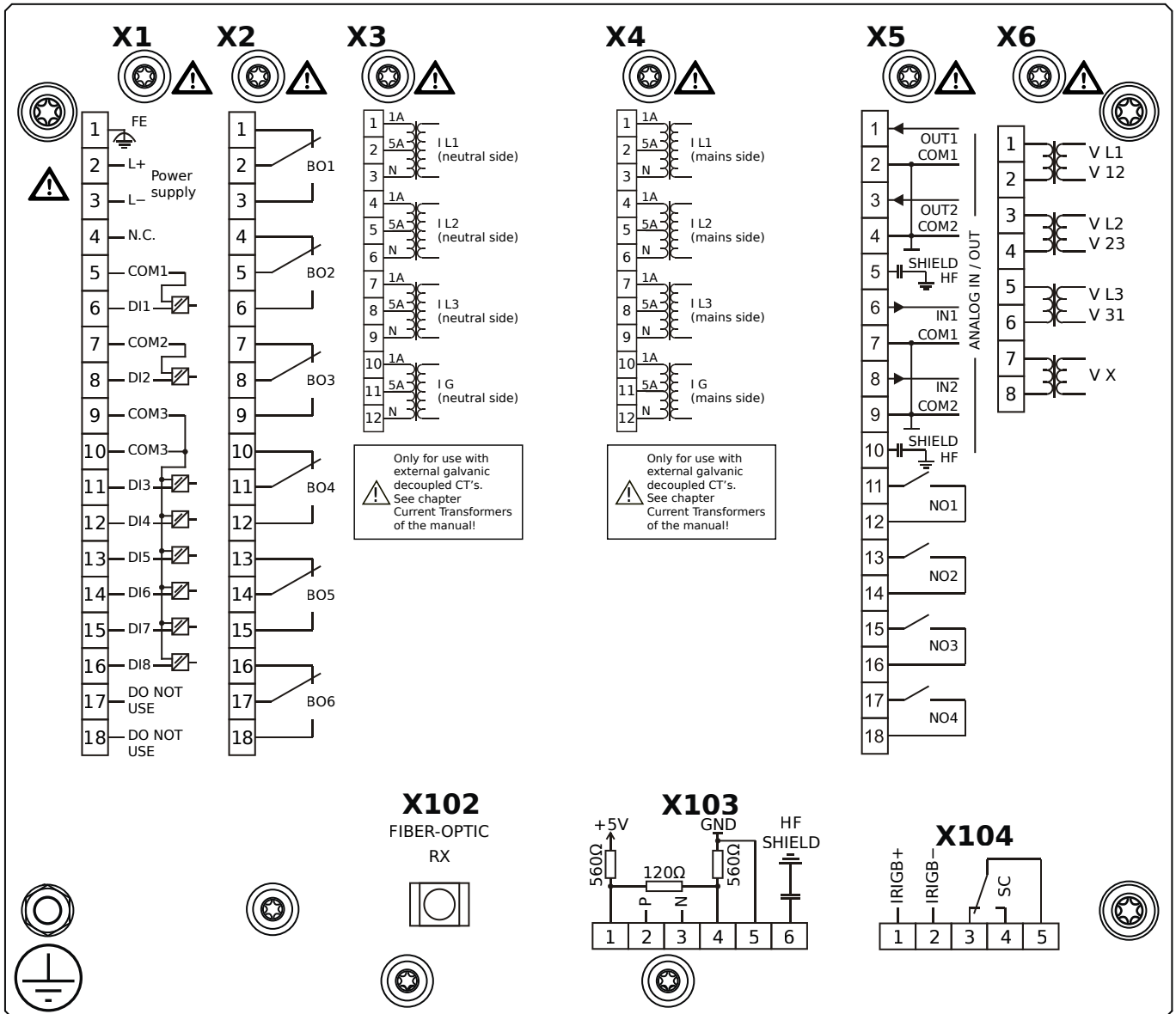

Housing B2, large display, 19" rack mounting

- + Conformal Coating (for installations in harsh environment)

- X1** – DI8-X1: Wide-range power supply unit, incl. 2 non-grouped digital inputs and 6 grouped digital inputs
- X2** – OR6: Assembly Group with 6 Output Relays (Changeover / Form C)
- X3** – TI: Standard current measuring card (for the neutral side of the differential protection)
- X4** – TI: Standard current measuring card (for the mains side of the differential protection)
- X5** – AnIO2-OR4: Assembly Group with 2 Analog Inputs, 2 Analog Outputs and 4 Output Relays
- X6** – TU: Card with 4 voltage transformer measuring inputs (0 ... 800 VAC, under UL: 0 ... 600 VAC)
- X102** – Universal Resistance-Temperature Detector (URTD) input, Fiber optics interface, Versatile Link
- X103** – Modbus RTU / IEC 60870-5-103 / DNP3.0 RTU, RS485, Terminals
- X104** – IRIG-B00X, incl. System Contact (Supervision Contact)

MCDGV4-2B0BCA

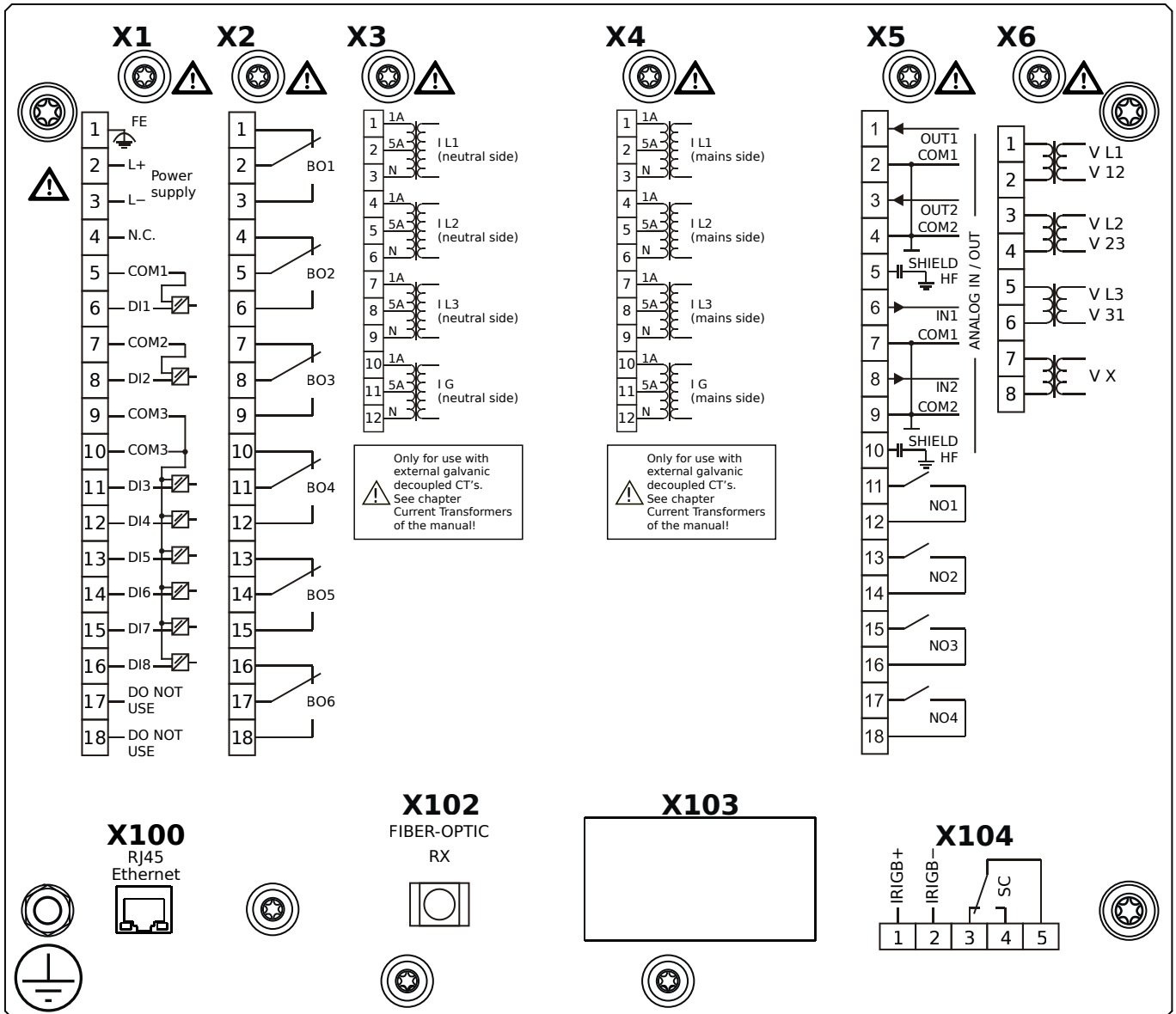

Housing B2, large display, 19" rack mounting

- X1** – DI8-X1: Wide-range power supply unit, incl. 2 non-grouped digital inputs and 6 grouped digital inputs
- X2** – OR6: Assembly Group with 6 Output Relays (Changeover / Form C)
- X3** – TI: Standard current measuring card (for the neutral side of the differential protection)
- X4** – TI: Standard current measuring card (for the mains side of the differential protection)
- X5** – AnIO2-OR4: Assembly Group with 2 Analog Inputs, 2 Analog Outputs and 4 Output Relays
- X6** – TU: Card with 4 voltage transformer measuring inputs (0 ... 800 VAC, under UL: 0 ... 600 VAC)
- X100** – Modbus TCP / DNP3.0 TCP/UDP, Ethernet interface, 100 Mbit/s, RJ45 (BASE100-FX)
- X102** – Universal Resistance-Temperature Detector (URTD) input, Fiber optics interface, Versatile Link
- X104** – IRIG-B00X, incl. System Contact (Supervision Contact)

MCDGV4-2B0BCB

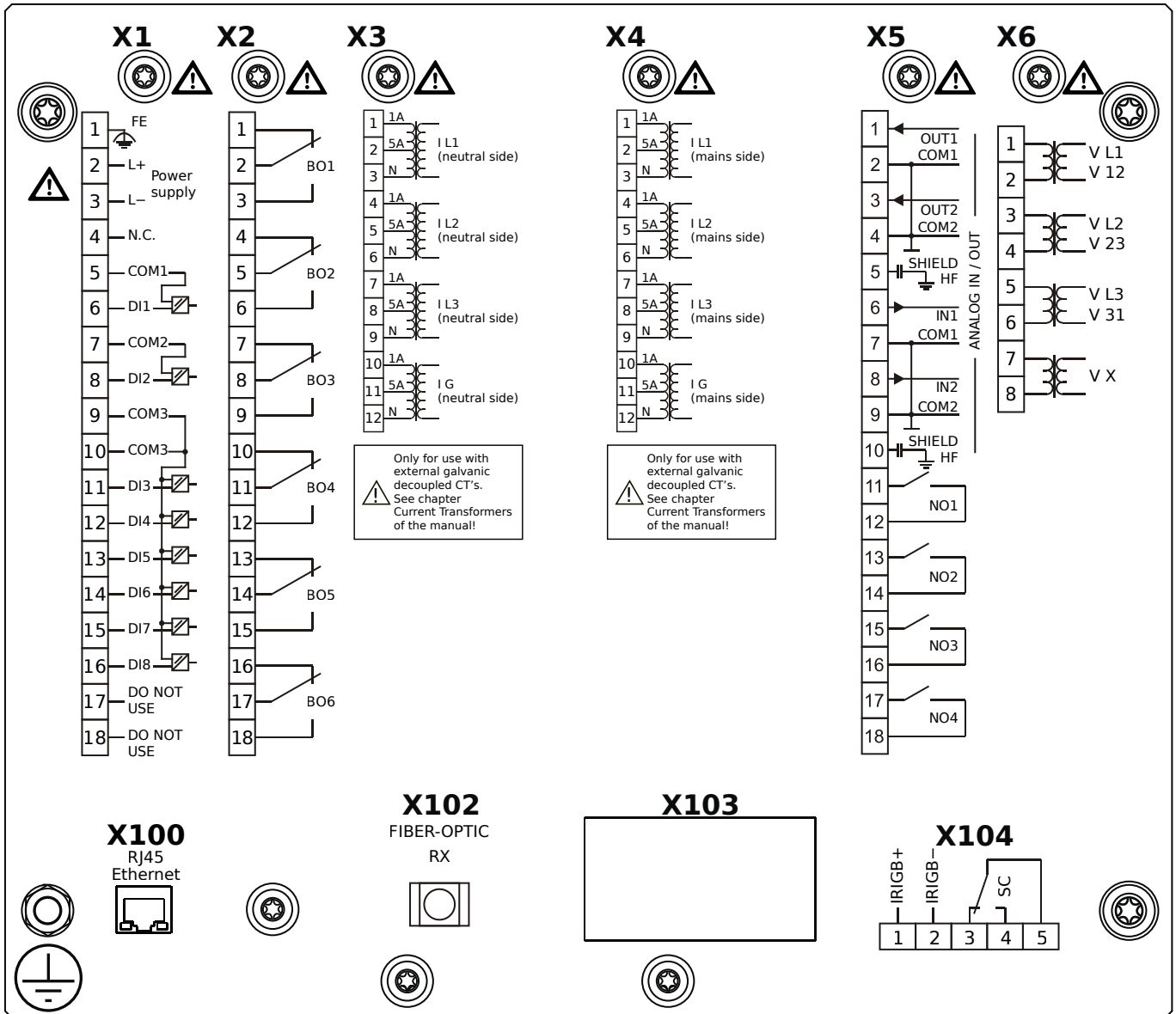

Housing B2, large display, 19" rack mounting

+ Conformal Coating (for installations in harsh environment)

- X1** – DI8-X1: Wide-range power supply unit, incl. 2 non-grouped digital inputs and 6 grouped digital inputs
- X2** – OR6: Assembly Group with 6 Output Relays (Changeover / Form C)
- X3** – TI: Standard current measuring card (for the neutral side of the differential protection)
- X4** – TI: Standard current measuring card (for the mains side of the differential protection)
- X5** – AnIO2-OR4: Assembly Group with 2 Analog Inputs, 2 Analog Outputs and 4 Output Relays
- X6** – TU: Card with 4 voltage transformer measuring inputs (0 ... 800 VAC, under UL: 0 ... 600 VAC)
- X100** – Modbus TCP / DNP3.0 TCP/UDP, Ethernet interface, 100 Mbit/s, RJ45 (BASE100-FX)
- X102** – Universal Resistance-Temperature Detector (URTD) input, Fiber optics interface, Versatile Link
- X104** – IRIG-B00X, incl. System Contact (Supervision Contact)

MCDGV4-2B0BDA

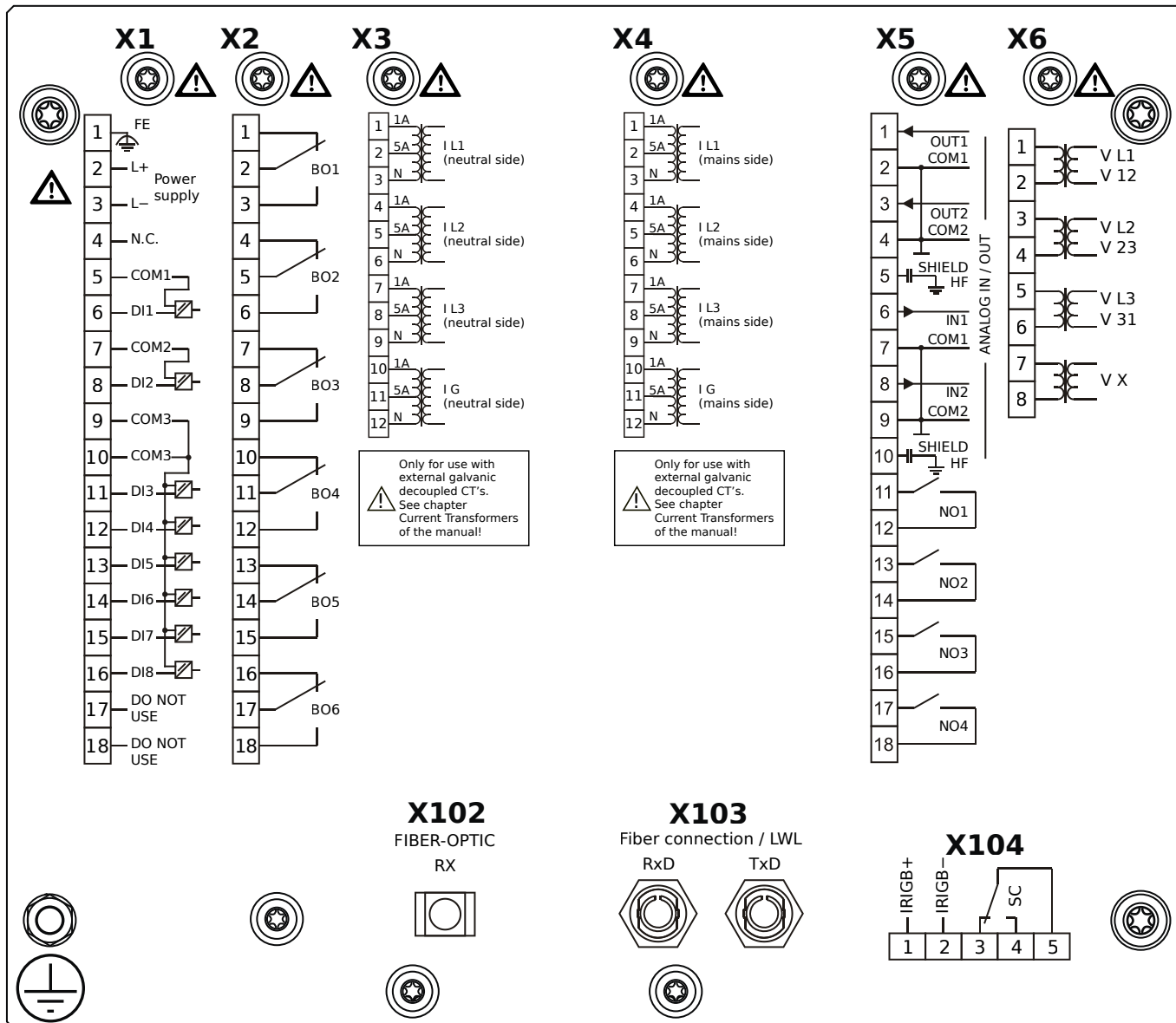

Housing B2, large display, 19" rack mounting

- X1** – DI8-X1: Wide-range power supply unit, incl. 2 non-grouped digital inputs and 6 grouped digital inputs
- X2** – OR6: Assembly Group with 6 Output Relays (Changeover / Form C)
- X3** – TI: Standard current measuring card (for the neutral side of the differential protection)
- X4** – TI: Standard current measuring card (for the mains side of the differential protection)
- X5** – AnIO2-OR4: Assembly Group with 2 Analog Inputs, 2 Analog Outputs and 4 Output Relays
- X6** – TU: Card with 4 voltage transformer measuring inputs (0 ... 800 VAC, under UL: 0 ... 600 VAC)
- X102** – Universal Resistance-Temperature Detector (URTD) input, Fiber optics interface, Versatile Link
- X103** – Profibus-DP, Fiber optics interface, ST Connector
- X104** – IRIG-B00X, incl. System Contact (Supervision Contact)

MCDGV4-2B0BDB

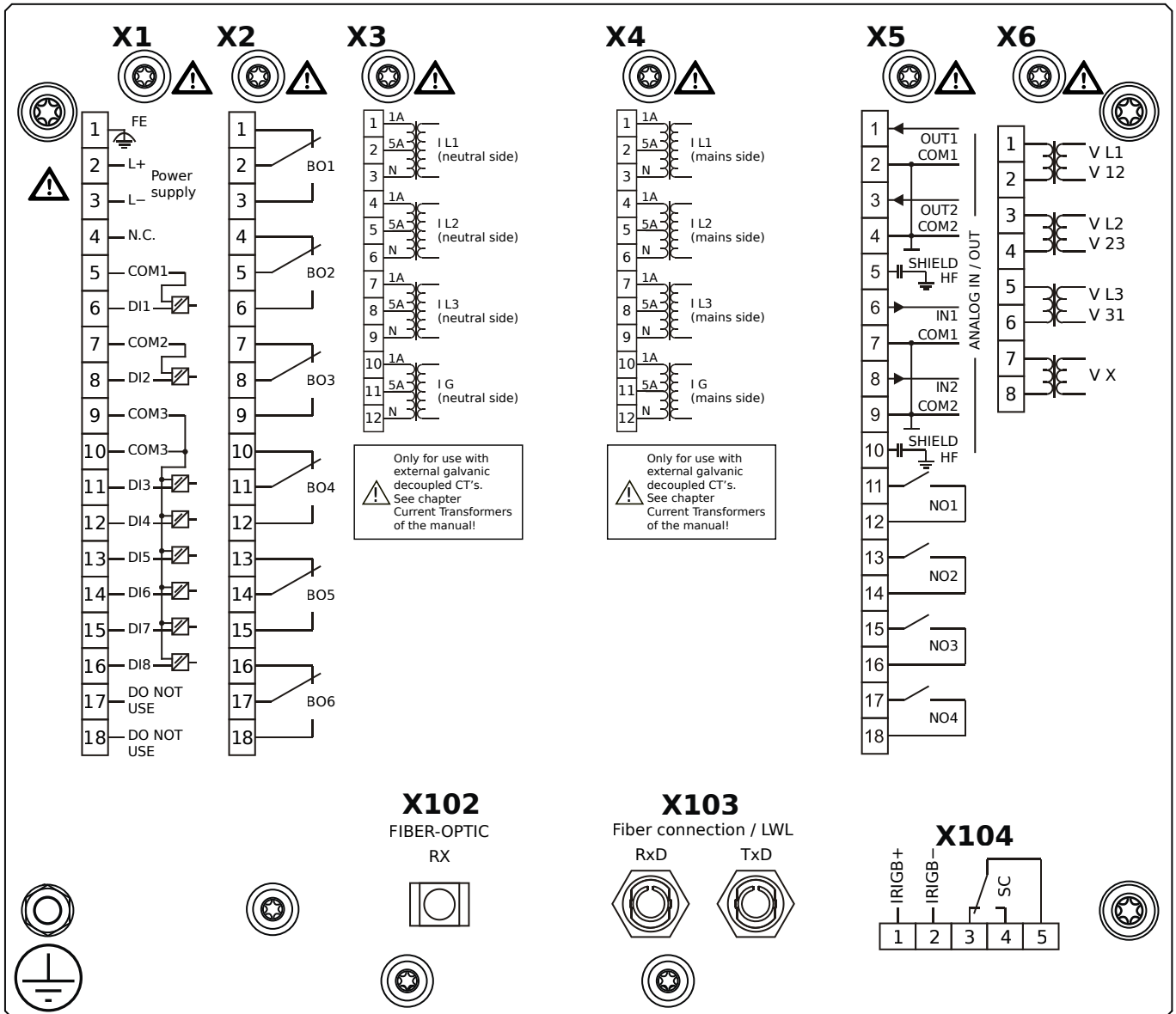

Housing B2, large display, 19" rack mounting

+ Conformal Coating (for installations in harsh environment)

- X1** – DI8-X1: Wide-range power supply unit, incl. 2 non-grouped digital inputs and 6 grouped digital inputs
- X2** – OR6: Assembly Group with 6 Output Relays (Changeover / Form C)
- X3** – TI: Standard current measuring card (for the neutral side of the differential protection)
- X4** – TI: Standard current measuring card (for the mains side of the differential protection)
- X5** – AnIO2-OR4: Assembly Group with 2 Analog Inputs, 2 Analog Outputs and 4 Output Relays
- X6** – TU: Card with 4 voltage transformer measuring inputs (0 ... 800 VAC, under UL: 0 ... 600 VAC)
- X102** – Universal Resistance-Temperature Detector (URTD) input, Fiber optics interface, Versatile Link
- X103** – Profibus-DP, Fiber optics interface, ST Connector
- X104** – IRIG-B00X, incl. System Contact (Supervision Contact)

MCDGV4-2B0BEA

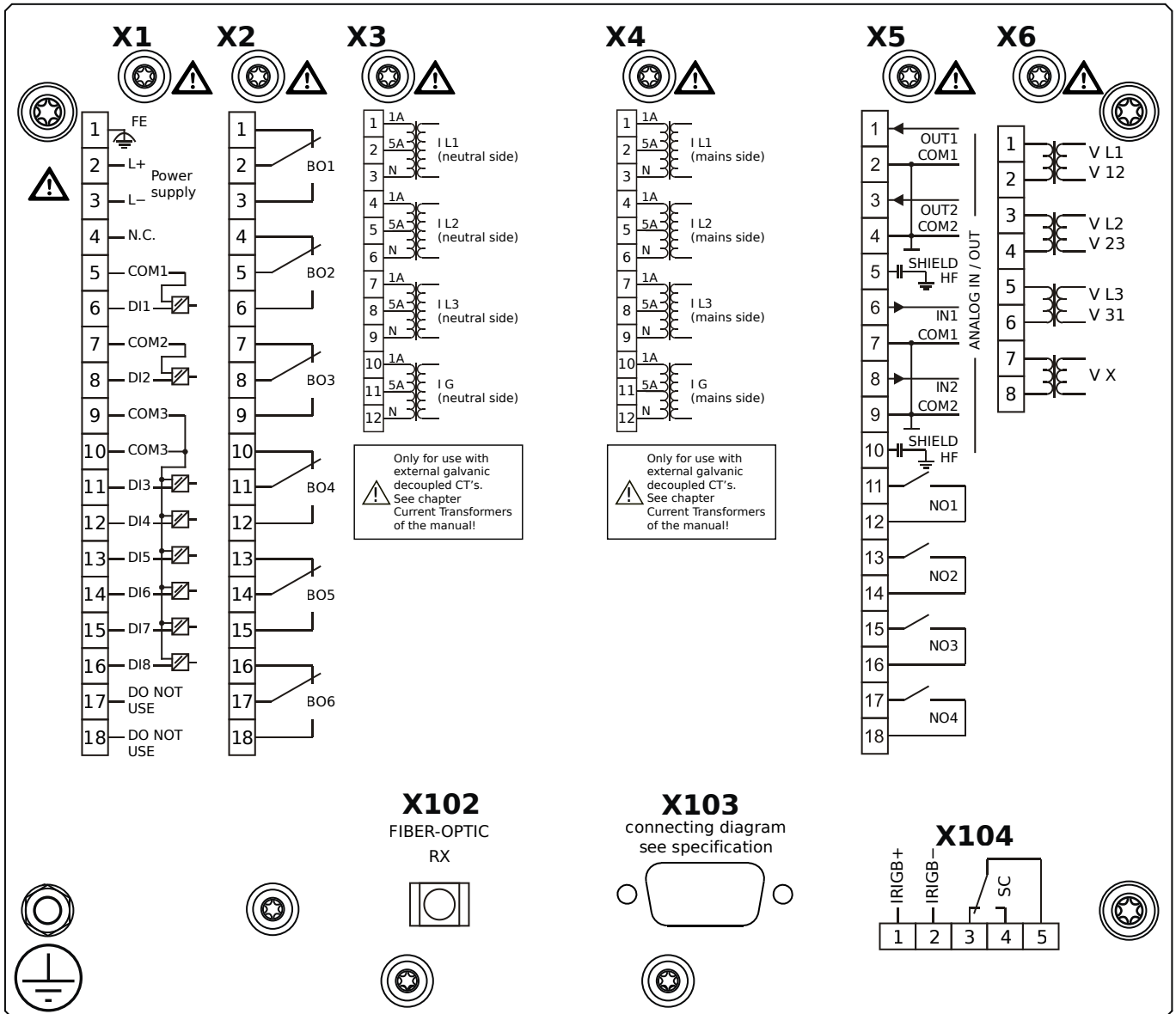

Housing B2, large display, 19" rack mounting

- X1** – DI8-X1: Wide-range power supply unit, incl. 2 non-grouped digital inputs and 6 grouped digital inputs
- X2** – OR6: Assembly Group with 6 Output Relays (Changeover / Form C)
- X3** – TI: Standard current measuring card (for the neutral side of the differential protection)
- X4** – TI: Standard current measuring card (for the mains side of the differential protection)
- X5** – AnIO2-OR4: Assembly Group with 2 Analog Inputs, 2 Analog Outputs and 4 Output Relays
- X6** – TU: Card with 4 voltage transformer measuring inputs (0 ... 800 VAC, under UL: 0 ... 600 VAC)
- X102** – Universal Resistance-Temperature Detector (URTD) input, Fiber optics interface, Versatile Link
- X103** – Profibus-DP, RS485, D-SUB
- X104** – IRIG-B00X, incl. System Contact (Supervision Contact)

MCDGV4-2B0BEB

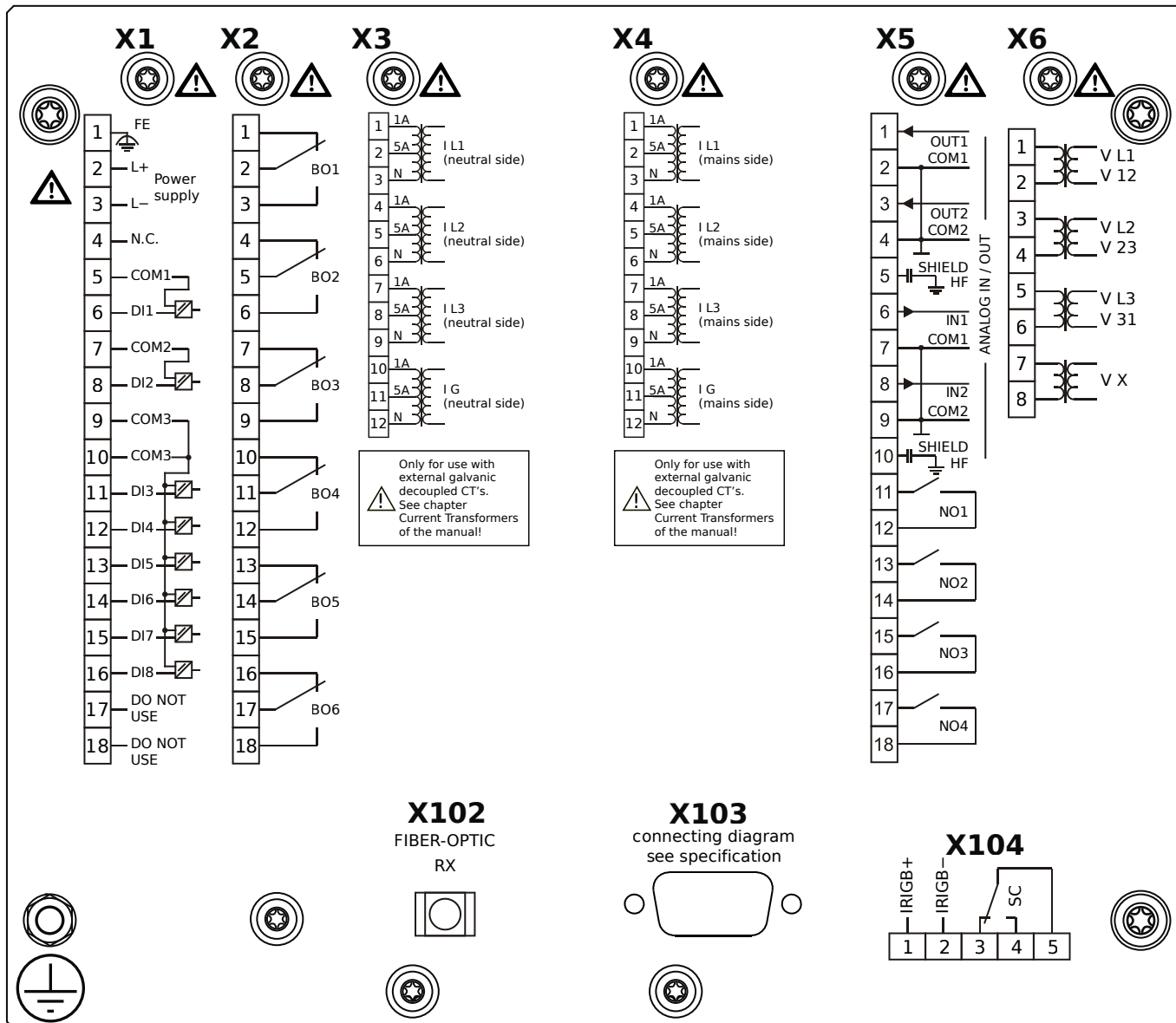

Housing B2, large display, 19" rack mounting

- + Conformal Coating (for installations in harsh environment)

- X1** – DI8-X1: Wide-range power supply unit, incl. 2 non-grouped digital inputs and 6 grouped digital inputs
- X2** – OR6: Assembly Group with 6 Output Relays (Changeover / Form C)
- X3** – TI: Standard current measuring card (for the neutral side of the differential protection)
- X4** – TI: Standard current measuring card (for the mains side of the differential protection)
- X5** – AnIO2-OR4: Assembly Group with 2 Analog Inputs, 2 Analog Outputs and 4 Output Relays
- X6** – TU: Card with 4 voltage transformer measuring inputs (0 ... 800 VAC, under UL: 0 ... 600 VAC)
- X102** – Universal Resistance-Temperature Detector (URTD) input, Fiber optics interface, Versatile Link
- X103** – Profibus-DP, RS485, D-SUB
- X104** – IRIG-B00X, incl. System Contact (Supervision Contact)

MCDGV4-2B0BFA

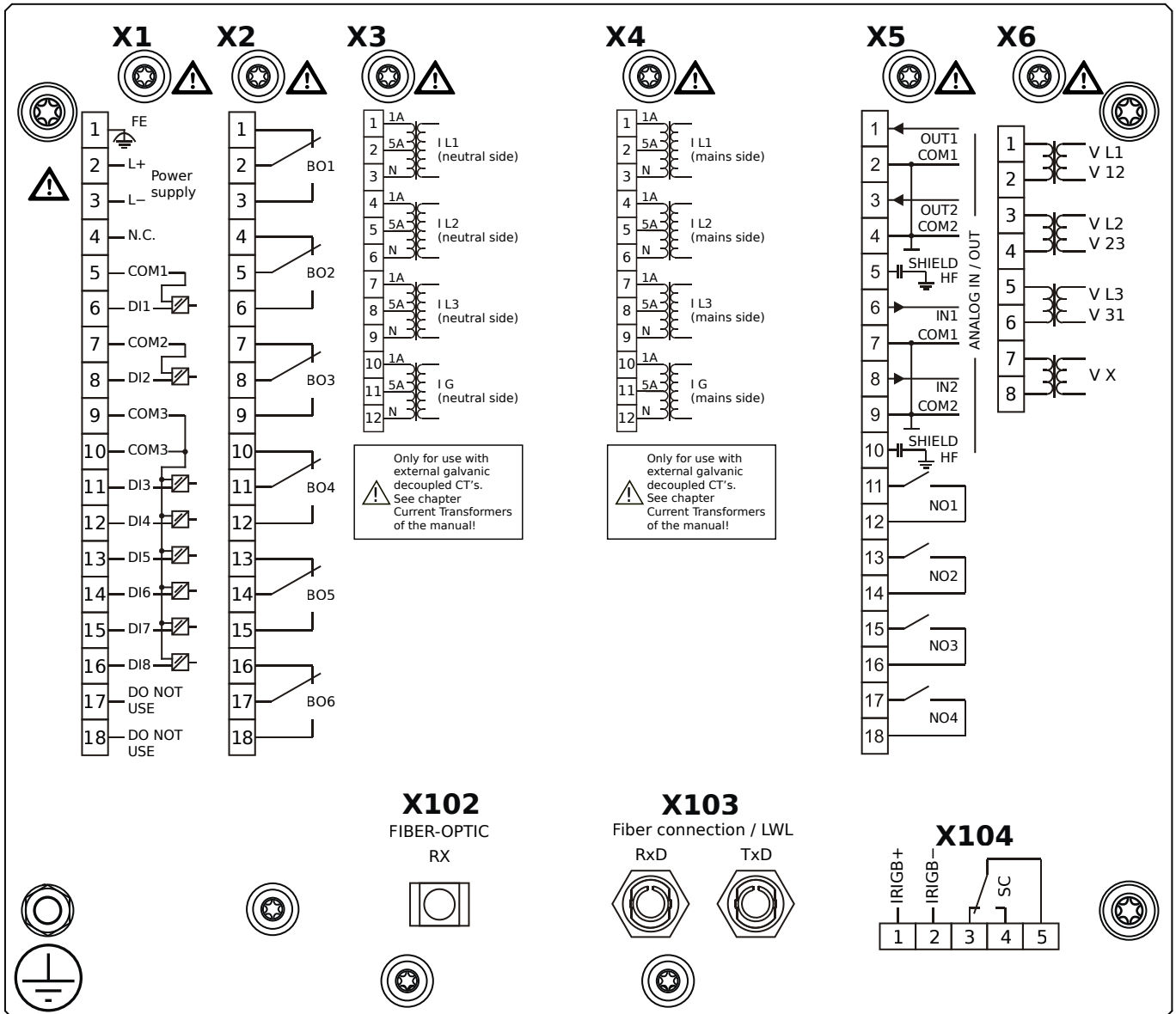

Housing B2, large display, 19" rack mounting

- X1** – DI8-X1: Wide-range power supply unit, incl. 2 non-grouped digital inputs and 6 grouped digital inputs
- X2** – OR6: Assembly Group with 6 Output Relays (Changeover / Form C)
- X3** – TI: Standard current measuring card (for the neutral side of the differential protection)
- X4** – TI: Standard current measuring card (for the mains side of the differential protection)
- X5** – AnIO2-OR4: Assembly Group with 2 Analog Inputs, 2 Analog Outputs and 4 Output Relays
- X6** – TU: Card with 4 voltage transformer measuring inputs (0 ... 800 VAC, under UL: 0 ... 600 VAC)
- X102** – Universal Resistance-Temperature Detector (URTD) input, Fiber optics interface, Versatile Link
- X103** – Modbus RTU / IEC 60870-5-103 / DNP3.0 RTU, Fiber optics interface, ST Connector
- X104** – IRIG-B00X, incl. System Contact (Supervision Contact)

MCDGV4-2B0BFB

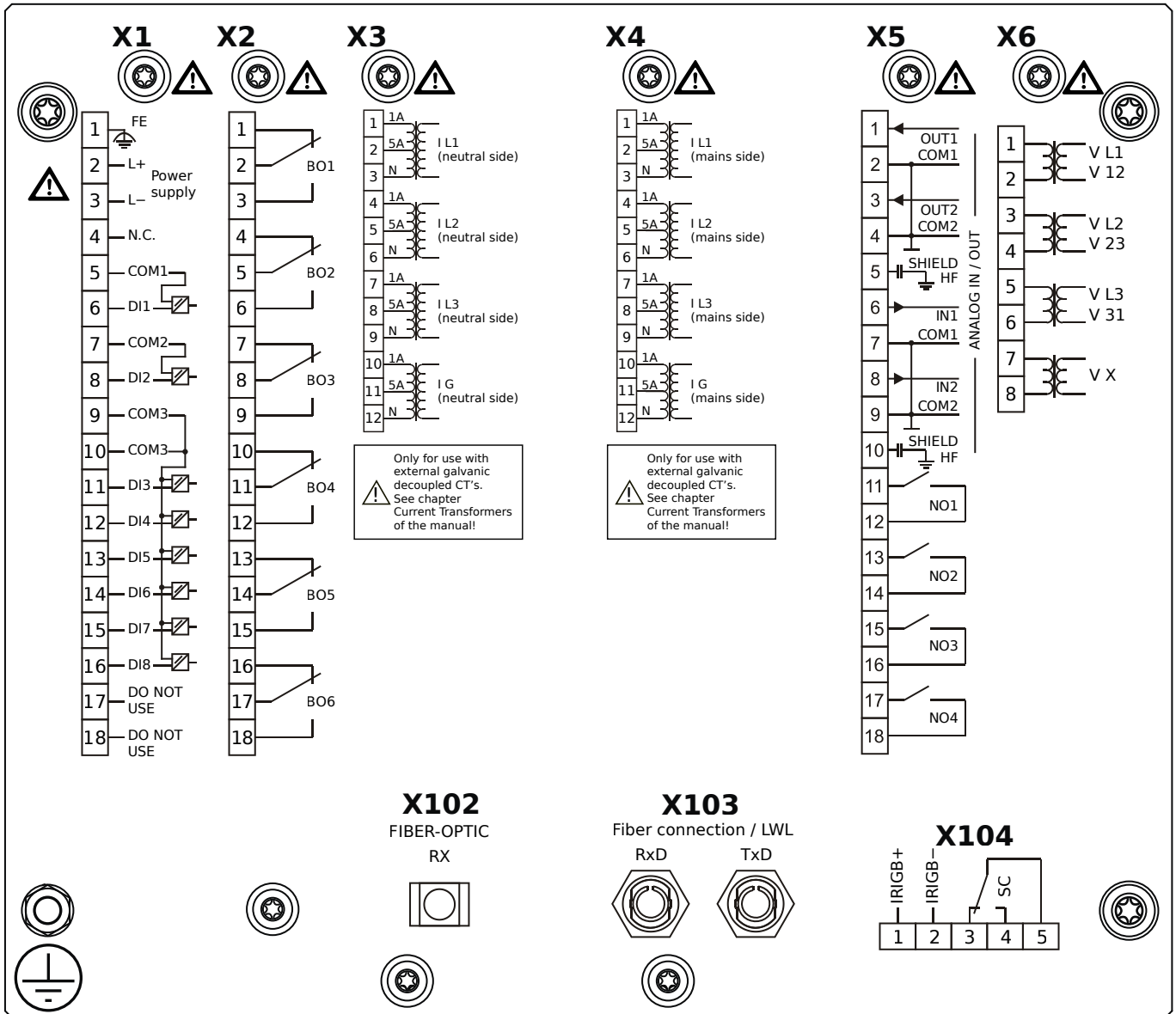

Housing B2, large display, 19" rack mounting

+ Conformal Coating (for installations in harsh environment)

- X1** – DI8-X1: Wide-range power supply unit, incl. 2 non-grouped digital inputs and 6 grouped digital inputs
- X2** – OR6: Assembly Group with 6 Output Relays (Changeover / Form C)
- X3** – TI: Standard current measuring card (for the neutral side of the differential protection)
- X4** – TI: Standard current measuring card (for the mains side of the differential protection)
- X5** – AnIO2-OR4: Assembly Group with 2 Analog Inputs, 2 Analog Outputs and 4 Output Relays
- X6** – TU: Card with 4 voltage transformer measuring inputs (0 ... 800 VAC, under UL: 0 ... 600 VAC)
- X102** – Universal Resistance-Temperature Detector (URTD) input, Fiber optics interface, Versatile Link
- X103** – Modbus RTU / IEC 60870-5-103 / DNP3.0 RTU, Fiber optics interface, ST Connector
- X104** – IRIG-B00X, incl. System Contact (Supervision Contact)

MCDGV4-2B0BGA

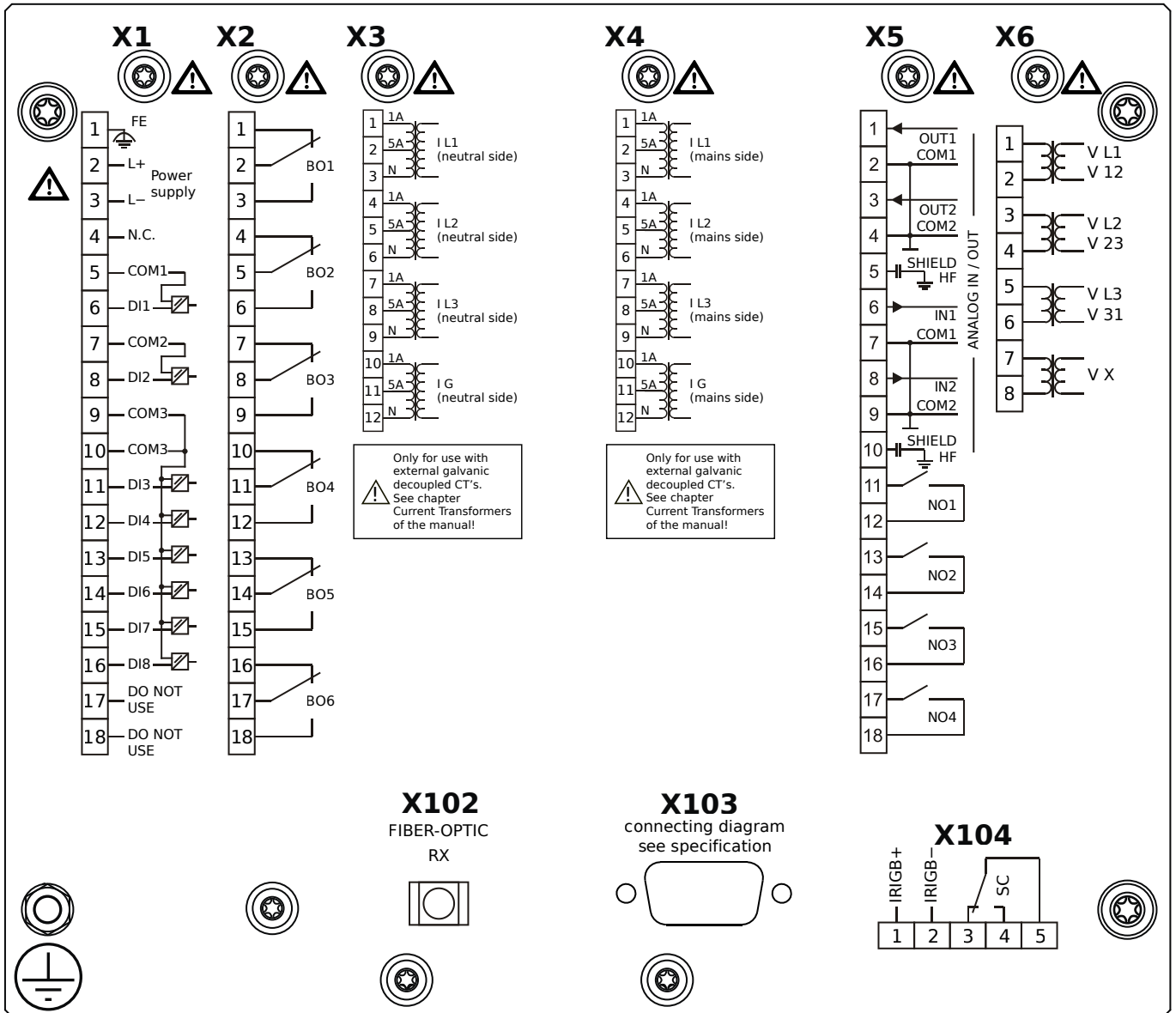

Housing B2, large display, 19" rack mounting

- X1** – DI8-X1: Wide-range power supply unit, incl. 2 non-grouped digital inputs and 6 grouped digital inputs
- X2** – OR6: Assembly Group with 6 Output Relays (Changeover / Form C)
- X3** – TI: Standard current measuring card (for the neutral side of the differential protection)
- X4** – TI: Standard current measuring card (for the mains side of the differential protection)
- X5** – AnIO2-OR4: Assembly Group with 2 Analog Inputs, 2 Analog Outputs and 4 Output Relays
- X6** – TU: Card with 4 voltage transformer measuring inputs (0 ... 800 VAC, under UL: 0 ... 600 VAC)
- X102** – Universal Resistance-Temperature Detector (URTD) input, Fiber optics interface, Versatile Link
- X103** – Modbus RTU / IEC 60870-5-103 / DNP3.0 RTU, RS485, D-SUB
- X104** – IRIG-B00X, incl. System Contact (Supervision Contact)

MCDGV4-2B0BGB

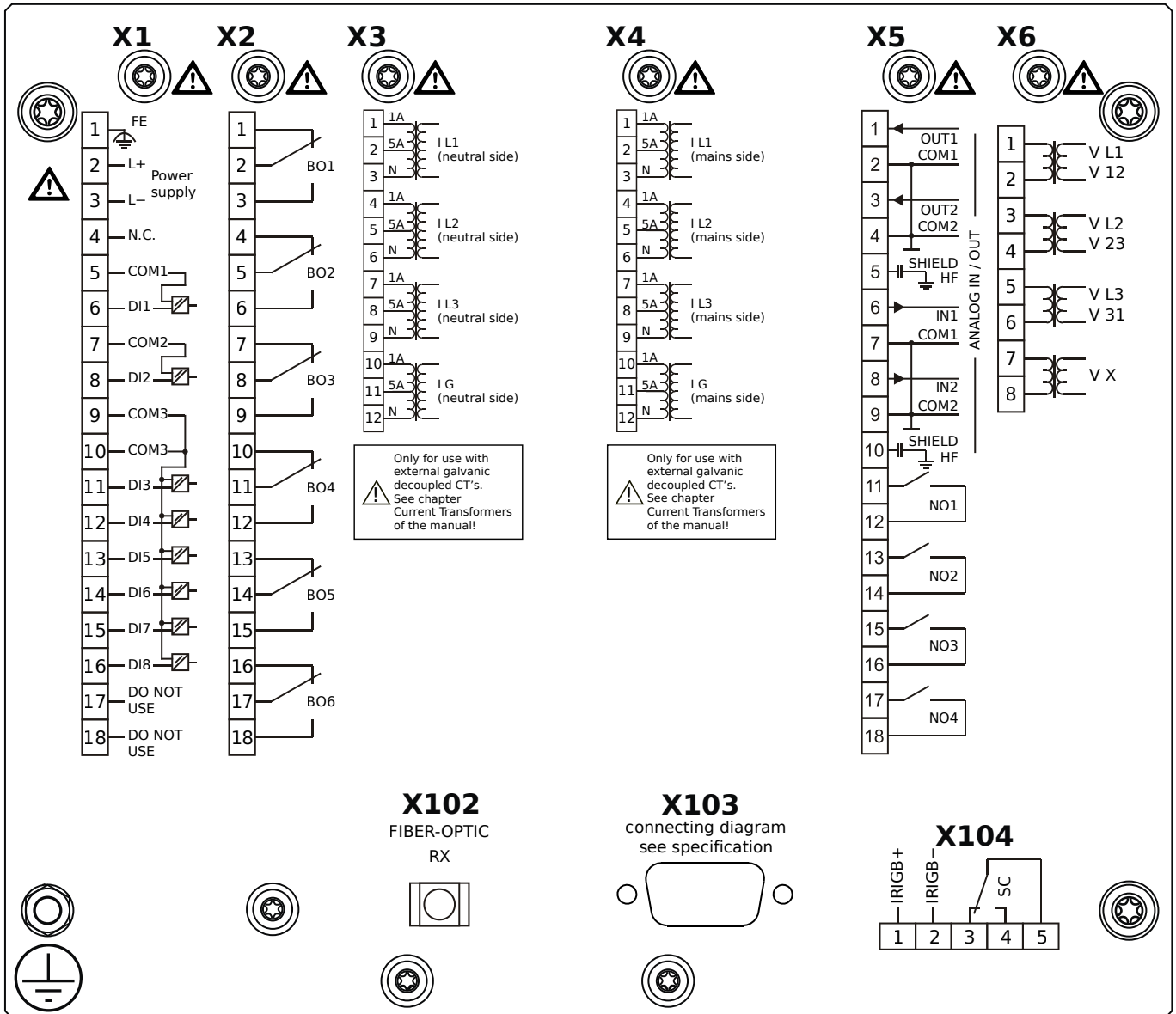

Housing B2, large display, 19" rack mounting

+ Conformal Coating (for installations in harsh environment)

- X1** – DI8-X1: Wide-range power supply unit, incl. 2 non-grouped digital inputs and 6 grouped digital inputs
- X2** – OR6: Assembly Group with 6 Output Relays (Changeover / Form C)
- X3** – TI: Standard current measuring card (for the neutral side of the differential protection)
- X4** – TI: Standard current measuring card (for the mains side of the differential protection)
- X5** – AnIO2-OR4: Assembly Group with 2 Analog Inputs, 2 Analog Outputs and 4 Output Relays
- X6** – TU: Card with 4 voltage transformer measuring inputs (0 ... 800 VAC, under UL: 0 ... 600 VAC)
- X102** – Universal Resistance-Temperature Detector (URTD) input, Fiber optics interface, Versatile Link
- X103** – Modbus RTU / IEC 60870-5-103 / DNP3.0 RTU, RS485, D-SUB
- X104** – IRIG-B00X, incl. System Contact (Supervision Contact)

MCDGV4-2B0BHA

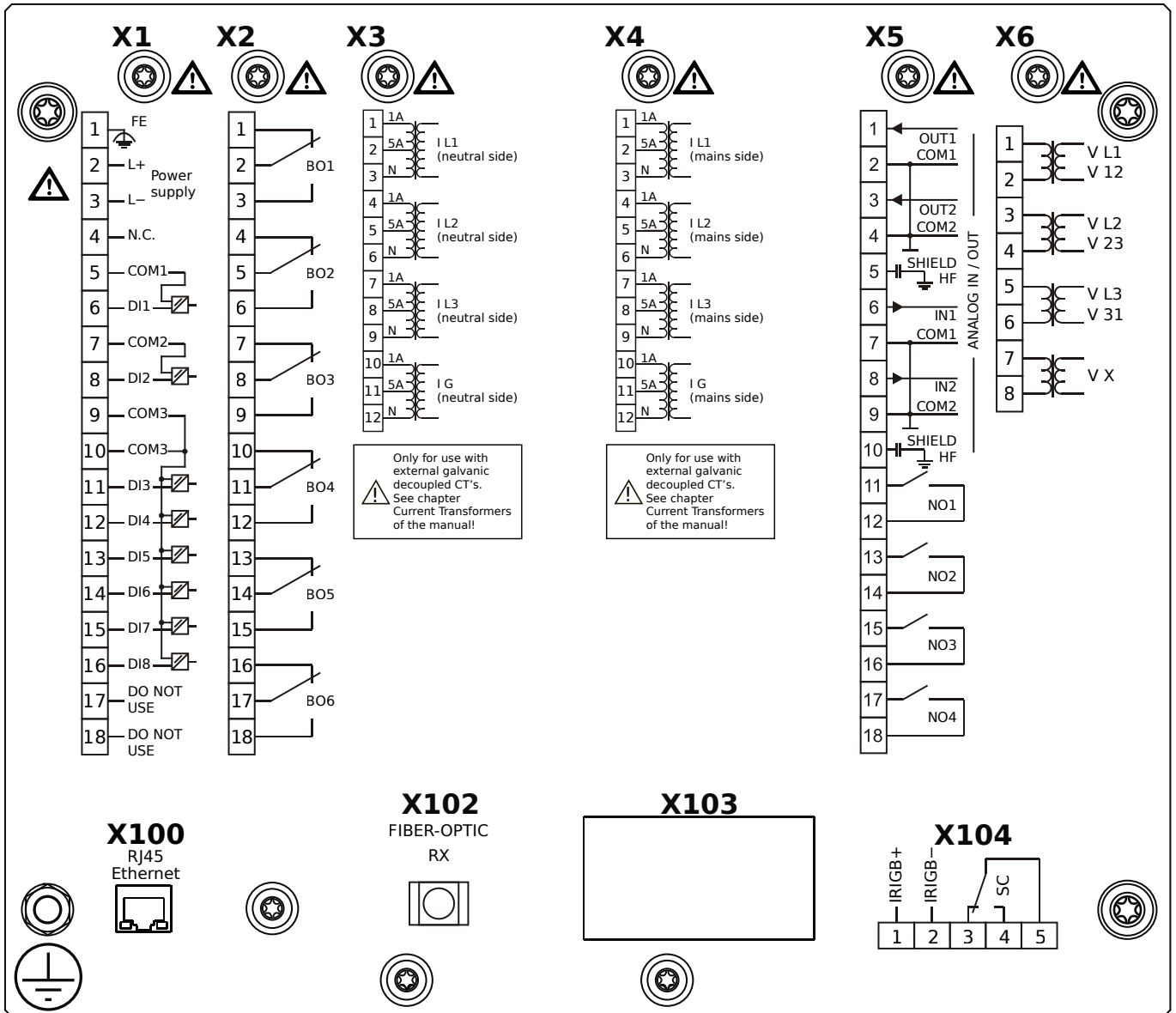

Housing B2, large display, 19" rack mounting

- X1** – DI8-X1: Wide-range power supply unit, incl. 2 non-grouped digital inputs and 6 grouped digital inputs
- X2** – OR6: Assembly Group with 6 Output Relays (Changeover / Form C)
- X3** – TI: Standard current measuring card (for the neutral side of the differential protection)
- X4** – TI: Standard current measuring card (for the mains side of the differential protection)
- X5** – AnIO2-OR4: Assembly Group with 2 Analog Inputs, 2 Analog Outputs and 4 Output Relays
- X6** – TU: Card with 4 voltage transformer measuring inputs (0 ... 800 VAC, under UL: 0 ... 600 VAC)
- X100** – IEC 61850 / Modbus TCP / DNP3.0 TCP/UDP, Ethernet interface, 100 Mbit/s, RJ45 (BASE100-FX)
- X102** – Universal Resistance-Temperature Detector (URTD) input, Fiber optics interface, Versatile Link
- X104** – IRIG-B00X, incl. System Contact (Supervision Contact)

MCDGV4-2B0BHB

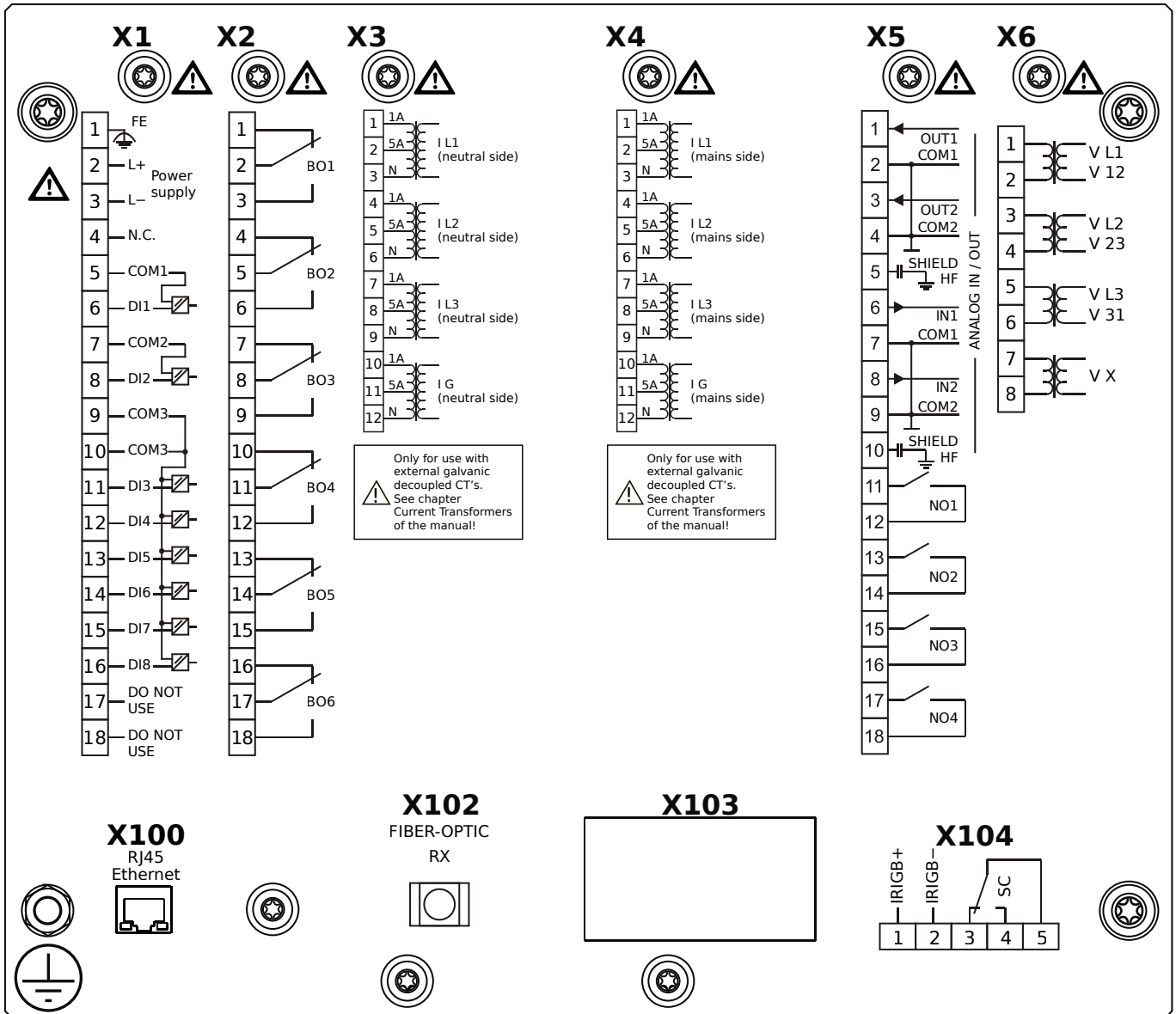

Housing B2, large display, 19" rack mounting

+ Conformal Coating (for installations in harsh environment)

- X1** – DI8-X1: Wide-range power supply unit, incl. 2 non-grouped digital inputs and 6 grouped digital inputs
- X2** – OR6: Assembly Group with 6 Output Relays (Changeover / Form C)
- X3** – TI: Standard current measuring card (for the neutral side of the differential protection)
- X4** – TI: Standard current measuring card (for the mains side of the differential protection)
- X5** – AnIO2-OR4: Assembly Group with 2 Analog Inputs, 2 Analog Outputs and 4 Output Relays
- X6** – TU: Card with 4 voltage transformer measuring inputs (0 ... 800 VAC, under UL: 0 ... 600 VAC)
- X100** – IEC 61850 / Modbus TCP / DNP3.0 TCP/UDP, Ethernet interface, 100 Mbit/s, RJ45 (BASE100-FX)
- X102** – Universal Resistance-Temperature Detector (URTD) input, Fiber optics interface, Versatile Link
- X104** – IRIG-B00X, incl. System Contact (Supervision Contact)

MCDGV4-2B0BIA

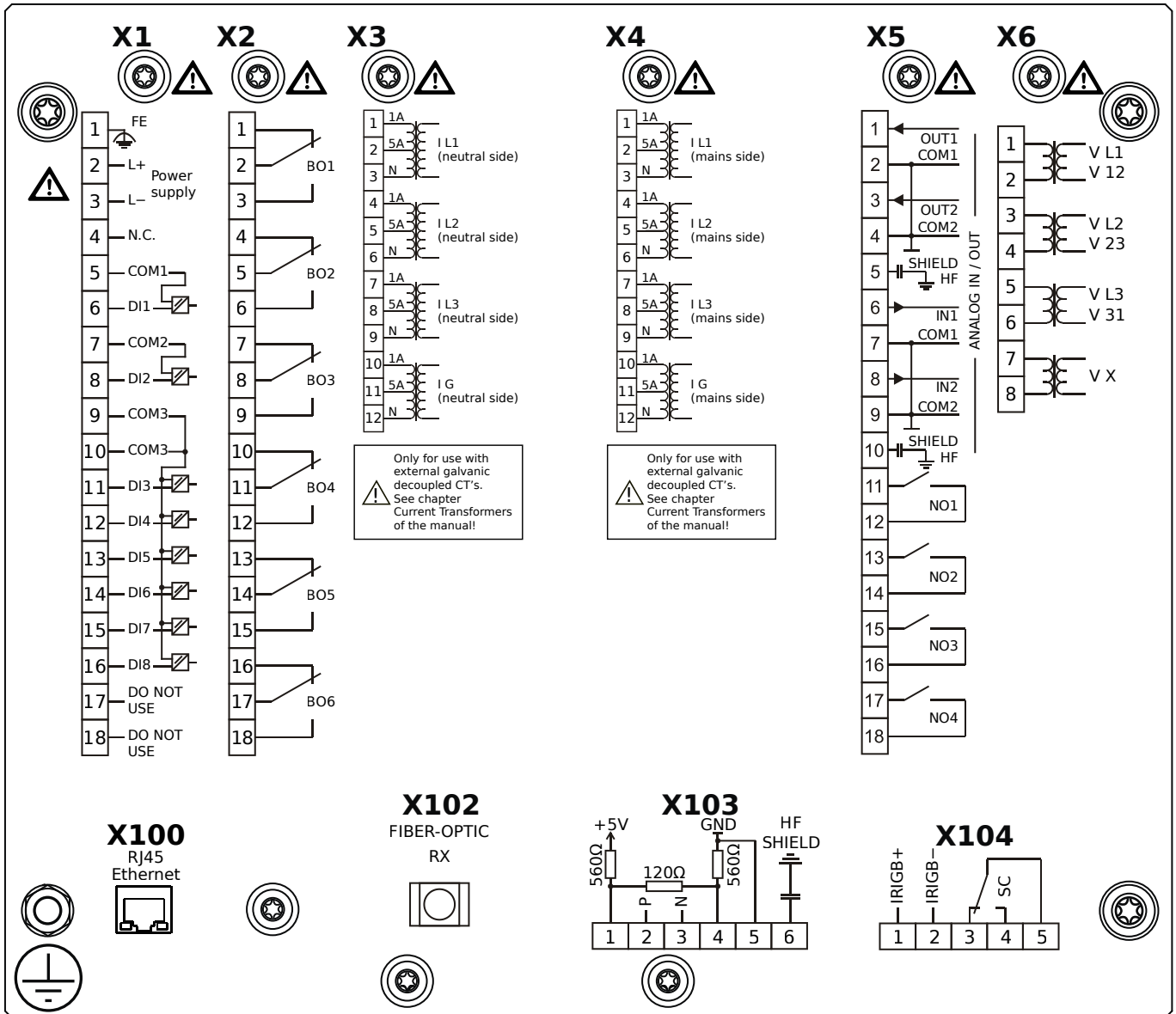

Housing B2, large display, 19" rack mounting

- X1** – DI8-X1: Wide-range power supply unit, incl. 2 non-grouped digital inputs and 6 grouped digital inputs
- X2** – OR6: Assembly Group with 6 Output Relays (Changeover / Form C)
- X3** – TI: Standard current measuring card (for the neutral side of the differential protection)
- X4** – TI: Standard current measuring card (for the mains side of the differential protection)
- X5** – AnIO2-OR4: Assembly Group with 2 Analog Inputs, 2 Analog Outputs and 4 Output Relays
- X6** – TU: Card with 4 voltage transformer measuring inputs (0 ... 800 VAC, under UL: 0 ... 600 VAC)
- X100** – Modbus TCP / DNP3.0 TCP/UDP, Ethernet interface, 100 Mbit/s, RJ45 (BASE100-FX)
- X102** – Universal Resistance-Temperature Detector (URTD) input, Fiber optics interface, Versatile Link
- X103** – IEC 60870-5-103 / Modbus RTU / DNP3.0 RTU, RS485, Terminals
- X104** – IRIG-B00X, incl. System Contact (Supervision Contact)

MCDGV4-2B0BIB

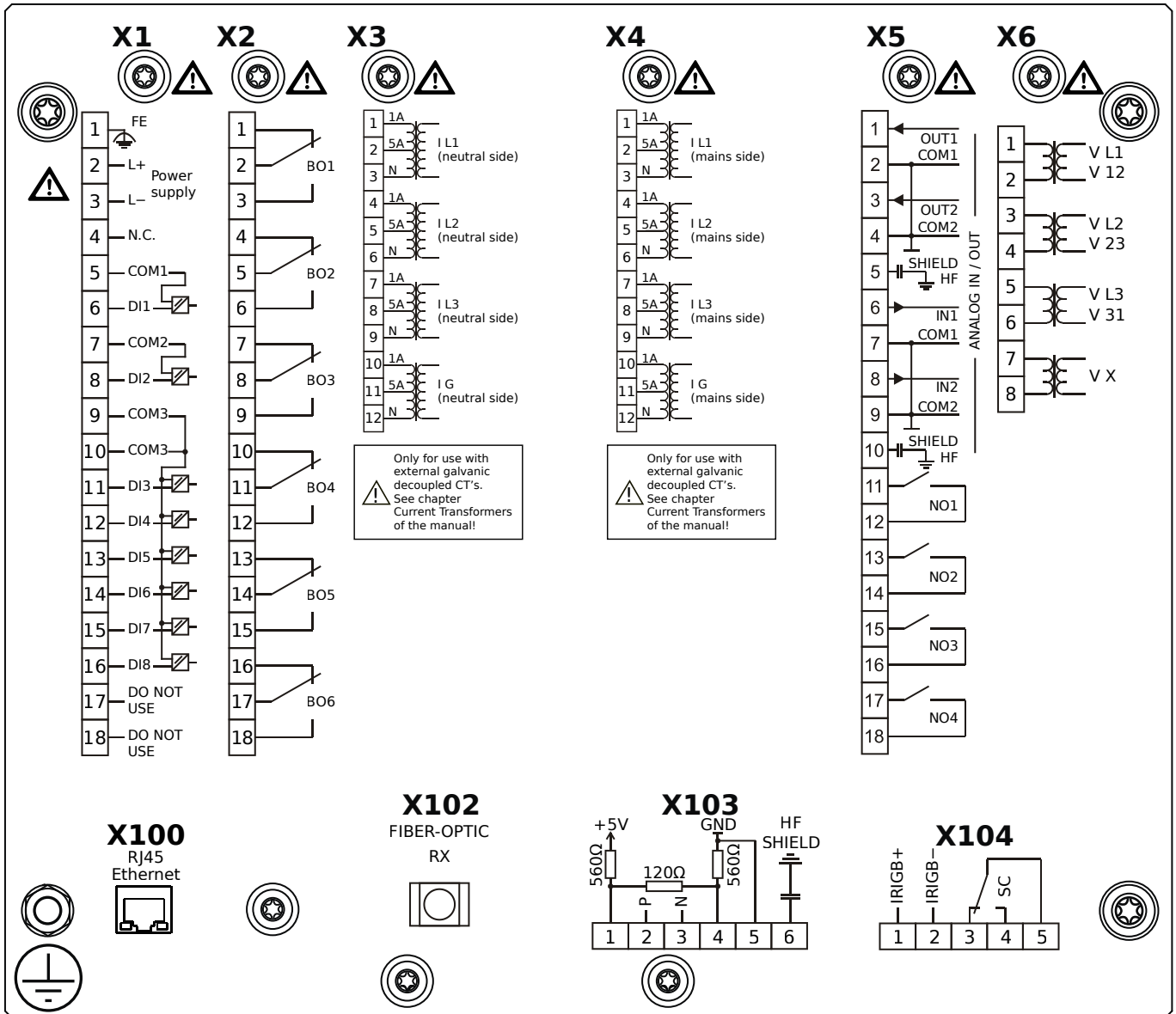

Housing B2, large display, 19" rack mounting

- + Conformal Coating (for installations in harsh environment)

- X1** – DI8-X1: Wide-range power supply unit, incl. 2 non-grouped digital inputs and 6 grouped digital inputs
- X2** – OR6: Assembly Group with 6 Output Relays (Changeover / Form C)
- X3** – TI: Standard current measuring card (for the neutral side of the differential protection)
- X4** – TI: Standard current measuring card (for the mains side of the differential protection)
- X5** – AnIO2-OR4: Assembly Group with 2 Analog Inputs, 2 Analog Outputs and 4 Output Relays
- X6** – TU: Card with 4 voltage transformer measuring inputs (0 ... 800 VAC, under UL: 0 ... 600 VAC)
- X100** – Modbus TCP / DNP3.0 TCP/UDP, Ethernet interface, 100 Mbit/s, RJ45 (BASE100-FX)
- X102** – Universal Resistance-Temperature Detector (URTD) input, Fiber optics interface, Versatile Link
- X103** – IEC 60870-5-103 / Modbus RTU / DNP3.0 RTU, RS485, Terminals
- X104** – IRIG-B00X, incl. System Contact (Supervision Contact)

MCDGV4-2B0BKA

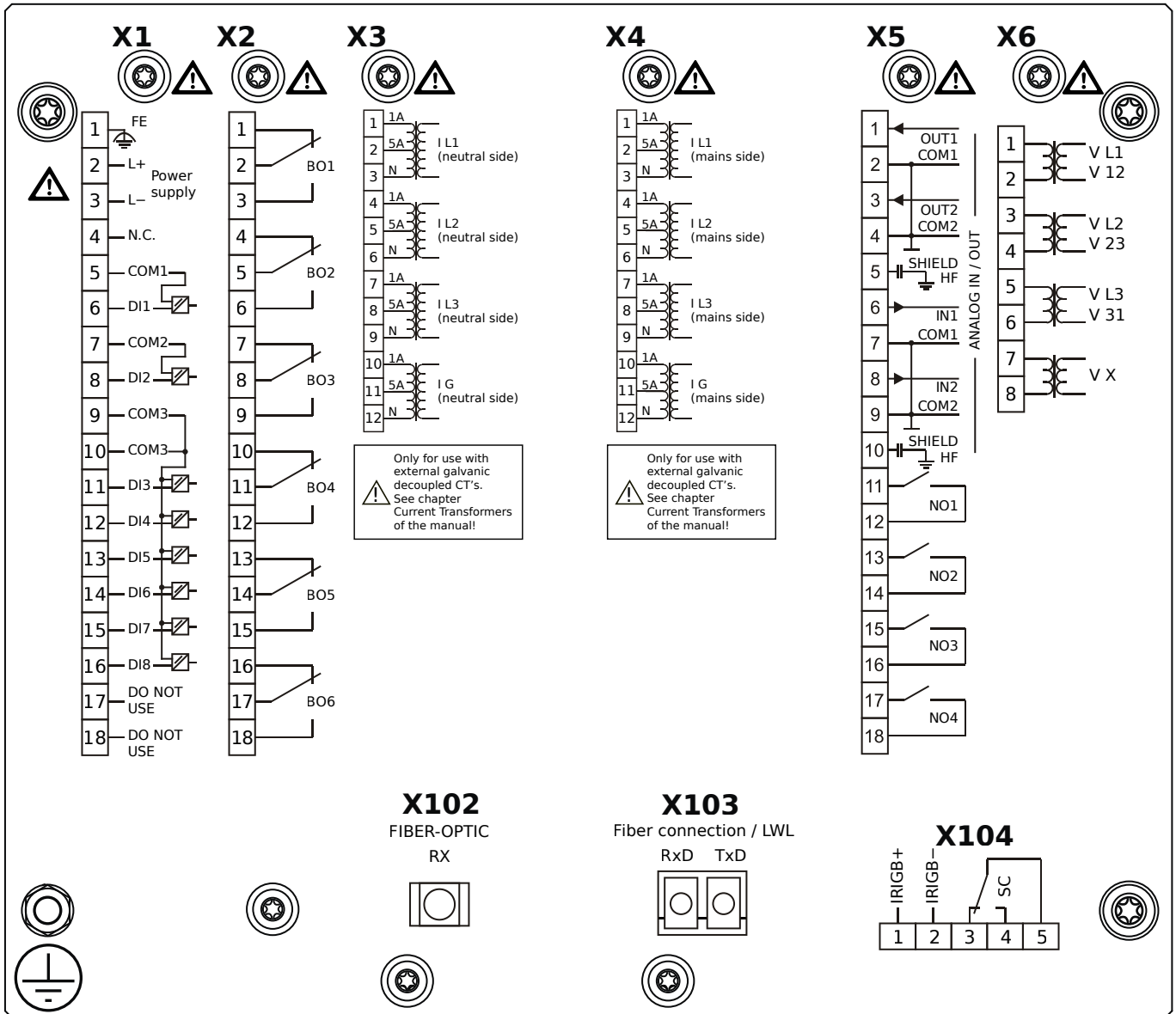

Housing B2, large display, 19" rack mounting

- X1** – DI8-X1: Wide-range power supply unit, incl. 2 non-grouped digital inputs and 6 grouped digital inputs
- X2** – OR6: Assembly Group with 6 Output Relays (Changeover / Form C)
- X3** – TI: Standard current measuring card (for the neutral side of the differential protection)
- X4** – TI: Standard current measuring card (for the mains side of the differential protection)
- X5** – AnIO2-OR4: Assembly Group with 2 Analog Inputs, 2 Analog Outputs and 4 Output Relays
- X6** – TU: Card with 4 voltage transformer measuring inputs (0 ... 800 VAC, under UL: 0 ... 600 VAC)
- X102** – Universal Resistance-Temperature Detector (URTD) input, Fiber optics interface, Versatile Link
- X103** – IEC 61850 / Modbus TCP / DNP3.0 TCP/UDP, Fiber optics interface, LC Connector
- X104** – IRIG-B00X, incl. System Contact (Supervision Contact)

MCDGV4-2B0BKB

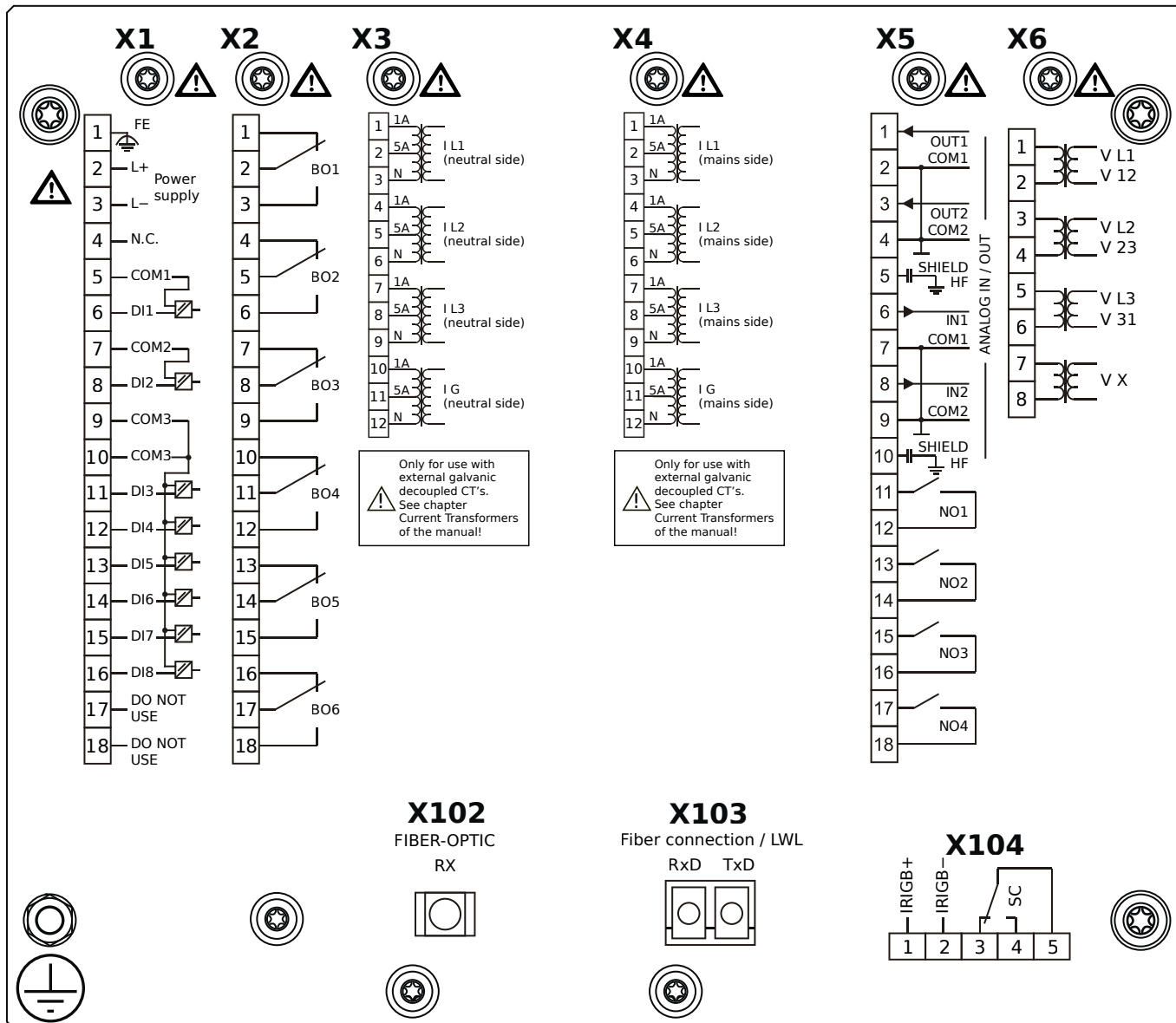

Housing B2, large display, 19" rack mounting

- + Conformal Coating (for installations in harsh environment)

- X1** – DI8-X1: Wide-range power supply unit, incl. 2 non-grouped digital inputs and 6 grouped digital inputs
- X2** – OR6: Assembly Group with 6 Output Relays (Changeover / Form C)
- X3** – TI: Standard current measuring card (for the neutral side of the differential protection)
- X4** – TI: Standard current measuring card (for the mains side of the differential protection)
- X5** – AnIO2-OR4: Assembly Group with 2 Analog Inputs, 2 Analog Outputs and 4 Output Relays
- X6** – TU: Card with 4 voltage transformer measuring inputs (0 ... 800 VAC, under UL: 0 ... 600 VAC)
- X102** – Universal Resistance-Temperature Detector (URTD) input, Fiber optics interface, Versatile Link
- X103** – IEC 61850 / Modbus TCP / DNP3.0 TCP/UDP, Fiber optics interface, LC Connector
- X104** – IRIG-B00X, incl. System Contact (Supervision Contact)

MCDGV4-2B0BLA

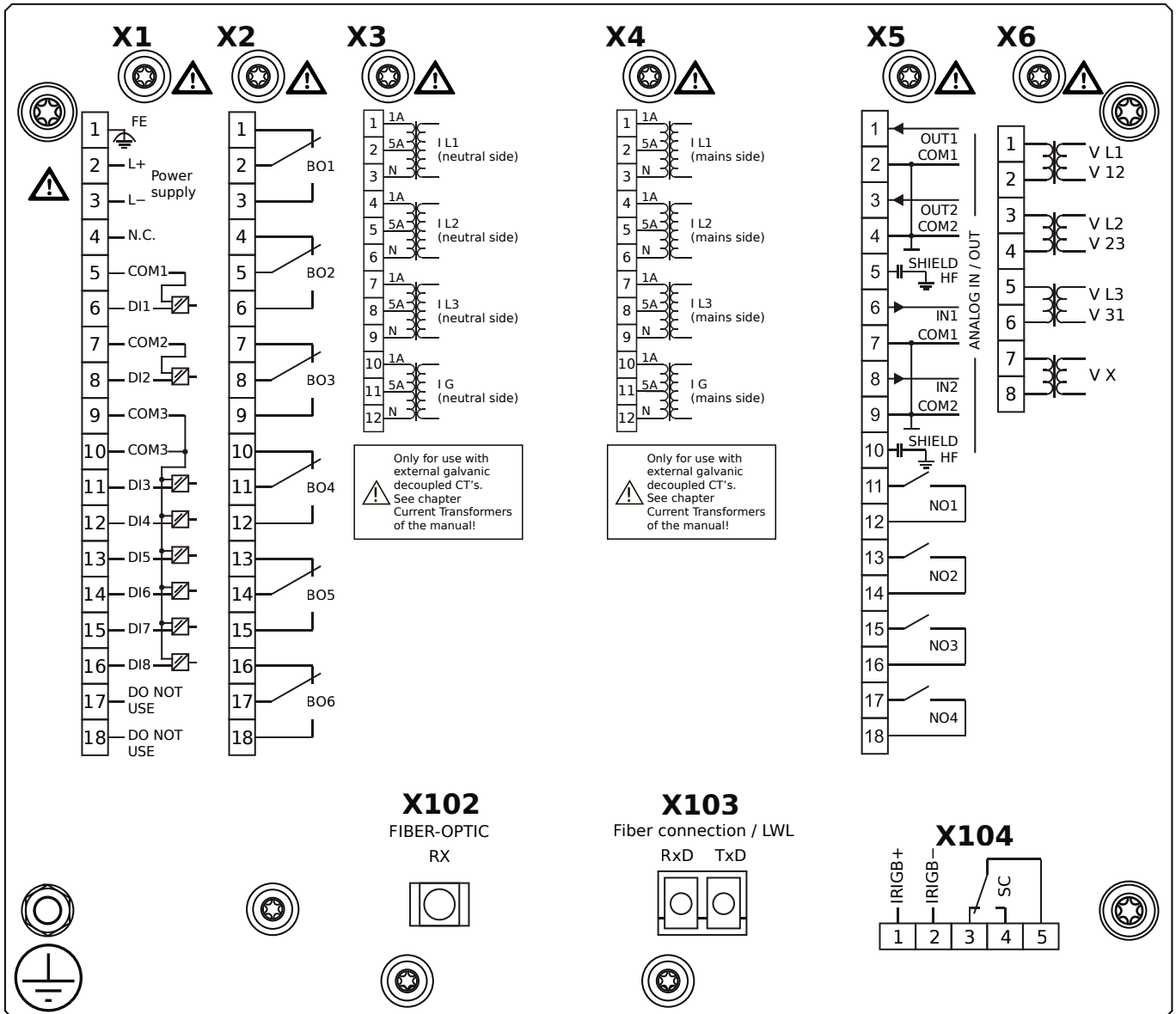

Housing B2, large display, 19" rack mounting

- X1** – DI8-X1: Wide-range power supply unit, incl. 2 non-grouped digital inputs and 6 grouped digital inputs
- X2** – OR6: Assembly Group with 6 Output Relays (Changeover / Form C)
- X3** – TI: Standard current measuring card (for the neutral side of the differential protection)
- X4** – TI: Standard current measuring card (for the mains side of the differential protection)
- X5** – AnIO2-OR4: Assembly Group with 2 Analog Inputs, 2 Analog Outputs and 4 Output Relays
- X6** – TU: Card with 4 voltage transformer measuring inputs (0 ... 800 VAC, under UL: 0 ... 600 VAC)
- X102** – Universal Resistance-Temperature Detector (URTD) input, Fiber optics interface, Versatile Link
- X103** – Modbus TCP / DNP3.0 TCP/UDP, Fiber optics interface, LC Connector
- X104** – IRIG-B00X, incl. System Contact (Supervision Contact)

MCDGV4-2B0BLB

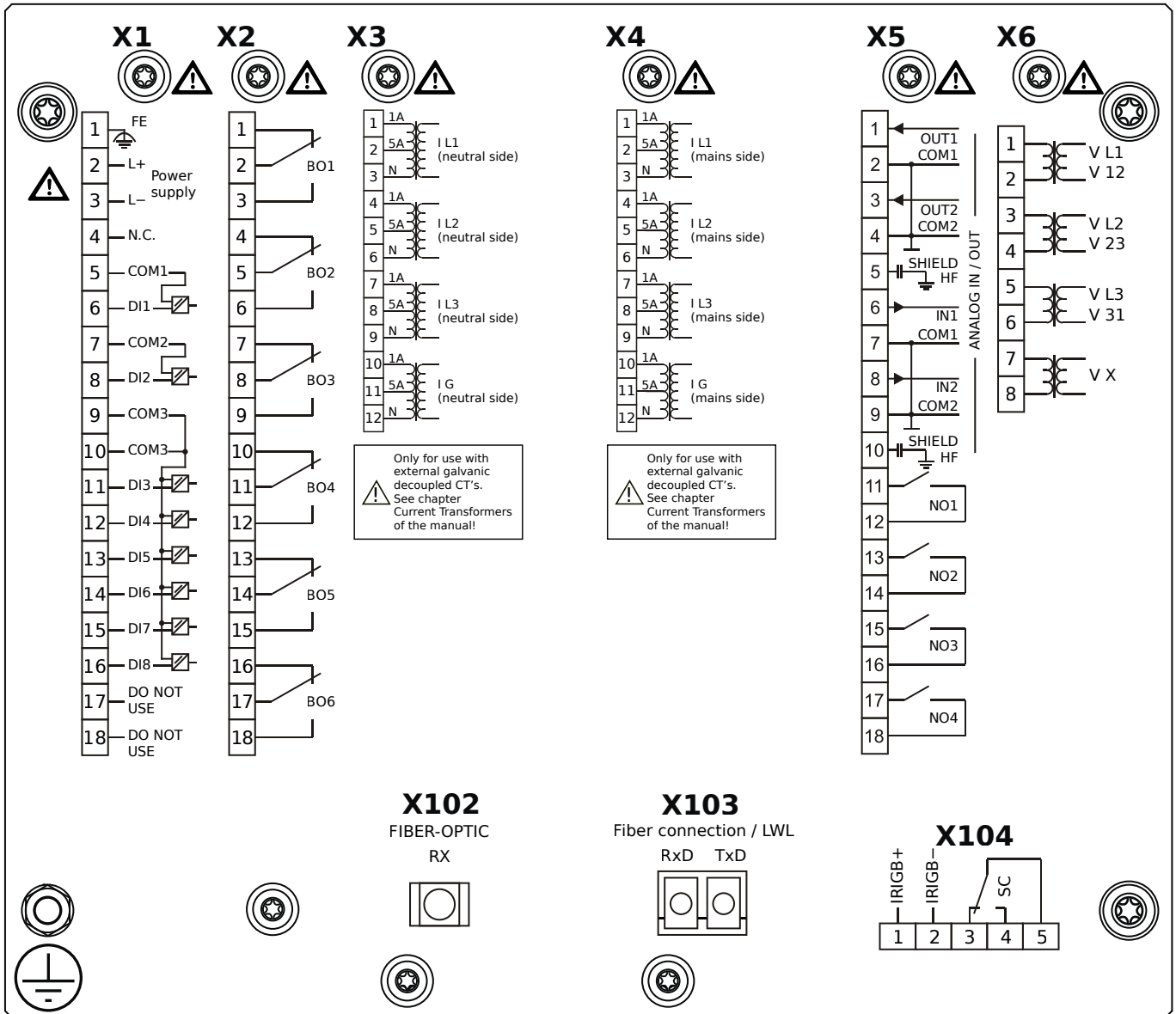

Housing B2, large display, 19" rack mounting

- + Conformal Coating (for installations in harsh environment)

- X1** – DI8-X1: Wide-range power supply unit, incl. 2 non-grouped digital inputs and 6 grouped digital inputs
- X2** – OR6: Assembly Group with 6 Output Relays (Changeover / Form C)
- X3** – TI: Standard current measuring card (for the neutral side of the differential protection)
- X4** – TI: Standard current measuring card (for the mains side of the differential protection)
- X5** – AnIO2-OR4: Assembly Group with 2 Analog Inputs, 2 Analog Outputs and 4 Output Relays
- X6** – TU: Card with 4 voltage transformer measuring inputs (0 ... 800 VAC, under UL: 0 ... 600 VAC)
- X102** – Universal Resistance-Temperature Detector (URTD) input, Fiber optics interface, Versatile Link
- X103** – Modbus TCP / DNP3.0 TCP/UDP, Fiber optics interface, LC Connector
- X104** – IRIG-B00X, incl. System Contact (Supervision Contact)

MCDGV4-2B0BTA

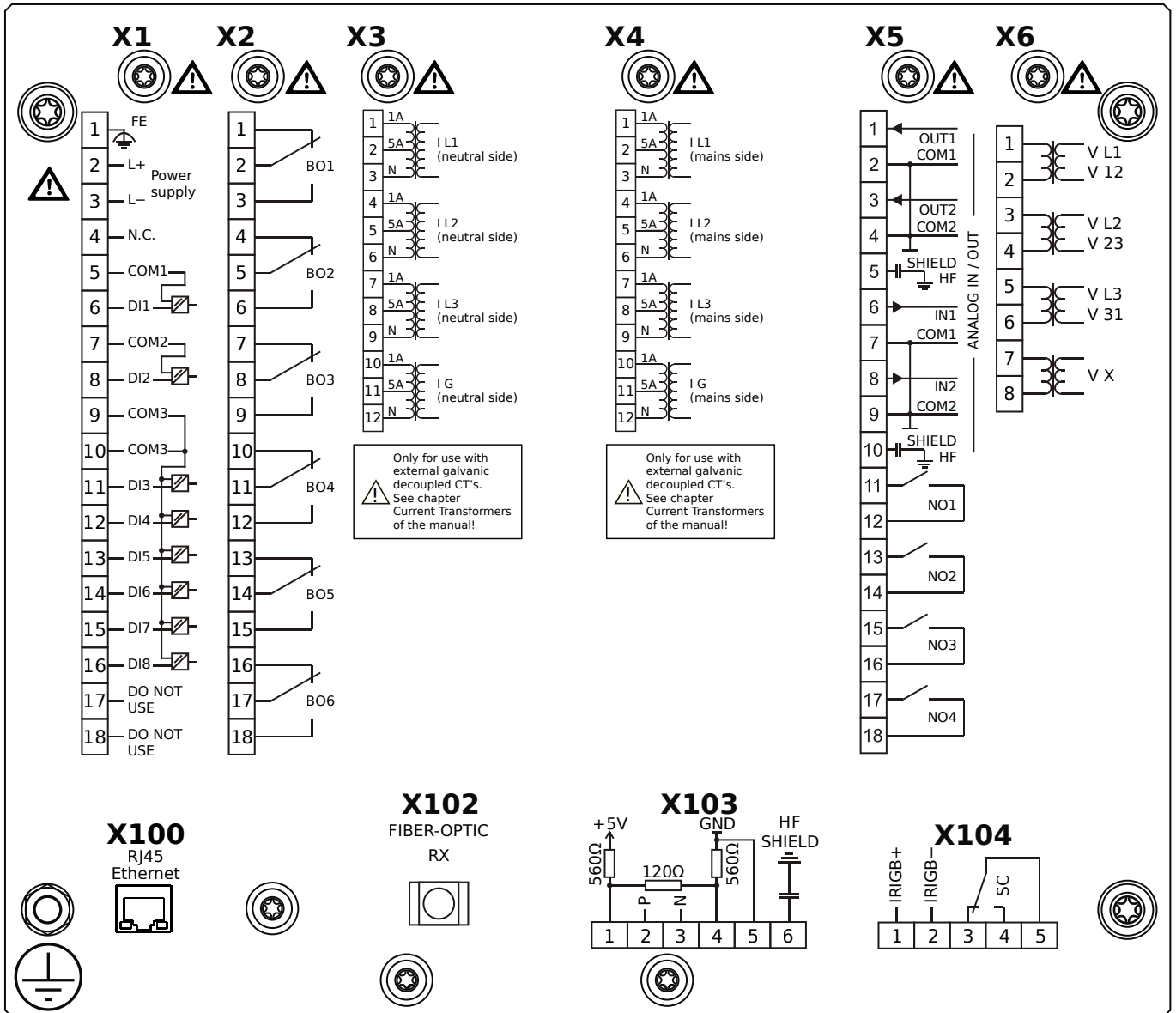

Housing B2, large display, 19" rack mounting

- X1** – DI8-X1: Wide-range power supply unit, incl. 2 non-grouped digital inputs and 6 grouped digital inputs
- X2** – OR6: Assembly Group with 6 Output Relays (Changeover / Form C)
- X3** – TI: Standard current measuring card (for the neutral side of the differential protection)
- X4** – TI: Standard current measuring card (for the mains side of the differential protection)
- X5** – AnIO2-OR4: Assembly Group with 2 Analog Inputs, 2 Analog Outputs and 4 Output Relays
- X6** – TU: Card with 4 voltage transformer measuring inputs (0 ... 800 VAC, under UL: 0 ... 600 VAC)
- X100** – IEC 61850 / Modbus TCP / DNP3.0 TCP/UDP, Ethernet interface, 100 Mbit/s, RJ45 (BASE100-FX)
- X102** – Universal Resistance-Temperature Detector (URTD) input, Fiber optics interface, Versatile Link
- X103** – IEC 60870-5-103 / Modbus RTU / DNP3.0 RTU, RS485, Terminals
- X104** – IRIG-B00X, incl. System Contact (Supervision Contact)

MCDGV4-2B0BTB

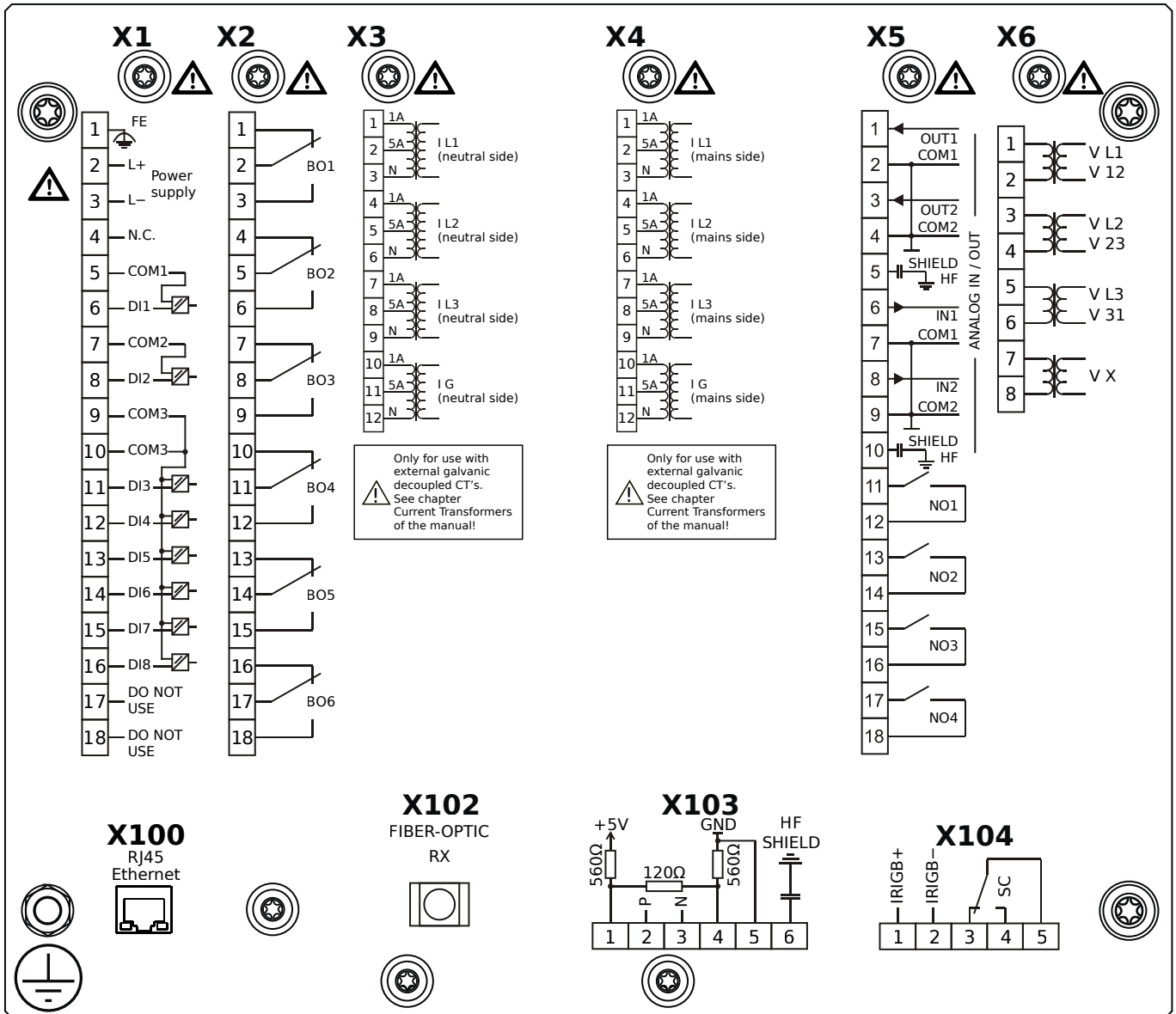

Housing B2, large display, 19" rack mounting

- + Conformal Coating (for installations in harsh environment)

- X1** – DI8-X1: Wide-range power supply unit, incl. 2 non-grouped digital inputs and 6 grouped digital inputs
- X2** – OR6: Assembly Group with 6 Output Relays (Changeover / Form C)
- X3** – TI: Standard current measuring card (for the neutral side of the differential protection)
- X4** – TI: Standard current measuring card (for the mains side of the differential protection)
- X5** – AnIO2-OR4: Assembly Group with 2 Analog Inputs, 2 Analog Outputs and 4 Output Relays
- X6** – TU: Card with 4 voltage transformer measuring inputs (0 ... 800 VAC, under UL: 0 ... 600 VAC)
- X100** – IEC 61850 / Modbus TCP / DNP3.0 TCP/UDP, Ethernet interface, 100 Mbit/s, RJ45 (BASE100-FX)
- X102** – Universal Resistance-Temperature Detector (URTD) input, Fiber optics interface, Versatile Link
- X103** – IEC 60870-5-103 / Modbus RTU / DNP3.0 RTU, RS485, Terminals
- X104** – IRIG-B00X, incl. System Contact (Supervision Contact)

MCDGV4-2B1AAA

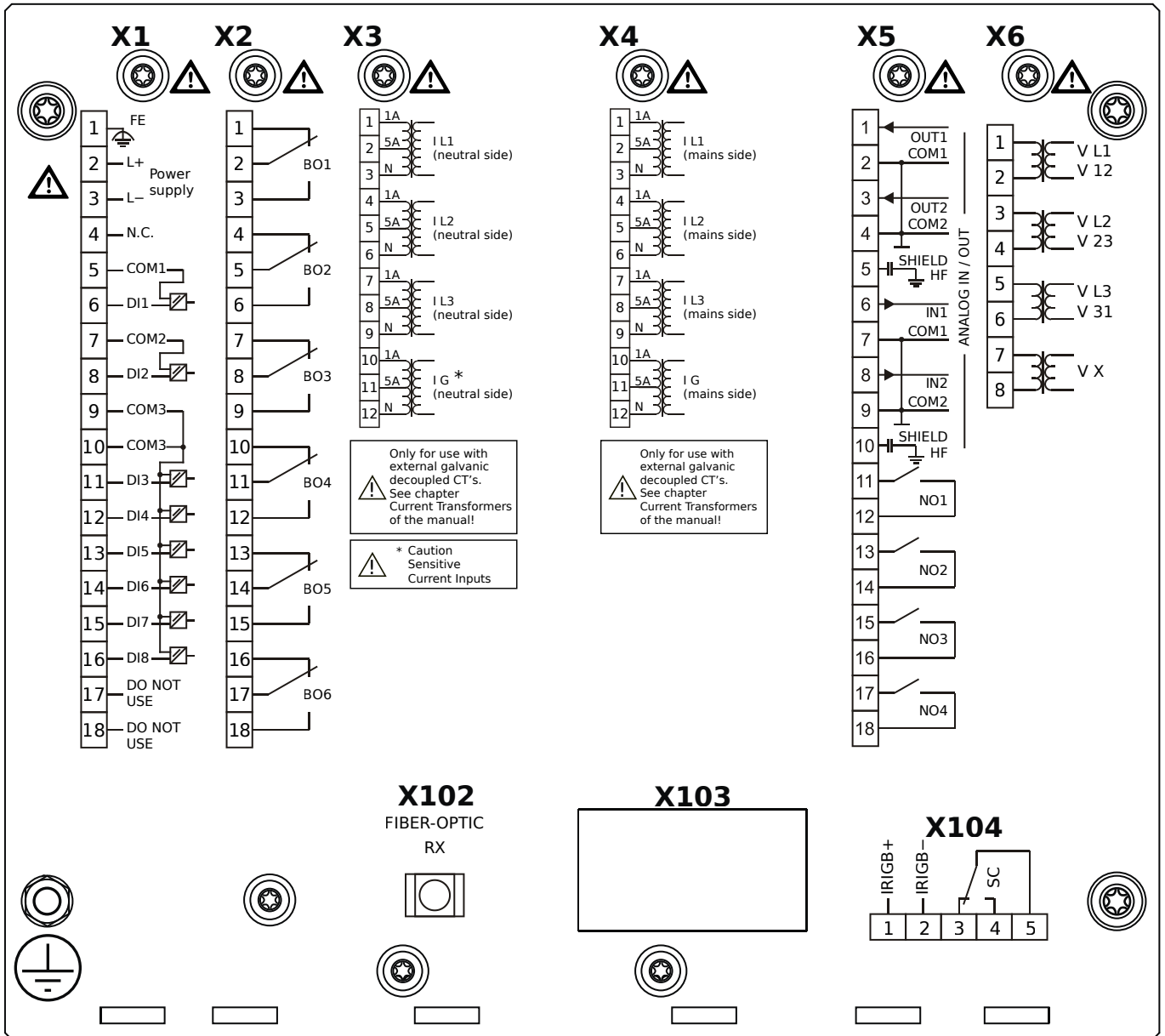

Housing B2, large display, door mounting

- X1** – DI8-X1: Wide-range power supply unit, incl. 2 non-grouped digital inputs and 6 grouped digital inputs
- X2** – OR6: Assembly Group with 6 Output Relays (Changeover / Form C)
- X3** – TIs: Standard phase current measuring card and sensitive ground current measuring (neutral side of the diff. prot.)
- X4** – TI: Standard current measuring card (for the mains side of the differential protection)
- X5** – AnIO2-OR4: Assembly Group with 2 Analog Inputs, 2 Analog Outputs and 4 Output Relays
- X6** – TU: Card with 4 voltage transformer measuring inputs (0 ... 800 VAC, under UL: 0 ... 600 VAC)
- X102** – Universal Resistance-Temperature Detector (URTD) input, Fiber optics interface, Versatile Link
- X104** – IRIG-B00X, incl. System Contact (Supervision Contact)

MCDGV4-2B1AAB

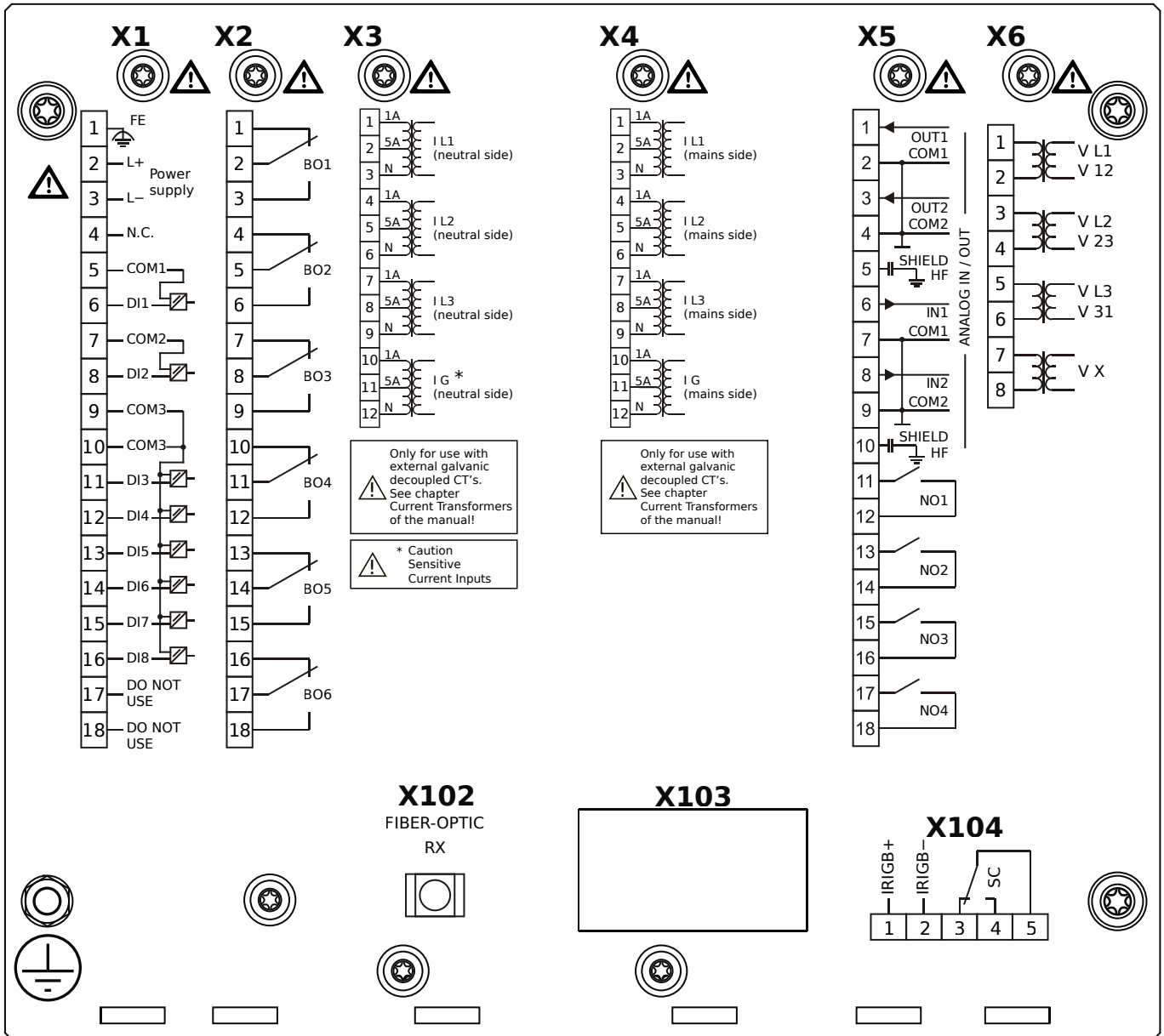

Housing B2, large display, door mounting

+ Conformal Coating (for installations in harsh environment)

- X1** – DI8-X1: Wide-range power supply unit, incl. 2 non-grouped digital inputs and 6 grouped digital inputs
- X2** – OR6: Assembly Group with 6 Output Relays (Changeover / Form C)
- X3** – TIs: Standard phase current measuring card and sensitive ground current measuring (neutral side of the diff. prot.)
- X4** – TI: Standard current measuring card (for the mains side of the differential protection)
- X5** – AnIO2-OR4: Assembly Group with 2 Analog Inputs, 2 Analog Outputs and 4 Output Relays
- X6** – TU: Card with 4 voltage transformer measuring inputs (0 ... 800 VAC, under UL: 0 ... 600 VAC)
- X102** – Universal Resistance-Temperature Detector (URTD) input, Fiber optics interface, Versatile Link
- X104** – IRIG-B00X, incl. System Contact (Supervision Contact)

MCDGV4-2B1ABA

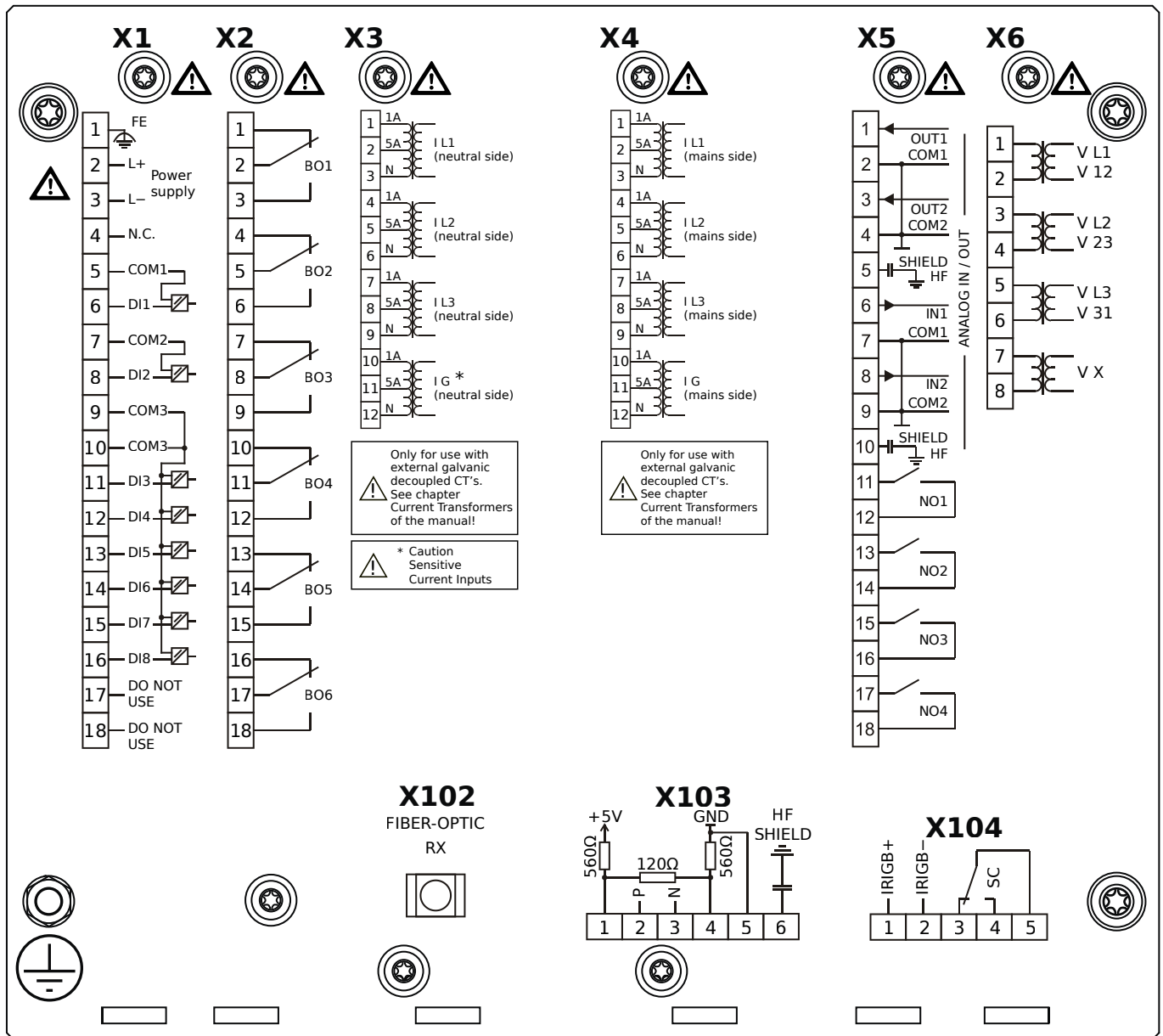

Housing B2, large display, door mounting

- X1** – DI8-X1: Wide-range power supply unit, incl. 2 non-grouped digital inputs and 6 grouped digital inputs
- X2** – OR6: Assembly Group with 6 Output Relays (Changeover / Form C)
- X3** – TI: Standard phase current measuring card and sensitive ground current measuring (neutral side of the diff. prot.)
- X4** – TI: Standard current measuring card (for the mains side of the differential protection)
- X5** – AnIO2-OR4: Assembly Group with 2 Analog Inputs, 2 Analog Outputs and 4 Output Relays
- X6** – TU: Card with 4 voltage transformer measuring inputs (0 ... 800 VAC, under UL: 0 ... 600 VAC)
- X102** – Universal Resistance-Temperature Detector (URTD) input, Fiber optics interface, Versatile Link
- X103** – Modbus RTU / IEC 60870-5-103 / DNP3.0 RTU, RS485, Terminals
- X104** – IRIG-B00X, incl. System Contact (Supervision Contact)

MCDGV4-2B1ABB

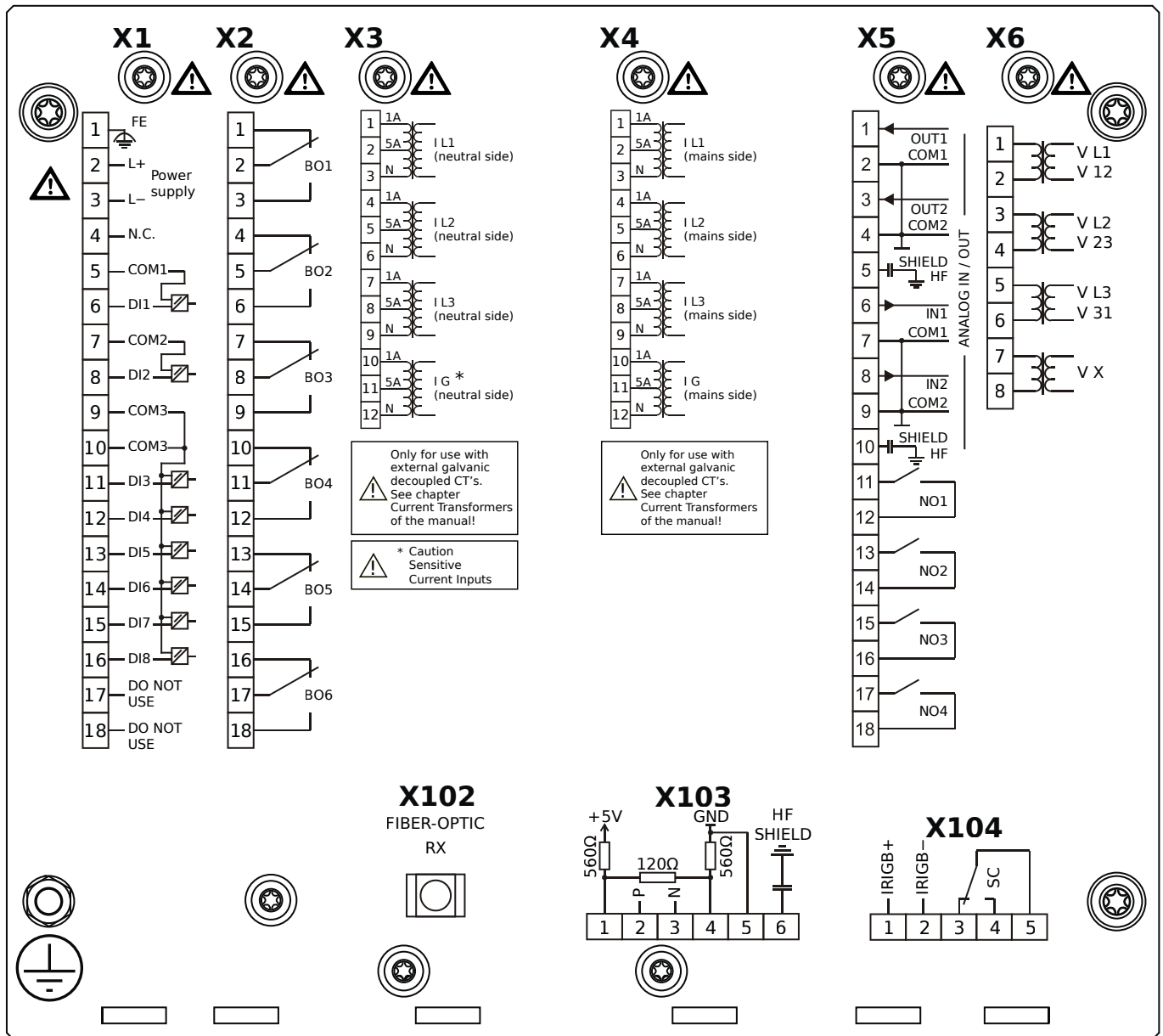

Housing B2, large display, door mounting

+ Conformal Coating (for installations in harsh environment)

- X1** – DI8-X1: Wide-range power supply unit, incl. 2 non-grouped digital inputs and 6 grouped digital inputs
- X2** – OR6: Assembly Group with 6 Output Relays (Changeover / Form C)
- X3** – TIs: Standard phase current measuring card and sensitive ground current measuring (neutral side of the diff. prot.)
- X4** – TI: Standard current measuring card (for the mains side of the differential protection)
- X5** – AnIO2-OR4: Assembly Group with 2 Analog Inputs, 2 Analog Outputs and 4 Output Relays
- X6** – TU: Card with 4 voltage transformer measuring inputs (0 ... 800 VAC, under UL: 0 ... 600 VAC)
- X102** – Universal Resistance-Temperature Detector (URTD) input, Fiber optics interface, Versatile Link
- X103** – Modbus RTU / IEC 60870-5-103 / DNP3.0 RTU, RS485, Terminals
- X104** – IRIG-B00X, incl. System Contact (Supervision Contact)

MCDGV4-2B1ACA

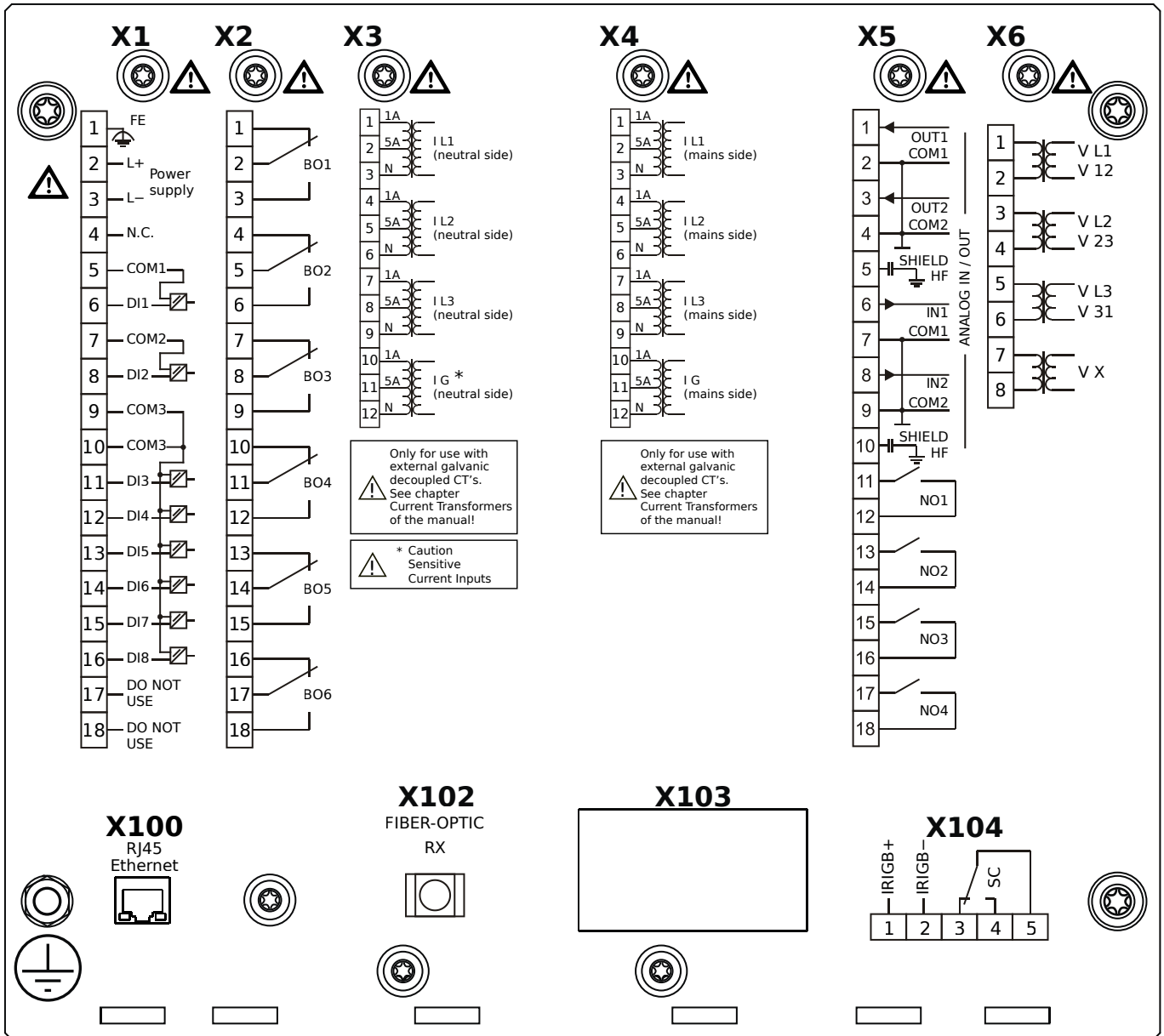

Housing B2, large display, door mounting

- X1** – DI8-X1: Wide-range power supply unit, incl. 2 non-grouped digital inputs and 6 grouped digital inputs
- X2** – OR6: Assembly Group with 6 Output Relays (Changeover / Form C)
- X3** – TI: Standard phase current measuring card and sensitive ground current measuring (neutral side of the diff. prot.)
- X4** – TI: Standard current measuring card (for the mains side of the differential protection)
- X5** – AnIO2-OR4: Assembly Group with 2 Analog Inputs, 2 Analog Outputs and 4 Output Relays
- X6** – TU: Card with 4 voltage transformer measuring inputs (0 ... 800 VAC, under UL: 0 ... 600 VAC)
- X100** – Modbus TCP / DNP3.0 TCP/UDP, Ethernet interface, 100 Mbit/s, RJ45 (BASE100-FX)
- X102** – Universal Resistance-Temperature Detector (URTD) input, Fiber optics interface, Versatile Link
- X104** – IRIG-B00X, incl. System Contact (Supervision Contact)

MCDGV4-2B1ACB

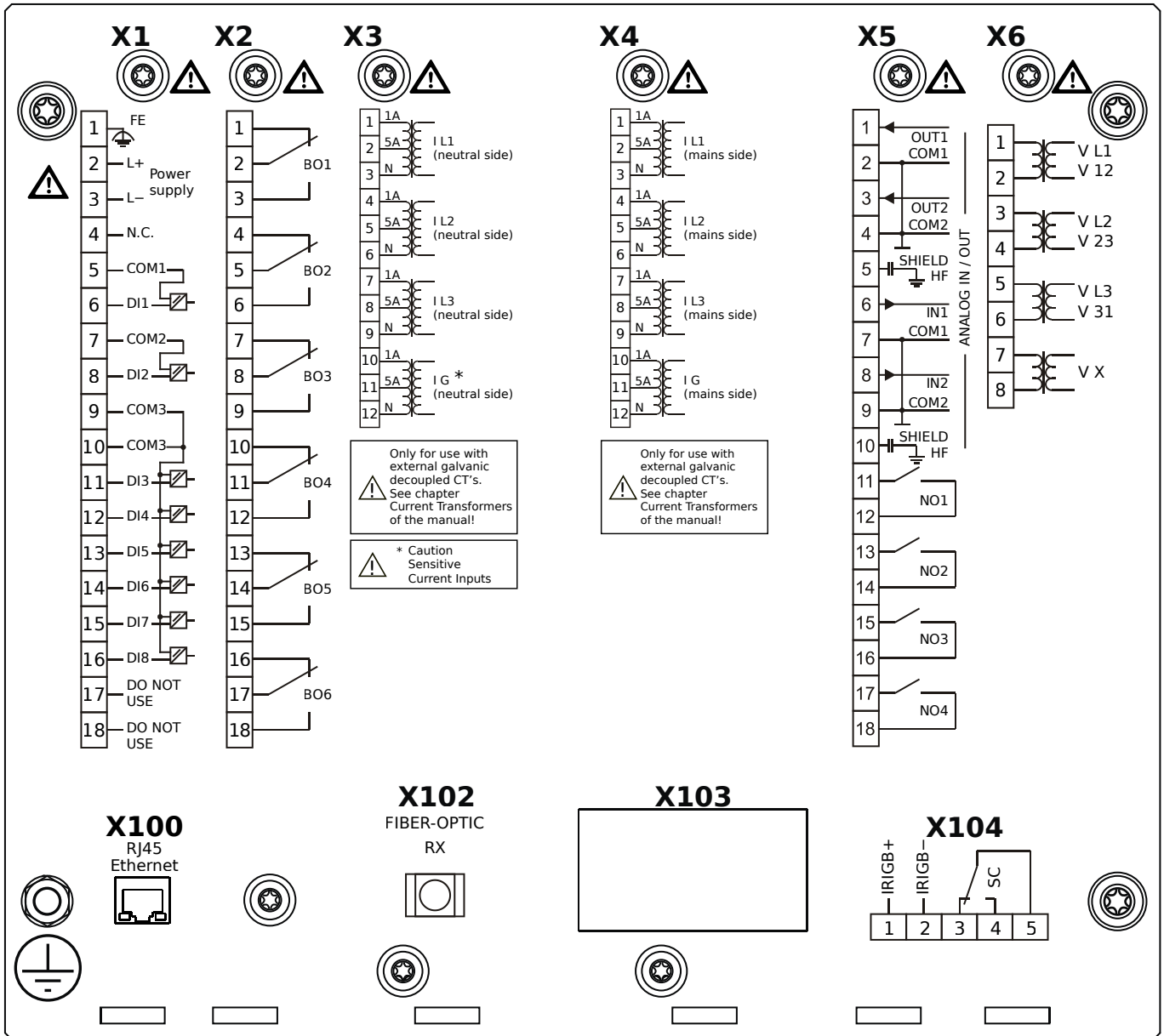

Housing B2, large display, door mounting

+ Conformal Coating (for installations in harsh environment)

- X1** – DI8-X1: Wide-range power supply unit, incl. 2 non-grouped digital inputs and 6 grouped digital inputs
- X2** – OR6: Assembly Group with 6 Output Relays (Changeover / Form C)
- X3** – TIs: Standard phase current measuring card and sensitive ground current measuring (neutral side of the diff. prot.)
- X4** – TI: Standard current measuring card (for the mains side of the differential protection)
- X5** – AnIO2-OR4: Assembly Group with 2 Analog Inputs, 2 Analog Outputs and 4 Output Relays
- X6** – TU: Card with 4 voltage transformer measuring inputs (0 ... 800 VAC, under UL: 0 ... 600 VAC)
- X100** – Modbus TCP / DNP3.0 TCP/UDP, Ethernet interface, 100 Mbit/s, RJ45 (BASE100-FX)
- X102** – Universal Resistance-Temperature Detector (URTD) input, Fiber optics interface, Versatile Link
- X104** – IRIG-B00X, incl. System Contact (Supervision Contact)

MCDGV4-2B1ADA

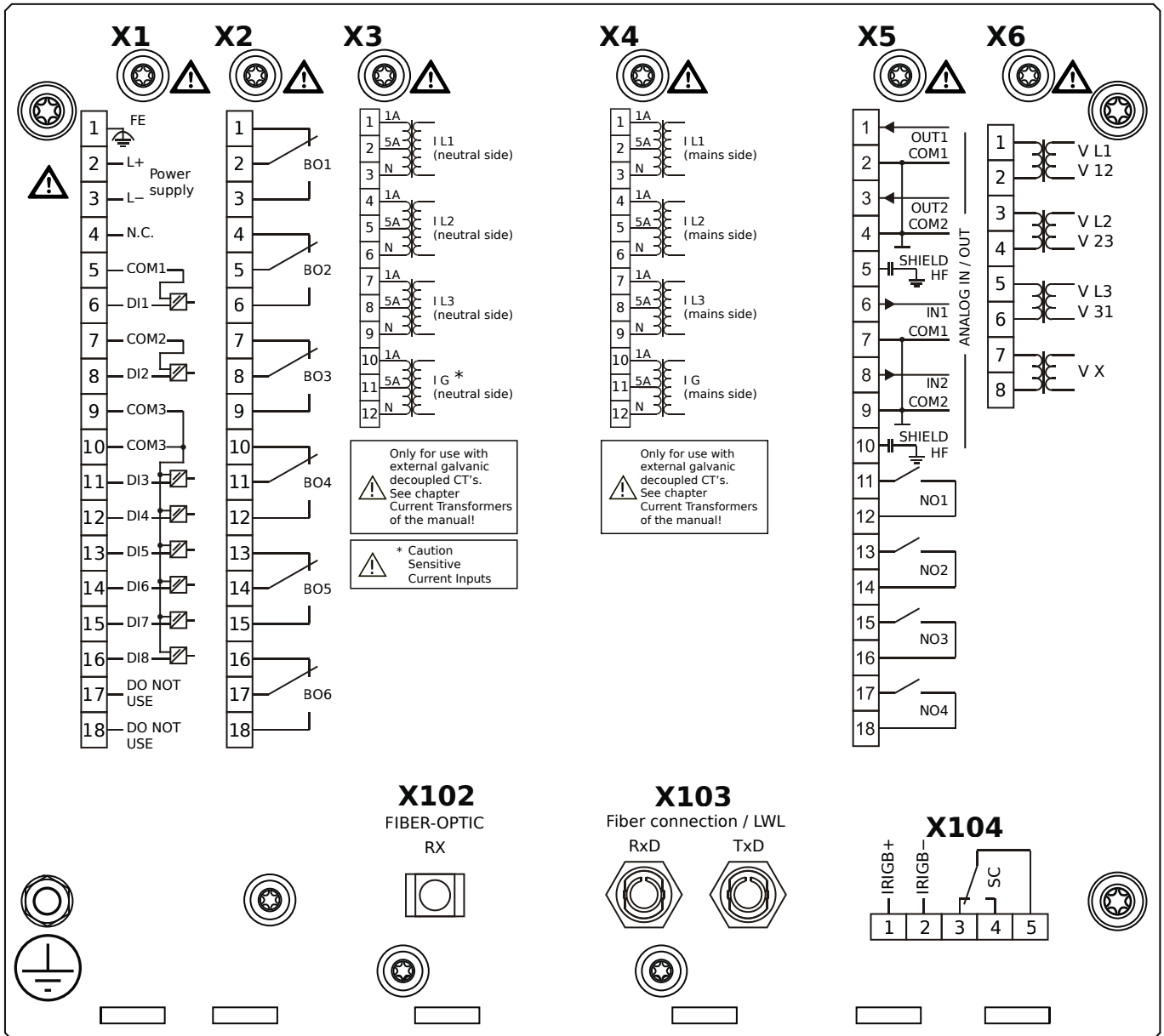

Housing B2, large display, door mounting

- X1** – DI8-X1: Wide-range power supply unit, incl. 2 non-grouped digital inputs and 6 grouped digital inputs
- X2** – OR6: Assembly Group with 6 Output Relays (Changeover / Form C)
- X3** – TI: Standard phase current measuring card and sensitive ground current measuring (neutral side of the diff. prot.)
- X4** – TI: Standard current measuring card (for the mains side of the differential protection)
- X5** – AnIO2-OR4: Assembly Group with 2 Analog Inputs, 2 Analog Outputs and 4 Output Relays
- X6** – TU: Card with 4 voltage transformer measuring inputs (0 ... 800 VAC, under UL: 0 ... 600 VAC)
- X102** – Universal Resistance-Temperature Detector (URTD) input, Fiber optics interface, Versatile Link
- X103** – Profibus-DP, Fiber optics interface, ST Connector
- X104** – IRIG-B00X, incl. System Contact (Supervision Contact)

MCDGV4-2B1ADB

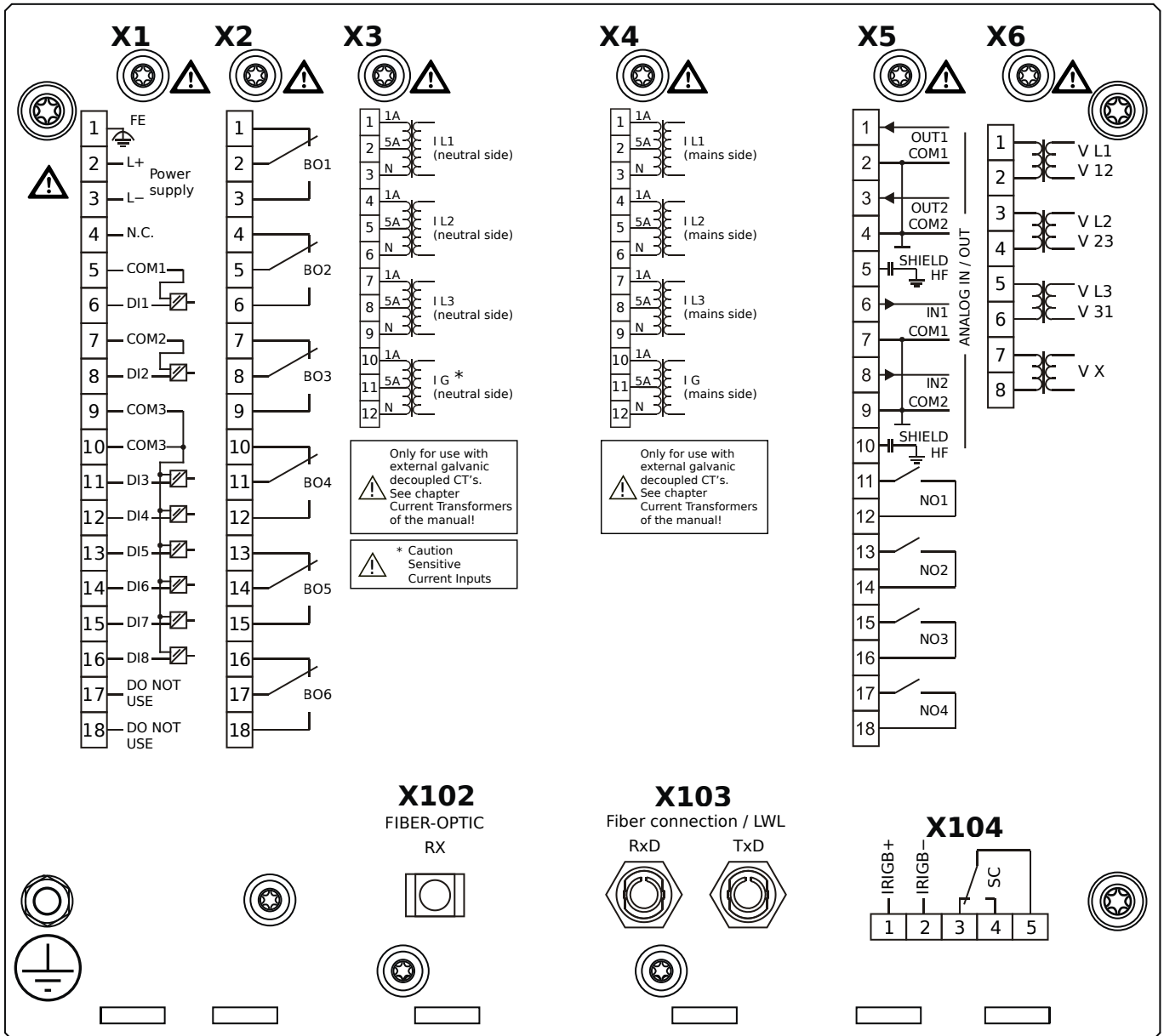

Housing B2, large display, door mounting

+ Conformal Coating (for installations in harsh environment)

- X1** – DI8-X1: Wide-range power supply unit, incl. 2 non-grouped digital inputs and 6 grouped digital inputs
- X2** – OR6: Assembly Group with 6 Output Relays (Changeover / Form C)
- X3** – TIs: Standard phase current measuring card and sensitive ground current measuring (neutral side of the diff. prot.)
- X4** – TI: Standard current measuring card (for the mains side of the differential protection)
- X5** – AnIO2-OR4: Assembly Group with 2 Analog Inputs, 2 Analog Outputs and 4 Output Relays
- X6** – TU: Card with 4 voltage transformer measuring inputs (0 ... 800 VAC, under UL: 0 ... 600 VAC)
- X102** – Universal Resistance-Temperature Detector (URTD) input, Fiber optics interface, Versatile Link
- X103** – Profibus-DP, Fiber optics interface, ST Connector
- X104** – IRIG-B00X, incl. System Contact (Supervision Contact)

MCDGV4-2B1AEA

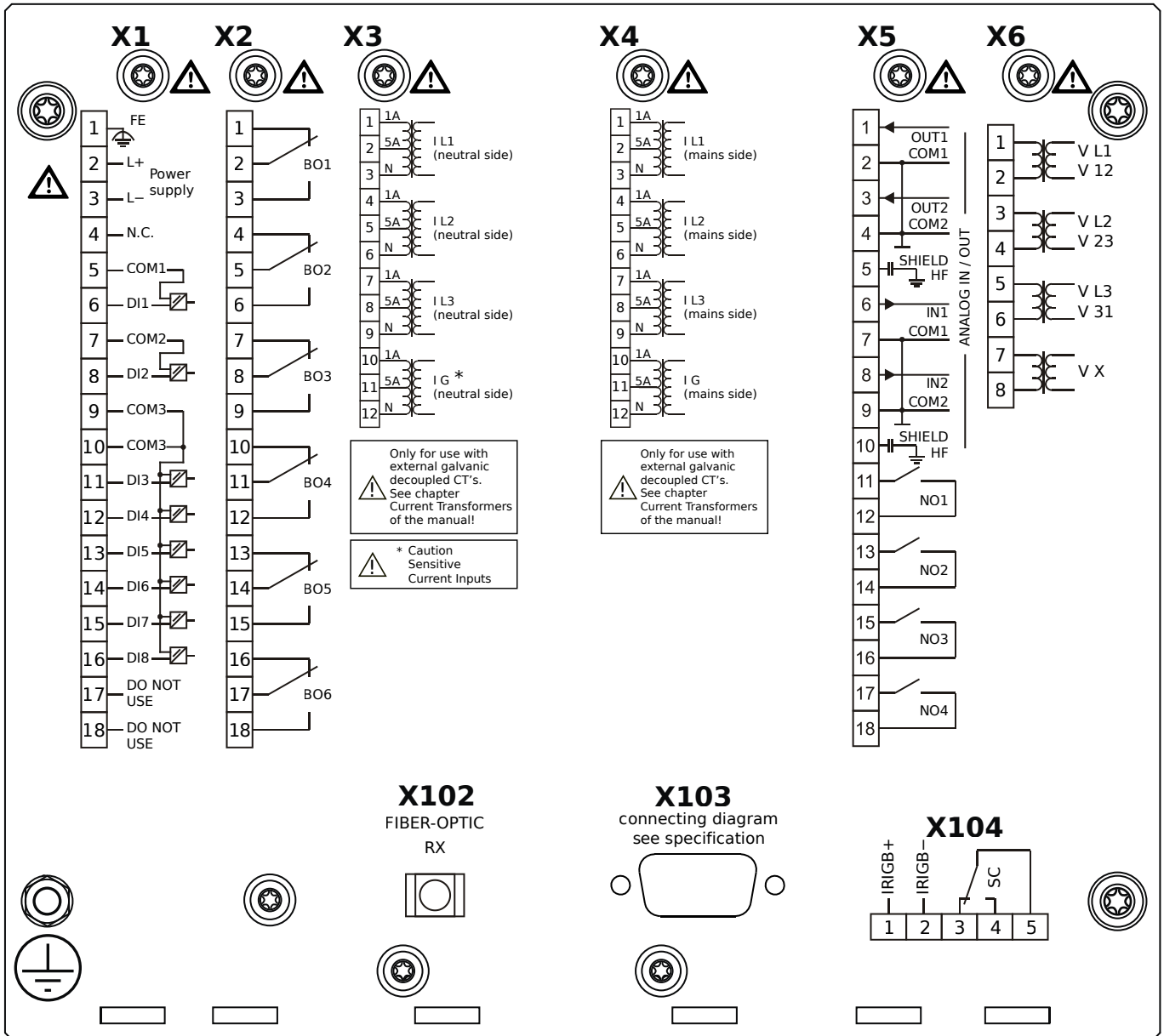

Housing B2, large display, door mounting

- X1** – DI8-X1: Wide-range power supply unit, incl. 2 non-grouped digital inputs and 6 grouped digital inputs
- X2** – OR6: Assembly Group with 6 Output Relays (Changeover / Form C)
- X3** – TI: Standard phase current measuring card and sensitive ground current measuring (neutral side of the diff. prot.)
- X4** – TI: Standard current measuring card (for the mains side of the differential protection)
- X5** – AnIO2-OR4: Assembly Group with 2 Analog Inputs, 2 Analog Outputs and 4 Output Relays
- X6** – TU: Card with 4 voltage transformer measuring inputs (0 ... 800 VAC, under UL: 0 ... 600 VAC)
- X102** – Universal Resistance-Temperature Detector (URTD) input, Fiber optics interface, Versatile Link
- X103** – Profibus-DP, RS485, D-SUB
- X104** – IRIG-B00X, incl. System Contact (Supervision Contact)

MCDGV4-2B1AEB

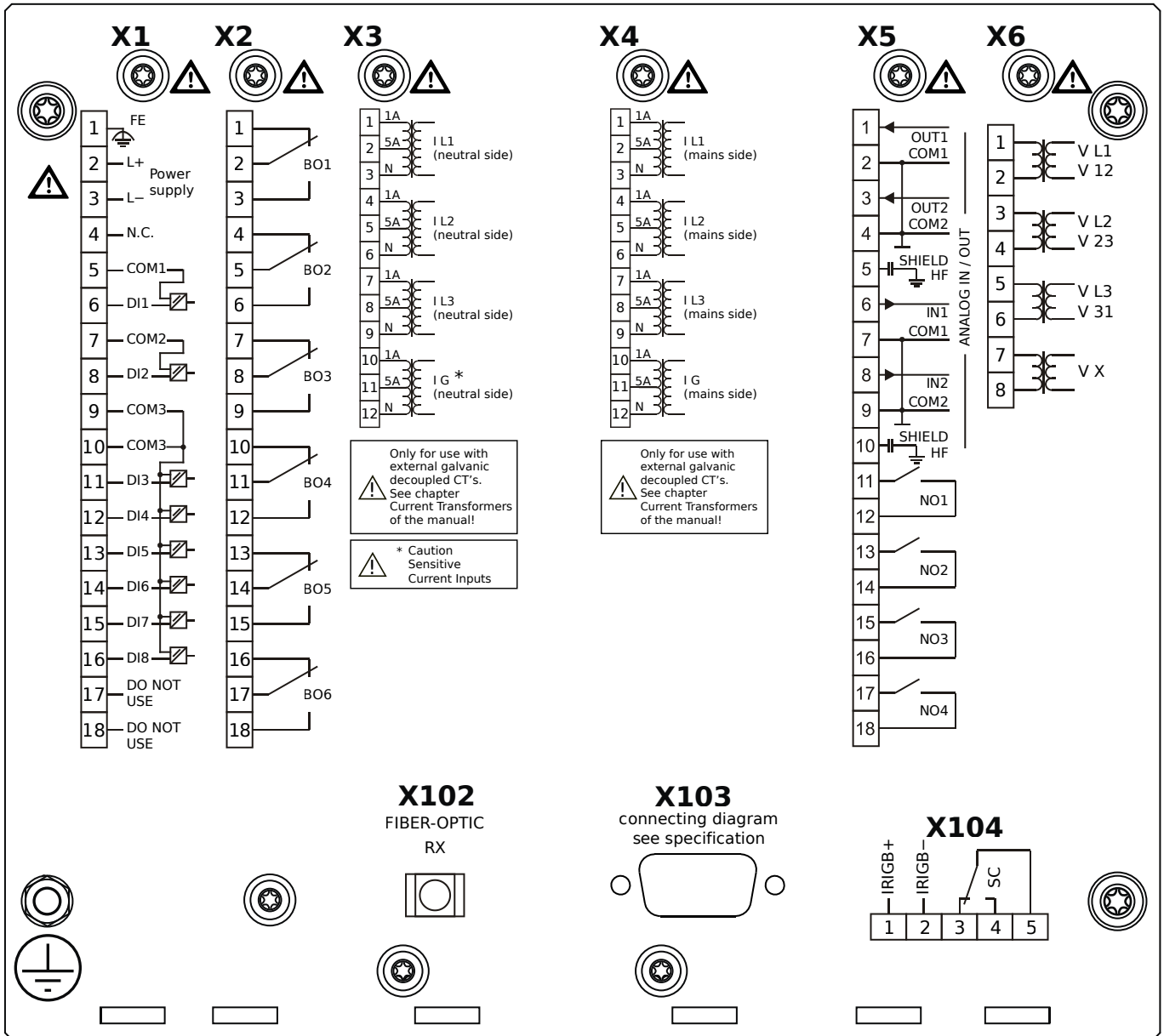

Housing B2, large display, door mounting

+ Conformal Coating (for installations in harsh environment)

- X1** – DI8-X1: Wide-range power supply unit, incl. 2 non-grouped digital inputs and 6 grouped digital inputs
- X2** – OR6: Assembly Group with 6 Output Relays (Changeover / Form C)
- X3** – TIs: Standard phase current measuring card and sensitive ground current measuring (neutral side of the diff. prot.)
- X4** – TI: Standard current measuring card (for the mains side of the differential protection)
- X5** – AnIO2-OR4: Assembly Group with 2 Analog Inputs, 2 Analog Outputs and 4 Output Relays
- X6** – TU: Card with 4 voltage transformer measuring inputs (0 ... 800 VAC, under UL: 0 ... 600 VAC)
- X102** – Universal Resistance-Temperature Detector (URTD) input, Fiber optics interface, Versatile Link
- X103** – Profibus-DP, RS485, D-SUB
- X104** – IRIG-B00X, incl. System Contact (Supervision Contact)

MCDGV4-2B1AFA

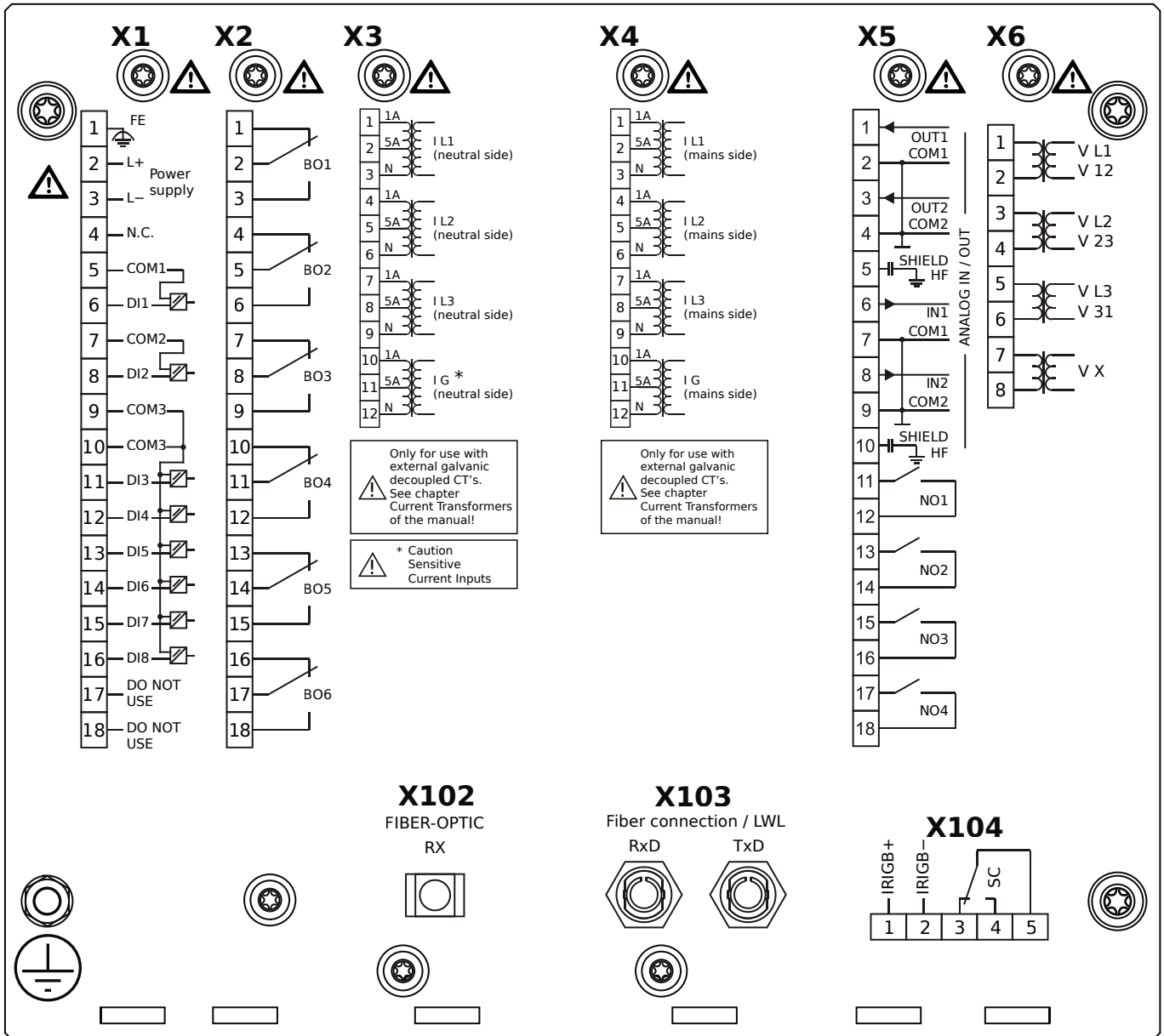

Housing B2, large display, door mounting

- X1** – DI8-X1: Wide-range power supply unit, incl. 2 non-grouped digital inputs and 6 grouped digital inputs
- X2** – OR6: Assembly Group with 6 Output Relays (Changeover / Form C)
- X3** – TIs: Standard phase current measuring card and sensitive ground current measuring (neutral side of the diff. prot.)
- X4** – TI: Standard current measuring card (for the mains side of the differential protection)
- X5** – AnIO2-OR4: Assembly Group with 2 Analog Inputs, 2 Analog Outputs and 4 Output Relays
- X6** – TU: Card with 4 voltage transformer measuring inputs (0 ... 800 VAC, under UL: 0 ... 600 VAC)
- X102** – Universal Resistance-Temperature Detector (URTD) input, Fiber optics interface, Versatile Link
- X103** – Modbus RTU / IEC 60870-5-103 / DNP3.0 RTU, Fiber optics interface, ST Connector
- X104** – IRIG-B00X, incl. System Contact (Supervision Contact)

MCDGV4-2B1AFB

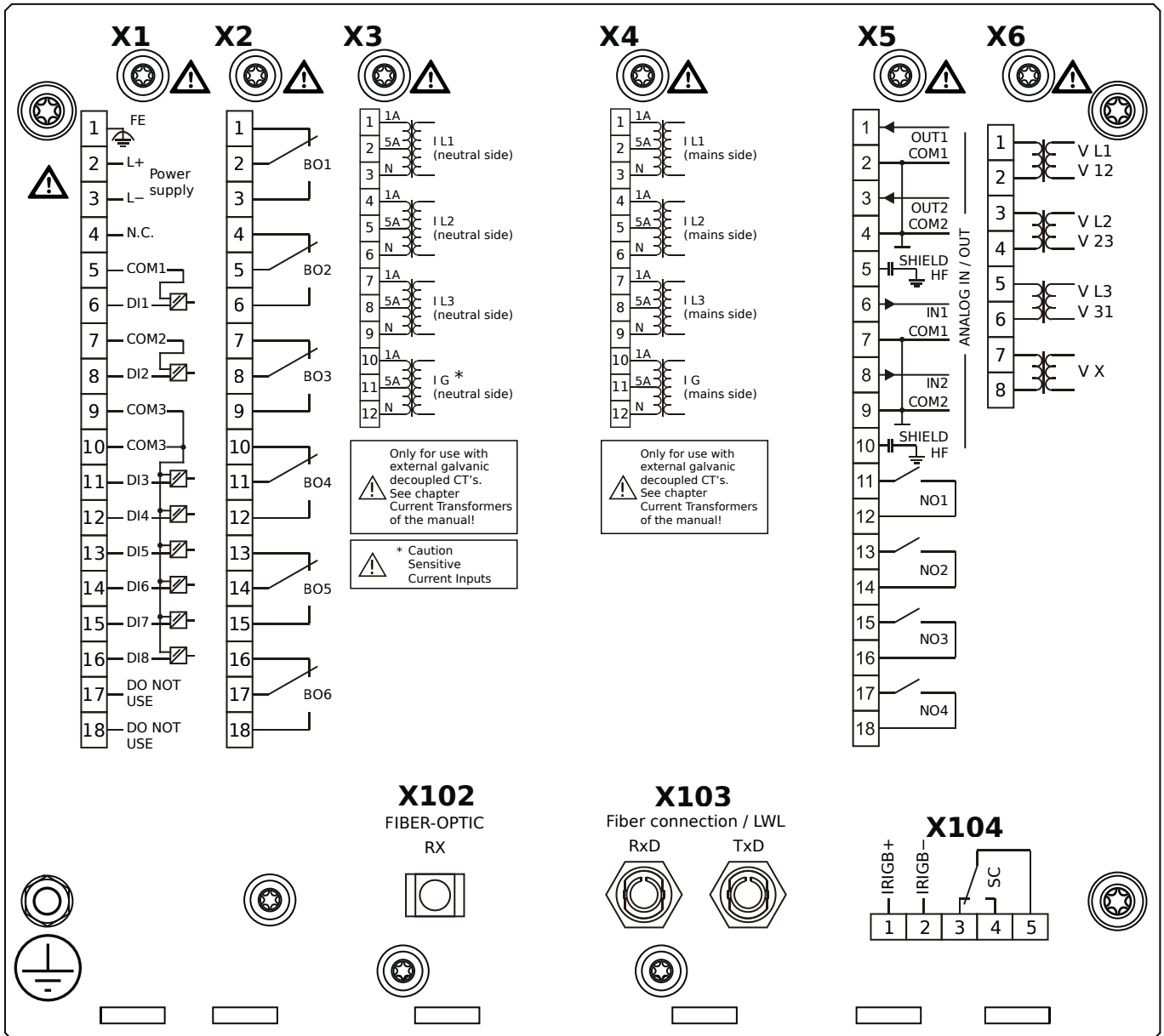

Housing B2, large display, door mounting

+ Conformal Coating (for installations in harsh environment)

- X1** – DI8-X1: Wide-range power supply unit, incl. 2 non-grouped digital inputs and 6 grouped digital inputs
- X2** – OR6: Assembly Group with 6 Output Relays (Changeover / Form C)
- X3** – TIs: Standard phase current measuring card and sensitive ground current measuring (neutral side of the diff. prot.)
- X4** – TI: Standard current measuring card (for the mains side of the differential protection)
- X5** – AnIO2-OR4: Assembly Group with 2 Analog Inputs, 2 Analog Outputs and 4 Output Relays
- X6** – TU: Card with 4 voltage transformer measuring inputs (0 ... 800 VAC, under UL: 0 ... 600 VAC)
- X102** – Universal Resistance-Temperature Detector (URTD) input, Fiber optics interface, Versatile Link
- X103** – Modbus RTU / IEC 60870-5-103 / DNP3.0 RTU, Fiber optics interface, ST Connector
- X104** – IRIG-B00X, incl. System Contact (Supervision Contact)

MCDGV4-2B1AGA

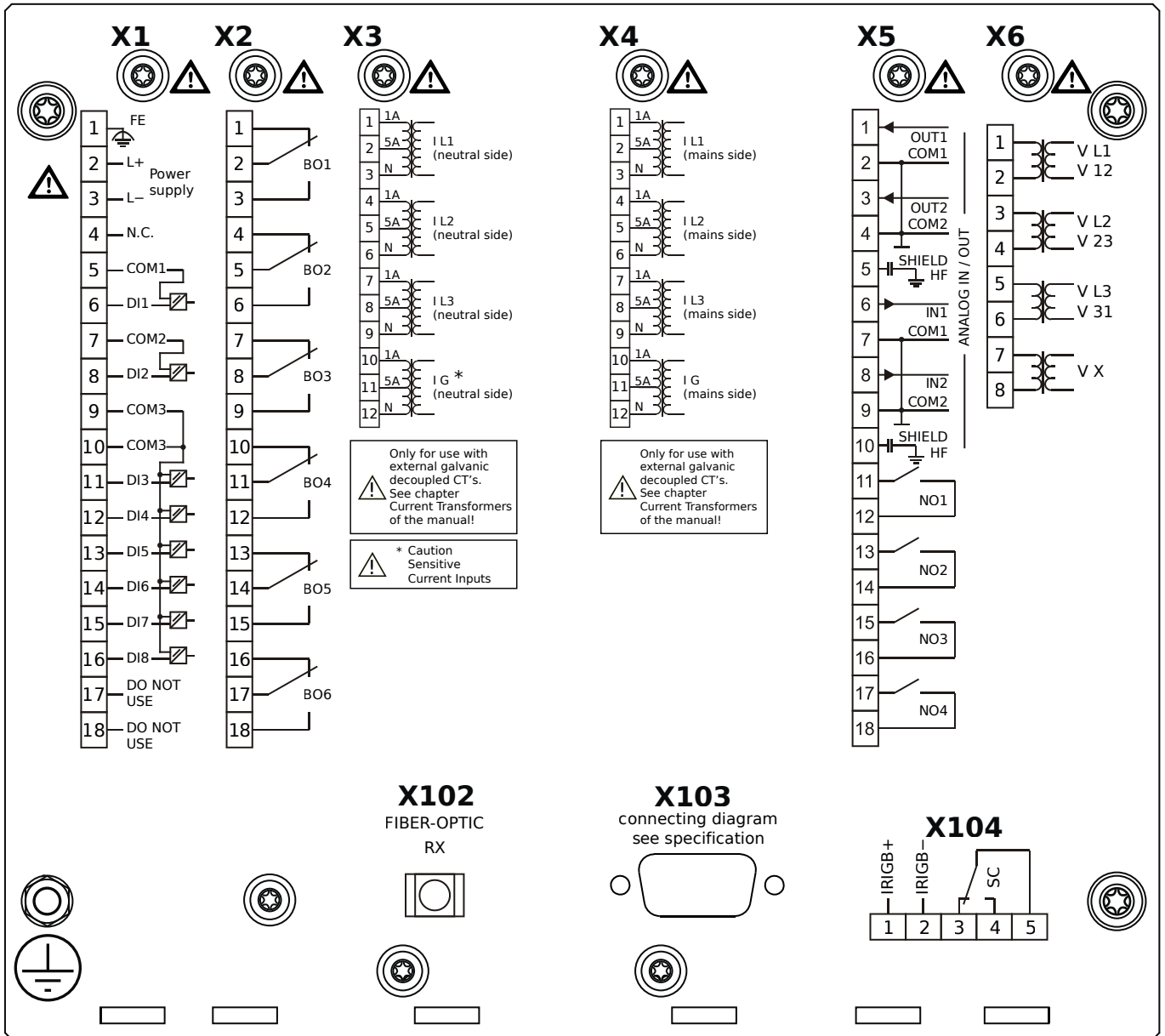

Housing B2, large display, door mounting

- X1** – DI8-X1: Wide-range power supply unit, incl. 2 non-grouped digital inputs and 6 grouped digital inputs
- X2** – OR6: Assembly Group with 6 Output Relays (Changeover / Form C)
- X3** – TIs: Standard phase current measuring card and sensitive ground current measuring (neutral side of the diff. prot.)
- X4** – TI: Standard current measuring card (for the mains side of the differential protection)
- X5** – AnIO2-OR4: Assembly Group with 2 Analog Inputs, 2 Analog Outputs and 4 Output Relays
- X6** – TU: Card with 4 voltage transformer measuring inputs (0 ... 800 VAC, under UL: 0 ... 600 VAC)
- X102** – Universal Resistance-Temperature Detector (URTD) input, Fiber optics interface, Versatile Link
- X103** – Modbus RTU / IEC 60870-5-103 / DNP3.0 RTU, RS485, D-SUB
- X104** – IRIG-B00X, incl. System Contact (Supervision Contact)

MCDGV4-2B1AGB

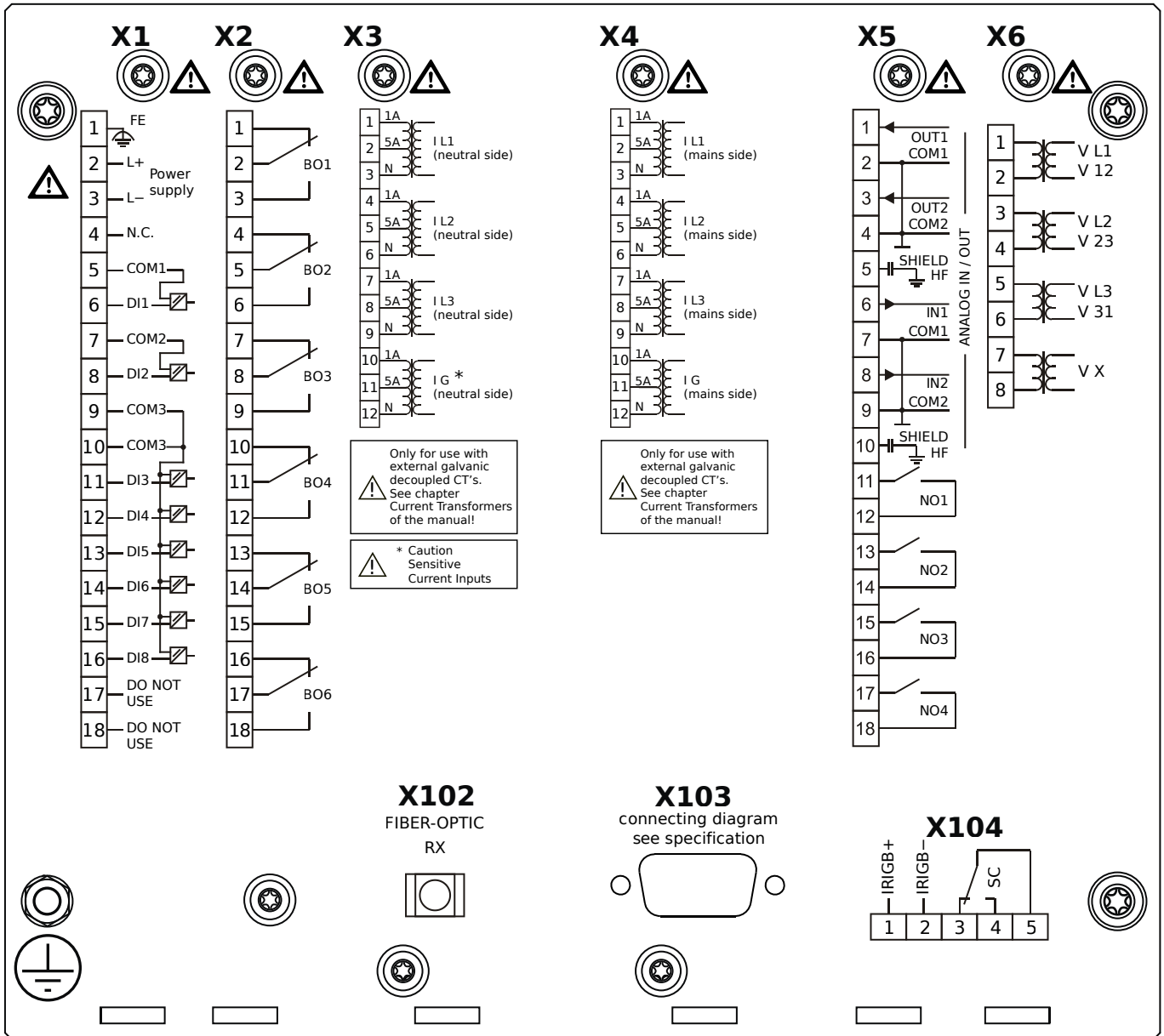

Housing B2, large display, door mounting

+ Conformal Coating (for installations in harsh environment)

- X1** – DI8-X1: Wide-range power supply unit, incl. 2 non-grouped digital inputs and 6 grouped digital inputs
- X2** – OR6: Assembly Group with 6 Output Relays (Changeover / Form C)
- X3** – TIs: Standard phase current measuring card and sensitive ground current measuring (neutral side of the diff. prot.)
- X4** – TI: Standard current measuring card (for the mains side of the differential protection)
- X5** – AnIO2-OR4: Assembly Group with 2 Analog Inputs, 2 Analog Outputs and 4 Output Relays
- X6** – TU: Card with 4 voltage transformer measuring inputs (0 ... 800 VAC, under UL: 0 ... 600 VAC)
- X102** – Universal Resistance-Temperature Detector (URTD) input, Fiber optics interface, Versatile Link
- X103** – Modbus RTU / IEC 60870-5-103 / DNP3.0 RTU, RS485, D-SUB
- X104** – IRIG-B00X, incl. System Contact (Supervision Contact)

MCDGV4-2B1AHA

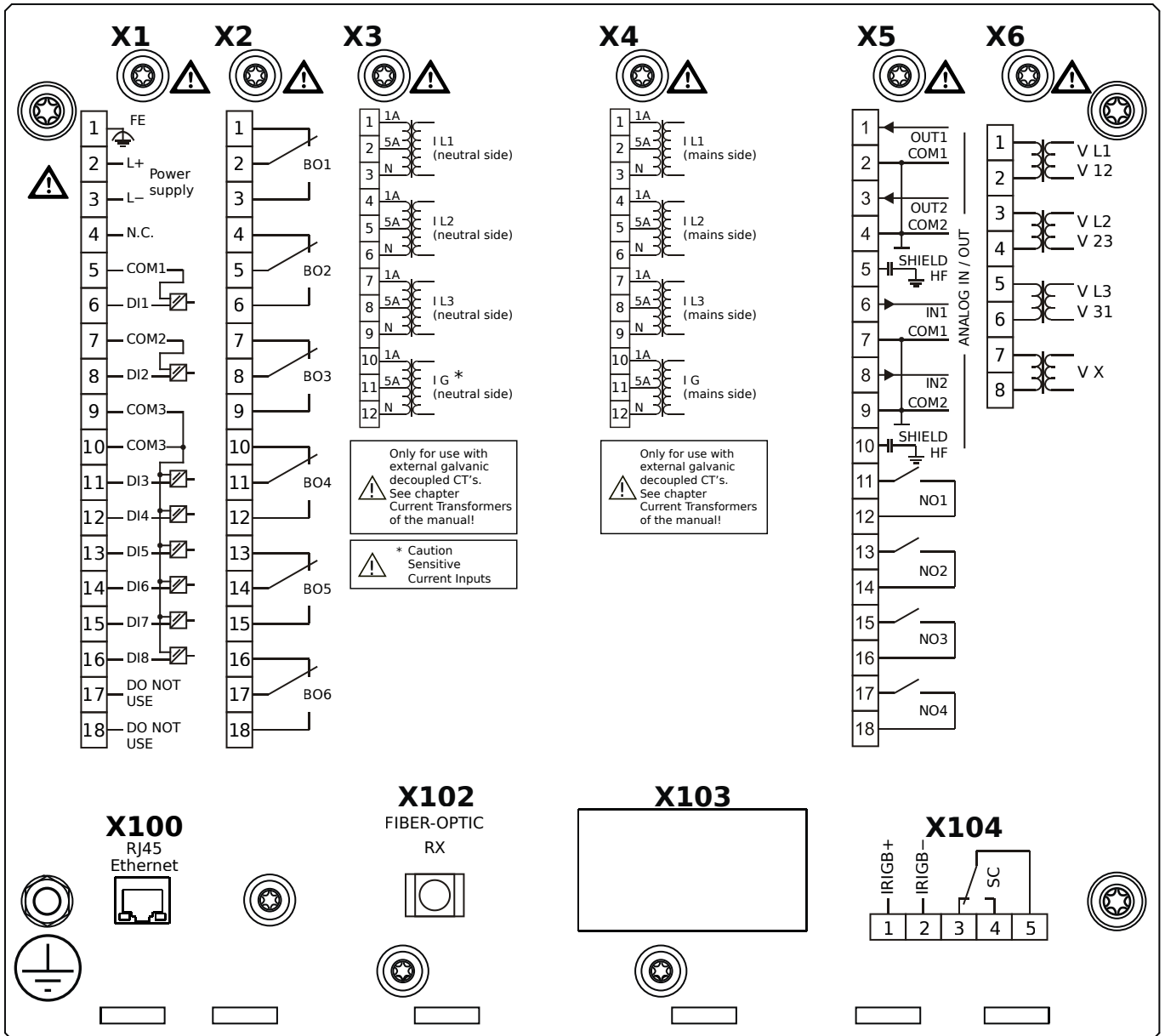

Housing B2, large display, door mounting

- X1** – DI8-X1: Wide-range power supply unit, incl. 2 non-grouped digital inputs and 6 grouped digital inputs
- X2** – OR6: Assembly Group with 6 Output Relays (Changeover / Form C)
- X3** – TI: Standard phase current measuring card and sensitive ground current measuring (neutral side of the diff. prot.)
- X4** – TI: Standard current measuring card (for the mains side of the differential protection)
- X5** – AnIO2-OR4: Assembly Group with 2 Analog Inputs, 2 Analog Outputs and 4 Output Relays
- X6** – TU: Card with 4 voltage transformer measuring inputs (0 ... 800 VAC, under UL: 0 ... 600 VAC)
- X100** – IEC 61850 / Modbus TCP / DNP3.0 TCP/UDP, Ethernet interface, 100 Mbit/s, RJ45 (BASE100-FX)
- X102** – Universal Resistance-Temperature Detector (URTD) input, Fiber optics interface, Versatile Link
- X104** – IRIGB-00X, incl. System Contact (Supervision Contact)

MCDGV4-2B1AHB

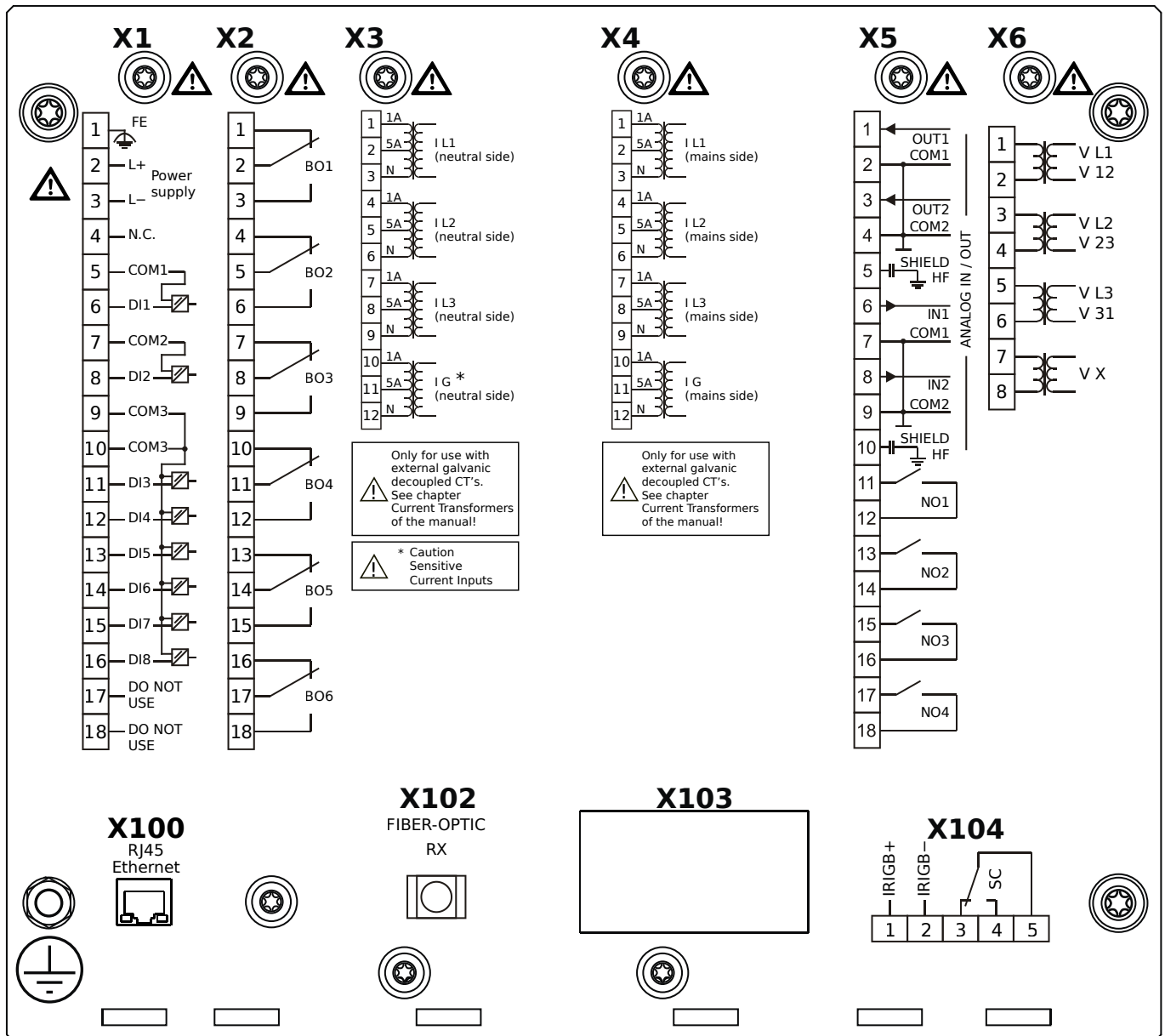

Housing B2, large display, door mounting

+ Conformal Coating (for installations in harsh environment)

- X1** – DI8-X1: Wide-range power supply unit, incl. 2 non-grouped digital inputs and 6 grouped digital inputs
- X2** – OR6: Assembly Group with 6 Output Relays (Changeover / Form C)
- X3** – TIs: Standard phase current measuring card and sensitive ground current measuring (neutral side of the diff. prot.)
- X4** – TI: Standard current measuring card (for the mains side of the differential protection)
- X5** – AnIO2-OR4: Assembly Group with 2 Analog Inputs, 2 Analog Outputs and 4 Output Relays
- X6** – TU: Card with 4 voltage transformer measuring inputs (0 ... 800 VAC, under UL: 0 ... 600 VAC)
- X100** – IEC 61850 / Modbus TCP / DNP3.0 TCP/UDP, Ethernet interface, 100 Mbit/s, RJ45 (BASE100-FX)
- X102** – Universal Resistance-Temperature Detector (URTD) input, Fiber optics interface, Versatile Link
- X104** – IRIG-B00X, incl. System Contact (Supervision Contact)

MCDGV4-2B1AIA

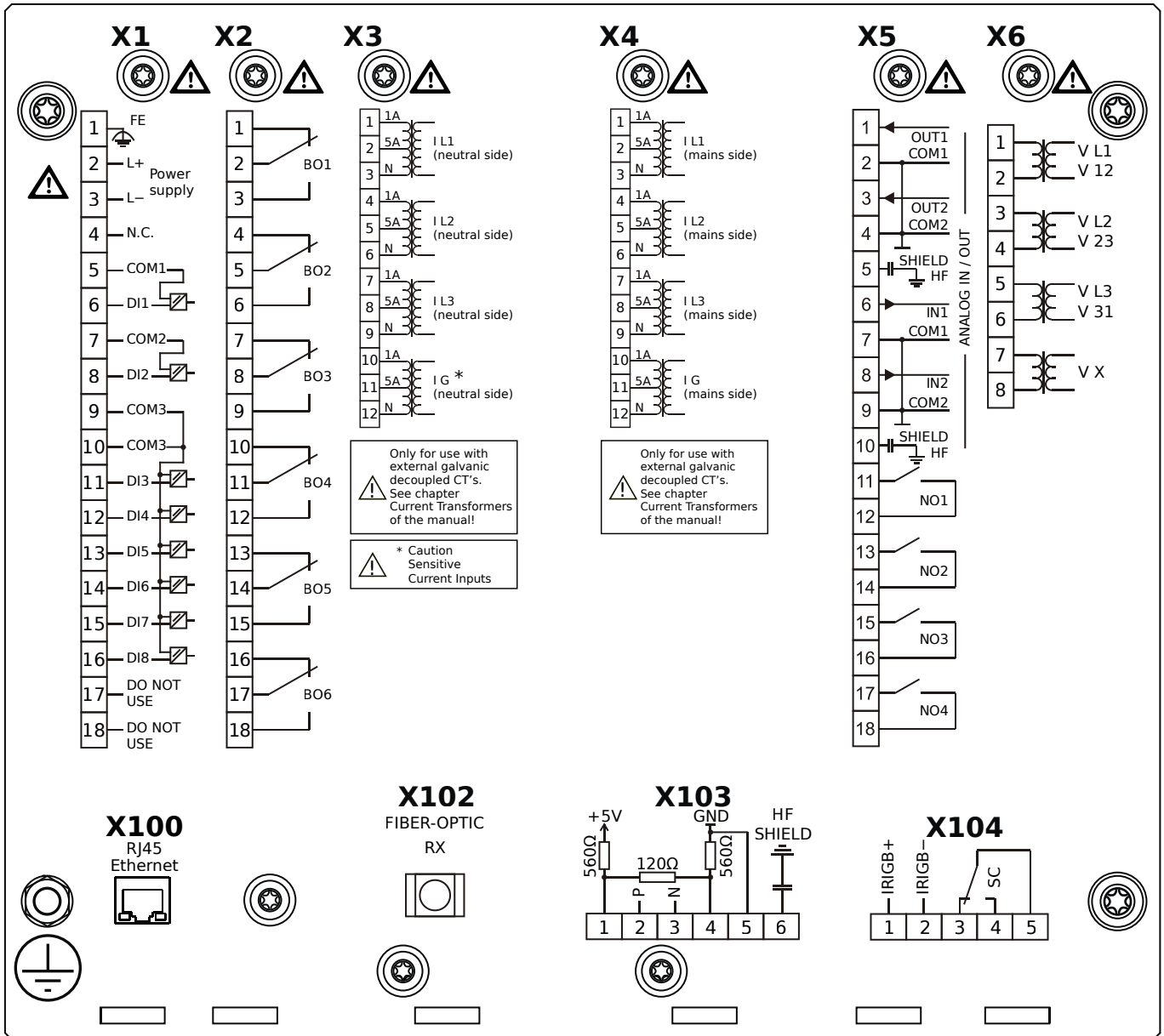

Housing B2, large display, door mounting

- X1** – DI8-X1: Wide-range power supply unit, incl. 2 non-grouped digital inputs and 6 grouped digital inputs
- X2** – OR6: Assembly Group with 6 Output Relays (Changeover / Form C)
- X3** – TIs: Standard phase current measuring card and sensitive ground current measuring (neutral side of the diff. prot.)
- X4** – TI: Standard current measuring card (for the mains side of the differential protection)
- X5** – AnIO2-OR4: Assembly Group with 2 Analog Inputs, 2 Analog Outputs and 4 Output Relays
- X6** – TU: Card with 4 voltage transformer measuring inputs (0 ... 800 VAC, under UL: 0 ... 600 VAC)
- X100** – Modbus TCP / DNP3.0 TCP/UDP, Ethernet interface, 100 Mbit/s, RJ45 (BASE100-FX)
- X102** – Universal Resistance-Temperature Detector (URTD) input, Fiber optics interface, Versatile Link
- X103** – IEC 60870-5-103 / Modbus RTU / DNP3.0 RTU, RS485, Terminals
- X104** – IRIG-B00X, incl. System Contact (Supervision Contact)

MCDGV4-2B1AIB

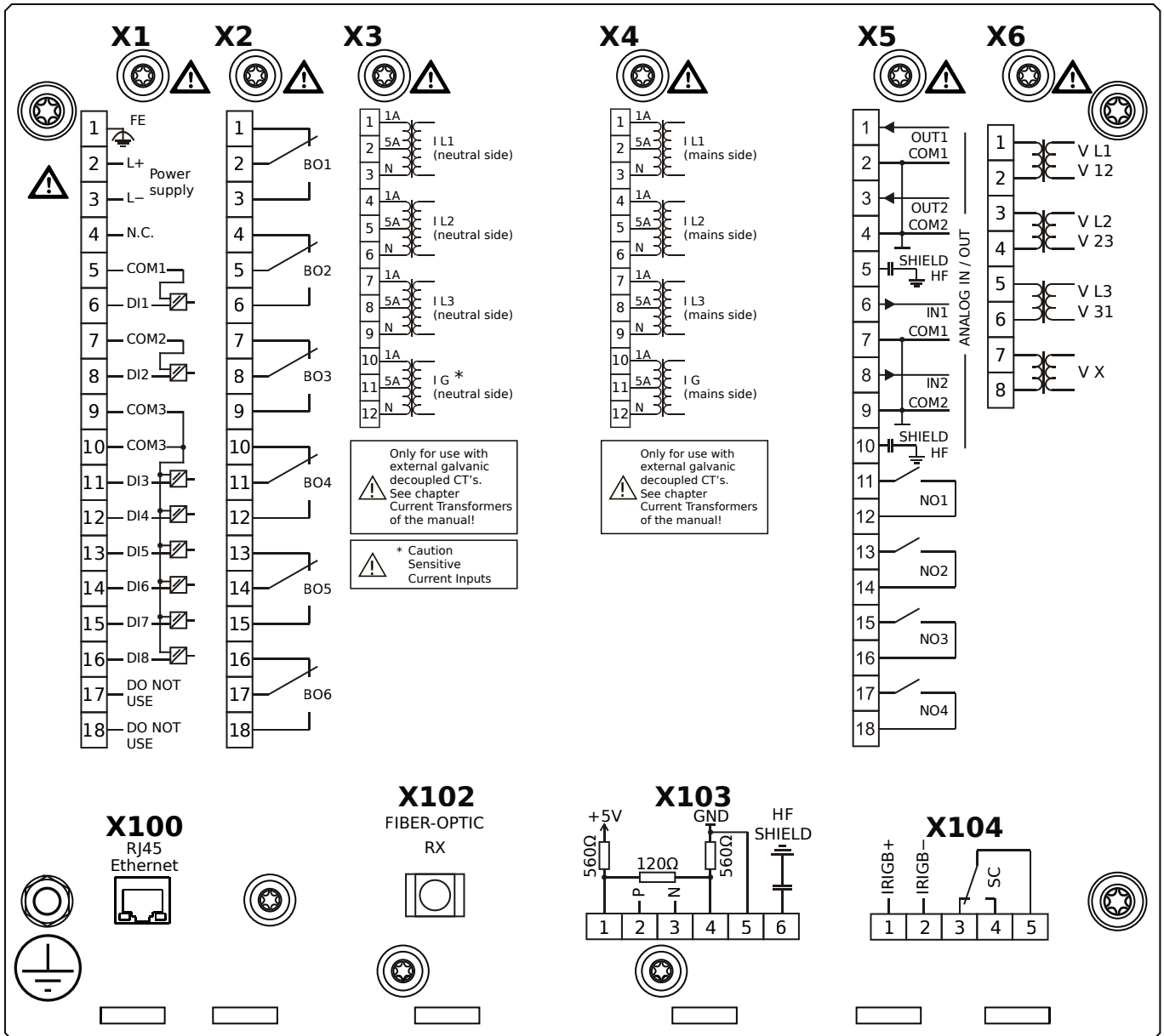

Housing B2, large display, door mounting

+ Conformal Coating (for installations in harsh environment)

- X1** – DI8-X1: Wide-range power supply unit, incl. 2 non-grouped digital inputs and 6 grouped digital inputs
- X2** – OR6: Assembly Group with 6 Output Relays (Changeover / Form C)
- X3** – TIs: Standard phase current measuring card and sensitive ground current measuring (neutral side of the diff. prot.)
- X4** – TI: Standard current measuring card (for the mains side of the differential protection)
- X5** – AnIO2-OR4: Assembly Group with 2 Analog Inputs, 2 Analog Outputs and 4 Output Relays
- X6** – TU: Card with 4 voltage transformer measuring inputs (0 ... 800 VAC, under UL: 0 ... 600 VAC)
- X100** – Modbus TCP / DNP3.0 TCP/UDP, Ethernet interface, 100 Mbit/s, RJ45 (BASE100-FX)
- X102** – Universal Resistance-Temperature Detector (URTD) input, Fiber optics interface, Versatile Link
- X103** – IEC 60870-5-103 / Modbus RTU / DNP3.0 RTU, RS485, Terminals
- X104** – IRIG-B00X, incl. System Contact (Supervision Contact)

MCDGV4-2B1AKA

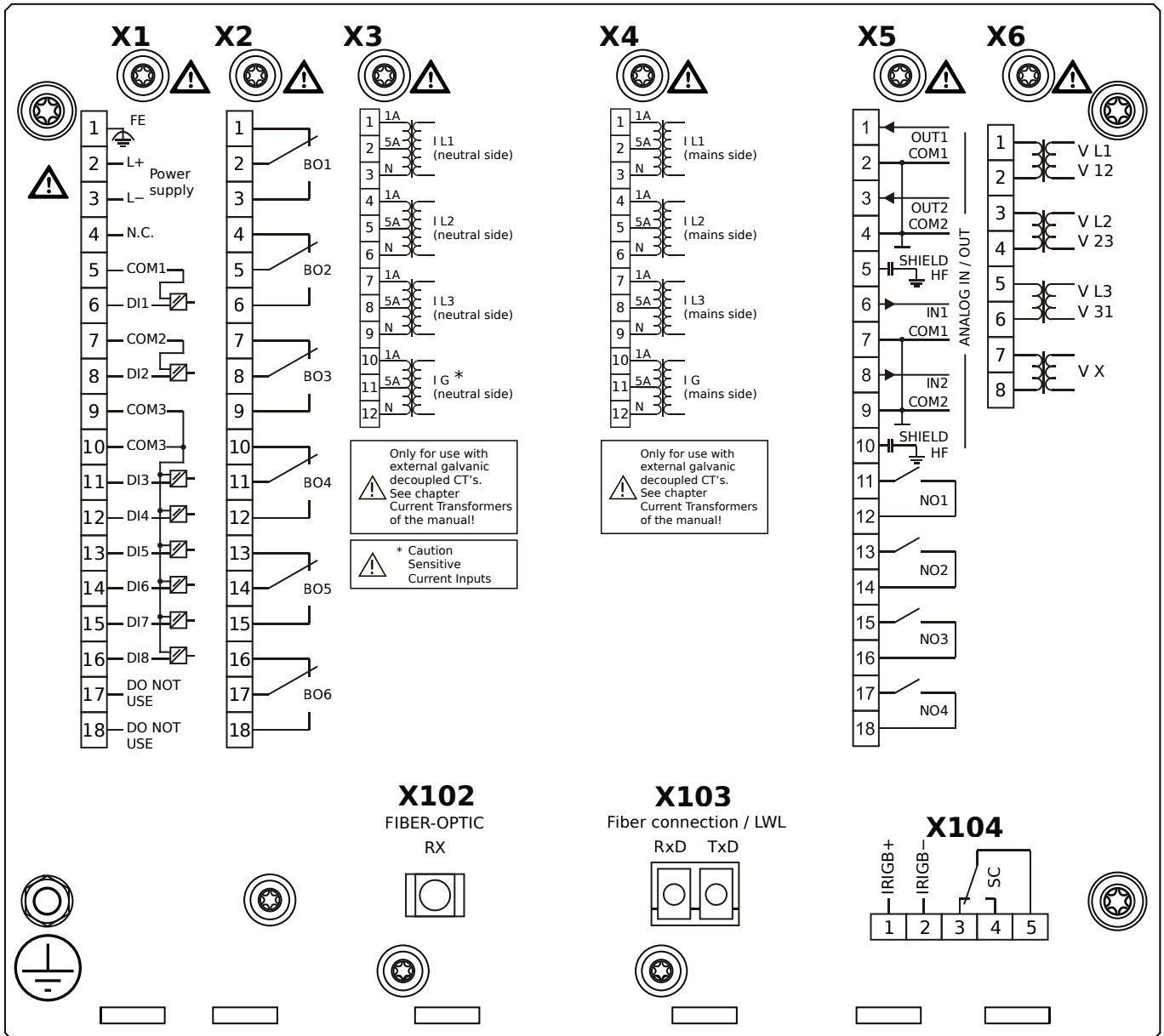

Housing B2, large display, door mounting

- X1** – DI8-X1: Wide-range power supply unit, incl. 2 non-grouped digital inputs and 6 grouped digital inputs
- X2** – OR6: Assembly Group with 6 Output Relays (Changeover / Form C)
- X3** – TIs: Standard phase current measuring card and sensitive ground current measuring (neutral side of the diff. prot.)
- X4** – TI: Standard current measuring card (for the mains side of the differential protection)
- X5** – AnIO2-OR4: Assembly Group with 2 Analog Inputs, 2 Analog Outputs and 4 Output Relays
- X6** – TU: Card with 4 voltage transformer measuring inputs (0 ... 800 VAC, under UL: 0 ... 600 VAC)
- X102** – Universal Resistance-Temperature Detector (URTD) input, Fiber optics interface, Versatile Link
- X103** – IEC 61850 / Modbus TCP / DNP3.0 TCP/UDP, Fiber optics interface, LC Connector
- X104** – IRIG-B00X, incl. System Contact (Supervision Contact)

MCDGV4-2B1AKB

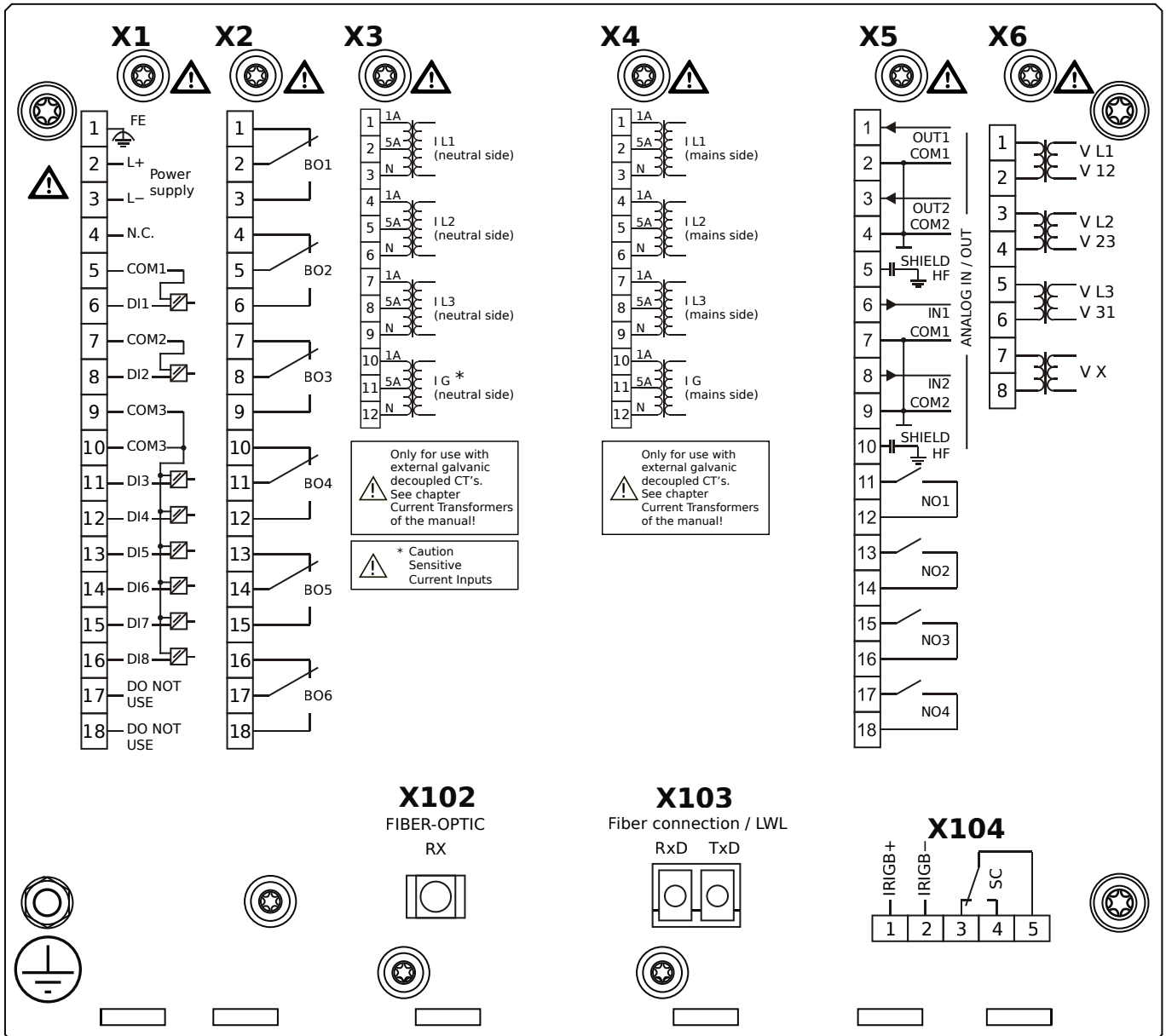

Housing B2, large display, door mounting

+ Conformal Coating (for installations in harsh environment)

- X1** – DI8-X1: Wide-range power supply unit, incl. 2 non-grouped digital inputs and 6 grouped digital inputs
- X2** – OR6: Assembly Group with 6 Output Relays (Changeover / Form C)
- X3** – TIs: Standard phase current measuring card and sensitive ground current measuring (neutral side of the diff. prot.)
- X4** – TI: Standard current measuring card (for the mains side of the differential protection)
- X5** – AnIO2-OR4: Assembly Group with 2 Analog Inputs, 2 Analog Outputs and 4 Output Relays
- X6** – TU: Card with 4 voltage transformer measuring inputs (0 ... 800 VAC, under UL: 0 ... 600 VAC)
- X102** – Universal Resistance-Temperature Detector (URTD) input, Fiber optics interface, Versatile Link
- X103** – IEC 61850 / Modbus TCP / DNP3.0 TCP/UDP, Fiber optics interface, LC Connector
- X104** – IRIG-B00X, incl. System Contact (Supervision Contact)

MCDGV4-2B1ALA

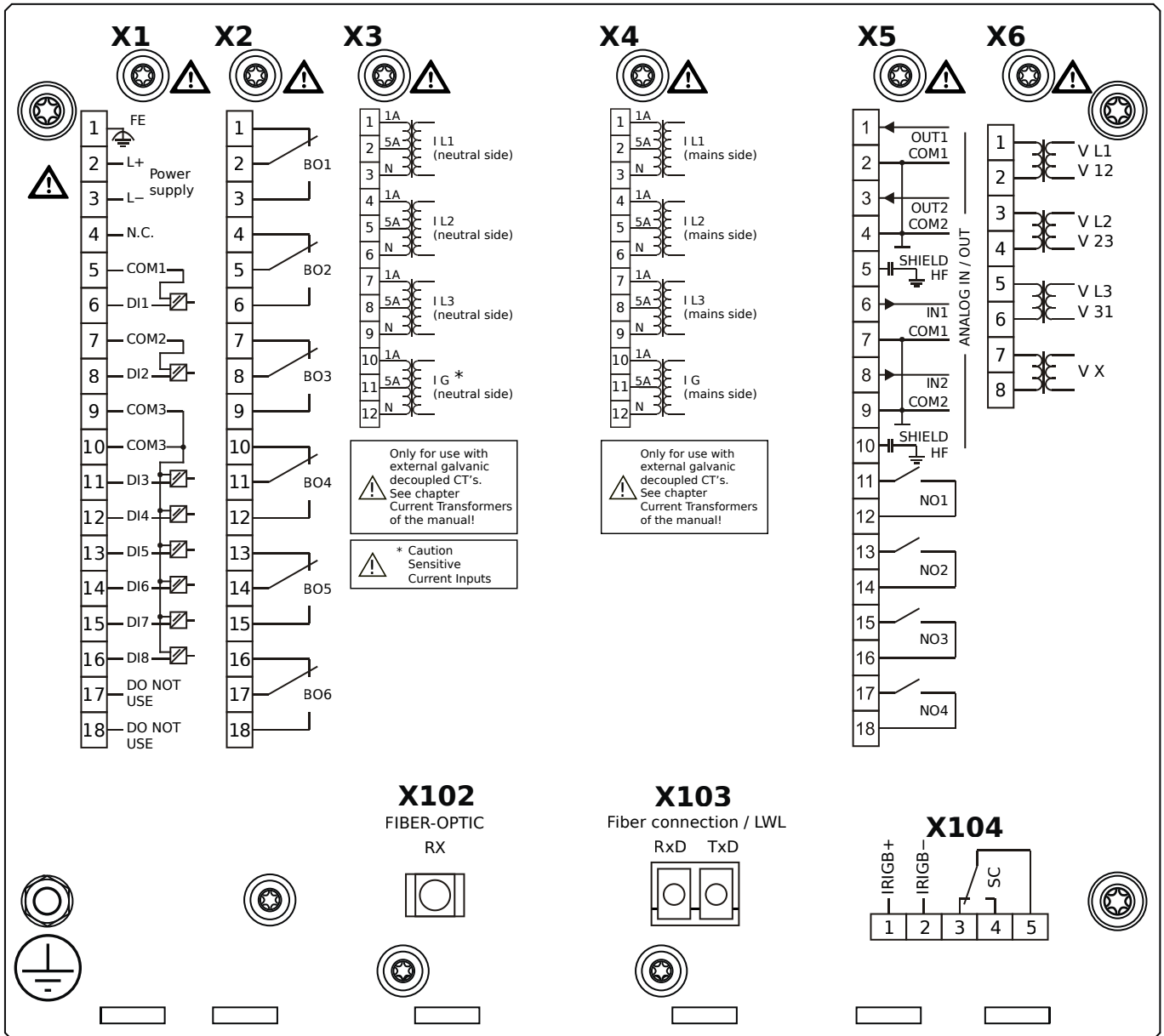

Housing B2, large display, door mounting

- X1** – DI8-X1: Wide-range power supply unit, incl. 2 non-grouped digital inputs and 6 grouped digital inputs
- X2** – OR6: Assembly Group with 6 Output Relays (Changeover / Form C)
- X3** – TIs: Standard phase current measuring card and sensitive ground current measuring (neutral side of the diff. prot.)
- X4** – TI: Standard current measuring card (for the mains side of the differential protection)
- X5** – AnIO2-OR4: Assembly Group with 2 Analog Inputs, 2 Analog Outputs and 4 Output Relays
- X6** – TU: Card with 4 voltage transformer measuring inputs (0 ... 800 VAC, under UL: 0 ... 600 VAC)
- X102** – Universal Resistance-Temperature Detector (URTD) input, Fiber optics interface, Versatile Link
- X103** – Modbus TCP / DNP3.0 TCP/UDP, Fiber optics interface, LC Connector
- X104** – IRIG-B00X, incl. System Contact (Supervision Contact)

MCDGV4-2B1ALB

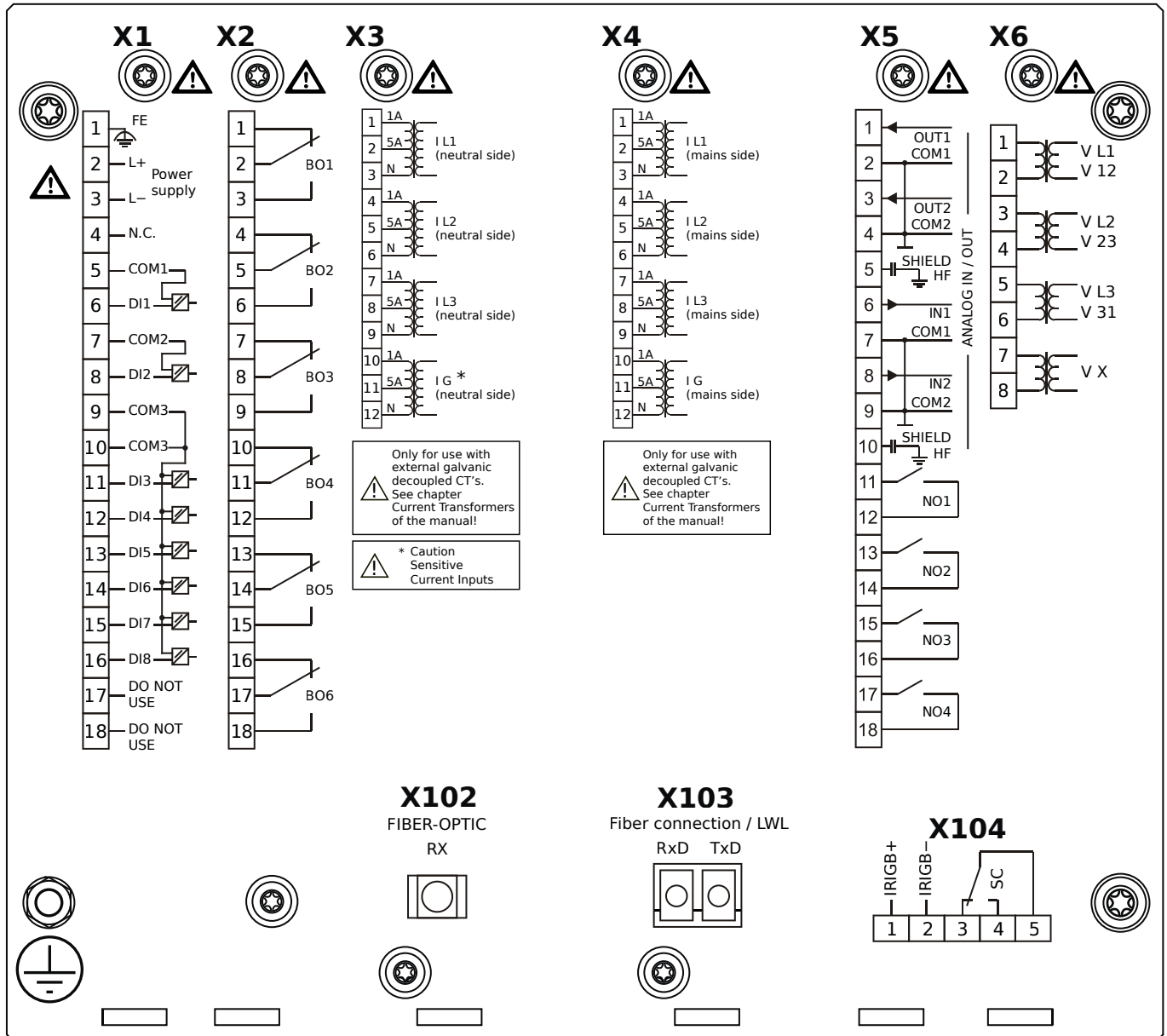

Housing B2, large display, door mounting

- + Conformal Coating (for installations in harsh environment)

- X1** – DI8-X1: Wide-range power supply unit, incl. 2 non-grouped digital inputs and 6 grouped digital inputs
- X2** – OR6: Assembly Group with 6 Output Relays (Changeover / Form C)
- X3** – TIs: Standard phase current measuring card and sensitive ground current measuring (neutral side of the diff. prot.)
- X4** – TI: Standard current measuring card (for the mains side of the differential protection)
- X5** – AnIO2-OR4: Assembly Group with 2 Analog Inputs, 2 Analog Outputs and 4 Output Relays
- X6** – TU: Card with 4 voltage transformer measuring inputs (0 ... 800 VAC, under UL: 0 ... 600 VAC)
- X102** – Universal Resistance-Temperature Detector (URTD) input, Fiber optics interface, Versatile Link
- X103** – Modbus TCP / DNP3.0 TCP/UDP, Fiber optics interface, LC Connector
- X104** – IRIG-B00X, incl. System Contact (Supervision Contact)

MCDGV4-2B1ATA

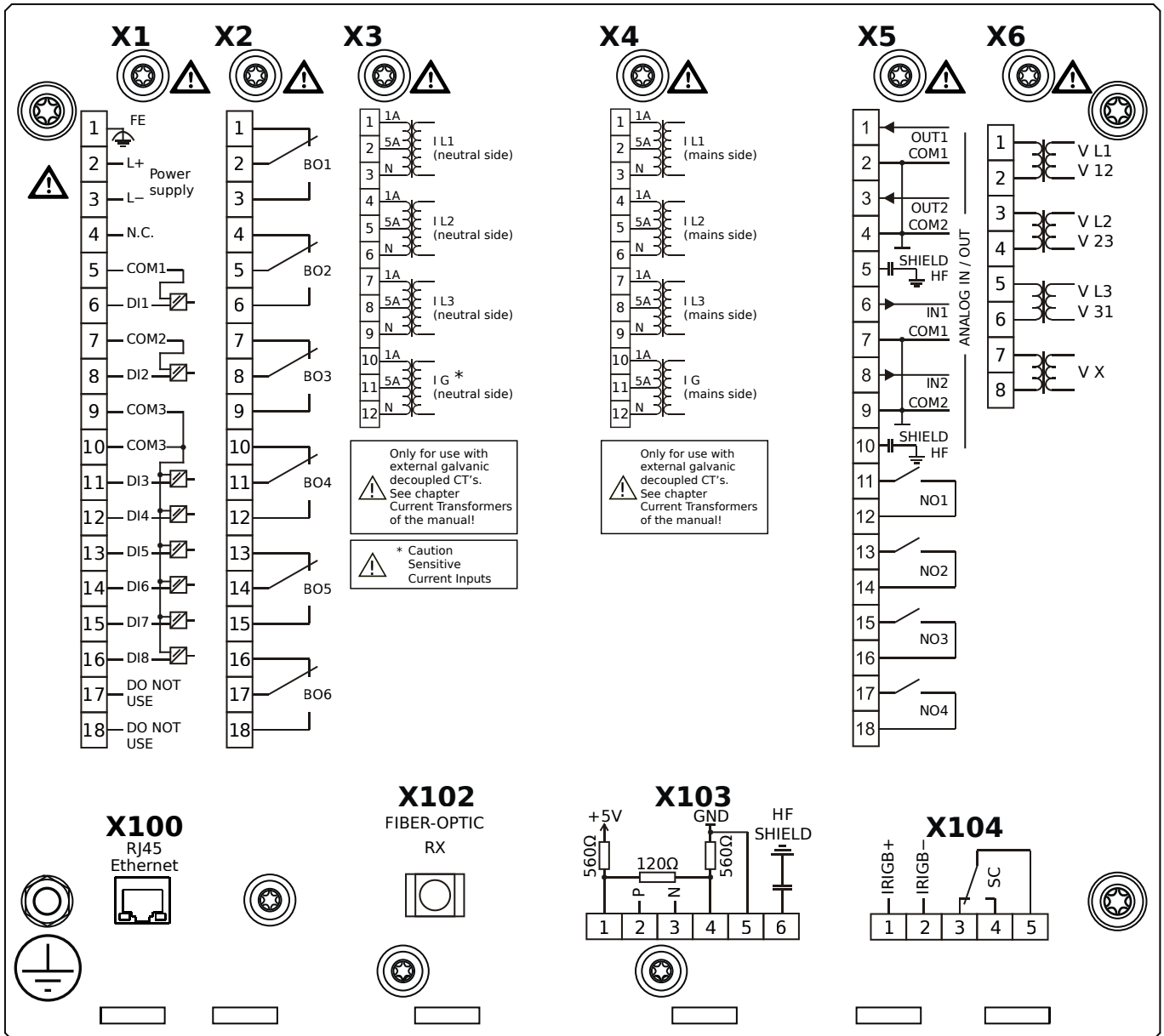

Housing B2, large display, door mounting

- X1** – DI8-X1: Wide-range power supply unit, incl. 2 non-grouped digital inputs and 6 grouped digital inputs
- X2** – OR6: Assembly Group with 6 Output Relays (Changeover / Form C)
- X3** – TIs: Standard phase current measuring card and sensitive ground current measuring (neutral side of the diff. prot.)
- X4** – TI: Standard current measuring card (for the mains side of the differential protection)
- X5** – AnIO2-OR4: Assembly Group with 2 Analog Inputs, 2 Analog Outputs and 4 Output Relays
- X6** – TU: Card with 4 voltage transformer measuring inputs (0 ... 800 VAC, under UL: 0 ... 600 VAC)
- X100** – IEC 61850 / Modbus TCP / DNP3.0 TCP/UDP, Ethernet interface, 100 Mbit/s, RJ45 (BASE100-FX)
- X102** – Universal Resistance-Temperature Detector (URTD) input, Fiber optics interface, Versatile Link
- X103** – IEC 60870-5-103 / Modbus RTU / DNP3.0 RTU, RS485, Terminals
- X104** – IRIG-B00X, incl. System Contact (Supervision Contact)

MCDGV4-2B1ATB

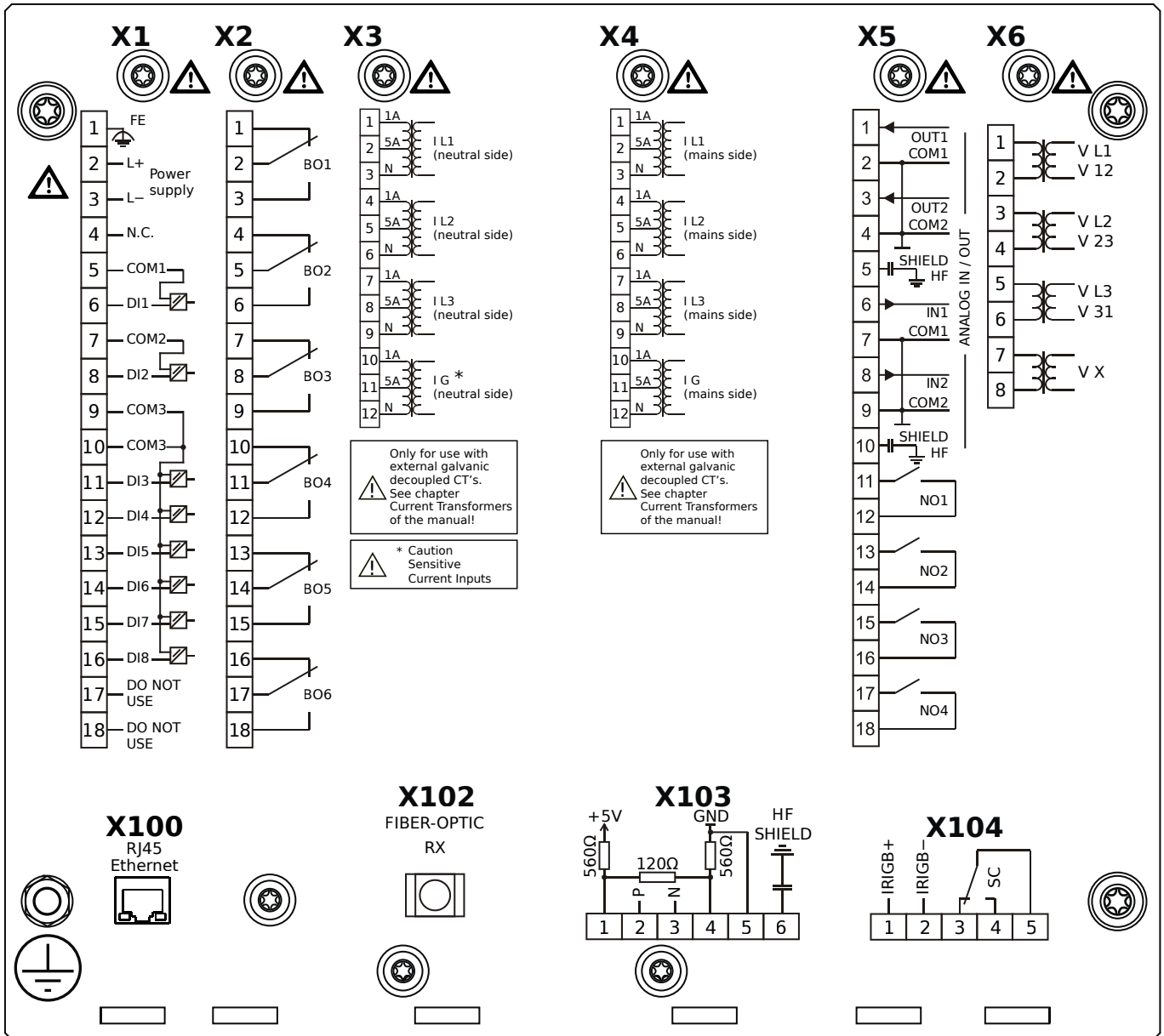

Housing B2, large display, door mounting

+ Conformal Coating (for installations in harsh environment)

- X1** – DI8-X1: Wide-range power supply unit, incl. 2 non-grouped digital inputs and 6 grouped digital inputs
- X2** – OR6: Assembly Group with 6 Output Relays (Changeover / Form C)
- X3** – TIs: Standard phase current measuring card and sensitive ground current measuring (neutral side of the diff. prot.)
- X4** – TI: Standard current measuring card (for the mains side of the differential protection)
- X5** – AnIO2-OR4: Assembly Group with 2 Analog Inputs, 2 Analog Outputs and 4 Output Relays
- X6** – TU: Card with 4 voltage transformer measuring inputs (0 ... 800 VAC, under UL: 0 ... 600 VAC)
- X100** – IEC 61850 / Modbus TCP / DNP3.0 TCP/UDP, Ethernet interface, 100 Mbit/s, RJ45 (BASE100-FX)
- X102** – Universal Resistance-Temperature Detector (URTD) input, Fiber optics interface, Versatile Link
- X103** – IEC 60870-5-103 / Modbus RTU / DNP3.0 RTU, RS485, Terminals
- X104** – IRIG-B00X, incl. System Contact (Supervision Contact)

MCDGV4-2B1BAA

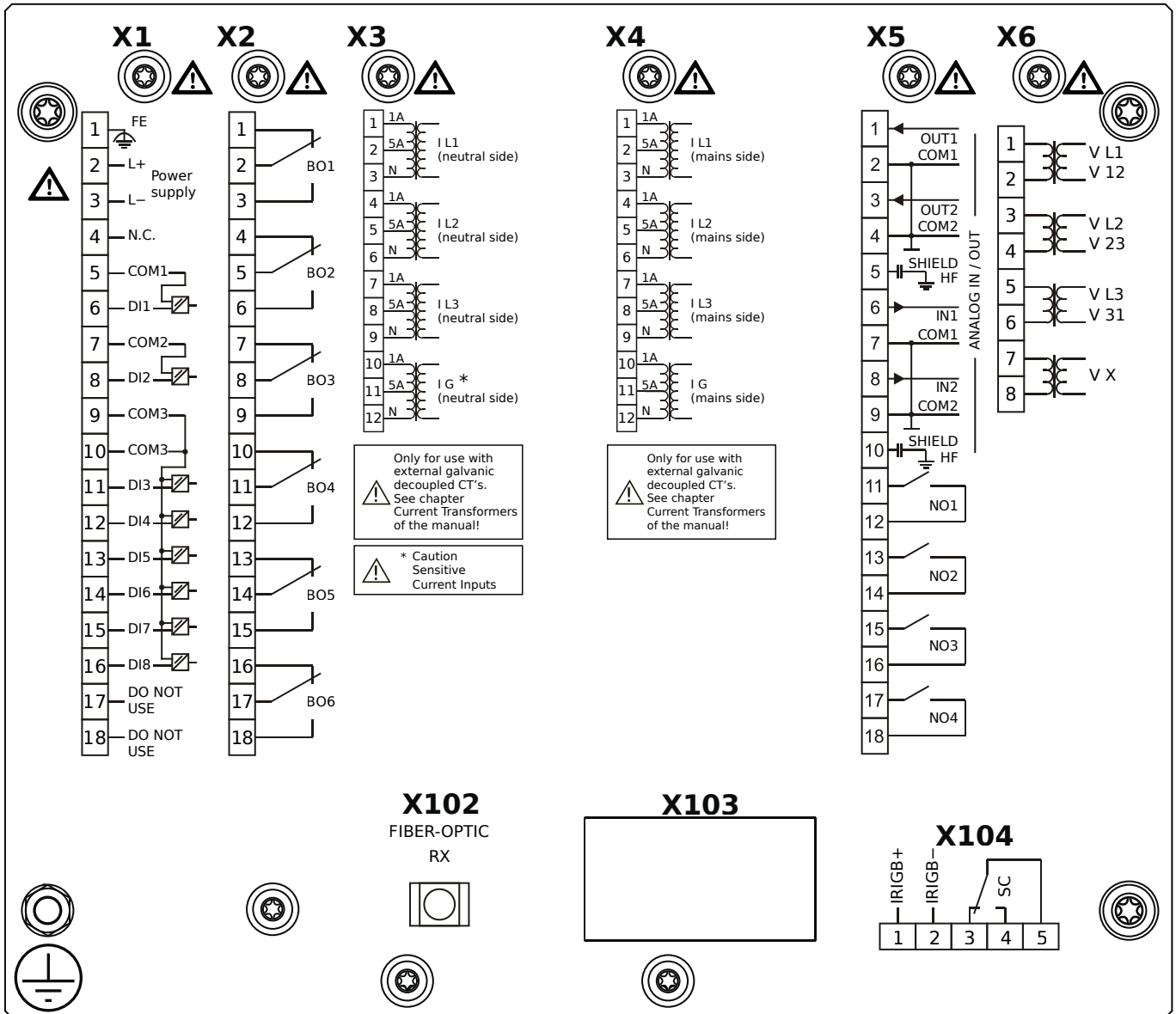

Housing B2, large display, 19" rack mounting

- X1** – DI8-X1: Wide-range power supply unit, incl. 2 non-grouped digital inputs and 6 grouped digital inputs
- X2** – OR6: Assembly Group with 6 Output Relays (Changeover / Form C)
- X3** – TI: Standard phase current measuring card and sensitive ground current measuring (neutral side of the diff. prot.)
- X4** – TI: Standard current measuring card (for the mains side of the differential protection)
- X5** – AnIO2-OR4: Assembly Group with 2 Analog Inputs, 2 Analog Outputs and 4 Output Relays
- X6** – TU: Card with 4 voltage transformer measuring inputs (0 ... 800 VAC, under UL: 0 ... 600 VAC)
- X102** – Universal Resistance-Temperature Detector (URTD) input, Fiber optics interface, Versatile Link
- X104** – IRIG-B00X, incl. System Contact (Supervision Contact)

MCDGV4-2B1BAB

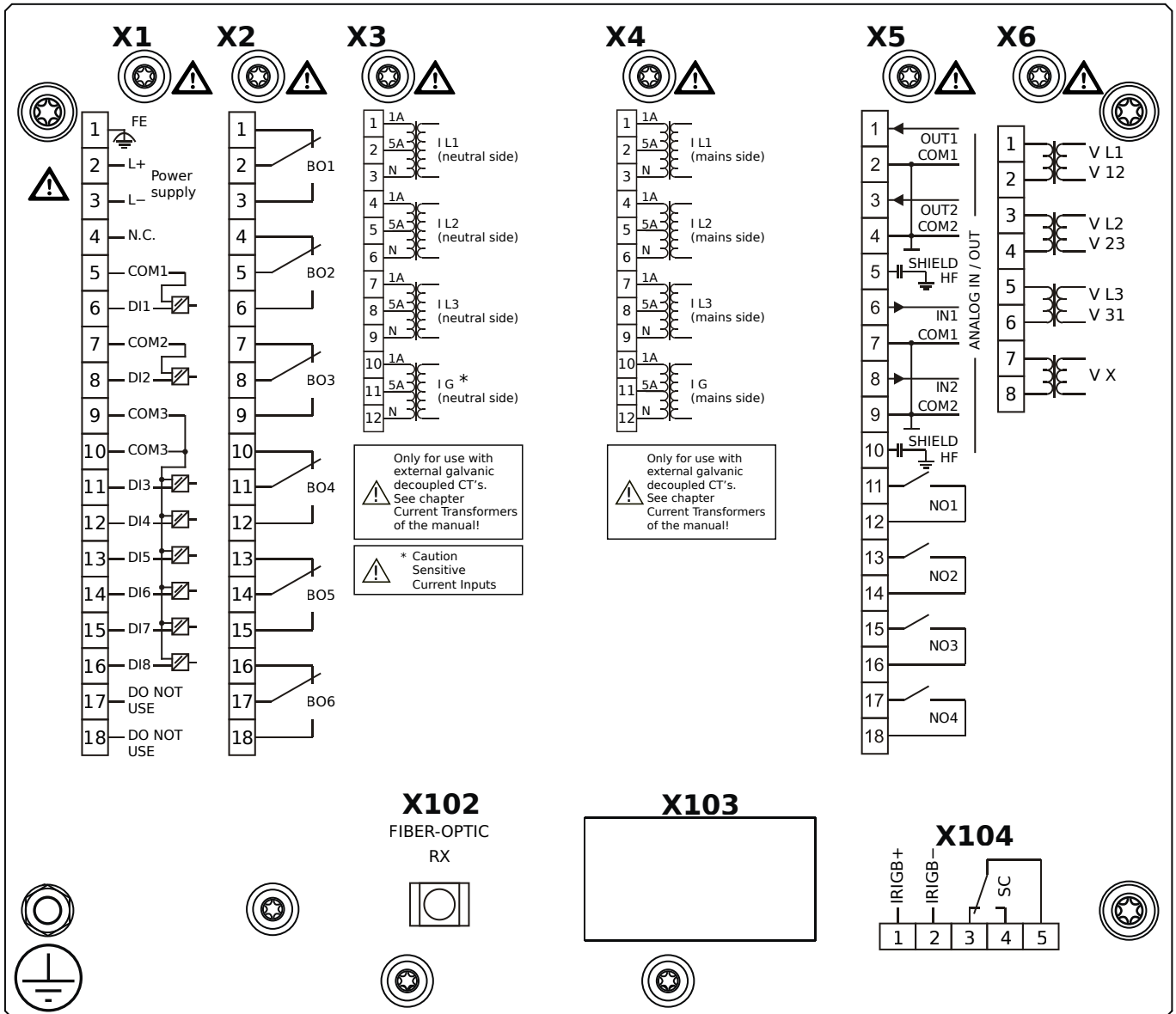

Housing B2, large display, 19" rack mounting

+ Conformal Coating (for installations in harsh environment)

- X1** – DI8-X1: Wide-range power supply unit, incl. 2 non-grouped digital inputs and 6 grouped digital inputs
- X2** – OR6: Assembly Group with 6 Output Relays (Changeover / Form C)
- X3** – TIs: Standard phase current measuring card and sensitive ground current measuring (neutral side of the diff. prot.)
- X4** – TI: Standard current measuring card (for the mains side of the differential protection)
- X5** – AnIO2-OR4: Assembly Group with 2 Analog Inputs, 2 Analog Outputs and 4 Output Relays
- X6** – TU: Card with 4 voltage transformer measuring inputs (0 ... 800 VAC, under UL: 0 ... 600 VAC)
- X102** – Universal Resistance-Temperature Detector (URTD) input, Fiber optics interface, Versatile Link
- X104** – IRIG-B00X, incl. System Contact (Supervision Contact)

MCDGV4-2B1BBA

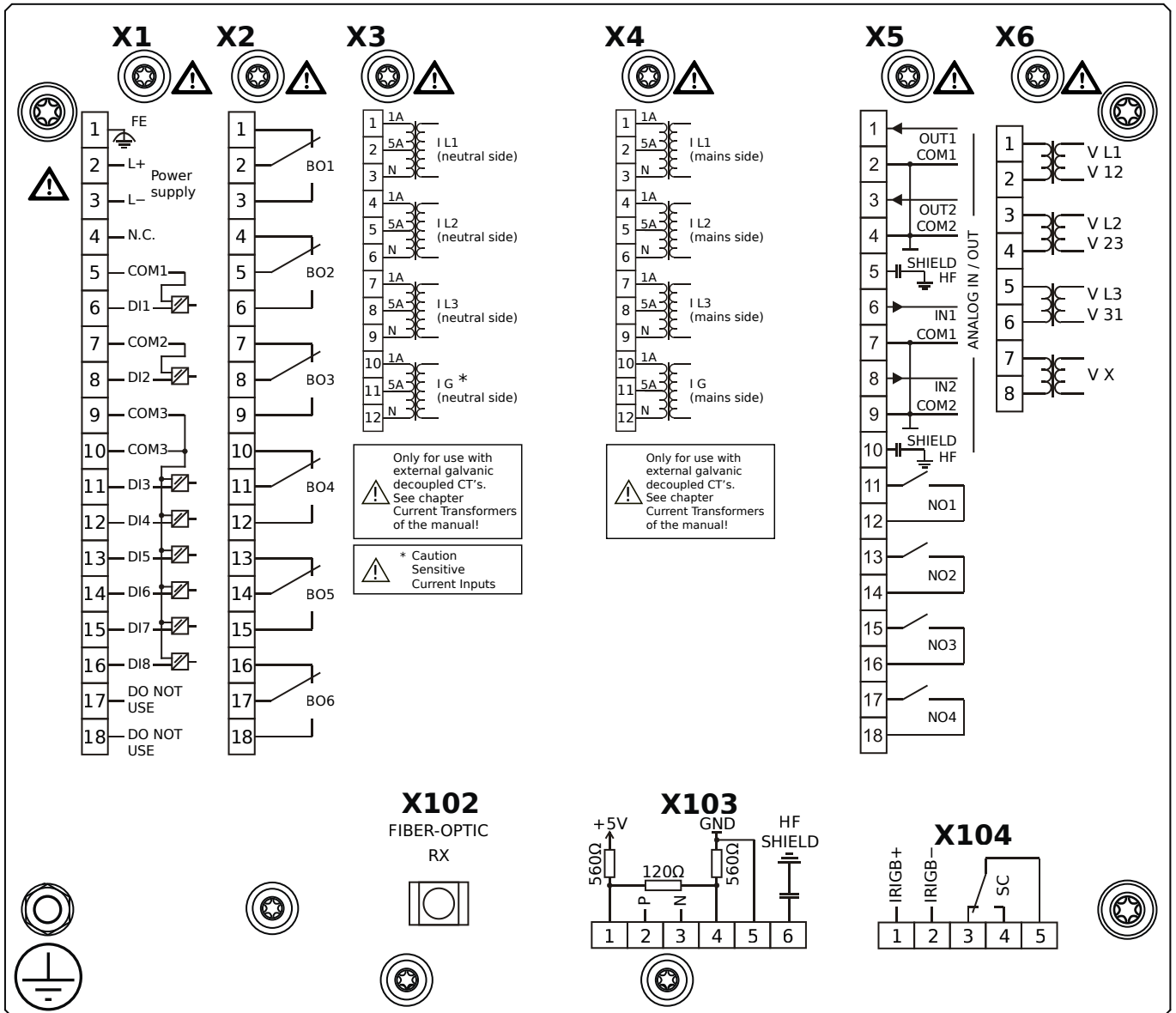

Housing B2, large display, 19" rack mounting

- X1** – DI8-X1: Wide-range power supply unit, incl. 2 non-grouped digital inputs and 6 grouped digital inputs
- X2** – OR6: Assembly Group with 6 Output Relays (Changeover / Form C)
- X3** – TIs: Standard phase current measuring card and sensitive ground current measuring (neutral side of the diff. prot.)
- X4** – TI: Standard current measuring card (for the mains side of the differential protection)
- X5** – AnIO2-OR4: Assembly Group with 2 Analog Inputs, 2 Analog Outputs and 4 Output Relays
- X6** – TU: Card with 4 voltage transformer measuring inputs (0 ... 800 VAC, under UL: 0 ... 600 VAC)
- X102** – Universal Resistance-Temperature Detector (URTD) input, Fiber optics interface, Versatile Link
- X103** – Modbus RTU / IEC 60870-5-103 / DNP3.0 RTU, RS485, Terminals
- X104** – IRIG-B00X, incl. System Contact (Supervision Contact)

MCDGV4-2B1BBB

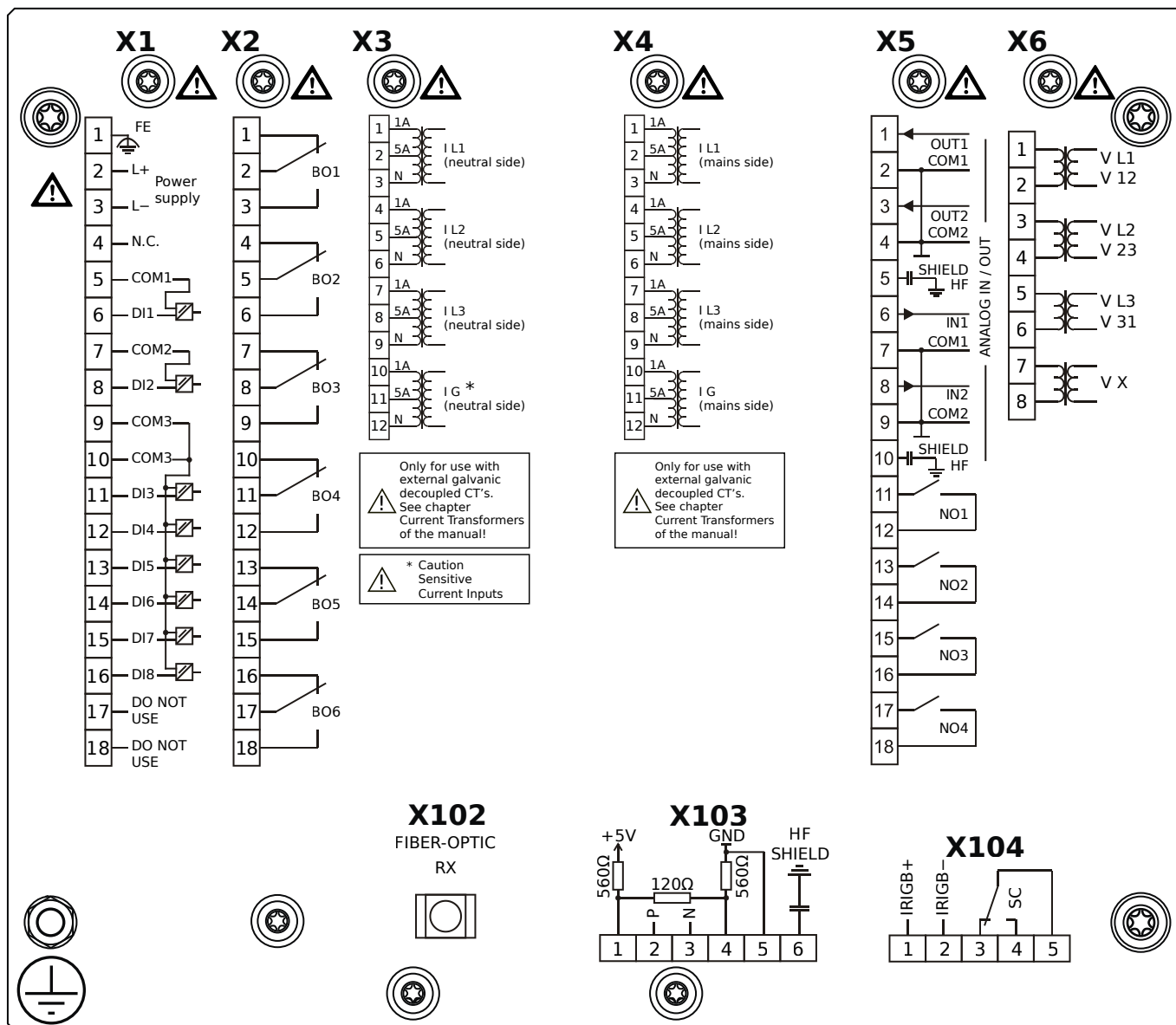

Housing B2, large display, 19" rack mounting

+ Conformal Coating (for installations in harsh environment)

- X1** – DI8-X1: Wide-range power supply unit, incl. 2 non-grouped digital inputs and 6 grouped digital inputs
- X2** – OR6: Assembly Group with 6 Output Relays (Changeover / Form C)
- X3** – TIs: Standard phase current measuring card and sensitive ground current measuring (neutral side of the diff. prot.)
- X4** – TI: Standard current measuring card (for the mains side of the differential protection)
- X5** – AnIO2-OR4: Assembly Group with 2 Analog Inputs, 2 Analog Outputs and 4 Output Relays
- X6** – TU: Card with 4 voltage transformer measuring inputs (0 ... 800 VAC, under UL: 0 ... 600 VAC)
- X102** – Universal Resistance-Temperature Detector (URTD) input, Fiber optics interface, Versatile Link
- X103** – Modbus RTU / IEC 60870-5-103 / DNP3.0 RTU, RS485, Terminals
- X104** – IRIG-B00X, incl. System Contact (Supervision Contact)

MCDGV4-2B1BCA

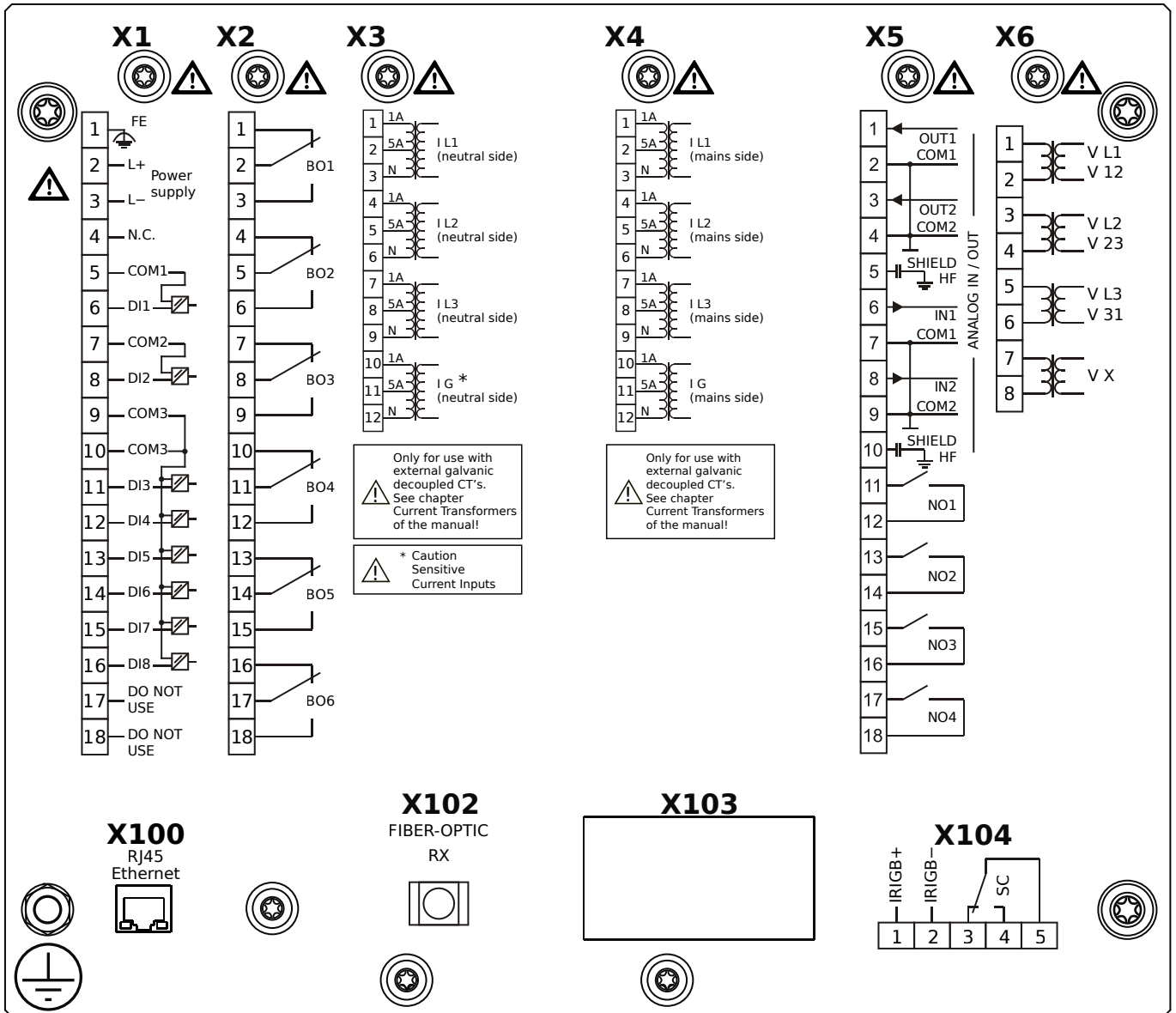

Housing B2, large display, 19" rack mounting

- X1** – DI8-X1: Wide-range power supply unit, incl. 2 non-grouped digital inputs and 6 grouped digital inputs
- X2** – OR6: Assembly Group with 6 Output Relays (Changeover / Form C)
- X3** – TI: Standard phase current measuring card and sensitive ground current measuring (neutral side of the diff. prot.)
- X4** – TI: Standard current measuring card (for the mains side of the differential protection)
- X5** – AnIO2-OR4: Assembly Group with 2 Analog Inputs, 2 Analog Outputs and 4 Output Relays
- X6** – TU: Card with 4 voltage transformer measuring inputs (0 ... 800 VAC, under UL: 0 ... 600 VAC)
- X100** – Modbus TCP / DNP3.0 TCP/UDP, Ethernet interface, 100 Mbit/s, RJ45 (BASE100-FX)
- X102** – Universal Resistance-Temperature Detector (URTD) input, Fiber optics interface, Versatile Link
- X104** – IRIG-B00X, incl. System Contact (Supervision Contact)

MCDGV4-2B1BCB

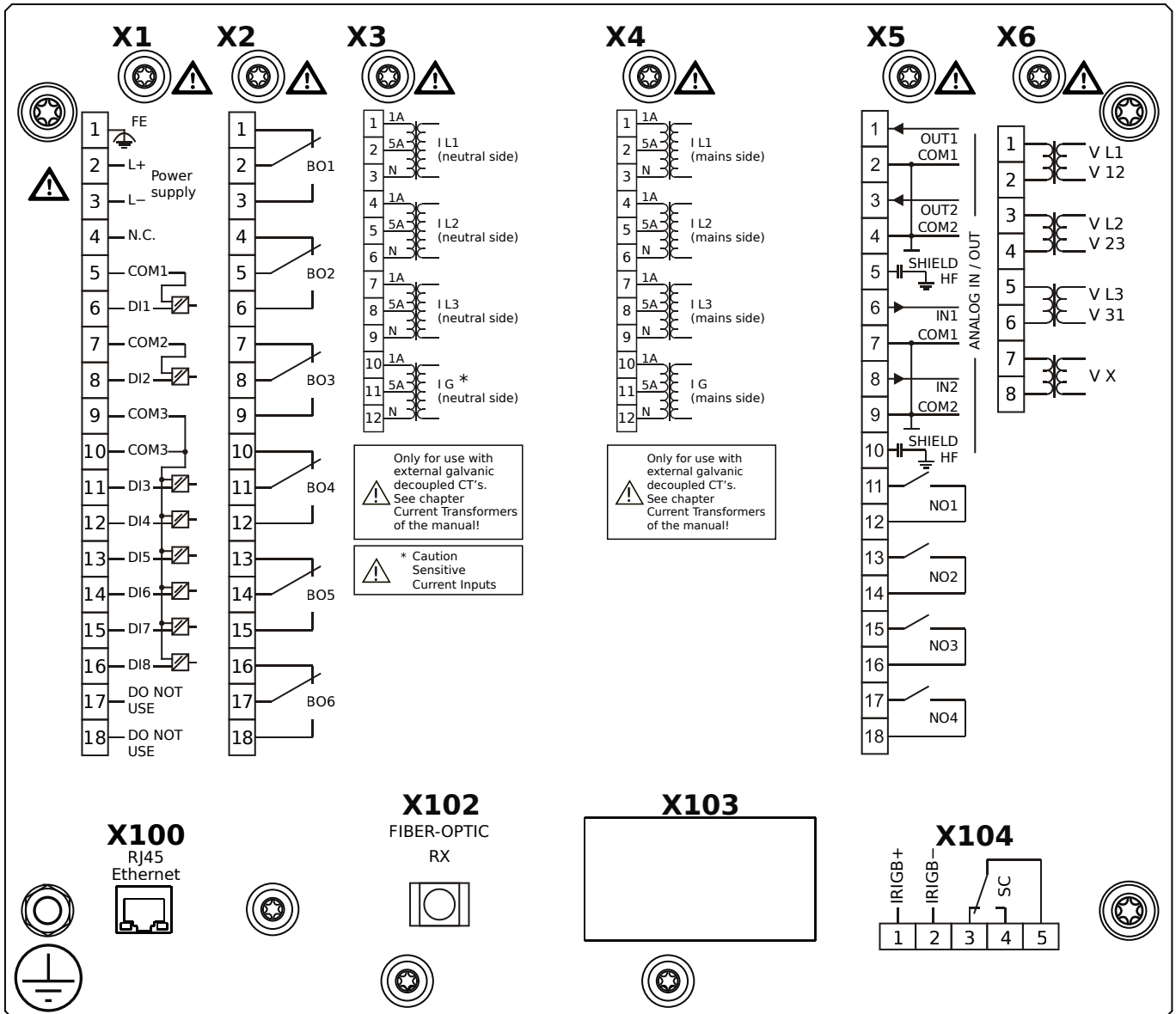

Housing B2, large display, 19" rack mounting

+ Conformal Coating (for installations in harsh environment)

- X1** – DI8-X1: Wide-range power supply unit, incl. 2 non-grouped digital inputs and 6 grouped digital inputs
- X2** – OR6: Assembly Group with 6 Output Relays (Changeover / Form C)
- X3** – TIs: Standard phase current measuring card and sensitive ground current measuring (neutral side of the diff. prot.)
- X4** – TI: Standard current measuring card (for the mains side of the differential protection)
- X5** – AnIO2-OR4: Assembly Group with 2 Analog Inputs, 2 Analog Outputs and 4 Output Relays
- X6** – TU: Card with 4 voltage transformer measuring inputs (0 ... 800 VAC, under UL: 0 ... 600 VAC)
- X100** – Modbus TCP / DNP3.0 TCP/UDP, Ethernet interface, 100 Mbit/s, RJ45 (BASE100-FX)
- X102** – Universal Resistance-Temperature Detector (URTD) input, Fiber optics interface, Versatile Link
- X104** – IRIG-B00X, incl. System Contact (Supervision Contact)

MCDGV4-2B1BDA

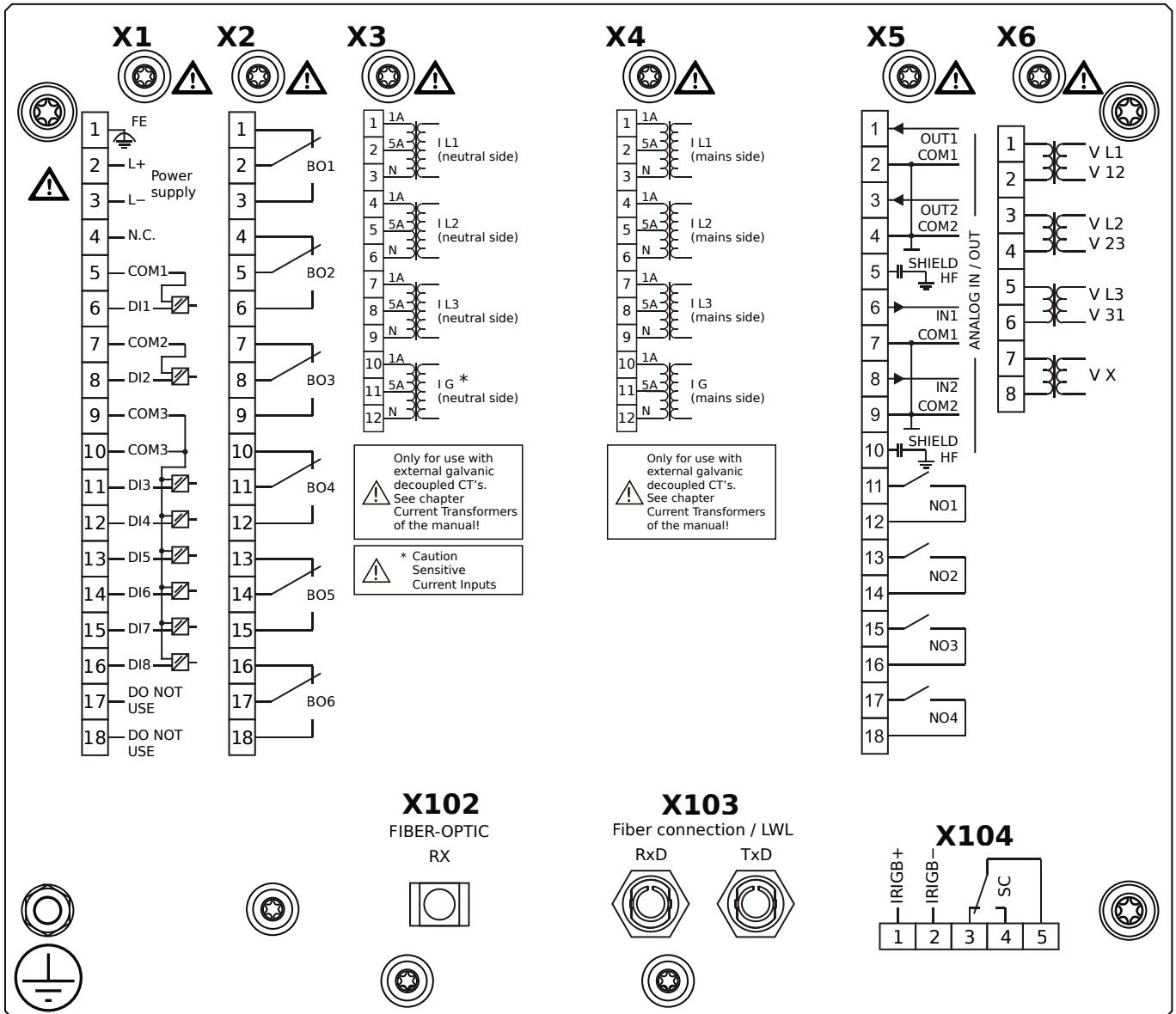

Housing B2, large display, 19" rack mounting

- X1** – DI8-X1: Wide-range power supply unit, incl. 2 non-grouped digital inputs and 6 grouped digital inputs
- X2** – OR6: Assembly Group with 6 Output Relays (Changeover / Form C)
- X3** – TI: Standard phase current measuring card and sensitive ground current measuring (neutral side of the diff. prot.)
- X4** – TI: Standard current measuring card (for the mains side of the differential protection)
- X5** – AnIO2-OR4: Assembly Group with 2 Analog Inputs, 2 Analog Outputs and 4 Output Relays
- X6** – TU: Card with 4 voltage transformer measuring inputs (0 ... 800 VAC, under UL: 0 ... 600 VAC)
- X102** – Universal Resistance-Temperature Detector (URTD) input, Fiber optics interface, Versatile Link
- X103** – Profibus-DP, Fiber optics interface, ST Connector
- X104** – IRIG-B00X, incl. System Contact (Supervision Contact)

MCDGV4-2B1BDB

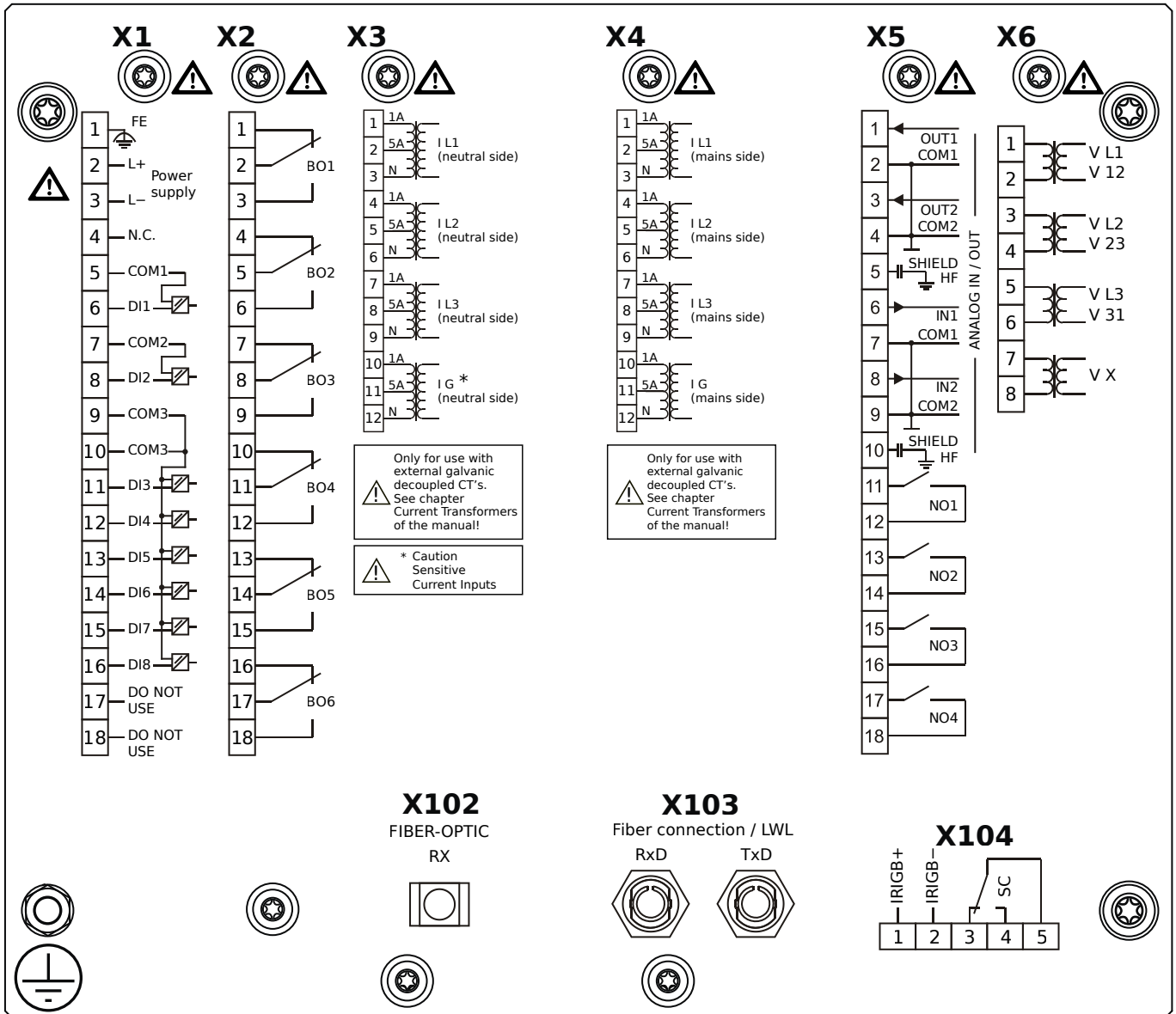

Housing B2, large display, 19" rack mounting

+ Conformal Coating (for installations in harsh environment)

- X1** – DI8-X1: Wide-range power supply unit, incl. 2 non-grouped digital inputs and 6 grouped digital inputs
- X2** – OR6: Assembly Group with 6 Output Relays (Changeover / Form C)
- X3** – TIs: Standard phase current measuring card and sensitive ground current measuring (neutral side of the diff. prot.)
- X4** – TI: Standard current measuring card (for the mains side of the differential protection)
- X5** – AnIO2-OR4: Assembly Group with 2 Analog Inputs, 2 Analog Outputs and 4 Output Relays
- X6** – TU: Card with 4 voltage transformer measuring inputs (0 ... 800 VAC, under UL: 0 ... 600 VAC)
- X102** – Universal Resistance-Temperature Detector (URTD) input, Fiber optics interface, Versatile Link
- X103** – Profibus-DP, Fiber optics interface, ST Connector
- X104** – IRIG-B00X, incl. System Contact (Supervision Contact)

MCDGV4-2B1BEA

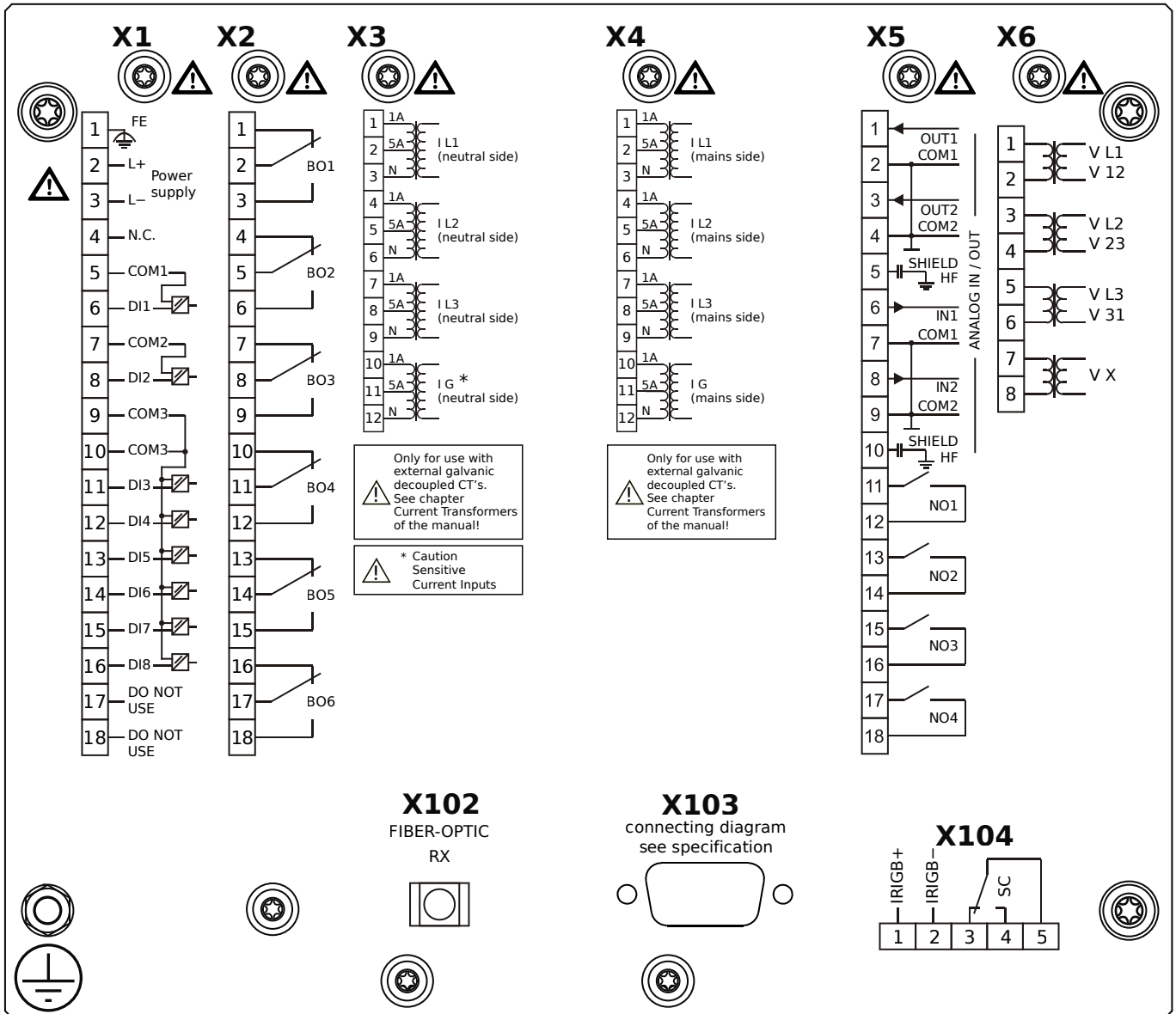

Housing B2, large display, 19" rack mounting

- X1** – DI8-X1: Wide-range power supply unit, incl. 2 non-grouped digital inputs and 6 grouped digital inputs
- X2** – OR6: Assembly Group with 6 Output Relays (Changeover / Form C)
- X3** – TIs: Standard phase current measuring card and sensitive ground current measuring (neutral side of the diff. prot.)
- X4** – TI: Standard current measuring card (for the mains side of the differential protection)
- X5** – AnIO2-OR4: Assembly Group with 2 Analog Inputs, 2 Analog Outputs and 4 Output Relays
- X6** – TU: Card with 4 voltage transformer measuring inputs (0 ... 800 VAC, under UL: 0 ... 600 VAC)
- X102** – Universal Resistance-Temperature Detector (URTD) input, Fiber optics interface, Versatile Link
- X103** – Profibus-DP, RS485, D-SUB
- X104** – IRIG-B00X, incl. System Contact (Supervision Contact)

MCDGV4-2B1BEB

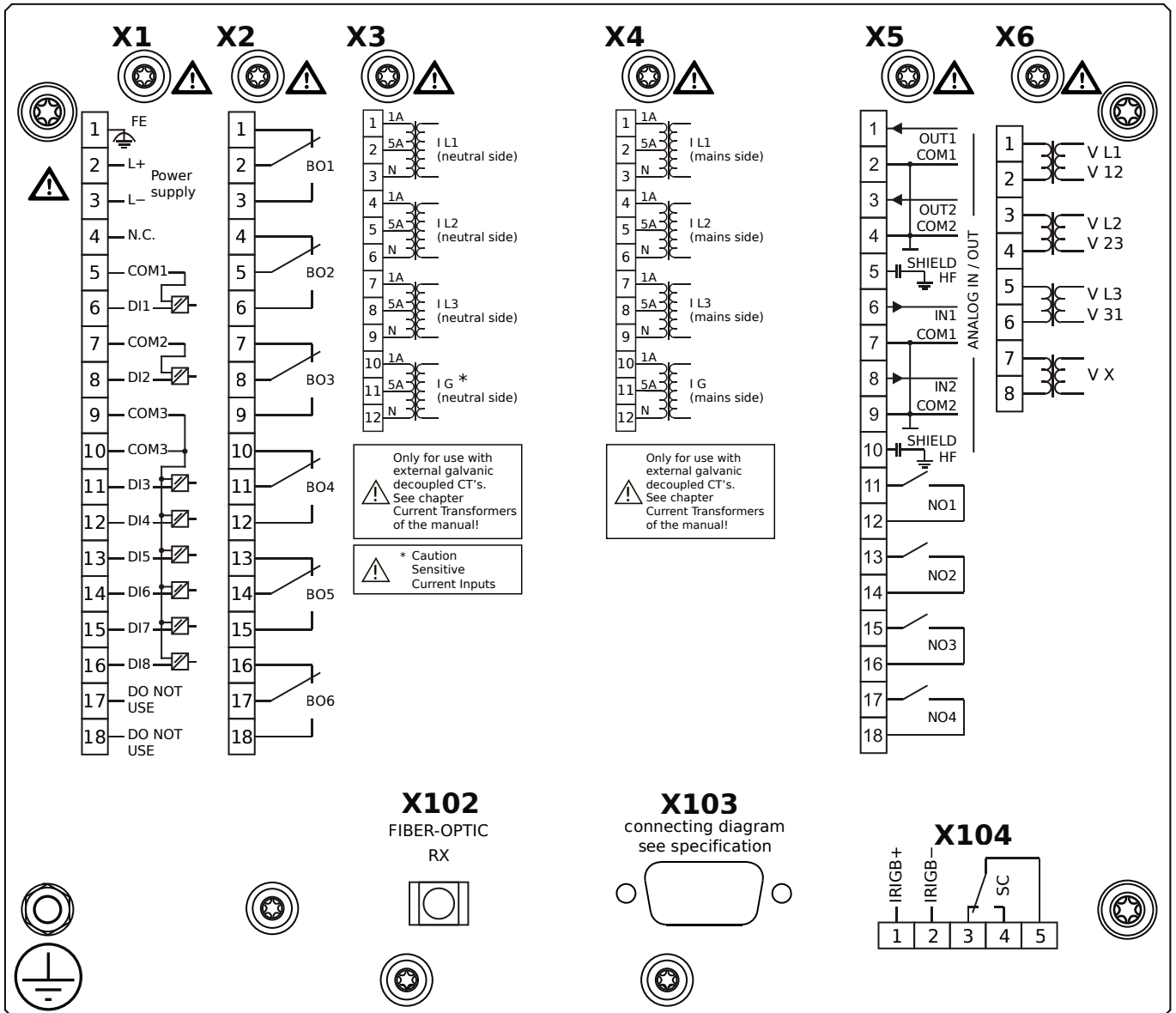

Housing B2, large display, 19" rack mounting

+ Conformal Coating (for installations in harsh environment)

- X1** – DI8-X1: Wide-range power supply unit, incl. 2 non-grouped digital inputs and 6 grouped digital inputs
- X2** – OR6: Assembly Group with 6 Output Relays (Changeover / Form C)
- X3** – TIs: Standard phase current measuring card and sensitive ground current measuring (neutral side of the diff. prot.)
- X4** – TI: Standard current measuring card (for the mains side of the differential protection)
- X5** – AnIO2-OR4: Assembly Group with 2 Analog Inputs, 2 Analog Outputs and 4 Output Relays
- X6** – TU: Card with 4 voltage transformer measuring inputs (0 ... 800 VAC, under UL: 0 ... 600 VAC)
- X102** – Universal Resistance-Temperature Detector (URTD) input, Fiber optics interface, Versatile Link
- X103** – Profibus-DP, RS485, D-SUB
- X104** – IRIG-B00X, incl. System Contact (Supervision Contact)

MCDGV4-2B1BFA

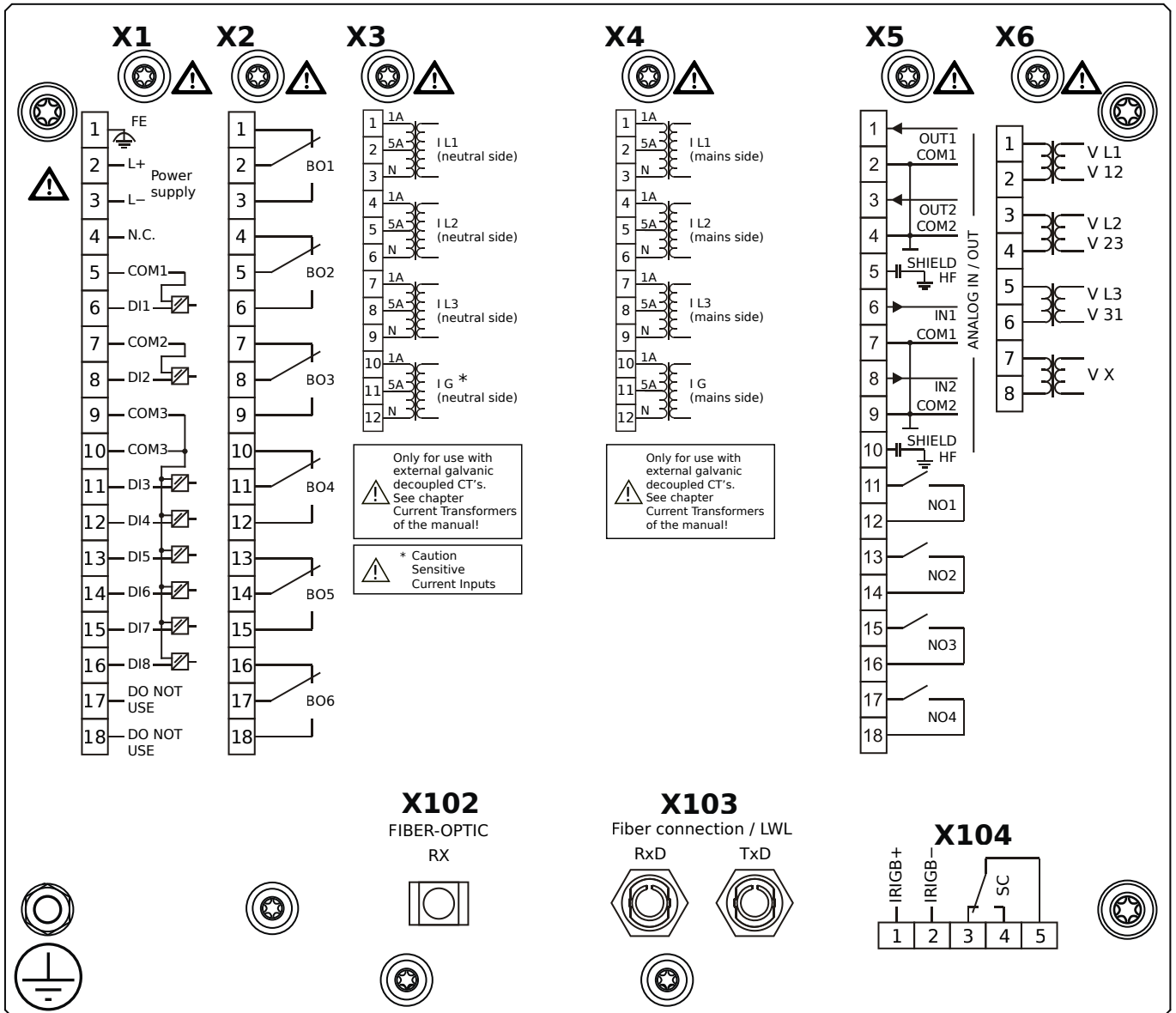

Housing B2, large display, 19" rack mounting

- X1** – DI8-X1: Wide-range power supply unit, incl. 2 non-grouped digital inputs and 6 grouped digital inputs
- X2** – OR6: Assembly Group with 6 Output Relays (Changeover / Form C)
- X3** – TIs: Standard phase current measuring card and sensitive ground current measuring (neutral side of the diff. prot.)
- X4** – TI: Standard current measuring card (for the mains side of the differential protection)
- X5** – AnIO2-OR4: Assembly Group with 2 Analog Inputs, 2 Analog Outputs and 4 Output Relays
- X6** – TU: Card with 4 voltage transformer measuring inputs (0 ... 800 VAC, under UL: 0 ... 600 VAC)
- X102** – Universal Resistance-Temperature Detector (URTD) input, Fiber optics interface, Versatile Link
- X103** – Modbus RTU / IEC 60870-5-103 / DNP3.0 RTU, Fiber optics interface, ST Connector
- X104** – IRIG-B00X, incl. System Contact (Supervision Contact)

MCDGV4-2B1BFB

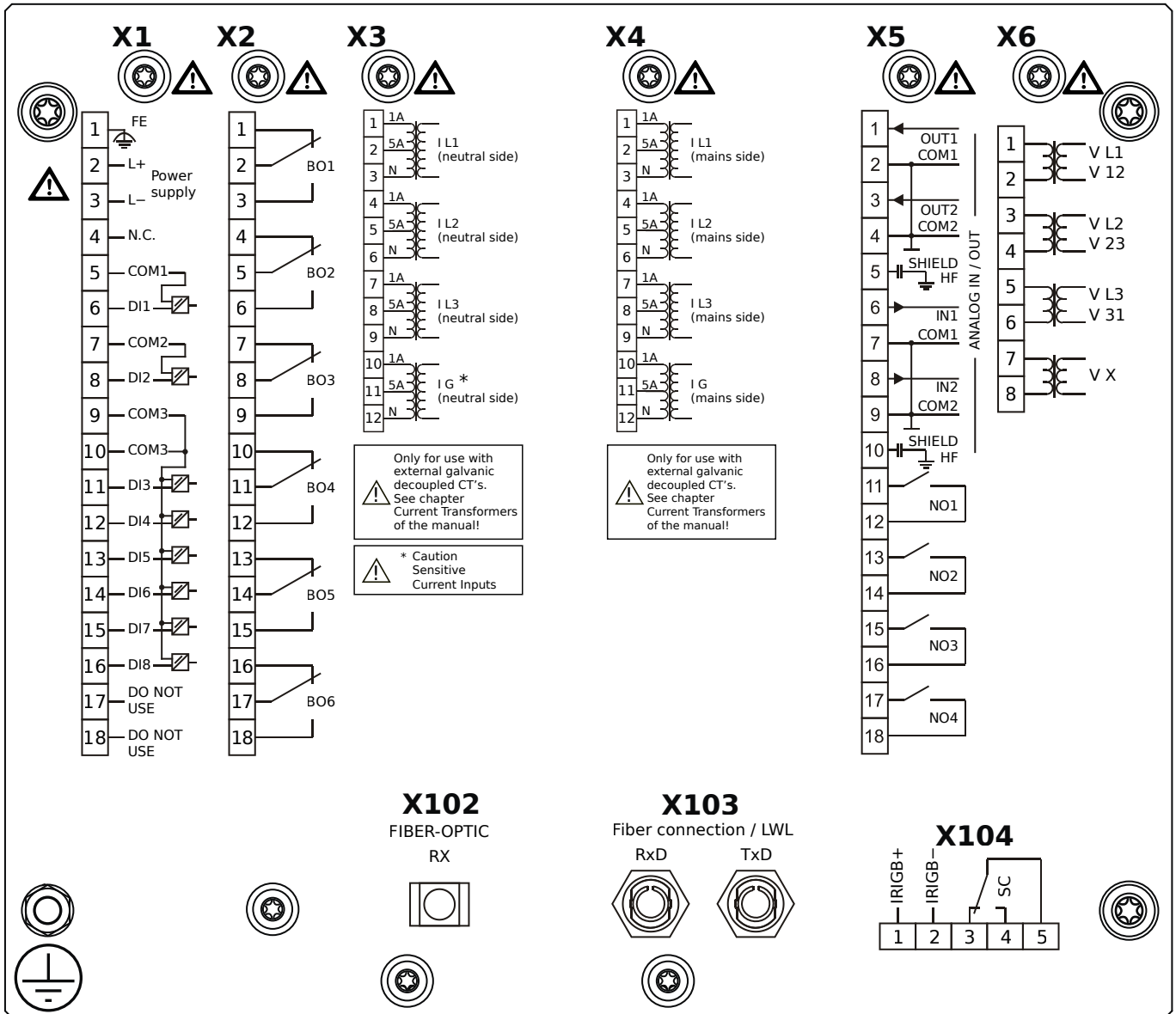

Housing B2, large display, 19" rack mounting

+ Conformal Coating (for installations in harsh environment)

- X1** – DI8-X1: Wide-range power supply unit, incl. 2 non-grouped digital inputs and 6 grouped digital inputs
- X2** – OR6: Assembly Group with 6 Output Relays (Changeover / Form C)
- X3** – TIs: Standard phase current measuring card and sensitive ground current measuring (neutral side of the diff. prot.)
- X4** – TI: Standard current measuring card (for the mains side of the differential protection)
- X5** – AnIO2-OR4: Assembly Group with 2 Analog Inputs, 2 Analog Outputs and 4 Output Relays
- X6** – TU: Card with 4 voltage transformer measuring inputs (0 ... 800 VAC, under UL: 0 ... 600 VAC)
- X102** – Universal Resistance-Temperature Detector (URTD) input, Fiber optics interface, Versatile Link
- X103** – Modbus RTU / IEC 60870-5-103 / DNP3.0 RTU, Fiber optics interface, ST Connector
- X104** – IRIG-B00X, incl. System Contact (Supervision Contact)

MCDGV4-2B1BGA

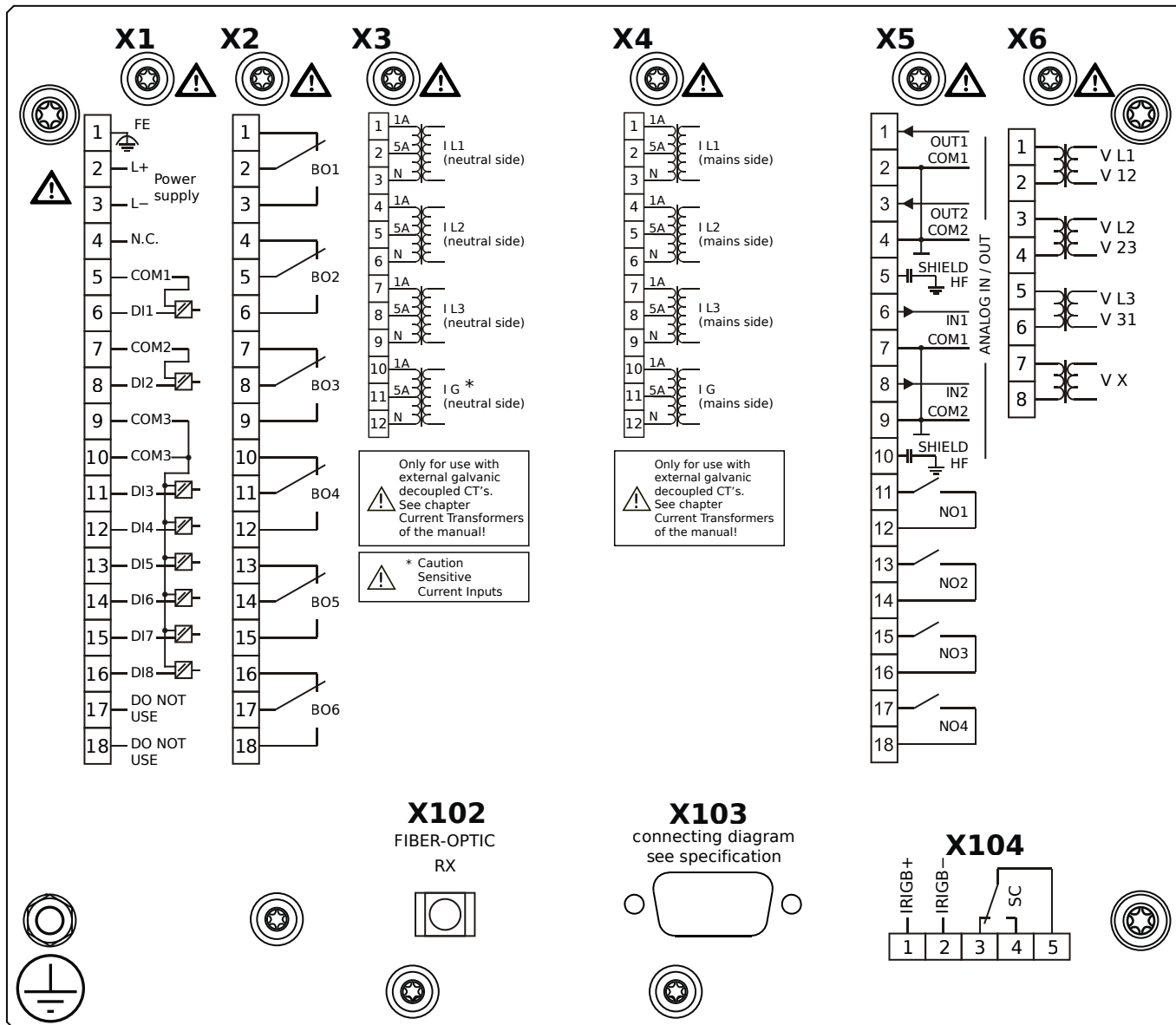

Housing B2, large display, 19" rack mounting

- X1** – DI8-X1: Wide-range power supply unit, incl. 2 non-grouped digital inputs and 6 grouped digital inputs
- X2** – OR6: Assembly Group with 6 Output Relays (Changeover / Form C)
- X3** – TIs: Standard phase current measuring card and sensitive ground current measuring (neutral side of the diff. prot.)
- X4** – TI: Standard current measuring card (for the mains side of the differential protection)
- X5** – AnIO2-OR4: Assembly Group with 2 Analog Inputs, 2 Analog Outputs and 4 Output Relays
- X6** – TU: Card with 4 voltage transformer measuring inputs (0 ... 800 VAC, under UL: 0 ... 600 VAC)
- X102** – Universal Resistance-Temperature Detector (URTD) input, Fiber optics interface, Versatile Link
- X103** – Modbus RTU / IEC 60870-5-103 / DNP3.0 RTU, RS485, D-SUB
- X104** – IRIG-B00X, incl. System Contact (Supervision Contact)

MCDGV4-2B1BGB

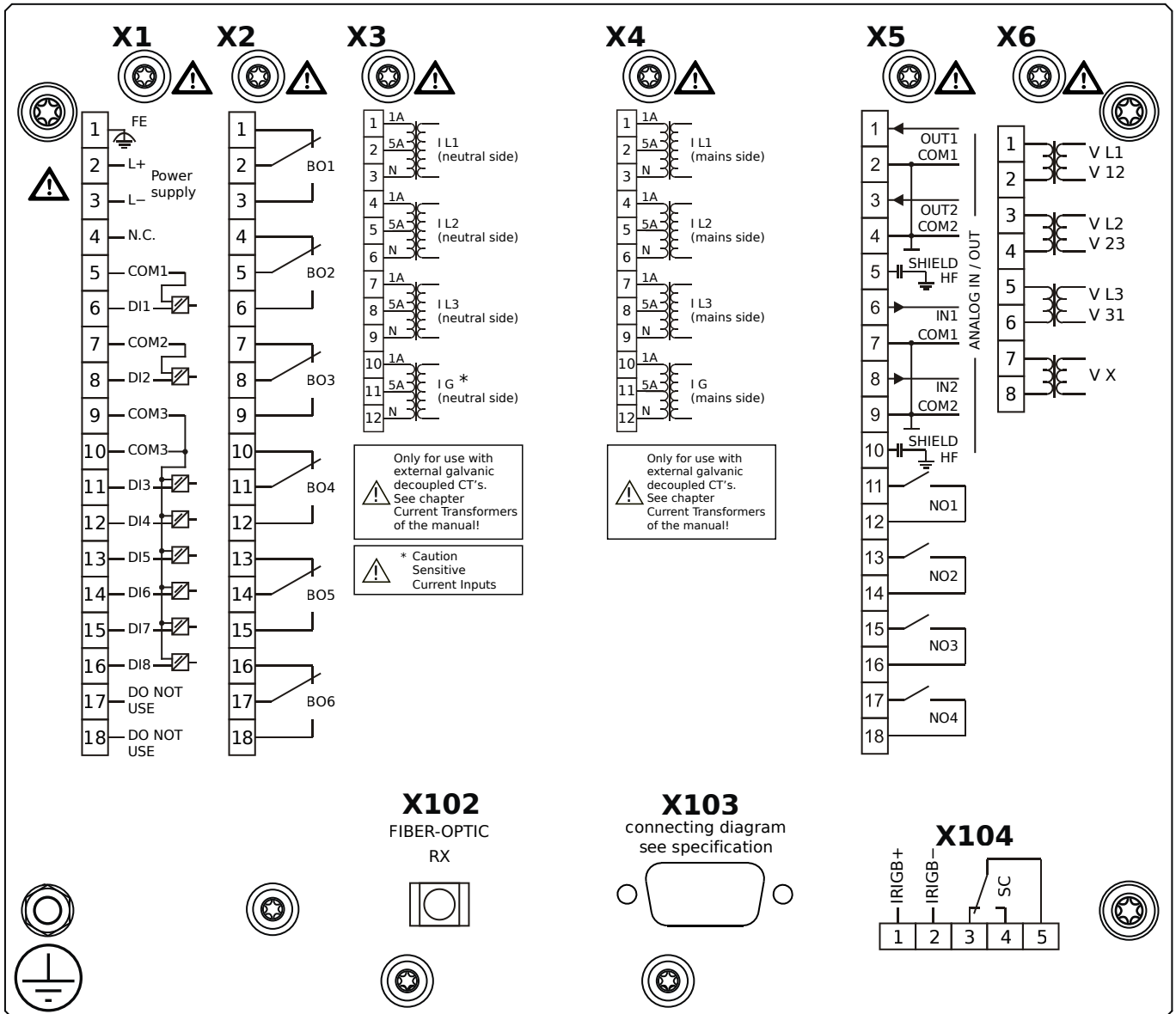

Housing B2, large display, 19" rack mounting

+ Conformal Coating (for installations in harsh environment)

- X1** – DI8-X1: Wide-range power supply unit, incl. 2 non-grouped digital inputs and 6 grouped digital inputs
- X2** – OR6: Assembly Group with 6 Output Relays (Changeover / Form C)
- X3** – TIs: Standard phase current measuring card and sensitive ground current measuring (neutral side of the diff. prot.)
- X4** – TI: Standard current measuring card (for the mains side of the differential protection)
- X5** – AnIO2-OR4: Assembly Group with 2 Analog Inputs, 2 Analog Outputs and 4 Output Relays
- X6** – TU: Card with 4 voltage transformer measuring inputs (0 ... 800 VAC, under UL: 0 ... 600 VAC)
- X102** – Universal Resistance-Temperature Detector (URTD) input, Fiber optics interface, Versatile Link
- X103** – Modbus RTU / IEC 60870-5-103 / DNP3.0 RTU, RS485, D-SUB
- X104** – IRIG-B00X, incl. System Contact (Supervision Contact)

MCDGV4-2B1BHA

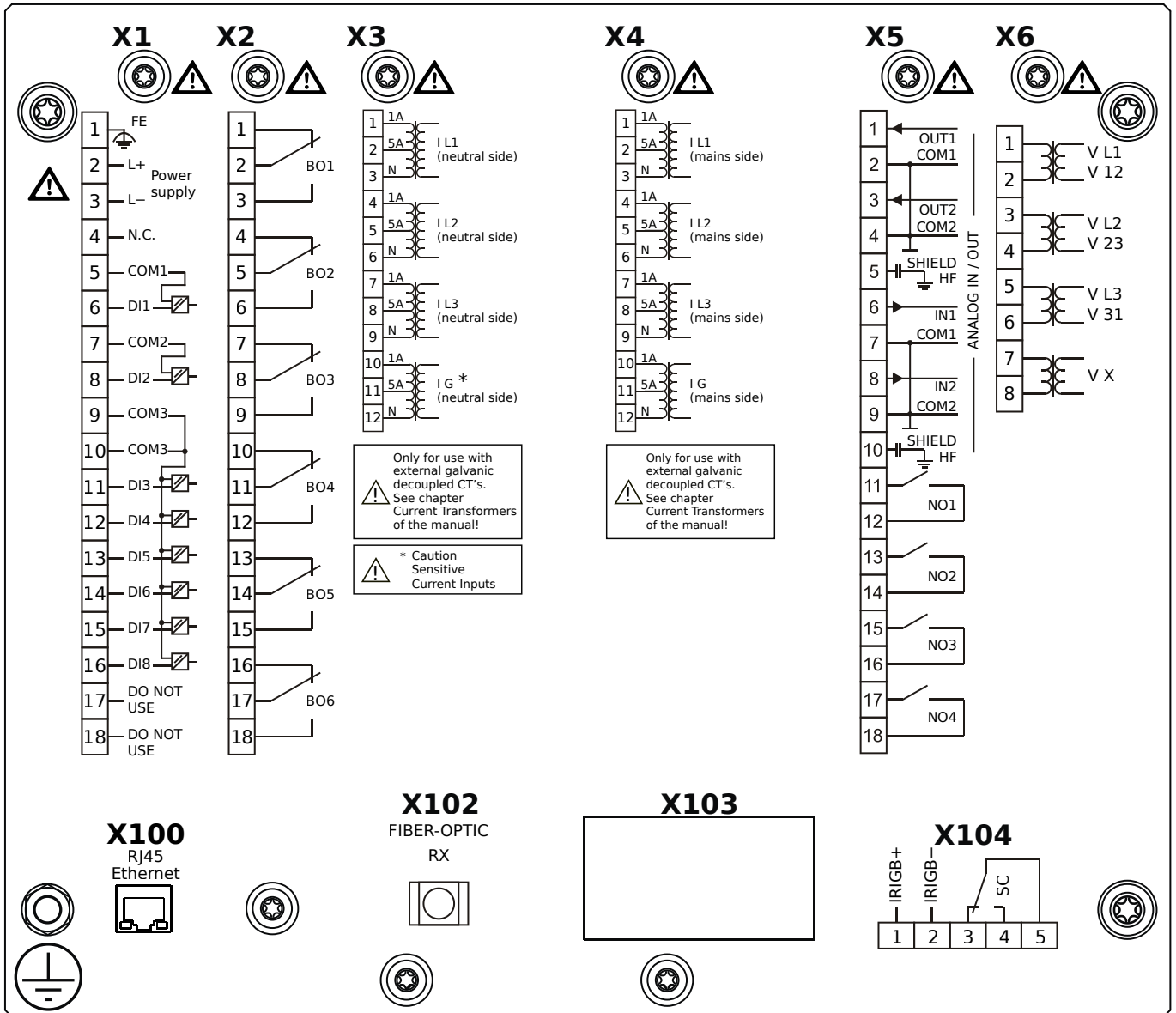

Housing B2, large display, 19" rack mounting

- X1** – DI8-X1: Wide-range power supply unit, incl. 2 non-grouped digital inputs and 6 grouped digital inputs
- X2** – OR6: Assembly Group with 6 Output Relays (Changeover / Form C)
- X3** – TI: Standard phase current measuring card and sensitive ground current measuring (neutral side of the diff. prot.)
- X4** – TI: Standard current measuring card (for the mains side of the differential protection)
- X5** – AnIO2-OR4: Assembly Group with 2 Analog Inputs, 2 Analog Outputs and 4 Output Relays
- X6** – TU: Card with 4 voltage transformer measuring inputs (0 ... 800 VAC, under UL: 0 ... 600 VAC)
- X100** – IEC 61850 / Modbus TCP / DNP3.0 TCP/UDP, Ethernet interface, 100 Mbit/s, RJ45 (BASE100-FX)
- X102** – Universal Resistance-Temperature Detector (URTD) input, Fiber optics interface, Versatile Link
- X104** – IRIG-B00X, incl. System Contact (Supervision Contact)

MCDGV4-2B1BHB

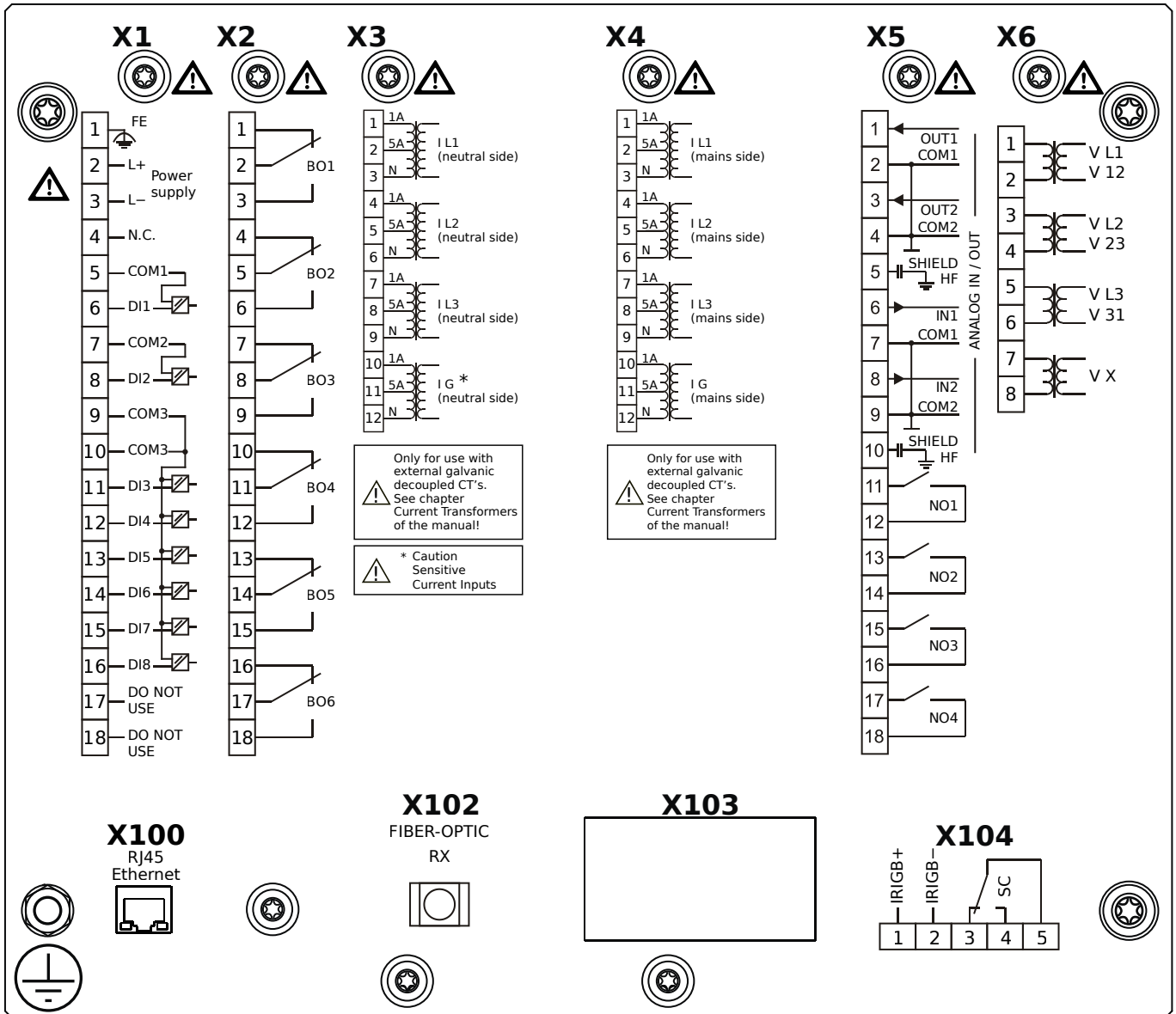

Housing B2, large display, 19" rack mounting

+ Conformal Coating (for installations in harsh environment)

- X1** – DI8-X1: Wide-range power supply unit, incl. 2 non-grouped digital inputs and 6 grouped digital inputs
- X2** – OR6: Assembly Group with 6 Output Relays (Changeover / Form C)
- X3** – TIs: Standard phase current measuring card and sensitive ground current measuring (neutral side of the diff. prot.)
- X4** – TI: Standard current measuring card (for the mains side of the differential protection)
- X5** – AnIO2-OR4: Assembly Group with 2 Analog Inputs, 2 Analog Outputs and 4 Output Relays
- X6** – TU: Card with 4 voltage transformer measuring inputs (0 ... 800 VAC, under UL: 0 ... 600 VAC)
- X100** – IEC 61850 / Modbus TCP / DNP3.0 TCP/UDP, Ethernet interface, 100 Mbit/s, RJ45 (BASE100-FX)
- X102** – Universal Resistance-Temperature Detector (URTD) input, Fiber optics interface, Versatile Link
- X104** – IRIG-B00X, incl. System Contact (Supervision Contact)

MCDGV4-2B1BIA

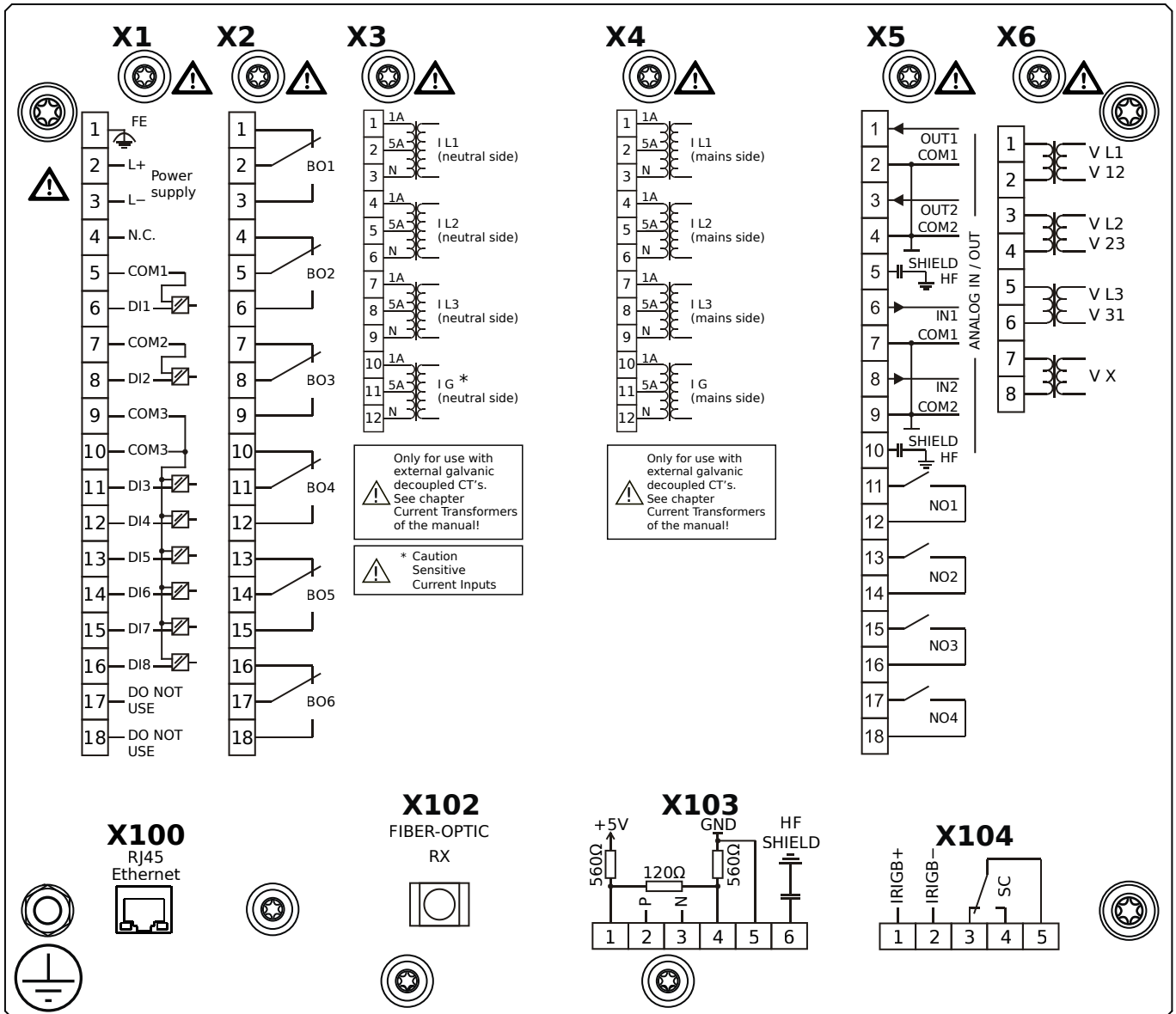

Housing B2, large display, 19" rack mounting

- X1** – DI8-X1: Wide-range power supply unit, incl. 2 non-grouped digital inputs and 6 grouped digital inputs
- X2** – OR6: Assembly Group with 6 Output Relays (Changeover / Form C)
- X3** – TIs: Standard phase current measuring card and sensitive ground current measuring (neutral side of the diff. prot.)
- X4** – TI: Standard current measuring card (for the mains side of the differential protection)
- X5** – AnIO2-OR4: Assembly Group with 2 Analog Inputs, 2 Analog Outputs and 4 Output Relays
- X6** – TU: Card with 4 voltage transformer measuring inputs (0 ... 800 VAC, under UL: 0 ... 600 VAC)
- X100** – Modbus TCP / DNP3.0 TCP/UDP, Ethernet interface, 100 Mbit/s, RJ45 (BASE100-FX)
- X102** – Universal Resistance-Temperature Detector (URTD) input, Fiber optics interface, Versatile Link
- X103** – IEC 60870-5-103 / Modbus RTU / DNP3.0 RTU, RS485, Terminals
- X104** – IRIG-B00X, incl. System Contact (Supervision Contact)

MCDGV4-2B1BIB

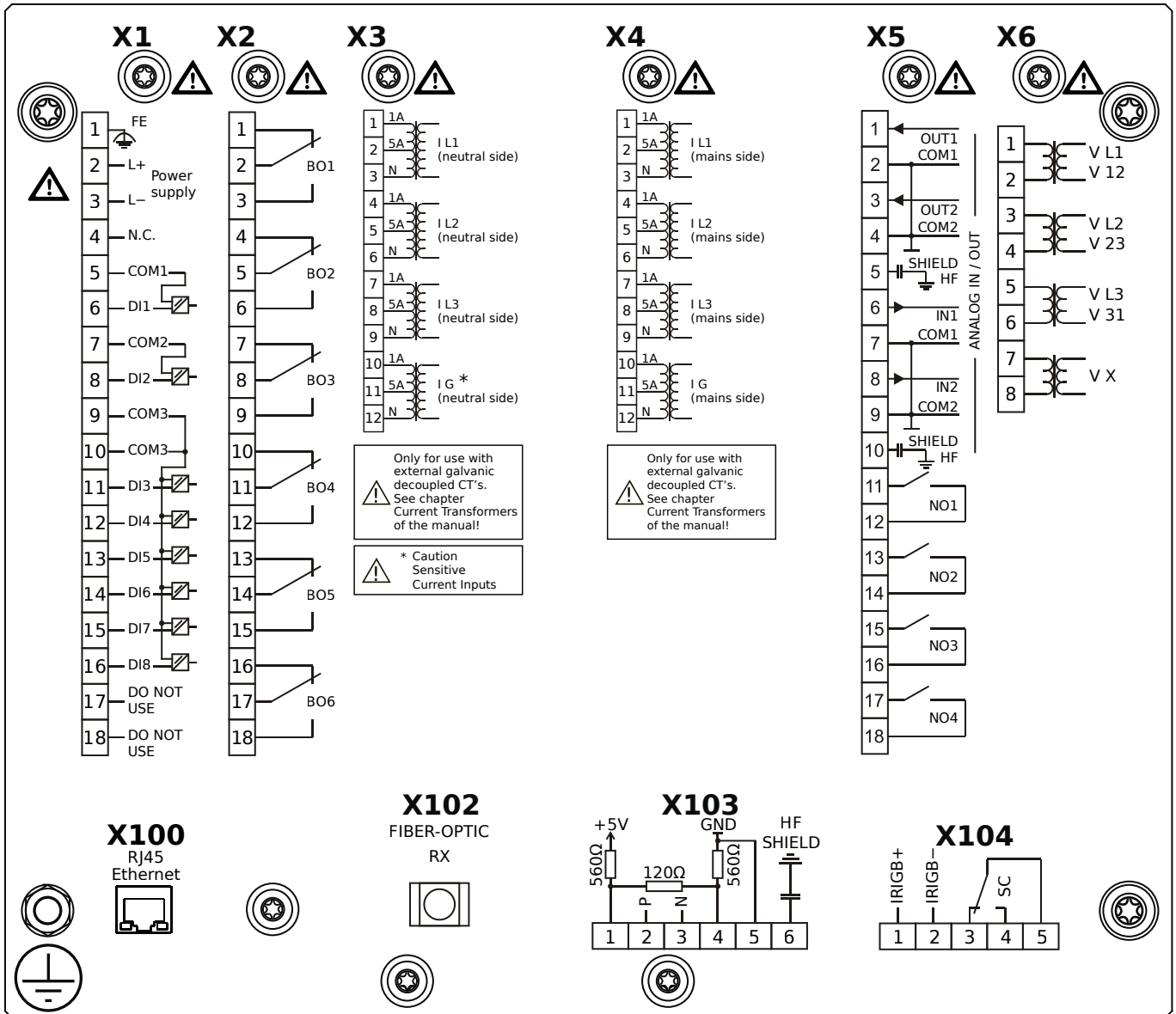

Housing B2, large display, 19" rack mounting

- + Conformal Coating (for installations in harsh environment)

- X1** – DI8-X1: Wide-range power supply unit, incl. 2 non-grouped digital inputs and 6 grouped digital inputs
- X2** – OR6: Assembly Group with 6 Output Relays (Changeover / Form C)
- X3** – TIs: Standard phase current measuring card and sensitive ground current measuring (neutral side of the diff. prot.)
- X4** – TI: Standard current measuring card (for the mains side of the differential protection)
- X5** – AnIO2-OR4: Assembly Group with 2 Analog Inputs, 2 Analog Outputs and 4 Output Relays
- X6** – TU: Card with 4 voltage transformer measuring inputs (0 ... 800 VAC, under UL: 0 ... 600 VAC)
- X100** – Modbus TCP / DNP3.0 TCP/UDP, Ethernet interface, 100 Mbit/s, RJ45 (BASE100-FX)
- X102** – Universal Resistance-Temperature Detector (URTD) input, Fiber optics interface, Versatile Link
- X103** – IEC 60870-5-103 / Modbus RTU / DNP3.0 RTU, RS485, Terminals
- X104** – IRIG-B00X, incl. System Contact (Supervision Contact)

MCDGV4-2B1BKA

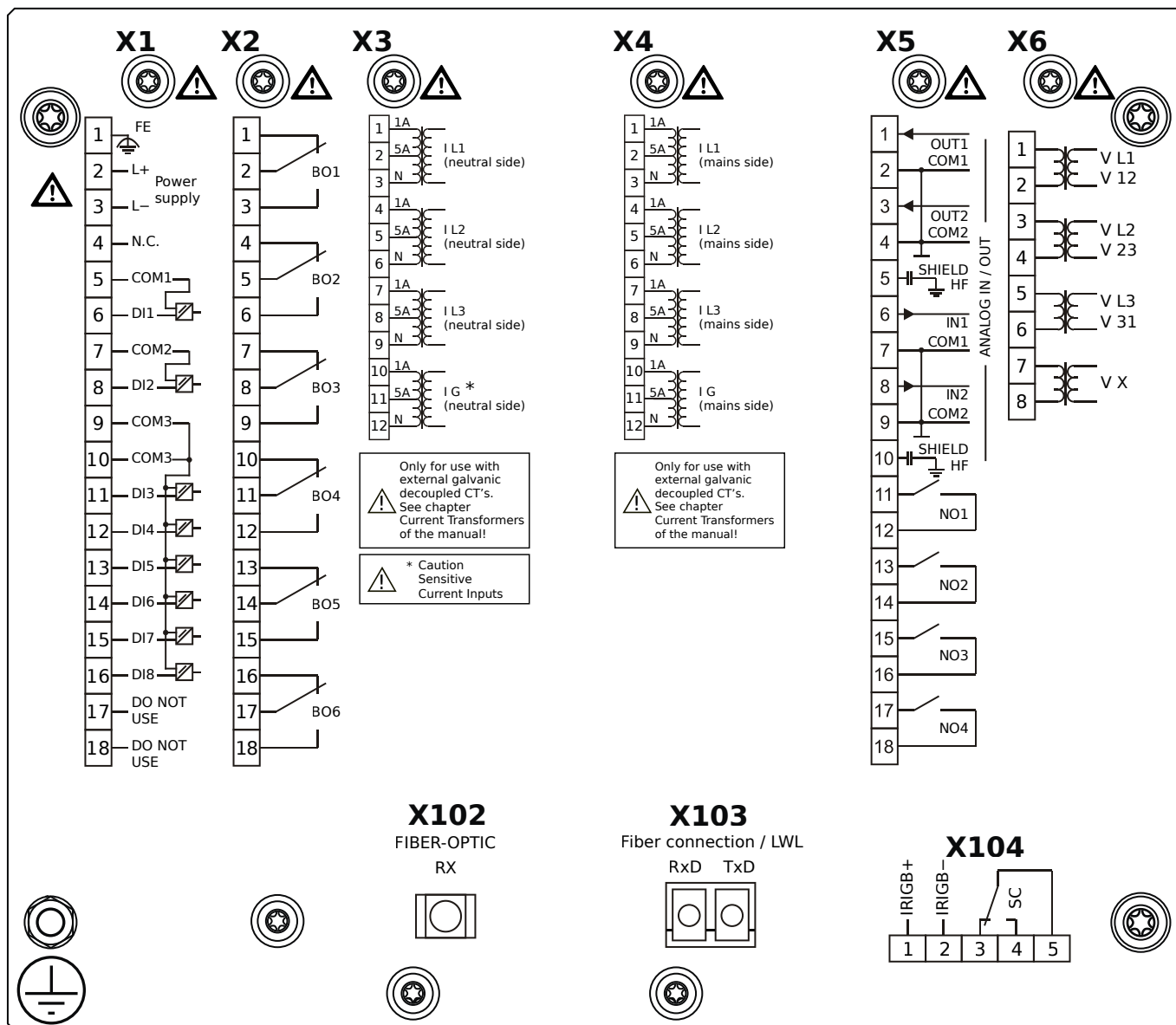

Housing B2, large display, 19" rack mounting

- X1** – DI8-X1: Wide-range power supply unit, incl. 2 non-grouped digital inputs and 6 grouped digital inputs
- X2** – OR6: Assembly Group with 6 Output Relays (Changeover / Form C)
- X3** – TIs: Standard phase current measuring card and sensitive ground current measuring (neutral side of the diff. prot.)
- X4** – TI: Standard current measuring card (for the mains side of the differential protection)
- X5** – AnIO2-OR4: Assembly Group with 2 Analog Inputs, 2 Analog Outputs and 4 Output Relays
- X6** – TU: Card with 4 voltage transformer measuring inputs (0 ... 800 VAC, under UL: 0 ... 600 VAC)
- X102** – Universal Resistance-Temperature Detector (URTD) input, Fiber optics interface, Versatile Link
- X103** – IEC 61850 / Modbus TCP / DNP3.0 TCP/UDP, Fiber optics interface, LC Connector
- X104** – IRIG-B00X, incl. System Contact (Supervision Contact)

MCDGV4-2B1BKB

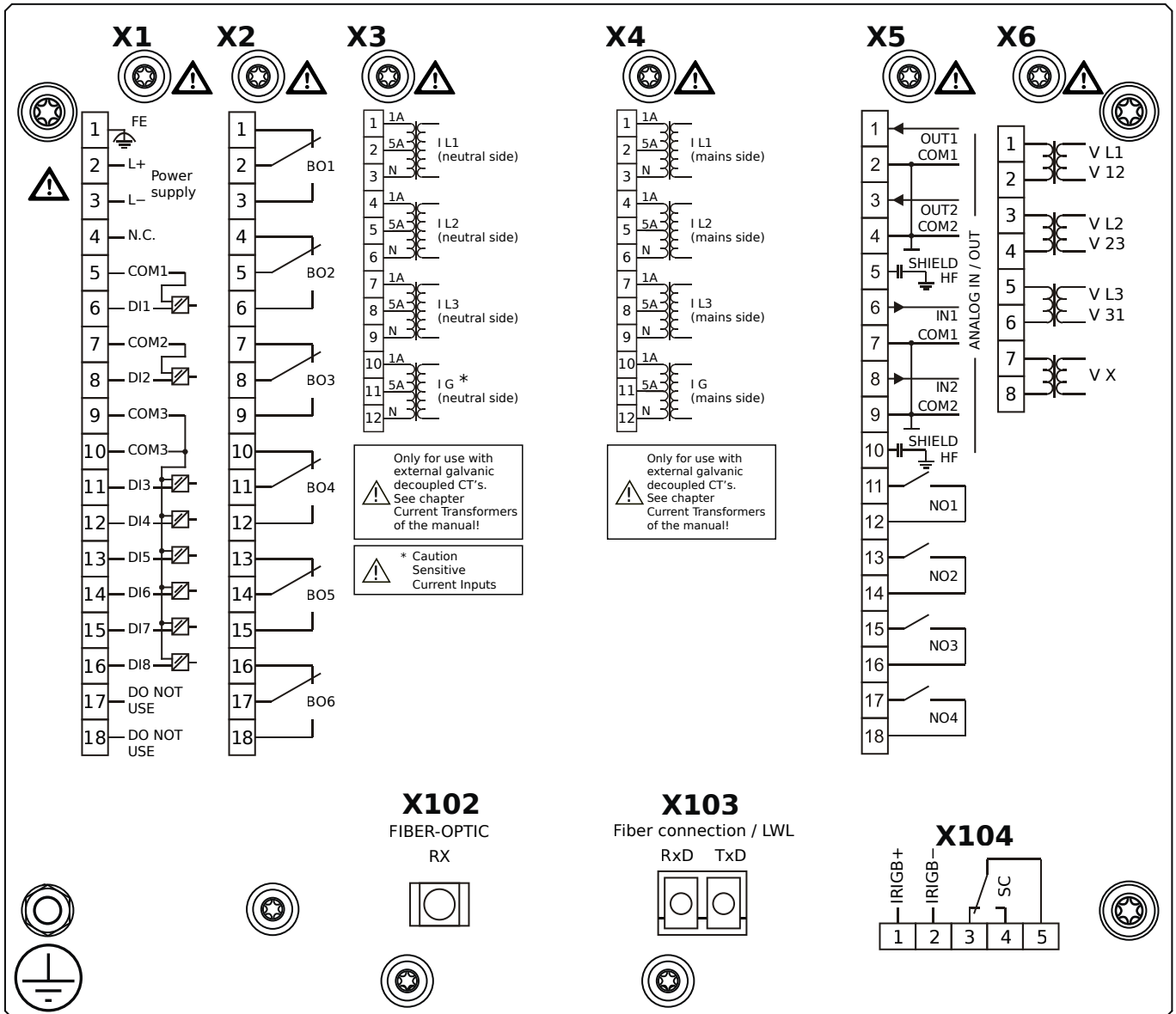

Housing B2, large display, 19" rack mounting

+ Conformal Coating (for installations in harsh environment)

- X1** – DI8-X1: Wide-range power supply unit, incl. 2 non-grouped digital inputs and 6 grouped digital inputs
- X2** – OR6: Assembly Group with 6 Output Relays (Changeover / Form C)
- X3** – TIs: Standard phase current measuring card and sensitive ground current measuring (neutral side of the diff. prot.)
- X4** – TI: Standard current measuring card (for the mains side of the differential protection)
- X5** – AnIO2-OR4: Assembly Group with 2 Analog Inputs, 2 Analog Outputs and 4 Output Relays
- X6** – TU: Card with 4 voltage transformer measuring inputs (0 ... 800 VAC, under UL: 0 ... 600 VAC)
- X102** – Universal Resistance-Temperature Detector (URTD) input, Fiber optics interface, Versatile Link
- X103** – IEC 61850 / Modbus TCP / DNP3.0 TCP/UDP, Fiber optics interface, LC Connector
- X104** – IRIG-B00X, incl. System Contact (Supervision Contact)

MCDGV4-2B1BLA

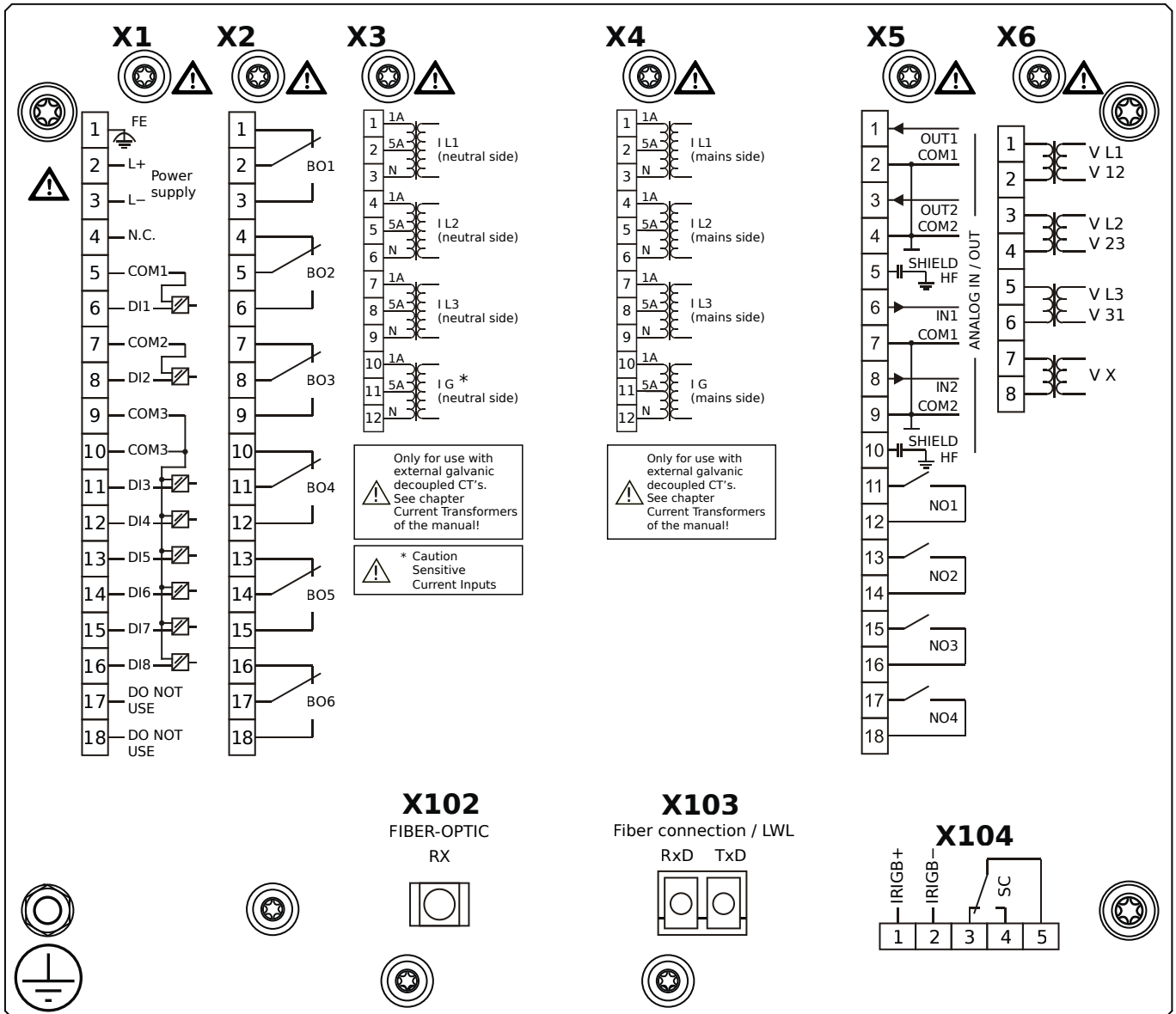

Housing B2, large display, 19" rack mounting

- X1** – DI8-X1: Wide-range power supply unit, incl. 2 non-grouped digital inputs and 6 grouped digital inputs
- X2** – OR6: Assembly Group with 6 Output Relays (Changeover / Form C)
- X3** – TIs: Standard phase current measuring card and sensitive ground current measuring (neutral side of the diff. prot.)
- X4** – TI: Standard current measuring card (for the mains side of the differential protection)
- X5** – AnIO2-OR4: Assembly Group with 2 Analog Inputs, 2 Analog Outputs and 4 Output Relays
- X6** – TU: Card with 4 voltage transformer measuring inputs (0 ... 800 VAC, under UL: 0 ... 600 VAC)
- X102** – Universal Resistance-Temperature Detector (URTD) input, Fiber optics interface, Versatile Link
- X103** – Modbus TCP / DNP3.0 TCP/UDP, Fiber optics interface, LC Connector
- X104** – IRIG-B00X, incl. System Contact (Supervision Contact)

MCDGV4-2B1BLB

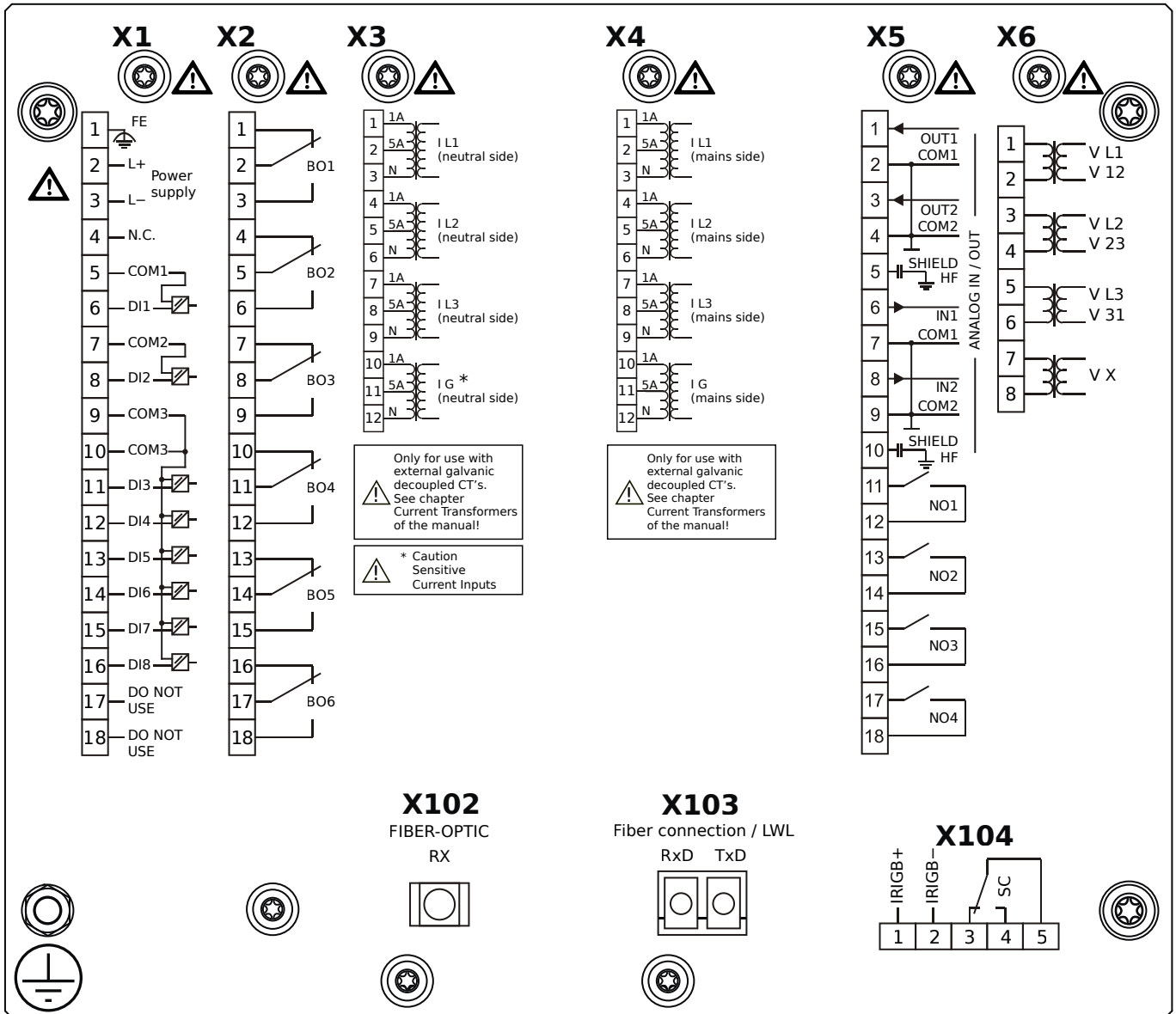

Housing B2, large display, 19" rack mounting

+ Conformal Coating (for installations in harsh environment)

- X1** – DI8-X1: Wide-range power supply unit, incl. 2 non-grouped digital inputs and 6 grouped digital inputs
- X2** – OR6: Assembly Group with 6 Output Relays (Changeover / Form C)
- X3** – TIs: Standard phase current measuring card and sensitive ground current measuring (neutral side of the diff. prot.)
- X4** – TI: Standard current measuring card (for the mains side of the differential protection)
- X5** – AnIO2-OR4: Assembly Group with 2 Analog Inputs, 2 Analog Outputs and 4 Output Relays
- X6** – TU: Card with 4 voltage transformer measuring inputs (0 ... 800 VAC, under UL: 0 ... 600 VAC)
- X102** – Universal Resistance-Temperature Detector (URTD) input, Fiber optics interface, Versatile Link
- X103** – Modbus TCP / DNP3.0 TCP/UDP, Fiber optics interface, LC Connector
- X104** – IRIG-B00X, incl. System Contact (Supervision Contact)

MCDGV4-2B1BTA

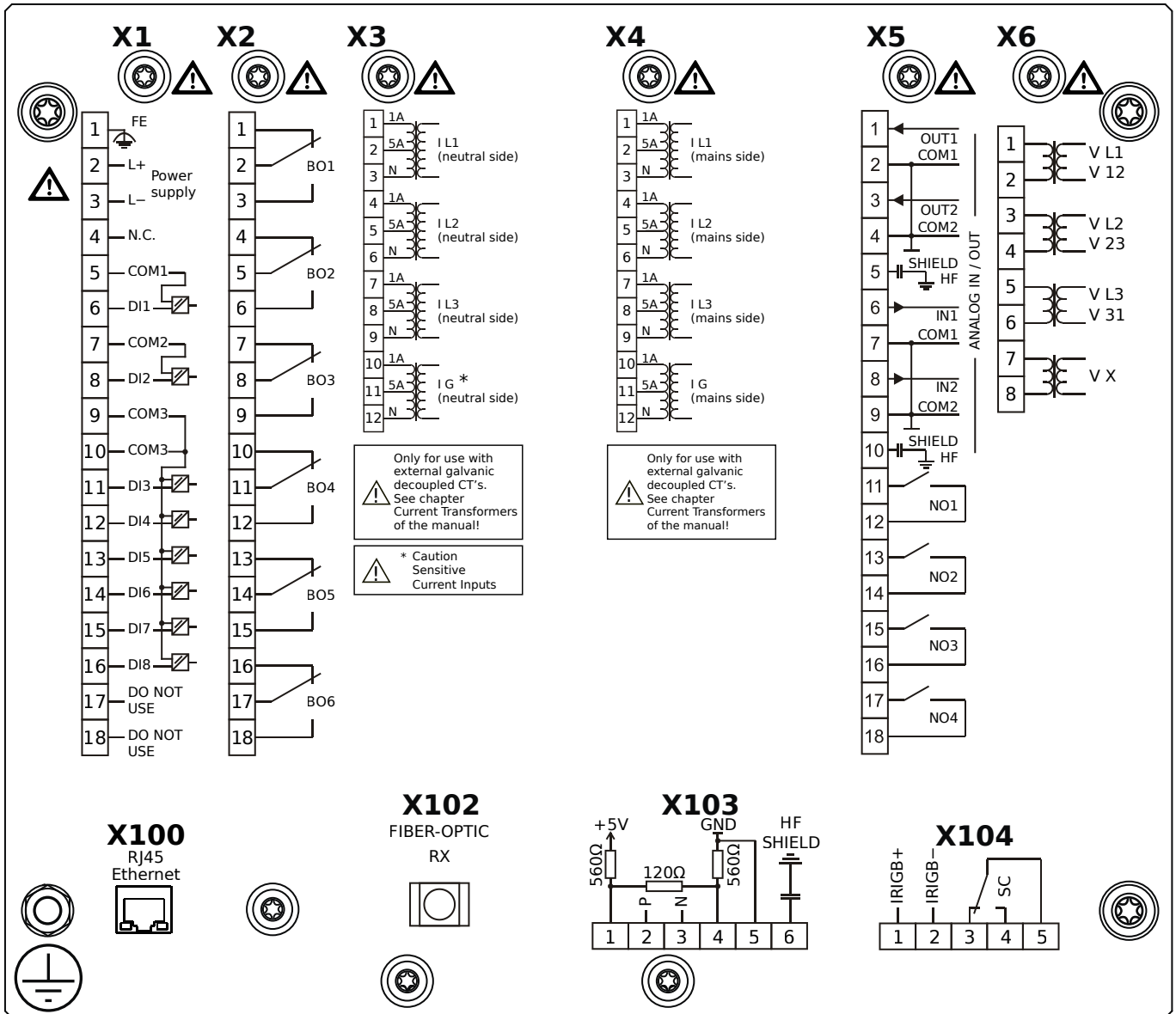

Housing B2, large display, 19" rack mounting

- X1** – DI8-X1: Wide-range power supply unit, incl. 2 non-grouped digital inputs and 6 grouped digital inputs
- X2** – OR6: Assembly Group with 6 Output Relays (Changeover / Form C)
- X3** – TI: Standard phase current measuring card and sensitive ground current measuring (neutral side of the diff. prot.)
- X4** – TI: Standard current measuring card (for the mains side of the differential protection)
- X5** – AnIO2-OR4: Assembly Group with 2 Analog Inputs, 2 Analog Outputs and 4 Output Relays
- X6** – TU: Card with 4 voltage transformer measuring inputs (0 ... 800 VAC, under UL: 0 ... 600 VAC)
- X100** – IEC 61850 / Modbus TCP / DNP3.0 TCP/UDP, Ethernet interface, 100 Mbit/s, RJ45 (BASE100-FX)
- X102** – Universal Resistance-Temperature Detector (URTD) input, Fiber optics interface, Versatile Link
- X103** – IEC 60870-5-103 / Modbus RTU / DNP3.0 RTU, RS485, Terminals
- X104** – IRIG-B00X, incl. System Contact (Supervision Contact)

MCDGV4-2B1BTB

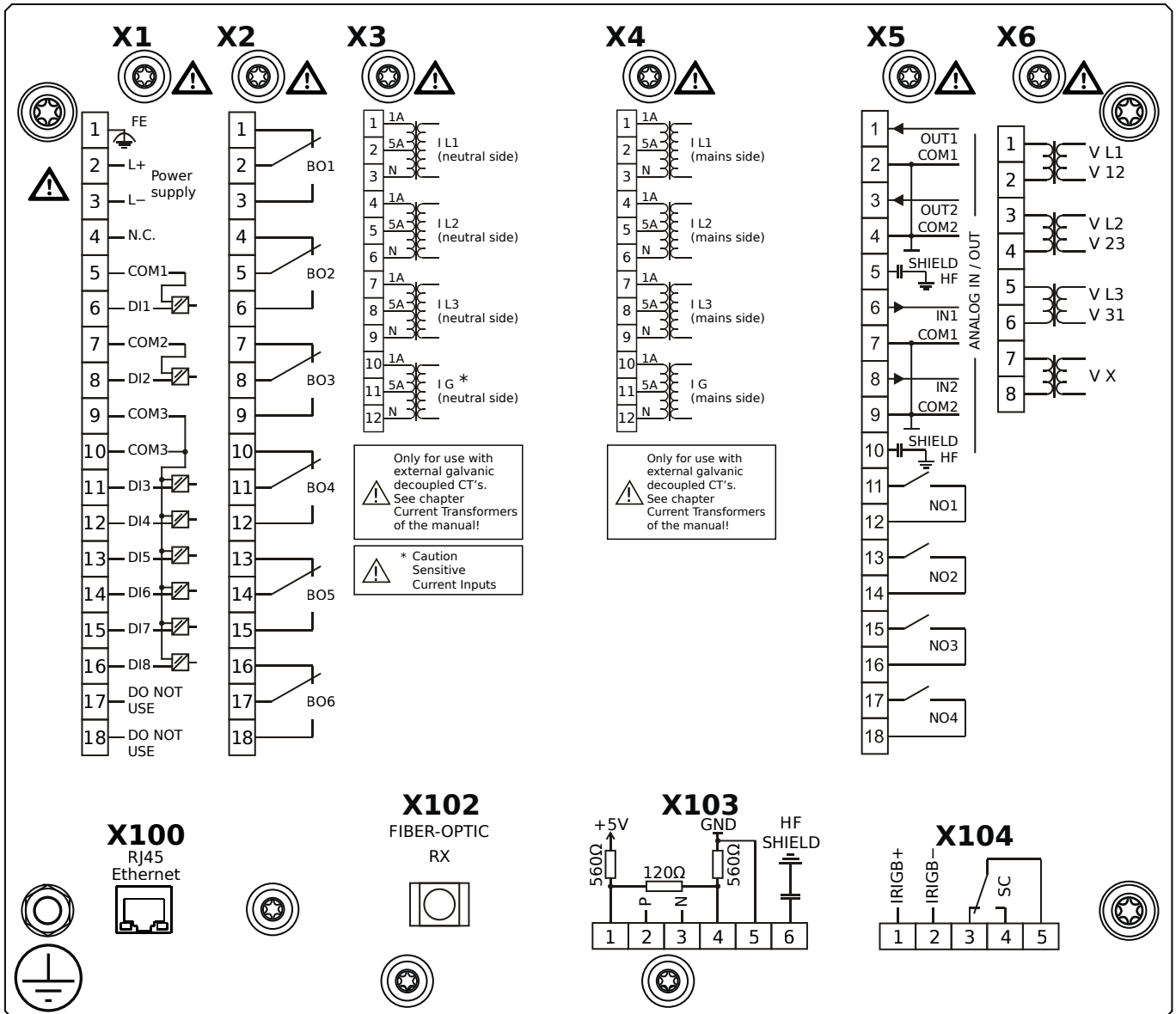

Housing B2, large display, 19" rack mounting

- + Conformal Coating (for installations in harsh environment)

- X1** – DI8-X1: Wide-range power supply unit, incl. 2 non-grouped digital inputs and 6 grouped digital inputs
- X2** – OR6: Assembly Group with 6 Output Relays (Changeover / Form C)
- X3** – TIs: Standard phase current measuring card and sensitive ground current measuring (neutral side of the diff. prot.)
- X4** – TI: Standard current measuring card (for the mains side of the differential protection)
- X5** – AnIO2-OR4: Assembly Group with 2 Analog Inputs, 2 Analog Outputs and 4 Output Relays
- X6** – TU: Card with 4 voltage transformer measuring inputs (0 ... 800 VAC, under UL: 0 ... 600 VAC)
- X100** – IEC 61850 / Modbus TCP / DNP3.0 TCP/UDP, Ethernet interface, 100 Mbit/s, RJ45 (BASE100-FX)
- X102** – Universal Resistance-Temperature Detector (URTD) input, Fiber optics interface, Versatile Link
- X103** – IEC 60870-5-103 / Modbus RTU / DNP3.0 RTU, RS485, Terminals
- X104** – IRIG-B00X, incl. System Contact (Supervision Contact)

MCDGV4-2C0AAA

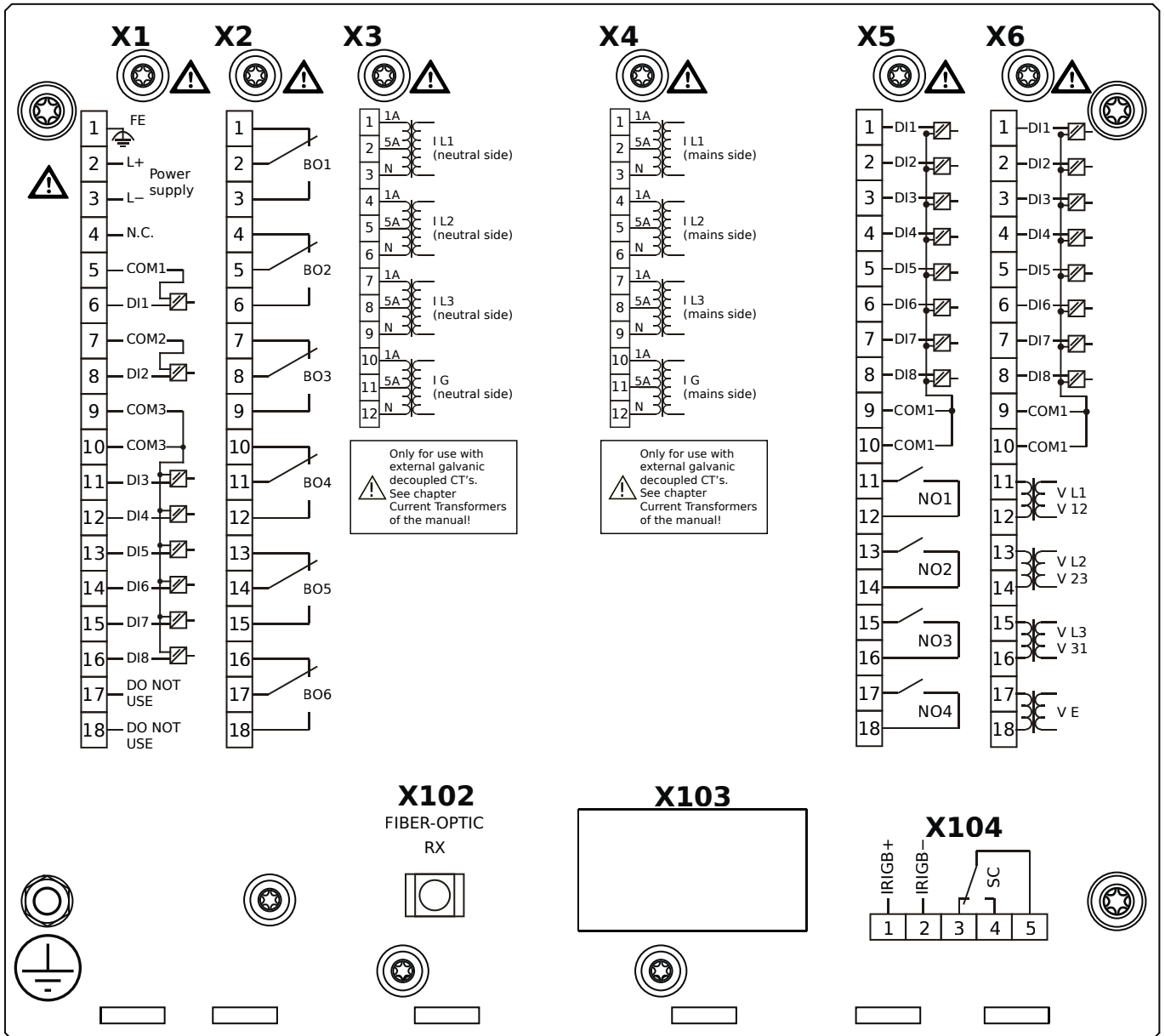

Housing B2, large display, door mounting

- X1** – DI8-X1: Wide-range power supply unit, incl. 2 non-grouped digital inputs and 6 grouped digital inputs
- X2** – OR6: Assembly Group with 6 Output Relays (Changeover / Form C)
- X3** – TI: Standard current measuring card (for the neutral side of the differential protection)
- X4** – TI: Standard current measuring card (for the mains side of the differential protection)
- X5** – DI8-OR4: Assembly Group with 8 Digital Inputs and 4 Output Relays (NO / Form A)
- X6** – TU-DI8: Voltage measuring (0 ... 300 VAC) assembly group with 8 Digital Inputs
- X102** – Universal Resistance-Temperature Detector (URTD) input, Fiber optics interface, Versatile Link
- X104** – IRIG-B00X, incl. System Contact (Supervision Contact)

MCDGV4-2C0AAB

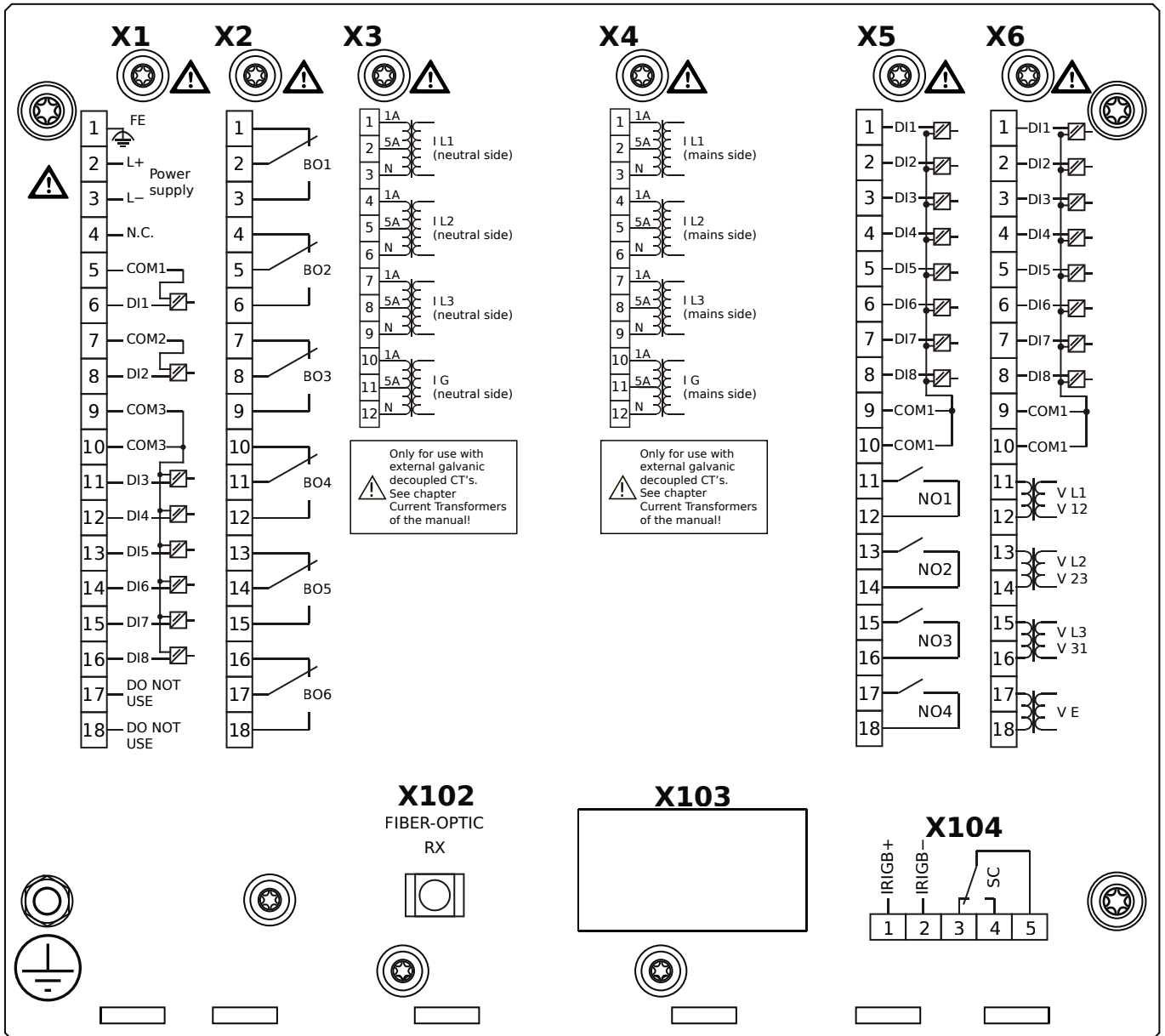

Housing B2, large display, door mounting

+ Conformal Coating (for installations in harsh environment)

- X1** – DI8-X1: Wide-range power supply unit, incl. 2 non-grouped digital inputs and 6 grouped digital inputs
- X2** – OR6: Assembly Group with 6 Output Relays (Changeover / Form C)
- X3** – TI: Standard current measuring card (for the neutral side of the differential protection)
- X4** – TI: Standard current measuring card (for the mains side of the differential protection)
- X5** – DI8-OR4: Assembly Group with 8 Digital Inputs and 4 Output Relays (NO / Form A)
- X6** – TU-DI8: Voltage measuring (0 ... 300 VAC) assembly group with 8 Digital Inputs
- X102** – Universal Resistance-Temperature Detector (URTD) input, Fiber optics interface, Versatile Link
- X104** – IRIG-B00X, incl. System Contact (Supervision Contact)

MCDGV4-2C0ABA

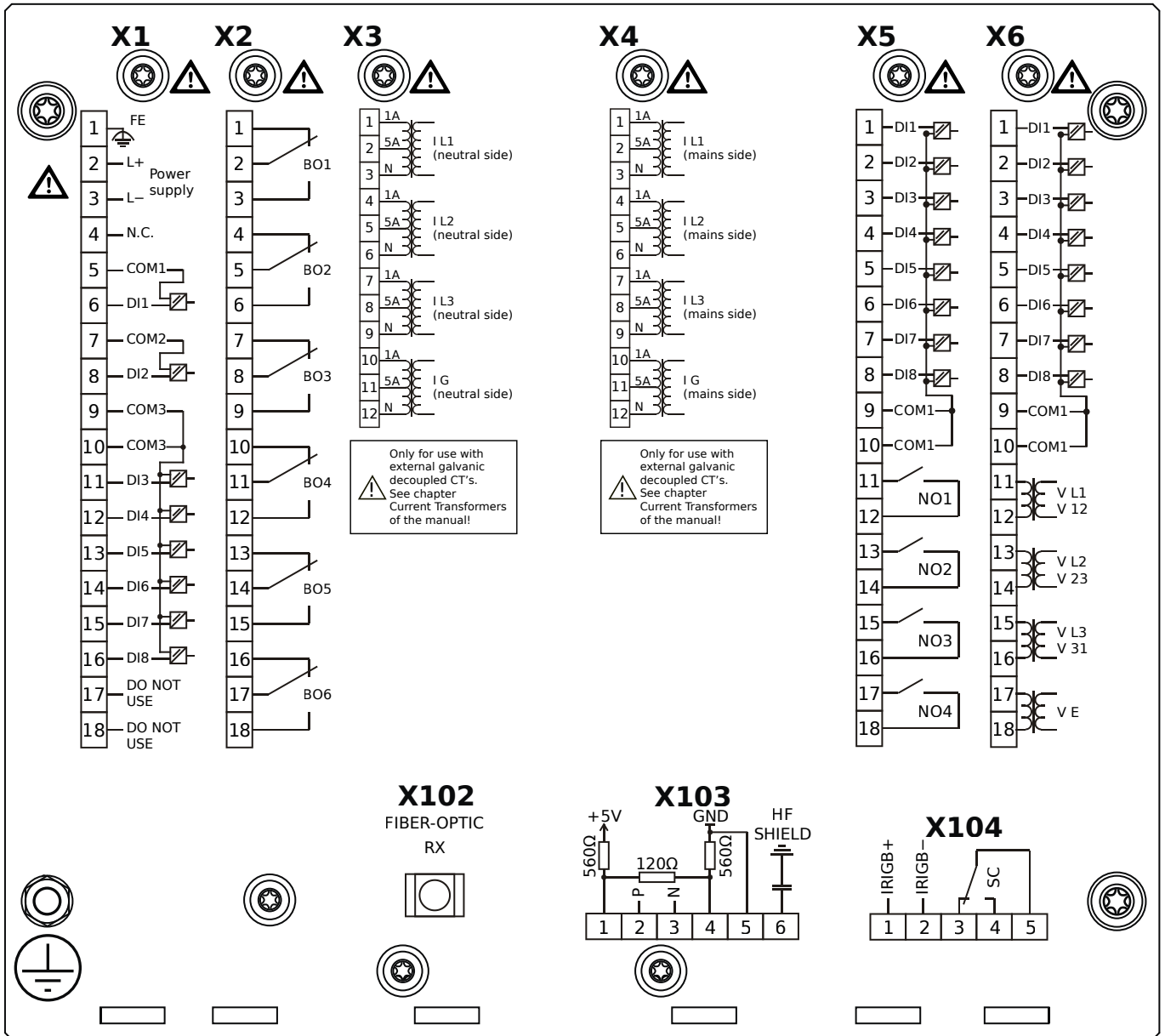

Housing B2, large display, door mounting

- X1** – DI8-X1: Wide-range power supply unit, incl. 2 non-grouped digital inputs and 6 grouped digital inputs
- X2** – OR6: Assembly Group with 6 Output Relays (Changeover / Form C)
- X3** – TI: Standard current measuring card (for the neutral side of the differential protection)
- X4** – TI: Standard current measuring card (for the mains side of the differential protection)
- X5** – DI8-OR4: Assembly Group with 8 Digital Inputs and 4 Output Relays (NO / Form A)
- X6** – TU-DI8: Voltage measuring (0 ... 300 VAC) assembly group with 8 Digital Inputs
- X102** – Universal Resistance-Temperature Detector (URTD) input, Fiber optics interface, Versatile Link
- X103** – Modbus RTU / IEC 60870-5-103 / DNP3.0 RTU, RS485, Terminals
- X104** – IRIG-B00X, incl. System Contact (Supervision Contact)

MCDGV4-2C0ABB

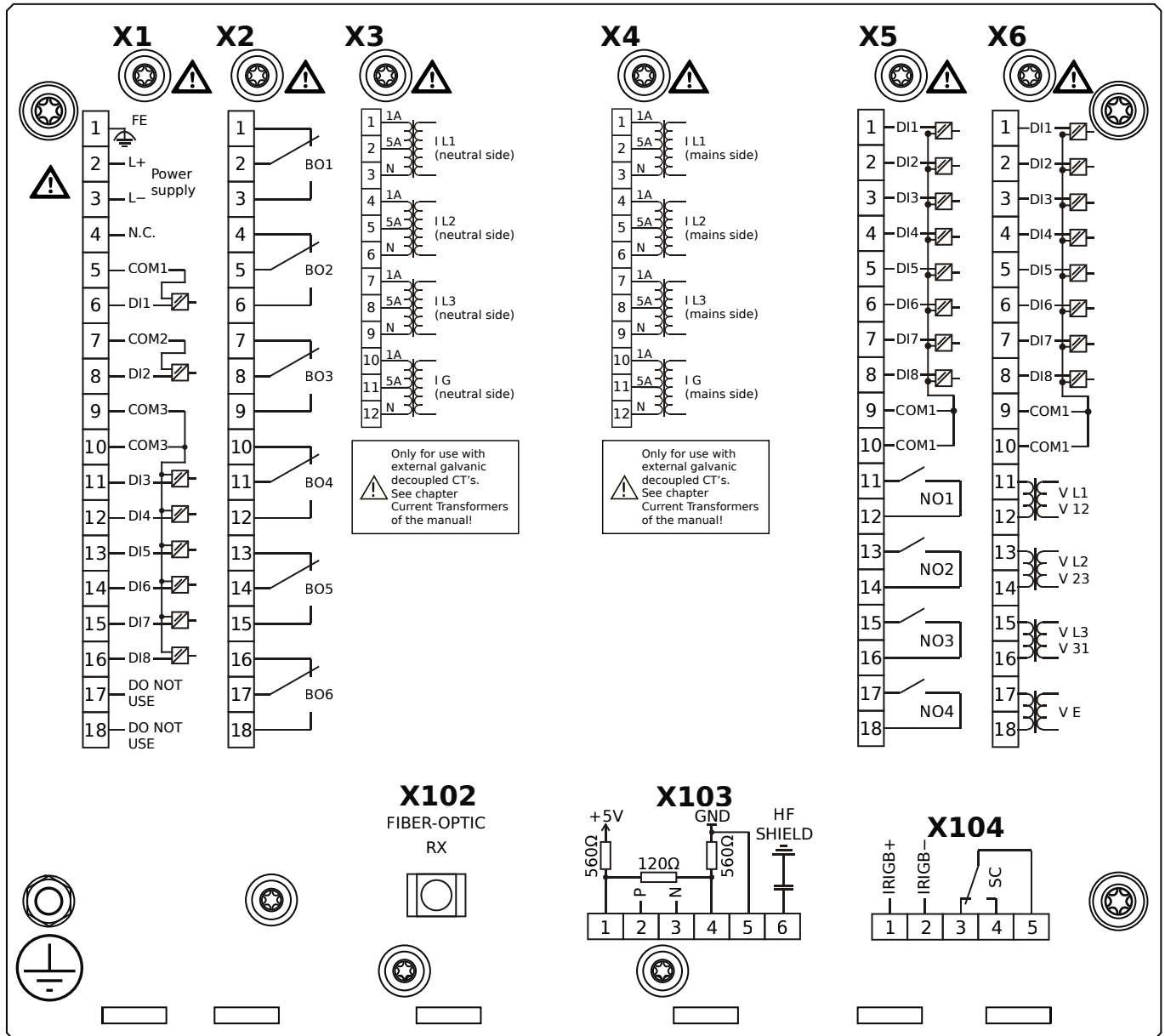

Housing B2, large display, door mounting

+ Conformal Coating (for installations in harsh environment)

- X1** – DI8-X1: Wide-range power supply unit, incl. 2 non-grouped digital inputs and 6 grouped digital inputs
- X2** – OR6: Assembly Group with 6 Output Relays (Changeover / Form C)
- X3** – TI: Standard current measuring card (for the neutral side of the differential protection)
- X4** – TI: Standard current measuring card (for the mains side of the differential protection)
- X5** – DI8-OR4: Assembly Group with 8 Digital Inputs and 4 Output Relays (NO / Form A)
- X6** – TU-DI8: Voltage measuring (0 ... 300 VAC) assembly group with 8 Digital Inputs
- X102** – Universal Resistance-Temperature Detector (URTD) input, Fiber optics interface, Versatile Link
- X103** – Modbus RTU / IEC 60870-5-103 / DNP3.0 RTU, RS485, Terminals
- X104** – IRIG-B00X, incl. System Contact (Supervision Contact)

MCDGV4-2C0ACA

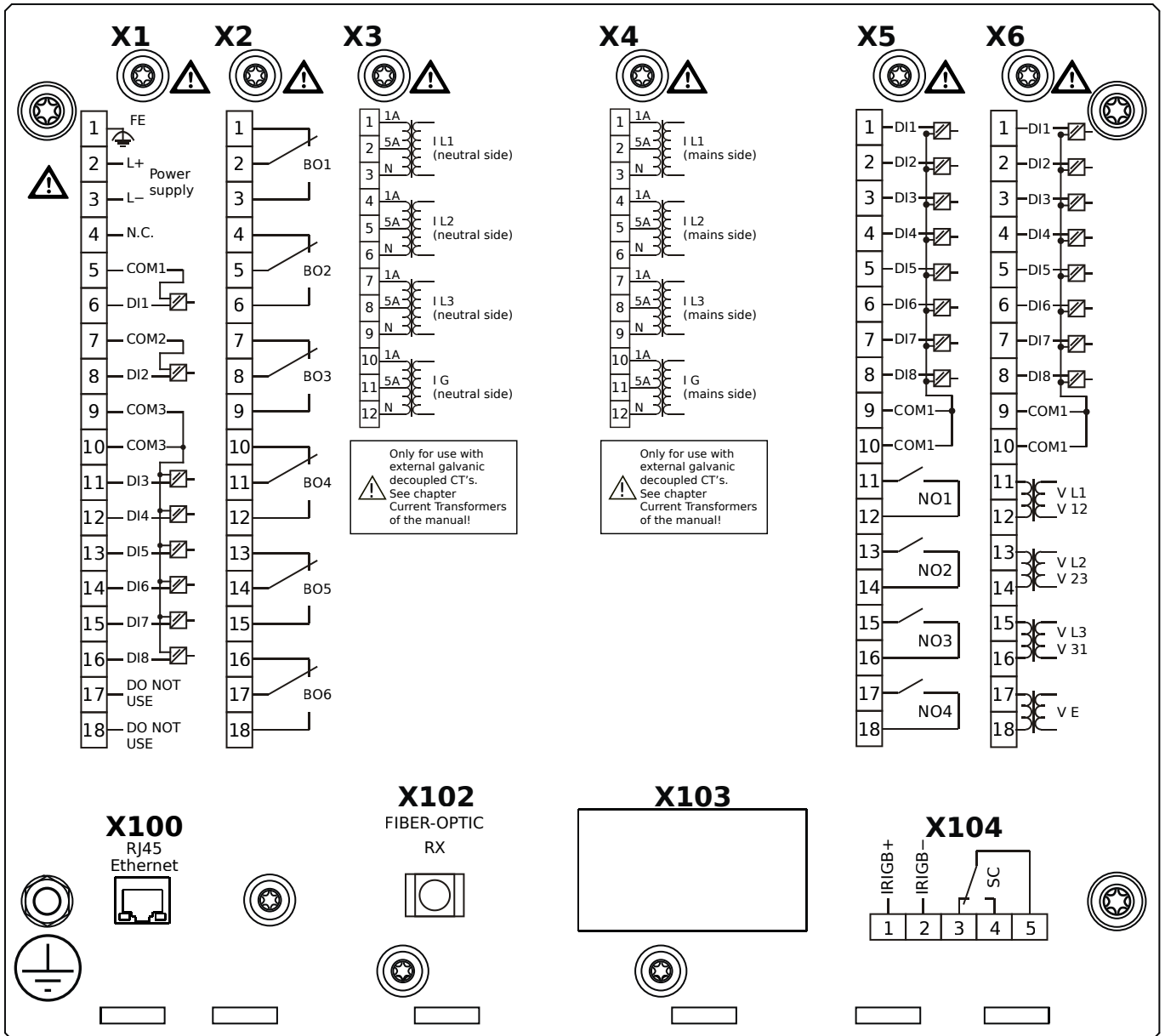

Housing B2, large display, door mounting

- X1** – DI8-X1: Wide-range power supply unit, incl. 2 non-grouped digital inputs and 6 grouped digital inputs
- X2** – OR6: Assembly Group with 6 Output Relays (Changeover / Form C)
- X3** – TI: Standard current measuring card (for the neutral side of the differential protection)
- X4** – TI: Standard current measuring card (for the mains side of the differential protection)
- X5** – DI8-OR4: Assembly Group with 8 Digital Inputs and 4 Output Relays (NO / Form A)
- X6** – TU-DI8: Voltage measuring (0 ... 300 VAC) assembly group with 8 Digital Inputs
- X100** – Modbus TCP / DNP3.0 TCP/UDP, Ethernet interface, 100 Mbit/s, RJ45 (BASE100-FX)
- X102** – Universal Resistance-Temperature Detector (URTD) input, Fiber optics interface, Versatile Link
- X104** – IRIG-B00X, incl. System Contact (Supervision Contact)

MCDGV4-2C0ACB

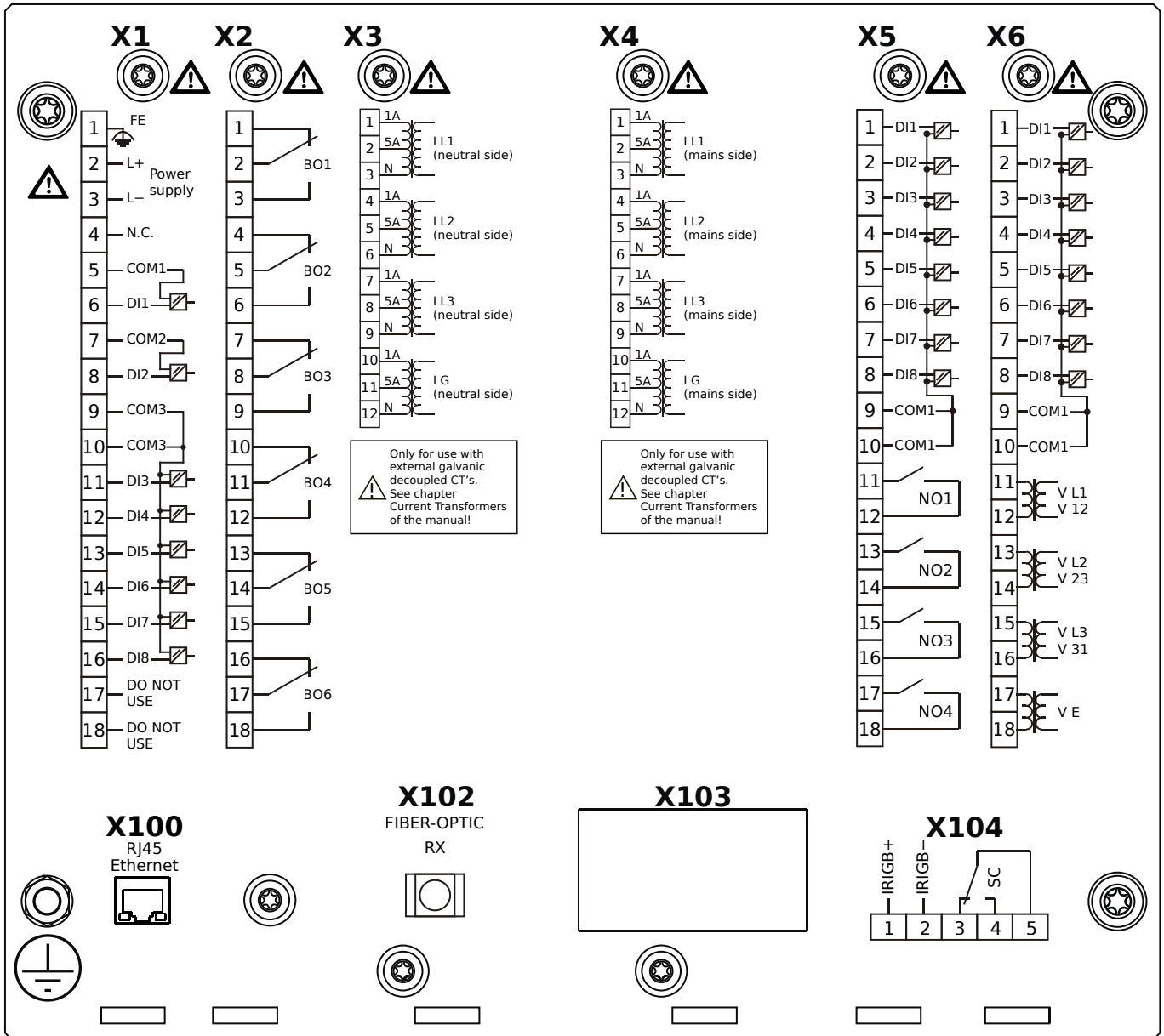

Housing B2, large display, door mounting

- + Conformal Coating (for installations in harsh environment)

- X1** – DI8-X1: Wide-range power supply unit, incl. 2 non-grouped digital inputs and 6 grouped digital inputs
- X2** – OR6: Assembly Group with 6 Output Relays (Changeover / Form C)
- X3** – TI: Standard current measuring card (for the neutral side of the differential protection)
- X4** – TI: Standard current measuring card (for the mains side of the differential protection)
- X5** – DI8-OR4: Assembly Group with 8 Digital Inputs and 4 Output Relays (NO / Form A)
- X6** – TU-DI8: Voltage measuring (0 ... 300 VAC) assembly group with 8 Digital Inputs
- X100** – Modbus TCP / DNP3.0 TCP/UDP, Ethernet interface, 100 Mbit/s, RJ45 (BASE100-FX)
- X102** – Universal Resistance-Temperature Detector (URTD) input, Fiber optics interface, Versatile Link
- X104** – IRIG-B00X, incl. System Contact (Supervision Contact)

MCDGV4-2C0ADA

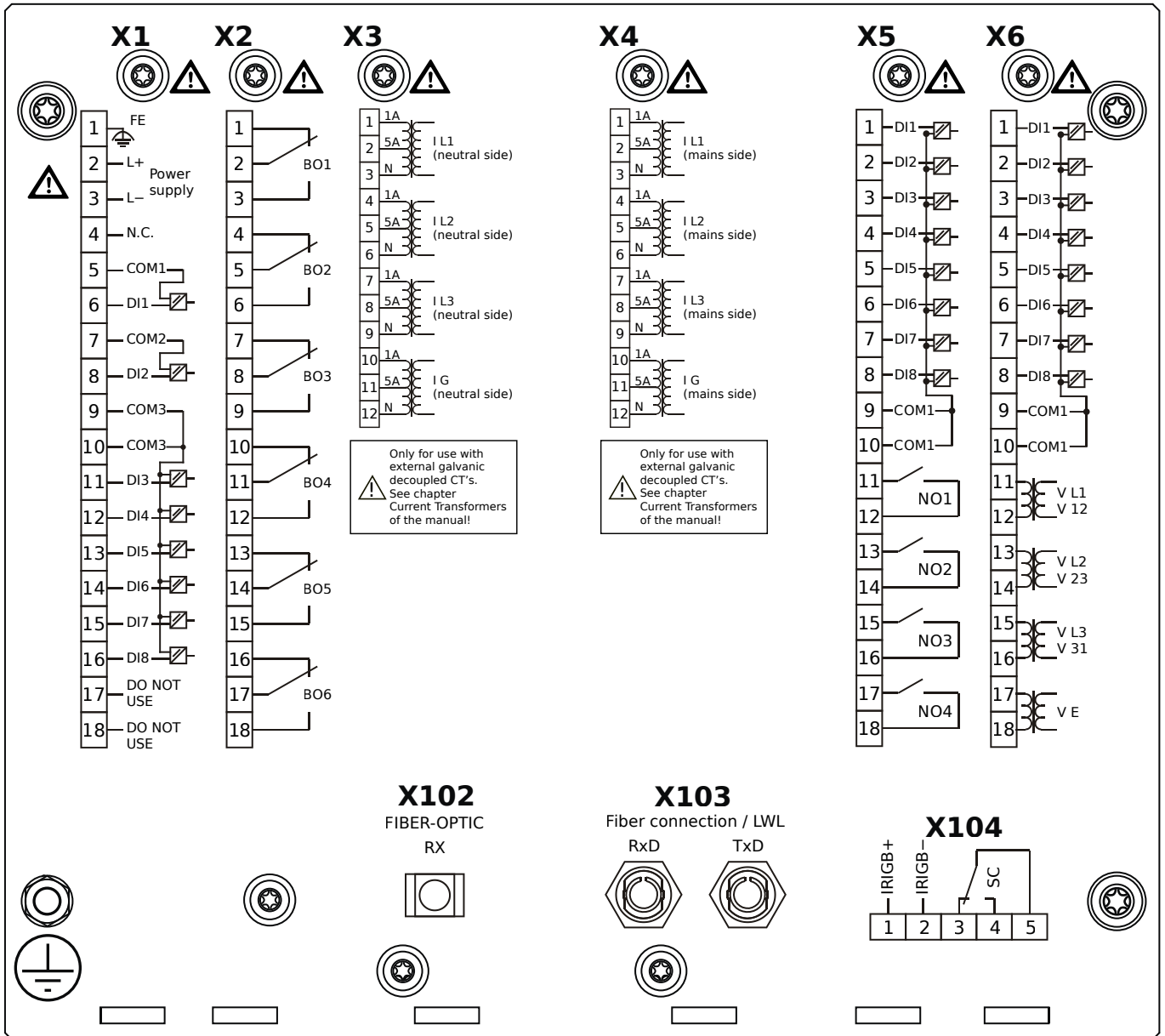

Housing B2, large display, door mounting

- X1** – DI8-X1: Wide-range power supply unit, incl. 2 non-grouped digital inputs and 6 grouped digital inputs
- X2** – OR6: Assembly Group with 6 Output Relays (Changeover / Form C)
- X3** – TI: Standard current measuring card (for the neutral side of the differential protection)
- X4** – TI: Standard current measuring card (for the mains side of the differential protection)
- X5** – DI8-OR4: Assembly Group with 8 Digital Inputs and 4 Output Relays (NO / Form A)
- X6** – TU-DI8: Voltage measuring (0 ... 300 VAC) assembly group with 8 Digital Inputs
- X102** – Universal Resistance-Temperature Detector (URTD) input, Fiber optics interface, Versatile Link
- X103** – Profibus-DP, Fiber optics interface, ST Connector
- X104** – IRIG-B00X, incl. System Contact (Supervision Contact)

MCDGV4-2C0ADB

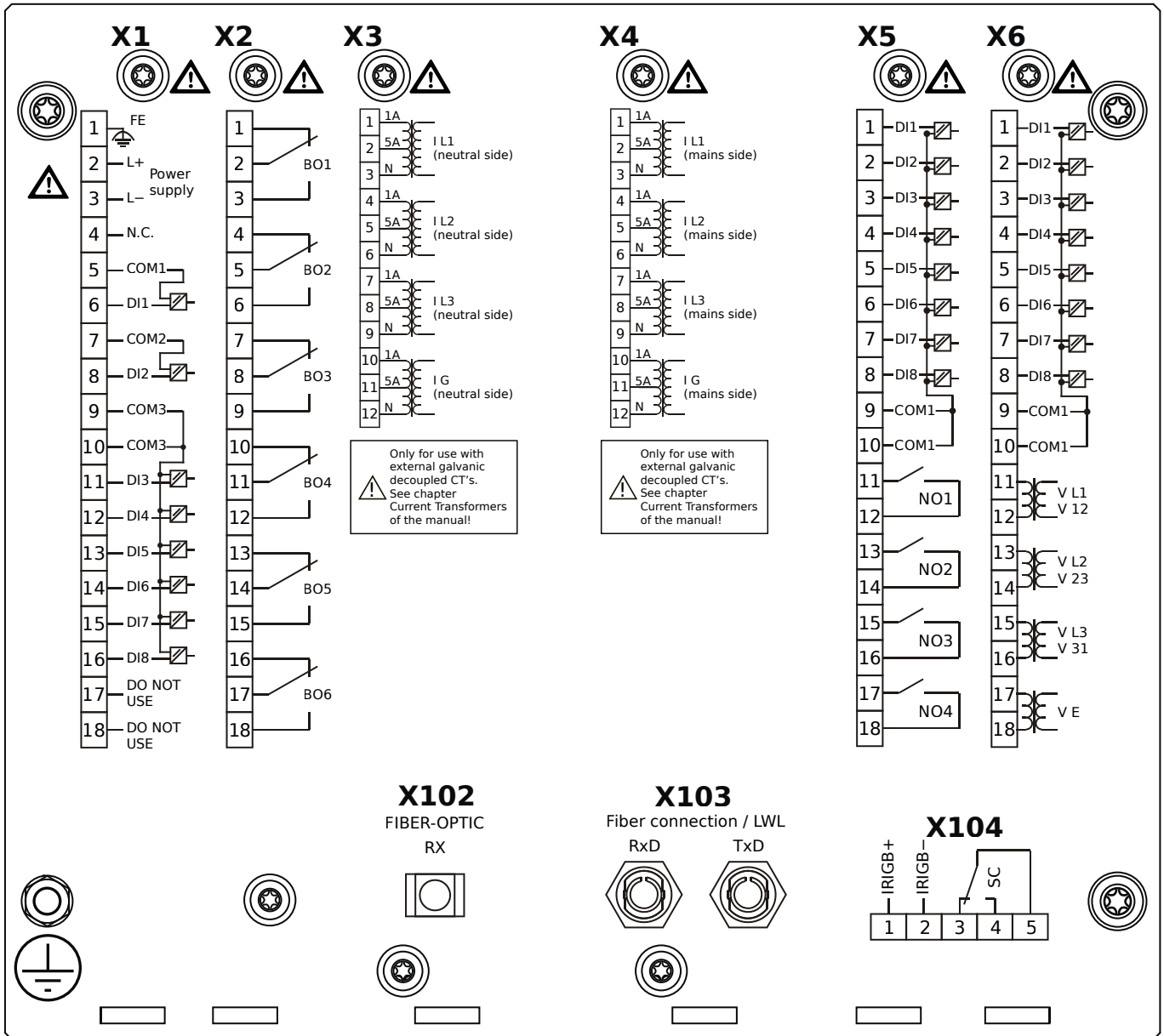

Housing B2, large display, door mounting

+ Conformal Coating (for installations in harsh environment)

- X1** – DI8-X1: Wide-range power supply unit, incl. 2 non-grouped digital inputs and 6 grouped digital inputs
- X2** – OR6: Assembly Group with 6 Output Relays (Changeover / Form C)
- X3** – TI: Standard current measuring card (for the neutral side of the differential protection)
- X4** – TI: Standard current measuring card (for the mains side of the differential protection)
- X5** – DI8-OR4: Assembly Group with 8 Digital Inputs and 4 Output Relays (NO / Form A)
- X6** – TU-DI8: Voltage measuring (0 ... 300 VAC) assembly group with 8 Digital Inputs
- X102** – Universal Resistance-Temperature Detector (URTD) input, Fiber optics interface, Versatile Link
- X103** – Profibus-DP, Fiber optics interface, ST Connector
- X104** – IRIG-B00X, incl. System Contact (Supervision Contact)

MCDGV4-2C0AEA

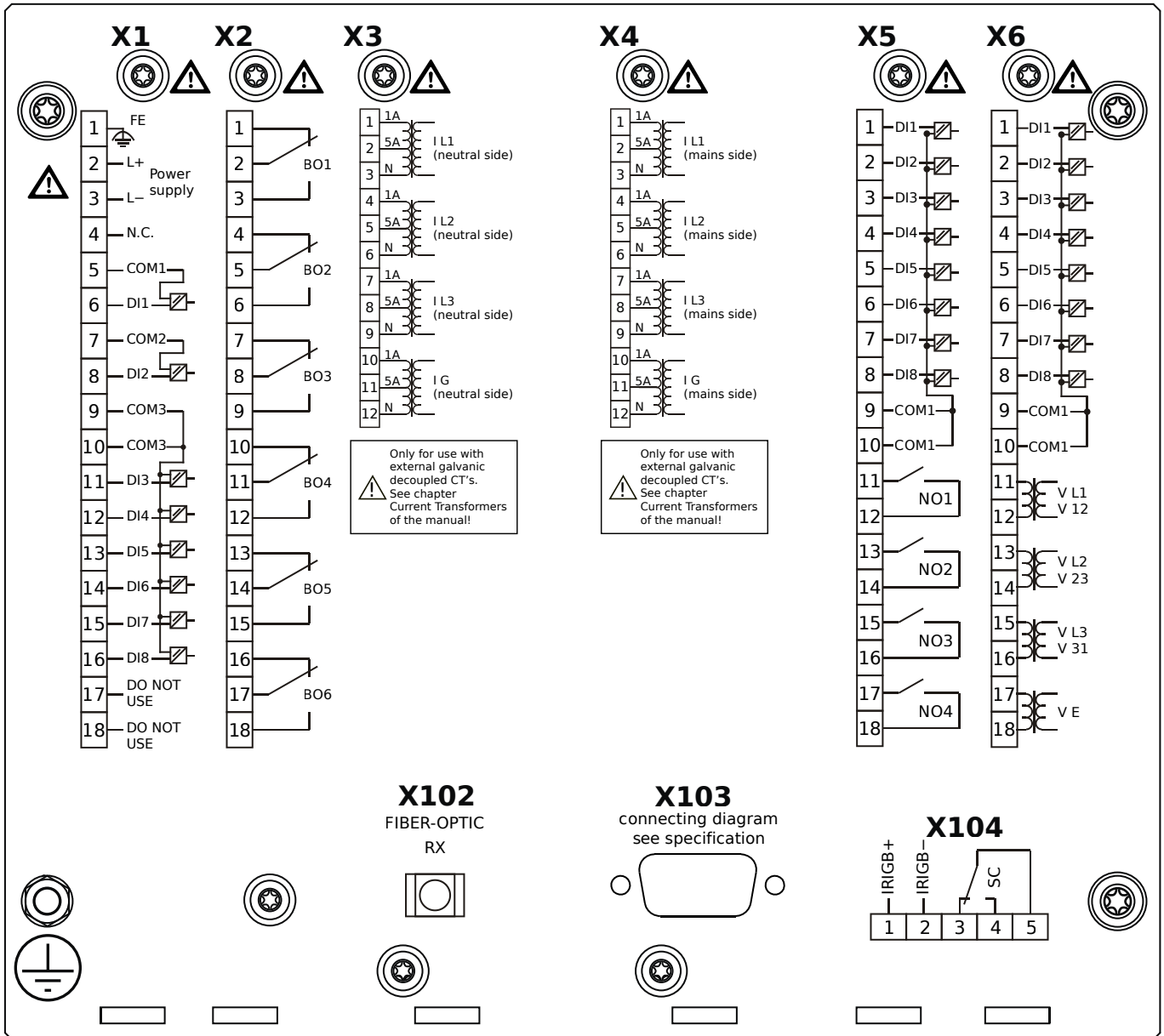

Housing B2, large display, door mounting

- X1** – DI8-X1: Wide-range power supply unit, incl. 2 non-grouped digital inputs and 6 grouped digital inputs
- X2** – OR6: Assembly Group with 6 Output Relays (Changeover / Form C)
- X3** – TI: Standard current measuring card (for the neutral side of the differential protection)
- X4** – TI: Standard current measuring card (for the mains side of the differential protection)
- X5** – DI8-OR4: Assembly Group with 8 Digital Inputs and 4 Output Relays (NO / Form A)
- X6** – TU-DI8: Voltage measuring (0 ... 300 VAC) assembly group with 8 Digital Inputs
- X102** – Universal Resistance-Temperature Detector (URTD) input, Fiber optics interface, Versatile Link
- X103** – Profibus-DP, RS485, D-SUB
- X104** – IRIG-B00X, incl. System Contact (Supervision Contact)

MCDGV4-2C0AEB

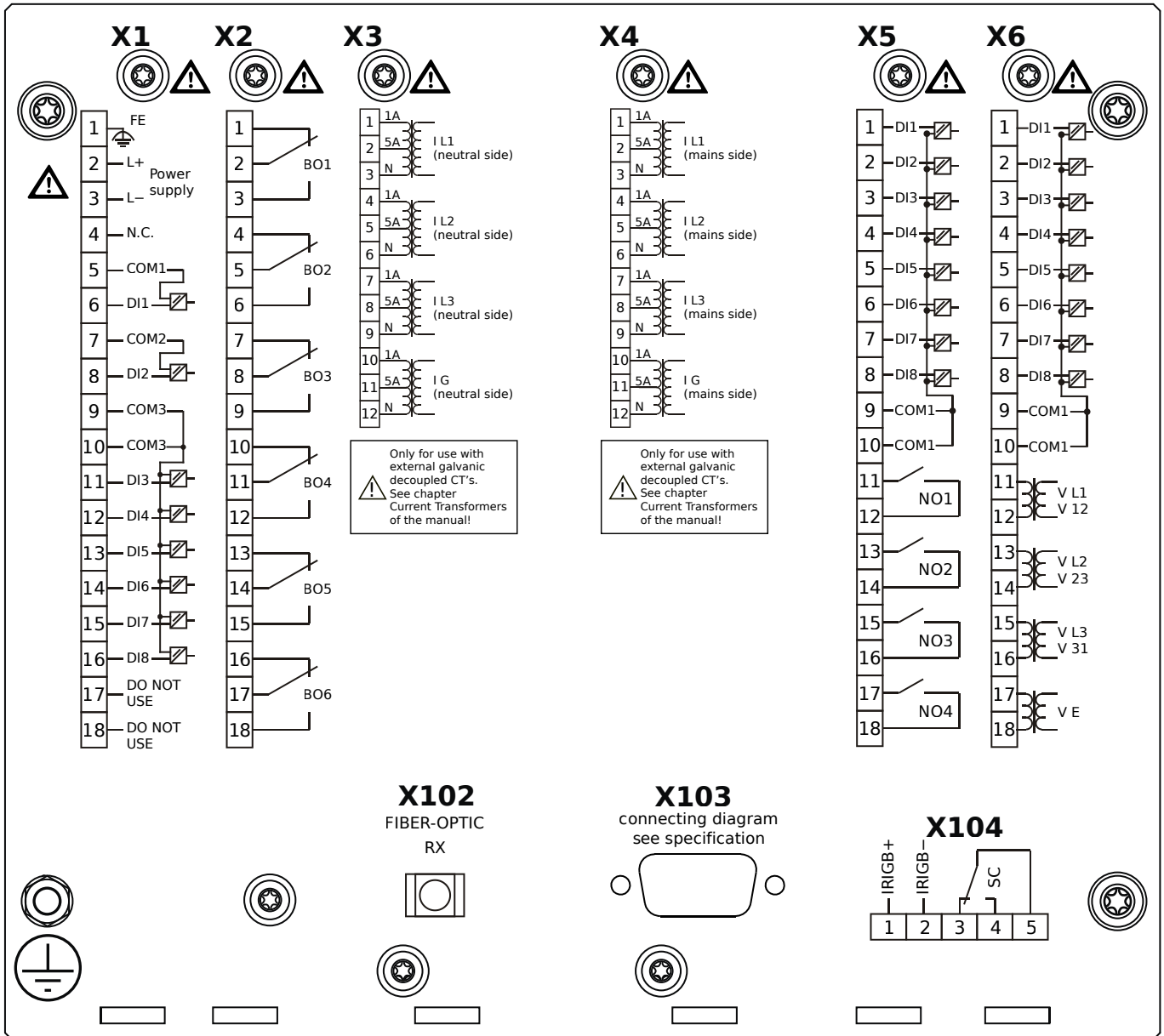

Housing B2, large display, door mounting

+ Conformal Coating (for installations in harsh environment)

- X1** – DI8-X1: Wide-range power supply unit, incl. 2 non-grouped digital inputs and 6 grouped digital inputs
- X2** – OR6: Assembly Group with 6 Output Relays (Changeover / Form C)
- X3** – TI: Standard current measuring card (for the neutral side of the differential protection)
- X4** – TI: Standard current measuring card (for the mains side of the differential protection)
- X5** – DI8-OR4: Assembly Group with 8 Digital Inputs and 4 Output Relays (NO / Form A)
- X6** – TU-DI8: Voltage measuring (0 ... 300 VAC) assembly group with 8 Digital Inputs
- X102** – Universal Resistance-Temperature Detector (URTD) input, Fiber optics interface, Versatile Link
- X103** – Profibus-DP, RS485, D-SUB
- X104** – IRIG-B00X, incl. System Contact (Supervision Contact)

MCDGV4-2C0AFA

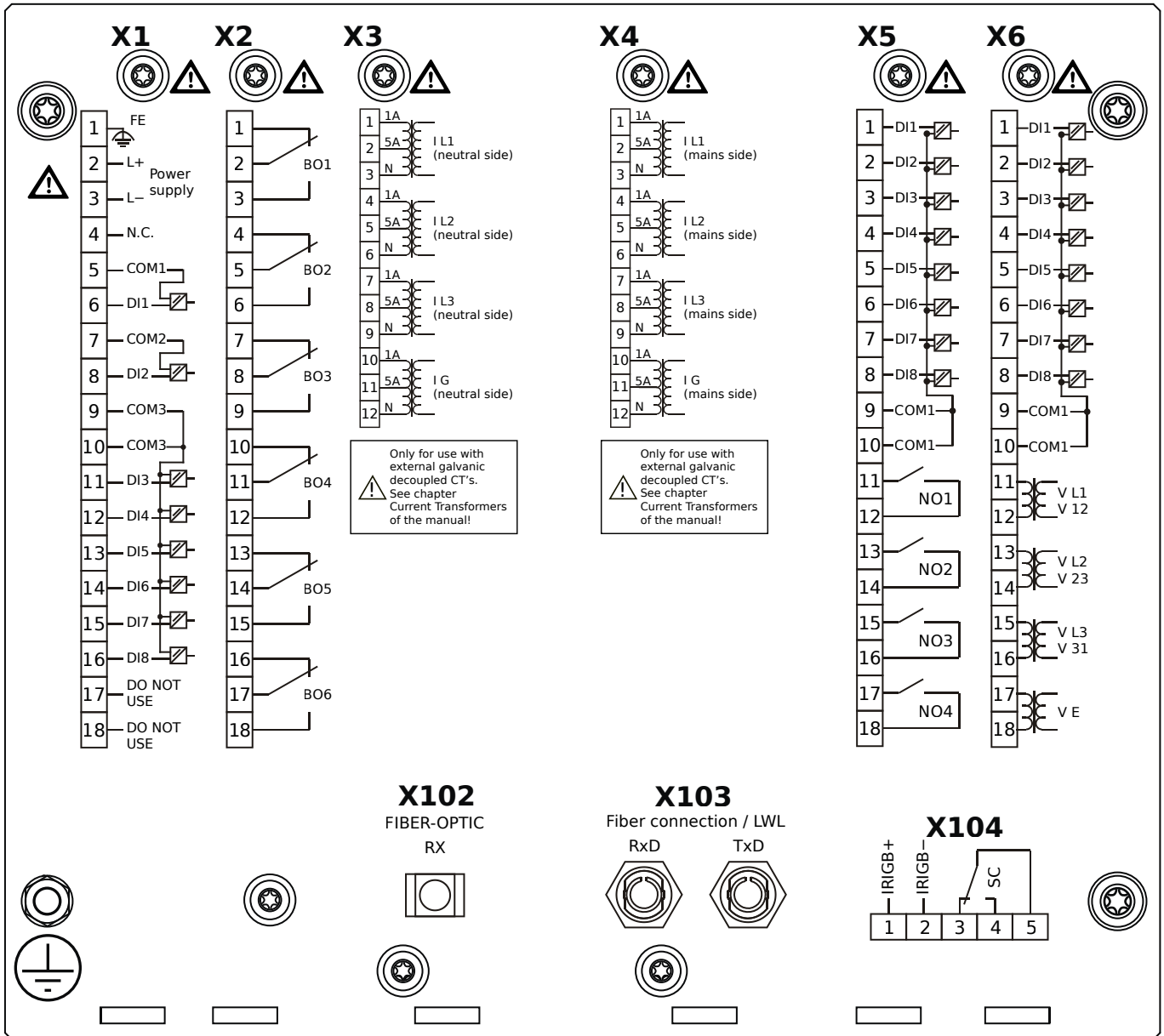

Housing B2, large display, door mounting

- X1** – DI8-X1: Wide-range power supply unit, incl. 2 non-grouped digital inputs and 6 grouped digital inputs
- X2** – OR6: Assembly Group with 6 Output Relays (Changeover / Form C)
- X3** – TI: Standard current measuring card (for the neutral side of the differential protection)
- X4** – TI: Standard current measuring card (for the mains side of the differential protection)
- X5** – DI8-OR4: Assembly Group with 8 Digital Inputs and 4 Output Relays (NO / Form A)
- X6** – TU-DI8: Voltage measuring (0 ... 300 VAC) assembly group with 8 Digital Inputs
- X102** – Universal Resistance-Temperature Detector (URTD) input, Fiber optics interface, Versatile Link
- X103** – Modbus RTU / IEC 60870-5-103 / DNP3.0 RTU, Fiber optics interface, ST Connector
- X104** – IRIG-B00X, incl. System Contact (Supervision Contact)

MCDGV4-2C0AFB

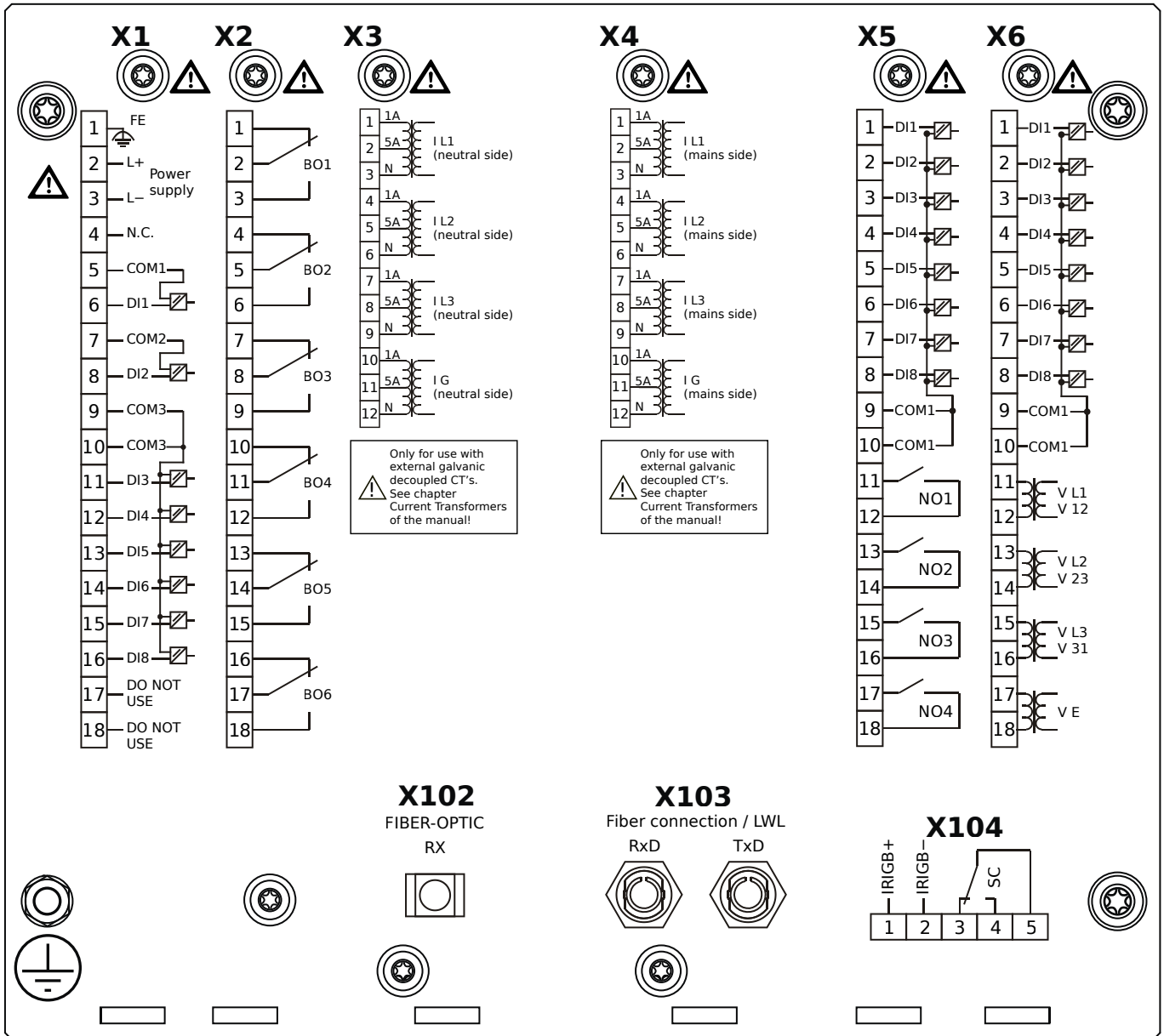

Housing B2, large display, door mounting

+ Conformal Coating (for installations in harsh environment)

- X1** – DI8-X1: Wide-range power supply unit, incl. 2 non-grouped digital inputs and 6 grouped digital inputs
- X2** – OR6: Assembly Group with 6 Output Relays (Changeover / Form C)
- X3** – TI: Standard current measuring card (for the neutral side of the differential protection)
- X4** – TI: Standard current measuring card (for the mains side of the differential protection)
- X5** – DI8-OR4: Assembly Group with 8 Digital Inputs and 4 Output Relays (NO / Form A)
- X6** – TU-DI8: Voltage measuring (0 ... 300 VAC) assembly group with 8 Digital Inputs
- X102** – Universal Resistance-Temperature Detector (URTD) input, Fiber optics interface, Versatile Link
- X103** – Modbus RTU / IEC 60870-5-103 / DNP3.0 RTU, Fiber optics interface, ST Connector
- X104** – IRIG-B00X, incl. System Contact (Supervision Contact)

MCDGV4-2C0AGA

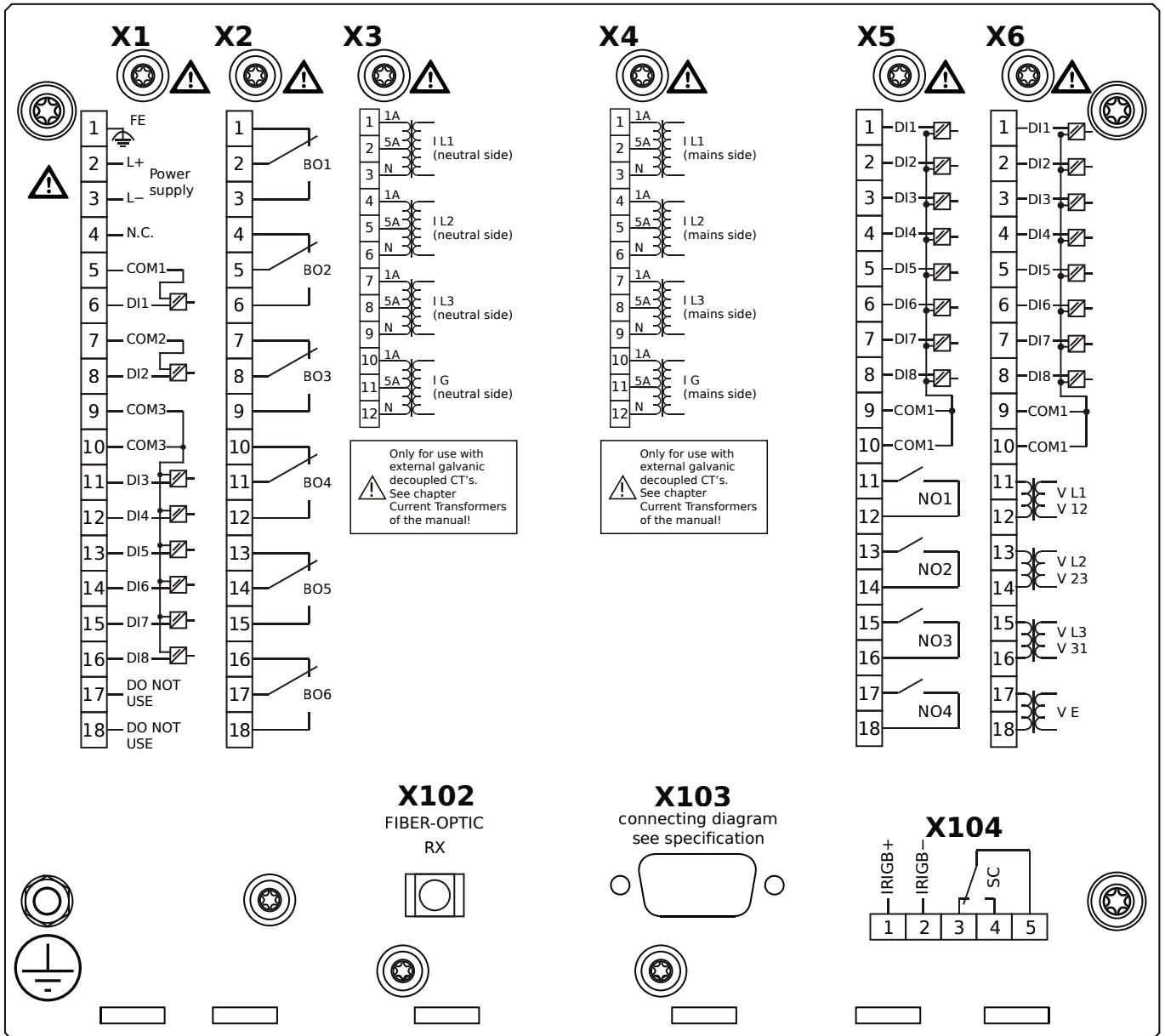

Housing B2, large display, door mounting

- X1** – DI8-X1: Wide-range power supply unit, incl. 2 non-grouped digital inputs and 6 grouped digital inputs
- X2** – OR6: Assembly Group with 6 Output Relays (Changeover / Form C)
- X3** – TI: Standard current measuring card (for the neutral side of the differential protection)
- X4** – TI: Standard current measuring card (for the mains side of the differential protection)
- X5** – DI8-OR4: Assembly Group with 8 Digital Inputs and 4 Output Relays (NO / Form A)
- X6** – TU-DI8: Voltage measuring (0 ... 300 VAC) assembly group with 8 Digital Inputs
- X102** – Universal Resistance-Temperature Detector (URTD) input, Fiber optics interface, Versatile Link
- X103** – Modbus RTU / IEC 60870-5-103 / DNP3.0 RTU, RS485, D-SUB
- X104** – IRIG-B00X, incl. System Contact (Supervision Contact)

MCDGV4-2C0AGB

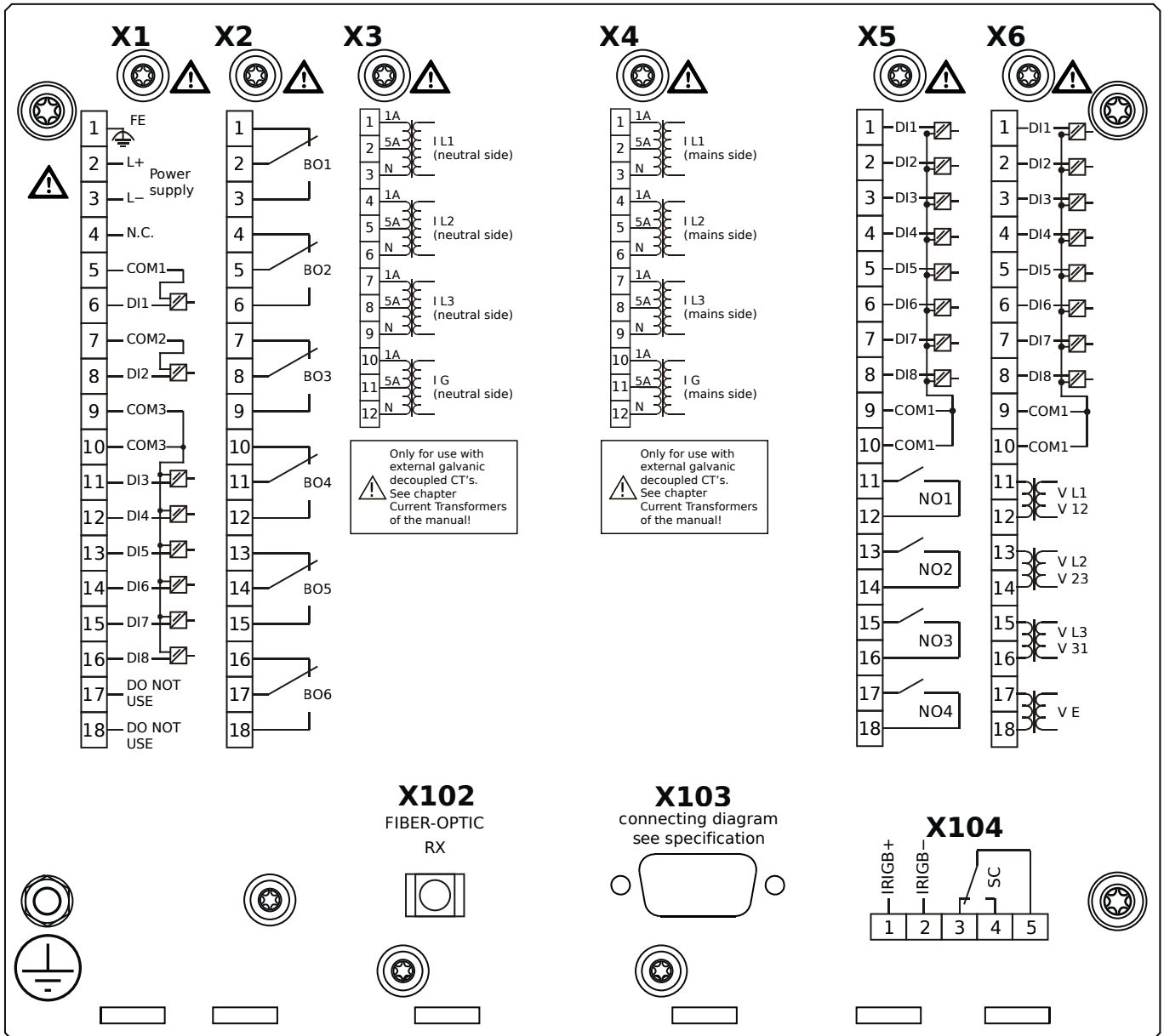

Housing B2, large display, door mounting

+ Conformal Coating (for installations in harsh environment)

- X1** – DI8-X1: Wide-range power supply unit, incl. 2 non-grouped digital inputs and 6 grouped digital inputs
- X2** – OR6: Assembly Group with 6 Output Relays (Changeover / Form C)
- X3** – TI: Standard current measuring card (for the neutral side of the differential protection)
- X4** – TI: Standard current measuring card (for the mains side of the differential protection)
- X5** – DI8-OR4: Assembly Group with 8 Digital Inputs and 4 Output Relays (NO / Form A)
- X6** – TU-DI8: Voltage measuring (0 ... 300 VAC) assembly group with 8 Digital Inputs
- X102** – Universal Resistance-Temperature Detector (URTD) input, Fiber optics interface, Versatile Link
- X103** – Modbus RTU / IEC 60870-5-103 / DNP3.0 RTU, RS485, D-SUB
- X104** – IRIG-B00X, incl. System Contact (Supervision Contact)

MCDGV4-2C0AHA

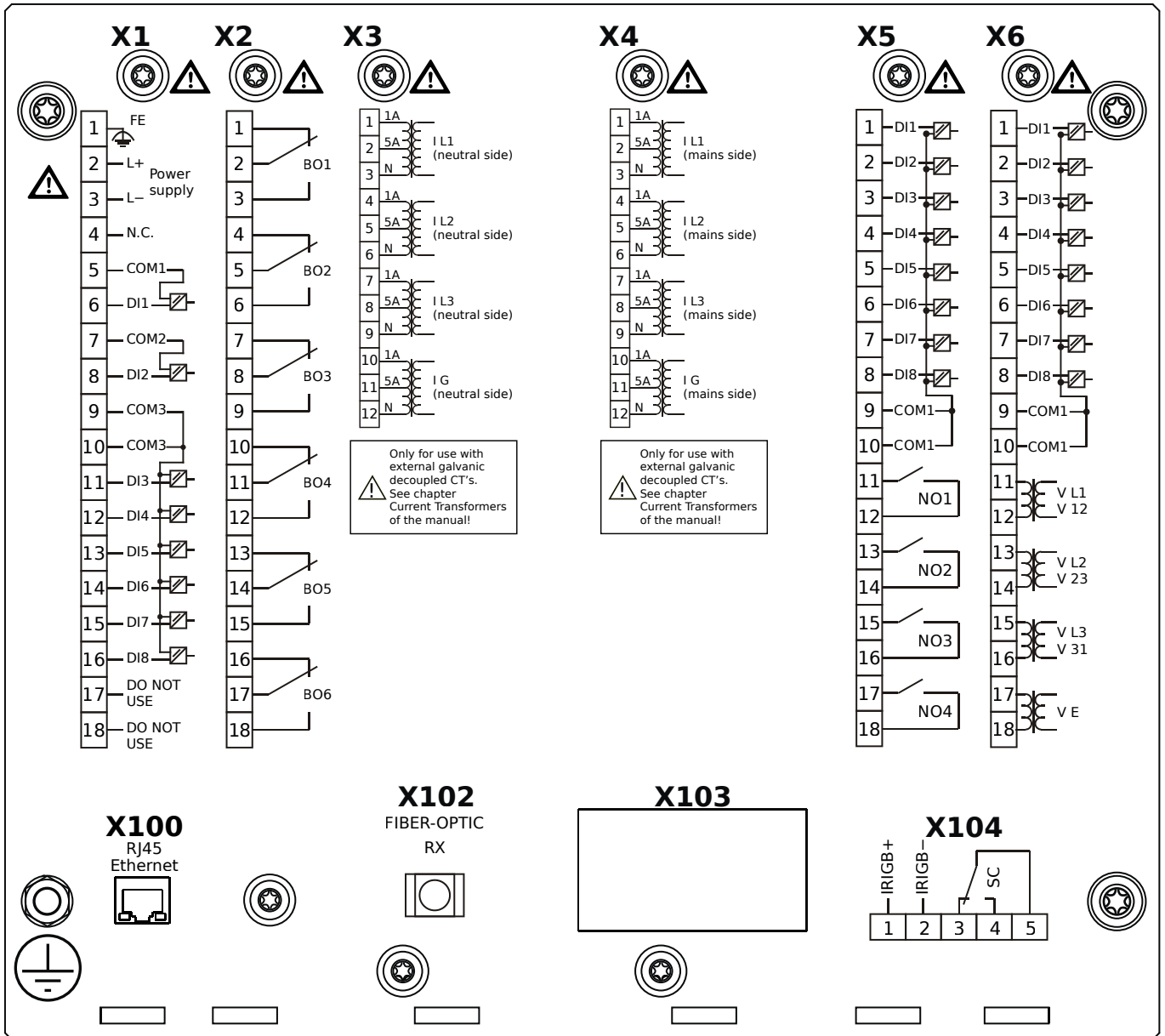

Housing B2, large display, door mounting

- X1** – DI8-X1: Wide-range power supply unit, incl. 2 non-grouped digital inputs and 6 grouped digital inputs
- X2** – OR6: Assembly Group with 6 Output Relays (Changeover / Form C)
- X3** – TI: Standard current measuring card (for the neutral side of the differential protection)
- X4** – TI: Standard current measuring card (for the mains side of the differential protection)
- X5** – DI8-OR4: Assembly Group with 8 Digital Inputs and 4 Output Relays (NO / Form A)
- X6** – TU-DI8: Voltage measuring (0 ... 300 VAC) assembly group with 8 Digital Inputs
- X100** – IEC 61850 / Modbus TCP / DNP3.0 TCP/UDP, Ethernet interface, 100 Mbit/s, RJ45 (BASE100-FX)
- X102** – Universal Resistance-Temperature Detector (URTD) input, Fiber optics interface, Versatile Link
- X104** – IRIG-B00X, incl. System Contact (Supervision Contact)

MCDGV4-2C0AHB

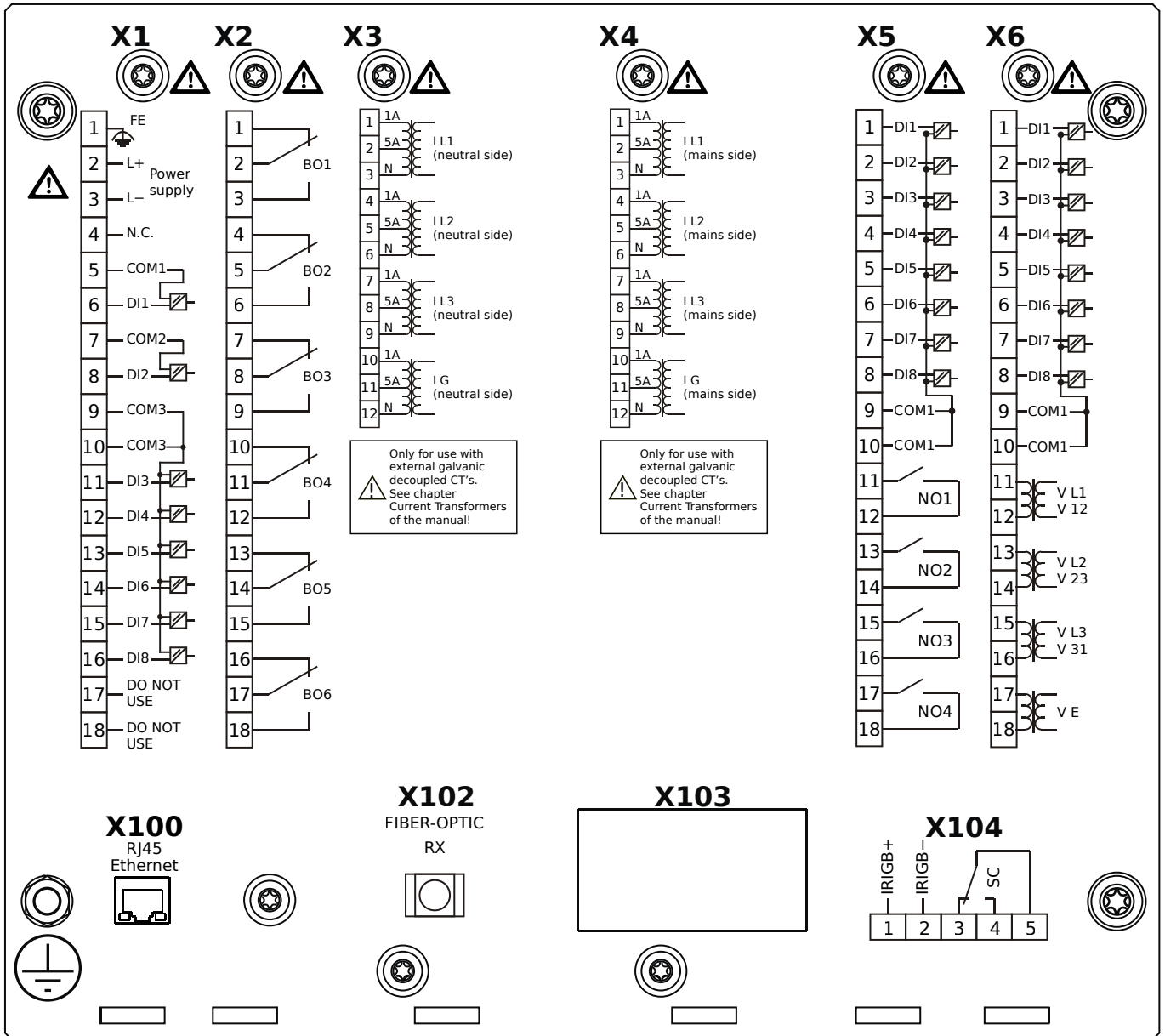

Housing B2, large display, door mounting

- + Conformal Coating (for installations in harsh environment)

- X1** – DI8-X1: Wide-range power supply unit, incl. 2 non-grouped digital inputs and 6 grouped digital inputs
- X2** – OR6: Assembly Group with 6 Output Relays (Changeover / Form C)
- X3** – TI: Standard current measuring card (for the neutral side of the differential protection)
- X4** – TI: Standard current measuring card (for the mains side of the differential protection)
- X5** – DI8-OR4: Assembly Group with 8 Digital Inputs and 4 Output Relays (NO / Form A)
- X6** – TU-DI8: Voltage measuring (0 ... 300 VAC) assembly group with 8 Digital Inputs
- X100** – IEC 61850 / Modbus TCP / DNP3.0 TCP/UDP, Ethernet interface, 100 Mbit/s, RJ45 (BASE100-FX)
- X102** – Universal Resistance-Temperature Detector (URTD) input, Fiber optics interface, Versatile Link
- X104** – IRIG-B00X, incl. System Contact (Supervision Contact)

MCDGV4-2C0AIA

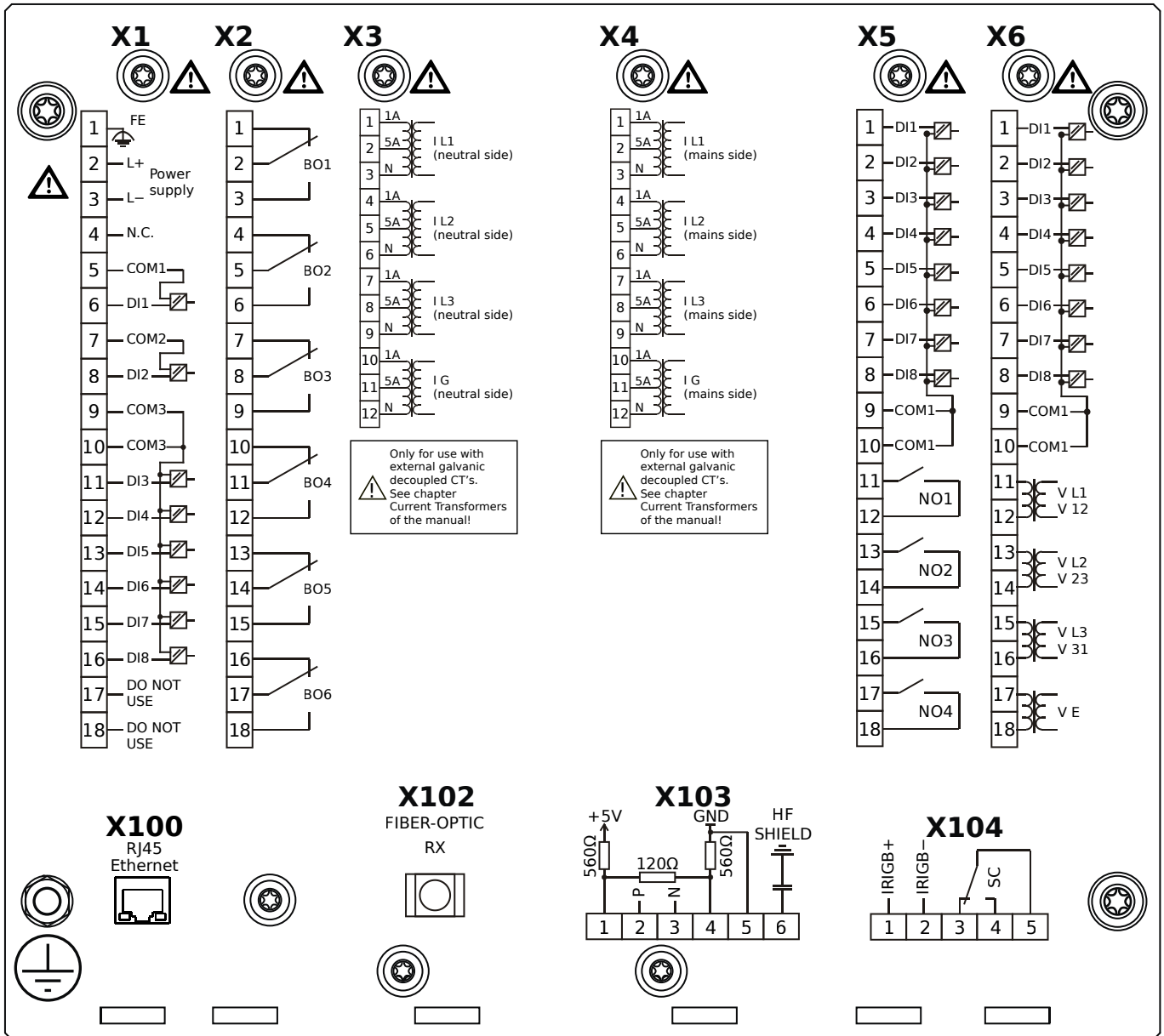

Housing B2, large display, door mounting

- X1** – DI8-X1: Wide-range power supply unit, incl. 2 non-grouped digital inputs and 6 grouped digital inputs
- X2** – OR6: Assembly Group with 6 Output Relays (Changeover / Form C)
- X3** – TI: Standard current measuring card (for the neutral side of the differential protection)
- X4** – TI: Standard current measuring card (for the mains side of the differential protection)
- X5** – DI8-OR4: Assembly Group with 8 Digital Inputs and 4 Output Relays (NO / Form A)
- X6** – TU-DI8: Voltage measuring (0 ... 300 VAC) assembly group with 8 Digital Inputs
- X100** – Modbus TCP / DNP3.0 TCP/UDP, Ethernet interface, 100 Mbit/s, RJ45 (BASE100-FX)
- X102** – Universal Resistance-Temperature Detector (URTD) input, Fiber optics interface, Versatile Link
- X103** – IEC 60870-5-103 / Modbus RTU / DNP3.0 RTU, RS485, Terminals
- X104** – IRIG-B00X, incl. System Contact (Supervision Contact)

MCDGV4-2C0AIB

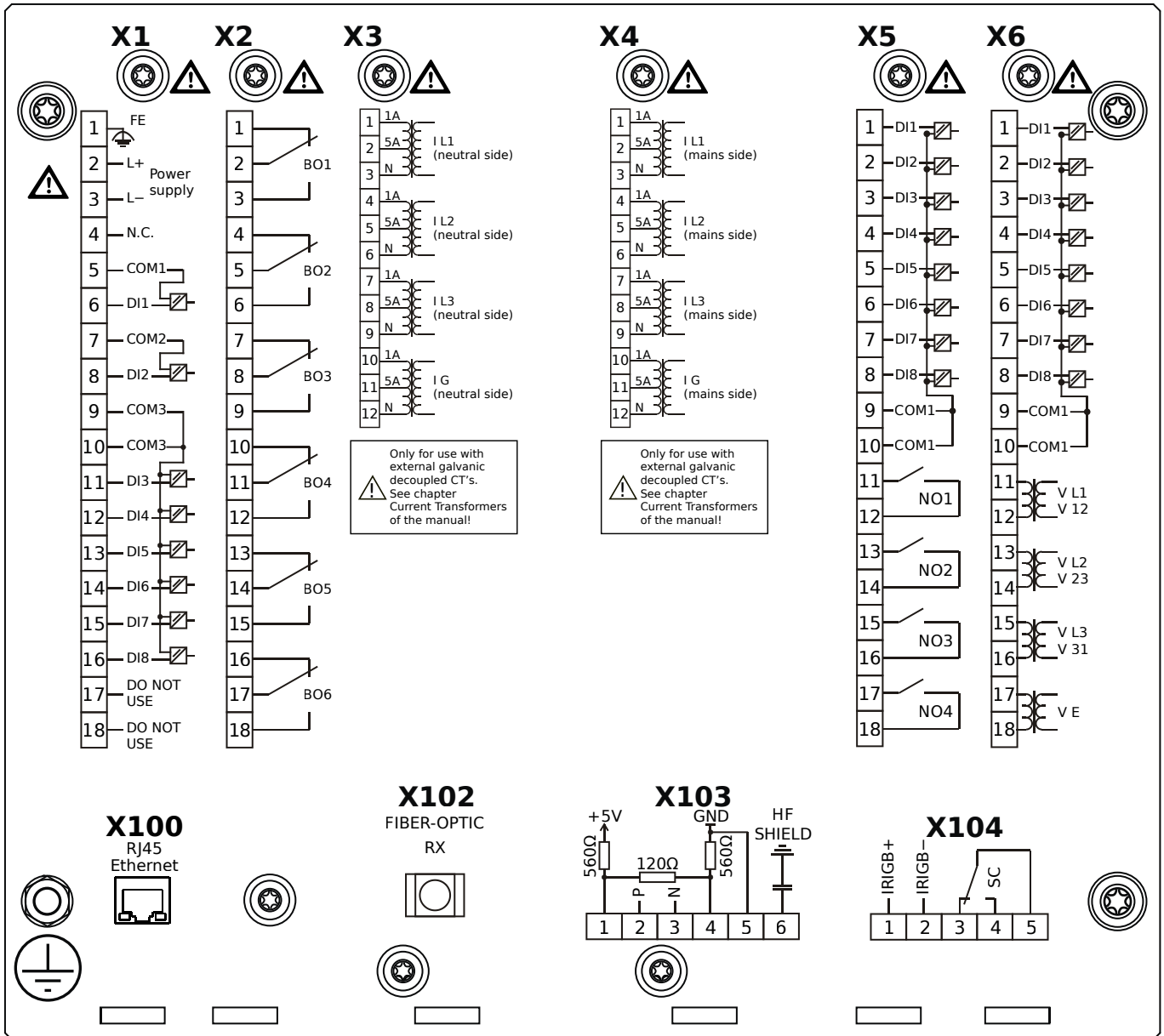

Housing B2, large display, door mounting

+ Conformal Coating (for installations in harsh environment)

- X1** – DI8-X1: Wide-range power supply unit, incl. 2 non-grouped digital inputs and 6 grouped digital inputs
- X2** – OR6: Assembly Group with 6 Output Relays (Changeover / Form C)
- X3** – TI: Standard current measuring card (for the neutral side of the differential protection)
- X4** – TI: Standard current measuring card (for the mains side of the differential protection)
- X5** – DI8-OR4: Assembly Group with 8 Digital Inputs and 4 Output Relays (NO / Form A)
- X6** – TU-DI8: Voltage measuring (0 ... 300 VAC) assembly group with 8 Digital Inputs
- X100** – Modbus TCP / DNP3.0 TCP/UDP, Ethernet interface, 100 Mbit/s, RJ45 (BASE100-FX)
- X102** – Universal Resistance-Temperature Detector (URTD) input, Fiber optics interface, Versatile Link
- X103** – IEC 60870-5-103 / Modbus RTU / DNP3.0 RTU, RS485, Terminals
- X104** – IRIG-B00X, incl. System Contact (Supervision Contact)

MCDGV4-2C0AKA

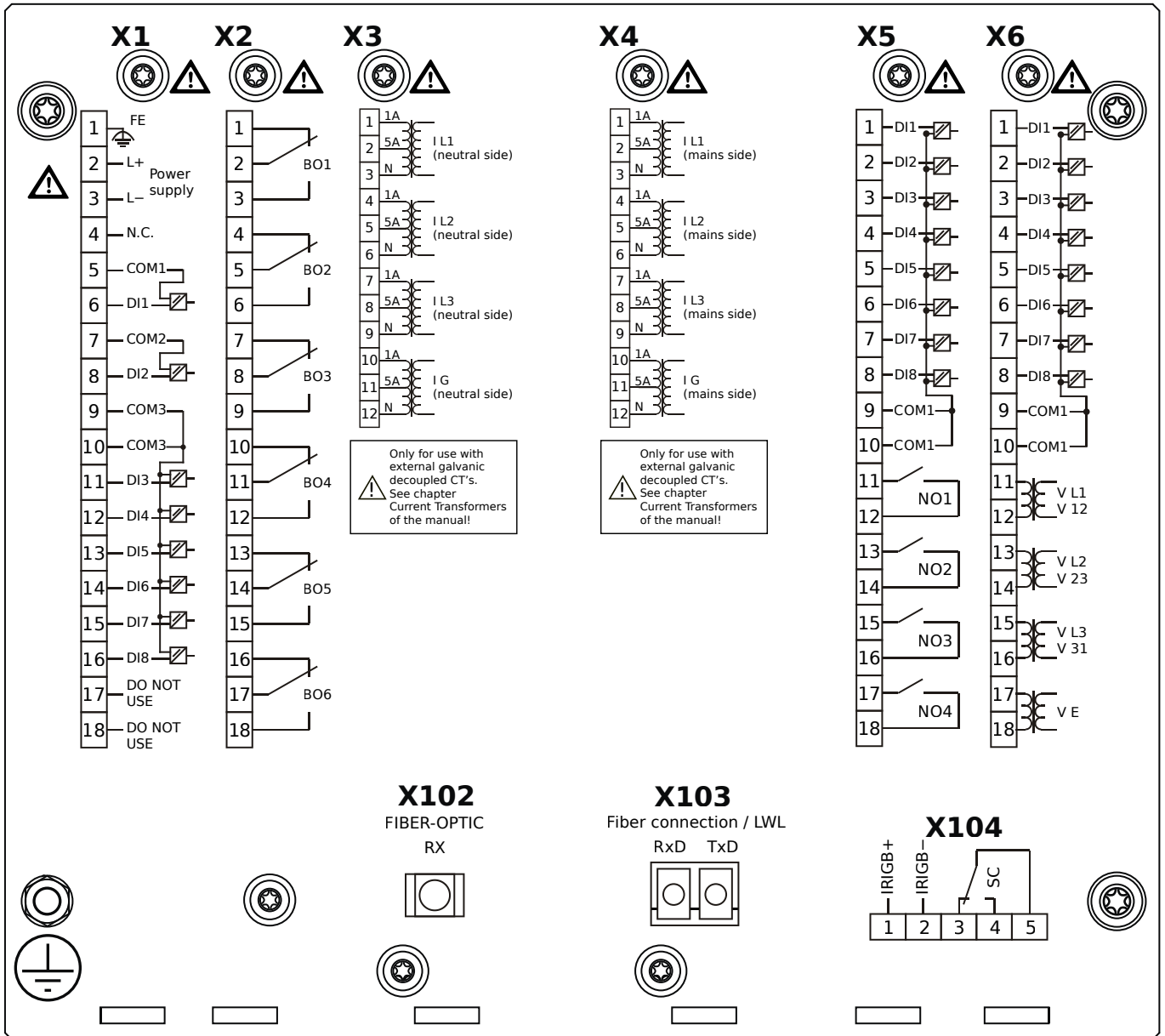

Housing B2, large display, door mounting

- X1** – DI8-X1: Wide-range power supply unit, incl. 2 non-grouped digital inputs and 6 grouped digital inputs
- X2** – OR6: Assembly Group with 6 Output Relays (Changeover / Form C)
- X3** – TI: Standard current measuring card (for the neutral side of the differential protection)
- X4** – TI: Standard current measuring card (for the mains side of the differential protection)
- X5** – DI8-OR4: Assembly Group with 8 Digital Inputs and 4 Output Relays (NO / Form A)
- X6** – TU-DI8: Voltage measuring (0 ... 300 VAC) assembly group with 8 Digital Inputs
- X102** – Universal Resistance-Temperature Detector (URTD) input, Fiber optics interface, Versatile Link
- X103** – IEC 61850 / Modbus TCP / DNP3.0 TCP/UDP, Fiber optics interface, LC Connector
- X104** – IRIG-B00X, incl. System Contact (Supervision Contact)

MCDGV4-2C0AKB

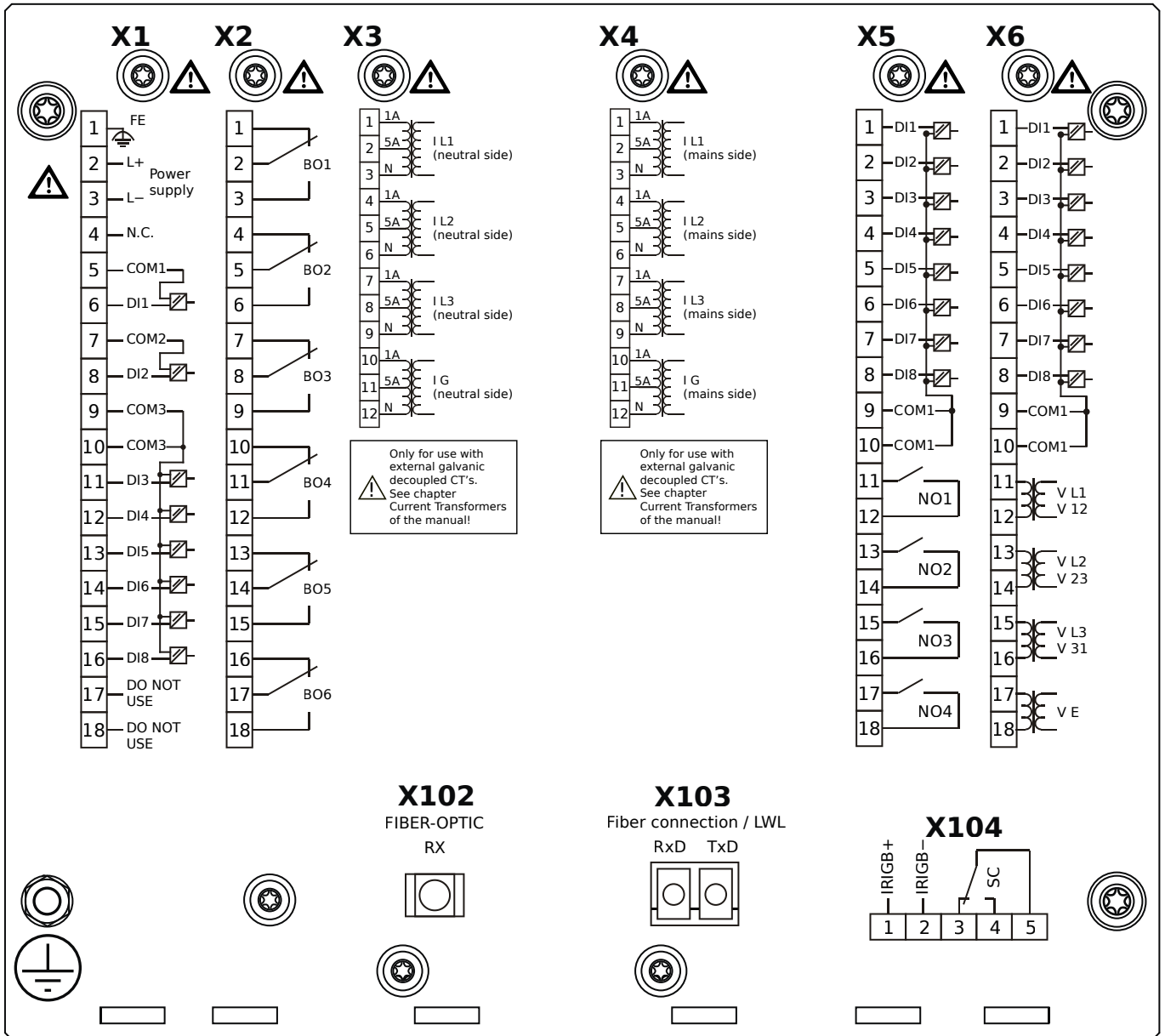

Housing B2, large display, door mounting

- + Conformal Coating (for installations in harsh environment)

- X1** – DI8-X1: Wide-range power supply unit, incl. 2 non-grouped digital inputs and 6 grouped digital inputs
- X2** – OR6: Assembly Group with 6 Output Relays (Changeover / Form C)
- X3** – TI: Standard current measuring card (for the neutral side of the differential protection)
- X4** – TI: Standard current measuring card (for the mains side of the differential protection)
- X5** – DI8-OR4: Assembly Group with 8 Digital Inputs and 4 Output Relays (NO / Form A)
- X6** – TU-DI8: Voltage measuring (0 ... 300 VAC) assembly group with 8 Digital Inputs
- X102** – Universal Resistance-Temperature Detector (URTD) input, Fiber optics interface, Versatile Link
- X103** – IEC 61850 / Modbus TCP / DNP3.0 TCP/UDP, Fiber optics interface, LC Connector
- X104** – IRIG-B00X, incl. System Contact (Supervision Contact)

MCDGV4-2C0ALA

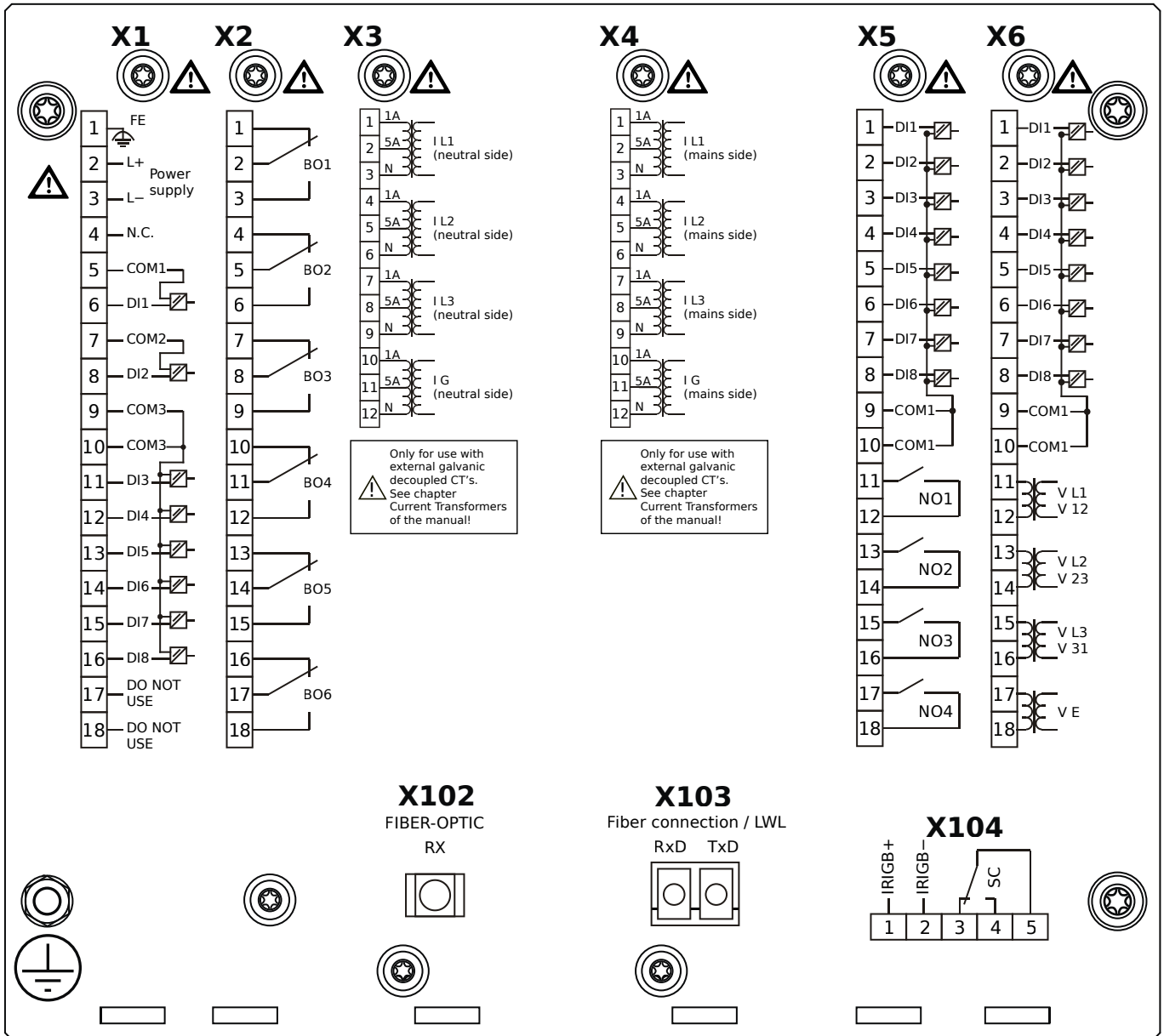

Housing B2, large display, door mounting

- X1** – DI8-X1: Wide-range power supply unit, incl. 2 non-grouped digital inputs and 6 grouped digital inputs
- X2** – OR6: Assembly Group with 6 Output Relays (Changeover / Form C)
- X3** – TI: Standard current measuring card (for the neutral side of the differential protection)
- X4** – TI: Standard current measuring card (for the mains side of the differential protection)
- X5** – DI8-OR4: Assembly Group with 8 Digital Inputs and 4 Output Relays (NO / Form A)
- X6** – TU-DI8: Voltage measuring (0 ... 300 VAC) assembly group with 8 Digital Inputs
- X102** – Universal Resistance-Temperature Detector (URTD) input, Fiber optics interface, Versatile Link
- X103** – Modbus TCP / DNP3.0 TCP/UDP, Fiber optics interface, LC Connector
- X104** – IRIG-B00X, incl. System Contact (Supervision Contact)

MCDGV4-2C0ALB

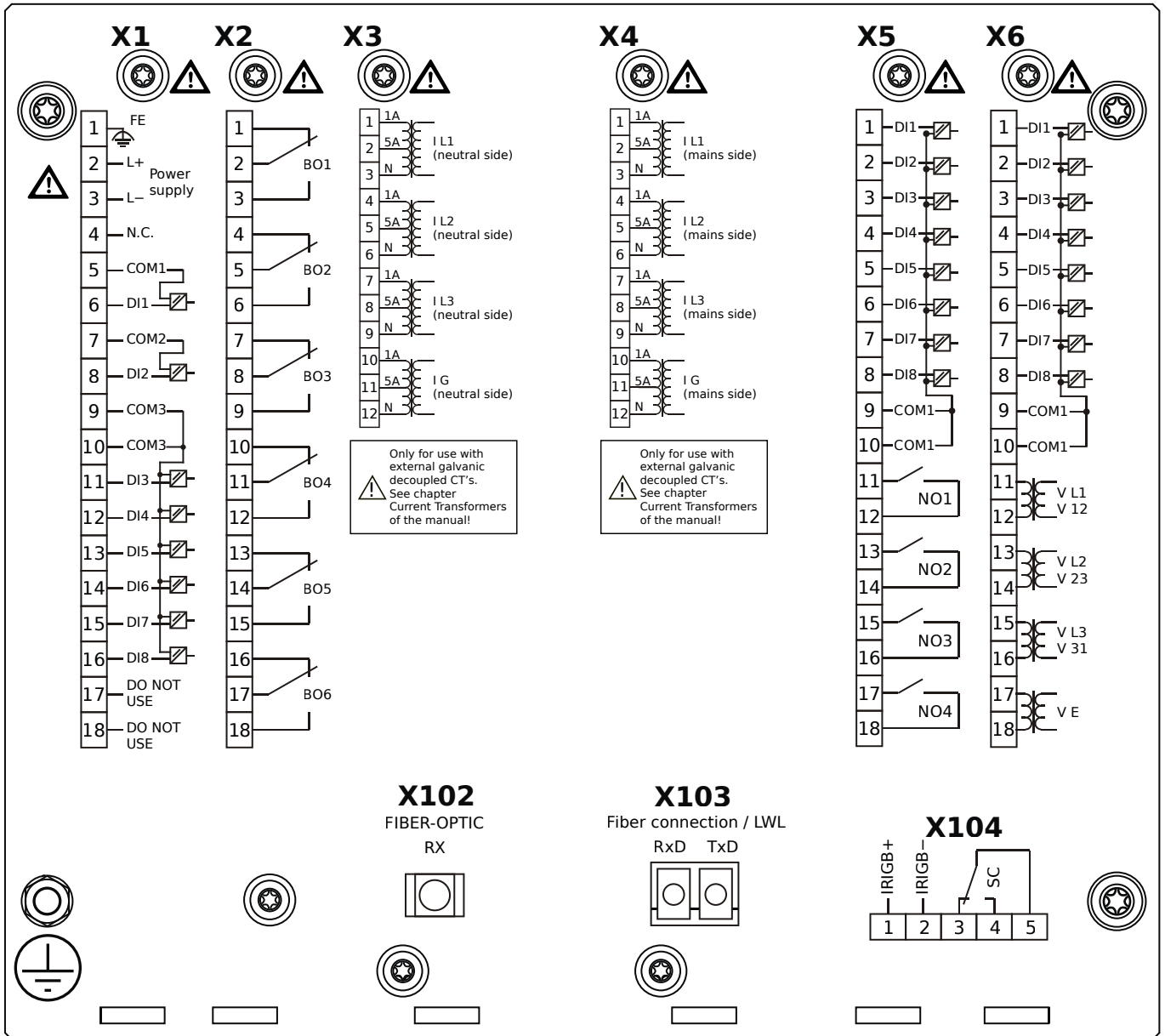

Housing B2, large display, door mounting

- + Conformal Coating (for installations in harsh environment)

- X1** – DI8-X1: Wide-range power supply unit, incl. 2 non-grouped digital inputs and 6 grouped digital inputs
- X2** – OR6: Assembly Group with 6 Output Relays (Changeover / Form C)
- X3** – TI: Standard current measuring card (for the neutral side of the differential protection)
- X4** – TI: Standard current measuring card (for the mains side of the differential protection)
- X5** – DI8-OR4: Assembly Group with 8 Digital Inputs and 4 Output Relays (NO / Form A)
- X6** – TU-DI8: Voltage measuring (0 ... 300 VAC) assembly group with 8 Digital Inputs
- X102** – Universal Resistance-Temperature Detector (URTD) input, Fiber optics interface, Versatile Link
- X103** – Modbus TCP / DNP3.0 TCP/UDP, Fiber optics interface, LC Connector
- X104** – IRIG-B00X, incl. System Contact (Supervision Contact)

MCDGV4-2C0ATA

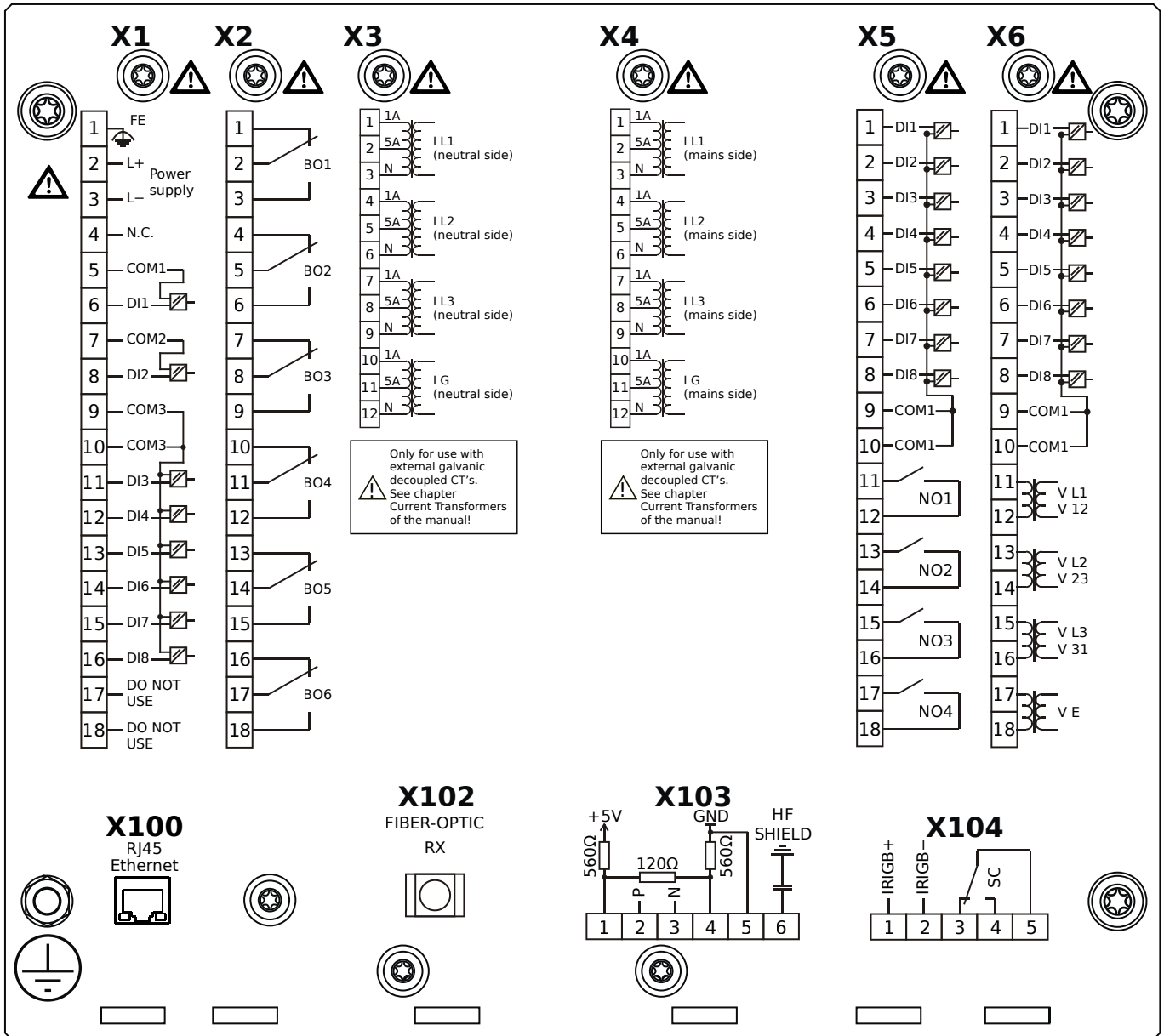

Housing B2, large display, door mounting

- X1** – DI8-X1: Wide-range power supply unit, incl. 2 non-grouped digital inputs and 6 grouped digital inputs
- X2** – OR6: Assembly Group with 6 Output Relays (Changeover / Form C)
- X3** – TI: Standard current measuring card (for the neutral side of the differential protection)
- X4** – TI: Standard current measuring card (for the mains side of the differential protection)
- X5** – DI8-OR4: Assembly Group with 8 Digital Inputs and 4 Output Relays (NO / Form A)
- X6** – TU-DI8: Voltage measuring (0 ... 300 VAC) assembly group with 8 Digital Inputs
- X100** – IEC 61850 / Modbus TCP / DNP3.0 TCP/UDP, Ethernet interface, 100 Mbit/s, RJ45 (BASE100-FX)
- X102** – Universal Resistance-Temperature Detector (URTD) input, Fiber optics interface, Versatile Link
- X103** – IEC 60870-5-103 / Modbus RTU / DNP3.0 RTU, RS485, Terminals
- X104** – IRIG-B00X, incl. System Contact (Supervision Contact)

MCDGV4-2C0ATB

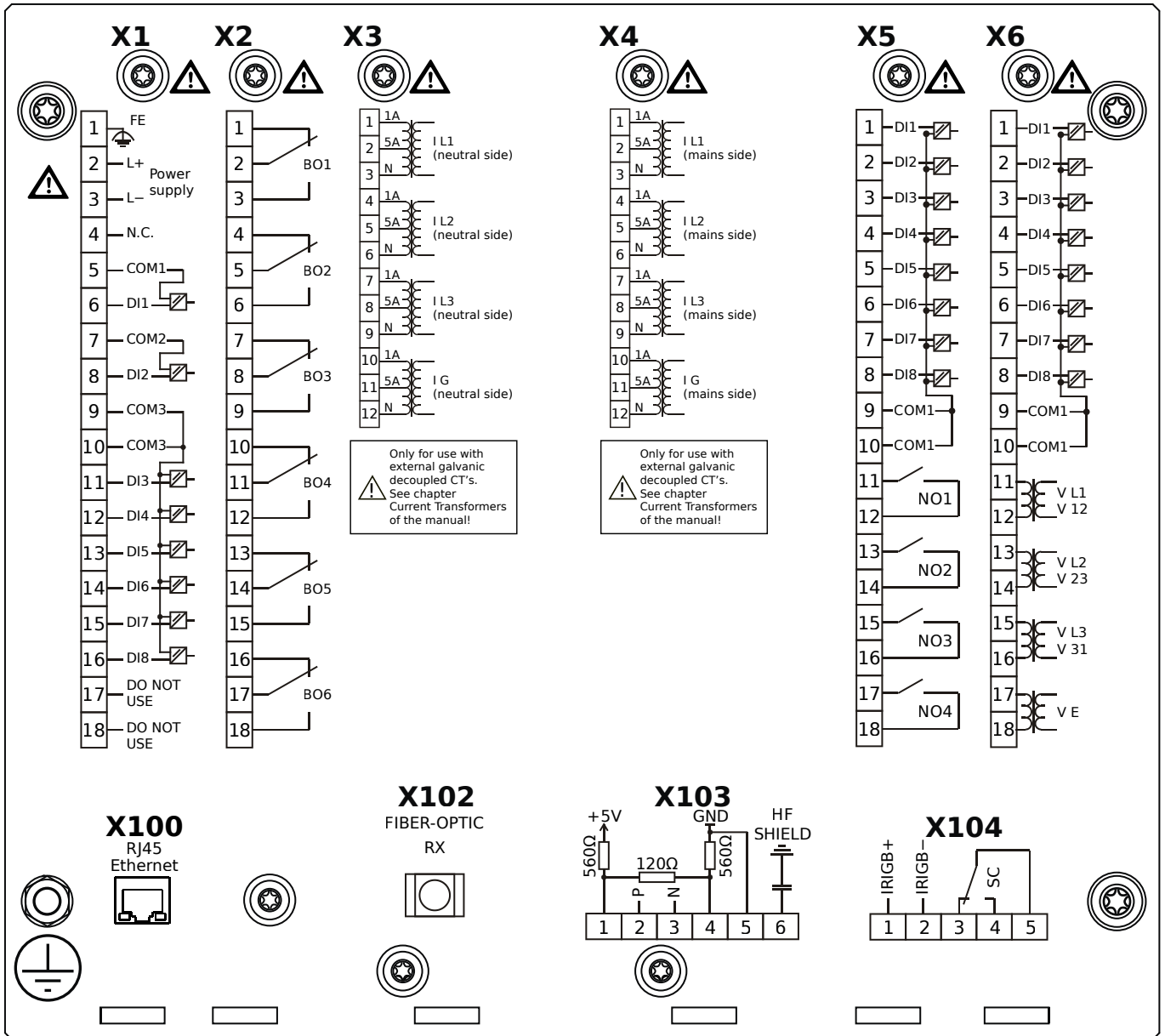

Housing B2, large display, door mounting

+ Conformal Coating (for installations in harsh environment)

- X1** – DI8-X1: Wide-range power supply unit, incl. 2 non-grouped digital inputs and 6 grouped digital inputs
- X2** – OR6: Assembly Group with 6 Output Relays (Changeover / Form C)
- X3** – TI: Standard current measuring card (for the neutral side of the differential protection)
- X4** – TI: Standard current measuring card (for the mains side of the differential protection)
- X5** – DI8-OR4: Assembly Group with 8 Digital Inputs and 4 Output Relays (NO / Form A)
- X6** – TU-DI8: Voltage measuring (0 ... 300 VAC) assembly group with 8 Digital Inputs
- X100** – IEC 61850 / Modbus TCP / DNP3.0 TCP/UDP, Ethernet interface, 100 Mbit/s, RJ45 (BASE100-FX)
- X102** – Universal Resistance-Temperature Detector (URTD) input, Fiber optics interface, Versatile Link
- X103** – IEC 60870-5-103 / Modbus RTU / DNP3.0 RTU, RS485, Terminals
- X104** – IRIG-B00X, incl. System Contact (Supervision Contact)

MCDGV4-2C0BAA

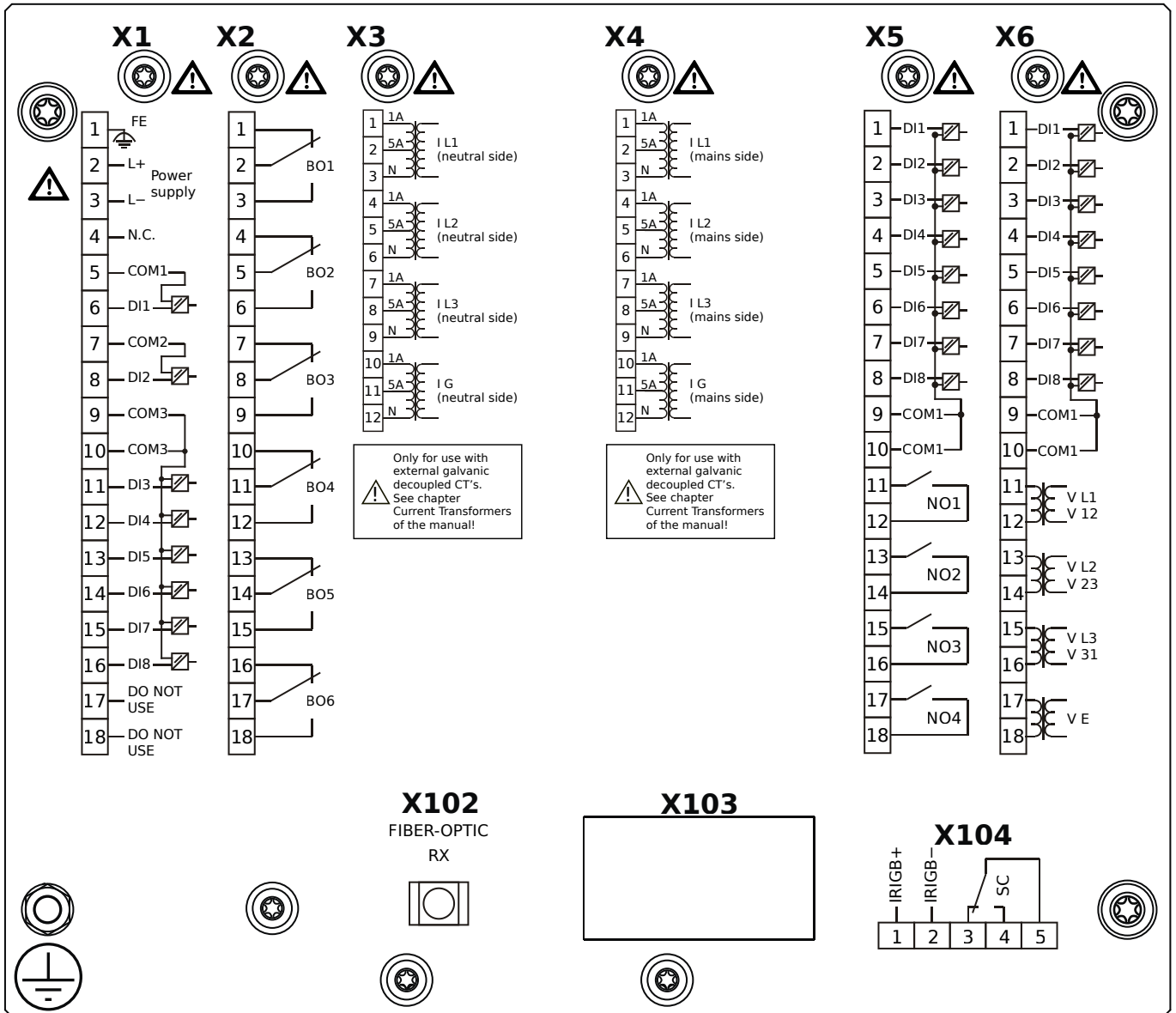

Housing B2, large display, 19" rack mounting

- X1** – DI8-X1: Wide-range power supply unit, incl. 2 non-grouped digital inputs and 6 grouped digital inputs
- X2** – OR6: Assembly Group with 6 Output Relays (Changeover / Form C)
- X3** – TI: Standard current measuring card (for the neutral side of the differential protection)
- X4** – TI: Standard current measuring card (for the mains side of the differential protection)
- X5** – DI8-OR4: Assembly Group with 8 Digital Inputs and 4 Output Relays (NO / Form A)
- X6** – TU-DI8: Voltage measuring (0 ... 300 VAC) assembly group with 8 Digital Inputs
- X102** – Universal Resistance-Temperature Detector (URTD) input, Fiber optics interface, Versatile Link
- X104** – IRIG-B00X, incl. System Contact (Supervision Contact)

MCDGV4-2C0BAB

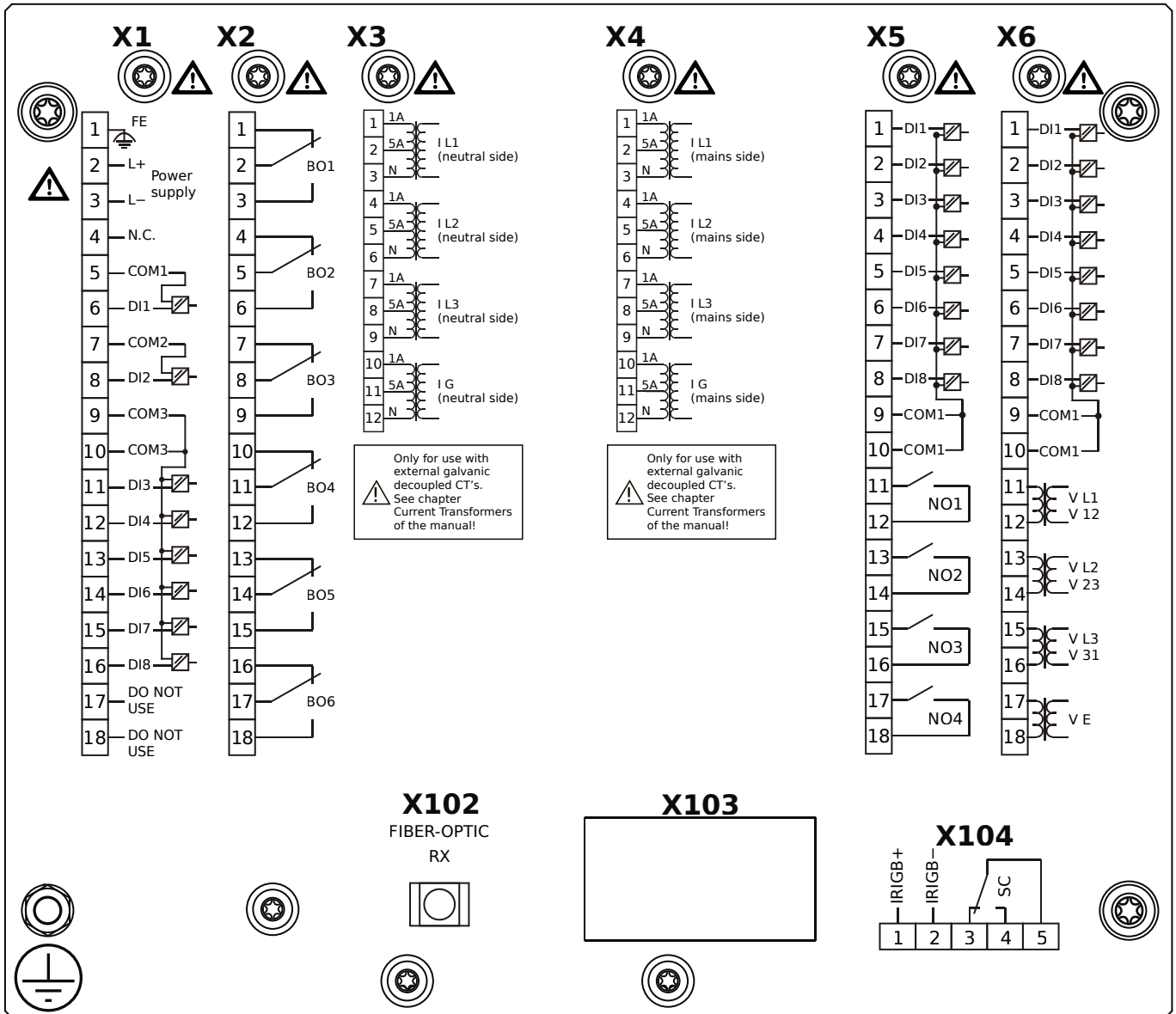

Housing B2, large display, 19" rack mounting

+ Conformal Coating (for installations in harsh environment)

- X1** – DI8-X1: Wide-range power supply unit, incl. 2 non-grouped digital inputs and 6 grouped digital inputs
- X2** – OR6: Assembly Group with 6 Output Relays (Changeover / Form C)
- X3** – TI: Standard current measuring card (for the neutral side of the differential protection)
- X4** – TI: Standard current measuring card (for the mains side of the differential protection)
- X5** – DI8-OR4: Assembly Group with 8 Digital Inputs and 4 Output Relays (NO / Form A)
- X6** – TU-DI8: Voltage measuring (0 ... 300 VAC) assembly group with 8 Digital Inputs
- X102** – Universal Resistance-Temperature Detector (URTD) input, Fiber optics interface, Versatile Link
- X104** – IRIG-B00X, incl. System Contact (Supervision Contact)

MCDGV4-2C0BBA

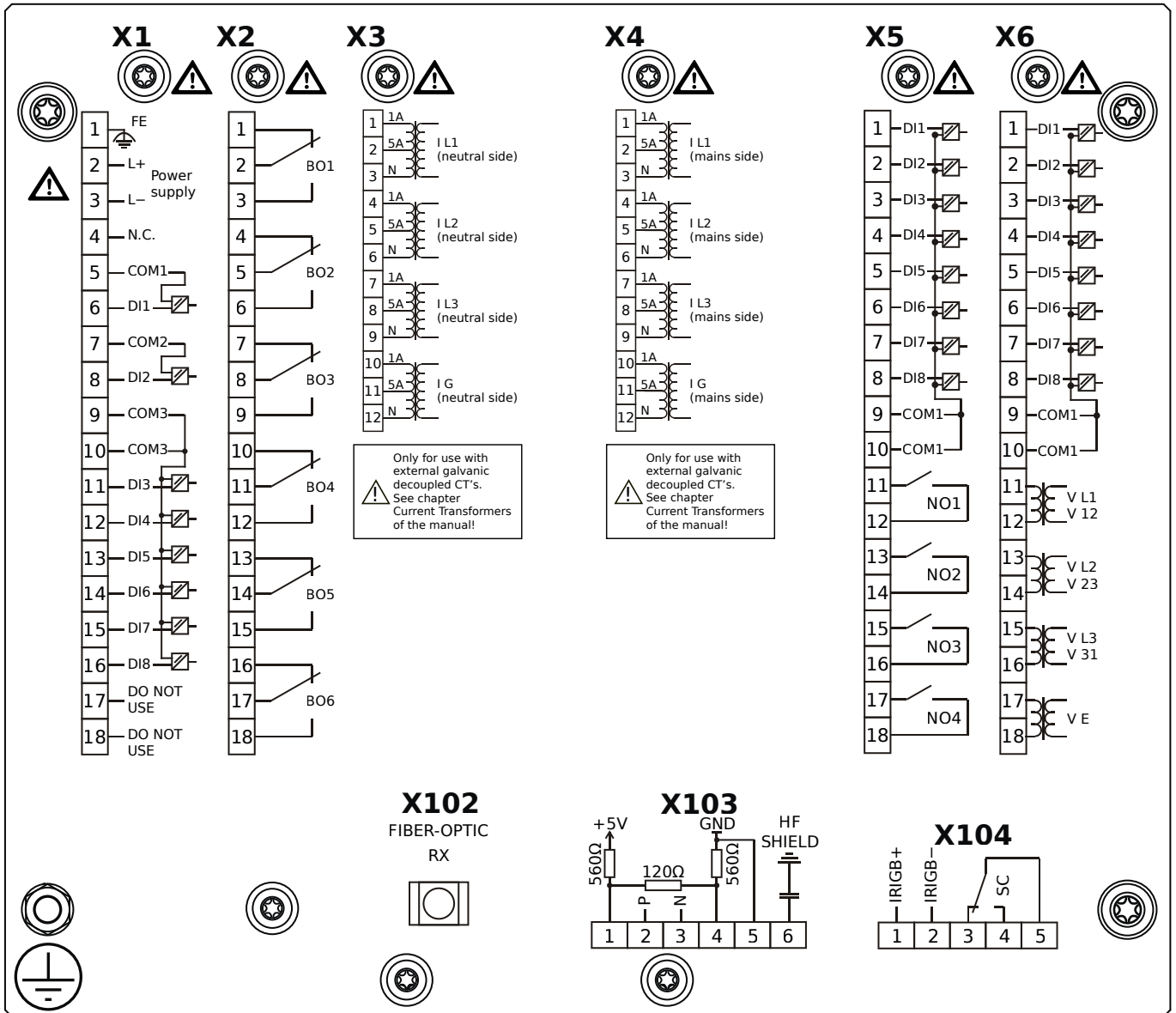

Housing B2, large display, 19" rack mounting

- X1** – DI8-X1: Wide-range power supply unit, incl. 2 non-grouped digital inputs and 6 grouped digital inputs
- X2** – OR6: Assembly Group with 6 Output Relays (Changeover / Form C)
- X3** – TI: Standard current measuring card (for the neutral side of the differential protection)
- X4** – TI: Standard current measuring card (for the mains side of the differential protection)
- X5** – DI8-OR4: Assembly Group with 8 Digital Inputs and 4 Output Relays (NO / Form A)
- X6** – TU-DI8: Voltage measuring (0 ... 300 VAC) assembly group with 8 Digital Inputs
- X102** – Universal Resistance-Temperature Detector (URTD) input, Fiber optics interface, Versatile Link
- X103** – Modbus RTU / IEC 60870-5-103 / DNP3.0 RTU, RS485, Terminals
- X104** – IRIG-B00X, incl. System Contact (Supervision Contact)

MCDGV4-2C0BBB

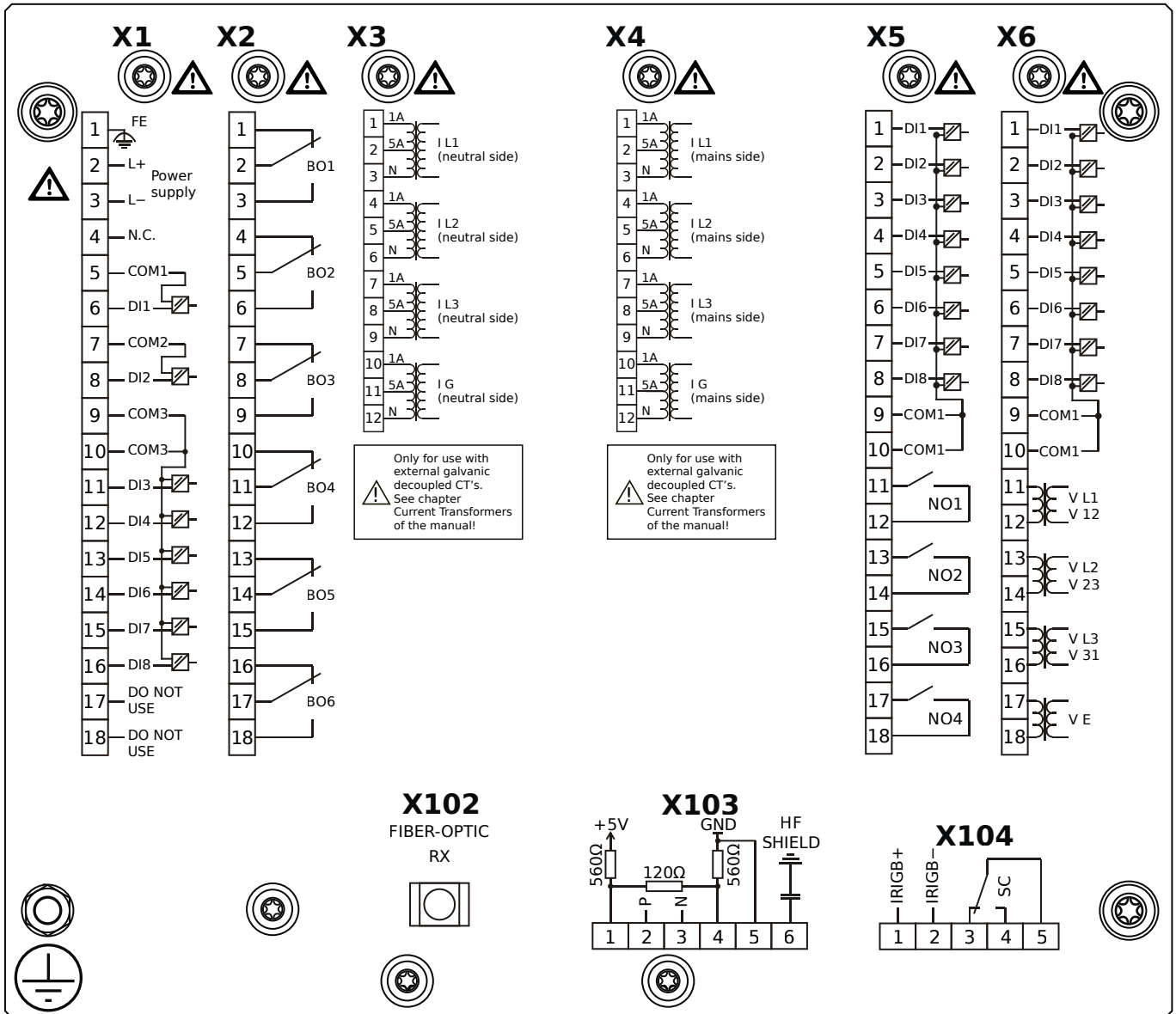

Housing B2, large display, 19" rack mounting

+ Conformal Coating (for installations in harsh environment)

- X1** – DI8-X1: Wide-range power supply unit, incl. 2 non-grouped digital inputs and 6 grouped digital inputs
- X2** – OR6: Assembly Group with 6 Output Relays (Changeover / Form C)
- X3** – TI: Standard current measuring card (for the neutral side of the differential protection)
- X4** – TI: Standard current measuring card (for the mains side of the differential protection)
- X5** – DI8-OR4: Assembly Group with 8 Digital Inputs and 4 Output Relays (NO / Form A)
- X6** – TU-DI8: Voltage measuring (0 ... 300 VAC) assembly group with 8 Digital Inputs
- X102** – Universal Resistance-Temperature Detector (URTD) input, Fiber optics interface, Versatile Link
- X103** – Modbus RTU / IEC 60870-5-103 / DNP3.0 RTU, RS485, Terminals
- X104** – IRIG-B00X, incl. System Contact (Supervision Contact)

MCDGV4-2C0BCA

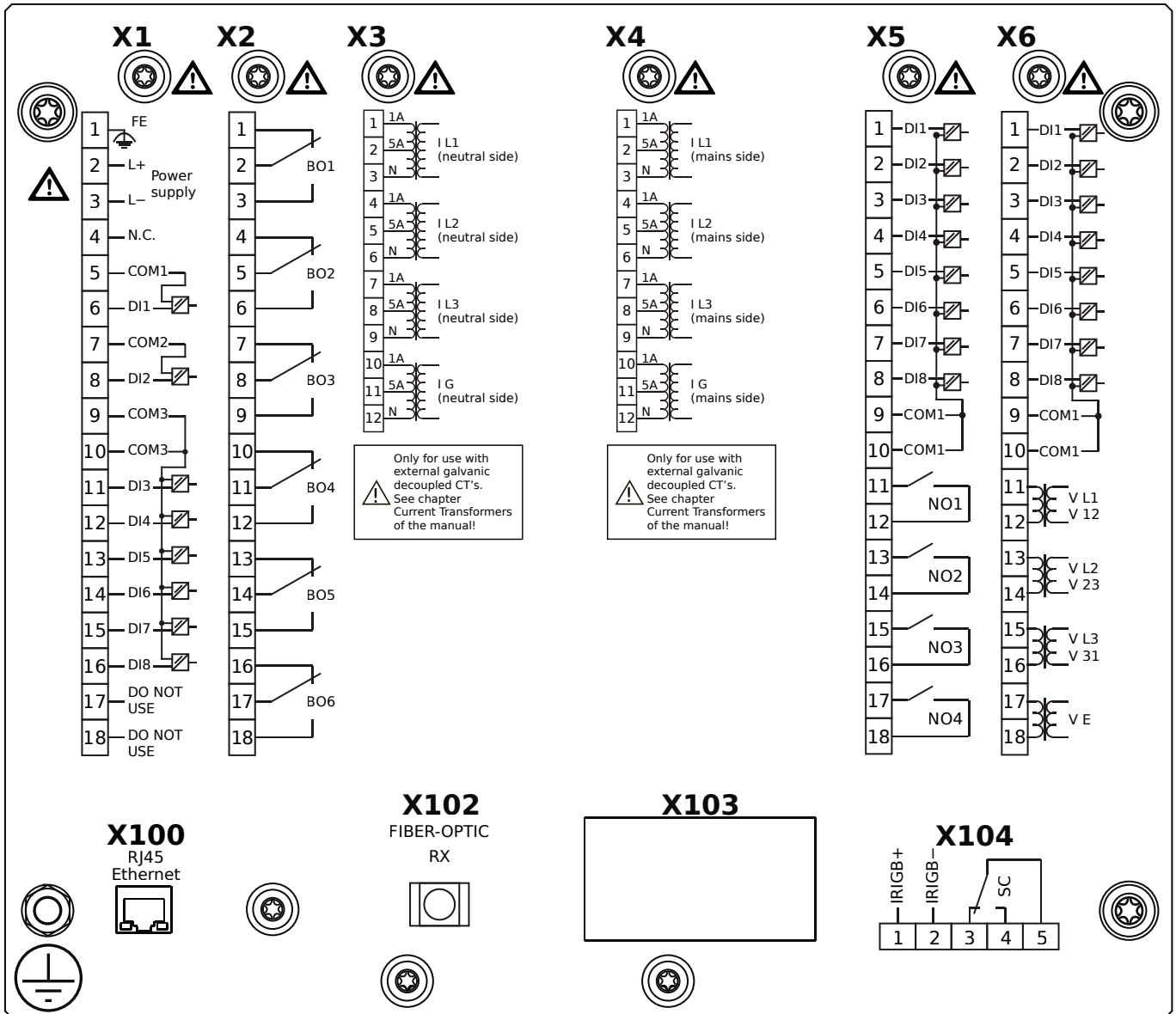

Housing B2, large display, 19" rack mounting

- X1** – DI8-X1: Wide-range power supply unit, incl. 2 non-grouped digital inputs and 6 grouped digital inputs
- X2** – OR6: Assembly Group with 6 Output Relays (Changeover / Form C)
- X3** – TI: Standard current measuring card (for the neutral side of the differential protection)
- X4** – TI: Standard current measuring card (for the mains side of the differential protection)
- X5** – DI8-OR4: Assembly Group with 8 Digital Inputs and 4 Output Relays (NO / Form A)
- X6** – TU-DI8: Voltage measuring (0 ... 300 VAC) assembly group with 8 Digital Inputs
- X100** – Modbus TCP / DNP3.0 TCP/UDP, Ethernet interface, 100 Mbit/s, RJ45 (BASE100-FX)
- X102** – Universal Resistance-Temperature Detector (URTD) input, Fiber optics interface, Versatile Link
- X104** – IRIG-B00X, incl. System Contact (Supervision Contact)

MCDGV4-2C0BCB

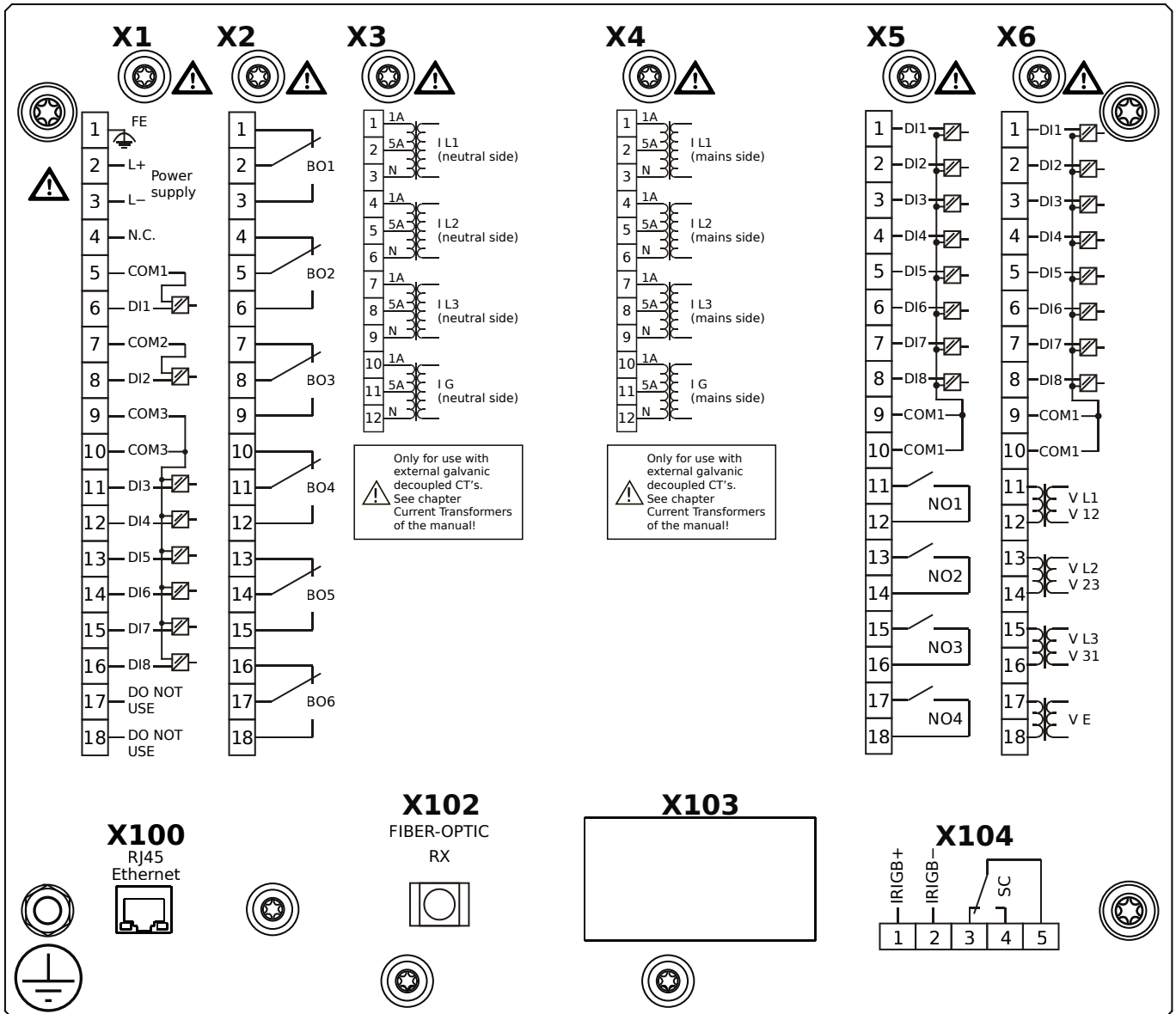

Housing B2, large display, 19" rack mounting

- + Conformal Coating (for installations in harsh environment)

- X1** – DI8-X1: Wide-range power supply unit, incl. 2 non-grouped digital inputs and 6 grouped digital inputs
- X2** – OR6: Assembly Group with 6 Output Relays (Changeover / Form C)
- X3** – TI: Standard current measuring card (for the neutral side of the differential protection)
- X4** – TI: Standard current measuring card (for the mains side of the differential protection)
- X5** – DI8-OR4: Assembly Group with 8 Digital Inputs and 4 Output Relays (NO / Form A)
- X6** – TU-DI8: Voltage measuring (0 ... 300 VAC) assembly group with 8 Digital Inputs
- X100** – Modbus TCP / DNP3.0 TCP/UDP, Ethernet interface, 100 Mbit/s, RJ45 (BASE100-FX)
- X102** – Universal Resistance-Temperature Detector (URTD) input, Fiber optics interface, Versatile Link
- X104** – IRIG-B00X, incl. System Contact (Supervision Contact)

MCDGV4-2C0BDA

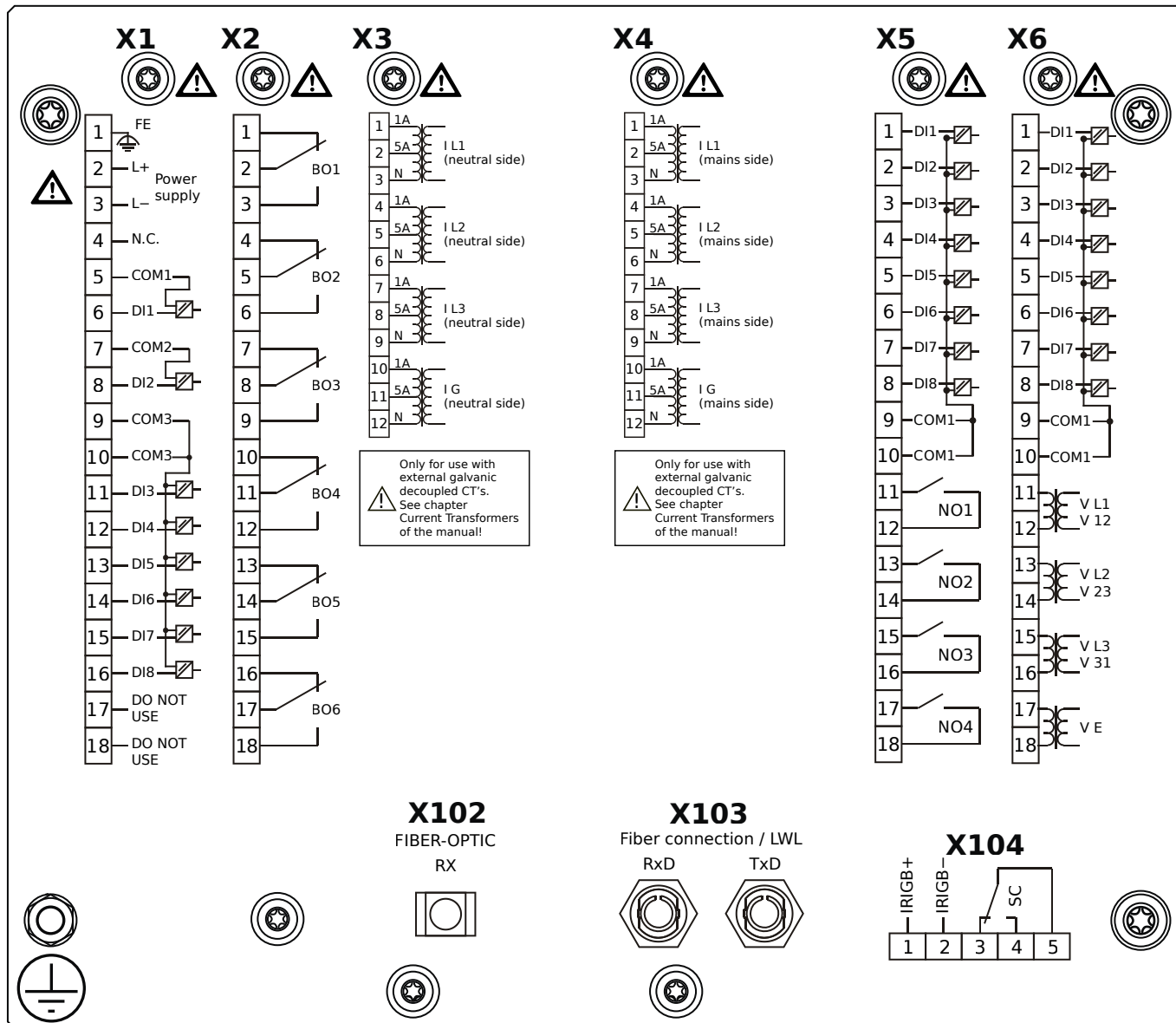

Housing B2, large display, 19" rack mounting

- X1** – DI8-X1: Wide-range power supply unit, incl. 2 non-grouped digital inputs and 6 grouped digital inputs
- X2** – OR6: Assembly Group with 6 Output Relays (Changeover / Form C)
- X3** – TI: Standard current measuring card (for the neutral side of the differential protection)
- X4** – TI: Standard current measuring card (for the mains side of the differential protection)
- X5** – DI8-OR4: Assembly Group with 8 Digital Inputs and 4 Output Relays (NO / Form A)
- X6** – TU-DI8: Voltage measuring (0 ... 300 VAC) assembly group with 8 Digital Inputs
- X102** – Universal Resistance-Temperature Detector (URTD) input, Fiber optics interface, Versatile Link
- X103** – Profibus-DP, Fiber optics interface, ST Connector
- X104** – IRIG-B00X, incl. System Contact (Supervision Contact)

MCDGV4-2C0BDB

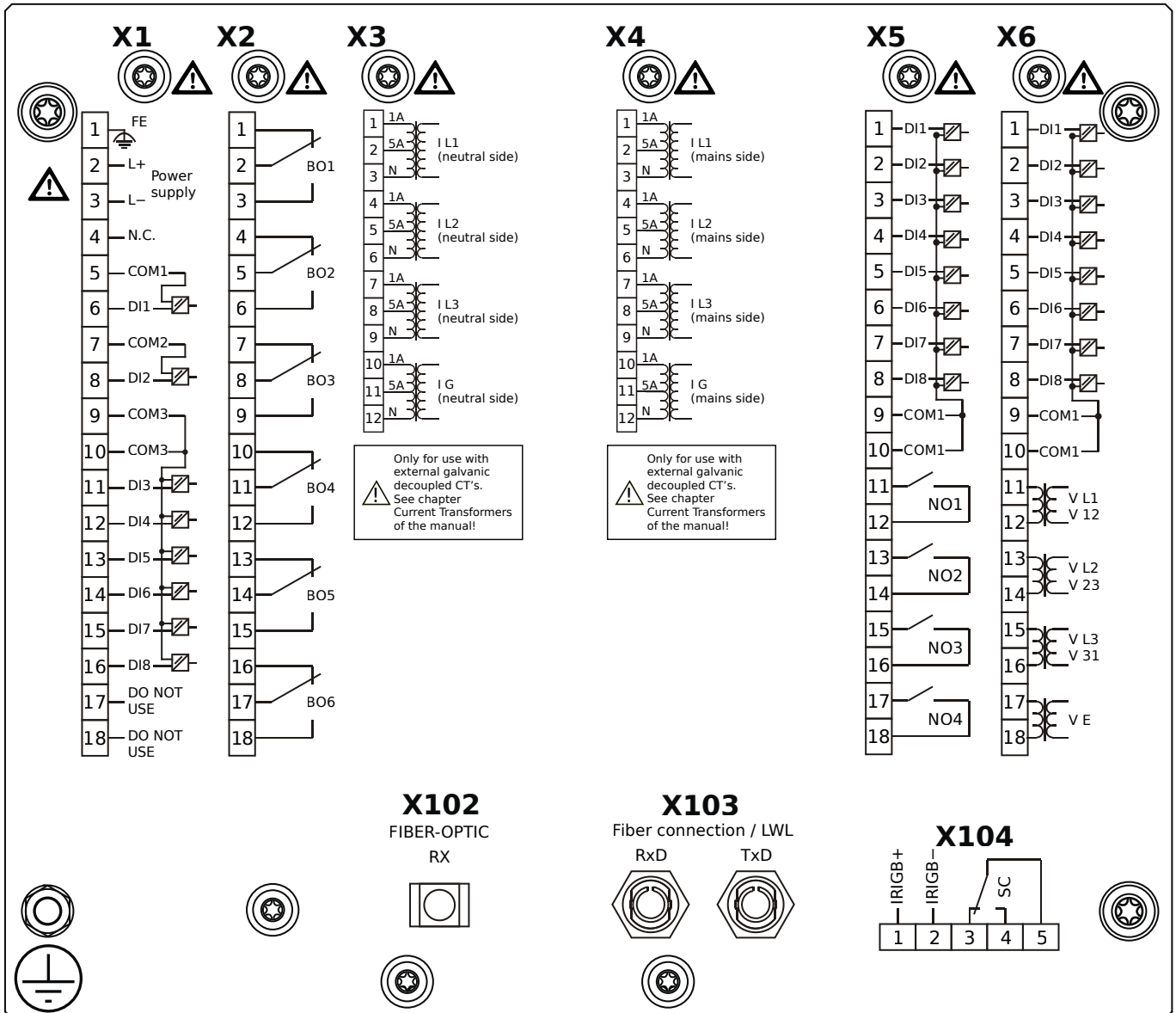

Housing B2, large display, 19" rack mounting

+ Conformal Coating (for installations in harsh environment)

- X1** – DI8-X1: Wide-range power supply unit, incl. 2 non-grouped digital inputs and 6 grouped digital inputs
- X2** – OR6: Assembly Group with 6 Output Relays (Changeover / Form C)
- X3** – TI: Standard current measuring card (for the neutral side of the differential protection)
- X4** – TI: Standard current measuring card (for the mains side of the differential protection)
- X5** – DI8-OR4: Assembly Group with 8 Digital Inputs and 4 Output Relays (NO / Form A)
- X6** – TU-DI8: Voltage measuring (0 ... 300 VAC) assembly group with 8 Digital Inputs
- X102** – Universal Resistance-Temperature Detector (URTD) input, Fiber optics interface, Versatile Link
- X103** – Profibus-DP, Fiber optics interface, ST Connector
- X104** – IRIG-B00X, incl. System Contact (Supervision Contact)

MCDGV4-2C0BEA

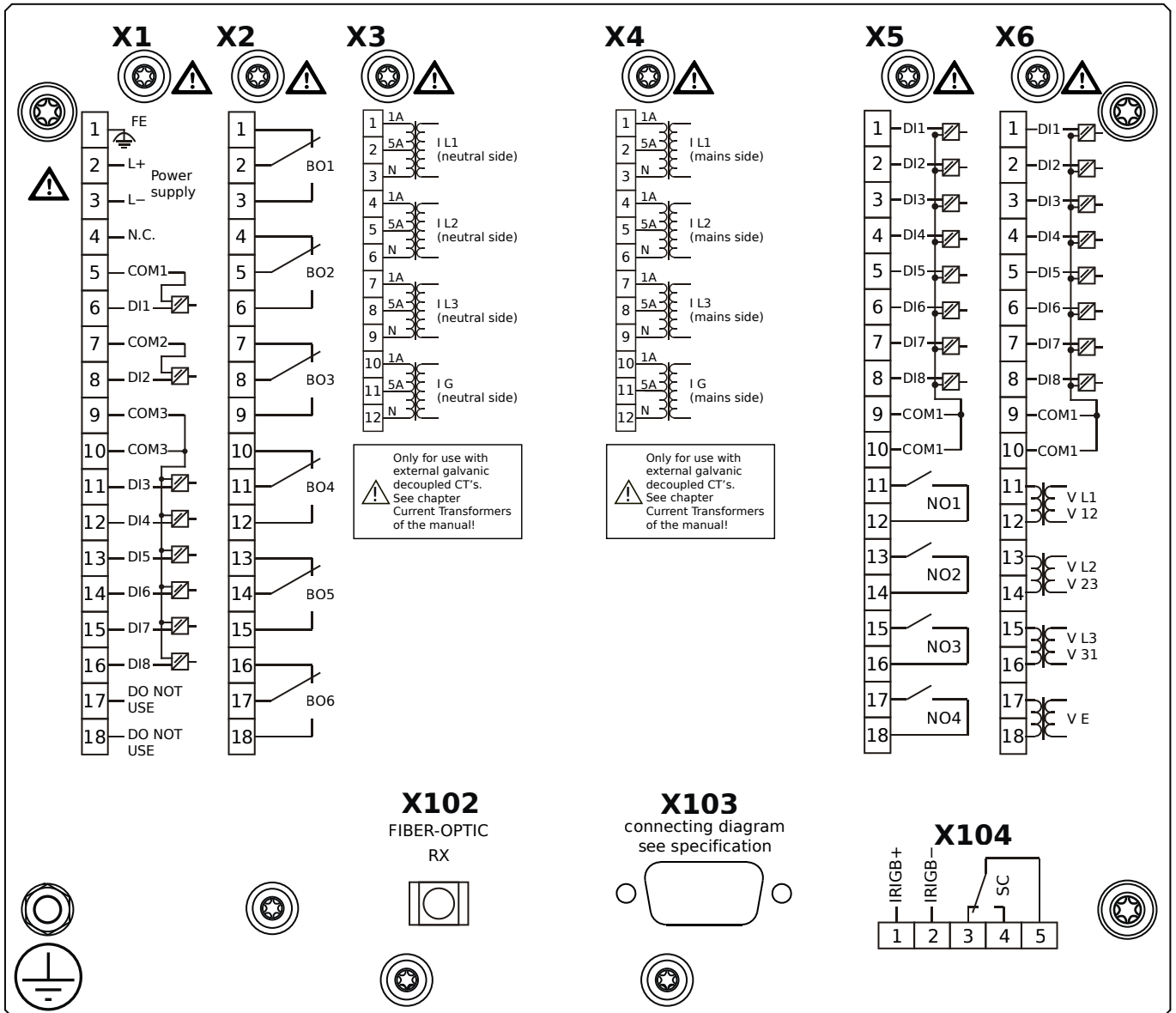

Housing B2, large display, 19" rack mounting

- X1** – DI8-X1: Wide-range power supply unit, incl. 2 non-grouped digital inputs and 6 grouped digital inputs
- X2** – OR6: Assembly Group with 6 Output Relays (Changeover / Form C)
- X3** – TI: Standard current measuring card (for the neutral side of the differential protection)
- X4** – TI: Standard current measuring card (for the mains side of the differential protection)
- X5** – DI8-OR4: Assembly Group with 8 Digital Inputs and 4 Output Relays (NO / Form A)
- X6** – TU-DI8: Voltage measuring (0 ... 300 VAC) assembly group with 8 Digital Inputs
- X102** – Universal Resistance-Temperature Detector (URTD) input, Fiber optics interface, Versatile Link
- X103** – Profibus-DP, RS485, D-SUB
- X104** – IRIG-B00X, incl. System Contact (Supervision Contact)

MCDGV4-2C0BEB

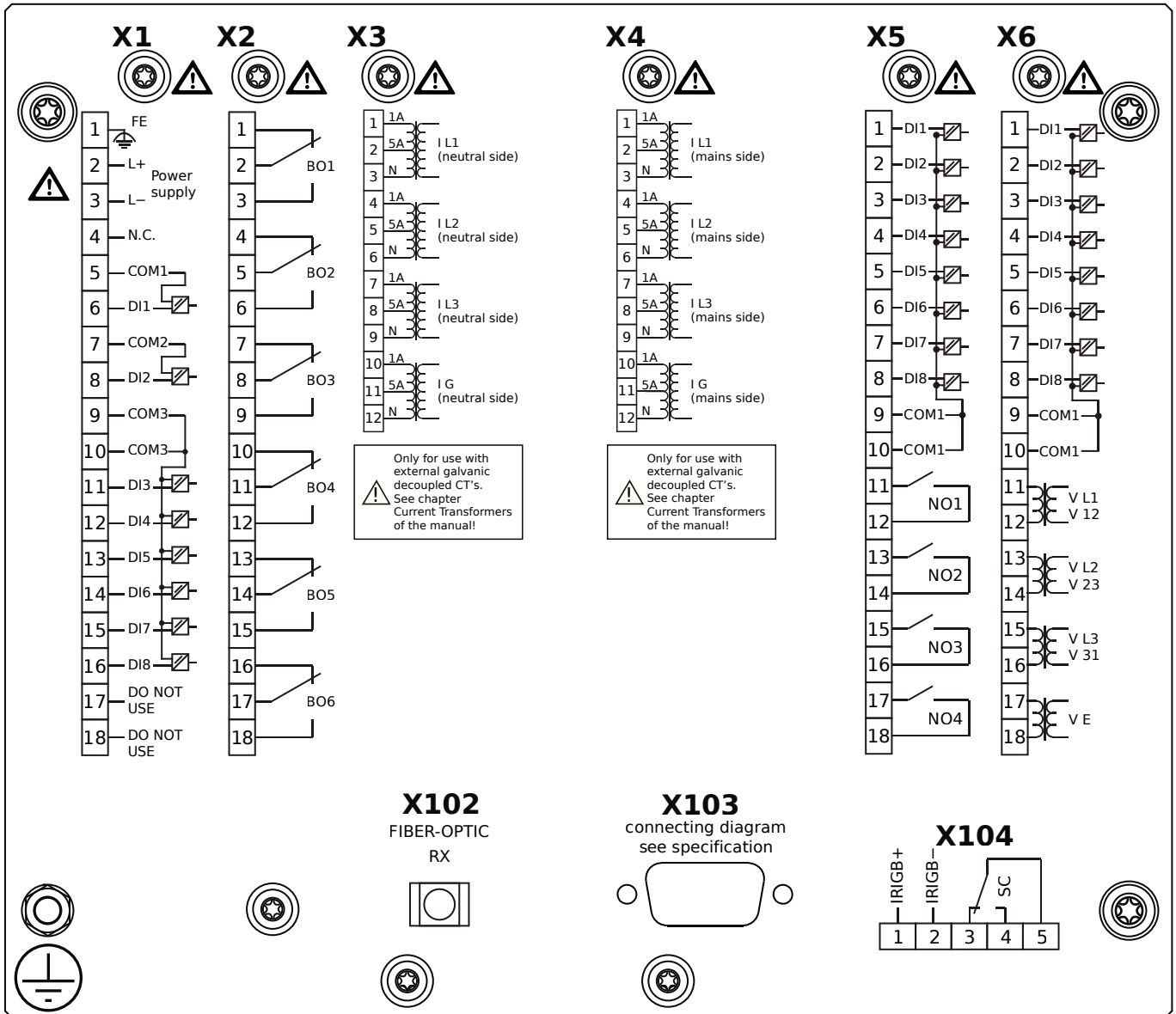

Housing B2, large display, 19" rack mounting

+ Conformal Coating (for installations in harsh environment)

- X1** – DI8-X1: Wide-range power supply unit, incl. 2 non-grouped digital inputs and 6 grouped digital inputs
- X2** – OR6: Assembly Group with 6 Output Relays (Changeover / Form C)
- X3** – TI: Standard current measuring card (for the neutral side of the differential protection)
- X4** – TI: Standard current measuring card (for the mains side of the differential protection)
- X5** – DI8-OR4: Assembly Group with 8 Digital Inputs and 4 Output Relays (NO / Form A)
- X6** – TU-DI8: Voltage measuring (0 ... 300 VAC) assembly group with 8 Digital Inputs
- X102** – Universal Resistance-Temperature Detector (URTD) input, Fiber optics interface, Versatile Link
- X103** – Profibus-DP, RS485, D-SUB
- X104** – IRIG-B00X, incl. System Contact (Supervision Contact)

MCDGV4-2C0BFA

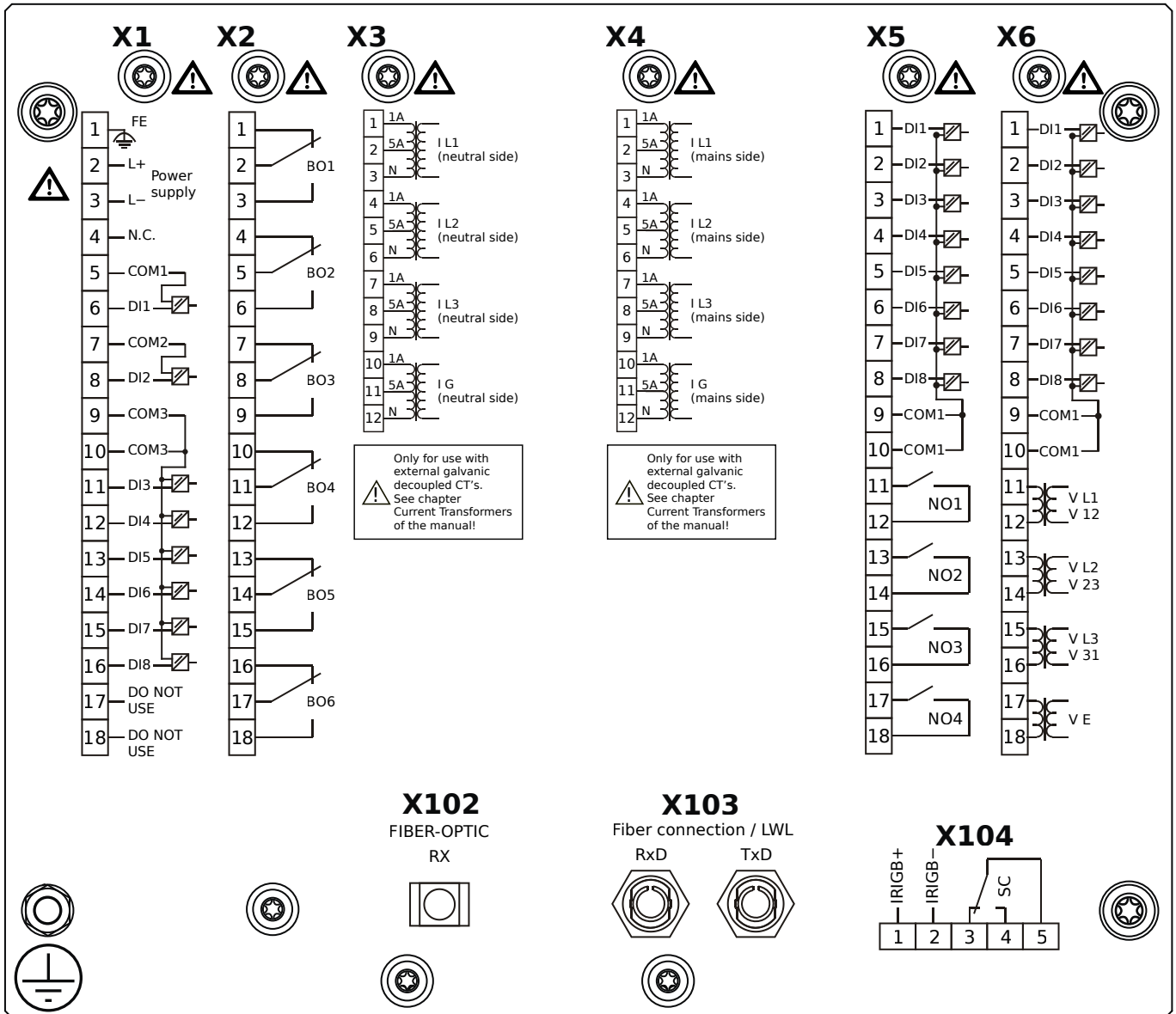

Housing B2, large display, 19" rack mounting

- X1** – DI8-X1: Wide-range power supply unit, incl. 2 non-grouped digital inputs and 6 grouped digital inputs
- X2** – OR6: Assembly Group with 6 Output Relays (Changeover / Form C)
- X3** – TI: Standard current measuring card (for the neutral side of the differential protection)
- X4** – TI: Standard current measuring card (for the mains side of the differential protection)
- X5** – DI8-OR4: Assembly Group with 8 Digital Inputs and 4 Output Relays (NO / Form A)
- X6** – TU-DI8: Voltage measuring (0 ... 300 VAC) assembly group with 8 Digital Inputs
- X102** – Universal Resistance-Temperature Detector (URTD) input, Fiber optics interface, Versatile Link
- X103** – Modbus RTU / IEC 60870-5-103 / DNP3.0 RTU, Fiber optics interface, ST Connector
- X104** – IRIG-B00X, incl. System Contact (Supervision Contact)

MCDGV4-2C0BFB

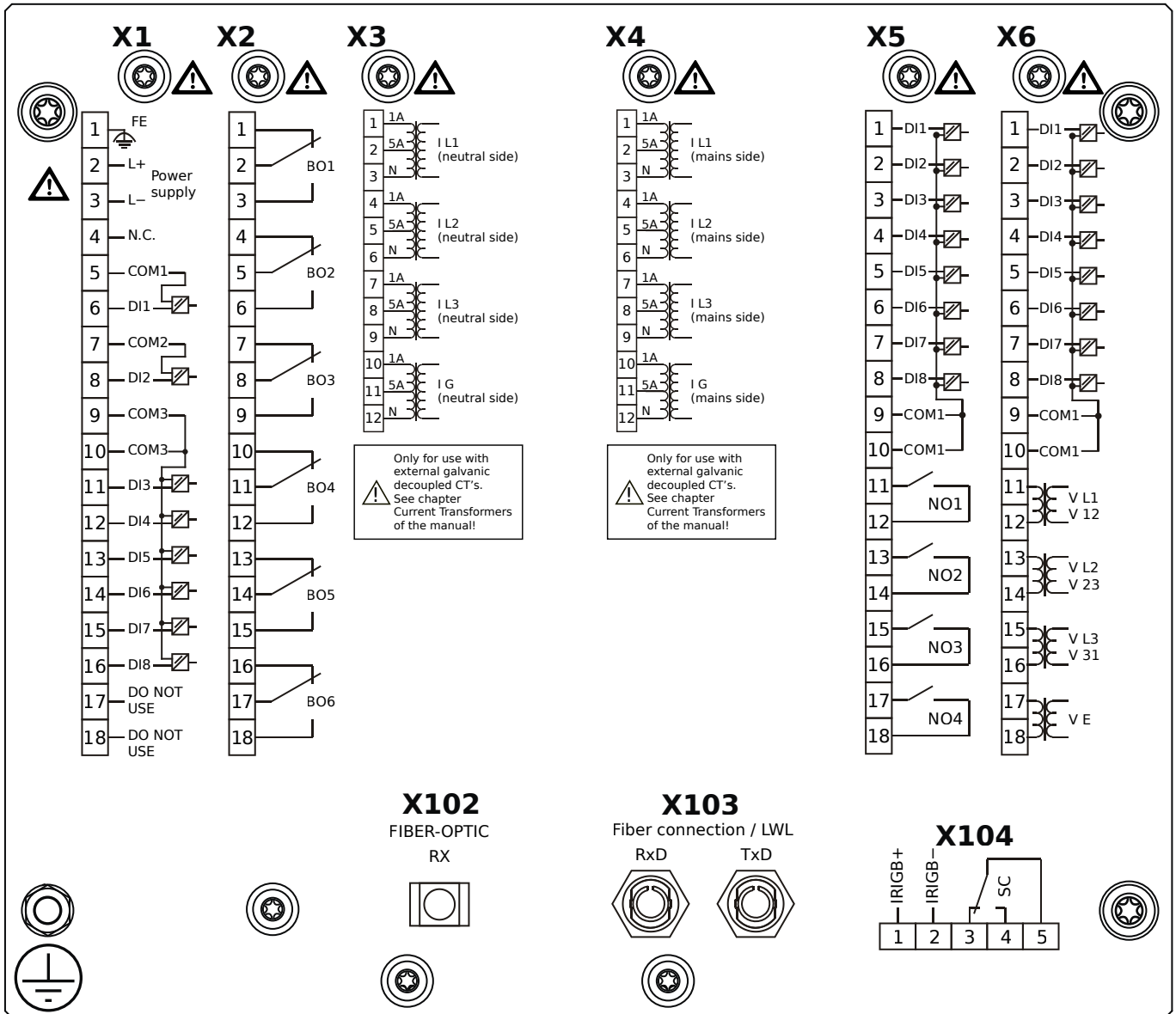

Housing B2, large display, 19" rack mounting

+ Conformal Coating (for installations in harsh environment)

- X1** – DI8-X1: Wide-range power supply unit, incl. 2 non-grouped digital inputs and 6 grouped digital inputs
- X2** – OR6: Assembly Group with 6 Output Relays (Changeover / Form C)
- X3** – TI: Standard current measuring card (for the neutral side of the differential protection)
- X4** – TI: Standard current measuring card (for the mains side of the differential protection)
- X5** – DI8-OR4: Assembly Group with 8 Digital Inputs and 4 Output Relays (NO / Form A)
- X6** – TU-DI8: Voltage measuring (0 ... 300 VAC) assembly group with 8 Digital Inputs
- X102** – Universal Resistance-Temperature Detector (URTD) input, Fiber optics interface, Versatile Link
- X103** – Modbus RTU / IEC 60870-5-103 / DNP3.0 RTU, Fiber optics interface, ST Connector
- X104** – IRIG-B00X, incl. System Contact (Supervision Contact)

MCDGV4-2C0BGA

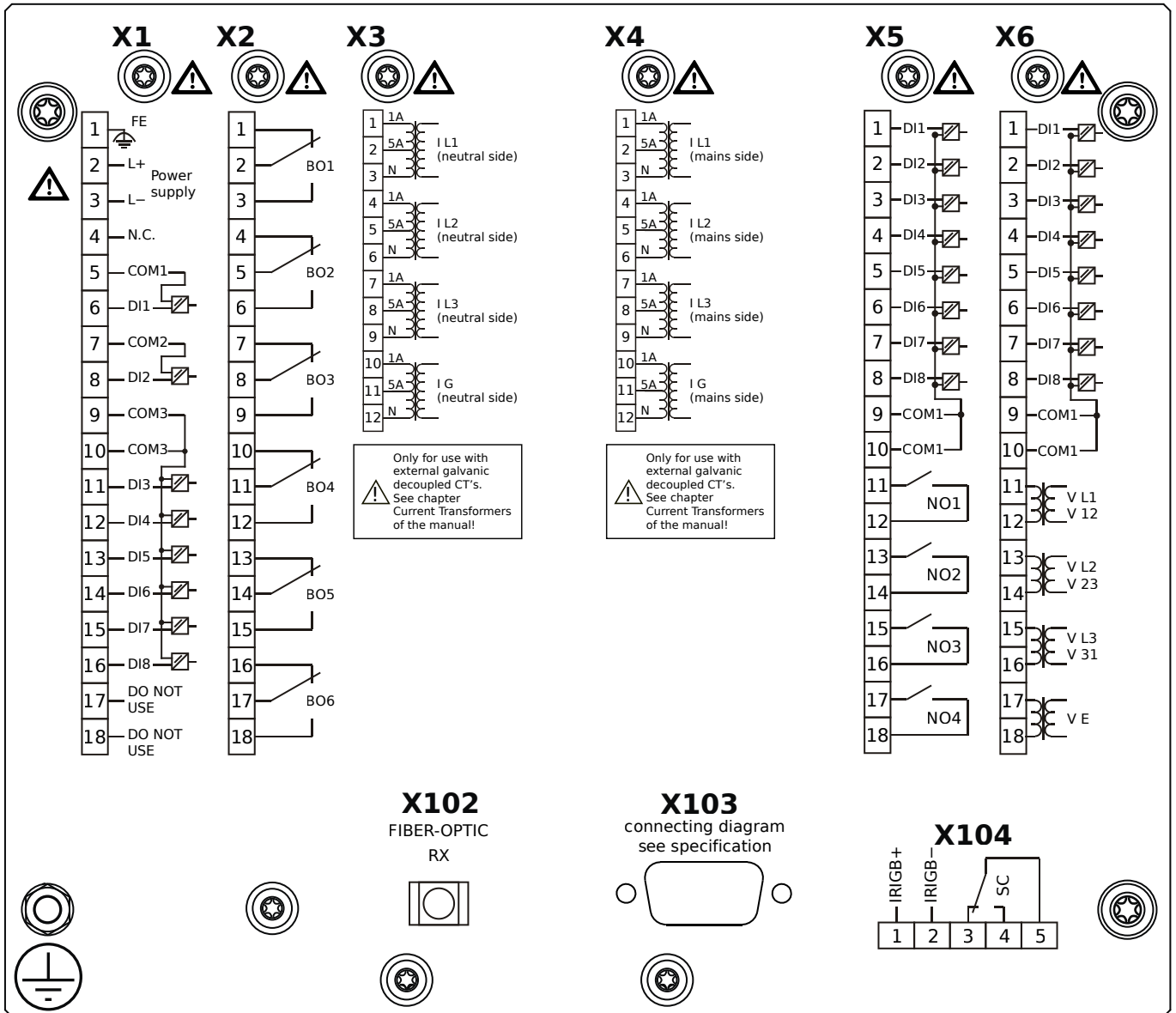

Housing B2, large display, 19" rack mounting

- X1** – DI8-X1: Wide-range power supply unit, incl. 2 non-grouped digital inputs and 6 grouped digital inputs
- X2** – OR6: Assembly Group with 6 Output Relays (Changeover / Form C)
- X3** – TI: Standard current measuring card (for the neutral side of the differential protection)
- X4** – TI: Standard current measuring card (for the mains side of the differential protection)
- X5** – DI8-OR4: Assembly Group with 8 Digital Inputs and 4 Output Relays (NO / Form A)
- X6** – TU-DI8: Voltage measuring (0 ... 300 VAC) assembly group with 8 Digital Inputs
- X102** – Universal Resistance-Temperature Detector (URTD) input, Fiber optics interface, Versatile Link
- X103** – Modbus RTU / IEC 60870-5-103 / DNP3.0 RTU, RS485, D-SUB
- X104** – IRIG-B00X, incl. System Contact (Supervision Contact)

MCDGV4-2C0BGB

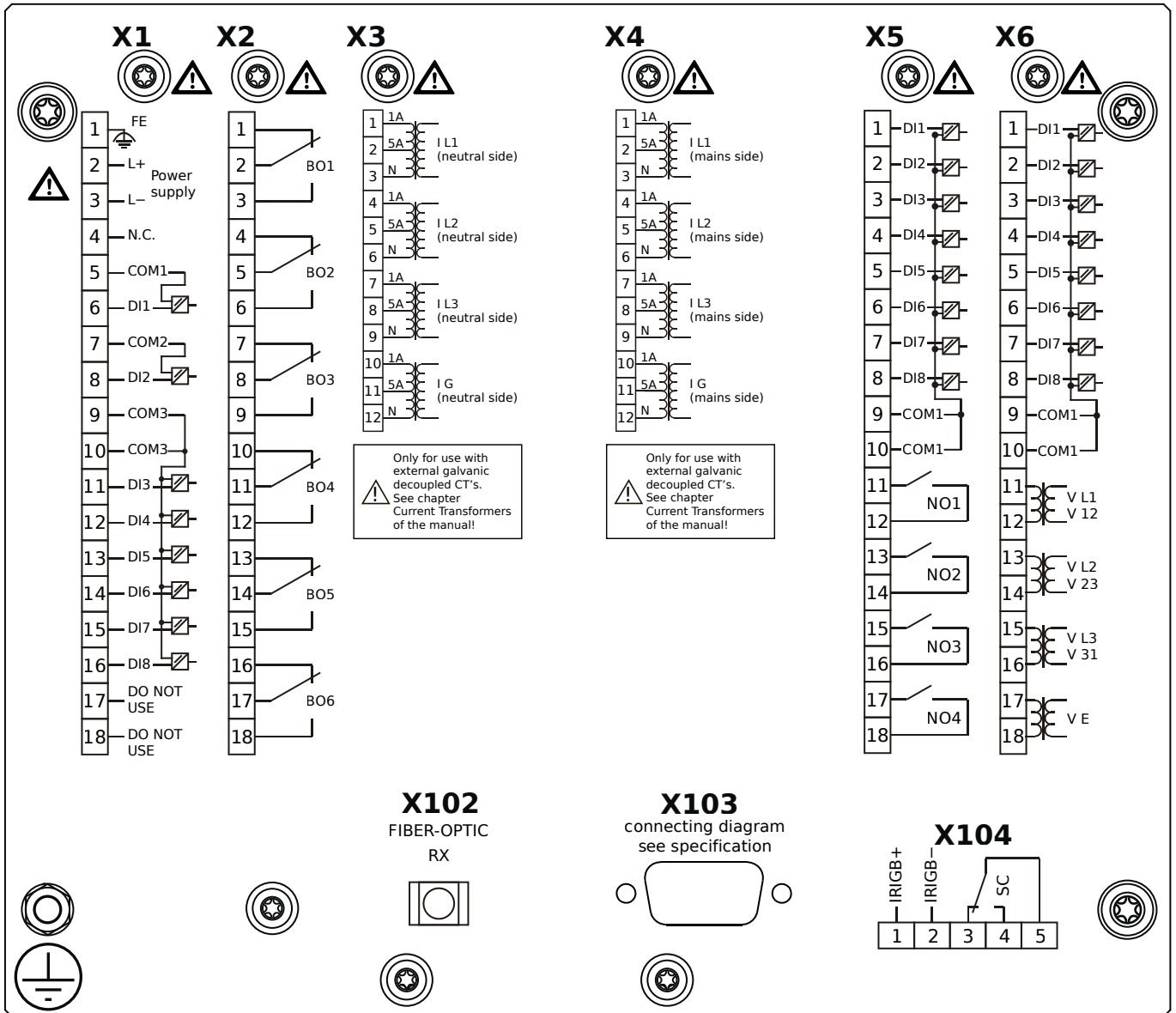

Housing B2, large display, 19" rack mounting

+ Conformal Coating (for installations in harsh environment)

- X1** – DI8-X1: Wide-range power supply unit, incl. 2 non-grouped digital inputs and 6 grouped digital inputs
- X2** – OR6: Assembly Group with 6 Output Relays (Changeover / Form C)
- X3** – TI: Standard current measuring card (for the neutral side of the differential protection)
- X4** – TI: Standard current measuring card (for the mains side of the differential protection)
- X5** – DI8-OR4: Assembly Group with 8 Digital Inputs and 4 Output Relays (NO / Form A)
- X6** – TU-DI8: Voltage measuring (0 ... 300 VAC) assembly group with 8 Digital Inputs
- X102** – Universal Resistance-Temperature Detector (URTD) input, Fiber optics interface, Versatile Link
- X103** – Modbus RTU / IEC 60870-5-103 / DNP3.0 RTU, RS485, D-SUB
- X104** – IRIG-B00X, incl. System Contact (Supervision Contact)

MCDGV4-2C0BHA

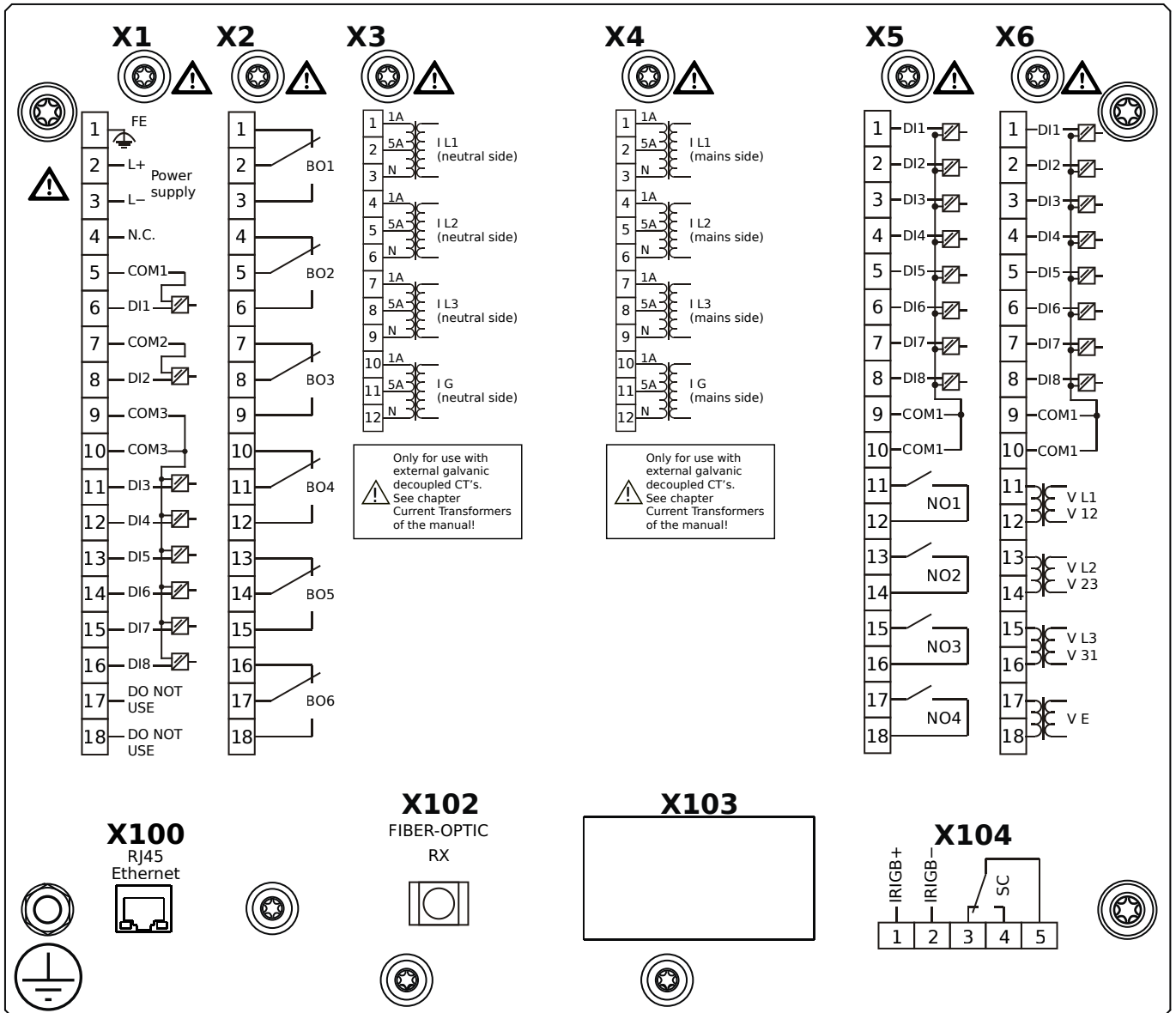

Housing B2, large display, 19" rack mounting

- X1** – DI8-X1: Wide-range power supply unit, incl. 2 non-grouped digital inputs and 6 grouped digital inputs
- X2** – OR6: Assembly Group with 6 Output Relays (Changeover / Form C)
- X3** – TI: Standard current measuring card (for the neutral side of the differential protection)
- X4** – TI: Standard current measuring card (for the mains side of the differential protection)
- X5** – DI8-OR4: Assembly Group with 8 Digital Inputs and 4 Output Relays (NO / Form A)
- X6** – TU-DI8: Voltage measuring (0 ... 300 VAC) assembly group with 8 Digital Inputs
- X100** – IEC 61850 / Modbus TCP / DNP3.0 TCP/UDP, Ethernet interface, 100 Mbit/s, RJ45 (BASE100-FX)
- X102** – Universal Resistance-Temperature Detector (URTD) input, Fiber optics interface, Versatile Link
- X104** – IRIG-B00X, incl. System Contact (Supervision Contact)

MCDGV4-2C0BHB

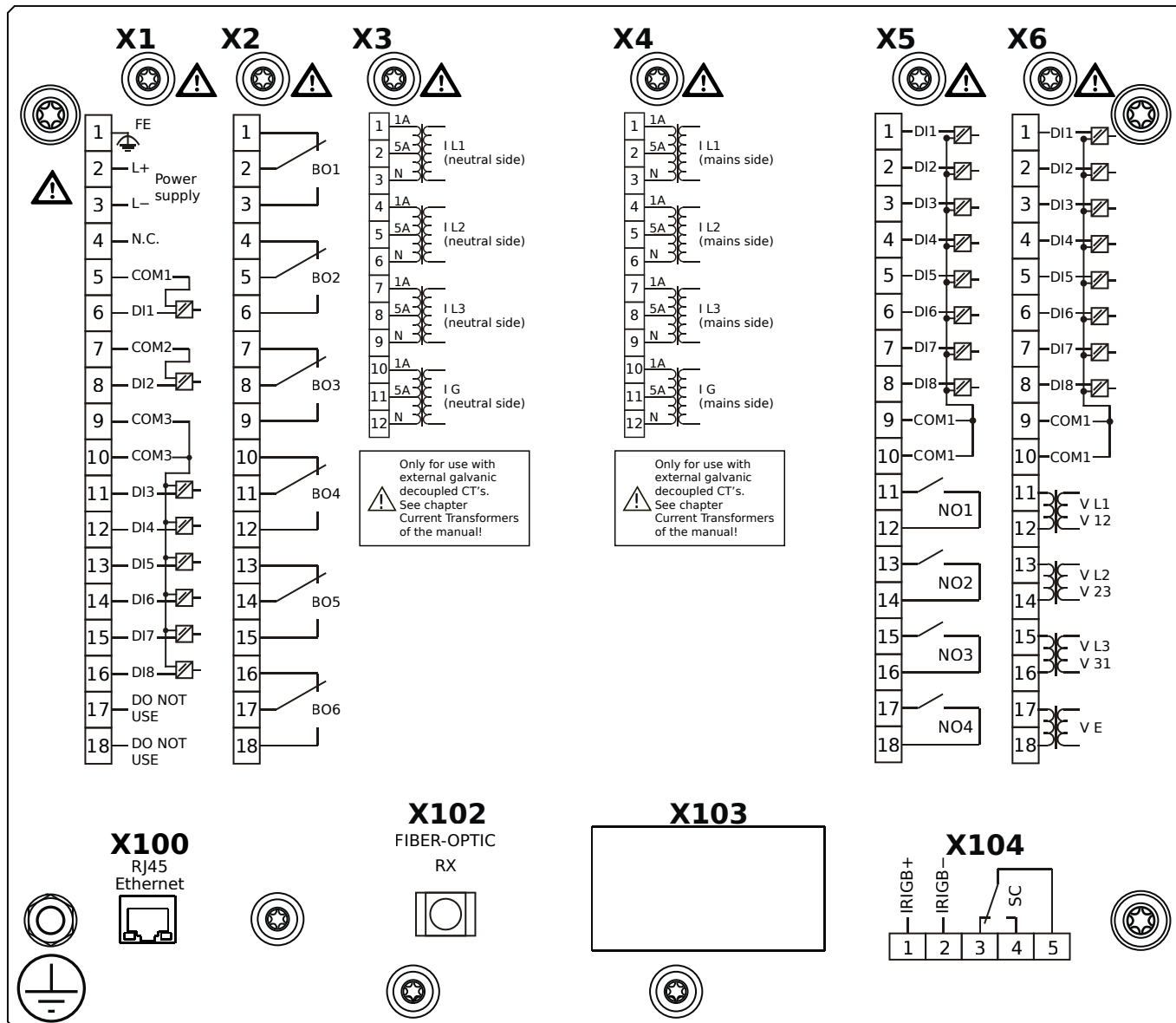

Housing B2, large display, 19" rack mounting

+ Conformal Coating (for installations in harsh environment)

- X1** – DI8-X1: Wide-range power supply unit, incl. 2 non-grouped digital inputs and 6 grouped digital inputs
- X2** – OR6: Assembly Group with 6 Output Relays (Changeover / Form C)
- X3** – TI: Standard current measuring card (for the neutral side of the differential protection)
- X4** – TI: Standard current measuring card (for the mains side of the differential protection)
- X5** – DI8-OR4: Assembly Group with 8 Digital Inputs and 4 Output Relays (NO / Form A)
- X6** – TU-DI8: Voltage measuring (0 ... 300 VAC) assembly group with 8 Digital Inputs
- X100** – IEC 61850 / Modbus TCP / DNP3.0 TCP/UDP, Ethernet interface, 100 Mbit/s, RJ45 (BASE100-FX)
- X102** – Universal Resistance-Temperature Detector (URTD) input, Fiber optics interface, Versatile Link
- X104** – IRIG-B00X, incl. System Contact (Supervision Contact)

MCDGV4-2C0BIA

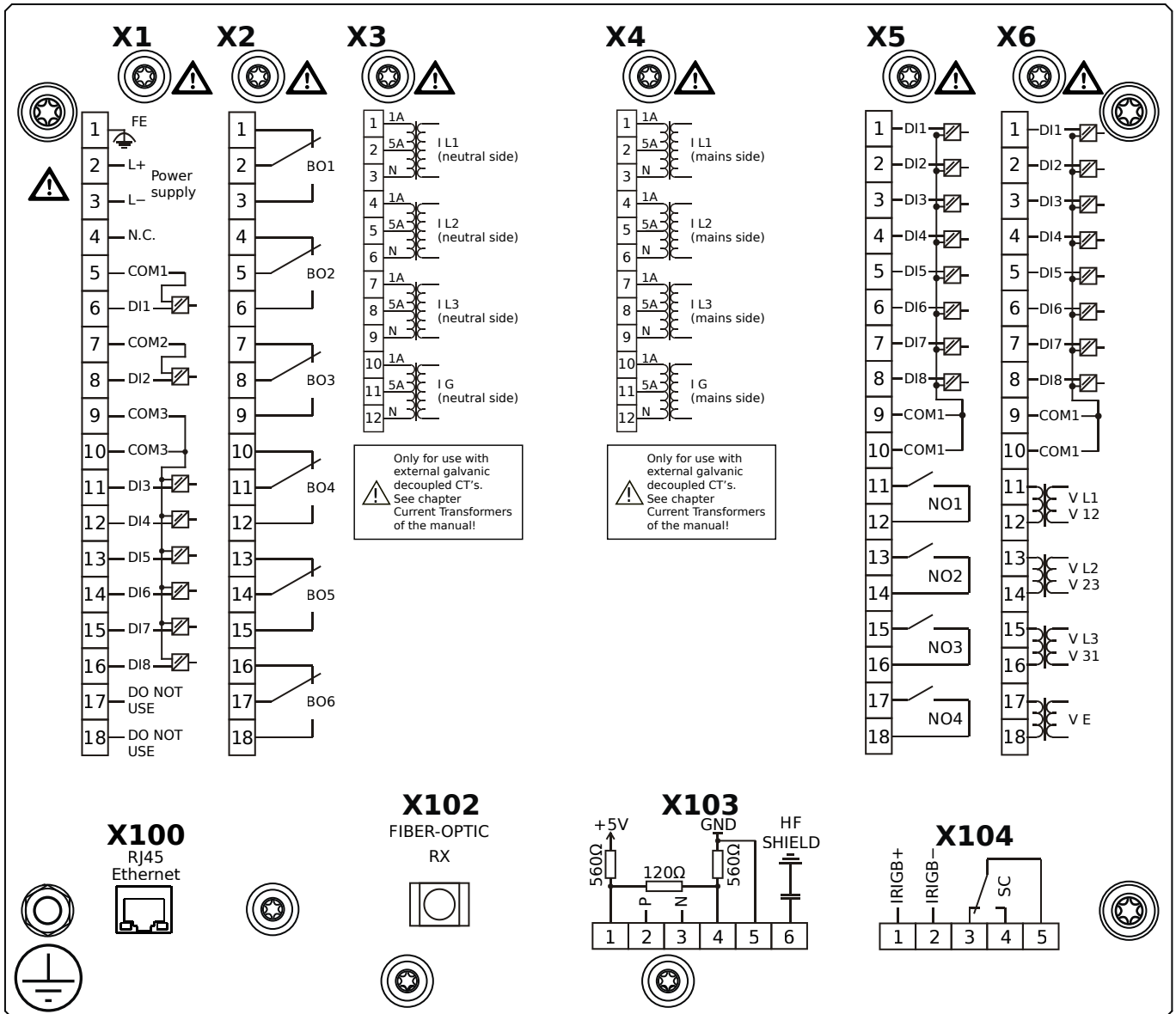

Housing B2, large display, 19" rack mounting

- X1** – DI8-X1: Wide-range power supply unit, incl. 2 non-grouped digital inputs and 6 grouped digital inputs
- X2** – OR6: Assembly Group with 6 Output Relays (Changeover / Form C)
- X3** – TI: Standard current measuring card (for the neutral side of the differential protection)
- X4** – TI: Standard current measuring card (for the mains side of the differential protection)
- X5** – DI8-OR4: Assembly Group with 8 Digital Inputs and 4 Output Relays (NO / Form A)
- X6** – TU-DI8: Voltage measuring (0 ... 300 VAC) assembly group with 8 Digital Inputs
- X100** – Modbus TCP / DNP3.0 TCP/UDP, Ethernet interface, 100 Mbit/s, RJ45 (BASE100-FX)
- X102** – Universal Resistance-Temperature Detector (URTD) input, Fiber optics interface, Versatile Link
- X103** – IEC 60870-5-103 / Modbus RTU / DNP3.0 RTU, RS485, Terminals
- X104** – IRIG-B00X, incl. System Contact (Supervision Contact)

MCDGV4-2C0BIB

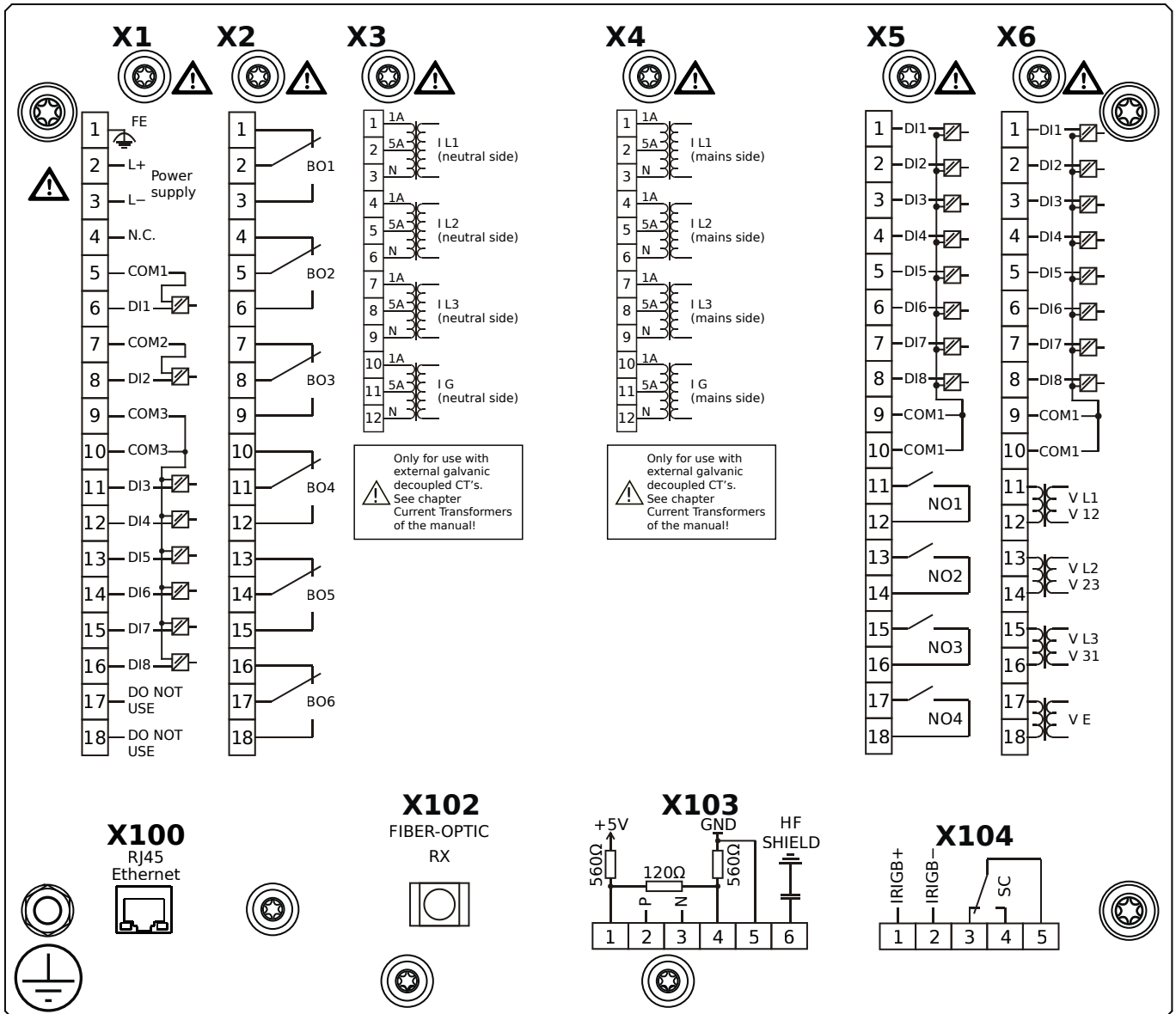

Housing B2, large display, 19" rack mounting

+ Conformal Coating (for installations in harsh environment)

- X1** – DI8-X1: Wide-range power supply unit, incl. 2 non-grouped digital inputs and 6 grouped digital inputs
- X2** – OR6: Assembly Group with 6 Output Relays (Changeover / Form C)
- X3** – TI: Standard current measuring card (for the neutral side of the differential protection)
- X4** – TI: Standard current measuring card (for the mains side of the differential protection)
- X5** – DI8-OR4: Assembly Group with 8 Digital Inputs and 4 Output Relays (NO / Form A)
- X6** – TU-DI8: Voltage measuring (0 ... 300 VAC) assembly group with 8 Digital Inputs
- X100** – Modbus TCP / DNP3.0 TCP/UDP, Ethernet interface, 100 Mbit/s, RJ45 (BASE100-FX)
- X102** – Universal Resistance-Temperature Detector (URTD) input, Fiber optics interface, Versatile Link
- X103** – IEC 60870-5-103 / Modbus RTU / DNP3.0 RTU, RS485, Terminals
- X104** – IRIG-B00X, incl. System Contact (Supervision Contact)

MCDGV4-2C0BKA

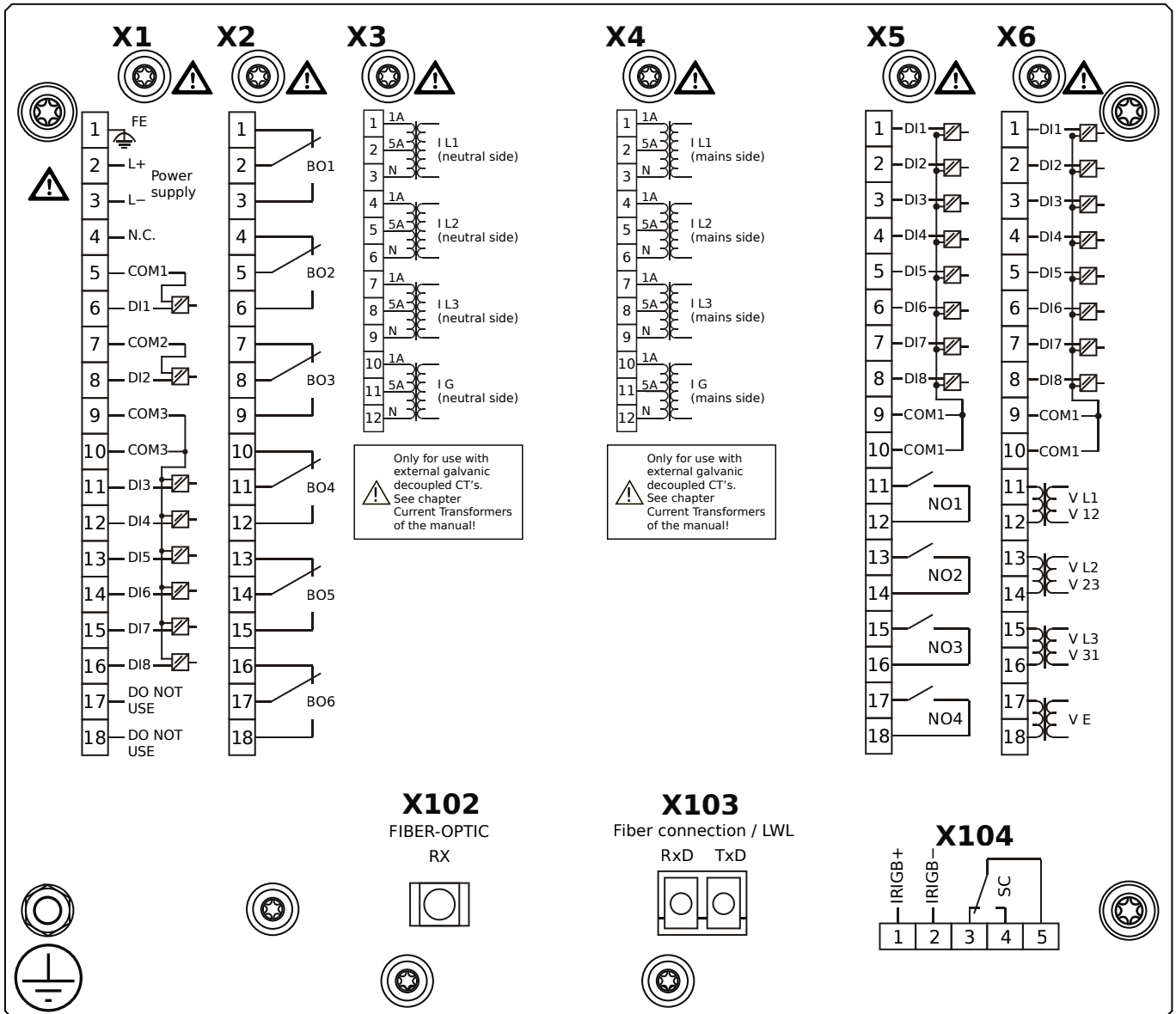

Housing B2, large display, 19" rack mounting

- X1** – DI8-X1: Wide-range power supply unit, incl. 2 non-grouped digital inputs and 6 grouped digital inputs
- X2** – OR6: Assembly Group with 6 Output Relays (Changeover / Form C)
- X3** – TI: Standard current measuring card (for the neutral side of the differential protection)
- X4** – TI: Standard current measuring card (for the mains side of the differential protection)
- X5** – DI8-OR4: Assembly Group with 8 Digital Inputs and 4 Output Relays (NO / Form A)
- X6** – TU-DI8: Voltage measuring (0 ... 300 VAC) assembly group with 8 Digital Inputs
- X102** – Universal Resistance-Temperature Detector (URTD) input, Fiber optics interface, Versatile Link
- X103** – IEC 61850 / Modbus TCP / DNP3.0 TCP/UDP, Fiber optics interface, LC Connector
- X104** – IRIG-B00X, incl. System Contact (Supervision Contact)

MCDGV4-2C0BKB

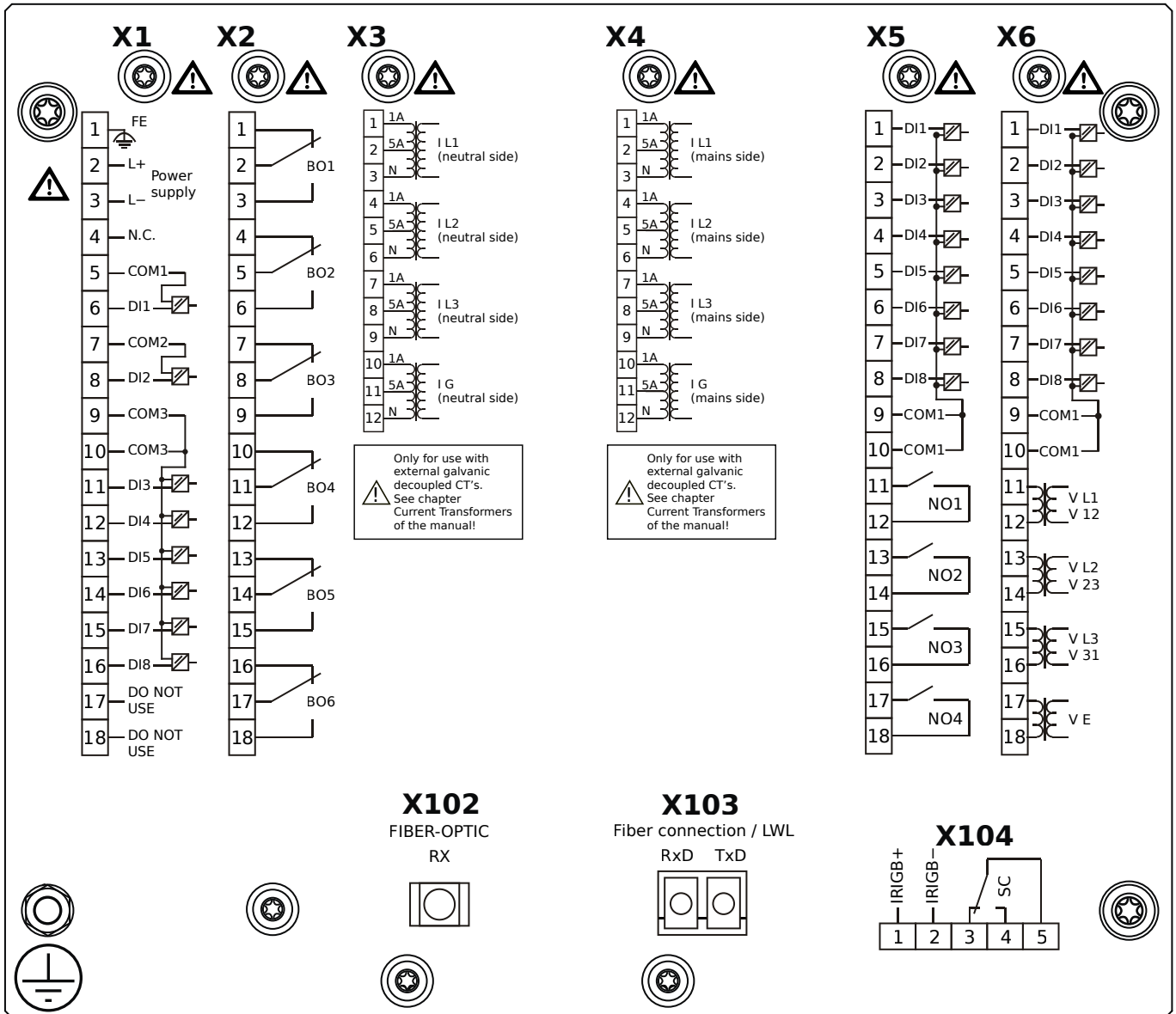

Housing B2, large display, 19" rack mounting

+ Conformal Coating (for installations in harsh environment)

- X1** – DI8-X1: Wide-range power supply unit, incl. 2 non-grouped digital inputs and 6 grouped digital inputs
- X2** – OR6: Assembly Group with 6 Output Relays (Changeover / Form C)
- X3** – TI: Standard current measuring card (for the neutral side of the differential protection)
- X4** – TI: Standard current measuring card (for the mains side of the differential protection)
- X5** – DI8-OR4: Assembly Group with 8 Digital Inputs and 4 Output Relays (NO / Form A)
- X6** – TU-DI8: Voltage measuring (0 ... 300 VAC) assembly group with 8 Digital Inputs
- X102** – Universal Resistance-Temperature Detector (URTD) input, Fiber optics interface, Versatile Link
- X103** – IEC 61850 / Modbus TCP / DNP3.0 TCP/UDP, Fiber optics interface, LC Connector
- X104** – IRIG-B00X, incl. System Contact (Supervision Contact)

MCDGV4-2C0BLA

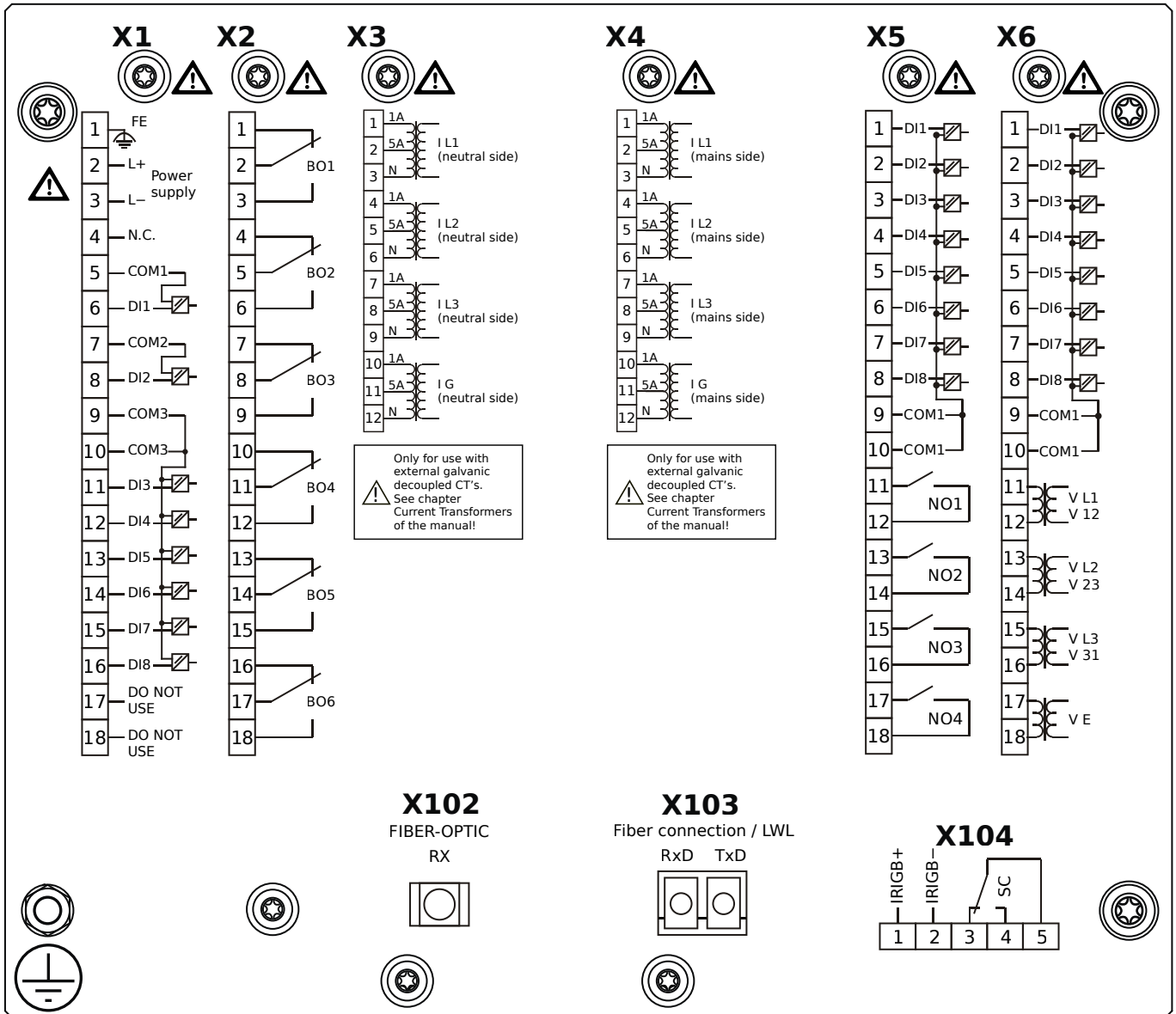

Housing B2, large display, 19" rack mounting

- X1** – DI8-X1: Wide-range power supply unit, incl. 2 non-grouped digital inputs and 6 grouped digital inputs
- X2** – OR6: Assembly Group with 6 Output Relays (Changeover / Form C)
- X3** – TI: Standard current measuring card (for the neutral side of the differential protection)
- X4** – TI: Standard current measuring card (for the mains side of the differential protection)
- X5** – DI8-OR4: Assembly Group with 8 Digital Inputs and 4 Output Relays (NO / Form A)
- X6** – TU-DI8: Voltage measuring (0 ... 300 VAC) assembly group with 8 Digital Inputs
- X102** – Universal Resistance-Temperature Detector (URTD) input, Fiber optics interface, Versatile Link
- X103** – Modbus TCP / DNP3.0 TCP/UDP, Fiber optics interface, LC Connector
- X104** – IRIG-B00X, incl. System Contact (Supervision Contact)

MCDGV4-2C0BLB

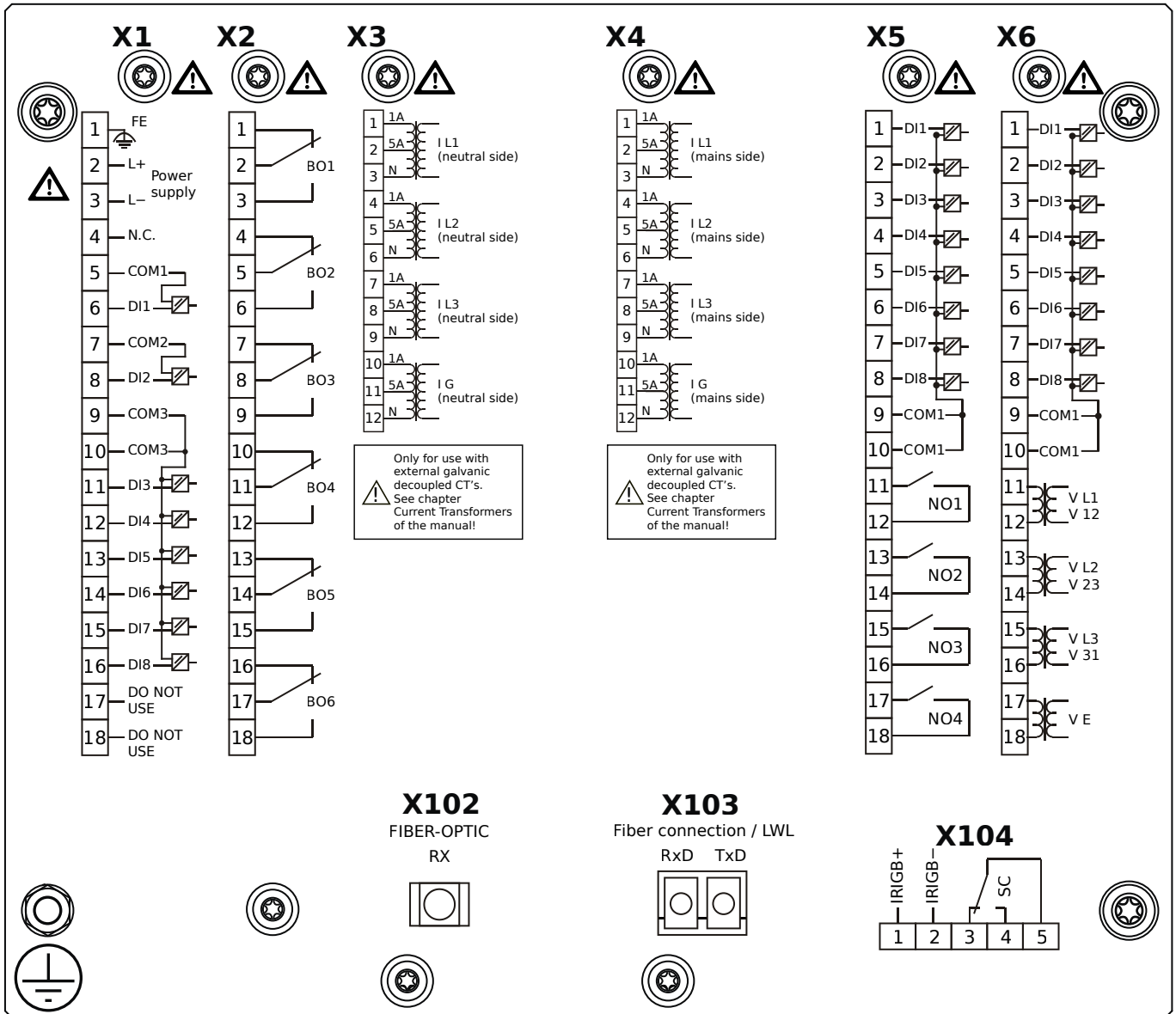

Housing B2, large display, 19" rack mounting

+ Conformal Coating (for installations in harsh environment)

- X1** – DI8-X1: Wide-range power supply unit, incl. 2 non-grouped digital inputs and 6 grouped digital inputs
- X2** – OR6: Assembly Group with 6 Output Relays (Changeover / Form C)
- X3** – TI: Standard current measuring card (for the neutral side of the differential protection)
- X4** – TI: Standard current measuring card (for the mains side of the differential protection)
- X5** – DI8-OR4: Assembly Group with 8 Digital Inputs and 4 Output Relays (NO / Form A)
- X6** – TU-DI8: Voltage measuring (0 ... 300 VAC) assembly group with 8 Digital Inputs
- X102** – Universal Resistance-Temperature Detector (URTD) input, Fiber optics interface, Versatile Link
- X103** – Modbus TCP / DNP3.0 TCP/UDP, Fiber optics interface, LC Connector
- X104** – IRIG-B00X, incl. System Contact (Supervision Contact)

MCDGV4-2C0BTA

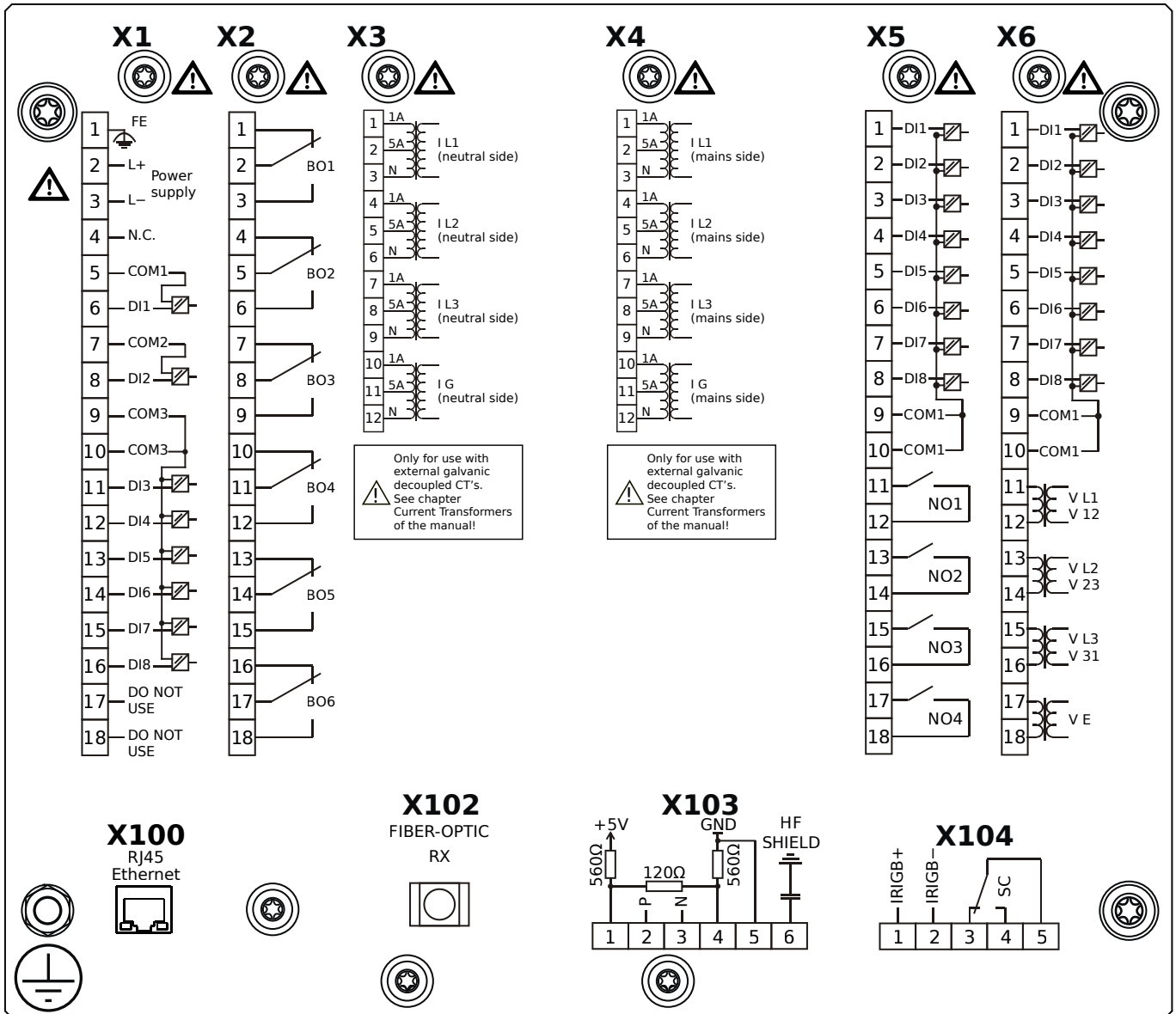

Housing B2, large display, 19" rack mounting

- X1** – DI8-X1: Wide-range power supply unit, incl. 2 non-grouped digital inputs and 6 grouped digital inputs
- X2** – OR6: Assembly Group with 6 Output Relays (Changeover / Form C)
- X3** – TI: Standard current measuring card (for the neutral side of the differential protection)
- X4** – TI: Standard current measuring card (for the mains side of the differential protection)
- X5** – DI8-OR4: Assembly Group with 8 Digital Inputs and 4 Output Relays (NO / Form A)
- X6** – TU-DI8: Voltage measuring (0 ... 300 VAC) assembly group with 8 Digital Inputs
- X100** – IEC 61850 / Modbus TCP / DNP3.0 TCP/UDP, Ethernet interface, 100 Mbit/s, RJ45 (BASE100-FX)
- X102** – Universal Resistance-Temperature Detector (URTD) input, Fiber optics interface, Versatile Link
- X103** – IEC 60870-5-103 / Modbus RTU / DNP3.0 RTU, RS485, Terminals
- X104** – IRIG-B00X, incl. System Contact (Supervision Contact)

MCDGV4-2C0BTB

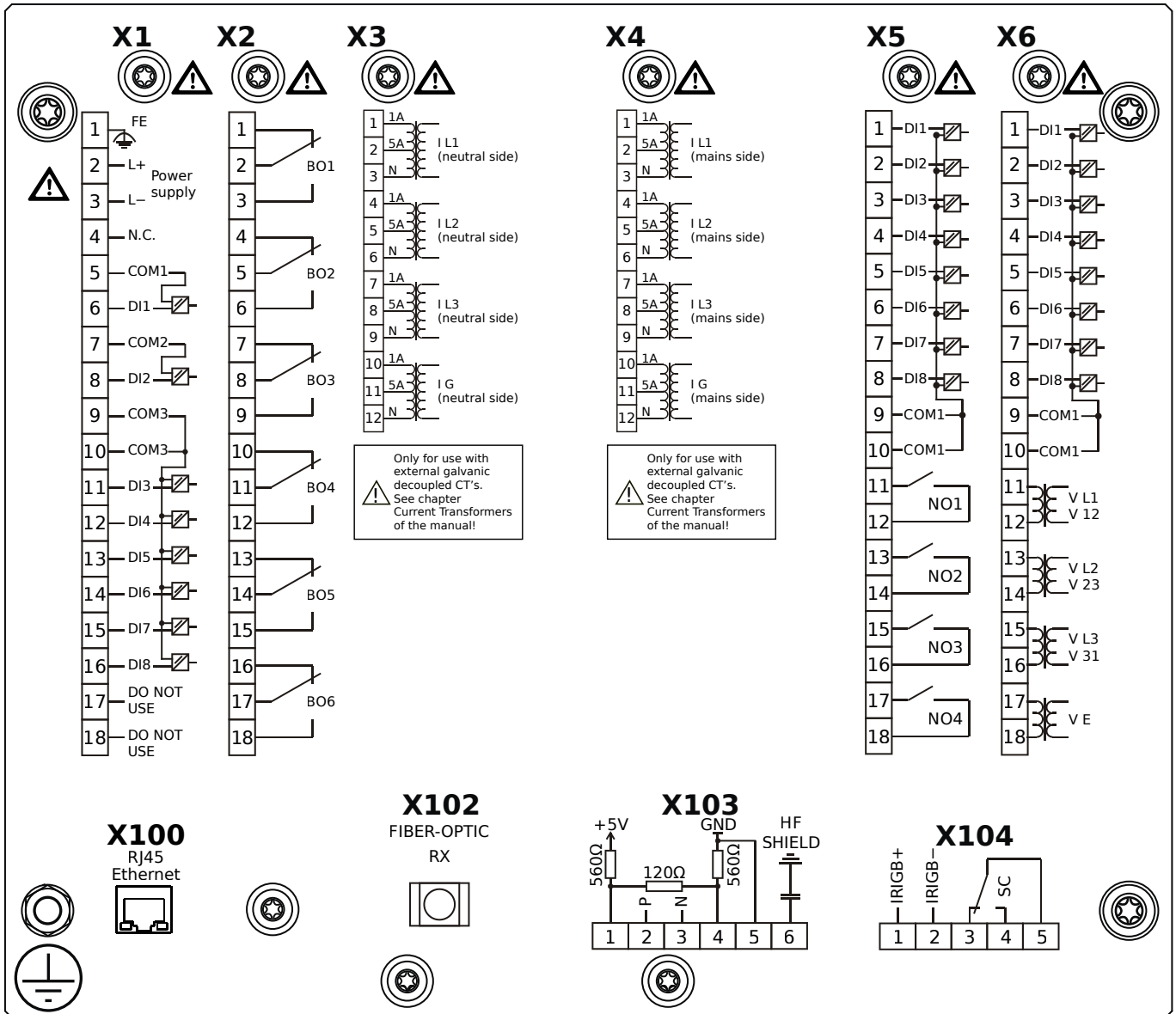

Housing B2, large display, 19" rack mounting

+ Conformal Coating (for installations in harsh environment)

- X1** – DI8-X1: Wide-range power supply unit, incl. 2 non-grouped digital inputs and 6 grouped digital inputs
- X2** – OR6: Assembly Group with 6 Output Relays (Changeover / Form C)
- X3** – TI: Standard current measuring card (for the neutral side of the differential protection)
- X4** – TI: Standard current measuring card (for the mains side of the differential protection)
- X5** – DI8-OR4: Assembly Group with 8 Digital Inputs and 4 Output Relays (NO / Form A)
- X6** – TU-DI8: Voltage measuring (0 ... 300 VAC) assembly group with 8 Digital Inputs
- X100** – IEC 61850 / Modbus TCP / DNP3.0 TCP/UDP, Ethernet interface, 100 Mbit/s, RJ45 (BASE100-FX)
- X102** – Universal Resistance-Temperature Detector (URTD) input, Fiber optics interface, Versatile Link
- X103** – IEC 60870-5-103 / Modbus RTU / DNP3.0 RTU, RS485, Terminals
- X104** – IRIG-B00X, incl. System Contact (Supervision Contact)

MCDGV4-2C1AAA

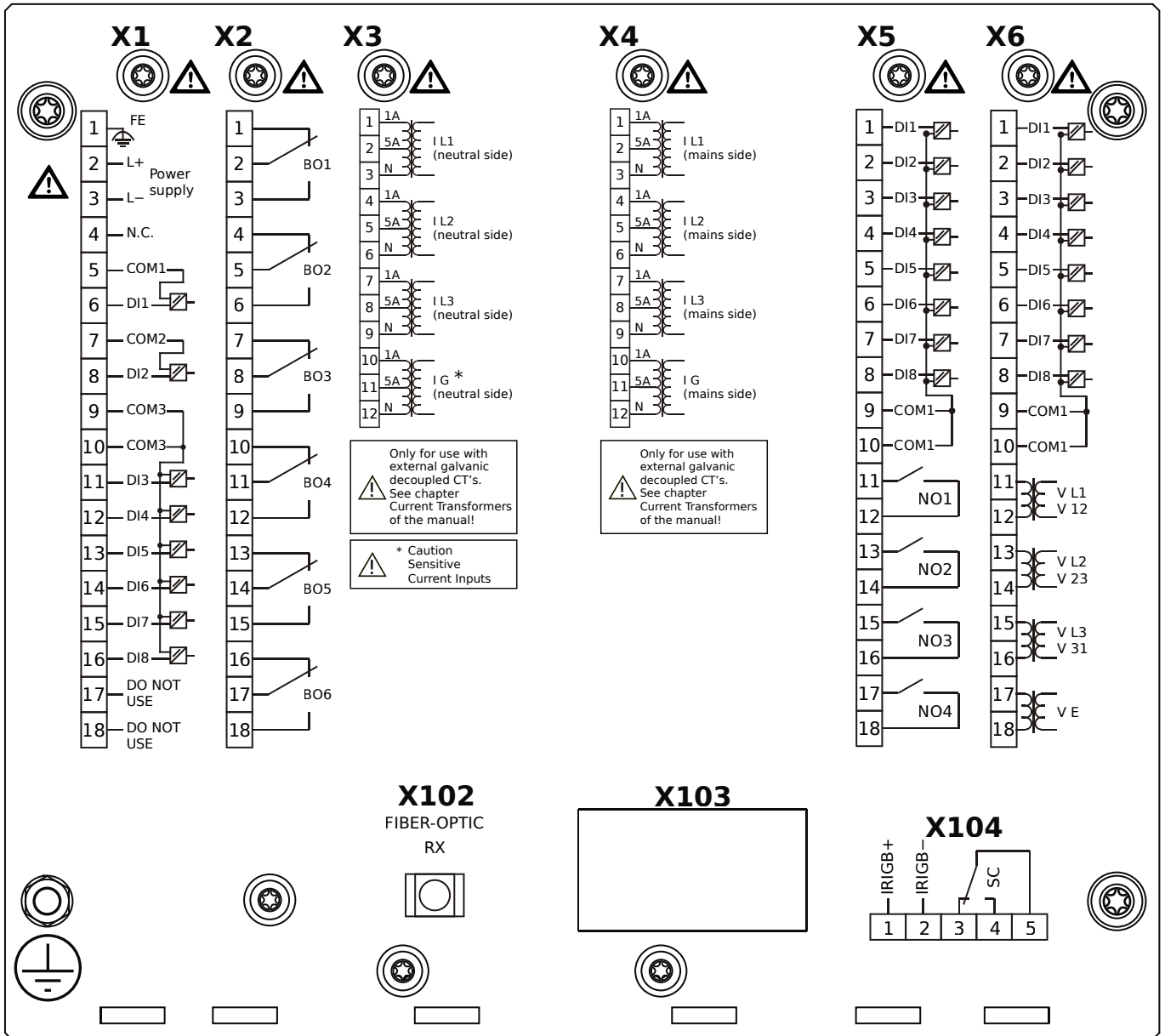

Housing B2, large display, door mounting

- X1** – DI8-X1: Wide-range power supply unit, incl. 2 non-grouped digital inputs and 6 grouped digital inputs
- X2** – OR6: Assembly Group with 6 Output Relays (Changeover / Form C)
- X3** – TI: Standard phase current measuring card and sensitive ground current measuring (neutral side of the diff. prot.)
- X4** – TI: Standard current measuring card (for the mains side of the differential protection)
- X5** – DI8-OR4: Assembly Group with 8 Digital Inputs and 4 Output Relays (NO / Form A)
- X6** – TU-DI8: Voltage measuring (0 ... 300 VAC) assembly group with 8 Digital Inputs
- X102** – Universal Resistance-Temperature Detector (URTD) input, Fiber optics interface, Versatile Link
- X104** – IRIG-B00X, incl. System Contact (Supervision Contact)

MCDGV4-2C1AAB

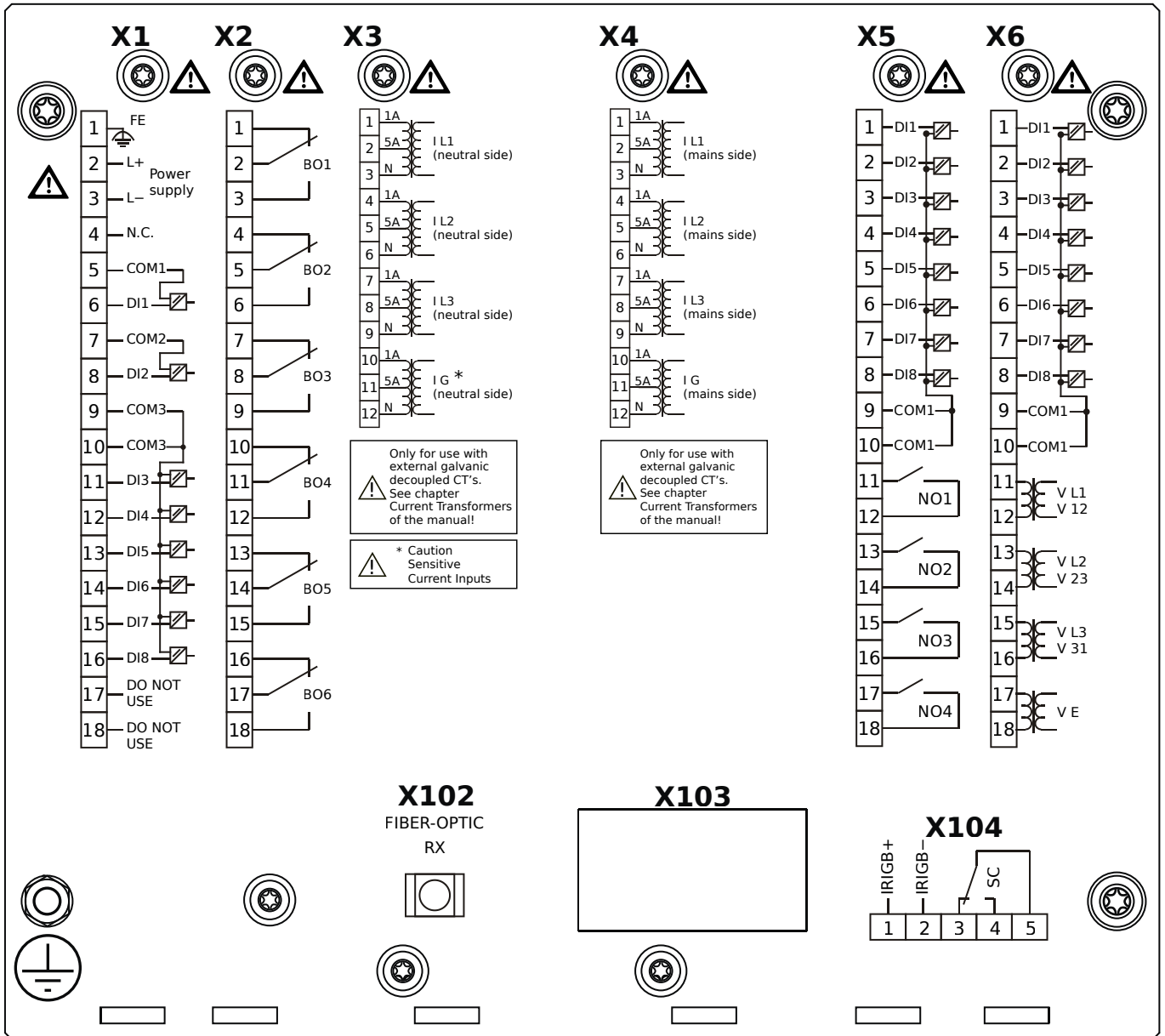

Housing B2, large display, door mounting

+ Conformal Coating (for installations in harsh environment)

- X1** – DI8-X1: Wide-range power supply unit, incl. 2 non-grouped digital inputs and 6 grouped digital inputs
- X2** – OR6: Assembly Group with 6 Output Relays (Changeover / Form C)
- X3** – TIs: Standard phase current measuring card and sensitive ground current measuring (neutral side of the diff. prot.)
- X4** – TI: Standard current measuring card (for the mains side of the differential protection)
- X5** – DI8-OR4: Assembly Group with 8 Digital Inputs and 4 Output Relays (NO / Form A)
- X6** – TU-DI8: Voltage measuring (0 ... 300 VAC) assembly group with 8 Digital Inputs
- X102** – Universal Resistance-Temperature Detector (URTD) input, Fiber optics interface, Versatile Link
- X104** – IRIG-B00X, incl. System Contact (Supervision Contact)

MCDGV4-2C1ABA

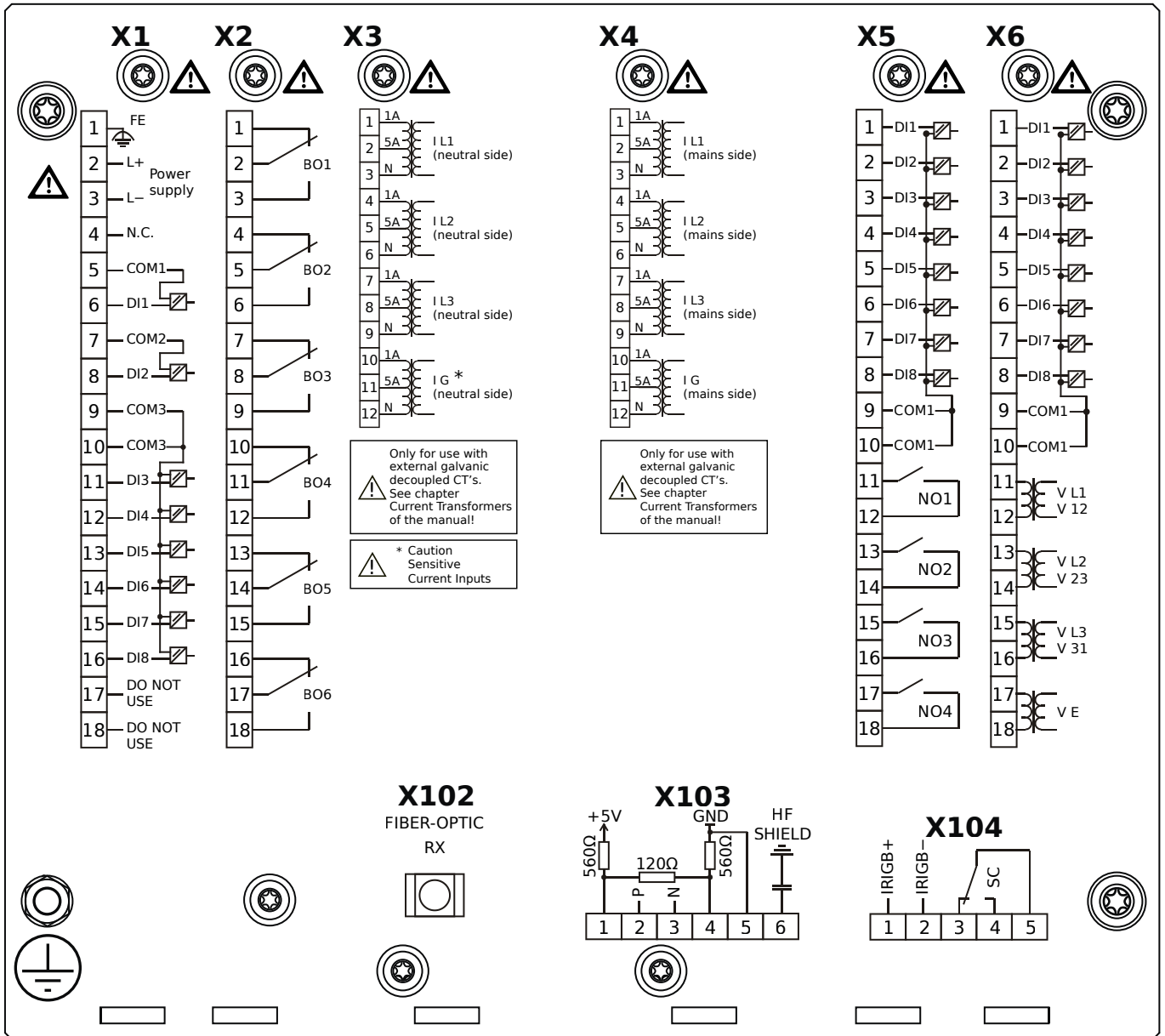

Housing B2, large display, door mounting

- X1** – DI8-X1: Wide-range power supply unit, incl. 2 non-grouped digital inputs and 6 grouped digital inputs
- X2** – OR6: Assembly Group with 6 Output Relays (Changeover / Form C)
- X3** – TIs: Standard phase current measuring card and sensitive ground current measuring (neutral side of the diff. prot.)
- X4** – TI: Standard current measuring card (for the mains side of the differential protection)
- X5** – DI8-OR4: Assembly Group with 8 Digital Inputs and 4 Output Relays (NO / Form A)
- X6** – TU-DI8: Voltage measuring (0 ... 300 VAC) assembly group with 8 Digital Inputs
- X102** – Universal Resistance-Temperature Detector (URTD) input, Fiber optics interface, Versatile Link
- X103** – Modbus RTU / IEC 60870-5-103 / DNP3.0 RTU, RS485, Terminals
- X104** – IRIG-B00X, incl. System Contact (Supervision Contact)

MCDGV4-2C1ABB

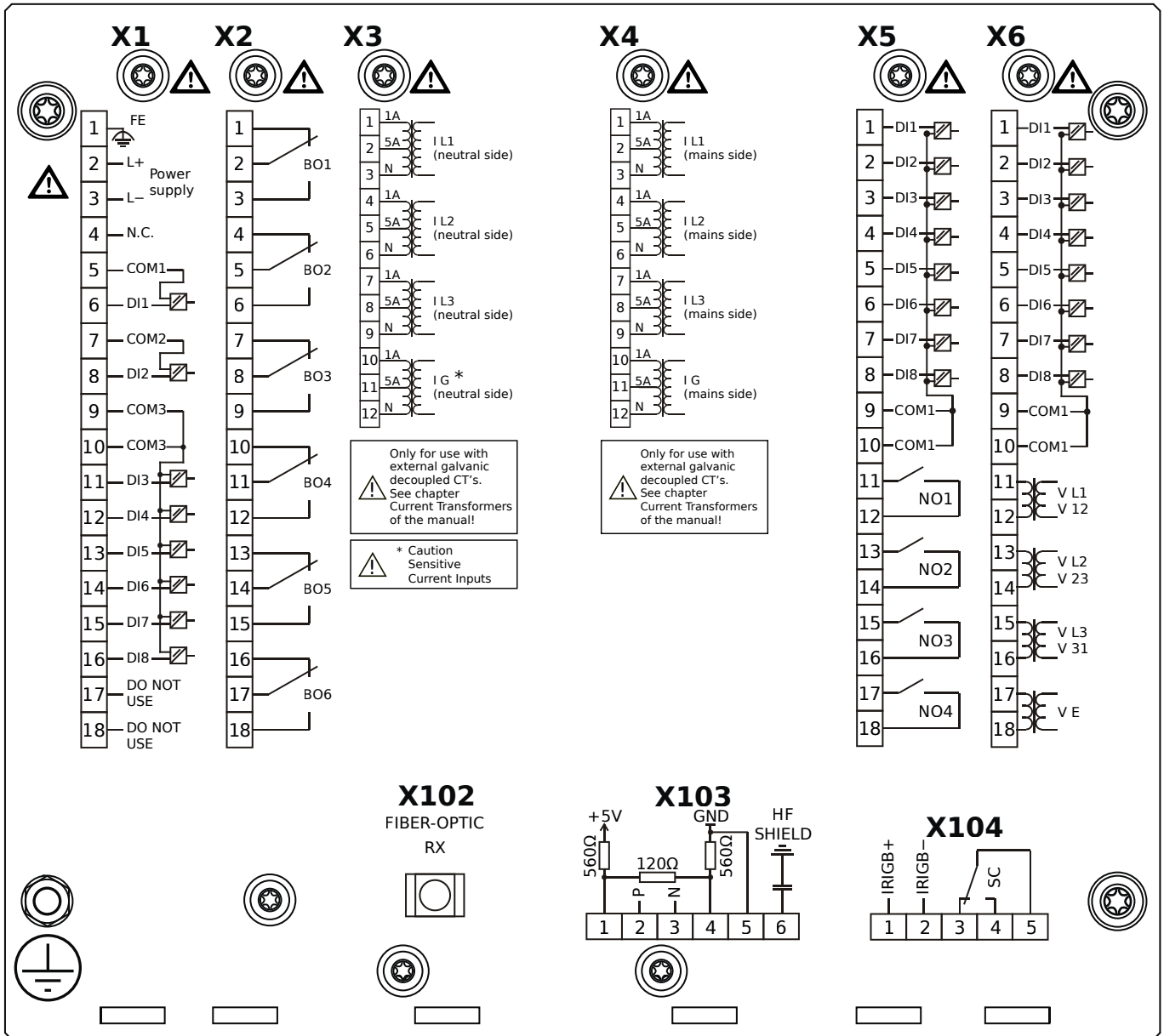

Housing B2, large display, door mounting

+ Conformal Coating (for installations in harsh environment)

- X1** – DI8-X1: Wide-range power supply unit, incl. 2 non-grouped digital inputs and 6 grouped digital inputs
- X2** – OR6: Assembly Group with 6 Output Relays (Changeover / Form C)
- X3** – TIs: Standard phase current measuring card and sensitive ground current measuring (neutral side of the diff. prot.)
- X4** – TI: Standard current measuring card (for the mains side of the differential protection)
- X5** – DI8-OR4: Assembly Group with 8 Digital Inputs and 4 Output Relays (NO / Form A)
- X6** – TU-DI8: Voltage measuring (0 ... 300 VAC) assembly group with 8 Digital Inputs
- X102** – Universal Resistance-Temperature Detector (URTD) input, Fiber optics interface, Versatile Link
- X103** – Modbus RTU / IEC 60870-5-103 / DNP3.0 RTU, RS485, Terminals
- X104** – IRIG-B00X, incl. System Contact (Supervision Contact)

MCDGV4-2C1ACA

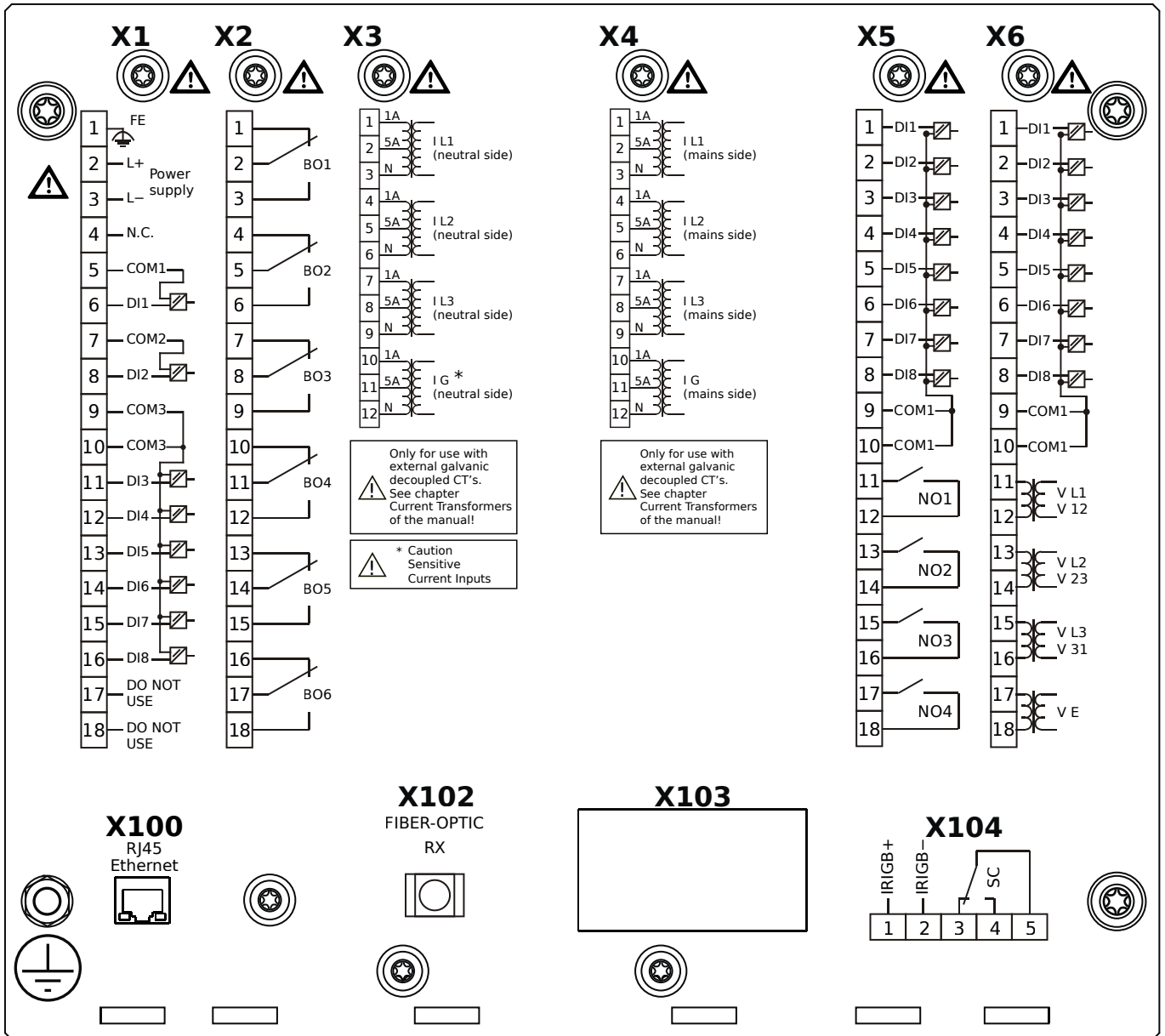

Housing B2, large display, door mounting

- X1** – DI8-X1: Wide-range power supply unit, incl. 2 non-grouped digital inputs and 6 grouped digital inputs
- X2** – OR6: Assembly Group with 6 Output Relays (Changeover / Form C)
- X3** – TI: Standard phase current measuring card and sensitive ground current measuring (neutral side of the diff. prot.)
- X4** – TI: Standard current measuring card (for the mains side of the differential protection)
- X5** – DI8-OR4: Assembly Group with 8 Digital Inputs and 4 Output Relays (NO / Form A)
- X6** – TU-DI8: Voltage measuring (0 ... 300 VAC) assembly group with 8 Digital Inputs
- X100** – Modbus TCP / DNP3.0 TCP/UDP, Ethernet interface, 100 Mbit/s, RJ45 (BASE100-FX)
- X102** – Universal Resistance-Temperature Detector (URTD) input, Fiber optics interface, Versatile Link
- X104** – IRIG-B00X, incl. System Contact (Supervision Contact)

MCDGV4-2C1ACB

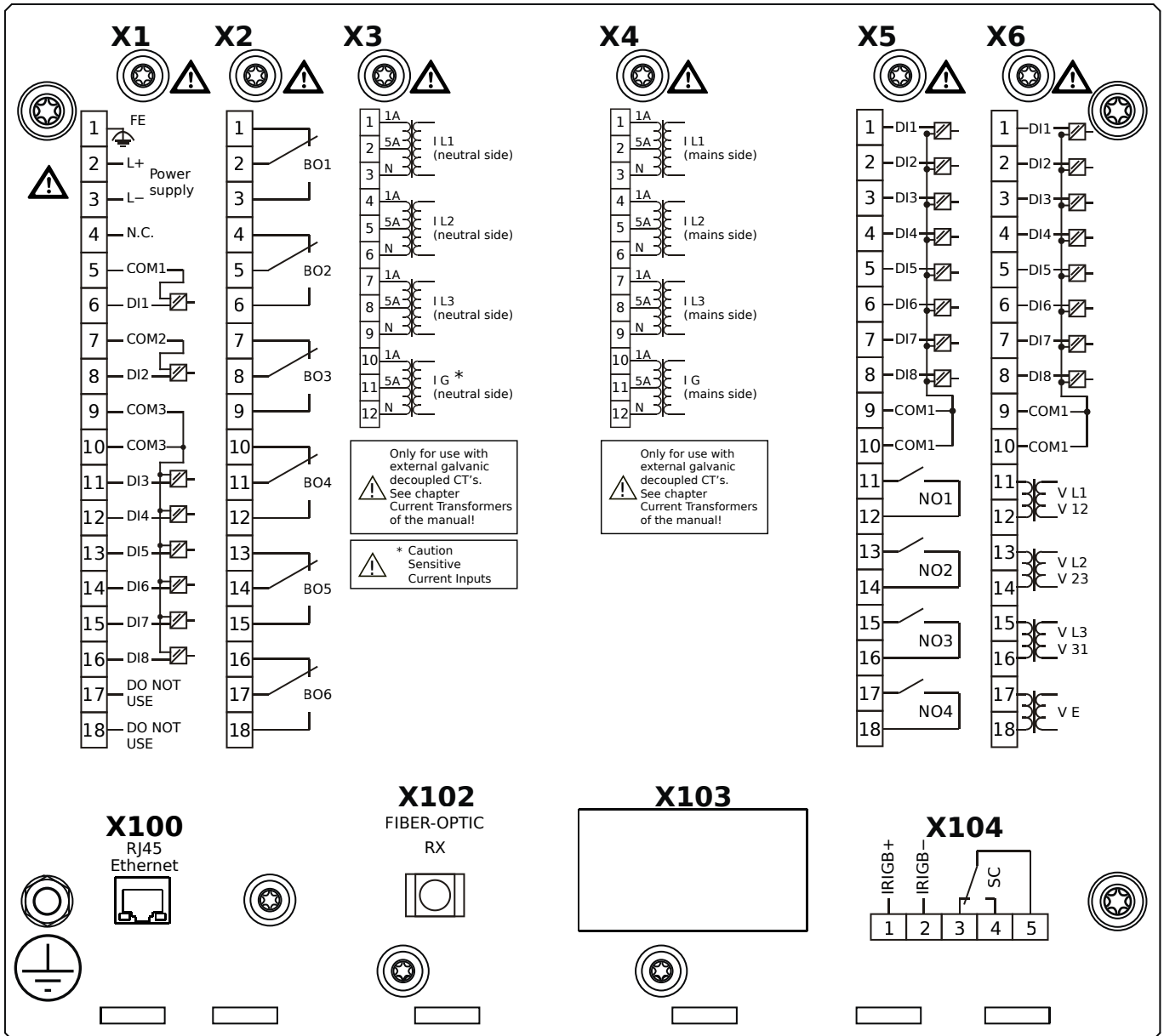

Housing B2, large display, door mounting

+ Conformal Coating (for installations in harsh environment)

- X1** – DI8-X1: Wide-range power supply unit, incl. 2 non-grouped digital inputs and 6 grouped digital inputs
- X2** – OR6: Assembly Group with 6 Output Relays (Changeover / Form C)
- X3** – TIs: Standard phase current measuring card and sensitive ground current measuring (neutral side of the diff. prot.)
- X4** – TI: Standard current measuring card (for the mains side of the differential protection)
- X5** – DI8-OR4: Assembly Group with 8 Digital Inputs and 4 Output Relays (NO / Form A)
- X6** – TU-DI8: Voltage measuring (0 ... 300 VAC) assembly group with 8 Digital Inputs
- X100** – Modbus TCP / DNP3.0 TCP/UDP, Ethernet interface, 100 Mbit/s, RJ45 (BASE100-FX)
- X102** – Universal Resistance-Temperature Detector (URTD) input, Fiber optics interface, Versatile Link
- X104** – IRIG-B00X, incl. System Contact (Supervision Contact)

MCDGV4-2C1ADA

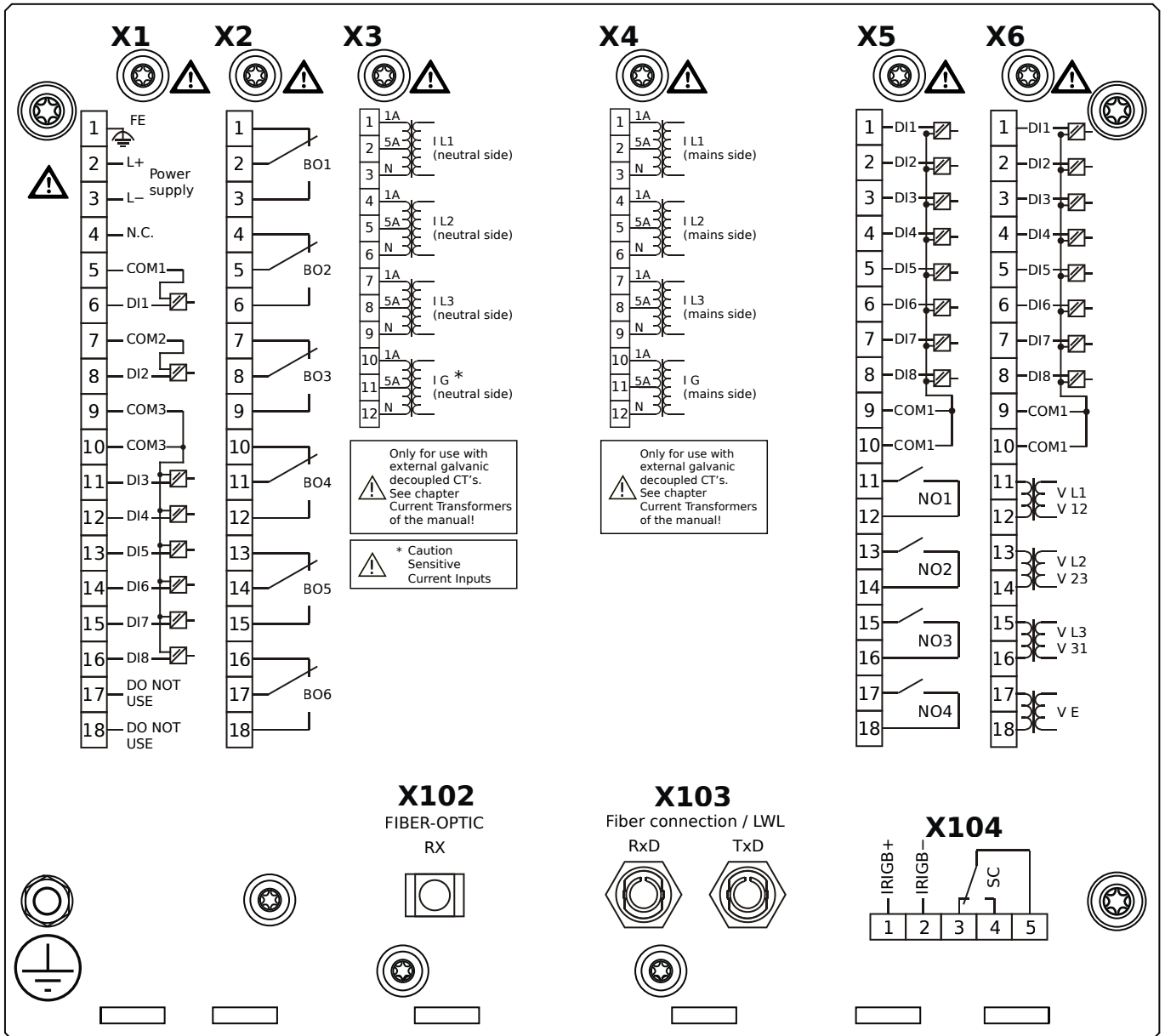

Housing B2, large display, door mounting

- X1** – DI8-X1: Wide-range power supply unit, incl. 2 non-grouped digital inputs and 6 grouped digital inputs
- X2** – OR6: Assembly Group with 6 Output Relays (Changeover / Form C)
- X3** – TI: Standard phase current measuring card and sensitive ground current measuring (neutral side of the diff. prot.)
- X4** – TI: Standard current measuring card (for the mains side of the differential protection)
- X5** – DI8-OR4: Assembly Group with 8 Digital Inputs and 4 Output Relays (NO / Form A)
- X6** – TU-DI8: Voltage measuring (0 ... 300 VAC) assembly group with 8 Digital Inputs
- X102** – Universal Resistance-Temperature Detector (URTD) input, Fiber optics interface, Versatile Link
- X103** – Profibus-DP, Fiber optics interface, ST Connector
- X104** – IRIG-B00X, incl. System Contact (Supervision Contact)

MCDGV4-2C1ADB

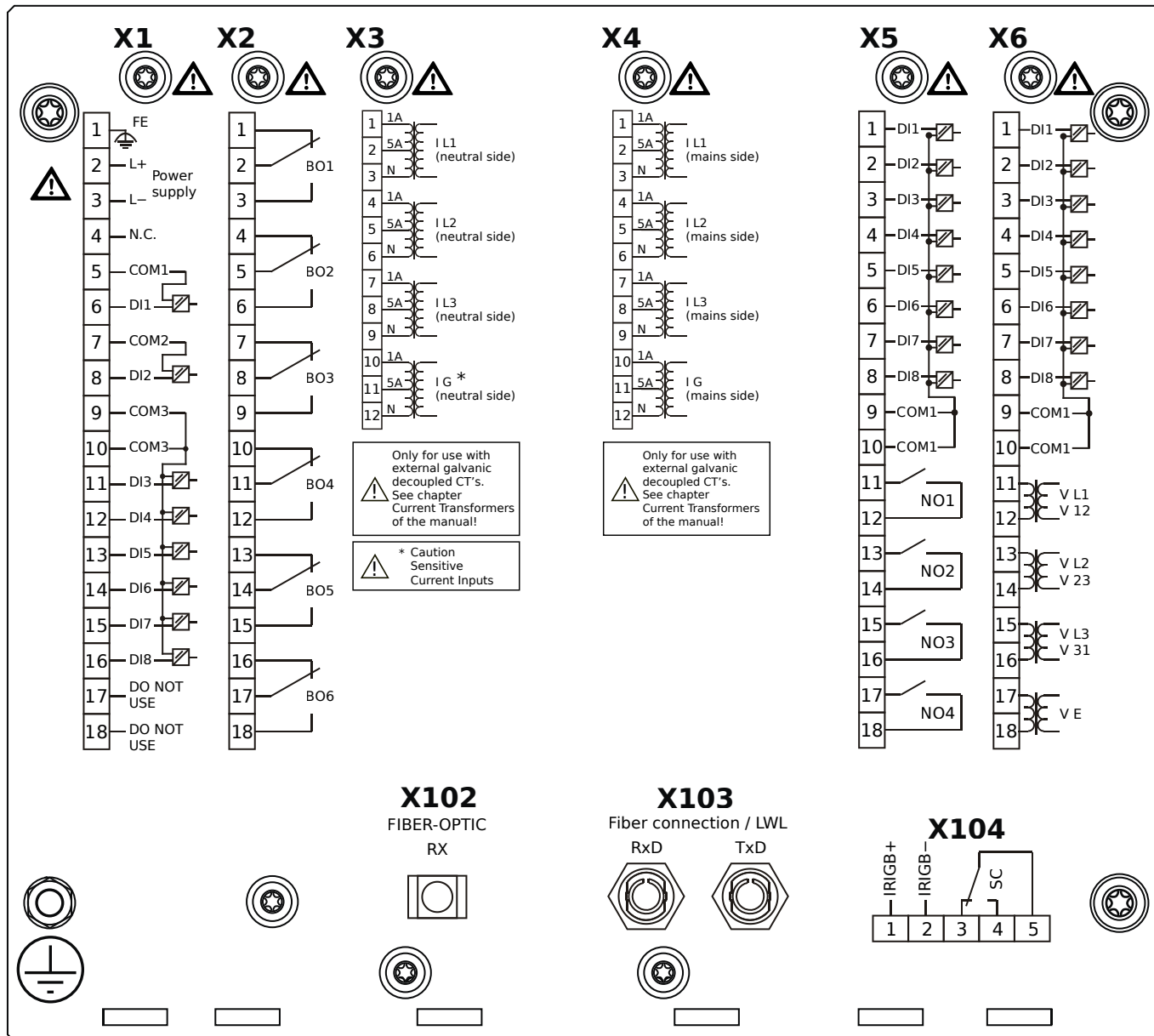

Housing B2, large display, door mounting

+ Conformal Coating (for installations in harsh environment)

- X1** – DI8-X1: Wide-range power supply unit, incl. 2 non-grouped digital inputs and 6 grouped digital inputs
- X2** – OR6: Assembly Group with 6 Output Relays (Changeover / Form C)
- X3** – TIs: Standard phase current measuring card and sensitive ground current measuring (neutral side of the diff. prot.)
- X4** – TI: Standard current measuring card (for the mains side of the differential protection)
- X5** – DI8-OR4: Assembly Group with 8 Digital Inputs and 4 Output Relays (NO / Form A)
- X6** – TU-DI8: Voltage measuring (0 ... 300 VAC) assembly group with 8 Digital Inputs
- X102** – Universal Resistance-Temperature Detector (URTD) input, Fiber optics interface, Versatile Link
- X103** – Profibus-DP, Fiber optics interface, ST Connector
- X104** – IRIG-B00X, incl. System Contact (Supervision Contact)

MCDGV4-2C1AEA

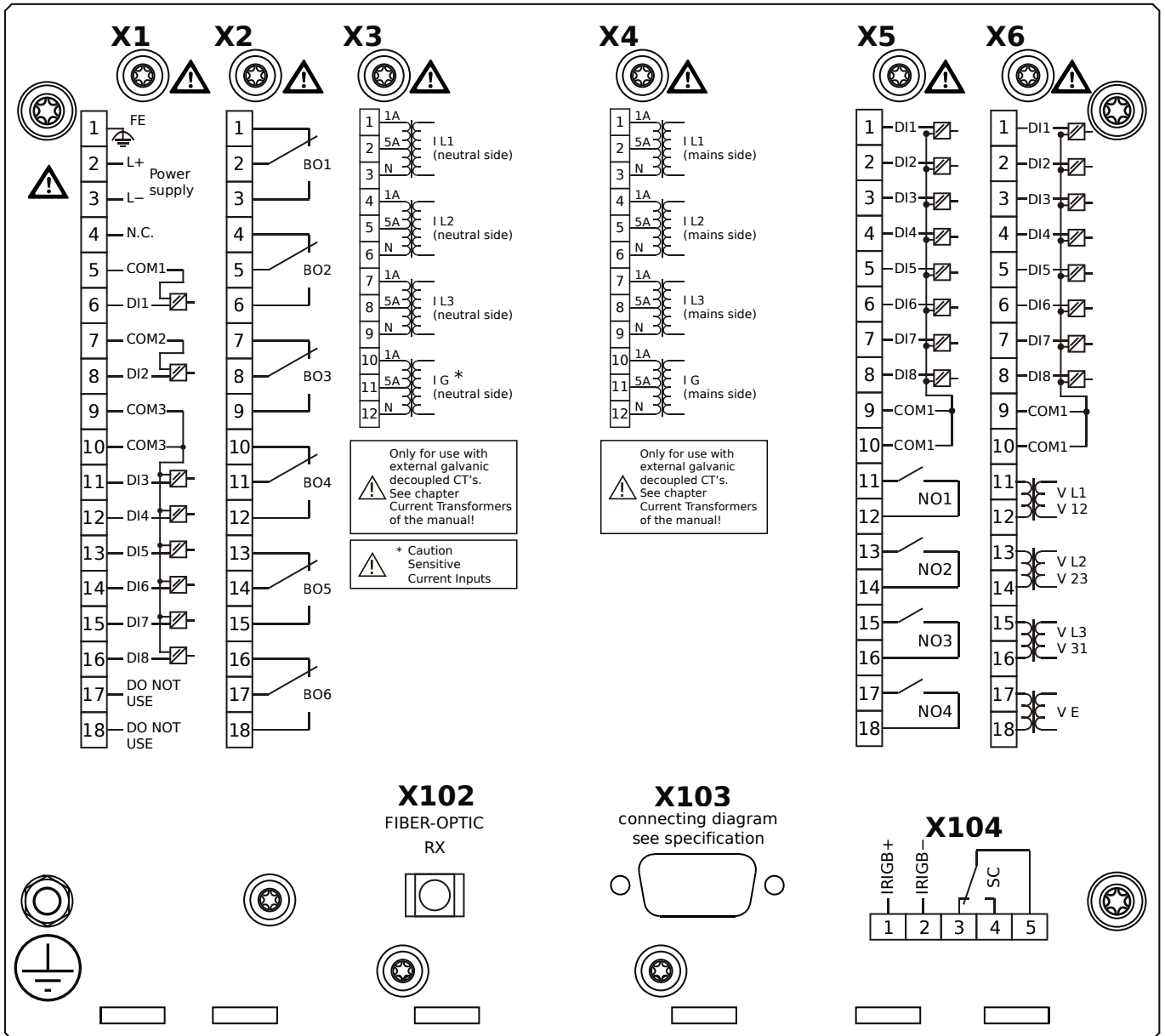

Housing B2, large display, door mounting

- X1** – DI8-X1: Wide-range power supply unit, incl. 2 non-grouped digital inputs and 6 grouped digital inputs
- X2** – OR6: Assembly Group with 6 Output Relays (Changeover / Form C)
- X3** – TI: Standard phase current measuring card and sensitive ground current measuring (neutral side of the diff. prot.)
- X4** – TI: Standard current measuring card (for the mains side of the differential protection)
- X5** – DI8-OR4: Assembly Group with 8 Digital Inputs and 4 Output Relays (NO / Form A)
- X6** – TU-DI8: Voltage measuring (0 ... 300 VAC) assembly group with 8 Digital Inputs
- X102** – Universal Resistance-Temperature Detector (URTD) input, Fiber optics interface, Versatile Link
- X103** – Profibus-DP, RS485, D-SUB
- X104** – IRIG-B00X, incl. System Contact (Supervision Contact)

MCDGV4-2C1AEB

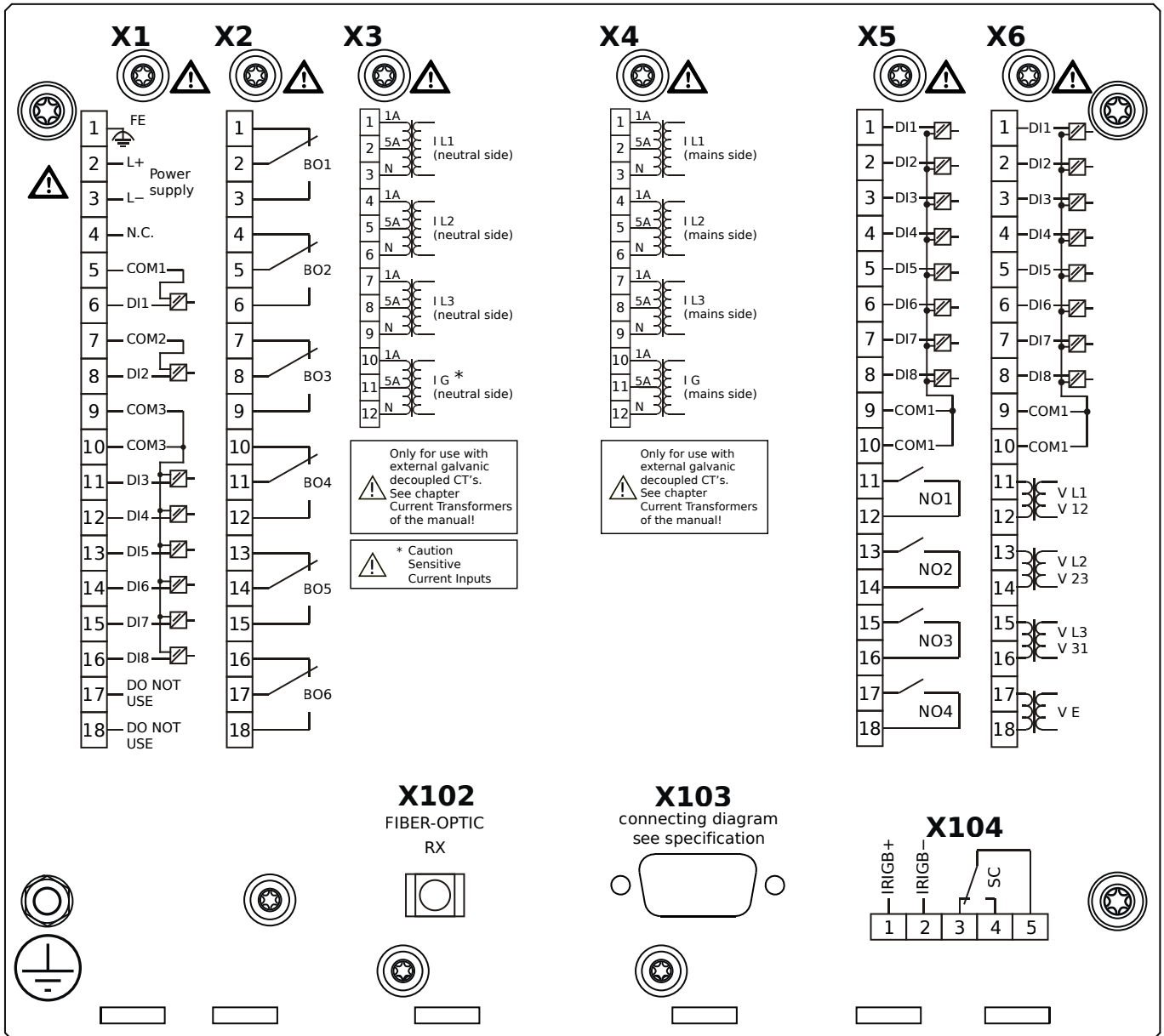

Housing B2, large display, door mounting

+ Conformal Coating (for installations in harsh environment)

- X1** – DI8-X1: Wide-range power supply unit, incl. 2 non-grouped digital inputs and 6 grouped digital inputs
- X2** – OR6: Assembly Group with 6 Output Relays (Changeover / Form C)
- X3** – TIs: Standard phase current measuring card and sensitive ground current measuring (neutral side of the diff. prot.)
- X4** – TI: Standard current measuring card (for the mains side of the differential protection)
- X5** – DI8-OR4: Assembly Group with 8 Digital Inputs and 4 Output Relays (NO / Form A)
- X6** – TU-DI8: Voltage measuring (0 ... 300 VAC) assembly group with 8 Digital Inputs
- X102** – Universal Resistance-Temperature Detector (URTD) input, Fiber optics interface, Versatile Link
- X103** – Profibus-DP, RS485, D-SUB
- X104** – IRIG-B00X, incl. System Contact (Supervision Contact)

MCDGV4-2C1AFA

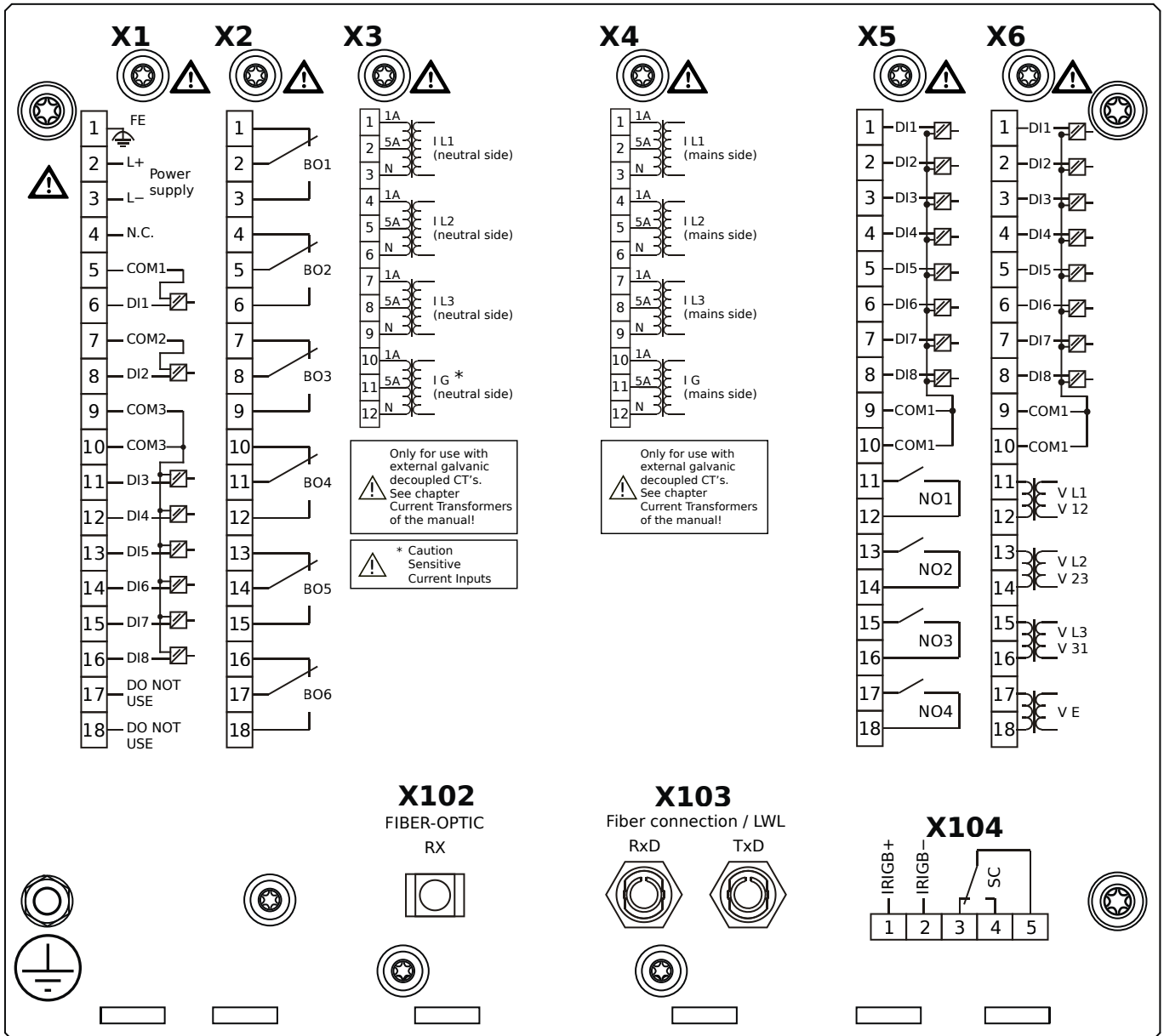

Housing B2, large display, door mounting

- X1** – DI8-X1: Wide-range power supply unit, incl. 2 non-grouped digital inputs and 6 grouped digital inputs
- X2** – OR6: Assembly Group with 6 Output Relays (Changeover / Form C)
- X3** – TIs: Standard phase current measuring card and sensitive ground current measuring (neutral side of the diff. prot.)
- X4** – TI: Standard current measuring card (for the mains side of the differential protection)
- X5** – DI8-OR4: Assembly Group with 8 Digital Inputs and 4 Output Relays (NO / Form A)
- X6** – TU-DI8: Voltage measuring (0 ... 300 VAC) assembly group with 8 Digital Inputs
- X102** – Universal Resistance-Temperature Detector (URTD) input, Fiber optics interface, Versatile Link
- X103** – Modbus RTU / IEC 60870-5-103 / DNP3.0 RTU, Fiber optics interface, ST Connector
- X104** – IRIG-B00X, incl. System Contact (Supervision Contact)

MCDGV4-2C1AFB

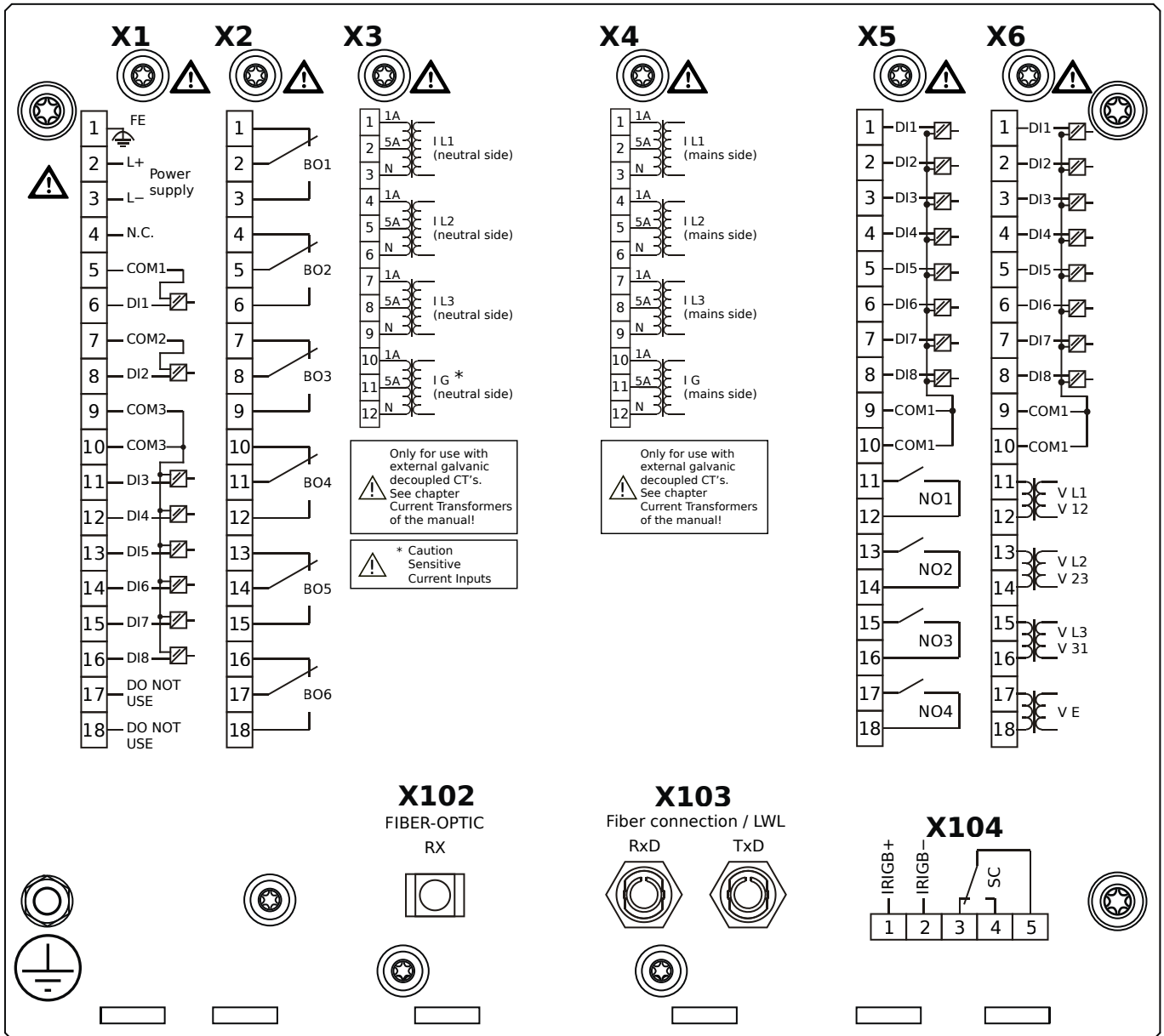

Housing B2, large display, door mounting

+ Conformal Coating (for installations in harsh environment)

- X1** – DI8-X1: Wide-range power supply unit, incl. 2 non-grouped digital inputs and 6 grouped digital inputs
- X2** – OR6: Assembly Group with 6 Output Relays (Changeover / Form C)
- X3** – TIs: Standard phase current measuring card and sensitive ground current measuring (neutral side of the diff. prot.)
- X4** – TI: Standard current measuring card (for the mains side of the differential protection)
- X5** – DI8-OR4: Assembly Group with 8 Digital Inputs and 4 Output Relays (NO / Form A)
- X6** – TU-DI8: Voltage measuring (0 ... 300 VAC) assembly group with 8 Digital Inputs
- X102** – Universal Resistance-Temperature Detector (URTD) input, Fiber optics interface, Versatile Link
- X103** – Modbus RTU / IEC 60870-5-103 / DNP3.0 RTU, Fiber optics interface, ST Connector
- X104** – IRIG-B00X, incl. System Contact (Supervision Contact)

MCDGV4-2C1AGA

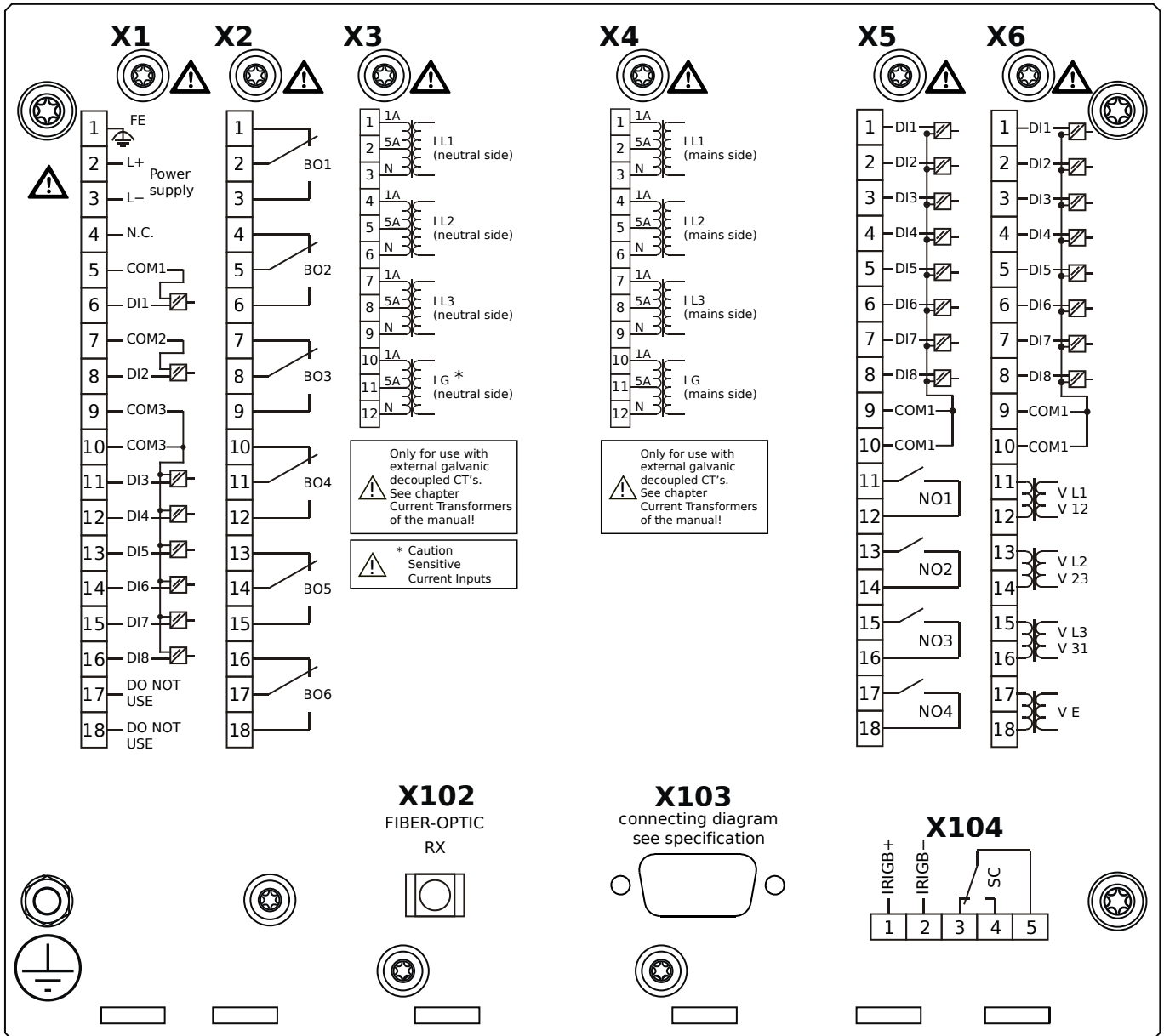

Housing B2, large display, door mounting

- X1** – DI8-X1: Wide-range power supply unit, incl. 2 non-grouped digital inputs and 6 grouped digital inputs
- X2** – OR6: Assembly Group with 6 Output Relays (Changeover / Form C)
- X3** – TIs: Standard phase current measuring card and sensitive ground current measuring (neutral side of the diff. prot.)
- X4** – TI: Standard current measuring card (for the mains side of the differential protection)
- X5** – DI8-OR4: Assembly Group with 8 Digital Inputs and 4 Output Relays (NO / Form A)
- X6** – TU-DI8: Voltage measuring (0 ... 300 VAC) assembly group with 8 Digital Inputs
- X102** – Universal Resistance-Temperature Detector (URTD) input, Fiber optics interface, Versatile Link
- X103** – Modbus RTU / IEC 60870-5-103 / DNP3.0 RTU, RS485, D-SUB
- X104** – IRIG-B00X, incl. System Contact (Supervision Contact)

MCDGV4-2C1AGB

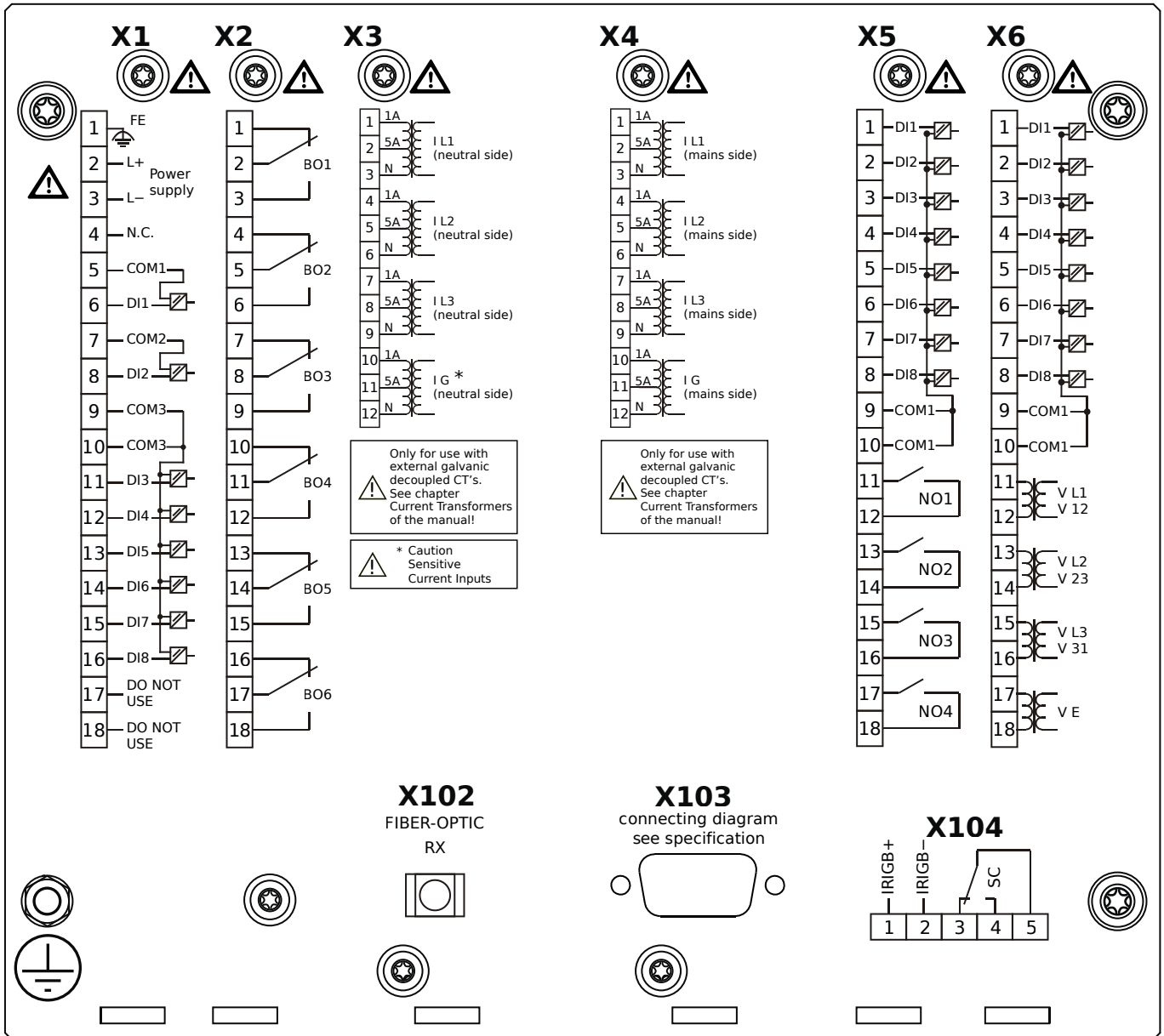

Housing B2, large display, door mounting

+ Conformal Coating (for installations in harsh environment)

- X1** – DI8-X1: Wide-range power supply unit, incl. 2 non-grouped digital inputs and 6 grouped digital inputs
- X2** – OR6: Assembly Group with 6 Output Relays (Changeover / Form C)
- X3** – TIs: Standard phase current measuring card and sensitive ground current measuring (neutral side of the diff. prot.)
- X4** – TI: Standard current measuring card (for the mains side of the differential protection)
- X5** – DI8-OR4: Assembly Group with 8 Digital Inputs and 4 Output Relays (NO / Form A)
- X6** – TU-DI8: Voltage measuring (0 ... 300 VAC) assembly group with 8 Digital Inputs
- X102** – Universal Resistance-Temperature Detector (URTD) input, Fiber optics interface, Versatile Link
- X103** – Modbus RTU / IEC 60870-5-103 / DNP3.0 RTU, RS485, D-SUB
- X104** – IRIG-B00X, incl. System Contact (Supervision Contact)

MCDGV4-2C1AHA

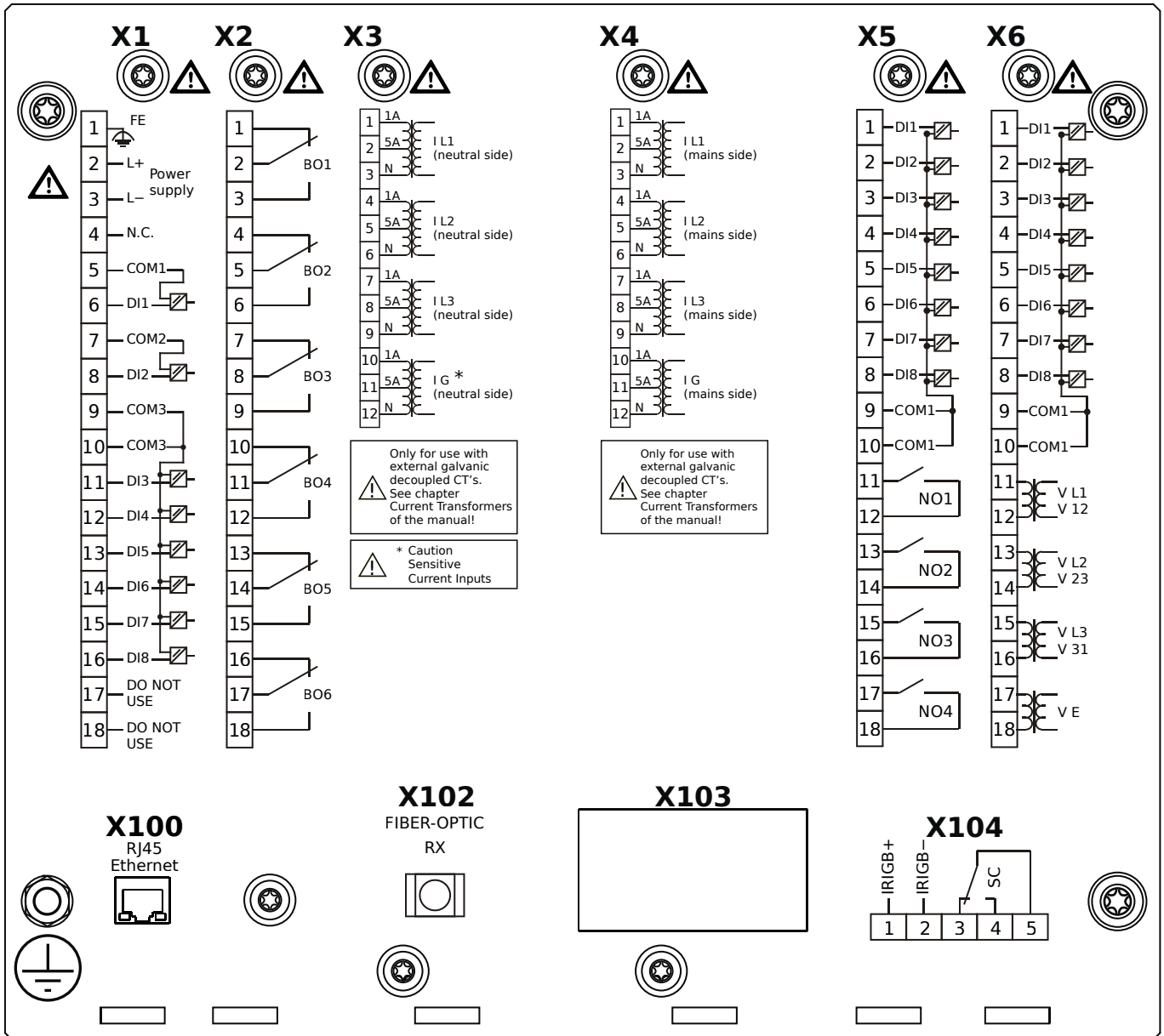

Housing B2, large display, door mounting

- X1** – DI8-X1: Wide-range power supply unit, incl. 2 non-grouped digital inputs and 6 grouped digital inputs
- X2** – OR6: Assembly Group with 6 Output Relays (Changeover / Form C)
- X3** – TIs: Standard phase current measuring card and sensitive ground current measuring (neutral side of the diff. prot.)
- X4** – TI: Standard current measuring card (for the mains side of the differential protection)
- X5** – DI8-OR4: Assembly Group with 8 Digital Inputs and 4 Output Relays (NO / Form A)
- X6** – TU-DI8: Voltage measuring (0 ... 300 VAC) assembly group with 8 Digital Inputs
- X100** – IEC 61850 / Modbus TCP / DNP3.0 TCP/UDP, Ethernet interface, 100 Mbit/s, RJ45 (BASE100-FX)
- X102** – Universal Resistance-Temperature Detector (URTD) input, Fiber optics interface, Versatile Link
- X104** – IRIG-B00X, incl. System Contact (Supervision Contact)

MCDGV4-2C1AHB

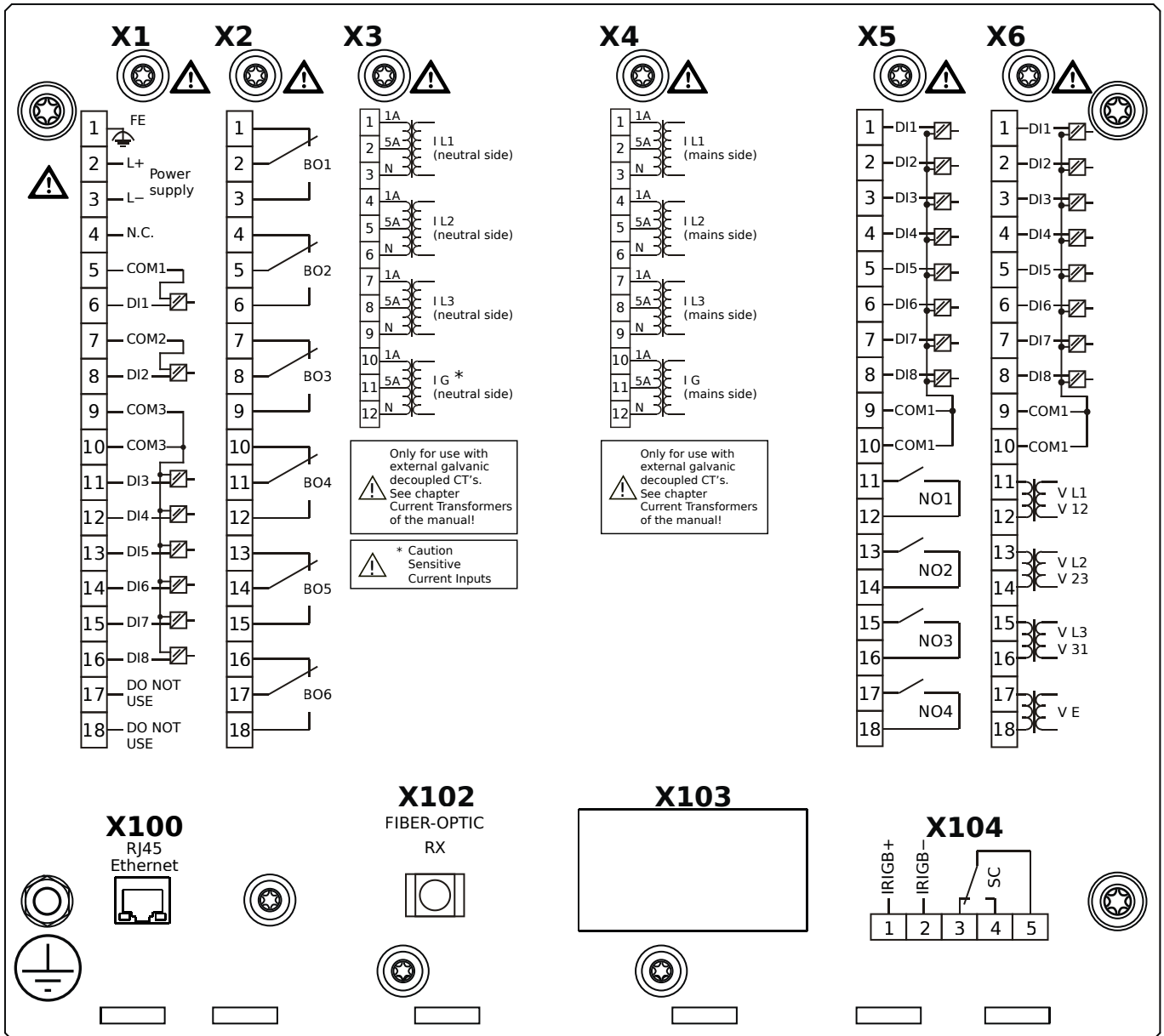

Housing B2, large display, door mounting

+ Conformal Coating (for installations in harsh environment)

- X1** – DI8-X1: Wide-range power supply unit, incl. 2 non-grouped digital inputs and 6 grouped digital inputs
- X2** – OR6: Assembly Group with 6 Output Relays (Changeover / Form C)
- X3** – TIs: Standard phase current measuring card and sensitive ground current measuring (neutral side of the diff. prot.)
- X4** – TI: Standard current measuring card (for the mains side of the differential protection)
- X5** – DI8-OR4: Assembly Group with 8 Digital Inputs and 4 Output Relays (NO / Form A)
- X6** – TU-DI8: Voltage measuring (0 ... 300 VAC) assembly group with 8 Digital Inputs
- X100** – IEC 61850 / Modbus TCP / DNP3.0 TCP/UDP, Ethernet interface, 100 Mbit/s, RJ45 (BASE100-FX)
- X102** – Universal Resistance-Temperature Detector (URTD) input, Fiber optics interface, Versatile Link
- X104** – IRIG-B00X, incl. System Contact (Supervision Contact)

MCDGV4-2C1AIA

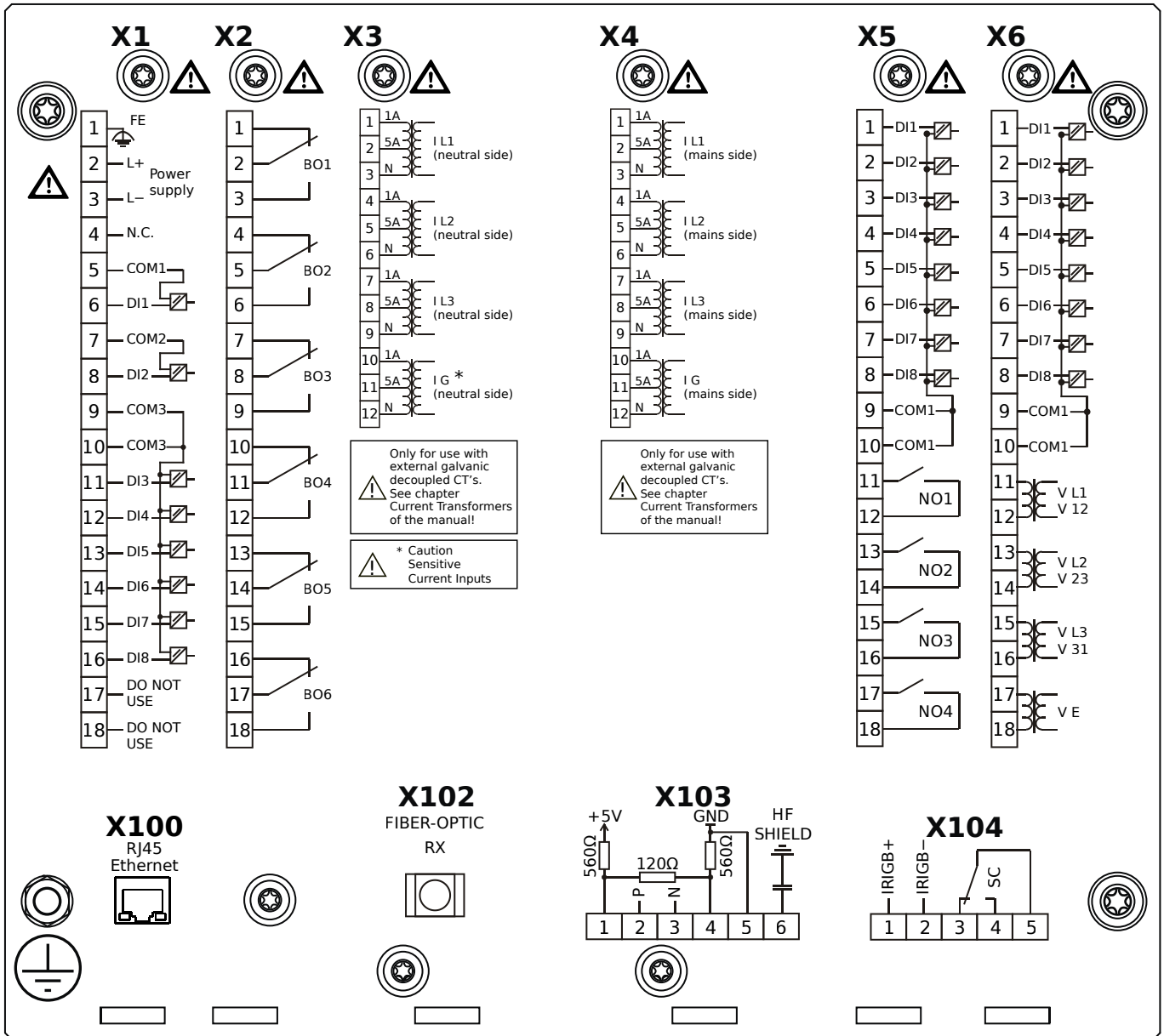

Housing B2, large display, door mounting

- X1** – DI8-X1: Wide-range power supply unit, incl. 2 non-grouped digital inputs and 6 grouped digital inputs
- X2** – OR6: Assembly Group with 6 Output Relays (Changeover / Form C)
- X3** – TI: Standard phase current measuring card and sensitive ground current measuring (neutral side of the diff. prot.)
- X4** – TI: Standard current measuring card (for the mains side of the differential protection)
- X5** – DI8-OR4: Assembly Group with 8 Digital Inputs and 4 Output Relays (NO / Form A)
- X6** – TU-DI8: Voltage measuring (0 ... 300 VAC) assembly group with 8 Digital Inputs
- X100** – Modbus TCP / DNP3.0 TCP/UDP, Ethernet interface, 100 Mbit/s, RJ45 (BASE100-FX)
- X102** – Universal Resistance-Temperature Detector (URTD) input, Fiber optics interface, Versatile Link
- X103** – IEC 60870-5-103 / Modbus RTU / DNP3.0 RTU, RS485, Terminals
- X104** – IRIG-B00X, incl. System Contact (Supervision Contact)

MCDGV4-2C1AIB

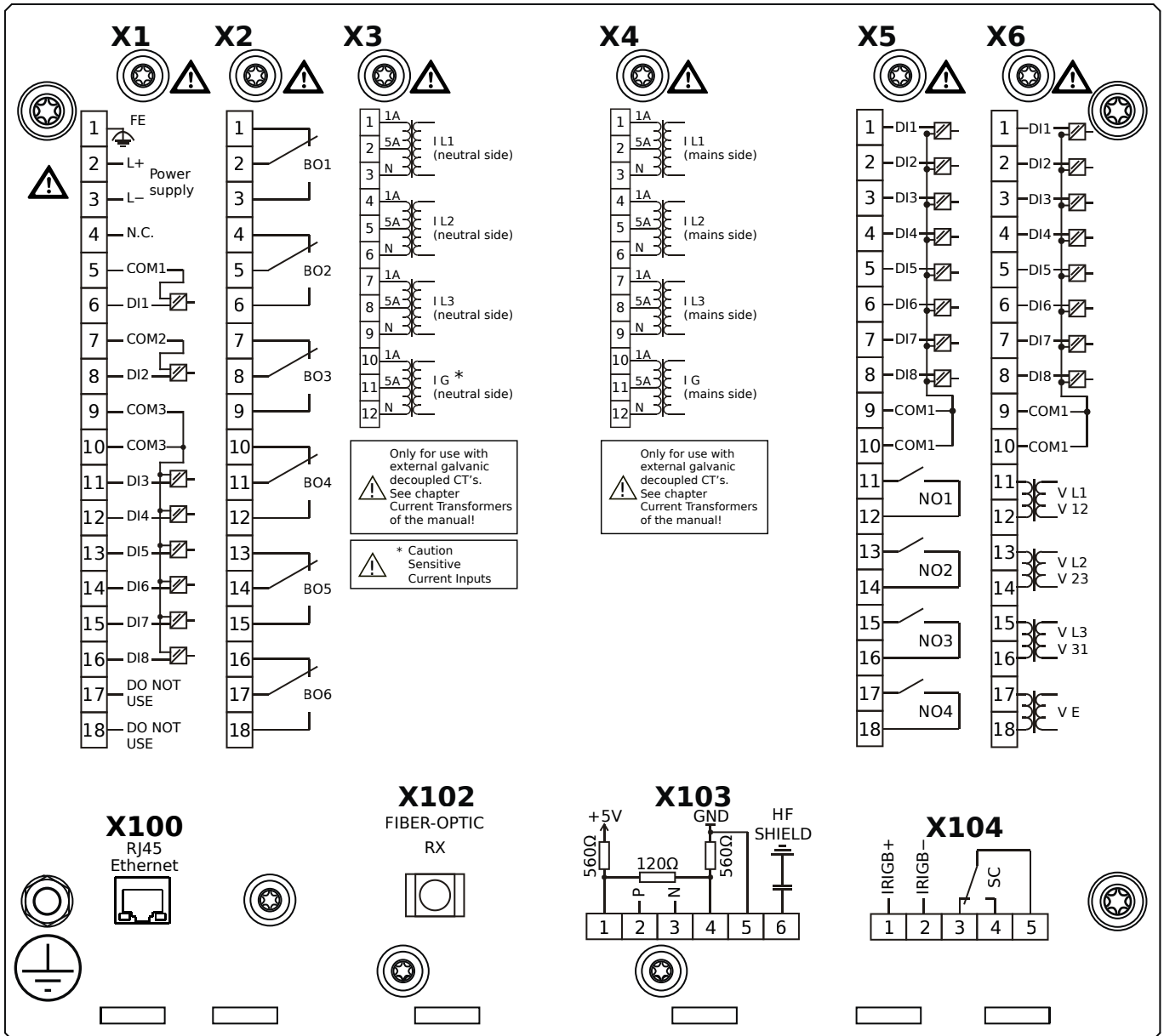

Housing B2, large display, door mounting

+ Conformal Coating (for installations in harsh environment)

- X1** – DI8-X1: Wide-range power supply unit, incl. 2 non-grouped digital inputs and 6 grouped digital inputs
- X2** – OR6: Assembly Group with 6 Output Relays (Changeover / Form C)
- X3** – TIs: Standard phase current measuring card and sensitive ground current measuring (neutral side of the diff. prot.)
- X4** – TI: Standard current measuring card (for the mains side of the differential protection)
- X5** – DI8-OR4: Assembly Group with 8 Digital Inputs and 4 Output Relays (NO / Form A)
- X6** – TU-DI8: Voltage measuring (0 ... 300 VAC) assembly group with 8 Digital Inputs
- X100** – Modbus TCP / DNP3.0 TCP/UDP, Ethernet interface, 100 Mbit/s, RJ45 (BASE100-FX)
- X102** – Universal Resistance-Temperature Detector (URTD) input, Fiber optics interface, Versatile Link
- X103** – IEC 60870-5-103 / Modbus RTU / DNP3.0 RTU, RS485, Terminals
- X104** – IRIG-B00X, incl. System Contact (Supervision Contact)

MCDGV4-2C1AKA

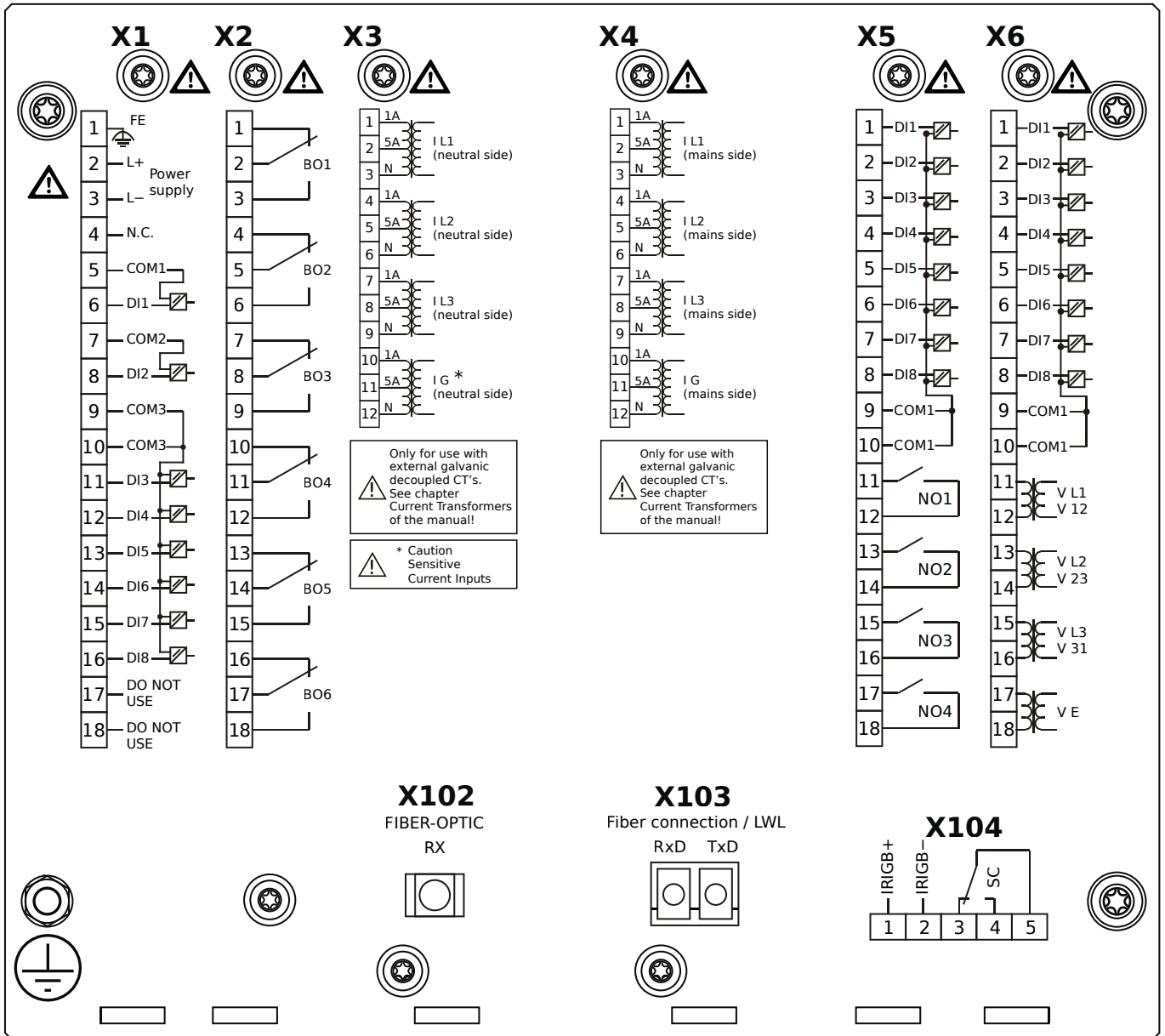

Housing B2, large display, door mounting

- X1** – DI8-X1: Wide-range power supply unit, incl. 2 non-grouped digital inputs and 6 grouped digital inputs
- X2** – OR6: Assembly Group with 6 Output Relays (Changeover / Form C)
- X3** – TI: Standard phase current measuring card and sensitive ground current measuring (neutral side of the diff. prot.)
- X4** – TI: Standard current measuring card (for the mains side of the differential protection)
- X5** – DI8-OR4: Assembly Group with 8 Digital Inputs and 4 Output Relays (NO / Form A)
- X6** – TU-DI8: Voltage measuring (0 ... 300 VAC) assembly group with 8 Digital Inputs
- X102** – Universal Resistance-Temperature Detector (URTD) input, Fiber optics interface, Versatile Link
- X103** – IEC 61850 / Modbus TCP / DNP3.0 TCP/UDP, Fiber optics interface, LC Connector
- X104** – IRIG-B00X, incl. System Contact (Supervision Contact)

MCDGV4-2C1AKB

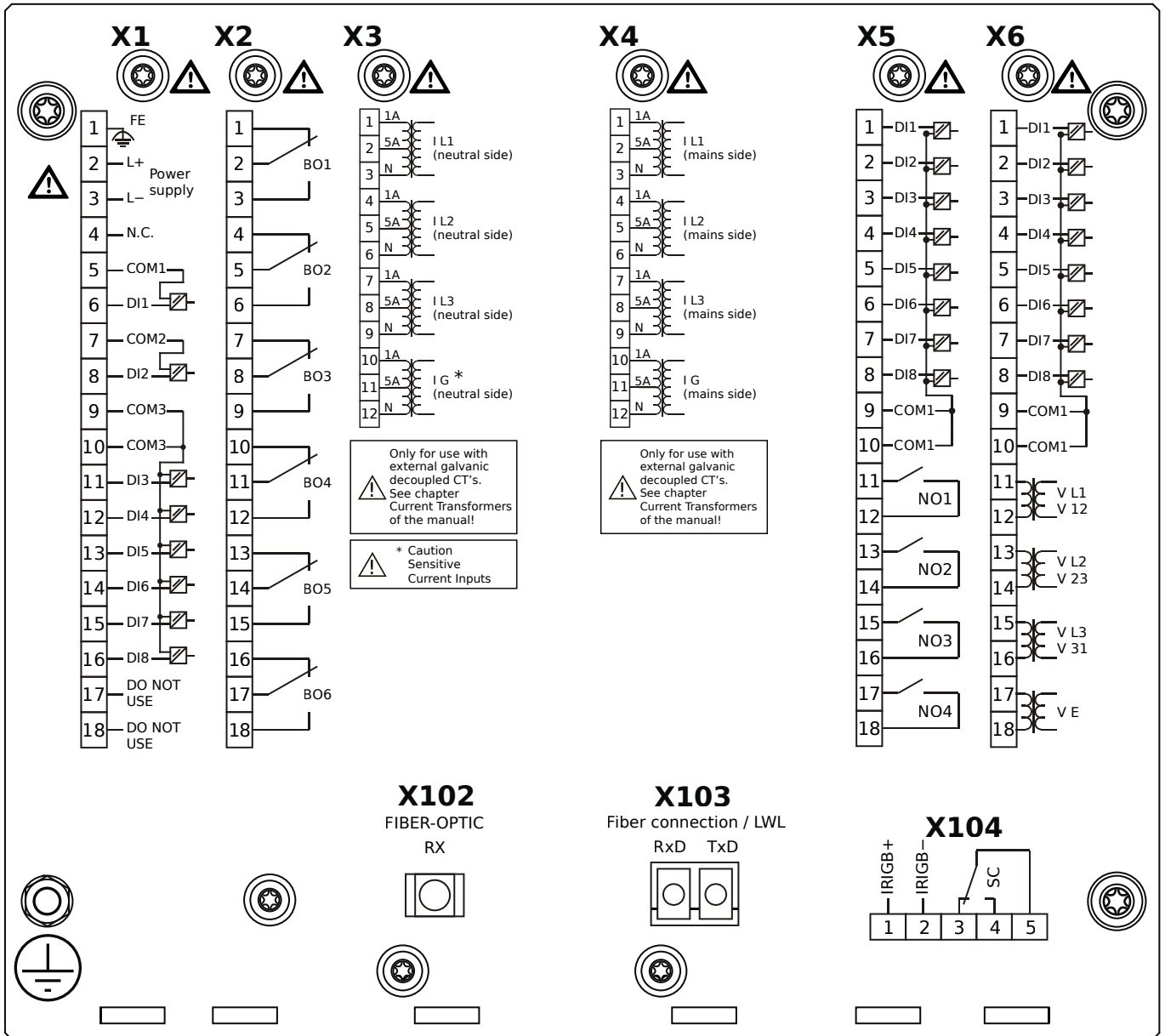

Housing B2, large display, door mounting

+ Conformal Coating (for installations in harsh environment)

- X1** – DI8-X1: Wide-range power supply unit, incl. 2 non-grouped digital inputs and 6 grouped digital inputs
- X2** – OR6: Assembly Group with 6 Output Relays (Changeover / Form C)
- X3** – TIs: Standard phase current measuring card and sensitive ground current measuring (neutral side of the diff. prot.)
- X4** – TI: Standard current measuring card (for the mains side of the differential protection)
- X5** – DI8-OR4: Assembly Group with 8 Digital Inputs and 4 Output Relays (NO / Form A)
- X6** – TU-DI8: Voltage measuring (0 ... 300 VAC) assembly group with 8 Digital Inputs
- X102** – Universal Resistance-Temperature Detector (URTD) input, Fiber optics interface, Versatile Link
- X103** – IEC 61850 / Modbus TCP / DNP3.0 TCP/UDP, Fiber optics interface, LC Connector
- X104** – IRIG-B00X, incl. System Contact (Supervision Contact)

MCDGV4-2C1ALA

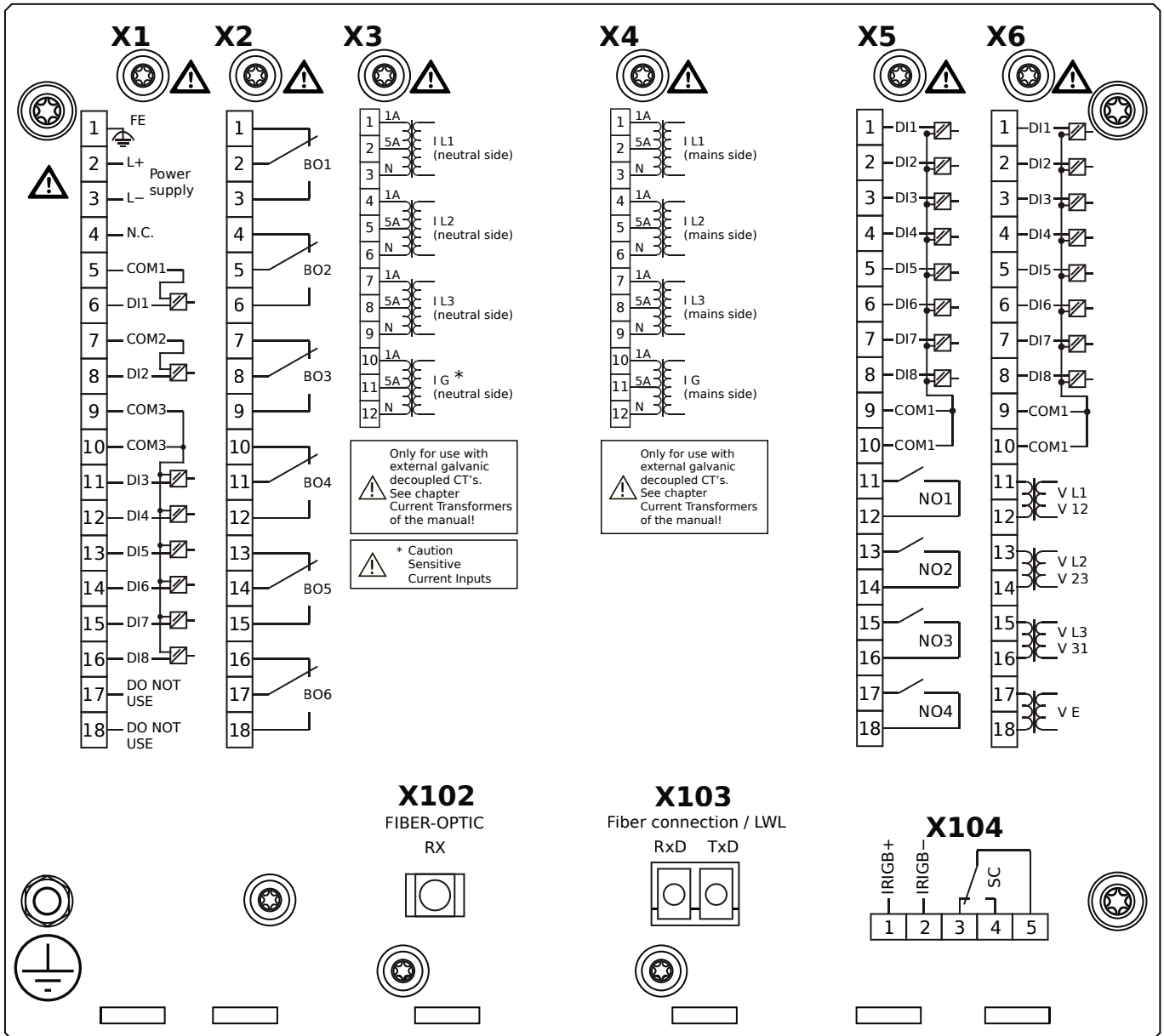

Housing B2, large display, door mounting

- X1** – DI8-X1: Wide-range power supply unit, incl. 2 non-grouped digital inputs and 6 grouped digital inputs
- X2** – OR6: Assembly Group with 6 Output Relays (Changeover / Form C)
- X3** – TI: Standard phase current measuring card and sensitive ground current measuring (neutral side of the diff. prot.)
- X4** – TI: Standard current measuring card (for the mains side of the differential protection)
- X5** – DI8-OR4: Assembly Group with 8 Digital Inputs and 4 Output Relays (NO / Form A)
- X6** – TU-DI8: Voltage measuring (0 ... 300 VAC) assembly group with 8 Digital Inputs
- X102** – Universal Resistance-Temperature Detector (URTD) input, Fiber optics interface, Versatile Link
- X103** – Modbus TCP / DNP3.0 TCP/UDP, Fiber optics interface, LC Connector
- X104** – IRIG-B00X, incl. System Contact (Supervision Contact)

MCDGV4-2C1ALB

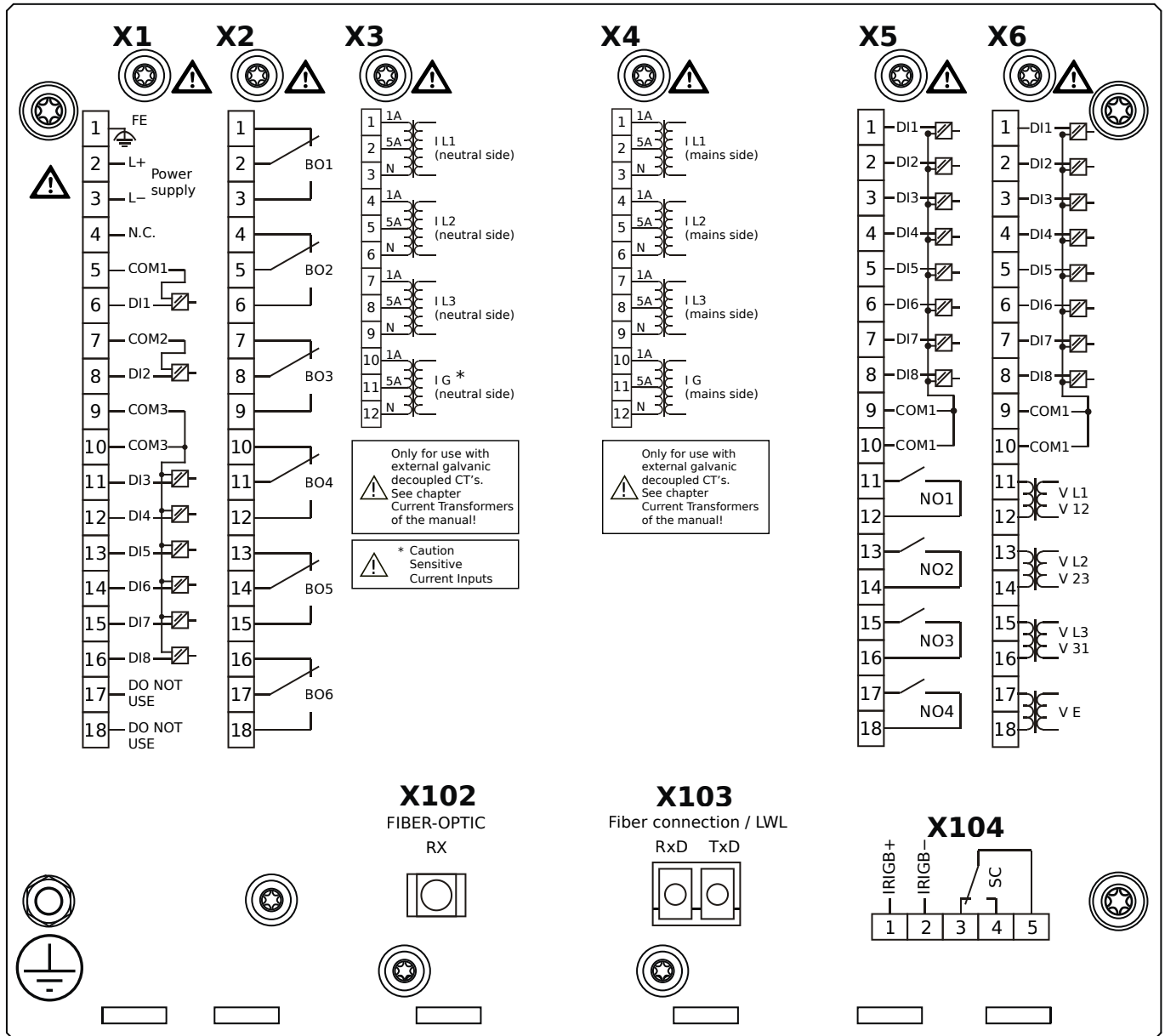

Housing B2, large display, door mounting

+ Conformal Coating (for installations in harsh environment)

- X1** – DI8-X1: Wide-range power supply unit, incl. 2 non-grouped digital inputs and 6 grouped digital inputs
- X2** – OR6: Assembly Group with 6 Output Relays (Changeover / Form C)
- X3** – TIs: Standard phase current measuring card and sensitive ground current measuring (neutral side of the diff. prot.)
- X4** – TI: Standard current measuring card (for the mains side of the differential protection)
- X5** – DI8-OR4: Assembly Group with 8 Digital Inputs and 4 Output Relays (NO / Form A)
- X6** – TU-DI8: Voltage measuring (0 ... 300 VAC) assembly group with 8 Digital Inputs
- X102** – Universal Resistance-Temperature Detector (URTD) input, Fiber optics interface, Versatile Link
- X103** – Modbus TCP / DNP3.0 TCP/UDP, Fiber optics interface, LC Connector
- X104** – IRIG-B00X, incl. System Contact (Supervision Contact)

MCDGV4-2C1ATA

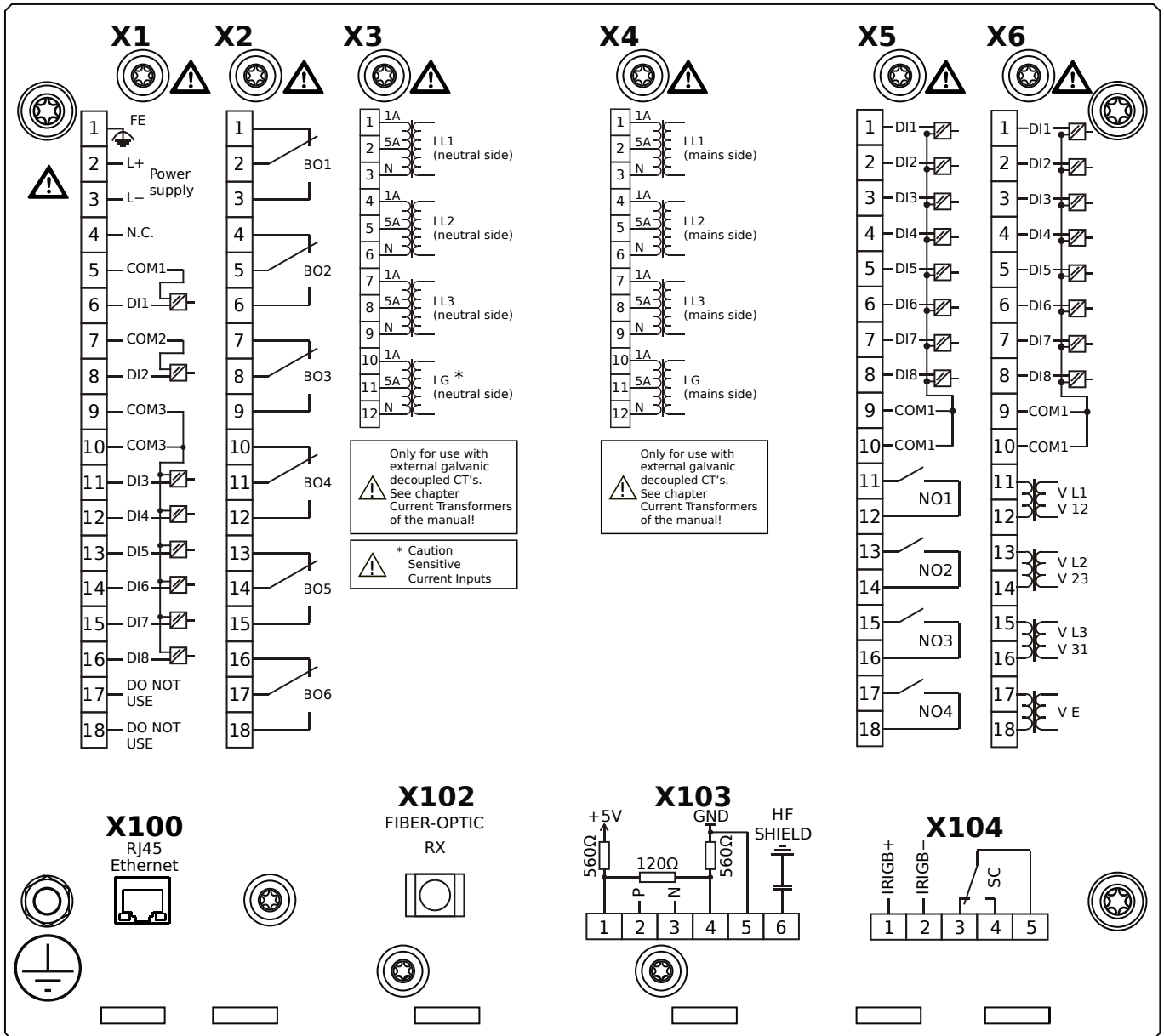

Housing B2, large display, door mounting

- X1** – DI8-X1: Wide-range power supply unit, incl. 2 non-grouped digital inputs and 6 grouped digital inputs
- X2** – OR6: Assembly Group with 6 Output Relays (Changeover / Form C)
- X3** – TIs: Standard phase current measuring card and sensitive ground current measuring (neutral side of the diff. prot.)
- X4** – TI: Standard current measuring card (for the mains side of the differential protection)
- X5** – DI8-OR4: Assembly Group with 8 Digital Inputs and 4 Output Relays (NO / Form A)
- X6** – TU-DI8: Voltage measuring (0 ... 300 VAC) assembly group with 8 Digital Inputs
- X100** – IEC 61850 / Modbus TCP / DNP3.0 TCP/UDP, Ethernet interface, 100 Mbit/s, RJ45 (BASE100-FX)
- X102** – Universal Resistance-Temperature Detector (URTD) input, Fiber optics interface, Versatile Link
- X103** – IEC 60870-5-103 / Modbus RTU / DNP3.0 RTU, RS485, Terminals
- X104** – IRIG-B00X, incl. System Contact (Supervision Contact)

MCDGV4-2C1ATB

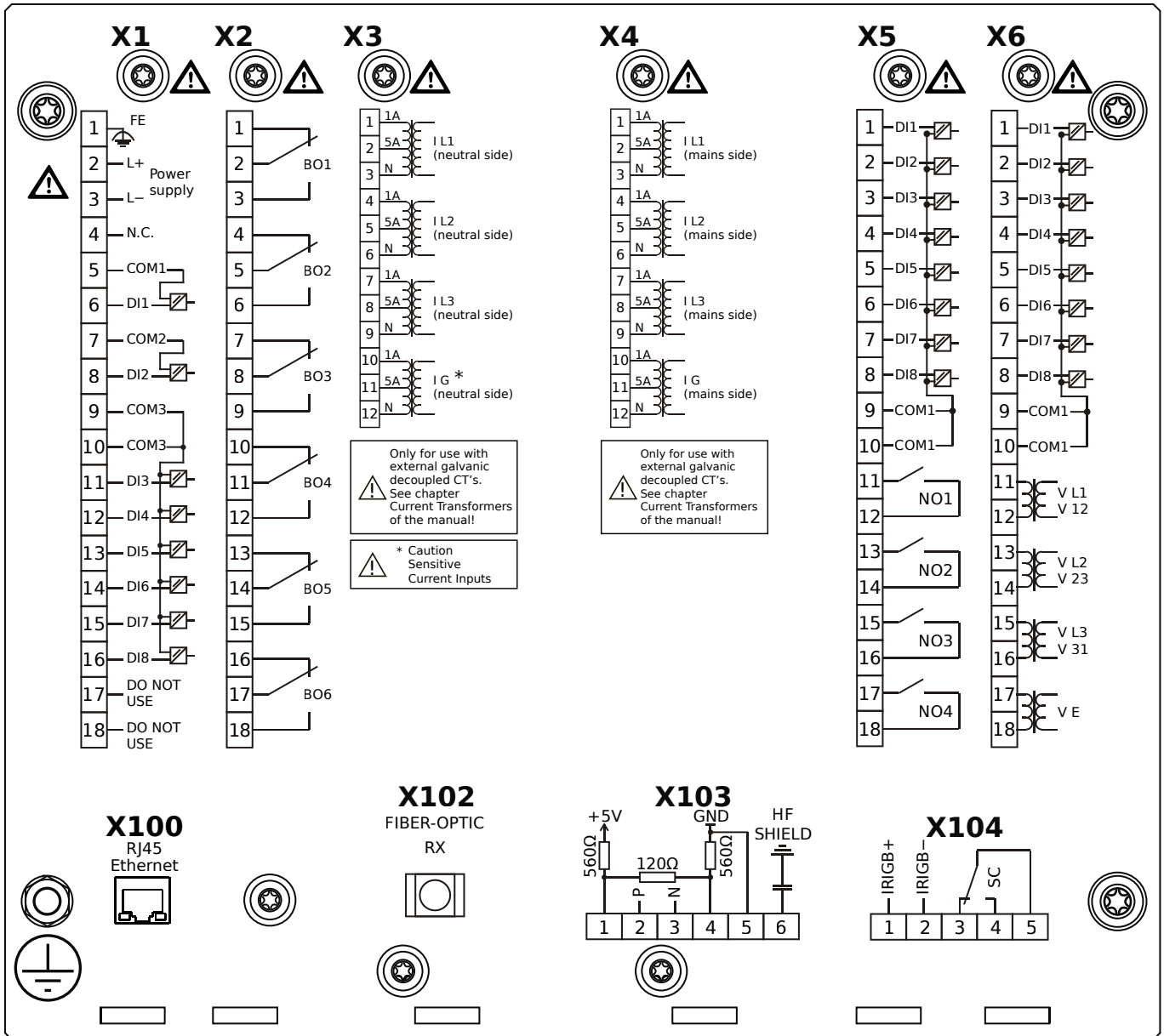

Housing B2, large display, door mounting

+ Conformal Coating (for installations in harsh environment)

- X1** – DI8-X1: Wide-range power supply unit, incl. 2 non-grouped digital inputs and 6 grouped digital inputs
- X2** – OR6: Assembly Group with 6 Output Relays (Changeover / Form C)
- X3** – TIs: Standard phase current measuring card and sensitive ground current measuring (neutral side of the diff. prot.)
- X4** – TI: Standard current measuring card (for the mains side of the differential protection)
- X5** – DI8-OR4: Assembly Group with 8 Digital Inputs and 4 Output Relays (NO / Form A)
- X6** – TU-DI8: Voltage measuring (0 ... 300 VAC) assembly group with 8 Digital Inputs
- X100** – IEC 61850 / Modbus TCP / DNP3.0 TCP/UDP, Ethernet interface, 100 Mbit/s, RJ45 (BASE100-FX)
- X102** – Universal Resistance-Temperature Detector (URTD) input, Fiber optics interface, Versatile Link
- X103** – IEC 60870-5-103 / Modbus RTU / DNP3.0 RTU, RS485, Terminals
- X104** – IRIG-B00X, incl. System Contact (Supervision Contact)

MCDGV4-2C1BAA

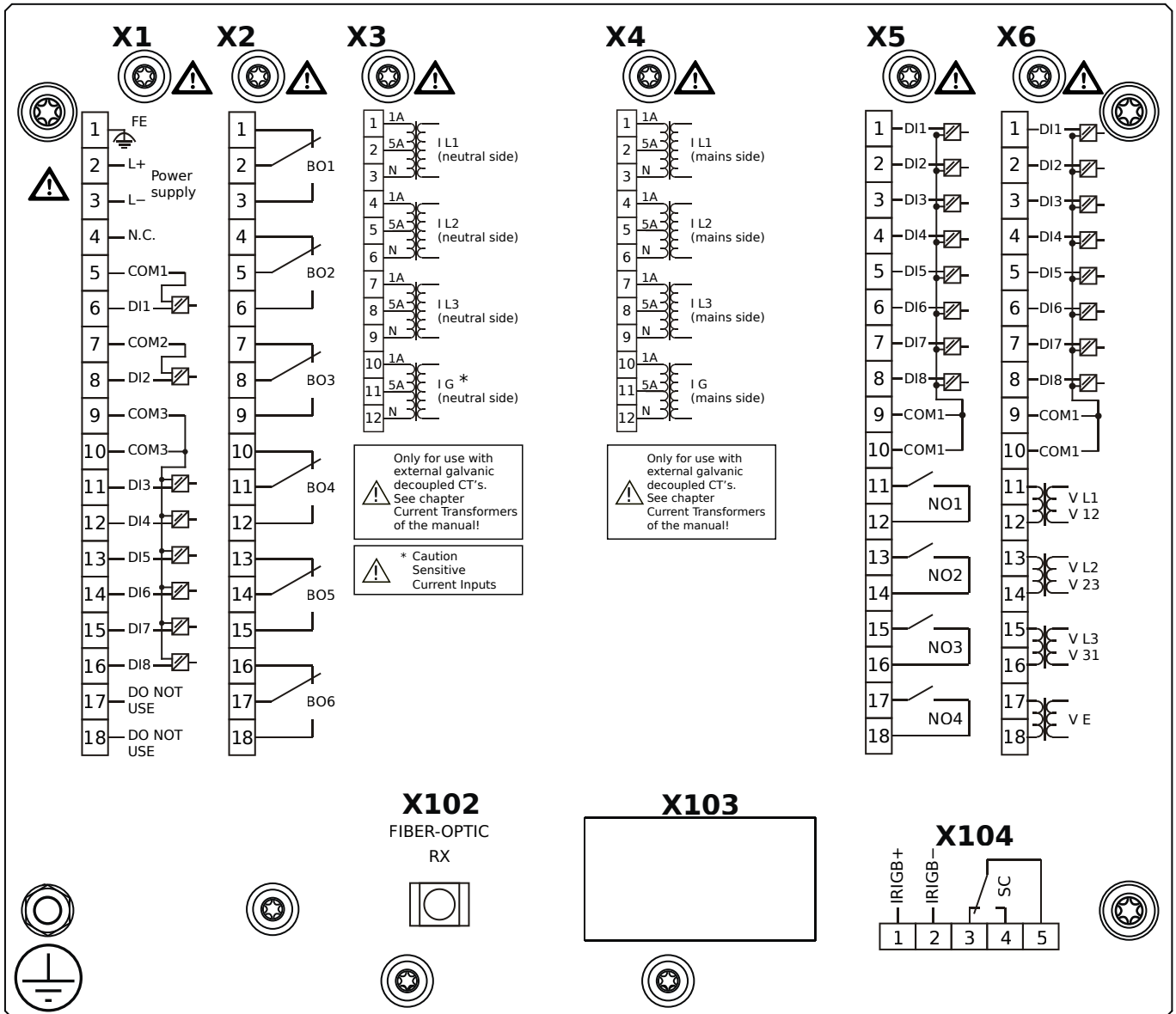

Housing B2, large display, 19" rack mounting

- X1** – DI8-X1: Wide-range power supply unit, incl. 2 non-grouped digital inputs and 6 grouped digital inputs
- X2** – OR6: Assembly Group with 6 Output Relays (Changeover / Form C)
- X3** – TIs: Standard phase current measuring card and sensitive ground current measuring (neutral side of the diff. prot.)
- X4** – TI: Standard current measuring card (for the mains side of the differential protection)
- X5** – DI8-OR4: Assembly Group with 8 Digital Inputs and 4 Output Relays (NO / Form A)
- X6** – TU-DI8: Voltage measuring (0 ... 300 VAC) assembly group with 8 Digital Inputs
- X102** – Universal Resistance-Temperature Detector (URTD) input, Fiber optics interface, Versatile Link
- X104** – IRIG-B00X, incl. System Contact (Supervision Contact)

MCDGV4-2C1BAB

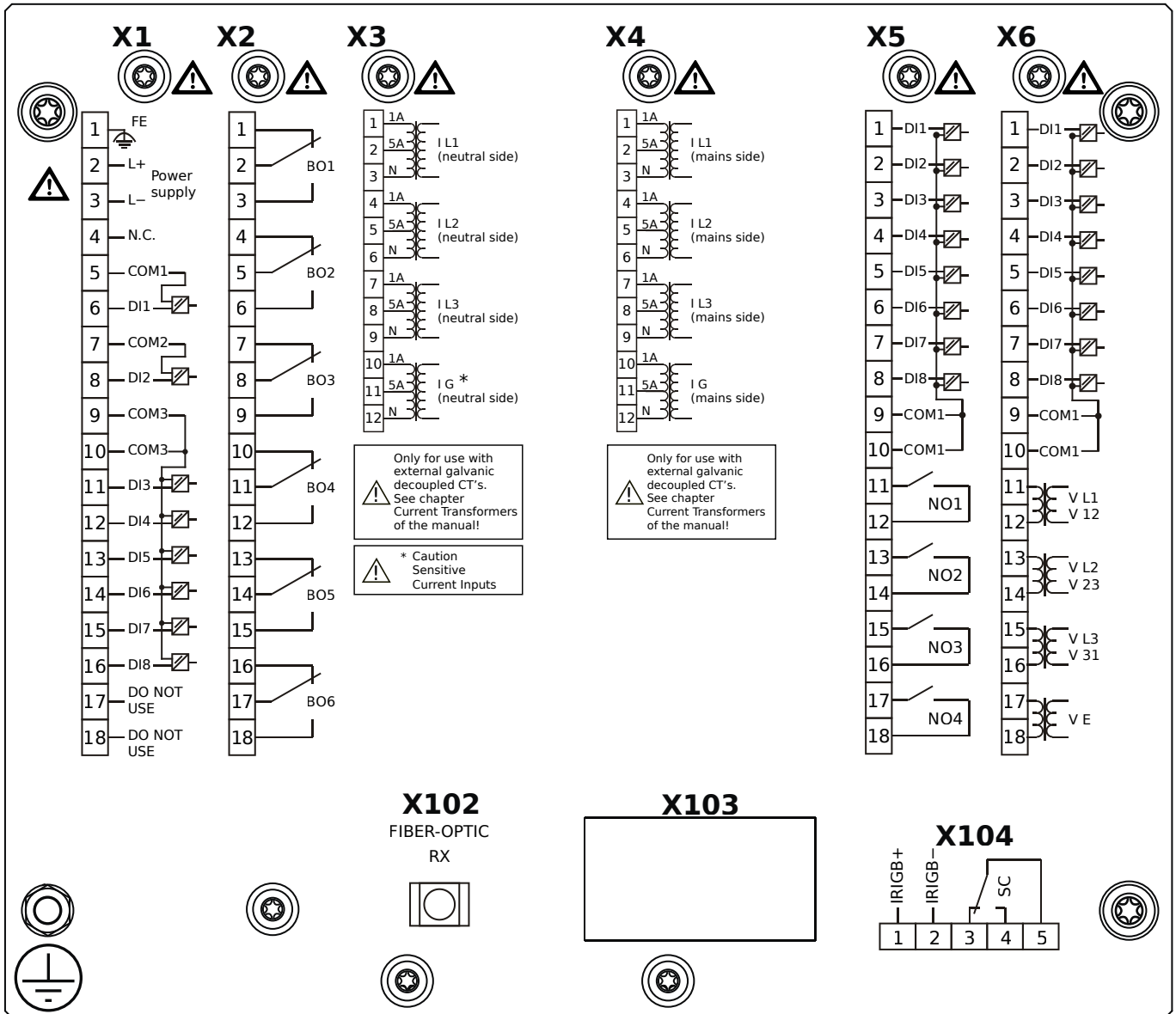

Housing B2, large display, 19" rack mounting

+ Conformal Coating (for installations in harsh environment)

- X1** – DI8-X1: Wide-range power supply unit, incl. 2 non-grouped digital inputs and 6 grouped digital inputs
- X2** – OR6: Assembly Group with 6 Output Relays (Changeover / Form C)
- X3** – TIs: Standard phase current measuring card and sensitive ground current measuring (neutral side of the diff. prot.)
- X4** – TI: Standard current measuring card (for the mains side of the differential protection)
- X5** – DI8-OR4: Assembly Group with 8 Digital Inputs and 4 Output Relays (NO / Form A)
- X6** – TU-DI8: Voltage measuring (0 ... 300 VAC) assembly group with 8 Digital Inputs
- X102** – Universal Resistance-Temperature Detector (URTD) input, Fiber optics interface, Versatile Link
- X104** – IRIG-B00X, incl. System Contact (Supervision Contact)

MCDGV4-2C1BBA

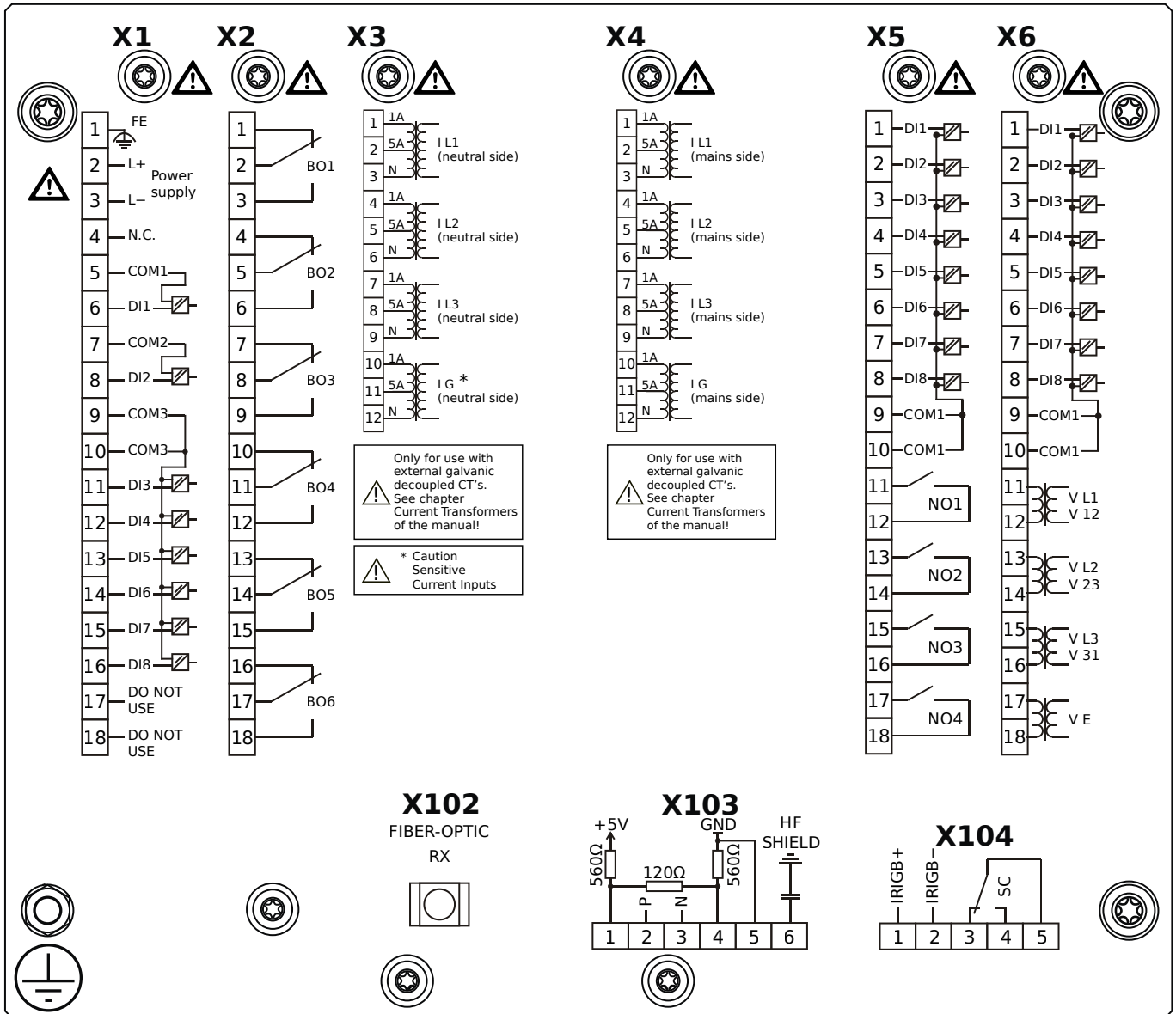

Housing B2, large display, 19" rack mounting

- X1** – DI8-X1: Wide-range power supply unit, incl. 2 non-grouped digital inputs and 6 grouped digital inputs
- X2** – OR6: Assembly Group with 6 Output Relays (Changeover / Form C)
- X3** – TIs: Standard phase current measuring card and sensitive ground current measuring (neutral side of the diff. prot.)
- X4** – TI: Standard current measuring card (for the mains side of the differential protection)
- X5** – DI8-OR4: Assembly Group with 8 Digital Inputs and 4 Output Relays (NO / Form A)
- X6** – TU-DI8: Voltage measuring (0 ... 300 VAC) assembly group with 8 Digital Inputs
- X102** – Universal Resistance-Temperature Detector (URTD) input, Fiber optics interface, Versatile Link
- X103** – Modbus RTU / IEC 60870-5-103 / DNP3.0 RTU, RS485, Terminals
- X104** – IRIG-B00X, incl. System Contact (Supervision Contact)

MCDGV4-2C1BBB

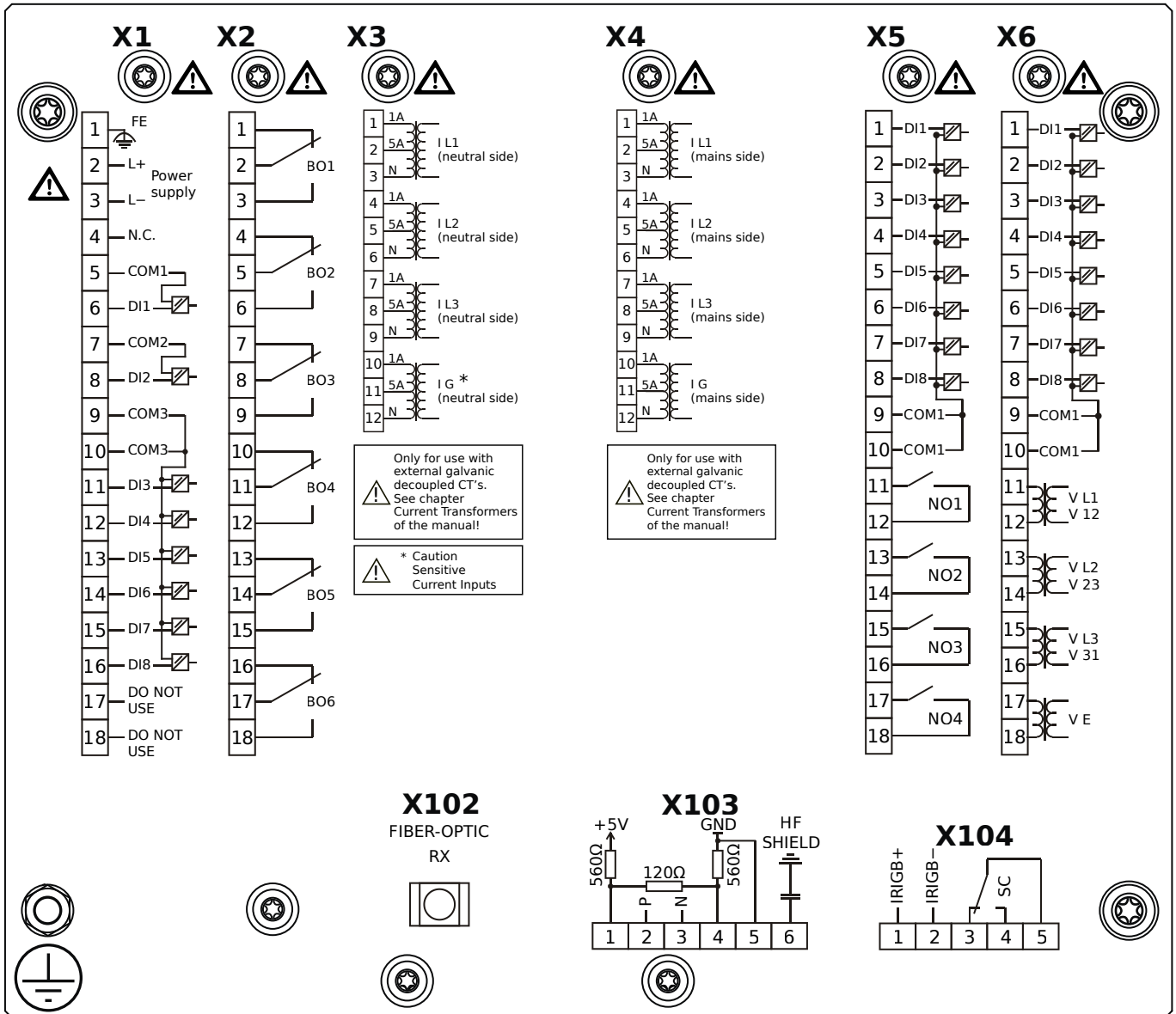

Housing B2, large display, 19" rack mounting

+ Conformal Coating (for installations in harsh environment)

- X1** – DI8-X1: Wide-range power supply unit, incl. 2 non-grouped digital inputs and 6 grouped digital inputs
- X2** – OR6: Assembly Group with 6 Output Relays (Changeover / Form C)
- X3** – TIs: Standard phase current measuring card and sensitive ground current measuring (neutral side of the diff. prot.)
- X4** – TI: Standard current measuring card (for the mains side of the differential protection)
- X5** – DI8-OR4: Assembly Group with 8 Digital Inputs and 4 Output Relays (NO / Form A)
- X6** – TU-DI8: Voltage measuring (0 ... 300 VAC) assembly group with 8 Digital Inputs
- X102** – Universal Resistance-Temperature Detector (URTD) input, Fiber optics interface, Versatile Link
- X103** – Modbus RTU / IEC 60870-5-103 / DNP3.0 RTU, RS485, Terminals
- X104** – IRIG-B00X, incl. System Contact (Supervision Contact)

MCDGV4-2C1BCA

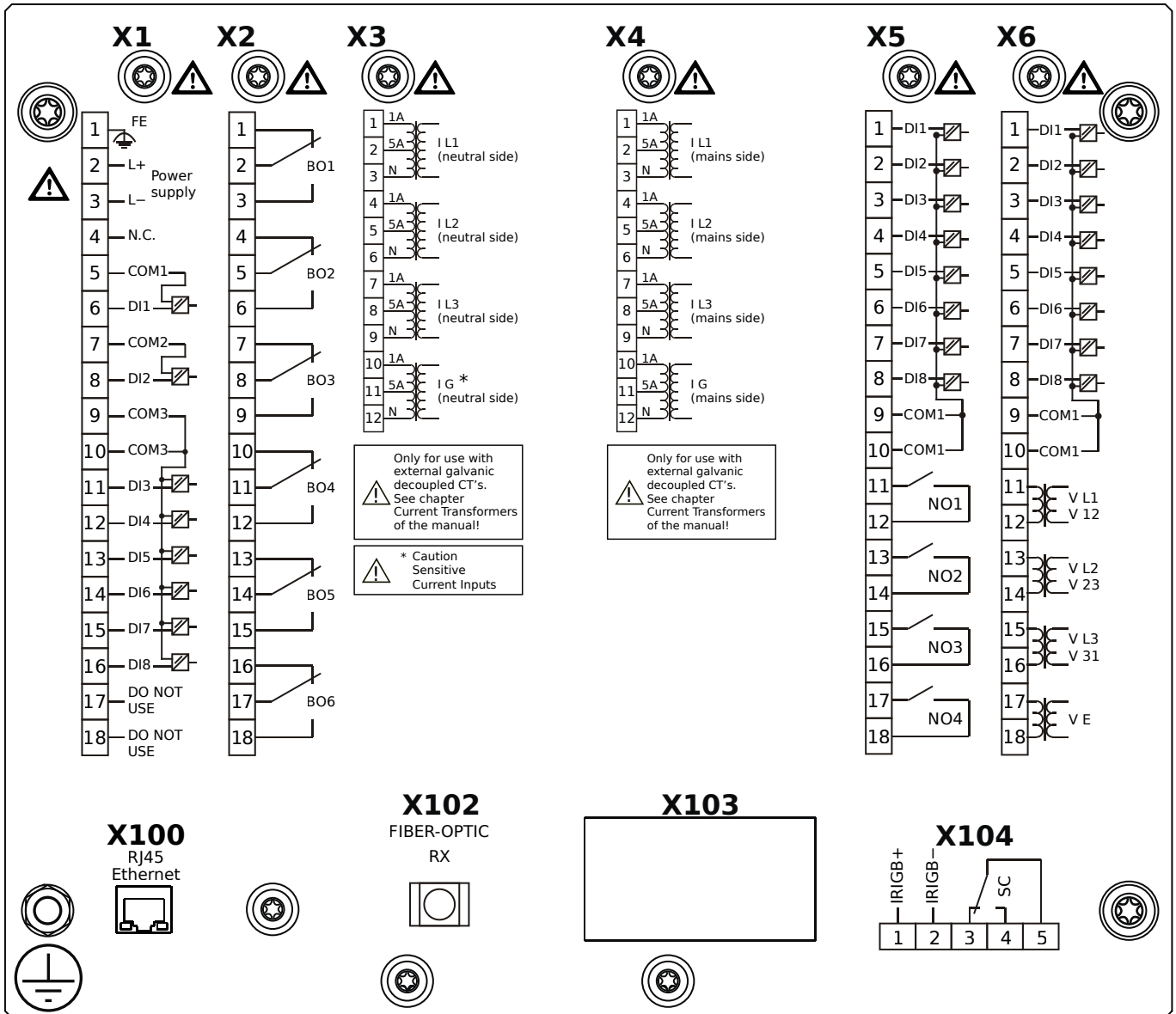

Housing B2, large display, 19" rack mounting

- X1** – DI8-X1: Wide-range power supply unit, incl. 2 non-grouped digital inputs and 6 grouped digital inputs
- X2** – OR6: Assembly Group with 6 Output Relays (Changeover / Form C)
- X3** – TIs: Standard phase current measuring card and sensitive ground current measuring (neutral side of the diff. prot.)
- X4** – TI: Standard current measuring card (for the mains side of the differential protection)
- X5** – DI8-OR4: Assembly Group with 8 Digital Inputs and 4 Output Relays (NO / Form A)
- X6** – TU-DI8: Voltage measuring (0 ... 300 VAC) assembly group with 8 Digital Inputs
- X100** – Modbus TCP / DNP3.0 TCP/UDP, Ethernet interface, 100 Mbit/s, RJ45 (BASE100-FX)
- X102** – Universal Resistance-Temperature Detector (URTD) input, Fiber optics interface, Versatile Link
- X104** – IRIG-B00X, incl. System Contact (Supervision Contact)

MCDGV4-2C1BCB

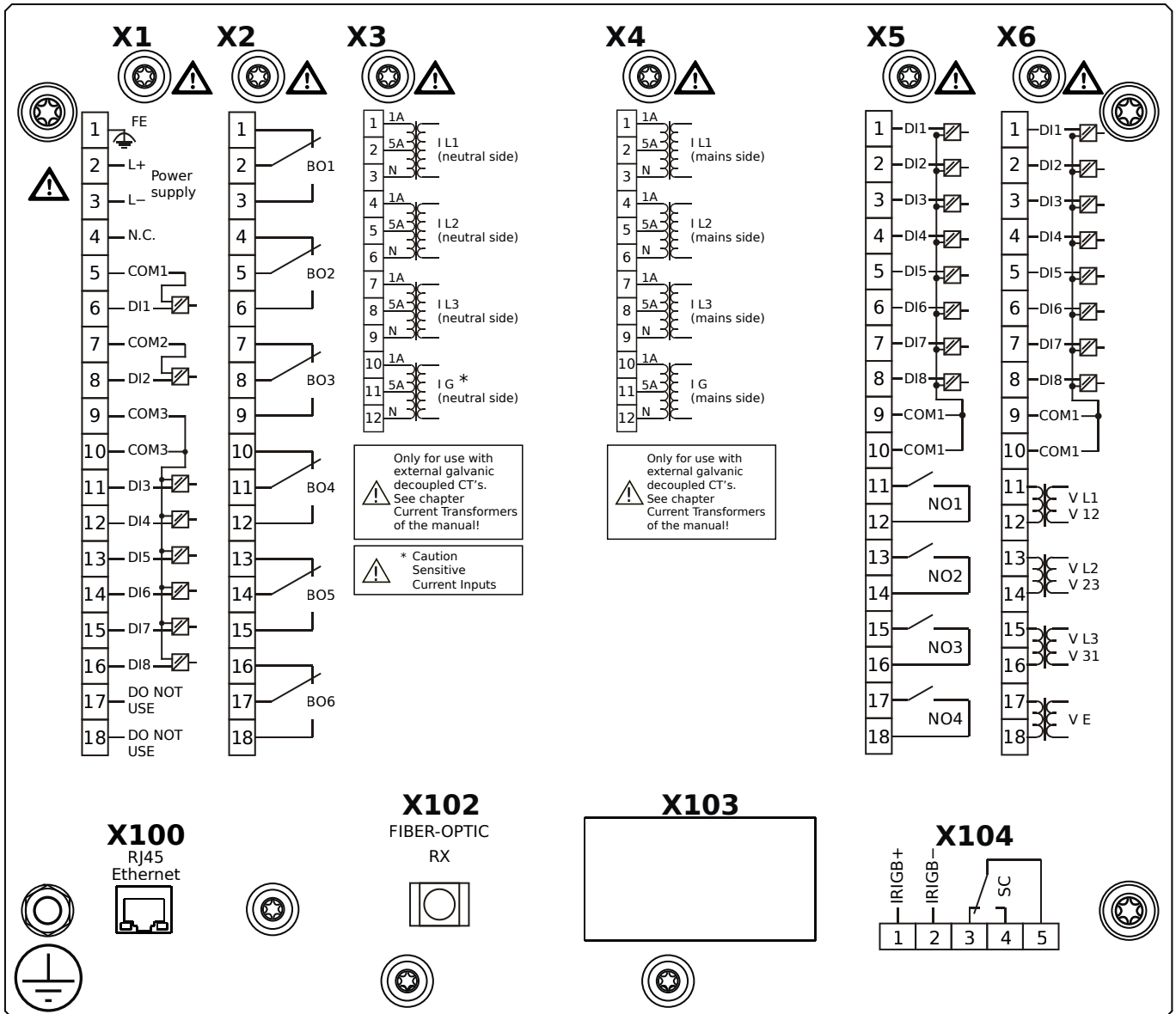

Housing B2, large display, 19" rack mounting

+ Conformal Coating (for installations in harsh environment)

- X1** – DI8-X1: Wide-range power supply unit, incl. 2 non-grouped digital inputs and 6 grouped digital inputs
- X2** – OR6: Assembly Group with 6 Output Relays (Changeover / Form C)
- X3** – TIs: Standard phase current measuring card and sensitive ground current measuring (neutral side of the diff. prot.)
- X4** – TI: Standard current measuring card (for the mains side of the differential protection)
- X5** – DI8-OR4: Assembly Group with 8 Digital Inputs and 4 Output Relays (NO / Form A)
- X6** – TU-DI8: Voltage measuring (0 ... 300 VAC) assembly group with 8 Digital Inputs
- X100** – Modbus TCP / DNP3.0 TCP/UDP, Ethernet interface, 100 Mbit/s, RJ45 (BASE100-FX)
- X102** – Universal Resistance-Temperature Detector (URTD) input, Fiber optics interface, Versatile Link
- X104** – IRIG-B00X, incl. System Contact (Supervision Contact)

MCDGV4-2C1BDA

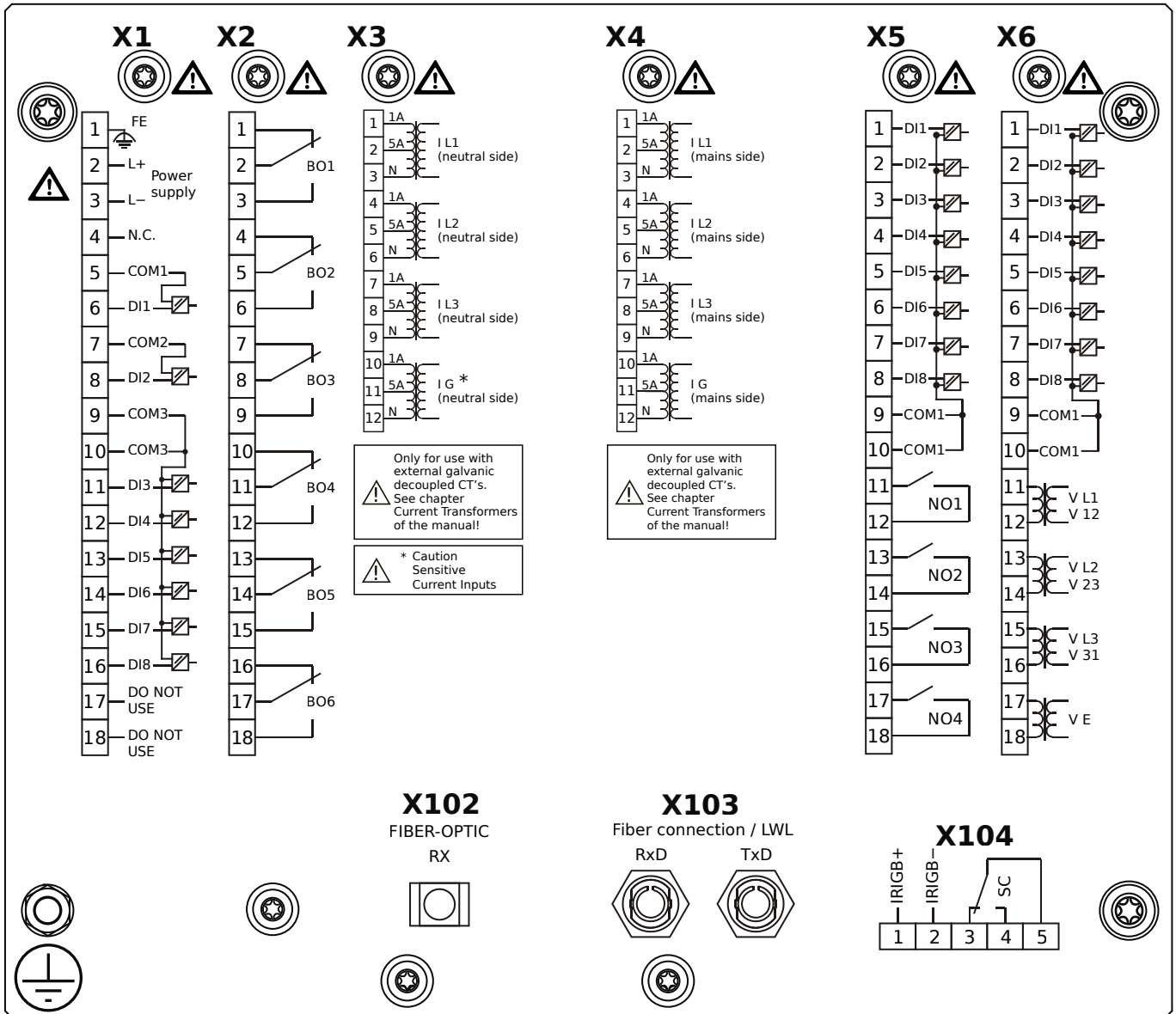

Housing B2, large display, 19" rack mounting

- X1** – DI8-X1: Wide-range power supply unit, incl. 2 non-grouped digital inputs and 6 grouped digital inputs
- X2** – OR6: Assembly Group with 6 Output Relays (Changeover / Form C)
- X3** – TIs: Standard phase current measuring card and sensitive ground current measuring (neutral side of the diff. prot.)
- X4** – TI: Standard current measuring card (for the mains side of the differential protection)
- X5** – DI8-OR4: Assembly Group with 8 Digital Inputs and 4 Output Relays (NO / Form A)
- X6** – TU-DI8: Voltage measuring (0 ... 300 VAC) assembly group with 8 Digital Inputs
- X102** – Universal Resistance-Temperature Detector (URTD) input, Fiber optics interface, Versatile Link
- X103** – Profibus-DP, Fiber optics interface, ST Connector
- X104** – IRIG-B00X, incl. System Contact (Supervision Contact)

MCDGV4-2C1BDB

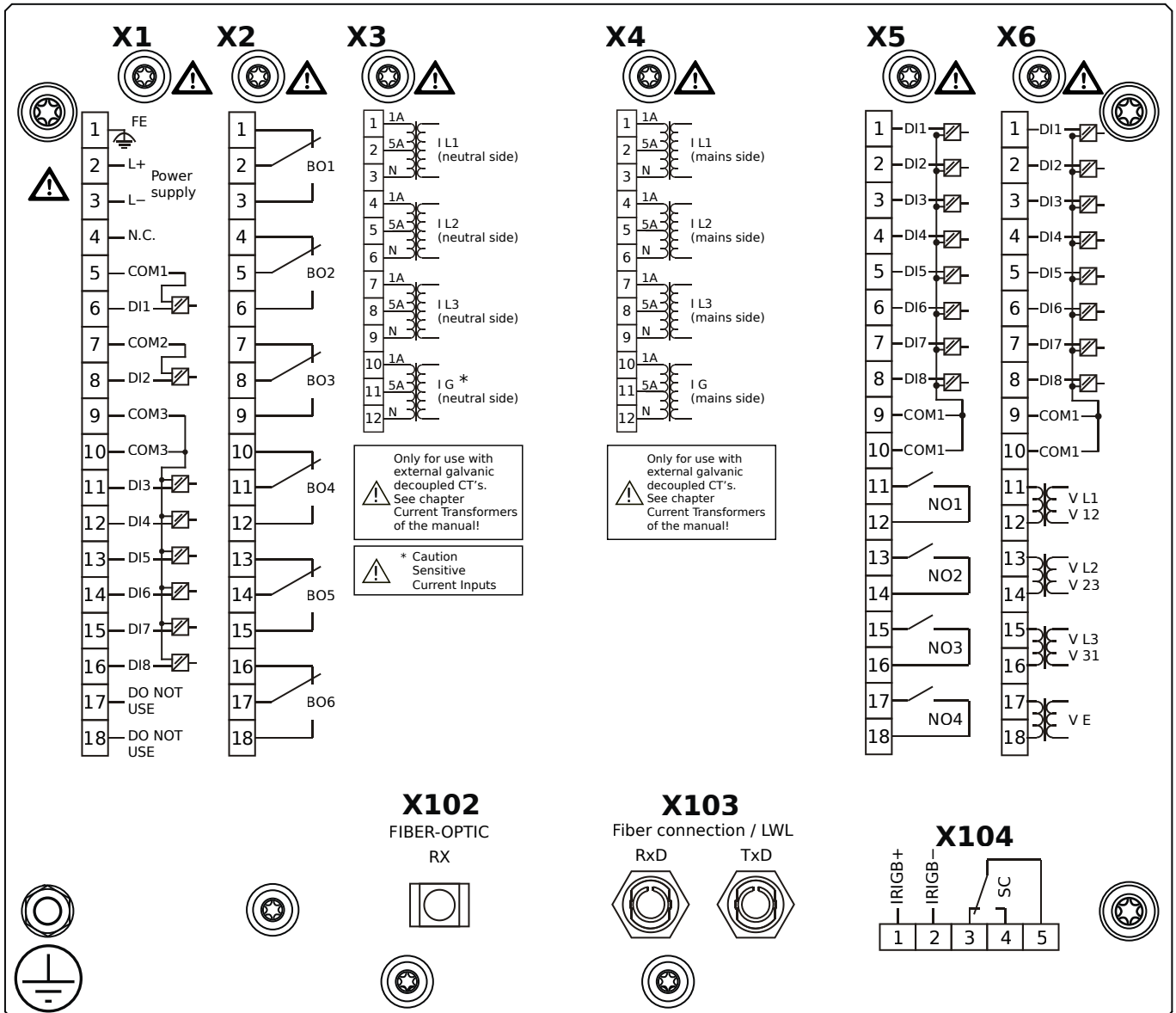

Housing B2, large display, 19" rack mounting

+ Conformal Coating (for installations in harsh environment)

- X1** – DI8-X1: Wide-range power supply unit, incl. 2 non-grouped digital inputs and 6 grouped digital inputs
- X2** – OR6: Assembly Group with 6 Output Relays (Changeover / Form C)
- X3** – TIs: Standard phase current measuring card and sensitive ground current measuring (neutral side of the diff. prot.)
- X4** – TI: Standard current measuring card (for the mains side of the differential protection)
- X5** – DI8-OR4: Assembly Group with 8 Digital Inputs and 4 Output Relays (NO / Form A)
- X6** – TU-DI8: Voltage measuring (0 ... 300 VAC) assembly group with 8 Digital Inputs
- X102** – Universal Resistance-Temperature Detector (URTD) input, Fiber optics interface, Versatile Link
- X103** – Profibus-DP, Fiber optics interface, ST Connector
- X104** – IRIG-B00X, incl. System Contact (Supervision Contact)

MCDGV4-2C1BEA

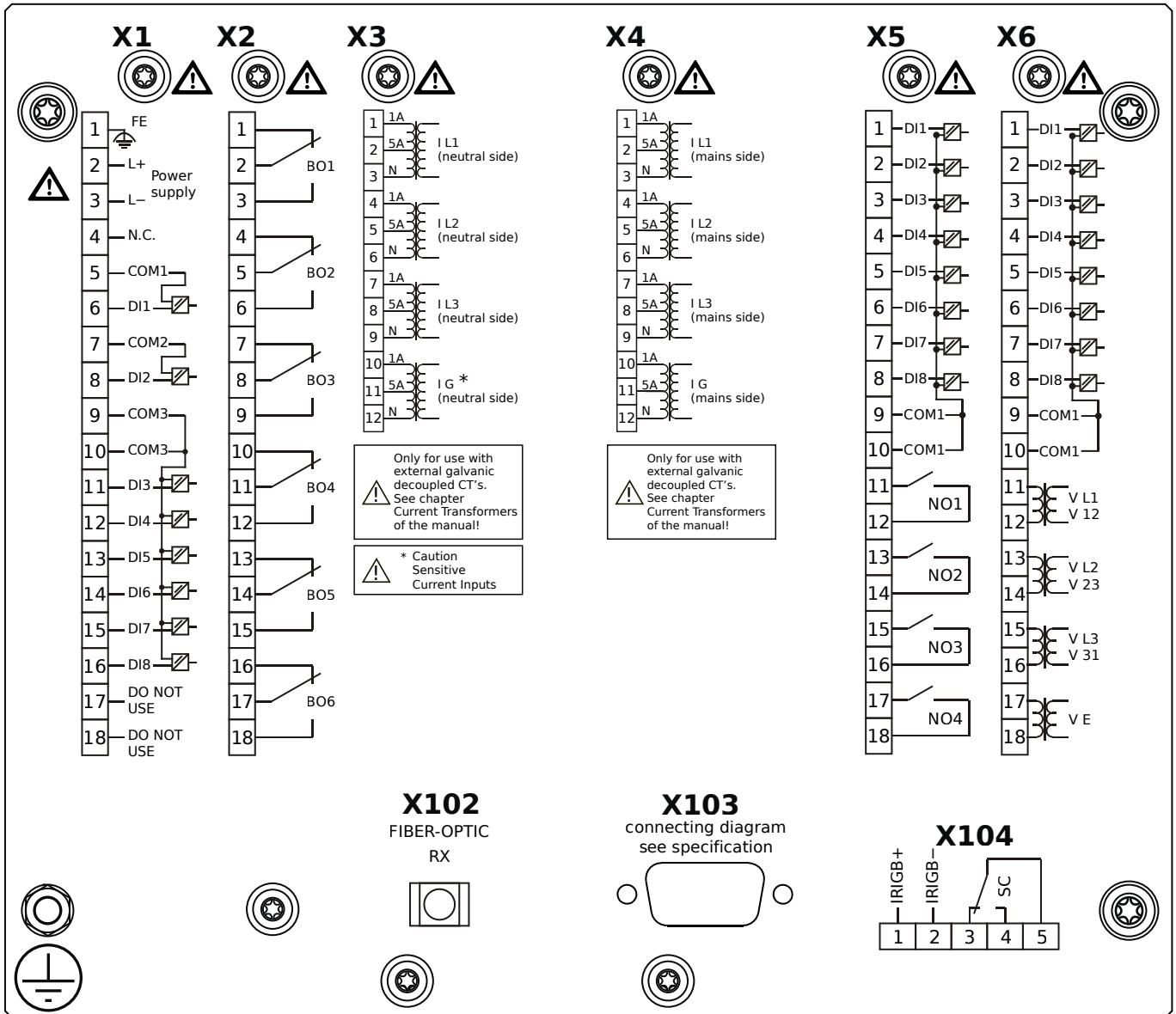

Housing B2, large display, 19" rack mounting

- X1** – DI8-X1: Wide-range power supply unit, incl. 2 non-grouped digital inputs and 6 grouped digital inputs
- X2** – OR6: Assembly Group with 6 Output Relays (Changeover / Form C)
- X3** – TIs: Standard phase current measuring card and sensitive ground current measuring (neutral side of the diff. prot.)
- X4** – TI: Standard current measuring card (for the mains side of the differential protection)
- X5** – DI8-OR4: Assembly Group with 8 Digital Inputs and 4 Output Relays (NO / Form A)
- X6** – TU-DI8: Voltage measuring (0 ... 300 VAC) assembly group with 8 Digital Inputs
- X102** – Universal Resistance-Temperature Detector (URTD) input, Fiber optics interface, Versatile Link
- X103** – Profibus-DP, RS485, D-SUB
- X104** – IRIG-B00X, incl. System Contact (Supervision Contact)

MCDGV4-2C1BEB

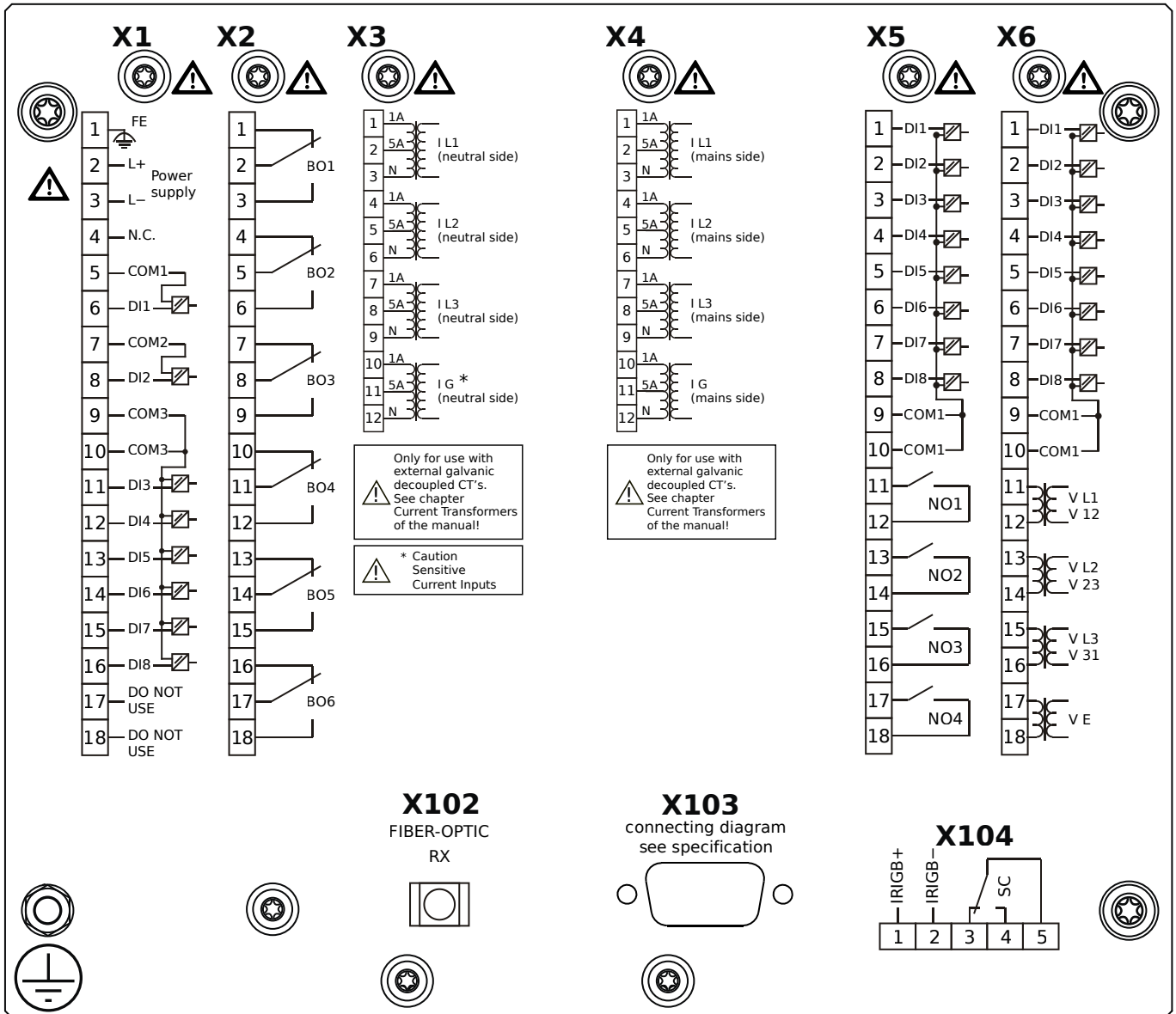

Housing B2, large display, 19" rack mounting

+ Conformal Coating (for installations in harsh environment)

- X1** – DI8-X1: Wide-range power supply unit, incl. 2 non-grouped digital inputs and 6 grouped digital inputs
- X2** – OR6: Assembly Group with 6 Output Relays (Changeover / Form C)
- X3** – TIs: Standard phase current measuring card and sensitive ground current measuring (neutral side of the diff. prot.)
- X4** – TI: Standard current measuring card (for the mains side of the differential protection)
- X5** – DI8-OR4: Assembly Group with 8 Digital Inputs and 4 Output Relays (NO / Form A)
- X6** – TU-DI8: Voltage measuring (0 ... 300 VAC) assembly group with 8 Digital Inputs
- X102** – Universal Resistance-Temperature Detector (URTD) input, Fiber optics interface, Versatile Link
- X103** – Profibus-DP, RS485, D-SUB
- X104** – IRIG-B00X, incl. System Contact (Supervision Contact)

MCDGV4-2C1BFA

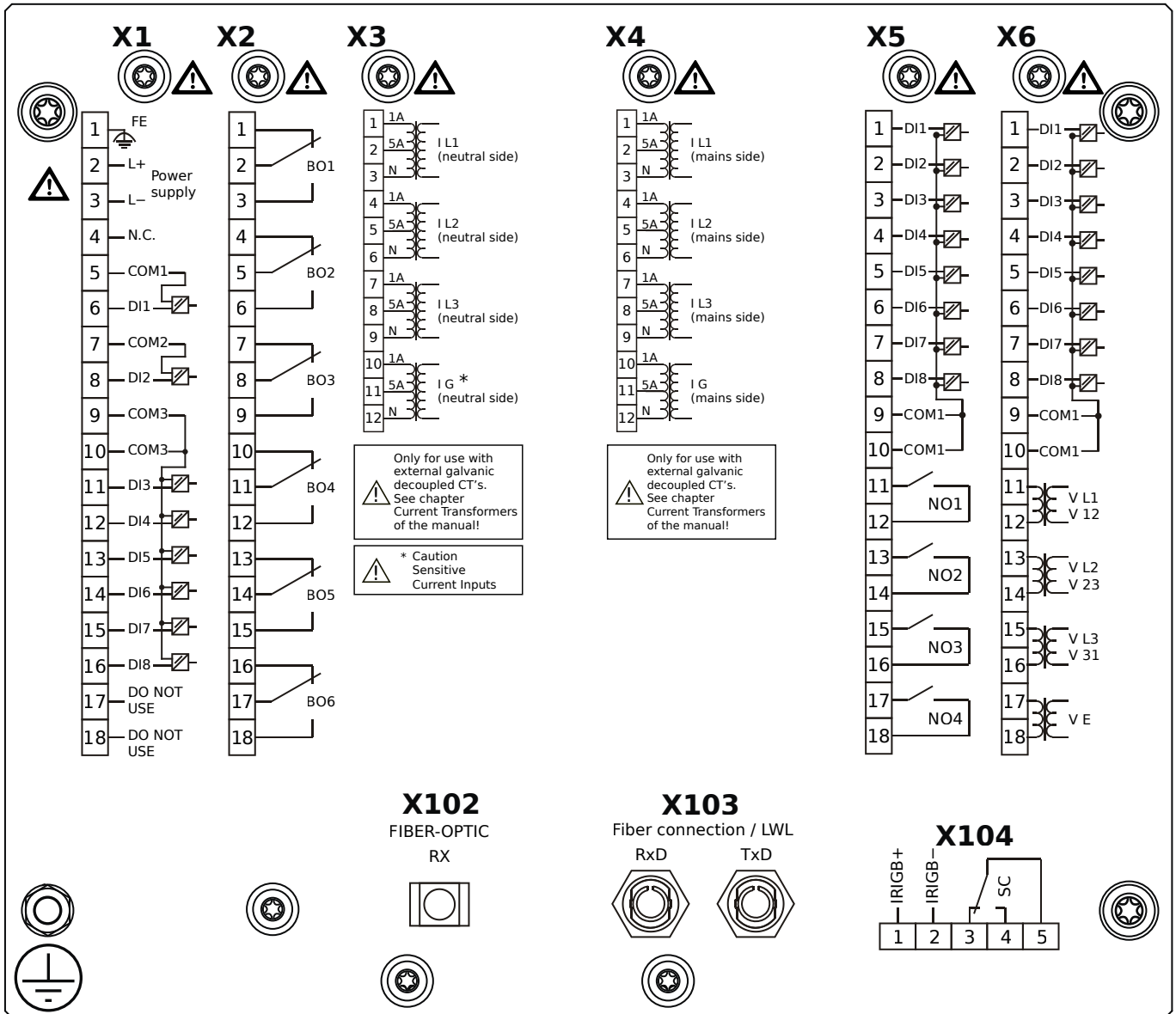

Housing B2, large display, 19" rack mounting

- X1** – DI8-X1: Wide-range power supply unit, incl. 2 non-grouped digital inputs and 6 grouped digital inputs
- X2** – OR6: Assembly Group with 6 Output Relays (Changeover / Form C)
- X3** – TIs: Standard phase current measuring card and sensitive ground current measuring (neutral side of the diff. prot.)
- X4** – TI: Standard current measuring card (for the mains side of the differential protection)
- X5** – DI8-OR4: Assembly Group with 8 Digital Inputs and 4 Output Relays (NO / Form A)
- X6** – TU-DI8: Voltage measuring (0 ... 300 VAC) assembly group with 8 Digital Inputs
- X102** – Universal Resistance-Temperature Detector (URTD) input, Fiber optics interface, Versatile Link
- X103** – Modbus RTU / IEC 60870-5-103 / DNP3.0 RTU, Fiber optics interface, ST Connector
- X104** – IRIG-B00X, incl. System Contact (Supervision Contact)

MCDGV4-2C1BFB

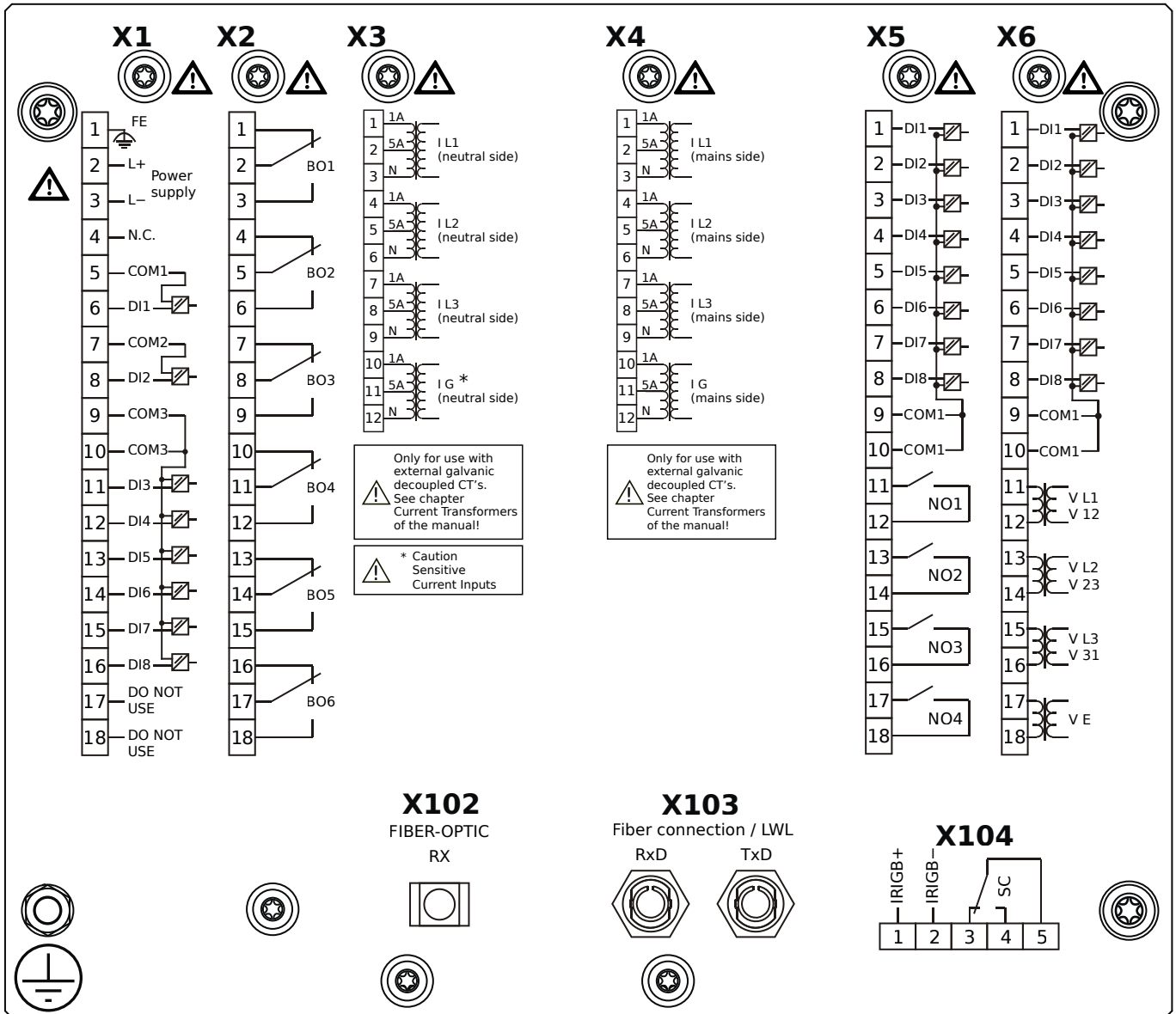

Housing B2, large display, 19" rack mounting

+ Conformal Coating (for installations in harsh environment)

- X1** – DI8-X1: Wide-range power supply unit, incl. 2 non-grouped digital inputs and 6 grouped digital inputs
- X2** – OR6: Assembly Group with 6 Output Relays (Changeover / Form C)
- X3** – TIs: Standard phase current measuring card and sensitive ground current measuring (neutral side of the diff. prot.)
- X4** – TI: Standard current measuring card (for the mains side of the differential protection)
- X5** – DI8-OR4: Assembly Group with 8 Digital Inputs and 4 Output Relays (NO / Form A)
- X6** – TU-DI8: Voltage measuring (0 ... 300 VAC) assembly group with 8 Digital Inputs
- X102** – Universal Resistance-Temperature Detector (URTD) input, Fiber optics interface, Versatile Link
- X103** – Modbus RTU / IEC 60870-5-103 / DNP3.0 RTU, Fiber optics interface, ST Connector
- X104** – IRIG-B00X, incl. System Contact (Supervision Contact)

MCDGV4-2C1BGA

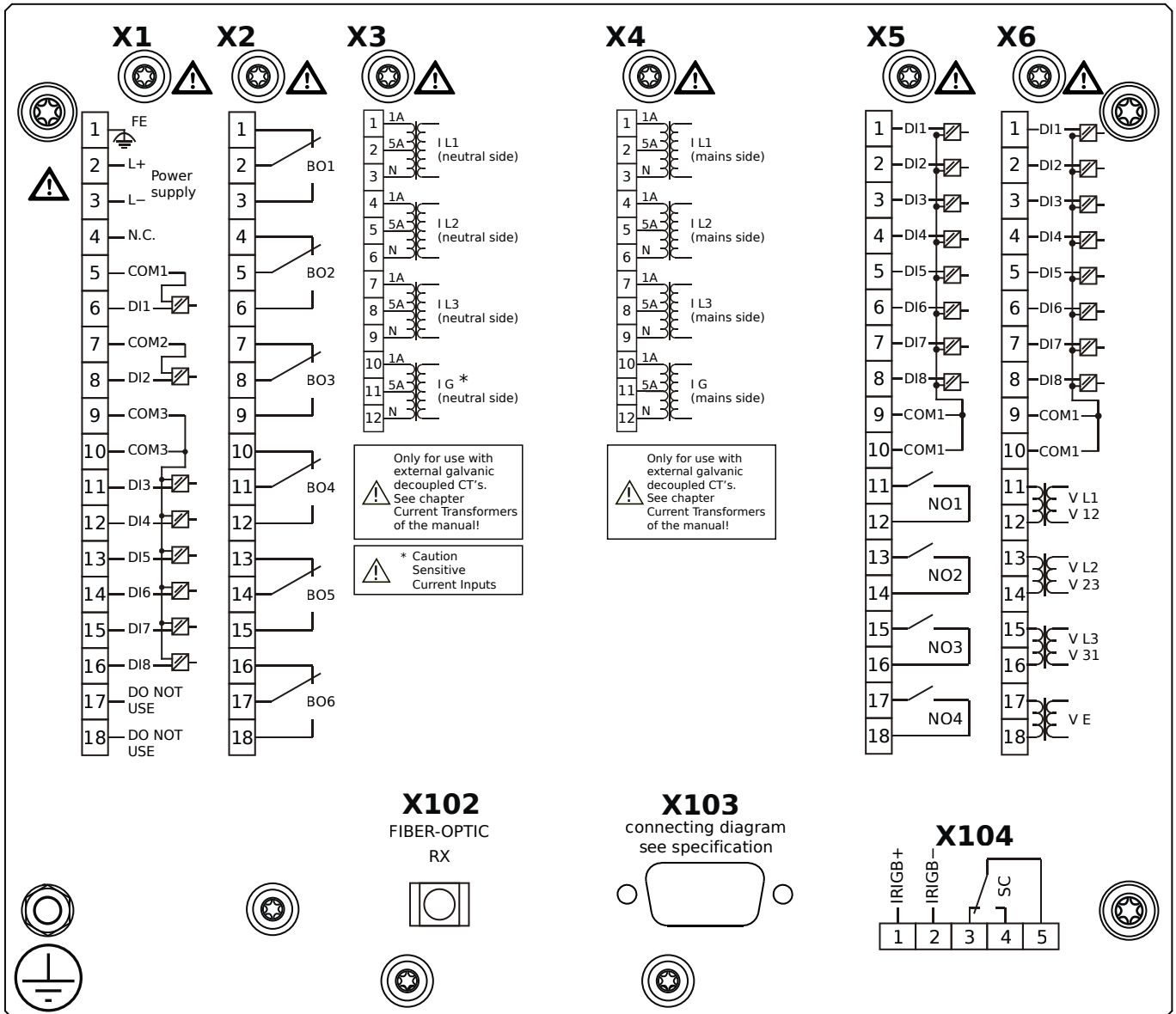

Housing B2, large display, 19" rack mounting

- X1** – DI8-X1: Wide-range power supply unit, incl. 2 non-grouped digital inputs and 6 grouped digital inputs
- X2** – OR6: Assembly Group with 6 Output Relays (Changeover / Form C)
- X3** – TIs: Standard phase current measuring card and sensitive ground current measuring (neutral side of the diff. prot.)
- X4** – TI: Standard current measuring card (for the mains side of the differential protection)
- X5** – DI8-OR4: Assembly Group with 8 Digital Inputs and 4 Output Relays (NO / Form A)
- X6** – TU-DI8: Voltage measuring (0 ... 300 VAC) assembly group with 8 Digital Inputs
- X102** – Universal Resistance-Temperature Detector (URTD) input, Fiber optics interface, Versatile Link
- X103** – Modbus RTU / IEC 60870-5-103 / DNP3.0 RTU, RS485, D-SUB
- X104** – IRIG-B00X, incl. System Contact (Supervision Contact)

MCDGV4-2C1BGB

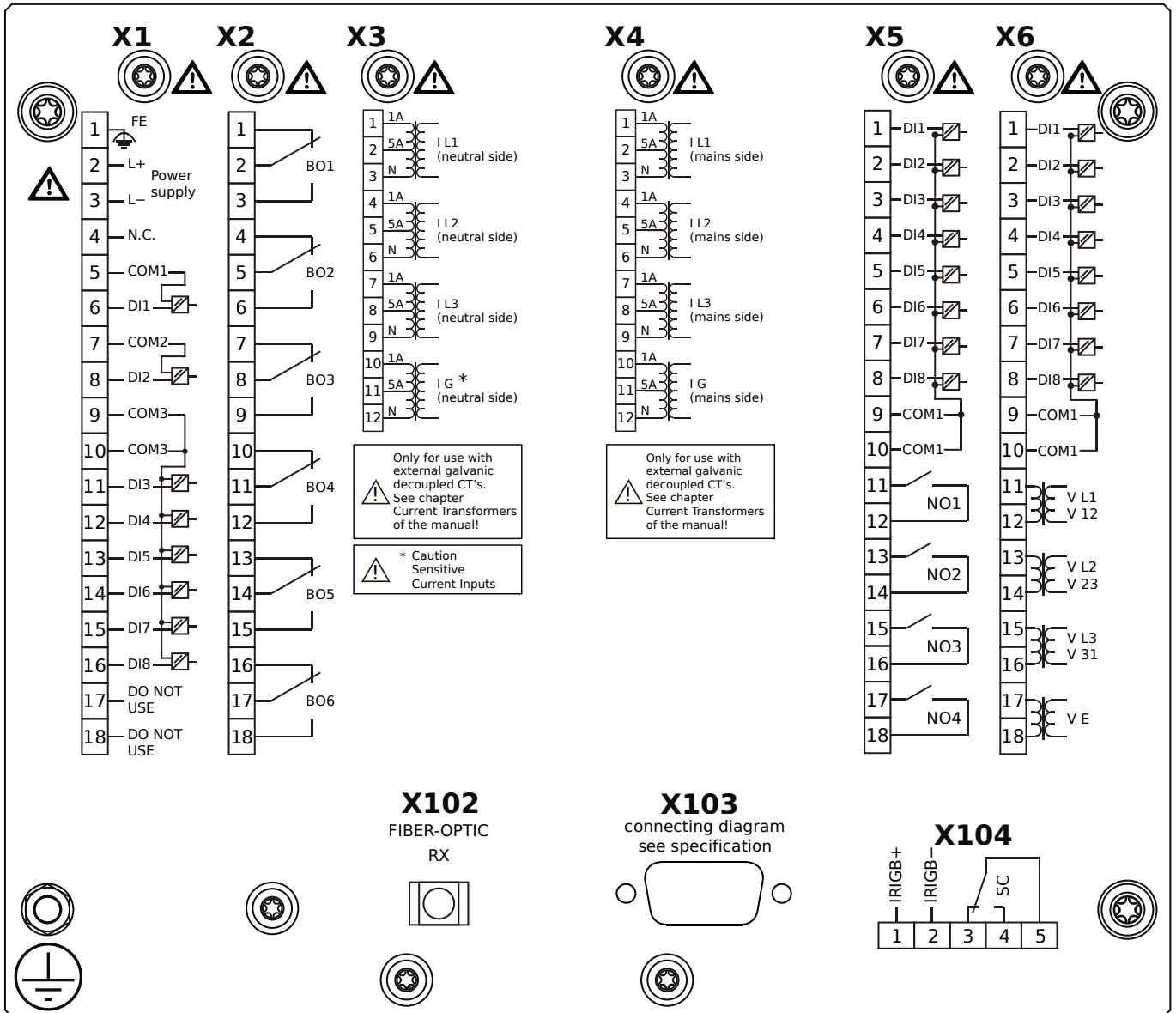

Housing B2, large display, 19" rack mounting

+ Conformal Coating (for installations in harsh environment)

- X1** – DI8-X1: Wide-range power supply unit, incl. 2 non-grouped digital inputs and 6 grouped digital inputs
- X2** – OR6: Assembly Group with 6 Output Relays (Changeover / Form C)
- X3** – TIs: Standard phase current measuring card and sensitive ground current measuring (neutral side of the diff. prot.)
- X4** – TI: Standard current measuring card (for the mains side of the differential protection)
- X5** – DI8-OR4: Assembly Group with 8 Digital Inputs and 4 Output Relays (NO / Form A)
- X6** – TU-DI8: Voltage measuring (0 ... 300 VAC) assembly group with 8 Digital Inputs
- X102** – Universal Resistance-Temperature Detector (URTD) input, Fiber optics interface, Versatile Link
- X103** – Modbus RTU / IEC 60870-5-103 / DNP3.0 RTU, RS485, D-SUB
- X104** – IRIG-B00X, incl. System Contact (Supervision Contact)

MCDGV4-2C1BHA

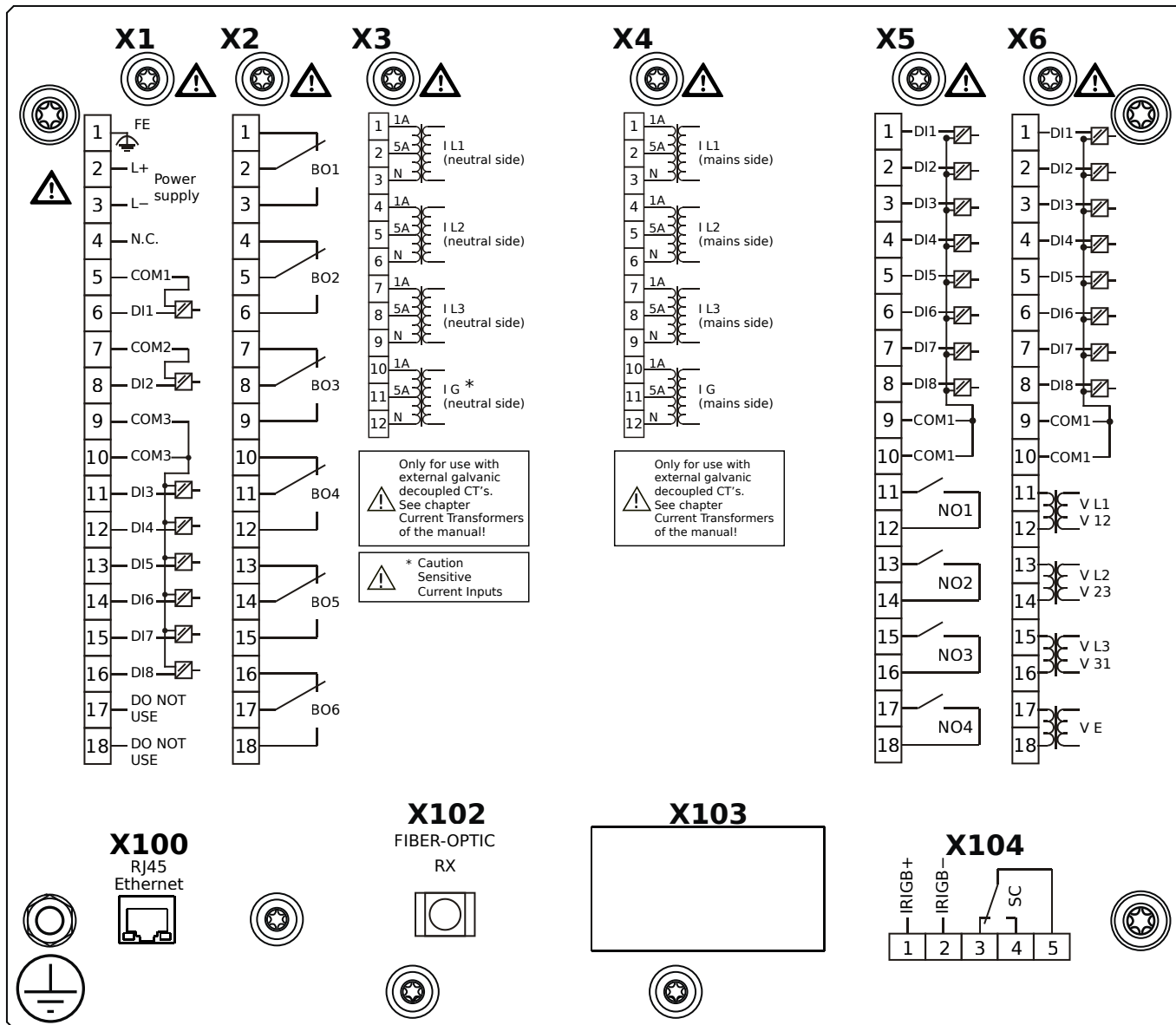

Housing B2, large display, 19" rack mounting

- X1** – DI8-X1: Wide-range power supply unit, incl. 2 non-grouped digital inputs and 6 grouped digital inputs
- X2** – OR6: Assembly Group with 6 Output Relays (Changeover / Form C)
- X3** – TIs: Standard phase current measuring card and sensitive ground current measuring (neutral side of the diff. prot.)
- X4** – TI: Standard current measuring card (for the mains side of the differential protection)
- X5** – DI8-OR4: Assembly Group with 8 Digital Inputs and 4 Output Relays (NO / Form A)
- X6** – TU-DI8: Voltage measuring (0 ... 300 VAC) assembly group with 8 Digital Inputs
- X100** – IEC 61850 / Modbus TCP / DNP3.0 TCP/UDP, Ethernet interface, 100 Mbit/s, RJ45 (BASE100-FX)
- X102** – Universal Resistance-Temperature Detector (URTD) input, Fiber optics interface, Versatile Link
- X104** – IRIG-B00X, incl. System Contact (Supervision Contact)

MCDGV4-2C1BHB

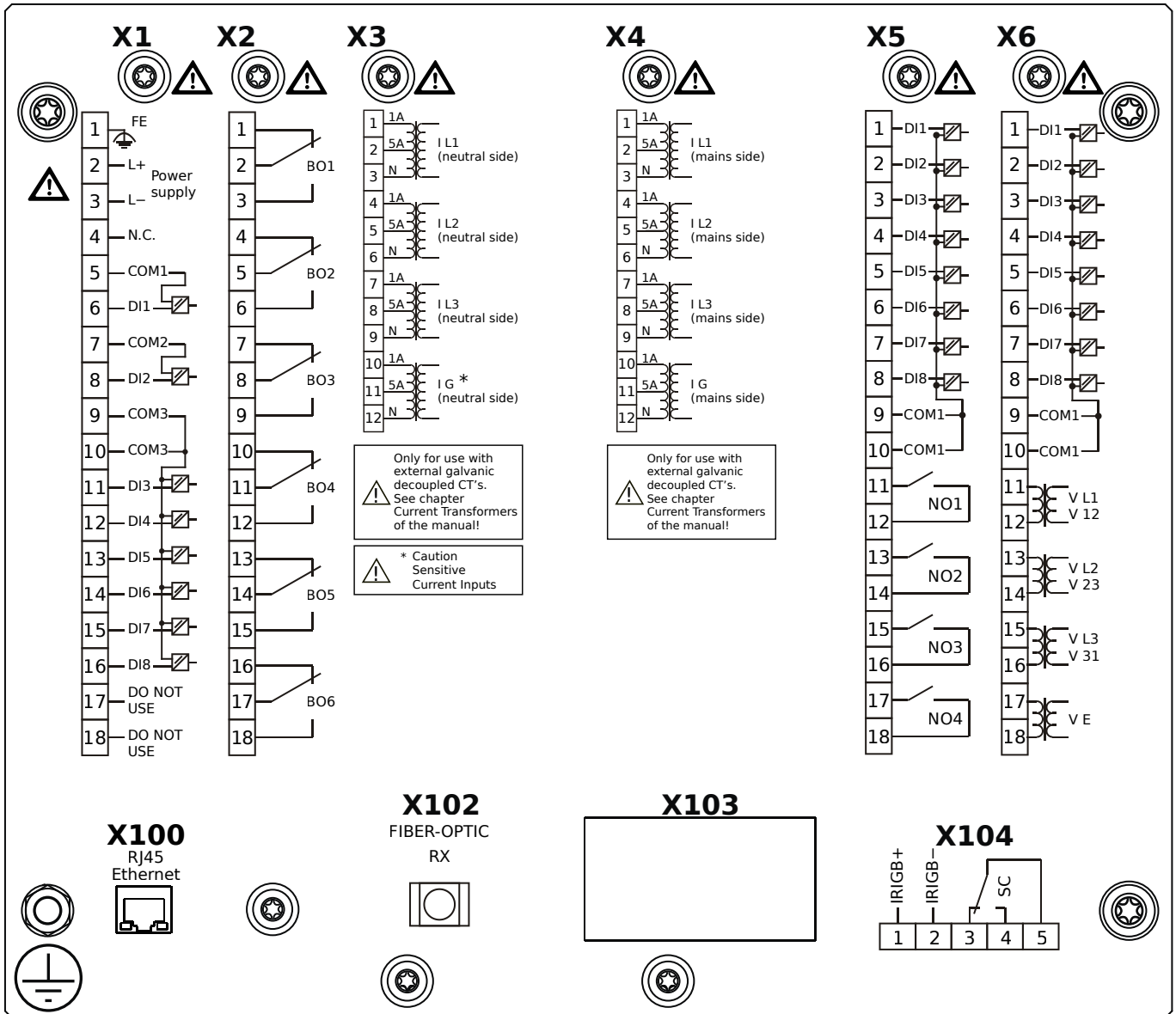

Housing B2, large display, 19" rack mounting

+ Conformal Coating (for installations in harsh environment)

- X1** – DI8-X1: Wide-range power supply unit, incl. 2 non-grouped digital inputs and 6 grouped digital inputs
- X2** – OR6: Assembly Group with 6 Output Relays (Changeover / Form C)
- X3** – TIs: Standard phase current measuring card and sensitive ground current measuring (neutral side of the diff. prot.)
- X4** – TI: Standard current measuring card (for the mains side of the differential protection)
- X5** – DI8-OR4: Assembly Group with 8 Digital Inputs and 4 Output Relays (NO / Form A)
- X6** – TU-DI8: Voltage measuring (0 ... 300 VAC) assembly group with 8 Digital Inputs
- X100** – IEC 61850 / Modbus TCP / DNP3.0 TCP/UDP, Ethernet interface, 100 Mbit/s, RJ45 (BASE100-FX)
- X102** – Universal Resistance-Temperature Detector (URTD) input, Fiber optics interface, Versatile Link
- X104** – IRIG-B00X, incl. System Contact (Supervision Contact)

MCDGV4-2C1BIA

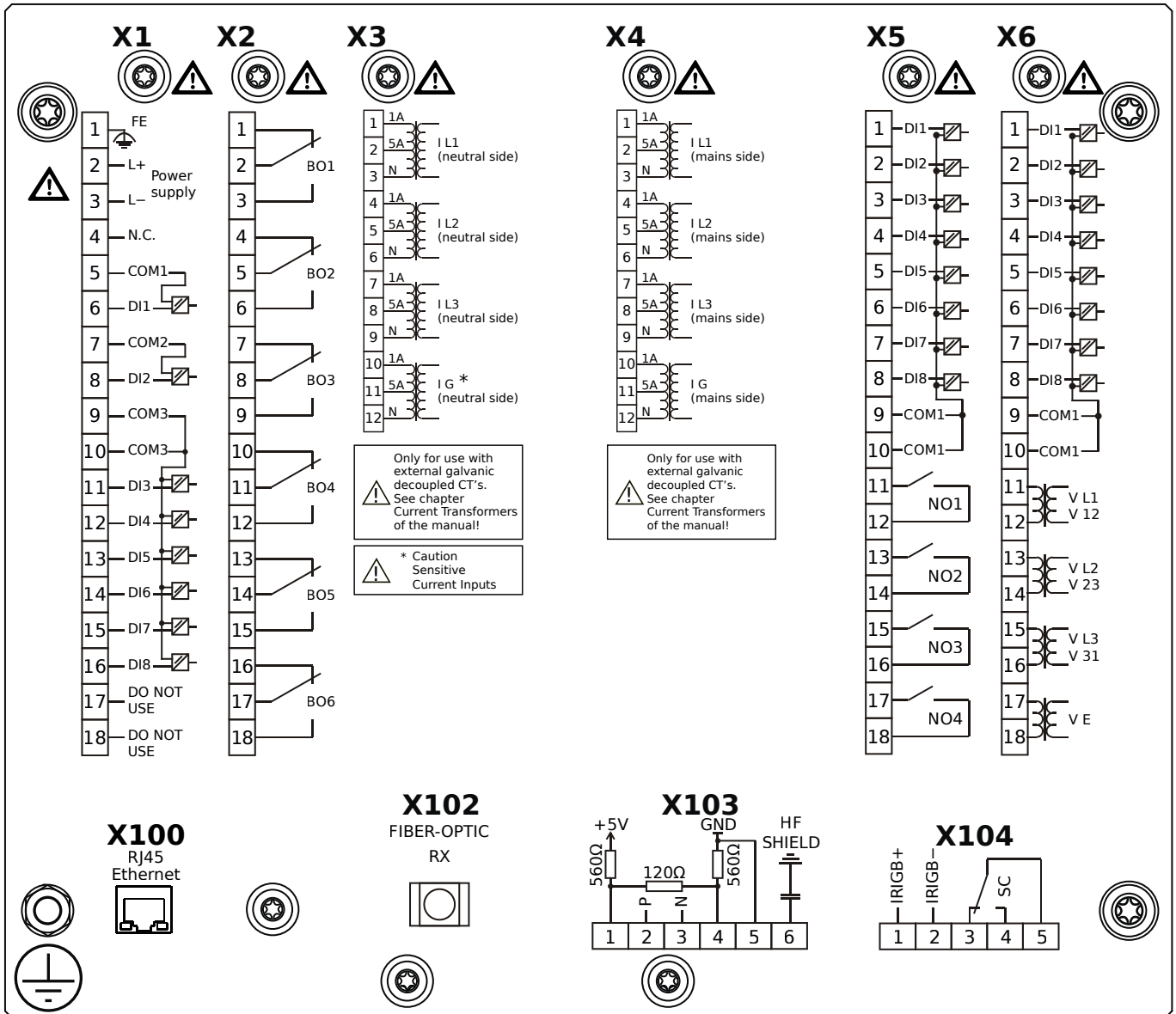

Housing B2, large display, 19" rack mounting

- X1** – DI8-X1: Wide-range power supply unit, incl. 2 non-grouped digital inputs and 6 grouped digital inputs
- X2** – OR6: Assembly Group with 6 Output Relays (Changeover / Form C)
- X3** – TI: Standard phase current measuring card and sensitive ground current measuring (neutral side of the diff. prot.)
- X4** – TI: Standard current measuring card (for the mains side of the differential protection)
- X5** – DI8-OR4: Assembly Group with 8 Digital Inputs and 4 Output Relays (NO / Form A)
- X6** – TU-DI8: Voltage measuring (0 ... 300 VAC) assembly group with 8 Digital Inputs
- X100** – Modbus TCP / DNP3.0 TCP/UDP, Ethernet interface, 100 Mbit/s, RJ45 (BASE100-FX)
- X102** – Universal Resistance-Temperature Detector (URTD) input, Fiber optics interface, Versatile Link
- X103** – IEC 60870-5-103 / Modbus RTU / DNP3.0 RTU, RS485, Terminals
- X104** – IRIG-B00X, incl. System Contact (Supervision Contact)

MCDGV4-2C1BIB

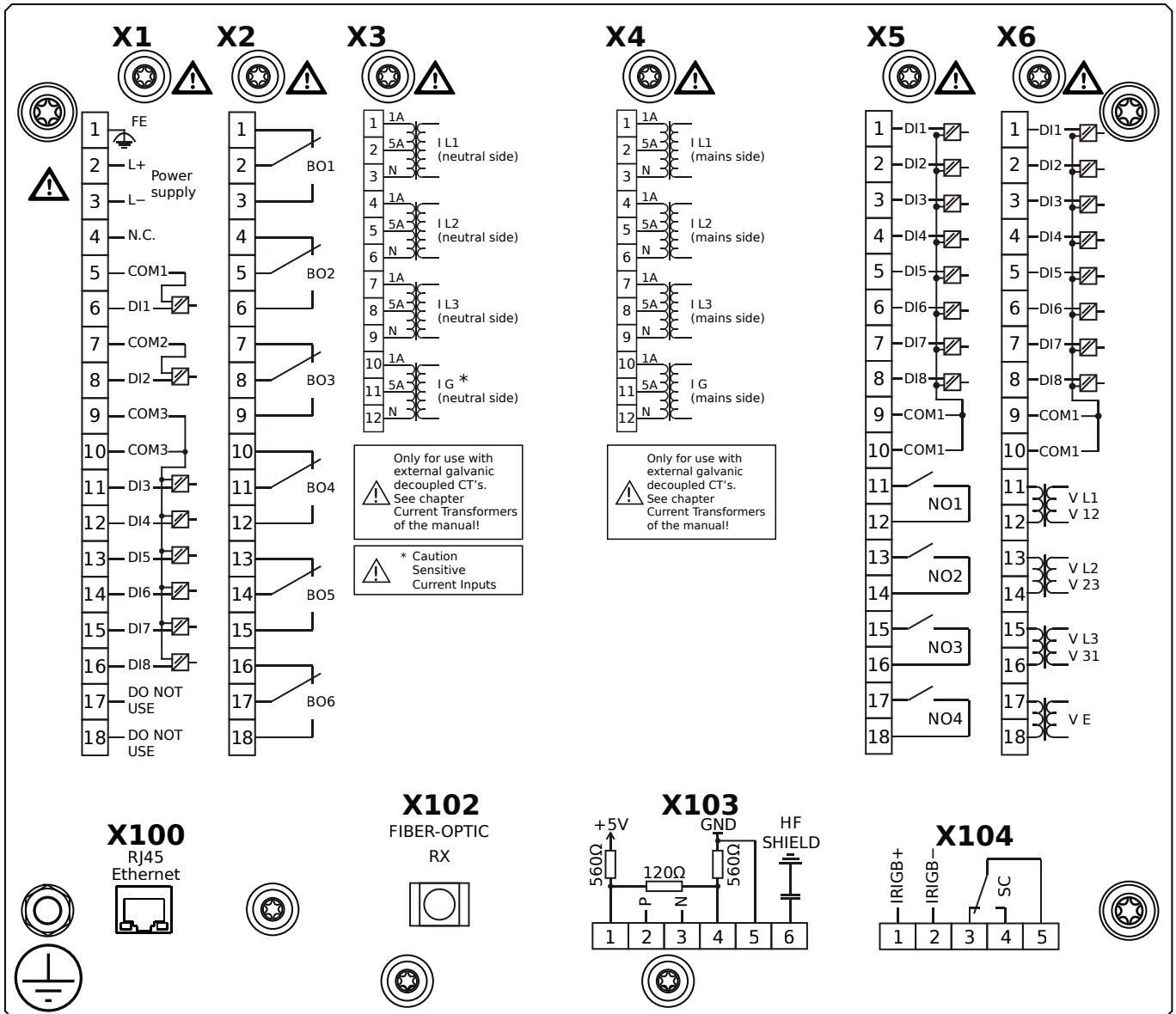

Housing B2, large display, 19" rack mounting

+ Conformal Coating (for installations in harsh environment)

- X1** – DI8-X1: Wide-range power supply unit, incl. 2 non-grouped digital inputs and 6 grouped digital inputs
- X2** – OR6: Assembly Group with 6 Output Relays (Changeover / Form C)
- X3** – TIs: Standard phase current measuring card and sensitive ground current measuring (neutral side of the diff. prot.)
- X4** – TI: Standard current measuring card (for the mains side of the differential protection)
- X5** – DI8-OR4: Assembly Group with 8 Digital Inputs and 4 Output Relays (NO / Form A)
- X6** – TU-DI8: Voltage measuring (0 ... 300 VAC) assembly group with 8 Digital Inputs
- X100** – Modbus TCP / DNP3.0 TCP/UDP, Ethernet interface, 100 Mbit/s, RJ45 (BASE100-FX)
- X102** – Universal Resistance-Temperature Detector (URTD) input, Fiber optics interface, Versatile Link
- X103** – IEC 60870-5-103 / Modbus RTU / DNP3.0 RTU, RS485, Terminals
- X104** – IRIG-B00X, incl. System Contact (Supervision Contact)

MCDGV4-2C1BKA

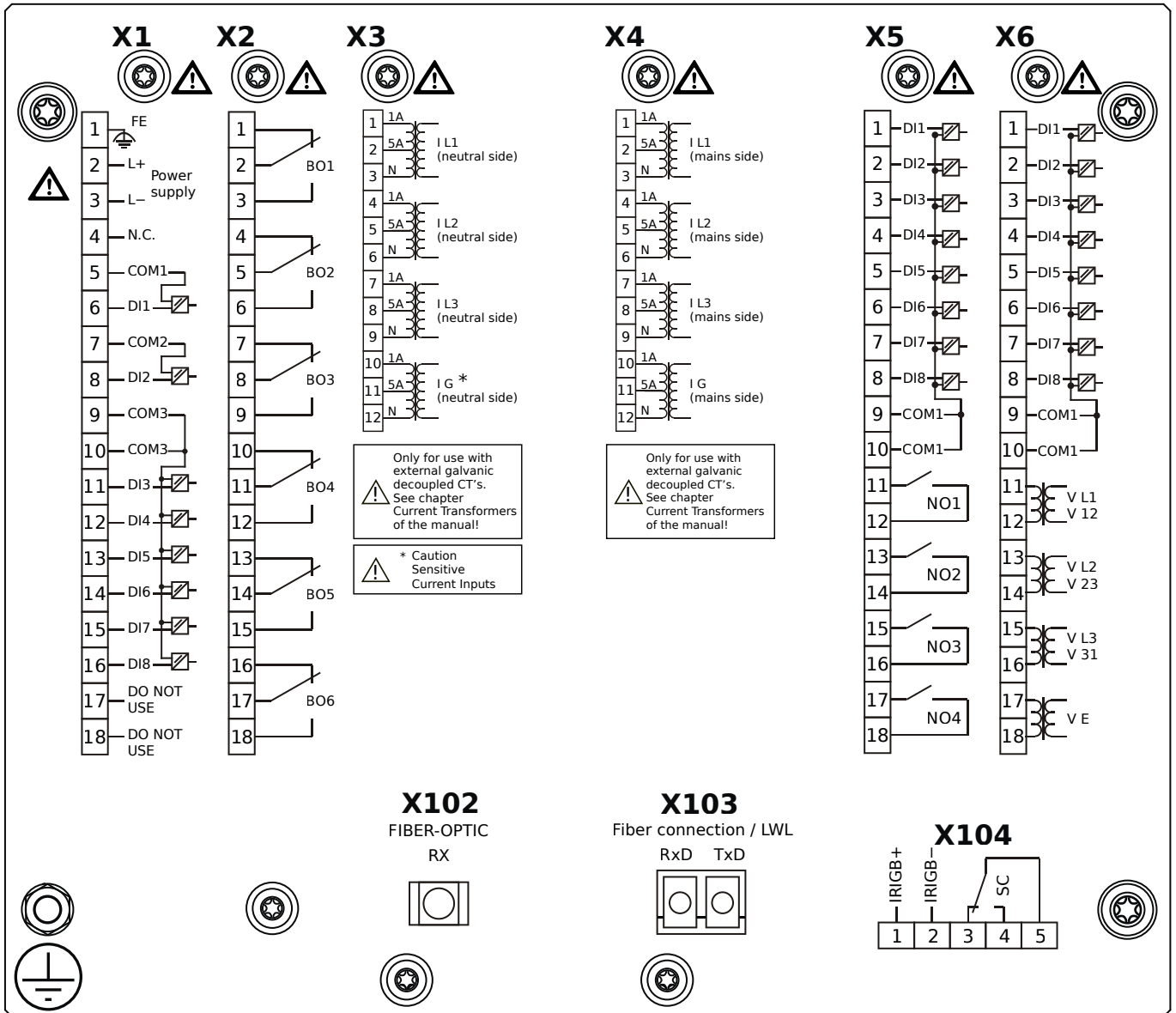

Housing B2, large display, 19" rack mounting

- X1** – DI8-X1: Wide-range power supply unit, incl. 2 non-grouped digital inputs and 6 grouped digital inputs
- X2** – OR6: Assembly Group with 6 Output Relays (Changeover / Form C)
- X3** – TIs: Standard phase current measuring card and sensitive ground current measuring (neutral side of the diff. prot.)
- X4** – TI: Standard current measuring card (for the mains side of the differential protection)
- X5** – DI8-OR4: Assembly Group with 8 Digital Inputs and 4 Output Relays (NO / Form A)
- X6** – TU-DI8: Voltage measuring (0 ... 300 VAC) assembly group with 8 Digital Inputs
- X102** – Universal Resistance-Temperature Detector (URTD) input, Fiber optics interface, Versatile Link
- X103** – IEC 61850 / Modbus TCP / DNP3.0 TCP/UDP, Fiber optics interface, LC Connector
- X104** – IRIG-B00X, incl. System Contact (Supervision Contact)

MCDGV4-2C1BKB

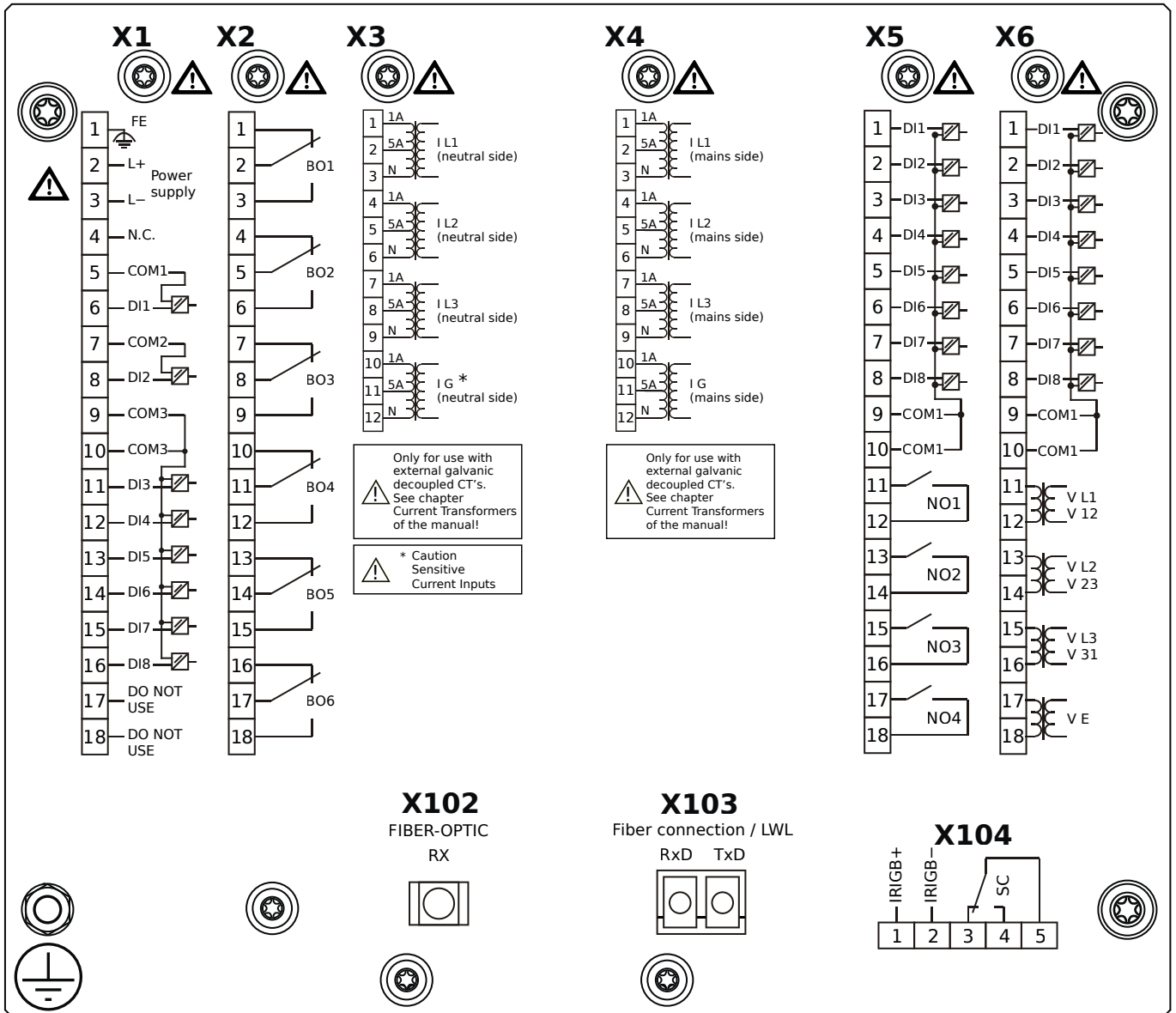

Housing B2, large display, 19" rack mounting

+ Conformal Coating (for installations in harsh environment)

- X1** – DI8-X1: Wide-range power supply unit, incl. 2 non-grouped digital inputs and 6 grouped digital inputs
- X2** – OR6: Assembly Group with 6 Output Relays (Changeover / Form C)
- X3** – TIs: Standard phase current measuring card and sensitive ground current measuring (neutral side of the diff. prot.)
- X4** – TI: Standard current measuring card (for the mains side of the differential protection)
- X5** – DI8-OR4: Assembly Group with 8 Digital Inputs and 4 Output Relays (NO / Form A)
- X6** – TU-DI8: Voltage measuring (0 ... 300 VAC) assembly group with 8 Digital Inputs
- X102** – Universal Resistance-Temperature Detector (URTD) input, Fiber optics interface, Versatile Link
- X103** – IEC 61850 / Modbus TCP / DNP3.0 TCP/UDP, Fiber optics interface, LC Connector
- X104** – IRIG-B00X, incl. System Contact (Supervision Contact)

MCDGV4-2C1BLA

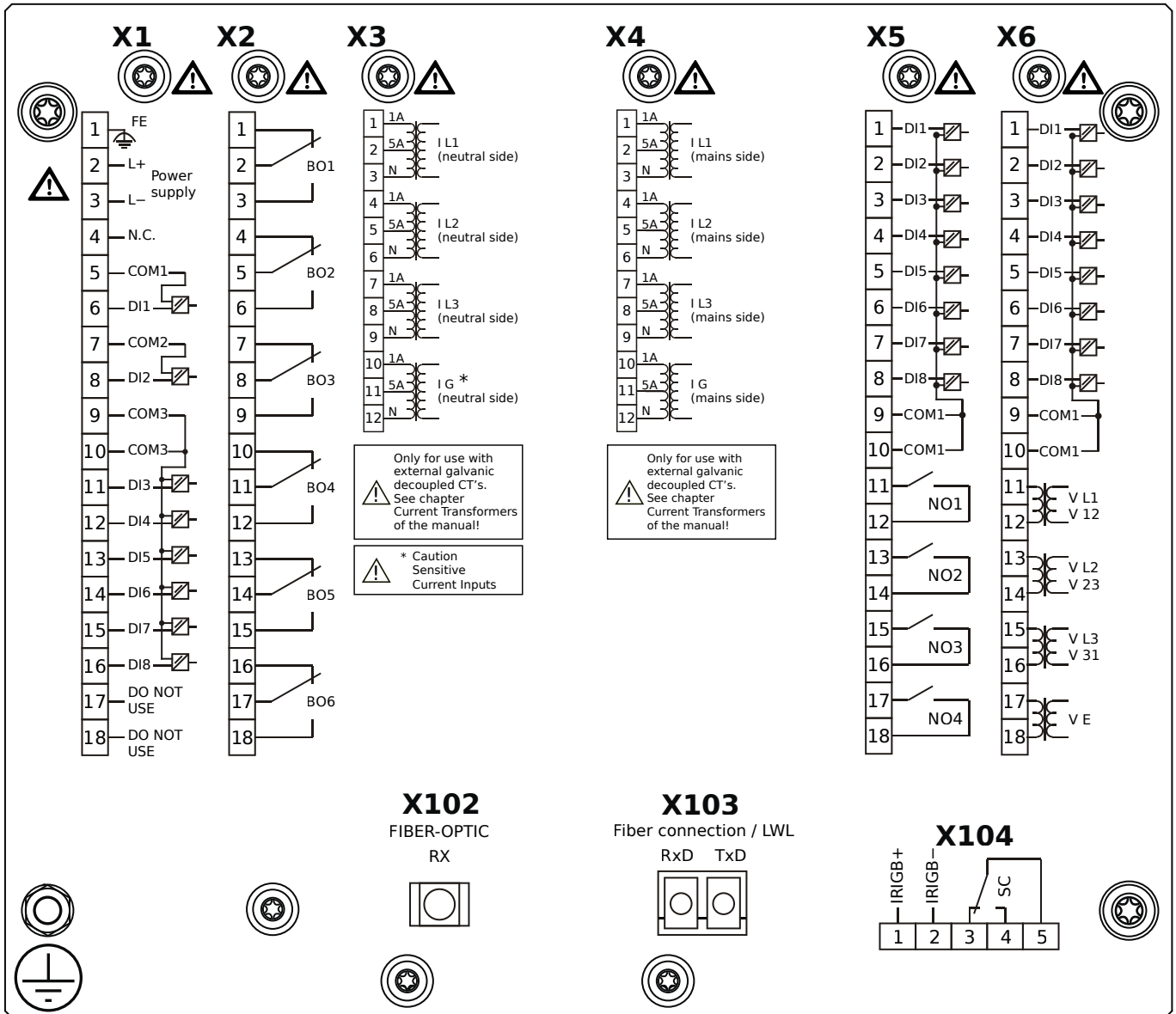

Housing B2, large display, 19" rack mounting

- X1** – DI8-X1: Wide-range power supply unit, incl. 2 non-grouped digital inputs and 6 grouped digital inputs
- X2** – OR6: Assembly Group with 6 Output Relays (Changeover / Form C)
- X3** – TIs: Standard phase current measuring card and sensitive ground current measuring (neutral side of the diff. prot.)
- X4** – TI: Standard current measuring card (for the mains side of the differential protection)
- X5** – DI8-OR4: Assembly Group with 8 Digital Inputs and 4 Output Relays (NO / Form A)
- X6** – TU-DI8: Voltage measuring (0 ... 300 VAC) assembly group with 8 Digital Inputs
- X102** – Universal Resistance-Temperature Detector (URTD) input, Fiber optics interface, Versatile Link
- X103** – Modbus TCP / DNP3.0 TCP/UDP, Fiber optics interface, LC Connector
- X104** – IRIG-B00X, incl. System Contact (Supervision Contact)

MCDGV4-2C1BLB

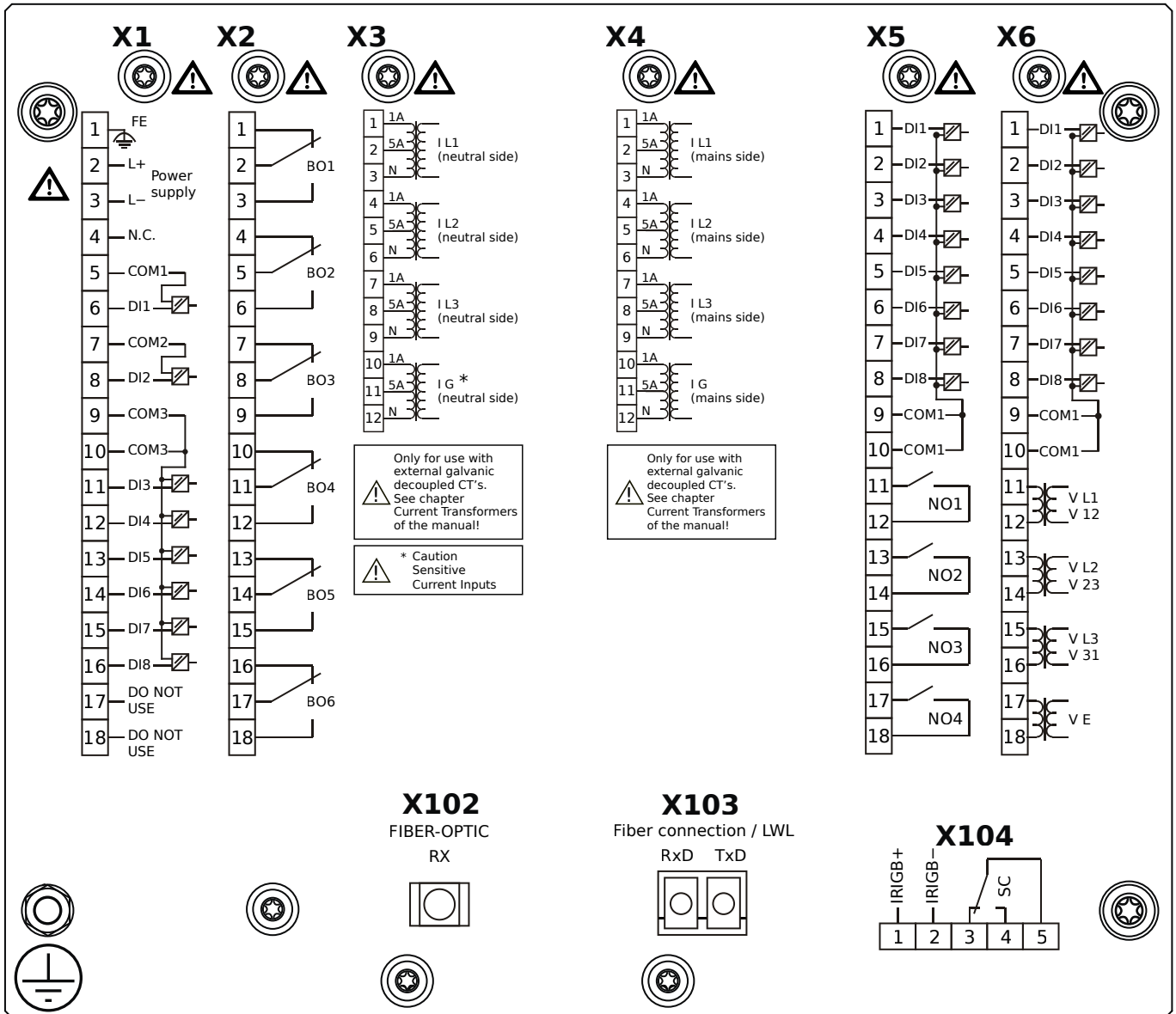

Housing B2, large display, 19" rack mounting

+ Conformal Coating (for installations in harsh environment)

- X1** – DI8-X1: Wide-range power supply unit, incl. 2 non-grouped digital inputs and 6 grouped digital inputs
- X2** – OR6: Assembly Group with 6 Output Relays (Changeover / Form C)
- X3** – TIs: Standard phase current measuring card and sensitive ground current measuring (neutral side of the diff. prot.)
- X4** – TI: Standard current measuring card (for the mains side of the differential protection)
- X5** – DI8-OR4: Assembly Group with 8 Digital Inputs and 4 Output Relays (NO / Form A)
- X6** – TU-DI8: Voltage measuring (0 ... 300 VAC) assembly group with 8 Digital Inputs
- X102** – Universal Resistance-Temperature Detector (URTD) input, Fiber optics interface, Versatile Link
- X103** – Modbus TCP / DNP3.0 TCP/UDP, Fiber optics interface, LC Connector
- X104** – IRIG-B00X, incl. System Contact (Supervision Contact)

MCDGV4-2C1BTA

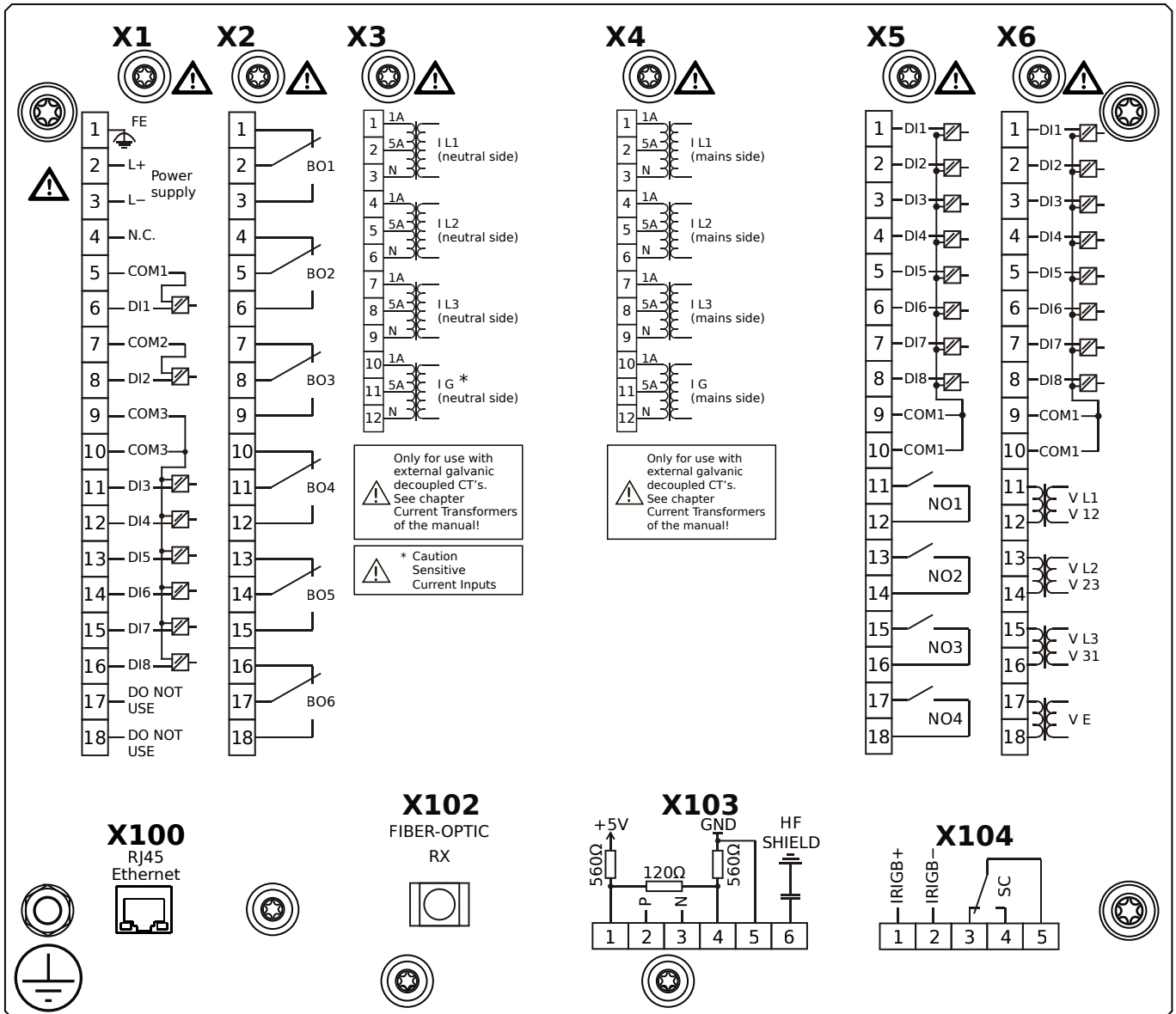

Housing B2, large display, 19" rack mounting

- X1** – DI8-X1: Wide-range power supply unit, incl. 2 non-grouped digital inputs and 6 grouped digital inputs
- X2** – OR6: Assembly Group with 6 Output Relays (Changeover / Form C)
- X3** – TI: Standard phase current measuring card and sensitive ground current measuring (neutral side of the diff. prot.)
- X4** – TI: Standard current measuring card (for the mains side of the differential protection)
- X5** – DI8-OR4: Assembly Group with 8 Digital Inputs and 4 Output Relays (NO / Form A)
- X6** – TU-DI8: Voltage measuring (0 ... 300 VAC) assembly group with 8 Digital Inputs
- X100** – IEC 61850 / Modbus TCP / DNP3.0 TCP/UDP, Ethernet interface, 100 Mbit/s, RJ45 (BASE100-FX)
- X102** – Universal Resistance-Temperature Detector (URTD) input, Fiber optics interface, Versatile Link
- X103** – IEC 60870-5-103 / Modbus RTU / DNP3.0 RTU, RS485, Terminals
- X104** – IRIG-B00X, incl. System Contact (Supervision Contact)

MCDGV4-2C1BTB

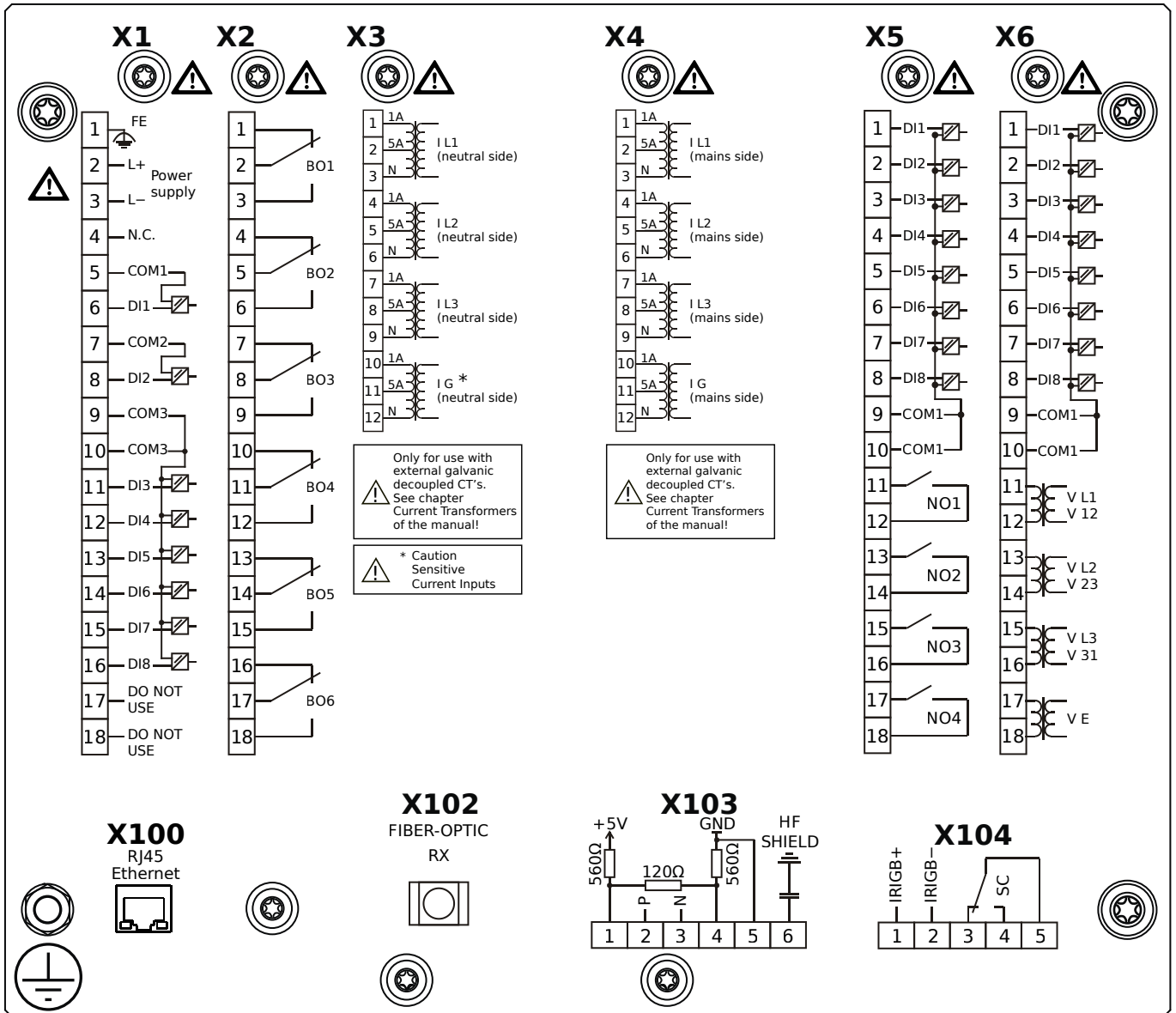

Housing B2, large display, 19" rack mounting

+ Conformal Coating (for installations in harsh environment)

- X1** – DI8-X1: Wide-range power supply unit, incl. 2 non-grouped digital inputs and 6 grouped digital inputs
- X2** – OR6: Assembly Group with 6 Output Relays (Changeover / Form C)
- X3** – TIs: Standard phase current measuring card and sensitive ground current measuring (neutral side of the diff. prot.)
- X4** – TI: Standard current measuring card (for the mains side of the differential protection)
- X5** – DI8-OR4: Assembly Group with 8 Digital Inputs and 4 Output Relays (NO / Form A)
- X6** – TU-DI8: Voltage measuring (0 ... 300 VAC) assembly group with 8 Digital Inputs
- X100** – IEC 61850 / Modbus TCP / DNP3.0 TCP/UDP, Ethernet interface, 100 Mbit/s, RJ45 (BASE100-FX)
- X102** – Universal Resistance-Temperature Detector (URTD) input, Fiber optics interface, Versatile Link
- X103** – IEC 60870-5-103 / Modbus RTU / DNP3.0 RTU, RS485, Terminals
- X104** – IRIG-B00X, incl. System Contact (Supervision Contact)

MCDGV4-2D0AAA

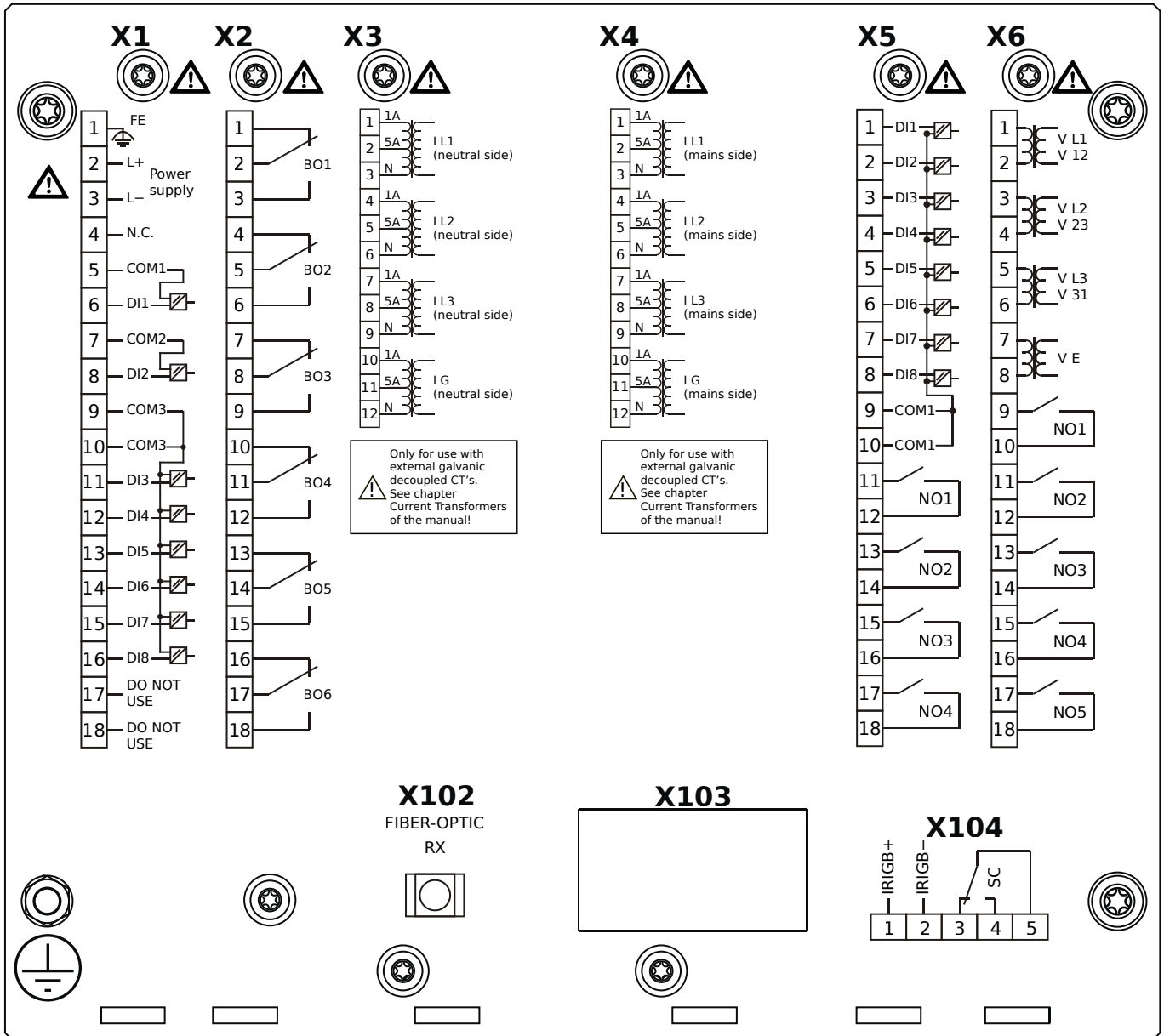

Housing B2, large display, door mounting

- X1** – DI8-X1: Wide-range power supply unit, incl. 2 non-grouped digital inputs and 6 grouped digital inputs
- X2** – OR6: Assembly Group with 6 Output Relays (Changeover / Form C)
- X3** – TI: Standard current measuring card (for the neutral side of the differential protection)
- X4** – TI: Standard current measuring card (for the mains side of the differential protection)
- X5** – DI8-OR4: Assembly Group with 8 Digital Inputs and 4 Output Relays (NO / Form A)
- X6** – TU-OR5: Voltage measuring (0 ... 300 VAC) assembly group with 5 additional Output Relays (NO / Form A)
- X102** – Universal Resistance-Temperature Detector (URTD) input, Fiber optics interface, Versatile Link
- X104** – IRIG-B00X, incl. System Contact (Supervision Contact)

MCDGV4-2D0AAB

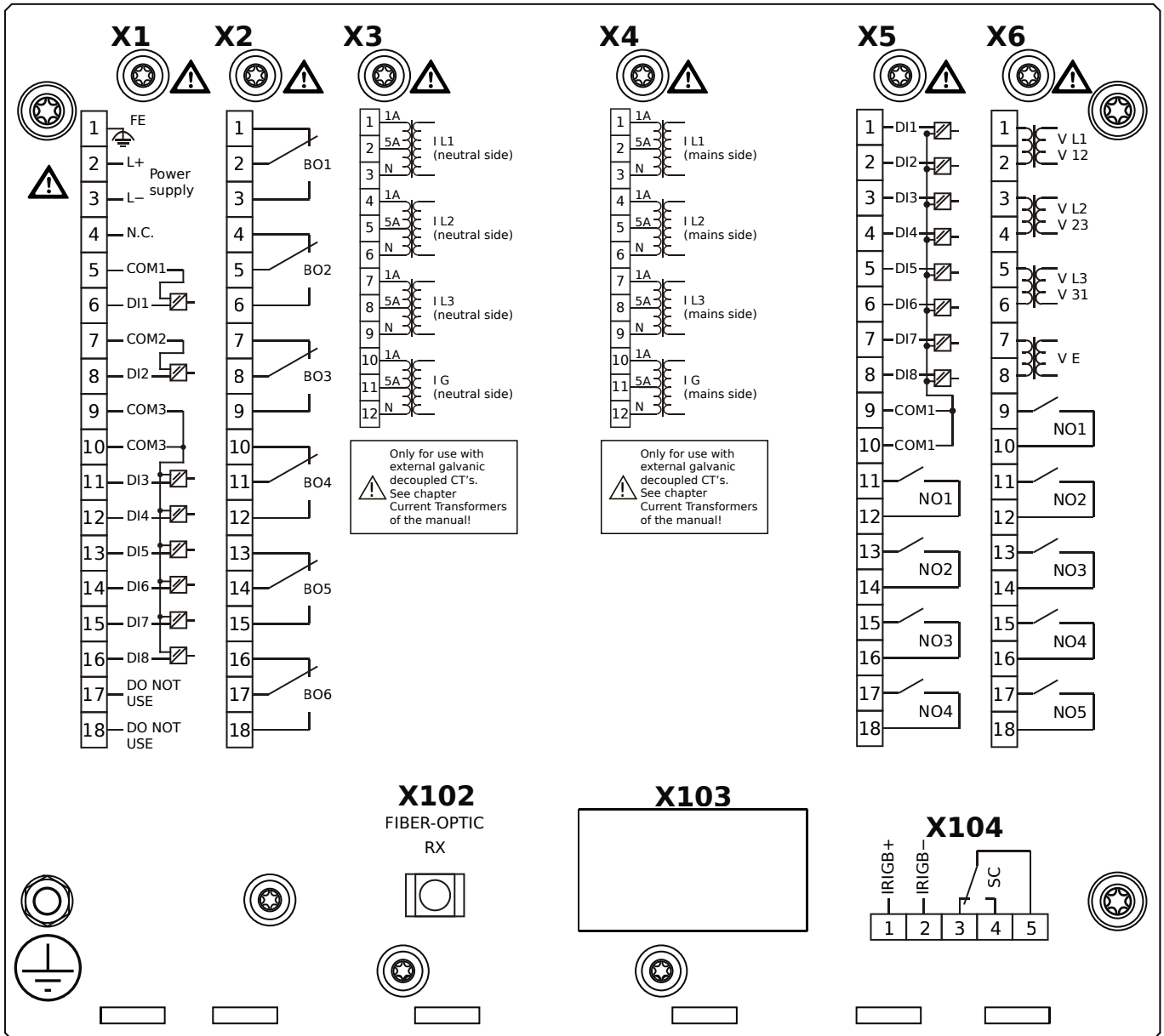

Housing B2, large display, door mounting

- + Conformal Coating (for installations in harsh environment)

- X1** – DI8-X1: Wide-range power supply unit, incl. 2 non-grouped digital inputs and 6 grouped digital inputs
- X2** – OR6: Assembly Group with 6 Output Relays (Changeover / Form C)
- X3** – TI: Standard current measuring card (for the neutral side of the differential protection)
- X4** – TI: Standard current measuring card (for the mains side of the differential protection)
- X5** – DI8-OR4: Assembly Group with 8 Digital Inputs and 4 Output Relays (NO / Form A)
- X6** – TU-OR5: Voltage measuring (0 ... 300 VAC) assembly group with 5 additional Output Relays (NO / Form A)
- X102** – Universal Resistance-Temperature Detector (URTD) input, Fiber optics interface, Versatile Link
- X104** – IRIG-B00X, incl. System Contact (Supervision Contact)

MCDGV4-2D0ABA

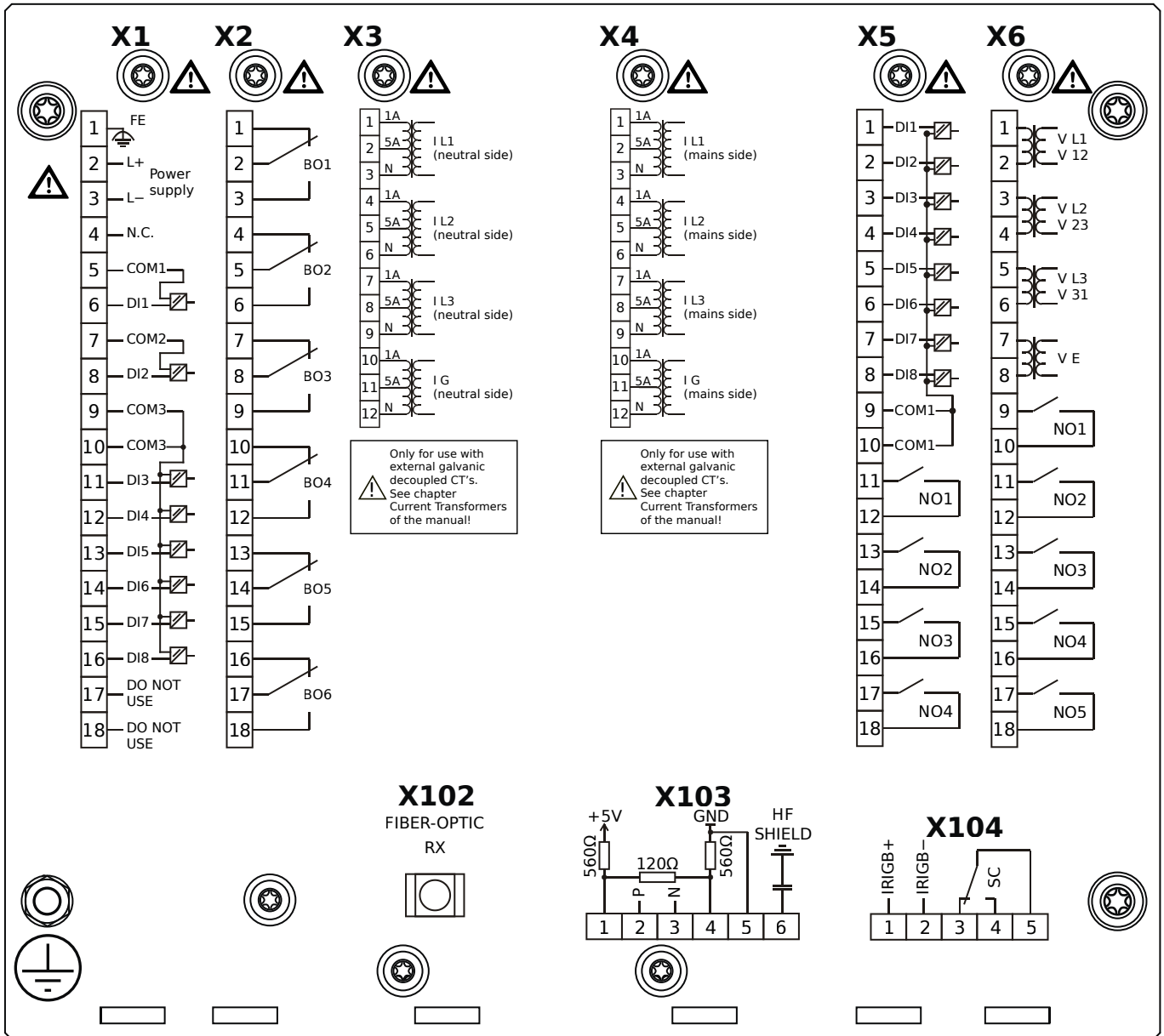

Housing B2, large display, door mounting

- X1** – DI8-X1: Wide-range power supply unit, incl. 2 non-grouped digital inputs and 6 grouped digital inputs
- X2** – OR6: Assembly Group with 6 Output Relays (Changeover / Form C)
- X3** – TI: Standard current measuring card (for the neutral side of the differential protection)
- X4** – TI: Standard current measuring card (for the mains side of the differential protection)
- X5** – DI8-OR4: Assembly Group with 8 Digital Inputs and 4 Output Relays (NO / Form A)
- X6** – TU-OR5: Voltage measuring (0 ... 300 VAC) assembly group with 5 additional Output Relays (NO / Form A)
- X102** – Universal Resistance-Temperature Detector (URTD) input, Fiber optics interface, Versatile Link
- X103** – Modbus RTU / IEC 60870-5-103 / DNP3.0 RTU, RS485, Terminals
- X104** – IRIG-B00X, incl. System Contact (Supervision Contact)

MCDGV4-2D0ABB

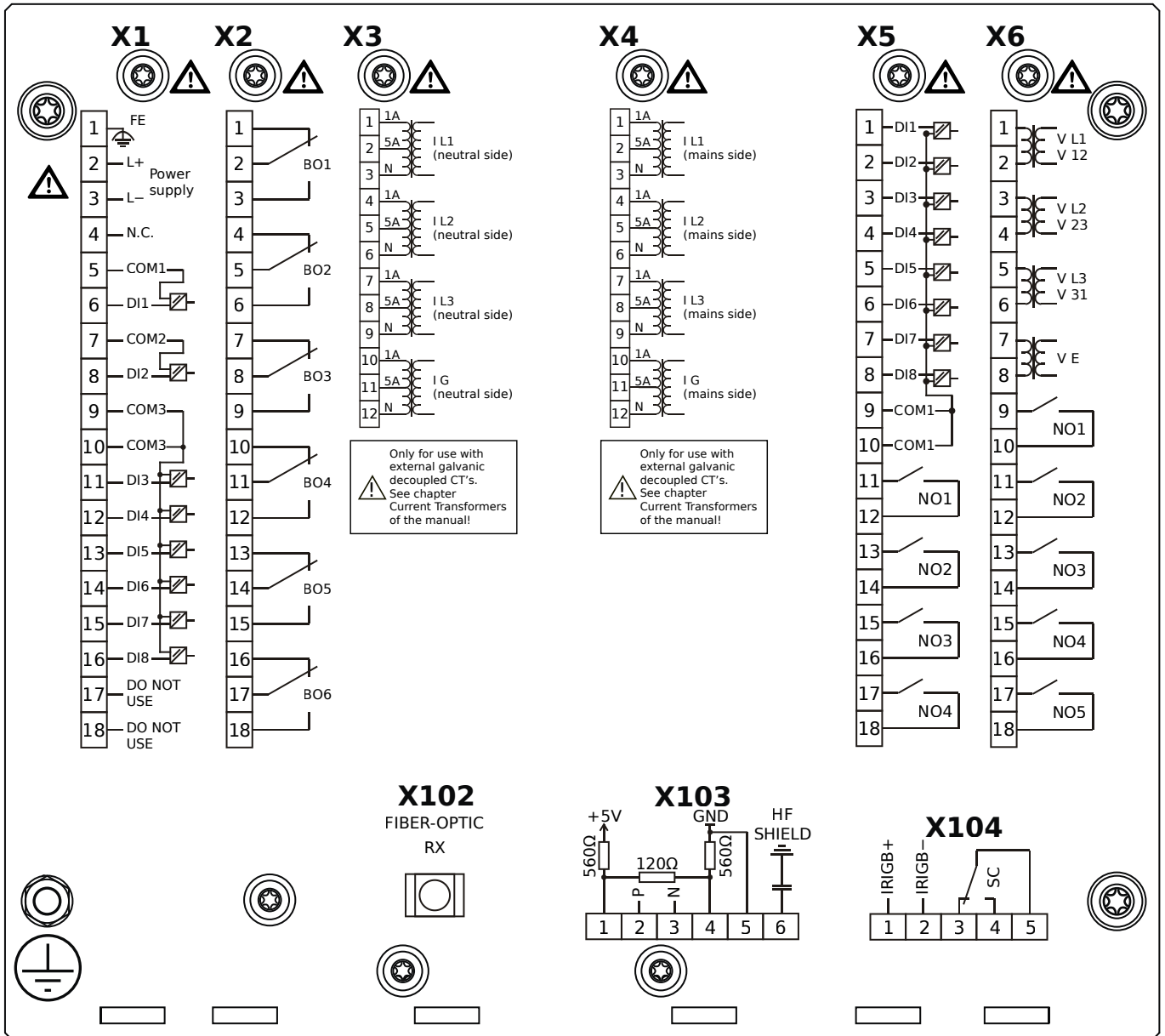

Housing B2, large display, door mounting

- + Conformal Coating (for installations in harsh environment)

- X1** – DI8-X1: Wide-range power supply unit, incl. 2 non-grouped digital inputs and 6 grouped digital inputs
- X2** – OR6: Assembly Group with 6 Output Relays (Changeover / Form C)
- X3** – TI: Standard current measuring card (for the neutral side of the differential protection)
- X4** – TI: Standard current measuring card (for the mains side of the differential protection)
- X5** – DI8-OR4: Assembly Group with 8 Digital Inputs and 4 Output Relays (NO / Form A)
- X6** – TU-OR5: Voltage measuring (0 ... 300 VAC) assembly group with 5 additional Output Relays (NO / Form A)
- X102** – Universal Resistance-Temperature Detector (URTD) input, Fiber optics interface, Versatile Link
- X103** – Modbus RTU / IEC 60870-5-103 / DNP3.0 RTU, RS485, Terminals
- X104** – IRIG-B00X, incl. System Contact (Supervision Contact)

MCDGV4-2D0ACA

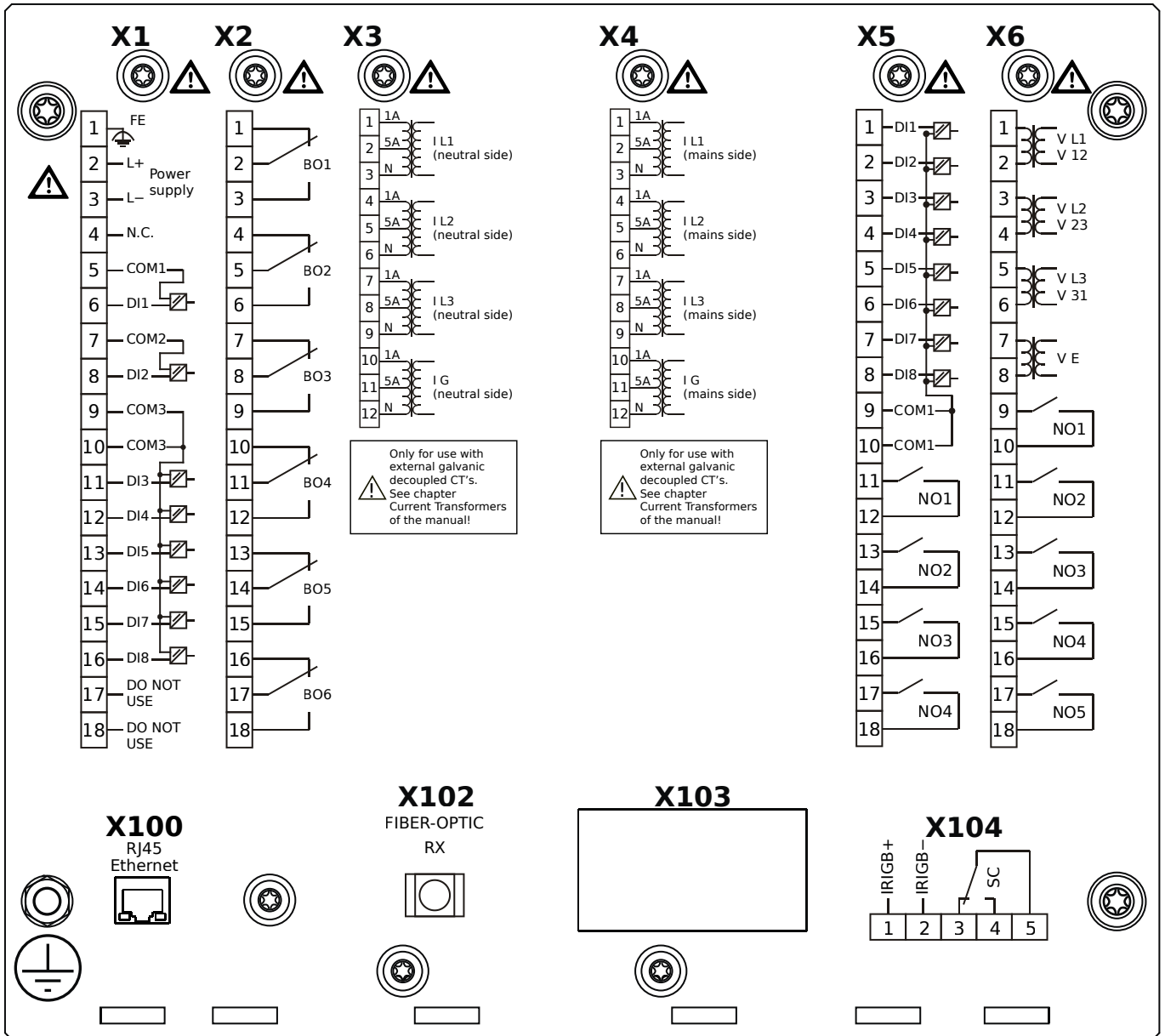

Housing B2, large display, door mounting

- X1** – DI8-X1: Wide-range power supply unit, incl. 2 non-grouped digital inputs and 6 grouped digital inputs
- X2** – OR6: Assembly Group with 6 Output Relays (Changeover / Form C)
- X3** – TI: Standard current measuring card (for the neutral side of the differential protection)
- X4** – TI: Standard current measuring card (for the mains side of the differential protection)
- X5** – DI8-OR4: Assembly Group with 8 Digital Inputs and 4 Output Relays (NO / Form A)
- X6** – TU-OR5: Voltage measuring (0 ... 300 VAC) assembly group with 5 additional Output Relays (NO / Form A)
- X100** – Modbus TCP / DNP3.0 TCP/UDP, Ethernet interface, 100 Mbit/s, RJ45 (BASE100-FX)
- X102** – Universal Resistance-Temperature Detector (URTD) input, Fiber optics interface, Versatile Link
- X104** – IRIG-B00X, incl. System Contact (Supervision Contact)

MCDGV4-2D0ACB

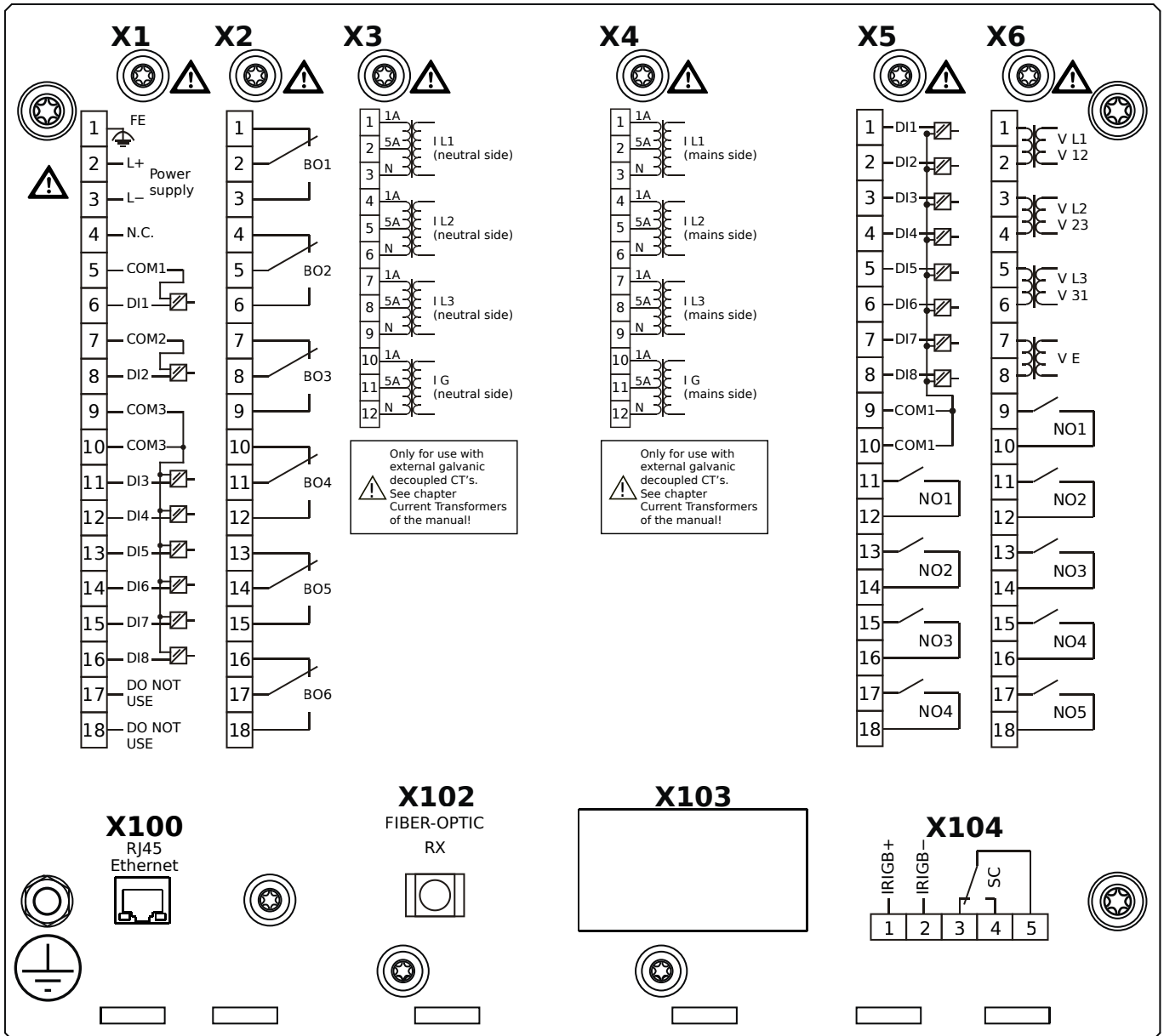

Housing B2, large display, door mounting

- + Conformal Coating (for installations in harsh environment)

- X1** – DI8-X1: Wide-range power supply unit, incl. 2 non-grouped digital inputs and 6 grouped digital inputs
- X2** – OR6: Assembly Group with 6 Output Relays (Changeover / Form C)
- X3** – TI: Standard current measuring card (for the neutral side of the differential protection)
- X4** – TI: Standard current measuring card (for the mains side of the differential protection)
- X5** – DI8-OR4: Assembly Group with 8 Digital Inputs and 4 Output Relays (NO / Form A)
- X6** – TU-OR5: Voltage measuring (0 ... 300 VAC) assembly group with 5 additional Output Relays (NO / Form A)
- X100** – Modbus TCP / DNP3.0 TCP/UDP, Ethernet interface, 100 Mbit/s, RJ45 (BASE100-FX)
- X102** – Universal Resistance-Temperature Detector (URTD) input, Fiber optics interface, Versatile Link
- X104** – IRIG-B00X, incl. System Contact (Supervision Contact)

MCDGV4-2D0ADA

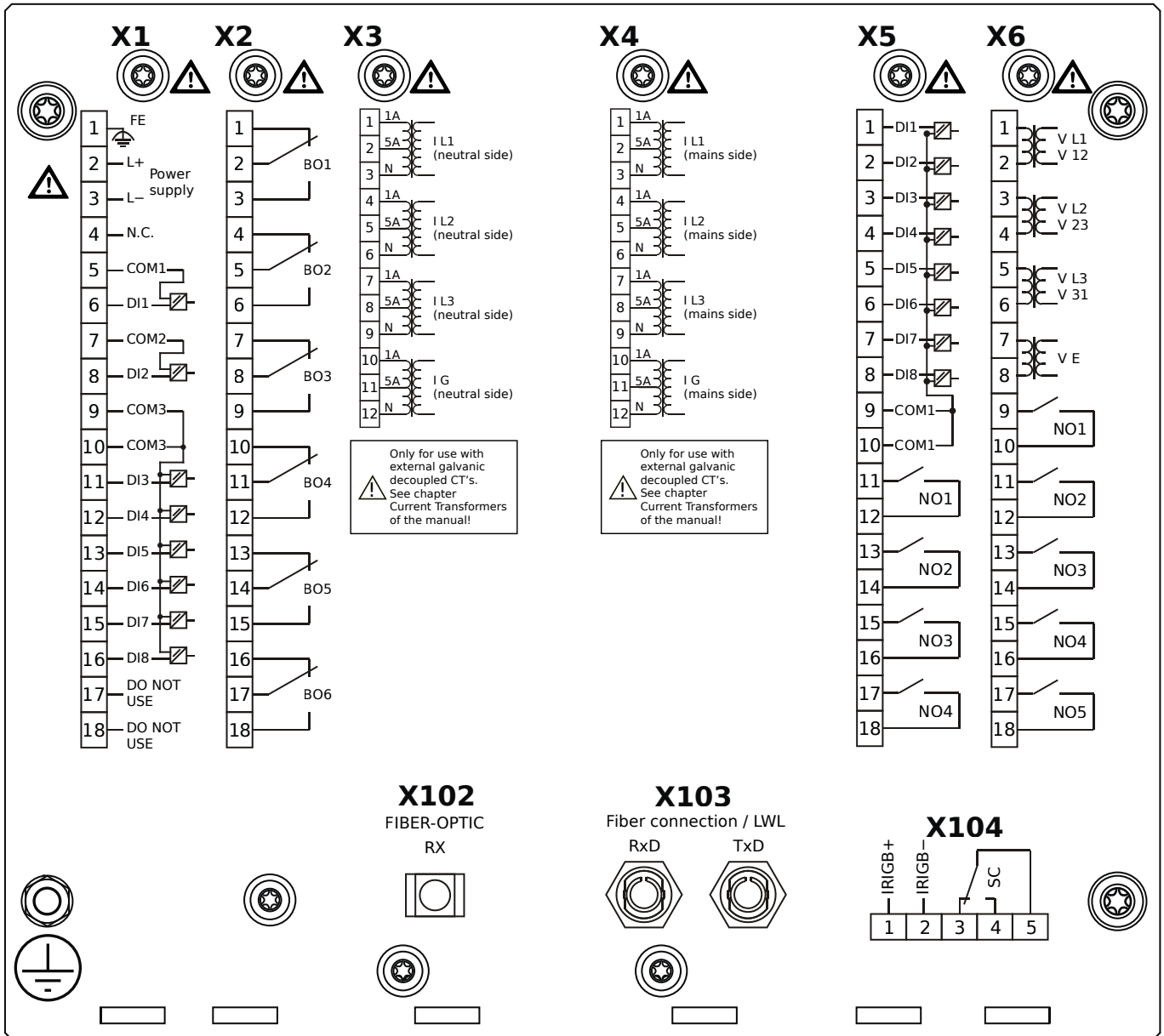

Housing B2, large display, door mounting

- X1** – DI8-X1: Wide-range power supply unit, incl. 2 non-grouped digital inputs and 6 grouped digital inputs
- X2** – OR6: Assembly Group with 6 Output Relays (Changeover / Form C)
- X3** – TI: Standard current measuring card (for the neutral side of the differential protection)
- X4** – TI: Standard current measuring card (for the mains side of the differential protection)
- X5** – DI8-OR4: Assembly Group with 8 Digital Inputs and 4 Output Relays (NO / Form A)
- X6** – TU-OR5: Voltage measuring (0 ... 300 VAC) assembly group with 5 additional Output Relays (NO / Form A)
- X102** – Universal Resistance-Temperature Detector (URTD) input, Fiber optics interface, Versatile Link
- X103** – Profibus-DP, Fiber optics interface, ST Connector
- X104** – IRIG-B00X, incl. System Contact (Supervision Contact)

MCDGV4-2D0ADB

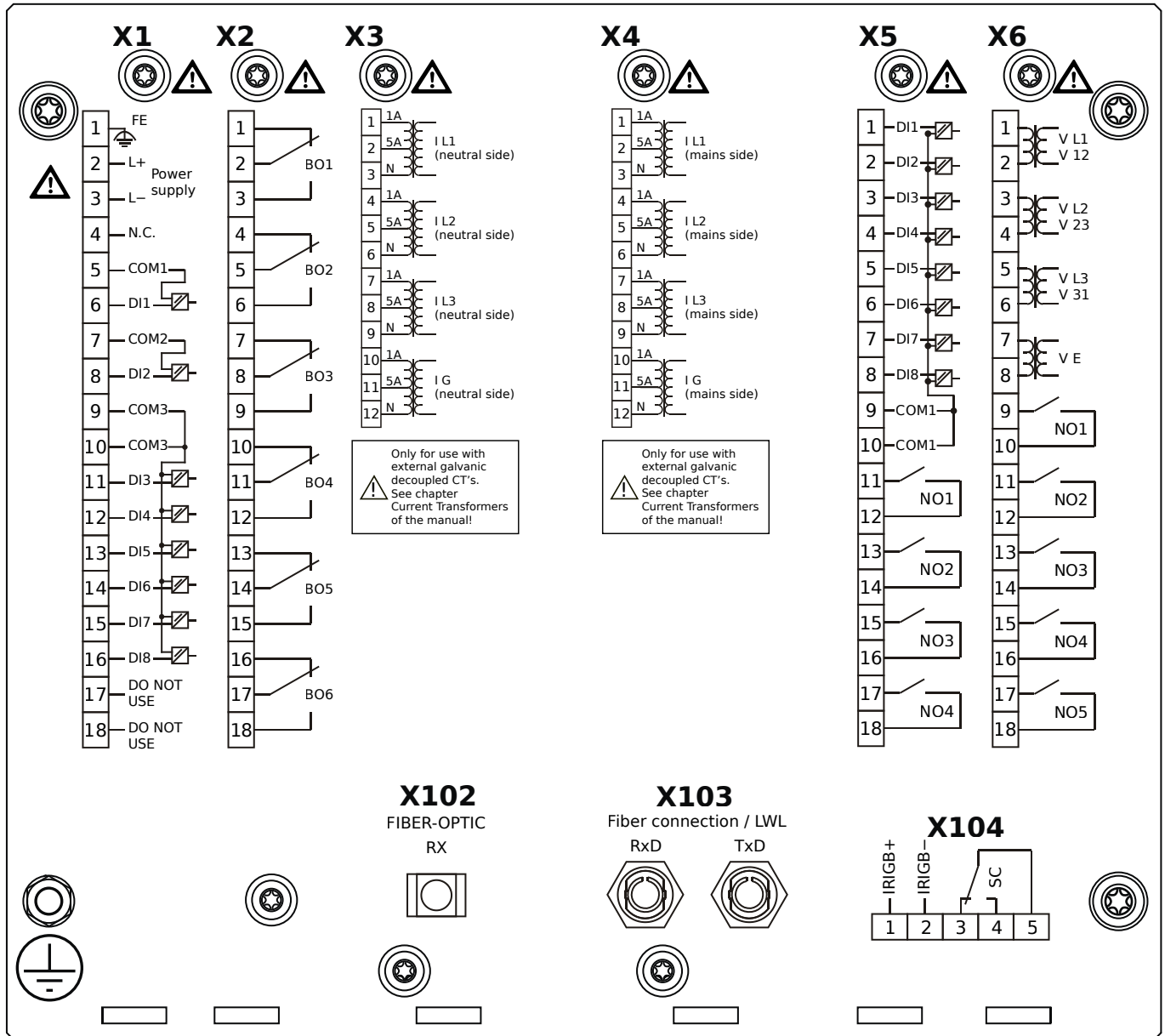

Housing B2, large display, door mounting

- + Conformal Coating (for installations in harsh environment)

- X1** – DI8-X1: Wide-range power supply unit, incl. 2 non-grouped digital inputs and 6 grouped digital inputs
- X2** – OR6: Assembly Group with 6 Output Relays (Changeover / Form C)
- X3** – TI: Standard current measuring card (for the neutral side of the differential protection)
- X4** – TI: Standard current measuring card (for the mains side of the differential protection)
- X5** – DI8-OR4: Assembly Group with 8 Digital Inputs and 4 Output Relays (NO / Form A)
- X6** – TU-OR5: Voltage measuring (0 ... 300 VAC) assembly group with 5 additional Output Relays (NO / Form A)
- X102** – Universal Resistance-Temperature Detector (URTD) input, Fiber optics interface, Versatile Link
- X103** – Profibus-DP, Fiber optics interface, ST Connector
- X104** – IRIG-B00X, incl. System Contact (Supervision Contact)

MCDGV4-2D0AEA

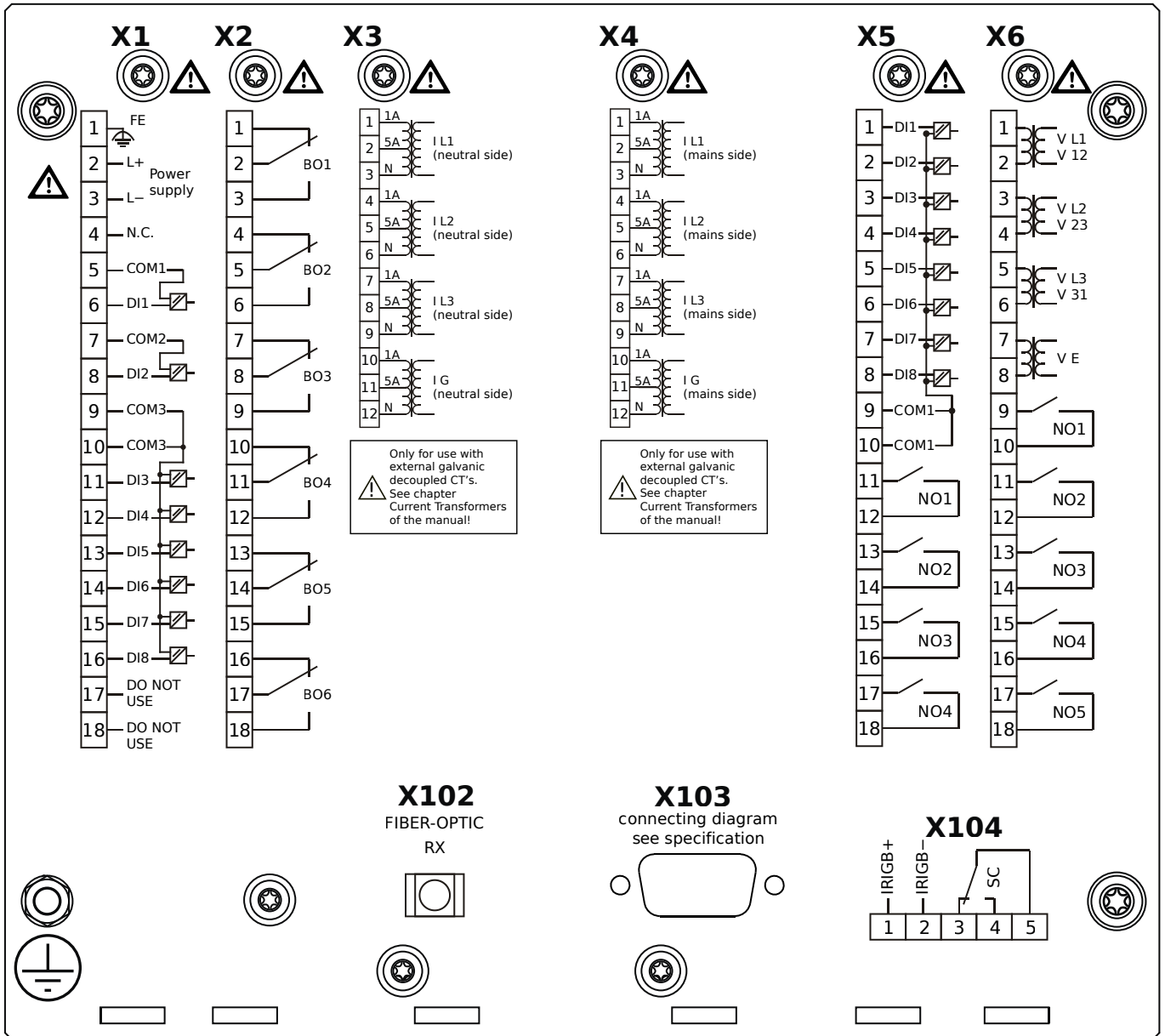

Housing B2, large display, door mounting

- X1** – DI8-X1: Wide-range power supply unit, incl. 2 non-grouped digital inputs and 6 grouped digital inputs
- X2** – OR6: Assembly Group with 6 Output Relays (Changeover / Form C)
- X3** – TI: Standard current measuring card (for the neutral side of the differential protection)
- X4** – TI: Standard current measuring card (for the mains side of the differential protection)
- X5** – DI8-OR4: Assembly Group with 8 Digital Inputs and 4 Output Relays (NO / Form A)
- X6** – TU-OR5: Voltage measuring (0 ... 300 VAC) assembly group with 5 additional Output Relays (NO / Form A)
- X102** – Universal Resistance-Temperature Detector (URTD) input, Fiber optics interface, Versatile Link
- X103** – Profibus-DP, RS485, D-SUB
- X104** – IRIG-B00X, incl. System Contact (Supervision Contact)

MCDGV4-2D0AEB

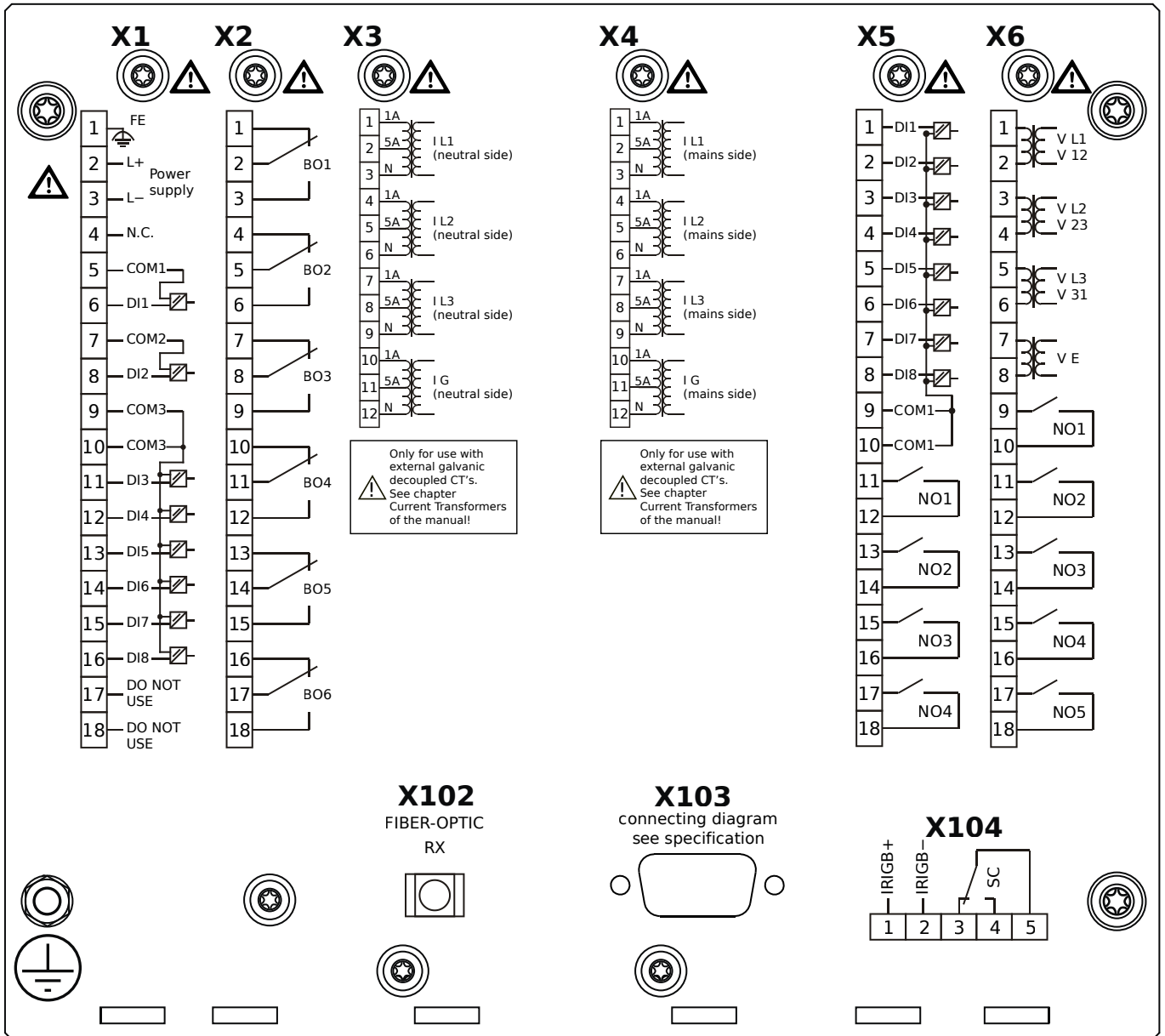

Housing B2, large display, door mounting

- + Conformal Coating (for installations in harsh environment)

- X1** – DI8-X1: Wide-range power supply unit, incl. 2 non-grouped digital inputs and 6 grouped digital inputs
- X2** – OR6: Assembly Group with 6 Output Relays (Changeover / Form C)
- X3** – TI: Standard current measuring card (for the neutral side of the differential protection)
- X4** – TI: Standard current measuring card (for the mains side of the differential protection)
- X5** – DI8-OR4: Assembly Group with 8 Digital Inputs and 4 Output Relays (NO / Form A)
- X6** – TU-OR5: Voltage measuring (0 ... 300 VAC) assembly group with 5 additional Output Relays (NO / Form A)
- X102** – Universal Resistance-Temperature Detector (URTD) input, Fiber optics interface, Versatile Link
- X103** – Profibus-DP, RS485, D-SUB
- X104** – IRIG-B00X, incl. System Contact (Supervision Contact)

MCDGV4-2D0AFA

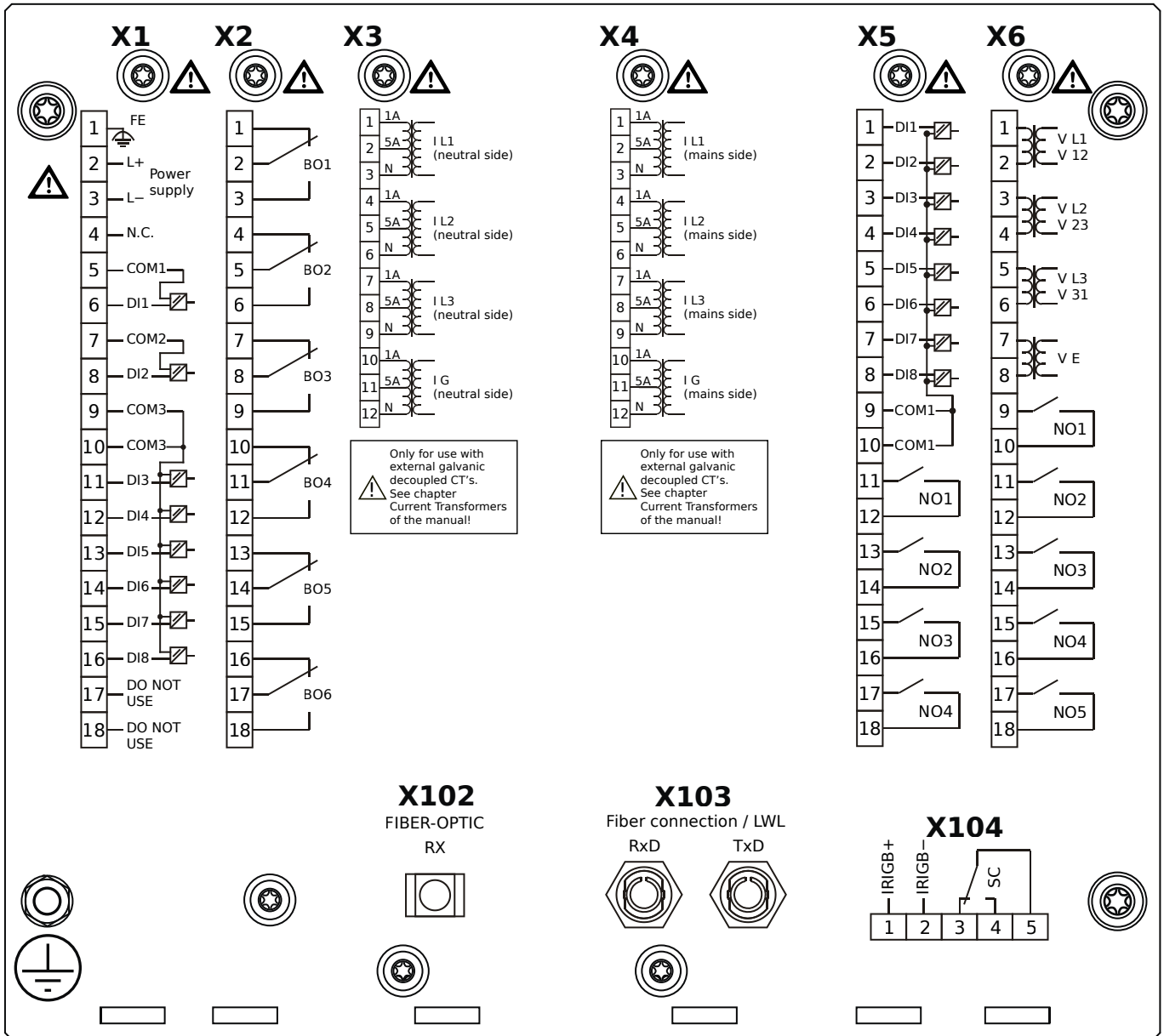

Housing B2, large display, door mounting

- X1** – DI8-X1: Wide-range power supply unit, incl. 2 non-grouped digital inputs and 6 grouped digital inputs
- X2** – OR6: Assembly Group with 6 Output Relays (Changeover / Form C)
- X3** – TI: Standard current measuring card (for the neutral side of the differential protection)
- X4** – TI: Standard current measuring card (for the mains side of the differential protection)
- X5** – DI8-OR4: Assembly Group with 8 Digital Inputs and 4 Output Relays (NO / Form A)
- X6** – TU-OR5: Voltage measuring (0 ... 300 VAC) assembly group with 5 additional Output Relays (NO / Form A)
- X102** – Universal Resistance-Temperature Detector (URTD) input, Fiber optics interface, Versatile Link
- X103** – Modbus RTU / IEC 60870-5-103 / DNP3.0 RTU, Fiber optics interface, ST Connector
- X104** – IRIG-B00X, incl. System Contact (Supervision Contact)

MCDGV4-2D0AFB

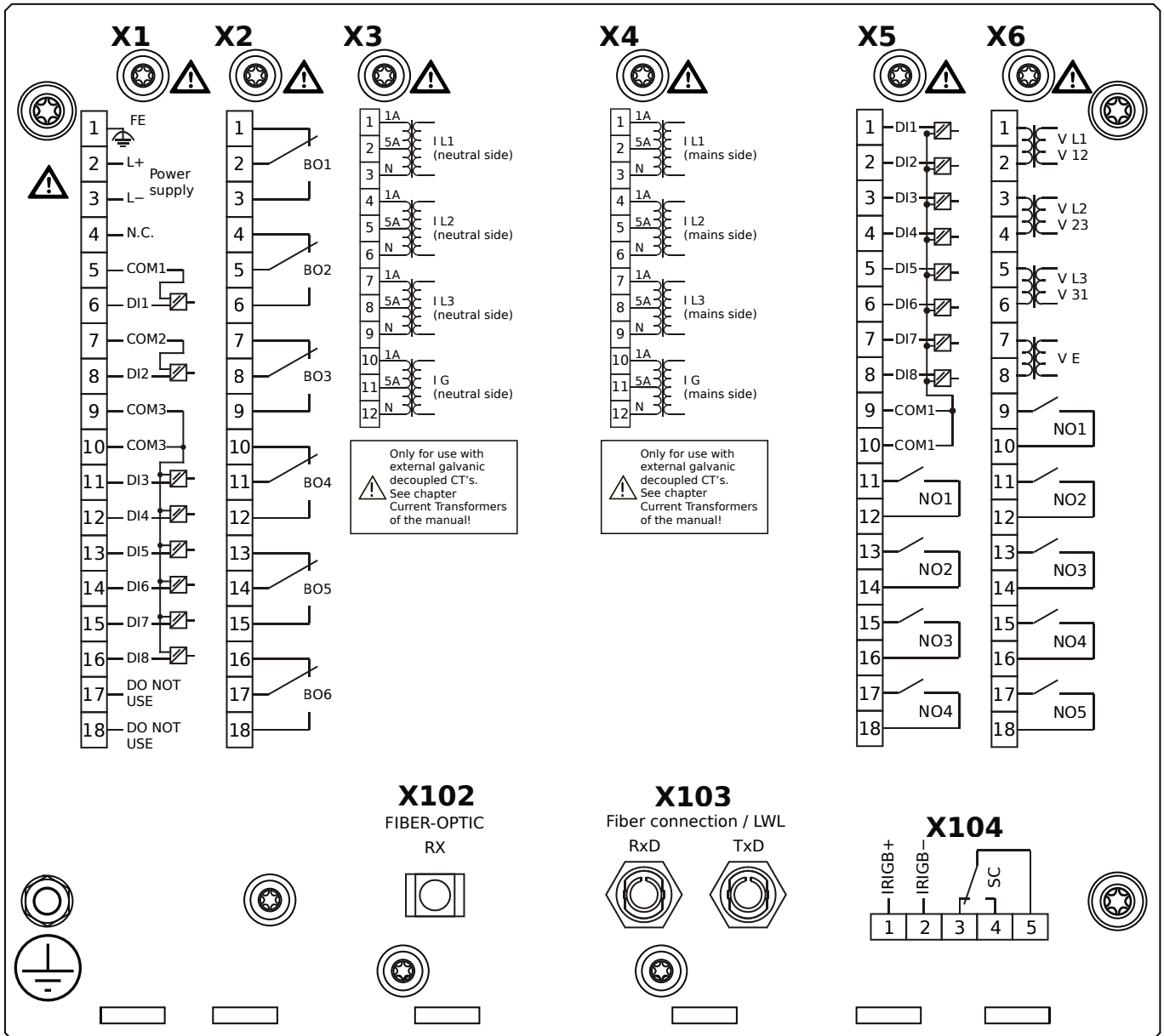

Housing B2, large display, door mounting

- + Conformal Coating (for installations in harsh environment)

- X1** – DI8-X1: Wide-range power supply unit, incl. 2 non-grouped digital inputs and 6 grouped digital inputs
- X2** – OR6: Assembly Group with 6 Output Relays (Changeover / Form C)
- X3** – TI: Standard current measuring card (for the neutral side of the differential protection)
- X4** – TI: Standard current measuring card (for the mains side of the differential protection)
- X5** – DI8-OR4: Assembly Group with 8 Digital Inputs and 4 Output Relays (NO / Form A)
- X6** – TU-OR5: Voltage measuring (0 ... 300 VAC) assembly group with 5 additional Output Relays (NO / Form A)
- X102** – Universal Resistance-Temperature Detector (URTD) input, Fiber optics interface, Versatile Link
- X103** – Modbus RTU / IEC 60870-5-103 / DNP3.0 RTU, Fiber optics interface, ST Connector
- X104** – IRIG-B00X, incl. System Contact (Supervision Contact)

MCDGV4-2D0AGA

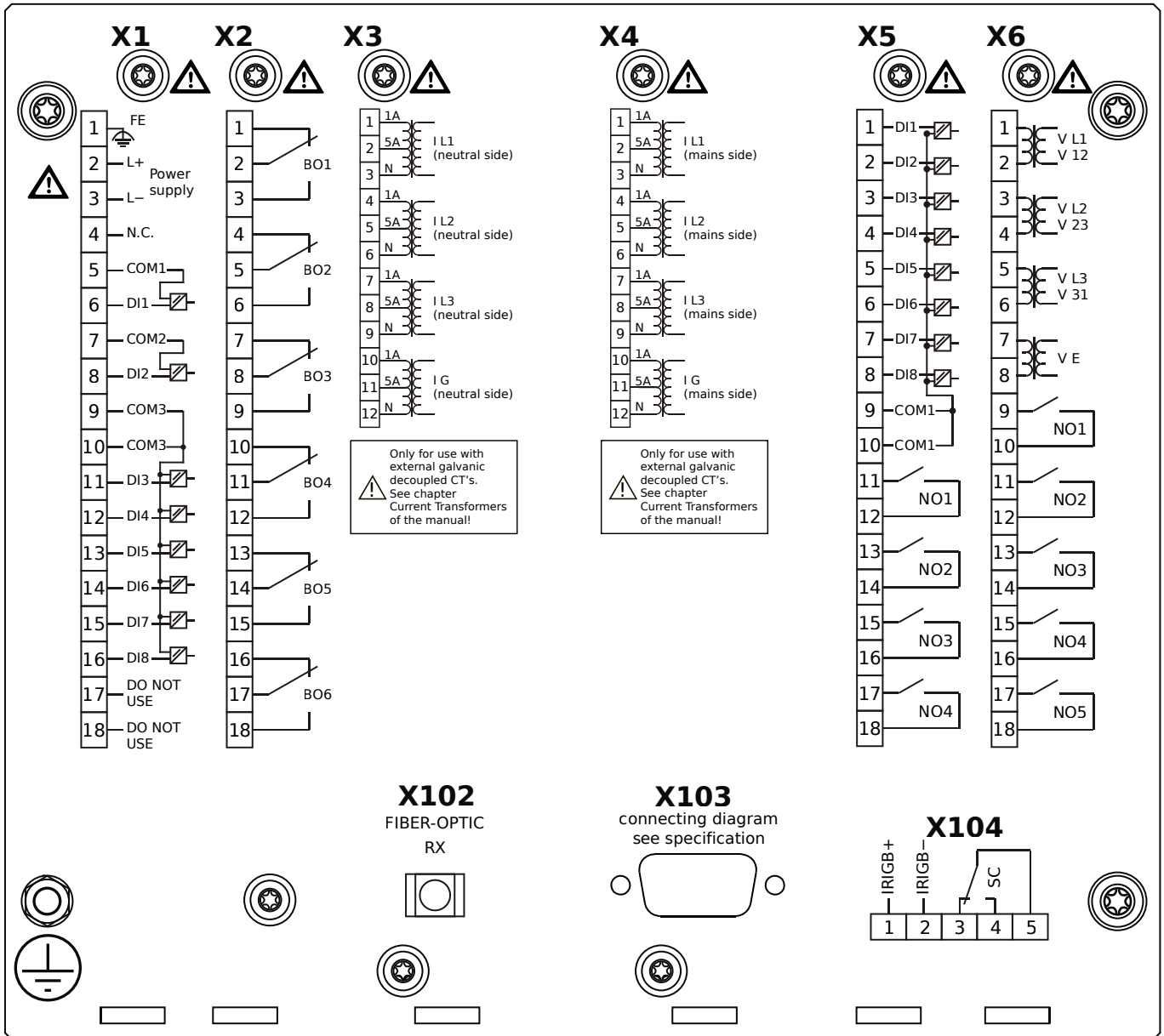

Housing B2, large display, door mounting

- X1** – DI8-X1: Wide-range power supply unit, incl. 2 non-grouped digital inputs and 6 grouped digital inputs
- X2** – OR6: Assembly Group with 6 Output Relays (Changeover / Form C)
- X3** – TI: Standard current measuring card (for the neutral side of the differential protection)
- X4** – TI: Standard current measuring card (for the mains side of the differential protection)
- X5** – DI8-OR4: Assembly Group with 8 Digital Inputs and 4 Output Relays (NO / Form A)
- X6** – TU-OR5: Voltage measuring (0 ... 300 VAC) assembly group with 5 additional Output Relays (NO / Form A)
- X102** – Universal Resistance-Temperature Detector (URTD) input, Fiber optics interface, Versatile Link
- X103** – Modbus RTU / IEC 60870-5-103 / DNP3.0 RTU, RS485, D-SUB
- X104** – IRIG-B00X, incl. System Contact (Supervision Contact)

MCDGV4-2D0AGB

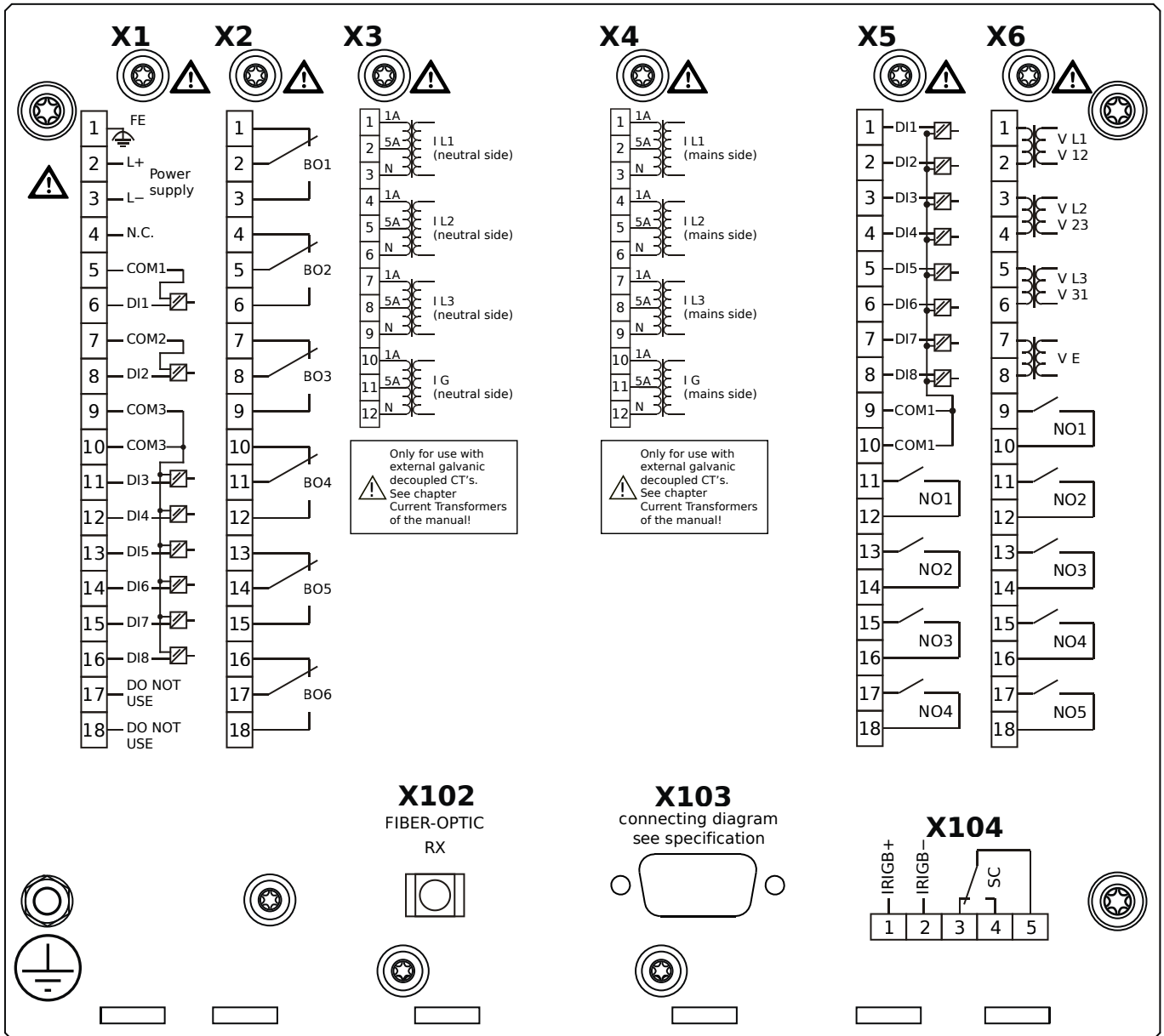

Housing B2, large display, door mounting

+ Conformal Coating (for installations in harsh environment)

- X1** – DI8-X1: Wide-range power supply unit, incl. 2 non-grouped digital inputs and 6 grouped digital inputs
- X2** – OR6: Assembly Group with 6 Output Relays (Changeover / Form C)
- X3** – TI: Standard current measuring card (for the neutral side of the differential protection)
- X4** – TI: Standard current measuring card (for the mains side of the differential protection)
- X5** – DI8-OR4: Assembly Group with 8 Digital Inputs and 4 Output Relays (NO / Form A)
- X6** – TU-OR5: Voltage measuring (0 ... 300 VAC) assembly group with 5 additional Output Relays (NO / Form A)
- X102** – Universal Resistance-Temperature Detector (URTD) input, Fiber optics interface, Versatile Link
- X103** – Modbus RTU / IEC 60870-5-103 / DNP3.0 RTU, RS485, D-SUB
- X104** – IRIG-B00X, incl. System Contact (Supervision Contact)

MCDGV4-2D0AHA

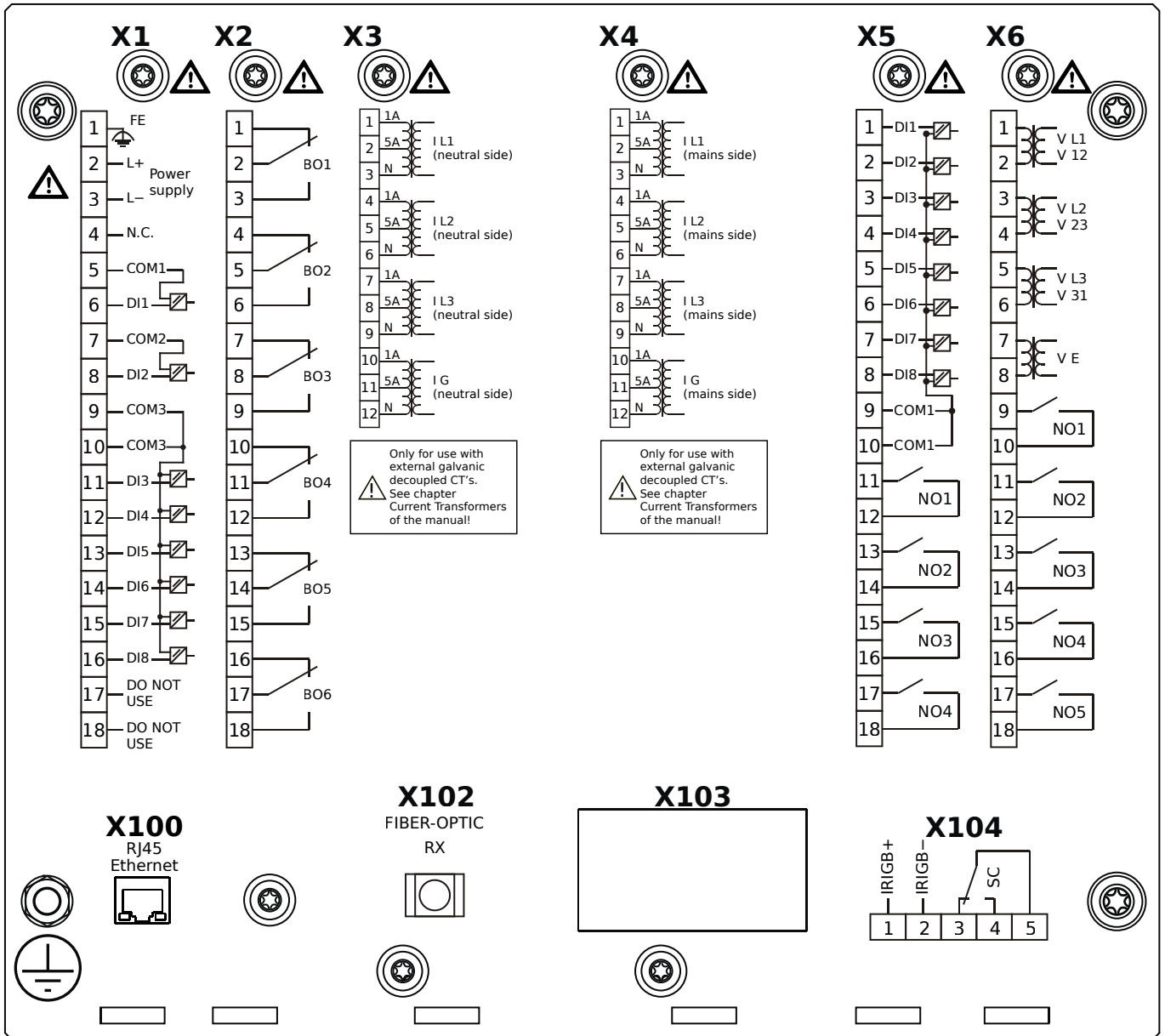

Housing B2, large display, door mounting

- X1** – DI8-X1: Wide-range power supply unit, incl. 2 non-grouped digital inputs and 6 grouped digital inputs
- X2** – OR6: Assembly Group with 6 Output Relays (Changeover / Form C)
- X3** – TI: Standard current measuring card (for the neutral side of the differential protection)
- X4** – TI: Standard current measuring card (for the mains side of the differential protection)
- X5** – DI8-OR4: Assembly Group with 8 Digital Inputs and 4 Output Relays (NO / Form A)
- X6** – TU-OR5: Voltage measuring (0 ... 300 VAC) assembly group with 5 additional Output Relays (NO / Form A)
- X100** – IEC 61850 / Modbus TCP / DNP3.0 TCP/UDP, Ethernet interface, 100 Mbit/s, RJ45 (BASE100-FX)
- X102** – Universal Resistance-Temperature Detector (URTD) input, Fiber optics interface, Versatile Link
- X104** – IRIG-B00X, incl. System Contact (Supervision Contact)

MCDGV4-2D0AHB

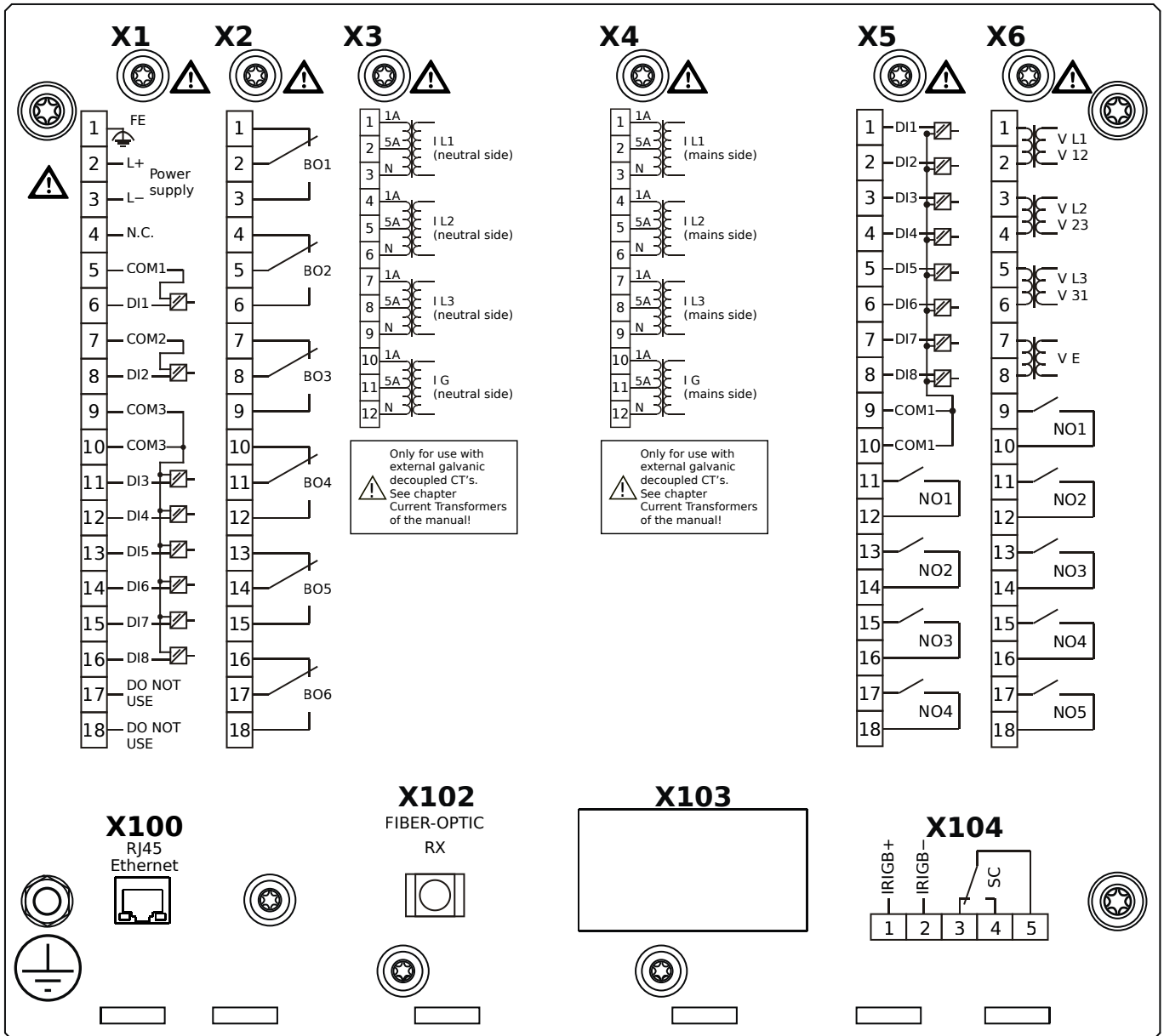

Housing B2, large display, door mounting

- + Conformal Coating (for installations in harsh environment)

- X1** – DI8-X1: Wide-range power supply unit, incl. 2 non-grouped digital inputs and 6 grouped digital inputs
- X2** – OR6: Assembly Group with 6 Output Relays (Changeover / Form C)
- X3** – TI: Standard current measuring card (for the neutral side of the differential protection)
- X4** – TI: Standard current measuring card (for the mains side of the differential protection)
- X5** – DI8-OR4: Assembly Group with 8 Digital Inputs and 4 Output Relays (NO / Form A)
- X6** – TU-OR5: Voltage measuring (0 ... 300 VAC) assembly group with 5 additional Output Relays (NO / Form A)
- X100** – IEC 61850 / Modbus TCP / DNP3.0 TCP/UDP, Ethernet interface, 100 Mbit/s, RJ45 (BASE100-FX)
- X102** – Universal Resistance-Temperature Detector (URTD) input, Fiber optics interface, Versatile Link
- X104** – IRIG-B00X, incl. System Contact (Supervision Contact)

MCDGV4-2D0AIA

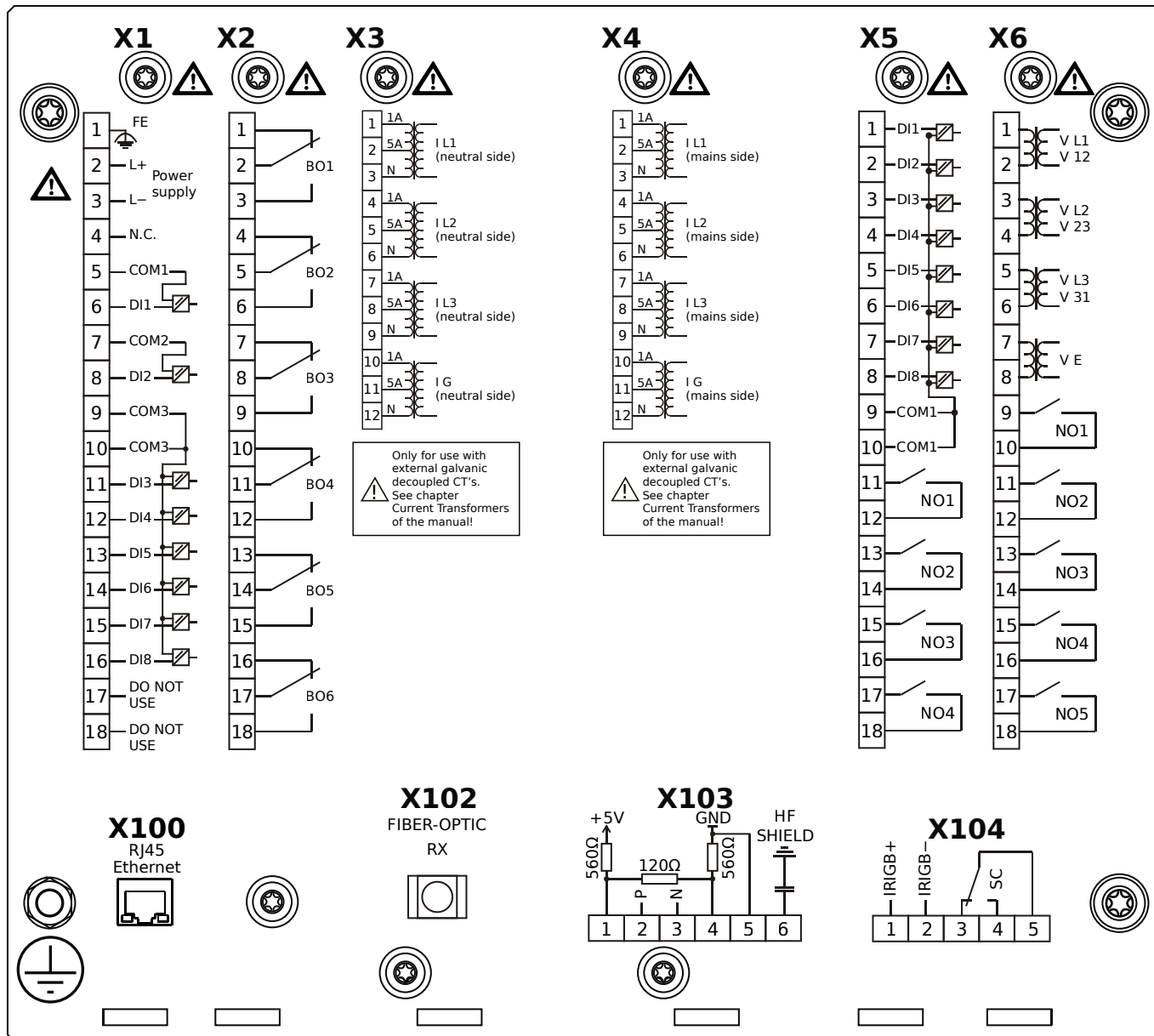

Housing B2, large display, door mounting

- X1** – DI8-X1: Wide-range power supply unit, incl. 2 non-grouped digital inputs and 6 grouped digital inputs
- X2** – OR6: Assembly Group with 6 Output Relays (Changeover / Form C)
- X3** – TI: Standard current measuring card (for the neutral side of the differential protection)
- X4** – TI: Standard current measuring card (for the mains side of the differential protection)
- X5** – DI8-OR4: Assembly Group with 8 Digital Inputs and 4 Output Relays (NO / Form A)
- X6** – TU-OR5: Voltage measuring (0 ... 300 VAC) assembly group with 5 additional Output Relays (NO / Form A)
- X100** – Modbus TCP / DNP3.0 TCP/UDP, Ethernet interface, 100 Mbit/s, RJ45 (BASE100-FX)
- X102** – Universal Resistance-Temperature Detector (URTD) input, Fiber optics interface, Versatile Link
- X103** – IEC 60870-5-103 / Modbus RTU / DNP3.0 RTU, RS485, Terminals
- X104** – IRIG-B00X, incl. System Contact (Supervision Contact)

MCDGV4-2D0AIB

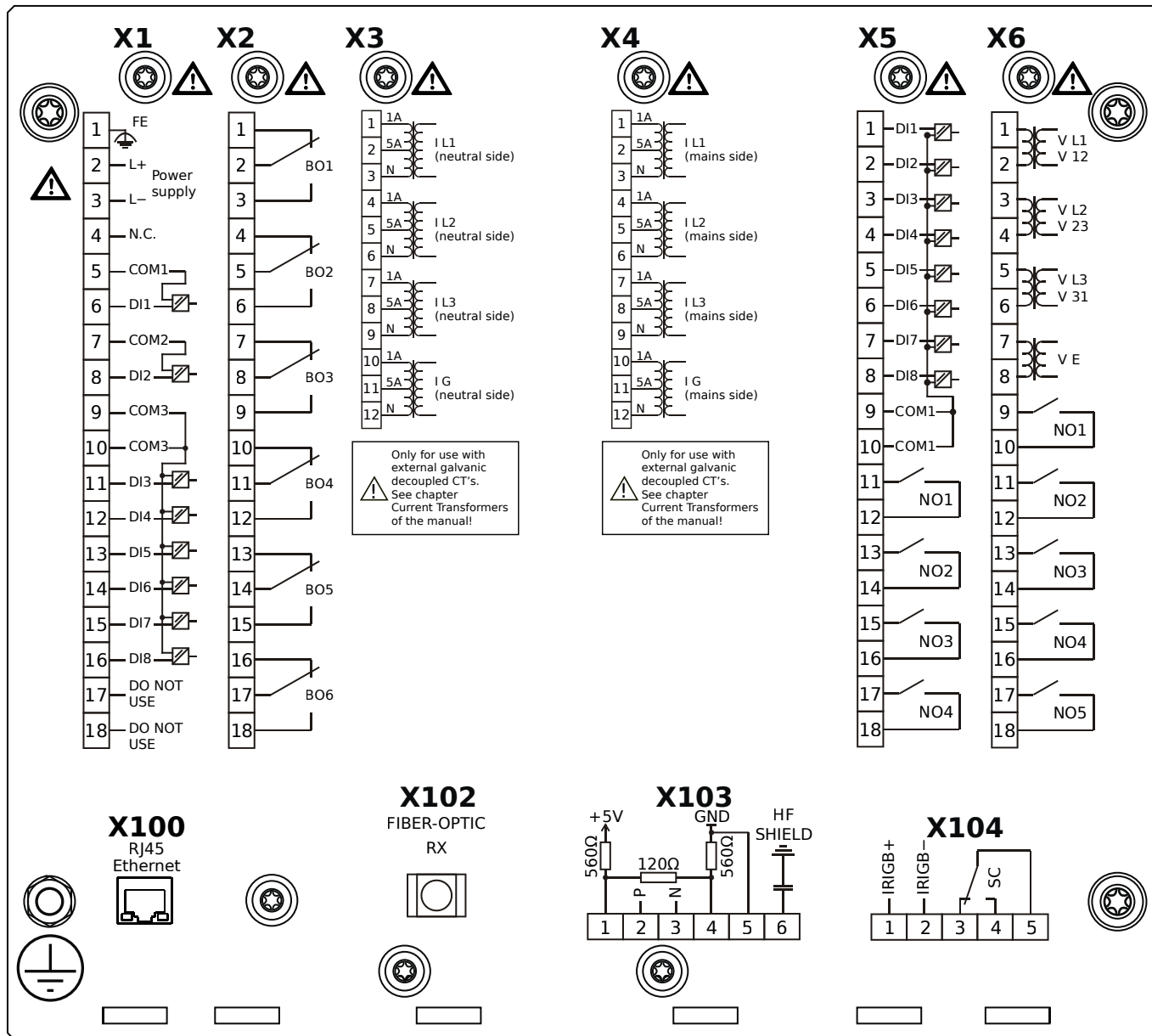

Housing B2, large display, door mounting

+ Conformal Coating (for installations in harsh environment)

- X1** – DI8-X1: Wide-range power supply unit, incl. 2 non-grouped digital inputs and 6 grouped digital inputs
- X2** – OR6: Assembly Group with 6 Output Relays (Changeover / Form C)
- X3** – TI: Standard current measuring card (for the neutral side of the differential protection)
- X4** – TI: Standard current measuring card (for the mains side of the differential protection)
- X5** – DI8-OR4: Assembly Group with 8 Digital Inputs and 4 Output Relays (NO / Form A)
- X6** – TU-OR5: Voltage measuring (0 ... 300 VAC) assembly group with 5 additional Output Relays (NO / Form A)
- X100** – Modbus TCP / DNP3.0 TCP/UDP, Ethernet interface, 100 Mbit/s, RJ45 (BASE100-FX)
- X102** – Universal Resistance-Temperature Detector (URTD) input, Fiber optics interface, Versatile Link
- X103** – IEC 60870-5-103 / Modbus RTU / DNP3.0 RTU, RS485, Terminals
- X104** – IRIG-B00X, incl. System Contact (Supervision Contact)

MCDGV4-2D0AKA

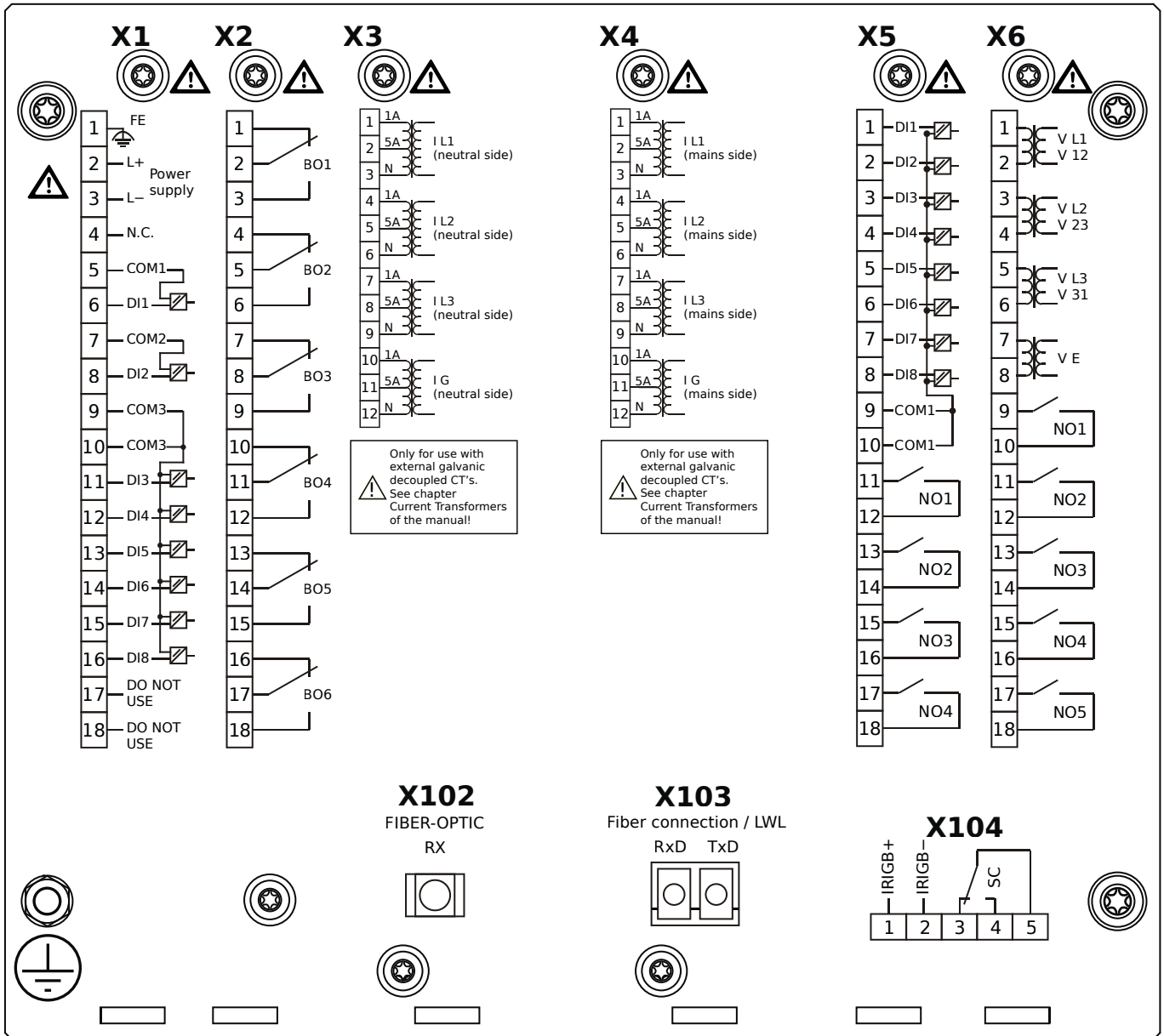

Housing B2, large display, door mounting

- X1** – DI8-X1: Wide-range power supply unit, incl. 2 non-grouped digital inputs and 6 grouped digital inputs
- X2** – OR6: Assembly Group with 6 Output Relays (Changeover / Form C)
- X3** – TI: Standard current measuring card (for the neutral side of the differential protection)
- X4** – TI: Standard current measuring card (for the mains side of the differential protection)
- X5** – DI8-OR4: Assembly Group with 8 Digital Inputs and 4 Output Relays (NO / Form A)
- X6** – TU-OR5: Voltage measuring (0 ... 300 VAC) assembly group with 5 additional Output Relays (NO / Form A)
- X102** – Universal Resistance-Temperature Detector (URTD) input, Fiber optics interface, Versatile Link
- X103** – IEC 61850 / Modbus TCP / DNP3.0 TCP/UDP, Fiber optics interface, LC Connector
- X104** – IRIG-B00X, incl. System Contact (Supervision Contact)

MCDGV4-2D0AKB

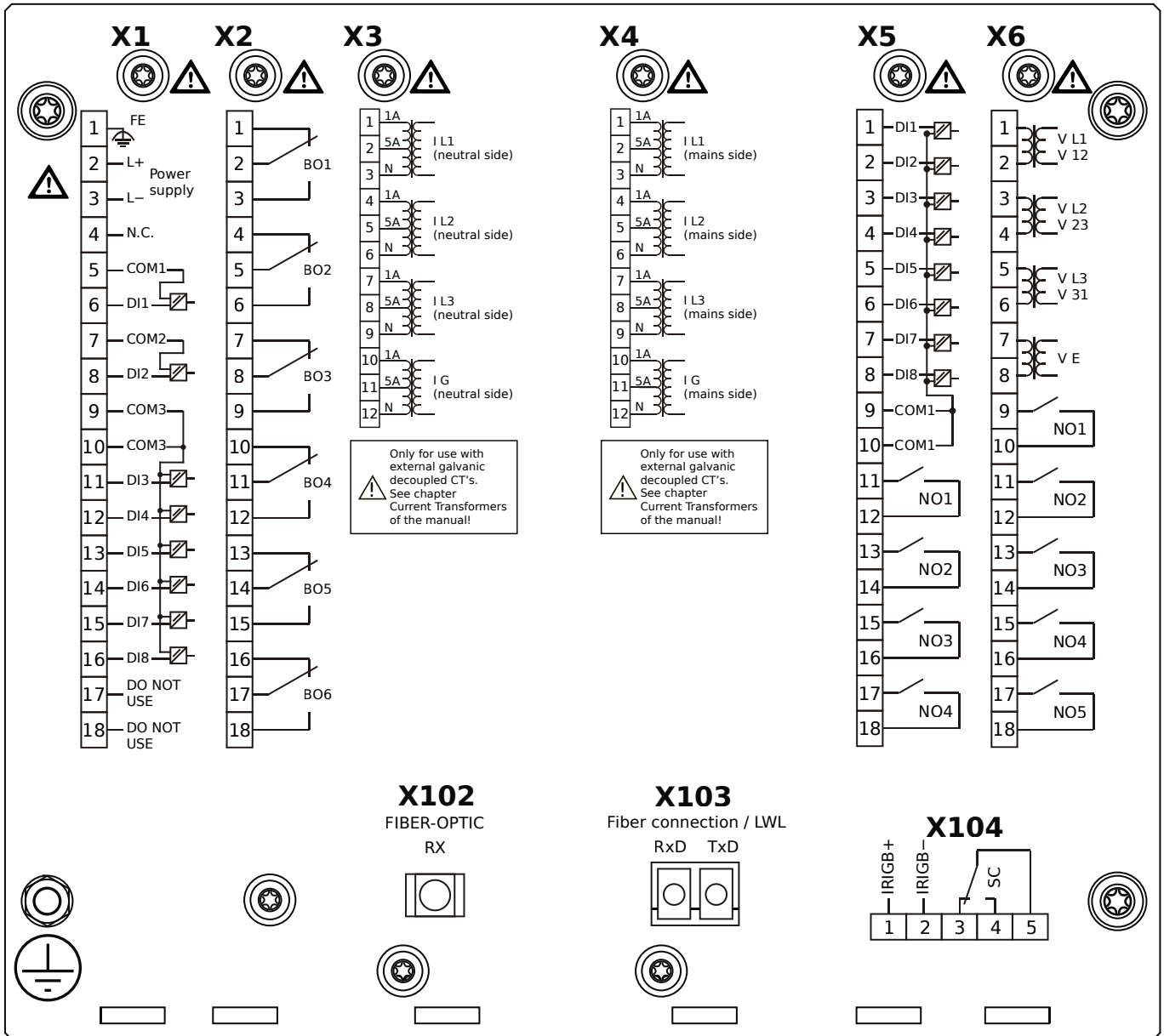

Housing B2, large display, door mounting

- + Conformal Coating (for installations in harsh environment)

- X1** – DI8-X1: Wide-range power supply unit, incl. 2 non-grouped digital inputs and 6 grouped digital inputs
- X2** – OR6: Assembly Group with 6 Output Relays (Changeover / Form C)
- X3** – TI: Standard current measuring card (for the neutral side of the differential protection)
- X4** – TI: Standard current measuring card (for the mains side of the differential protection)
- X5** – DI8-OR4: Assembly Group with 8 Digital Inputs and 4 Output Relays (NO / Form A)
- X6** – TU-OR5: Voltage measuring (0 ... 300 VAC) assembly group with 5 additional Output Relays (NO / Form A)
- X102** – Universal Resistance-Temperature Detector (URTD) input, Fiber optics interface, Versatile Link
- X103** – IEC 61850 / Modbus TCP / DNP3.0 TCP/UDP, Fiber optics interface, LC Connector
- X104** – IRIG-B00X, incl. System Contact (Supervision Contact)

MCDGV4-2D0ALA

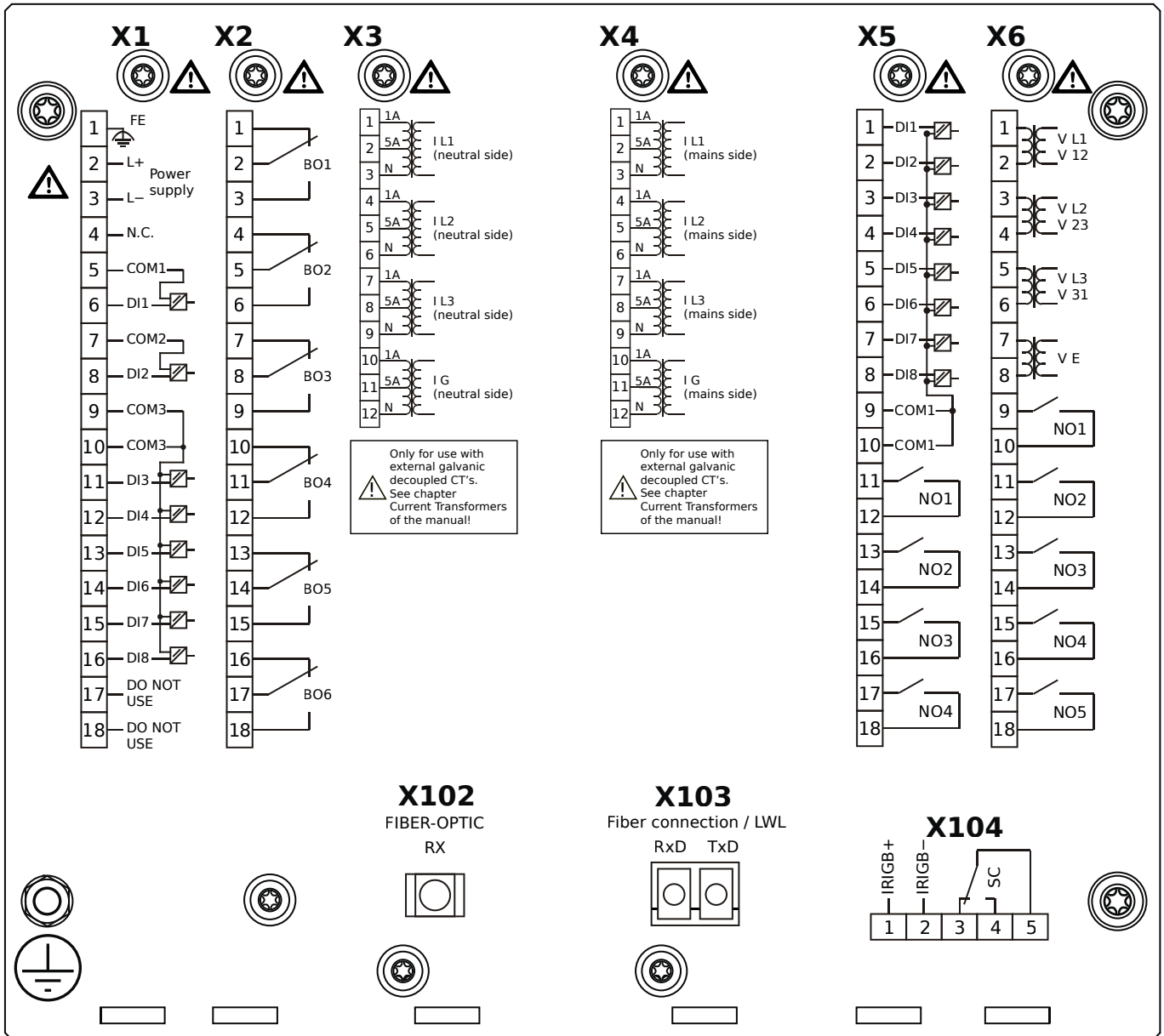

Housing B2, large display, door mounting

- X1** – DI8-X1: Wide-range power supply unit, incl. 2 non-grouped digital inputs and 6 grouped digital inputs
- X2** – OR6: Assembly Group with 6 Output Relays (Changeover / Form C)
- X3** – TI: Standard current measuring card (for the neutral side of the differential protection)
- X4** – TI: Standard current measuring card (for the mains side of the differential protection)
- X5** – DI8-OR4: Assembly Group with 8 Digital Inputs and 4 Output Relays (NO / Form A)
- X6** – TU-OR5: Voltage measuring (0 ... 300 VAC) assembly group with 5 additional Output Relays (NO / Form A)
- X102** – Universal Resistance-Temperature Detector (URTD) input, Fiber optics interface, Versatile Link
- X103** – Modbus TCP / DNP3.0 TCP/UDP, Fiber optics interface, LC Connector
- X104** – IRIG-B00X, incl. System Contact (Supervision Contact)

MCDGV4-2D0ALB

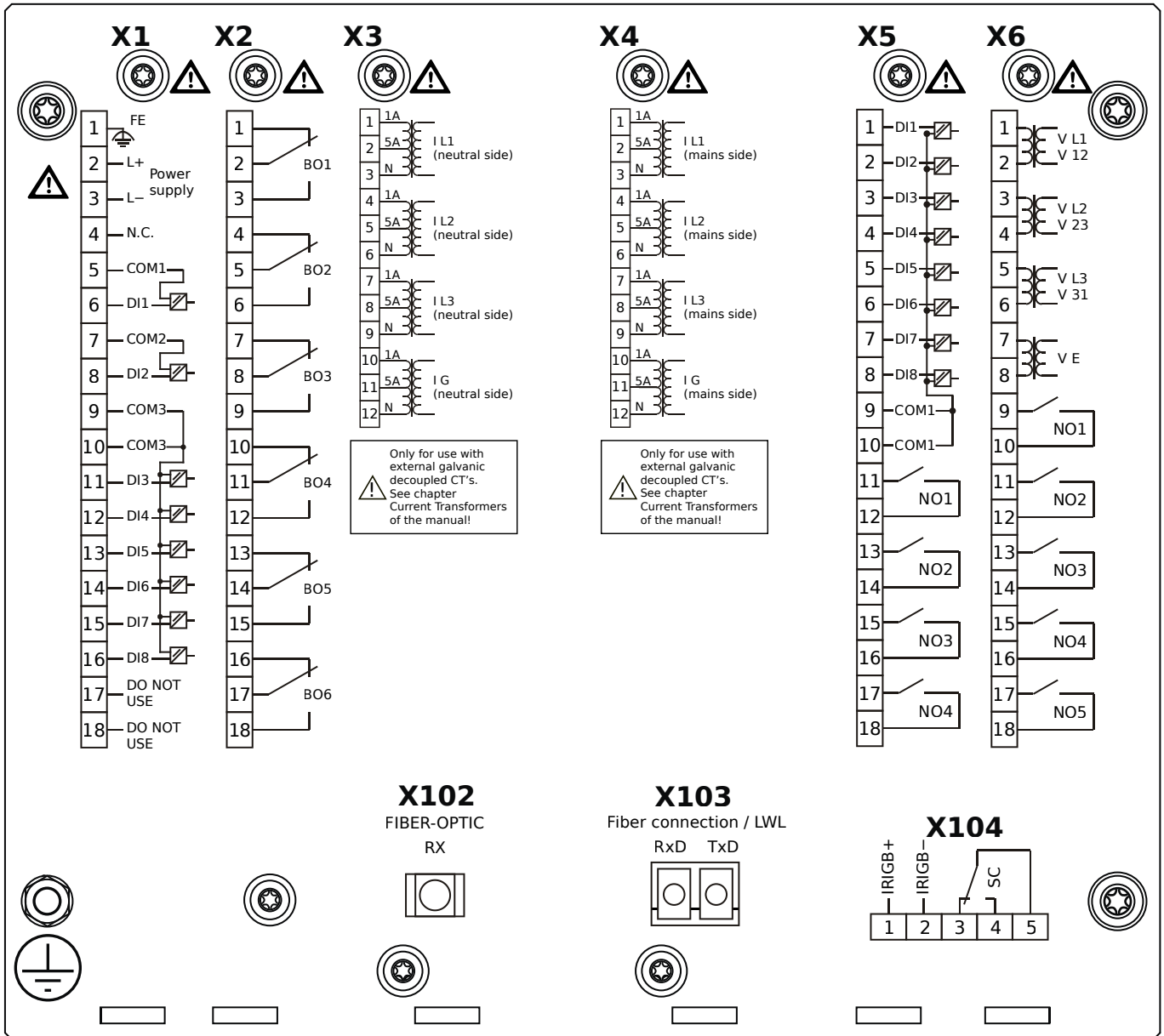

Housing B2, large display, door mounting

+ Conformal Coating (for installations in harsh environment)

- X1** – DI8-X1: Wide-range power supply unit, incl. 2 non-grouped digital inputs and 6 grouped digital inputs
- X2** – OR6: Assembly Group with 6 Output Relays (Changeover / Form C)
- X3** – TI: Standard current measuring card (for the neutral side of the differential protection)
- X4** – TI: Standard current measuring card (for the mains side of the differential protection)
- X5** – DI8-OR4: Assembly Group with 8 Digital Inputs and 4 Output Relays (NO / Form A)
- X6** – TU-OR5: Voltage measuring (0 ... 300 VAC) assembly group with 5 additional Output Relays (NO / Form A)
- X102** – Universal Resistance-Temperature Detector (URTD) input, Fiber optics interface, Versatile Link
- X103** – Modbus TCP / DNP3.0 TCP/UDP, Fiber optics interface, LC Connector
- X104** – IRIG-B00X, incl. System Contact (Supervision Contact)

MCDGV4-2D0ATA

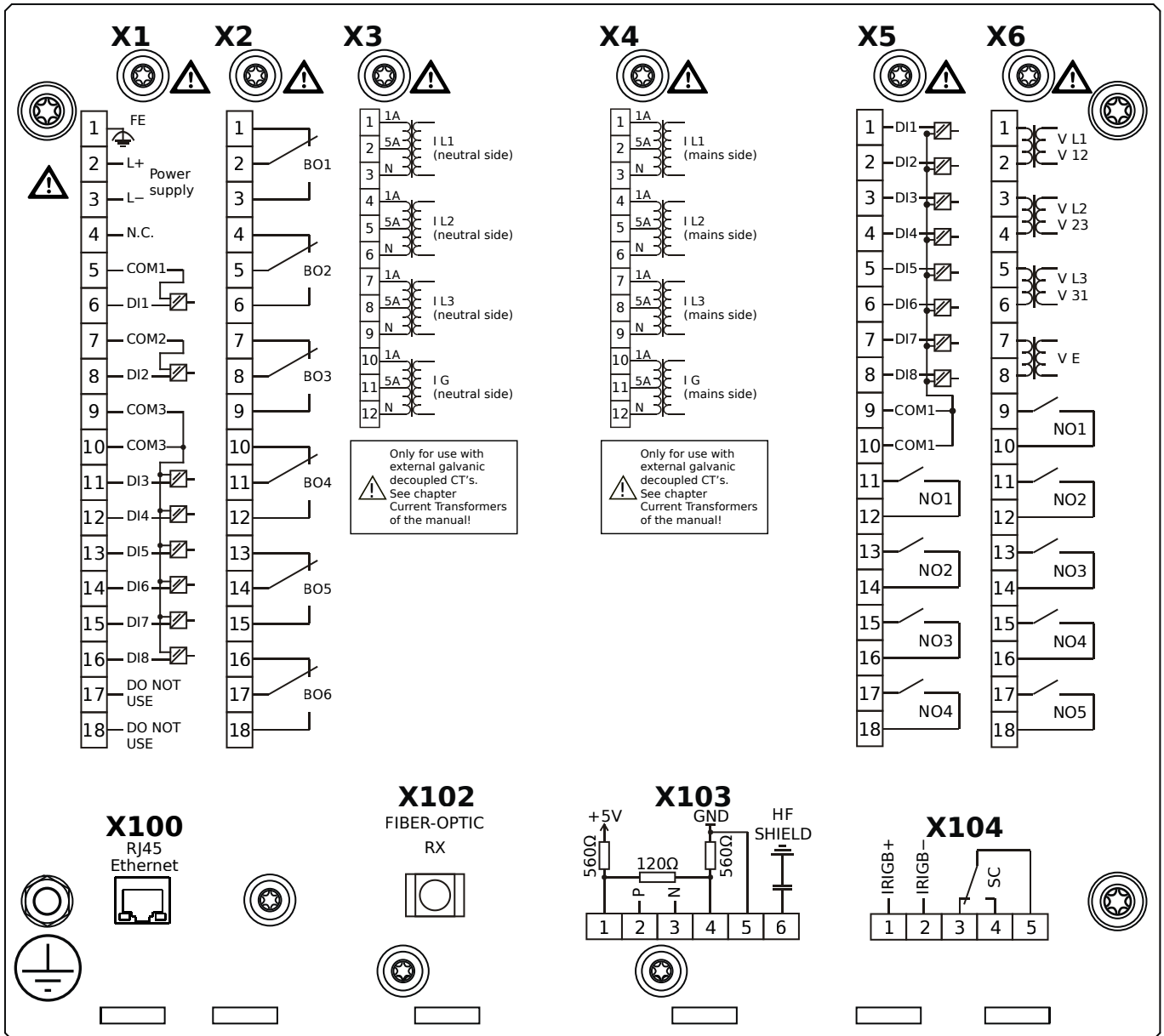

Housing B2, large display, door mounting

- X1** – DI8-X1: Wide-range power supply unit, incl. 2 non-grouped digital inputs and 6 grouped digital inputs
- X2** – OR6: Assembly Group with 6 Output Relays (Changeover / Form C)
- X3** – TI: Standard current measuring card (for the neutral side of the differential protection)
- X4** – TI: Standard current measuring card (for the mains side of the differential protection)
- X5** – DI8-OR4: Assembly Group with 8 Digital Inputs and 4 Output Relays (NO / Form A)
- X6** – TU-OR5: Voltage measuring (0 ... 300 VAC) assembly group with 5 additional Output Relays (NO / Form A)
- X100** – IEC 61850 / Modbus TCP / DNP3.0 TCP/UDP, Ethernet interface, 100 Mbit/s, RJ45 (BASE100-FX)
- X102** – Universal Resistance-Temperature Detector (URTD) input, Fiber optics interface, Versatile Link
- X103** – IEC 60870-5-103 / Modbus RTU / DNP3.0 RTU, RS485, Terminals
- X104** – IRIG-B00X, incl. System Contact (Supervision Contact)

MCDGV4-2D0ATB

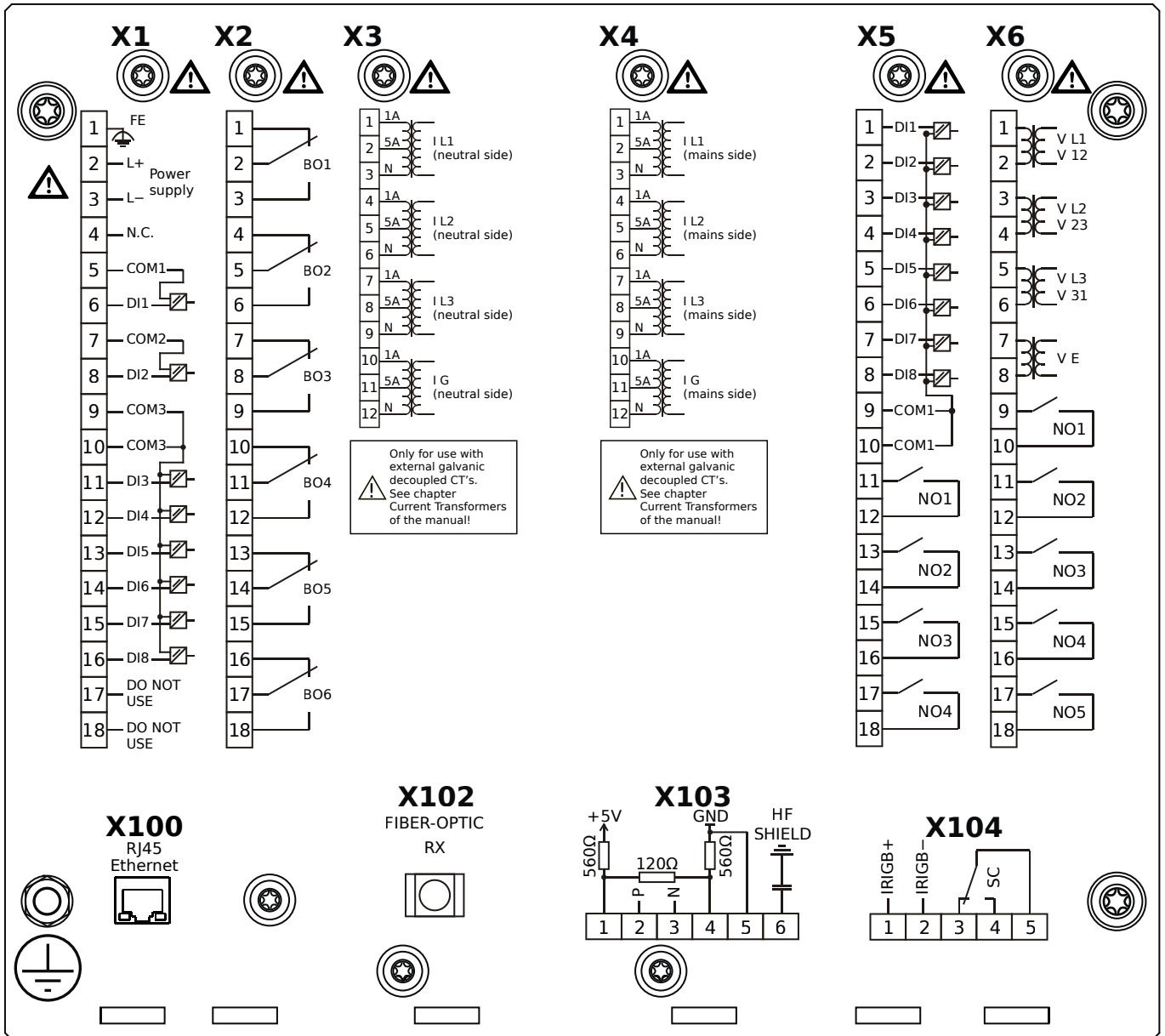

Housing B2, large display, door mounting

+ Conformal Coating (for installations in harsh environment)

- X1** – DI8-X1: Wide-range power supply unit, incl. 2 non-grouped digital inputs and 6 grouped digital inputs
- X2** – OR6: Assembly Group with 6 Output Relays (Changeover / Form C)
- X3** – TI: Standard current measuring card (for the neutral side of the differential protection)
- X4** – TI: Standard current measuring card (for the mains side of the differential protection)
- X5** – DI8-OR4: Assembly Group with 8 Digital Inputs and 4 Output Relays (NO / Form A)
- X6** – TU-OR5: Voltage measuring (0 ... 300 VAC) assembly group with 5 additional Output Relays (NO / Form A)
- X100** – IEC 61850 / Modbus TCP / DNP3.0 TCP/UDP, Ethernet interface, 100 Mbit/s, RJ45 (BASE100-FX)
- X102** – Universal Resistance-Temperature Detector (URTD) input, Fiber optics interface, Versatile Link
- X103** – IEC 60870-5-103 / Modbus RTU / DNP3.0 RTU, RS485, Terminals
- X104** – IRIG-B00X, incl. System Contact (Supervision Contact)

MCDGV4-2D0BAA

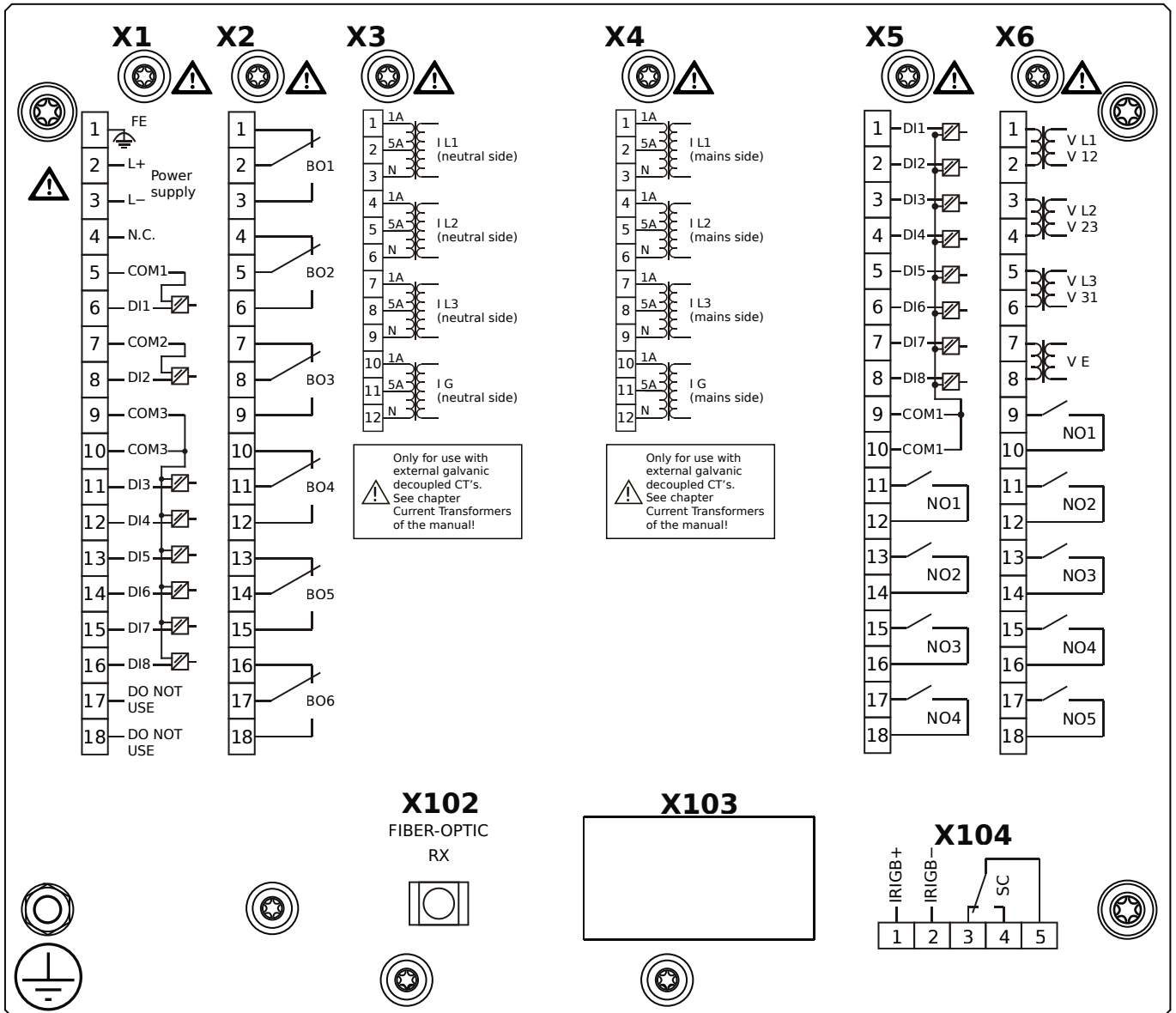

Housing B2, large display, 19" rack mounting

- X1** – DI8-X1: Wide-range power supply unit, incl. 2 non-grouped digital inputs and 6 grouped digital inputs
- X2** – OR6: Assembly Group with 6 Output Relays (Changeover / Form C)
- X3** – TI: Standard current measuring card (for the neutral side of the differential protection)
- X4** – TI: Standard current measuring card (for the mains side of the differential protection)
- X5** – DI8-OR4: Assembly Group with 8 Digital Inputs and 4 Output Relays (NO / Form A)
- X6** – TU-OR5: Voltage measuring (0 ... 300 VAC) assembly group with 5 additional Output Relays (NO / Form A)
- X102** – Universal Resistance-Temperature Detector (URTD) input, Fiber optics interface, Versatile Link
- X104** – IRIG-B00X, incl. System Contact (Supervision Contact)

MCDGV4-2D0BAB

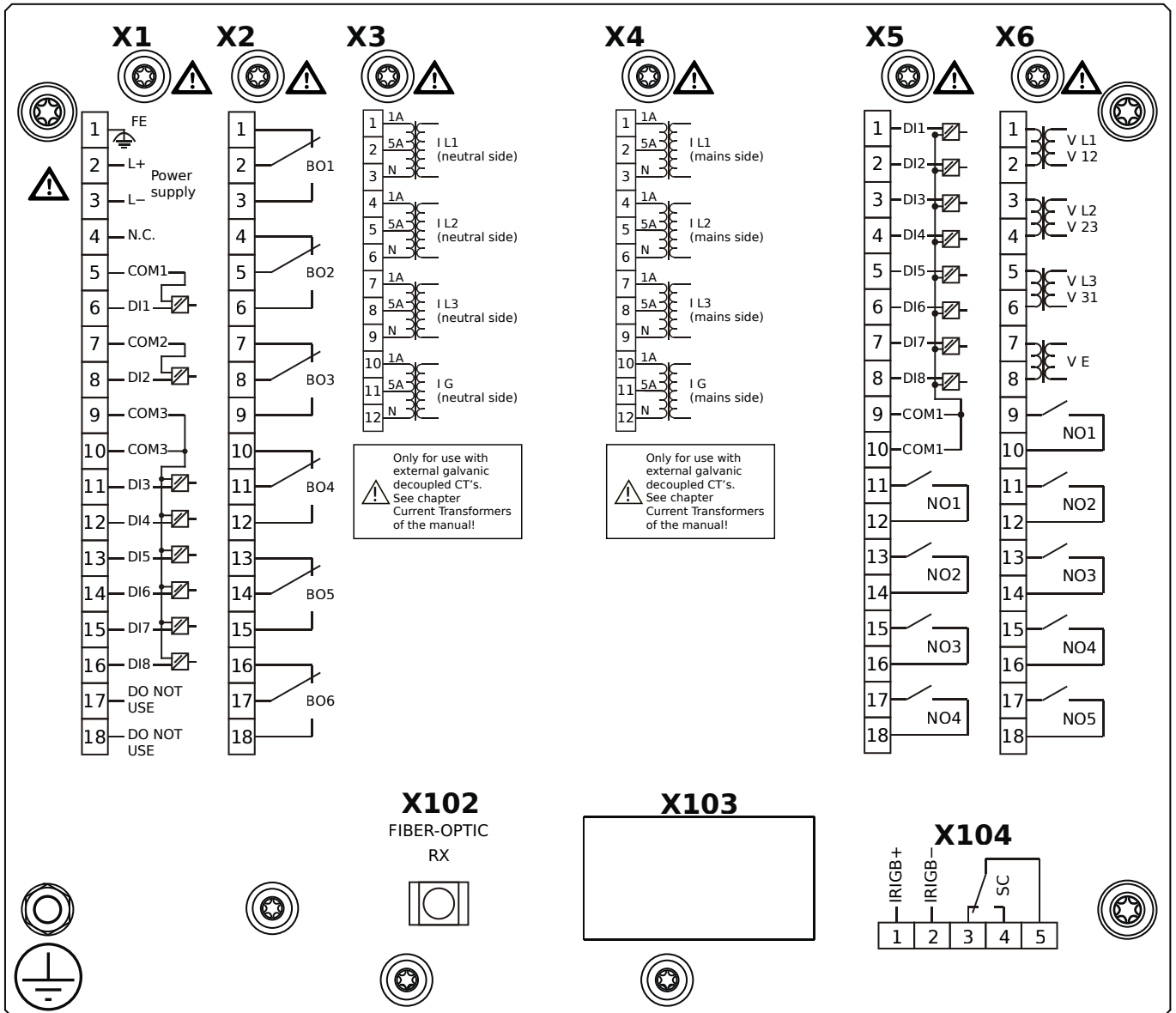

Housing B2, large display, 19" rack mounting

- + Conformal Coating (for installations in harsh environment)

- X1** – DI8-X1: Wide-range power supply unit, incl. 2 non-grouped digital inputs and 6 grouped digital inputs
- X2** – OR6: Assembly Group with 6 Output Relays (Changeover / Form C)
- X3** – TI: Standard current measuring card (for the neutral side of the differential protection)
- X4** – TI: Standard current measuring card (for the mains side of the differential protection)
- X5** – DI8-OR4: Assembly Group with 8 Digital Inputs and 4 Output Relays (NO / Form A)
- X6** – TU-OR5: Voltage measuring (0 ... 300 VAC) assembly group with 5 additional Output Relays (NO / Form A)
- X102** – Universal Resistance-Temperature Detector (URTD) input, Fiber optics interface, Versatile Link
- X104** – IRIG-B00X, incl. System Contact (Supervision Contact)

MCDGV4-2D0BBA

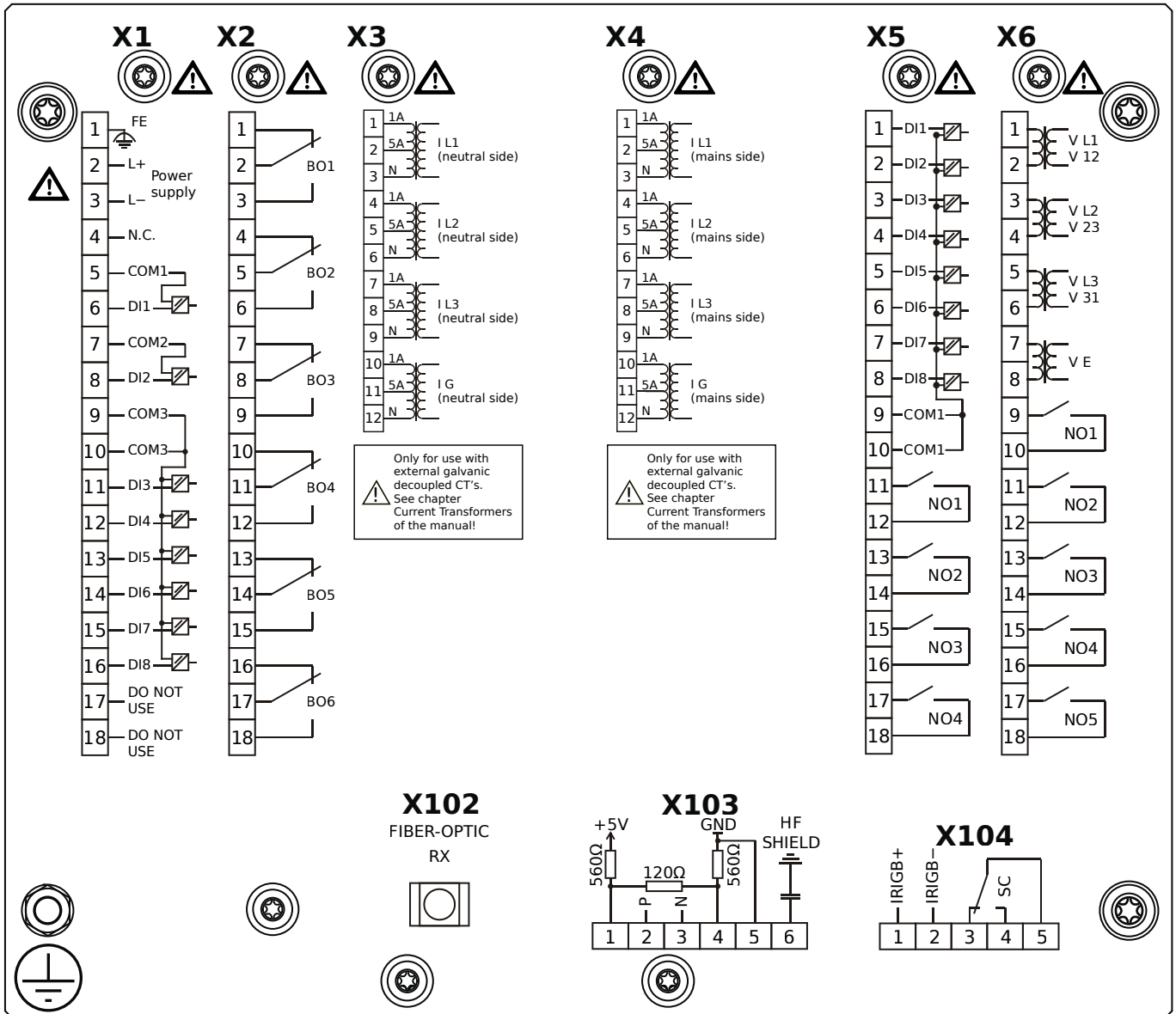

Housing B2, large display, 19" rack mounting

- X1** – DI8-X1: Wide-range power supply unit, incl. 2 non-grouped digital inputs and 6 grouped digital inputs
- X2** – OR6: Assembly Group with 6 Output Relays (Changeover / Form C)
- X3** – TI: Standard current measuring card (for the neutral side of the differential protection)
- X4** – TI: Standard current measuring card (for the mains side of the differential protection)
- X5** – DI8-OR4: Assembly Group with 8 Digital Inputs and 4 Output Relays (NO / Form A)
- X6** – TU-OR5: Voltage measuring (0 ... 300 VAC) assembly group with 5 additional Output Relays (NO / Form A)
- X102** – Universal Resistance-Temperature Detector (URTD) input, Fiber optics interface, Versatile Link
- X103** – Modbus RTU / IEC 60870-5-103 / DNP3.0 RTU, RS485, Terminals
- X104** – IRIG-B00X, incl. System Contact (Supervision Contact)

MCDGV4-2D0BBB

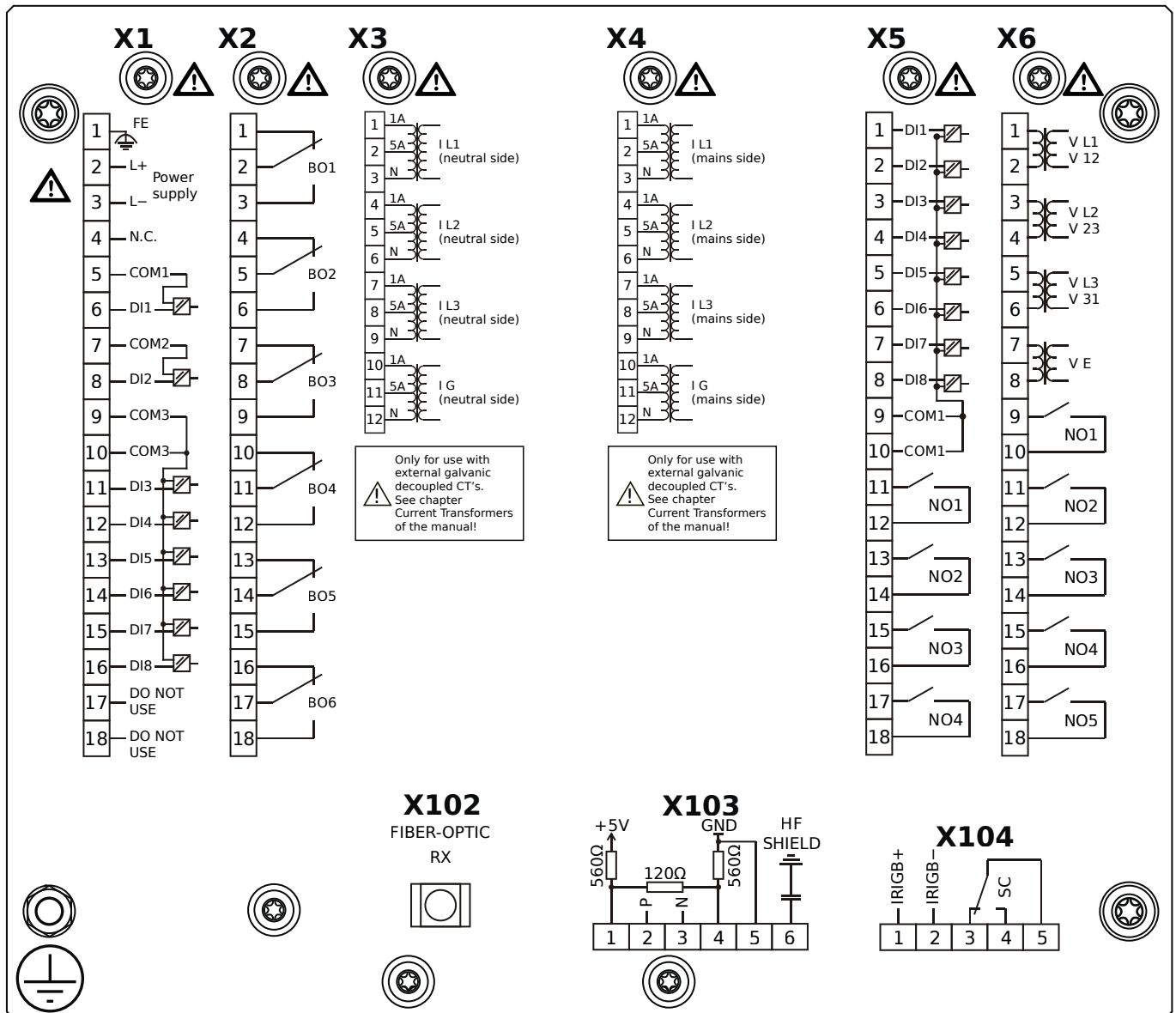

Housing B2, large display, 19" rack mounting

- + Conformal Coating (for installations in harsh environment)

- X1** – DI8-X1: Wide-range power supply unit, incl. 2 non-grouped digital inputs and 6 grouped digital inputs
- X2** – OR6: Assembly Group with 6 Output Relays (Changeover / Form C)
- X3** – TI: Standard current measuring card (for the neutral side of the differential protection)
- X4** – TI: Standard current measuring card (for the mains side of the differential protection)
- X5** – DI8-OR4: Assembly Group with 8 Digital Inputs and 4 Output Relays (NO / Form A)
- X6** – TU-OR5: Voltage measuring (0 ... 300 VAC) assembly group with 5 additional Output Relays (NO / Form A)
- X102** – Universal Resistance-Temperature Detector (URTD) input, Fiber optics interface, Versatile Link
- X103** – Modbus RTU / IEC 60870-5-103 / DNP3.0 RTU, RS485, Terminals
- X104** – IRIG-B00X, incl. System Contact (Supervision Contact)

MCDGV4-2D0BCA

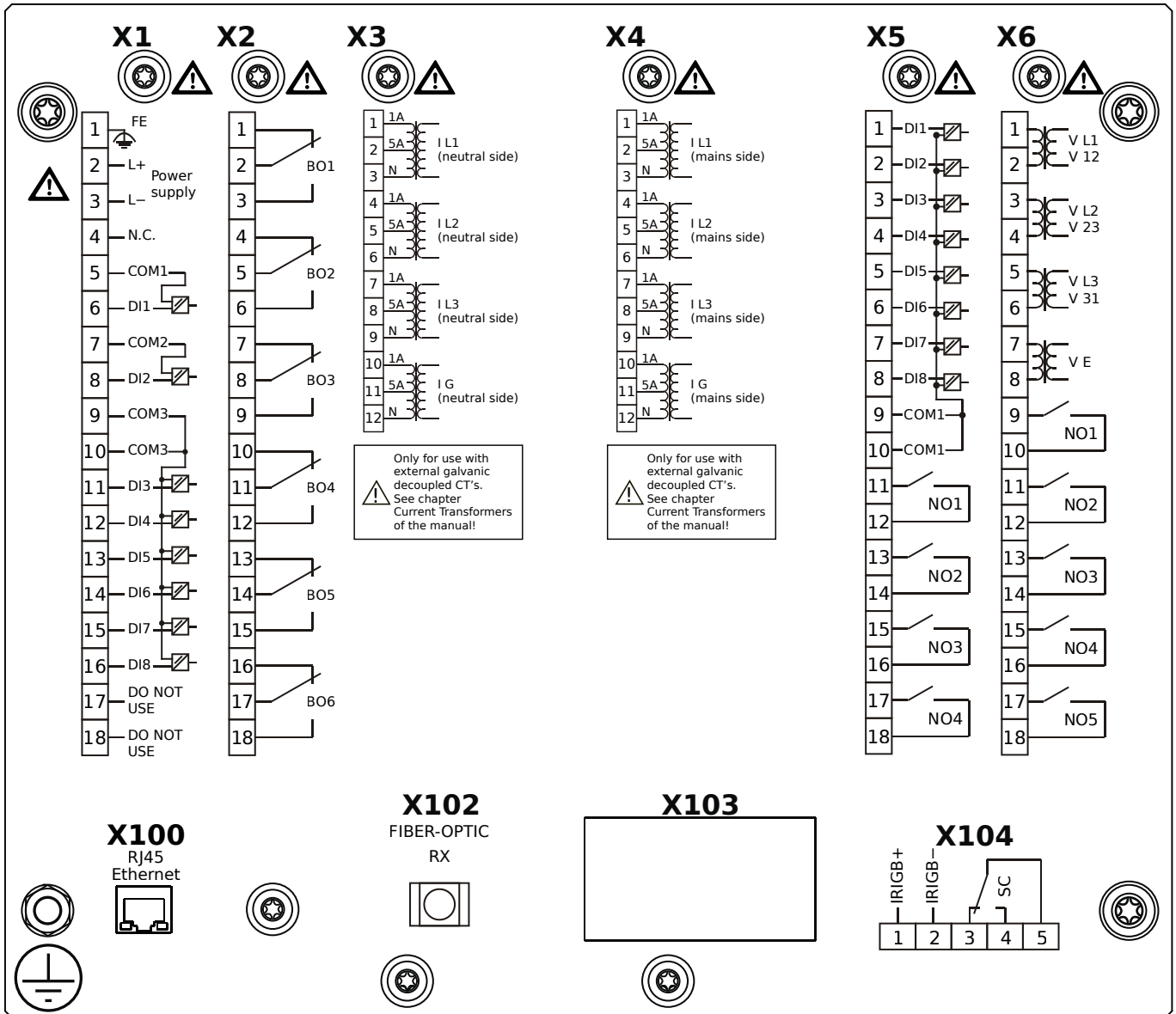

Housing B2, large display, 19" rack mounting

- X1** – DI8-X1: Wide-range power supply unit, incl. 2 non-grouped digital inputs and 6 grouped digital inputs
- X2** – OR6: Assembly Group with 6 Output Relays (Changeover / Form C)
- X3** – TI: Standard current measuring card (for the neutral side of the differential protection)
- X4** – TI: Standard current measuring card (for the mains side of the differential protection)
- X5** – DI8-OR4: Assembly Group with 8 Digital Inputs and 4 Output Relays (NO / Form A)
- X6** – TU-OR5: Voltage measuring (0 ... 300 VAC) assembly group with 5 additional Output Relays (NO / Form A)
- X100** – Modbus TCP / DNP3.0 TCP/UDP, Ethernet interface, 100 Mbit/s, RJ45 (BASE100-FX)
- X102** – Universal Resistance-Temperature Detector (URTD) input, Fiber optics interface, Versatile Link
- X104** – IRIG-B00X, incl. System Contact (Supervision Contact)

MCDGV4-2D0BCB

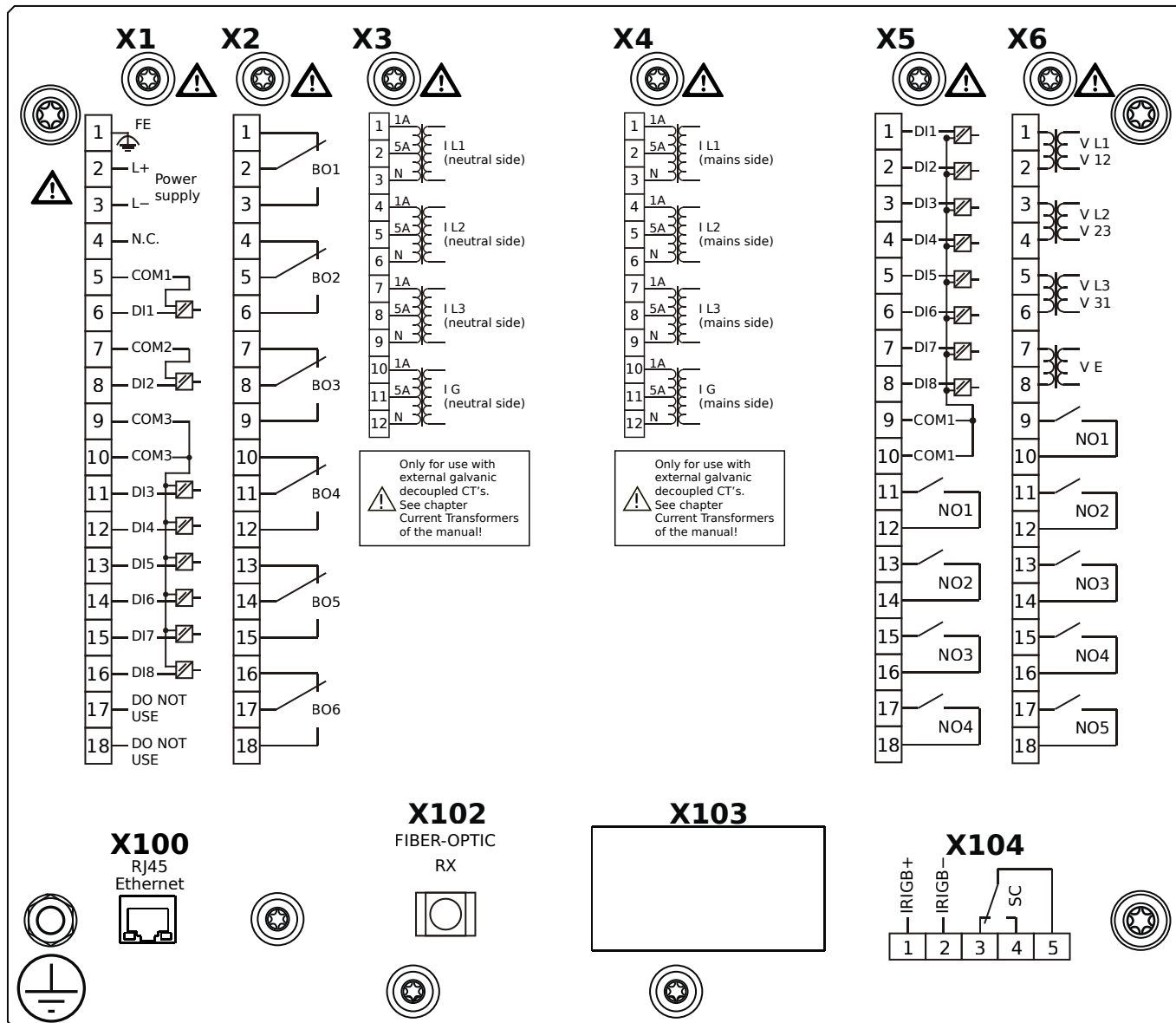

Housing B2, large display, 19" rack mounting

- + Conformal Coating (for installations in harsh environment)

- X1** – DI8-X1: Wide-range power supply unit, incl. 2 non-grouped digital inputs and 6 grouped digital inputs
- X2** – OR6: Assembly Group with 6 Output Relays (Changeover / Form C)
- X3** – TI: Standard current measuring card (for the neutral side of the differential protection)
- X4** – TI: Standard current measuring card (for the mains side of the differential protection)
- X5** – DI8-OR4: Assembly Group with 8 Digital Inputs and 4 Output Relays (NO / Form A)
- X6** – TU-OR5: Voltage measuring (0 ... 300 VAC) assembly group with 5 additional Output Relays (NO / Form A)
- X100** – Modbus TCP / DNP3.0 TCP/UDP, Ethernet interface, 100 Mbit/s, RJ45 (BASE100-FX)
- X102** – Universal Resistance-Temperature Detector (URTD) input, Fiber optics interface, Versatile Link
- X104** – IRIG-B00X, incl. System Contact (Supervision Contact)

MCDGV4-2D0BDA

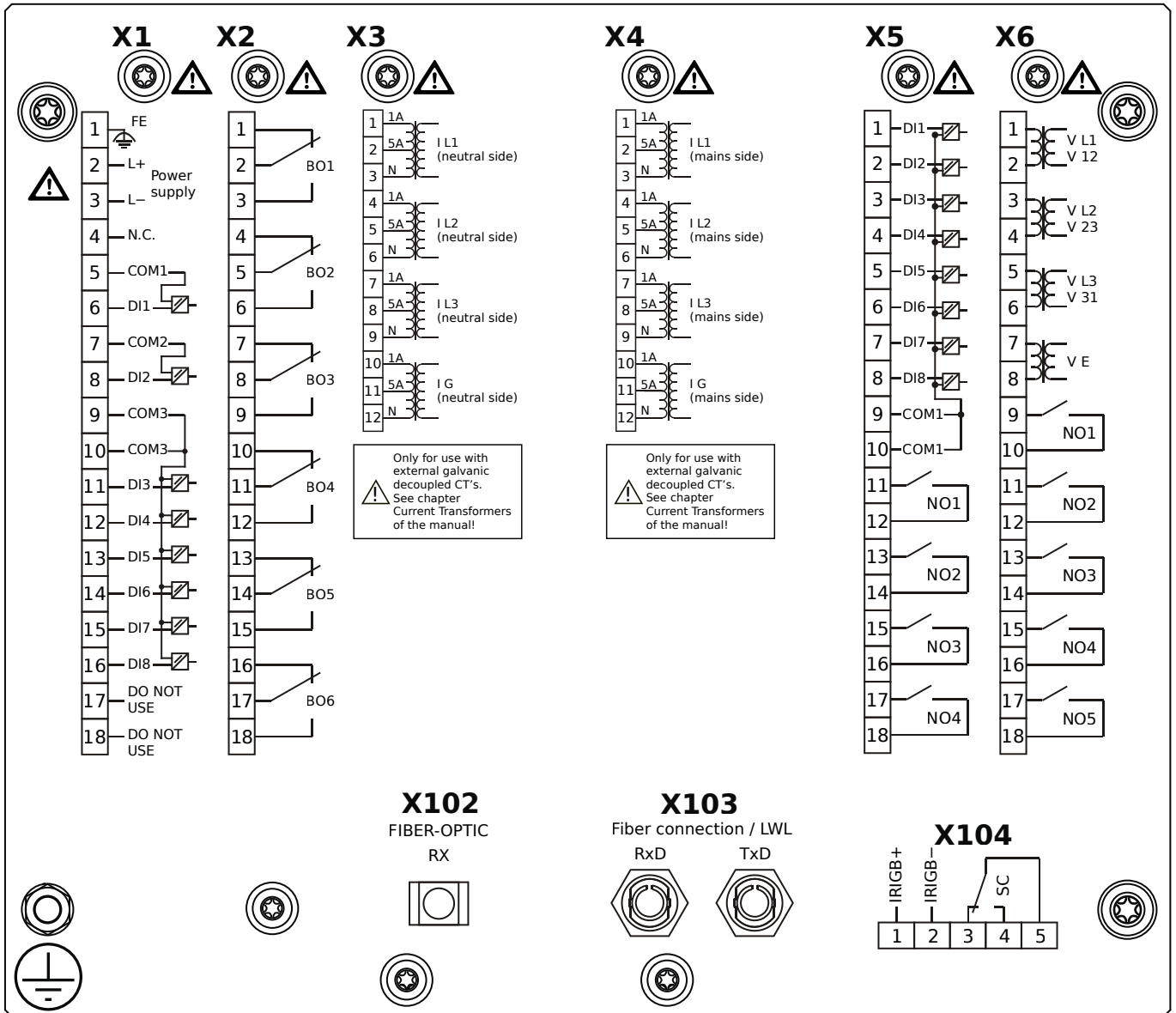

Housing B2, large display, 19" rack mounting

- X1** – DI8-X1: Wide-range power supply unit, incl. 2 non-grouped digital inputs and 6 grouped digital inputs
- X2** – OR6: Assembly Group with 6 Output Relays (Changeover / Form C)
- X3** – TI: Standard current measuring card (for the neutral side of the differential protection)
- X4** – TI: Standard current measuring card (for the mains side of the differential protection)
- X5** – DI8-OR4: Assembly Group with 8 Digital Inputs and 4 Output Relays (NO / Form A)
- X6** – TU-OR5: Voltage measuring (0 ... 300 VAC) assembly group with 5 additional Output Relays (NO / Form A)
- X102** – Universal Resistance-Temperature Detector (URTD) input, Fiber optics interface, Versatile Link
- X103** – Profibus-DP, Fiber optics interface, ST Connector
- X104** – IRIG-B00X, incl. System Contact (Supervision Contact)

MCDGV4-2D0BDB

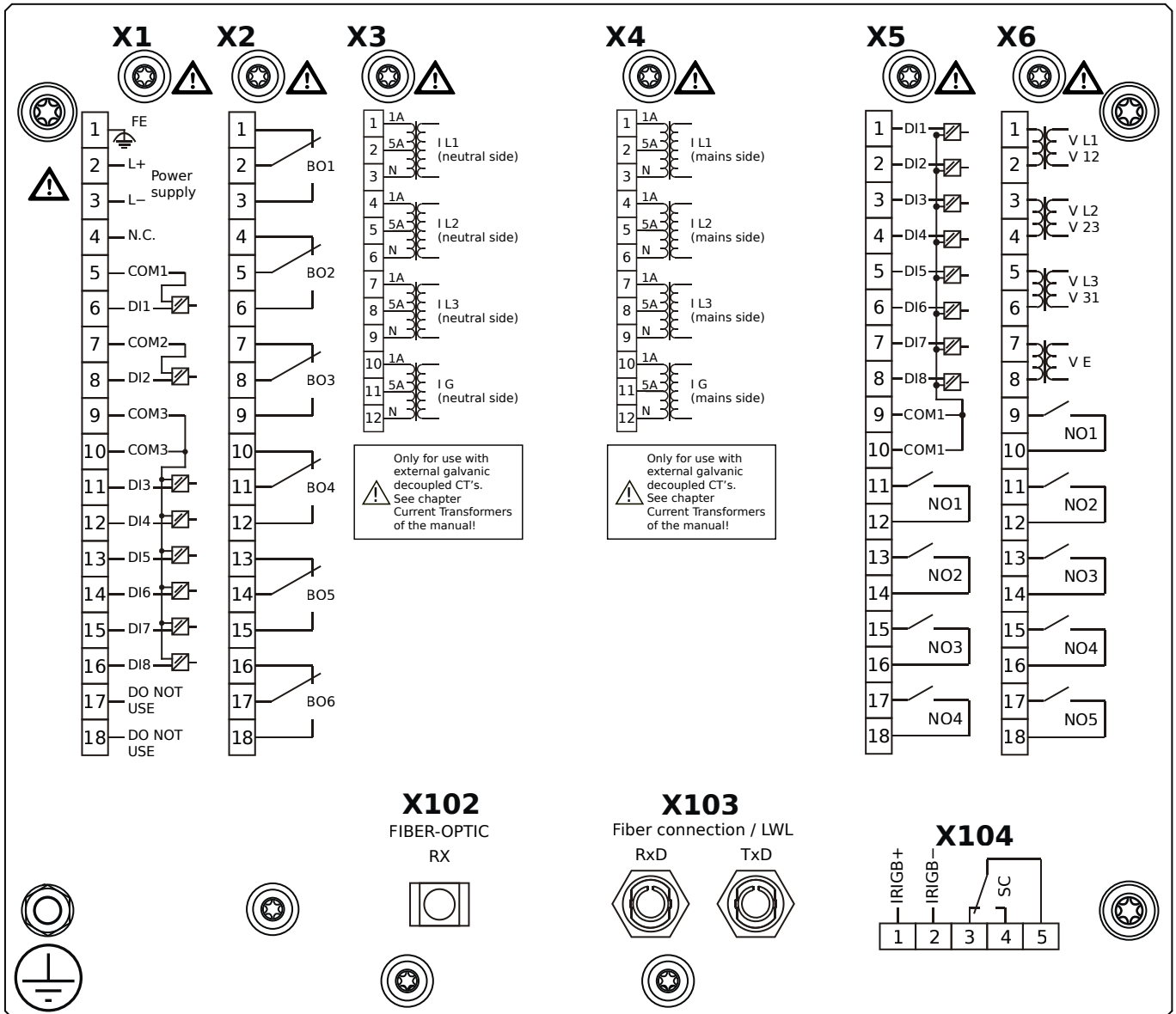

Housing B2, large display, 19" rack mounting

- + Conformal Coating (for installations in harsh environment)

- X1** – DI8-X1: Wide-range power supply unit, incl. 2 non-grouped digital inputs and 6 grouped digital inputs
- X2** – OR6: Assembly Group with 6 Output Relays (Changeover / Form C)
- X3** – TI: Standard current measuring card (for the neutral side of the differential protection)
- X4** – TI: Standard current measuring card (for the mains side of the differential protection)
- X5** – DI8-OR4: Assembly Group with 8 Digital Inputs and 4 Output Relays (NO / Form A)
- X6** – TU-OR5: Voltage measuring (0 ... 300 VAC) assembly group with 5 additional Output Relays (NO / Form A)
- X102** – Universal Resistance-Temperature Detector (URTD) input, Fiber optics interface, Versatile Link
- X103** – Profibus-DP, Fiber optics interface, ST Connector
- X104** – IRIG-B00X, incl. System Contact (Supervision Contact)

MCDGV4-2D0BEA

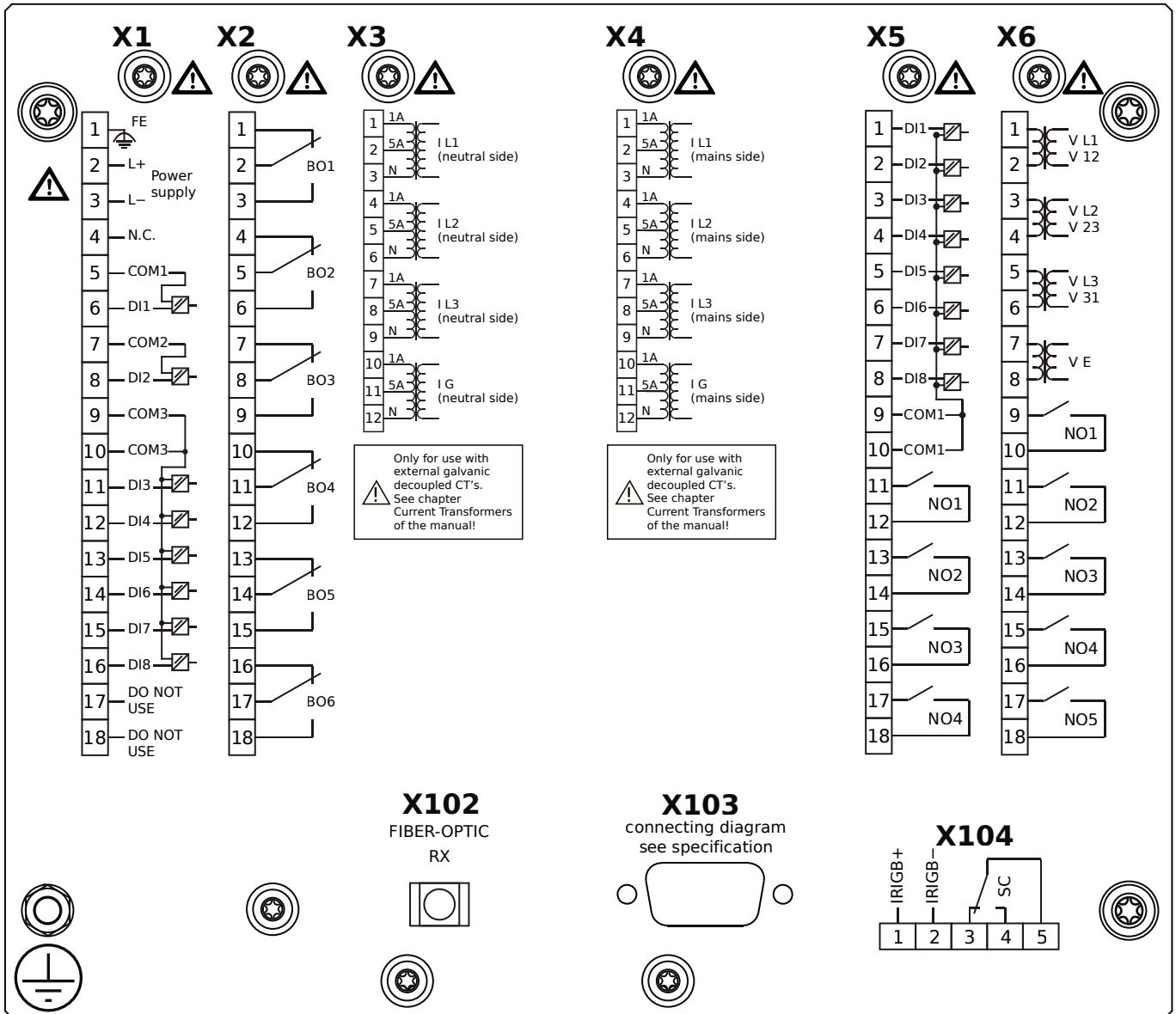

Housing B2, large display, 19" rack mounting

- X1** – DI8-X1: Wide-range power supply unit, incl. 2 non-grouped digital inputs and 6 grouped digital inputs
- X2** – OR6: Assembly Group with 6 Output Relays (Changeover / Form C)
- X3** – TI: Standard current measuring card (for the neutral side of the differential protection)
- X4** – TI: Standard current measuring card (for the mains side of the differential protection)
- X5** – DI8-OR4: Assembly Group with 8 Digital Inputs and 4 Output Relays (NO / Form A)
- X6** – TU-OR5: Voltage measuring (0 ... 300 VAC) assembly group with 5 additional Output Relays (NO / Form A)
- X102** – Universal Resistance-Temperature Detector (URTD) input, Fiber optics interface, Versatile Link
- X103** – Profibus-DP, RS485, D-SUB
- X104** – IRIG-B00X, incl. System Contact (Supervision Contact)

MCDGV4-2D0BEB

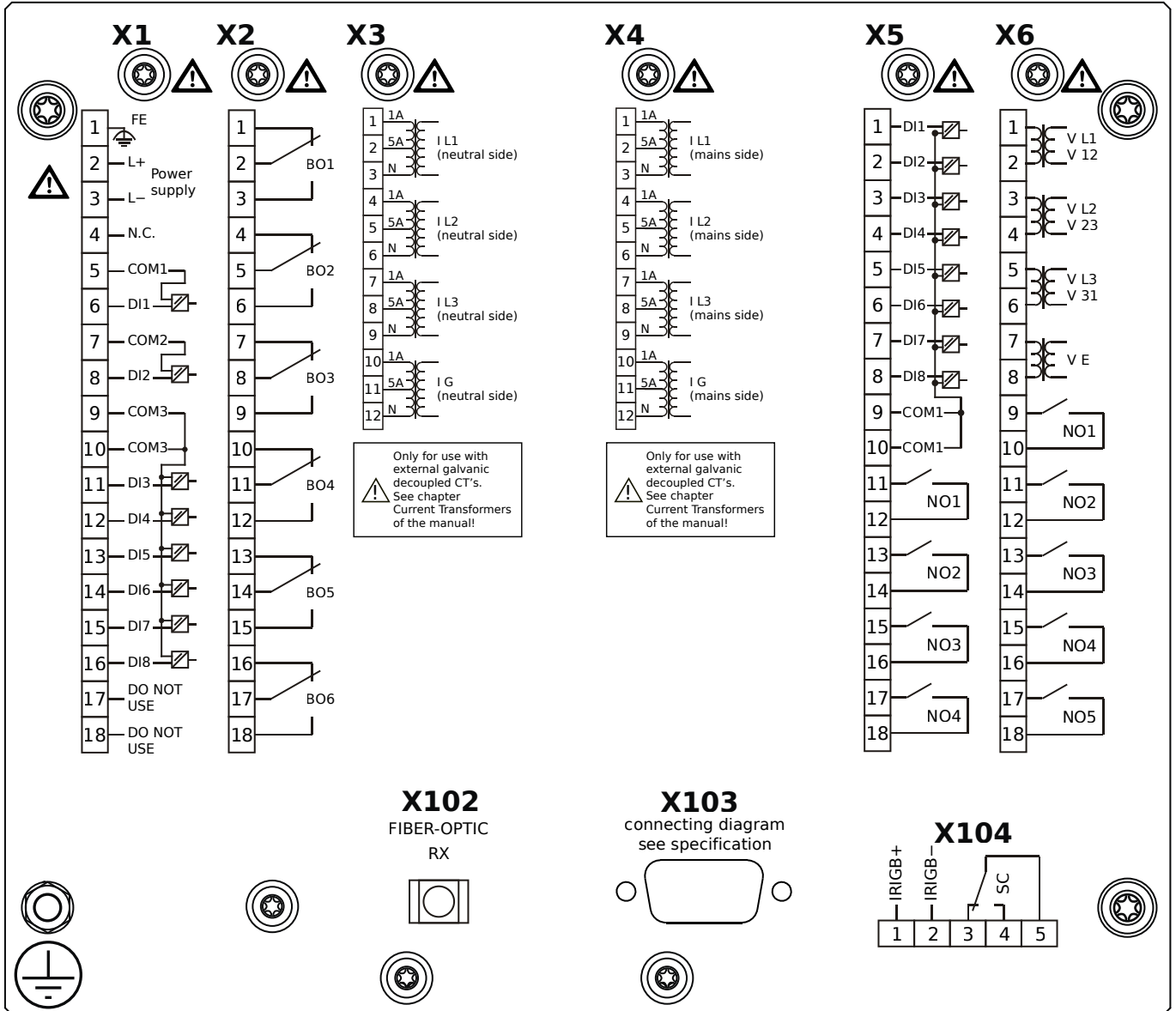

Housing B2, large display, 19" rack mounting

+ Conformal Coating (for installations in harsh environment)

- X1** – DI8-X1: Wide-range power supply unit, incl. 2 non-grouped digital inputs and 6 grouped digital inputs
- X2** – OR6: Assembly Group with 6 Output Relays (Changeover / Form C)
- X3** – TI: Standard current measuring card (for the neutral side of the differential protection)
- X4** – TI: Standard current measuring card (for the mains side of the differential protection)
- X5** – DI8-OR4: Assembly Group with 8 Digital Inputs and 4 Output Relays (NO / Form A)
- X6** – TU-OR5: Voltage measuring (0 ... 300 VAC) assembly group with 5 additional Output Relays (NO / Form A)
- X102** – Universal Resistance-Temperature Detector (URTD) input, Fiber optics interface, Versatile Link
- X103** – Profibus-DP, RS485, D-SUB
- X104** – IRIG-B00X, incl. System Contact (Supervision Contact)

MCDGV4-2D0BFA

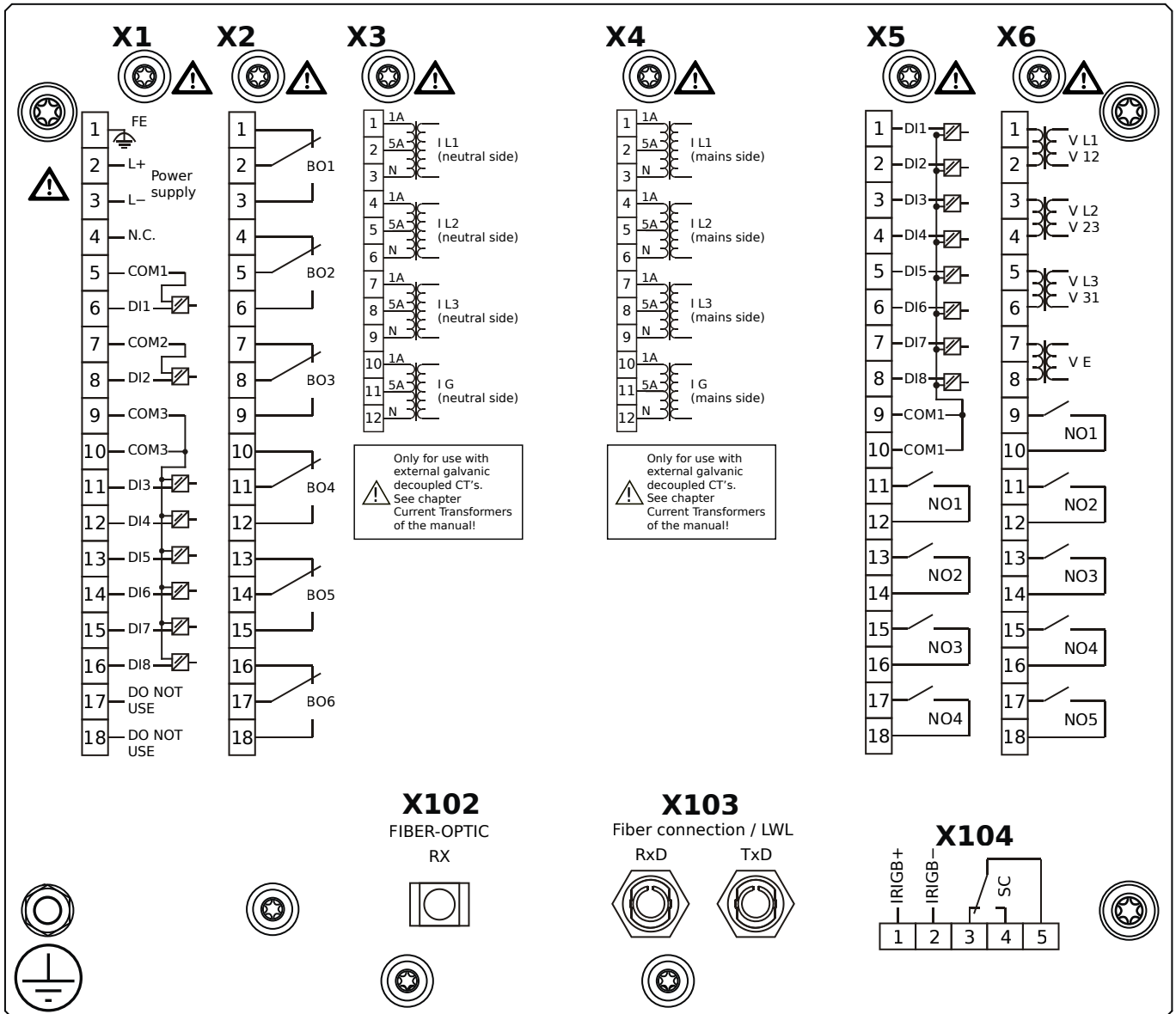

Housing B2, large display, 19" rack mounting

- X1** – DI8-X1: Wide-range power supply unit, incl. 2 non-grouped digital inputs and 6 grouped digital inputs
- X2** – OR6: Assembly Group with 6 Output Relays (Changeover / Form C)
- X3** – TI: Standard current measuring card (for the neutral side of the differential protection)
- X4** – TI: Standard current measuring card (for the mains side of the differential protection)
- X5** – DI8-OR4: Assembly Group with 8 Digital Inputs and 4 Output Relays (NO / Form A)
- X6** – TU-OR5: Voltage measuring (0 ... 300 VAC) assembly group with 5 additional Output Relays (NO / Form A)
- X102** – Universal Resistance-Temperature Detector (URTD) input, Fiber optics interface, Versatile Link
- X103** – Modbus RTU / IEC 60870-5-103 / DNP3.0 RTU, Fiber optics interface, ST Connector
- X104** – IRIG-B00X, incl. System Contact (Supervision Contact)

MCDGV4-2D0BFB

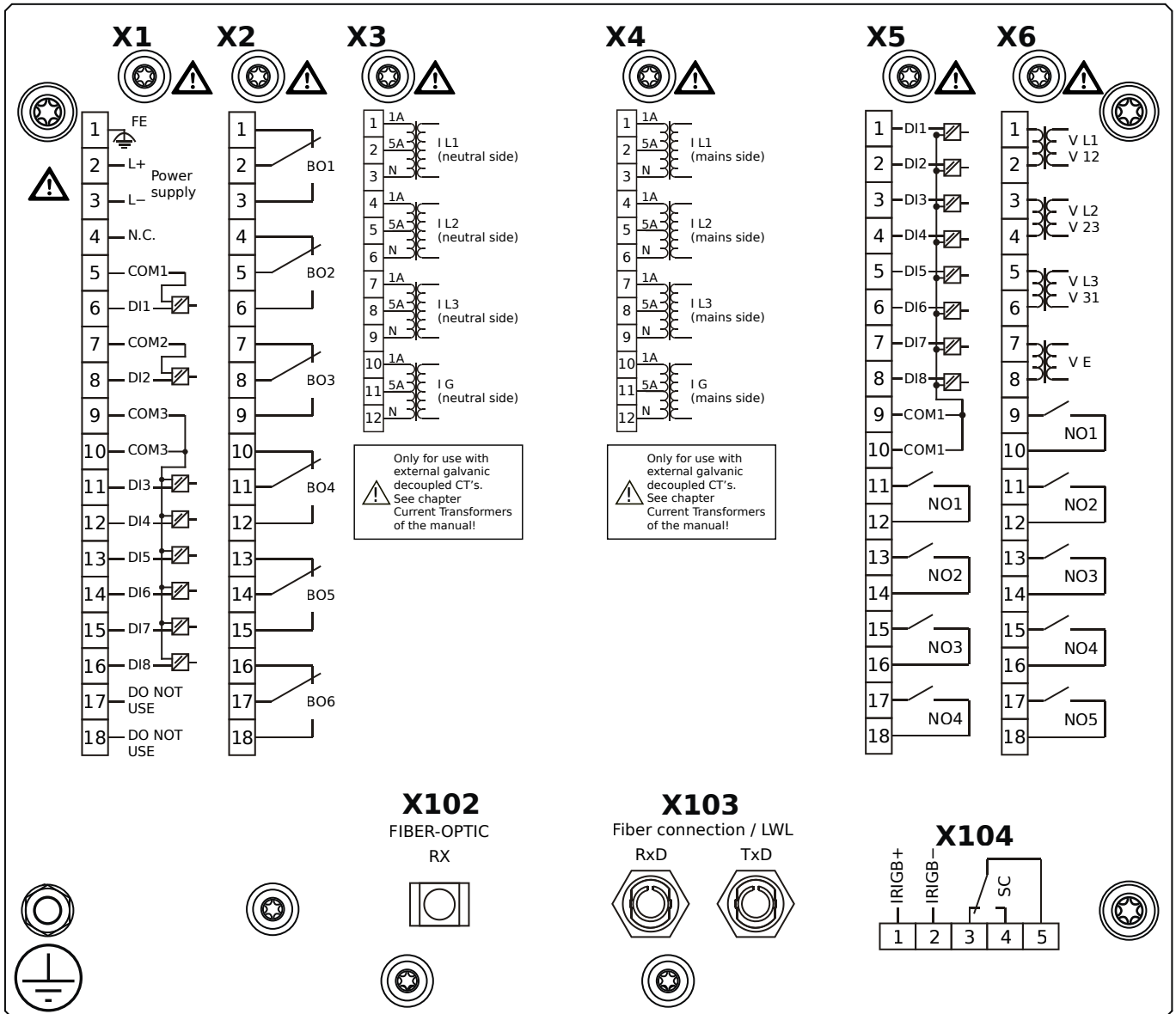

Housing B2, large display, 19" rack mounting

- + Conformal Coating (for installations in harsh environment)

- X1** – DI8-X1: Wide-range power supply unit, incl. 2 non-grouped digital inputs and 6 grouped digital inputs
- X2** – OR6: Assembly Group with 6 Output Relays (Changeover / Form C)
- X3** – TI: Standard current measuring card (for the neutral side of the differential protection)
- X4** – TI: Standard current measuring card (for the mains side of the differential protection)
- X5** – DI8-OR4: Assembly Group with 8 Digital Inputs and 4 Output Relays (NO / Form A)
- X6** – TU-OR5: Voltage measuring (0 ... 300 VAC) assembly group with 5 additional Output Relays (NO / Form A)
- X102** – Universal Resistance-Temperature Detector (URTD) input, Fiber optics interface, Versatile Link
- X103** – Modbus RTU / IEC 60870-5-103 / DNP3.0 RTU, Fiber optics interface, ST Connector
- X104** – IRIG-B00X, incl. System Contact (Supervision Contact)

MCDGV4-2D0BGA

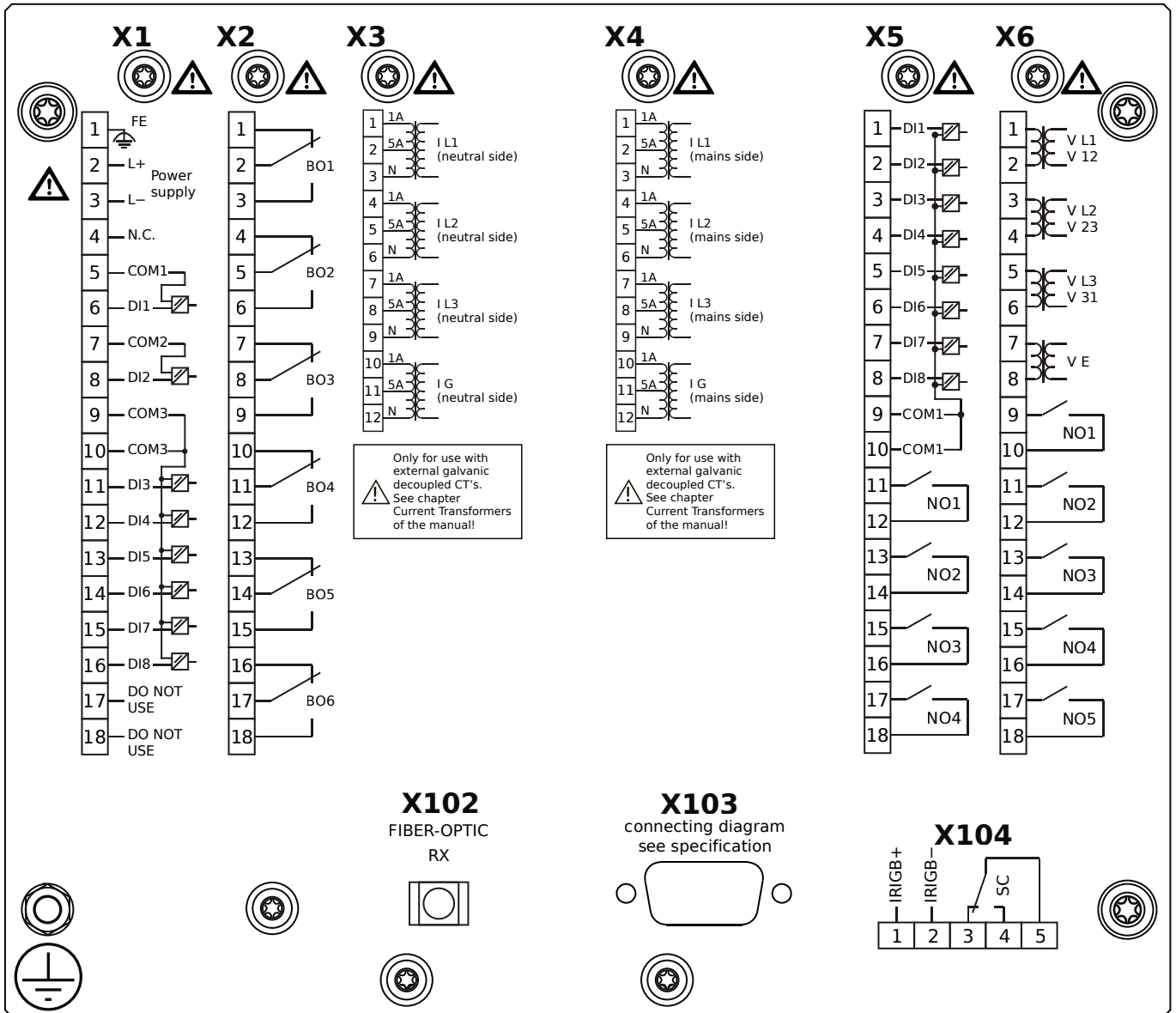

Housing B2, large display, 19" rack mounting

- X1** – DI8-X1: Wide-range power supply unit, incl. 2 non-grouped digital inputs and 6 grouped digital inputs
- X2** – OR6: Assembly Group with 6 Output Relays (Changeover / Form C)
- X3** – TI: Standard current measuring card (for the neutral side of the differential protection)
- X4** – TI: Standard current measuring card (for the mains side of the differential protection)
- X5** – DI8-OR4: Assembly Group with 8 Digital Inputs and 4 Output Relays (NO / Form A)
- X6** – TU-OR5: Voltage measuring (0 ... 300 VAC) assembly group with 5 additional Output Relays (NO / Form A)
- X102** – Universal Resistance-Temperature Detector (URTD) input, Fiber optics interface, Versatile Link
- X103** – Modbus RTU / IEC 60870-5-103 / DNP3.0 RTU, RS485, D-SUB
- X104** – IRIG-B00X, incl. System Contact (Supervision Contact)

MCDGV4-2D0BGB

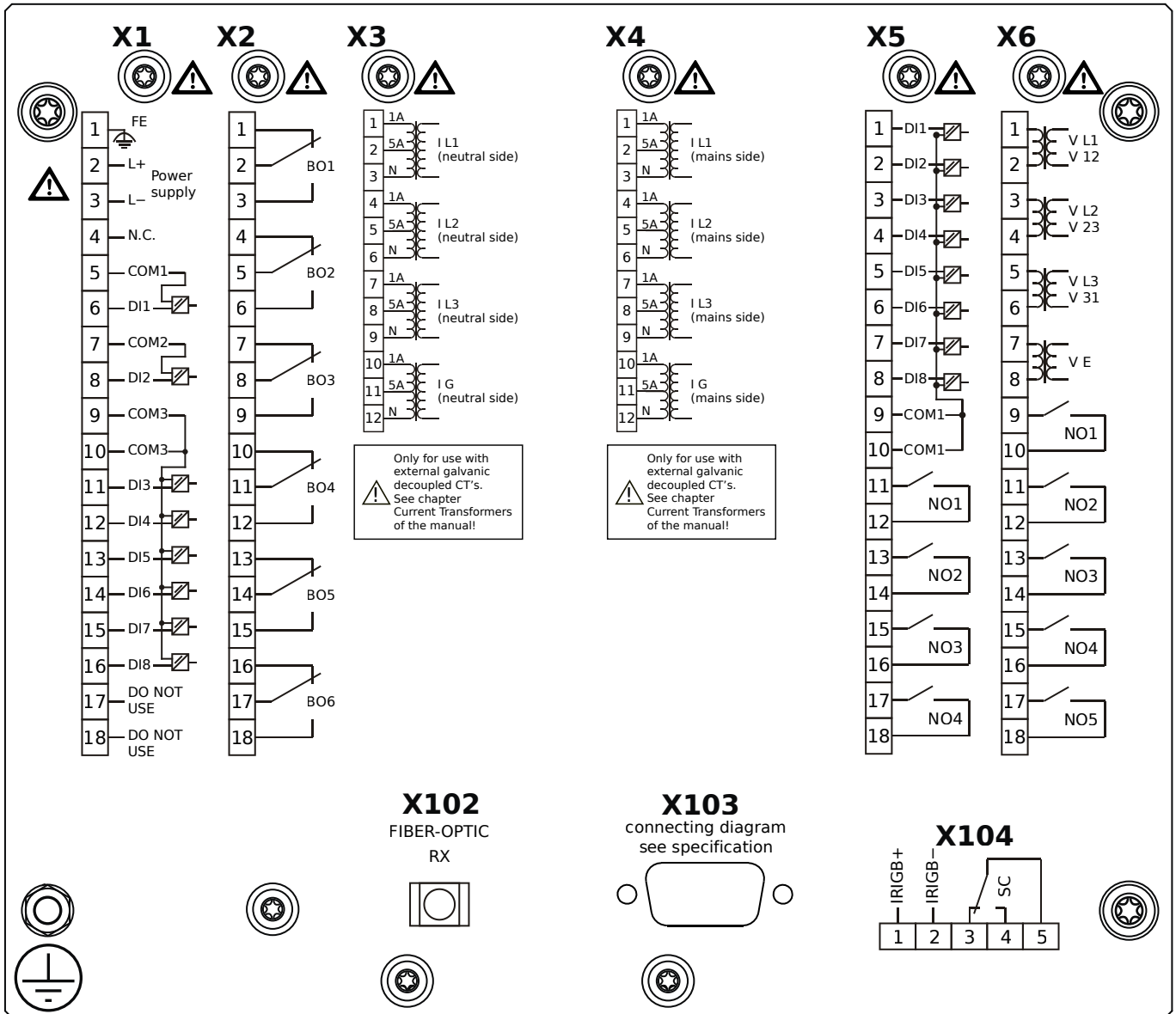

Housing B2, large display, 19" rack mounting

+ Conformal Coating (for installations in harsh environment)

- X1** – DI8-X1: Wide-range power supply unit, incl. 2 non-grouped digital inputs and 6 grouped digital inputs
- X2** – OR6: Assembly Group with 6 Output Relays (Changeover / Form C)
- X3** – TI: Standard current measuring card (for the neutral side of the differential protection)
- X4** – TI: Standard current measuring card (for the mains side of the differential protection)
- X5** – DI8-OR4: Assembly Group with 8 Digital Inputs and 4 Output Relays (NO / Form A)
- X6** – TU-OR5: Voltage measuring (0 ... 300 VAC) assembly group with 5 additional Output Relays (NO / Form A)
- X102** – Universal Resistance-Temperature Detector (URTD) input, Fiber optics interface, Versatile Link
- X103** – Modbus RTU / IEC 60870-5-103 / DNP3.0 RTU, RS485, D-SUB
- X104** – IRIG-B00X, incl. System Contact (Supervision Contact)

MCDGV4-2D0BHA

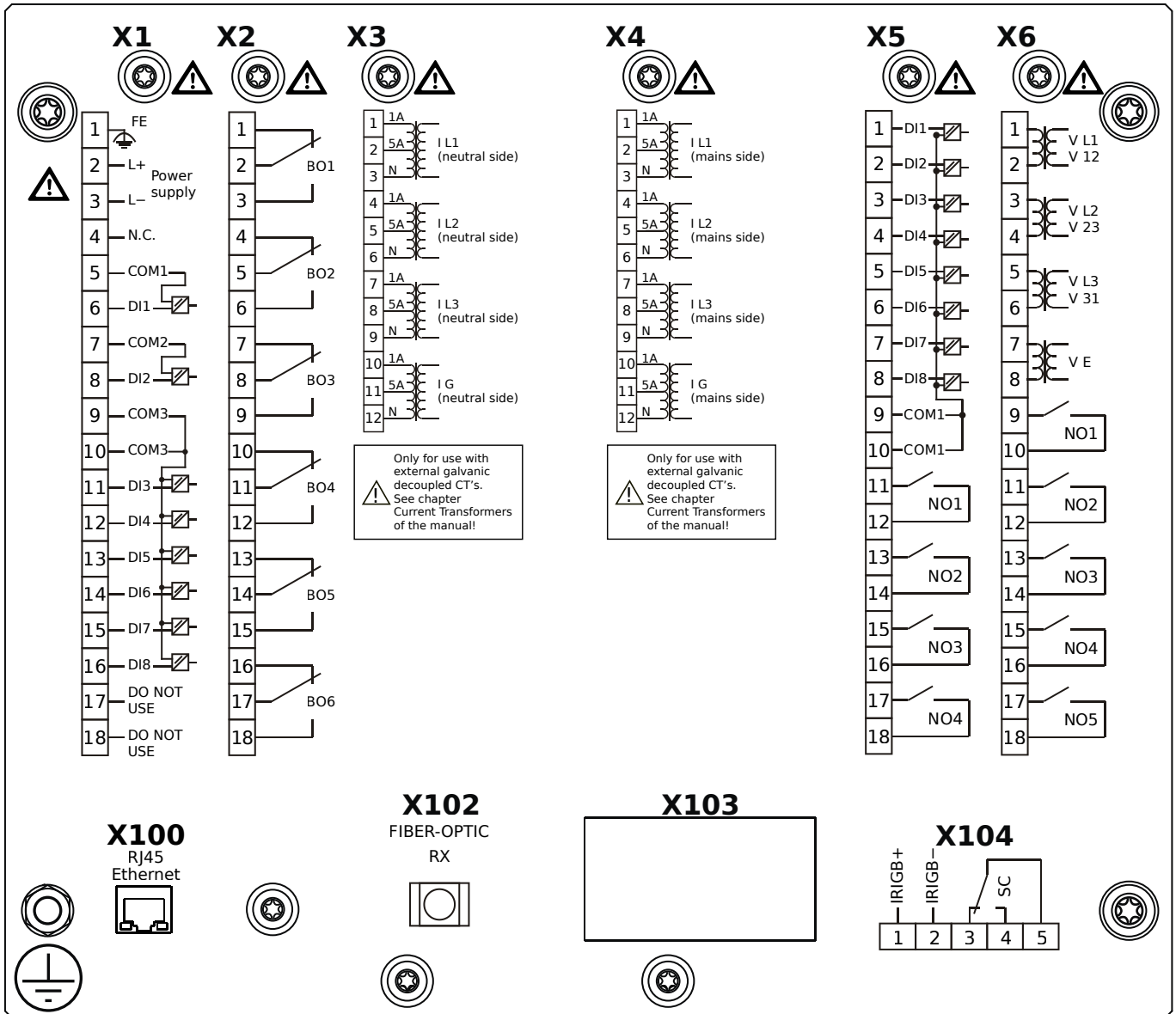

Housing B2, large display, 19" rack mounting

- X1** – DI8-X1: Wide-range power supply unit, incl. 2 non-grouped digital inputs and 6 grouped digital inputs
- X2** – OR6: Assembly Group with 6 Output Relays (Changeover / Form C)
- X3** – TI: Standard current measuring card (for the neutral side of the differential protection)
- X4** – TI: Standard current measuring card (for the mains side of the differential protection)
- X5** – DI8-OR4: Assembly Group with 8 Digital Inputs and 4 Output Relays (NO / Form A)
- X6** – TU-OR5: Voltage measuring (0 ... 300 VAC) assembly group with 5 additional Output Relays (NO / Form A)
- X100** – IEC 61850 / Modbus TCP / DNP3.0 TCP/UDP, Ethernet interface, 100 Mbit/s, RJ45 (BASE100-FX)
- X102** – Universal Resistance-Temperature Detector (URTD) input, Fiber optics interface, Versatile Link
- X104** – IRIG-B00X, incl. System Contact (Supervision Contact)

MCDGV4-2D0BHB

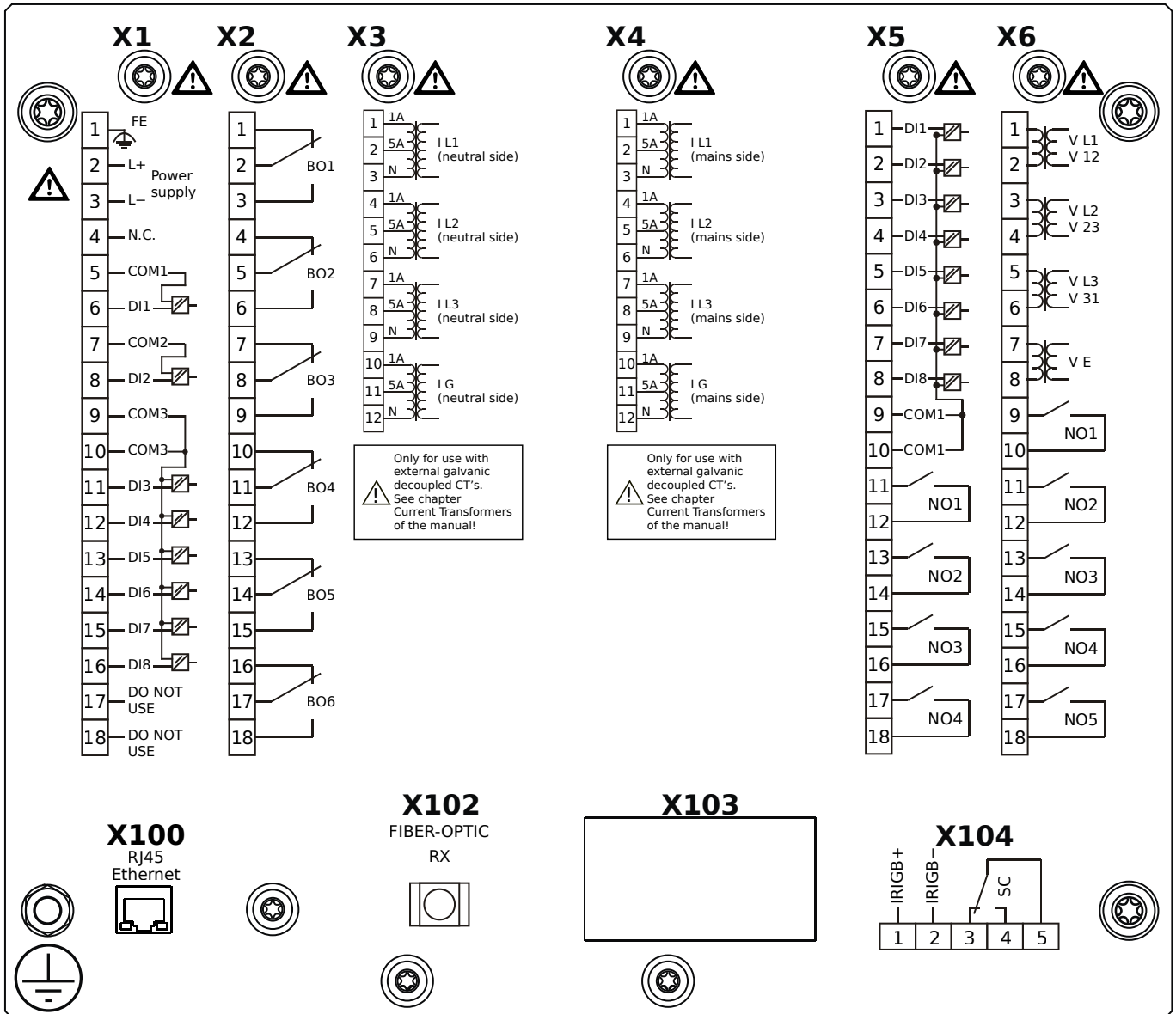

Housing B2, large display, 19" rack mounting

- + Conformal Coating (for installations in harsh environment)

- X1** – DI8-X1: Wide-range power supply unit, incl. 2 non-grouped digital inputs and 6 grouped digital inputs
- X2** – OR6: Assembly Group with 6 Output Relays (Changeover / Form C)
- X3** – TI: Standard current measuring card (for the neutral side of the differential protection)
- X4** – TI: Standard current measuring card (for the mains side of the differential protection)
- X5** – DI8-OR4: Assembly Group with 8 Digital Inputs and 4 Output Relays (NO / Form A)
- X6** – TU-OR5: Voltage measuring (0 ... 300 VAC) assembly group with 5 additional Output Relays (NO / Form A)
- X100** – IEC 61850 / Modbus TCP / DNP3.0 TCP/UDP, Ethernet interface, 100 Mbit/s, RJ45 (BASE100-FX)
- X102** – Universal Resistance-Temperature Detector (URTD) input, Fiber optics interface, Versatile Link
- X104** – IRIG-B00X, incl. System Contact (Supervision Contact)

MCDGV4-2D0BIA

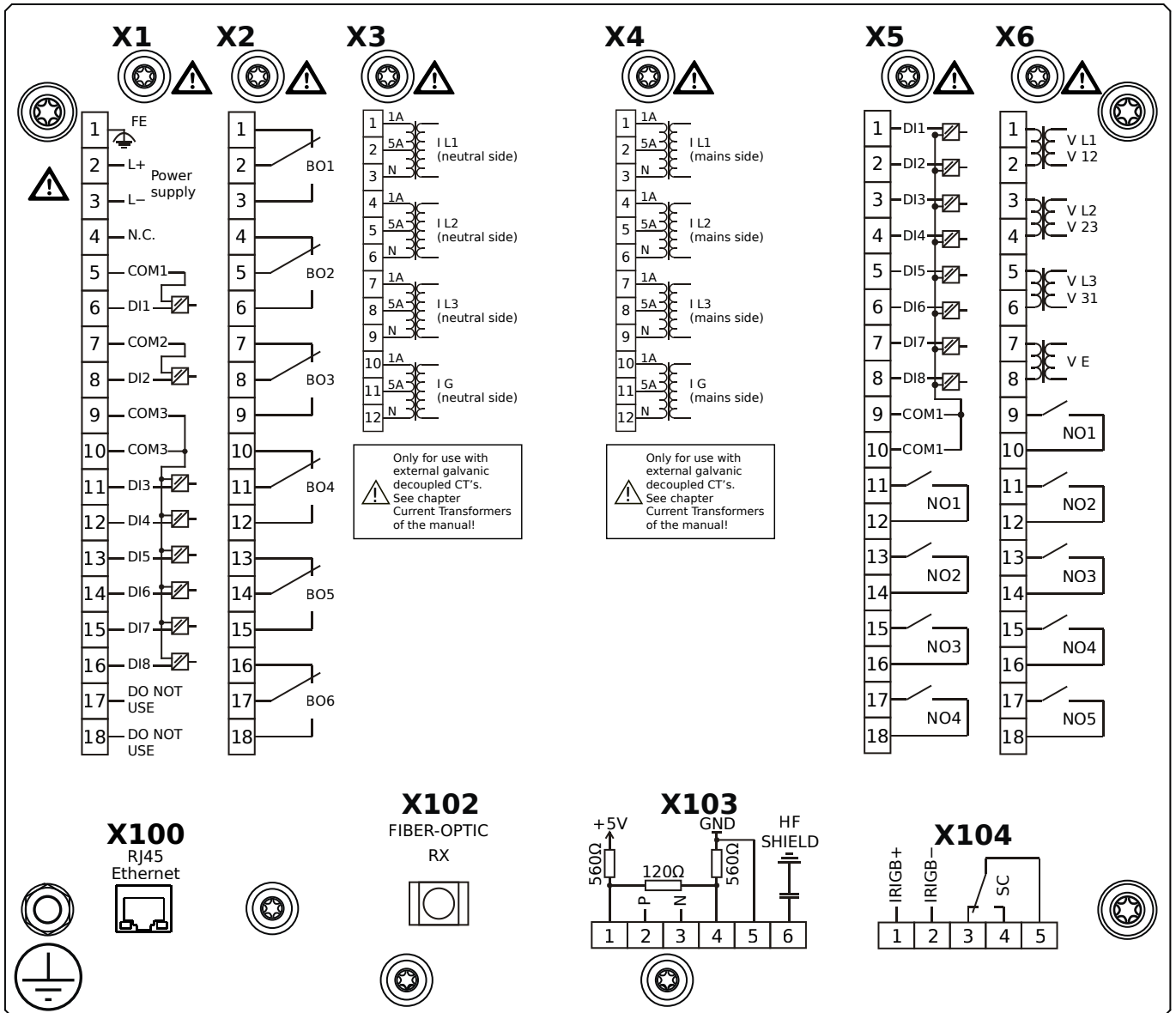

Housing B2, large display, 19" rack mounting

- X1** – DI8-X1: Wide-range power supply unit, incl. 2 non-grouped digital inputs and 6 grouped digital inputs
- X2** – OR6: Assembly Group with 6 Output Relays (Changeover / Form C)
- X3** – TI: Standard current measuring card (for the neutral side of the differential protection)
- X4** – TI: Standard current measuring card (for the mains side of the differential protection)
- X5** – DI8-OR4: Assembly Group with 8 Digital Inputs and 4 Output Relays (NO / Form A)
- X6** – TU-OR5: Voltage measuring (0 ... 300 VAC) assembly group with 5 additional Output Relays (NO / Form A)
- X100** – Modbus TCP / DNP3.0 TCP/UDP, Ethernet interface, 100 Mbit/s, RJ45 (BASE100-FX)
- X102** – Universal Resistance-Temperature Detector (URTD) input, Fiber optics interface, Versatile Link
- X103** – IEC 60870-5-103 / Modbus RTU / DNP3.0 RTU, RS485, Terminals
- X104** – IRIG-B00X, incl. System Contact (Supervision Contact)

MCDGV4-2D0BIB

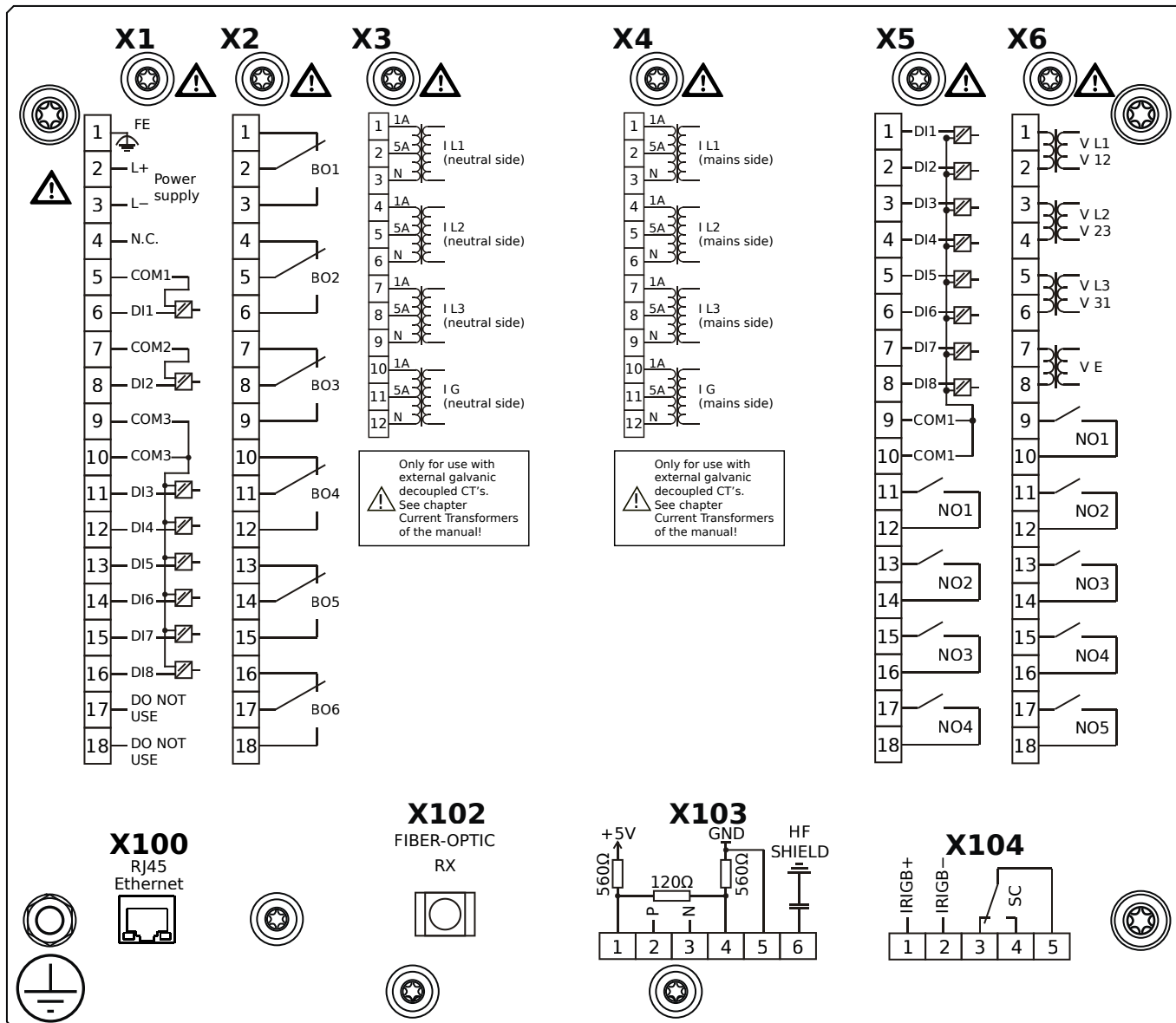

Housing B2, large display, 19" rack mounting

+ Conformal Coating (for installations in harsh environment)

- X1** – DI8-X1: Wide-range power supply unit, incl. 2 non-grouped digital inputs and 6 grouped digital inputs
- X2** – OR6: Assembly Group with 6 Output Relays (Changeover / Form C)
- X3** – TI: Standard current measuring card (for the neutral side of the differential protection)
- X4** – TI: Standard current measuring card (for the mains side of the differential protection)
- X5** – DI8-OR4: Assembly Group with 8 Digital Inputs and 4 Output Relays (NO / Form A)
- X6** – TU-OR5: Voltage measuring (0 ... 300 VAC) assembly group with 5 additional Output Relays (NO / Form A)
- X100** – Modbus TCP / DNP3.0 TCP/UDP, Ethernet interface, 100 Mbit/s, RJ45 (BASE100-FX)
- X102** – Universal Resistance-Temperature Detector (URTD) input, Fiber optics interface, Versatile Link
- X103** – IEC 60870-5-103 / Modbus RTU / DNP3.0 RTU, RS485, Terminals
- X104** – IRIG-B00X, incl. System Contact (Supervision Contact)

MCDGV4-2D0BKA

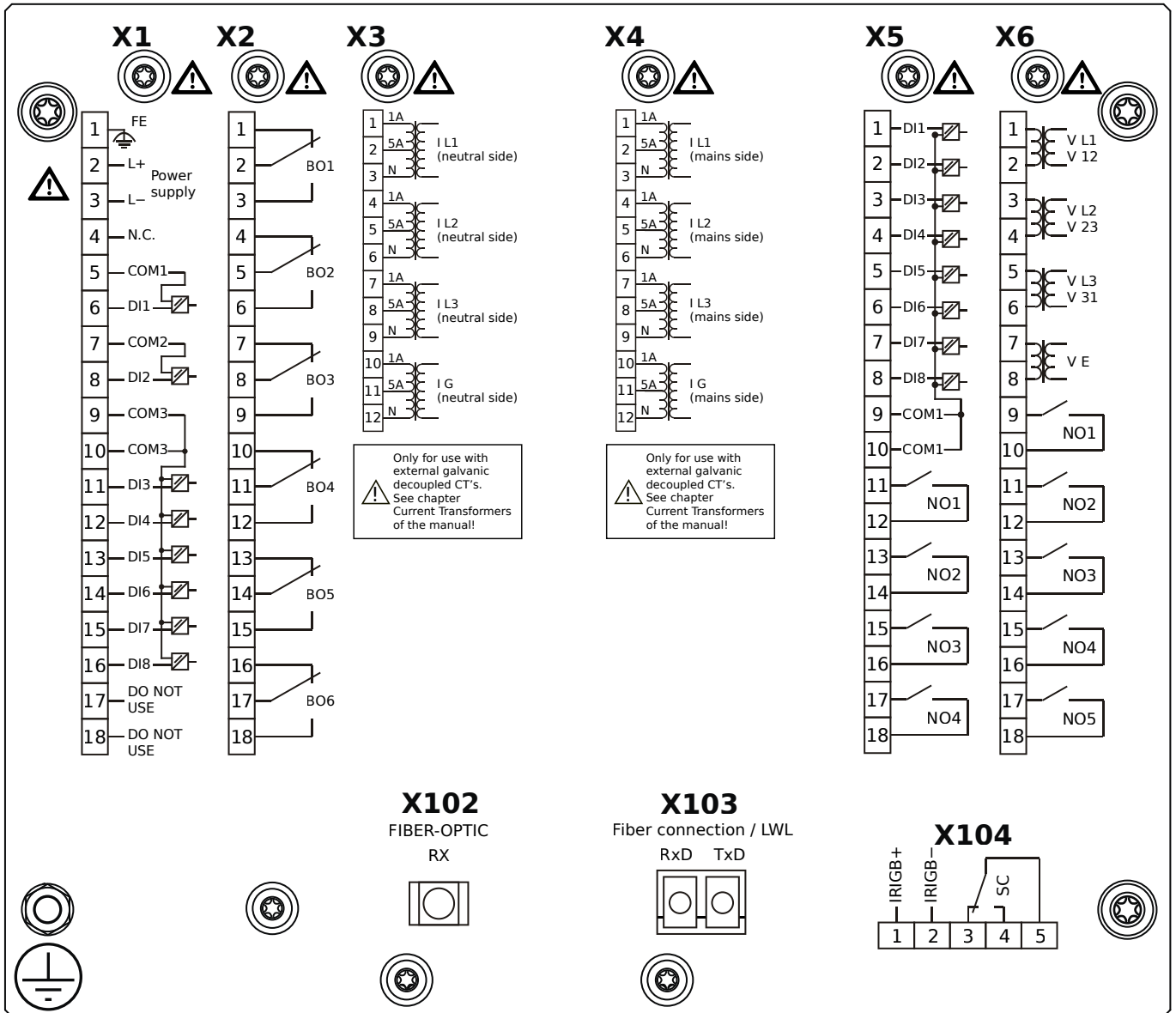

Housing B2, large display, 19" rack mounting

- X1** – DI8-X1: Wide-range power supply unit, incl. 2 non-grouped digital inputs and 6 grouped digital inputs
- X2** – OR6: Assembly Group with 6 Output Relays (Changeover / Form C)
- X3** – TI: Standard current measuring card (for the neutral side of the differential protection)
- X4** – TI: Standard current measuring card (for the mains side of the differential protection)
- X5** – DI8-OR4: Assembly Group with 8 Digital Inputs and 4 Output Relays (NO / Form A)
- X6** – TU-OR5: Voltage measuring (0 ... 300 VAC) assembly group with 5 additional Output Relays (NO / Form A)
- X102** – Universal Resistance-Temperature Detector (URTD) input, Fiber optics interface, Versatile Link
- X103** – IEC 61850 / Modbus TCP / DNP3.0 TCP/UDP, Fiber optics interface, LC Connector
- X104** – IRIG-B00X, incl. System Contact (Supervision Contact)

MCDGV4-2D0BKB

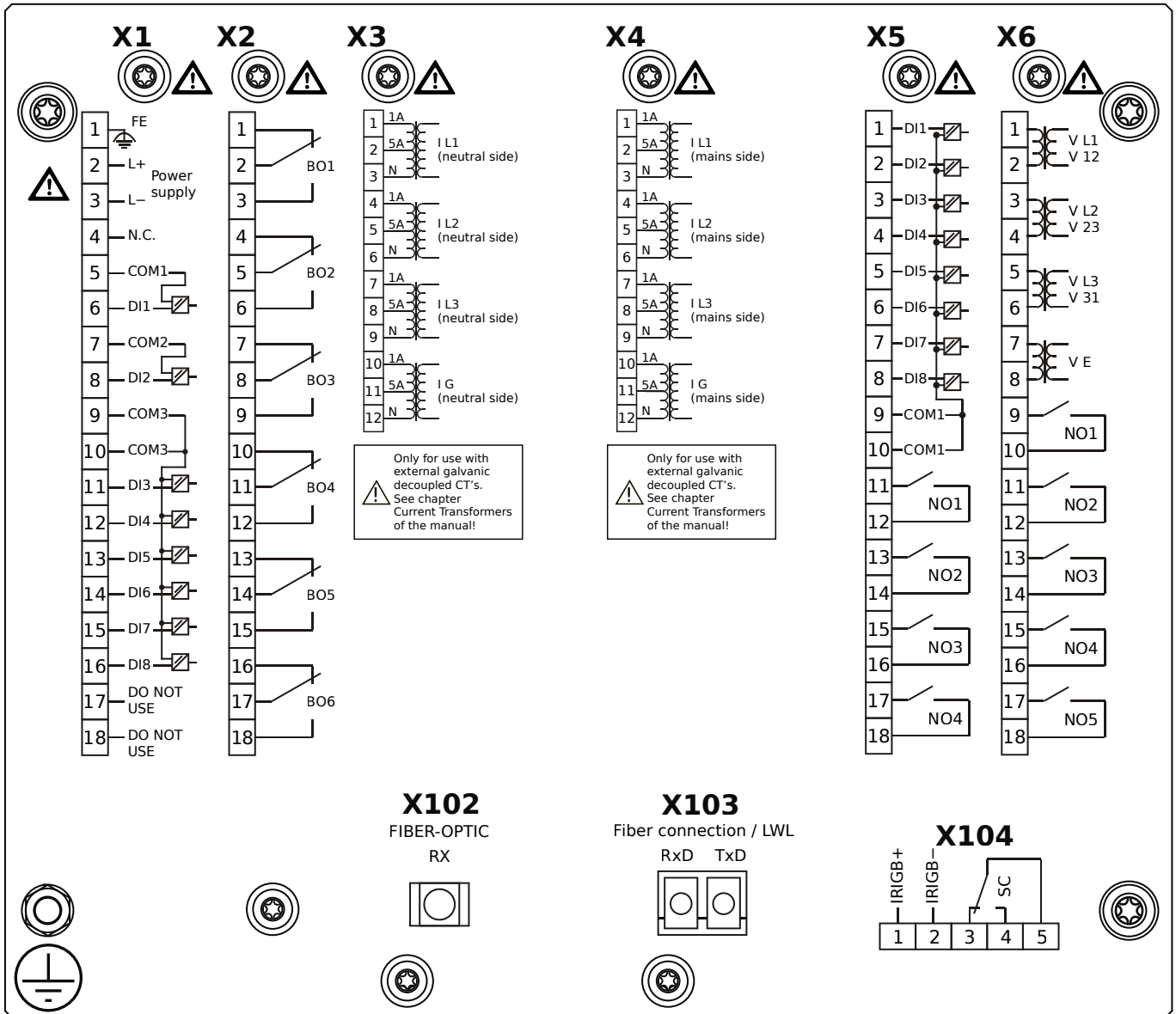

Housing B2, large display, 19" rack mounting

- + Conformal Coating (for installations in harsh environment)

- X1** – DI8-X1: Wide-range power supply unit, incl. 2 non-grouped digital inputs and 6 grouped digital inputs
- X2** – OR6: Assembly Group with 6 Output Relays (Changeover / Form C)
- X3** – TI: Standard current measuring card (for the neutral side of the differential protection)
- X4** – TI: Standard current measuring card (for the mains side of the differential protection)
- X5** – DI8-OR4: Assembly Group with 8 Digital Inputs and 4 Output Relays (NO / Form A)
- X6** – TU-OR5: Voltage measuring (0 ... 300 VAC) assembly group with 5 additional Output Relays (NO / Form A)
- X102** – Universal Resistance-Temperature Detector (URTD) input, Fiber optics interface, Versatile Link
- X103** – IEC 61850 / Modbus TCP / DNP3.0 TCP/UDP, Fiber optics interface, LC Connector
- X104** – IRIG-B00X, incl. System Contact (Supervision Contact)

MCDGV4-2D0BLA

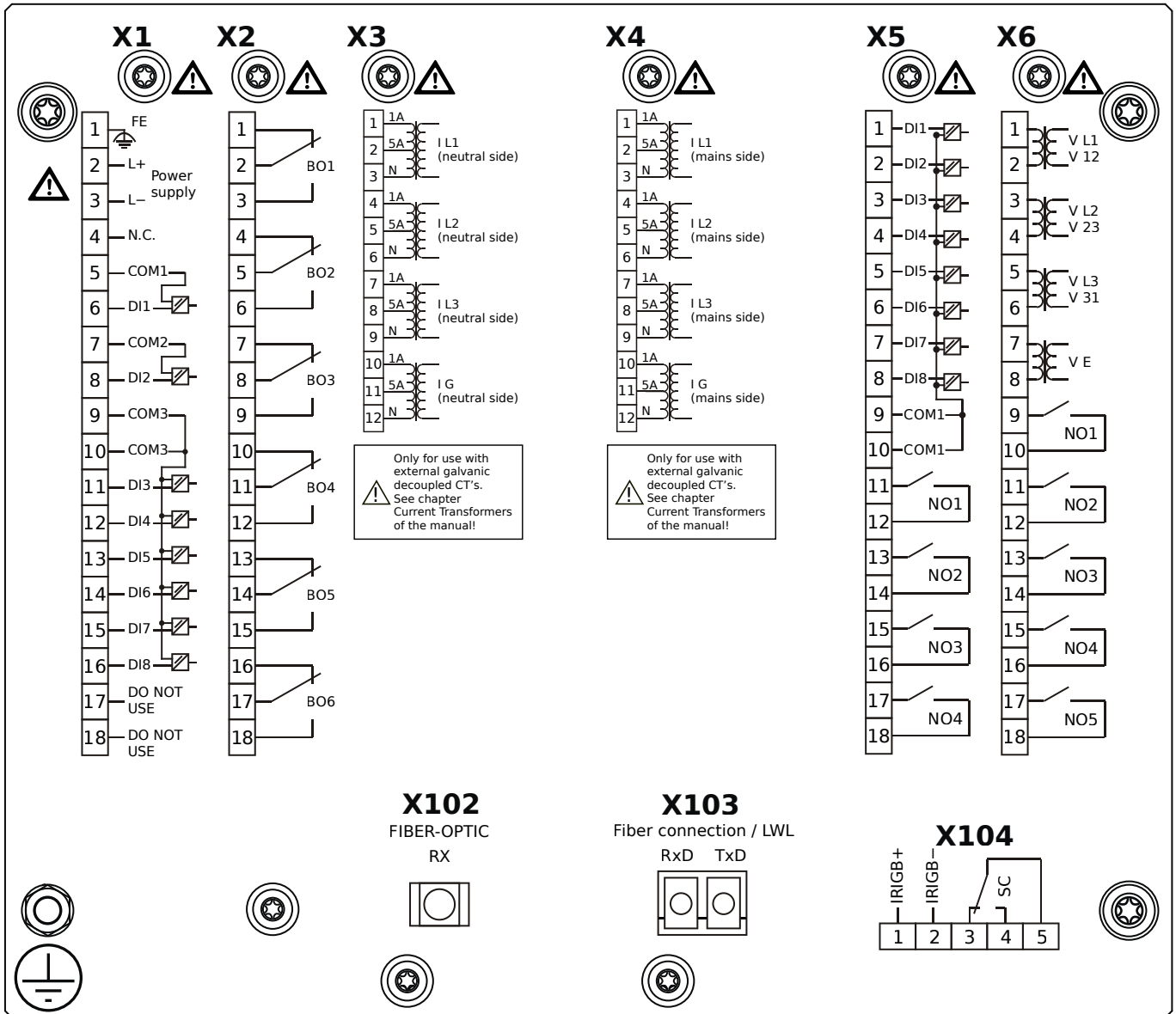

Housing B2, large display, 19" rack mounting

- X1** – DI8-X1: Wide-range power supply unit, incl. 2 non-grouped digital inputs and 6 grouped digital inputs
- X2** – OR6: Assembly Group with 6 Output Relays (Changeover / Form C)
- X3** – TI: Standard current measuring card (for the neutral side of the differential protection)
- X4** – TI: Standard current measuring card (for the mains side of the differential protection)
- X5** – DI8-OR4: Assembly Group with 8 Digital Inputs and 4 Output Relays (NO / Form A)
- X6** – TU-OR5: Voltage measuring (0 ... 300 VAC) assembly group with 5 additional Output Relays (NO / Form A)
- X102** – Universal Resistance-Temperature Detector (URTD) input, Fiber optics interface, Versatile Link
- X103** – Modbus TCP / DNP3.0 TCP/UDP, Fiber optics interface, LC Connector
- X104** – IRIG-B00X, incl. System Contact (Supervision Contact)

MCDGV4-2D0BLB

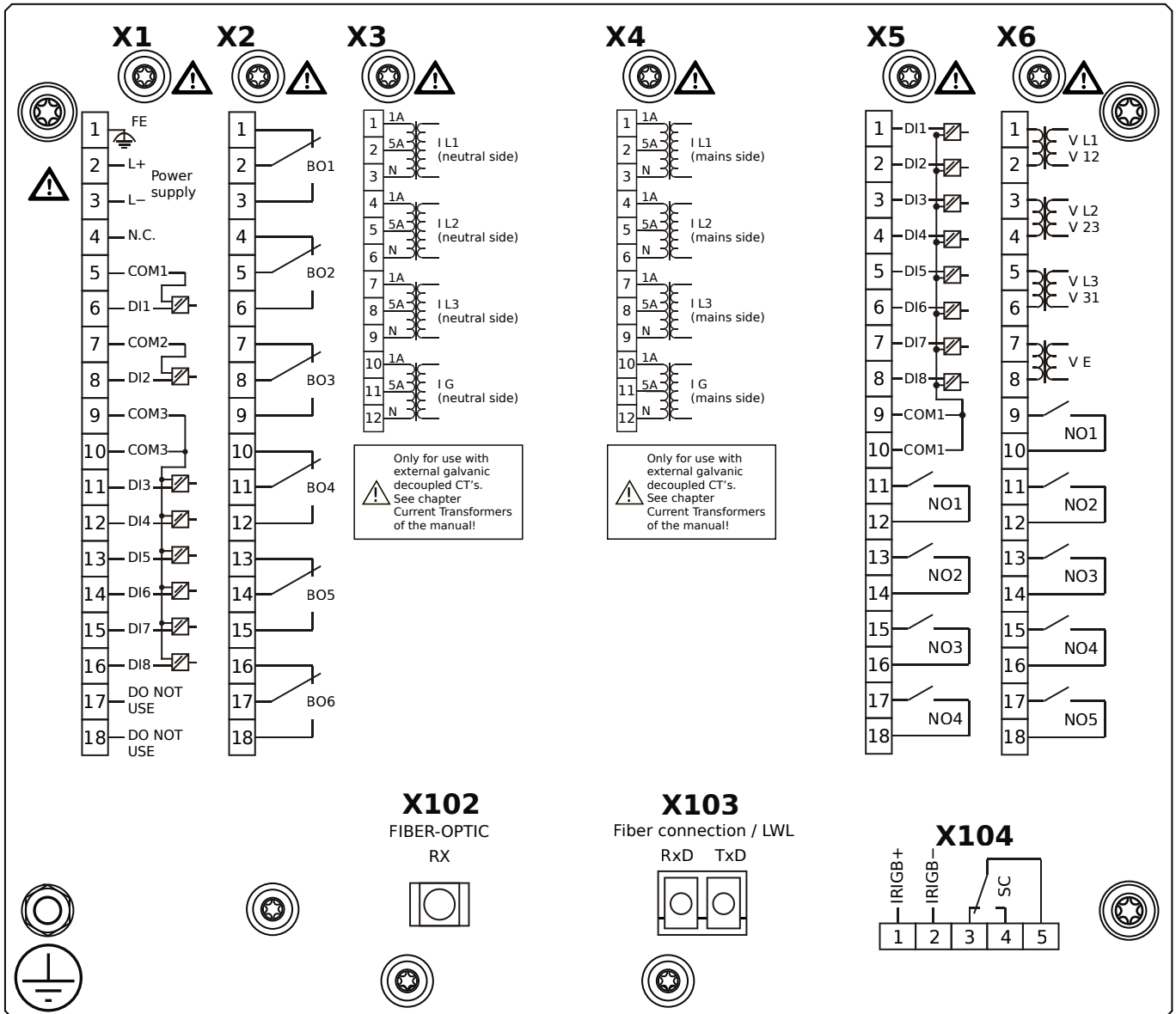

Housing B2, large display, 19" rack mounting

- + Conformal Coating (for installations in harsh environment)

- X1** – DI8-X1: Wide-range power supply unit, incl. 2 non-grouped digital inputs and 6 grouped digital inputs
- X2** – OR6: Assembly Group with 6 Output Relays (Changeover / Form C)
- X3** – TI: Standard current measuring card (for the neutral side of the differential protection)
- X4** – TI: Standard current measuring card (for the mains side of the differential protection)
- X5** – DI8-OR4: Assembly Group with 8 Digital Inputs and 4 Output Relays (NO / Form A)
- X6** – TU-OR5: Voltage measuring (0 ... 300 VAC) assembly group with 5 additional Output Relays (NO / Form A)
- X102** – Universal Resistance-Temperature Detector (URTD) input, Fiber optics interface, Versatile Link
- X103** – Modbus TCP / DNP3.0 TCP/UDP, Fiber optics interface, LC Connector
- X104** – IRIG-B00X, incl. System Contact (Supervision Contact)

MCDGV4-2D0BTA

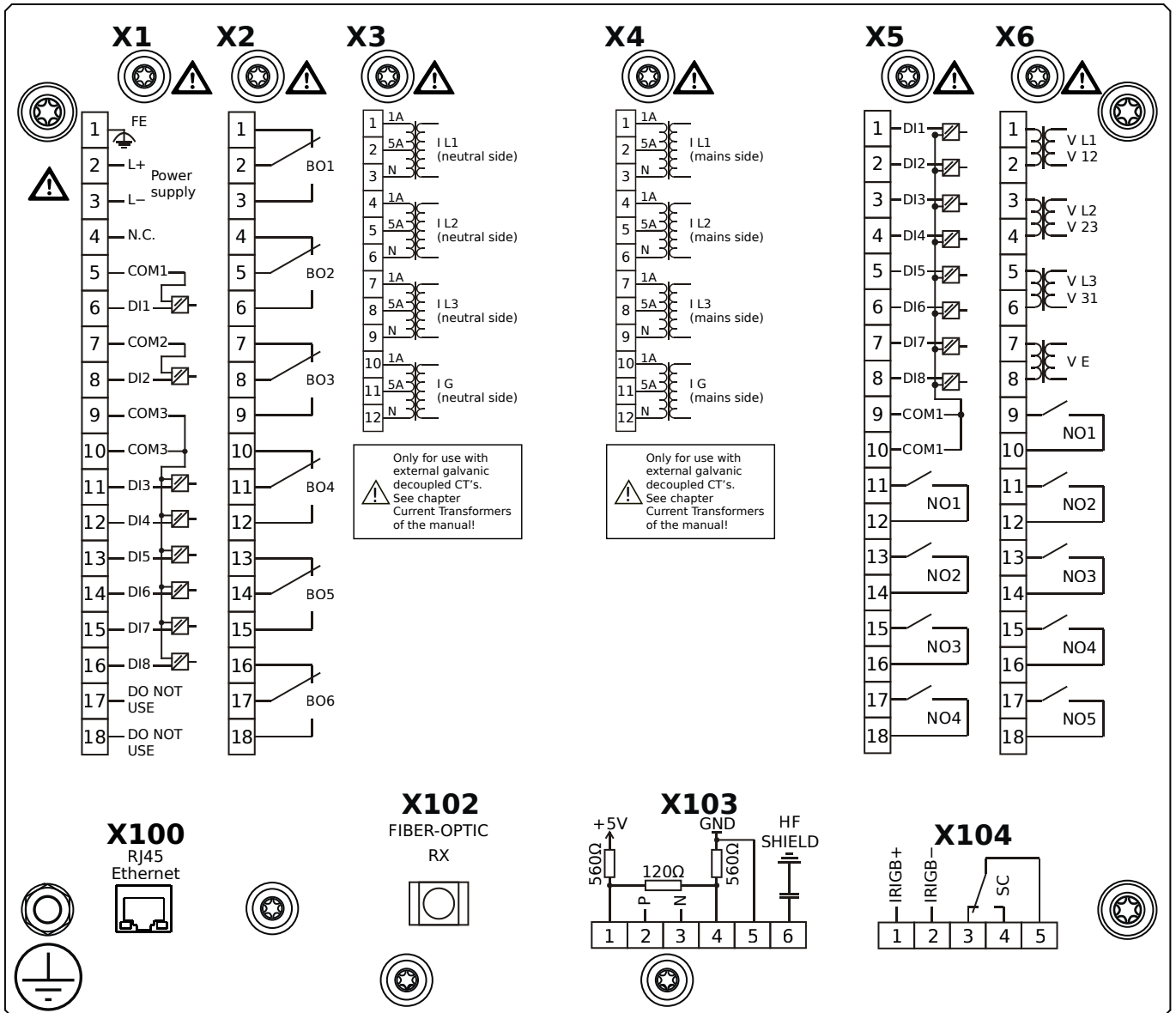

Housing B2, large display, 19" rack mounting

- X1** – DI8-X1: Wide-range power supply unit, incl. 2 non-grouped digital inputs and 6 grouped digital inputs
- X2** – OR6: Assembly Group with 6 Output Relays (Changeover / Form C)
- X3** – TI: Standard current measuring card (for the neutral side of the differential protection)
- X4** – TI: Standard current measuring card (for the mains side of the differential protection)
- X5** – DI8-OR4: Assembly Group with 8 Digital Inputs and 4 Output Relays (NO / Form A)
- X6** – TU-OR5: Voltage measuring (0 ... 300 VAC) assembly group with 5 additional Output Relays (NO / Form A)
- X100** – IEC 61850 / Modbus TCP / DNP3.0 TCP/UDP, Ethernet interface, 100 Mbit/s, RJ45 (BASE100-FX)
- X102** – Universal Resistance-Temperature Detector (URTD) input, Fiber optics interface, Versatile Link
- X103** – IEC 60870-5-103 / Modbus RTU / DNP3.0 RTU, RS485, Terminals
- X104** – IRIG-B00X, incl. System Contact (Supervision Contact)

MCDGV4-2D0BTB

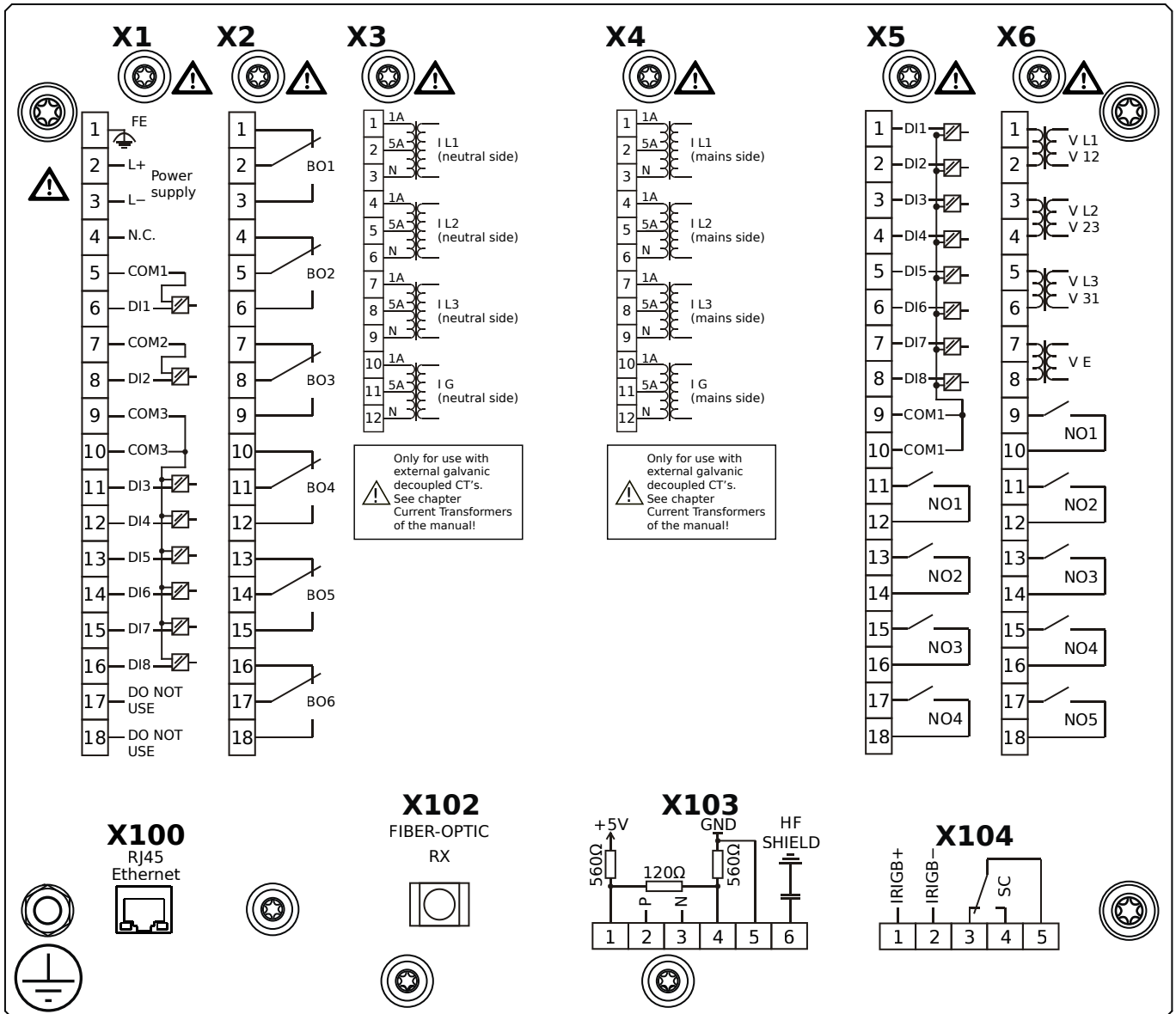

Housing B2, large display, 19" rack mounting

+ Conformal Coating (for installations in harsh environment)

- X1** – DI8-X1: Wide-range power supply unit, incl. 2 non-grouped digital inputs and 6 grouped digital inputs
- X2** – OR6: Assembly Group with 6 Output Relays (Changeover / Form C)
- X3** – TI: Standard current measuring card (for the neutral side of the differential protection)
- X4** – TI: Standard current measuring card (for the mains side of the differential protection)
- X5** – DI8-OR4: Assembly Group with 8 Digital Inputs and 4 Output Relays (NO / Form A)
- X6** – TU-OR5: Voltage measuring (0 ... 300 VAC) assembly group with 5 additional Output Relays (NO / Form A)
- X100** – IEC 61850 / Modbus TCP / DNP3.0 TCP/UDP, Ethernet interface, 100 Mbit/s, RJ45 (BASE100-FX)
- X102** – Universal Resistance-Temperature Detector (URTD) input, Fiber optics interface, Versatile Link
- X103** – IEC 60870-5-103 / Modbus RTU / DNP3.0 RTU, RS485, Terminals
- X104** – IRIG-B00X, incl. System Contact (Supervision Contact)

MCDGV4-2D1AAA

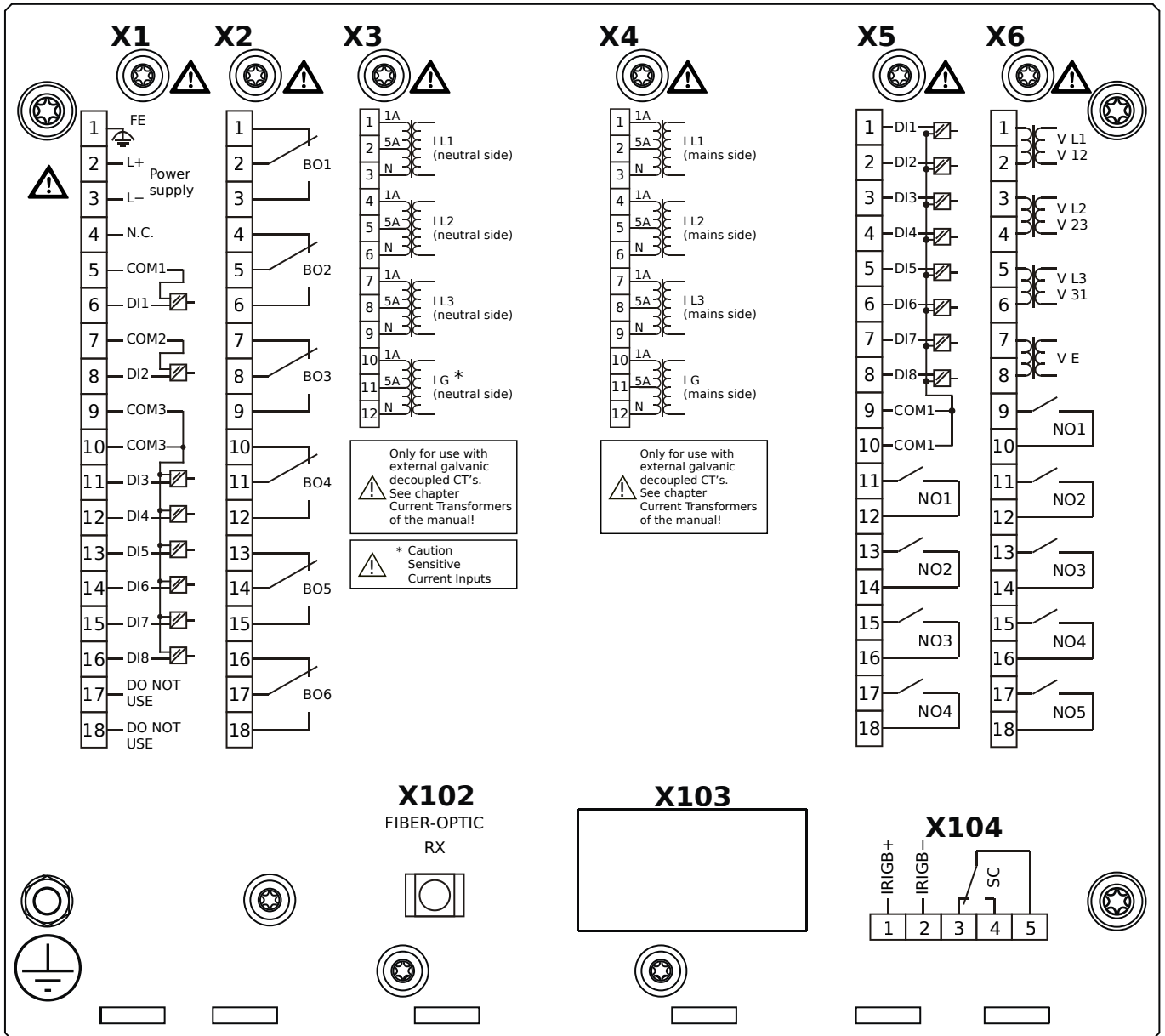

Housing B2, large display, door mounting

- X1** – DI8-X1: Wide-range power supply unit, incl. 2 non-grouped digital inputs and 6 grouped digital inputs
- X2** – OR6: Assembly Group with 6 Output Relays (Changeover / Form C)
- X3** – TIs: Standard phase current measuring card and sensitive ground current measuring (neutral side of the diff. prot.)
- X4** – TI: Standard current measuring card (for the mains side of the differential protection)
- X5** – DI8-OR4: Assembly Group with 8 Digital Inputs and 4 Output Relays (NO / Form A)
- X6** – TU-OR5: Voltage measuring (0 ... 300 VAC) assembly group with 5 additional Output Relays (NO / Form A)
- X102** – Universal Resistance-Temperature Detector (URTD) input, Fiber optics interface, Versatile Link
- X104** – IRIG-B00X, incl. System Contact (Supervision Contact)

MCDGV4-2D1AAB

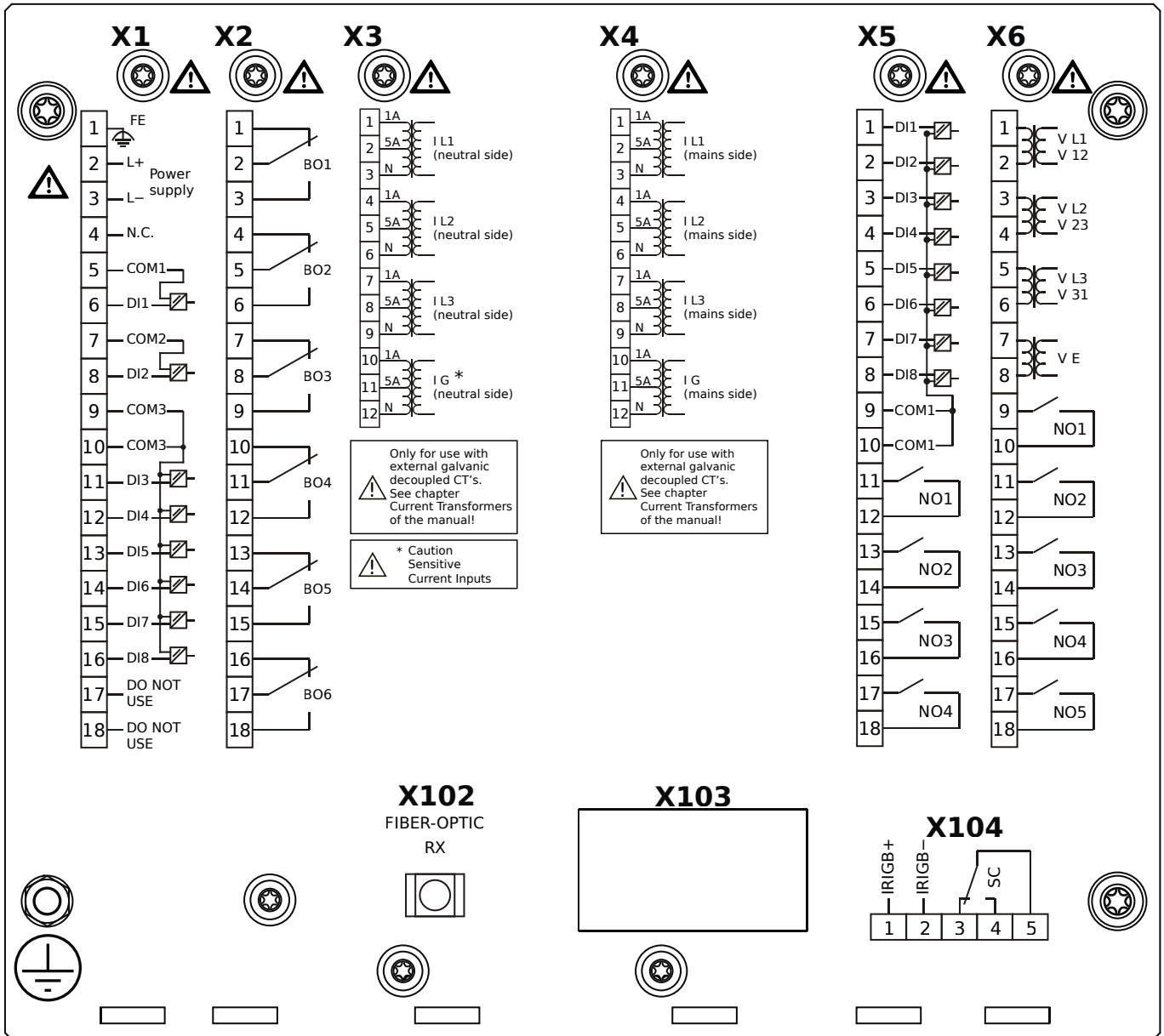

Housing B2, large display, door mounting

- + Conformal Coating (for installations in harsh environment)

- X1** – DI8-X1: Wide-range power supply unit, incl. 2 non-grouped digital inputs and 6 grouped digital inputs
- X2** – OR6: Assembly Group with 6 Output Relays (Changeover / Form C)
- X3** – TIs: Standard phase current measuring card and sensitive ground current measuring (neutral side of the diff. prot.)
- X4** – TI: Standard current measuring card (for the mains side of the differential protection)
- X5** – DI8-OR4: Assembly Group with 8 Digital Inputs and 4 Output Relays (NO / Form A)
- X6** – TU-OR5: Voltage measuring (0 ... 300 VAC) assembly group with 5 additional Output Relays (NO / Form A)
- X102** – Universal Resistance-Temperature Detector (URTD) input, Fiber optics interface, Versatile Link
- X104** – IRIG-B00X, incl. System Contact (Supervision Contact)

MCDGV4-2D1ABA

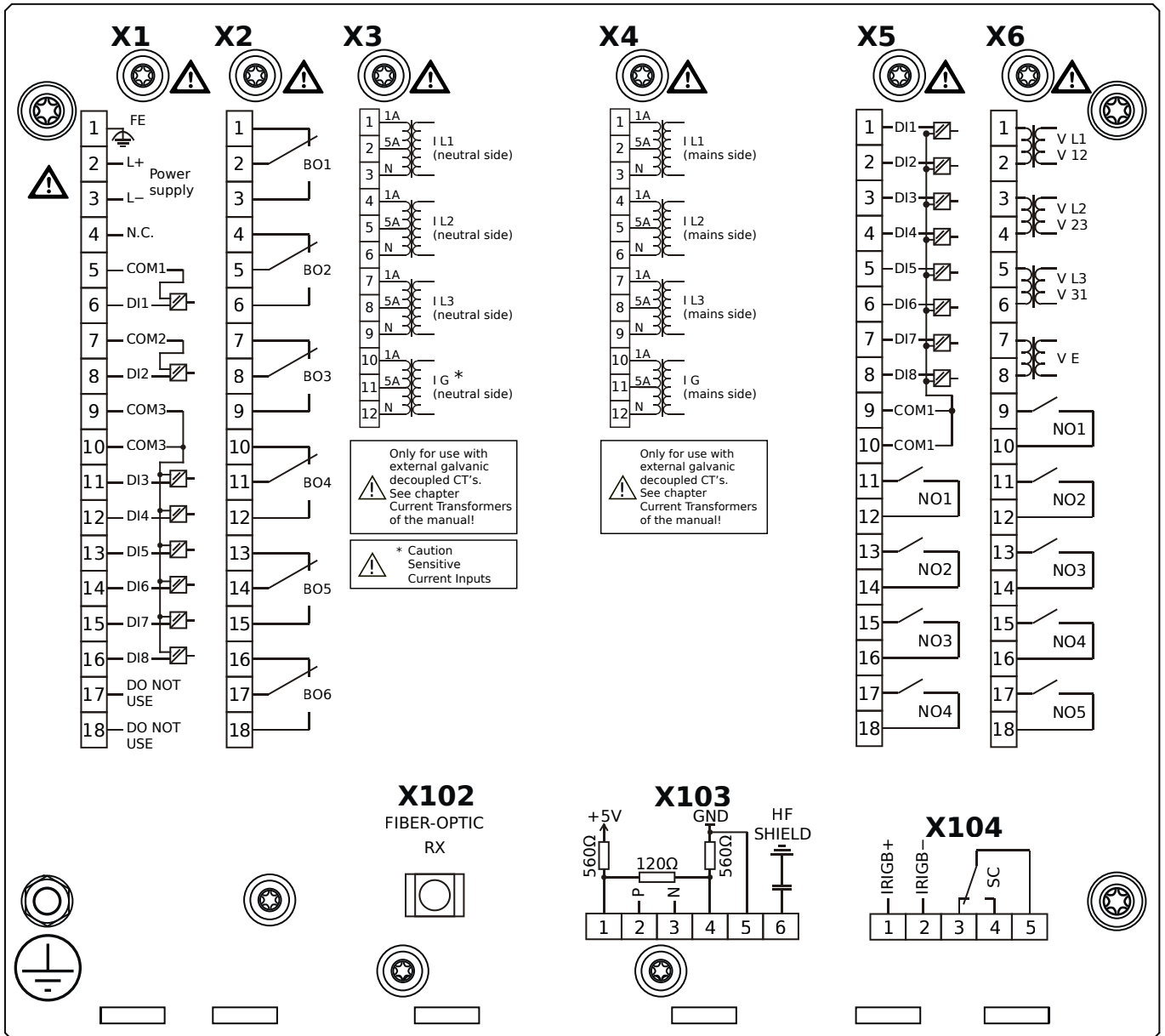

Housing B2, large display, door mounting

- X1** – DI8-X1: Wide-range power supply unit, incl. 2 non-grouped digital inputs and 6 grouped digital inputs
- X2** – OR6: Assembly Group with 6 Output Relays (Changeover / Form C)
- X3** – TIs: Standard phase current measuring card and sensitive ground current measuring (neutral side of the diff. prot.)
- X4** – TI: Standard current measuring card (for the mains side of the differential protection)
- X5** – DI8-OR4: Assembly Group with 8 Digital Inputs and 4 Output Relays (NO / Form A)
- X6** – TU-OR5: Voltage measuring (0 ... 300 VAC) assembly group with 5 additional Output Relays (NO / Form A)
- X102** – Universal Resistance-Temperature Detector (URTD) input, Fiber optics interface, Versatile Link
- X103** – Modbus RTU / IEC 60870-5-103 / DNP3.0 RTU, RS485, Terminals
- X104** – IRIG-B00X, incl. System Contact (Supervision Contact)

MCDGV4-2D1ABB

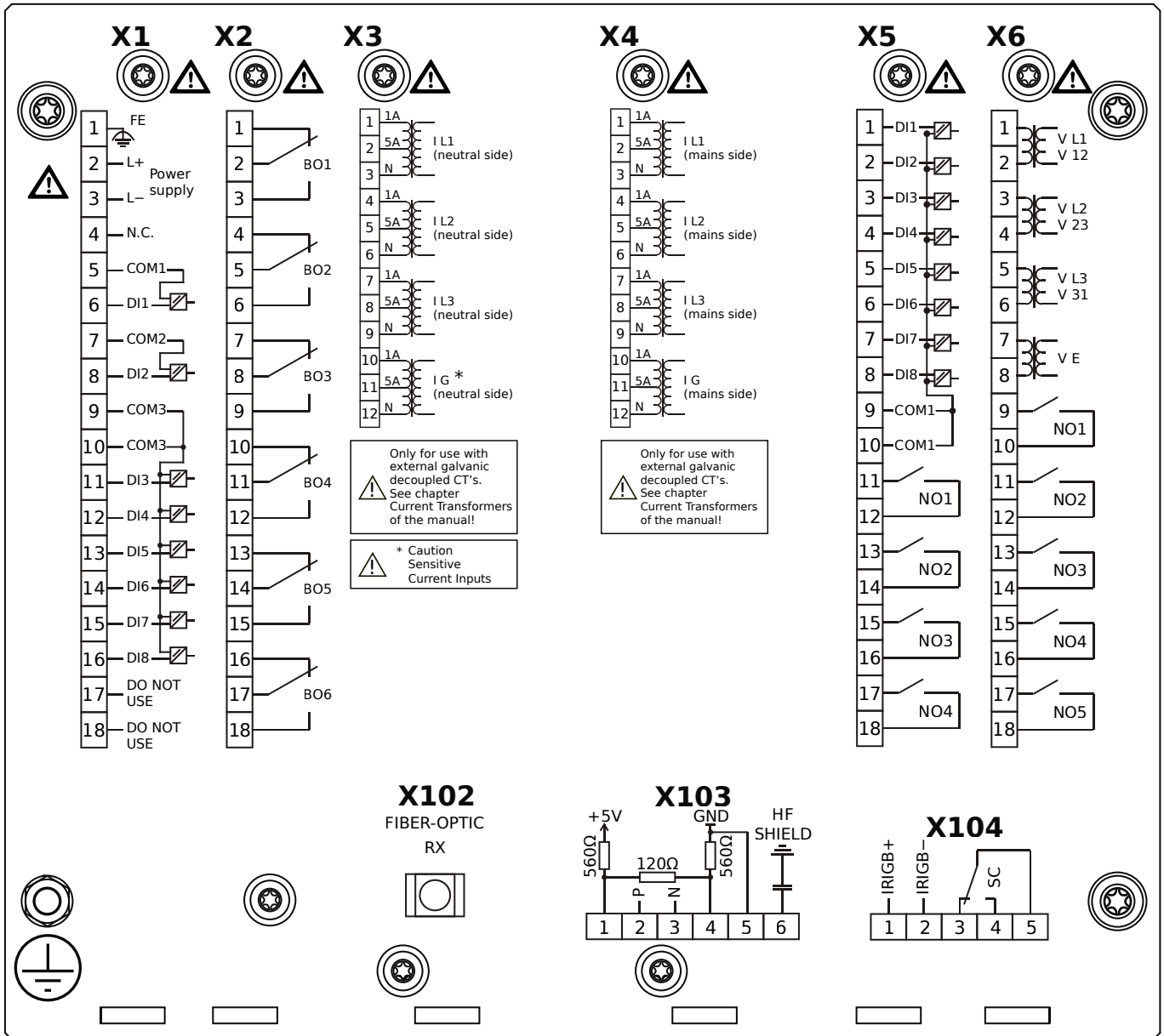

Housing B2, large display, door mounting

+ Conformal Coating (for installations in harsh environment)

- X1** – DI8-X1: Wide-range power supply unit, incl. 2 non-grouped digital inputs and 6 grouped digital inputs
- X2** – OR6: Assembly Group with 6 Output Relays (Changeover / Form C)
- X3** – TIs: Standard phase current measuring card and sensitive ground current measuring (neutral side of the diff. prot.)
- X4** – TI: Standard current measuring card (for the mains side of the differential protection)
- X5** – DI8-OR4: Assembly Group with 8 Digital Inputs and 4 Output Relays (NO / Form A)
- X6** – TU-OR5: Voltage measuring (0 ... 300 VAC) assembly group with 5 additional Output Relays (NO / Form A)
- X102** – Universal Resistance-Temperature Detector (URTD) input, Fiber optics interface, Versatile Link
- X103** – Modbus RTU / IEC 60870-5-103 / DNP3.0 RTU, RS485, Terminals
- X104** – IRIG-B00X, incl. System Contact (Supervision Contact)

MCDGV4-2D1ACA

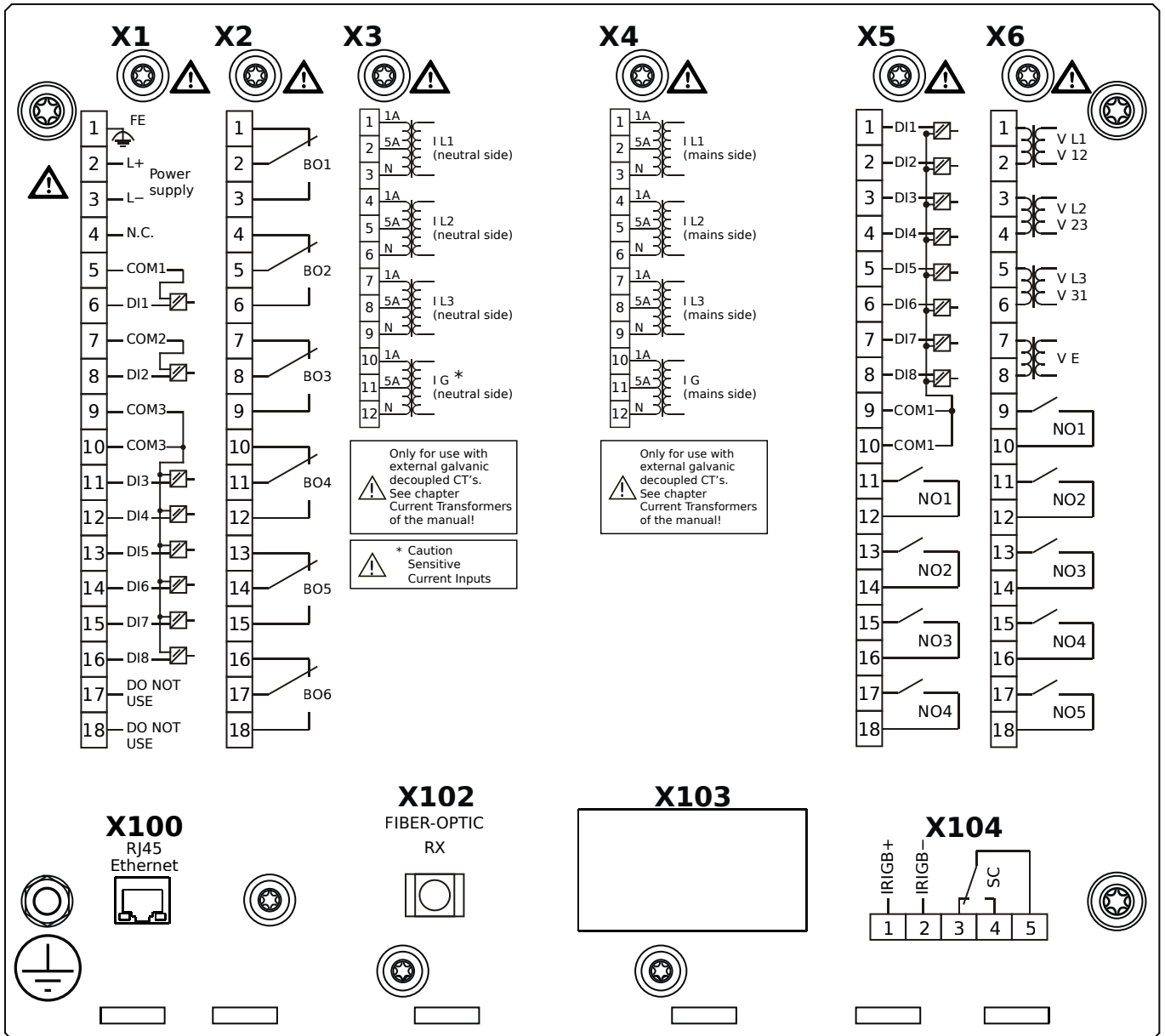

Housing B2, large display, door mounting

- X1** – DI8-X1: Wide-range power supply unit, incl. 2 non-grouped digital inputs and 6 grouped digital inputs
- X2** – OR6: Assembly Group with 6 Output Relays (Changeover / Form C)
- X3** – TIs: Standard phase current measuring card and sensitive ground current measuring (neutral side of the diff. prot.)
- X4** – TI: Standard current measuring card (for the mains side of the differential protection)
- X5** – DI8-OR4: Assembly Group with 8 Digital Inputs and 4 Output Relays (NO / Form A)
- X6** – TU-OR5: Voltage measuring (0 ... 300 VAC) assembly group with 5 additional Output Relays (NO / Form A)
- X100** – Modbus TCP / DNP3.0 TCP/UDP, Ethernet interface, 100 Mbit/s, RJ45 (BASE100-FX)
- X102** – Universal Resistance-Temperature Detector (URTD) input, Fiber optics interface, Versatile Link
- X104** – IRIG-B00X, incl. System Contact (Supervision Contact)

MCDGV4-2D1ACB

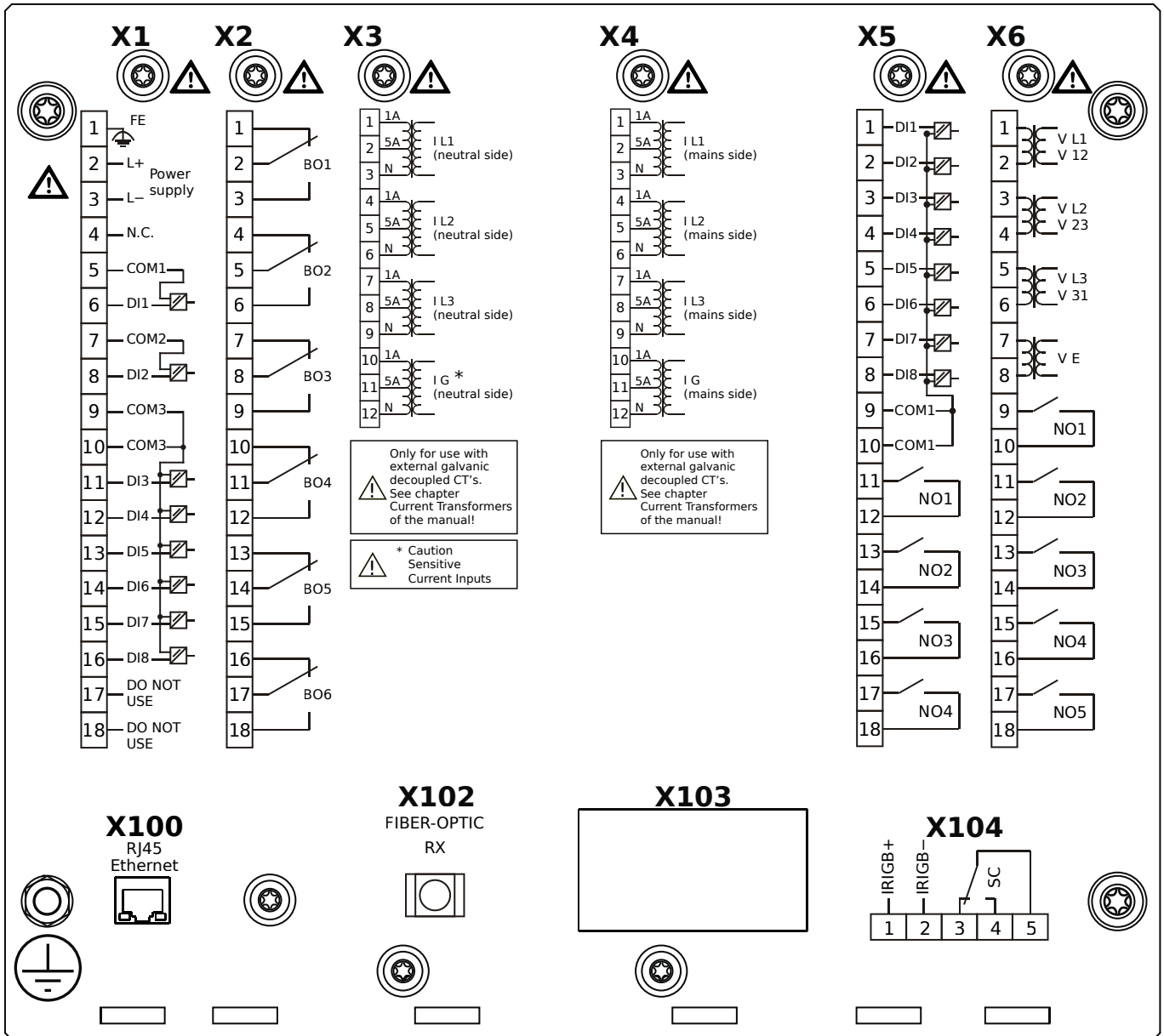

Housing B2, large display, door mounting

+ Conformal Coating (for installations in harsh environment)

- X1** – DI8-X1: Wide-range power supply unit, incl. 2 non-grouped digital inputs and 6 grouped digital inputs
- X2** – OR6: Assembly Group with 6 Output Relays (Changeover / Form C)
- X3** – TIs: Standard phase current measuring card and sensitive ground current measuring (neutral side of the diff. prot.)
- X4** – TI: Standard current measuring card (for the mains side of the differential protection)
- X5** – DI8-OR4: Assembly Group with 8 Digital Inputs and 4 Output Relays (NO / Form A)
- X6** – TU-OR5: Voltage measuring (0 ... 300 VAC) assembly group with 5 additional Output Relays (NO / Form A)
- X100** – Modbus TCP / DNP3.0 TCP/UDP, Ethernet interface, 100 Mbit/s, RJ45 (BASE100-FX)
- X102** – Universal Resistance-Temperature Detector (URTD) input, Fiber optics interface, Versatile Link
- X104** – IRIG-B00X, incl. System Contact (Supervision Contact)

MCDGV4-2D1ADA

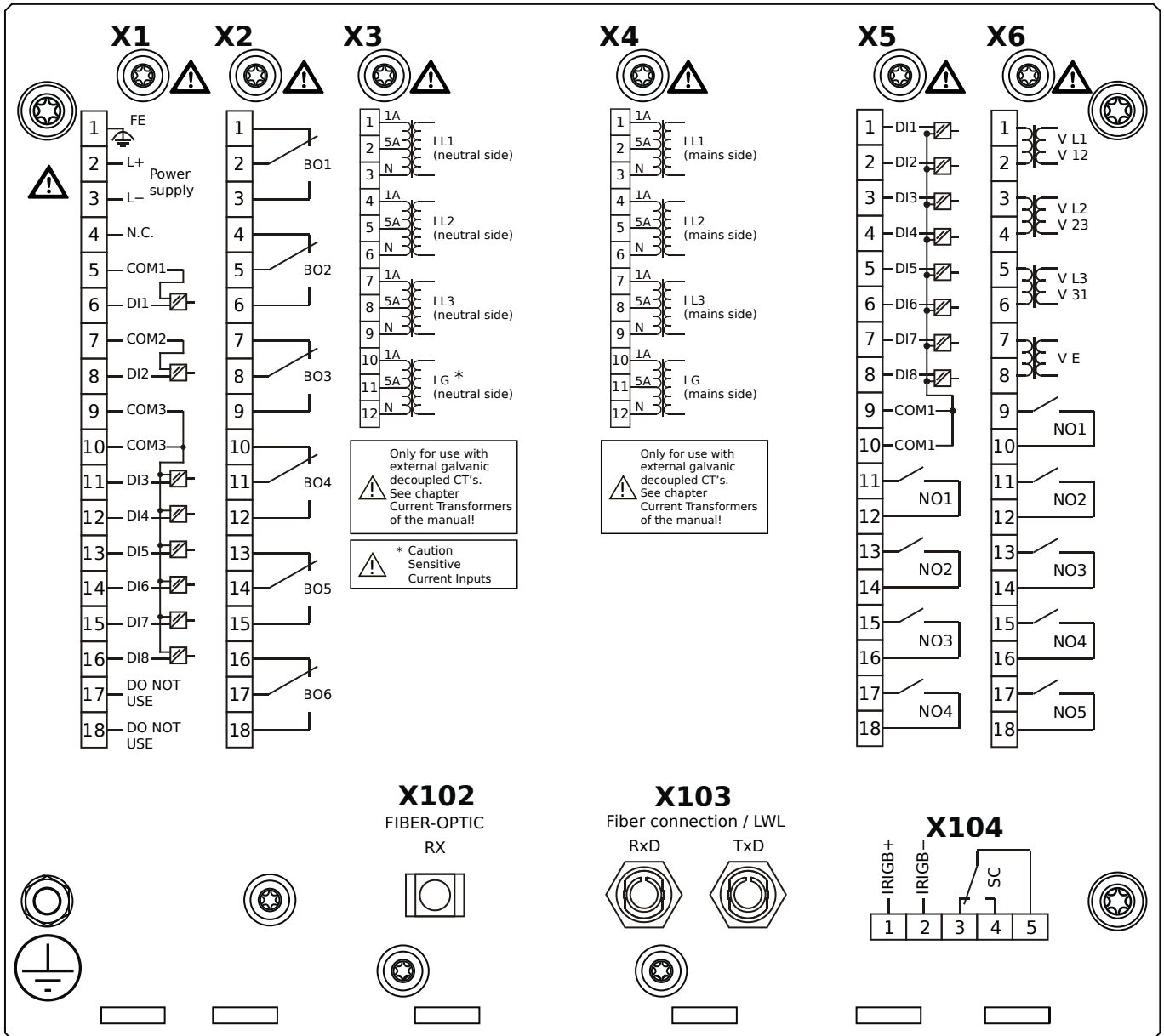

Housing B2, large display, door mounting

- X1** – DI8-X1: Wide-range power supply unit, incl. 2 non-grouped digital inputs and 6 grouped digital inputs
- X2** – OR6: Assembly Group with 6 Output Relays (Changeover / Form C)
- X3** – TIs: Standard phase current measuring card and sensitive ground current measuring (neutral side of the diff. prot.)
- X4** – TI: Standard current measuring card (for the mains side of the differential protection)
- X5** – DI8-OR4: Assembly Group with 8 Digital Inputs and 4 Output Relays (NO / Form A)
- X6** – TU-OR5: Voltage measuring (0 ... 300 VAC) assembly group with 5 additional Output Relays (NO / Form A)
- X102** – Universal Resistance-Temperature Detector (URTD) input, Fiber optics interface, Versatile Link
- X103** – Profibus-DP, Fiber optics interface, ST Connector
- X104** – IRIG-B00X, incl. System Contact (Supervision Contact)

MCDGV4-2D1ADB

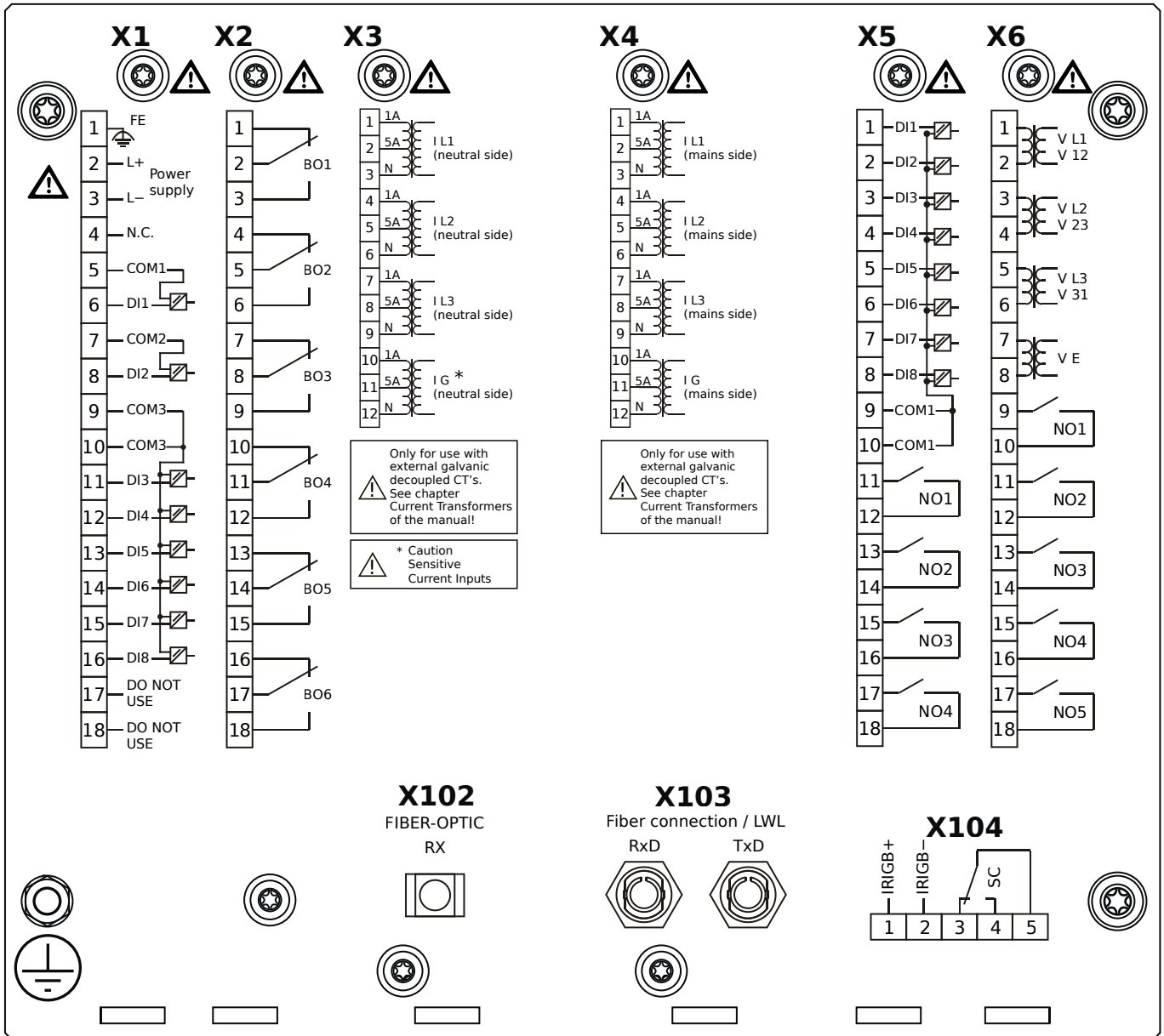

Housing B2, large display, door mounting

+ Conformal Coating (for installations in harsh environment)

- X1** – DI8-X1: Wide-range power supply unit, incl. 2 non-grouped digital inputs and 6 grouped digital inputs
- X2** – OR6: Assembly Group with 6 Output Relays (Changeover / Form C)
- X3** – TIs: Standard phase current measuring card and sensitive ground current measuring (neutral side of the diff. prot.)
- X4** – TI: Standard current measuring card (for the mains side of the differential protection)
- X5** – DI8-OR4: Assembly Group with 8 Digital Inputs and 4 Output Relays (NO / Form A)
- X6** – TU-OR5: Voltage measuring (0 ... 300 VAC) assembly group with 5 additional Output Relays (NO / Form A)
- X102** – Universal Resistance-Temperature Detector (URTD) input, Fiber optics interface, Versatile Link
- X103** – Profibus-DP, Fiber optics interface, ST Connector
- X104** – IRIG-B00X, incl. System Contact (Supervision Contact)

MCDGV4-2D1AEA

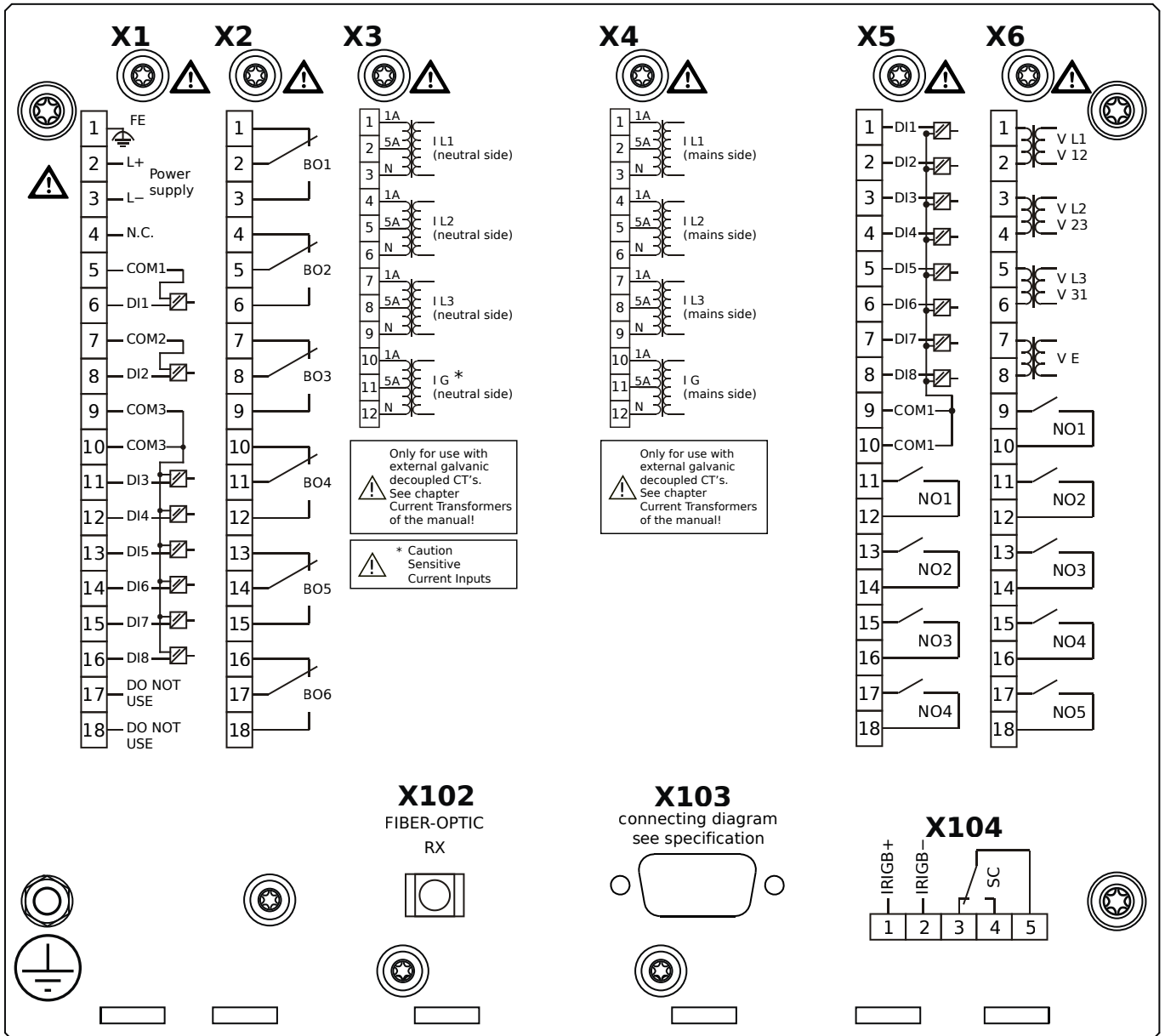

Housing B2, large display, door mounting

- X1** – DI8-X1: Wide-range power supply unit, incl. 2 non-grouped digital inputs and 6 grouped digital inputs
- X2** – OR6: Assembly Group with 6 Output Relays (Changeover / Form C)
- X3** – TI: Standard phase current measuring card and sensitive ground current measuring (neutral side of the diff. prot.)
- X4** – TI: Standard current measuring card (for the mains side of the differential protection)
- X5** – DI8-OR4: Assembly Group with 8 Digital Inputs and 4 Output Relays (NO / Form A)
- X6** – TU-OR5: Voltage measuring (0 ... 300 VAC) assembly group with 5 additional Output Relays (NO / Form A)
- X102** – Universal Resistance-Temperature Detector (URTD) input, Fiber optics interface, Versatile Link
- X103** – Profibus-DP, RS485, D-SUB
- X104** – IRIG-B00X, incl. System Contact (Supervision Contact)

MCDGV4-2D1AEB

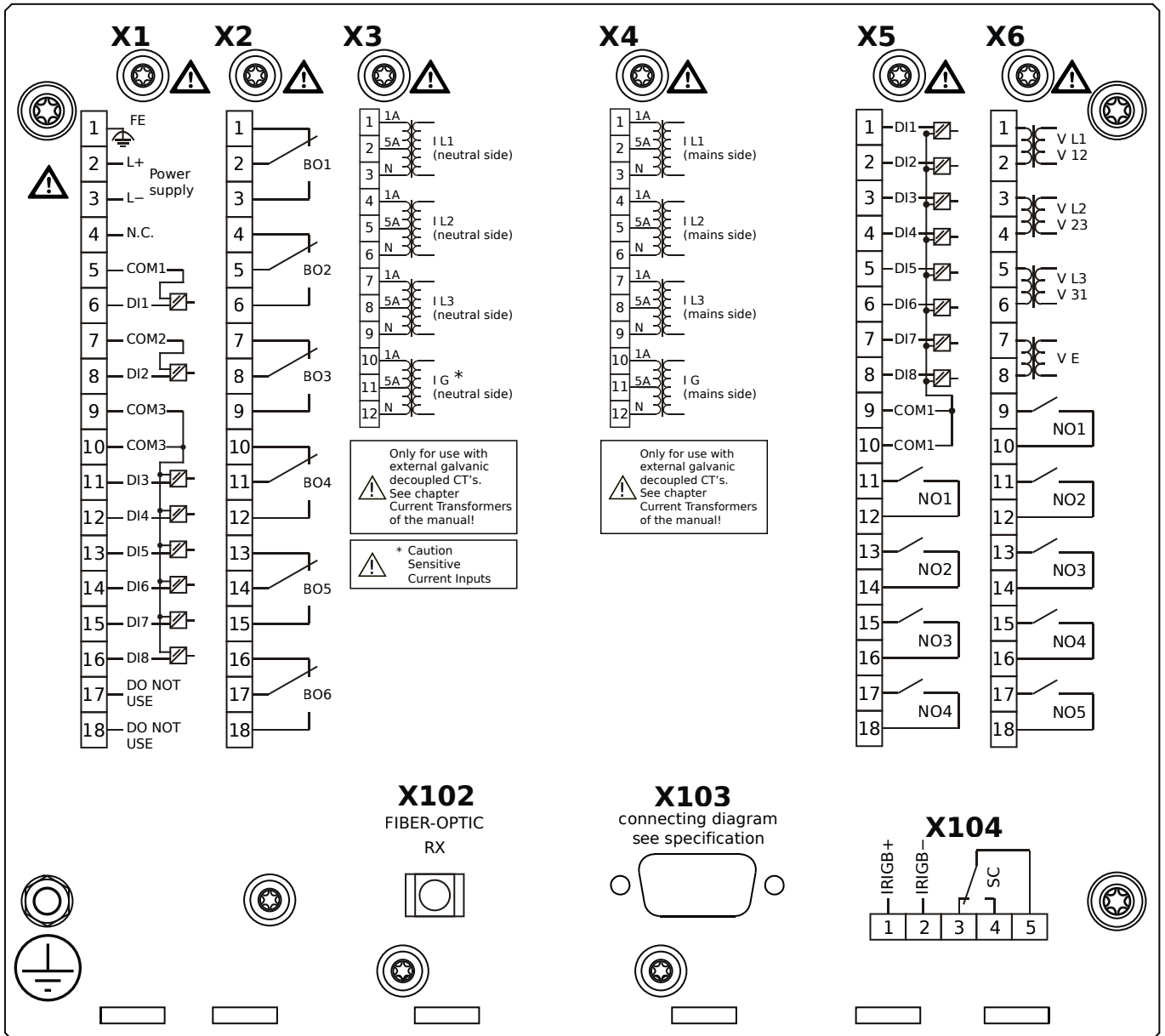

Housing B2, large display, door mounting

+ Conformal Coating (for installations in harsh environment)

- X1** – DI8-X1: Wide-range power supply unit, incl. 2 non-grouped digital inputs and 6 grouped digital inputs
- X2** – OR6: Assembly Group with 6 Output Relays (Changeover / Form C)
- X3** – TIs: Standard phase current measuring card and sensitive ground current measuring (neutral side of the diff. prot.)
- X4** – TI: Standard current measuring card (for the mains side of the differential protection)
- X5** – DI8-OR4: Assembly Group with 8 Digital Inputs and 4 Output Relays (NO / Form A)
- X6** – TU-OR5: Voltage measuring (0 ... 300 VAC) assembly group with 5 additional Output Relays (NO / Form A)
- X102** – Universal Resistance-Temperature Detector (URTD) input, Fiber optics interface, Versatile Link
- X103** – Profibus-DP, RS485, D-SUB
- X104** – IRIG-B00X, incl. System Contact (Supervision Contact)

MCDGV4-2D1AFA

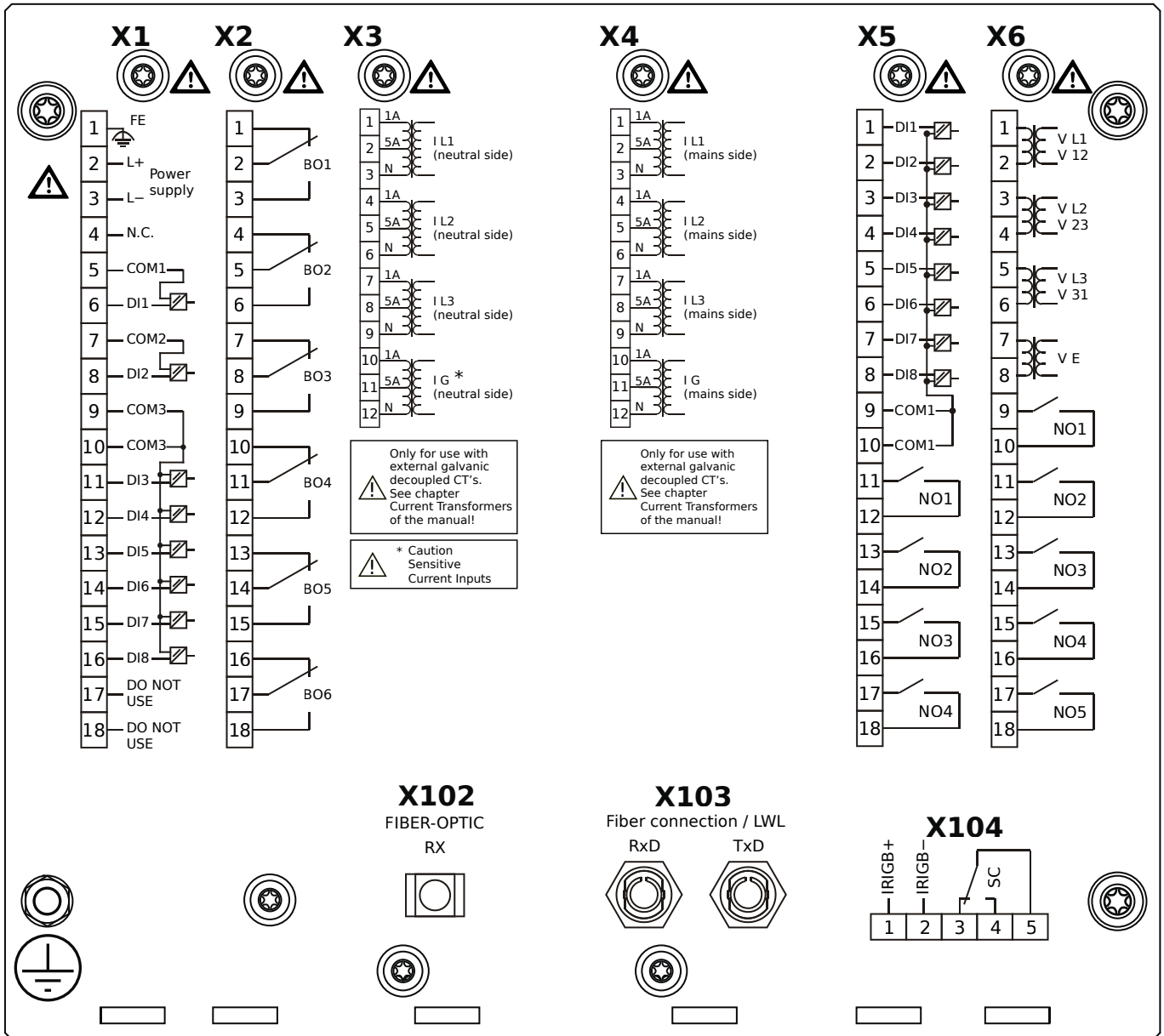

Housing B2, large display, door mounting

- X1** – DI8-X1: Wide-range power supply unit, incl. 2 non-grouped digital inputs and 6 grouped digital inputs
- X2** – OR6: Assembly Group with 6 Output Relays (Changeover / Form C)
- X3** – TIs: Standard phase current measuring card and sensitive ground current measuring (neutral side of the diff. prot.)
- X4** – TI: Standard current measuring card (for the mains side of the differential protection)
- X5** – DI8-OR4: Assembly Group with 8 Digital Inputs and 4 Output Relays (NO / Form A)
- X6** – TU-OR5: Voltage measuring (0 ... 300 VAC) assembly group with 5 additional Output Relays (NO / Form A)
- X102** – Universal Resistance-Temperature Detector (URTD) input, Fiber optics interface, Versatile Link
- X103** – Modbus RTU / IEC 60870-5-103 / DNP3.0 RTU, Fiber optics interface, ST Connector
- X104** – IRIG-B00X, incl. System Contact (Supervision Contact)

MCDGV4-2D1AFB

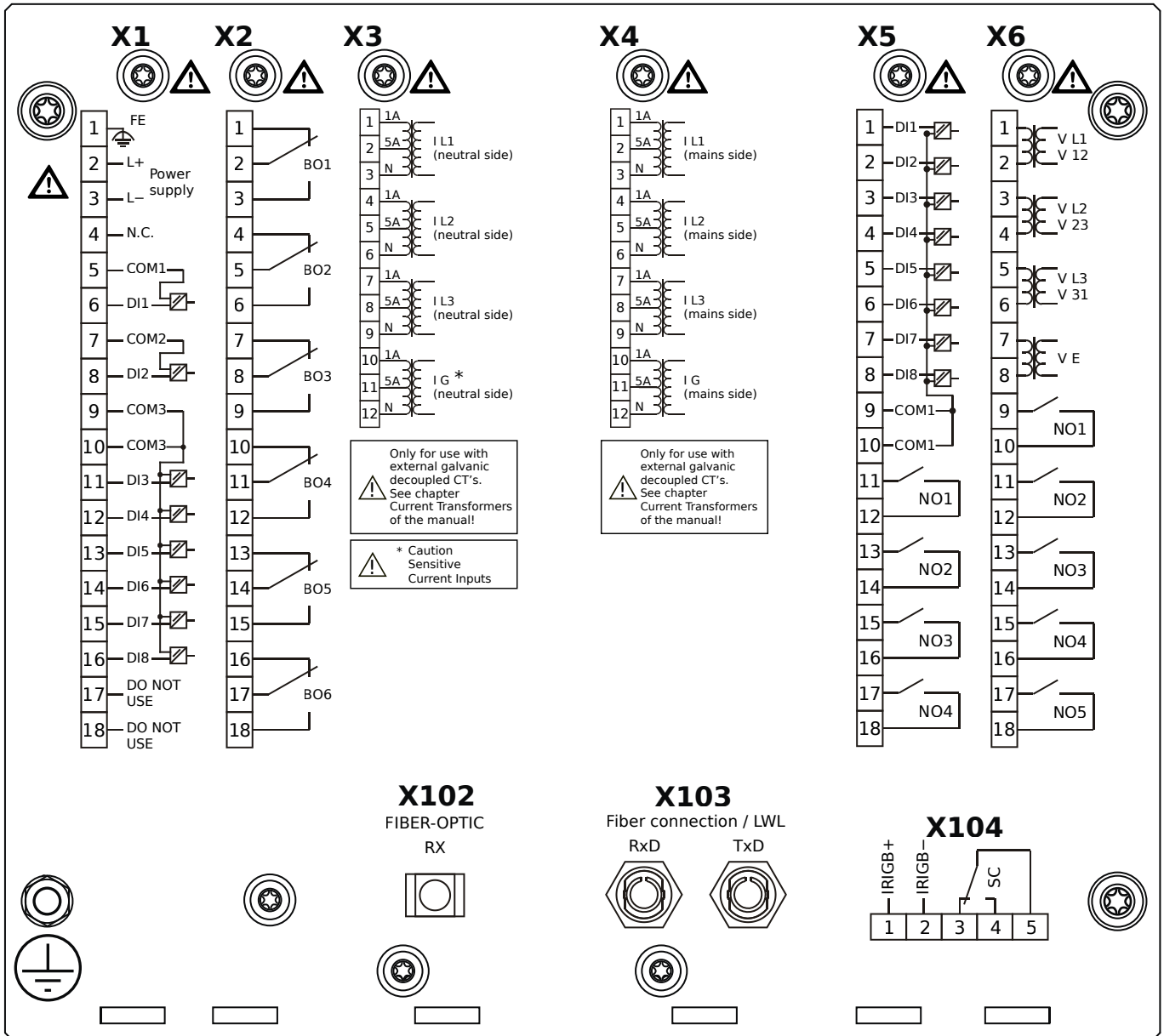

Housing B2, large display, door mounting

+ Conformal Coating (for installations in harsh environment)

- X1** – DI8-X1: Wide-range power supply unit, incl. 2 non-grouped digital inputs and 6 grouped digital inputs
- X2** – OR6: Assembly Group with 6 Output Relays (Changeover / Form C)
- X3** – TIs: Standard phase current measuring card and sensitive ground current measuring (neutral side of the diff. prot.)
- X4** – TI: Standard current measuring card (for the mains side of the differential protection)
- X5** – DI8-OR4: Assembly Group with 8 Digital Inputs and 4 Output Relays (NO / Form A)
- X6** – TU-OR5: Voltage measuring (0 ... 300 VAC) assembly group with 5 additional Output Relays (NO / Form A)
- X102** – Universal Resistance-Temperature Detector (URTD) input, Fiber optics interface, Versatile Link
- X103** – Modbus RTU / IEC 60870-5-103 / DNP3.0 RTU, Fiber optics interface, ST Connector
- X104** – IRIG-B00X, incl. System Contact (Supervision Contact)

MCDGV4-2D1AGA

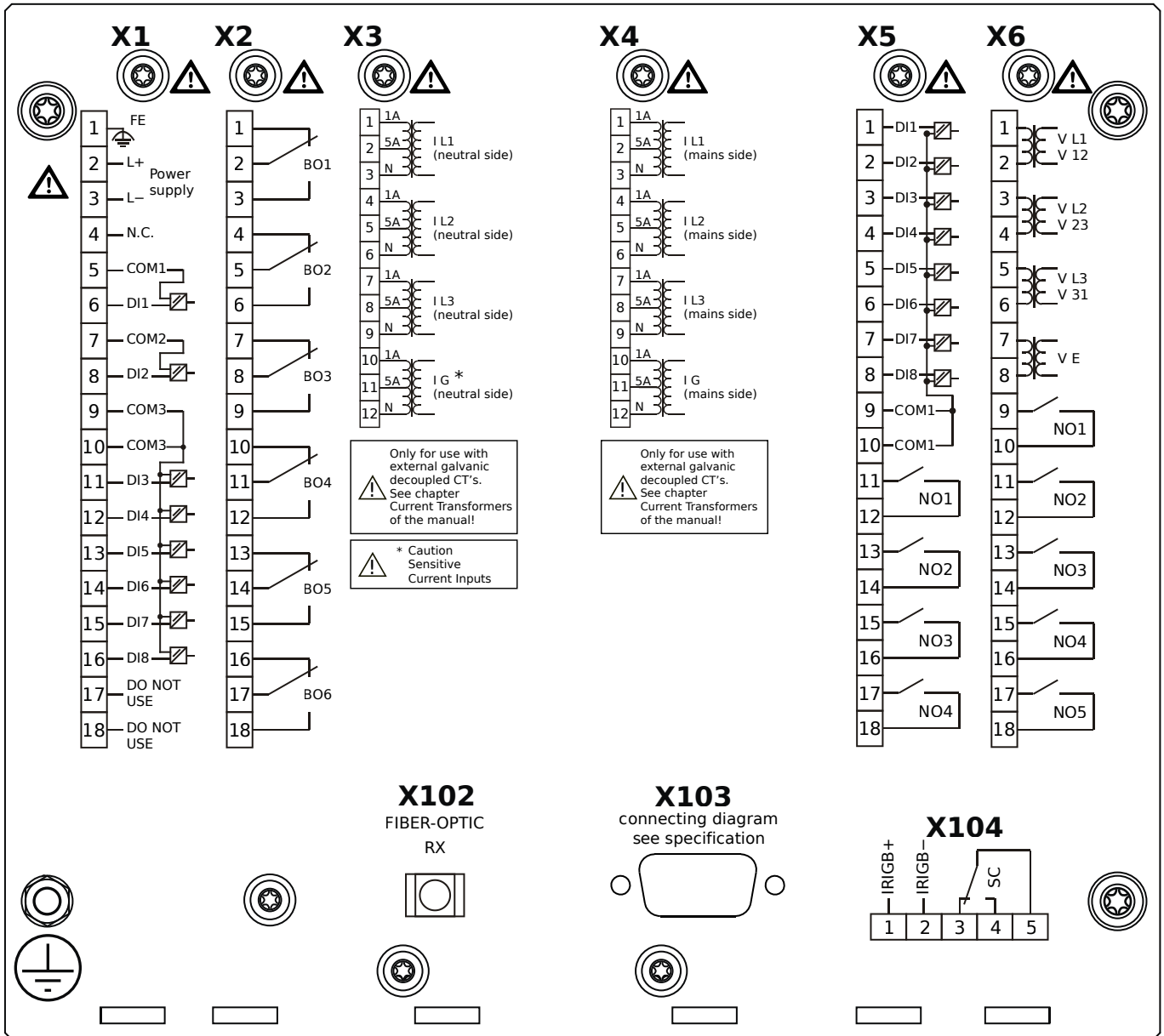

Housing B2, large display, door mounting

- X1** – DI8-X1: Wide-range power supply unit, incl. 2 non-grouped digital inputs and 6 grouped digital inputs
- X2** – OR6: Assembly Group with 6 Output Relays (Changeover / Form C)
- X3** – TIs: Standard phase current measuring card and sensitive ground current measuring (neutral side of the diff. prot.)
- X4** – TI: Standard current measuring card (for the mains side of the differential protection)
- X5** – DI8-OR4: Assembly Group with 8 Digital Inputs and 4 Output Relays (NO / Form A)
- X6** – TU-OR5: Voltage measuring (0 ... 300 VAC) assembly group with 5 additional Output Relays (NO / Form A)
- X102** – Universal Resistance-Temperature Detector (URTD) input, Fiber optics interface, Versatile Link
- X103** – Modbus RTU / IEC 60870-5-103 / DNP3.0 RTU, RS485, D-SUB
- X104** – IRIG-B00X, incl. System Contact (Supervision Contact)

MCDGV4-2D1AGB

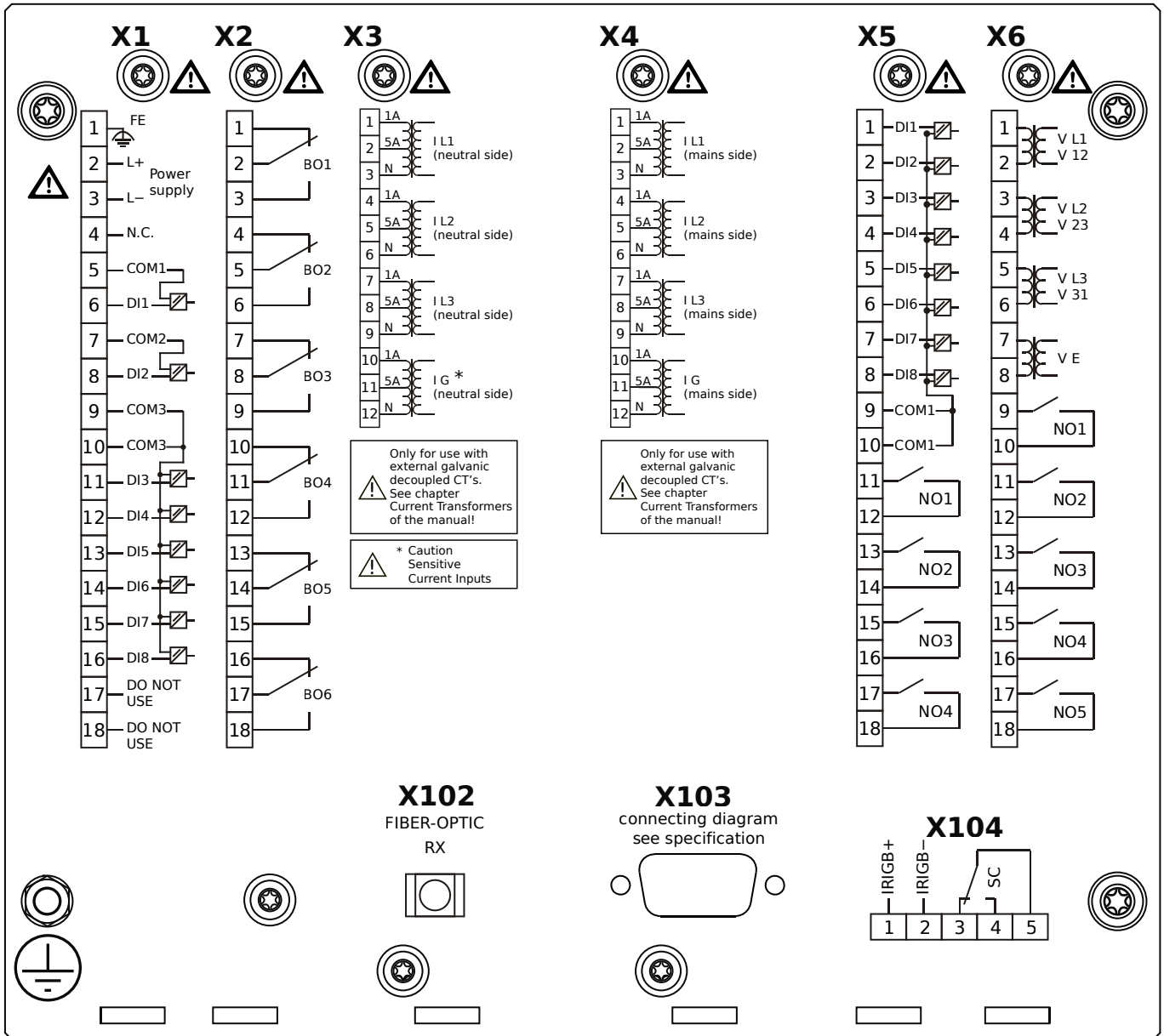

Housing B2, large display, door mounting

+ Conformal Coating (for installations in harsh environment)

- X1** – DI8-X1: Wide-range power supply unit, incl. 2 non-grouped digital inputs and 6 grouped digital inputs
- X2** – OR6: Assembly Group with 6 Output Relays (Changeover / Form C)
- X3** – TIs: Standard phase current measuring card and sensitive ground current measuring (neutral side of the diff. prot.)
- X4** – TI: Standard current measuring card (for the mains side of the differential protection)
- X5** – DI8-OR4: Assembly Group with 8 Digital Inputs and 4 Output Relays (NO / Form A)
- X6** – TU-OR5: Voltage measuring (0 ... 300 VAC) assembly group with 5 additional Output Relays (NO / Form A)
- X102** – Universal Resistance-Temperature Detector (URTD) input, Fiber optics interface, Versatile Link
- X103** – Modbus RTU / IEC 60870-5-103 / DNP3.0 RTU, RS485, D-SUB
- X104** – IRIG-B00X, incl. System Contact (Supervision Contact)

MCDGV4-2D1AHA

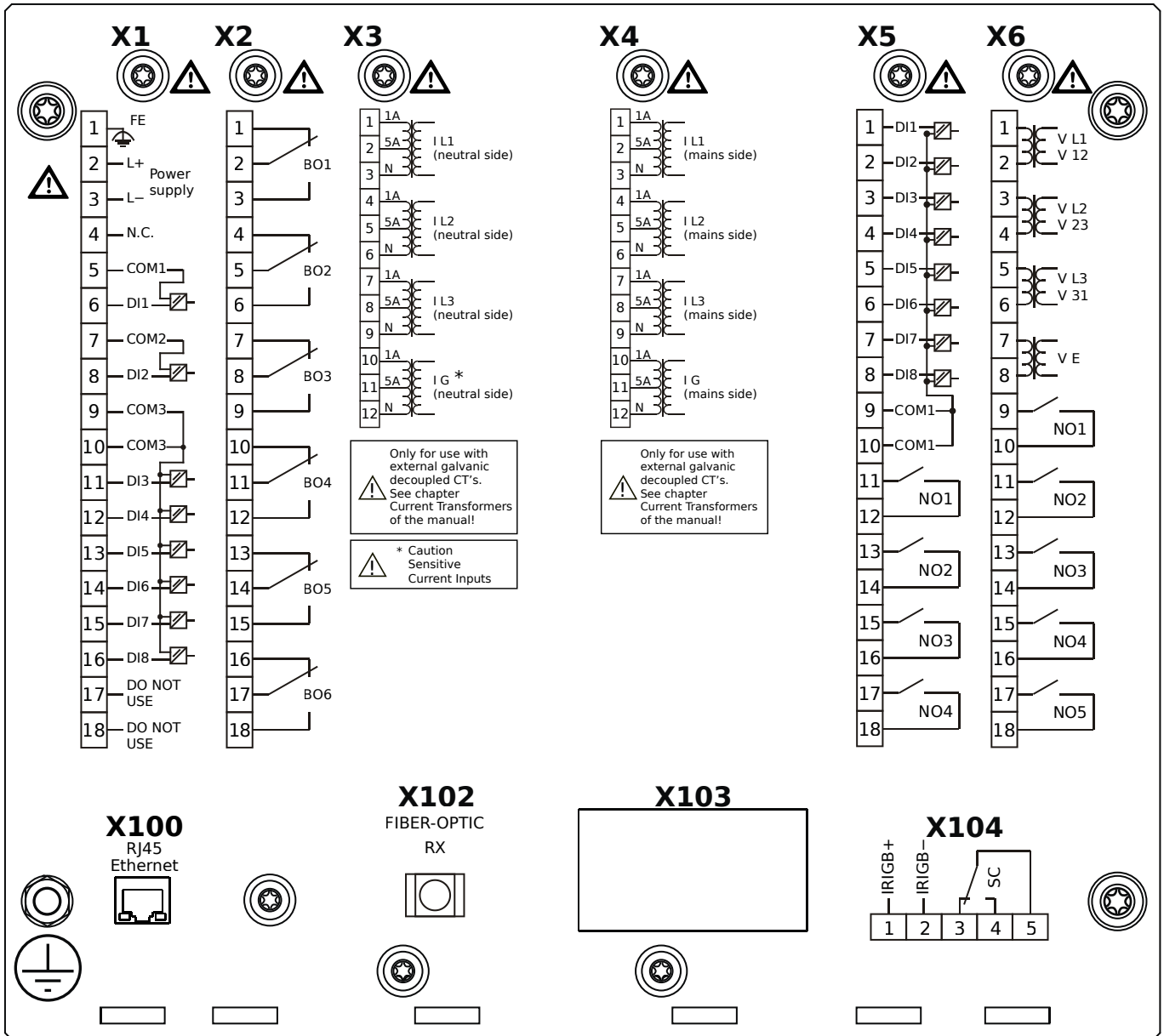

Housing B2, large display, door mounting

- X1** – DI8-X1: Wide-range power supply unit, incl. 2 non-grouped digital inputs and 6 grouped digital inputs
- X2** – OR6: Assembly Group with 6 Output Relays (Changeover / Form C)
- X3** – TIs: Standard phase current measuring card and sensitive ground current measuring (neutral side of the diff. prot.)
- X4** – TI: Standard current measuring card (for the mains side of the differential protection)
- X5** – DI8-OR4: Assembly Group with 8 Digital Inputs and 4 Output Relays (NO / Form A)
- X6** – TU-OR5: Voltage measuring (0 ... 300 VAC) assembly group with 5 additional Output Relays (NO / Form A)
- X100** – IEC 61850 / Modbus TCP / DNP3.0 TCP/UDP, Ethernet interface, 100 Mbit/s, RJ45 (BASE100-FX)
- X102** – Universal Resistance-Temperature Detector (URTD) input, Fiber optics interface, Versatile Link
- X104** – IRIG-B00X, incl. System Contact (Supervision Contact)

MCDGV4-2D1AHB

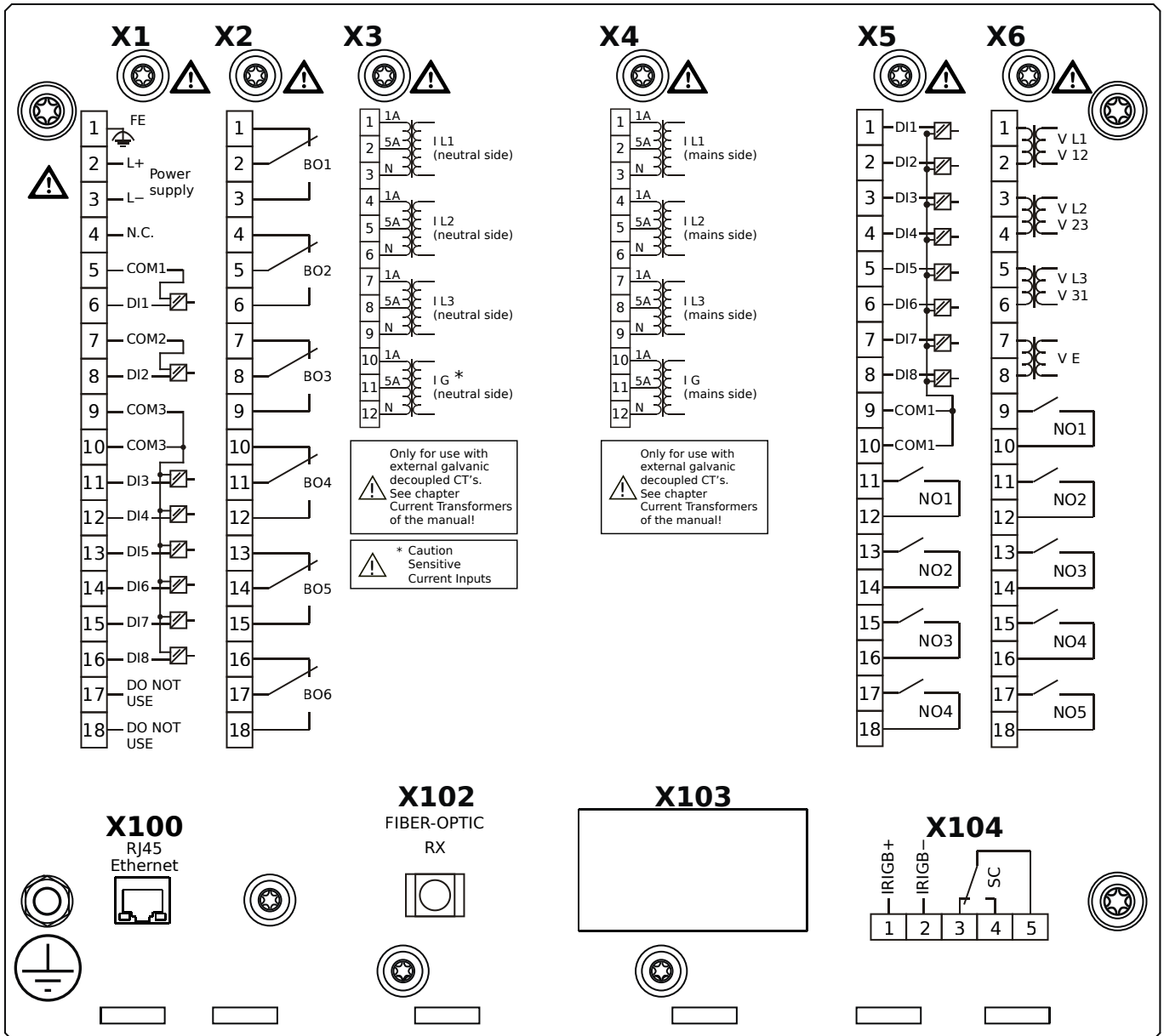

Housing B2, large display, door mounting

+ Conformal Coating (for installations in harsh environment)

- X1** – DI8-X1: Wide-range power supply unit, incl. 2 non-grouped digital inputs and 6 grouped digital inputs
- X2** – OR6: Assembly Group with 6 Output Relays (Changeover / Form C)
- X3** – TIs: Standard phase current measuring card and sensitive ground current measuring (neutral side of the diff. prot.)
- X4** – TI: Standard current measuring card (for the mains side of the differential protection)
- X5** – DI8-OR4: Assembly Group with 8 Digital Inputs and 4 Output Relays (NO / Form A)
- X6** – TU-OR5: Voltage measuring (0 ... 300 VAC) assembly group with 5 additional Output Relays (NO / Form A)
- X100** – IEC 61850 / Modbus TCP / DNP3.0 TCP/UDP, Ethernet interface, 100 Mbit/s, RJ45 (BASE100-FX)
- X102** – Universal Resistance-Temperature Detector (URTD) input, Fiber optics interface, Versatile Link
- X104** – IRIG-B00X, incl. System Contact (Supervision Contact)

MCDGV4-2D1AIA

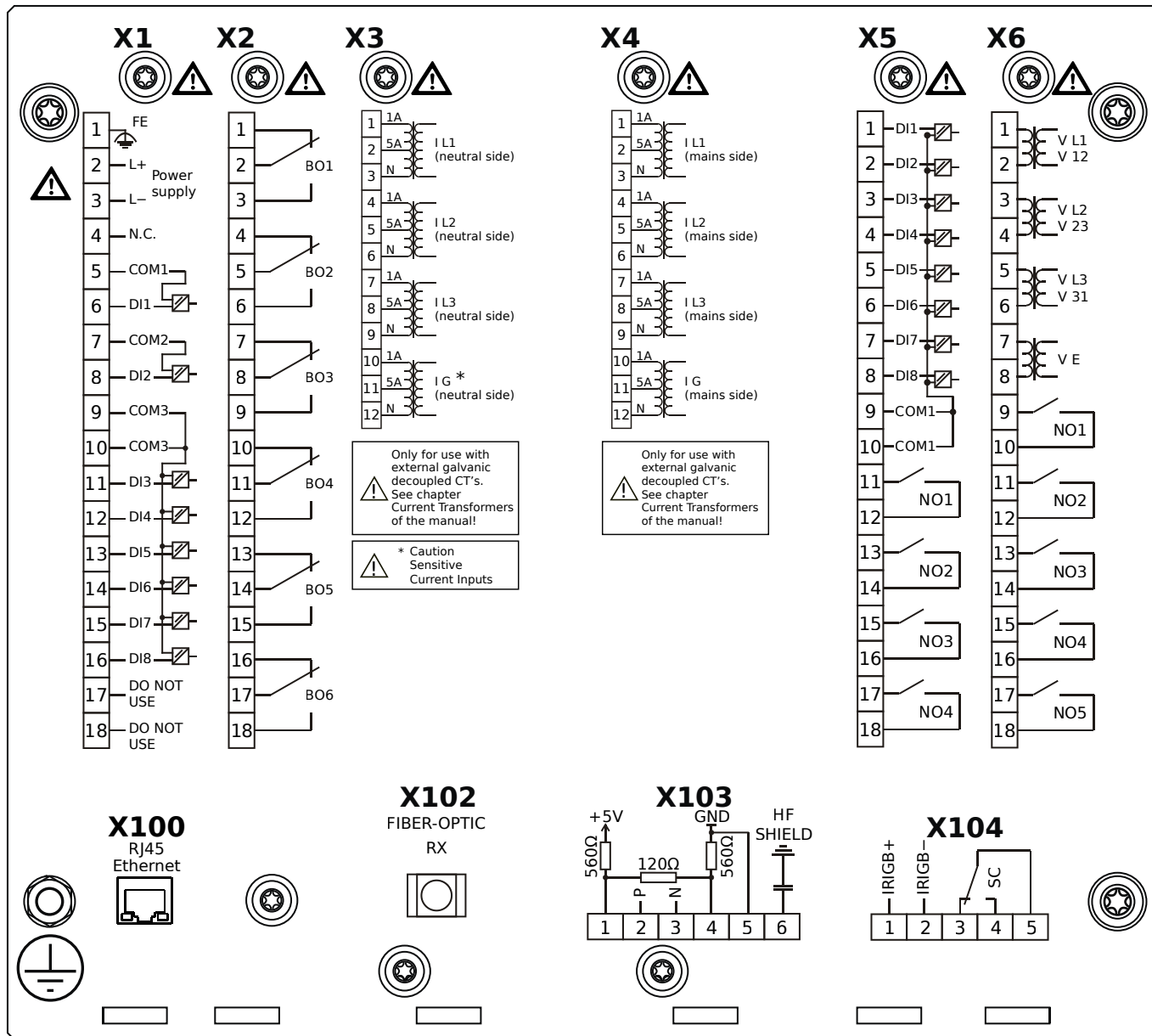

Housing B2, large display, door mounting

- X1** – DI8-X1: Wide-range power supply unit, incl. 2 non-grouped digital inputs and 6 grouped digital inputs
- X2** – OR6: Assembly Group with 6 Output Relays (Changeover / Form C)
- X3** – TIs: Standard phase current measuring card and sensitive ground current measuring (neutral side of the diff. prot.)
- X4** – TI: Standard current measuring card (for the mains side of the differential protection)
- X5** – DI8-OR4: Assembly Group with 8 Digital Inputs and 4 Output Relays (NO / Form A)
- X6** – TU-OR5: Voltage measuring (0 ... 300 VAC) assembly group with 5 additional Output Relays (NO / Form A)
- X100** – Modbus TCP / DNP3.0 TCP/UDP, Ethernet interface, 100 Mbit/s, RJ45 (BASE100-FX)
- X102** – Universal Resistance-Temperature Detector (URTD) input, Fiber optics interface, Versatile Link
- X103** – IEC 60870-5-103 / Modbus RTU / DNP3.0 RTU, RS485, Terminals
- X104** – IRIG-B00X, incl. System Contact (Supervision Contact)

MCDGV4-2D1AIB

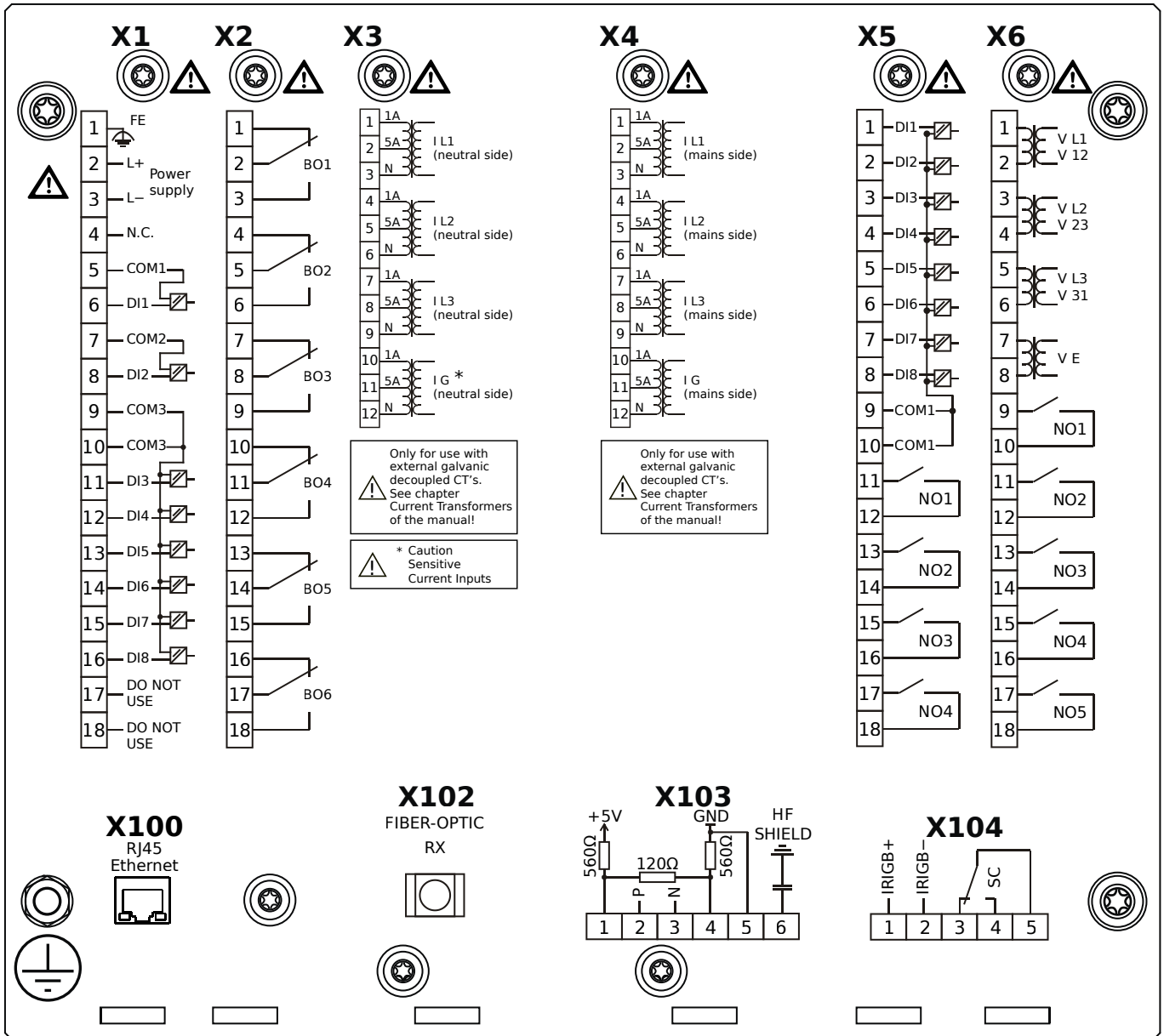

Housing B2, large display, door mounting

+ Conformal Coating (for installations in harsh environment)

- X1** – DI8-X1: Wide-range power supply unit, incl. 2 non-grouped digital inputs and 6 grouped digital inputs
- X2** – OR6: Assembly Group with 6 Output Relays (Changeover / Form C)
- X3** – TIs: Standard phase current measuring card and sensitive ground current measuring (neutral side of the diff. prot.)
- X4** – TI: Standard current measuring card (for the mains side of the differential protection)
- X5** – DI8-OR4: Assembly Group with 8 Digital Inputs and 4 Output Relays (NO / Form A)
- X6** – TU-OR5: Voltage measuring (0 ... 300 VAC) assembly group with 5 additional Output Relays (NO / Form A)
- X100** – Modbus TCP / DNP3.0 TCP/UDP, Ethernet interface, 100 Mbit/s, RJ45 (BASE100-FX)
- X102** – Universal Resistance-Temperature Detector (URTD) input, Fiber optics interface, Versatile Link
- X103** – IEC 60870-5-103 / Modbus RTU / DNP3.0 RTU, RS485, Terminals
- X104** – IRIG-B00X, incl. System Contact (Supervision Contact)

MCDGV4-2D1AKA

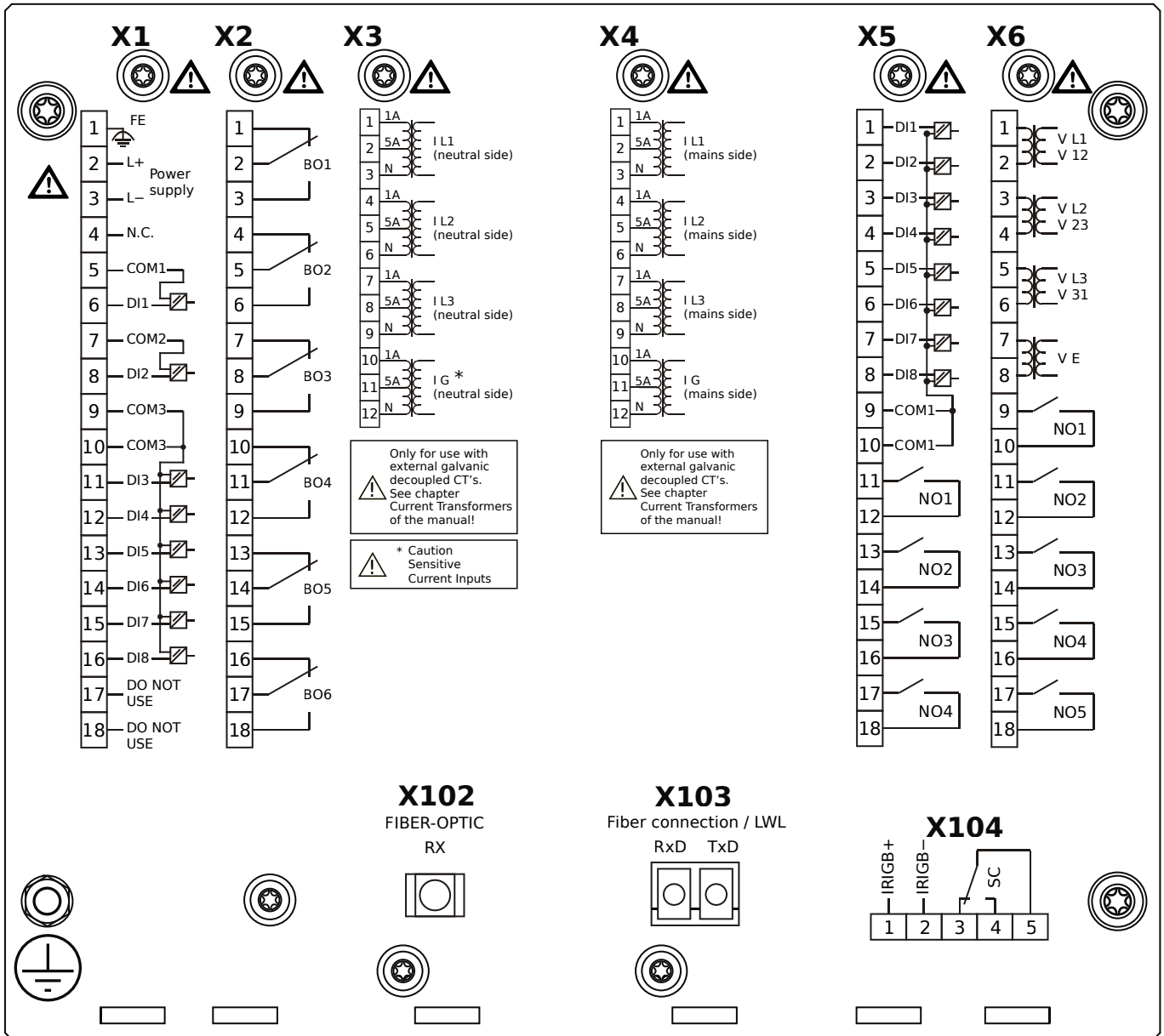

Housing B2, large display, door mounting

- X1** – DI8-X1: Wide-range power supply unit, incl. 2 non-grouped digital inputs and 6 grouped digital inputs
- X2** – OR6: Assembly Group with 6 Output Relays (Changeover / Form C)
- X3** – TIs: Standard phase current measuring card and sensitive ground current measuring (neutral side of the diff. prot.)
- X4** – TI: Standard current measuring card (for the mains side of the differential protection)
- X5** – DI8-OR4: Assembly Group with 8 Digital Inputs and 4 Output Relays (NO / Form A)
- X6** – TU-OR5: Voltage measuring (0 ... 300 VAC) assembly group with 5 additional Output Relays (NO / Form A)
- X102** – Universal Resistance-Temperature Detector (URTD) input, Fiber optics interface, Versatile Link
- X103** – IEC 61850 / Modbus TCP / DNP3.0 TCP/UDP, Fiber optics interface, LC Connector
- X104** – IRIG-B00X, incl. System Contact (Supervision Contact)

MCDGV4-2D1AKB

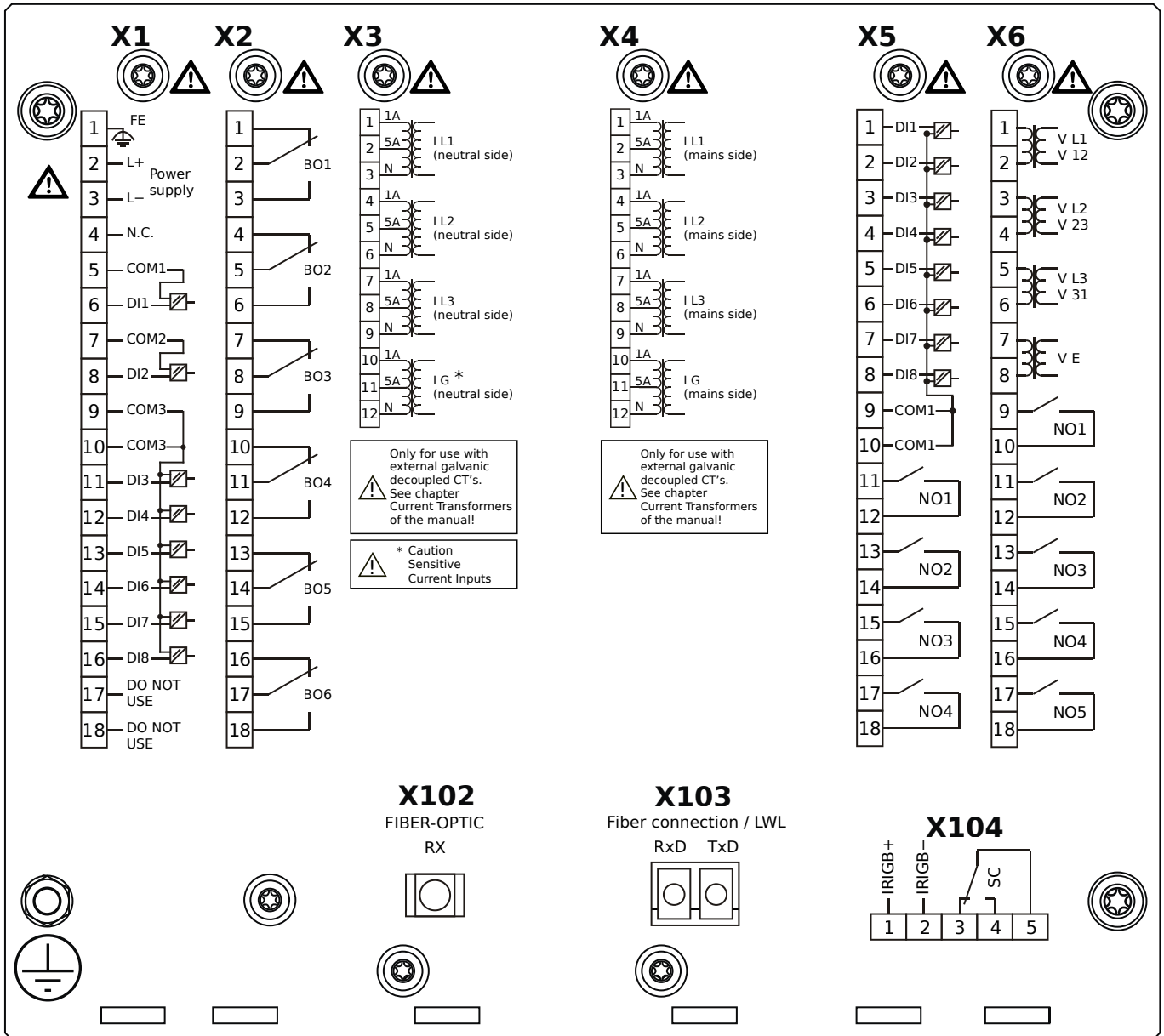

Housing B2, large display, door mounting

+ Conformal Coating (for installations in harsh environment)

- X1** – DI8-X1: Wide-range power supply unit, incl. 2 non-grouped digital inputs and 6 grouped digital inputs
- X2** – OR6: Assembly Group with 6 Output Relays (Changeover / Form C)
- X3** – TIs: Standard phase current measuring card and sensitive ground current measuring (neutral side of the diff. prot.)
- X4** – TI: Standard current measuring card (for the mains side of the differential protection)
- X5** – DI8-OR4: Assembly Group with 8 Digital Inputs and 4 Output Relays (NO / Form A)
- X6** – TU-OR5: Voltage measuring (0 ... 300 VAC) assembly group with 5 additional Output Relays (NO / Form A)
- X102** – Universal Resistance-Temperature Detector (URTD) input, Fiber optics interface, Versatile Link
- X103** – IEC 61850 / Modbus TCP / DNP3.0 TCP/UDP, Fiber optics interface, LC Connector
- X104** – IRIG-B00X, incl. System Contact (Supervision Contact)

MCDGV4-2D1ALA

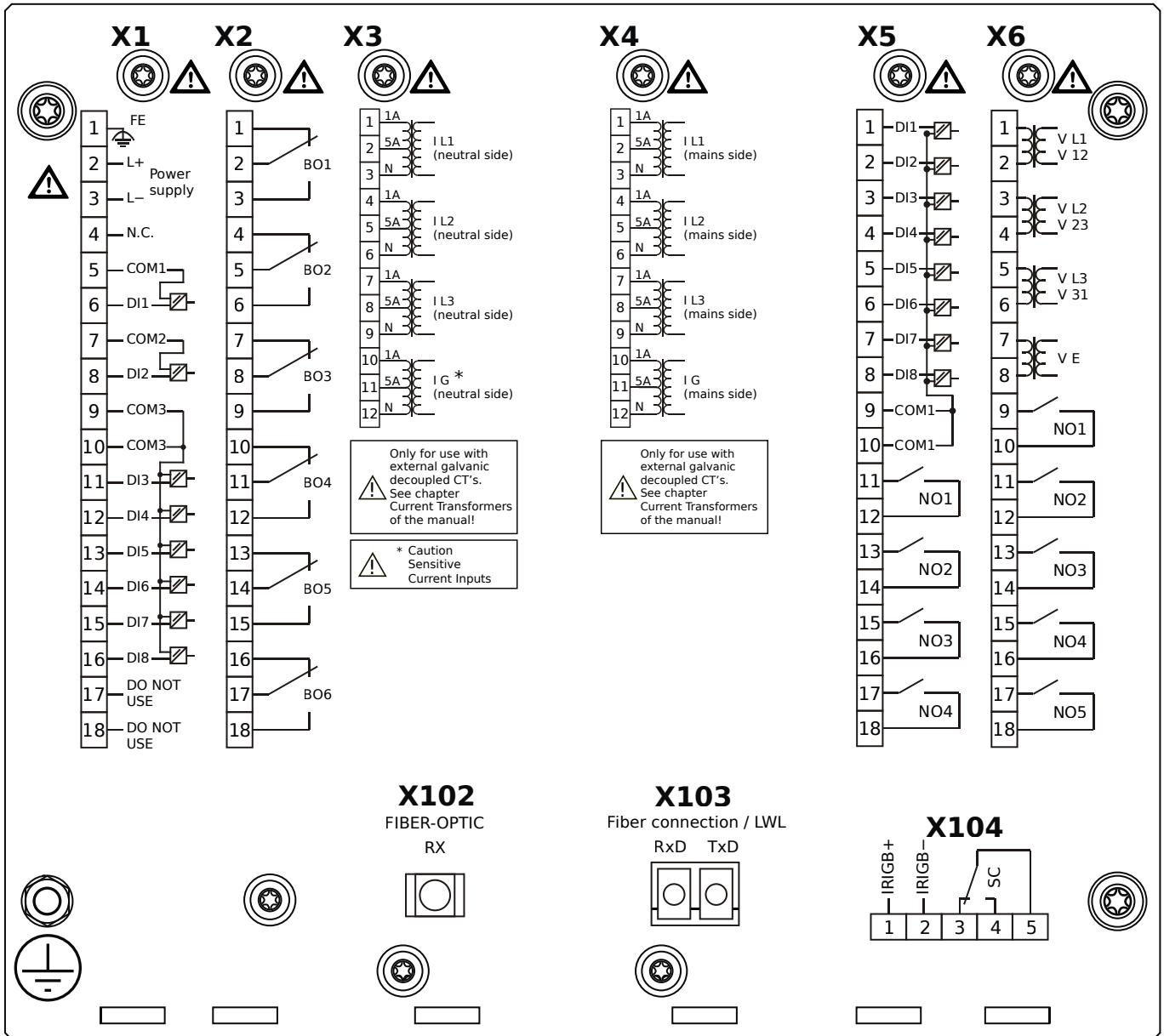

Housing B2, large display, door mounting

- X1** – DI8-X1: Wide-range power supply unit, incl. 2 non-grouped digital inputs and 6 grouped digital inputs
- X2** – OR6: Assembly Group with 6 Output Relays (Changeover / Form C)
- X3** – TIs: Standard phase current measuring card and sensitive ground current measuring (neutral side of the diff. prot.)
- X4** – TI: Standard current measuring card (for the mains side of the differential protection)
- X5** – DI8-OR4: Assembly Group with 8 Digital Inputs and 4 Output Relays (NO / Form A)
- X6** – TU-OR5: Voltage measuring (0 ... 300 VAC) assembly group with 5 additional Output Relays (NO / Form A)
- X102** – Universal Resistance-Temperature Detector (URTD) input, Fiber optics interface, Versatile Link
- X103** – Modbus TCP / DNP3.0 TCP/UDP, Fiber optics interface, LC Connector
- X104** – IRIG-B00X, incl. System Contact (Supervision Contact)

MCDGV4-2D1ALB

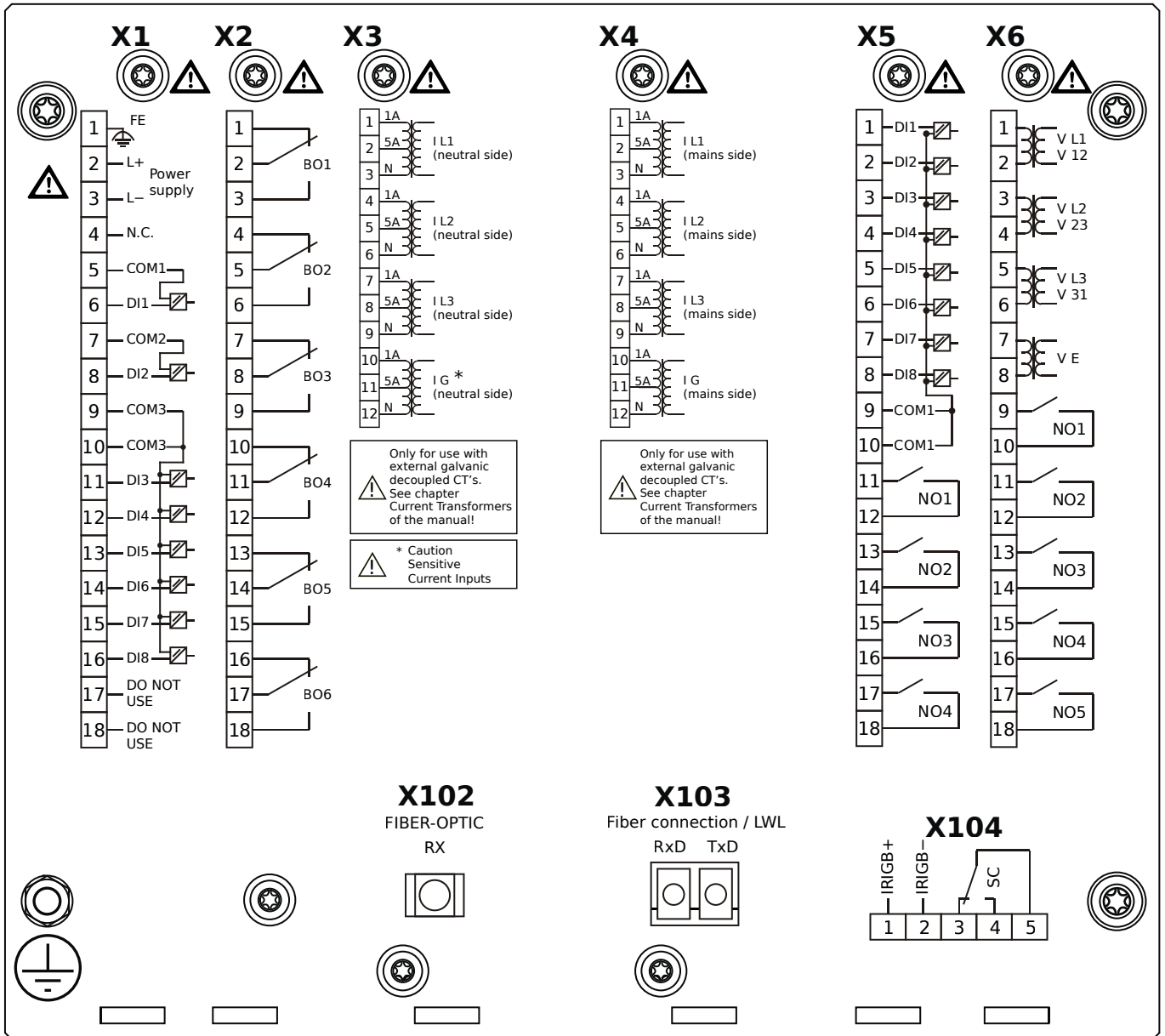

Housing B2, large display, door mounting

+ Conformal Coating (for installations in harsh environment)

- X1** – DI8-X1: Wide-range power supply unit, incl. 2 non-grouped digital inputs and 6 grouped digital inputs
- X2** – OR6: Assembly Group with 6 Output Relays (Changeover / Form C)
- X3** – TIs: Standard phase current measuring card and sensitive ground current measuring (neutral side of the diff. prot.)
- X4** – TI: Standard current measuring card (for the mains side of the differential protection)
- X5** – DI8-OR4: Assembly Group with 8 Digital Inputs and 4 Output Relays (NO / Form A)
- X6** – TU-OR5: Voltage measuring (0 ... 300 VAC) assembly group with 5 additional Output Relays (NO / Form A)
- X102** – Universal Resistance-Temperature Detector (URTD) input, Fiber optics interface, Versatile Link
- X103** – Modbus TCP / DNP3.0 TCP/UDP, Fiber optics interface, LC Connector
- X104** – IRIG-B00X, incl. System Contact (Supervision Contact)

MCDGV4-2D1ATA

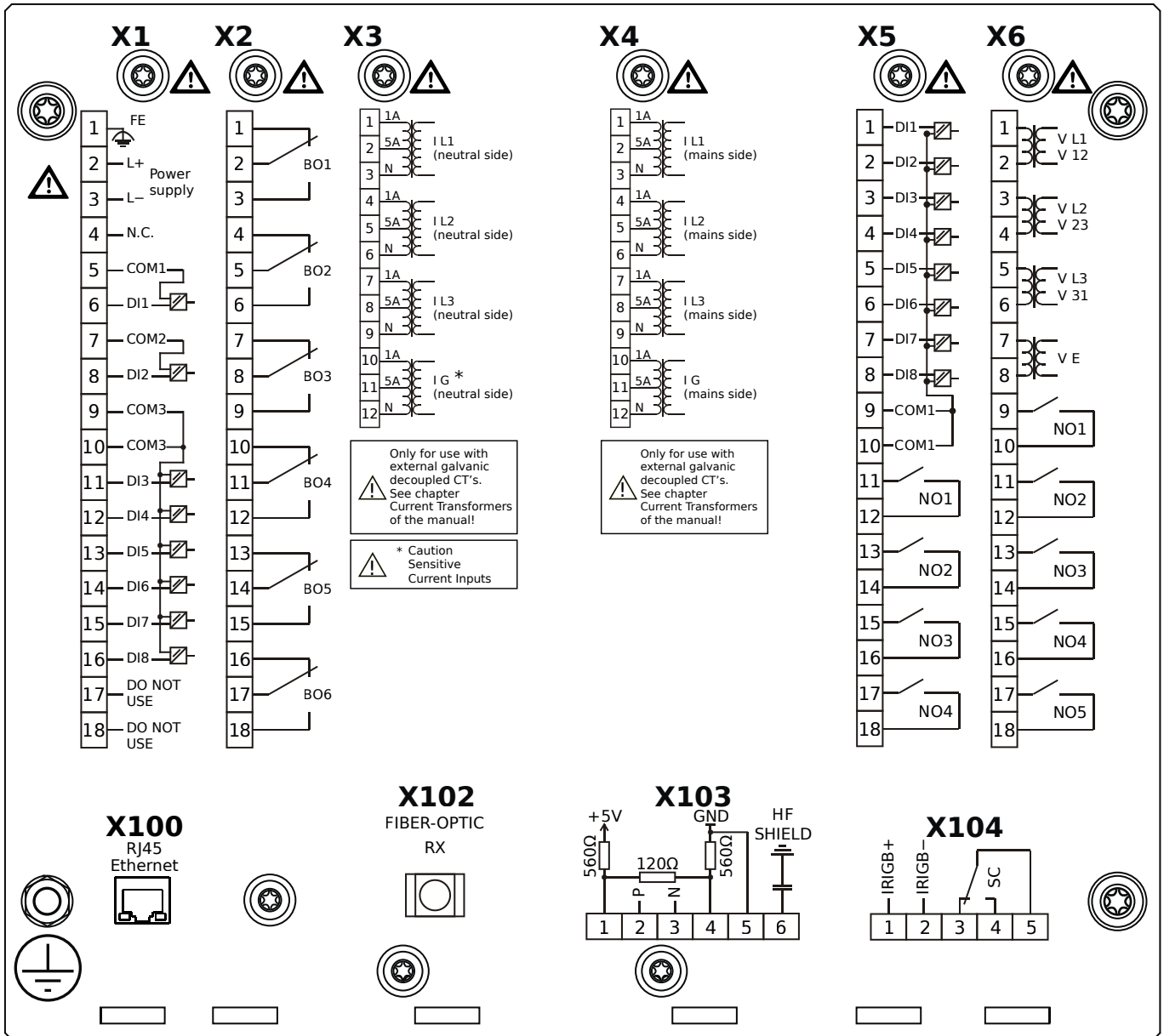

Housing B2, large display, door mounting

- X1** – DI8-X1: Wide-range power supply unit, incl. 2 non-grouped digital inputs and 6 grouped digital inputs
- X2** – OR6: Assembly Group with 6 Output Relays (Changeover / Form C)
- X3** – TIs: Standard phase current measuring card and sensitive ground current measuring (neutral side of the diff. prot.)
- X4** – TI: Standard current measuring card (for the mains side of the differential protection)
- X5** – DI8-OR4: Assembly Group with 8 Digital Inputs and 4 Output Relays (NO / Form A)
- X6** – TU-OR5: Voltage measuring (0 ... 300 VAC) assembly group with 5 additional Output Relays (NO / Form A)
- X100** – IEC 61850 / Modbus TCP / DNP3.0 TCP/UDP, Ethernet interface, 100 Mbit/s, RJ45 (BASE100-FX)
- X102** – Universal Resistance-Temperature Detector (URTD) input, Fiber optics interface, Versatile Link
- X103** – IEC 60870-5-103 / Modbus RTU / DNP3.0 RTU, RS485, Terminals
- X104** – IRIG-B00X, incl. System Contact (Supervision Contact)

MCDGV4-2D1ATB

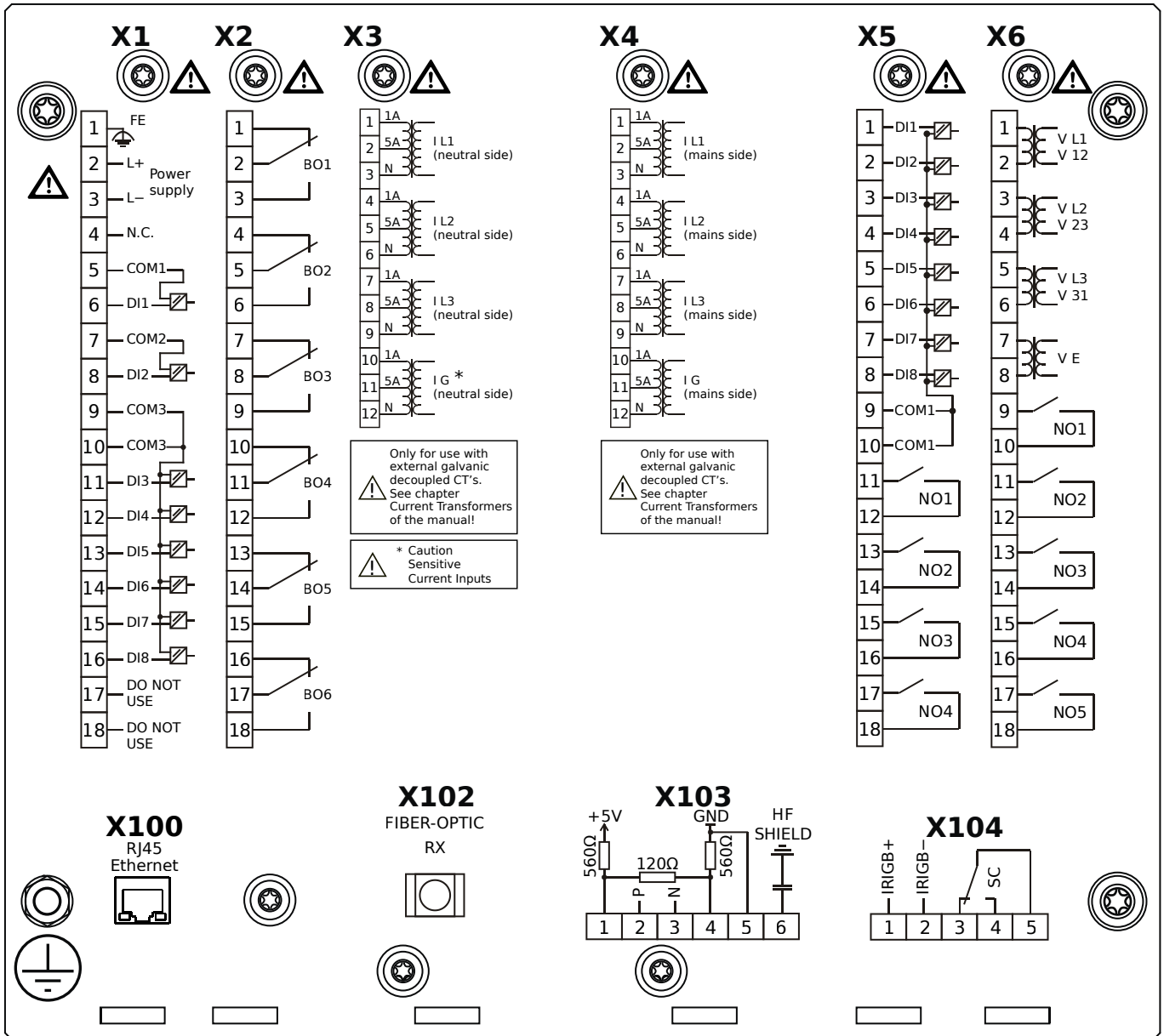

Housing B2, large display, door mounting

+ Conformal Coating (for installations in harsh environment)

- X1** – DI8-X1: Wide-range power supply unit, incl. 2 non-grouped digital inputs and 6 grouped digital inputs
- X2** – OR6: Assembly Group with 6 Output Relays (Changeover / Form C)
- X3** – TIs: Standard phase current measuring card and sensitive ground current measuring (neutral side of the diff. prot.)
- X4** – TI: Standard current measuring card (for the mains side of the differential protection)
- X5** – DI8-OR4: Assembly Group with 8 Digital Inputs and 4 Output Relays (NO / Form A)
- X6** – TU-OR5: Voltage measuring (0 ... 300 VAC) assembly group with 5 additional Output Relays (NO / Form A)
- X100** – IEC 61850 / Modbus TCP / DNP3.0 TCP/UDP, Ethernet interface, 100 Mbit/s, RJ45 (BASE100-FX)
- X102** – Universal Resistance-Temperature Detector (URTD) input, Fiber optics interface, Versatile Link
- X103** – IEC 60870-5-103 / Modbus RTU / DNP3.0 RTU, RS485, Terminals
- X104** – IRIG-B00X, incl. System Contact (Supervision Contact)

MCDGV4-2D1BAA

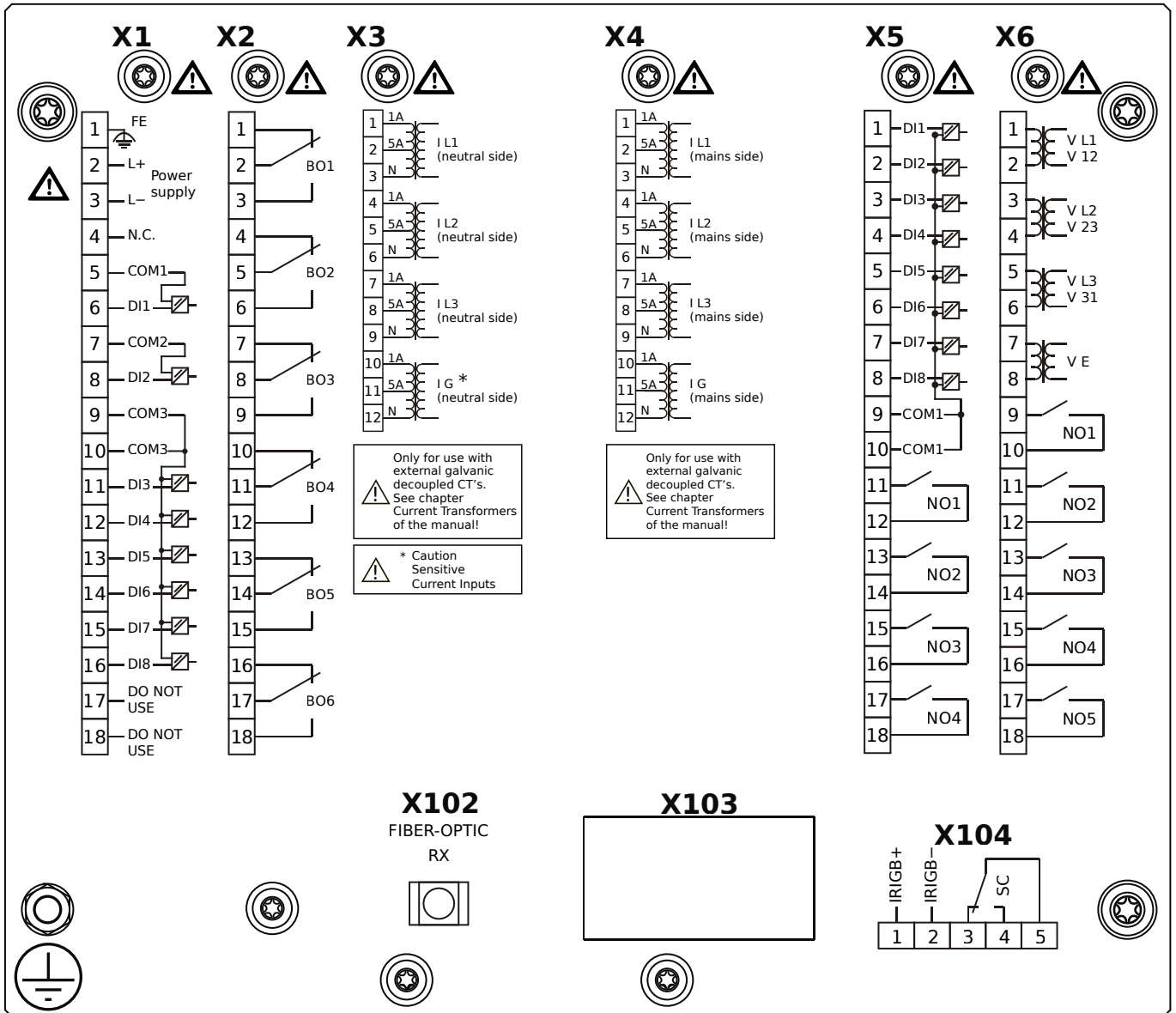

Housing B2, large display, 19" rack mounting

- X1** – DI8-X1: Wide-range power supply unit, incl. 2 non-grouped digital inputs and 6 grouped digital inputs
- X2** – OR6: Assembly Group with 6 Output Relays (Changeover / Form C)
- X3** – TIs: Standard phase current measuring card and sensitive ground current measuring (neutral side of the diff. prot.)
- X4** – TI: Standard current measuring card (for the mains side of the differential protection)
- X5** – DI8-OR4: Assembly Group with 8 Digital Inputs and 4 Output Relays (NO / Form A)
- X6** – TU-OR5: Voltage measuring (0 ... 300 VAC) assembly group with 5 additional Output Relays (NO / Form A)
- X102** – Universal Resistance-Temperature Detector (URTD) input, Fiber optics interface, Versatile Link
- X104** – IRIG-B00X, incl. System Contact (Supervision Contact)

MCDGV4-2D1BAB

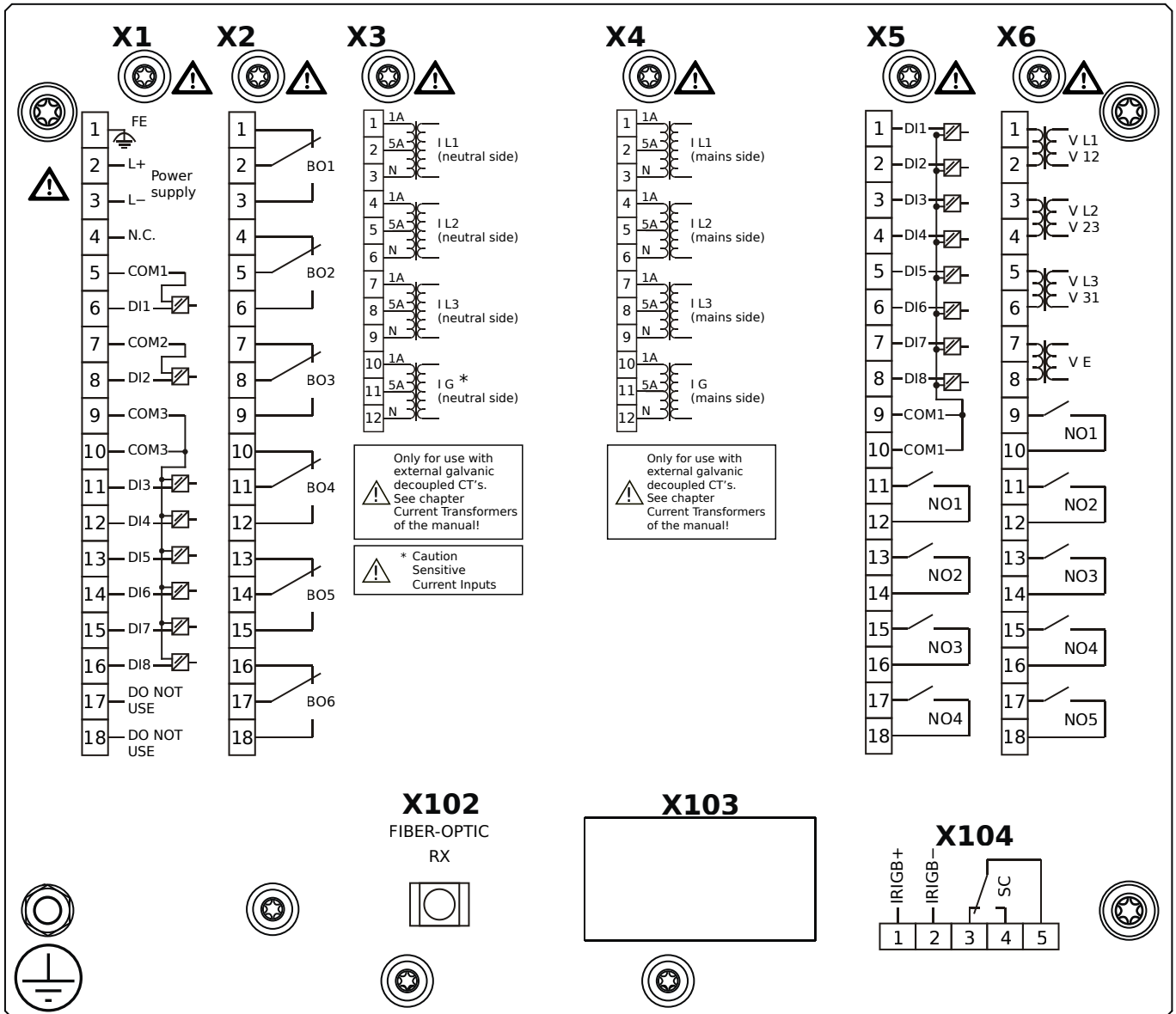

Housing B2, large display, 19" rack mounting

+ Conformal Coating (for installations in harsh environment)

- X1** – DI8-X1: Wide-range power supply unit, incl. 2 non-grouped digital inputs and 6 grouped digital inputs
- X2** – OR6: Assembly Group with 6 Output Relays (Changeover / Form C)
- X3** – TIs: Standard phase current measuring card and sensitive ground current measuring (neutral side of the diff. prot.)
- X4** – TI: Standard current measuring card (for the mains side of the differential protection)
- X5** – DI8-OR4: Assembly Group with 8 Digital Inputs and 4 Output Relays (NO / Form A)
- X6** – TU-OR5: Voltage measuring (0 ... 300 VAC) assembly group with 5 additional Output Relays (NO / Form A)
- X102** – Universal Resistance-Temperature Detector (URTD) input, Fiber optics interface, Versatile Link
- X104** – IRIG-B00X, incl. System Contact (Supervision Contact)

MCDGV4-2D1BBA

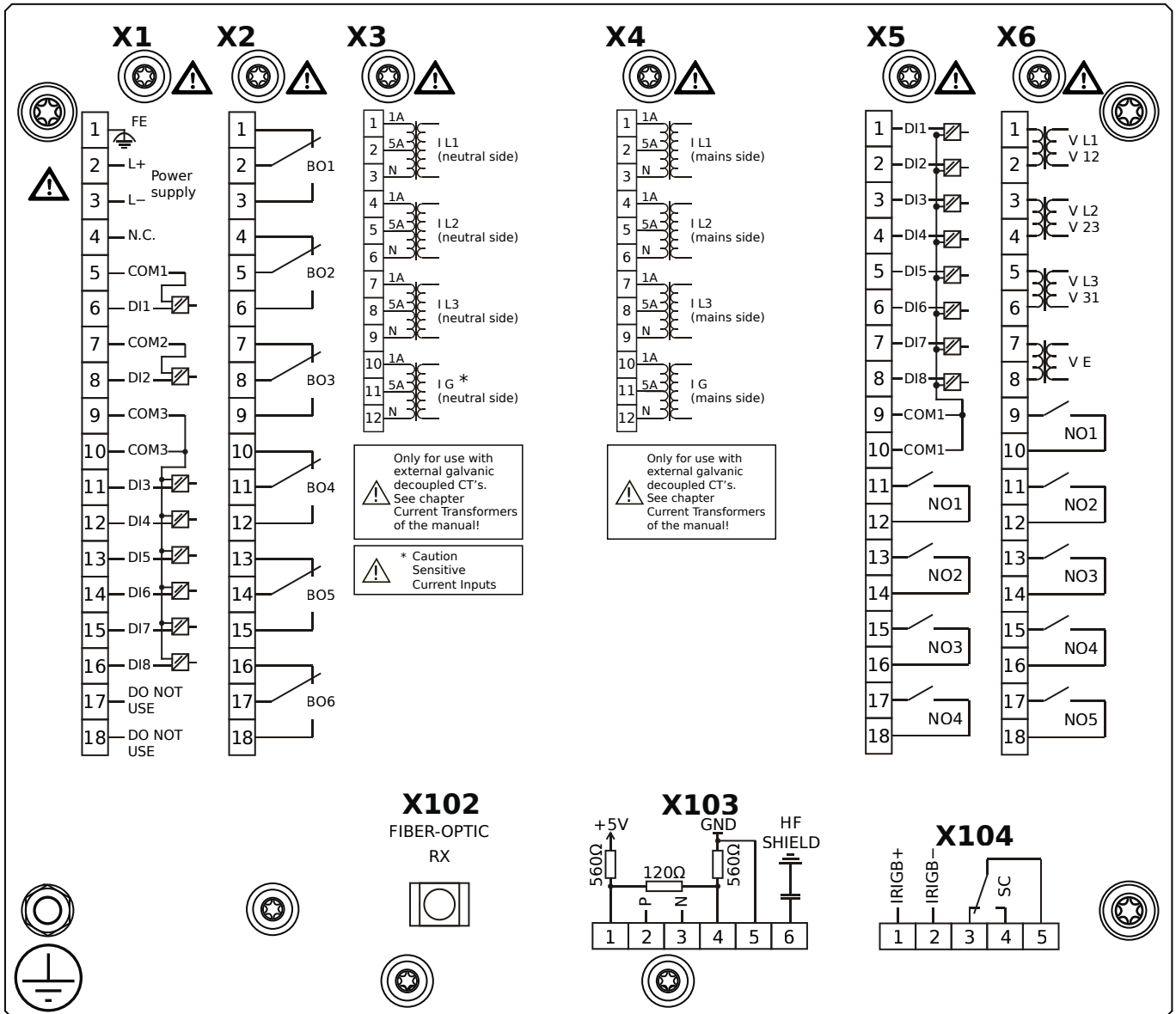

Housing B2, large display, 19" rack mounting

- X1** – DI8-X1: Wide-range power supply unit, incl. 2 non-grouped digital inputs and 6 grouped digital inputs
- X2** – OR6: Assembly Group with 6 Output Relays (Changeover / Form C)
- X3** – TIs: Standard phase current measuring card and sensitive ground current measuring (neutral side of the diff. prot.)
- X4** – TI: Standard current measuring card (for the mains side of the differential protection)
- X5** – DI8-OR4: Assembly Group with 8 Digital Inputs and 4 Output Relays (NO / Form A)
- X6** – TU-OR5: Voltage measuring (0 ... 300 VAC) assembly group with 5 additional Output Relays (NO / Form A)
- X102** – Universal Resistance-Temperature Detector (URTD) input, Fiber optics interface, Versatile Link
- X103** – Modbus RTU / IEC 60870-5-103 / DNP3.0 RTU, RS485, Terminals
- X104** – IRIG-B00X, incl. System Contact (Supervision Contact)

MCDGV4-2D1BBB

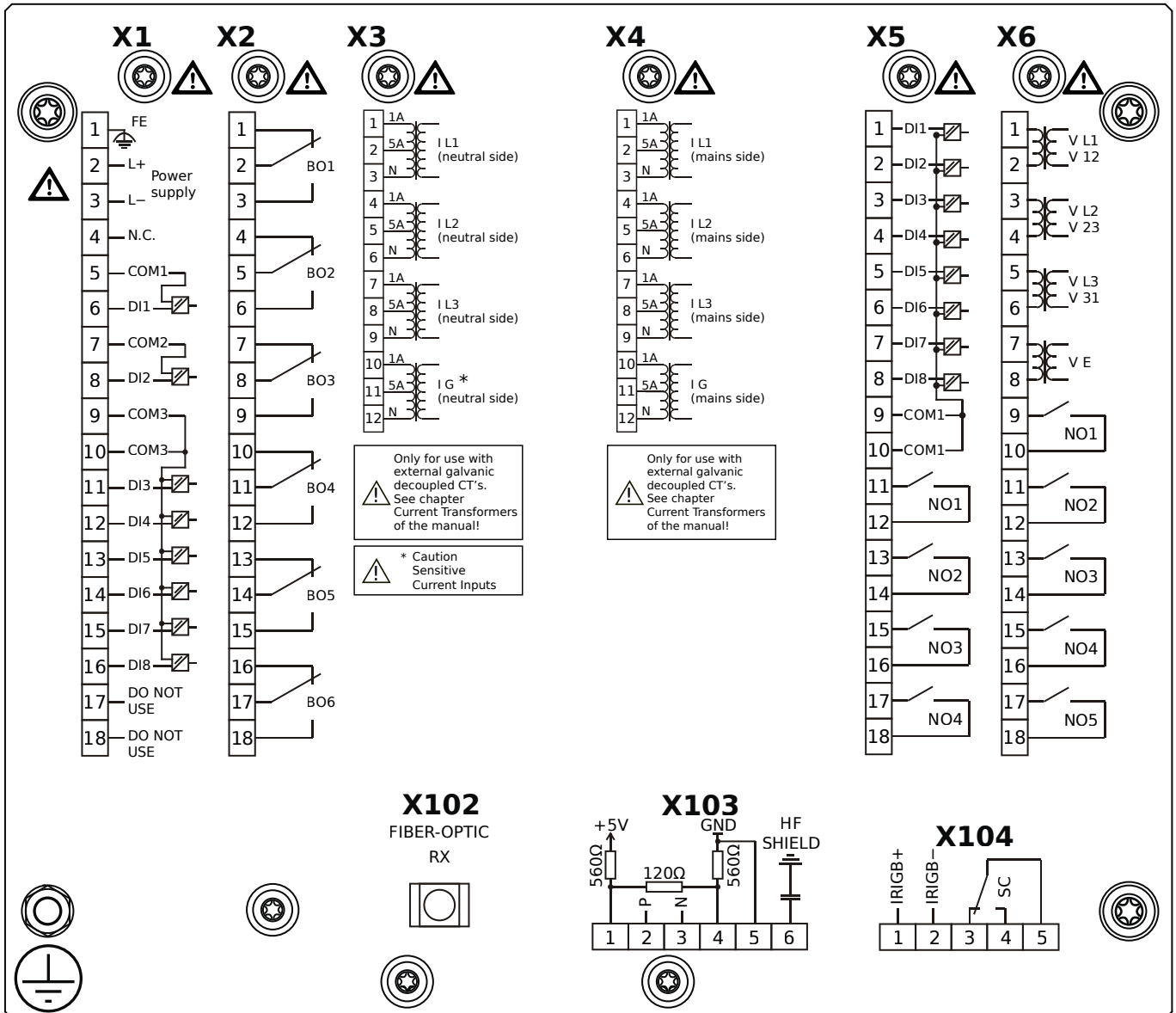

Housing B2, large display, 19" rack mounting

+ Conformal Coating (for installations in harsh environment)

- X1** – DI8-X1: Wide-range power supply unit, incl. 2 non-grouped digital inputs and 6 grouped digital inputs
- X2** – OR6: Assembly Group with 6 Output Relays (Changeover / Form C)
- X3** – TIs: Standard phase current measuring card and sensitive ground current measuring (neutral side of the diff. prot.)
- X4** – TI: Standard current measuring card (for the mains side of the differential protection)
- X5** – DI8-OR4: Assembly Group with 8 Digital Inputs and 4 Output Relays (NO / Form A)
- X6** – TU-OR5: Voltage measuring (0 ... 300 VAC) assembly group with 5 additional Output Relays (NO / Form A)
- X102** – Universal Resistance-Temperature Detector (URTD) input, Fiber optics interface, Versatile Link
- X103** – Modbus RTU / IEC 60870-5-103 / DNP3.0 RTU, RS485, Terminals
- X104** – IRIG-B00X, incl. System Contact (Supervision Contact)

MCDGV4-2D1BCA

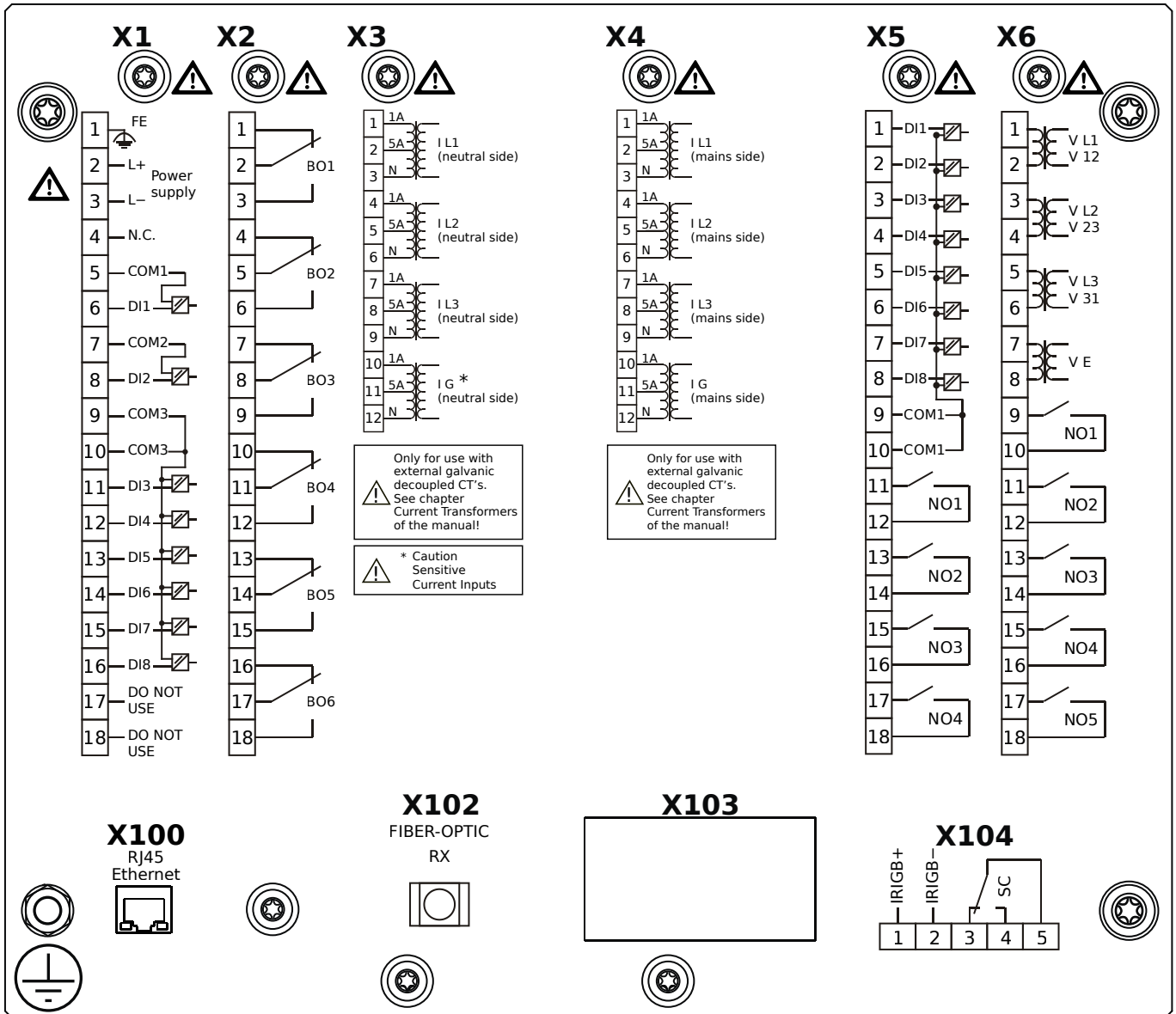

Housing B2, large display, 19" rack mounting

- X1** – DI8-X1: Wide-range power supply unit, incl. 2 non-grouped digital inputs and 6 grouped digital inputs
- X2** – OR6: Assembly Group with 6 Output Relays (Changeover / Form C)
- X3** – TIs: Standard phase current measuring card and sensitive ground current measuring (neutral side of the diff. prot.)
- X4** – TI: Standard current measuring card (for the mains side of the differential protection)
- X5** – DI8-OR4: Assembly Group with 8 Digital Inputs and 4 Output Relays (NO / Form A)
- X6** – TU-OR5: Voltage measuring (0 ... 300 VAC) assembly group with 5 additional Output Relays (NO / Form A)
- X100** – Modbus TCP / DNP3.0 TCP/UDP, Ethernet interface, 100 Mbit/s, RJ45 (BASE100-FX)
- X102** – Universal Resistance-Temperature Detector (URTD) input, Fiber optics interface, Versatile Link
- X104** – IRIG-B00X, incl. System Contact (Supervision Contact)

MCDGV4-2D1BCB

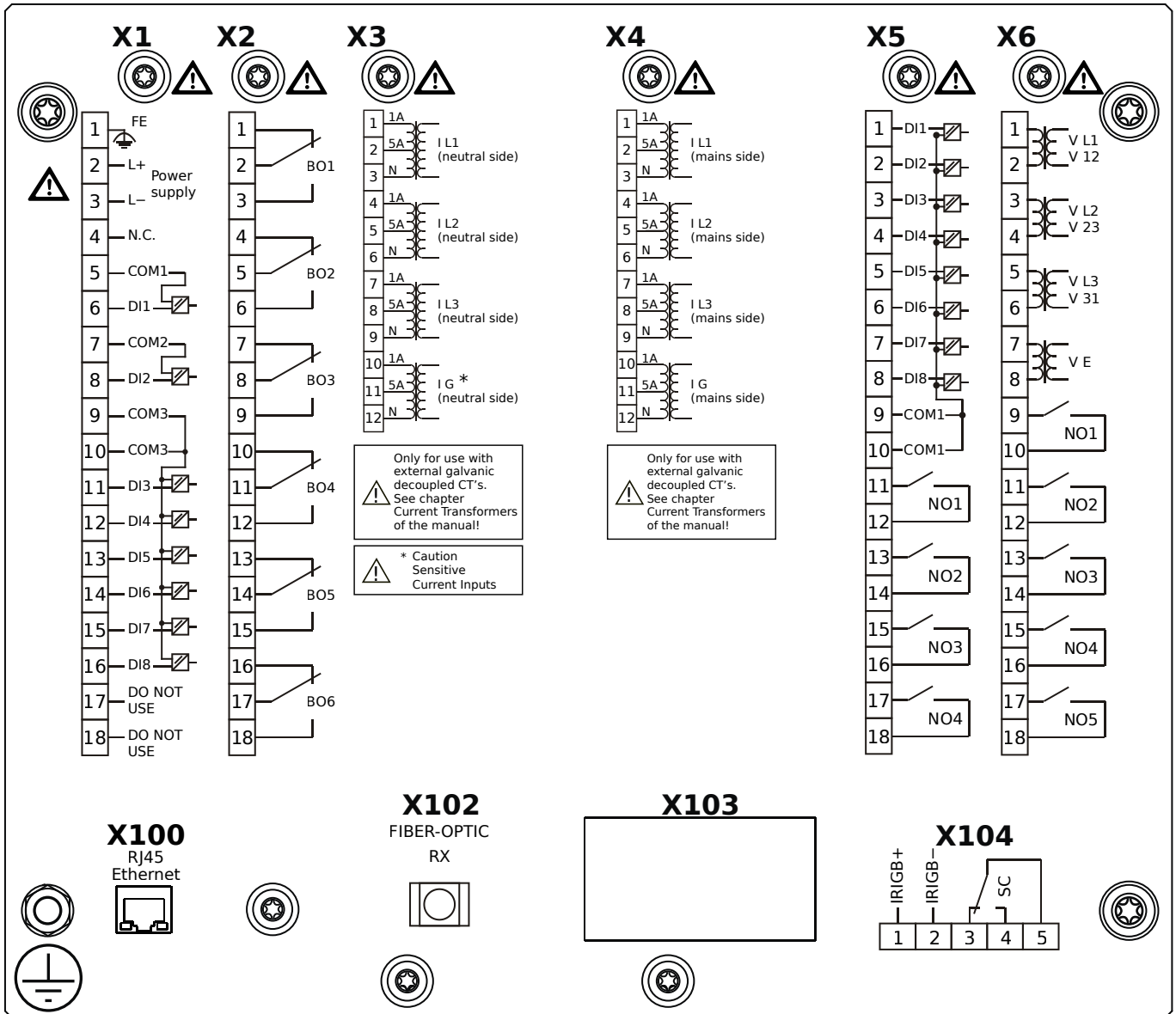

Housing B2, large display, 19" rack mounting

+ Conformal Coating (for installations in harsh environment)

- X1** – DI8-X1: Wide-range power supply unit, incl. 2 non-grouped digital inputs and 6 grouped digital inputs
- X2** – OR6: Assembly Group with 6 Output Relays (Changeover / Form C)
- X3** – TIs: Standard phase current measuring card and sensitive ground current measuring (neutral side of the diff. prot.)
- X4** – TI: Standard current measuring card (for the mains side of the differential protection)
- X5** – DI8-OR4: Assembly Group with 8 Digital Inputs and 4 Output Relays (NO / Form A)
- X6** – TU-OR5: Voltage measuring (0 ... 300 VAC) assembly group with 5 additional Output Relays (NO / Form A)
- X100** – Modbus TCP / DNP3.0 TCP/UDP, Ethernet interface, 100 Mbit/s, RJ45 (BASE100-FX)
- X102** – Universal Resistance-Temperature Detector (URTD) input, Fiber optics interface, Versatile Link
- X104** – IRIG-B00X, incl. System Contact (Supervision Contact)

MCDGV4-2D1BDA

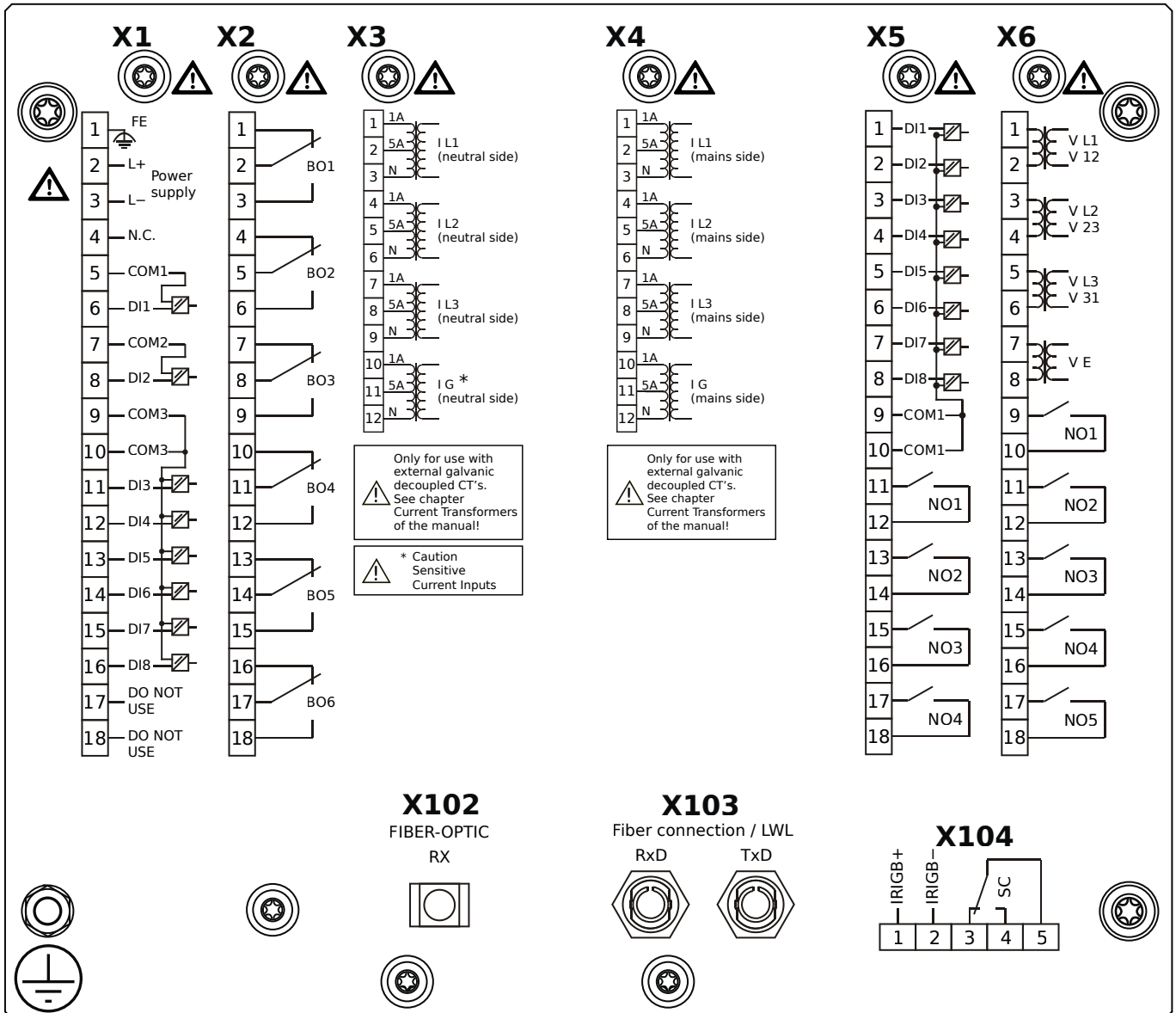

Housing B2, large display, 19" rack mounting

- X1** – DI8-X1: Wide-range power supply unit, incl. 2 non-grouped digital inputs and 6 grouped digital inputs
- X2** – OR6: Assembly Group with 6 Output Relays (Changeover / Form C)
- X3** – TIs: Standard phase current measuring card and sensitive ground current measuring (neutral side of the diff. prot.)
- X4** – TI: Standard current measuring card (for the mains side of the differential protection)
- X5** – DI8-OR4: Assembly Group with 8 Digital Inputs and 4 Output Relays (NO / Form A)
- X6** – TU-OR5: Voltage measuring (0 ... 300 VAC) assembly group with 5 additional Output Relays (NO / Form A)
- X102** – Universal Resistance-Temperature Detector (URTD) input, Fiber optics interface, Versatile Link
- X103** – Profibus-DP, Fiber optics interface, ST Connector
- X104** – IRIG-B00X, incl. System Contact (Supervision Contact)

MCDGV4-2D1BDB

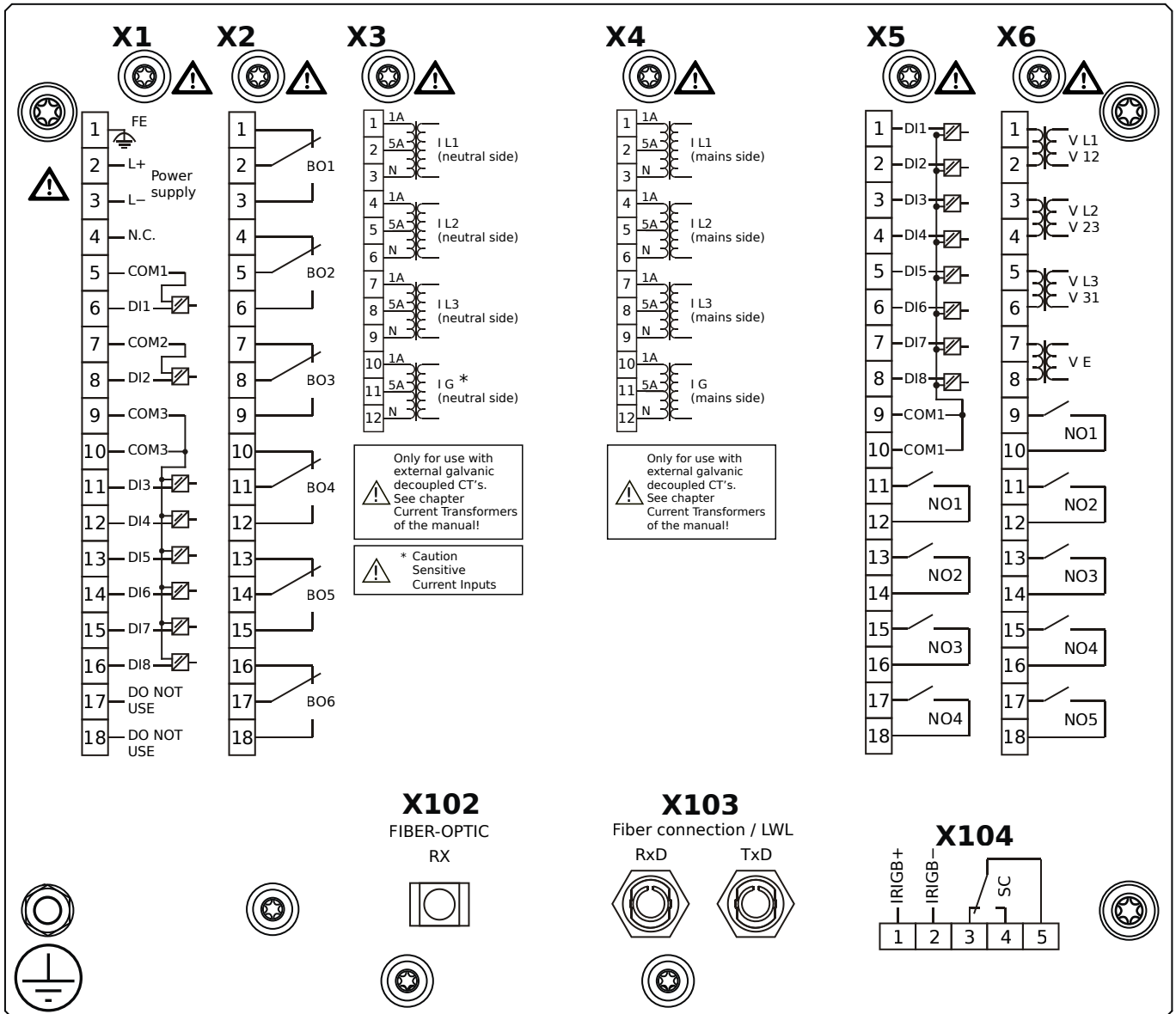

Housing B2, large display, 19" rack mounting

+ Conformal Coating (for installations in harsh environment)

- X1** – DI8-X1: Wide-range power supply unit, incl. 2 non-grouped digital inputs and 6 grouped digital inputs
- X2** – OR6: Assembly Group with 6 Output Relays (Changeover / Form C)
- X3** – TIs: Standard phase current measuring card and sensitive ground current measuring (neutral side of the diff. prot.)
- X4** – TI: Standard current measuring card (for the mains side of the differential protection)
- X5** – DI8-OR4: Assembly Group with 8 Digital Inputs and 4 Output Relays (NO / Form A)
- X6** – TU-OR5: Voltage measuring (0 ... 300 VAC) assembly group with 5 additional Output Relays (NO / Form A)
- X102** – Universal Resistance-Temperature Detector (URTD) input, Fiber optics interface, Versatile Link
- X103** – Profibus-DP, Fiber optics interface, ST Connector
- X104** – IRIG-B00X, incl. System Contact (Supervision Contact)

MCDGV4-2D1BEA

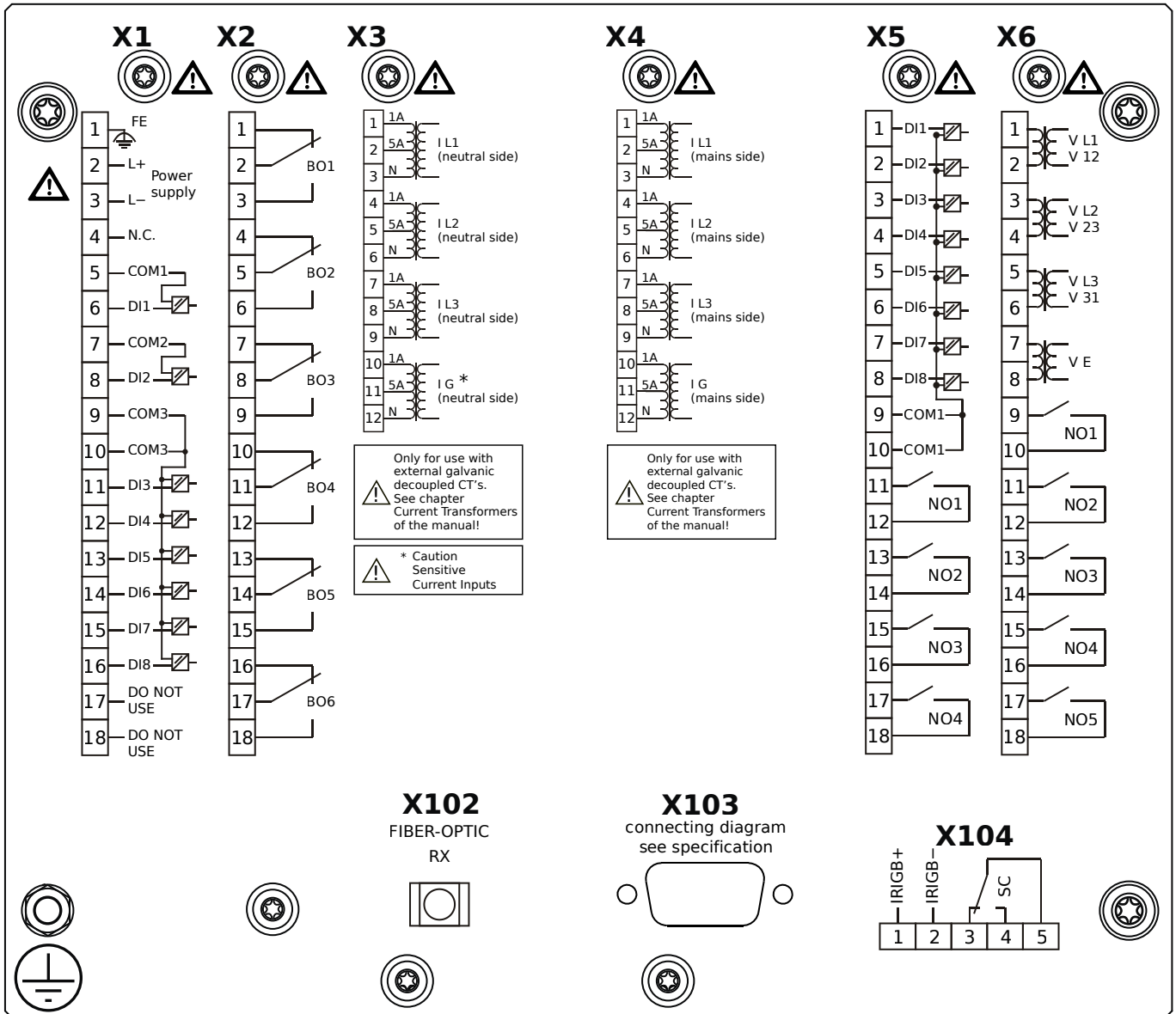

Housing B2, large display, 19" rack mounting

- X1** – DI8-X1: Wide-range power supply unit, incl. 2 non-grouped digital inputs and 6 grouped digital inputs
- X2** – OR6: Assembly Group with 6 Output Relays (Changeover / Form C)
- X3** – TIs: Standard phase current measuring card and sensitive ground current measuring (neutral side of the diff. prot.)
- X4** – TI: Standard current measuring card (for the mains side of the differential protection)
- X5** – DI8-OR4: Assembly Group with 8 Digital Inputs and 4 Output Relays (NO / Form A)
- X6** – TU-OR5: Voltage measuring (0 ... 300 VAC) assembly group with 5 additional Output Relays (NO / Form A)
- X102** – Universal Resistance-Temperature Detector (URTD) input, Fiber optics interface, Versatile Link
- X103** – Profibus-DP, RS485, D-SUB
- X104** – IRIG-B00X, incl. System Contact (Supervision Contact)

MCDGV4-2D1BEB

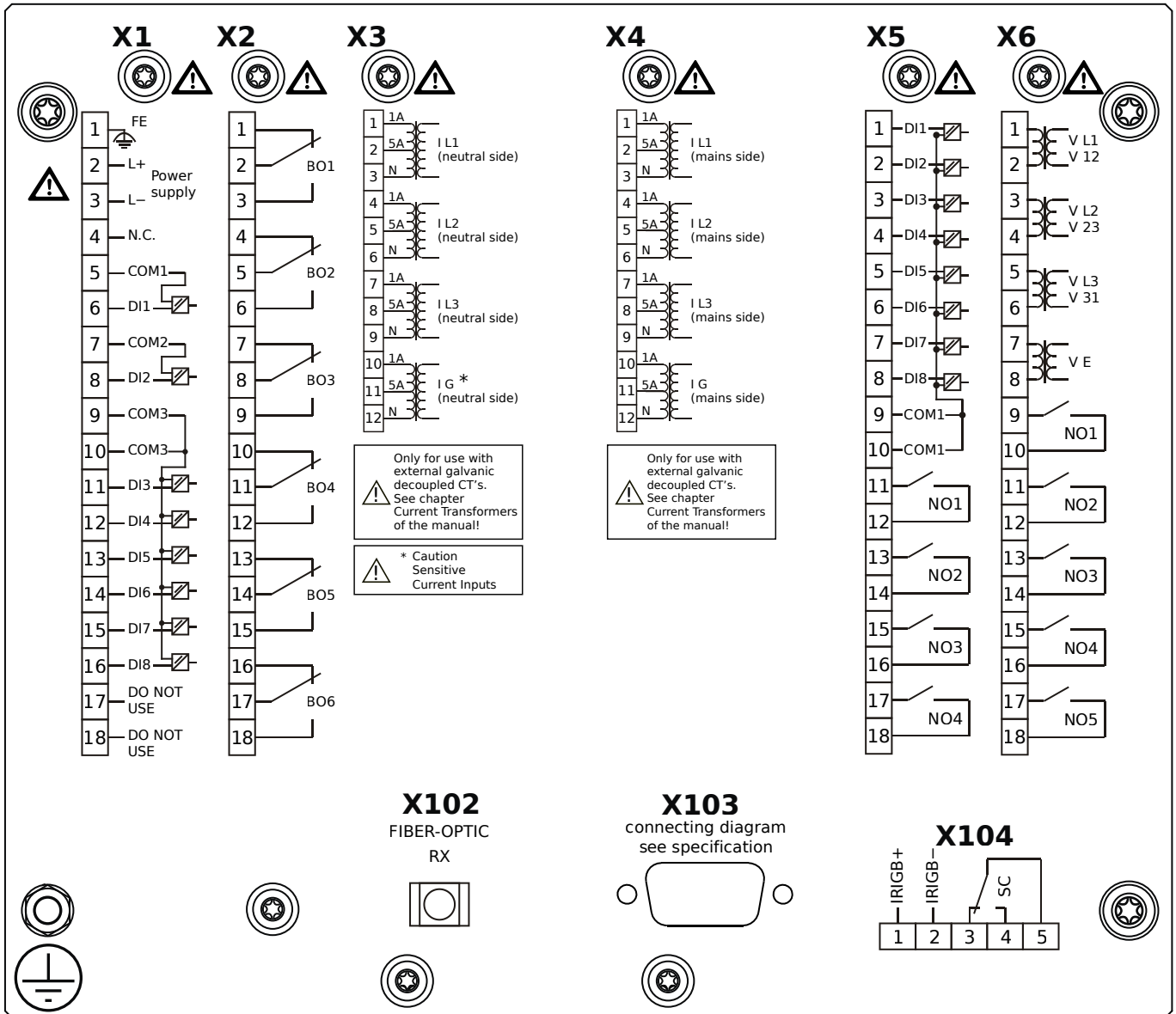

Housing B2, large display, 19" rack mounting

+ Conformal Coating (for installations in harsh environment)

- X1** – DI8-X1: Wide-range power supply unit, incl. 2 non-grouped digital inputs and 6 grouped digital inputs
- X2** – OR6: Assembly Group with 6 Output Relays (Changeover / Form C)
- X3** – TIs: Standard phase current measuring card and sensitive ground current measuring (neutral side of the diff. prot.)
- X4** – TI: Standard current measuring card (for the mains side of the differential protection)
- X5** – DI8-OR4: Assembly Group with 8 Digital Inputs and 4 Output Relays (NO / Form A)
- X6** – TU-OR5: Voltage measuring (0 ... 300 VAC) assembly group with 5 additional Output Relays (NO / Form A)
- X102** – Universal Resistance-Temperature Detector (URTD) input, Fiber optics interface, Versatile Link
- X103** – Profibus-DP, RS485, D-SUB
- X104** – IRIG-B00X, incl. System Contact (Supervision Contact)

MCDGV4-2D1BFA

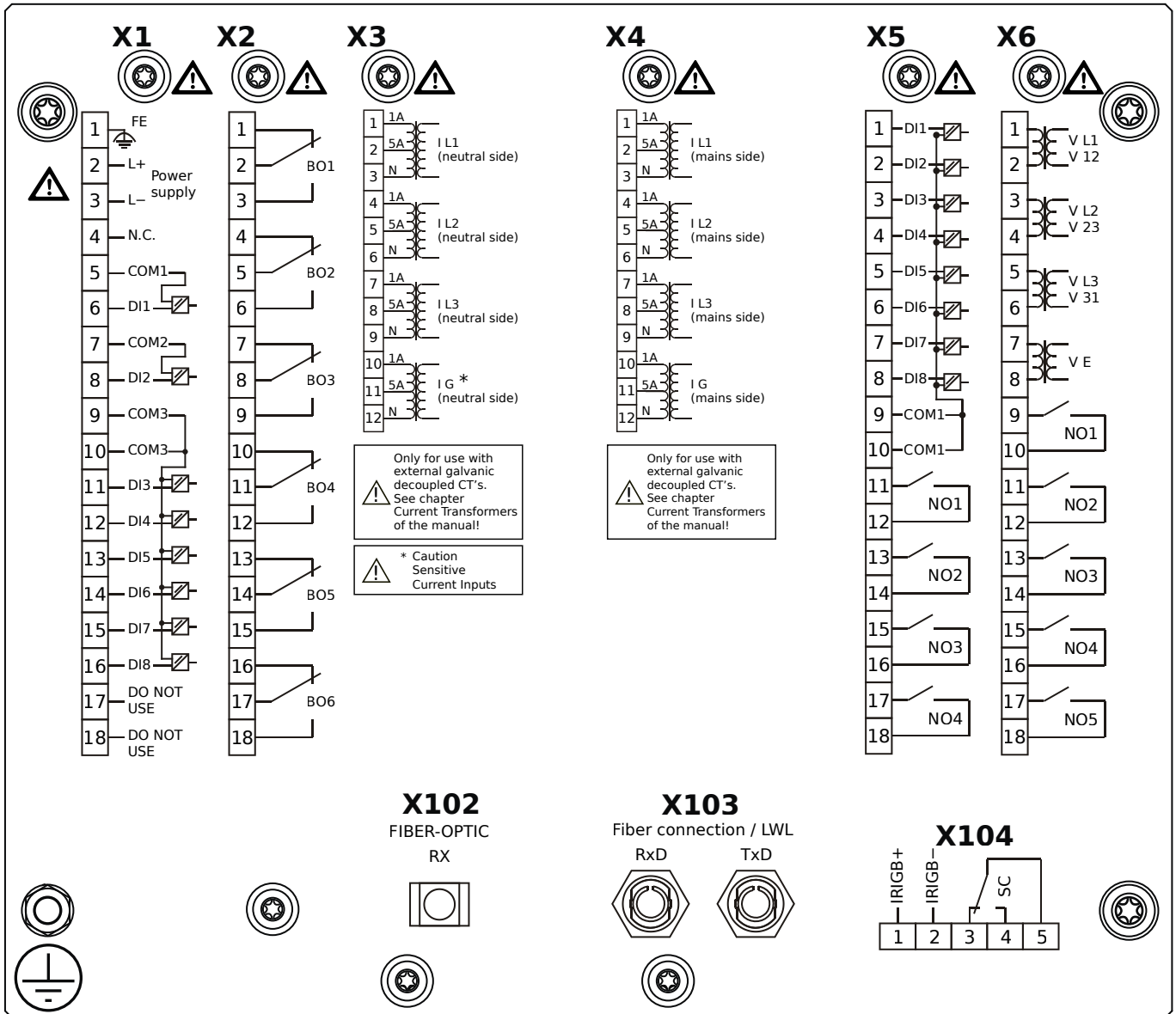

Housing B2, large display, 19" rack mounting

- X1** – DI8-X1: Wide-range power supply unit, incl. 2 non-grouped digital inputs and 6 grouped digital inputs
- X2** – OR6: Assembly Group with 6 Output Relays (Changeover / Form C)
- X3** – TIs: Standard phase current measuring card and sensitive ground current measuring (neutral side of the diff. prot.)
- X4** – TI: Standard current measuring card (for the mains side of the differential protection)
- X5** – DI8-OR4: Assembly Group with 8 Digital Inputs and 4 Output Relays (NO / Form A)
- X6** – TU-OR5: Voltage measuring (0 ... 300 VAC) assembly group with 5 additional Output Relays (NO / Form A)
- X102** – Universal Resistance-Temperature Detector (URTD) input, Fiber optics interface, Versatile Link
- X103** – Modbus RTU / IEC 60870-5-103 / DNP3.0 RTU, Fiber optics interface, ST Connector
- X104** – IRIG-B00X, incl. System Contact (Supervision Contact)

MCDGV4-2D1BFB

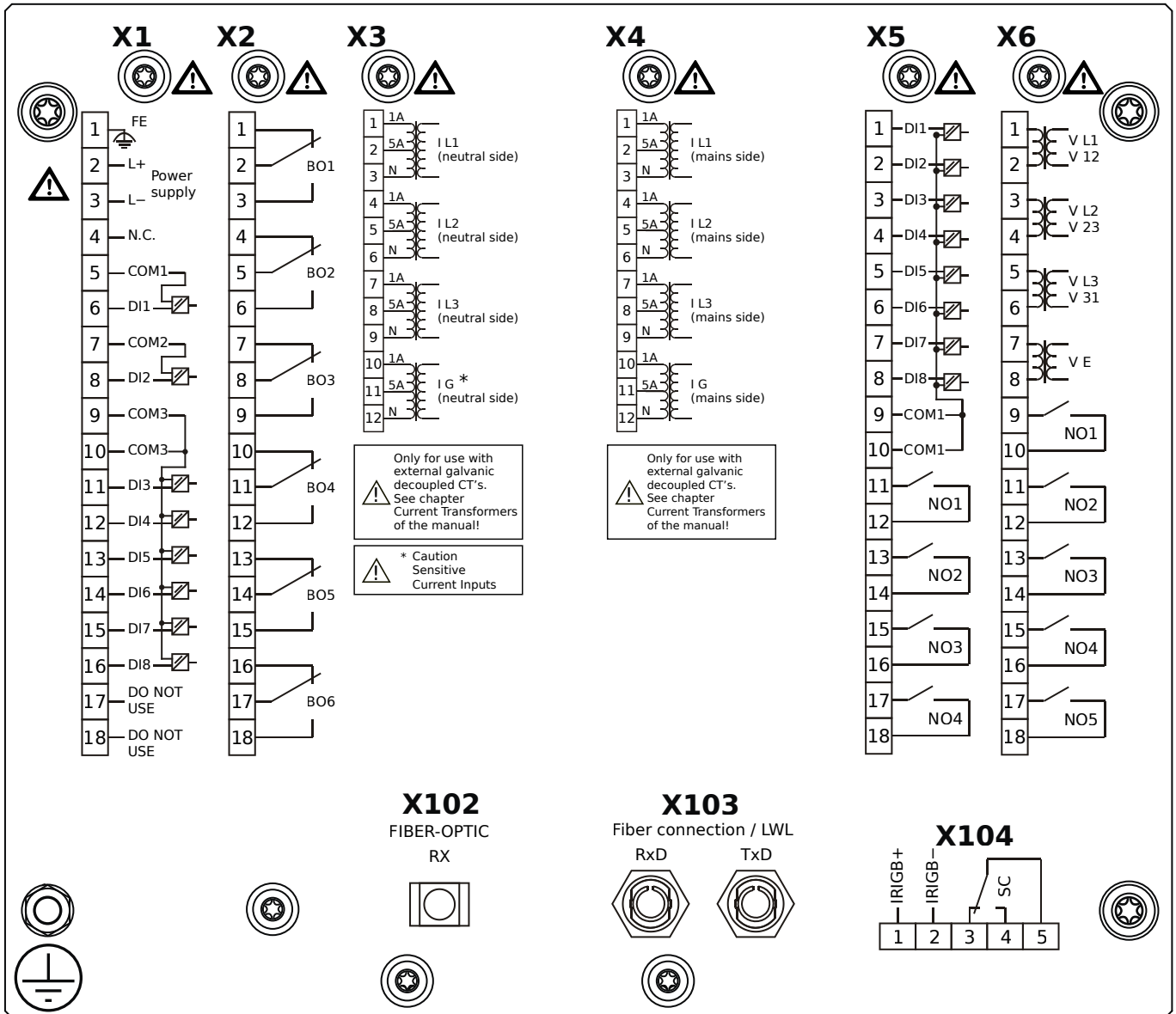

Housing B2, large display, 19" rack mounting

+ Conformal Coating (for installations in harsh environment)

- X1** – DI8-X1: Wide-range power supply unit, incl. 2 non-grouped digital inputs and 6 grouped digital inputs
- X2** – OR6: Assembly Group with 6 Output Relays (Changeover / Form C)
- X3** – TIs: Standard phase current measuring card and sensitive ground current measuring (neutral side of the diff. prot.)
- X4** – TI: Standard current measuring card (for the mains side of the differential protection)
- X5** – DI8-OR4: Assembly Group with 8 Digital Inputs and 4 Output Relays (NO / Form A)
- X6** – TU-OR5: Voltage measuring (0 ... 300 VAC) assembly group with 5 additional Output Relays (NO / Form A)
- X102** – Universal Resistance-Temperature Detector (URTD) input, Fiber optics interface, Versatile Link
- X103** – Modbus RTU / IEC 60870-5-103 / DNP3.0 RTU, Fiber optics interface, ST Connector
- X104** – IRIG-B00X, incl. System Contact (Supervision Contact)

MCDGV4-2D1BGA

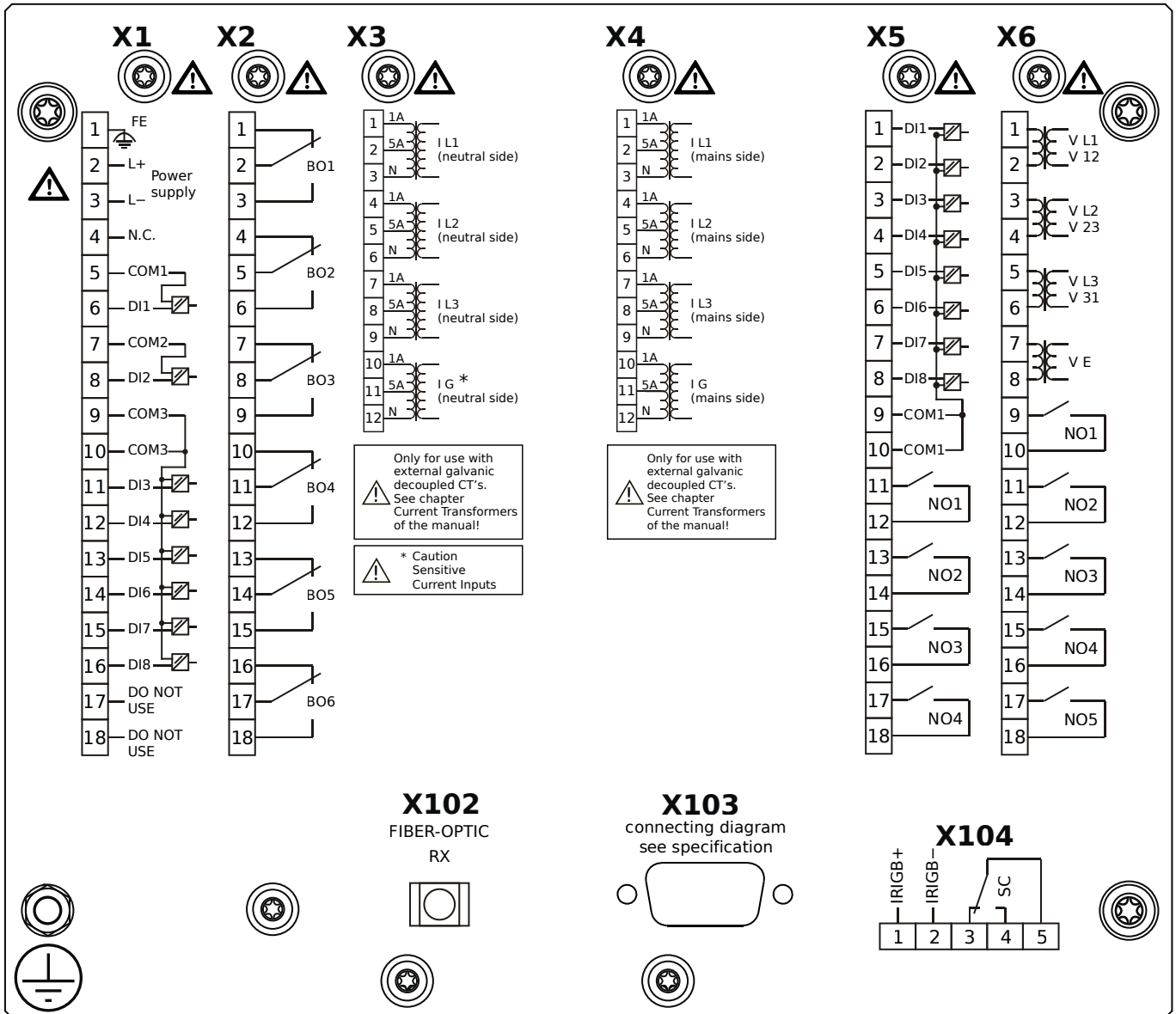

Housing B2, large display, 19" rack mounting

- X1** – DI8-X1: Wide-range power supply unit, incl. 2 non-grouped digital inputs and 6 grouped digital inputs
- X2** – OR6: Assembly Group with 6 Output Relays (Changeover / Form C)
- X3** – TIs: Standard phase current measuring card and sensitive ground current measuring (neutral side of the diff. prot.)
- X4** – TI: Standard current measuring card (for the mains side of the differential protection)
- X5** – DI8-OR4: Assembly Group with 8 Digital Inputs and 4 Output Relays (NO / Form A)
- X6** – TU-OR5: Voltage measuring (0 ... 300 VAC) assembly group with 5 additional Output Relays (NO / Form A)
- X102** – Universal Resistance-Temperature Detector (URTD) input, Fiber optics interface, Versatile Link
- X103** – Modbus RTU / IEC 60870-5-103 / DNP3.0 RTU, RS485, D-SUB
- X104** – IRIG-B00X, incl. System Contact (Supervision Contact)

MCDGV4-2D1BGB

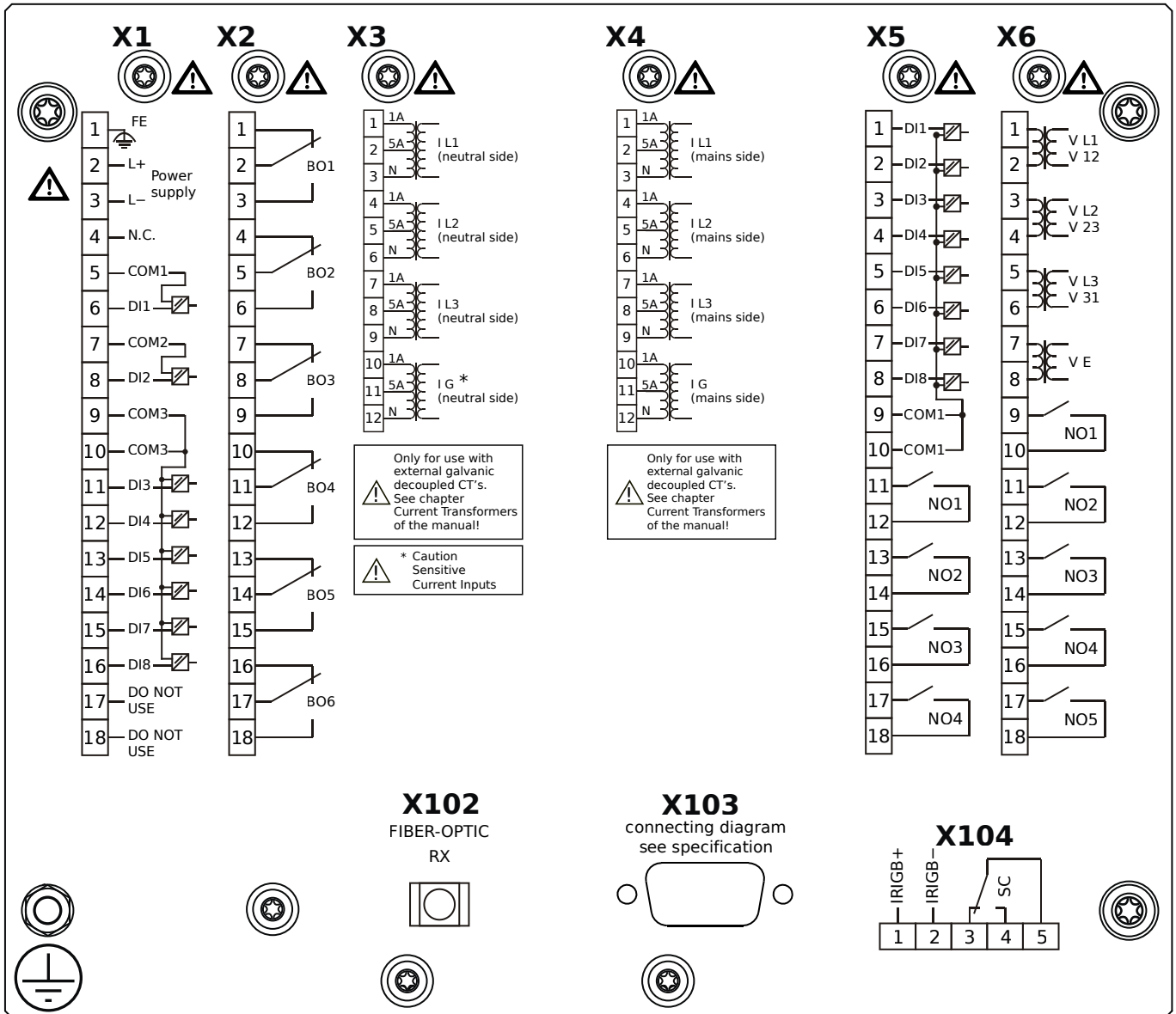

Housing B2, large display, 19" rack mounting

+ Conformal Coating (for installations in harsh environment)

- X1** – DI8-X1: Wide-range power supply unit, incl. 2 non-grouped digital inputs and 6 grouped digital inputs
- X2** – OR6: Assembly Group with 6 Output Relays (Changeover / Form C)
- X3** – TIs: Standard phase current measuring card and sensitive ground current measuring (neutral side of the diff. prot.)
- X4** – TI: Standard current measuring card (for the mains side of the differential protection)
- X5** – DI8-OR4: Assembly Group with 8 Digital Inputs and 4 Output Relays (NO / Form A)
- X6** – TU-OR5: Voltage measuring (0 ... 300 VAC) assembly group with 5 additional Output Relays (NO / Form A)
- X102** – Universal Resistance-Temperature Detector (URTD) input, Fiber optics interface, Versatile Link
- X103** – Modbus RTU / IEC 60870-5-103 / DNP3.0 RTU, RS485, D-SUB
- X104** – IRIG-B00X, incl. System Contact (Supervision Contact)

MCDGV4-2D1BHA

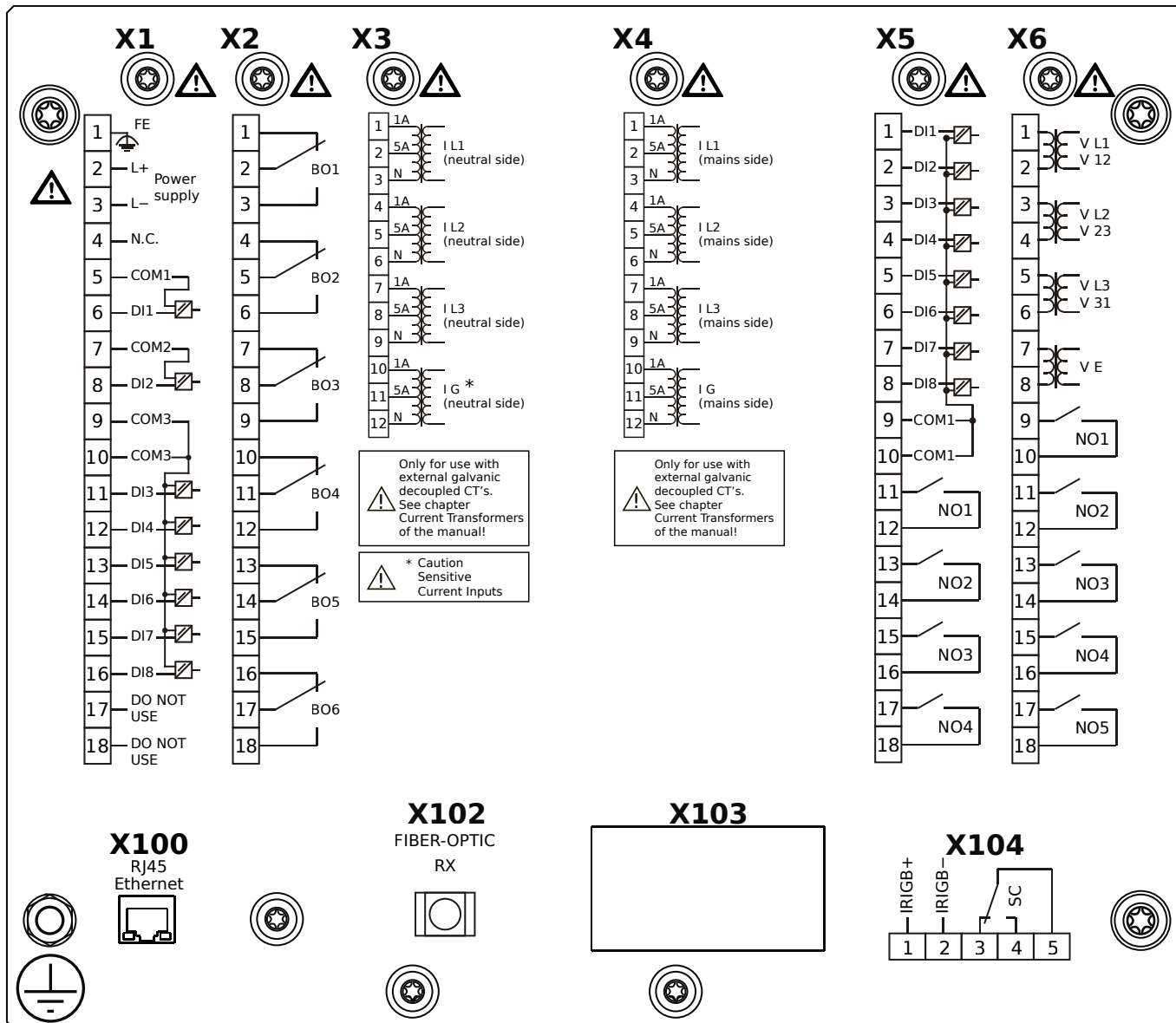

Housing B2, large display, 19" rack mounting

- X1** – DI8-X1: Wide-range power supply unit, incl. 2 non-grouped digital inputs and 6 grouped digital inputs
- X2** – OR6: Assembly Group with 6 Output Relays (Changeover / Form C)
- X3** – TIs: Standard phase current measuring card and sensitive ground current measuring (neutral side of the diff. prot.)
- X4** – TI: Standard current measuring card (for the mains side of the differential protection)
- X5** – DI8-OR4: Assembly Group with 8 Digital Inputs and 4 Output Relays (NO / Form A)
- X6** – TU-OR5: Voltage measuring (0 ... 300 VAC) assembly group with 5 additional Output Relays (NO / Form A)
- X100** – IEC 61850 / Modbus TCP / DNP3.0 TCP/UDP, Ethernet interface, 100 Mbit/s, RJ45 (BASE100-FX)
- X102** – Universal Resistance-Temperature Detector (URTD) input, Fiber optics interface, Versatile Link
- X104** – IRIG-B00X, incl. System Contact (Supervision Contact)

MCDGV4-2D1BHB

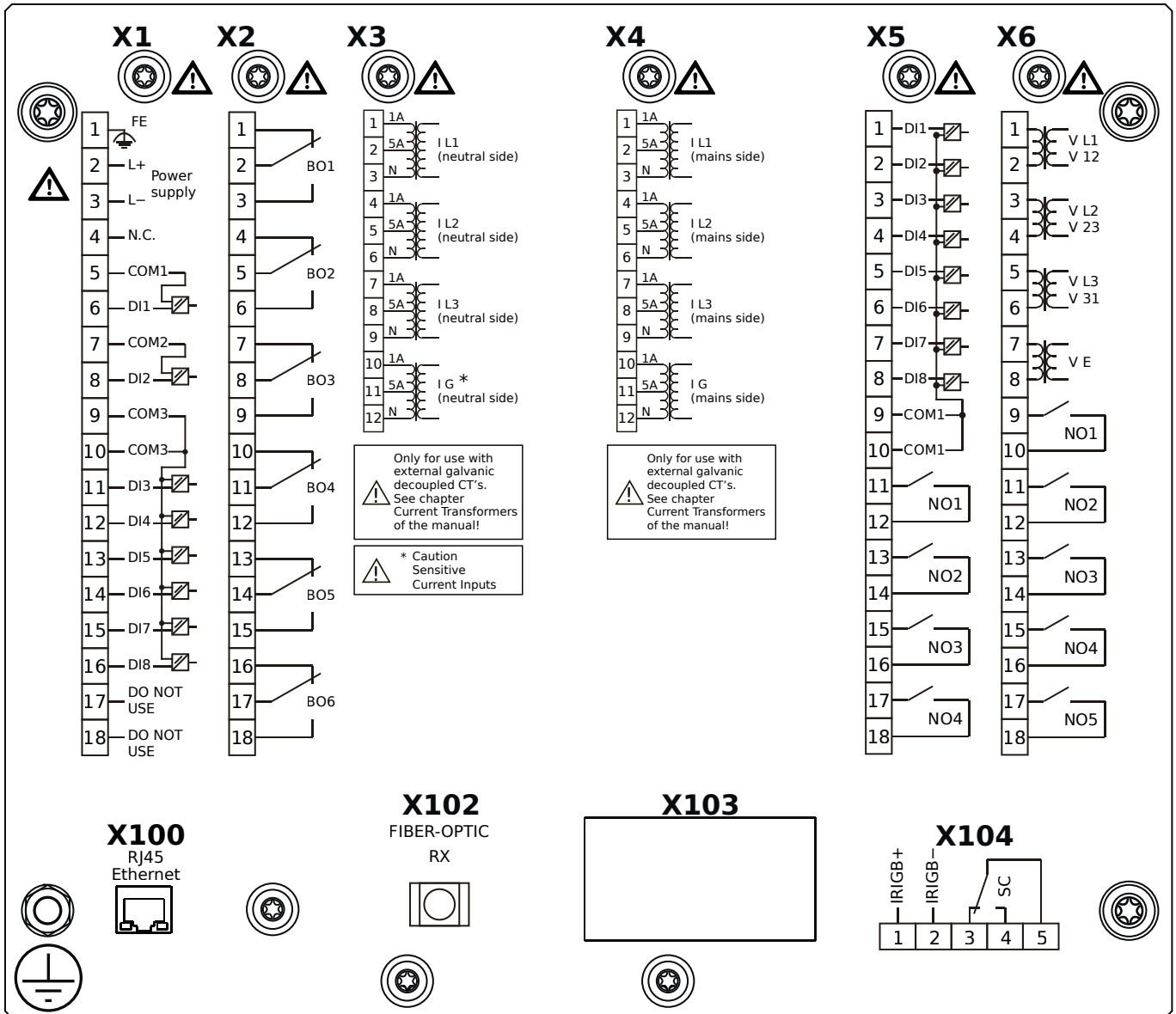

Housing B2, large display, 19" rack mounting

+ Conformal Coating (for installations in harsh environment)

- X1** – DI8-X1: Wide-range power supply unit, incl. 2 non-grouped digital inputs and 6 grouped digital inputs
- X2** – OR6: Assembly Group with 6 Output Relays (Changeover / Form C)
- X3** – TIs: Standard phase current measuring card and sensitive ground current measuring (neutral side of the diff. prot.)
- X4** – TI: Standard current measuring card (for the mains side of the differential protection)
- X5** – DI8-OR4: Assembly Group with 8 Digital Inputs and 4 Output Relays (NO / Form A)
- X6** – TU-OR5: Voltage measuring (0 ... 300 VAC) assembly group with 5 additional Output Relays (NO / Form A)
- X100** – IEC 61850 / Modbus TCP / DNP3.0 TCP/UDP, Ethernet interface, 100 Mbit/s, RJ45 (BASE100-FX)
- X102** – Universal Resistance-Temperature Detector (URTD) input, Fiber optics interface, Versatile Link
- X104** – IRIG-B00X, incl. System Contact (Supervision Contact)

MCDGV4-2D1BIA

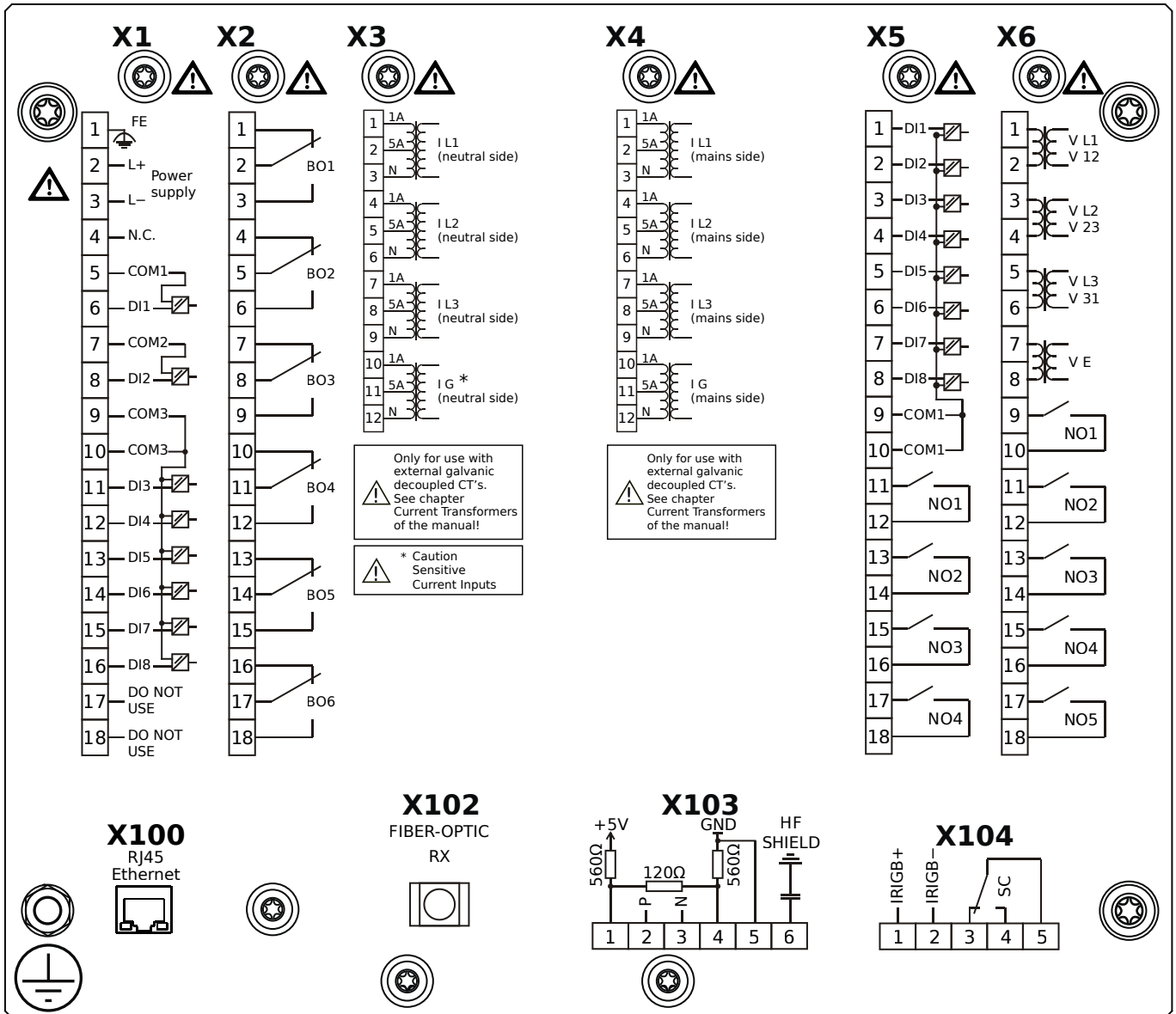

Housing B2, large display, 19" rack mounting

- X1** – DI8-X1: Wide-range power supply unit, incl. 2 non-grouped digital inputs and 6 grouped digital inputs
- X2** – OR6: Assembly Group with 6 Output Relays (Changeover / Form C)
- X3** – TIs: Standard phase current measuring card and sensitive ground current measuring (neutral side of the diff. prot.)
- X4** – TI: Standard current measuring card (for the mains side of the differential protection)
- X5** – DI8-OR4: Assembly Group with 8 Digital Inputs and 4 Output Relays (NO / Form A)
- X6** – TU-OR5: Voltage measuring (0 ... 300 VAC) assembly group with 5 additional Output Relays (NO / Form A)
- X100** – Modbus TCP / DNP3.0 TCP/UDP, Ethernet interface, 100 Mbit/s, RJ45 (BASE100-FX)
- X102** – Universal Resistance-Temperature Detector (URTD) input, Fiber optics interface, Versatile Link
- X103** – IEC 60870-5-103 / Modbus RTU / DNP3.0 RTU, RS485, Terminals
- X104** – IRIG-B00X, incl. System Contact (Supervision Contact)

MCDGV4-2D1BIB

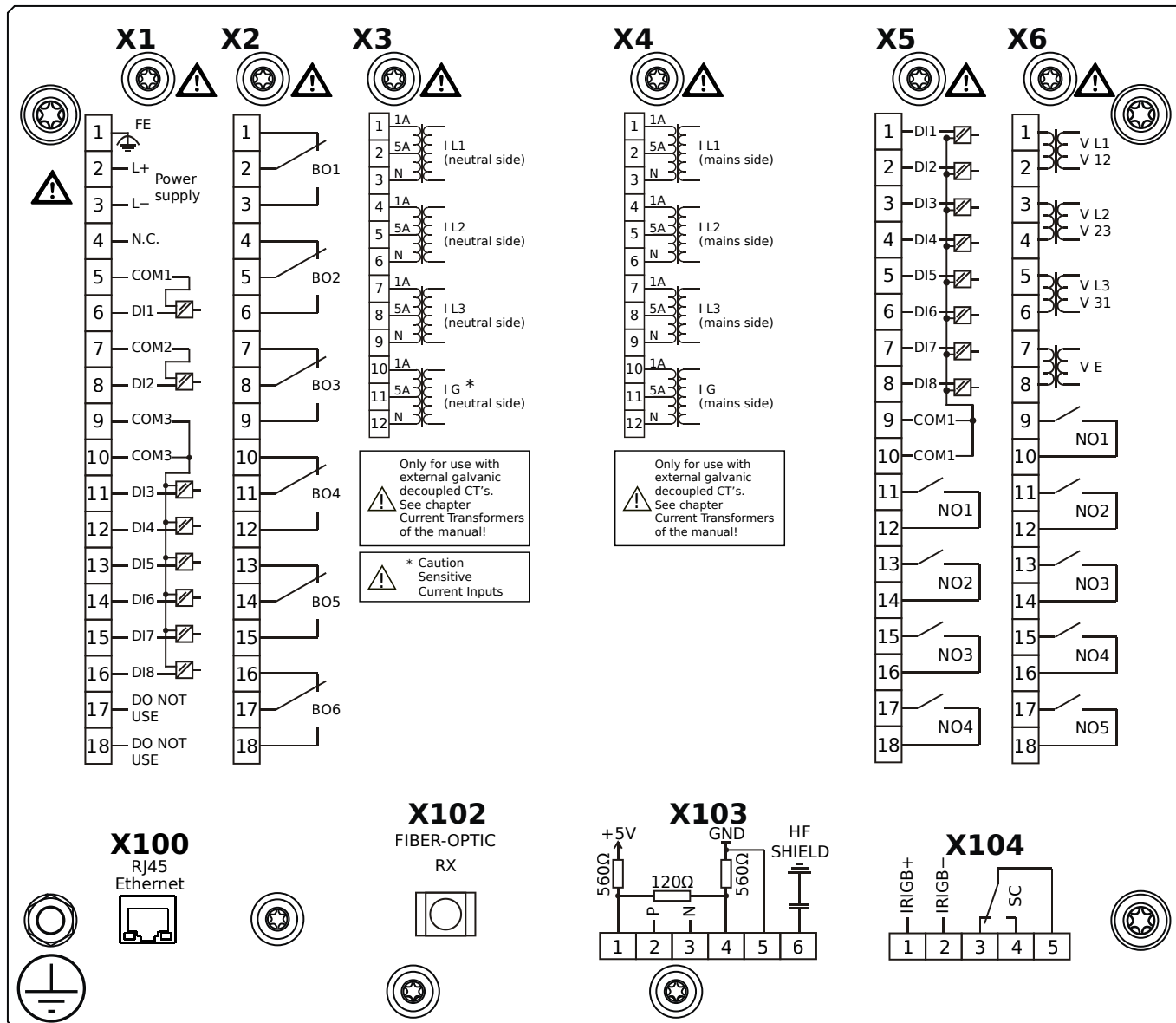

Housing B2, large display, 19" rack mounting

+ Conformal Coating (for installations in harsh environment)

- X1** – DI8-X1: Wide-range power supply unit, incl. 2 non-grouped digital inputs and 6 grouped digital inputs
- X2** – OR6: Assembly Group with 6 Output Relays (Changeover / Form C)
- X3** – TIs: Standard phase current measuring card and sensitive ground current measuring (neutral side of the diff. prot.)
- X4** – TI: Standard current measuring card (for the mains side of the differential protection)
- X5** – DI8-OR4: Assembly Group with 8 Digital Inputs and 4 Output Relays (NO / Form A)
- X6** – TU-OR5: Voltage measuring (0 ... 300 VAC) assembly group with 5 additional Output Relays (NO / Form A)
- X100** – Modbus TCP / DNP3.0 TCP/UDP, Ethernet interface, 100 Mbit/s, RJ45 (BASE100-FX)
- X102** – Universal Resistance-Temperature Detector (URTD) input, Fiber optics interface, Versatile Link
- X103** – IEC 60870-5-103 / Modbus RTU / DNP3.0 RTU, RS485, Terminals
- X104** – IRIG-B00X, incl. System Contact (Supervision Contact)

MCDGV4-2D1BKA

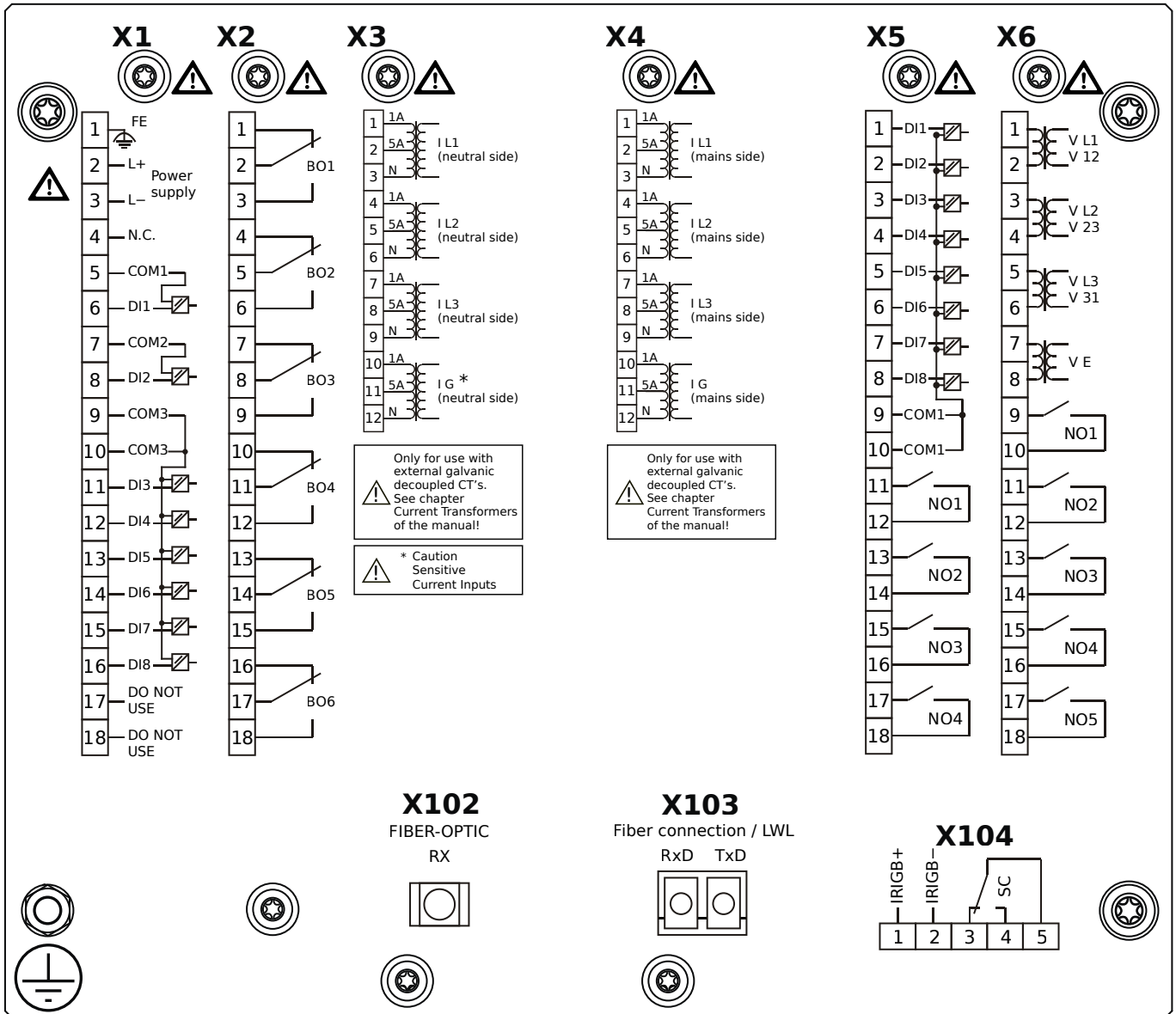

Housing B2, large display, 19" rack mounting

- X1** – DI8-X1: Wide-range power supply unit, incl. 2 non-grouped digital inputs and 6 grouped digital inputs
- X2** – OR6: Assembly Group with 6 Output Relays (Changeover / Form C)
- X3** – TIs: Standard phase current measuring card and sensitive ground current measuring (neutral side of the diff. prot.)
- X4** – TI: Standard current measuring card (for the mains side of the differential protection)
- X5** – DI8-OR4: Assembly Group with 8 Digital Inputs and 4 Output Relays (NO / Form A)
- X6** – TU-OR5: Voltage measuring (0 ... 300 VAC) assembly group with 5 additional Output Relays (NO / Form A)
- X102** – Universal Resistance-Temperature Detector (URTD) input, Fiber optics interface, Versatile Link
- X103** – IEC 61850 / Modbus TCP / DNP3.0 TCP/UDP, Fiber optics interface, LC Connector
- X104** – IRIG-B00X, incl. System Contact (Supervision Contact)

MCDGV4-2D1BKB

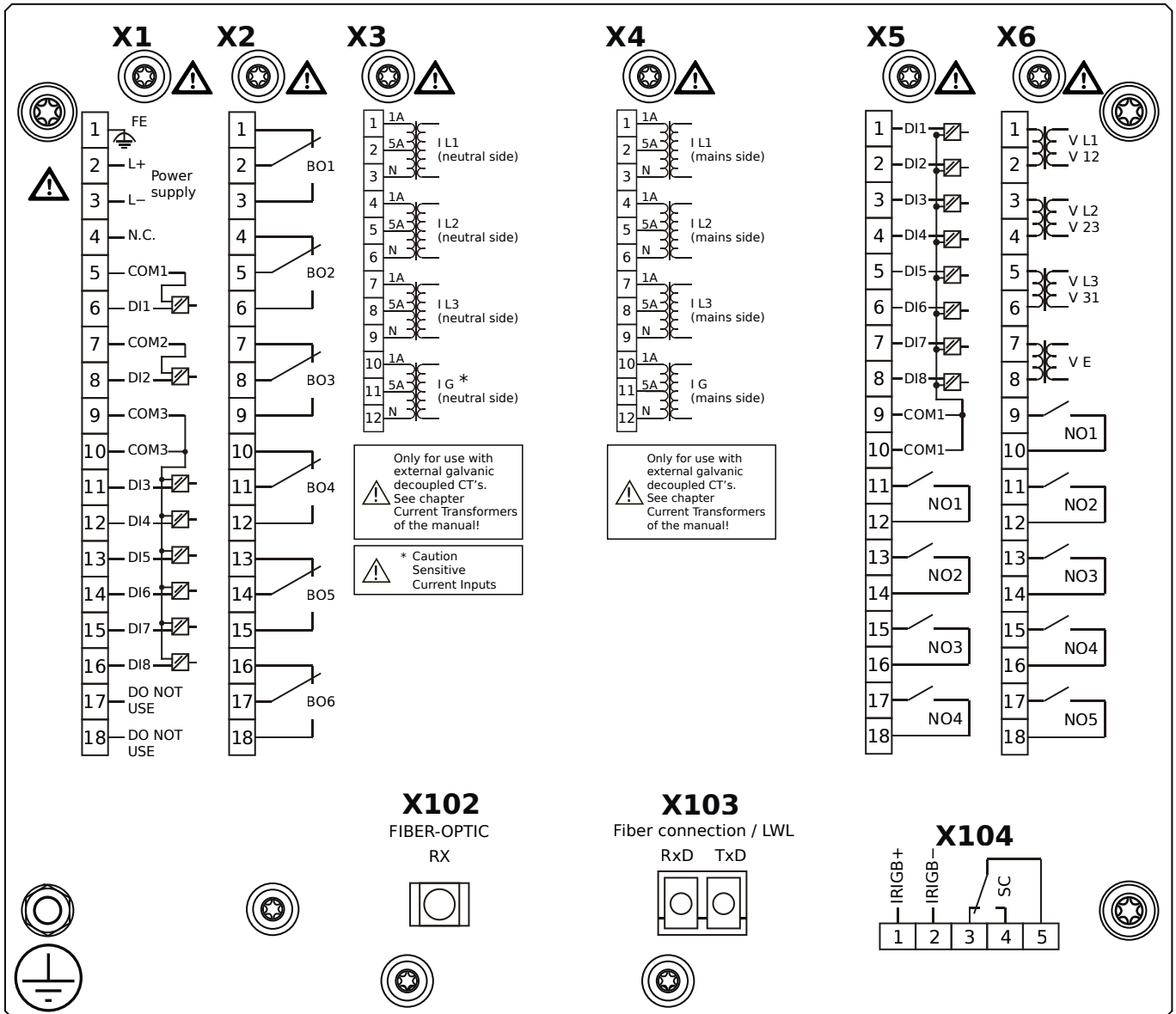

Housing B2, large display, 19" rack mounting

+ Conformal Coating (for installations in harsh environment)

- X1** – DI8-X1: Wide-range power supply unit, incl. 2 non-grouped digital inputs and 6 grouped digital inputs
- X2** – OR6: Assembly Group with 6 Output Relays (Changeover / Form C)
- X3** – TIs: Standard phase current measuring card and sensitive ground current measuring (neutral side of the diff. prot.)
- X4** – TI: Standard current measuring card (for the mains side of the differential protection)
- X5** – DI8-OR4: Assembly Group with 8 Digital Inputs and 4 Output Relays (NO / Form A)
- X6** – TU-OR5: Voltage measuring (0 ... 300 VAC) assembly group with 5 additional Output Relays (NO / Form A)
- X102** – Universal Resistance-Temperature Detector (URTD) input, Fiber optics interface, Versatile Link
- X103** – IEC 61850 / Modbus TCP / DNP3.0 TCP/UDP, Fiber optics interface, LC Connector
- X104** – IRIG-B00X, incl. System Contact (Supervision Contact)

MCDGV4-2D1BLA

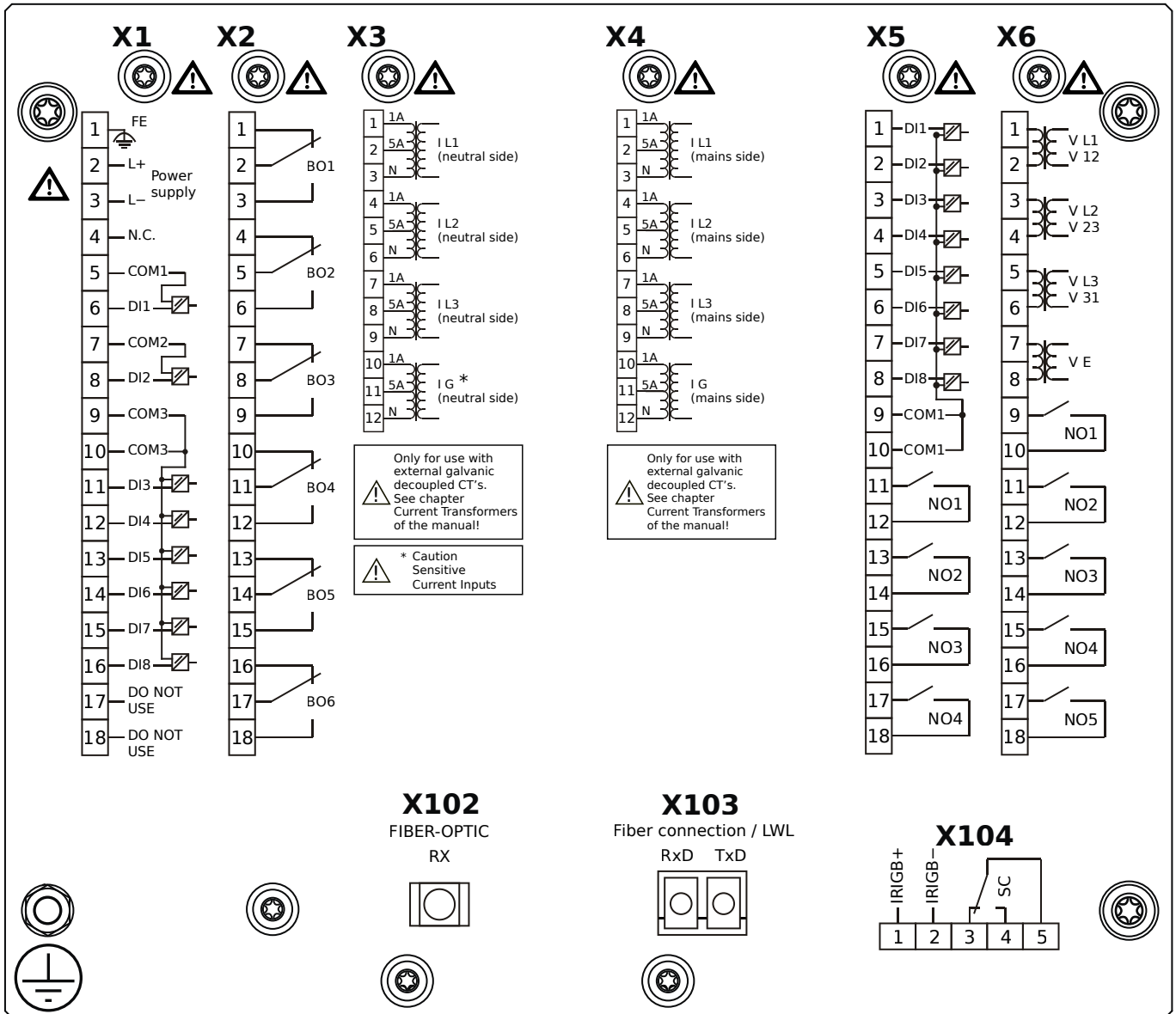

Housing B2, large display, 19" rack mounting

- X1** – DI8-X1: Wide-range power supply unit, incl. 2 non-grouped digital inputs and 6 grouped digital inputs
- X2** – OR6: Assembly Group with 6 Output Relays (Changeover / Form C)
- X3** – TIs: Standard phase current measuring card and sensitive ground current measuring (neutral side of the diff. prot.)
- X4** – TI: Standard current measuring card (for the mains side of the differential protection)
- X5** – DI8-OR4: Assembly Group with 8 Digital Inputs and 4 Output Relays (NO / Form A)
- X6** – TU-OR5: Voltage measuring (0 ... 300 VAC) assembly group with 5 additional Output Relays (NO / Form A)
- X102** – Universal Resistance-Temperature Detector (URTD) input, Fiber optics interface, Versatile Link
- X103** – Modbus TCP / DNP3.0 TCP/UDP, Fiber optics interface, LC Connector
- X104** – IRIG-B00X, incl. System Contact (Supervision Contact)

MCDGV4-2D1BLB

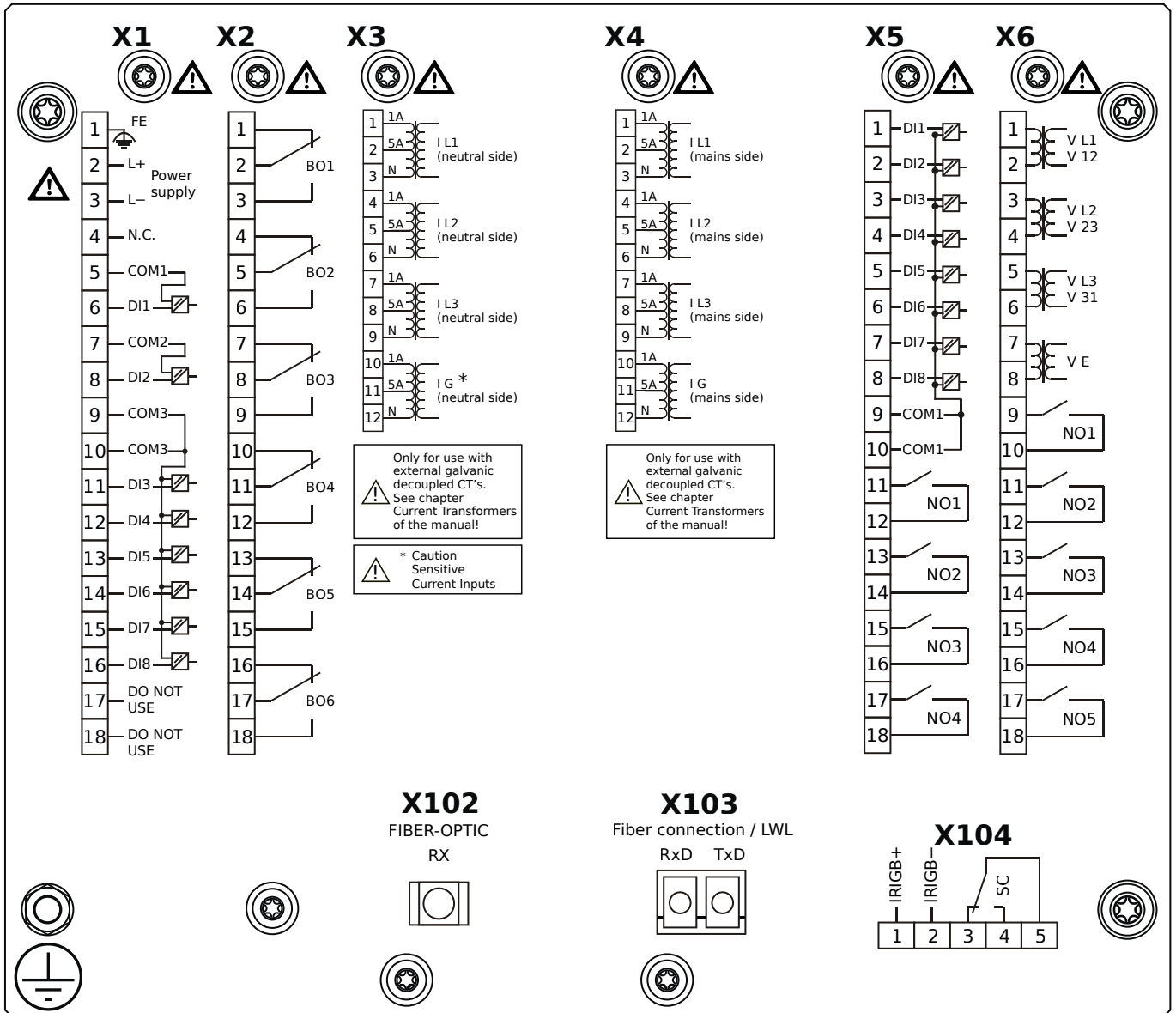

Housing B2, large display, 19" rack mounting

+ Conformal Coating (for installations in harsh environment)

- X1** – DI8-X1: Wide-range power supply unit, incl. 2 non-grouped digital inputs and 6 grouped digital inputs
- X2** – OR6: Assembly Group with 6 Output Relays (Changeover / Form C)
- X3** – TIs: Standard phase current measuring card and sensitive ground current measuring (neutral side of the diff. prot.)
- X4** – TI: Standard current measuring card (for the mains side of the differential protection)
- X5** – DI8-OR4: Assembly Group with 8 Digital Inputs and 4 Output Relays (NO / Form A)
- X6** – TU-OR5: Voltage measuring (0 ... 300 VAC) assembly group with 5 additional Output Relays (NO / Form A)
- X102** – Universal Resistance-Temperature Detector (URTD) input, Fiber optics interface, Versatile Link
- X103** – Modbus TCP / DNP3.0 TCP/UDP, Fiber optics interface, LC Connector
- X104** – IRIG-B00X, incl. System Contact (Supervision Contact)

MCDGV4-2D1BTA

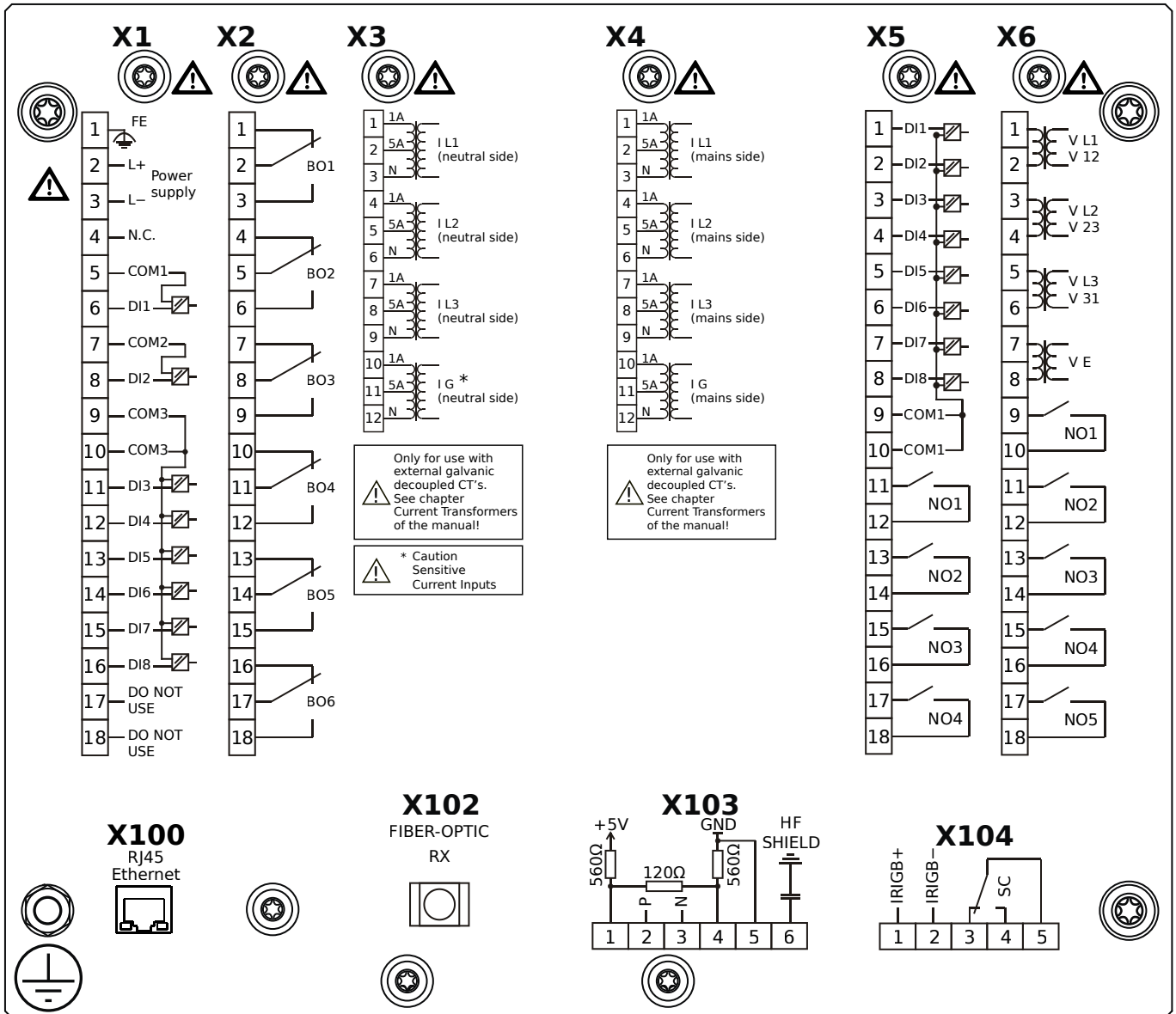

Housing B2, large display, 19" rack mounting

- X1** – DI8-X1: Wide-range power supply unit, incl. 2 non-grouped digital inputs and 6 grouped digital inputs
- X2** – OR6: Assembly Group with 6 Output Relays (Changeover / Form C)
- X3** – TIs: Standard phase current measuring card and sensitive ground current measuring (neutral side of the diff. prot.)
- X4** – TI: Standard current measuring card (for the mains side of the differential protection)
- X5** – DI8-OR4: Assembly Group with 8 Digital Inputs and 4 Output Relays (NO / Form A)
- X6** – TU-OR5: Voltage measuring (0 ... 300 VAC) assembly group with 5 additional Output Relays (NO / Form A)
- X100** – IEC 61850 / Modbus TCP / DNP3.0 TCP/UDP, Ethernet interface, 100 Mbit/s, RJ45 (BASE100-FX)
- X102** – Universal Resistance-Temperature Detector (URTD) input, Fiber optics interface, Versatile Link
- X103** – IEC 60870-5-103 / Modbus RTU / DNP3.0 RTU, RS485, Terminals
- X104** – IRIG-B00X, incl. System Contact (Supervision Contact)

MCDGV4-2D1BTB

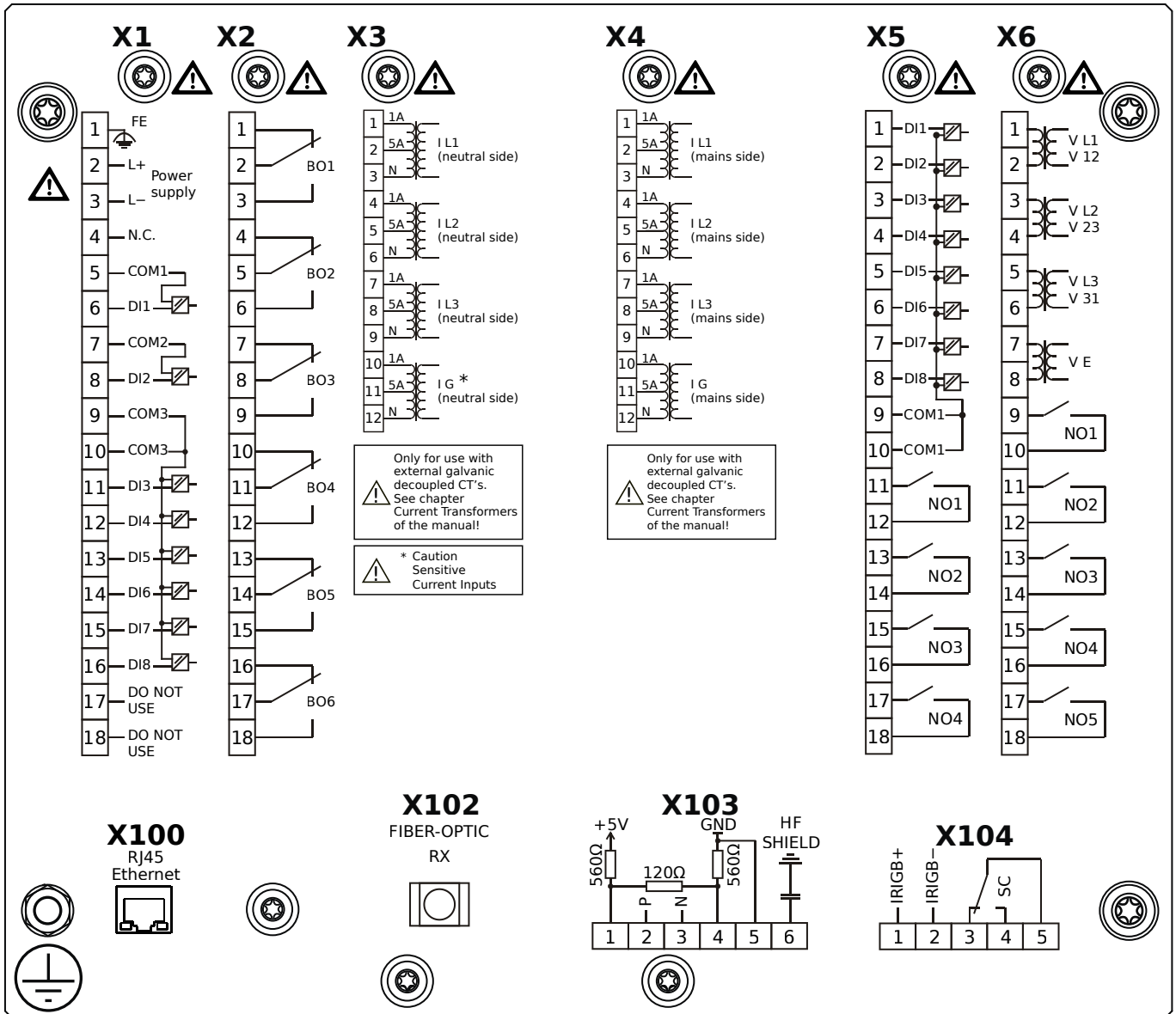

Housing B2, large display, 19" rack mounting

+ Conformal Coating (for installations in harsh environment)

- X1** – DI8-X1: Wide-range power supply unit, incl. 2 non-grouped digital inputs and 6 grouped digital inputs
- X2** – OR6: Assembly Group with 6 Output Relays (Changeover / Form C)
- X3** – TIs: Standard phase current measuring card and sensitive ground current measuring (neutral side of the diff. prot.)
- X4** – TI: Standard current measuring card (for the mains side of the differential protection)
- X5** – DI8-OR4: Assembly Group with 8 Digital Inputs and 4 Output Relays (NO / Form A)
- X6** – TU-OR5: Voltage measuring (0 ... 300 VAC) assembly group with 5 additional Output Relays (NO / Form A)
- X100** – IEC 61850 / Modbus TCP / DNP3.0 TCP/UDP, Ethernet interface, 100 Mbit/s, RJ45 (BASE100-FX)
- X102** – Universal Resistance-Temperature Detector (URTD) input, Fiber optics interface, Versatile Link
- X103** – IEC 60870-5-103 / Modbus RTU / DNP3.0 RTU, RS485, Terminals
- X104** – IRIG-B00X, incl. System Contact (Supervision Contact)

Appendix – Legend

In this legend designations of various device types are listed, e.g. transformer protection, motor protection, generator protection, etc. Therefore it can occur that not every designation actually appears on the wiring diagram of your device.

PE	– Connection of protective earth (see chapter Grounding in the Technical Manual).
FE	– Connection of functional earth (see chapter Grounding in the Technical Manual).
Power Supply	– Connection for auxiliary power supply.
IL1	– Phase current input L1 (in some countries designated as IA).
IL2	– Phase current input L2 (in some countries designated as IB).
IL3	– Phase current input L3 (in some countries designated as IC).
ILx C–D	– WIC1 Test windings.
ILx S1–S2	– WIC1 phase current inputs.
IL1 W1 ... IL3 W1	– Phase current input L1...L3, winding side 1.
IL1 W2 ... IL3 W2	– Phase current input L1...L3, winding side 2.
IG	– Ground (earth) current input.
IG W1, IG W2	– Ground (earth) current input, winding side 1 / 2.
VL1	– Phase-to-neutral voltage L1 (in some countries designated as VA).
VL2	– Phase-to-neutral voltage L2 (in some countries designated as VB).
VL3	– Phase-to-neutral voltage L3 (in some countries designated as VC).
VL12	– Phase-to-phase voltage V12 (in some countries designated as VAB).
VL23	– Phase-to-phase voltage V23 (in some countries designated as VBC).
VL31	– Phase-to-phase voltage V31 (in some countries designated as VCA).
VX	– 4th voltage measuring input for measuring residual voltage or synchro-check.
BO	– Binary output relay.
NO / NC	– Contact output, normally open (Form A) / closed (Form B).
DI	– Digital input.
COM	– Common connection of digital inputs.
Out+, AnOut	– Analog output + (0/4...20 mA or 0...10 V).
In–, AnIn	– Analog input + (0/4...20 mA or 0...10 V).
n.c.	– Not connected.
DO NOT USE	– Do not use. (Caution: Non-usable internal wiring may exist.)
SC	– Self-supervision contact.
HF SHIELD	– Connection cable shield.
Fiber Optics / LWL	– Fiber optic connection.

High **PROTEC**

MCDGV4

WIRING DIAGRAMS

