

MCDGV4

Generator Protection

Version: 3.6.b (Build 42255)

Original document · English

Revision: - (Build 42342)

© 2019

Original reference manual

Woodward Kempen GmbH

Krefelder Weg 47 • D-47906 Kempen (Germany)

Postfach 10 07 55 (P.O.Box) • D-47884 Kempen (Germany)

Telephone: +49 (0) 21 52 145 1

© 2019 Woodward Kempen GmbH

Table of Contents

1	About This Reference Manual	14
2	Hardware	17
2.1	Device Configuration	17
2.2	Digital Inputs	19
2.2.1	DI Slot X1 (“DI8-X1”)	19
2.2.2	DI Slot X5	20
2.2.3	DI Slot X6	21
2.3	Binary Outputs	22
2.3.1	BO Slot X2 (6 Binary Outputs)	22
2.3.2	BO Slot X5 (4 Binary Outputs)	34
2.3.3	BO Slot X6 (5 Binary Outputs)	42
2.4	Analog Inputs	51
2.4.1	AnIn[1]	51
2.4.2	AnIn[2]	52
2.5	Analog Outputs	53
2.5.1	AnOut[1]	53
2.5.2	AnOut[2]	54
2.6	LEDs	55
2.6.1	LEDs group A	55
2.6.2	LEDs group B	64
2.7	HMI	73
2.7.1	HMI: Global Parameters	73
2.7.2	HMI: Direct Controls	74
2.7.3	HMI: Values	74
3	Security	75
4	Field settings	77
4.1	Field Para: Global Parameters	77
4.2	VT	78
4.2.1	VT: Global Parameters	78
4.2.2	VT: Signals (Output States)	83
4.2.3	VT: Values	83
4.2.4	VT: Statistical Values	88
4.3	CT Ntrl	92
4.3.1	CT Ntrl: Global Parameters	92
4.3.2	CT Ntrl: Signals (Output States)	93
4.3.3	CT Ntrl: Values	94
4.3.4	CT Ntrl: Statistical Values	97
4.4	CT Mains	101
4.4.1	CT Mains: Global Parameters	101

- 4.4.2 CT Mains: Signals (Output States) 102
- 4.4.3 CT Mains: Values 103
- 4.4.4 CT Mains: Statistical Values 106
- 4.5 Generator 110
- 4.5.1 Generator: Global Parameters 110
- 4.5.2 Generator: Direct Controls 110
- 4.5.3 Generator: Signals (Output States) 110
- 4.5.4 Generator: Values 111
- 4.6 Transformer 112
- 4.6.1 Transformer: Device Planning Parameters 112
- 4.6.2 Transformer: Global Parameters 112

- 5 System 114**
- 5.1 Sys: Global Parameters 114
- 5.2 Sys: Direct Controls 116
- 5.3 Sys: Input States 117
- 5.4 Sys: Signals (Output States) 118
- 5.5 Sys: Values 120

- 6 Measured Values 122**
- 6.1 Z 123
- 6.1.1 Z: Global Parameters 123
- 6.1.2 Z: Values 123
- 6.2 Id 125
- 6.2.1 Id: Global Parameters 125
- 6.2.2 Id: Values 125
- 6.2.3 Id: Statistical Values 126
- 6.3 IdG 127
- 6.3.1 IdG: Global Parameters 127
- 6.3.2 IdG: Values 127
- 6.3.3 IdG: Statistical Values 127
- 6.4 PQSCr 129
- 6.4.1 PQSCr: Global Parameters 129
- 6.4.2 PQSCr: Direct Controls 129
- 6.4.3 PQSCr: Signals (Output States) 129
- 6.4.4 PQSCr: Values 131
- 6.4.5 PQSCr: Statistical Values 132

- 7 Statistics 135**
- 7.1 Statistics: Global Parameters 135
- 7.2 Statistics: Direct Controls 138
- 7.3 Statistics: Input States 139
- 7.4 Statistics: Signals (Output States) 140
- 7.5 Statistics: Counters 140

8	Communication	142
8.1	Scada: Device Planning Parameters	142
8.2	Scada: Signals (Output States)	142
8.3	Tcplp	143
8.3.1	Tcplp: Global Parameters	143
8.4	DNP3	144
8.4.1	DNP3: Global Parameters	144
8.4.2	DNP3: Direct Controls	149
8.4.3	DNP3: Input States	149
8.4.4	DNP3: Signals (Output States)	150
8.4.5	DNP3: Counters	150
8.5	Modbus	152
8.5.1	Modbus: Global Parameters	152
8.5.2	Modbus: Direct Controls	155
8.5.3	Modbus: Input States	155
8.5.4	Modbus: Signals (Output States)	155
8.5.5	Modbus: Values	156
8.5.6	Modbus: Counters	157
8.6	IEC 61850	159
8.6.1	IEC 61850: Global Parameters	159
8.6.2	IEC 61850: Direct Controls	159
8.6.3	IEC 61850: Signals (Output States)	159
8.6.4	IEC 61850: Values	160
8.6.5	IEC 61850: Counters	161
8.6.6	IEC 61850 - Virt.Outp.	163
8.7	IEC103	164
8.7.1	IEC103: Global Parameters	164
8.7.2	IEC103: Direct Controls	166
8.7.3	IEC103: Signals (Output States)	167
8.7.4	IEC103: Counters	167
8.8	IEC104	169
8.8.1	IEC104: Global Parameters	169
8.8.2	IEC104: Direct Controls	172
8.8.3	IEC104: Signals (Output States)	172
8.8.4	IEC104: Values	172
8.8.5	IEC104: Counters	173
8.9	Profibus	174
8.9.1	Profibus: Global Parameters	174
8.9.2	Profibus: Direct Controls	174
8.9.3	Profibus: Input States	175
8.9.4	Profibus: Signals (Output States)	175
8.9.5	Profibus: Values	176
8.9.6	Profibus: Counters	177

8.10	IRIG-B	178
8.10.1	IRIG-B: Device Planning Parameters	178
8.10.2	IRIG-B: Global Parameters	178
8.10.3	IRIG-B: Direct Controls	178
8.10.4	IRIG-B: Signals (Output States)	179
8.10.5	IRIG-B: Counters	179
8.11	SNTP	180
8.11.1	SNTP: Device Planning Parameters	180
8.11.2	SNTP: Global Parameters	180
8.11.3	SNTP: Direct Controls	181
8.11.4	SNTP: Signals (Output States)	181
8.11.5	SNTP: Values	181
8.11.6	SNTP: Counters	182
8.12	TimeSync	184
8.12.1	TimeSync: Global Parameters	184
8.12.2	TimeSync: Signals (Output States)	186
9	Protection Parameter	187
9.1	Prot: Global Parameters	187
9.2	Prot: Direct Controls	188
9.3	Prot: Input States	188
9.4	Prot: Signals (Output States)	188
9.5	Prot: Values	192
9.6	Id	193
9.6.1	Id: Device Planning Parameters	193
9.6.2	Id: Global Parameters	193
9.6.3	Id: Setting Group Parameters	193
9.6.4	Id: Input States	197
9.6.5	Id: Signals (Output States)	197
9.6.6	Id: Values	201
9.6.7	Id: Statistical Values	201
9.7	IdH	203
9.7.1	IdH: Device Planning Parameters	203
9.7.2	IdH: Global Parameters	203
9.7.3	IdH: Setting Group Parameters	203
9.7.4	IdH: Input States	204
9.7.5	IdH: Signals (Output States)	205
9.8	IdG[1] ... IdG[2]	207
9.8.1	IdG[1]: Device Planning Parameters	207
9.8.2	IdG[1]: Global Parameters	207
9.8.3	IdG[1]: Setting Group Parameters	207
9.8.4	IdG[1]: Input States	209
9.8.5	IdG[1]: Signals (Output States)	209
9.9	IdGH[1] ... IdGH[2]	211

9.9.1	IdGH[1]: Device Planning Parameters	211
9.9.2	IdGH[1]: Global Parameters	211
9.9.3	IdGH[1]: Setting Group Parameters	211
9.9.4	IdGH[1]: Input States	212
9.9.5	IdGH[1]: Signals (Output States)	213
9.10	IH2	214
9.10.1	IH2: Device Planning Parameters.	214
9.10.2	IH2: Global Parameters	214
9.10.3	IH2: Setting Group Parameters.	214
9.10.4	IH2: Input States	215
9.10.5	IH2: Signals (Output States).	215
9.11	I[1] I[6].	217
9.11.1	I[1]: Device Planning Parameters.	217
9.11.2	I[1]: Global Parameters	217
9.11.3	I[1]: Setting Group Parameters.	218
9.11.4	I[1]: Input States	222
9.11.5	I[1]: Signals (Output States).	223
9.12	IG[1] IG[4].	226
9.12.1	IG[1]: Device Planning Parameters.	226
9.12.2	IG[1]: Global Parameters	226
9.12.3	IG[1]: Setting Group Parameters	228
9.12.4	IG[1]: Input States	231
9.12.5	IG[1]: Signals (Output States).	232
9.13	ThR.	235
9.13.1	ThR: Device Planning Parameters.	235
9.13.2	ThR: Global Parameters	235
9.13.3	ThR: Setting Group Parameters	236
9.13.4	ThR: Direct Controls	237
9.13.5	ThR: Input States	237
9.13.6	ThR: Signals (Output States)	238
9.13.7	ThR: Values.	238
9.13.8	ThR: Statistical Values	239
9.14	I2>[1] I2>[2].	240
9.14.1	I2>[1]: Device Planning Parameters.	240
9.14.2	I2>[1]: Global Parameters	240
9.14.3	I2>[1]: Setting Group Parameters	241
9.14.4	I2>[1]: Input States	243
9.14.5	I2>[1]: Signals (Output States)	243
9.15	I2>G[1] I2>G[2].	245
9.15.1	I2>G[1]: Device Planning Parameters	245
9.15.2	I2>G[1]: Global Parameters	245
9.15.3	I2>G[1]: Setting Group Parameters	245
9.15.4	I2>G[1]: Input States	247
9.15.5	I2>G[1]: Signals (Output States)	247

9.16	V[1] ... V[6]	249
9.16.1	V[1]: Device Planning Parameters	249
9.16.2	V[1]: Global Parameters	249
9.16.3	V[1]: Setting Group Parameters	249
9.16.4	V[1]: Input States	252
9.16.5	V[1]: Signals (Output States)	253
9.17	df/dt	255
9.17.1	df/dt: Device Planning Parameters	255
9.17.2	df/dt: Global Parameters	255
9.17.3	df/dt: Setting Group Parameters	255
9.17.4	df/dt: Input States	258
9.17.5	df/dt: Signals (Output States)	258
9.18	delta phi	260
9.18.1	delta phi: Device Planning Parameters	260
9.18.2	delta phi: Global Parameters	260
9.18.3	delta phi: Setting Group Parameters	260
9.18.4	delta phi: Input States	263
9.18.5	delta phi: Signals (Output States)	263
9.19	Intertripping	265
9.19.1	Intertripping: Device Planning Parameters	265
9.19.2	Intertripping: Global Parameters	265
9.19.3	Intertripping: Setting Group Parameters	266
9.19.4	Intertripping: Input States	267
9.19.5	Intertripping: Signals (Output States)	267
9.20	P[1] ... P[3]	269
9.20.1	P[1]: Device Planning Parameters	269
9.20.2	P[1]: Global Parameters	269
9.20.3	P[1]: Setting Group Parameters	269
9.20.4	P[1]: Input States	272
9.20.5	P[1]: Signals (Output States)	272
9.21	Q	274
9.21.1	Q: Device Planning Parameters	274
9.21.2	Q: Global Parameters	274
9.21.3	Q: Setting Group Parameters	274
9.21.4	Q: Input States	276
9.21.5	Q: Signals (Output States)	277
9.22	LVRT[1] ... LVRT[2]	279
9.22.1	LVRT[1]: Device Planning Parameters	279
9.22.2	LVRT[1]: Global Parameters	279
9.22.3	LVRT[1]: Setting Group Parameters	279
9.22.4	LVRT[1]: Direct Controls	284
9.22.5	LVRT[1]: Input States	284
9.22.6	LVRT[1]: Signals (Output States)	284
9.22.7	LVRT[1]: Counters	286

9.23	VG[1] ... VG[2].	287
9.23.1	VG[1]: Device Planning Parameters	287
9.23.2	VG[1]: Global Parameters.	287
9.23.3	VG[1]: Setting Group Parameters.	288
9.23.4	VG[1]: Input States.	289
9.23.5	VG[1]: Signals (Output States).	290
9.24	V012[1] ... V012[6]	292
9.24.1	V012[1]: Device Planning Parameters	292
9.24.2	V012[1]: Global Parameters.	292
9.24.3	V012[1]: Setting Group Parameters.	293
9.24.4	V012[1]: Input States.	294
9.24.5	V012[1]: Signals (Output States).	295
9.25	f[1] ... f[6]	296
9.25.1	f[1]: Device Planning Parameters.	296
9.25.2	f[1]: Global Parameters	296
9.25.3	f[1]: Setting Group Parameters.	296
9.25.4	f[1]: Input States	298
9.25.5	f[1]: Signals (Output States).	299
9.26	PQS[1] ... PQS[6].	301
9.26.1	PQS[1]: Device Planning Parameters	301
9.26.2	PQS[1]: Global Parameters.	301
9.26.3	PQS[1]: Setting Group Parameters.	301
9.26.4	PQS[1]: Input States.	304
9.26.5	PQS[1]: Signals (Output States).	304
9.27	PF[1] ... PF[2].	306
9.27.1	PF[1]: Device Planning Parameters	306
9.27.2	PF[1]: Global Parameters	306
9.27.3	PF[1]: Setting Group Parameters	306
9.27.4	PF[1]: Input States	308
9.27.5	PF[1]: Signals (Output States)	309
9.28	Q->&V<.	310
9.28.1	Q->&V<: Device Planning Parameters.	310
9.28.2	Q->&V<: Global Parameters	310
9.28.3	Q->&V<: Setting Group Parameters.	310
9.28.4	Q->&V<: Input States	313
9.28.5	Q->&V<: Signals (Output States).	313
9.29	ReCon[1] ... ReCon[2]	315
9.29.1	ReCon[1]: Device Planning Parameters	315
9.29.2	ReCon[1]: Global Parameters.	315
9.29.3	ReCon[1]: Setting Group Parameters.	316
9.29.4	ReCon[1]: Input States.	319
9.29.5	ReCon[1]: Signals (Output States).	319
9.30	Sync	321
9.30.1	Sync: Device Planning Parameters.	321

9.30.2	Sync: Global Parameters	321
9.30.3	Sync: Setting Group Parameters	322
9.30.4	Sync: Input States	325
9.30.5	Sync: Signals (Output States).	325
9.30.6	Sync: Values.	326
9.31	LoE-Z1[1] . . . LoE-Z1[2].	328
9.31.1	LoE-Z1[1]: Device Planning Parameters.	328
9.31.2	LoE-Z1[1]: Global Parameters.	328
9.31.3	LoE-Z1[1]: Setting Group Parameters.	328
9.31.4	LoE-Z1[1]: Input States	330
9.31.5	LoE-Z1[1]: Signals (Output States).	331
9.32	LoE-Z2[1] . . . LoE-Z2[2].	333
9.32.1	LoE-Z2[1]: Device Planning Parameters.	333
9.32.2	LoE-Z2[1]: Global Parameters.	333
9.32.3	LoE-Z2[1]: Setting Group Parameters.	333
9.32.4	LoE-Z2[1]: Input States	336
9.32.5	LoE-Z2[1]: Signals (Output States).	336
9.33	OST.	338
9.33.1	OST: Device Planning Parameters.	338
9.33.2	OST: Global Parameters	338
9.33.3	OST: Setting Group Parameters	338
9.33.4	OST: Input States	342
9.33.5	OST: Signals (Output States)	342
9.34	V/f>[1] . . . V/f>[2].	345
9.34.1	V/f>[1]: Device Planning Parameters.	345
9.34.2	V/f>[1]: Global Parameters	345
9.34.3	V/f>[1]: Setting Group Parameters.	345
9.34.4	V/f>[1]: Input States	347
9.34.5	V/f>[1]: Signals (Output States).	347
9.35	InEn	349
9.35.1	InEn: Device Planning Parameters	349
9.35.2	InEn: Global Parameters.	349
9.35.3	InEn: Setting Group Parameters.	350
9.35.4	InEn: Input States.	351
9.35.5	InEn: Signals (Output States).	352
9.36	Z[1] . . . Z[2]	353
9.36.1	Z[1]: Device Planning Parameters	353
9.36.2	Z[1]: Global Parameters.	353
9.36.3	Z[1]: Setting Group Parameters	355
9.36.4	Z[1]: Input States.	364
9.36.5	Z[1]: Signals (Output States)	365
9.37	LB.	367
9.37.1	LB: Device Planning Parameters.	367
9.37.2	LB: Global Parameters	367

9.37.3	LB: Setting Group Parameters	367
9.37.4	LB: Input States	369
9.37.5	LB: Signals (Output States)	369
9.38	PSB	370
9.38.1	PSB: Device Planning Parameters	370
9.38.2	PSB: Global Parameters	370
9.38.3	PSB: Setting Group Parameters	370
9.38.4	PSB: Input States	373
9.38.5	PSB: Signals (Output States)	373
9.39	SOTF	376
9.39.1	SOTF: Device Planning Parameters	376
9.39.2	SOTF: Global Parameters	376
9.39.3	SOTF: Setting Group Parameters	377
9.39.4	SOTF: Input States	378
9.39.5	SOTF: Signals (Output States)	378
9.40	CLPU	380
9.40.1	CLPU: Device Planning Parameters	380
9.40.2	CLPU: Global Parameters	380
9.40.3	CLPU: Setting Group Parameters	381
9.40.4	CLPU: Input States	382
9.40.5	CLPU: Signals (Output States)	382
9.41	Exp[1] ... Exp[4]	384
9.41.1	Exp[1]: Device Planning Parameters	384
9.41.2	Exp[1]: Global Parameters	384
9.41.3	Exp[1]: Setting Group Parameters	385
9.41.4	Exp[1]: Input States	386
9.41.5	Exp[1]: Signals (Output States)	386
9.42	Ext Sudd Press	388
9.42.1	Ext Sudd Press: Device Planning Parameters	388
9.42.2	Ext Sudd Press: Global Parameters	388
9.42.3	Ext Sudd Press: Setting Group Parameters	389
9.42.4	Ext Sudd Press: Input States	390
9.42.5	Ext Sudd Press: Signals (Output States)	390
9.43	Ext Oil Temp	392
9.43.1	Ext Oil Temp: Device Planning Parameters	392
9.43.2	Ext Oil Temp: Global Parameters	392
9.43.3	Ext Oil Temp: Setting Group Parameters	393
9.43.4	Ext Oil Temp: Input States	394
9.43.5	Ext Oil Temp: Signals (Output States)	394
9.44	Ext Temp Superv[1] ... Ext Temp Superv[3]	396
9.44.1	Ext Temp Superv[1]: Device Planning Parameters	396
9.44.2	Ext Temp Superv[1]: Global Parameters	396
9.44.3	Ext Temp Superv[1]: Setting Group Parameters	397
9.44.4	Ext Temp Superv[1]: Input States	398

9.44.5	Ext Temp Superv[1]: Signals (Output States)	398
9.45	URTD	400
9.45.1	URTD: Global Parameters	400
9.45.2	URTD: Direct Controls	400
9.45.3	URTD: Signals (Output States)	404
9.45.4	URTD: Values	405
9.45.5	URTD: Statistical Values	406
9.46	RTD	408
9.46.1	RTD: Device Planning Parameters	408
9.46.2	RTD: Global Parameters	408
9.46.3	RTD: Setting Group Parameters	409
9.46.4	RTD: Input States	423
9.46.5	RTD: Signals (Output States)	423
9.46.6	RTD: Counters	432
9.47	AnaP[1] AnaP[4].	433
9.47.1	AnaP[1]: Device Planning Parameters	433
9.47.2	AnaP[1]: Global Parameters	433
9.47.3	AnaP[1]: Setting Group Parameters	434
9.47.4	AnaP[1]: Input States	435
9.47.5	AnaP[1]: Signals (Output States)	435
9.48	Supervision.	437
9.48.1	CBF.	437
9.48.2	TCS.	441
9.48.3	CTS.	444
9.48.4	LOP.	447
10	Control	451
10.1	Ctrl: Device Planning Parameters.	451
10.2	Ctrl: Global Parameters	451
10.3	Ctrl: Direct Controls	451
10.4	Ctrl: Input States	452
10.5	Ctrl: Signals (Output States).	452
10.6	Ctrl: Values.	453
10.7	SG[1] SG[6].	454
10.7.1	SG[1]: Global Parameters.	454
10.7.2	SG[1]: Direct Controls	458
10.7.3	SG[1]: Input States.	459
10.7.4	SG[1]: Signals (Output States).	460
10.7.5	Breaker Wear	464
11	System Alarms	470
11.1	SysA: Device Planning Parameters.	470
11.2	SysA: Global Parameters	470
11.3	SysA: Input States	471
11.4	SysA: Signals (Output States).	471

12	Records	474
12.1	Event rec	474
12.1.1	Event rec: Direct Controls	474
12.1.2	Event rec: Signals (Output States)	474
12.2	Disturb rec	475
12.2.1	Disturb rec: Global Parameters	475
12.2.2	Disturb rec: Direct Controls	476
12.2.3	Disturb rec: Input States	476
12.2.4	Disturb rec: Signals (Output States)	476
12.2.5	Disturb rec: Values	477
12.3	Fault rec	478
12.3.1	Fault rec: Global Parameters	478
12.3.2	Fault rec: Direct Controls	478
12.3.3	Fault rec: Signals (Output States)	478
12.4	Trend rec	479
12.4.1	Trend rec: Global Parameters	479
12.4.2	Trend rec: Direct Controls	481
12.4.3	Trend rec: Signals (Output States)	481
12.4.4	Trend rec: Counters	481
13	Logic	482
13.1	Logics	482
13.1.1	Logics: Device Planning Parameters	482
13.1.2	Logics ... Logics	483
14	Self-Supervision	486
14.1	SSV: Direct Controls	486
14.2	SSV: Signals (Output States)	486
14.3	SSV: Counters	486
15	Service	487
15.1	Sgen	488
15.1.1	Sgen: Device Planning Parameters	488
15.1.2	Sgen: Global Parameters	488
15.1.3	Sgen: Direct Controls	489
15.1.4	Sgen: Input States	489
15.1.5	Sgen: Signals (Output States)	490
15.1.6	Sgen: Values	491
15.1.7	Sgen	492
15.1.8	Sgen ... Sgen	496
16	Selection Lists	500
17	Index	846

1 About This Reference Manual

This document is a reference of all the Setting Values, Direct Commands and Signals of the MCDGV4. In other words, it lists all parameters that are available (or can be made available) with the (optionally) full featured versions of the MCDGV4 protection device.

CAUTION!



This document does not intend to give long and/or detailed description, nor does it intend to replace the full Technical Manual in any way. Only a quite short description is given for each parameter.

This document is a reference of all the Setting Values, Direct Commands and Signals of the MCDGV4.

Every HighPROTEC protection device operates using a lot of digital values of various types. Throughout our Technical Documentation, we are talking of “settings” (or “parameters”) or “signals” or “(measured) values”, depending on the type.

Please consult the Technical Manual, in particular Chapter “Modules, Settings, Signals and Values”, for details of the existing data types.

Modules

The firmware of every HighPROTEC protection device can be thought of being sub-divided in several independent function blocks, the so-called “modules”. Every protection function, for example, is a module of its own. But one of the fundamental concepts of a HighPROTEC protection device is to implement this with great consequence: The functionality of calculating statistical data is a module (named »Statistics«), every communication protocol is a module, the control of switchgear devices is a module (named »Ctrl«), but the properties of the switchgear itself is part of another module. There is even a general protection module (named »Prot«) that interacts all specific protection modules.

Every parameter, every value and every signal is therefore a member of some module.

But note that the settings dialogs (on the panel (HMI) or in the *Smart view* operating software) often omit the module name whenever it is clear from the menu branch. This means the parameters are often displayed only with their individual parameter names, i. e. simply »Function« instead of the full-blown »I[1] . Function«. This increases the overview and simplifies all configuration and operation work; however, it is good to know that the writing »Function« is just an abbreviation. In fact, **every** parameter **always** belongs to a module, and therefore – to make this concept absolutely clear – the reference tables have always the module name added in front of every parameter name

Especially for protection functions it is often required to have several instances active. For example, overcurrent protection usually has several “stages”, and all of these are running at the same time (using their individual setting values). Therefore it is an important feature of every HighPROTEC protection device that a lot of modules exist in several “instances”, which are numbered (in brackets): For the overcurrent protection, for example: »I[1]«, I[2]«, ...

In the reference tables, usually every module has its own dedicated chapter, which lists the available number of instances at the beginning. Then, however, in the sub-chapters listing the various parameter types, only the first instance (e. g. »I[1]«) is mentioned, because all the other instances are identical anyway.









Structure of a Reference Table

Since (almost) every module can be activated or deactivated independently of the other modules and all parameters of an inactive module disappear from the menu branch it would not be helpful if this Reference Manual would list parameters sorted according to the menu structure. Instead, we list categories of modules (e. g. “Protection Functions”) and all the modules within a category.

For each parameter, there is a table with its properties, looking like this:

Module . Parameter	[Menu Path to This Parameter]	
Default Value	Value Range	Perm.
For some parameters:		
• Availability restrictions		
Type <i>Short descriptive text explaining the functionality of this parameter.</i>		

“Type” is the data type of the parameter, which is denoted by a small icon. The following types are possible:



-  Setting Parameter
-  Direct Control
-  Input State
-  Signal (Output State)
-  Statistical Value
-  Counter
-  (Measuring) Value
-  Dialog — Such a dialog can feature several data objects using a special representation and/or functionality.

“Perm.” means “permission”, i. e. the access level and password that is required to modify the parameter. (Please refer to the “Security” chapter in the full Technical Manual for details.)

“ Adapt. Param.” means that this parameter supports Adaptive Parameter Sets. (See the “Adaptive Parameter Sets” section in the User Manual.)

For some parameter types (e. g. Input and Output States), the second row (default, value range, permission) is useless and therefore omitted.

Example of a parameter:

I[1] . Mode	[Device planning]	
non directional	Selection List  Mode: -, non directional, forward, reverse	S.3
 <i>general operation mode</i>		

This means that one can find the parameter in the menu [Device planning], and its values are picked from a selection list named "Mode". The "↔" arrow indicates a cross-reference (hyperlink) into the "Selection Lists" chapter, and a click takes you to a table that lists all available choices. The access level "S.3" means the access level "Supervisor-Lv3", which is required to modify the parameter.

Audience of This Manual

The manual serves as working basis for:

- Engineers in the protection field,
- commissioning engineers,
- people dealing with setting, testing and maintenance of protection and control devices,
- as well as trained personnel for electrical installations and power stations.

All functions concerning the MCDGV4 are listed. Should there be a description of any functions, parameters or inputs/outputs which do not apply to the device in use, please ignore that information.

This manual describes the (optionally) full featured versions of the devices.

All technical information and data included in this manual reflect their state at the time this document was issued. We reserve the right to carry out technical modifications in line with further development without changing this manual and without previous notice. Hence no claim can be brought based on the information and descriptions this manual includes.

We do not accept any liability for damage and operational failures caused by operating errors or disregarding the directions of this manual.

No part of this manual is allowed to be reproduced or passed on to others in any form, unless *Woodward* have approved in writing.

This Reference Manual is part of the delivery scope when purchasing the device. In case the device is passed on (sold) to a third party, the manual has to be handed over as well.

Information Concerning Liability and Warranty

Woodward does not accept any liability for damage resulting from conversions or changes carried out on the device or planning (projecting) work, parameter setting or adjustment changes done by the customer.

The warranty expires after a device has been opened by others than *Woodward* specialists.

Warranty and liability conditions stated in *Woodward* General Terms and Conditions are not supplemented by the above mentioned explanations.

2 Hardware

2.1 Device Configuration

Generator Protection													
MCDGV4	-2	#	#	#	#	#							
Hardware Variant 1													
16 digital inputs 11 binary output relays Operating Range Voltage measuring inputs: 0-800VAC							A						
8 digital inputs 11 binary output relays 2 Analog Inputs 2 Analog Outputs Operating Range Voltage measuring inputs: 0-800VAC							B						
24 digital inputs 11 binary output relays Operating Range Voltage measuring inputs: 0-300VAC							C						
16 digital inputs 16 binary output relays Operating Range Voltage measuring inputs: 0-300VAC							D						
Hardware Variant 2													
Phase Current 5A/1A, Ground Current 5A/1A							0						
Phase Current 5A/1A, Sensitive Ground Current 5A/1A							1						
Housing													
Flush mounting							A						
19 inch mounting (semi-flush)							B						
Customized Version 1							H						
Customized Version 2							K						
Communication													
Without							A						
RS 485: Modbus RTU IEC 60870-5-103 DNP3 RTU							B						
Ethernet: Modbus TCP DNP3 UDP/TCP IEC 60870-5-104							C						
Fiber Optics: Profibus-DP							D						
D-SUB: Profibus-DP							E						
Fiber Optics: Modbus RTU IEC 60870-5-103 DNP3 RTU							F						
RS 485/D-SUB: Modbus RTU IEC 60870-5-103 DNP3 RTU							G						
Ethernet: IEC 61850 communication Modbus TCP DNP3 UDP/TCP IEC 60870-5-104							H						
RS 485, Ethernet: Modbus TCP/RTU IEC 60870-5-103 IEC 60870-5-104 DNP3 UDP/TCP/RTU							I						

Generator Protection						
MCDGV4	-2	#	#	#	#	#
Ethernet/Fiber Optics: IEC 61850 communication Modbus TCP DNP3 UDP/TCP IEC 60870-5-104					K	
Ethernet/Fiber Optics: Modbus TCP DNP3 UDP/TCP IEC 60870-5-104					L	
RS 485, Ethernet: IEC 61850 Modbus TCP/RTU IEC 60870-5-103 IEC 60870-5-104 DNP3 UDP/TCP/RTU					T	
Printed Circuit Board						
Standard					A	
printed circuit boards are conformal coated					B	

2.2 Digital Inputs

2.2.1 DI Slot X1 (“DI8-X1”)

DI Slot X1 . Nom voltage	[Device Para / Digital Inputs / DI Slot X1 / Group 1] [Device Para / Digital Inputs / DI Slot X1 / Group 2] [Device Para / Digital Inputs / DI Slot X1 / Group 3]	
24 VDC	24 VDC, 48 VDC, 60 VDC, 110 VDC, 230 VDC, 110 VAC, 230 VAC ↳ Nom voltage.	S.3
 <i>Nominal voltage of the digital inputs</i>		

DI Slot X1 . Inverting 1 ... DI Slot X1 . Inverting 8	[Device Para / Digital Inputs / DI Slot X1 / Group 1] [Device Para / Digital Inputs / DI Slot X1 / Group 2] [Device Para / Digital Inputs / DI Slot X1 / Group 3]	
inactive	inactive, active ↳ Mode.	S.3
 <i>Inverting the input signals.</i>		

DI Slot X1 . Debouncing time 1 ... DI Slot X1 . Debouncing time 8	[Device Para / Digital Inputs / DI Slot X1 / Group 1] [Device Para / Digital Inputs / DI Slot X1 / Group 2] [Device Para / Digital Inputs / DI Slot X1 / Group 3]	
no debouncing time	no debouncing time, 20 ms, 50 ms, 100 ms ↳ Debouncing time.	S.3
 <i>A change of the state of a digital input will only be recognized after the debouncing time has expired (become effective). Thus, transient signals will not be misinterpreted.</i>		

DI Slot X1 . DI 1 ... DI Slot X1 . DI 8	[Device Para / Digital Inputs / DI Slot X1 / Group 1] [Device Para / Digital Inputs / DI Slot X1 / Group 2] [Device Para / Digital Inputs / DI Slot X1 / Group 3]	
 <i>Signal: Digital Input</i>		

2.2.2 DI Slot X5

DI Slot X5 . Nom voltage	[Device Para / Digital Inputs / DI Slot X5 / Group 1]	
24 VDC	24 VDC, 48 VDC, 60 VDC, 110 VDC, 230 VDC, 110 VAC, 230 VAC ↳ Nom voltage.	S.3
 <i>Nominal voltage of the digital inputs</i>		

DI Slot X5 . Inverting 1 ... DI Slot X5 . Inverting 8	[Device Para / Digital Inputs / DI Slot X5 / Group 1]	
inactive	inactive, active ↳ Mode.	S.3
 <i>Inverting the input signals.</i>		

DI Slot X5 . Debouncing time 1 ... DI Slot X5 . Debouncing time 8	[Device Para / Digital Inputs / DI Slot X5 / Group 1]	
no debouncing time	no debouncing time, 20 ms, 50 ms, 100 ms ↳ Debouncing time.	S.3
 <i>A change of the state of a digital input will only be recognized after the debouncing time has expired (become effective). Thus, transient signals will not be misinterpreted.</i>		

DI Slot X5 . DI 1 ... DI Slot X5 . DI 8	[Device Para / Digital Inputs / DI Slot X5 / Group 1]	
 <i>Signal: Digital Input</i>		

2.2.3 DI Slot X6

DI Slot X6 . Nom voltage	[Device Para / Digital Inputs / DI Slot X6 / Group 1]	
24 VDC	24 VDC, 48 VDC, 60 VDC, 110 VDC, 230 VDC, 110 VAC, 230 VAC ↳ Nom voltage.	S.3
 <i>Nominal voltage of the digital inputs</i>		

DI Slot X6 . Inverting 1 ... DI Slot X6 . Inverting 8	[Device Para / Digital Inputs / DI Slot X6 / Group 1]	
inactive	inactive, active ↳ Mode.	S.3
 <i>Inverting the input signals.</i>		

DI Slot X6 . Debouncing time 1 ... DI Slot X6 . Debouncing time 8	[Device Para / Digital Inputs / DI Slot X6 / Group 1]	
no debouncing time	no debouncing time, 20 ms, 50 ms, 100 ms ↳ Debouncing time.	S.3
 <i>A change of the state of a digital input will only be recognized after the debouncing time has expired (become effective). Thus, transient signals will not be misinterpreted.</i>		

DI Slot X6 . DI 1 ... DI Slot X6 . DI 8	[Device Para / Digital Inputs / DI Slot X6 / Group 1]	
 <i>Signal: Digital Input</i>		

2.3 Binary Outputs

2.3.1 BO Slot X2 (6 Binary Outputs)

BO Slot X2 . Operating Mode	[Device Para / Binary Outputs / BO Slot X2 / BO 1]	
Normally open (NO)	Normally open (NO), Normally closed (NC) ↳ 1...n Operating Modes.	S.3
 <i>Operating Mode</i>		

BO Slot X2 . t-hold	[Device Para / Binary Outputs / BO Slot X2 / BO 1]	
0.00s	0.00s ... 300.00s	S.3
 <i>To clearly identify the state transition of a binary output relay, the "new state" is being hold, at least for the duration of the hold time.</i>		

BO Slot X2 . t-Off Delay	[Device Para / Binary Outputs / BO Slot X2 / BO 1]	
0.00s	0.00s ... 300.00s	S.3
 <i>Switch Off Delay</i>		

BO Slot X2 . Latched	[Device Para / Binary Outputs / BO Slot X2 / BO 1]	
inactive	inactive, active ↳ Mode.	S.3
 <i>Defines whether the Relay Output will be latched when it picks up.</i>		

BO Slot X2 . Acknowledgement	[Device Para / Binary Outputs / BO Slot X2 / BO 1]	
"_"	"_" ... Sys . Internal test state ↳ 1..n, Assignment List.	S.3
<i>Only available if:</i>		
• BO Slot X2 . Latched = active		
 <i>Acknowledgement Signal - An acknowledgement signal (that acknowledges the corresponding binary output relay) can be assigned to each output relay. The acknowledgement-signal is only effective if the parameter "Latched" is set to active.</i>		

BO Slot X2 . Inverting	[Device Para / Binary Outputs / BO Slot X2 / BO 1]	
inactive	inactive, active ↳ Mode.	S.3
 <i>Inverting of the collective signal (OR-gate/disjunction). In combination with inverted input signals an AND-gate can be programmed (Conjunction).</i>		

BO Slot X2 . Assignment 1	[Device Para / Binary Outputs / BO Slot X2 / BO 1]	
SG[1] . TripCmd	“-” ... Sys . Internal test state ↳ 1..n, Assignment List.	S.3
🔗 <i>Assignment</i>		











BO Slot X2 . Inverting 1	[Device Para / Binary Outputs / BO Slot X2 / BO 1]	
...		
BO Slot X2 . Inverting 7		
inactive	inactive, active ↳ Mode.	S.3
🔗 <i>Inverting of the state of the assigned signal.</i>		

BO Slot X2 . Assignment 2	[Device Para / Binary Outputs / BO Slot X2 / BO 1]	
...		
BO Slot X2 . Assignment 7		
“-”	“-” ... Sys . Internal test state ↳ 1..n, Assignment List.	S.3
🔗 <i>Assignment</i>		

BO Slot X2 . Operating Mode	[Device Para / Binary Outputs / BO Slot X2 / BO 2]	
Normally open (NO)	Normally open (NO), Normally closed (NC) ↳ 1...n Operating Modes.	S.3
🔗 <i>Operating Mode</i>		

BO Slot X2 . t-hold	[Device Para / Binary Outputs / BO Slot X2 / BO 2]	
0.00s	0.00s ... 300.00s	S.3
🔗 <i>To clearly identify the state transition of a binary output relay, the "new state" is being hold, at least for the duration of the hold time.</i>		

BO Slot X2 . t-Off Delay	[Device Para / Binary Outputs / BO Slot X2 / BO 2]	
0.00s	0.00s ... 300.00s	S.3
🔗 <i>Switch Off Delay</i>		

BO Slot X2 . Latched	[Device Para / Binary Outputs / BO Slot X2 / BO 2]	
inactive	inactive, active  Mode.	S.3
	<i>Defines whether the Relay Output will be latched when it picks up.</i>	
BO Slot X2 . Acknowledgement	[Device Para / Binary Outputs / BO Slot X2 / BO 2]	
"_"	"_" ... Sys . Internal test state	S.3
Only available if:	 1..n, Assignment List.	
• BO Slot X2 . Latched = active		
	<i>Acknowledgement Signal - An acknowledgement signal (that acknowledges the corresponding binary output relay) can be assigned to each output relay. The acknowledgement-signal is only effective if the parameter "Latched" is set to active.</i>	
BO Slot X2 . Inverting	[Device Para / Binary Outputs / BO Slot X2 / BO 2]	
inactive	inactive, active  Mode.	S.3
	<i>Inverting of the collective signal (OR-gate/disjunction). In combination with inverted input signals an AND-gate can be programmed (Conjunction).</i>	
BO Slot X2 . Assignment 1	[Device Para / Binary Outputs / BO Slot X2 / BO 2]	
Prot . Alarm	"_" ... Sys . Internal test state	S.3
	 1..n, Assignment List.	
	<i>Assignment</i>	
BO Slot X2 . Inverting 1	[Device Para / Binary Outputs / BO Slot X2 / BO 2]	
...		
BO Slot X2 . Inverting 7	[Device Para / Binary Outputs / BO Slot X2 / BO 2]	
inactive	inactive, active  Mode.	S.3
	<i>Inverting of the state of the assigned signal.</i>	

BO Slot X2 . Assignment 2	[Device Para / Binary Outputs / BO Slot X2 / BO 2]	
...		
BO Slot X2 . Assignment 7		
"_"	"_" ... Sys . Internal test state ↳ 1..n, Assignment List.	S.3
 Assignment		

BO Slot X2 . Operating Mode	[Device Para / Binary Outputs / BO Slot X2 / BO 3]	
Normally open (NO)	Normally open (NO), Normally closed (NC) ↳ 1...n Operating Modes.	S.3
 Operating Mode		

BO Slot X2 . t-hold	[Device Para / Binary Outputs / BO Slot X2 / BO 3]	
0.00s	0.00s ... 300.00s	S.3
 To clearly identify the state transition of a binary output relay, the "new state" is being hold, at least for the duration of the hold time.		

BO Slot X2 . t-Off Delay	[Device Para / Binary Outputs / BO Slot X2 / BO 3]	
0.00s	0.00s ... 300.00s	S.3
 Switch Off Delay		

BO Slot X2 . Latched	[Device Para / Binary Outputs / BO Slot X2 / BO 3]	
inactive	inactive, active ↳ Mode.	S.3
 Defines whether the Relay Output will be latched when it picks up.		

BO Slot X2 . Acknowledgement	[Device Para / Binary Outputs / BO Slot X2 / BO 3]	
"_"	"_" ... Sys . Internal test state	S.3
Only available if:	↳ 1..n, Assignment List.	
• BO Slot X2 . Latched = active		
 Acknowledgement Signal - An acknowledgement signal (that acknowledges the corresponding binary output relay) can be assigned to each output relay. The acknowledgement-signal is only effective if the parameter "Latched" is set to active.		

BO Slot X2 . Inverting		[Device Para / Binary Outputs / BO Slot X2 / BO 3]
inactive	inactive, active	S.3
	↳ Mode.	
 <i>Inverting of the collective signal (OR-gate/disjunction). In combination with inverted input signals an AND-gate can be programmed (Conjunction).</i>		

BO Slot X2 . Assignment 1		[Device Para / Binary Outputs / BO Slot X2 / BO 3]
SG[1] . ON Cmd	"-" ... Sys . Internal test state	S.3
	↳ 1..n, Assignment List.	
 <i>Assignment</i>		



BO Slot X2 . Inverting 1		[Device Para / Binary Outputs / BO Slot X2 / BO 3]
...		
BO Slot X2 . Inverting 7		
inactive	inactive, active	S.3
	↳ Mode.	
 <i>Inverting of the state of the assigned signal.</i>		



BO Slot X2 . Assignment 2		[Device Para / Binary Outputs / BO Slot X2 / BO 3]
...		
BO Slot X2 . Assignment 7		
"-"	"-" ... Sys . Internal test state	S.3
	↳ 1..n, Assignment List.	
 <i>Assignment</i>		



BO Slot X2 . Operating Mode		[Device Para / Binary Outputs / BO Slot X2 / BO 4]
Normally open (NO)	Normally open (NO), Normally closed (NC)	S.3
	↳ 1...n Operating Modes.	
 <i>Operating Mode</i>		



BO Slot X2 . t-hold		[Device Para / Binary Outputs / BO Slot X2 / BO 4]
0.00s	0.00s ... 300.00s	S.3
	<i>To clearly identify the state transition of a binary output relay, the "new state" is being hold, at least for the duration of the hold time.</i>	

BO Slot X2 . t-Off Delay		[Device Para / Binary Outputs / BO Slot X2 / BO 4]
0.00s	0.00s ... 300.00s	S.3
	<i>Switch Off Delay</i>	

BO Slot X2 . Latched		[Device Para / Binary Outputs / BO Slot X2 / BO 4]
inactive	inactive, active  Mode.	S.3
	<i>Defines whether the Relay Output will be latched when it picks up.</i>	

BO Slot X2 . Acknowledgement		[Device Para / Binary Outputs / BO Slot X2 / BO 4]
"-"	"-" ... Sys . Internal test state  1..n, Assignment List.	S.3
<i>Only available if:</i>		
<ul style="list-style-type: none"> • BO Slot X2 . Latched = active 		
	<i>Acknowledgement Signal - An acknowledgement signal (that acknowledges the corresponding binary output relay) can be assigned to each output relay. The acknowledgement-signal is only effective if the parameter "Latched" is set to active.</i>	

BO Slot X2 . Inverting		[Device Para / Binary Outputs / BO Slot X2 / BO 4]
inactive	inactive, active  Mode.	S.3
	<i>Inverting of the collective signal (OR-gate/disjunction). In combination with inverted input signals an AND-gate can be programmed (Conjunction).</i>	

BO Slot X2 . Assignment 1		[Device Para / Binary Outputs / BO Slot X2 / BO 4]
SG[1] . OFF Cmd	"-" ... Sys . Internal test state  1..n, Assignment List.	S.3
	<i>Assignment</i>	

BO Slot X2 . Inverting 1	[Device Para / Binary Outputs / BO Slot X2 / BO 4]	
...		
BO Slot X2 . Inverting 7		
inactive	inactive, active ↳ Mode.	S.3
 <i>Inverting of the state of the assigned signal.</i>		

BO Slot X2 . Assignment 2	[Device Para / Binary Outputs / BO Slot X2 / BO 4]	
...		
BO Slot X2 . Assignment 7		
"_"	"_" ... Sys . Internal test state ↳ 1..n, Assignment List.	S.3
 <i>Assignment</i>		

BO Slot X2 . Operating Mode	[Device Para / Binary Outputs / BO Slot X2 / BO 5]	
Normally open (NO)	Normally open (NO), Normally closed (NC) ↳ 1...n Operating Modes.	S.3
 <i>Operating Mode</i>		

BO Slot X2 . t-hold	[Device Para / Binary Outputs / BO Slot X2 / BO 5]	
0.00s	0.00s ... 300.00s	S.3
 <i>To clearly identify the state transition of a binary output relay, the "new state" is being hold, at least for the duration of the hold time.</i>		

BO Slot X2 . t-Off Delay	[Device Para / Binary Outputs / BO Slot X2 / BO 5]	
0.00s	0.00s ... 300.00s	S.3
 <i>Switch Off Delay</i>		

BO Slot X2 . Latched	[Device Para / Binary Outputs / BO Slot X2 / BO 5]	
inactive	inactive, active ↳ Mode.	S.3
 <i>Defines whether the Relay Output will be latched when it picks up.</i>		

BO Slot X2 . Acknowledgement		[Device Para / Binary Outputs / BO Slot X2 / BO 5]	
“-”	“-” ... Sys . Internal test state		S.3
Only available if:	↳ 1..n, Assignment List.		
• BO Slot X2 . Latched = active			
	<i>Acknowledgement Signal - An acknowledgement signal (that acknowledges the corresponding binary output relay) can be assigned to each output relay. The acknowledgement-signal is only effective if the parameter "Latched" is set to active.</i>		

BO Slot X2 . Inverting		[Device Para / Binary Outputs / BO Slot X2 / BO 5]	
inactive	inactive, active		S.3
	↳ Mode.		
	<i>Inverting of the collective signal (OR-gate/disjunction). In combination with inverted input signals an AND-gate can be programmed (Conjunction).</i>		



BO Slot X2 . Assignment 1		[Device Para / Binary Outputs / BO Slot X2 / BO 5]	
...			
BO Slot X2 . Assignment 7			
“-”	“-” ... Sys . Internal test state		S.3
	↳ 1..n, Assignment List.		
	<i>Assignment</i>		



BO Slot X2 . Inverting 1		[Device Para / Binary Outputs / BO Slot X2 / BO 5]	
...			
BO Slot X2 . Inverting 7			
inactive	inactive, active		S.3
	↳ Mode.		
	<i>Inverting of the state of the assigned signal.</i>		



BO Slot X2 . Operating Mode		[Device Para / Binary Outputs / BO Slot X2 / BO 6]	
Normally open (NO)	Normally open (NO), Normally closed (NC)		S.3
	↳ 1...n Operating Modes.		
	<i>Operating Mode</i>		



BO Slot X2 . t-hold		[Device Para / Binary Outputs / BO Slot X2 / BO 6]	
0.00s		0.00s ... 300.00s	S.3
	<i>To clearly identify the state transition of a binary output relay, the "new state" is being hold, at least for the duration of the hold time.</i>		



BO Slot X2 . t-Off Delay		[Device Para / Binary Outputs / BO Slot X2 / BO 6]	
0.00s		0.00s ... 300.00s	S.3
	<i>Switch Off Delay</i>		

BO Slot X2 . Latched		[Device Para / Binary Outputs / BO Slot X2 / BO 6]	
inactive		inactive, active  Mode.	S.3
	<i>Defines whether the Relay Output will be latched when it picks up.</i>		

BO Slot X2 . Acknowledgement		[Device Para / Binary Outputs / BO Slot X2 / BO 6]	
"_"		"_" ... Sys . Internal test state  1..n, Assignment List.	S.3
<i>Only available if:</i>			
<ul style="list-style-type: none"> • BO Slot X2 . Latched = active 			
	<i>Acknowledgement Signal - An acknowledgement signal (that acknowledges the corresponding binary output relay) can be assigned to each output relay. The acknowledgement-signal is only effective if the parameter "Latched" is set to active.</i>		

BO Slot X2 . Inverting		[Device Para / Binary Outputs / BO Slot X2 / BO 6]	
inactive		inactive, active  Mode.	S.3
	<i>Inverting of the collective signal (OR-gate/disjunction). In combination with inverted input signals an AND-gate can be programmed (Conjunction).</i>		

BO Slot X2 . Assignment 1		[Device Para / Binary Outputs / BO Slot X2 / BO 6]	
...			
BO Slot X2 . Assignment 7			
"_"		"_" ... Sys . Internal test state  1..n, Assignment List.	S.3
	<i>Assignment</i>		

BO Slot X2 . Inverting 1 ... BO Slot X2 . Inverting 7	[Device Para / Binary Outputs / BO Slot X2 / BO 6]	
inactive	inactive, active  Mode.	S.3
 <i>Inverting of the state of the assigned signal.</i>		



2.3.1.1 BO Slot X2: Service

BO Slot X2 . DISARMED Ctrl		[Service / Test (Prot inhibit) / DISARMED / BO Slot X2]
inactive	inactive, active	S.3
	↳ active/inactive.	
	<i>Enables and disables the disarming of the relay outputs. This is the first step of a two step process, to inhibit the operation or the relay outputs. Please refer to "DISARMED" for the second step.</i>	



BO Slot X2 . Disarm Mode		[Service / Test (Prot inhibit) / DISARMED / BO Slot X2]
permanent	permanent, timeout	S.3
	↳ Mode.	
	<i>CAUTION! RELAYS DISARMED in order to safely perform maintenance while eliminating the risk of taking an entire process off-line. (Note: The Supervision Contact cannot be disarmed). YOU MUST ENSURE that the relays are ARMED AGAIN after maintenance.</i>	



BO Slot X2 . t-Timeout DISARM		[Service / Test (Prot inhibit) / DISARMED / BO Slot X2]
0.03s	0.00s ... 300.00s	S.3
<i>Only available if:</i>		
<ul style="list-style-type: none"> • BO Slot X2 . Disarm Mode = timeout 		
	<i>The relays will be armed again after expiring of this time.</i>	

BO Slot X2 . DISARMED		[Service / Test (Prot inhibit) / DISARMED / BO Slot X2]
inactive	inactive, active	S.3
	↳ active/inactive.	
	<i>This is the second step, after the "DISARMED Ctrl" has been activated, that is required to DISARM the relay outputs. This will DISARM those output relays that are currently not latched and that are not on "hold" by a pending minimum hold time. CAUTION! RELAYS DISARMED in order to safely perform maintenance while eliminating the risk of taking an entire process off-line. (Note: Zone Interlocking and Supervision Contact cannot be disarmed). YOU MUST ENSURE that the relays are ARMED AGAIN after maintenance.</i>	

BO Slot X2 . Force Mode	[Service / Test (Prot inhibit) / Force OR / BO Slot X2]	
permanent	permanent, timeout  Mode.	S.3
	<i>By means of this function the normal Output Relay States can be overwritten (forced) in case that the Relay is not in a disarmed state. The relays can be set from normal operation (relay works according to the assigned signals) to "force energized" or "force de-energized" state.</i>	

BO Slot X2 . t-Timeout Force	[Service / Test (Prot inhibit) / Force OR / BO Slot X2]	
0.03s Only available if: • BO Slot X2 . Force Mode = timeout	0.00s ... 300.00s	S.3
	<i>The Output State will be set by force for the duration of this time. That means for the duration of this time the Output Relay does not show the state of the signals that are assigned on it.</i>	

BO Slot X2 . Force all Outs	[Service / Test (Prot inhibit) / Force OR / BO Slot X2]	
Normal	Normal, De-Energized, Energized  Relay operating modes.	S.3
	<i>By means of this function the normal Output Relay State can be overwritten (forced). The relay can be set from normal operation (relay works according to the assigned signals) to "force energized" or "force de-energized" state. Forcing all outputs relays of an entire assembly group is superior to forcing a single output relay.</i>	

BO Slot X2 . Force OR1 ... BO Slot X2 . Force OR6	[Service / Test (Prot inhibit) / Force OR / BO Slot X2]	
Normal	Normal, De-Energized, Energized  Relay operating modes.	S.3
	<i>By means of this function the normal Output Relay State can be overwritten (forced). The relay can be set from normal operation (relay works according to the assigned signals) to "force energized" or "force de-energized" state.</i>	

2.3.2 BO Slot X5 (4 Binary Outputs)

BO Slot X5 . Operating Mode	[Device Para / Binary Outputs / BO Slot X5 / BO 1]	
Normally open (NO)	Normally open (NO), Normally closed (NC)	S.3
	↳ 1...n Operating Modes.	
 <i>Operating Mode</i>		

BO Slot X5 . t-hold	[Device Para / Binary Outputs / BO Slot X5 / BO 1]	
0.00s	0.00s ... 300.00s	S.3
 <i>To clearly identify the state transition of a binary output relay, the "new state" is being hold, at least for the duration of the hold time.</i>		

BO Slot X5 . t-Off Delay	[Device Para / Binary Outputs / BO Slot X5 / BO 1]	
0.00s	0.00s ... 300.00s	S.3
 <i>Switch Off Delay</i>		

BO Slot X5 . Latched	[Device Para / Binary Outputs / BO Slot X5 / BO 1]	
inactive	inactive, active	S.3
	↳ Mode.	
 <i>Defines whether the Relay Output will be latched when it picks up.</i>		

BO Slot X5 . Acknowledgement	[Device Para / Binary Outputs / BO Slot X5 / BO 1]	
"_"	"_" ... Sys . Internal test state	S.3
<i>Only available if:</i>	↳ 1..n, Assignment List.	
<ul style="list-style-type: none"> • BO Slot X5 . Latched = active 		
 <i>Acknowledgement Signal - An acknowledgement signal (that acknowledges the corresponding binary output relay) can be assigned to each output relay. The acknowledgement-signal is only effective if the parameter "Latched" is set to active.</i>		

BO Slot X5 . Inverting	[Device Para / Binary Outputs / BO Slot X5 / BO 1]	
inactive	inactive, active	S.3
	↳ Mode.	
 <i>Inverting of the collective signal (OR-gate/disjunction). In combination with inverted input signals an AND-gate can be programmed (Conjunction).</i>		

BO Slot X5 . Assignment 1	[Device Para / Binary Outputs / BO Slot X5 / BO 1]	
...		
BO Slot X5 . Assignment 7		
"-"	"-" ... Sys . Internal test state ↳ 1..n, Assignment List.	S.3
 <i>Assignment</i>		



BO Slot X5 . Inverting 1	[Device Para / Binary Outputs / BO Slot X5 / BO 1]	
...		
BO Slot X5 . Inverting 7		
inactive	inactive, active ↳ Mode.	S.3
 <i>Inverting of the state of the assigned signal.</i>		



BO Slot X5 . Operating Mode	[Device Para / Binary Outputs / BO Slot X5 / BO 2]	
Normally open (NO)	Normally open (NO), Normally closed (NC) ↳ 1...n Operating Modes.	S.3
 <i>Operating Mode</i>		



BO Slot X5 . t-hold	[Device Para / Binary Outputs / BO Slot X5 / BO 2]	
0.00s	0.00s ... 300.00s	S.3
 <i>To clearly identify the state transition of a binary output relay, the "new state" is being hold, at least for the duration of the hold time.</i>		



BO Slot X5 . t-Off Delay	[Device Para / Binary Outputs / BO Slot X5 / BO 2]	
0.00s	0.00s ... 300.00s	S.3
 <i>Switch Off Delay</i>		



BO Slot X5 . Latched	[Device Para / Binary Outputs / BO Slot X5 / BO 2]	
inactive	inactive, active ↳ Mode.	S.3
 <i>Defines whether the Relay Output will be latched when it picks up.</i>		

BO Slot X5 . Acknowledgement		[Device Para / Binary Outputs / BO Slot X5 / BO 2]	
“-”	“-” ... Sys . Internal test state		S.3
<i>Only available if:</i> <ul style="list-style-type: none"> • BO Slot X5 . Latched = active 		 1..n, Assignment List.	
	<i>Acknowledgement Signal - An acknowledgement signal (that acknowledges the corresponding binary output relay) can be assigned to each output relay. The acknowledgement-signal is only effective if the parameter "Latched" is set to active.</i>		

BO Slot X5 . Inverting		[Device Para / Binary Outputs / BO Slot X5 / BO 2]	
inactive	inactive, active		S.3
		 Mode.	
	<i>Inverting of the collective signal (OR-gate/disjunction). In combination with inverted input signals an AND-gate can be programmed (Conjunction).</i>		



BO Slot X5 . Assignment 1		[Device Para / Binary Outputs / BO Slot X5 / BO 2]	
...			
BO Slot X5 . Assignment 7			
“-”	“-” ... Sys . Internal test state		S.3
		 1..n, Assignment List.	
	<i>Assignment</i>		



BO Slot X5 . Inverting 1		[Device Para / Binary Outputs / BO Slot X5 / BO 2]	
...			
BO Slot X5 . Inverting 7			
inactive	inactive, active		S.3
		 Mode.	
	<i>Inverting of the state of the assigned signal.</i>		



BO Slot X5 . Operating Mode		[Device Para / Binary Outputs / BO Slot X5 / BO 3]	
Normally open (NO)	Normally open (NO), Normally closed (NC)		S.3
		 1...n Operating Modes.	
	<i>Operating Mode</i>		



BO Slot X5 . t-hold	[Device Para / Binary Outputs / BO Slot X5 / BO 3]	
0.00s	0.00s ... 300.00s	S.3
	<i>To clearly identify the state transition of a binary output relay, the "new state" is being hold, at least for the duration of the hold time.</i>	







BO Slot X5 . t-Off Delay	[Device Para / Binary Outputs / BO Slot X5 / BO 3]	
0.00s	0.00s ... 300.00s	S.3
	<i>Switch Off Delay</i>	



BO Slot X5 . Latched	[Device Para / Binary Outputs / BO Slot X5 / BO 3]	
inactive	inactive, active  Mode.	S.3
	<i>Defines whether the Relay Output will be latched when it picks up.</i>	



BO Slot X5 . Acknowledgement	[Device Para / Binary Outputs / BO Slot X5 / BO 3]	
"_"	"_" ... Sys . Internal test state	S.3
<i>Only available if:</i>	 1..n, Assignment List.	
<ul style="list-style-type: none"> • BO Slot X5 . Latched = active 		
	<i>Acknowledgement Signal - An acknowledgement signal (that acknowledges the corresponding binary output relay) can be assigned to each output relay. The acknowledgement-signal is only effective if the parameter "Latched" is set to active.</i>	



BO Slot X5 . Inverting	[Device Para / Binary Outputs / BO Slot X5 / BO 3]	
inactive	inactive, active  Mode.	S.3
	<i>Inverting of the collective signal (OR-gate/disjunction). In combination with inverted input signals an AND-gate can be programmed (Conjunction).</i>	

BO Slot X5 . Assignment 1	[Device Para / Binary Outputs / BO Slot X5 / BO 3]	
...		
BO Slot X5 . Assignment 7		
"_"	"_" ... Sys . Internal test state	S.3
	 1..n, Assignment List.	
	<i>Assignment</i>	

BO Slot X5 . Inverting 1		[Device Para / Binary Outputs / BO Slot X5 / BO 3]	
...			
BO Slot X5 . Inverting 7			
inactive	inactive, active		S.3
		↳ Mode.	
 <i>Inverting of the state of the assigned signal.</i>			
BO Slot X5 . Operating Mode		[Device Para / Binary Outputs / BO Slot X5 / BO 4]	
Normally open (NO)	Normally open (NO), Normally closed (NC)		S.3
		↳ 1...n Operating Modes.	
 <i>Operating Mode</i>			
BO Slot X5 . t-hold		[Device Para / Binary Outputs / BO Slot X5 / BO 4]	
0.00s	0.00s ... 300.00s		S.3
 <i>To clearly identify the state transition of a binary output relay, the "new state" is being hold, at least for the duration of the hold time.</i>			
BO Slot X5 . t-Off Delay		[Device Para / Binary Outputs / BO Slot X5 / BO 4]	
0.00s	0.00s ... 300.00s		S.3
 <i>Switch Off Delay</i>			
BO Slot X5 . Latched		[Device Para / Binary Outputs / BO Slot X5 / BO 4]	
inactive	inactive, active		S.3
		↳ Mode.	
 <i>Defines whether the Relay Output will be latched when it picks up.</i>			
BO Slot X5 . Acknowledgement		[Device Para / Binary Outputs / BO Slot X5 / BO 4]	
"_"	"_" ... Sys . Internal test state		S.3
<i>Only available if:</i> <ul style="list-style-type: none"> • BO Slot X5 . Latched = active 		↳ 1..n, Assignment List.	
 <i>Acknowledgement Signal - An acknowledgement signal (that acknowledges the corresponding binary output relay) can be assigned to each output relay. The acknowledgement-signal is only effective if the parameter "Latched" is set to active.</i>			

BO Slot X5 . Inverting	[Device Para / Binary Outputs / BO Slot X5 / BO 4]	
inactive	inactive, active  Mode.	S.3
 <i>Inverting of the collective signal (OR-gate/disjunction). In combination with inverted input signals an AND-gate can be programmed (Conjunction).</i>		

BO Slot X5 . Assignment 1	[Device Para / Binary Outputs / BO Slot X5 / BO 4]	
...		
BO Slot X5 . Assignment 7		
"_"	"_" ... Sys . Internal test state  1..n, Assignment List.	S.3
 <i>Assignment</i>		

BO Slot X5 . Inverting 1	[Device Para / Binary Outputs / BO Slot X5 / BO 4]	
...		
BO Slot X5 . Inverting 7		
inactive	inactive, active  Mode.	S.3
 <i>Inverting of the state of the assigned signal.</i>		



2.3.2.1 BO Slot X5: Service

BO Slot X5 . DISARMED Ctrl		[Service / Test (Prot inhibit) / DISARMED / BO Slot X5]
inactive	inactive, active	S.3
	↳ active/inactive.	
	<i>Enables and disables the disarming of the relay outputs. This is the first step of a two step process, to inhibit the operation or the relay outputs. Please refer to "DISARMED" for the second step.</i>	



BO Slot X5 . Disarm Mode		[Service / Test (Prot inhibit) / DISARMED / BO Slot X5]
permanent	permanent, timeout	S.3
	↳ Mode.	
	<i>CAUTION! RELAYS DISARMED in order to safely perform maintenance while eliminating the risk of taking an entire process off-line. (Note: The Supervision Contact cannot be disarmed). YOU MUST ENSURE that the relays are ARMED AGAIN after maintenance.</i>	



BO Slot X5 . t-Timeout DISARM		[Service / Test (Prot inhibit) / DISARMED / BO Slot X5]
0.03s	0.00s ... 300.00s	S.3
<i>Only available if:</i>		
<ul style="list-style-type: none"> • BO Slot X5 . Disarm Mode = timeout 		
	<i>The relays will be armed again after expiring of this time.</i>	

BO Slot X5 . DISARMED		[Service / Test (Prot inhibit) / DISARMED / BO Slot X5]
inactive	inactive, active	S.3
	↳ active/inactive.	
	<i>This is the second step, after the "DISARMED Ctrl" has been activated, that is required to DISARM the relay outputs. This will DISARM those output relays that are currently not latched and that are not on "hold" by a pending minimum hold time. CAUTION! RELAYS DISARMED in order to safely perform maintenance while eliminating the risk of taking an entire process off-line. (Note: Zone Interlocking and Supervision Contact cannot be disarmed). YOU MUST ENSURE that the relays are ARMED AGAIN after maintenance.</i>	

BO Slot X5 . Force Mode	[Service / Test (Prot inhibit) / Force OR / BO Slot X5]	
permanent	permanent, timeout  Mode.	S.3
	<i>By means of this function the normal Output Relay States can be overwritten (forced) in case that the Relay is not in a disarmed state. The relays can be set from normal operation (relay works according to the assigned signals) to "force energized" or "force de-energized" state.</i>	

BO Slot X5 . t-Timeout Force	[Service / Test (Prot inhibit) / Force OR / BO Slot X5]	
0.03s Only available if: • BO Slot X5 . Force Mode = timeout	0.00s ... 300.00s	S.3
	<i>The Output State will be set by force for the duration of this time. That means for the duration of this time the Output Relay does not show the state of the signals that are assigned on it.</i>	

BO Slot X5 . Force all Outs	[Service / Test (Prot inhibit) / Force OR / BO Slot X5]	
Normal	Normal, De-Energized, Energized  Relay operating modes.	S.3
	<i>By means of this function the normal Output Relay State can be overwritten (forced). The relay can be set from normal operation (relay works according to the assigned signals) to "force energized" or "force de-energized" state. Forcing all outputs relays of an entire assembly group is superior to forcing a single output relay.</i>	

BO Slot X5 . Force OR1 ... BO Slot X5 . Force OR4	[Service / Test (Prot inhibit) / Force OR / BO Slot X5]	
Normal	Normal, De-Energized, Energized  Relay operating modes.	S.3
	<i>By means of this function the normal Output Relay State can be overwritten (forced). The relay can be set from normal operation (relay works according to the assigned signals) to "force energized" or "force de-energized" state.</i>	

2.3.3 BO Slot X6 (5 Binary Outputs)

BO Slot X6 . Operating Mode	[Device Para / Binary Outputs / BO Slot X6 / BO 1]	
Normally open (NO)	Normally open (NO), Normally closed (NC)	S.3
	↳ 1...n Operating Modes.	
 <i>Operating Mode</i>		

BO Slot X6 . t-hold	[Device Para / Binary Outputs / BO Slot X6 / BO 1]	
0.00s	0.00s ... 300.00s	S.3
 <i>To clearly identify the state transition of a binary output relay, the "new state" is being hold, at least for the duration of the hold time.</i>		

BO Slot X6 . t-Off Delay	[Device Para / Binary Outputs / BO Slot X6 / BO 1]	
0.00s	0.00s ... 300.00s	S.3
 <i>Switch Off Delay</i>		

BO Slot X6 . Latched	[Device Para / Binary Outputs / BO Slot X6 / BO 1]	
inactive	inactive, active	S.3
	↳ Mode.	
 <i>Defines whether the Relay Output will be latched when it picks up.</i>		

BO Slot X6 . Acknowledgement	[Device Para / Binary Outputs / BO Slot X6 / BO 1]	
"_"	"_" ... Sys . Internal test state	S.3
<i>Only available if:</i>	↳ 1..n, Assignment List.	
<ul style="list-style-type: none"> • BO Slot X6 . Latched = active 		
 <i>Acknowledgement Signal - An acknowledgement signal (that acknowledges the corresponding binary output relay) can be assigned to each output relay. The acknowledgement-signal is only effective if the parameter "Latched" is set to active.</i>		

BO Slot X6 . Inverting	[Device Para / Binary Outputs / BO Slot X6 / BO 1]	
inactive	inactive, active	S.3
	↳ Mode.	
 <i>Inverting of the collective signal (OR-gate/disjunction). In combination with inverted input signals an AND-gate can be programmed (Conjunction).</i>		

BO Slot X6 . Assignment 1	[Device Para / Binary Outputs / BO Slot X6 / BO 1]	
...		
BO Slot X6 . Assignment 7		
"-"	"-" ... Sys . Internal test state ↳ 1..n, Assignment List.	S.3
 Assignment		

BO Slot X6 . Inverting 1	[Device Para / Binary Outputs / BO Slot X6 / BO 1]	
...		
BO Slot X6 . Inverting 7		
inactive	inactive, active ↳ Mode.	S.3
 Inverting of the state of the assigned signal.		

BO Slot X6 . Operating Mode	[Device Para / Binary Outputs / BO Slot X6 / BO 2]	
Normally open (NO)	Normally open (NO), Normally closed (NC) ↳ 1...n Operating Modes.	S.3
 Operating Mode		

BO Slot X6 . t-hold	[Device Para / Binary Outputs / BO Slot X6 / BO 2]	
0.00s	0.00s ... 300.00s	S.3
 To clearly identify the state transition of a binary output relay, the "new state" is being hold, at least for the duration of the hold time.		

BO Slot X6 . t-Off Delay	[Device Para / Binary Outputs / BO Slot X6 / BO 2]	
0.00s	0.00s ... 300.00s	S.3
 Switch Off Delay		

BO Slot X6 . Latched	[Device Para / Binary Outputs / BO Slot X6 / BO 2]	
inactive	inactive, active ↳ Mode.	S.3
 Defines whether the Relay Output will be latched when it picks up.		

BO Slot X6 . Acknowledgement		[Device Para / Binary Outputs / BO Slot X6 / BO 2]	
“-”	“-” ... Sys . Internal test state		S.3
Only available if:	↳ 1..n, Assignment List.		
• BO Slot X6 . Latched = active			
	<i>Acknowledgement Signal - An acknowledgement signal (that acknowledges the corresponding binary output relay) can be assigned to each output relay. The acknowledgement-signal is only effective if the parameter "Latched" is set to active.</i>		

BO Slot X6 . Inverting		[Device Para / Binary Outputs / BO Slot X6 / BO 2]	
inactive	inactive, active		S.3
	↳ Mode.		
	<i>Inverting of the collective signal (OR-gate/disjunction). In combination with inverted input signals an AND-gate can be programmed (Conjunction).</i>		



BO Slot X6 . Assignment 1		[Device Para / Binary Outputs / BO Slot X6 / BO 2]	
...			
BO Slot X6 . Assignment 7			
“-”	“-” ... Sys . Internal test state		S.3
	↳ 1..n, Assignment List.		
	<i>Assignment</i>		



BO Slot X6 . Inverting 1		[Device Para / Binary Outputs / BO Slot X6 / BO 2]	
...			
BO Slot X6 . Inverting 7			
inactive	inactive, active		S.3
	↳ Mode.		
	<i>Inverting of the state of the assigned signal.</i>		



BO Slot X6 . Operating Mode		[Device Para / Binary Outputs / BO Slot X6 / BO 3]	
Normally open (NO)	Normally open (NO), Normally closed (NC)		S.3
	↳ 1...n Operating Modes.		
	<i>Operating Mode</i>		



BO Slot X6 . t-hold	[Device Para / Binary Outputs / BO Slot X6 / BO 3]	
0.00s	0.00s ... 300.00s	S.3
	<i>To clearly identify the state transition of a binary output relay, the "new state" is being hold, at least for the duration of the hold time.</i>	







BO Slot X6 . t-Off Delay	[Device Para / Binary Outputs / BO Slot X6 / BO 3]	
0.00s	0.00s ... 300.00s	S.3
	<i>Switch Off Delay</i>	

BO Slot X6 . Latched	[Device Para / Binary Outputs / BO Slot X6 / BO 3]	
inactive	inactive, active  Mode.	S.3
	<i>Defines whether the Relay Output will be latched when it picks up.</i>	

BO Slot X6 . Acknowledgement	[Device Para / Binary Outputs / BO Slot X6 / BO 3]	
"_"	"_" ... Sys . Internal test state	S.3
<i>Only available if:</i>	 1..n, Assignment List.	
<ul style="list-style-type: none"> • BO Slot X6 . Latched = active 		
	<i>Acknowledgement Signal - An acknowledgement signal (that acknowledges the corresponding binary output relay) can be assigned to each output relay. The acknowledgement-signal is only effective if the parameter "Latched" is set to active.</i>	

BO Slot X6 . Inverting	[Device Para / Binary Outputs / BO Slot X6 / BO 3]	
inactive	inactive, active  Mode.	S.3
	<i>Inverting of the collective signal (OR-gate/disjunction). In combination with inverted input signals an AND-gate can be programmed (Conjunction).</i>	

BO Slot X6 . Assignment 1	[Device Para / Binary Outputs / BO Slot X6 / BO 3]	
...		
BO Slot X6 . Assignment 7	[Device Para / Binary Outputs / BO Slot X6 / BO 3]	
"_"	"_" ... Sys . Internal test state	S.3
	 1..n, Assignment List.	
	<i>Assignment</i>	

BO Slot X6 . Inverting 1		[Device Para / Binary Outputs / BO Slot X6 / BO 3]	
...			
BO Slot X6 . Inverting 7			
inactive	inactive, active		S.3
		↳ Mode.	
 <i>Inverting of the state of the assigned signal.</i>			
BO Slot X6 . Operating Mode		[Device Para / Binary Outputs / BO Slot X6 / BO 4]	
Normally open (NO)	Normally open (NO), Normally closed (NC)		S.3
		↳ 1...n Operating Modes.	
 <i>Operating Mode</i>			
BO Slot X6 . t-hold		[Device Para / Binary Outputs / BO Slot X6 / BO 4]	
0.00s	0.00s ... 300.00s		S.3
 <i>To clearly identify the state transition of a binary output relay, the "new state" is being hold, at least for the duration of the hold time.</i>			
BO Slot X6 . t-Off Delay		[Device Para / Binary Outputs / BO Slot X6 / BO 4]	
0.00s	0.00s ... 300.00s		S.3
 <i>Switch Off Delay</i>			
BO Slot X6 . Latched		[Device Para / Binary Outputs / BO Slot X6 / BO 4]	
inactive	inactive, active		S.3
		↳ Mode.	
 <i>Defines whether the Relay Output will be latched when it picks up.</i>			
BO Slot X6 . Acknowledgement		[Device Para / Binary Outputs / BO Slot X6 / BO 4]	
"_"	"_" ... Sys . Internal test state		S.3
<i>Only available if:</i> <ul style="list-style-type: none"> • BO Slot X6 . Latched = active 		↳ 1..n, Assignment List.	
 <i>Acknowledgement Signal - An acknowledgement signal (that acknowledges the corresponding binary output relay) can be assigned to each output relay. The acknowledgement-signal is only effective if the parameter "Latched" is set to active.</i>			

BO Slot X6 . Inverting		[Device Para / Binary Outputs / BO Slot X6 / BO 4]
inactive	inactive, active	S.3
		↳ Mode.
 <i>Inverting of the collective signal (OR-gate/disjunction). In combination with inverted input signals an AND-gate can be programmed (Conjunction).</i>		





BO Slot X6 . Assignment 1		[Device Para / Binary Outputs / BO Slot X6 / BO 4]
...		
BO Slot X6 . Assignment 7		
"_"	"_" ... Sys . Internal test state	S.3
		↳ 1..n, Assignment List.
 <i>Assignment</i>		

BO Slot X6 . Inverting 1		[Device Para / Binary Outputs / BO Slot X6 / BO 4]
...		
BO Slot X6 . Inverting 7		
inactive	inactive, active	S.3
		↳ Mode.
 <i>Inverting of the state of the assigned signal.</i>		

BO Slot X6 . Operating Mode		[Device Para / Binary Outputs / BO Slot X6 / BO 5]
Normally open (NO)	Normally open (NO), Normally closed (NC)	S.3
		↳ 1...n Operating Modes.
 <i>Operating Mode</i>		

BO Slot X6 . t-hold		[Device Para / Binary Outputs / BO Slot X6 / BO 5]
0.00s	0.00s ... 300.00s	S.3
 <i>To clearly identify the state transition of a binary output relay, the "new state" is being hold, at least for the duration of the hold time.</i>		

BO Slot X6 . t-Off Delay		[Device Para / Binary Outputs / BO Slot X6 / BO 5]
0.00s	0.00s ... 300.00s	S.3
 <i>Switch Off Delay</i>		

BO Slot X6 . Latched		[Device Para / Binary Outputs / BO Slot X6 / BO 5]	
inactive	inactive, active		S.3
	↳ Mode.		
	<i>Defines whether the Relay Output will be latched when it picks up.</i>		
BO Slot X6 . Acknowledgement		[Device Para / Binary Outputs / BO Slot X6 / BO 5]	
"_"	"_" ... Sys . Internal test state		S.3
Only available if:	↳ 1..n, Assignment List.		
	• BO Slot X6 . Latched = active		
	<i>Acknowledgement Signal - An acknowledgement signal (that acknowledges the corresponding binary output relay) can be assigned to each output relay. The acknowledgement-signal is only effective if the parameter "Latched" is set to active.</i>		
BO Slot X6 . Inverting		[Device Para / Binary Outputs / BO Slot X6 / BO 5]	
inactive	inactive, active		S.3
	↳ Mode.		
	<i>Inverting of the collective signal (OR-gate/disjunction). In combination with inverted input signals an AND-gate can be programmed (Conjunction).</i>		
BO Slot X6 . Assignment 1		[Device Para / Binary Outputs / BO Slot X6 / BO 5]	
...			
BO Slot X6 . Assignment 7			
"_"	"_" ... Sys . Internal test state		S.3
	↳ 1..n, Assignment List.		
	<i>Assignment</i>		
BO Slot X6 . Inverting 1		[Device Para / Binary Outputs / BO Slot X6 / BO 5]	
...			
BO Slot X6 . Inverting 7			
inactive	inactive, active		S.3
	↳ Mode.		
	<i>Inverting of the state of the assigned signal.</i>		





2.3.3.1 BO Slot X6: Service

BO Slot X6 . DISARMED Ctrl		[Service / Test (Prot inhibit) / DISARMED / BO Slot X6]
inactive	inactive, active	S.3
	↳ active/inactive.	
	<i>Enables and disables the disarming of the relay outputs. This is the first step of a two step process, to inhibit the operation or the relay outputs. Please refer to "DISARMED" for the second step.</i>	

BO Slot X6 . Disarm Mode		[Service / Test (Prot inhibit) / DISARMED / BO Slot X6]
permanent	permanent, timeout	S.3
	↳ Mode.	
	<i>CAUTION! RELAYS DISARMED in order to safely perform maintenance while eliminating the risk of taking an entire process off-line. (Note: The Supervision Contact cannot be disarmed). YOU MUST ENSURE that the relays are ARMED AGAIN after maintenance.</i>	

BO Slot X6 . t-Timeout DISARM		[Service / Test (Prot inhibit) / DISARMED / BO Slot X6]
0.03s	0.00s ... 300.00s	S.3
<i>Only available if:</i>		
<ul style="list-style-type: none"> • BO Slot X6 . Disarm Mode = timeout 		
	<i>The relays will be armed again after expiring of this time.</i>	

BO Slot X6 . DISARMED		[Service / Test (Prot inhibit) / DISARMED / BO Slot X6]
inactive	inactive, active	S.3
	↳ active/inactive.	
	<i>This is the second step, after the "DISARMED Ctrl" has been activated, that is required to DISARM the relay outputs. This will DISARM those output relays that are currently not latched and that are not on "hold" by a pending minimum hold time. CAUTION! RELAYS DISARMED in order to safely perform maintenance while eliminating the risk of taking an entire process off-line. (Note: Zone Interlocking and Supervision Contact cannot be disarmed). YOU MUST ENSURE that the relays are ARMED AGAIN after maintenance.</i>	



BO Slot X6 . Force Mode		[Service / Test (Prot inhibit) / Force OR / BO Slot X6]
permanent	permanent, timeout	S.3
	↳ Mode.	
<p> By means of this function the normal Output Relay States can be overwritten (forced) in case that the Relay is not in a disarmed state. The relays can be set from normal operation (relay works according to the assigned signals) to "force energized" or "force de-energized" state.</p>		
BO Slot X6 . t-Timeout Force		[Service / Test (Prot inhibit) / Force OR / BO Slot X6]
0.03s	0.00s ... 300.00s	S.3
<p>Only available if:</p> <ul style="list-style-type: none"> • BO Slot X6 . Force Mode = timeout 		
<p> The Output State will be set by force for the duration of this time. That means for the duration of this time the Output Relay does not show the state of the signals that are assigned on it.</p>		
BO Slot X6 . Force all Outs		[Service / Test (Prot inhibit) / Force OR / BO Slot X6]
Normal	Normal, De-Energized, Energized	S.3
	↳ Relay operating modes.	
<p> By means of this function the normal Output Relay State can be overwritten (forced). The relay can be set from normal operation (relay works according to the assigned signals) to "force energized" or "force de-energized" state. Forcing all outputs relays of an entire assembly group is superior to forcing a single output relay.</p>		
BO Slot X6 . Force OR1		[Service / Test (Prot inhibit) / Force OR / BO Slot X6]
...		
BO Slot X6 . Force OR5		
Normal	Normal, De-Energized, Energized	S.3
	↳ Relay operating modes.	
<p> By means of this function the normal Output Relay State can be overwritten (forced). The relay can be set from normal operation (relay works according to the assigned signals) to "force energized" or "force de-energized" state.</p>		

2.4 Analog Inputs

2.4.1 AnIn[1]

AnIn[1] . Mode	[Device Para / Analog Inputs / AnIn[1]]
0...20 mA	0...20 mA, 4...20 mA, 0...10V ↳ Type of Input.
 <i>The threshold depends to the mode/ mA or V</i>	S.3

2.4.2 AnIn[2]

AnIn[2] . Mode	[Device Para / Analog Inputs / AnIn[2]]	
0...20 mA	0...20 mA, 4...20 mA, 0...10V  Type of Input.	S.3
 <i>The threshold depends to the mode/ mA or V</i>		

2.5 Analog Outputs

2.5.1 AnOut[1]

AnOut[1] . Assignment		[Device Para / Analog Outputs / AnOut[1]]
“-”	“-” ... PQSCr . Wq-	S.3
	↳ 1..n, AnalogOutputList.	
	<i>Assignment</i>	

AnOut[1] . Range		[Device Para / Analog Outputs / AnOut[1]]
0...20mA	0...20mA, 4...20mA, 0...10V	S.3
	↳ Type of Output.	
	<i>Adjustable range</i>	

AnOut[1] . Range max		[Device Para / Analog Outputs / AnOut[1]]
1.00°C	-999999.00°C ... 999999.00°C	S.3
	<i>Adjustable range maximum.</i>	

AnOut[1] . Range min		[Device Para / Analog Outputs / AnOut[1]]
0.00°C	-999999.00°C ... 999999.00°C	S.3
	<i>Adjustable range minimum.</i>	

2.5.2 AnOut[2]

AnOut[2] . Assignment		[Device Para / Analog Outputs / AnOut[2]]	
“-”		“-” ... PQSCr . Wq-	S.3
		↳ 1..n, AnalogOutputList.	
	<i>Assignment</i>		

AnOut[2] . Range		[Device Para / Analog Outputs / AnOut[2]]	
0...20mA		0...20mA, 4...20mA, 0...10V	S.3
		↳ Type of Output.	
	<i>Adjustable range</i>		



AnOut[2] . Range max		[Device Para / Analog Outputs / AnOut[2]]	
1.00°C		-999999.00°C ... 999999.00°C	S.3
	<i>Adjustable range maximum.</i>		



AnOut[2] . Range min		[Device Para / Analog Outputs / AnOut[2]]	
0.00°C		-999999.00°C ... 999999.00°C	S.3
	<i>Adjustable range minimum.</i>		



2.6 LEDs



2.6.1 LEDs group A



LEDs group A . Latched		[Device Para / LEDs / LEDs group A / LED 1]
inactive	inactive, active, active, ack. by alarm ↳ Mode.	S.3
 Defines whether the LED will be latched when it picks up.		
LEDs group A . Ack signal		[Device Para / LEDs / LEDs group A / LED 1]
"-"	"-" ... Sys . Internal test state ↳ 1..n, Assignment List.	S.3
 Acknowledgement signal for the LED. If latching is set to active the LED can only be acknowledged if those signals that initiated the setting are no longer present.		
LEDs group A . LED active color		[Device Para / LEDs / LEDs group A / LED 1]
green	green, red, red flash, green flash, "-" ↳ LED active color.	S.3
 The LED lights up in this color if the state of the OR-assignment of the signals is true.		
LEDs group A . LED inactive color		[Device Para / LEDs / LEDs group A / LED 1]
"-"	green, red, red flash, green flash, "-" ↳ LED active color.	S.3
 The LED lights up in this color if the state of the OR-assignment of the signals is untrue.		
LEDs group A . Assignment 1		[Device Para / LEDs / LEDs group A / LED 1]
Prot . active	"-" ... Sys . Internal test state ↳ 1..n, Assignment List.	S.3
 Assignment		

LEDs group A . Inverting 1	[Device Para / LEDs / LEDs group A / LED 1]	
...		
LEDs group A . Inverting 5		
inactive	inactive, active  Mode.	S.3
 <i>Inverting of the state of the assigned signal.</i>		

LEDs group A . Assignment 2	[Device Para / LEDs / LEDs group A / LED 1]	
...		
LEDs group A . Assignment 5		
"-"	"-" ... Sys . Internal test state  1..n, Assignment List.	S.3
 <i>Assignment</i>		

LEDs group A . Latched	[Device Para / LEDs / LEDs group A / LED 2]	
active	inactive, active, active, ack. by alarm  Mode.	S.3
 <i>Defines whether the LED will be latched when it picks up.</i>		

LEDs group A . Ack signal	[Device Para / LEDs / LEDs group A / LED 2]	
"-"	"-" ... Sys . Internal test state  1..n, Assignment List.	S.3
 <i>Acknowledgement signal for the LED. If latching is set to active the LED can only be acknowledged if those signals that initiated the setting are no longer present.</i>		

LEDs group A . LED active color	[Device Para / LEDs / LEDs group A / LED 2]	
red	green, red, red flash, green flash, "-"  LED active color.	S.3
 <i>The LED lights up in this color if the state of the OR-assignment of the signals is true.</i>		





LEDs group A . LED inactive color	[Device Para / LEDs / LEDs group A / LED 2]	
"_"	green, red, red flash, green flash, "-"	S.3
	↳ LED active color.	
 <i>The LED lights up in this color if the state of the OR-assignment of the signals is untrue.</i>		

LEDs group A . Assignment 1	[Device Para / LEDs / LEDs group A / LED 2]	
SG[1] . TripCmd	"_" ... Sys . Internal test state	S.3
	↳ 1..n, Assignment List.	
 <i>Assignment</i>		

LEDs group A . Inverting 1	[Device Para / LEDs / LEDs group A / LED 2]	
...		
LEDs group A . Inverting 5		
inactive	inactive, active	S.3
	↳ Mode.	
 <i>Inverting of the state of the assigned signal.</i>		

LEDs group A . Assignment 2	[Device Para / LEDs / LEDs group A / LED 2]	
...		
LEDs group A . Assignment 5		
"_"	"_" ... Sys . Internal test state	S.3
	↳ 1..n, Assignment List.	
 <i>Assignment</i>		

LEDs group A . Latched	[Device Para / LEDs / LEDs group A / LED 3]	
inactive	inactive, active, active, ack. by alarm	S.3
	↳ Mode.	
 <i>Defines whether the LED will be latched when it picks up.</i>		

LEDs group A . Ack signal		[Device Para / LEDs / LEDs group A / LED 3]
"_"	"_" ... Sys . Internal test state ↳ 1..n, Assignment List.	S.3
 Acknowledgement signal for the LED. If latching is set to active the LED can only be acknowledged if those signals that initiated the setting are no longer present.		
LEDs group A . LED active color		[Device Para / LEDs / LEDs group A / LED 3]
red flash	green, red, red flash, green flash, "-" ↳ LED active color.	S.3
 The LED lights up in this color if the state of the OR-assignment of the signals is true.		
LEDs group A . LED inactive color		[Device Para / LEDs / LEDs group A / LED 3]
"_"	green, red, red flash, green flash, "-" ↳ LED active color.	S.3
 The LED lights up in this color if the state of the OR-assignment of the signals is untrue.		
LEDs group A . Assignment 1		[Device Para / LEDs / LEDs group A / LED 3]
Prot . Alarm	"_" ... Sys . Internal test state ↳ 1..n, Assignment List.	S.3
 Assignment		
LEDs group A . Inverting 1		[Device Para / LEDs / LEDs group A / LED 3]
...		
LEDs group A . Inverting 5		
inactive	inactive, active ↳ Mode.	S.3
 Inverting of the state of the assigned signal.		

LEDs group A . Assignment 2	[Device Para / LEDs / LEDs group A / LED 3]	
...		
LEDs group A . Assignment 5		
"-"	"-" ... Sys . Internal test state ↳ 1..n, Assignment List.	S.3
 <i>Assignment</i>		

LEDs group A . Latched	[Device Para / LEDs / LEDs group A / LED 4]	
inactive	inactive, active, active, ack. by alarm ↳ Mode.	S.3
 <i>Defines whether the LED will be latched when it picks up.</i>		

LEDs group A . Ack signal	[Device Para / LEDs / LEDs group A / LED 4]	
"-"	"-" ... Sys . Internal test state ↳ 1..n, Assignment List.	S.3
 <i>Acknowledgement signal for the LED. If latching is set to active the LED can only be acknowledged if those signals that initiated the setting are no longer present.</i>		

LEDs group A . LED active color	[Device Para / LEDs / LEDs group A / LED 4]	
red	green, red, red flash, green flash, "-" ↳ LED active color.	S.3
 <i>The LED lights up in this color if the state of the OR-assignment of the signals is true.</i>		

LEDs group A . LED inactive color	[Device Para / LEDs / LEDs group A / LED 4]	
"-"	green, red, red flash, green flash, "-" ↳ LED active color.	S.3
 <i>The LED lights up in this color if the state of the OR-assignment of the signals is untrue.</i>		

LEDs group A . Assignment 1 ... LEDs group A . Assignment 5	[Device Para / LEDs / LEDs group A / LED 4]	
"-"	"-" ... Sys . Internal test state ↳ 1..n, Assignment List.	S.3
 <i>Assignment</i>		

LEDs group A . Inverting 1 ... LEDs group A . Inverting 5	[Device Para / LEDs / LEDs group A / LED 4]	
inactive	inactive, active ↳ Mode.	S.3
 <i>Inverting of the state of the assigned signal.</i>		

LEDs group A . Latched	[Device Para / LEDs / LEDs group A / LED 5]	
inactive	inactive, active, active, ack. by alarm ↳ Mode.	S.3
 <i>Defines whether the LED will be latched when it picks up.</i>		

LEDs group A . Ack signal	[Device Para / LEDs / LEDs group A / LED 5]	
"-"	"-" ... Sys . Internal test state ↳ 1..n, Assignment List.	S.3
 <i>Acknowledgement signal for the LED. If latching is set to active the LED can only be acknowledged if those signals that initiated the setting are no longer present.</i>		

LEDs group A . LED active color	[Device Para / LEDs / LEDs group A / LED 5]	
red	green, red, red flash, green flash, "-" ↳ LED active color.	S.3
 <i>The LED lights up in this color if the state of the OR-assignment of the signals is true.</i>		

LEDs group A . LED inactive color	[Device Para / LEDs / LEDs group A / LED 5]	
"_"	green, red, red flash, green flash, "-"	S.3
	↳ LED active color.	
 The LED lights up in this color if the state of the OR-assignment of the signals is untrue.		

LEDs group A . Assignment 1	[Device Para / LEDs / LEDs group A / LED 5]	
...		
LEDs group A . Assignment 5		
"_"	"_" ... Sys . Internal test state	S.3
	↳ 1..n, Assignment List.	
 Assignment		

LEDs group A . Inverting 1	[Device Para / LEDs / LEDs group A / LED 5]	
...		
LEDs group A . Inverting 5		
inactive	inactive, active	S.3
	↳ Mode.	
 Inverting of the state of the assigned signal.		

LEDs group A . Latched	[Device Para / LEDs / LEDs group A / LED 6]	
inactive	inactive, active, active, ack. by alarm	S.3
	↳ Mode.	
 Defines whether the LED will be latched when it picks up.		

LEDs group A . Ack signal	[Device Para / LEDs / LEDs group A / LED 6]	
"_"	"_" ... Sys . Internal test state	S.3
	↳ 1..n, Assignment List.	
 Acknowledgement signal for the LED. If latching is set to active the LED can only be acknowledged if those signals that initiated the setting are no longer present.		

LEDs group A . LED active color		[Device Para / LEDs / LEDs group A / LED 6]
red	green, red, red flash, green flash, “-” ↳ LED active color.	S.3
 <i>The LED lights up in this color if the state of the OR-assignment of the signals is true.</i>		

LEDs group A . LED inactive color		[Device Para / LEDs / LEDs group A / LED 6]
“-”	green, red, red flash, green flash, “-” ↳ LED active color.	S.3
 <i>The LED lights up in this color if the state of the OR-assignment of the signals is untrue.</i>		

LEDs group A . Assignment 1 ... LEDs group A . Assignment 5		[Device Para / LEDs / LEDs group A / LED 6]
“-”	“-” ... Sys . Internal test state ↳ 1..n, Assignment List.	S.3
 <i>Assignment</i>		

LEDs group A . Inverting 1 ... LEDs group A . Inverting 5		[Device Para / LEDs / LEDs group A / LED 6]
inactive	inactive, active ↳ Mode.	S.3
 <i>Inverting of the state of the assigned signal.</i>		

LEDs group A . Latched		[Device Para / LEDs / LEDs group A / LED 7]
inactive	inactive, active, active, ack. by alarm ↳ Mode.	S.3
 <i>Defines whether the LED will be latched when it picks up.</i>		

LEDs group A . Ack signal	[Device Para / LEDs / LEDs group A / LED 7]	
"_"	"_" ... Sys . Internal test state ↳ 1..n, Assignment List.	S.3
 Acknowledgement signal for the LED. If latching is set to active the LED can only be acknowledged if those signals that initiated the setting are no longer present.		

LEDs group A . LED active color	[Device Para / LEDs / LEDs group A / LED 7]	
red	green, red, red flash, green flash, "-" ↳ LED active color.	S.3
 The LED lights up in this color if the state of the OR-assignment of the signals is true.		

LEDs group A . LED inactive color	[Device Para / LEDs / LEDs group A / LED 7]	
"_"	green, red, red flash, green flash, "-" ↳ LED active color.	S.3
 The LED lights up in this color if the state of the OR-assignment of the signals is untrue.		

LEDs group A . Assignment 1 ... LEDs group A . Assignment 5	[Device Para / LEDs / LEDs group A / LED 7]	
"_"	"_" ... Sys . Internal test state ↳ 1..n, Assignment List.	S.3
 Assignment		

LEDs group A . Inverting 1 ... LEDs group A . Inverting 5	[Device Para / LEDs / LEDs group A / LED 7]	
inactive	inactive, active ↳ Mode.	S.3
 Inverting of the state of the assigned signal.		

2.6.2 LEDs group B



LEDs group B . Latched		[Device Para / LEDs / LEDs group B / LED 1]
inactive	inactive, active, active, ack. by alarm	S.3
	↳ Mode.	
	<i>Defines whether the LED will be latched when it picks up.</i>	



LEDs group B . Ack signal		[Device Para / LEDs / LEDs group B / LED 1]
"-"	"-" ... Sys . Internal test state	S.3
	↳ 1..n, Assignment List.	
	<i>Acknowledgement signal for the LED. If latching is set to active the LED can only be acknowledged if those signals that initiated the setting are no longer present.</i>	



LEDs group B . LED active color		[Device Para / LEDs / LEDs group B / LED 1]
red	green, red, red flash, green flash, "-"	S.3
	↳ LED active color.	
	<i>The LED lights up in this color if the state of the OR-assignment of the signals is true.</i>	



LEDs group B . LED inactive color		[Device Para / LEDs / LEDs group B / LED 1]
"-"	green, red, red flash, green flash, "-"	S.3
	↳ LED active color.	
	<i>The LED lights up in this color if the state of the OR-assignment of the signals is untrue.</i>	



LEDs group B . Assignment 1		[Device Para / LEDs / LEDs group B / LED 1]
...		
LEDs group B . Assignment 5		
"-"	"-" ... Sys . Internal test state	S.3
	↳ 1..n, Assignment List.	
	<i>Assignment</i>	

LEDs group B . Inverting 1	[Device Para / LEDs / LEDs group B / LED 1]	
...		
LEDs group B . Inverting 5		
inactive	inactive, active  Mode.	S.3
	<i>Inverting of the state of the assigned signal.</i>	

LEDs group B . Latched	[Device Para / LEDs / LEDs group B / LED 2]	
inactive	inactive, active, active, ack. by alarm  Mode.	S.3
	<i>Defines whether the LED will be latched when it picks up.</i>	

LEDs group B . Ack signal	[Device Para / LEDs / LEDs group B / LED 2]	
"-"	"-" ... Sys . Internal test state  1..n, Assignment List.	S.3
	<i>Acknowledgement signal for the LED. If latching is set to active the LED can only be acknowledged if those signals that initiated the setting are no longer present.</i>	

LEDs group B . LED active color	[Device Para / LEDs / LEDs group B / LED 2]	
red	green, red, red flash, green flash, "-"  LED active color.	S.3
	<i>The LED lights up in this color if the state of the OR-assignment of the signals is true.</i>	

LEDs group B . LED inactive color	[Device Para / LEDs / LEDs group B / LED 2]	
"-"	green, red, red flash, green flash, "-"  LED active color.	S.3
	<i>The LED lights up in this color if the state of the OR-assignment of the signals is untrue.</i>	

LEDs group B . Assignment 1	[Device Para / LEDs / LEDs group B / LED 2]	
...		
LEDs group B . Assignment 5		
"-"	"-" ... Sys . Internal test state ↳ 1..n, Assignment List.	S.3
 <i>Assignment</i>		

LEDs group B . Inverting 1	[Device Para / LEDs / LEDs group B / LED 2]	
...		
LEDs group B . Inverting 5		
inactive	inactive, active ↳ Mode.	S.3
 <i>Inverting of the state of the assigned signal.</i>		

LEDs group B . Latched	[Device Para / LEDs / LEDs group B / LED 3]	
inactive	inactive, active, active, ack. by alarm ↳ Mode.	S.3
 <i>Defines whether the LED will be latched when it picks up.</i>		

LEDs group B . Ack signal	[Device Para / LEDs / LEDs group B / LED 3]	
"-"	"-" ... Sys . Internal test state ↳ 1..n, Assignment List.	S.3
 <i>Acknowledgement signal for the LED. If latching is set to active the LED can only be acknowledged if those signals that initiated the setting are no longer present.</i>		

LEDs group B . LED active color	[Device Para / LEDs / LEDs group B / LED 3]	
red	green, red, red flash, green flash, "-" ↳ LED active color.	S.3
 <i>The LED lights up in this color if the state of the OR-assignment of the signals is true.</i>		



LEDs group B . LED inactive color	[Device Para / LEDs / LEDs group B / LED 3]	
"_"	green, red, red flash, green flash, "-"	S.3
	↳ LED active color.	
 The LED lights up in this color if the state of the OR-assignment of the signals is untrue.		



LEDs group B . Assignment 1	[Device Para / LEDs / LEDs group B / LED 3]	
...		
LEDs group B . Assignment 5		
"_"	"_" ... Sys . Internal test state	S.3
	↳ 1..n, Assignment List.	
 Assignment		



LEDs group B . Inverting 1	[Device Para / LEDs / LEDs group B / LED 3]	
...		
LEDs group B . Inverting 5		
inactive	inactive, active	S.3
	↳ Mode.	
 Inverting of the state of the assigned signal.		



LEDs group B . Latched	[Device Para / LEDs / LEDs group B / LED 4]	
inactive	inactive, active, active, ack. by alarm	S.3
	↳ Mode.	
 Defines whether the LED will be latched when it picks up.		



LEDs group B . Ack signal	[Device Para / LEDs / LEDs group B / LED 4]	
"_"	"_" ... Sys . Internal test state	S.3
	↳ 1..n, Assignment List.	
 Acknowledgement signal for the LED. If latching is set to active the LED can only be acknowledged if those signals that initiated the setting are no longer present.		

LEDs group B . LED active color		[Device Para / LEDs / LEDs group B / LED 4]
red	green, red, red flash, green flash, “-”  LED active color.	S.3
 <i>The LED lights up in this color if the state of the OR-assignment of the signals is true.</i>		

LEDs group B . LED inactive color		[Device Para / LEDs / LEDs group B / LED 4]
“-”	green, red, red flash, green flash, “-”  LED active color.	S.3
 <i>The LED lights up in this color if the state of the OR-assignment of the signals is untrue.</i>		

LEDs group B . Assignment 1 ... LEDs group B . Assignment 5		[Device Para / LEDs / LEDs group B / LED 4]
“-”	“-” ... Sys . Internal test state  1..n, Assignment List.	S.3
 <i>Assignment</i>		

LEDs group B . Inverting 1 ... LEDs group B . Inverting 5		[Device Para / LEDs / LEDs group B / LED 4]
inactive	inactive, active  Mode.	S.3
 <i>Inverting of the state of the assigned signal.</i>		

LEDs group B . Latched		[Device Para / LEDs / LEDs group B / LED 5]
inactive	inactive, active, active, ack. by alarm  Mode.	S.3
 <i>Defines whether the LED will be latched when it picks up.</i>		











LEDs group B . Ack signal		[Device Para / LEDs / LEDs group B / LED 5]
"_"	"-" ... Sys . Internal test state ↳ 1..n, Assignment List.	S.3
 <i>Acknowledgement signal for the LED. If latching is set to active the LED can only be acknowledged if those signals that initiated the setting are no longer present.</i>		



LEDs group B . LED active color		[Device Para / LEDs / LEDs group B / LED 5]
red	green, red, red flash, green flash, "-" ↳ LED active color.	S.3
 <i>The LED lights up in this color if the state of the OR-assignment of the signals is true.</i>		



LEDs group B . LED inactive color		[Device Para / LEDs / LEDs group B / LED 5]
"_"	green, red, red flash, green flash, "-" ↳ LED active color.	S.3
 <i>The LED lights up in this color if the state of the OR-assignment of the signals is untrue.</i>		



LEDs group B . Assignment 1		[Device Para / LEDs / LEDs group B / LED 5]
...		
LEDs group B . Assignment 5		
"_"	"-" ... Sys . Internal test state ↳ 1..n, Assignment List.	S.3
 <i>Assignment</i>		



LEDs group B . Inverting 1		[Device Para / LEDs / LEDs group B / LED 5]
...		
LEDs group B . Inverting 5		
inactive	inactive, active ↳ Mode.	S.3
 <i>Inverting of the state of the assigned signal.</i>		



LEDs group B . Latched		[Device Para / LEDs / LEDs group B / LED 6]	
inactive	inactive, active, active, ack. by alarm  Mode.	S.3	
 Defines whether the LED will be latched when it picks up.			
LEDs group B . Ack signal		[Device Para / LEDs / LEDs group B / LED 6]	
"_"	"_" ... Sys . Internal test state  1..n, Assignment List.	S.3	
 Acknowledgement signal for the LED. If latching is set to active the LED can only be acknowledged if those signals that initiated the setting are no longer present.			
LEDs group B . LED active color		[Device Para / LEDs / LEDs group B / LED 6]	
red	green, red, red flash, green flash, "-"  LED active color.	S.3	
 The LED lights up in this color if the state of the OR-assignment of the signals is true.			
LEDs group B . LED inactive color		[Device Para / LEDs / LEDs group B / LED 6]	
"_"	green, red, red flash, green flash, "-"  LED active color.	S.3	
 The LED lights up in this color if the state of the OR-assignment of the signals is untrue.			
LEDs group B . Assignment 1		[Device Para / LEDs / LEDs group B / LED 6]	
...			
LEDs group B . Assignment 5			
"_"	"_" ... Sys . Internal test state  1..n, Assignment List.	S.3	
 Assignment			

LEDs group B . Inverting 1	[Device Para / LEDs / LEDs group B / LED 6]	
...		
LEDs group B . Inverting 5		
inactive	inactive, active  Mode.	S.3
	<i>Inverting of the state of the assigned signal.</i>	

LEDs group B . Latched	[Device Para / LEDs / LEDs group B / LED 7]	
inactive	inactive, active, active, ack. by alarm  Mode.	S.3
	<i>Defines whether the LED will be latched when it picks up.</i>	

LEDs group B . Ack signal	[Device Para / LEDs / LEDs group B / LED 7]	
"-"	"-" ... Sys . Internal test state  1..n, Assignment List.	S.3
	<i>Acknowledgement signal for the LED. If latching is set to active the LED can only be acknowledged if those signals that initiated the setting are no longer present.</i>	

LEDs group B . LED active color	[Device Para / LEDs / LEDs group B / LED 7]	
red	green, red, red flash, green flash, "-"  LED active color.	S.3
	<i>The LED lights up in this color if the state of the OR-assignment of the signals is true.</i>	

LEDs group B . LED inactive color	[Device Para / LEDs / LEDs group B / LED 7]	
"-"	green, red, red flash, green flash, "-"  LED active color.	S.3
	<i>The LED lights up in this color if the state of the OR-assignment of the signals is untrue.</i>	

LEDs group B . Assignment 1 ... LEDs group B . Assignment 5	[Device Para / LEDs / LEDs group B / LED 7]	
"-"	"-" ... Sys . Internal test state ↳ 1..n, Assignment List.	S.3
 <i>Assignment</i>		

LEDs group B . Inverting 1 ... LEDs group B . Inverting 5	[Device Para / LEDs / LEDs group B / LED 7]	
inactive	inactive, active ↳ Mode.	S.3
 <i>Inverting of the state of the assigned signal.</i>		

2.7 HMI



front-panel



Password	[Device Para / Security / Password]
 This item represents a special dialog. (See the Technical Manual for details.)	
	<i>Changing the password</i>

Access Level	[Device Para / Security / Access Level]
 This item represents a special dialog. (See the Technical Manual for details.)	
	<i>Access Level</i>

2.7.1 HMI: Global Parameters



HMI . Display Off	[Device Para / HMI]
180s	20s ... 3600s S.3
 <i>The display back light will be turned off when this timer has expired.</i>	

HMI . Menu language	[Device Para / HMI]
English	English ... Romanian S.3
	 Selection.
 <i>Selection of the language</i>	



HMI . Display ANSI Device No.	[Device Para / HMI]
active	inactive, active S.3
	 Mode.
 <i>Display ANSI Device Numbers</i>	

HMI . t-max Edit/Access	[Device Para / Security / General Settings]
180s	20s ... 3600s S.3
 <i>If no other key(s) is pressed at the panel, after expiration of this time, all cached (changed) parameters are canceled. The device access will be locked by falling back into Read-only level Lv0.</i>	







2.7.2 HMI: Direct Controls



HMI . Contrast		[Device Para / HMI]
50%	0% ... 100%	S.3
	<i>Contrast</i>	
HMI . Config. Device Reset		[Device Para / Security / General Settings]
"Fact.def.", "PW rst"	"Fact.def.", "PW rst", Only "Fact.defaults", Reset deact.  Config. Device Reset.	S.3
	<i>If the »C« key is pressed while the device is performing a cold restart a general Reset Dialog appears on the screen. Select which options shall be available with this dialog.</i>	



2.7.3 HMI: Values



HMI . Config. Device Reset		[Operation / Security / Security States]
"Fact.def.", "PW rst"	"Fact.def.", "PW rst", Only "Fact.defaults", Reset deact.  Config. Device Reset.	
	<i>If the »C« key is pressed while the device is performing a cold restart a general Reset Dialog appears on the screen. Select which options shall be available with this dialog.</i>	



3 Security

- Ctrl . Switching Authority:  Tab.
- HMI . Config. Device Reset:  Tab.
- HMI . t-max Edit/Access:  Tab.
- HMI . Config. Device Reset:  Tab.
- Password:  Tab.
- Access Level:  Tab.

Sys . Smart view via USB	[Operation / Security / Security States]
active	inactive, active  Mode.
 <i>Information whether or not the Smart view access via the USB interface is activated (allowed).</i>	



Sys . Smart view via Eth	[Operation / Security / Security States]
active <i>Avail. depends on HW</i>	inactive, active  Mode.
 <i>Information whether or not the Smart view access via the Ethernet interface is activated (allowed).</i>	



Sys . Passw. for USB conn.	[Operation / Security / Security States]
disabled	disabled, default, def. by user  Type of passw. def..
 <i>Type / Security-level of the connection password that is used for a USB connection.</i>	

Sys . Passw.remote net.conn.	[Operation / Security / Security States]
disabled <i>Avail. depends on HW</i>	disabled, default, def. by user  Type of passw. def..
 <i>Type / Security-level of the connection password that is used for a Smart view connection via some network interface.</i>	

Sys . TLS Certificate		[Operation / Security / Security States]
Device-specific	Device-specific, Basic, Corrupt	
	 TLS Certificate.	
	<i>Type of certificate that the device uses for the encrypted communication. This value is directly related to the security-level of the communication.</i>	

Security Logger		[Operation / Security / Security Logger]
	This item represents a special dialog. (See the Technical Manual for details.)	
	<i>Security-related messages</i>	



Sys . Smart view via USB		[Device Para / Security / Communication]
active	inactive, active	S.3
	 Mode.	
	<i>Activate (allow) or inactivate (disallow) the Smart view access via the USB interface.</i>	



Sys . Smart view via Eth		[Device Para / Security / Communication]
active	inactive, active	S.3
<i>Avail. depends on HW</i>	 Mode.	
	<i>Activate (allow) or inactivate (disallow) the Smart view access via the Ethernet interface.</i>	

4 Field settings

Field settings

4.1 Field Para: Global Parameters

Field Para . Phase Sequence	[Field Para / General Settings]	
ABC	ABC, ACB  Phase Sequence.	S.3
 <i>Phase Sequence direction</i>		

Field Para . f	[Field Para / General Settings]	
50Hz	50Hz, 60Hz  fN.	S.3
 <i>Nominal frequency</i>		

4.2 VT

Voltage Transformer

4.2.1 VT: Global Parameters

VT . V Cutoff Level	[Device Para / Measurment Display / Voltage]	
0.005Vn	0.0Vn ... 0.100Vn	S.3
	<i>The Phase Voltage shown in the Display or within the PC Software will be displayed as zero, if the Phase Voltage falls below this Cutoff Level. This parameter has no impact on recorders. This parameter is related to the voltage that is connected to the device (phase-to-phase or phase-to-earth).</i>	



VT . VG meas Cutoff Level	[Device Para / Measurment Display / Voltage]	
0.005Vn	0.0Vn ... 0.100Vn	S.3
	<i>The measured Residual Voltage shown in the Display or within the PC Software will be displayed as zero, if the measured Residual Voltage falls below this Cutoff Level. This parameter has no impact on recorders.</i>	

VT . VG calc Cutoff Level	[Device Para / Measurment Display / Voltage]	
0.005Vn	0.0Vn ... 0.100Vn	S.3
	<i>The calculated Residual Voltage shown in the Display or within the PC Software will be displayed as zero, if the calculated Residual Voltage falls below this Cutoff Level. This parameter has no impact on recorders.</i>	

VT . V012 Comp Cutoff Level	[Device Para / Measurment Display / Voltage]	
0.005Vn	0.0Vn ... 0.100Vn	S.3
	<i>The Symmetrical Component shown in the Display or within the PC Software will be displayed as zero, if the Symmetrical Component falls below this Cutoff Level. This parameter has no impact on recorders.</i>	

VT . VT pri	[Field Para / VT]	
10500V	60V ... 500000V	S.3
	<i>Nominal voltage of the Voltage Transformers at the primary side. Note that always the phase-to-phase voltage must be entered here.</i>	

VT . VT sec	[Field Para / VT]	
100V	If: slot 6 = Voltage measuring inputs <ul style="list-style-type: none"> • 60.00V ... 520.00V If: slot 6 = Voltage measurement 8 digital inputs <ul style="list-style-type: none"> • 60.00V ... 200.00V If: slot 6 = Voltage measurement 5 binary output relays <ul style="list-style-type: none"> • 60.00V ... 200.00V 	S.3
	<i>Nominal voltage of the Voltage Transformers at the secondary side. Note that always the phase-to-phase voltage must be entered here.</i>	

VT . VT con	[Field Para / VT]	
Phase to Ground	Phase to Phase, Phase to Ground  VT con.	S.3
	<i>This parameter has to be set in order to ensure the correct assignment of the voltage measurement channels in the device.</i>	

VT . EVT pri	[Field Para / VT]	
10500V	60V ... 500000V	S.3
	<i>Primary nominal voltage of the e-n winding of the voltage transformers, which is only taken into account in the direct measurement of the residual voltage (GVT con=measured/broken delta).</i>	

VT . EVT sec	[Field Para / VT]	
100V	If: slot 6 = Voltage measuring inputs <ul style="list-style-type: none"> • 35.00V ... 520.00V If: slot 6 = Voltage measurement 8 digital inputs <ul style="list-style-type: none"> • 35.00V ... 200.00V If: slot 6 = Voltage measurement 5 binary output relays <ul style="list-style-type: none"> • 35.00V ... 200.00V 	S.3
	<i>Secondary nominal voltage of the e-n winding of the voltage transformers, which is only taken into account in the direct measurement of the residual voltage.</i>	

VT . V Sync		[Field Para / VT]	
L12	L1, L2, L3, L12, L23, L31		S.3
	↳ Voltages to be synchronized.		
🔗	<i>The fourth measuring input of the voltage measuring card measures the voltage that is to be synchronized.</i>		
VT . Phase MTA		[Field Para / Direction / General]	
45°	0° ... 360°		S.3
🔗	<i>Maximum Torque Angle: Angle between phase current and reference voltage in case of a short circuit. This angle is needed to determine the fault direction in case of short circuits.</i>		
	<i>Note: If »Phase Sequence« = "ACB" then the device internally adapts the direction angle by adding 180°.</i>		
VT . 3V0 Source		[Field Para / Direction / General]	
measured	measured, calculated		S.3
	↳ 3V0 Source.		
🔗	<i>Earth overcurrent protection elements take into account this parameter for direction decisions. You have to ensure, that this parameter is set to "Measured" only if the residual voltage is fed to the fourth measuring input of the voltage measuring card.</i>		
VT . Ground MTA		[Field Para / Direction / General]	
110°	0° ... 360°		S.3
🔗	<i>Ground Maximum Torque Angle: Angle between chosen operating quantity and chosen reference quantity in case of a ground fault. This angle is needed to determine the ground fault direction in case of a short circuit. Depending on the selected ground direction option, different MTA values are used: IGcalc 3V0, IGmeas 3V0 : Ground MTA; IGcalc Neg, IGmeas Neg : 90° + Phase MTA; IGcalc IPol : 0°; IGcalc Dual : 0° (if I2 and V2 available) or Ground MTA; IGmeas Dual : 90° + Phase MTA (if I2 and V2 available) or Ground MTA.</i>		
VT . ECT Angle Cor		[Field Para / Direction / General]	
0°	-45.0° ... 45.0°		S.3
🔗	<i>Fine adjustment of the measuring angle of the earth current transformers. By means of the Angle Correction, faults of the earth voltage transformers can be taken into account.</i>		
VT . IG meas dir control		[Field Para / Direction / General]	
IG meas 3V0	IG meas 3V0, I2,V2, Dual, cos(φ) , sin(φ)		S.3
	↳ IG meas dir control.		
🔗	<i>Options for direction detection. IGmeas is used as operating quantity.</i>		

VT . IG calc dir control	[Field Para / Direction / General]	
IG calc 3V0	IG calc 3V0, IG calc IPol (IG meas), Dual, I2,V2, $\cos(\phi)$, $\sin(\phi)$ ↳ IG calc dir control.	S.3
	<i>Options for direction detection. IGcalc is used as operating quantity.</i>	

VT . 3V0 min	[Field Para / Direction / Wattmetric]	
0.2Vn	0.01Vn ... 2.00Vn	S.3
	<i>Voltage threshold for the direction detection of ground (earth) faults</i>	

VT . t(3V0 min)	[Field Para / Direction / Wattmetric]	
0.1s	0.00s ... 60.00s	S.3
	<i>Release timer for the direction detection of ground (earth) faults: When 3V0 rises above the setting »3V0 min« this timer is started. Direction results are released after this timer has elapsed.</i>	

VT . IG meas min	[Field Para / Direction / Wattmetric]	
0.1In	If: Sensitive Ground Current = 0 • 0.02In ... 2.00In If: Sensitive Ground Current \neq 0 • 0.002In ... 2.000In	S.3
<i>Only available if:</i>		
<ul style="list-style-type: none"> • VT . IG meas dir control = $\cos(\phi)$ • VT . IG meas dir control = $\sin(\phi)$ 		
	<i>Current threshold for the direction detection methods $\cos(\phi)$, $\sin(\phi)$ with measured ground (earth) current</i>	

VT . IG meas limit angle $\lambda 1$	[Field Para / Direction / Wattmetric]	
3°	1° ... 20°	S.3
<i>Only available if:</i>		
<ul style="list-style-type: none"> • VT . IG meas dir control = $\cos(\phi)$ • VT . IG meas dir control = $\sin(\phi)$ 		
	<i>Limit angle 1 for cos or sin method with measured earth current</i>	



VT . IG meas limit angle $\lambda 2$	[Field Para / Direction / Wattmetric]	
3° <i>Only available if:</i> <ul style="list-style-type: none"> • VT . IG meas dir control = $\cos(\phi)$ • VT . IG meas dir control = $\sin(\phi)$ 	1° ... 20°	S.3
 <i>Limit angle 2 for cos or sin method with measured earth current</i>		

VT . IG calc min	[Field Para / Direction / Wattmetric]	
0.1In <i>Only available if:</i> <ul style="list-style-type: none"> • VT . IG calc dir control = $\cos(\phi)$ • VT . IG calc dir control = $\sin(\phi)$ 	0.02In ... 2.00In	S.3
 <i>Current threshold for the direction detection methods $\cos(\phi)$, $\sin(\phi)$ with measured ground (earth) current</i>		

VT . IG calc limit angle $\lambda 1$	[Field Para / Direction / Wattmetric]	
3° <i>Only available if:</i> <ul style="list-style-type: none"> • VT . IG calc dir control = $\cos(\phi)$ • VT . IG calc dir control = $\sin(\phi)$ 	1° ... 20°	S.3
 <i>Limit angle 1 for ground fault direction determination with method “$\cos(\phi)$” or “$\sin(\phi)$”</i>		

VT . IG calc limit angle $\lambda 2$	[Field Para / Direction / Wattmetric]	
3° <i>Only available if:</i> <ul style="list-style-type: none"> • VT . IG calc dir control = $\cos(\phi)$ • VT . IG calc dir control = $\sin(\phi)$ 	1° ... 20°	S.3
 <i>Limit angle 2 for ground fault direction determination with method “$\cos(\phi)$” or “$\sin(\phi)$”</i>		

VT . V Block f	[Field Para / Frequency]	
0.5Vn	0.15Vn ... 0.90Vn	S.3
 <i>Threshold for the release of the frequency stages</i>		

VT . delta phi - Mode	[Field Para / Frequency]	
two phases	one phase, two phases, three phases	S.3
	 delta phi - Mode.	
	<i>The delta phi element (vector surge) trips, if the permissible voltage angle shift (delta phi) of the three measured voltages (phase-ground or phase-phase) in: one phase, two phases or within all phases is exceeded.</i>	

VT . Stab. window f	[Field Para / Frequency]	
0	0 ... 10	S.3
	<i>Stabilizing window, for stabilizing the frequency values against momentary fluctuations. The setting value is in cycles at the rated frequency.</i>	

VT . Window df/dt	[Field Para / Frequency]	
4	2 ... 10	S.3
	<i>Window for the determination of df/dt (ROCOF). The setting value is in cycles at the rated frequency.</i>	

VT . Stab. window df/dt	[Field Para / Frequency]	
5	2 ... 10	S.3
	<i>Stabilizing window, for stabilizing the df/dt (ROCOF) values against momentary fluctuations. The setting value is in cycles at the rated frequency.</i>	













4.2.2 VT: Signals (Output States)

VT . Phase seq. wrong	[Operation / Status Display / Supervision / Phase Sequence]	
	<i>Signal that the device has detected a phase sequence (L1-L2-L3 / L1-L3-L2) that is different from the one that had been set at [Field settings / General Settings] »Phase Sequence«.</i>	









4.2.3 VT: Values

VT . f	[Operation / Measured Values / Voltage]	
	<i>Measured value: Frequency</i>	







VT . VL12	[Operation / Measured Values / Voltage]	
	<i>Measured value: Phase-to-phase voltage (fundamental)</i>	

VT . VL23	[Operation / Measured Values / Voltage]
 <i>Measured value: Phase-to-phase voltage (fundamental)</i>	
VT . VL31	[Operation / Measured Values / Voltage]
 <i>Measured value: Phase-to-phase voltage (fundamental)</i>	
VT . VL1	[Operation / Measured Values / Voltage]
 <i>Measured value: Phase-to-neutral voltage (fundamental)</i>	
VT . VL2	[Operation / Measured Values / Voltage]
 <i>Measured value: Phase-to-neutral voltage (fundamental)</i>	
VT . VL3	[Operation / Measured Values / Voltage]
 <i>Measured value: Phase-to-neutral voltage (fundamental)</i>	
VT . VX meas	[Operation / Measured Values / Voltage]
 <i>Measured value (measured): VX measured (fundamental)</i>	
VT . VG calc	[Operation / Measured Values / Voltage]
 <i>Measured value (calculated): VG (fundamental)</i>	
VT . V0	[Operation / Measured Values / Voltage]
 <i>Measured value (calculated): Symmetrical components Zero voltage(fundamental)</i>	
VT . V1	[Operation / Measured Values / Voltage]
 <i>Measured value (calculated): Symmetrical components positive phase sequence voltage(fundamental)</i>	
VT . V2	[Operation / Measured Values / Voltage]
 <i>Measured value (calculated): Symmetrical components negative phase sequence voltage(fundamental)</i>	
VT . %(V2/V1)	[Operation / Measured Values / Voltage]
 <i>Measured value (calculated): V2/V1, phase sequence will be taken into account automatically.</i>	
VT . VX meas H3	[Operation / Measured Values / Voltage]
 <i>Third harmonic of measured neutral voltage used to detect generator stator ground faults.</i>	

VT . phi VL12	[Operation / Measured Values / Voltage]
✎	<p><i>Measured value (calculated): Angle of Phasor VL12</i></p> <p><i>Reference phasor is required to calculate the angle. This is the first measured voltage (or current) channel with sufficiently high amplitude.</i></p>
VT . phi VL23	[Operation / Measured Values / Voltage]
✎	<p><i>Measured value (calculated): Angle of Phasor VL23</i></p> <p><i>Reference phasor is required to calculate the angle. This is the first measured voltage (or current) channel with sufficiently high amplitude.</i></p>
VT . phi VL31	[Operation / Measured Values / Voltage]
✎	<p><i>Measured value (calculated): Angle of Phasor VL31</i></p> <p><i>Reference phasor is required to calculate the angle. This is the first measured voltage (or current) channel with sufficiently high amplitude.</i></p>
VT . phi VL1	[Operation / Measured Values / Voltage]
✎	<p><i>Measured value (calculated): Angle of Phasor VL1</i></p> <p><i>Reference phasor is required to calculate the angle. This is the first measured voltage (or current) channel with sufficiently high amplitude.</i></p>
VT . phi VL2	[Operation / Measured Values / Voltage]
✎	<p><i>Measured value (calculated): Angle of Phasor VL2</i></p> <p><i>Reference phasor is required to calculate the angle. This is the first measured voltage (or current) channel with sufficiently high amplitude.</i></p>
VT . phi VL3	[Operation / Measured Values / Voltage]
✎	<p><i>Measured value (calculated): Angle of Phasor VL3</i></p> <p><i>Reference phasor is required to calculate the angle. This is the first measured voltage (or current) channel with sufficiently high amplitude.</i></p>
VT . phi VX meas	[Operation / Measured Values / Voltage]
✎	<p><i>Measured value: Angle of Phasor VX meas</i></p> <p><i>Reference phasor is required to calculate the angle. This is the first measured voltage (or current) channel with sufficiently high amplitude.</i></p>

VT . phi VG calc	[Operation / Measured Values / Voltage]
 Measured value (calculated): Angle of Phasor VG calc	
	Reference phasor is required to calculate the angle. This is the first measured voltage (or current) channel with sufficiently high amplitude.
VT . phi V0	[Operation / Measured Values / Voltage]
 Measured value (calculated): Angle Zero Sequence System	
	Reference phasor is required to calculate the angle. This is the first measured voltage (or current) channel with sufficiently high amplitude.
VT . phi V1	[Operation / Measured Values / Voltage]
 Measured value (calculated): Angle of Positive Sequence System	
	Reference phasor is required to calculate the angle. This is the first measured voltage (or current) channel with sufficiently high amplitude.
VT . phi V2	[Operation / Measured Values / Voltage]
 Measured Value (calculated): Angle of Negative Sequence System	
	Reference phasor is required to calculate the angle. This is the first measured voltage (or current) channel with sufficiently high amplitude.
VT . df/dt	[Operation / Measured Values / Voltage]
 Measured value (calculated): Rate-of-frequency-change.	
VT . delta phi	[Operation / Measured Values / Voltage]
 Measured value (calculated): Vector surge	
VT . VL12 RMS	[Operation / Measured Values / Voltage RMS]
 Measured value: Phase-to-phase voltage (RMS)	
VT . VL23 RMS	[Operation / Measured Values / Voltage RMS]
 Measured value: Phase-to-phase voltage (RMS)	
VT . VL31 RMS	[Operation / Measured Values / Voltage RMS]
 Measured value: Phase-to-phase voltage (RMS)	

VT . VL1 RMS	[Operation / Measured Values / Voltage RMS]
 <i>Measured value: Phase-to-neutral voltage (RMS)</i>	
VT . VL2 RMS	[Operation / Measured Values / Voltage RMS]
 <i>Measured value: Phase-to-neutral voltage (RMS)</i>	
VT . VL3 RMS	[Operation / Measured Values / Voltage RMS]
 <i>Measured value: Phase-to-neutral voltage (RMS)</i>	
VT . VX meas RMS	[Operation / Measured Values / Voltage RMS]
 <i>Measured value (measured): VX measured (RMS)</i>	
VT . VG calc RMS	[Operation / Measured Values / Voltage RMS]
 <i>Measured value (calculated): VG (RMS)</i>	
VT . V/f	[Operation / Measured Values / Voltage RMS]
 <i>Ratio Volts/Hertz in relation to nominal values.</i>	
VT . %VL12 THD	[Operation / Measured Values / Voltage RMS]
 <i>Measured value (calculated): V12 Total Harmonic Distortion / Ground wave</i>	
VT . %VL23 THD	[Operation / Measured Values / Voltage RMS]
 <i>Measured value (calculated): V23 Total Harmonic Distortion / Ground wave</i>	
VT . %VL31 THD	[Operation / Measured Values / Voltage RMS]
 <i>Measured value (calculated): V31 Total Harmonic Distortion / Ground wave</i>	
VT . %VL1 THD	[Operation / Measured Values / Voltage RMS]
 <i>Measured value (calculated): VL1 Total Harmonic Distortion / Ground wave</i>	
VT . %VL2 THD	[Operation / Measured Values / Voltage RMS]
 <i>Measured value (calculated): VL2 Total Harmonic Distortion / Ground wave</i>	
VT . %VL3 THD	[Operation / Measured Values / Voltage RMS]
 <i>Measured value (calculated): VL3 Total Harmonic Distortion / Ground wave</i>	

VT . VL12 THD	[Operation / Measured Values / Voltage RMS]
 <i>Measured value (calculated): V12 Total Harmonic Distortion</i>	
VT . VL23 THD	[Operation / Measured Values / Voltage RMS]
 <i>Measured value (calculated): V23 Total Harmonic Distortion</i>	
VT . VL31 THD	[Operation / Measured Values / Voltage RMS]
 <i>Measured value (calculated): V31 Total Harmonic Distortion</i>	
VT . VL1 THD	[Operation / Measured Values / Voltage RMS]
 <i>Measured value (calculated): VL1 Total Harmonic Distortion</i>	
VT . VL2 THD	[Operation / Measured Values / Voltage RMS]
 <i>Measured value (calculated): VL2 Total Harmonic Distortion</i>	
VT . VL3 THD	[Operation / Measured Values / Voltage RMS]
 <i>Measured value (calculated): VL3 Total Harmonic Distortion</i>	

4.2.4 VT: Statistical Values

VT . f max	[Operation / Statistics / Max / Voltage]
<input checked="" type="checkbox"/> <i>Max. frequency value</i>	
VT . VL12 max RMS	[Operation / Statistics / Max / Voltage]
<input checked="" type="checkbox"/> <i>VL12 maximum value (RMS)</i>	
VT . VL23 max RMS	[Operation / Statistics / Max / Voltage]
<input checked="" type="checkbox"/> <i>VL23 maximum value (RMS)</i>	
VT . VL31 max RMS	[Operation / Statistics / Max / Voltage]
<input checked="" type="checkbox"/> <i>VL31 maximum value (RMS)</i>	
VT . VL1 max RMS	[Operation / Statistics / Max / Voltage]
<input checked="" type="checkbox"/> <i>VL1 maximum value (RMS)</i>	

VT . VL2 max RMS	[Operation / Statistics / Max / Voltage]
<input checked="" type="checkbox"/> VL2 maximum value (RMS)	
VT . VL3 max RMS	[Operation / Statistics / Max / Voltage]
<input checked="" type="checkbox"/> VL3 maximum value (RMS)	
VT . VX meas max RMS	[Operation / Statistics / Max / Voltage]
<input checked="" type="checkbox"/> Measured value: VX maximum value (RMS)	
VT . VG calc max RMS	[Operation / Statistics / Max / Voltage]
<input checked="" type="checkbox"/> Measured value (calculated):VX maximum value (RMS)	
VT . V1 max	[Operation / Statistics / Max / Voltage]
<input checked="" type="checkbox"/> Maximum value: Symmetrical components positive phase sequence voltage(fundamental)	
VT . V2 max	[Operation / Statistics / Max / Voltage]
<input checked="" type="checkbox"/> Maximum value: Symmetrical components negative phase sequence voltage(fundamental)	
VT . %(V2/V1) max	[Operation / Statistics / Max / Voltage]
<input checked="" type="checkbox"/> Measured value (calculated):V2/V1 maximum value, phase sequence will be taken into account automatically	
VT . V/f max	[Operation / Statistics / Max / Voltage]
<input checked="" type="checkbox"/> Maximum value: Ratio Volts/Hertz in relation to nominal values.	
VT . VX meas H3 max	[Operation / Statistics / Max / Voltage]
<input checked="" type="checkbox"/> Maximum value: Third harmonic of measured neutral voltage used to detect generator stator ground faults.	
VT . f min	[Operation / Statistics / Min / Voltage]
<input checked="" type="checkbox"/> Min. frequency value	
VT . VL12 min RMS	[Operation / Statistics / Min / Voltage]
<input checked="" type="checkbox"/> VL12 minimum value (RMS)	
VT . VL23 min RMS	[Operation / Statistics / Min / Voltage]
<input checked="" type="checkbox"/> VL23 minimum value (RMS)	

VT . VL31 min RMS	[Operation / Statistics / Min / Voltage]
<input checked="" type="checkbox"/> <i>VL31 minimum value (RMS)</i>	
VT . VL1 min RMS	[Operation / Statistics / Min / Voltage]
<input checked="" type="checkbox"/> <i>VL1 minimum value (RMS)</i>	
VT . VL2 min RMS	[Operation / Statistics / Min / Voltage]
<input checked="" type="checkbox"/> <i>VL2 minimum value (RMS)</i>	
VT . VL3 min RMS	[Operation / Statistics / Min / Voltage]
<input checked="" type="checkbox"/> <i>VL3 minimum value (RMS)</i>	
VT . VX meas min RMS	[Operation / Statistics / Min / Voltage]
<input checked="" type="checkbox"/> <i>Measured value: VX minimum value (RMS)</i>	
VT . VG calc min RMS	[Operation / Statistics / Min / Voltage]
<input checked="" type="checkbox"/> <i>Measured value (calculated):VX minimum value (RMS)</i>	
VT . V1 min	[Operation / Statistics / Min / Voltage]
<input checked="" type="checkbox"/> <i>Minimum value: Symmetrical components positive phase sequence voltage(fundamental)</i>	
VT . V2 min	[Operation / Statistics / Min / Voltage]
<input checked="" type="checkbox"/> <i>Minimum value: Symmetrical components negative phase sequence voltage(fundamental)</i>	
VT . %(V2/V1) min	[Operation / Statistics / Min / Voltage]
<input checked="" type="checkbox"/> <i>Measured value (calculated):V2/V1 minimum value , phase sequence will be taken into account automatically</i>	
VT . V/f min	[Operation / Statistics / Min / Voltage]
<input checked="" type="checkbox"/> <i>Minimum value: Ratio Volts/Hertz in relation to nominal values.</i>	
VT . VX meas H3 min	[Operation / Statistics / Min / Voltage]
<input checked="" type="checkbox"/> <i>Minimum value: Third harmonic of measured neutral voltage used to detect generator stator ground faults.</i>	
VT . VL12 avg RMS	[Operation / Statistics / Vavg]
<input checked="" type="checkbox"/> <i>VL12 average value (RMS)</i>	

VT . VL23 avg RMS	[Operation / Statistics / Vavg]
<input checked="" type="checkbox"/> VL23 average value (RMS)	
VT . VL31 avg RMS	[Operation / Statistics / Vavg]
<input checked="" type="checkbox"/> VL31 average value (RMS)	
VT . VL1 avg RMS	[Operation / Statistics / Vavg]
<input checked="" type="checkbox"/> VL1 average value (RMS)	
VT . VL2 avg RMS	[Operation / Statistics / Vavg]
<input checked="" type="checkbox"/> VL2 average value (RMS)	
VT . VL3 avg RMS	[Operation / Statistics / Vavg]
<input checked="" type="checkbox"/> VL3 average value (RMS)	

4.3 CT Ntrl

Current transformers on the neutral side

4.3.1 CT Ntrl: Global Parameters

CT Ntrl . IL1, IL2, IL3 Cutoff Level		[Device Para / Measur em Display / CT Ntrl]
0.005In	0.0In ... 0.100In	S.3
	<i>The Current shown in the Display or within the PC Software will be displayed as zero, if the Current falls below this Cutoff Level. This parameter has no impact on recorders.</i>	



CT Ntrl . IG meas Cutoff Level		[Device Para / Measur em Display / CT Ntrl]
0.005In	0.0In ... 0.100In	S.3
	<i>The measured Earth Current shown in the Display or within the PC Software will be displayed as zero, if the measured Earth Current falls below this Cutoff Level. This parameter has no impact on recorders.</i>	

CT Ntrl . IG calc Cutoff Level		[Device Para / Measur em Display / CT Ntrl]
0.005In	0.0In ... 0.100In	S.3
	<i>The calculated Earth Current shown in the Display or within the PC Software will be displayed as zero, if the calculated Earth Current falls below this Cutoff Level. This parameter has no impact on recorders.</i>	



CT Ntrl . I012 Cutoff Level		[Device Para / Measur em Display / CT Ntrl]
0.005In	0.0In ... 0.100In	S.3
	<i>The Symmetrical Component shown in the Display or within the PC Software will be displayed as zero, if the Symmetrical Component falls below this Cutoff Level. This parameter has no impact on recorders.</i>	



CT Ntrl . CT pri		[Field Para / CT Ntrl]
1000A	1A ... 50000A	S.3
	<i>Nominal current of the primary side of the current transformers.</i>	

CT Ntrl . CT sec		[Field Para / CT Ntrl]
1A	1A, 5A	S.3
	 Ratio prim/sec.	
	<i>Nominal current of the secondary side of the current transformers.</i>	

CT Ntrl . CT dir	[Field Para / CT Ntrl]	
0°	0°, 180°  Polarity.	S.3
	<i>Protection functions with directional feature can only work properly if the connection of the current transformers is free of wiring errors. If all current transformers are connected to the device with an incorrect polarity, the wiring error can be compensated by this parameter. This parameter turns the current vectors by 180 degrees.</i>	

CT Ntrl . ECT pri	[Field Para / CT Ntrl]	
1000A	1A ... 50000A	S.3
	<i>This parameter defines the primary nominal current of the connected earth current transformer. If the earth current is measured via the Holmgreen connection, the primary value of the phase current transformer must be entered here.</i>	











CT Ntrl . ECT sec	[Field Para / CT Ntrl]	
1A	1A, 5A  Ratio prim/sec.	S.3
	<i>This parameter defines the secondary nominal current of the connected earth current transformer. If the earth current is done via the Holmgreen connection, the primary value of the phase current transformer must be entered here.</i>	









CT Ntrl . ECT dir	[Field Para / CT Ntrl]	
0°	0°, 180°  Polarity.	S.3
	<i>Earth fault protection with directional feature depends also on the correct wiring of the earth current transformer. An incorrect polarity/wiring can be corrected by means of the settings "0°" or "180°". The operator has the possibility of turning the current vector by 180 degrees (change of sign) without modification of the wiring. This means, that - in terms of figures - the determined current indicator was turned by 180° by the device.</i>	











4.3.2 CT Ntrl: Signals (Output States)

CT Ntrl . Phase seq. wrong	[Operation / Status Display / Supervision / Phase Sequence]	
	<i>Signal that the device has detected a phase sequence (L1-L2-L3 / L1-L3-L2) that is different from the one that had been set at [Field settings / General Settings] »Phase Sequence«.</i>	

4.3.3 CT Ntrl: Values

CT Ntrl . IL1	[Operation / Measured Values / CT Ntrl / Current]
 <i>Measured value: Phase current (fundamental)</i>	
CT Ntrl . IL2	[Operation / Measured Values / CT Ntrl / Current]
 <i>Measured value: Phase current (fundamental)</i>	
CT Ntrl . IL3	[Operation / Measured Values / CT Ntrl / Current]
 <i>Measured value: Phase current (fundamental)</i>	
CT Ntrl . IG meas	[Operation / Measured Values / CT Ntrl / Current]
 <i>Measured value (measured): IG (fundamental)</i>	
CT Ntrl . IG calc	[Operation / Measured Values / CT Ntrl / Current]
 <i>Measured value (calculated): IG (fundamental)</i>	
CT Ntrl . I0	[Operation / Measured Values / CT Ntrl / Current]
 <i>Measured value (calculated): Zero current (fundamental)</i>	
CT Ntrl . I1	[Operation / Measured Values / CT Ntrl / Current]
 <i>Measured value (calculated): Positive phase sequence current (fundamental)</i>	
CT Ntrl . I2	[Operation / Measured Values / CT Ntrl / Current]
 <i>Measured value (calculated): Unbalanced load current (fundamental)</i>	
CT Ntrl . IL1 H2	[Operation / Measured Values / CT Ntrl / Current]
 <i>Measured value: 2nd harmonic/1st harmonic of IL1</i>	
CT Ntrl . IL2 H2	[Operation / Measured Values / CT Ntrl / Current]
 <i>Measured value: 2nd harmonic/1st harmonic of IL2</i>	
CT Ntrl . IL3 H2	[Operation / Measured Values / CT Ntrl / Current]
 <i>Measured value: 2nd harmonic/1st harmonic of IL3</i>	

CT Ntrl . IG H2 meas	[Operation / Measured Values / CT Ntrl / Current]
 Measured value: 2nd harmonic/1st harmonic of IG (measured)	
CT Ntrl . IG H2 calc	[Operation / Measured Values / CT Ntrl / Current]
 Measured value (calculated): 2nd harmonic/1st harmonic of IG (calculated)	
CT Ntrl . %(I2/I1)	[Operation / Measured Values / CT Ntrl / Current]
 Measured value (calculated): I2/I1, phase sequence will be taken into account automatically.	
CT Ntrl . phi IL1	[Operation / Measured Values / CT Ntrl / Current]
 Measured value (calculated): Angle of Phasor IL1	
<i>Reference phasor is required to calculate the angle. This is the first measured voltage (or current) channel with sufficiently high amplitude.</i>	
CT Ntrl . phi IL2	[Operation / Measured Values / CT Ntrl / Current]
 Measured value (calculated): Angle of Phasor IL2	
<i>Reference phasor is required to calculate the angle. This is the first measured voltage (or current) channel with sufficiently high amplitude.</i>	
CT Ntrl . phi IL3	[Operation / Measured Values / CT Ntrl / Current]
 Measured value (calculated): Angle of Phasor IL3	
<i>Reference phasor is required to calculate the angle. This is the first measured voltage (or current) channel with sufficiently high amplitude.</i>	
CT Ntrl . phi IG meas	[Operation / Measured Values / CT Ntrl / Current]
 Measured value (calculated): Angle of Phasor IG meas	
<i>Reference phasor is required to calculate the angle. This is the first measured voltage (or current) channel with sufficiently high amplitude.</i>	
CT Ntrl . phi IG calc	[Operation / Measured Values / CT Ntrl / Current]
 Measured value (calculated): Angle of Phasor IG calc	
<i>Reference phasor is required to calculate the angle. This is the first measured voltage (or current) channel with sufficiently high amplitude.</i>	

CT Ntrl . phi I0	[Operation / Measured Values / CT Ntrl / Current]
 Measured value (calculated): Angle Zero Sequence System	
	Reference phasor is required to calculate the angle. This is the first measured voltage (or current) channel with sufficiently high amplitude.
CT Ntrl . phi I1	[Operation / Measured Values / CT Ntrl / Current]
 Measured value (calculated): Angle of Positive Sequence System	
	Reference phasor is required to calculate the angle. This is the first measured voltage (or current) channel with sufficiently high amplitude.
CT Ntrl . phi I2	[Operation / Measured Values / CT Ntrl / Current]
 Measured Value (calculated): Angle of Negative Sequence System	
	Reference phasor is required to calculate the angle. This is the first measured voltage (or current) channel with sufficiently high amplitude.
CT Ntrl . IL1 RMS	[Operation / Measured Values / CT Ntrl / Current RMS]
 Measured value: Phase current (RMS)	
CT Ntrl . IL2 RMS	[Operation / Measured Values / CT Ntrl / Current RMS]
 Measured value: Phase current (RMS)	
CT Ntrl . IL3 RMS	[Operation / Measured Values / CT Ntrl / Current RMS]
 Measured value: Phase current (RMS)	
CT Ntrl . IG meas RMS	[Operation / Measured Values / CT Ntrl / Current RMS]
 Measured value (measured): IG (RMS)	
CT Ntrl . IG calc RMS	[Operation / Measured Values / CT Ntrl / Current RMS]
 Measured value (calculated): IG (RMS)	
CT Ntrl . %IL1 THD	[Operation / Measured Values / CT Ntrl / Current RMS]
 Measured value (calculated): IL1 Total Harmonic Distortion	
CT Ntrl . %IL2 THD	[Operation / Measured Values / CT Ntrl / Current RMS]
 Measured value (calculated): IL2 Total Harmonic Distortion	

CT Ntrl . %IL3 THD	[Operation / Measured Values / CT Ntrl / Current RMS]
 <i>Measured value (calculated): IL3 Total Harmonic Distortion</i>	

CT Ntrl . IL1 THD	[Operation / Measured Values / CT Ntrl / Current RMS]
 <i>Measured value (calculated): IL1 Total Harmonic Current</i>	

CT Ntrl . IL2 THD	[Operation / Measured Values / CT Ntrl / Current RMS]
 <i>Measured value (calculated): IL2 Total Harmonic Current</i>	

CT Ntrl . IL3 THD	[Operation / Measured Values / CT Ntrl / Current RMS]
 <i>Measured value (calculated): IL3 Total Harmonic Current</i>	

4.3.4 CT Ntrl: Statistical Values

CT Ntrl . IL1 avg RMS	[Operation / Statistics / Demand / CT Ntrl]
<input checked="" type="checkbox"/> <i>IL1 average value (RMS)</i>	

CT Ntrl . IL2 avg RMS	[Operation / Statistics / Demand / CT Ntrl]
<input checked="" type="checkbox"/> <i>IL2 average value (RMS)</i>	

CT Ntrl . IL3 avg RMS	[Operation / Statistics / Demand / CT Ntrl]
<input checked="" type="checkbox"/> <i>IL3 average value (RMS)</i>	

CT Ntrl . IL1 Peak demand	[Operation / Statistics / Demand / CT Ntrl]
<input checked="" type="checkbox"/> <i>IL1 Peak value, RMS value</i>	

CT Ntrl . IL2 Peak demand	[Operation / Statistics / Demand / CT Ntrl]
<input checked="" type="checkbox"/> <i>IL2 Peak value, RMS value</i>	

CT Ntrl . IL3 Peak demand	[Operation / Statistics / Demand / CT Ntrl]
<input checked="" type="checkbox"/> <i>IL3 Peak value, RMS value</i>	

CT Ntrl . IL1 max RMS	[Operation / Statistics / Max / CT Ntrl]
<input checked="" type="checkbox"/> <i>IL1 maximum value (RMS)</i>	

4 Field settings

4.3 CT Ntrl

CT Ntrl . IL2 max RMS	[Operation / Statistics / Max / CT Ntrl]
<input checked="" type="checkbox"/> <i>IL2 maximum value (RMS)</i>	
CT Ntrl . IL3 max RMS	[Operation / Statistics / Max / CT Ntrl]
<input checked="" type="checkbox"/> <i>IL3 maximum value (RMS)</i>	
CT Ntrl . IG meas max RMS	[Operation / Statistics / Max / CT Ntrl]
<input checked="" type="checkbox"/> <i>Measured value: IG maximum value (RMS)</i>	
CT Ntrl . IG calc max RMS	[Operation / Statistics / Max / CT Ntrl]
<input checked="" type="checkbox"/> <i>Measured value (calculated):IG maximum value (RMS)</i>	
CT Ntrl . I1 max	[Operation / Statistics / Max / CT Ntrl]
<input checked="" type="checkbox"/> <i>Maximum value positive phase sequence current (fundamental)</i>	
CT Ntrl . I2 max	[Operation / Statistics / Max / CT Ntrl]
<input checked="" type="checkbox"/> <i>Maximum value negative sequence current (fundamental)</i>	
CT Ntrl . %(I2/I1) max	[Operation / Statistics / Max / CT Ntrl]
<input checked="" type="checkbox"/> <i>Measured value (calculated): I2/I1 maximum value, phase sequence will be taken into account automatically</i>	
CT Ntrl . IL1 H2 max	[Operation / Statistics / Max / CT Ntrl]
<input checked="" type="checkbox"/> <i>Maximum ratio of 2nd harmonic over fundamental of IL1</i>	
CT Ntrl . IL2 H2 max	[Operation / Statistics / Max / CT Ntrl]
<input checked="" type="checkbox"/> <i>Maximum ratio of 2nd harmonic over fundamental of IL2</i>	
CT Ntrl . IL3 H2 max	[Operation / Statistics / Max / CT Ntrl]
<input checked="" type="checkbox"/> <i>Maximum ratio of 2nd harmonic over fundamental of IL3</i>	
CT Ntrl . IG H2 meas max	[Operation / Statistics / Max / CT Ntrl]
<input checked="" type="checkbox"/> <i>Measured value: Maximum ratio of 2nd harmonic over fundamental of IG (measured)</i>	
CT Ntrl . IG H2 calc max	[Operation / Statistics / Max / CT Ntrl]
<input checked="" type="checkbox"/> <i>Measured value (calculated): Maximum ratio of 2nd harmonic over fundamental of IG (calculated)</i>	

CT Ntrl . IL1 min RMS	[Operation / Statistics / Min / CT Ntrl]
<input checked="" type="checkbox"/> <i>IL1 minimum value (RMS)</i>	
CT Ntrl . IL2 min RMS	[Operation / Statistics / Min / CT Ntrl]
<input checked="" type="checkbox"/> <i>IL2 minimum value (RMS)</i>	
CT Ntrl . IL3 min RMS	[Operation / Statistics / Min / CT Ntrl]
<input checked="" type="checkbox"/> <i>IL3 minimum value (RMS)</i>	
CT Ntrl . IG meas min RMS	[Operation / Statistics / Min / CT Ntrl]
<input checked="" type="checkbox"/> <i>Measured value: IG minimum value (RMS)</i>	
CT Ntrl . IG calc min RMS	[Operation / Statistics / Min / CT Ntrl]
<input checked="" type="checkbox"/> <i>Measured value (calculated):IG minimum value (RMS)</i>	
CT Ntrl . I1 min	[Operation / Statistics / Min / CT Ntrl]
<input checked="" type="checkbox"/> <i>Minimum value positive phase sequence current (fundamental)</i>	
CT Ntrl . I2 min	[Operation / Statistics / Min / CT Ntrl]
<input checked="" type="checkbox"/> <i>Minimum value unbalanced load current (fundamental)</i>	
CT Ntrl . %(I2/I1) min	[Operation / Statistics / Min / CT Ntrl]
<input checked="" type="checkbox"/> <i>Measured value (calculated): I2/I1 minimum value, phase sequence will be taken into account automatically</i>	
CT Ntrl . IL1 H2 min	[Operation / Statistics / Min / CT Ntrl]
<input checked="" type="checkbox"/> <i>Minimum ratio of 2nd harmonic over fundamental of IL1</i>	
CT Ntrl . IL2 H2 min	[Operation / Statistics / Min / CT Ntrl]
<input checked="" type="checkbox"/> <i>Minimum ratio of 2nd harmonic over fundamental of IL2</i>	
CT Ntrl . IL3 H2 min	[Operation / Statistics / Min / CT Ntrl]
<input checked="" type="checkbox"/> <i>Minimum ratio of 2nd harmonic/1st harmonic minimum value of IL3</i>	
CT Ntrl . IG H2 meas min	[Operation / Statistics / Min / CT Ntrl]
<input checked="" type="checkbox"/> <i>Measured value: Minimum ratio of 2nd harmonic over fundamental of IG (measured)</i>	

4 Field settings

4.3 CT Ntrl

CT Ntrl . **IG H2 calc min**







[Operation / Statistics / Min / CT Ntrl]

IG H2 calc min

4.4 CT Mains

Current Transformer Main Side

4.4.1 CT Mains: Global Parameters

CT Mains . IL1, IL2, IL3 Cutoff Level	[Device Para / Measurment Display / CT Mains]	
0.005In	0.0In ... 0.100In	S.3
	<i>The Current shown in the Display or within the PC Software will be displayed as zero, if the Current falls below this Cutoff Level. This parameter has no impact on recorders.</i>	
CT Mains . IG meas Cutoff Level	[Device Para / Measurment Display / CT Mains]	
0.005In	0.0In ... 0.100In	S.3
	<i>The measured Earth Current shown in the Display or within the PC Software will be displayed as zero, if the measured Earth Current falls below this Cutoff Level. This parameter has no impact on recorders.</i>	
CT Mains . IG calc Cutoff Level	[Device Para / Measurment Display / CT Mains]	
0.005In	0.0In ... 0.100In	S.3
	<i>The calculated Earth Current shown in the Display or within the PC Software will be displayed as zero, if the calculated Earth Current falls below this Cutoff Level. This parameter has no impact on recorders.</i>	
CT Mains . I012 Cutoff Level	[Device Para / Measurment Display / CT Mains]	
0.005In	0.0In ... 0.100In	S.3
	<i>The Symmetrical Component shown in the Display or within the PC Software will be displayed as zero, if the Symmetrical Component falls below this Cutoff Level. This parameter has no impact on recorders.</i>	
CT Mains . CT pri	[Field Para / CT Mains]	
1000A	1A ... 50000A	S.3
	<i>Nominal current of the primary side of the current transformers.</i>	
CT Mains . CT sec	[Field Para / CT Mains]	
1A	1A, 5A	S.3
	 Ratio prim/sec.	
	<i>Nominal current of the secondary side of the current transformers.</i>	

CT Mains . CT dir		[Field Para / CT Mains]
0°	0°, 180°	S.3
	↳ Polarity.	
	<i>Protection functions with directional feature can only work properly if the connection of the current transformers is free of wiring errors. If all current transformers are connected to the device with an incorrect polarity, the wiring error can be compensated by this parameter. This parameter turns the current vectors by 180 degrees.</i>	

CT Mains . ECT pri		[Field Para / CT Mains]
1000A	1A ... 50000A	S.3
	<i>This parameter defines the primary nominal current of the connected earth current transformer. If the earth current is measured via the Holmgreen connection, the primary value of the phase current transformer must be entered here.</i>	











CT Mains . ECT sec		[Field Para / CT Mains]
1A	1A, 5A	S.3
	↳ Ratio prim/sec.	
	<i>This parameter defines the secondary nominal current of the connected earth current transformer. If the earth current is done via the Holmgreen connection, the primary value of the phase current transformer must be entered here.</i>	









CT Mains . ECT dir		[Field Para / CT Mains]
0°	0°, 180°	S.3
	↳ Polarity.	
	<i>Earth fault protection with directional feature depends also on the correct wiring of the earth current transformer. An incorrect polarity/wiring can be corrected by means of the settings "0°" or "180°". The operator has the possibility of turning the current vector by 180 degrees (change of sign) without modification of the wiring. This means, that - in terms of figures - the determined current indicator was turned by 180° by the device.</i>	











4.4.2 CT Mains: Signals (Output States)





CT Mains . Phase seq. wrong		[Operation / Status Display / Supervision / Phase Sequence]
	<i>Signal that the device has detected a phase sequence (L1-L2-L3 / L1-L3-L2) that is different from the one that had been set at [Field settings / General Settings] »Phase Sequence«.</i>	

4.4.3 CT Mains: Values

CT Mains . IL1	[Operation / Measured Values / CT Mains / Current]
 <i>Measured value: Phase current (fundamental)</i>	
CT Mains . IL2	[Operation / Measured Values / CT Mains / Current]
 <i>Measured value: Phase current (fundamental)</i>	
CT Mains . IL3	[Operation / Measured Values / CT Mains / Current]
 <i>Measured value: Phase current (fundamental)</i>	
CT Mains . IG meas	[Operation / Measured Values / CT Mains / Current]
 <i>Measured value (measured): IG (fundamental)</i>	
CT Mains . IG calc	[Operation / Measured Values / CT Mains / Current]
 <i>Measured value (calculated): IG (fundamental)</i>	
CT Mains . I0	[Operation / Measured Values / CT Mains / Current]
 <i>Measured value (calculated): Zero current (fundamental)</i>	
CT Mains . I1	[Operation / Measured Values / CT Mains / Current]
 <i>Measured value (calculated): Positive phase sequence current (fundamental)</i>	
CT Mains . I2	[Operation / Measured Values / CT Mains / Current]
 <i>Measured value (calculated): Unbalanced load current (fundamental)</i>	
CT Mains . IL1 H2	[Operation / Measured Values / CT Mains / Current]
 <i>Measured value: 2nd harmonic/1st harmonic of IL1</i>	
CT Mains . IL2 H2	[Operation / Measured Values / CT Mains / Current]
 <i>Measured value: 2nd harmonic/1st harmonic of IL2</i>	
CT Mains . IL3 H2	[Operation / Measured Values / CT Mains / Current]
 <i>Measured value: 2nd harmonic/1st harmonic of IL3</i>	

CT Mains . IG H2 meas	[Operation / Measured Values / CT Mains / Current]
 Measured value: 2nd harmonic/1st harmonic of IG (measured)	
CT Mains . IG H2 calc	[Operation / Measured Values / CT Mains / Current]
 Measured value (calculated): 2nd harmonic/1st harmonic of IG (calculated)	
CT Mains . %(I2/I1)	[Operation / Measured Values / CT Mains / Current]
 Measured value (calculated): I2/I1, phase sequence will be taken into account automatically.	
CT Mains . phi IL1	[Operation / Measured Values / CT Mains / Current]
 Measured value (calculated): Angle of Phasor IL1	
<i>Reference phasor is required to calculate the angle. This is the first measured voltage (or current) channel with sufficiently high amplitude.</i>	
CT Mains . phi IL2	[Operation / Measured Values / CT Mains / Current]
 Measured value (calculated): Angle of Phasor IL2	
<i>Reference phasor is required to calculate the angle. This is the first measured voltage (or current) channel with sufficiently high amplitude.</i>	
CT Mains . phi IL3	[Operation / Measured Values / CT Mains / Current]
 Measured value (calculated): Angle of Phasor IL3	
<i>Reference phasor is required to calculate the angle. This is the first measured voltage (or current) channel with sufficiently high amplitude.</i>	
CT Mains . phi IG meas	[Operation / Measured Values / CT Mains / Current]
 Measured value (calculated): Angle of Phasor IG meas	
<i>Reference phasor is required to calculate the angle. This is the first measured voltage (or current) channel with sufficiently high amplitude.</i>	
CT Mains . phi IG calc	[Operation / Measured Values / CT Mains / Current]
 Measured value (calculated): Angle of Phasor IG calc	
<i>Reference phasor is required to calculate the angle. This is the first measured voltage (or current) channel with sufficiently high amplitude.</i>	

CT Mains . phi I0	[Operation / Measured Values / CT Mains / Current]
 Measured value (calculated): Angle Zero Sequence System	
	Reference phasor is required to calculate the angle. This is the first measured voltage (or current) channel with sufficiently high amplitude.
CT Mains . phi I1	[Operation / Measured Values / CT Mains / Current]
 Measured value (calculated): Angle of Positive Sequence System	
	Reference phasor is required to calculate the angle. This is the first measured voltage (or current) channel with sufficiently high amplitude.
CT Mains . phi I2	[Operation / Measured Values / CT Mains / Current]
 Measured Value (calculated): Angle of Negative Sequence System	
	Reference phasor is required to calculate the angle. This is the first measured voltage (or current) channel with sufficiently high amplitude.
CT Mains . IL1 RMS	[Operation / Measured Values / CT Mains / Current RMS]
 Measured value: Phase current (RMS)	
CT Mains . IL2 RMS	[Operation / Measured Values / CT Mains / Current RMS]
 Measured value: Phase current (RMS)	
CT Mains . IL3 RMS	[Operation / Measured Values / CT Mains / Current RMS]
 Measured value: Phase current (RMS)	
CT Mains . IG meas RMS	[Operation / Measured Values / CT Mains / Current RMS]
 Measured value (measured): IG (RMS)	
CT Mains . IG calc RMS	[Operation / Measured Values / CT Mains / Current RMS]
 Measured value (calculated): IG (RMS)	
CT Mains . %IL1 THD	[Operation / Measured Values / CT Mains / Current RMS]
 Measured value (calculated): IL1 Total Harmonic Distortion	
CT Mains . %IL2 THD	[Operation / Measured Values / CT Mains / Current RMS]
 Measured value (calculated): IL2 Total Harmonic Distortion	

CT Mains . %IL3 THD	[Operation / Measured Values / CT Mains / Current RMS]
 <i>Measured value (calculated): IL3 Total Harmonic Distortion</i>	
CT Mains . IL1 THD	[Operation / Measured Values / CT Mains / Current RMS]
 <i>Measured value (calculated): IL1 Total Harmonic Current</i>	
CT Mains . IL2 THD	[Operation / Measured Values / CT Mains / Current RMS]
 <i>Measured value (calculated): IL2 Total Harmonic Current</i>	
CT Mains . IL3 THD	[Operation / Measured Values / CT Mains / Current RMS]
 <i>Measured value (calculated): IL3 Total Harmonic Current</i>	

4.4.4 CT Mains: Statistical Values

CT Mains . IL1 avg RMS	[Operation / Statistics / Demand / CT Mains]
<input checked="" type="checkbox"/> <i>IL1 average value (RMS)</i>	
CT Mains . IL2 avg RMS	[Operation / Statistics / Demand / CT Mains]
<input checked="" type="checkbox"/> <i>IL2 average value (RMS)</i>	
CT Mains . IL3 avg RMS	[Operation / Statistics / Demand / CT Mains]
<input checked="" type="checkbox"/> <i>IL3 average value (RMS)</i>	
CT Mains . IL1 Peak demand	[Operation / Statistics / Demand / CT Mains]
<input checked="" type="checkbox"/> <i>IL1 Peak value, RMS value</i>	
CT Mains . IL2 Peak demand	[Operation / Statistics / Demand / CT Mains]
<input checked="" type="checkbox"/> <i>IL2 Peak value, RMS value</i>	
CT Mains . IL3 Peak demand	[Operation / Statistics / Demand / CT Mains]
<input checked="" type="checkbox"/> <i>IL3 Peak value, RMS value</i>	
CT Mains . IL1 max RMS	[Operation / Statistics / Max / CT Mains]
<input checked="" type="checkbox"/> <i>IL1 maximum value (RMS)</i>	

CT Mains . IL2 max RMS	[Operation / Statistics / Max / CT Mains]
<input checked="" type="checkbox"/> <i>IL2 maximum value (RMS)</i>	
CT Mains . IL3 max RMS	[Operation / Statistics / Max / CT Mains]
<input checked="" type="checkbox"/> <i>IL3 maximum value (RMS)</i>	
CT Mains . IG meas max RMS	[Operation / Statistics / Max / CT Mains]
<input checked="" type="checkbox"/> <i>Measured value: IG maximum value (RMS)</i>	
CT Mains . IG calc max RMS	[Operation / Statistics / Max / CT Mains]
<input checked="" type="checkbox"/> <i>Measured value (calculated):IG maximum value (RMS)</i>	
CT Mains . I1 max	[Operation / Statistics / Max / CT Mains]
<input checked="" type="checkbox"/> <i>Maximum value positive phase sequence current (fundamental)</i>	
CT Mains . I2 max	[Operation / Statistics / Max / CT Mains]
<input checked="" type="checkbox"/> <i>Maximum value negative sequence current (fundamental)</i>	
CT Mains . %(I2/I1) max	[Operation / Statistics / Max / CT Mains]
<input checked="" type="checkbox"/> <i>Measured value (calculated): I2/I1 maximum value, phase sequence will be taken into account automatically</i>	
CT Mains . IL1 H2 max	[Operation / Statistics / Max / CT Mains]
<input checked="" type="checkbox"/> <i>Maximum ratio of 2nd harmonic over fundamental of IL1</i>	
CT Mains . IL2 H2 max	[Operation / Statistics / Max / CT Mains]
<input checked="" type="checkbox"/> <i>Maximum ratio of 2nd harmonic over fundamental of IL2</i>	
CT Mains . IL3 H2 max	[Operation / Statistics / Max / CT Mains]
<input checked="" type="checkbox"/> <i>Maximum ratio of 2nd harmonic over fundamental of IL3</i>	
CT Mains . IG H2 meas max	[Operation / Statistics / Max / CT Mains]
<input checked="" type="checkbox"/> <i>Measured value: Maximum ratio of 2nd harmonic over fundamental of IG (measured)</i>	
CT Mains . IG H2 calc max	[Operation / Statistics / Max / CT Mains]
<input checked="" type="checkbox"/> <i>Measured value (calculated): Maximum ratio of 2nd harmonic over fundamental of IG (calculated)</i>	

4 Field settings

4.4 CT Mains

CT Mains . IL1 min RMS	[Operation / Statistics / Min / CT Mains]
<input checked="" type="checkbox"/> <i>IL1 minimum value (RMS)</i>	
CT Mains . IL2 min RMS	[Operation / Statistics / Min / CT Mains]
<input checked="" type="checkbox"/> <i>IL2 minimum value (RMS)</i>	
CT Mains . IL3 min RMS	[Operation / Statistics / Min / CT Mains]
<input checked="" type="checkbox"/> <i>IL3 minimum value (RMS)</i>	
CT Mains . IG meas min RMS	[Operation / Statistics / Min / CT Mains]
<input checked="" type="checkbox"/> <i>Measured value: IG minimum value (RMS)</i>	
CT Mains . IG calc min RMS	[Operation / Statistics / Min / CT Mains]
<input checked="" type="checkbox"/> <i>Measured value (calculated):IG minimum value (RMS)</i>	
CT Mains . I1 min	[Operation / Statistics / Min / CT Mains]
<input checked="" type="checkbox"/> <i>Minimum value positive phase sequence current (fundamental)</i>	
CT Mains . I2 min	[Operation / Statistics / Min / CT Mains]
<input checked="" type="checkbox"/> <i>Minimum value unbalanced load current (fundamental)</i>	
CT Mains . %(I2/I1) min	[Operation / Statistics / Min / CT Mains]
<input checked="" type="checkbox"/> <i>Measured value (calculated): I2/I1 minimum value, phase sequence will be taken into account automatically</i>	
CT Mains . IL1 H2 min	[Operation / Statistics / Min / CT Mains]
<input checked="" type="checkbox"/> <i>Minimum ratio of 2nd harmonic over fundamental of IL1</i>	
CT Mains . IL2 H2 min	[Operation / Statistics / Min / CT Mains]
<input checked="" type="checkbox"/> <i>Minimum ratio of 2nd harmonic over fundamental of IL2</i>	
CT Mains . IL3 H2 min	[Operation / Statistics / Min / CT Mains]
<input checked="" type="checkbox"/> <i>Minimum ratio of 2nd harmonic/1st harmonic minimum value of IL3</i>	
CT Mains . IG H2 meas min	[Operation / Statistics / Min / CT Mains]
<input checked="" type="checkbox"/> <i>Measured value: Minimum ratio of 2nd harmonic over fundamental of IG (measured)</i>	

CT Mains . **IG H2 calc min**

[Operation / Statistics / Min / CT Mains]

IG H2 calc min

4.5 Generator

Generator

4.5.1 Generator: Global Parameters

Generator . SN	[Field Para / Generator]	
11MVA	0.001MVA ... 2000.000MVA	P.2
 Rated Power of the Generator in MVA		

Generator . Rated Voltage	[Field Para / Generator]	
10500V	60V ... 60000V	P.2
 Rated Voltage of the Generator (Phase-Phase)		

Generator . Running hours Limit	[Field Para / Generator]	
1000.00h	1.00h ... 1000000.00h	P.2
 Running hours Limit		

Generator . Running hours Initial	[Field Para / Generator]	
0.00h	0.00h ... 999999.00h	P.2
 Running hours Initial		

4.5.2 Generator: Direct Controls

Generator . t - Res Gen Op Hours	[Operation / Reset]	
inactive	inactive, active  Mode.	P.1
<input checked="" type="radio"/> Resettable Generator running hours		

4.5.3 Generator: Signals (Output States)

Generator . Running hours Alarm	[Operation / Status Display / Generator]	
 Running hours Alarm		

Generator . Res Running hours	[Operation / Status Display / Generator]
 <i>Reset Running hours</i>	



4.5.4 Generator: Values

Generator . Gen Op Hours	[Operation / Measured Values / Generator]
 <i>Generator running hours</i>	

4.6 Transformer

Transformer

4.6.1 Transformer: Device Planning Parameters



Transformer . Mode	[Device planning]	
"_"	"_", use  Mode.	S.3
	<i>Mode selects, if power transformer is used in protection-zone. Note! For linediff application, setting for local and remote device must be equal.</i>	



4.6.2 Transformer: Global Parameters

Transformer . SN	[Field Para / Transformer]	
11MVA	0.001MVA ... 2000.000MVA	P.2
	<i>Rated Power of the Transformer in MVA</i>	

Transformer . Rated W1 (HV)	[Field Para / Transformer]	
110000V	60V ... 500000V	P.2
	<i>Transformer rated voltage (phase to phase) of the HV side. At the protective device, this is connected to the current measuring input W1 (slot X3).</i>	



Transformer . Rated W2 (LV)	[Field Para / Transformer]	
10500V	60V ... 500000V	P.2
	<i>Transformer rated voltage (phase to phase) of the LV side. At the protective device, this is connected to the current measuring input W2 (slot X4).</i>	

Transformer . W1 Connection/ Grounding	[Field Para / Transformer]	
YN	Y, D, Z, YN, ZN  W1 Connection/Grounding.	P.2
	<i>Note: The zero current will be removed in order to prevent faulty tripping of the differential protection. If a star point is connected to ground according to the winding connection, the zero current (symmetrical components) will be removed.</i>	

Transformer . W2 Connection/ Grounding		[Field Para / Transformer]
d	y, d, z, yn, zn	P.2
		 W2 Connection/Grounding.
	<i>Note: The zero current will be removed in order to prevent faulty tripping of the differential protection. If a star point is connected to ground according to the winding connection, the zero current (symmetrical components) will be removed.</i>	

Transformer . Phase Shift		[Field Para / Transformer]
5	0 ... 11	P.2
	<i>Phase Shift between W1 side and W2 side. The phase shift angle is a factor (1, 2, 3,..., 11) multiplied with 30 degrees.</i>	

Transformer . Tap changer		[Field Para / Transformer]
0%	-15% ... 15%	P.2
	<i>Tap changer (referring to the W1 side)</i>	

Transformer . Generator side		[Field Para / Transformer]
W2	W2, W1	P.2
		 Generator side.
	<i>Defines which winding of the transformer is connected to the generator.</i>	
<i>In general, the W2 (low voltage) winding of a step-up transformer is connected to the generator.</i>		

5 System

System

5.1 Sys: Global Parameters

Sys . Scaling		[Device Para / Measurment Display / General Settings]
Per unit values	Per unit values, Primary values, Secondary values	S.3
		↳ Scaling.
 <i>Display of the measured values as primary, secondary or per unit values</i>		

Sys . Ack via »C« key		[Device Para / Acknowledge]
Ack LEDs w/o passw.	Nothing, Ack LEDs w/o passw., Ack LEDs, Ack LEDs and relays, Ack Everything	P.2
		↳ Ack via »C« key.
 <i>Select which acknowledgeable elements can be reset via pressing the »C« key.</i>		

Sys . Remote Reset		[Device Para / Acknowledge]
active	inactive, active	P.2
		↳ Mode.
 <i>Enables or disables the option to acknowledge from external/remote via signals (assignments) and SCADA.</i>		

Sys . Ack LED		[Device Para / Acknowledge]
"_"	"_" ... Sys . Internal test state	S.3
<i>Only available if:</i> <ul style="list-style-type: none"> • Sys . Remote Reset = active 		↳ 1..n, Assignment List.
 <i>All acknowledgeable LEDs will be acknowledged if the state of the assigned signal becomes true.</i>		

Sys . Ack BO		[Device Para / Acknowledge]
“-”	“-” ... Sys . Internal test state	S.3
<i>Only available if:</i> <ul style="list-style-type: none"> • Sys . Remote Reset = active 		↳ 1..n, Assignment List.
	<i>All acknowledgeable binary output relays will be acknowledged if the state of the assigned signal becomes true.</i>	

Sys . Ack Scada		[Device Para / Acknowledge]
“-”	“-” ... Sys . Internal test state	S.3
<i>Only available if:</i> <ul style="list-style-type: none"> • Sys . Remote Reset = active 		↳ 1..n, Assignment List.
	<i>Latched SCADA signals are acknowledged if the state of the assigned signal becomes true.</i>	

Sys . Setting Lock		[Field Para / General Settings]
“-”	“-” ... Sys . Internal test state	P.2
		↳ 1..n, Assignment List.
	<i>No parameters can be changed as long as this input is true. The parameter settings are locked.</i>	

Sys . PSet-Switch		[Protection Para / PSet-Switch]
PS1	PS1, PS2, PS3, PS4, PSS via Inp fct, PSS via Scada	P.2
		↳ PSet-Switch.
	<i>Switching Parameter Set</i>	

Sys . PS1: activated by	[Protection Para / PSet-Switch]	
...		
Sys . PS4: activated by		
"-"	"-" ... Logics . LE80.Out inverted ↳ 1..n, PSS.	P.2
	<i>This Setting Group will be the active one if: The Parameter Setting Group Switch is set to "Switch via Input" and the other three input functions are inactive at the same time. In case that there is more than one input function active, no Parameter Setting Group Switch will be executed. In case all input functions are inactive, the device will keep working with the Setting Group that was activated lastly.</i>	

5.2 Sys: Direct Controls

Sys . Ack BO LED Scd TCmd	[Operation / Acknowledge]	
inactive	inactive, active ↳ Mode.	P.1
	<i>Reset the binary output relays, LEDs, SCADA and the Trip Command.</i>	

Sys . Ack LED	[Operation / Acknowledge]	
inactive	inactive, active ↳ Mode.	P.1
	<i>All acknowledgeable LEDs will be acknowledged.</i>	

Sys . Ack BO	[Operation / Acknowledge]	
inactive	inactive, active ↳ Mode.	P.1
	<i>All acknowledgeable binary output relays will be acknowledged.</i>	

Sys . Ack Scada	[Operation / Acknowledge]	
inactive	inactive, active ↳ Mode.	P.1
	<i>Latched SCADA signals are acknowledged.</i>	

Sys . Setting Lock Bypass	[Field Para / General Settings]	
inactive	inactive, active ↳ Mode.	P.1
☉ <i>Short-period unlock of the Setting Lock</i>		

Sys . Reboot	[Service / General]	
no	no, yes ↳ yes/no.	S.3
☉ <i>Rebooting the device.</i>		

5.3 Sys: Input States

Sys . Ack LED-I	[Operation / Status Display / Sys]	
↓	<i>Module input state: LEDs acknowledgement by digital input</i>	

Sys . Ack BO-I	[Operation / Status Display / Sys]	
↓	<i>Module input state: Acknowledgement of the binary Output Relays</i>	

Sys . Ack Scada-I	[Operation / Status Display / Sys]	
↓	<i>Module input state: Acknowledge latched SCADA signals.</i>	







Sys . PS1-I	[Operation / Status Display / Sys]	
...		
Sys . PS4-I		
↓	<i>State of the module input respectively of the signal, that should activate this Parameter Setting Group.</i>	

Sys . Setting Lock-I	[Operation / Status Display / Sys]	
↓	<i>State of the module input: No parameters can be changed as long as this input is true. The parameter settings are locked.</i>	





5.4 Sys: Signals (Output States)





Sys . Reboot	[Operation / Status Display / Sys]
<p>↑ Signal: <i>Rebooting the device.</i></p> <p><i>Device Start-up Codes: 1=Normal Start-up; 2=Reboot by the Operator; 3=Reboot by means of Super Reset; 4=outdated; 5=outdated; 6=Unknown Error Source; 7=Forced Reboot (initiated by the main processor); 8=Exceeded Time Limit of the Protection Cycle; 9= Forced Reboot (initiated by the digital signal processor); 10=Exceeded Time Limit of the Measured Value Processing; 11=Sags of the Supply Voltage; 12=Illegal Memory Access.</i></p>	
Sys . Act Set	[Operation / Status Display / Sys]
	[Protection Para / PSet-Switch]
<p>↑ Signal: <i>Active Parameter Set</i></p>	
Sys . PS 1	[Operation / Status Display / Sys]
<p>↑ Signal: <i>The currently active Parameter Set is PS 1</i></p>	
Sys . PS 2	[Operation / Status Display / Sys]
<p>↑ Signal: <i>The currently active Parameter Set is PS 2</i></p>	
Sys . PS 3	[Operation / Status Display / Sys]
<p>↑ Signal: <i>The currently active Parameter Set is PS 3</i></p>	
Sys . PS 4	[Operation / Status Display / Sys]
<p>↑ Signal: <i>The currently active Parameter Set is PS 4</i></p>	
Sys . PSS manual	[Operation / Status Display / Sys]
<p>↑ Signal: <i>Manual Switch over of a Parameter Set</i></p>	
Sys . PSS via Scada	[Operation / Status Display / Sys]
<p>↑ Signal: <i>Parameter Set Switch via Scada. Write into this output byte the integer of the parameter set that should become active (e.g. 4 => Switch onto parameter set 4).</i></p>	
Sys . PSS via Inp fct	[Operation / Status Display / Sys]
<p>↑ Signal: <i>Parameter Set Switch via input function</i></p>	

Sys . min 1 param changed	[Operation / Status Display / Sys]
⤴	<i>Signal: At least one parameter has been changed</i>
Sys . Setting Lock Bypass	[Operation / Status Display / Sys]
⤴	<i>Signal: Short-period unlock of the Setting Lock</i>
Sys . Ack LED	[Operation / Status Display / Sys]
⤴	<i>Signal: LEDs acknowledgement</i>
Sys . Ack BO	[Operation / Status Display / Sys]
⤴	<i>Signal: Acknowledgement of the Binary Outputs</i>
Sys . Ack Scada	[Operation / Status Display / Sys]
⤴	<i>Signal: Acknowledge latched SCADA signals</i>
Sys . Ack TripCmd	[Operation / Status Display / Sys]
⤴	<i>Signal: Reset Trip Command</i>
Sys . Ack LED-HMI	[Operation / Status Display / Sys]
⤴	<i>Signal: LEDs acknowledgement :HMI</i>
Sys . Ack BO-HMI	[Operation / Status Display / Sys]
⤴	<i>Signal: Acknowledgement of the Binary Outputs :HMI</i>
Sys . Ack Scada-HMI	[Operation / Status Display / Sys]
⤴	<i>Signal: Acknowledge latched SCADA signals :HMI</i>
Sys . Ack TripCmd-HMI	[Operation / Status Display / Sys]
⤴	<i>Signal: Reset Trip Command :HMI</i>
Sys . Ack LED-Sca	[Operation / Status Display / Sys]
⤴	<i>Signal: LEDs acknowledgement :SCADA</i>
Sys . Ack BO-Sca	[Operation / Status Display / Sys]
⤴	<i>Signal: Acknowledgement of the Binary Outputs :SCADA</i>

























Sys . Ack Counter-Sca	[Operation / Status Display / Sys]
 <i>Signal: Reset of all Counters :SCADA</i>	
Sys . Ack Scada-Sca	[Operation / Status Display / Sys]
 <i>Signal: Acknowledge latched SCADA signals :SCADA</i>	
Sys . Ack TripCmd-Sca	[Operation / Status Display / Sys]
 <i>Signal: Reset Trip Command :SCADA</i>	
Sys . Res OperationsCr	[Operation / Status Display / Sys]
 <i>Signal:: Res OperationsCr</i>	
Sys . Res AlarmCr	[Operation / Status Display / Sys]
 <i>Signal:: Res AlarmCr</i>	
Sys . Res TripCmdCr	[Operation / Status Display / Sys]
 <i>Signal:: Res TripCmdCr</i>	
Sys . Res TotalCr	[Operation / Status Display / Sys]
 <i>Signal:: Res TotalCr</i>	

5.5 Sys: Values

Sys . Operating hours Cr	[Operation / Count and RevData / Sys]
 <i>Operating hours counter of the protective device</i>	
Sys . DM version	[Device Para / Version]
3.6.b	3.6.b 
 <i>Version of the device model</i>	
Sys . SW version	[Device Para / Version]
 <i>Version of the device firmware</i>	

Sys . Build	[Device Para / Version]
 <i>Build Number</i>	
Sys . CAT No	[Device Para / Version]
 <i>»CAT No.«, Order Code as printed on the nameplate of the device.</i>	
Sys . REV.	[Device Para / Version]
 <i>Revision (as printed on the nameplate of the device).</i>	
Sys . S/N	[Device Para / Version]
 <i>The serial number of the device.</i>	
Sys . Bootloader Build	[Device Para / Version]
 <i>Build number of the bootloader</i>	



6 Measured Values

- HMI:  "HMI: Values"
- VT:  "VT: Values"
- CT Ntrl:  "CT Ntrl: Values"
- CT Mains:  "CT Mains: Values"
- Generator:  "Generator: Values"
- System:  "Sys: Values"
- Z:  "Z: Values"
- Id:  "Id: Values"
- IdG:  "IdG: Values"
- PQSCr:  "PQSCr: Values"
- Modbus:  "Modbus: Values"
- IEC 61850:  "IEC 61850: Values"
- IEC104:  "IEC104: Values"
- Profibus:  "Profibus: Values"
- SNTP:  "SNTP: Values"
- Protection Parameter:  "Prot: Values"
- Id:  "Id: Values"
- ThR:  "ThR: Values"
- Sync:  "Sync: Values"
- URTD:  "URTD: Values"
- Control:  "Ctrl: Values"
- Breaker Wear:  "SG[1]: Values"
- Disturb rec:  "Disturb rec: Values"
- Sgen:  "Sgen: Values"

6.1 Z









Measured impedance

6.1.1 Z: Global Parameters

Z . Scaling Z	[Device Para / Measurem Display / General Settings]	
Secondary values	Primary values, Secondary values  Scaling.	S.3
	<i>Display of the measured values as primary, secondary or per unit values.</i>	
	<i>Note: The Disturbance Recorder and SCADA always use primary impedance values.</i>	

6.1.2 Z: Values

Z . Z L1-L2	[Operation / Measured Values / Impedance / Z L1-L2]	
	<i>Impedance, phase L1-L2</i>	
Z . phi(Z L1-L2)	[Operation / Measured Values / Impedance / Z L1-L2]	
	<i>Angle of the impedance Z L1-L2</i>	
Z . R L1-L2	[Operation / Measured Values / Impedance / Z L1-L2]	
	<i>Resistance part of impedance Z L1-L2</i>	
Z . X L1-L2	[Operation / Measured Values / Impedance / Z L1-L2]	
	<i>Reactance part of impedance Z L1-L2</i>	
Z . Z L2-L3	[Operation / Measured Values / Impedance / Z L2-L3]	
	<i>Impedance, phase L2-L3</i>	
Z . phi(Z L2-L3)	[Operation / Measured Values / Impedance / Z L2-L3]	
	<i>Angle of the impedance Z L2-L3</i>	
Z . R L2-L3	[Operation / Measured Values / Impedance / Z L2-L3]	
	<i>Resistance part of impedance Z L2-L3</i>	

Z . X L2-L3	[Operation / Measured Values / Impedance / Z L2-L3]
 <i>Reactance part of impedance Z L2-L3</i>	
Z . Z L3-L1	[Operation / Measured Values / Impedance / Z L3-L1]
 <i>Impedance, phase L3-L1</i>	
Z . phi(Z L3-L1)	[Operation / Measured Values / Impedance / Z L3-L1]
 <i>Angle of the impedance Z L3-L1</i>	
Z . R L3-L1	[Operation / Measured Values / Impedance / Z L3-L1]
 <i>Resistance part of impedance Z L3-L1</i>	
Z . X L3-L1	[Operation / Measured Values / Impedance / Z L3-L1]
 <i>Reactance part of impedance Z L3-L1</i>	
Z . Z1	[Operation / Measured Values / Impedance / Z1]
 <i>Measured positive-sequence impedance</i>	
Z . phi(Z1)	[Operation / Measured Values / Impedance / Z1]
 <i>Angle of the impedance Measured positive-sequence impedance</i>	
Z . R1	[Operation / Measured Values / Impedance / Z1]
 <i>Resistance part of impedance Measured positive-sequence impedance</i>	
Z . X1	[Operation / Measured Values / Impedance / Z1]
 <i>Reactance part of impedance Measured positive-sequence impedance</i>	

6.2 Id

Motor Differential Protection Module

6.2.1 Id: Global Parameters

Id . Id Cutoff Level	[Device Para / Measurem Display / Diff]
0.005In	0.0In ... 0.100In S.3
	<i>The Differential Current shown in the Display or within the PC Software will be displayed as zero, if the Differential Current falls below this Cutoff Level. This parameter has no impact on recorders.</i>

Id . IS Cutoff Level	[Device Para / Measurem Display / Diff]
0.005In	0.0In ... 0.100In S.3
	<i>The Restraint Current shown in the Display or within the PC Software will be displayed as zero, if the Restraint Current falls below this Cutoff Level. This parameter has no impact on recorders.</i>

6.2.2 Id: Values

Id . Is L1	[Operation / Measured Values / Id]
	<i>Measured value (calculated): Restraint Current Phase L1</i>

Id . Is L2	[Operation / Measured Values / Id]
	<i>Measured value (calculated): Restraint Current Phase L2</i>

Id . Is L3	[Operation / Measured Values / Id]
	<i>Measured value (calculated): Restraint Current Phase L3</i>

Id . Id L1	[Operation / Measured Values / Id]
	<i>Measured value (calculated): Differential Current Phase L1</i>

Id . Id L2	[Operation / Measured Values / Id]
	<i>Measured value (calculated): Differential Current Phase L2</i>

Id . Id L3	[Operation / Measured Values / Id]
	<i>Measured value (calculated): Differential Current Phase L3</i>

6.2.3 Id: Statistical Values

Id . Is L1 max	[Operation / Statistics / Max / Id]
<input checked="" type="checkbox"/>	<i>Measured value (calculated): Restraint Current Phase L1 Maximum Value</i>
Id . Is L2 max	[Operation / Statistics / Max / Id]
<input checked="" type="checkbox"/>	<i>Measured value (calculated): Restraint Current Phase L2 Maximum Value</i>
Id . Is L3 max	[Operation / Statistics / Max / Id]
<input checked="" type="checkbox"/>	<i>Measured value (calculated): Restraint Current Phase L3 Maximum Value</i>
Id . Id L1 max	[Operation / Statistics / Max / Id]
<input checked="" type="checkbox"/>	<i>Measured value (calculated): Differential Current Phase L1 Maximum Value</i>
Id . Id L2 max	[Operation / Statistics / Max / Id]
<input checked="" type="checkbox"/>	<i>Measured value (calculated): Differential Current Phase L2 Maximum Value</i>
Id . Id L3 max	[Operation / Statistics / Max / Id]
<input checked="" type="checkbox"/>	<i>Measured value (calculated): Differential Current Phase L3 Maximum Value</i>

6.3 IdG

Restricted Ground Fault Differential Protection Module

6.3.1 IdG: Global Parameters

IdG . IdG Cutoff Level	[Device Para / Measurem Display / Diff]	
0.005In	0.0In ... 0.100In	S.3
	<i>The Ground Differential Current shown in the Display or within the PC Software will be displayed as zero, if the Ground Differential Current falls below this Cutoff Level. This parameter has no impact on recorders.</i>	

IdG . ISG Cutoff Level	[Device Para / Measurem Display / Diff]	
0.005In	0.0In ... 0.100In	S.3
	<i>The GroundRestraint Current shown in the Display or within the PC Software will be displayed as zero, if the Ground Restraint Current falls below this Cutoff Level. This parameter has no impact on recorders.</i>	

6.3.2 IdG: Values

IdG . IsG (X3)	[Operation / Measured Values / IdG[1]]
	<i>Measured value (calculated): Ground Stabilizing Current slot X3</i>

IdG . IdG (X3)	[Operation / Measured Values / IdG[1]]
	<i>Measured value (calculated): Ground Differential Current IdG slot X3</i>

IdG . IsG (X4)	[Operation / Measured Values / IdG[2]]
	<i>Measured value (calculated): Ground Stabilizing Current slot X4</i>

IdG . IdG (X4)	[Operation / Measured Values / IdG[2]]
	<i>Measured value (calculated): Ground Differential Current IdG slot X4</i>

6.3.3 IdG: Statistical Values

IdG . IsG max (X3)	[Operation / Statistics / Max / IdG[1]]
<input checked="" type="checkbox"/>	<i>Measured value (calculated): Ground Stabilizing Current Maximum Value slot X3</i>

IdG . IdG max (X3)	[Operation / Statistics / Max / IdG[1]]
<input checked="" type="checkbox"/>	<i>Measured value (calculated): Ground Differential Current IdG Maximum Value slot X3</i>



IdG . IsG max (X4)	[Operation / Statistics / Max / IdG[2]]
<input checked="" type="checkbox"/>	<i>Measured value (calculated): Ground Stabilizing Current Maximum Value slot X4</i>



IdG . IdG max (X4)	[Operation / Statistics / Max / IdG[2]]
<input checked="" type="checkbox"/>	<i>Measured value (calculated): Ground Differential Current IdG Maximum Value slot X4</i>

6.4 PQSCr

Power and Energy



6.4.1 PQSCr: Global Parameters

PQSCr . Power Units		[Device Para / Measurment Display / General Settings]
Power Auto Scaling	Power Auto Scaling, kW/kVAr/kVA, MW/MVAr/MVA, GW/GVAr/GVA	S.3
		 1..n Power Scaling.
	<i>Power Units</i>	

PQSCr . Energy Units		[Device Para / Measurment Display / General Settings]
MWh/MVArh/MVAh	Energy Auto Scaling, kWh/kVArh/kVAh, MWh/MVArh/MVAh, GWh/GVArh/GVAh	S.3
		 1..n Energy Scaling.
	<i>Energy Units</i>	

PQSCr . S, P, Q Cutoff Level		[Device Para / Measurment Display / Power]
0.005Sn	0.05Sn ... 0.100Sn	S.3
	<i>The Active/Reactive/Apparent Power shown in the Display or within the PC Software will be displayed as zero, if the absolute value of the corresponding Power falls below this Cutoff Level. This parameter has no impact on recorders.</i>	

6.4.2 PQSCr: Direct Controls

PQSCr . Res all Energy Cr		[Operation / Reset]
inactive	inactive, active	P.1
		 Mode.
	<i>Reset of all Energy Counters</i>	

6.4.3 PQSCr: Signals (Output States)

PQSCr . Cr OfW Ws Net		[Operation / Status Display / PQSCr]
	<i>Signal: Counter Ws Net will overflow soon</i>	

PQSCr . Cr OflwW Wp Net	[Operation / Status Display / PQSCr]
 <i>Signal: Counter Wp Net will overflow soon</i>	
PQSCr . Cr OflwW Wp+	[Operation / Status Display / PQSCr]
 <i>Signal: Counter Wp+ will overflow soon</i>	
PQSCr . Cr OflwW Wp-	[Operation / Status Display / PQSCr]
 <i>Signal: Counter Wp- will overflow soon</i>	
PQSCr . Cr OflwW Wq Net	[Operation / Status Display / PQSCr]
 <i>Signal: Counter Wq Net will overflow soon</i>	
PQSCr . Cr OflwW Wq+	[Operation / Status Display / PQSCr]
 <i>Signal: Counter Wq+ will overflow soon</i>	
PQSCr . Cr OflwW Wq-	[Operation / Status Display / PQSCr]
 <i>Signal: Counter Wq- will overflow soon</i>	
PQSCr . Cr Oflw Ws Net	[Operation / Status Display / PQSCr]
 <i>Signal: Counter Overflow Ws Net</i>	
PQSCr . Cr Oflw Wp Net	[Operation / Status Display / PQSCr]
 <i>Signal: Counter Overflow Wp Net</i>	
PQSCr . Cr Oflw Wp+	[Operation / Status Display / PQSCr]
 <i>Signal: Counter Overflow Wp+</i>	
PQSCr . Cr Oflw Wp-	[Operation / Status Display / PQSCr]
 <i>Signal: Counter Overflow Wp-</i>	
PQSCr . Cr Oflw Wq Net	[Operation / Status Display / PQSCr]
 <i>Signal: Counter Overflow Wq Net</i>	
PQSCr . Cr Oflw Wq+	[Operation / Status Display / PQSCr]
 <i>Signal: Counter Overflow Wq+</i>	

PQSCr . Cr Oflw Wq-	[Operation / Status Display / PQSCr]
 <i>Signal: Counter Overflow Wq-</i>	

PQSCr . Res all Energy Cr	[Operation / Status Display / PQSCr]
 <i>Signal: Reset of all Energy Counters</i>	

6.4.4 PQSCr: Values

PQSCr . S	[Operation / Measured Values / Power]
 <i>Measured Value (Calculated): Apparent power (fundamental)</i>	

PQSCr . P	[Operation / Measured Values / Power]
 <i>Measured value (calculated): Active power (P_- = Fed Active Power, P_+ = Consumpted Active Power) (fundamental)</i>	

PQSCr . Q	[Operation / Measured Values / Power]
 <i>Measured value (calculated): Reactive power (Q_- = Fed Reactive Power, Q_+ = Consumpted Reactive Power) (fundamental)</i>	

PQSCr . cos phi	[Operation / Measured Values / Power]
 <i>Measured value (calculated): Power factor: Sign Convention: $sign(PF) = sign(P)$</i>	

PQSCr . P 1	[Operation / Measured Values / Power]
 <i>Measured value (calculated): Active power in positive sequence system (P_- = Fed Active Power, P_+ = Consumpted Active Power)</i>	

PQSCr . Q 1	[Operation / Measured Values / Power]
 <i>Measured value (calculated): Reactive power in positive sequence system (Q_- = Fed Reactive Power, Q_+ = Consumpted Reactive Power)</i>	

PQSCr . S RMS	[Operation / Measured Values / Power RMS]
 <i>Measured Value (Calculated): Apparent power (RMS)</i>	

PQSCr . P RMS	[Operation / Measured Values / Power RMS]
 <i>Measured value (calculated): Active power (P_- = Fed Active Power, P_+ = Consumpted Active Power) (RMS)</i>	

PQSCr . cos phi RMS	[Operation / Measured Values / Power RMS]
 <i>Measured value (calculated): Power factor: Sign Convention: $sign(PF) = sign(P)$</i>	
PQSCr . Wp+	[Operation / Measured Values / Energy]
 <i>Positive Active Power is consumed active energy</i>	
PQSCr . Wp-	[Operation / Measured Values / Energy]
 <i>Negative Active Power (Fed Energy)</i>	
PQSCr . Wq+	[Operation / Measured Values / Energy]
 <i>Positive Reactive Power is consumed Reactive Energy</i>	
PQSCr . Wq-	[Operation / Measured Values / Energy]
 <i>Negative Reactive Power (Fed Energy)</i>	
PQSCr . Ws Net	[Operation / Measured Values / Energy]
 <i>Absolute Apparent Power Hours</i>	
PQSCr . Wp Net	[Operation / Measured Values / Energy]
 <i>Absolute Active Power Hours</i>	
PQSCr . Wq Net	[Operation / Measured Values / Energy]
 <i>Absolute Reactive Power Hours</i>	
PQSCr . Start Date/Time	[Operation / Measured Values / Energy]
 <i>Energy counters run since... (Date and time of last reset)</i>	

6.4.5 PQSCr: Statistical Values

PQSCr . S avg	[Operation / Statistics / Demand / Power Demand]
<input checked="" type="checkbox"/> <i>Average of the apparent power</i>	
PQSCr . P avg	[Operation / Statistics / Demand / Power Demand]
<input checked="" type="checkbox"/> <i>Average of the active power</i>	

PQScr . Q avg	[Operation / Statistics / Demand / Power Demand]
<input checked="" type="checkbox"/> Average of the reactive power	
PQScr . VA Peak demand	[Operation / Statistics / Demand / Power Demand]
<input checked="" type="checkbox"/> VA Peak value, RMS value	
PQScr . Watt Peak demand	[Operation / Statistics / Demand / Power Demand]
<input checked="" type="checkbox"/> WATTS Peak value, RMS value	
PQScr . VAR Peak demand	[Operation / Statistics / Demand / Power Demand]
<input checked="" type="checkbox"/> VARs Peak value, RMS value	
PQScr . S max	[Operation / Statistics / Max / Power]
<input checked="" type="checkbox"/> Maximum value of the apparent power	
PQScr . P max	[Operation / Statistics / Max / Power]
<input checked="" type="checkbox"/> Maximum value of the active power	
PQScr . Q max	[Operation / Statistics / Max / Power]
<input checked="" type="checkbox"/> Maximum value of the reactive power	
PQScr . cos phi max RMS	[Operation / Statistics / Max / Power]
<input checked="" type="checkbox"/> Maximum value of the power factor: Sign Convention: $sign(PF) = sign(P)$	
PQScr . cos phi max	[Operation / Statistics / Max / Power]
<input checked="" type="checkbox"/> Maximum value of the power factor: Sign Convention: $sign(PF) = sign(P)$	
PQScr . S min	[Operation / Statistics / Min / Power]
<input checked="" type="checkbox"/> Minimum value of the apparent power	
PQScr . P min	[Operation / Statistics / Min / Power]
<input checked="" type="checkbox"/> Minimum value of the active power	
PQScr . Q min	[Operation / Statistics / Min / Power]
<input checked="" type="checkbox"/> Minimum value of the reactive power	

PQScr . **cos phi min RMS**

[Operation / Statistics / Min / Power]









Minimum value of the power factor: Sign Convention: $sign(PF) = sign(P)$

PQScr . **cos phi min**



[Operation / Statistics / Min / Power]



Minimum value of the power factor: Sign Convention: $sign(PF) = sign(P)$



7 Statistics

- VT:  "VT: Statistical Values"
- CT Ntrl:  "CT Ntrl: Statistical Values"
- CT Mains:  "CT Mains: Statistical Values"
- Id:  "Id: Statistical Values"
- IdG:  "IdG: Statistical Values"
- PQSCr:  "PQSCr: Statistical Values"
- Id:  "Id: Statistical Values"
- ThR:  "ThR: Statistical Values"
- URTD:  "URTD: Statistical Values"

7.1 Statistics: Global Parameters

Statistics . Start I Demand via:	[Device Para / Statistics / Demand / Current Demand]	
Duration	Duration, StartFct  Duration.	S.3
 Start Current demand by:		

Statistics . Start I Demand Fc	[Device Para / Statistics / Demand / Current Demand]	
"_" Only available if: • Statistics . Start I Demand via: = StartFct	"_" ... Sys . Internal test state  1..n, Assignment List.	S.3
 Start of the calculation, if the assigned signal becomes true.		

Statistics . ResFc I Demand	[Device Para / Statistics / Demand / Current Demand]	
"_"	"_" ... Sys . Internal test state  1..n, Assignment List.	S.3
 Resetting of Statistics - Current Demand (avg, peak avg)		

Statistics . Duration I Demand		[Device Para / Statistics / Demand / Current Demand]
15 s	2 s ... 30 d	S.3
<i>Only available if:</i> <ul style="list-style-type: none"> Statistics . Start I Demand via: = Duration 		↳ Duration.
 Recording time		

Statistics . Window I Demand		[Device Para / Statistics / Demand / Current Demand]
sliding	sliding, fixed	S.3
		↳ Window configuration.
 Window configuration		

Statistics . Start P Demand via:		[Device Para / Statistics / Demand / Power Demand]
Duration	Duration, StartFct	S.3
		↳ Duration.
 Start Active Power demand by:		

Statistics . Start P Demand Fc		[Device Para / Statistics / Demand / Power Demand]
"_"	"_" ... Sys . Internal test state	S.3
<i>Only available if:</i> <ul style="list-style-type: none"> Statistics . Start P Demand via: = StartFct 		↳ 1..n, Assignment List.
 Start of the calculation, if the assigned signal becomes true.		

Statistics . ResFc P Demand		[Device Para / Statistics / Demand / Power Demand]
"_"	"_" ... Sys . Internal test state	S.3
		↳ 1..n, Assignment List.
 Resetting of Statistics - Power Demand (avg, peak avg)		

Statistics . Duration P Demand		[Device Para / Statistics / Demand / Power Demand]
15 s	2 s ... 30 d	S.3
<i>Only available if:</i> <ul style="list-style-type: none"> Statistics . Start P Demand via: = Duration 		↳ Duration.
 <i>Recording time</i>		

Statistics . Window P Demand		[Device Para / Statistics / Demand / Power Demand]
sliding	sliding, fixed	S.3
		↳ Window configuration.
 <i>Window configuration</i>		

Statistics . ResFc Max		[Device Para / Statistics / Min / Max]
"_"	"_" ... Sys . Internal test state	S.3
		↳ 1..n, Assignment List.
 <i>Resetting of all Maximum values</i>		

Statistics . ResFc Min		[Device Para / Statistics / Min / Max]
"_"	"_" ... Sys . Internal test state	S.3
		↳ 1..n, Assignment List.
 <i>Resetting of all Minimum values</i>		

Statistics . Start Vavg via:		[Device Para / Statistics / Vavg]
Duration	Duration, StartFct	S.3
		↳ Duration.
 <i>Start sliding average supervision by:</i>		

Statistics . Start Vavg Fc		[Device Para / Statistics / Vavg]
"_"	"_" ... Sys . Internal test state	S.3
<i>Only available if:</i> <ul style="list-style-type: none"> Statistics . Start Vavg via: = StartFct 		↳ 1..n, Assignment List.
 <i>Start of the calculation, if the assigned signal becomes true.</i>		

Statistics . ResFc Vavg		[Device Para / Statistics / Vavg]
"_"	"-" ... Sys . Internal test state	S.3
	↳ 1..n, Assignment List.	
 <i>Resetting of the sliding average calculation.</i>		

Statistics . Duration Vavg		[Device Para / Statistics / Vavg]
10 min	2 s ... 30 d	S.3
Only available if:	↳ Duration.	
<ul style="list-style-type: none"> Statistics . Start Vavg via: = Duration 		
 <i>Recording time</i>		

Statistics . Window Vavg		[Device Para / Statistics / Vavg]
sliding	sliding, fixed	S.3
	↳ Window configuration.	
 <i>Window configuration</i>		

7.2 Statistics: Direct Controls

Statistics . ResFc all		[Operation / Reset]
inactive	inactive, active	P.1
	↳ Mode.	
 <i>Resetting of all Statistic values (Current Demand, Power Demand, Min, Max)</i>		

Statistics . ResFc Max		[Operation / Reset]
inactive	inactive, active	P.1
	↳ Mode.	
 <i>Resetting of all Maximum values</i>		

Statistics . ResFc Min	[Operation / Reset]
inactive	inactive, active ↳ Mode.
<input checked="" type="radio"/> <i>Resetting of all Minimum values</i>	

Statistics . ResFc I Demand	[Operation / Reset]
inactive	inactive, active ↳ Mode.
<input checked="" type="radio"/> <i>Resetting of Statistics - Current Demand (avg, peak avg)</i>	

Statistics . ResFc P Demand	[Operation / Reset]
inactive	inactive, active ↳ Mode.
<input checked="" type="radio"/> <i>Resetting of Statistics - Power Demand (avg, peak avg)</i>	

Statistics . ResFc Vavg	[Operation / Reset]
inactive	inactive, active ↳ Mode.
<input checked="" type="radio"/> <i>Resetting of the sliding average calculation.</i>	

7.3 Statistics: Input States

Statistics . StartFc Vavg-I	[Operation / Status Display / Statistics]
↓	<i>State of the module input: Start of Statistics Average Voltage</i>

Statistics . StartFc I Demand-I	[Operation / Status Display / Statistics]
↓	<i>State of the module input: Start of the Statistics of the Current Demand</i>

Statistics . StartFc P Demand-I	[Operation / Status Display / Statistics]
↓	<i>State of the module input: Start of the Statistics of the Active Power Demand</i>

7.4 Statistics: Signals (Output States)

Statistics . ResFc all	[Operation / Status Display / Statistics]
⬇	<i>Signal: Resetting of all Statistic values (Current Demand, Power Demand, Min, Max)</i>
Statistics . ResFc Vavg	[Operation / Status Display / Statistics]
⬇	<i>Signal: Resetting of the sliding average calculation.</i>
Statistics . ResFc I Demand	[Operation / Status Display / Statistics]
⬇	<i>Signal: Resetting of Statistics - Current Demand (avg, peak avg)</i>
Statistics . ResFc P Demand	[Operation / Status Display / Statistics]
⬇	<i>Signal: Resetting of Statistics - Power Demand (avg, peak avg)</i>
Statistics . ResFc Max	[Operation / Status Display / Statistics]
⬇	<i>Signal: Resetting of all Maximum values</i>
Statistics . ResFc Min	[Operation / Status Display / Statistics]
⬇	<i>Signal: Resetting of all Minimum values</i>

7.5 Statistics: Counters

Statistics . Res Cr I Demand	[Operation / Statistics / Demand / CT Ntrl] [Operation / Statistics / Demand / CT Mains]
#	<i>Number of resets since last booting. The timestamp shows date and time of the last reset.</i>
Statistics . Res Cr P Demand	[Operation / Statistics / Demand / Power Demand]
#	<i>Number of resets since last booting. The timestamp shows date and time of the last reset.</i>
Statistics . Res Cr Max values	[Operation / Statistics / Max / Voltage] ... [Operation / Statistics / Max / URTD]
#	<i>Number of resets since last booting. The timestamp shows date and time of the last reset.</i>



Statistics . Res Cr Min values	[Operation / Statistics / Min / Voltage] ... [Operation / Statistics / Min / Power]
#	<i>Number of resets since last booting. The timestamp shows date and time of the last reset.</i>

Statistics . Res Cr Vavg	[Operation / Statistics / Vavg]
#	<i>Number of resets since last booting. The timestamp shows date and time of the last reset.</i>



8 Communication

Scada

8.1 Scada: Device Planning Parameters

Scada . Protocol	[Device planning]	
"_"	"-" ... Profibus  Used Protocol.	S.3
	<i>Select the SCADA protocol to be used.</i>	

8.2 Scada: Signals (Output States)

Scada . SCADA connected	[Operation / Status Display / Scada]
	<i>At least one SCADA System is connected to the device.</i>
Scada . SCADA not connected	[Operation / Status Display / Scada]
	<i>No SCADA System is connected to the device</i>

8.3 Tcplp

Tcplp

TCP/IP config	[Device Para / TCP/IP / TCP/IP config]
	This item represents a special dialog. (See the Technical Manual for details.) <i>configuration of the TCP/IP protocol</i>

8.3.1 Tcplp: Global Parameters

Tcplp . Keep Alive Time	[Device Para / TCP/IP / Advanced Settings]
720s	1s ... 7200s S.3
	<i>Keep Alive Time is the duration between two keep alive transmissions in idle condition</i>



Tcplp . Keep Alive Interval	[Device Para / TCP/IP / Advanced Settings]
15s	1s ... 60s S.3
	<i>Keep Alive Interval is the duration between two successive keep alive retransmissions, if the acknowledgement to the previous keepalive transmission was not received.</i>

Tcplp . Keep Alive Retry	[Device Para / TCP/IP / Advanced Settings]
3	3 ... 3 S.3
	<i>Keep alive retry is the number of retransmissions to be carried out before declaring that the remote end is not available.</i>



8.4 DNP3



Distributed Network Protocol



8.4.1 DNP3: Global Parameters



DNP3 . Function	[Device Para / DNP3 / Communication]	
inactive	inactive, active  Mode.	S.3
	<i>Permanent activation or deactivation of module/stage.</i>	



DNP3 . IP Port Number	[Device Para / DNP3 / Communication]	
20000	0 ... 65535	S.3
	<i>IP Port Number.</i> <i>In general it is recommended to keep the default value. If this is not possible then select a number out of the private range 49152-52151 or 52164-65535 that is not yet in use within your network.</i>	

DNP3 . Baud rate	[Device Para / DNP3 / Communication]	
19200	1200 ... 115200  Baud rate.	S.3
	<i>Baud rate for communication</i>	

DNP3 . Frame Layout	[Device Para / DNP3 / Communication]	
8E1	8E1, 8O1, 8N1, 8N2  Byte Frame.	S.3
	<i>Frame Layout</i>	



DNP3 . Optical rest position	[Device Para / DNP3 / Communication]	
Light on <i>Avail. depends on HW</i>	Light off, Light on  Optical rest position.	S.3
	<i>Optical rest position</i>	

DNP3 . SelfAddress	[Device Para / DNP3 / Communication]	
inactive	inactive, active  Mode.	S.3
	<i>Support of self (automatic) addresses</i>	

DNP3 . DataLink confirm	[Device Para / DNP3 / Communication]	
Never	Never, Always, On_Large  Communication Start Variants.	S.3
	<i>Enables or disables the data layer confirmation (ack).</i>	







DNP3 . t-DataLink confirm	[Device Para / DNP3 / Communication]	
1s	0.1s ... 10.0s	S.3
	<i>Data layer confirmation timeout</i>	



DNP3 . DataLink num retries	[Device Para / DNP3 / Communication]	
3	0 ... 255	S.3
	<i>Number of repetition of data link packet sending after failing</i>	

DNP3 . Direction Bit	[Device Para / DNP3 / Communication]	
inactive	inactive, active  Mode.	S.3
	<i>Enables Direction Bit functionality. The Direction Bit is 0 for SlaveStation and 1 for MasterStation</i>	



DNP3 . Max Frame Size	[Device Para / DNP3 / Communication]	
255	64 ... 255	S.3
	<i>This value is used to limit the net Frame Size</i>	

DNP3 . Test Link Period	[Device Para / DNP3 / Communication]	
0s	0.0s ... 120.0s	S.3
	<i>This value specifies the time period when to send a Test Link-Frame</i>	



DNP3 . AppLink confirm		[Device Para / DNP3 / Communication]
Always	Never, Always, Event	S.3
	↳ <code>_AL_ResponseType_k</code> .	
	<i>Determines if the device will request that the Application Layer response be confirmed or not</i>	
DNP3 . t-AppLink confirm		[Device Para / DNP3 / Communication]
5s	0.1s ... 10.0s	S.3
	<i>Application layer response timeout</i>	
DNP3 . AppLink num retries		[Device Para / DNP3 / Communication]
0	0 ... 255	S.3
	<i>The number of times the device will retransmit an Application Layer fragment</i>	
DNP3 . Unsol Reporting		[Device Para / DNP3 / Communication]
inactive	inactive, active	S.3
	↳ <code>Mode</code> .	
	<i>Enables unsolicited reporting. This is available only for DNP3 TCP connections, and for DNP3 RTU in case of a peer-to-peer connection.</i>	
DNP3 . Unsol Reporting Timeout		[Device Para / DNP3 / Communication]
10s	1.0s ... 60.0s	S.3
	<i>Set the amount of time that the outstation will wait for an Application Layer confirmation back from the master indicating that the master received the unsolicited response message.</i>	
DNP3 . Unsol Reporting Retry		[Device Para / DNP3 / Communication]
2	0 ... 255	S.3
	<i>Set the number of retries that an outstation transmits in each unsolicited response series if it does not receive confirmation back from the master.</i>	
DNP3 . TestSeqNo		[Device Para / DNP3 / Communication]
inactive	inactive, active	S.3
	↳ <code>Mode</code> .	
	<i>Test if sequence number of request is incremented. If it is not correctly incremented the request will be ignored. It is recommended to have it inactive but some older DNP implementations need it activated.</i>	

DNP3 . TestSBO		[Device Para / DNP3 / Communication]	
active	inactive, active		S.3
	 Mode.		
	<i>It enables a stricter comparing of SBO and operate command. For older DNP versions it is recommended to deactivated it.</i>		

DNP3 . Timeout SBO		[Device Para / DNP3 / Communication]	
30s	1.0s ... 60.0s		S.3
	<i>DNP Outputs can be controlled in a two stage procedure (SBO: Select Before Operate). These outputs are to be selected first by a Select command. After this the bit is reserved for this Operate request. This setting defines the timer for this reservation: After the timer has elapsed the bit is released.</i>		

DNP3 . ColdRestart		[Device Para / DNP3 / Communication]	
inactive	inactive, active		S.3
	 Mode.		
	<i>Enables support for Cold Restart function.</i>		

DNP3 . Deadb integr time		[Device Para / DNP3 / Communication]	
1	0 ... 300		S.3
	<i>Deadband integration time.</i>		

DNP3 . BinaryInput 0		[Device Para / DNP3 / Point map / Binary Inputs]	
...			
DNP3 . BinaryInput 63			
"_"	"_" ... Sys . Internal test state		S.3
	 1..n, Assignment List.		
	<i>Virtual Digital Input (DNP). This corresponds to a virtual binary output of the protective device.</i>		

DNP3 . DoubleBitInput 0	[Device Para / DNP3 / Point map / Double Bit Inputs]	
...		
DNP3 . DoubleBitInput 5		
"_"	"-", SG[1] . Pos, SG[2] . Pos, SG[3] . Pos, SG[4] . Pos, SG[5] . Pos, SG[6] . Pos ↳ 1..n, Assignment List.	S.3
	<i>Double Bit Digital Input (DNP). This corresponds to a double bit binary output of the protective device.</i>	



DNP3 . BinaryCounter 0	[Device Para / DNP3 / Point map / BinaryCounter]	
...		
DNP3 . BinaryCounter 7		
"_"	"-" ... Sys . Operating hours Cr ↳ 1..n, Assignment List.	S.3
	<i>Counter can be used to report counter values to the DNP master.</i>	

DNP3 . Analog value 0	[Device Para / DNP3 / Point map / Analog Input]	
...		
DNP3 . Analog value 31		
"_"	"-" ... PQSCr . cos phi RMS ↳ 1..n, TrendReclList.	S.3
	<i>Analog value can be used to report values to the master (DNP)</i>	

DNP3 . Scale Factor 0	[Device Para / DNP3 / Point map / Analog Input]	
...		
DNP3 . Scale Factor 31		
1	0.001 ... 1000000 ↳ Scale Factor.	S.3
	<i>The scale factor is used to convert the measured value in an integer format</i>	

DNP3 . Dead Band 0	[Device Para / DNP3 / Point map / Analog Input]	
...		
DNP3 . Dead Band 31		
1%	0.01% ... 100.00%	S.3
	<i>If a change of measured value is greater than the deadband value it will be reported to the master.</i>	

8.4.2 DNP3: Direct Controls

DNP3 . Res all Diag Cr	[Operation / Count and RevData / DNP3]	
	[Operation / Reset]	
inactive	inactive, active	S.3
	 Mode.	
	<i>Reset all diagnosis counters</i>	

DNP3 . Slave Id	[Device Para / DNP3 / Communication]	
1	0 ... 65519	S.3
	<i>SlaveId defines the DNP3 address of this device (Outstation)</i>	

DNP3 . Master Id	[Device Para / DNP3 / Communication]	
65500	0 ... 65519	S.3
	<i>MasterId defines the DNP3 address of master (SCADA)</i>	

8.4.3 DNP3: Input States

DNP3 . BinaryInput0-I	[Operation / Status Display / DNP3 / Binary Inputs]	
...		
DNP3 . BinaryInput63-I		
	<i>Virtual Digital Input (DNP). This corresponds to a virtual binary output of the protective device.</i>	

DNP3 . DoubleBitInput0-I	[Operation / Status Display / DNP3 / Double Bit Inputs]
...	
DNP3 . DoubleBitInput5-I	
↓	<i>Double Bit Digital Input (DNP). This corresponds to a double bit binary output of the protective device.</i>

8.4.4 DNP3: Signals (Output States)

DNP3 . busy	[Operation / Status Display / DNP3 / State]
↓	<i>This message is set if the protocol is started. It will be reset if the protocol is shut down.</i>

DNP3 . ready	[Operation / Status Display / DNP3 / State]
↓	<i>The message will be set if the protocol is successfully started and ready for data exchange.</i>

DNP3 . active	[Operation / Status Display / DNP3 / State]
↓	<i>The communication with the Master (SCADA) is active.</i>
	<i>Note that for TCP/UDP, this state is permanently “Low” unless »DataLink confirm« is set to “Always”.</i>

8.4.5 DNP3: Counters

DNP3 . NReceived	[Operation / Count and RevData / DNP3]
#	<i>Diagnostic counter: Number of received characters</i>

DNP3 . NSent	[Operation / Count and RevData / DNP3]
#	<i>Diagnostic counter: Number of sent characters</i>

DNP3 . NBadFramings	[Operation / Count and RevData / DNP3]
#	<i>Diagnostic counter: Number of bad framings. A large number indicates a disturbed serial connection.</i>

DNP3 . NBadParities	[Operation / Count and RevData / DNP3]
#	<i>Diagnostic counter: Number of parity errors. A large number indicates a disturbed serial connection.</i>

DNP3 . NBreakSignals

[Operation / Count and RevData / DNP3]

Diagnostic counter: Number of break signals. A large number indicates a disturbed serial connection.

DNP3 . NBadChecksum

[Operation / Count and RevData / DNP3]



Diagnostic counter: Number of frames received with bad checksum.



8.5 Modbus



Modbus



8.5.1 Modbus: Global Parameters

Modbus . t-call	[Device Para / Modbus / Communication / General Settings]	
10s	1s ... 3600s	S.3
	<i>If there is no request telegram sent from Scada to the device after expiry of this time - the device concludes a communication failure within the Scada system.</i>	

Modbus . Scada CmdBlo	[Device Para / Modbus / Communication / General Settings]	
inactive	inactive, active	S.3
	 Mode.	
	<i>Activating (allowing)/ Deactivating (disallowing) the blocking of the Scada Commands</i>	

Modbus . Disable Latching	[Device Para / Modbus / Communication / General Settings]	
inactive	inactive, active	S.3
	 Mode.	
	<i>Disable Latching: If this parameter is active (true), none of the Modbus states will be latched. That means that trip signals wont be latched by Modbus.</i>	

Modbus . AllowGap	[Device Para / Modbus / Communication / General Settings]	
inactive	inactive, active	S.3
	 Mode.	
	<i>If this parameter is active (True), the user can request a set of modbus register without getting an exception, because of invalid address in the requested array. The invalid addresses have a special value 0xFAFA, but the user is responsible for ignoring invalid addresses. Attention: This special value can be valid, if address is valid.</i>	

Modbus . Optical rest position	[Device Para / Modbus / Communication / General Settings]	
Light on	Light off, Light on	S.3
Avail. depends on HW	 Optical rest position.	
	<i>Optical rest position</i>	

Modbus . TCP Port Config		[Device Para / Modbus / Communication / TCP]
Default	Default, Private	S.3
	↳ Port selection.	
	<i>TCP Port Configuration. This parameter needs to be set to "Private" only if another TCP Port than the default one shall be used.</i>	

Modbus . Port		[Device Para / Modbus / Communication / TCP]
502	If: Modbus . TCP Port Config = Default • 502 ... 502 If: Modbus . TCP Port Config = Private • 49152 ... 65535	S.3
	<i>IP Port Number. In general it is recommended to keep the default value. if this is not possible then select a number out of the private range 49152-52151 or 52164-65535 that is not yet in use within your network.</i>	

Modbus . t-timeout		[Device Para / Modbus / Communication / RTU]
1s	0.01s ... 10.00s	S.3
	<i>Within this time the answer has to be received by the SCADA system, otherwise the request will be disregarded. In that case the Scada system detects a communication failure and the Scada System has to send a new request.</i>	

Modbus . Baud rate		[Device Para / Modbus / Communication / RTU]
19200	1200, 2400, 4800, 9600, 19200, 38400	S.3
	↳ Baud rate.	
	<i>Baud rate</i>	

Modbus . Physical Settings		[Device Para / Modbus / Communication / RTU]
8E1	8E1, 8O1, 8N1, 8N2	S.3
	↳ Byte Frame.	
	<i>Digit 1: Number of bits. Digit 2: E=even parity, O=odd parity, N=no parity. Digit 3: Number of stop bits. More information on the parity: It is possible that the last data bit is followed by a parity bit which is used for recognition of communication errors. The parity bit ensures that with even parity ("EVEN") always an even number of bits with valence "1" or with odd parity ("ODD") an odd number of "1" valence bits are transmitted. But it is also possible to transmit no parity bits (here the setting is "Parity = None"). More information on the stop-bits: The end of a data byte is terminated by the stop-bits.</i>	

Modbus . Config Bin Inp1 ... Modbus . Config Bin Inp32	[Device Para / Modbus / Configb Registers / States]	
"-"	"-" ... Sys . Internal test state ↳ 1..n, Assignment List.	S.3
 <i>Virtual Digital Input. This corresponds to a virtual binary output of the protective device.</i>		

Modbus . Latched Config Bin Inp1 ... Modbus . Latched Config Bin Inp32	[Device Para / Modbus / Configb Registers / States]	
inactive	inactive, active ↳ Mode.	S.3
 <i>Latched Configurable Binary Input</i>		

Modbus . Mapped Meas 1 ... Modbus . Mapped Meas 16	[Device Para / Modbus / Configb Registers / Measured Values]	
"-"	"-" ... AnIn[2] . Value ↳ 1..n, TrendReclList.	S.3
 <i>Mapped Measured Values. They can be used to provide measured values to the Modbus Master.</i>		

Modbus . Type of SCADA mapping	[Device Para / Modbus / Config. Data Obj.]	
Standard	Standard, User-defined ↳ Type of SCADA mapping.	S.3
 <i>This setting decides whether the communication protocol shall use the default mapping of data objects, or some user-defined mapping that has been loaded from a *.HptSMap file.</i>		

8.5.2 Modbus: Direct Controls

Modbus . Res Diagn Cr	[Operation / Reset]	
inactive	inactive, active	P.1
	 Mode.	
<p>☉ All Modbus Diagnosis Counters will be reset.</p>		

Modbus . Unit ID	[Device Para / Modbus / Communication / TCP]	
255	1 ... 255	P.1
<p>☉ The Unit Identifier is used for routing. This parameter is to be set, if a Modbus RTU and a Modbus TCP network should be coupled.</p>		

Modbus . Slave ID	[Device Para / Modbus / Communication / RTU]	
1	1 ... 247	P.1
<p>☉ Device address (Slave ID) within the bus system. Each device address has to be unique within a bus system.</p>		

8.5.3 Modbus: Input States

Modbus . Config Bin Inp1-I	[Operation / Status Display / Modbus / Config Registers]	
...		
Modbus . Config Bin Inp32-I		
<p>↓ State of the module input: Config Bin Inp</p>		

8.5.4 Modbus: Signals (Output States)

Modbus . Transmission RTU	[Operation / Status Display / Modbus / State]	
<p>↑ Signal: SCADA active</p>		
Modbus . Transmission TCP	[Operation / Status Display / Modbus / State]	
<p>↑ Signal: SCADA active</p>		

Modbus . Device Type		[Operation / Status Display / Modbus / State]
↑	<i>Device Type: Device type code for relationship between device name and its Modbus code.</i>	
	<i>Woodward:</i>	
	<i>MRI4 - 1000</i>	
	<i>MRU4 - 1001</i>	
	<i>MRA4 - 1002</i>	
	<i>MCA4 - 1003</i>	
	<i>MRDT4 - 1005</i>	
	<i>MCDTV4 - 1006</i>	
	<i>MCDGV4 - 1007</i>	
	<i>MRM4 - 1009</i>	
	<i>MRMV4 - 1010</i>	
	<i>MCDLV4 - 1011</i>	

Modbus . Comm Version		[Operation / Status Display / Modbus / State]
↑	<i>Modbus Communication version. This version number changes if something becomes incompatible between different Modbus releases.</i>	



Modbus . Scada Cmd 1		[Operation / Status Display / Modbus / Commands]
	...	
Modbus . Scada Cmd 16		
↑	<i>Scada Command</i>	

8.5.5 Modbus: Values

Modbus . Mapped Meas 1		[Operation / Count and RevData / Modbus / Measured Values]
	...	
Modbus . Mapped Meas 16		
✎	<i>Mapped Measured Values. They can be used to provide measured values to the Modbus Master.</i>	

Modbus . Config info		[Device Para / Modbus / Config. Data Obj.]
✎	<i>Configuration comment (entered by the user during SCADA configuration)</i>	

Modbus . Config version	[Device Para / Modbus / Config. Data Obj.]
 <i>Version of the user-defined SCADA configuration</i>	

Modbus . Config status	[Device Para / Modbus / Config. Data Obj.]
Changing	Changing, OK, Config. not avail., Error  Config status.
 <i>Status of the user-defined SCADA configuration.</i>	
<i>Possible values:</i>	
- New SCADA configuration is being loaded, but not active yet.	
- The SCADA configuration is active.	
- The user-defined SCADA configuration is not available (e.g. has not been loaded into the device).	
- Unexpected error. Please contact our service-team.	

8.5.6 Modbus: Counters

Modbus . NoOfRequestsTotal	[Operation / Count and RevData / Modbus / TCP] [Operation / Count and RevData / Modbus / RTU]
 <i>Total number of requests. Includes requests for other slaves.</i>	

Modbus . NoOfRequestsForMe	[Operation / Count and RevData / Modbus / TCP] [Operation / Count and RevData / Modbus / RTU]
 <i>Total Number of requests for this slave.</i>	

Modbus . NoOfResponse	[Operation / Count and RevData / Modbus / TCP] [Operation / Count and RevData / Modbus / RTU]
 <i>Total number of requests having been responded.</i>	

Modbus . NoOfQueryInvalid	[Operation / Count and RevData / Modbus / TCP]
 <i>Total number of Request errors. Request could not be interpreted</i>	



Modbus . NoOfInternalError	[Operation / Count and RevData / Modbus / TCP]
 <i>Total Number of Internal errors while interpreting the request.</i>	

Modbus . NoOfFrameErrors	[Operation / Count and RevData / Modbus / RTU]
#	<i>Total Number of Frame Errors. Physically corrupted Frame.</i>
Modbus . NoOfParityErrors	[Operation / Count and RevData / Modbus / RTU]
#	<i>Total number of parity errors. Physically corrupted Frame.</i>
Modbus . NoOfResponseTimeOverruns	[Operation / Count and RevData / Modbus / RTU]
#	<i>Total number of requests with exceeded response time. Physically corrupted Frame.</i>
Modbus . NoOfOverrunErrors	[Operation / Count and RevData / Modbus / RTU]
#	<i>Total Number of Overrun Failures. Physically corrupted Frame.</i>
Modbus . NoOfBreaks	[Operation / Count and RevData / Modbus / RTU]
#	<i>Number of detected communication aborts</i>

8.6 IEC 61850



IEC 61850 communication

8.6.1 IEC 61850: Global Parameters

IEC 61850 . Function	[Device Para / IEC 61850 / Communication]	
inactive	inactive, active  1..n, OnOffList.	S.3
	<i>Permanent activation or deactivation of module/stage.</i>	

IEC 61850 . Deadb integr time	[Device Para / IEC 61850 / Communication]	
0	0 ... 300	S.3
	<i>Deadband integration time.</i>	

8.6.2 IEC 61850: Direct Controls

IEC 61850 . ResetStatistic	[Operation / Reset]	
inactive	inactive, active  Mode.	P.1
	<i>Reset of all IEC61850 diagnostic counters</i>	

8.6.3 IEC 61850: Signals (Output States)

IEC 61850 . MMS Client connected	[Operation / Status Display / IEC 61850 / State]
	<i>At least one MMS client is connected to the device</i>



IEC 61850 . All Goose Subscriber active	[Operation / Status Display / IEC 61850 / State]
	<i>All Goose subscriber in the device are working</i>



IEC 61850 . SPCSO1 ... IEC 61850 . SPCSO32	[Operation / Status Display / IEC 61850 / ControllInputs]
	<i>Status bit that can be set by clients like e.g. SCADA (Single Point Controllable Status Output).</i>



IEC 61850 . GOSINGGIO1.Ind1.stVal	[Operation / Status Display / IEC 61850 / Virtual Inputs 1]
...	[Operation / Status Display / IEC 61850 / Virtual Inputs 2]
IEC 61850 . GOSINGGIO2.Ind32.stVal	
 <i>Signal: Virtual Input (IEC61850 GGIO Ind): State</i>	

IEC 61850 . GOSINGGIO1.Ind1.q	[Operation / Status Display / IEC 61850 / Virtual Inputs 1]
...	[Operation / Status Display / IEC 61850 / Virtual Inputs 2]
IEC 61850 . GOSINGGIO2.Ind32.q	
 <i>Signal: Virtual Input (IEC61850 GGIO Ind): Self-Supervision of the GGIO Input</i>	

8.6.4 IEC 61850: Values

IEC 61850 . GoosePublisherState	[Operation / Status Display / IEC 61850 / State]
Off	Off, On, Error  State.
 <i>State of the GOOSE Publisher (on or off)</i>	

IEC 61850 . GooseSubscriberState	[Operation / Status Display / IEC 61850 / State]
Off	Off, On, Error  State.
 <i>State of the GOOSE Subscriber (on or off)</i>	

IEC 61850 . MmsServerState	[Operation / Status Display / IEC 61850 / State]
Off	Off, On, Error  State.
 <i>State of MMS Server (on or off)</i>	

8.6.5 IEC 61850: Counters

IEC 61850 . NoOfGooseRxAll	[Operation / Count and RevData / IEC 61850]
#	<i>Total number of received GOOSE messages including messages for other devices (subscribed and not subscribed messages).</i>
IEC 61850 . NoOfGooseRxSubscribed	[Operation / Count and RevData / IEC 61850]
#	<i>Total Number of subscribed GOOSE messages including messages with incorrect content.</i>
IEC 61850 . NoOfGooseRxCorrect	[Operation / Count and RevData / IEC 61850]
#	<i>Total Number of subscribed and correctly received GOOSE messages.</i>
IEC 61850 . NoOfGooseRxNew	[Operation / Count and RevData / IEC 61850]
#	<i>Number of subscribed and correctly received GOOSE messages with new content.</i>
IEC 61850 . NoOfGooseTxAll	[Operation / Count and RevData / IEC 61850]
#	<i>Total Number of GOOSE messages that have been published by this device.</i>
IEC 61850 . NoOfGooseTxNew	[Operation / Count and RevData / IEC 61850]
#	<i>Total Number of new GOOSE messages (modified content) that have been published by this device.</i>
IEC 61850 . NoOfServerRequestsAll	[Operation / Count and RevData / IEC 61850]
#	<i>Total number of MMS Server requests including incorrect requests.</i>
IEC 61850 . NoOfDataReadAll	[Operation / Count and RevData / IEC 61850]
#	<i>Total Number of values read from this device including incorrect requests.</i>
IEC 61850 . NoOfDataReadCorrect	[Operation / Count and RevData / IEC 61850]
#	<i>Total Number of correctly read values from this device.</i>
IEC 61850 . NoOfDataWrittenAll	[Operation / Count and RevData / IEC 61850]
#	<i>Total Number of values written by this device including incorrect ones.</i>

IEC 61850 . NoOfDataWrittenCorrect	[Operation / Count and RevData / IEC 61850]
--	---

#	<i>Total Number of correctly written values by this device.</i>
---	---

IEC 61850 . NoOfDataChangeNotification	[Operation / Count and RevData / IEC 61850]
--	---

#	<i>Number of detected changes within the datasets that are published with GOOSE messages.</i>
---	---



IEC 61850 . No of Client Connections	[Operation / Count and RevData / IEC 61850]
---	---

#	<i>Number of active MMS client connections</i>
---	--

8.6.6 IEC 61850 - Virt.Outp.

IEC 61850 communication

8.6.6.1 IEC 61850: Global Parameters

IEC 61850 . COU_{TGGIO1}.Ind1.stVal ... IEC 61850 . COU_{TGGIO1}.Ind32.stVal	[Device Para / IEC 61850 / Virtual Outputs 1]	
“-”	“-” ... Sys . Internal test state  1..n, Assignment List.	S.3
 <i>Virtual Output. This signal can be assigned or visualized via the SCD file to other devices within the IEC61850 substation.</i>		



8.6.6.2 IEC 61850: Input States

IEC 61850 . COU_{TGGIO1}.Ind1.stVal-I ... IEC 61850 . COU_{TGGIO1}.Ind32.stVal-I	[Operation / Status Display / IEC 61850 / Virtual Outputs 1]	
 <i>Module input state: Binary state of the Virtual Output (GGIO)</i>		



8.7 IEC103



IEC 60870-5-103 communication

8.7.1 IEC103: Global Parameters

IEC103 . Function	[Device Para / IEC103]	
inactive	inactive, active  Mode.	S.3
 <i>Activation or deactivation of the IEC103 communication.</i>		

IEC103 . Slave ID	[Device Para / IEC103]	
1	1 ... 247	S.3
 <i>Device address (Slave ID) within the bus system. Each device address has to be unique within a bus system.</i>		

IEC103 . Baud rate	[Device Para / IEC103]	
19200	1200, 2400, 4800, 9600, 19200, 38400, 57600  Baud rate.	S.3
 <i>Baud rate</i>		

IEC103 . Physical Settings	[Device Para / IEC103]	
8E1	8E1, 8O1, 8N1, 8N2  Byte Frame.	S.3
 <i>Digit 1: Number of bits. Digit 2: E=even parity, O=odd parity, N=no parity. Digit 3: Number of stop bits. More information on the parity: It is possible that the last data bit is followed by a parity bit which is used for recognition of communication errors. The parity bit ensures that with even parity ("EVEN") always an even number of bits with valence "1" or with odd parity ("ODD") an odd number of "1" valence bits are transmitted. But it is also possible to transmit no parity bits (here the setting is "Parity = None"). More information on the stop-bits: The end of a data byte is terminated by the stop-bits.</i>		

IEC103 . t-call	[Device Para / IEC103]	
60s	1s ... 3600s	S.3
 <i>If there is no request telegram sent from Scada to the device after expiry of this time - the device concludes a communication failure within the Scada system.</i>		

IEC103 . Transm priv meas val		[Device Para / IEC103]
inactive	inactive, active	S.3
	↳ Mode.	
 <i>Transmit additional (private) measuring values</i>		

IEC103 . Transfer Disturb Rec		[Device Para / IEC103]
inactive	inactive, active	S.3
	↳ Mode.	
 <i>Activates the transmission of disturbance records</i>		

IEC103 . Timezone		[Device Para / IEC103]
UTC	UTC, Local Time	S.3
	↳ Timezone.	
 <i>Selection whether the timestamps in IEC103 messages shall be given as UTC or local time. ("Local time" always includes the actual daylight saving settings.)</i>		

IEC103 . Energy Pulse Rate		[Device Para / IEC103]
0	0 ... 100	S.3
 <i>The energy values are always transmitted as counter values (i.e. as integer numbers). This setting defines the unit: If "1" is set then each counter increment is 1 kWh, if "2" is set then each counter increment is 2 kWh, etc. The setting "0" has the effect that no energy values are transmitted.</i>		

IEC103 . DFC-Compat.		[Device Para / IEC103]
inactive	inactive, active	S.3
	↳ Mode.	
 <i>This setting is only required for certain substation implementations. If there should be communication problems related to the Command Response Queue this setting switches the device over to a different behavior.</i>		

IEC103 . Optical rest position		[Device Para / IEC103]
Light on	Light off, Light on	S.3
Avail. depends on HW	↳ Optical rest position.	
 <i>Optical rest position</i>		

IEC103 . Ex activate test mode		[Service / Test (Prot inhibit) / Scada / IEC103]
Sgen . Running	"-" ... Sys . Internal test state ↳ 1..n, Assignment List.	S.3
	<i>The signal assigned to this parameter switches the IEC103 communication into Test Mode.</i>	

IEC103 . Ex activate Block MD		[Service / Test (Prot inhibit) / Scada / IEC103]
"_"	"_" ... Sys . Internal test state ↳ 1..n, Assignment List.	S.3
	<i>The signal assigned to this parameter activates the blocking of IEC103 transmission in monitor direction.</i>	

8.7.2 IEC103: Direct Controls

IEC103 . Res all Diag Cr		[Operation / Reset]
inactive	inactive, active ↳ Mode.	S.3
	<i>Reset all diagnosis counters</i>	

IEC103 . Activate test mode		[Service / Test (Prot inhibit) / Scada / IEC103]
inactive	inactive, active ↳ Mode.	S.3
	<i>This Direct Control parameter switches the IEC103 communication into Test Mode (or back to normal mode).</i>	

IEC103 . Activate Block MD		[Service / Test (Prot inhibit) / Scada / IEC103]
inactive	inactive, active ↳ Mode.	S.3
	<i>This Direct Control parameter activates (or deactivates) the blocking of IEC103 transmission in monitor direction.</i>	

8.7.3 IEC103: Signals (Output States)

IEC103 . Scada Cmd 1	[Operation / Status Display / IEC103]
...	
IEC103 . Scada Cmd 10	
⬆	<i>Scada Command</i>

IEC103 . Transmission	[Operation / Status Display / IEC103]
⬆	<i>Signal: SCADA active</i>

IEC103 . Failure Event lost	[Operation / Status Display / IEC103]
⬆	<i>Failure event lost</i>

IEC103 . Test mode active	[Operation / Status Display / IEC103]
⬆	<i>Signal: IEC103 communication has been switched over into Test Mode.</i>

IEC103 . Block MD active	[Operation / Status Display / IEC103]
⬆	<i>Signal: The blocking of IEC103 transmission in monitor direction has been activated.</i>

8.7.4 IEC103: Counters

IEC103 . NReceived	[Operation / Count and RevData / IEC103]
#	<i>Total Number of received Messages</i>

IEC103 . NSent	[Operation / Count and RevData / IEC103]
#	<i>Total Number of sent Messages</i>

IEC103 . NBadFramings	[Operation / Count and RevData / IEC103]
#	<i>Number of bad Messages</i>

IEC103 . NBadParities	[Operation / Count and RevData / IEC103]
#	<i>Number of Parity Errors</i>

IEC103 . NBreakSignals	[Operation / Count and RevData / IEC103]
#	<i>Number of Communication Interrupts</i>

IEC103 . **NInternalError**

[Operation / Count and RevData / IEC103]

Number of Internal Errors

IEC103 . **NBadCharChecksum**



[Operation / Count and RevData / IEC103]



Number of Checksum Errors

8.8 IEC104



IEC 60870-5-104 communication

8.8.1 IEC104: Global Parameters









IEC104 . Function	[Device Para / IEC104 / General Settings]	
inactive	inactive, active  Mode.	S.3
	<i>Activation or deactivation of the IEC104 communication.</i>	

IEC104 . TCP Port Config	[Device Para / IEC104 / General Settings]	
Default	Default, Private  Port selection.	S.3
	<i>TCP Port Configuration. This parameter needs to be set to "Private" only if another TCP Port than the default one shall be used.</i>	

IEC104 . Port	[Device Para / IEC104 / General Settings]	
2404	If: IEC104 . TCP Port Config = Default <ul style="list-style-type: none"> • 2404 ... 2404 If: IEC104 . TCP Port Config = Private <ul style="list-style-type: none"> • 49152 ... 65535 	S.3
	<i>IP Port Number.</i> <i>In general it is recommended to keep the default value. if this is not possible then select a number out of the private range 49152-52151 or 52164-65535 that is not yet in use within your network.</i>	

IEC104 . Timezone	[Device Para / IEC104 / General Settings]	
UTC	UTC, Local Time  Timezone.	S.3
	<i>Selection whether the timestamps in the transmitted communication telegrams shall be given as UTC or local time. ("Local time" always includes the actual daylight saving settings.)</i>	



IEC104 . Deadb integr time	[Device Para / IEC104 / General Settings]	
1s	0s ... 1000s	S.3
	<i>Deadband integration time.</i>	



IEC104 . Timeout SBE		[Device Para / IEC104 / General Settings]	
30s	1s ... 60s		S.3
	<i>The communication outputs can be controlled in a two-stage procedure (SBE: Select Before Execute). These outputs have to be selected first by a Select command. After this the bit is reserved for this Execute request. This setting defines the timer for this reservation: After the timer has elapsed the bit is released.</i>		
IEC104 . Timeout t0		[Device Para / IEC104 / Advanced]	
30s	30s ... 30s		S.3
	<i>Timeout of connection establishment</i>		
IEC104 . Timeout t1		[Device Para / IEC104 / Advanced]	
15s	15s ... 15s		S.3
	<i>Timeout of send or test APDUs</i>		
IEC104 . Timeout t2		[Device Para / IEC104 / Advanced]	
10s	10s ... 10s		S.3
	<i>Timeout for acknowledges in case of no data messages</i>		
IEC104 . Timeout t3		[Device Para / IEC104 / Advanced]	
20s	20s ... 20s		S.3
	<i>Timeout for sending test frames in case of a long idle state</i>		
IEC104 . Param k		[Device Para / IEC104 / Advanced]	
12	12 ... 12		S.3
	<i>Protocol parameter k</i>		
IEC104 . Param w		[Device Para / IEC104 / Advanced]	
8	8 ... 8		S.3
	<i>Protocol parameter w</i>		
IEC104 . Length of address		[Device Para / IEC104 / Advanced]	
2	2 ... 2		S.3
	<i>Number of bytes of the Common Address of the ASDU</i>		



IEC104 . Length of CoT	[Device Para / IEC104 / Advanced]	
2	2 ... 2	S.3
	<i>Number of bytes of the Cause of Transmission</i>	

IEC104 . Length of Inf Obj addr	[Device Para / IEC104 / Advanced]	
3	3 ... 3	S.3
	<i>Number of bytes of the address of the Information Object</i>	



IEC104 . Update time	[Device Para / IEC104 / Advanced]	
1s	1s ... 60s	S.3
	<i>This setting specifies the time after which measurement values are refreshed. If cyclic transmission is selected new values are reported after this time has elapsed.</i>	

IEC104 . Transmit Int. State	[Device Para / IEC104 / Advanced]	
active	inactive, active  Mode.	S.3
	<i>If this parameter is set to "active" (default) then the intermediate position of a switchgear, too, is transmitted. This needs to be changed to "inactive" only in the rare case that the substation communication does not support the reporting of intermediate positions.</i>	

IEC104 . Trans. Cmd. State	[Device Para / IEC104 / Advanced]	
active	inactive, active  Mode.	S.3
	<i>_ If false it suppress change events for command states (Same address as cmd)</i>	

IEC104 . Type of SCADA mapping	[Device Para / IEC104 / Config. Data Obj.]	
Standard	Standard, User-defined  Type of SCADA mapping.	S.3
	<i>This setting decides whether the communication protocol shall use the default mapping of data objects, or some user-defined mapping that has been loaded from a *.HptSMap file.</i>	

8.8.2 IEC104: Direct Controls

IEC104 . Res all Diag Cr	[Operation / Reset]	
inactive	inactive, active  Mode.	S.3
 <i>Reset all diagnosis counters</i>		

IEC104 . Common address	[Device Para / IEC104 / General Settings]	
1	1 ... 65535	S.3
 <i>Common Address of the ASDU</i>		

8.8.3 IEC104: Signals (Output States)

IEC104 . Scada Cmd 1	[Operation / Status Display / IEC104]	
...		
IEC104 . Scada Cmd 16		
 <i>Scada Command</i>		

IEC104 . busy	[Operation / Status Display / IEC104]	
 <i>This message is set if the protocol is started. It will be reset if the protocol is shut down.</i>		

IEC104 . ready	[Operation / Status Display / IEC104]	
 <i>The message will be set if the protocol is successfully started and ready for data exchange.</i>		

IEC104 . Transmission	[Operation / Status Display / IEC104]	
 <i>Signal: SCADA active</i>		

IEC104 . Failure Event lost	[Operation / Status Display / IEC104]	
 <i>Failure event lost</i>		

8.8.4 IEC104: Values

IEC104 . Config info	[Device Para / IEC104 / Config. Data Obj.]	
 <i>Configuration comment (entered by the user during SCADA configuration)</i>		

IEC104 . Config version	[Device Para / IEC104 / Config. Data Obj.]
 <i>Version of the user-defined SCADA configuration</i>	

IEC104 . Config status	[Device Para / IEC104 / Config. Data Obj.]
Changing	Changing, OK, Config. not avail., Error  Config status.

 <i>Status of the user-defined SCADA configuration.</i>
<i>Possible values:</i>
- <i>Changing: New SCADA configuration is being loaded, but not active yet.</i>
- <i>OK: The SCADA configuration is active.</i>
- <i>Config. not avail.: The user-defined SCADA configuration is not available (e.g. has not been loaded into the device).</i>
- <i>Error: Unexpected error. Please contact our service-team.</i>

8.8.5 IEC104: Counters

IEC104 . NReceived	[Operation / Count and RevData / IEC104]
 <i>Diagnostic counter: Number of received characters</i>	

IEC104 . NSent	[Operation / Count and RevData / IEC104]
 <i>Diagnostic counter: Number of sent characters</i>	

IEC104 . Num. of lost conn.	[Operation / Count and RevData / IEC104]
 <i>Diagnostic counter: Number of lost connections</i>	

IEC104 . NBadChecksum	[Operation / Count and RevData / IEC104]
 <i>Diagnostic counter: Number of frames received with bad checksum.</i>	

8.9 Profibus

Profibus Module

8.9.1 Profibus: Global Parameters



Profibus . Config Bin Inp 1	[Device Para / Profibus / Config Bin Inp 1-16]	
...	[Device Para / Profibus / Config Bin Inp 17-32]	
Profibus . Config Bin Inp 32		
"-"	"-" ... Sys . Internal test state ↳ 1..n, Assignment List.	S.3
 <i>Virtual Digital Input. This corresponds to a virtual binary output of the protective device.</i>		

Profibus . Latched 1	[Device Para / Profibus / Config Bin Inp 1-16]	
...	[Device Para / Profibus / Config Bin Inp 17-32]	
Profibus . Latched 32		
inactive	inactive, active ↳ Mode.	S.3
 <i>Defines whether the Input is latched.</i>		

Profibus . Type of SCADA mapping	[Device Para / Profibus / Config. Data Obj.]	
Standard	Standard, User-defined ↳ Type of SCADA mapping.	S.3
 <i>This setting decides whether the communication protocol shall use the default mapping of data objects, or some user-defined mapping that has been loaded from a *.HptSMap file.</i>		

8.9.2 Profibus: Direct Controls

Profibus . Slave ID	[Operation / Status Display / Profibus / State] [Device Para / Profibus / Bus parameters]	
2	2 ... 125	P.1
 <i>Device address (Slave ID) within the bus system. Each device address has to be unique within a bus system.</i>		

Profibus . Reset Comds	[Operation / Reset]	
inactive	inactive, active  Mode.	P.1
 <i>All Profibus Commands will be reset.</i>		

8.9.3 Profibus: Input States

Profibus . Assignment 1-I	[Operation / Status Display / Profibus / Config Bin Inp 1-16]
...	[Operation / Status Display / Profibus / Config Bin Inp 17-32]
Profibus . Assignment 32-I	
 <i>Module input state: Scada Assignment</i>	

8.9.4 Profibus: Signals (Output States)

Profibus . Data OK	[Operation / Status Display / Profibus / State]
 <i>Data within the Input field are OK (Yes=1)</i>	



Profibus . SubModul Err	[Operation / Status Display / Profibus / State]
 <i>Assignable Signal, Failure in Sub-Module, Communication Failure.</i>	



Profibus . Connection active	[Operation / Status Display / Profibus / State]
 <i>Connection active</i>	

Profibus . Scada Cmd 1	[Operation / Status Display / Profibus / Commands]
...	
Profibus . Scada Cmd 16	
 <i>Scada Command</i>	

8.9.5 Profibus: Values

Profibus . Slave State	[Operation / Status Display / Profibus / State]
Baud Search	Baud Search ... Data exchange  State.
	<i>Communication State between Slave and Master.</i>

Profibus . Baud rate	[Operation / Status Display / Profibus / State]
--	12 Mb/s ... --  Baud rate.
	<i>The baud rate that has been detected lastly, will still be shown after a connection issue.</i>

Profibus . PNO Id	[Operation / Status Display / Profibus / State]
0C50h	0C50h  PNO Id.
	<i>PNO Identification Number. GSD Identification Number.</i>

Profibus . Config info	[Operation / Status Display / Profibus / State] [Device Para / Profibus / Config. Data Obj.]
	<i>Configuration comment (entered by the user during SCADA configuration)</i>

Profibus . Config version	[Operation / Status Display / Profibus / State] [Device Para / Profibus / Config. Data Obj.]
	<i>Version of the user-defined SCADA configuration</i>

Profibus . Config status	[Operation / Status Display / Profibus / State] [Device Para / Profibus / Config. Data Obj.]
Changing	Changing, OK, Config. not avail., Error  Config status.
	<i>Status of the user-defined SCADA configuration. Possible values:</i>



8.9.6 Profibus: Counters

Profibus . Master ID	[Operation / Status Display / Profibus / State]
#	<i>Device address (Master ID) within the bus system. Each device address has to be unique within a bus system.</i>
Profibus . HO Id PSub	[Operation / Status Display / Profibus / State]
#	<i>Handoff Id of PbSub</i>
Profibus . t-WatchDog	[Operation / Status Display / Profibus / State]
#	<i>The Profibus Chip detects a communication issue if this timer is expired without any communication (Parameterising telegram).</i>
Profibus . Fr Sync Err	[Operation / Count and RevData / Profibus]
#	<i>Frames, that were sent from the Master to the Slave are faulty.</i>
Profibus . Num. CRC err.	[Operation / Count and RevData / Profibus]
#	<i>Number of CRC errors that the subsystem manager has recognized in the received response frames from the subsystem. (Each error caused a subsystem reset.)</i>
Profibus . Num. frame loss err.	[Operation / Count and RevData / Profibus]
#	<i>Number of frame loss errors that the subsystem manager has recognized in the received response frames from the subsystem. (Each error caused a subsystem reset.)</i>
Profibus . Num. trig. CRC err.	[Operation / Count and RevData / Profibus]
#	<i>Number of CRC errors that the subsystem has recognized in the received trigger frames from the host.</i>
Profibus . Num. subsys. res.	[Operation / Count and RevData / Profibus]
#	<i>Number of subsystem restarts or resets that the subsystem manager has caused.</i>



8.10 IRIG-B



IRIG-B-Module

8.10.1 IRIG-B: Device Planning Parameters



IRIG-B . Mode	[Device planning]	
"_"	"_", use  Mode.	S.3
 <i>IRIG-B-Module, general operation mode</i>		

8.10.2 IRIG-B: Global Parameters

IRIG-B . Function	[Device Para / Time / TimeSync / IRIG-B]	
inactive	inactive, active  Mode.	S.3
 <i>Permanent activation or deactivation of module/stage.</i>		

IRIG-B . IRIG-B00X	[Device Para / Time / TimeSync / IRIG-B]	
IRIGB-000	IRIGB-000 ... IRIGB-007  IRIG-B00X.	S.3
 <i>Determination of the Type: IRIG-B00X. IRIG-B types differ in types of included "Coded Expressions" (year, control-functions, straight-binary-seconds).</i>		

8.10.3 IRIG-B: Direct Controls

IRIG-B . Res IRIG-B Cr	[Operation / Reset]	
inactive	inactive, active  Mode.	P.1
 <i>Resetting of the Diagnosis Counters: IRIG-B</i>		

8.10.4 IRIG-B: Signals (Output States)

IRIG-B . IRIG-B active	[Operation / Status Display / TimeSync / IRIG-B]
⬇	<i>Signal: If there is no valid IRIG-B signal for 60 sec, IRIG-B is regarded as inactive.</i>
IRIG-B . High-Low Invert	[Operation / Status Display / TimeSync / IRIG-B]
⬇	<i>Signal: The High and Low signals of the IRIG-B are inverted. This does NOT mean that the wiring is faulty. If the wiring is faulty no IRIG-B signal will be detected.</i>
IRIG-B . Control Signal1 ... IRIG-B . Control Signal18	[Operation / Status Display / TimeSync / IRIG-B]
⬇	<i>Signal: IRIG-B Control Signal. The external IRIG-B generator can set these signals. They can be used for further control procedures inside the device (e.g. logic funtions).</i>



8.10.5 IRIG-B: Counters

IRIG-B . NoOfFramesOK	[Operation / Count and RevData / TimeSync / IRIG-B]
#	<i>Total Number valid Frames.</i>
IRIG-B . NoOfFrameErrors	[Operation / Count and RevData / TimeSync / IRIG-B]
#	<i>Total Number of Frame Errors. Physically corrupted Frame.</i>
IRIG-B . Edges	[Operation / Count and RevData / TimeSync / IRIG-B]
#	<i>Edges: Total number of rising and falling edges. This signal indicates if a signal is available at the IRIG-B input.</i>



8.11 SNTP

SNTP-Module



8.11.1 SNTP: Device Planning Parameters

SNTP . Mode	[Device planning]	
"_"	"_", use  Mode.	S.3
 <i>SNTP-Module, general operation mode</i>		



8.11.2 SNTP: Global Parameters

SNTP . Server1	[Device Para / Time / TimeSync / SNTP]	
inactive	inactive, active  Mode.	S.3
 <i>Server 1</i>		

SNTP . IP Byte1	[Device Para / Time / TimeSync / SNTP]	
...		
SNTP . IP Byte4		
0	0 ... 255	S.3
 <i>IP1.IP2.IP3.IP4</i>		

SNTP . Server2	[Device Para / Time / TimeSync / SNTP]	
inactive	inactive, active  Mode.	S.3
 <i>Server 2</i>		



8.11.3 SNTP: Direct Controls

SNTP . Res Counter	[Operation / Reset]	
inactive	inactive, active  Mode.	P.1
 Reset all Counters.		

8.11.4 SNTP: Signals (Output States)



SNTP . SNTP active	[Operation / Status Display / TimeSync / SNTP]	
 Signal: If there is no valid SNTP signal for 120 sec, SNTP is regarded as inactive.		



8.11.5 SNTP: Values

SNTP . Used Server	[Operation / Status Display / TimeSync / SNTP]	
None	Server1, Server2, None  Server State.	
 Which Server is used for SNTP synchronization.		

SNTP . PrecServer1	[Operation / Status Display / TimeSync / SNTP]	
 Precision of Server 1		

SNTP . PrecServer2	[Operation / Status Display / TimeSync / SNTP]	
 Precision of Server 2		

SNTP . ServerQlty	[Operation / Status Display / TimeSync / SNTP]	
"_"	GOOD, SUFFICIENT, BAD, "-"  State.	
 Quality of Server used for Synchronization (GOOD, SUFFICIENT, BAD)		

SNTP . NetConn	[Operation / Status Display / TimeSync / SNTP]
"_"	GOOD, SUFFICIENT, BAD, "-"  State.
	<i>Quality of Network Connection (GOOD, SUFFICIENT, BAD).</i>

8.11.6 SNTP: Counters

SNTP . StratumServer1	[Operation / Status Display / TimeSync / SNTP]
#	<i>Stratum of Server 1</i>

SNTP . StratumServer2	[Operation / Status Display / TimeSync / SNTP]
#	<i>Stratum of Server 2</i>

SNTP . NoOfSyncs	[Operation / Count and RevData / TimeSync / SNTP]
#	<i>Total Number of Synchronizations.</i>

SNTP . NoOfConnectLost	[Operation / Count and RevData / TimeSync / SNTP]
#	<i>Total Number of lost SNTP Connections (no sync for 120 sec).</i>

SNTP . NoOfSmallSyncs	[Operation / Count and RevData / TimeSync / SNTP]
#	<i>Service counter: Total Number of very small Time Corrections.</i>

SNTP . NoOfNormSyncs	[Operation / Count and RevData / TimeSync / SNTP]
#	<i>Service counter: Total Number of normal Time Corrections</i>

SNTP . NoOfBigSyncs	[Operation / Count and RevData / TimeSync / SNTP]
#	<i>Service counter: Total Number of big Time Corrections</i>

SNTP . NoOfFiltSyncs	[Operation / Count and RevData / TimeSync / SNTP]
#	<i>Service counter: Total Number of filtered Time Corrections</i>

SNTP . NoOfSlowTrans	[Operation / Count and RevData / TimeSync / SNTP]
#	<i>Service counter: Total Number of slow Transfers.</i>

SNTP . NoOfHighOffs	[Operation / Count and RevData / TimeSync / SNTP]
----------------------------	---

#	<i>Service counter: Total Number of high Offsets.</i>
---	---

SNTP . NoOfIntTimeouts	[Operation / Count and RevData / TimeSync / SNTP]
-------------------------------	---



#	<i>Service counter: Total Number of internal timeouts.</i>
---	--

8.12 TimeSync



Time synchronisation



Date and Time		[Device Para / Time / Date and Time]
	This item represents a special dialog. (See the Technical Manual for details.) <i>(Re-)setting Date and Time</i>	

8.12.1 TimeSync: Global Parameters

TimeSync . Time Zones		[Device Para / Time / Timezone]
UTC+0 London	UTC+14 Kiritimati ... UTC-11 Midway Islands	S.3
	 Time Zones.	
	<i>Time Zones</i>	

TimeSync . DST offset		[Device Para / Time / Timezone]
60min	-180min ... 180min	S.3
	<i>Difference to wintertime</i>	

TimeSync . DST manual		[Device Para / Time / Timezone]
active	inactive, active	S.3
	 Mode.	
	<i>Manual setting of the Daylight Saving Time</i>	

TimeSync . Summertime		[Device Para / Time / Timezone]
inactive	inactive, active	S.3
	 Mode.	
	<i>Daylight Saving Time</i>	

TimeSync . Summertime m		[Device Para / Time / Timezone]
March	January ... December	S.3
	 Month of clock change.	
	<i>Month of clock change summertime</i>	

TimeSync . Summertime d		[Device Para / Time / Timezone]
Sunday	Sunday ... General day	S.3
	↳ Date.	
	<i>Day of clock change summertime</i>	

TimeSync . Summertime w		[Device Para / Time / Timezone]
Last	First, Second, Third, Fourth, Last	S.3
	↳ Day of clock change.	
	<i>Place of selected day in month (for clock change summertime)</i>	

TimeSync . Summertime h		[Device Para / Time / Timezone]
2h	0h ... 23h	S.3
	<i>Hour of clock change summertime</i>	

TimeSync . Summertime min		[Device Para / Time / Timezone]
0min	0min ... 59min	S.3
	<i>Minute of clock change summertime</i>	



TimeSync . Wintertime m		[Device Para / Time / Timezone]
October	January ... December	S.3
	↳ Month of clock change.	
	<i>Month of clock change wintertime</i>	

TimeSync . Wintertime d		[Device Para / Time / Timezone]
Sunday	Sunday ... General day	S.3
	↳ Date.	
	<i>Day of clock change wintertime</i>	

TimeSync . Wintertime w		[Device Para / Time / Timezone]
Last	First, Second, Third, Fourth, Last	S.3
	↳ Day of clock change.	
	<i>Place of selected day in month (for clock change wintertime)</i>	

TimeSync . Wintertime h	[Device Para / Time / Timezone]	
3h	0h ... 23h	S.3
	<i>Hour of clock change wintertime</i>	

TimeSync . Wintertime min	[Device Para / Time / Timezone]	
0min	0min ... 59min	S.3
	<i>Minute of clock change wintertime</i>	

TimeSync . TimeSync	[Device Para / Time / TimeSync / TimeSync]	
"_"	"_", IRIG-B . IRIG-B, SNTP . SNTP, Modbus . Modbus, IEC103 . IEC 60870-5-103, IEC104 . IEC104, DNP3 . DNP3  Used Protocol.	S.3
	<i>Time synchronisation</i>	



8.12.2 TimeSync: Signals (Output States)



TimeSync . synchronized	[Operation / Status Display / TimeSync / TimeSync]	
	<i>Clock is synchronized.</i>	



9 Protection Parameter



Module General Protection



9.1 Prot: Global Parameters

Prot . Function	[Protection Para / Global Prot Para / Prot]	
active	inactive, active  Mode.	P.2
 Permanent activation or deactivation of module/stage.		

Prot . ExBlo Fc	[Protection Para / Global Prot Para / Prot]	
inactive	inactive, active  active/inactive.	P.2
 Activate (allow) the external blocking of the global protection functionality of the device.		

Prot . ExBlo1 Prot . ExBlo2	[Protection Para / Global Prot Para / Prot]	
"_"	"_" ... Sys . Internal test state  1..n, Assignment List.	P.2
 If external blocking of this module is activated (allowed), the global protection functionality of the device will be blocked if the state of the assigned signal becomes true.		

Prot . Blo TripCmd	[Protection Para / Global Prot Para / Prot]	
inactive	inactive, active  Mode.	P.2
 Permanent blocking of the Trip Command of the entire Protection.		



Prot . ExBlo TripCmd Fc	[Protection Para / Global Prot Para / Prot]	
inactive	inactive, active  active/inactive.	P.2
 Activate (allow) the external blocking of the trip command of the entire device.		

Prot . ExBlo TripCmd	[Protection Para / Global Prot Para / Prot]	
"_"	"_" ... Sys . Internal test state ↳ 1..n, Assignment List.	P.2
	<i>If external blocking of the tripping command is activated (allowed), the tripping command of the entire device will be blocked if the state of the assigned signal becomes true.</i>	



9.2 Prot: Direct Controls

Prot . Res FaultNo a GridFaultNo	[Operation / Reset]	
inactive	inactive, active ↳ Mode.	P.1
	<i>Resetting of fault number and grid fault number.</i>	

9.3 Prot: Input States

Prot . ExBlo1-I	[Operation / Status Display / Prot]	
	<i>Module input state: External blocking1</i>	
Prot . ExBlo2-I	[Operation / Status Display / Prot]	
	<i>Module input state: External blocking2</i>	
Prot . ExBlo TripCmd-I	[Operation / Status Display / Prot]	
	<i>Module input state: External Blocking of the Trip Command</i>	

9.4 Prot: Signals (Output States)

Prot . active	[Operation / Status Display / All Actives] [Operation / Status Display / Prot]	
	<i>Signal: active</i>	
Prot . Alarm	[Operation / Status Display / Alarms] [Operation / Status Display / Prot]	
	<i>Signal: General Alarm</i>	

Prot . Trip	[Operation / Status Display / Trips] [Operation / Status Display / Prot]
⬆️ <i>Signal: General Trip</i>	
Prot . available	[Operation / Status Display / Prot]
⬆️ <i>Signal: Protection is available</i>	
Prot . ExBlo	[Operation / Status Display / Prot]
⬆️ <i>Signal: External Blocking</i>	
Prot . Blo TripCmd	[Operation / Status Display / Prot]
⬆️ <i>Signal: Trip Command blocked</i>	
Prot . ExBlo TripCmd	[Operation / Status Display / Prot]
⬆️ <i>Signal: External Blocking of the Trip Command</i>	
Prot . Alarm L1	[Operation / Status Display / Prot]
⬆️ <i>Signal: General-Alarm L1</i>	
Prot . Alarm L2	[Operation / Status Display / Prot]
⬆️ <i>Signal: General-Alarm L2</i>	
Prot . Alarm L3	[Operation / Status Display / Prot]
⬆️ <i>Signal: General-Alarm L3</i>	
Prot . Alarm G	[Operation / Status Display / Prot]
⬆️ <i>Signal: General-Alarm - Earth fault</i>	
Prot . Trip L1	[Operation / Status Display / Prot]
⬆️ <i>Signal: General Trip L1</i>	
Prot . Trip L2	[Operation / Status Display / Prot]
⬆️ <i>Signal: General Trip L2</i>	

Prot . Trip L3	[Operation / Status Display / Prot]
 <i>Signal: General Trip L3</i>	
Prot . Trip G	[Operation / Status Display / Prot]
 <i>Signal: General Trip Ground fault</i>	
Prot . Res FaultNo a GridFaultNo	[Operation / Status Display / Prot]
 <i>Signal: Resetting of fault number and grid fault number.</i>	
Prot . I dir fwd	[Operation / Status Display / Prot]
 <i>Signal: Phase current failure forward direction</i>	
Prot . I dir rev	[Operation / Status Display / Prot]
 <i>Signal: Phase current failure reverse direction</i>	
Prot . I dir n poss	[Operation / Status Display / Prot]
 <i>Signal: Phase fault - missing reference voltage</i>	
Prot . IG calc dir fwd	[Operation / Status Display / Prot]
 <i>Signal: Ground fault (calculated) forward</i>	
Prot . IG calc dir rev	[Operation / Status Display / Prot]
 <i>Signal: Ground fault (calculated) reverse direction</i>	
Prot . IG calc dir n poss	[Operation / Status Display / Prot]
 <i>Signal: Ground fault (calculated) direction detection not possible</i>	
Prot . IG meas dir fwd	[Operation / Status Display / Prot]
 <i>Signal: Ground fault (measured) forward</i>	
Prot . IG meas dir rev	[Operation / Status Display / Prot]
 <i>Signal: Ground fault (measured) reverse direction</i>	
Prot . IG meas dir n poss	[Operation / Status Display / Prot]
 <i>Signal: Ground fault (measured) direction detection not possible</i>	

Prot . f(VL123)<10Hz	[Operation / Status Display / Prot]
 <i>Frequency of the measuring channels 1-3 (VL1,VL2,VL3) is lower than 10Hz.</i>	

Prot . f(VL123)>10Hz	[Operation / Status Display / Prot]
 <i>Frequency of the measuring channels 1-3 (VL1,VL2,VL3) is greater than 10Hz.</i>	

Prot . f(VL123)<70Hz	[Operation / Status Display / Prot]
 <i>Frequency of the measuring channels 1-3 (VL1,VL2,VL3) is lower than 70Hz.</i>	

Prot . f(VL123)>70Hz	[Operation / Status Display / Prot]
 <i>Frequency of the measuring channels 1-3 (VL1,VL2,VL3) is greater than 70Hz.</i>	

Prot . DFT Invalid	[Operation / Status Display / Prot]
 <i>DFT values of fundamental and harmonics (except VX) are not valid. They depend on period time of frequency and measured channels 1-3 (VL1,VL2,VL3).</i>	

Prot . DFT Valid	[Operation / Status Display / Prot]
 <i>DFT values of fundamental and harmonics (except VX) are valid. They depend on period time of frequency and measured channels 1-3 (VL1,VL2,VL3).</i>	

Prot . f(VX)<10Hz	[Operation / Status Display / Prot]
 <i>Frequency of the measuring channel 4 (VX) is lower than 10Hz.</i>	

Prot . f(VX)>10Hz	[Operation / Status Display / Prot]
 <i>Frequency of the measuring channel 4 (VX) is greater than 10Hz.</i>	

Prot . f(VX)<70Hz	[Operation / Status Display / Prot]
 <i>Frequency of the measuring channel 4 (VX) is lower than 70Hz.</i>	

Prot . f(VX)>70Hz	[Operation / Status Display / Prot]
 <i>Frequency of the measuring channel 4 (VX) is greater than 70Hz.</i>	



Prot . DFT Invalid (VX)	[Operation / Status Display / Prot]
 <i>DFT values of fundamental and harmonics of VX (only) are not valid.</i>	



Prot . DFT Valid (VX)	[Operation / Status Display / Prot]
 <i>DFT values of fundamental and harmonics of VX (only) are valid.</i>	



Prot . FaultNo	[Operation / Count and RevData / Prot]
 <i>Fault number</i>	

Prot . No. of Grid Fault	[Operation / Count and RevData / Prot]
 <i>Number of grid fault: A grid fault, e.g. a short circuit, might cause several faults with trip and autoreclosing; in this case, the fault number counts each fault, but the grid fault number remains the same.</i>	

9.5 Prot: Values

Prot . Dir. I	[Operation / Measured Values / Direction]
not possible	reverse, forward, not possible  Direction.
 <i>The detected direction of the phase current flow.</i>	



Prot . Dir. IG meas.	[Operation / Measured Values / Direction]
not possible	reverse, forward, not possible  Direction.
 <i>The detected direction of the current flow of the measured residual current.</i>	

Prot . Dir. IG calc.	[Operation / Measured Values / Direction]
not possible	reverse, forward, not possible  Direction.
 <i>The detected direction of the current flow of the calculated residual current.</i>	



9.6 Id



Differential Protection Module

9.6.1 Id: Device Planning Parameters



Id . Mode	[Device planning]	
use	“-”, use  Mode.	S.3
 <i>general operation mode</i>		

9.6.2 Id: Global Parameters

Id . ExBlo1	[Protection Para / Global Prot Para / Diff-Prot / Id]	
Id . ExBlo2		
“-”	“-” ... Sys . Internal test state  1..n, Assignment List.	P.2
 <i>External blocking of the module, if blocking is activated (allowed) within a parameter set and if the state of the assigned signal is true.</i>		

Id . ExBlo TripCmd	[Protection Para / Global Prot Para / Diff-Prot / Id]	
“-”	“-” ... Sys . Internal test state  1..n, Assignment List.	P.2
 <i>External blocking of the Trip Command of the module/the stage, if blocking is activated (allowed) within a parameter set and if the state of the assigned signal is true.</i>		

9.6.3 Id: Setting Group Parameters

Id . Function	[Protection Para / Set 1...4 / Diff-Prot / Id]	
active	inactive, active  Mode.	P.2
 <i>Permanent activation or deactivation of module/stage.</i>		

Id . ExBlo Fc	[Protection Para / Set 1...4 / Diff-Prot / Id]	
inactive	inactive, active ↳ active/inactive.	P.2
	<i>Activate (allow) or inactivate (disallow) blocking of the module/stage. This parameter is only effective if a signal is assigned to the corresponding global protection parameter. If the signal becomes true, those modules/stages are blocked that are parameterized "ExBlo Fc=active".</i>	

Id . Blo TripCmd	[Protection Para / Set 1...4 / Diff-Prot / Id]	
inactive	inactive, active ↳ Mode.	P.2
	<i>Permanent blocking of the Trip Command of the module/stage.</i>	

Id . ExBlo TripCmd Fc	[Protection Para / Set 1...4 / Diff-Prot / Id]	
inactive	inactive, active ↳ active/inactive.	P.2
	<i>Activate (allow) or inactivate (disallow) blocking of the module/stage. This parameter is only effective if a signal is assigned to the corresponding global protection parameter. If the signal becomes true, those modules/stages are blocked that are parameterized "ExBlo TripCmd Fc=active".</i>	

Id . Id min	[Protection Para / Set 1...4 / Diff-Prot / Id]	
0.2Ib	0.05Ib ... 1.00Ib	P.2
	<i>Constant minimum pickup current (differential current). Pickup value of the differential current based on the rated current Ib of the protection object.</i>	

Id . Id(Is0)	[Protection Para / Set 1...4 / Diff-Prot / Id]	
0.0Ib	0.0Ib ... 1.00Ib	P.2
	<i>Starting point of the static tripping characteristic at Is0</i>	

Id . Id(Is1)	[Protection Para / Set 1...4 / Diff-Prot / Id]	
0.6Ib	0.2Ib ... 2.00Ib	P.2
	<i>Breaking point of the static tripping characteristic at Is1</i>	



Id . Id(Is2)	[Protection Para / Set 1...4 / Diff-Prot / Id]	
6.2Ib	1.0Ib ... 8.0Ib	P.2
	<i>Value of the static tripping characteristic at Is2</i>	

Id . Is1	[Protection Para / Set 1...4 / Diff-Prot / Id]	
2.0Ib	0.5Ib ... 4.0Ib	P.2
	<i>Breaking point of the static tripping characteristic when Is1</i>	

Id . Is2	[Protection Para / Set 1...4 / Diff-Prot / Id]	
10.0Ib	5.0Ib ... 10.0Ib	P.2
	<i>Value of the static tripping characteristic at Is2</i>	











Id . Char Reset%	[Protection Para / Set 1...4 / Diff-Prot / Id]	
95%	90% ... 98%	P.2
	<i>Drop Out (in percent of the setting). Settable Drop Out works only on the gradients. Id min uses a fix Drop Out.</i>	



Id . d(H,m)	[Protection Para / Set 1...4 / Diff-Prot / Id]	
8Ib	0.0Ib ... 30.0Ib	P.2
	<i>Restraining factor for rising the static tripping characteristic in case of stationary or transient harmonic components, which are ascertained by Fourier analysis (H) or transients monitor (m).</i>	

Id . Stab H2	[Protection Para / Set 1...4 / Diff-Prot / Id]	
inactive	inactive, active  Mode.	P.2
	<i>Restraining of differential protection function against stationary or transient components of the 2nd harmonic at the phase current (e.g. rush-effect).</i>	

Id . H2 Sta	[Protection Para / Set 1...4 / Diff-Prot / Id]	
25%	10% ... 60%	P.2
	<i>Threshold (2nd harmonic - basic wave ratio) for restraining the differential protection function against stationary 2nd harmonic.</i>	

Id . H2 Tra	[Protection Para / Set 1...4 / Diff-Prot / Id]	
10%	10% ... 60%	P.2
	<i>Threshold (2nd harmonic - basic wave ratio) for temporary stabilisation of the differential protection function against transient 2nd harmonic.</i>	

Id . Stab H4	[Protection Para / Set 1...4 / Diff-Prot / Id]	
inactive	inactive, active  Mode.	P.2
	<i>Restraining of differential protection function against stationary components of the 4th harmonic at the phase current.</i>	
Id . H4 Sta	[Protection Para / Set 1...4 / Diff-Prot / Id]	
20%	10% ... 60%	P.2
	<i>Threshold (4th harmonic - basic wave ratio) for restraining the differential protection function against stationary 4th harmonic.</i>	
Id . Stab H5	[Protection Para / Set 1...4 / Diff-Prot / Id]	
inactive	inactive, active  Mode.	P.2
	<i>Stabilisation of differential protection function against stationary or transient components of the 5th harmonic at the phase current (e.g. transformer overexcitation).</i>	
Id . H5 Sta	[Protection Para / Set 1...4 / Diff-Prot / Id]	
30%	10% ... 60%	P.2
	<i>Threshold (5thd harmonic - basic wave ratio) for stabilising the differential protection function against stationary 5th harmonic.</i>	
Id . H5 Tra	[Protection Para / Set 1...4 / Diff-Prot / Id]	
15%	10% ... 60%	P.2
	<i>Threshold (5th harmonic - basic wave ratio) for temporary restraining of the differential protection function against transient 5th harmonic.</i>	
Id . t-Trans	[Protection Para / Set 1...4 / Diff-Prot / Id]	
2s	0.05s ... 100.00s	P.2
	<i>Time of temporary stabilisation of the differential protection function when thresholds for „H2 Tra“ and „H5 Tra“ (transient harmonic) are exceeded.</i>	
Id . Crossbl	[Protection Para / Set 1...4 / Diff-Prot / Id]	
inactive	inactive, active  Mode.	P.2
	<i>Active = Phase overlapping stabilisation of the differential protection function. Inactive = Phase selective stabilisation of the differential protection function.</i>	

Id . CT Satur. Stab.	[Protection Para / Set 1...4 / Diff-Prot / Id]	
inactive	inactive, active  Mode.	P.2
	<i>Enable (or disable) temporary restraining of the differential protection triggered by the detection of an external fault in case of CT saturation.</i>	

Id . CT Sat. Stab. tBlock	[Protection Para / Set 1...4 / Diff-Prot / Id]	
0.30s	0.01s ... 10.00s	P.2
	<i>Maximum stabilization duration time for temporary restraining via CT saturation stabilization. The setting value should be (among other dependencies) coordinated with the maximum fault clearing time for an external fault.</i>	

9.6.4 Id: Input States

Id . ExBlo1-I	[Operation / Status Display / Diff-Prot / Id]	
	<i>Module input state: External blocking1</i>	

Id . ExBlo2-I	[Operation / Status Display / Diff-Prot / Id]	
	<i>Module input state: External blocking2</i>	

Id . ExBlo TripCmd-I	[Operation / Status Display / Diff-Prot / Id]	
	<i>Module input state: External Blocking of the Trip Command</i>	











9.6.5 Id: Signals (Output States)

Id . active	[Operation / Status Display / All Actives]	
	[Operation / Status Display / Diff-Prot / Id]	
	<i>Signal: active</i>	









Id . Alarm	[Operation / Status Display / Alarms]	
	[Operation / Status Display / Diff-Prot / Id]	
	<i>Signal: Alarm</i>	

Id . Trip	[Operation / Status Display / Trips] [Operation / Status Display / Diff-Prot / Id]
 <i>Signal: Trip</i>	
Id . TripCmd	[Operation / Status Display / TripCmds] [Operation / Status Display / Diff-Prot / Id]
 <i>Signal: Trip Command</i>	
Id . ExBlo	[Operation / Status Display / Diff-Prot / Id]
 <i>Signal: External Blocking</i>	
Id . Blo TripCmd	[Operation / Status Display / Diff-Prot / Id]
 <i>Signal: Trip Command blocked</i>	
Id . ExBlo TripCmd	[Operation / Status Display / Diff-Prot / Id]
 <i>Signal: External Blocking of the Trip Command</i>	
Id . Alarm L1	[Operation / Status Display / Diff-Prot / Id]
 <i>Signal: Alarm System Phase L1</i>	
Id . Alarm L2	[Operation / Status Display / Diff-Prot / Id]
 <i>Signal: Alarm System Phase L2</i>	
Id . Alarm L3	[Operation / Status Display / Diff-Prot / Id]
 <i>Signal: Alarm System L3</i>	
Id . Trip L1	[Operation / Status Display / Diff-Prot / Id]
 <i>Signal: Trip System Phase L1</i>	
Id . Trip L2	[Operation / Status Display / Diff-Prot / Id]
 <i>Signal: Trip System Phase L2</i>	
Id . Trip L3	[Operation / Status Display / Diff-Prot / Id]
 <i>Signal: Trip System Phase L3</i>	

Id . Blo H2	[Operation / Status Display / Diff-Prot / Id]
⬆	<i>Signal: Blocked by Harmonic:2</i>
Id . Blo H4	[Operation / Status Display / Diff-Prot / Id]
⬆	<i>Signal: Blocked by Harmonic:4</i>
Id . Blo H5	[Operation / Status Display / Diff-Prot / Id]
⬆	<i>Signal: Blocked by Harmonic:5</i>
Id . H2,H4,H5 Blo	[Operation / Status Display / Diff-Prot / Id]
⬆	<i>Signal: Blocked by Harmonics (Inhibit)</i>
Id . CT Satur.Stab. triggered	[Operation / Status Display / Diff-Prot / Id]
⬆	<i>Signal: Temporary restraining of the Phase Differential Protection, triggered by the detection of an external fault in case of CT saturation.</i>
Id . Transient	[Operation / Status Display / Diff-Prot / Id]
⬆	<i>Signal: Temporary stabilization of the differential protection afterwards the transformer is being energized.</i>
Id . Restraining	[Operation / Status Display / Diff-Prot / Id]
⬆	<i>Signal: Restraining of the differential protection by means of rising the tripping curve.</i>
Id . CT Satur.Stab. L1 trig.	[Operation / Status Display / Diff-Prot / Id]
⬆	<i>Signal: Temporary restraining of the Phase Differential Protection in phase L1, triggered by the detection of an external phase L1 fault in case of CT saturation.</i>
Id . CT Satur.Stab. L2 trig.	[Operation / Status Display / Diff-Prot / Id]
⬆	<i>Signal: Temporary restraining of the Phase Differential Protection in phase L2, triggered by the detection of an external phase L2 fault in case of CT saturation.</i>
Id . CT Satur.Stab. L3 trig.	[Operation / Status Display / Diff-Prot / Id]
⬆	<i>Signal: Temporary restraining of the Phase Differential Protection in phase L3, triggered by the detection of an external phase L3 fault in case of CT saturation.</i>
Id . Restraining: L1	[Operation / Status Display / Diff-Prot / Id]
⬆	<i>Restraining: L1</i>

Id . Restraining: L2	[Operation / Status Display / Diff-Prot / Id]
 <i>Restraining: L2</i>	
Id . Restraining: L3	[Operation / Status Display / Diff-Prot / Id]
 <i>Restraining: L3</i>	
Id . IH2 Blo L1	[Operation / Status Display / Diff-Prot / Id]
 <i>Signal:Phase L1: Blocking of the Phase Differential Protection because of second Harmonic.</i>	
Id . IH2 Blo L2	[Operation / Status Display / Diff-Prot / Id]
 <i>Signal:Phase L2: Blocking of the Phase Differential Protection because of second Harmonic.</i>	
Id . IH2 Blo L3	[Operation / Status Display / Diff-Prot / Id]
 <i>Signal:Phase L3: Blocking of the Phase Differential Protection because of second Harmonic.</i>	
Id . IH4 Blo L1	[Operation / Status Display / Diff-Prot / Id]
 <i>Signal:Phase L1: Blocking of the Phase Differential Protection because of fourth Harmonic.</i>	
Id . IH4 Blo L2	[Operation / Status Display / Diff-Prot / Id]
 <i>Signal:Phase L2: Blocking of the Phase Differential Protection because of fourth Harmonic.</i>	
Id . IH4 Blo L3	[Operation / Status Display / Diff-Prot / Id]
 <i>Signal:Phase L3: Blocking of the Phase Differential Protection because of fourth Harmonic.</i>	
Id . IH5 Blo L1	[Operation / Status Display / Diff-Prot / Id]
 <i>Signal:Phase L1: Blocking of the Phase Differential Protection because of fifth Harmonic.</i>	
Id . IH5 Blo L2	[Operation / Status Display / Diff-Prot / Id]
 <i>Signal:Phase L2: Blocking of the Phase Differential Protection because of fifth Harmonic.</i>	
Id . IH5 Blo L3	[Operation / Status Display / Diff-Prot / Id]
 <i>Signal:Phase L3: Blocking of the Phase Differential Protection because of fifth Harmonic.</i>	

9.6.6 Id: Values

Id . Id L1 H2	[Operation / Measured Values / Id]
 <i>Measured value (calculated): Differential Current Phase L1 Harmonic:2</i>	
Id . Id L2 H2	[Operation / Measured Values / Id]
 <i>Measured value (calculated): Differential Current Phase L2 Harmonic:2</i>	
Id . Id L3 H2	[Operation / Measured Values / Id]
 <i>Measured value (calculated): Differential Current Phase L3 Harmonic:2</i>	
Id . Id L1 H4	[Operation / Measured Values / Id]
 <i>Measured value (calculated): Differential Current Phase L1 Harmonic:4</i>	
Id . Id L2 H4	[Operation / Measured Values / Id]
 <i>Measured value (calculated): Differential Current Phase L2 Harmonic:4</i>	
Id . Id L3 H4	[Operation / Measured Values / Id]
 <i>Measured value (calculated): Differential Current Phase L3 Harmonic:4</i>	
Id . Id L1 H5	[Operation / Measured Values / Id]
 <i>Measured value (calculated): Differential Current Phase L1 Harmonic:5</i>	
Id . Id L2 H5	[Operation / Measured Values / Id]
 <i>Measured value (calculated): Differential Current Phase L2 Harmonic:5</i>	
Id . Id L3 H5	[Operation / Measured Values / Id]
 <i>Measured value (calculated): Differential Current Phase L3 Harmonic:5</i>	

9.6.7 Id: Statistical Values



Id . Id L1H2max	[Operation / Statistics / Max / Id]
<input checked="" type="checkbox"/> <i>Maximum Value Id L1H2</i>	
Id . Id L2H2max	[Operation / Statistics / Max / Id]
<input checked="" type="checkbox"/> <i>Maximum Value Id L2H2</i>	

Id . Id L3H2max	[Operation / Statistics / Max / Id]
<input checked="" type="checkbox"/> <i>Maximum Value Id L3H2</i>	
Id . Id L1H4max	[Operation / Statistics / Max / Id]
<input checked="" type="checkbox"/> <i>Maximum Value Id L1H4</i>	
Id . Id L2H4max	[Operation / Statistics / Max / Id]
<input checked="" type="checkbox"/> <i>Maximum Value Id L2H4</i>	
Id . Id L3H4max	[Operation / Statistics / Max / Id]
<input checked="" type="checkbox"/> <i>Maximum Value Id L3H4</i>	
Id . Id L1H5max	[Operation / Statistics / Max / Id]
<input checked="" type="checkbox"/> <i>Maximum Value Id L1H5</i>	
Id . Id L2H5max	[Operation / Statistics / Max / Id]
<input checked="" type="checkbox"/> <i>Maximum Value Id L2H5</i>	
Id . Id L3H5max	[Operation / Statistics / Max / Id]
<input checked="" type="checkbox"/> <i>Maximum Value Id L3H5</i>	



9.7 IdH



High-Set Differential Protection Module

9.7.1 IdH: Device Planning Parameters



IdH . Mode	[Device planning]	
use	“-”, use  Mode.	S.3
	<i>general operation mode</i>	



9.7.2 IdH: Global Parameters



IdH . ExBlo1	[Protection Para / Global Prot Para / Diff-Prot / IdH]	
IdH . ExBlo2		
“-”	“-” ... Sys . Internal test state  1..n, Assignment List.	P.2
	<i>External blocking of the module, if blocking is activated (allowed) within a parameter set and if the state of the assigned signal is true.</i>	



IdH . ExBlo TripCmd	[Protection Para / Global Prot Para / Diff-Prot / IdH]	
“-”	“-” ... Sys . Internal test state  1..n, Assignment List.	P.2
	<i>External blocking of the Trip Command of the module/the stage, if blocking is activated (allowed) within a parameter set and if the state of the assigned signal is true.</i>	

9.7.3 IdH: Setting Group Parameters

IdH . Function	[Protection Para / Set 1...4 / Diff-Prot / IdH]	
active	inactive, active  Mode.	P.2
	<i>Permanent activation or deactivation of module/stage.</i>	

IdH . ExBlo Fc	[Protection Para / Set 1...4 / Diff-Prot / IdH]	
inactive	inactive, active  active/inactive.	P.2
	<i>Activate (allow) or inactivate (disallow) blocking of the module/stage. This parameter is only effective if a signal is assigned to the corresponding global protection parameter. If the signal becomes true, those modules/stages are blocked that are parameterized "ExBlo Fc=active".</i>	

IdH . Blo TripCmd	[Protection Para / Set 1...4 / Diff-Prot / IdH]	
inactive	inactive, active  Mode.	P.2
	<i>Permanent blocking of the Trip Command of the module/stage.</i>	

IdH . ExBlo TripCmd Fc	[Protection Para / Set 1...4 / Diff-Prot / IdH]	
inactive	inactive, active  active/inactive.	P.2
	<i>Activate (allow) or inactivate (disallow) blocking of the module/stage. This parameter is only effective if a signal is assigned to the corresponding global protection parameter. If the signal becomes true, those modules/stages are blocked that are parameterized "ExBlo TripCmd Fc=active".</i>	

IdH . Id>>	[Protection Para / Set 1...4 / Diff-Prot / IdH]	
10.0Ib	0.5Ib ... 30.0Ib	P.2
	<i>Highset Differential Current Protection/Unstabilized high-phase fault: Pickup value of the differential current based on the rated current Ib of the protection object.</i>	

9.7.4 IdH: Input States

IdH . ExBlo1-I	[Operation / Status Display / Diff-Prot / IdH]	
	<i>Module input state: External blocking1</i>	

IdH . ExBlo2-I	[Operation / Status Display / Diff-Prot / IdH]	
	<i>Module input state: External blocking2</i>	

IdH . ExBlo TripCmd-I	[Operation / Status Display / Diff-Prot / IdH]	
	<i>Module input state: External Blocking of the Trip Command</i>	

9.7.5 IdH: Signals (Output States)

IdH . active	[Operation / Status Display / All Actives] [Operation / Status Display / Diff-Prot / IdH]
⤴ <i>Signal: active</i>	
IdH . Alarm	[Operation / Status Display / Alarms] [Operation / Status Display / Diff-Prot / IdH]
⤴ <i>Signal: Alarm</i>	
IdH . Trip	[Operation / Status Display / Trips] [Operation / Status Display / Diff-Prot / IdH]
⤴ <i>Signal: Trip</i>	
IdH . TripCmd	[Operation / Status Display / TripCmds] [Operation / Status Display / Diff-Prot / IdH]
⤴ <i>Signal: Trip Command</i>	
IdH . ExBlo	[Operation / Status Display / Diff-Prot / IdH]
⤴ <i>Signal: External Blocking</i>	
IdH . Blo TripCmd	[Operation / Status Display / Diff-Prot / IdH]
⤴ <i>Signal: Trip Command blocked</i>	
IdH . ExBlo TripCmd	[Operation / Status Display / Diff-Prot / IdH]
⤴ <i>Signal: External Blocking of the Trip Command</i>	
IdH . Alarm L1	[Operation / Status Display / Diff-Prot / IdH]
⤴ <i>Signal: Alarm System Phase L1</i>	
IdH . Alarm L2	[Operation / Status Display / Diff-Prot / IdH]
⤴ <i>Signal: Alarm System Phase L2</i>	

IdH . Alarm L3	[Operation / Status Display / Diff-Prot / IdH]
⤴ <i>Signal: Alarm System L3</i>	
IdH . Trip L1	[Operation / Status Display / Diff-Prot / IdH]
⤴ <i>Signal: Trip System Phase L1</i>	
IdH . Trip L2	[Operation / Status Display / Diff-Prot / IdH]
⤴ <i>Signal: Trip System Phase L2</i>	
IdH . Trip L3	[Operation / Status Display / Diff-Prot / IdH]
⤴ <i>Signal: Trip System Phase L3</i>	

9.8 IdG[1] ... IdG[2]

Restricted Ground Fault Differential Protection Module

9.8.1 IdG[1]: Device Planning Parameters

IdG[1] . Mode	[Device planning]	
"_"	"_", use ↳ Mode.	S.3
 <i>general operation mode</i>		

9.8.2 IdG[1]: Global Parameters

IdG[1] . ExBlo1 IdG[1] . ExBlo2	[Protection Para / Global Prot Para / Diff-Prot / IdG[1]]	
"_"	"_" ... Sys . Internal test state ↳ 1..n, Assignment List.	P.2
 <i>External blocking of the module, if blocking is activated (allowed) within a parameter set and if the state of the assigned signal is true.</i>		

IdG[1] . ExBlo TripCmd	[Protection Para / Global Prot Para / Diff-Prot / IdG[1]]	
"_"	"_" ... Sys . Internal test state ↳ 1..n, Assignment List.	P.2
 <i>External blocking of the Trip Command of the module/the stage, if blocking is activated (allowed) within a parameter set and if the state of the assigned signal is true.</i>		

9.8.3 IdG[1]: Setting Group Parameters

IdG[1] . Function	[Protection Para / Set 1...4 / Diff-Prot / IdG[1]]	
inactive	inactive, active ↳ Mode.	P.2
 <i>Permanent activation or deactivation of module/stage.</i>		

IdG[1] . ExBlo Fc	[Protection Para / Set 1...4 / Diff-Prot / IdG[1]]	
inactive	inactive, active ↳ active/inactive.	P.2
	<i>Activate (allow) or inactivate (disallow) blocking of the module/stage. This parameter is only effective if a signal is assigned to the corresponding global protection parameter. If the signal becomes true, those modules/stages are blocked that are parameterized "ExBlo Fc=active".</i>	

IdG[1] . Blo TripCmd	[Protection Para / Set 1...4 / Diff-Prot / IdG[1]]	
inactive	inactive, active ↳ Mode.	P.2
	<i>Permanent blocking of the Trip Command of the module/stage.</i>	

IdG[1] . ExBlo TripCmd Fc	[Protection Para / Set 1...4 / Diff-Prot / IdG[1]]	
inactive	inactive, active ↳ active/inactive.	P.2
	<i>Activate (allow) or inactivate (disallow) blocking of the module/stage. This parameter is only effective if a signal is assigned to the corresponding global protection parameter. If the signal becomes true, those modules/stages are blocked that are parameterized "ExBlo TripCmd Fc=active".</i>	

IdG[1] . IdG min	[Protection Para / Set 1...4 / Diff-Prot / IdG[1]]	
0.05Ib	0.05Ib ... 1.00Ib	P.2
	<i>Constant minimum pickup current (earth differential current). Pickup value of the differential current based on the rated current Ib of the related protection object.</i>	

IdG[1] . IdG(Is0)	[Protection Para / Set 1...4 / Diff-Prot / IdG[1]]	
0.1Ib	0.00Ib ... 1.00Ib	P.2
	<i>Starting point of the static tripping characteristic at Is0</i>	

IdG[1] . IdG(Is1)	[Protection Para / Set 1...4 / Diff-Prot / IdG[1]]	
0.2Ib	0.2Ib ... 2.00Ib	P.2
	<i>Breaking point of the static tripping characteristic at Is1</i>	

IdG[1] . IdG(Is2)	[Protection Para / Set 1...4 / Diff-Prot / IdG[1]]	
2.0Ib	1.0Ib ... 8.0Ib	P.2
	<i>Value of the static tripping characteristic at Is2</i>	

IdG[1] . Is1	[Protection Para / Set 1...4 / Diff-Prot / IdG[1]]
2.0Ib	0.5Ib ... 5.0Ib P.2
	<i>Breaking point of the static tripping characteristic when Is1</i>

IdG[1] . Is2	[Protection Para / Set 1...4 / Diff-Prot / IdG[1]]
10.0Ib	5.0Ib ... 10.0Ib P.2
	<i>Value of the static tripping characteristic at Is2</i>

9.8.4 IdG[1]: Input States

IdG[1] . ExBlo1-I	[Operation / Status Display / Diff-Prot / IdG[1]]
	<i>Module input state: External blocking1</i>

IdG[1] . ExBlo2-I	[Operation / Status Display / Diff-Prot / IdG[1]]
	<i>Module input state: External blocking2</i>

IdG[1] . ExBlo TripCmd-I	[Operation / Status Display / Diff-Prot / IdG[1]]
	<i>Module input state: External Blocking of the Trip Command</i>

9.8.5 IdG[1]: Signals (Output States)

IdG[1] . active	[Operation / Status Display / All Actives] [Operation / Status Display / Diff-Prot / IdG[1]]
	<i>Signal: active</i>

IdG[1] . Alarm	[Operation / Status Display / Alarms] [Operation / Status Display / Diff-Prot / IdG[1]]
	<i>Signal: Alarm</i>

IdG[1] . Trip	[Operation / Status Display / Trips] [Operation / Status Display / Diff-Prot / IdG[1]]
	<i>Signal: Trip</i>

IdG[1] . TripCmd	[Operation / Status Display / TripCmds] [Operation / Status Display / Diff-Prot / IdG[1]]
⬆	<i>Signal: Trip Command</i>

IdG[1] . ExBlo	[Operation / Status Display / Diff-Prot / IdG[1]]
⬆	<i>Signal: External Blocking</i>

IdG[1] . Blo TripCmd	[Operation / Status Display / Diff-Prot / IdG[1]]
⬆	<i>Signal: Trip Command blocked</i>

IdG[1] . ExBlo TripCmd	[Operation / Status Display / Diff-Prot / IdG[1]]
⬆	<i>Signal: External Blocking of the Trip Command</i>

9.9 IdGH[1] ... IdGH[2]

Restricted Ground Fault Highset Protection Module

9.9.1 IdGH[1]: Device Planning Parameters

IdGH[1] . Mode	[Device planning]	
"_"	"_", use ↳ Mode.	S.3
 <i>general operation mode</i>		

9.9.2 IdGH[1]: Global Parameters

IdGH[1] . ExBlo1 IdGH[1] . ExBlo2	[Protection Para / Global Prot Para / Diff-Prot / IdGH[1]]	
"_"	"_" ... Sys . Internal test state ↳ 1..n, Assignment List.	P.2
 <i>External blocking of the module, if blocking is activated (allowed) within a parameter set and if the state of the assigned signal is true.</i>		

IdGH[1] . ExBlo TripCmd	[Protection Para / Global Prot Para / Diff-Prot / IdGH[1]]	
"_"	"_" ... Sys . Internal test state ↳ 1..n, Assignment List.	P.2
 <i>External blocking of the Trip Command of the module/the stage, if blocking is activated (allowed) within a parameter set and if the state of the assigned signal is true.</i>		

9.9.3 IdGH[1]: Setting Group Parameters

IdGH[1] . Function	[Protection Para / Set 1...4 / Diff-Prot / IdGH[1]]	
inactive	inactive, active ↳ Mode.	P.2
 <i>Permanent activation or deactivation of module/stage.</i>		

IdGH[1] . ExBlo Fc		[Protection Para / Set 1...4 / Diff-Prot / IdGH[1]]
inactive	inactive, active	P.2
	↳ active/inactive.	
	<i>Activate (allow) or inactivate (disallow) blocking of the module/stage. This parameter is only effective if a signal is assigned to the corresponding global protection parameter. If the signal becomes true, those modules/stages are blocked that are parameterized "ExBlo Fc=active".</i>	

IdGH[1] . Blo TripCmd		[Protection Para / Set 1...4 / Diff-Prot / IdGH[1]]
inactive	inactive, active	P.2
	↳ Mode.	
	<i>Permanent blocking of the Trip Command of the module/stage.</i>	

IdGH[1] . ExBlo TripCmd Fc		[Protection Para / Set 1...4 / Diff-Prot / IdGH[1]]
inactive	inactive, active	P.2
	↳ active/inactive.	
	<i>Activate (allow) or inactivate (disallow) blocking of the module/stage. This parameter is only effective if a signal is assigned to the corresponding global protection parameter. If the signal becomes true, those modules/stages are blocked that are parameterized "ExBlo TripCmd Fc=active".</i>	

IdGH[1] . IdG>>		[Protection Para / Set 1...4 / Diff-Prot / IdGH[1]]
2.00Ib	0.50Ib ... 20.00Ib	P.2
	<i>Highset Ground Differential Current Protection/Unstabilized high-phase restricted earth fault: Pickup value of the earth differential current based on the rated current Ib of the related protection object.</i>	

9.9.4 IdGH[1]: Input States

IdGH[1] . ExBlo1-I		[Operation / Status Display / Diff-Prot / IdGH[1]]
	<i>Module input state: External blocking1</i>	

IdGH[1] . ExBlo2-I		[Operation / Status Display / Diff-Prot / IdGH[1]]
	<i>Module input state: External blocking2</i>	

IdGH[1] . ExBlo TripCmd-I	[Operation / Status Display / Diff-Prot / IdGH[1]]
 <i>Module input state: External Blocking of the Trip Command</i>	

9.9.5 IdGH[1]: Signals (Output States)

IdGH[1] . active	[Operation / Status Display / All Actives] [Operation / Status Display / Diff-Prot / IdGH[1]]
 <i>Signal: active</i>	

IdGH[1] . Alarm	[Operation / Status Display / Alarms] [Operation / Status Display / Diff-Prot / IdGH[1]]
 <i>Signal: Alarm</i>	

IdGH[1] . Trip	[Operation / Status Display / Trips] [Operation / Status Display / Diff-Prot / IdGH[1]]
 <i>Signal: Trip</i>	

IdGH[1] . TripCmd	[Operation / Status Display / TripCmds] [Operation / Status Display / Diff-Prot / IdGH[1]]
 <i>Signal: Trip Command</i>	

IdGH[1] . ExBlo	[Operation / Status Display / Diff-Prot / IdGH[1]]
 <i>Signal: External Blocking</i>	



IdGH[1] . Blo TripCmd	[Operation / Status Display / Diff-Prot / IdGH[1]]
 <i>Signal: Trip Command blocked</i>	

IdGH[1] . ExBlo TripCmd	[Operation / Status Display / Diff-Prot / IdGH[1]]
 <i>Signal: External Blocking of the Trip Command</i>	



9.10 IH2

Module Inrush



9.10.1 IH2: Device Planning Parameters



IH2 . Mode	[Device planning]	
"_"	"_" , use  Device planning.	S.3
 <i>Module Inrush, general operation mode</i>		

9.10.2 IH2: Global Parameters



IH2 . ExBlo1	[Protection Para / Global Prot Para / I-Prot / IH2]	
IH2 . ExBlo2		
"_"	"_" ... Sys . Internal test state  1..n, Assignment List.	P.2
 <i>External blocking of the module, if blocking is activated (allowed) within a parameter set and if the state of the assigned signal is true.</i>		

9.10.3 IH2: Setting Group Parameters

IH2 . Function	[Protection Para / Set 1...4 / I-Prot / IH2]	
inactive	inactive, active  Mode.	P.2
 <i>Permanent activation or deactivation of module/stage.</i>		

IH2 . ExBlo Fc	[Protection Para / Set 1...4 / I-Prot / IH2]	
inactive	inactive, active  active/inactive.	P.2
 <i>Activate (allow) or inactivate (disallow) blocking of the module/stage. This parameter is only effective if a signal is assigned to the corresponding global protection parameter. If the signal becomes true, those modules/stages are blocked that are parameterized "ExBlo Fc=active".</i>		

IH2 . IH2 / IH1	[Protection Para / Set 1...4 / I-Prot / IH2]
15%	10% ... 40% P.2
	<i>Maximum permissible percentage of the 2nd harmonic of the 1st harmonic.</i>

IH2 . block mode	[Protection Para / Set 1...4 / I-Prot / IH2]
1-ph Blo	1-ph Blo, 3-ph Blo P.2  block mode.
	<i>1-ph Blo: If an inrush is detected in one phase, the corresponding phase of those modules will be blocked, where inrush blocking is set to active./3-ph Blo: If an inrush is detected in at least one phase, all three phases of those modules where inrush blocking is set to active will be blocked (cross blocking).</i>

9.10.4 IH2: Input States

IH2 . ExBlo1-I	[Operation / Status Display / I-Prot / IH2]
	<i>Module input state: External blocking1</i>

IH2 . ExBlo2-I	[Operation / Status Display / I-Prot / IH2]
	<i>Module input state: External blocking2</i>

9.10.5 IH2: Signals (Output States)

IH2 . active	[Operation / Status Display / All Actives] [Operation / Status Display / I-Prot / IH2]
	<i>Signal: active</i>

IH2 . ExBlo	[Operation / Status Display / I-Prot / IH2]
	<i>Signal: External Blocking</i>

IH2 . Blo L1	[Operation / Status Display / I-Prot / IH2]
	<i>Signal: Blocked L1</i>

IH2 . Blo L2	[Operation / Status Display / I-Prot / IH2]
	<i>Signal: Blocked L2</i>

IH2 . Blo L3	[Operation / Status Display / I-Prot / IH2]
⤴	<i>Signal: Blocked L3</i>
IH2 . Blo IG meas	[Operation / Status Display / I-Prot / IH2]
⤴	<i>Signal: Blocking of the ground (earth) protection module (measured ground current)</i>
IH2 . Blo IG calc	[Operation / Status Display / I-Prot / IH2]
⤴	<i>Signal: Blocking of the ground (earth) protection module (calculated ground current)</i>
IH2 . 3-ph Blo	[Operation / Status Display / I-Prot / IH2]
⤴	<i>Signal: Inrush was detected in at least one phase - trip command blocked.</i>

9.11 I[1] ... I[6]

Phase Overcurrent Stage

9.11.1 I[1]: Device Planning Parameters

I[1] . Mode	[Device planning]	
non directional	"-", non directional, forward, reverse ↳ I>.	S.3
 Phase Overcurrent Stage, general operation mode		

9.11.2 I[1]: Global Parameters

I[1] . CT Winding Side	[Protection Para / Global Prot Para / I-Prot / I[1]]	
. CT Ntrl	. CT Ntrl, . CT Mains ↳ CT Winding Side.	P.2
 Measuring values will be used from this winding side		

I[1] . ExBlo1	[Protection Para / Global Prot Para / I-Prot / I[1]]	
I[1] . ExBlo2		
"_"	"_" ... Sys . Internal test state ↳ 1..n, Assignment List.	P.2
 External blocking of the module, if blocking is activated (allowed) within a parameter set and if the state of the assigned signal is true.		

I[1] . ExBlo TripCmd	[Protection Para / Global Prot Para / I-Prot / I[1]]	
"_"	"_" ... Sys . Internal test state ↳ 1..n, Assignment List.	P.2
 External blocking of the Trip Command of the module/the stage, if blocking is activated (allowed) within a parameter set and if the state of the assigned signal is true.		

I[1] . Ex rev Interl	[Protection Para / Global Prot Para / I-Prot / I[1]]	
"_"	"_" ... Sys . Internal test state ↳ 1..n, Assignment List.	P.2
	<i>External blocking of the module by external reverse interlocking, if blocking is activated (allowed) within a parameter set and if the state of the assigned signal is true.</i>	

I[1] . AdaptSet 1	[Protection Para / Global Prot Para / I-Prot / I[1]]	
"_"	"_" ... Logics . LE80.Out inverted ↳ AdaptSet.	P.2
	<i>Assignment Adaptive Parameter 1</i>	

I[1] . AdaptSet 2	[Protection Para / Global Prot Para / I-Prot / I[1]]	
"_"	"_" ... Logics . LE80.Out inverted ↳ AdaptSet.	P.2
	<i>Assignment Adaptive Parameter 2</i>	

I[1] . AdaptSet 3	[Protection Para / Global Prot Para / I-Prot / I[1]]	
"_"	"_" ... Logics . LE80.Out inverted ↳ AdaptSet.	P.2
	<i>Assignment Adaptive Parameter 3</i>	

I[1] . AdaptSet 4	[Protection Para / Global Prot Para / I-Prot / I[1]]	
"_"	"_" ... Logics . LE80.Out inverted ↳ AdaptSet.	P.2
	<i>Assignment Adaptive Parameter 4</i>	

9.11.3 I[1]: Setting Group Parameters

I[1] . Function	[Protection Para / Set 1...4 / I-Prot / I[1]]	
active	inactive, active ↳ Mode.	P.2
	<i>Permanent activation or deactivation of module/stage.</i>	

I[1] . ExBlo Fc	[Protection Para / Set 1...4 / I-Prot / I[1]]	
inactive	inactive, active ↳ active/inactive.	P.2
	<i>Activate (allow) or inactivate (disallow) blocking of the module/stage. This parameter is only effective if a signal is assigned to the corresponding global protection parameter. If the signal becomes true, those modules/stages are blocked that are parameterized "ExBlo Fc=active".</i>	

I[1] . Ex rev Interl Fc	[Protection Para / Set 1...4 / I-Prot / I[1]]	
inactive	inactive, active ↳ active/inactive.	P.2
	<i>Activate (allow) or inactivate (disallow) blocking of the module/stage. This parameter is only effective if a signal is assigned to the corresponding global protection parameter. If the signal becomes true, those modules/stages are blocked that are parameterized "Ex rev Interl Fc = active".</i>	

I[1] . Blo TripCmd	[Protection Para / Set 1...4 / I-Prot / I[1]]	
inactive	inactive, active ↳ Mode.	P.2
	<i>Permanent blocking of the Trip Command of the module/stage.</i>	

I[1] . ExBlo TripCmd Fc	[Protection Para / Set 1...4 / I-Prot / I[1]]	
inactive	inactive, active ↳ active/inactive.	P.2
	<i>Activate (allow) or inactivate (disallow) blocking of the module/stage. This parameter is only effective if a signal is assigned to the corresponding global protection parameter. If the signal becomes true, those modules/stages are blocked that are parameterized "ExBlo TripCmd Fc=active".</i>	



I[1] . Measuring method	[Protection Para / Set 1...4 / I-Prot / I[1]]	
Fundamental	Fundamental, True RMS, I2 ↳ Measuring method.	P.2
	<i>Measuring method: fundamental or rms or 3rd harmonic (only generator protection relays)</i>	

I[1] . I>	[Protection Para / Set 1...4 / I-Prot / I[1]]	
1.00In ⊕ Adapt. Param.	If: I[1] . VRestraint = active • 0.10In ... 40.00In If: I[1] . VRestraint = inactive • 0.02In ... 40.00In	P.2
 <i>If the pickup value is exceeded, the module/element starts to time out to trip.</i>		

I[1] . Char	[Protection Para / Set 1...4 / I-Prot / I[1]]	
DEFT ⊕ Adapt. Param.	DEFT ... I4T  Char.	P.2
 <i>Characteristic</i>		

I[1] . t	[Protection Para / Set 1...4 / I-Prot / I[1]]	
1.00s ⊕ Adapt. Param.	0.00s ... 300.00s	P.2
 <i>Tripping delay</i>		

I[1] . tchar	[Protection Para / Set 1...4 / I-Prot / I[1]]	
1 ⊕ Adapt. Param.	0.02 ... 20.00	P.2
 <i>Time multiplier/tripping characteristic factor. The setting range depends on the selected tripping curve.</i>		

I[1] . Reset Mode	[Protection Para / Set 1...4 / I-Prot / I[1]]	
instantaneous ⊕ Adapt. Param.	instantaneous, delayed, calculated  Reset Mode.	P.2
 <i>Reset Mode</i>		

I[1] . t-reset delay	[Protection Para / Set 1...4 / I-Prot / I[1]]
0s	0.00s ... 60.00s
<i>Only available if:</i> <ul style="list-style-type: none"> I[1] . Reset Mode = delayed 	
⊕ Adapt. Param.	
 <i>Reset delay for intermittent phase failures (INV characteristics only)</i>	



I[1] . IH2 Blo	[Protection Para / Set 1...4 / I-Prot / I[1]]
Sys . inactive	Sys . inactive, IH2 . active
⊕ Adapt. Param.	↳ IH2 Blo.
 <i>Blocking the trip command, if an inrush is detected.</i>	

I[1] . nondir Trip at V=0	[Protection Para / Set 1...4 / I-Prot / I[1]]
inactive	inactive, active
⊕ Adapt. Param.	↳ active/inactive.
 <i>Only relevant for current protection modules/stages with directional feature! The device will trip non directional if this parameter is set to active and no direction could be determined because no reference voltage (V=0) could be measured any more (e.g. if there is a three-phase short circuit close to the device). If this parameter is set to inactive, the protection stage will be blocked in case of V=0.</i>	





I[1] . VRestraint	[Protection Para / Set 1...4 / I-Prot / I[1]]
inactive	inactive, active
⊕ Adapt. Param.	↳ Mode.
 <i>Voltage Restraint Protection</i>	

I[1] . Measuring Mode	[Protection Para / Set 1...4 / I-Prot / I[1]]
Phase to Ground	Phase to Ground, Phase to Phase
<i>Only available if:</i> <ul style="list-style-type: none"> I[1] . VRestraint = active 	↳ Measuring Mode.
⊕ Adapt. Param.	
 <i>Measuring Mode</i>	

I[1] . VRestraint max	[Protection Para / Set 1...4 / I-Prot / I[1]]	
1.00Vn <i>Only available if:</i> • I[1] . VRestraint = active ⊕ Adapt. Param.	0.04Vn ... 2.00Vn	P.2
	<i>Maximum voltage restraint level. Definition of Vn: Vn is dependent on the System Parameter setting of "VT con". When the System Parameters "VT con" is set to "phase-to-phase", "Vn = VT sec ". When the System Parameters "VT con" is set to "phase-to-ground", "Vn = VT sec/ SQRT(3)".</i>	

I[1] . Meas Circuit Superv	[Protection Para / Set 1...4 / I-Prot / I[1]]	
Sys . inactive <i>Only available if:</i> • I[1] . VRestraint = active ⊕ Adapt. Param.	Sys . inactive, LOP . active  VTS Block.	P.2
	<i>Activates the use of the measuring circuit supervision. In this case the module will be blocked if a measuring circuit supervision module (e.g. LOP, VTS) signals a disturbed measuring circuit (e.g. caused by a fuse failure).</i>	

9.11.4 I[1]: Input States

I[1] . ExBlo1-I	[Operation / Status Display / I-Prot / I[1]]	
	<i>Module input state: External blocking1</i>	
I[1] . ExBlo2-I	[Operation / Status Display / I-Prot / I[1]]	
	<i>Module input state: External blocking2</i>	
I[1] . ExBlo TripCmd-I	[Operation / Status Display / I-Prot / I[1]]	
	<i>Module input state: External Blocking of the Trip Command</i>	
I[1] . Ex rev Interl-I	[Operation / Status Display / I-Prot / I[1]]	
	<i>Module input state: External reverse interlocking</i>	
I[1] . AdaptSet1-I	[Operation / Status Display / I-Prot / I[1]]	
	<i>Module input state: Adaptive Parameter1</i>	

I[1] . AdaptSet2-I	[Operation / Status Display / I-Prot / I[1]]
↓	<i>Module input state: Adaptive Parameter2</i>

I[1] . AdaptSet3-I	[Operation / Status Display / I-Prot / I[1]]
↓	<i>Module input state: Adaptive Parameter3</i>

I[1] . AdaptSet4-I	[Operation / Status Display / I-Prot / I[1]]
↓	<i>Module input state: Adaptive Parameter4</i>

9.11.5 I[1]: Signals (Output States)

I[1] . active	[Operation / Status Display / All Actives] [Operation / Status Display / I-Prot / I[1]]
↓	<i>Signal: active</i>

I[1] . Alarm	[Operation / Status Display / Alarms] [Operation / Status Display / I-Prot / I[1]]
↓	<i>Signal: Alarm</i>

I[1] . Trip	[Operation / Status Display / Trips] [Operation / Status Display / I-Prot / I[1]]
↓	<i>Signal: Trip</i>

I[1] . TripCmd	[Operation / Status Display / TripCmds] [Operation / Status Display / I-Prot / I[1]]
↓	<i>Signal: Trip Command</i>

I[1] . ExBlo	[Operation / Status Display / I-Prot / I[1]]
↓	<i>Signal: External Blocking</i>

I[1] . Ex rev Interl	[Operation / Status Display / I-Prot / I[1]]
↓	<i>Signal: External reverse Interlocking</i>

I[1] . Blo TripCmd	[Operation / Status Display / I-Prot / I[1]]
⤴	<i>Signal: Trip Command blocked</i>
I[1] . ExBlo TripCmd	[Operation / Status Display / I-Prot / I[1]]
⤴	<i>Signal: External Blocking of the Trip Command</i>
I[1] . IH2 Blo	[Operation / Status Display / I-Prot / I[1]]
⤴	<i>Signal: Blocking the trip command by an inrush</i>
I[1] . Alarm L1	[Operation / Status Display / I-Prot / I[1]]
⤴	<i>Signal: Alarm L1</i>
I[1] . Alarm L2	[Operation / Status Display / I-Prot / I[1]]
⤴	<i>Signal: Alarm L2</i>
I[1] . Alarm L3	[Operation / Status Display / I-Prot / I[1]]
⤴	<i>Signal: Alarm L3</i>
I[1] . Trip L1	[Operation / Status Display / I-Prot / I[1]]
⤴	<i>Signal: General Trip Phase L1</i>
I[1] . Trip L2	[Operation / Status Display / I-Prot / I[1]]
⤴	<i>Signal: General Trip Phase L2</i>
I[1] . Trip L3	[Operation / Status Display / I-Prot / I[1]]
⤴	<i>Signal: General Trip Phase L3</i>
I[1] . DefaultSet	[Operation / Status Display / I-Prot / I[1]]
⤴	<i>Signal: Default Parameter Set</i>
I[1] . AdaptSet 1	[Operation / Status Display / I-Prot / I[1]]
⤴	<i>Signal: Adaptive Parameter 1</i>
I[1] . AdaptSet 2	[Operation / Status Display / I-Prot / I[1]]
⤴	<i>Signal: Adaptive Parameter 2</i>

I[1] . AdaptSet 3	[Operation / Status Display / I-Prot / I[1]]
⬆	<i>Signal: Adaptive Parameter 3</i>

I[1] . AdaptSet 4	[Operation / Status Display / I-Prot / I[1]]
⬆	<i>Signal: Adaptive Parameter 4</i>

9.12 IG[1] ... IG[4]

Earth current protection - Stage

9.12.1 IG[1]: Device Planning Parameters

IG[1] . Mode	[Device planning]	
"_"	"_", non directional, forward, reverse ↳ Earth overcurrent.	S.3
 <i>Earth current protection - Stage, general operation mode</i>		

IG[1] . Superv. only	[Device planning]	
no	no, yes ↳ yes/no.	S.3
 <i>Earth current protection - Stage, if set to "Yes": Restriction of the function to a supervision functionality, i.e. there is no general alarm, no general trip and no trip command.</i>		

9.12.2 IG[1]: Global Parameters

IG[1] . CT Winding Side	[Protection Para / Global Prot Para / I-Prot / IG[1]]	
. CT Ntrl	. CT Ntrl, . CT Mains ↳ CT Winding Side.	P.2
 <i>Measuring values will be used from this winding side</i>		

IG[1] . ExBlo1	[Protection Para / Global Prot Para / I-Prot / IG[1]]	
IG[1] . ExBlo2		
"_"	"_" ... Sys . Internal test state ↳ 1..n, Assignment List.	P.2
 <i>External blocking of the module, if blocking is activated (allowed) within a parameter set and if the state of the assigned signal is true.</i>		

IG[1] . ExBlo TripCmd	[Protection Para / Global Prot Para / I-Prot / IG[1]]	
"_"	"_" ... Sys . Internal test state	P.2
Only available if:	↳ 1..n, Assignment List.	
• IG[1] . Superv. only = no		
	<i>External blocking of the Trip Command of the module/the stage, if blocking is activated (allowed) within a parameter set and if the state of the assigned signal is true.</i>	

IG[1] . Ex rev Interl	[Protection Para / Global Prot Para / I-Prot / IG[1]]	
"_"	"_" ... Sys . Internal test state	P.2
	↳ 1..n, Assignment List.	
	<i>External blocking of the module by external reverse interlocking, if blocking is activated (allowed) within a parameter set and if the state of the assigned signal is true.</i>	



IG[1] . AdaptSet 1	[Protection Para / Global Prot Para / I-Prot / IG[1]]	
"_"	"_" ... Logics . LE80.Out inverted	P.2
	↳ AdaptSet.	
	<i>Assignment Adaptive Parameter 1</i>	



IG[1] . AdaptSet 2	[Protection Para / Global Prot Para / I-Prot / IG[1]]	
"_"	"_" ... Logics . LE80.Out inverted	P.2
	↳ AdaptSet.	
	<i>Assignment Adaptive Parameter 2</i>	



IG[1] . AdaptSet 3	[Protection Para / Global Prot Para / I-Prot / IG[1]]	
"_"	"_" ... Logics . LE80.Out inverted	P.2
	↳ AdaptSet.	
	<i>Assignment Adaptive Parameter 3</i>	



IG[1] . AdaptSet 4	[Protection Para / Global Prot Para / I-Prot / IG[1]]	
"_"	"_" ... Logics . LE80.Out inverted	P.2
	↳ AdaptSet.	
	<i>Assignment Adaptive Parameter 4</i>	



9.12.3 IG[1]: Setting Group Parameters

IG[1] . Function	[Protection Para / Set 1...4 / I-Prot / IG[1]]
inactive	inactive, active  Mode.
 Permanent activation or deactivation of module/stage.	

IG[1] . ExBlo Fc	[Protection Para / Set 1...4 / I-Prot / IG[1]]
inactive	inactive, active  active/inactive.
 Activate (allow) or inactivate (disallow) blocking of the module/stage. This parameter is only effective if a signal is assigned to the corresponding global protection parameter. If the signal becomes true, those modules/stages are blocked that are parameterized "ExBlo Fc=active".	

IG[1] . Ex rev Interl Fc	[Protection Para / Set 1...4 / I-Prot / IG[1]]
inactive	inactive, active  active/inactive.
 Activate (allow) or inactivate (disallow) blocking of the module/stage. This parameter is only effective if a signal is assigned to the corresponding global protection parameter. If the signal becomes true, those modules/stages are blocked that are parameterized "Ex rev Interl Fc = active".	

IG[1] . Blo TripCmd	[Protection Para / Set 1...4 / I-Prot / IG[1]]
inactive	inactive, active
<i>Only available if:</i> <ul style="list-style-type: none"> IG[1] . Superv. only = no 	 Mode.
 Permanent blocking of the Trip Command of the module/stage.	

IG[1] . ExBlo TripCmd Fc	[Protection Para / Set 1...4 / I-Prot / IG[1]]
inactive	inactive, active
<i>Only available if:</i> <ul style="list-style-type: none"> IG[1] . Superv. only = no 	 active/inactive.
 Activate (allow) or inactivate (disallow) blocking of the module/stage. This parameter is only effective if a signal is assigned to the corresponding global protection parameter. If the signal becomes true, those modules/stages are blocked that are parameterized "ExBlo TripCmd Fc=active".	

IG[1] . IG Source	[Protection Para / Set 1...4 / I-Prot / IG[1]]	
CT Ntrl . calculated	If: IG[1] . CT Winding Side = . CT Ntrl <ul style="list-style-type: none"> • CT Ntrl . sensitive measurement, CT Ntrl . measured, CT Ntrl . calculated If: IG[1] . CT Winding Side = . CT Mains <ul style="list-style-type: none"> • CT Ntrl . calculated, CT Mains . measured (X4) ↪ Measuring Channel.	P.2
 Selection if measured or calculated ground current should be used.		

IG[1] . Measuring method	[Protection Para / Set 1...4 / I-Prot / IG[1]]	
Fundamental	Fundamental, True RMS ↪ Measuring method.	P.2
 Measuring method: fundamental or rms or 3rd harmonic (only generator protection relays)		

IG[1] . VX Source	[Protection Para / Set 1...4 / I-Prot / IG[1]]	
measured	measured, calculated ↪ VX Source.	P.2
 Selection if VG is measured or calculated (neutral voltage or residual voltage)		

IG[1] . Meas Circuit Superv	[Protection Para / Set 1...4 / I-Prot / IG[1]]	
Sys . inactive Only available if: <ul style="list-style-type: none"> • IG[1] . VX Source = calculated 	Sys . inactive, LOP . active ↪ VTS Block.	P.2
 Activates the use of the measuring circuit supervision. In this case the module will be blocked if a measuring circuit supervision module (e.g. LOP, VTS) signals a disturbed measuring circuit (e.g. caused by a fuse failure).		

IG[1] . IG>	[Protection Para / Set 1...4 / I-Prot / IG[1]]	
0.02In ↻ Adapt. Param.	0.02In ... 20.00In	P.2
 If the pickup value is exceeded, the module/stage will be started.		

IG[1] . IGs>	[Protection Para / Set 1...4 / I-Prot / IG[1]]	
0.02In ⊕ Adapt. Param.	0.002In ... 2.000In	P.2
 <i>If the pickup value is exceeded, the module/stage will be started.</i>		

IG[1] . Char	[Protection Para / Set 1...4 / I-Prot / IG[1]]	
DEFT ⊕ Adapt. Param.	DEFT ... RXIDG ↳ Char.	P.2
 <i>Characteristic</i>		

IG[1] . t	[Protection Para / Set 1...4 / I-Prot / IG[1]]	
0.00s ⊕ Adapt. Param.	0.00s ... 300.00s	P.2
 <i>Tripping delay</i>		

IG[1] . tchar	[Protection Para / Set 1...4 / I-Prot / IG[1]]	
1 ⊕ Adapt. Param.	0.02 ... 20.00	P.2
 <i>Time multiplier/tripping characteristic factor. The setting range depends on the selected tripping curve.</i>		

IG[1] . Reset Mode	[Protection Para / Set 1...4 / I-Prot / IG[1]]	
instantaneous ⊕ Adapt. Param.	instantaneous, delayed, calculated ↳ Reset Mode.	P.2
 <i>Reset Mode</i>		

IG[1] . t-reset delay	[Protection Para / Set 1...4 / I-Prot / IG[1]]	
0.00s Only available if: • IG[1] . Reset Mode = delayed ⊕ Adapt. Param.	0.00s ... 60.00s	P.2
 <i>Reset delay for intermittent phase failures (INV characteristics only)</i>		

IG[1] . IH2 Blo	[Protection Para / Set 1...4 / I-Prot / IG[1]]	
Sys . inactive	Sys . inactive, IH2 . active	P.2
↻ Adapt. Param.	↳ IH2 Blo.	
🔗	<i>Blocking the trip command, if an inrush is detected.</i>	

IG[1] . Dir n poss->Nondir Trip	[Protection Para / Set 1...4 / I-Prot / IG[1]]	
inactive	inactive, active	P.2
↻ Adapt. Param.	↳ active/inactive.	
🔗	<i>Only relevant for current protection elements with directional feature! The device will trip non directional if this parameter is set to active and no direction could be determined. Direction detection is impossible e.g. if the required quantities for the direction detection cannot be measured or validated. Direction detection is also impossible if the frequency deviates significantly from the nominal frequency. Caution: If this parameter is set to inactive, the protective element will trip only if the direction can be detected.</i>	

IG[1] . VX Blo	[Protection Para / Set 1...4 / I-Prot / IG[1]]	
inactive	inactive, active	P.2
↻ Adapt. Param.	↳ active/inactive.	
🔗	<i>VX Blo = active means that the IG-stage will only excite if a residual voltage higher than the pickup value is measured at the same time. VX Blo = inactive means that the excitation of the IG stage does not depend on any residual voltage stage.</i>	

IG[1] . VG>	[Protection Para / Set 1...4 / I-Prot / IG[1]]	
1.00Vn	0.01Vn ... 2.00Vn	P.2
↻ Adapt. Param.		
🔗	<i>If the pickup value is exceeded, the module/stage will be started.</i>	

9.12.4 IG[1]: Input States

IG[1] . ExBlo1-I	[Operation / Status Display / I-Prot / IG[1]]	
↓	<i>Module input state: External blocking1</i>	

IG[1] . ExBlo2-I	[Operation / Status Display / I-Prot / IG[1]]	
↓	<i>Module input state: External blocking2</i>	

IG[1] . ExBlo TripCmd-I	[Operation / Status Display / I-Prot / IG[1]]
↓	<p><i>Only available if:</i></p> <ul style="list-style-type: none"> • IG[1] . Superv. only = no <p><i>Module input state: External Blocking of the Trip Command</i></p>
IG[1] . Ex rev Interl-I	[Operation / Status Display / I-Prot / IG[1]]
↓	<i>Module input state: External reverse interlocking</i>
IG[1] . AdaptSet1-I	[Operation / Status Display / I-Prot / IG[1]]
↓	<i>Module input state: Adaptive Parameter1</i>
IG[1] . AdaptSet2-I	[Operation / Status Display / I-Prot / IG[1]]
↓	<i>Module input state: Adaptive Parameter2</i>
IG[1] . AdaptSet3-I	[Operation / Status Display / I-Prot / IG[1]]
↓	<i>Module input state: Adaptive Parameter3</i>
IG[1] . AdaptSet4-I	[Operation / Status Display / I-Prot / IG[1]]
↓	<i>Module input state: Adaptive Parameter4</i>

9.12.5 IG[1]: Signals (Output States)

IG[1] . active	[Operation / Status Display / All Actives] [Operation / Status Display / I-Prot / IG[1]]
↑	<i>Signal: active</i>
IG[1] . Alarm	[Operation / Status Display / Alarms] [Operation / Status Display / I-Prot / IG[1]]
↑	<i>Signal: Alarm IG</i>
IG[1] . Trip	[Operation / Status Display / Trips] [Operation / Status Display / I-Prot / IG[1]]
↑	<i>Signal: Trip</i>

IG[1] . TripCmd	[Operation / Status Display / TripCmds] [Operation / Status Display / I-Prot / IG[1]]
<p>⬆️ <i>Only available if:</i></p> <ul style="list-style-type: none"> • IG[1] . Superv. only = no <p><i>Signal: Trip Command</i></p>	
IG[1] . ExBlo	[Operation / Status Display / I-Prot / IG[1]]
<p>⬆️ <i>Signal: External Blocking</i></p>	
IG[1] . Ex rev Interl	[Operation / Status Display / I-Prot / IG[1]]
<p>⬆️ <i>Signal: External reverse Interlocking</i></p>	
IG[1] . Blo TripCmd	[Operation / Status Display / I-Prot / IG[1]]
<p>⬆️ <i>Only available if:</i></p> <ul style="list-style-type: none"> • IG[1] . Superv. only = no <p><i>Signal: Trip Command blocked</i></p>	
IG[1] . ExBlo TripCmd	[Operation / Status Display / I-Prot / IG[1]]
<p>⬆️ <i>Only available if:</i></p> <ul style="list-style-type: none"> • IG[1] . Superv. only = no <p><i>Signal: External Blocking of the Trip Command</i></p>	
IG[1] . IGH2 Blo	[Operation / Status Display / I-Prot / IG[1]]
<p>⬆️ <i>Signal: blocked by an inrush</i></p>	
IG[1] . DefaultSet	[Operation / Status Display / I-Prot / IG[1]]
<p>⬆️ <i>Signal: Default Parameter Set</i></p>	
IG[1] . AdaptSet 1	[Operation / Status Display / I-Prot / IG[1]]
<p>⬆️ <i>Signal: Adaptive Parameter 1</i></p>	
IG[1] . AdaptSet 2	[Operation / Status Display / I-Prot / IG[1]]
<p>⬆️ <i>Signal: Adaptive Parameter 2</i></p>	



IG[1] . AdaptSet 3	[Operation / Status Display / I-Prot / IG[1]]
⬇	<i>Signal: Adaptive Parameter 3</i>

IG[1] . AdaptSet 4	[Operation / Status Display / I-Prot / IG[1]]
⬇	<i>Signal: Adaptive Parameter 4</i>

9.13 ThR



Thermal replica module



9.13.1 ThR: Device Planning Parameters

ThR . Mode	[Device planning]	
"_"	"_", use  Device planning.	S.3
	Thermal replica module, general operation mode	

9.13.2 ThR: Global Parameters

ThR . CT Winding Side	[Protection Para / Global Prot Para / I-Prot / ThR]	
. CT Ntrl	. CT Ntrl, . CT Mains  CT Winding Side.	P.2
	Measuring values will be used from this winding side	

ThR . ExBlo1	[Protection Para / Global Prot Para / I-Prot / ThR]	
ThR . ExBlo2		
"_"	"_" ... Sys . Internal test state  1..n, Assignment List.	P.2
	External blocking of the module, if blocking is activated (allowed) within a parameter set and if the state of the assigned signal is true.	

ThR . ExBlo TripCmd	[Protection Para / Global Prot Para / I-Prot / ThR]	
"_"	"_" ... Sys . Internal test state  1..n, Assignment List.	P.2
	External blocking of the Trip Command of the module/the stage, if blocking is activated (allowed) within a parameter set and if the state of the assigned signal is true.	

9.13.3 ThR: Setting Group Parameters

ThR . Function	[Protection Para / Set 1...4 / I-Prot / ThR]	
inactive	inactive, active ↳ Mode.	P.2
 <i>Permanent activation or deactivation of module/stage.</i>		

ThR . ExBlo Fc	[Protection Para / Set 1...4 / I-Prot / ThR]	
inactive	inactive, active ↳ active/inactive.	P.2
 <i>Activate (allow) or inactivate (disallow) blocking of the module/stage. This parameter is only effective if a signal is assigned to the corresponding global protection parameter. If the signal becomes true, those modules/stages are blocked that are parameterized "ExBlo Fc=active".</i>		

ThR . Blo TripCmd	[Protection Para / Set 1...4 / I-Prot / ThR]	
inactive	inactive, active ↳ Mode.	P.2
 <i>Permanent blocking of the Trip Command of the module/stage.</i>		

ThR . ExBlo TripCmd Fc	[Protection Para / Set 1...4 / I-Prot / ThR]	
inactive	inactive, active ↳ active/inactive.	P.2
 <i>Activate (allow) or inactivate (disallow) blocking of the module/stage. This parameter is only effective if a signal is assigned to the corresponding global protection parameter. If the signal becomes true, those modules/stages are blocked that are parameterized "ExBlo TripCmd Fc=active".</i>		

ThR . Ib	[Protection Para / Set 1...4 / I-Prot / ThR]	
1.00In	0.01In ... 4.00In	P.2
 <i>Base current: Maximum permissible thermal continuous current.</i>		



ThR . K	[Protection Para / Set 1...4 / I-Prot / ThR]	
1.00	0.80 ... 1.50	P.2
 <i>Overload Factor: The maximum thermal limit is defined as $k \cdot I_B$, the product of the overload factor and the base current.</i>		

ThR . Alarm Theta	[Protection Para / Set 1...4 / I-Prot / ThR]	
80%	50% ... 100%	P.2
 Pickup value		

ThR . τ-warm	[Protection Para / Set 1...4 / I-Prot / ThR]	
10s	1s ... 60000s	P.2
 Warming-up time constant		

ThR . τ-cool	[Protection Para / Set 1...4 / I-Prot / ThR]	
10s	1s ... 60000s	P.2
 Cooling time constant		

9.13.4 ThR: Direct Controls

ThR . Reset	[Operation / Reset]	
inactive	inactive, active  Mode.	P.1
 Reset the Thermal Replica		









9.13.5 ThR: Input States

ThR . ExBlo1-I	[Operation / Status Display / I-Prot / ThR]	
 Module input state: External blocking1		

ThR . ExBlo2-I	[Operation / Status Display / I-Prot / ThR]	
 Module input state: External blocking2		

ThR . ExBlo TripCmd-I	[Operation / Status Display / I-Prot / ThR]	
 Module input state: External Blocking of the Trip Command		

9.13.6 ThR: Signals (Output States)

ThR . active	[Operation / Status Display / All Actives] [Operation / Status Display / I-Prot / ThR]
 <i>Signal: active</i>	
ThR . Alarm	[Operation / Status Display / Alarms] [Operation / Status Display / I-Prot / ThR]
 <i>Signal: Alarm Thermal Overload</i>	
ThR . Trip	[Operation / Status Display / Trips] [Operation / Status Display / I-Prot / ThR]
 <i>Signal: Trip</i>	
ThR . TripCmd	[Operation / Status Display / TripCmds] [Operation / Status Display / I-Prot / ThR]
 <i>Signal: Trip Command</i>	
ThR . ExBlo	[Operation / Status Display / I-Prot / ThR]
 <i>Signal: External Blocking</i>	
ThR . Blo TripCmd	[Operation / Status Display / I-Prot / ThR]
 <i>Signal: Trip Command blocked</i>	
ThR . ExBlo TripCmd	[Operation / Status Display / I-Prot / ThR]
 <i>Signal: External Blocking of the Trip Command</i>	
ThR . Res Thermal Cap	[Operation / Status Display / I-Prot / ThR]
 <i>Signal: Resetting Thermal Replica</i>	

9.13.7 ThR: Values

ThR . Thermal Cap Used	[Operation / Measured Values / ThR]
 <i>Measured value: Thermal Capacity Used</i>	

ThR . Time To Trip	[Operation / Measured Values / ThR]
<input type="checkbox"/> <i>Measured value (calculated/measured): Remaining time until the thermal overload module will trip</i>	



9.13.8 ThR: Statistical Values

ThR . Thermal Cap max	[Operation / Statistics / Max / ThR]
<input checked="" type="checkbox"/> <i>Thermal Capacity maximum value</i>	

9.14 I2>[1] ... I2>[2]



Unbalanced Load-Stage



9.14.1 I2>[1]: Device Planning Parameters

I2>[1] . Mode	[Device planning]	
"_"	"_", use  Device planning.	S.3
	<i>Unbalanced Load-Stage, general operation mode</i>	

9.14.2 I2>[1]: Global Parameters

I2>[1] . CT Winding Side	[Protection Para / Global Prot Para / I-Prot / I2>[1]]	
. CT Ntrl	. CT Ntrl, . CT Mains  CT Winding Side.	P.2
	<i>Measuring values will be used from this winding side</i>	

I2>[1] . ExBlo1	[Protection Para / Global Prot Para / I-Prot / I2>[1]]	
I2>[1] . ExBlo2		
"_"	"_" ... Sys . Internal test state  1..n, Assignment List.	P.2
	<i>External blocking of the module, if blocking is activated (allowed) within a parameter set and if the state of the assigned signal is true.</i>	

I2>[1] . ExBlo TripCmd	[Protection Para / Global Prot Para / I-Prot / I2>[1]]	
"_"	"_" ... Sys . Internal test state  1..n, Assignment List.	P.2
	<i>External blocking of the Trip Command of the module/the stage, if blocking is activated (allowed) within a parameter set and if the state of the assigned signal is true.</i>	

I2>[1] . CurrentBase	[Protection Para / Global Prot Para / I-Prot / I2>[1]]	
Device Rating	Device Rating, Protected Object Rating ↳ CurrentBase.	P.2
 Base Current Selection (based on Device Rating (1A/5A)/Protected Object Rating).		

9.14.3 I2>[1]: Setting Group Parameters

I2>[1] . Function	[Protection Para / Set 1...4 / I-Prot / I2>[1]]	
inactive	inactive, active ↳ Mode.	P.2
 Permanent activation or deactivation of module/stage.		



I2>[1] . ExBlo Fc	[Protection Para / Set 1...4 / I-Prot / I2>[1]]	
inactive	inactive, active ↳ active/inactive.	P.2
 Activate (allow) or inactivate (disallow) blocking of the module/stage. This parameter is only effective if a signal is assigned to the corresponding global protection parameter. If the signal becomes true, those modules/stages are blocked that are parameterized "ExBlo Fc=active".		

I2>[1] . Blo TripCmd	[Protection Para / Set 1...4 / I-Prot / I2>[1]]	
inactive	inactive, active ↳ Mode.	P.2
 Permanent blocking of the Trip Command of the module/stage.		

I2>[1] . ExBlo TripCmd Fc	[Protection Para / Set 1...4 / I-Prot / I2>[1]]	
inactive	inactive, active ↳ active/inactive.	P.2
 Activate (allow) or inactivate (disallow) blocking of the module/stage. This parameter is only effective if a signal is assigned to the corresponding global protection parameter. If the signal becomes true, those modules/stages are blocked that are parameterized "ExBlo TripCmd Fc=active".		

I2>[1] . I2>	[Protection Para / Set 1...4 / I-Prot / I2>[1]]	
0.01In	0.01In ... 4.00In	P.2
<i>Only available if:</i> <ul style="list-style-type: none"> I2>[1] . CurrentBase = Device Rating 		
	<i>The Threshold setting defines a minimum operating current magnitude of I2 for the 46 function to operate, which ensures that the relay has a solid basis for initiating a current unbalance trip. This is a supervisory function and not a trip level.</i>	

I2>[1] . I2/FLA	[Protection Para / Set 1...4 / I-Prot / I2>[1]]	
0.08Ib	0.000Ib ... 1.000Ib	P.2
<i>Only available if:</i> <ul style="list-style-type: none"> I2>[1] . CurrentBase = Protected Object Rating 		
	<i>Generator/motor unbalance current pickup value based on the full load current(FLA) (Setting from Continuous Unbalance Current Capability)</i>	

I2>[1] . %(I2/I1)	[Protection Para / Set 1...4 / I-Prot / I2>[1]]	
inactive	inactive, active	P.2
 Mode.		
	<i>The %(I2/I1) setting is the unbalance trip pickup setting. It is defined by the ratio of negative sequence current to positive sequence current (% Unbalance=I2/I1). Phase sequence will be taken into account automatically.</i>	

I2>[1] . %(I2/I1)	[Protection Para / Set 1...4 / I-Prot / I2>[1]]	
20%	2% ... 40%	P.2
	<i>The %(I2/I1) setting is the unbalance trip pickup setting. It is defined by the ratio of negative sequence current to positive sequence current (% Unbalance=I2/I1). Phase sequence will be taken into account automatically.</i>	

I2>[1] . Char	[Protection Para / Set 1...4 / I-Prot / I2>[1]]	
DEFT	DEFT, INV	P.2
 Char.		
	<i>Characteristic</i>	

I2>[1] . t	[Protection Para / Set 1...4 / I-Prot / I2>[1]]
0.00s	0.00s ... 300.00s P.2
 Tripping delay	

I2>[1] . K	[Protection Para / Set 1...4 / I-Prot / I2>[1]]
10.0s	1.00s ... 200.00s P.2
 This setting is the negative sequence capability constant. This value is normally provided by the generator manufacturer.	

I2>[1] . τ-cool	[Protection Para / Set 1...4 / I-Prot / I2>[1]]
0.0s	0.0s ... 60000.0s P.2
 If the unbalanced load current falls below the pickup value, the cooling-off time is taken into account. If the unbalanced load exceeds the pickup value again, than the saved heat within the electrical equipment will lead to an accelerated trip.	

9.14.4 I2>[1]: Input States

I2>[1] . ExBlo1-I	[Operation / Status Display / I-Prot / I2>[1]]
 Module input state: External blocking1	





I2>[1] . ExBlo2-I	[Operation / Status Display / I-Prot / I2>[1]]
 Module input state: External blocking2	

I2>[1] . ExBlo TripCmd-I	[Operation / Status Display / I-Prot / I2>[1]]
 Module input state: External Blocking of the Trip Command	

9.14.5 I2>[1]: Signals (Output States)

I2>[1] . active	[Operation / Status Display / All Actives] [Operation / Status Display / I-Prot / I2>[1]]
 Signal: active	

I2>[1] . Alarm	[Operation / Status Display / Alarms] [Operation / Status Display / I-Prot / I2>[1]]
 Signal: Alarm Negative Sequence	

I2>[1] . Trip	[Operation / Status Display / Trips] [Operation / Status Display / I-Prot / I2>[1]]
 <i>Signal: Trip</i>	
I2>[1] . TripCmd	[Operation / Status Display / TripCmds] [Operation / Status Display / I-Prot / I2>[1]]
 <i>Signal: Trip Command</i>	
I2>[1] . ExBlo	[Operation / Status Display / I-Prot / I2>[1]]
 <i>Signal: External Blocking</i>	
I2>[1] . Blo TripCmd	[Operation / Status Display / I-Prot / I2>[1]]
 <i>Signal: Trip Command blocked</i>	
I2>[1] . ExBlo TripCmd	[Operation / Status Display / I-Prot / I2>[1]]
 <i>Signal: External Blocking of the Trip Command</i>	

9.15 I2>G[1] ... I2>G[2]

Unbalanced Load-StageG

9.15.1 I2>G[1]: Device Planning Parameters

I2>G[1] . Mode	[Device planning]	
"_"	"_", use ↳ Device planning.	S.3
 <i>Unbalanced Load-Stage, general operation mode</i>		

9.15.2 I2>G[1]: Global Parameters

I2>G[1] . ExBlo1	[Protection Para / Global Prot Para / I-Prot / I2>G[1]]	
I2>G[1] . ExBlo2		
"_"	"_" ... Sys . Internal test state ↳ 1..n, Assignment List.	P.2
 <i>External blocking of the module, if blocking is activated (allowed) within a parameter set and if the state of the assigned signal is true.</i>		

I2>G[1] . ExBlo TripCmd	[Protection Para / Global Prot Para / I-Prot / I2>G[1]]	
"_"	"_" ... Sys . Internal test state ↳ 1..n, Assignment List.	P.2
 <i>External blocking of the Trip Command of the module/the stage, if blocking is activated (allowed) within a parameter set and if the state of the assigned signal is true.</i>		

9.15.3 I2>G[1]: Setting Group Parameters

I2>G[1] . Function	[Protection Para / Set 1...4 / I-Prot / I2>G[1]]	
inactive	inactive, active ↳ Mode.	P.2
 <i>Permanent activation or deactivation of module/stage.</i>		

I2>G[1] . ExBlo Fc	[Protection Para / Set 1...4 / I-Prot / I2>G[1]]	
inactive	inactive, active ↳ active/inactive.	P.2
	<i>Activate (allow) or inactivate (disallow) blocking of the module/stage. This parameter is only effective if a signal is assigned to the corresponding global protection parameter. If the signal becomes true, those modules/stages are blocked that are parameterized "ExBlo Fc=active".</i>	

I2>G[1] . Blo TripCmd	[Protection Para / Set 1...4 / I-Prot / I2>G[1]]	
inactive	inactive, active ↳ Mode.	P.2
	<i>Permanent blocking of the Trip Command of the module/stage.</i>	

I2>G[1] . ExBlo TripCmd Fc	[Protection Para / Set 1...4 / I-Prot / I2>G[1]]	
inactive	inactive, active ↳ active/inactive.	P.2
	<i>Activate (allow) or inactivate (disallow) blocking of the module/stage. This parameter is only effective if a signal is assigned to the corresponding global protection parameter. If the signal becomes true, those modules/stages are blocked that are parameterized "ExBlo TripCmd Fc=active".</i>	

I2>G[1] . I2/FLA	[Protection Para / Set 1...4 / I-Prot / I2>G[1]]	
0.08Ib	0.000Ib ... 1.000Ib	P.2
	<i>Generator/motor unbalance current pickup value based on the full load current(FLA) (Setting from Continuous Unbalance Current Capability)</i>	

I2>G[1] . K	[Protection Para / Set 1...4 / I-Prot / I2>G[1]]	
10.0s	1.00s ... 200.00s	P.2
	<i>This setting is the negative sequence capability constant. This value is normally provided by the generator manufacturer.</i>	

I2>G[1] . τ-cool	[Protection Para / Set 1...4 / I-Prot / I2>G[1]]	
240.0s	0.0s ... 60000.0s	P.2
	<i>If the unbalanced load current falls below the pickup value, the cooling-off time is taken into account. If the unbalanced load exceeds the pickup value again, than the saved heat within the electrical equipment will lead to an accelerated trip.</i>	

I2>G[1] . Tmax	[Protection Para / Set 1...4 / I-Prot / I2>G[1]]
600.00s	0.00s ... 1000.00s P.2
	<i>Maximum operating time for inverse characteristics which limit the tripping time for low level unbalance.</i>

I2>G[1] . Tmin	[Protection Para / Set 1...4 / I-Prot / I2>G[1]]
0.25s	0.00s ... 50.00s P.2
	<i>Minimum operating time for inverse characteristics which prevent false trips for faults that would be cleared normally by system protection.</i>

9.15.4 I2>G[1]: Input States

I2>G[1] . ExBlo1-I	[Operation / Status Display / I-Prot / I2>G[1]]
	<i>Module input state: External blocking1</i>

I2>G[1] . ExBlo2-I	[Operation / Status Display / I-Prot / I2>G[1]]
	<i>Module input state: External blocking2</i>

I2>G[1] . ExBlo TripCmd-I	[Operation / Status Display / I-Prot / I2>G[1]]
	<i>Module input state: External Blocking of the Trip Command</i>

9.15.5 I2>G[1]: Signals (Output States)

I2>G[1] . active	[Operation / Status Display / All Actives] [Operation / Status Display / I-Prot / I2>G[1]]
	<i>Signal: active</i>

I2>G[1] . Alarm	[Operation / Status Display / Alarms] [Operation / Status Display / I-Prot / I2>G[1]]
	<i>Signal: Alarm Negative Sequence</i>

I2>G[1] . Trip	[Operation / Status Display / Trips] [Operation / Status Display / I-Prot / I2>G[1]]
	<i>Signal: Trip</i>

I2>G[1] . TripCmd	[Operation / Status Display / TripCmds] [Operation / Status Display / I-Prot / I2>G[1]]
 <i>Signal: Trip Command</i>	

I2>G[1] . ExBlo	[Operation / Status Display / I-Prot / I2>G[1]]
 <i>Signal: External Blocking</i>	



I2>G[1] . Blo TripCmd	[Operation / Status Display / I-Prot / I2>G[1]]
 <i>Signal: Trip Command blocked</i>	

I2>G[1] . ExBlo TripCmd	[Operation / Status Display / I-Prot / I2>G[1]]
 <i>Signal: External Blocking of the Trip Command</i>	



9.16 V[1] ... V[6]



Voltage-stage

9.16.1 V[1]: Device Planning Parameters



V[1] . Mode	[Device planning]	
V>	"-", V>, V<  Device planning.	S.3
	Voltage-stage, general operation mode	

9.16.2 V[1]: Global Parameters

V[1] . ExBlo1	[Protection Para / Global Prot Para / V-Prot / V[1]]	
V[1] . ExBlo2		
"-"	"-" ... Sys . Internal test state  1..n, Assignment List.	P.2
	External blocking of the module, if blocking is activated (allowed) within a parameter set and if the state of the assigned signal is true.	

V[1] . ExBlo TripCmd	[Protection Para / Global Prot Para / V-Prot / V[1]]	
"-"	"-" ... Sys . Internal test state  1..n, Assignment List.	P.2
	External blocking of the Trip Command of the module/the stage, if blocking is activated (allowed) within a parameter set and if the state of the assigned signal is true.	

9.16.3 V[1]: Setting Group Parameters

V[1] . Function	[Protection Para / Set 1...4 / V-Prot / V[1]]	
active	inactive, active  Mode.	P.2
	Permanent activation or deactivation of module/stage.	

V[1] . ExBlo Fc	[Protection Para / Set 1...4 / V-Prot / V[1]]	
inactive	inactive, active ↳ active/inactive.	P.2
	<i>Activate (allow) or inactivate (disallow) blocking of the module/stage. This parameter is only effective if a signal is assigned to the corresponding global protection parameter. If the signal becomes true, those modules/stages are blocked that are parameterized "ExBlo Fc=active".</i>	







V[1] . Blo TripCmd	[Protection Para / Set 1...4 / V-Prot / V[1]]	
inactive	inactive, active ↳ Mode.	P.2
	<i>Permanent blocking of the Trip Command of the module/stage.</i>	



V[1] . ExBlo TripCmd Fc	[Protection Para / Set 1...4 / V-Prot / V[1]]	
inactive	inactive, active ↳ active/inactive.	P.2
	<i>Activate (allow) or inactivate (disallow) blocking of the module/stage. This parameter is only effective if a signal is assigned to the corresponding global protection parameter. If the signal becomes true, those modules/stages are blocked that are parameterized "ExBlo TripCmd Fc=active".</i>	

V[1] . Measuring Mode	[Protection Para / Set 1...4 / V-Prot / V[1]]	
Phase to Ground	Phase to Ground, Phase to Phase ↳ Measuring Mode.	P.2
	<i>Measuring/Supervision Mode: Determines if the phase-to-phase or phase-to-earth voltages are to be supervised</i>	

V[1] . Measuring method	[Protection Para / Set 1...4 / V-Prot / V[1]]	
Fundamental	Fundamental, True RMS, Vavg ↳ Measuring method.	P.2
	<i>Measuring method: fundamental or rms or "sliding average supervision"</i>	

V[1] . Alarm Mode	[Protection Para / Set 1...4 / V-Prot / V[1]]	
any one	any one, any two, all ↳ Alarm Mode.	P.2
	<i>Alarm criterion for the voltage protection stage.</i>	

V[1] . V>	[Protection Para / Set 1...4 / V-Prot / V[1]]	
1.1Vn	0.01Vn ... 2.000Vn	P.2
	<i>If the pickup value is exceeded, the module/element will be started. The definition of Vn is dependent on both the Field Parameter »VT con« and the Setting Group Parameter »Measuring Mode«: If the measuring inputs of the voltage measuring card are fed with phase-to-ground voltages (»VT con« = "Phase-to-Ground") then the setting »Measuring Mode« = "Phase-to-Ground" means that Vn=VTsec/SQRT(3), and »Measuring Mode« = "Phase-to-Phase" means that Vn=VTsec. However, if the measuring inputs of the voltage measuring card are fed with phase-to-phase voltages (»VT con« = "Phase-to-Phase") then the setting of "Measuring Mode" is ignored and internally set to "Phase-to-Phase" instead, so that Vn=VTsec.</i>	
V[1] . V> Reset%	[Protection Para / Set 1...4 / V-Prot / V[1]]	
98.5%	80% ... 99.0%	P.2
	<i>Drop Out (is in percent of setting)</i>	
V[1] . V<	[Protection Para / Set 1...4 / V-Prot / V[1]]	
0.80Vn	0.01Vn ... 2.000Vn	P.2
	<i>If the pickup value is exceeded, the module/element will be started. The definition of Vn is dependent on both the Field Parameter »VT con« and the Setting Group Parameter »Measuring Mode«: If the measuring inputs of the voltage measuring card are fed with phase-to-ground voltages (»VT con« = "Phase-to-Ground") then the setting »Measuring Mode« = "Phase-to-Ground" means that Vn=VTsec/SQRT(3), and »Measuring Mode« = "Phase-to-Phase" means that Vn=VTsec. However, if the measuring inputs of the voltage measuring card are fed with phase-to-phase voltages (»VT con« = "Phase-to-Phase") then the setting of "Measuring Mode" is ignored and internally set to "Phase-to-Phase" instead, so that Vn=VTsec.</i>	
V[1] . V< Reset%	[Protection Para / Set 1...4 / V-Prot / V[1]]	
101.5%	101% ... 110.0%	P.2
	<i>Drop Out (is in percent of setting)</i>	
V[1] . t	[Protection Para / Set 1...4 / V-Prot / V[1]]	
1s	0.00s ... 3000.00s	P.2
	<i>Tripping delay</i>	
V[1] . Meas Circuit Superv	[Protection Para / Set 1...4 / V-Prot / V[1]]	
Sys . inactive	Sys . inactive, LOP . active  VTS Block.	P.2
	<i>Activates the use of the measuring circuit supervision. In this case the module will be blocked if a measuring circuit supervision module (e.g. LOP, VTS) signals a disturbed measuring circuit (e.g. caused by a fuse failure).</i>	

V[1] . Imin release check	[Protection Para / Set 1...4 / V-Prot / V[1]]	
inactive	inactive, active  Mode.	P.2
	<i>Enable a minimum current check. This monitors the current flow (in the CT on the VT side), to detect whether the circuit breaker is permanently in open state; in this case the undervoltage detection is blocked.</i>	

V[1] . Threshold Imin	[Protection Para / Set 1...4 / V-Prot / V[1]]	
0.05In	0.02In ... 10.00In	P.2
<i>Only available if:</i>		
<ul style="list-style-type: none"> • V[1] . Imin release check = active 		
	<i>Threshold value that is used for the Imin release (minimum current) check. If the current flow is below this value, it is assumed that the circuit breaker is permanently in open state.</i>	

V[1] . t-delay Imin	[Protection Para / Set 1...4 / V-Prot / V[1]]	
0.03s	0.00s ... 3000.00s	P.2
<i>Only available if:</i>		
<ul style="list-style-type: none"> • V[1] . Imin release check = active 		
	<i>Release delay for the undervoltage detection. This delay is effective only after the minimum current check had blocked the undervoltage detection. When the circuit breaker has been closed and the current flow is re-establishing, this delay continues to block the undervoltage detection; during this time the voltage can rise above the pickup value »V<<.</i>	

9.16.4 V[1]: Input States

V[1] . ExBlo1-I	[Operation / Status Display / V-Prot / V[1]]	
	<i>Module input state: External blocking1</i>	

V[1] . ExBlo2-I	[Operation / Status Display / V-Prot / V[1]]	
	<i>Module input state: External blocking2</i>	

V[1] . ExBlo TripCmd-I	[Operation / Status Display / V-Prot / V[1]]	
	<i>Module input state: External Blocking of the Trip Command</i>	

9.16.5 V[1]: Signals (Output States)



V[1] . active	[Operation / Status Display / All Actives] [Operation / Status Display / V-Prot / V[1]]
⬇	<i>Signal: active</i>
V[1] . Alarm	[Operation / Status Display / Alarms] [Operation / Status Display / V-Prot / V[1]]
⬇	<i>Signal: Alarm voltage stage</i>
V[1] . Trip	[Operation / Status Display / Trips] [Operation / Status Display / V-Prot / V[1]]
⬇	<i>Signal: Trip</i>
V[1] . TripCmd	[Operation / Status Display / TripCmds] [Operation / Status Display / V-Prot / V[1]]
⬇	<i>Signal: Trip Command</i>
V[1] . ExBlo	[Operation / Status Display / V-Prot / V[1]]
⬇	<i>Signal: External Blocking</i>
V[1] . Blo TripCmd	[Operation / Status Display / V-Prot / V[1]]
⬇	<i>Signal: Trip Command blocked</i>
V[1] . ExBlo TripCmd	[Operation / Status Display / V-Prot / V[1]]
⬇	<i>Signal: External Blocking of the Trip Command</i>
V[1] . Alarm L1	[Operation / Status Display / V-Prot / V[1]]
⬇	<i>Signal: Alarm L1</i>
V[1] . Alarm L2	[Operation / Status Display / V-Prot / V[1]]
⬇	<i>Signal: Alarm L2</i>

V[1] . Alarm L3	[Operation / Status Display / V-Prot / V[1]]
↕	<i>Signal: Alarm L3</i>
V[1] . Trip L1	[Operation / Status Display / V-Prot / V[1]]
↕	<i>Signal: General Trip Phase L1</i>
V[1] . Trip L2	[Operation / Status Display / V-Prot / V[1]]
↕	<i>Signal: General Trip Phase L2</i>
V[1] . Trip L3	[Operation / Status Display / V-Prot / V[1]]
↕	<i>Signal: General Trip Phase L3</i>
V[1] . Imin release active	[Operation / Status Display / V-Prot / V[1]]
↕	<i>Signal that the Imin release (minimum current) check is enabled and does not block the undervoltage detection at the moment.</i>



9.17 df/dt



Rate-of-frequency-change.

9.17.1 df/dt: Device Planning Parameters



df/dt . Mode	[Device planning]	
"_"	"_" , use  Device planning.	S.3
	Frequency Protection Module, general operation mode	

9.17.2 df/dt: Global Parameters

df/dt . ExBlo1 df/dt . ExBlo2	[Protection Para / Global Prot Para / Intercon-Prot / Mains Decouplg / df/dt]	
"_"	"_" ... Sys . Internal test state  1..n, Assignment List.	P.2
	External blocking of the module, if blocking is activated (allowed) within a parameter set and if the state of the assigned signal is true.	

df/dt . ExBlo TripCmd	[Protection Para / Global Prot Para / Intercon-Prot / Mains Decouplg / df/dt]	
"_"	"_" ... Sys . Internal test state  1..n, Assignment List.	P.2
	External blocking of the Trip Command of the module/the stage, if blocking is activated (allowed) within a parameter set and if the state of the assigned signal is true.	

9.17.3 df/dt: Setting Group Parameters

df/dt . Function	[Protection Para / Set 1...4 / Intercon-Prot / Mains Decouplg / df/dt]	
inactive	inactive, active  Mode.	P.2
	Permanent activation or deactivation of module/stage.	

df/dt . ExBlo Fc	[Protection Para / Set 1...4 / Intercon-Prot / Mains Decouplg / df/dt]	
inactive	inactive, active ↳ active/inactive.	P.2
	<i>Activate (allow) or inactivate (disallow) blocking of the module/stage. This parameter is only effective if a signal is assigned to the corresponding global protection parameter. If the signal becomes true, those modules/stages are blocked that are parameterized "ExBlo Fc=active".</i>	

df/dt . Blo TripCmd	[Protection Para / Set 1...4 / Intercon-Prot / Mains Decouplg / df/dt]	
inactive	inactive, active ↳ Mode.	P.2
	<i>Permanent blocking of the Trip Command of the module/stage.</i>	

df/dt . ExBlo TripCmd Fc	[Protection Para / Set 1...4 / Intercon-Prot / Mains Decouplg / df/dt]	
inactive	inactive, active ↳ active/inactive.	P.2
	<i>Activate (allow) or inactivate (disallow) blocking of the module/stage. This parameter is only effective if a signal is assigned to the corresponding global protection parameter. If the signal becomes true, those modules/stages are blocked that are parameterized "ExBlo TripCmd Fc=active".</i>	

df/dt . f>	[Protection Para / Set 1...4 / Intercon-Prot / Mains Decouplg / df/dt]	
51.00Hz	40.00Hz ... 69.00Hz	P.2
	<i>Pickup value for overfrequency.</i>	

df/dt . f<	[Protection Para / Set 1...4 / Intercon-Prot / Mains Decouplg / df/dt]	
49.00Hz	40.00Hz ... 69.00Hz	P.2
	<i>Pickup value for underfrequency.</i>	

df/dt . Freq. drop-off	[Protection Para / Set 1...4 / Intercon-Prot / Mains Decouplg / df/dt]	
0.020Hz	0.010Hz ... 0.100Hz	P.2
	<i>Drop-off for the Frequency function. This setting modifies the shape of the hysteresis that is used for the frequency protection.</i>	



df/dt . t	[Protection Para / Set 1...4 / Intercon-Prot / Mains Decouplg / df/dt]
1.00s	0.00s ... 3600.00s P.2
 Tripping delay	

df/dt . df/dt	[Protection Para / Set 1...4 / Intercon-Prot / Mains Decouplg / df/dt]
1.000Hz/s	0.100Hz/s ... 10.000Hz/s P.2
 Measured value (calculated): Rate-of-frequency-change.	

df/dt . t-df/dt	[Protection Para / Set 1...4 / Intercon-Prot / Mains Decouplg / df/dt]
1.00s	0.00s ... 300.00s P.2
 Trip delay df/dt	

df/dt . DF	[Protection Para / Set 1...4 / Intercon-Prot / Mains Decouplg / df/dt]
1.00Hz	0.0Hz ... 10.0Hz P.2
 Frequency difference for the maximum admissible variation of the mean of the rate of frequency-change. This function is inactive if DF=0.	

df/dt . DT	[Protection Para / Set 1...4 / Intercon-Prot / Mains Decouplg / df/dt]
1.00s	0.1s ... 10.0s P.2
 Time interval of the maximum admissible rate-of-frequency-change.	

df/dt . df/dt mode	[Protection Para / Set 1...4 / Intercon-Prot / Mains Decouplg / df/dt]
absolute df/dt	absolute df/dt, positive df/dt, negative df/dt P.2  Mode.
 df/dt mode	

df/dt . delta phi	[Protection Para / Set 1...4 / Intercon-Prot / Mains Decouplg / df/dt]
10°	1° ... 30° P.2
 Measured value (calculated): Vector surge	

9.17.4 df/dt: Input States

df/dt . ExBlo1-I	[Operation / Status Display / Intercon-Prot / Mains Decouplg / df/dt]
-------------------------	---

↓ *Module input state: External blocking1*

df/dt . ExBlo2-I	[Operation / Status Display / Intercon-Prot / Mains Decouplg / df/dt]
-------------------------	---

↓ *Module input state: External blocking2*

df/dt . ExBlo TripCmd-I	[Operation / Status Display / Intercon-Prot / Mains Decouplg / df/dt]
--------------------------------	---

↓ *Module input state: External Blocking of the Trip Command*

9.17.5 df/dt: Signals (Output States)

df/dt . active	[Operation / Status Display / All Actives] [Operation / Status Display / Intercon-Prot / Mains Decouplg / df/dt]
-----------------------	---

↑ *Signal: active*

df/dt . Alarm	[Operation / Status Display / Alarms] [Operation / Status Display / Intercon-Prot / Mains Decouplg / df/dt]
----------------------	--

↑ *Signal: Alarm Frequency Protection (collective signal)*

df/dt . Trip	[Operation / Status Display / Trips] [Operation / Status Display / Intercon-Prot / Mains Decouplg / df/dt]
---------------------	---

↑ *Signal: Trip Frequency Protection (collective signal)*

df/dt . TripCmd	[Operation / Status Display / TripCmds] [Operation / Status Display / Intercon-Prot / Mains Decouplg / df/dt]
------------------------	--



↑ *Signal: Trip Command*

df/dt . ExBlo	[Operation / Status Display / Intercon-Prot / Mains Decouplg / df/dt]
⬆	<i>Signal: External Blocking</i>
df/dt . Blo by V<	[Operation / Status Display / Intercon-Prot / Mains Decouplg / df/dt]
⬆	<i>Signal: Module is blocked by undervoltage.</i>
df/dt . Blo TripCmd	[Operation / Status Display / Intercon-Prot / Mains Decouplg / df/dt]
⬆	<i>Signal: Trip Command blocked</i>
df/dt . ExBlo TripCmd	[Operation / Status Display / Intercon-Prot / Mains Decouplg / df/dt]
⬆	<i>Signal: External Blocking of the Trip Command</i>



9.18 delta phi



Vector surge

9.18.1 delta phi: Device Planning Parameters



delta phi . Mode	[Device planning]	
"_"	"_", use  Device planning.	S.3
	Frequency Protection Module, general operation mode	



9.18.2 delta phi: Global Parameters



delta phi . ExBlo1 delta phi . ExBlo2	[Protection Para / Global Prot Para / Intercon-Prot / Mains Decouplg / delta phi]	
"_"	"_" ... Sys . Internal test state  1..n, Assignment List.	P.2
	External blocking of the module, if blocking is activated (allowed) within a parameter set and if the state of the assigned signal is true.	

delta phi . ExBlo TripCmd	[Protection Para / Global Prot Para / Intercon-Prot / Mains Decouplg / delta phi]	
"_"	"_" ... Sys . Internal test state  1..n, Assignment List.	P.2
	External blocking of the Trip Command of the module/the stage, if blocking is activated (allowed) within a parameter set and if the state of the assigned signal is true.	

9.18.3 delta phi: Setting Group Parameters

delta phi . Function	[Protection Para / Set 1...4 / Intercon-Prot / Mains Decouplg / delta phi]	
inactive	inactive, active  Mode.	P.2
	Permanent activation or deactivation of module/stage.	

delta phi . ExBlo Fc	[Protection Para / Set 1...4 / Intercon-Prot / Mains Decouplg / delta phi]	
inactive	inactive, active  active/inactive.	P.2
	<i>Activate (allow) or inactivate (disallow) blocking of the module/stage. This parameter is only effective if a signal is assigned to the corresponding global protection parameter. If the signal becomes true, those modules/stages are blocked that are parameterized "ExBlo Fc=active".</i>	

delta phi . Blo TripCmd	[Protection Para / Set 1...4 / Intercon-Prot / Mains Decouplg / delta phi]	
inactive	inactive, active  Mode.	P.2
	<i>Permanent blocking of the Trip Command of the module/stage.</i>	

delta phi . ExBlo TripCmd Fc	[Protection Para / Set 1...4 / Intercon-Prot / Mains Decouplg / delta phi]	
inactive	inactive, active  active/inactive.	P.2
	<i>Activate (allow) or inactivate (disallow) blocking of the module/stage. This parameter is only effective if a signal is assigned to the corresponding global protection parameter. If the signal becomes true, those modules/stages are blocked that are parameterized "ExBlo TripCmd Fc=active".</i>	

delta phi . f>	[Protection Para / Set 1...4 / Intercon-Prot / Mains Decouplg / delta phi]	
51.00Hz	40.00Hz ... 69.00Hz	P.2
	<i>Pickup value for overfrequency.</i>	

delta phi . f<	[Protection Para / Set 1...4 / Intercon-Prot / Mains Decouplg / delta phi]	
49.00Hz	40.00Hz ... 69.00Hz	P.2
	<i>Pickup value for underfrequency.</i>	

delta phi . Freq. drop-off	[Protection Para / Set 1...4 / Intercon-Prot / Mains Decouplg / delta phi]	
0.020Hz	0.010Hz ... 0.100Hz	P.2
	<i>Drop-off for the Frequency function. This setting modifies the shape of the hysteresis that is used for the frequency protection.</i>	

9 Protection Parameter

9.18 delta phi



delta phi . t	[Protection Para / Set 1...4 / Intercon-Prot / Mains Decouplg / delta phi]	
1.00s	0.00s ... 3600.00s	P.2
 <i>Tripping delay</i>		

delta phi . df/dt	[Protection Para / Set 1...4 / Intercon-Prot / Mains Decouplg / delta phi]	
1.000Hz/s	0.100Hz/s ... 10.000Hz/s	P.2
 <i>Measured value (calculated): Rate-of-frequency-change.</i>		

delta phi . t-df/dt	[Protection Para / Set 1...4 / Intercon-Prot / Mains Decouplg / delta phi]	
1.00s	0.00s ... 300.00s	P.2
 <i>Trip delay df/dt</i>		

delta phi . DF	[Protection Para / Set 1...4 / Intercon-Prot / Mains Decouplg / delta phi]	
1.00Hz	0.0Hz ... 10.0Hz	P.2
 <i>Frequency difference for the maximum admissible variation of the mean of the rate of frequency-change. This function is inactive if DF=0.</i>		

delta phi . DT	[Protection Para / Set 1...4 / Intercon-Prot / Mains Decouplg / delta phi]	
1.00s	0.1s ... 10.0s	P.2
 <i>Time interval of the maximum admissible rate-of-frequency-change.</i>		

delta phi . df/dt mode	[Protection Para / Set 1...4 / Intercon-Prot / Mains Decouplg / delta phi]	
absolute df/dt	absolute df/dt, positive df/dt, negative df/dt  Mode.	P.2
 <i>df/dt mode</i>		

delta phi . delta phi	[Protection Para / Set 1...4 / Intercon-Prot / Mains Decouplg / delta phi]	
10°	1° ... 30°	P.2
 <i>Measured value (calculated): Vector surge</i>		

9.18.4 delta phi: Input States

delta phi . ExBlo1-I	[Operation / Status Display / Intercon-Prot / Mains Decouplg / delta phi]
-----------------------------	---

↓ *Module input state: External blocking1*

delta phi . ExBlo2-I	[Operation / Status Display / Intercon-Prot / Mains Decouplg / delta phi]
-----------------------------	---

↓ *Module input state: External blocking2*

delta phi . ExBlo TripCmd-I	[Operation / Status Display / Intercon-Prot / Mains Decouplg / delta phi]
------------------------------------	---

↓ *Module input state: External Blocking of the Trip Command*

9.18.5 delta phi: Signals (Output States)

delta phi . active	[Operation / Status Display / All Actives]
	[Operation / Status Display / Intercon-Prot / Mains Decouplg / delta phi]

↑ *Signal: active*

delta phi . Alarm	[Operation / Status Display / Alarms]
	[Operation / Status Display / Intercon-Prot / Mains Decouplg / delta phi]





↑ *Signal: Alarm Frequency Protection (collective signal)*

delta phi . Trip	[Operation / Status Display / Trips]
	[Operation / Status Display / Intercon-Prot / Mains Decouplg / delta phi]

↑ *Signal: Trip Frequency Protection (collective signal)*

delta phi . TripCmd	[Operation / Status Display / TripCmds]
	[Operation / Status Display / Intercon-Prot / Mains Decouplg / delta phi]



↑ *Signal: Trip Command*

delta phi . ExBlo	[Operation / Status Display / Intercon-Prot / Mains Decouplg / delta phi]
 <i>Signal: External Blocking</i>	
delta phi . Blo by V<	[Operation / Status Display / Intercon-Prot / Mains Decouplg / delta phi]
 <i>Signal: Module is blocked by undervoltage.</i>	
delta phi . Blo TripCmd	[Operation / Status Display / Intercon-Prot / Mains Decouplg / delta phi]
 <i>Signal: Trip Command blocked</i>	
delta phi . ExBlo TripCmd	[Operation / Status Display / Intercon-Prot / Mains Decouplg / delta phi]
 <i>Signal: External Blocking of the Trip Command</i>	



9.19 Intertripping



Intertripping



9.19.1 Intertripping: Device Planning Parameters

Intertripping . Mode	[Device planning]	
"_"	"_" , use  Device planning.	S.3
	External Protection - Module, general operation mode	

9.19.2 Intertripping: Global Parameters

Intertripping . ExBlo1 Intertripping . ExBlo2	[Protection Para / Global Prot Para / Intercon-Prot / Mains Decouplg / Intertripping]	
"_"	"_" ... Sys . Internal test state  1..n, Assignment List.	P.2
	External blocking of the module, if blocking is activated (allowed) within a parameter set and if the state of the assigned signal is true.	

Intertripping . ExBlo TripCmd	[Protection Para / Global Prot Para / Intercon-Prot / Mains Decouplg / Intertripping]	
"_"	"_" ... Sys . Internal test state  1..n, Assignment List.	P.2
	External blocking of the Trip Command of the module/the stage, if blocking is activated (allowed) within a parameter set and if the state of the assigned signal is true.	

Intertripping . Alarm	[Protection Para / Global Prot Para / Intercon-Prot / Mains Decouplg / Intertripping]	
"_"	"_" ... Sys . Internal test state  1..n, Assignment List.	P.2
	Assignment for External Alarm	

Intertripping . Trip	[Protection Para / Global Prot Para / Intercon-Prot / Mains Decouplg / Intertripping]	
"_"	"_" ... Sys . Internal test state ↳ 1..n, Assignment List.	P.2
	<i>External trip of the CB if the state of the assigned signal is true.</i>	

9.19.3 Intertripping: Setting Group Parameters

Intertripping . Function	[Protection Para / Set 1...4 / Intercon-Prot / Mains Decouplg / Intertripping]	
inactive	inactive, active ↳ Mode.	P.2
	<i>Permanent activation or deactivation of module/stage.</i>	

Intertripping . ExBlo Fc	[Protection Para / Set 1...4 / Intercon-Prot / Mains Decouplg / Intertripping]	
inactive	inactive, active ↳ active/inactive.	P.2
	<i>Activate (allow) or inactivate (disallow) blocking of the module/stage. This parameter is only effective if a signal is assigned to the corresponding global protection parameter. If the signal becomes true, those modules/stages are blocked that are parameterized "ExBlo Fc=active".</i>	

Intertripping . Blo TripCmd	[Protection Para / Set 1...4 / Intercon-Prot / Mains Decouplg / Intertripping]	
inactive	inactive, active ↳ Mode.	P.2
	<i>Permanent blocking of the Trip Command of the module/stage.</i>	

Intertripping . ExBlo TripCmd Fc	[Protection Para / Set 1...4 / Intercon-Prot / Mains Decouplg / Intertripping]
inactive	inactive, active ↳ active/inactive.
	<i>Activate (allow) or inactivate (disallow) blocking of the module/stage. This parameter is only effective if a signal is assigned to the corresponding global protection parameter. If the signal becomes true, those modules/stages are blocked that are parameterized "ExBlo TripCmd Fc=active".</i>

9.19.4 Intertripping: Input States

Intertripping . ExBlo1-I	[Operation / Status Display / Intercon-Prot / Mains Decouplg / Intertripping]
	<i>Module input state: External blocking1</i>

Intertripping . ExBlo2-I	[Operation / Status Display / Intercon-Prot / Mains Decouplg / Intertripping]
	<i>Module input state: External blocking2</i>

Intertripping . ExBlo TripCmd-I	[Operation / Status Display / Intercon-Prot / Mains Decouplg / Intertripping]
	<i>Module input state: External Blocking of the Trip Command</i>

Intertripping . Alarm-I	[Operation / Status Display / Intercon-Prot / Mains Decouplg / Intertripping]
	<i>Module input state: Alarm</i>

Intertripping . Trip-I	[Operation / Status Display / Intercon-Prot / Mains Decouplg / Intertripping]
	<i>Module input state: Trip</i>

9.19.5 Intertripping: Signals (Output States)

Intertripping . active	[Operation / Status Display / All Actives] [Operation / Status Display / Intercon-Prot / Mains Decouplg / Intertripping]
	<i>Signal: active</i>

Intertripping . Alarm	[Operation / Status Display / Alarms] [Operation / Status Display / Intercon-Prot / Mains Decouplg / Intertripping]
⤴	<i>Signal: Alarm</i>

Intertripping . Trip	[Operation / Status Display / Trips] [Operation / Status Display / Intercon-Prot / Mains Decouplg / Intertripping]
⤴	<i>Signal: Trip</i>

Intertripping . TripCmd	[Operation / Status Display / TripCmds] [Operation / Status Display / Intercon-Prot / Mains Decouplg / Intertripping]
⤴	<i>Signal: Trip Command</i>

Intertripping . ExBlo	[Operation / Status Display / Intercon-Prot / Mains Decouplg / Intertripping]
⤴	<i>Signal: External Blocking</i>



Intertripping . Blo TripCmd	[Operation / Status Display / Intercon-Prot / Mains Decouplg / Intertripping]
⤴	<i>Signal: Trip Command blocked</i>

Intertripping . ExBlo TripCmd	[Operation / Status Display / Intercon-Prot / Mains Decouplg / Intertripping]
⤴	<i>Signal: External Blocking of the Trip Command</i>



9.20 P[1] ... P[3]



Reverse Active Power

9.20.1 P[1]: Device Planning Parameters



P[1] . Mode	[Device planning]	
"_"	"_", P>, Pr>  Mode.	S.3
	Power Protection - Module, general operation mode	

9.20.2 P[1]: Global Parameters

P[1] . ExBlo1 P[1] . ExBlo2	[Protection Para / Global Prot Para / Intercon-Prot / Mains Decouplg / P[1]]	
"_"	"_" ... Sys . Internal test state  1..n, Assignment List.	P.2
	External blocking of the module, if blocking is activated (allowed) within a parameter set and if the state of the assigned signal is true.	

P[1] . ExBlo TripCmd	[Protection Para / Global Prot Para / Intercon-Prot / Mains Decouplg / P[1]]	
"_"	"_" ... Sys . Internal test state  1..n, Assignment List.	P.2
	External blocking of the Trip Command of the module/the stage, if blocking is activated (allowed) within a parameter set and if the state of the assigned signal is true.	

9.20.3 P[1]: Setting Group Parameters

P[1] . Function	[Protection Para / Set 1...4 / Intercon-Prot / Mains Decouplg / P[1]]	
inactive	inactive, active  Mode.	P.2
	Permanent activation or deactivation of module/stage.	

P[1] . ExBlo Fc		[Protection Para / Set 1...4 / Intercon-Prot / Mains Decouplg / P[1]]
inactive	inactive, active	P.2
	↳ active/inactive.	
	<i>Activate (allow) or inactivate (disallow) blocking of the module/stage. This parameter is only effective if a signal is assigned to the corresponding global protection parameter. If the signal becomes true, those modules/stages are blocked that are parameterized "ExBlo Fc=active".</i>	

P[1] . Blo TripCmd		[Protection Para / Set 1...4 / Intercon-Prot / Mains Decouplg / P[1]]
inactive	inactive, active	P.2
	↳ Mode.	
	<i>Permanent blocking of the Trip Command of the module/stage.</i>	

P[1] . ExBlo TripCmd Fc		[Protection Para / Set 1...4 / Intercon-Prot / Mains Decouplg / P[1]]
inactive	inactive, active	P.2
	↳ active/inactive.	
	<i>Activate (allow) or inactivate (disallow) blocking of the module/stage. This parameter is only effective if a signal is assigned to the corresponding global protection parameter. If the signal becomes true, those modules/stages are blocked that are parameterized "ExBlo TripCmd Fc=active".</i>	

P[1] . MeasCircSv Volt		[Protection Para / Set 1...4 / Intercon-Prot / Mains Decouplg / P[1]]
Sys . inactive	Sys . inactive, LOP . active	P.2
	↳ VTS Block.	
	<i>Measuring Circuit Supervision Voltage</i>	

P[1] . MeasCircSv Curr		[Protection Para / Set 1...4 / Intercon-Prot / Mains Decouplg / P[1]]
Sys . inactive	Sys . inactive, CTS . active	P.2
	↳ VTS Block.	
	<i>Measuring Circuit Supervision Current</i>	



P[1] . P>	[Protection Para / Set 1...4 / Intercon-Prot / Mains Decouplg / P[1]]
1.20Sn	0.003Sn ... 10.000Sn P.2
	<i>Over(load) Active Power Pickup Value. Can be used for monitoring the maximum allowed forward power limits of transformers or overhead lines. Definition for Sn is as follows: $S_n = 1.7321 * VT \text{ rating} * CT \text{ rating}$. The voltage is the line-to-line voltage.</i>

P[1] . Pr>	[Protection Para / Set 1...4 / Intercon-Prot / Mains Decouplg / P[1]]
0.5Sn	0.003Sn ... 10.000Sn P.2
	<i>Overload Reverse Active Power Pickup Value. Protection against reverse feeding into the power supply network. Definition for Sn is as follows: $S_n = 1.7321 * VT \text{ rating} * CT \text{ rating}$. The voltage is the line-to-line voltage.</i>

P[1] . S>	[Protection Para / Set 1...4 / Intercon-Prot / Mains Decouplg / P[1]]
1.20Sn	0.02Sn ... 10.00Sn P.2
	<i>Over(load) Apparent Power Pickup Value Definition for Sn is as follows: $S_n = 1.7321 * VT \text{ rating} * CT \text{ rating}$. The voltage is the line-to-line voltage.</i>

P[1] . S<	[Protection Para / Set 1...4 / Intercon-Prot / Mains Decouplg / P[1]]
0.80Sn	0.02Sn ... 10.00Sn P.2
	<i>Under(load) Apparent Power Pickup Value Definition for Sn is as follows: $S_n = 1.7321 * VT \text{ rating} * CT \text{ rating}$. The voltage is the line-to-line voltage.</i>

P[1] . t	[Protection Para / Set 1...4 / Intercon-Prot / Mains Decouplg / P[1]]
0.01s	0.00s ... 1100.00s P.2
	<i>Tripping delay</i>

P[1] . PowMeasMethod	[Protection Para / Set 1...4 / Intercon-Prot / Mains Decouplg / P[1]]
True RMS	Fundamental, True RMS P.2  PowMeasMethod.
	<i>Determines if the active power, reactive power and apparent power are calculated on the basis of RMS or DFT.</i>

9.20.4 P[1]: Input States

P[1] . ExBlo1-I	[Operation / Status Display / Intercon-Prot / Mains Decouplg / P[1]]
P[1] . ExBlo2-I	
↓	<i>Module input state: External blocking</i>

P[1] . ExBlo TripCmd-I	[Operation / Status Display / Intercon-Prot / Mains Decouplg / P[1]]
↓	<i>Module input state: External Blocking of the Trip Command</i>

9.20.5 P[1]: Signals (Output States)

P[1] . active	[Operation / Status Display / All Actives]
	[Operation / Status Display / Intercon-Prot / Mains Decouplg / P[1]]
↑	<i>Signal: active</i>

P[1] . Alarm	[Operation / Status Display / Alarms]
	[Operation / Status Display / Intercon-Prot / Mains Decouplg / P[1]]
↑	<i>Signal: Alarm Power Protection</i>

P[1] . Trip	[Operation / Status Display / Trips]
	[Operation / Status Display / Intercon-Prot / Mains Decouplg / P[1]]
↑	<i>Signal: Trip Power Protection</i>

P[1] . TripCmd	[Operation / Status Display / TripCmds]
	[Operation / Status Display / Intercon-Prot / Mains Decouplg / P[1]]
↑	<i>Signal: Trip Command</i>



P[1] . ExBlo	[Operation / Status Display / Intercon-Prot / Mains Decouplg / P[1]]
↑	<i>Signal: External Blocking</i>

P[1] . Blo TripCmd	[Operation / Status Display / Intercon-Prot / Mains Decouplg / P[1]]
⬆	<i>Signal: Trip Command blocked</i>
P[1] . ExBlo TripCmd	[Operation / Status Display / Intercon-Prot / Mains Decouplg / P[1]]
⬆	<i>Signal: External Blocking of the Trip Command</i>



9.21 Q



Q

9.21.1 Q: Device Planning Parameters



Q . Mode	[Device planning]	
"_"	"_", Q>, Qr>  Mode.	S.3
	<i>Power Protection - Module, general operation mode</i>	



9.21.2 Q: Global Parameters



Q . ExBlo1 Q . ExBlo2	[Protection Para / Global Prot Para / Intercon-Prot / Mains Decouplg / Q]	
"_"	"_" ... Sys . Internal test state  1..n, Assignment List.	P.2
	<i>External blocking of the module, if blocking is activated (allowed) within a parameter set and if the state of the assigned signal is true.</i>	



Q . ExBlo TripCmd	[Protection Para / Global Prot Para / Intercon-Prot / Mains Decouplg / Q]	
"_"	"_" ... Sys . Internal test state  1..n, Assignment List.	P.2
	<i>External blocking of the Trip Command of the module/the stage, if blocking is activated (allowed) within a parameter set and if the state of the assigned signal is true.</i>	



9.21.3 Q: Setting Group Parameters



Q . Function	[Protection Para / Set 1...4 / Intercon-Prot / Mains Decouplg / Q]	
inactive	inactive, active  Mode.	P.2
	<i>Permanent activation or deactivation of module/stage.</i>	

Q . ExBlo Fc	[Protection Para / Set 1...4 / Intercon-Prot / Mains Decouplg / Q]	
inactive	inactive, active  active/inactive.	P.2
	<i>Activate (allow) or inactivate (disallow) blocking of the module/stage. This parameter is only effective if a signal is assigned to the corresponding global protection parameter. If the signal becomes true, those modules/stages are blocked that are parameterized "ExBlo Fc=active".</i>	

Q . Blo TripCmd	[Protection Para / Set 1...4 / Intercon-Prot / Mains Decouplg / Q]	
inactive	inactive, active  Mode.	P.2
	<i>Permanent blocking of the Trip Command of the module/stage.</i>	

Q . ExBlo TripCmd Fc	[Protection Para / Set 1...4 / Intercon-Prot / Mains Decouplg / Q]	
inactive	inactive, active  active/inactive.	P.2
	<i>Activate (allow) or inactivate (disallow) blocking of the module/stage. This parameter is only effective if a signal is assigned to the corresponding global protection parameter. If the signal becomes true, those modules/stages are blocked that are parameterized "ExBlo TripCmd Fc=active".</i>	

Q . MeasCircSv Volt	[Protection Para / Set 1...4 / Intercon-Prot / Mains Decouplg / Q]	
Sys . inactive	Sys . inactive, LOP . active  VTS Block.	P.2
	<i>Measuring Circuit Supervision Voltage</i>	

Q . MeasCircSv Curr	[Protection Para / Set 1...4 / Intercon-Prot / Mains Decouplg / Q]	
Sys . inactive	Sys . inactive, CTS . active  VTS Block.	P.2
	<i>Measuring Circuit Supervision Current</i>	

Q . Q>	[Protection Para / Set 1...4 / Intercon-Prot / Mains Decouplg / Q]
1.20Sn	0.003Sn ... 10.000Sn P.2
	<i>Over(load) Reactive Power Pickup Value. Monitoring the maximum allowed reactive power of the electrical equipment like transformers or overhead lines). If the maximum value is exceeded a condensator bank could be switched off. Definition for Sn is as follows: $S_n = 1.7321 * VT \text{ rating} * CT \text{ rating}$. The voltage is the line-to-line voltage.</i>

Q . Qr>	[Protection Para / Set 1...4 / Intercon-Prot / Mains Decouplg / Q]
0.5Sn	0.003Sn ... 10.000Sn P.2
	<i>Overload Reverse Reactive Power Pickup Value Definition for Sn is as follows: $S_n = 1.7321 * VT \text{ rating} * CT \text{ rating}$. The voltage is the line-to-line voltage.</i>

Q . S>	[Protection Para / Set 1...4 / Intercon-Prot / Mains Decouplg / Q]
1.20Sn	0.02Sn ... 10.00Sn P.2
	<i>Over(load) Apparent Power Pickup Value Definition for Sn is as follows: $S_n = 1.7321 * VT \text{ rating} * CT \text{ rating}$. The voltage is the line-to-line voltage.</i>

Q . S<	[Protection Para / Set 1...4 / Intercon-Prot / Mains Decouplg / Q]
0.80Sn	0.02Sn ... 10.00Sn P.2
	<i>Under(load) Apparent Power Pickup Value Definition for Sn is as follows: $S_n = 1.7321 * VT \text{ rating} * CT \text{ rating}$. The voltage is the line-to-line voltage.</i>

Q . t	[Protection Para / Set 1...4 / Intercon-Prot / Mains Decouplg / Q]
0.01s	0.00s ... 1100.00s P.2
	<i>Tripping delay</i>

9.21.4 Q: Input States

Q . ExBlo1-I	[Operation / Status Display / Intercon-Prot / Mains Decouplg / Q]
Q . ExBlo2-I	
	<i>Module input state: External blocking</i>

Q . ExBlo TripCmd-I	[Operation / Status Display / Intercon-Prot / Mains Decouplg / Q]
 <i>Module input state: External Blocking of the Trip Command</i>	

9.21.5 Q: Signals (Output States)

Q . active	[Operation / Status Display / All Actives] [Operation / Status Display / Intercon-Prot / Mains Decouplg / Q]
 <i>Signal: active</i>	

Q . Alarm	[Operation / Status Display / Alarms] [Operation / Status Display / Intercon-Prot / Mains Decouplg / Q]
 <i>Signal: Alarm Power Protection</i>	

Q . Trip	[Operation / Status Display / Trips] [Operation / Status Display / Intercon-Prot / Mains Decouplg / Q]
 <i>Signal: Trip Power Protection</i>	

Q . TripCmd	[Operation / Status Display / TripCmds] [Operation / Status Display / Intercon-Prot / Mains Decouplg / Q]
 <i>Signal: Trip Command</i>	

Q . ExBlo	[Operation / Status Display / Intercon-Prot / Mains Decouplg / Q]
 <i>Signal: External Blocking</i>	

Q . Blo TripCmd	[Operation / Status Display / Intercon-Prot / Mains Decouplg / Q]
 <i>Signal: Trip Command blocked</i>	

Q . ExBlo TripCmd

[Operation / Status Display / Intercon-Prot / Mains Decouplg / Q]

 *Signal: External Blocking of the Trip Command*

9.22 LVRT[1] ... LVRT[2]

Low Voltage Ride Through

9.22.1 LVRT[1]: Device Planning Parameters

LVRT[1] . Mode	[Device planning]	
"_"	"_", use ↳ Device planning.	S.3
 <i>general operation mode</i>		

9.22.2 LVRT[1]: Global Parameters

LVRT[1] . ExBlo1	[Protection Para / Global Prot Para / Intercon-Prot / LVRT[1]]	
LVRT[1] . ExBlo2		
"_"	"_" ... Sys . Internal test state ↳ 1..n, Assignment List.	P.2
 <i>External blocking of the module, if blocking is activated (allowed) within a parameter set and if the state of the assigned signal is true.</i>		

LVRT[1] . ExBlo TripCmd	[Protection Para / Global Prot Para / Intercon-Prot / LVRT[1]]	
"_"	"_" ... Sys . Internal test state ↳ 1..n, Assignment List.	P.2
 <i>External blocking of the Trip Command of the module/the stage, if blocking is activated (allowed) within a parameter set and if the state of the assigned signal is true.</i>		

9.22.3 LVRT[1]: Setting Group Parameters

LVRT[1] . Function	[Protection Para / Set 1...4 / Intercon-Prot / LVRT[1] / General Settings]	
inactive	inactive, active ↳ Mode.	P.2
 <i>Permanent activation or deactivation of module/stage.</i>		





LVRT[1] . ExBlo Fc		[Protection Para / Set 1...4 / Intercon-Prot / LVRT[1] / General Settings]
inactive	inactive, active	P.2
	↳ active/inactive.	
	<i>Activate (allow) or inactivate (disallow) blocking of the module/stage. This parameter is only effective if a signal is assigned to the corresponding global protection parameter. If the signal becomes true, those modules/stages are blocked that are parameterized "ExBlo Fc=active".</i>	

LVRT[1] . Blo TripCmd		[Protection Para / Set 1...4 / Intercon-Prot / LVRT[1] / General Settings]
inactive	inactive, active	P.2
	↳ Mode.	
	<i>Permanent blocking of the Trip Command of the module/stage.</i>	

LVRT[1] . ExBlo TripCmd Fc		[Protection Para / Set 1...4 / Intercon-Prot / LVRT[1] / General Settings]
inactive	inactive, active	P.2
	↳ active/inactive.	
	<i>Activate (allow) or inactivate (disallow) blocking of the module/stage. This parameter is only effective if a signal is assigned to the corresponding global protection parameter. If the signal becomes true, those modules/stages are blocked that are parameterized "ExBlo TripCmd Fc=active".</i>	

LVRT[1] . Measuring Mode		[Protection Para / Set 1...4 / Intercon-Prot / LVRT[1] / General Settings]
Phase to Ground	Phase to Ground, Phase to Phase	P.2
	↳ Measuring Mode.	
	<i>Measuring/Supervision Mode: Determines if the phase-to-phase or phase-to-earth voltages are to be supervised</i>	

LVRT[1] . Measuring method		[Protection Para / Set 1...4 / Intercon-Prot / LVRT[1] / General Settings]
Fundamental	Fundamental, True RMS	P.2
	↳ Measuring method.	
	<i>Measuring method: fundamental or rms or 3rd harmonic (only generator protection relays)</i>	

LVRT[1] . Alarm Mode		[Protection Para / Set 1...4 / Intercon-Prot / LVRT[1] / General Settings]	
any one	any one, any two, all, only 2		P.2
	↳ Alarm Mode.		
	<i>Alarm criterion for the voltage protection stage.</i>		
LVRT[1] . Meas Circuit Superv		[Protection Para / Set 1...4 / Intercon-Prot / LVRT[1] / General Settings]	
Sys . inactive	Sys . inactive, LOP . active		P.2
	↳ VTS Block.		
	<i>Activates the use of the measuring circuit supervision. In this case the module will be blocked if a measuring circuit supervision module (e.g. LOP, VTS) signals a disturbed measuring circuit (e.g. caused by a fuse failure).</i>		
LVRT[1] . AR controlled LVRT		[Protection Para / Set 1...4 / Intercon-Prot / LVRT[1] / General Settings]	
inactive	inactive, active		P.2
	↳ active/inactive.		
	<i>Activates the supervision of the number of voltage dips during a defined time (t-LVRT).</i>		
LVRT[1] . Number of V dips to trip		[Protection Para / Set 1...4 / Intercon-Prot / LVRT[1] / General Settings]	
1	1 ... 6		P.2
<i>Only available if:</i> <ul style="list-style-type: none"> • LVRT[1] . AR controlled LVRT = active 			
	<i>Number of voltage dips until the disconnection signal (trip) will be issued.</i>		

LVRT[1] . t-LVRT	[Protection Para / Set 1...4 / Intercon-Prot / LVRT[1] / General Settings]	
30.00s	0.00s ... 3000.00s	P.2
<i>Only available if:</i> <ul style="list-style-type: none"> • LVRT[1] . AR controlled LVRT = active 		
	<i>This timer defines the supervision interval (window/period) for counting the number of voltage dips to trip ("No of V dips to trip"). The first voltage dip will start the timer. The counted number of voltage dips will be reset if the timer is expired. The timer will also be reset if the maximum "No of V dips to trip" is reached.</i>	

LVRT[1] . Vstart<	[Protection Para / Set 1...4 / Intercon-Prot / LVRT[1] / LVRT Profile]	
0.90Vn	0.00Vn ... 2.00Vn	P.2
	<i>A voltage dip is detected if the measured voltage falls below this threshold.</i>	

LVRT[1] . Vrecover>	[Protection Para / Set 1...4 / Intercon-Prot / LVRT[1] / LVRT Profile]	
0.93Vn	0.10Vn ... 2.00Vn	P.2
	<i>The voltage is recovered if the measured voltage raises above this threshold.</i>	

LVRT[1] . V(t1) LVRT[1] . V(t2)	[Protection Para / Set 1...4 / Intercon-Prot / LVRT[1] / LVRT Profile]	
0.00Vn	0.00Vn ... 2.00Vn	P.2
	<i>Voltage value of a point V(t(n)). These points define the LVRT profile.</i>	

LVRT[1] . t1	[Protection Para / Set 1...4 / Intercon-Prot / LVRT[1] / LVRT Profile]	
0.00s	0.00s ... 20.00s	P.2
	<i>Point in time for the corresponding voltage value V(t(n)). These points define the LVRT profile.</i>	

LVRT[1] . t2 LVRT[1] . t3	[Protection Para / Set 1...4 / Intercon-Prot / LVRT[1] / LVRT Profile]	
0.15s	0.00s ... 20.00s	P.2
	<i>Point in time for the corresponding voltage value V(t(n)). These points define the LVRT profile.</i>	

LVRT[1] . V(t3)	[Protection Para / Set 1...4 / Intercon-Prot / LVRT[1] / LVRT Profile]	
LVRT[1] . V(t4)		
0.70Vn	0.00Vn ... 2.00Vn	P.2
 Voltage value of a point $V(t(n))$. These points define the LVRT profile.		

LVRT[1] . t4	[Protection Para / Set 1...4 / Intercon-Prot / LVRT[1] / LVRT Profile]	
0.70s	0.00s ... 20.00s	P.2
 Point in time for the corresponding voltage value $V(t(n))$. These points define the LVRT profile.		

LVRT[1] . V(t5)	[Protection Para / Set 1...4 / Intercon-Prot / LVRT[1] / LVRT Profile]	
...		
LVRT[1] . V(t10)		
0.90Vn	0.00Vn ... 2.00Vn	P.2
 Voltage value of a point $V(t(n))$. These points define the LVRT profile.		

LVRT[1] . t5	[Protection Para / Set 1...4 / Intercon-Prot / LVRT[1] / LVRT Profile]	
1.50s	0.00s ... 20.00s	P.2
 Point in time for the corresponding voltage value $V(t(n))$. These points define the LVRT profile.		

LVRT[1] . t6	[Protection Para / Set 1...4 / Intercon-Prot / LVRT[1] / LVRT Profile]	
...		
LVRT[1] . t10		
3.00s	0.00s ... 20.00s	P.2
 Point in time for the corresponding voltage value $V(t(n))$. These points define the LVRT profile.		

9.22.4 LVRT[1]: Direct Controls

LVRT[1] . Res LVRT Cr	[Operation / Reset]	
inactive	inactive, active  Mode.	P.1
<p>● <i>Reset of the counter for the total number of voltage dips and reset of the counter of the total number of voltage dips that caused a trip.</i></p>		

9.22.5 LVRT[1]: Input States

LVRT[1] . ExBlo1-I	[Operation / Status Display / Intercon-Prot / LVRT[1]]
 Module input state: External blocking1	

LVRT[1] . ExBlo2-I	[Operation / Status Display / Intercon-Prot / LVRT[1]]
 Module input state: External blocking2	

LVRT[1] . ExBlo TripCmd-I	[Operation / Status Display / Intercon-Prot / LVRT[1]]
 Module input state: External Blocking of the Trip Command	

9.22.6 LVRT[1]: Signals (Output States)

LVRT[1] . active	[Operation / Status Display / All Actives] [Operation / Status Display / Intercon-Prot / LVRT[1]]
 Signal: active	

LVRT[1] . Alarm	[Operation / Status Display / Alarms] [Operation / Status Display / Intercon-Prot / LVRT[1]]
 Signal: Alarm voltage stage	

LVRT[1] . Trip	[Operation / Status Display / Trips] [Operation / Status Display / Intercon-Prot / LVRT[1]]
 Signal: Trip	

LVRT[1] . TripCmd	[Operation / Status Display / TripCmds] [Operation / Status Display / Intercon-Prot / LVRT[1]]
⤴	<i>Signal: Trip Command</i>
LVRT[1] . ExBlo	[Operation / Status Display / Intercon-Prot / LVRT[1]]
⤴	<i>Signal: External Blocking</i>
LVRT[1] . Blo TripCmd	[Operation / Status Display / Intercon-Prot / LVRT[1]]
⤴	<i>Signal: Trip Command blocked</i>
LVRT[1] . ExBlo TripCmd	[Operation / Status Display / Intercon-Prot / LVRT[1]]
⤴	<i>Signal: External Blocking of the Trip Command</i>
LVRT[1] . Alarm L1	[Operation / Status Display / Intercon-Prot / LVRT[1]]
⤴	<i>Signal: Alarm L1</i>
LVRT[1] . Alarm L2	[Operation / Status Display / Intercon-Prot / LVRT[1]]
⤴	<i>Signal: Alarm L2</i>
LVRT[1] . Alarm L3	[Operation / Status Display / Intercon-Prot / LVRT[1]]
⤴	<i>Signal: Alarm L3</i>
LVRT[1] . Trip L1	[Operation / Status Display / Intercon-Prot / LVRT[1]]
⤴	<i>Signal: General Trip Phase L1</i>
LVRT[1] . Trip L2	[Operation / Status Display / Intercon-Prot / LVRT[1]]
⤴	<i>Signal: General Trip Phase L2</i>
LVRT[1] . Trip L3	[Operation / Status Display / Intercon-Prot / LVRT[1]]
⤴	<i>Signal: General Trip Phase L3</i>
LVRT[1] . t-LVRT is running	[Operation / Status Display / Intercon-Prot / LVRT[1]]
⤴	<i>Signal: t-LVRT is running</i>

9.22.7 LVRT[1]: Counters

LVRT[1] . NumOf Vdips in t-LVRT	[Operation / Count and RevData / LVRT[1]]
#	<i>Number of Voltage dips during t-LVRT</i>
LVRT[1] . Cr Tot Numb of Vdips	[Operation / Count and RevData / LVRT[1]]
#	<i>Counter Total number of voltage dips.</i>
LVRT[1] . Cr Tot Numb of Vdips to Trip	[Operation / Count and RevData / LVRT[1]]
#	<i>Counter Total number of voltage dips that caused a Trip.</i>

9.23 VG[1] ... VG[2]

Residual voltage-Stage

9.23.1 VG[1]: Device Planning Parameters

VG[1] . Mode	[Device planning]	
"_"	"_", V>, V< ↳ Device planning.	S.3
	Residual voltage-Stage, general operation mode	



VG[1] . Superv. only	[Device planning]	
no	no, yes ↳ yes/no.	S.3
	Residual voltage-Stage, if set to "Yes": Restriction of the function to a supervision functionality, i.e. there is no general alarm, no general trip and no trip command.	



9.23.2 VG[1]: Global Parameters



VG[1] . ExBlo1	[Protection Para / Global Prot Para / V-Prot / VG[1]]	
VG[1] . ExBlo2		
"_"	"_" ... Sys . Internal test state ↳ 1..n, Assignment List.	P.2
	External blocking of the module, if blocking is activated (allowed) within a parameter set and if the state of the assigned signal is true.	



VG[1] . ExBlo TripCmd	[Protection Para / Global Prot Para / V-Prot / VG[1]]	
"_"	"_" ... Sys . Internal test state ↳ 1..n, Assignment List.	P.2
Only available if:		
• VG[1] . Superv. only = no		
	External blocking of the Trip Command of the module/the stage, if blocking is activated (allowed) within a parameter set and if the state of the assigned signal is true.	



9.23.3 VG[1]: Setting Group Parameters



VG[1] . Function	[Protection Para / Set 1...4 / V-Prot / VG[1]]	
inactive	inactive, active  Mode.	P.2
 Permanent activation or deactivation of module/stage.		

VG[1] . ExBlo Fc	[Protection Para / Set 1...4 / V-Prot / VG[1]]	
inactive	inactive, active  active/inactive.	P.2
 Activate (allow) or inactivate (disallow) blocking of the module/stage. This parameter is only effective if a signal is assigned to the corresponding global protection parameter. If the signal becomes true, those modules/stages are blocked that are parameterized "ExBlo Fc=active".		

VG[1] . Blo TripCmd	[Protection Para / Set 1...4 / V-Prot / VG[1]]	
inactive	inactive, active  Mode.	P.2
Only available if:		
<ul style="list-style-type: none"> • VG[1] . Superv. only = no 		
 Permanent blocking of the Trip Command of the module/stage.		

VG[1] . ExBlo TripCmd Fc	[Protection Para / Set 1...4 / V-Prot / VG[1]]	
inactive	inactive, active  active/inactive.	P.2
Only available if:		
<ul style="list-style-type: none"> • VG[1] . Superv. only = no 		
 Activate (allow) or inactivate (disallow) blocking of the module/stage. This parameter is only effective if a signal is assigned to the corresponding global protection parameter. If the signal becomes true, those modules/stages are blocked that are parameterized "ExBlo TripCmd Fc=active".		



VG[1] . VX Source	[Protection Para / Set 1...4 / V-Prot / VG[1]]	
measured	measured, calculated  VX Source.	P.2
 Selection if VG is measured or calculated (neutral voltage or residual voltage)		

VG[1] . Measuring method	[Protection Para / Set 1...4 / V-Prot / VG[1]]	
Fundamental	Fundamental, True RMS, VX meas H3  Measuring method.	P.2
	<i>Measuring method: fundamental or rms or 3rd harmonic (only generator protection relays)</i>	

VG[1] . VG>	[Protection Para / Set 1...4 / V-Prot / VG[1]]	
1Vn	0.01Vn ... 2.00Vn	P.2
	<i>If the pickup value is exceeded, the module/stage will be started.</i>	

VG[1] . VG<	[Protection Para / Set 1...4 / V-Prot / VG[1]]	
0.8Vn	0.01Vn ... 2.00Vn	P.2
	<i>Undervoltage Threshold</i>	

VG[1] . t	[Protection Para / Set 1...4 / V-Prot / VG[1]]	
0.00s	0.00s ... 300.00s	P.2
	<i>Tripping delay</i>	

VG[1] . Meas Circuit Superv	[Protection Para / Set 1...4 / V-Prot / VG[1]]	
Sys . inactive	Sys . inactive, LOP . active  VTS Block.	P.2
	<i>Activates the use of the measuring circuit supervision. In this case the module will be blocked if a measuring circuit supervision module (e.g. LOP, VTS) signals a disturbed measuring circuit (e.g. caused by a fuse failure).</i>	

9.23.4 VG[1]: Input States

VG[1] . ExBlo1-I	[Operation / Status Display / V-Prot / VG[1]]	
	<i>Module input state: External blocking1</i>	

VG[1] . ExBlo2-I	[Operation / Status Display / V-Prot / VG[1]]	
	<i>Module input state: External blocking2</i>	

VG[1] . ExBlo TripCmd-I	[Operation / Status Display / V-Prot / VG[1]]
<p>↓ Only available if:</p> <ul style="list-style-type: none"> • VG[1] . Superv. only = no <p>Module input state: External Blocking of the Trip Command</p>	

9.23.5 VG[1]: Signals (Output States)

VG[1] . active	[Operation / Status Display / All Actives] [Operation / Status Display / V-Prot / VG[1]]
<p>↓ Signal: active</p>	

VG[1] . Alarm	[Operation / Status Display / Alarms] [Operation / Status Display / V-Prot / VG[1]]
<p>↓ Signal: Alarm Residual Voltage Supervision-stage</p>	

VG[1] . Trip	[Operation / Status Display / Trips] [Operation / Status Display / V-Prot / VG[1]]
<p>↓ Signal: Trip</p>	

VG[1] . TripCmd	[Operation / Status Display / TripCmds] [Operation / Status Display / V-Prot / VG[1]]
<p>↓ Only available if:</p> <ul style="list-style-type: none"> • VG[1] . Superv. only = no <p>Signal: Trip Command</p>	

VG[1] . ExBlo	[Operation / Status Display / V-Prot / VG[1]]
<p>↓ Signal: External Blocking</p>	

VG[1] . Blo TripCmd	[Operation / Status Display / V-Prot / VG[1]]
<p>↓ Only available if:</p> <ul style="list-style-type: none"> • VG[1] . Superv. only = no <p>Signal: Trip Command blocked</p>	

VG[1] . **ExBlo TripCmd**

[Operation / Status Display / V-Prot / VG[1]]

⇅ *Only available if:*

- VG[1] . Superv. only = no

Signal: External Blocking of the Trip Command

9.24 V012[1] ... V012[6]

Symmetrical Components: Supervision of the Positive Phase Sequence or Negative Phase Sequence

9.24.1 V012[1]: Device Planning Parameters

V012[1] . Mode	[Device planning]	
"_"	"_", V1>, V1<, V2> ↳ Device planning.	S.3
	<i>Unbalance Protection: Supervision of the Voltage System</i>	

9.24.2 V012[1]: Global Parameters

V012[1] . ExBlo1	[Protection Para / Global Prot Para / V-Prot / V012[1]]	
"_"	"_" ... Sys . Internal test state ↳ 1..n, Assignment List.	P.2
	<i>External blocking of the module, if blocking is activated (allowed) within a parameter set and if the state of the assigned signal is true.1</i>	

V012[1] . ExBlo2	[Protection Para / Global Prot Para / V-Prot / V012[1]]	
"_"	"_" ... Sys . Internal test state ↳ 1..n, Assignment List.	P.2
	<i>External blocking of the module, if blocking is activated (allowed) within a parameter set and if the state of the assigned signal is true.2</i>	

V012[1] . ExBlo TripCmd	[Protection Para / Global Prot Para / V-Prot / V012[1]]	
"_"	"_" ... Sys . Internal test state ↳ 1..n, Assignment List.	P.2
	<i>External blocking of the Trip Command of the module/the stage, if blocking is activated (allowed) within a parameter set and if the state of the assigned signal is true.</i>	

9.24.3 V012[1]: Setting Group Parameters

V012[1] . Function		[Protection Para / Set 1...4 / V-Prot / V012[1]]
inactive	inactive, active	P.2
	↳ Mode.	
 Permanent activation or deactivation of module/stage.		

V012[1] . ExBlo Fc		[Protection Para / Set 1...4 / V-Prot / V012[1]]
inactive	inactive, active	P.2
	↳ active/inactive.	
 Activate (allow) or inactivate (disallow) blocking of the module/stage. This parameter is only effective if a signal is assigned to the corresponding global protection parameter. If the signal becomes true, those modules/stages are blocked that are parameterized "ExBlo Fc=active".		



V012[1] . Blo TripCmd		[Protection Para / Set 1...4 / V-Prot / V012[1]]
inactive	inactive, active	P.2
	↳ Mode.	
 Permanent blocking of the Trip Command of the module/stage.		

V012[1] . ExBlo TripCmd Fc		[Protection Para / Set 1...4 / V-Prot / V012[1]]
inactive	inactive, active	P.2
	↳ active/inactive.	
 Activate (allow) or inactivate (disallow) blocking of the module/stage. This parameter is only effective if a signal is assigned to the corresponding global protection parameter. If the signal becomes true, those modules/stages are blocked that are parameterized "ExBlo TripCmd Fc=active".		

V012[1] . V1>		[Protection Para / Set 1...4 / V-Prot / V012[1]]
1.00Vn	0.01Vn ... 2.00Vn	P.2
 Positive Phase Sequence Overvoltage		



V012[1] . V1<		[Protection Para / Set 1...4 / V-Prot / V012[1]]
1.00Vn	0.01Vn ... 2.00Vn	P.2
 Positive Phase Sequence Undervoltage		

V012[1] . V2>	[Protection Para / Set 1...4 / V-Prot / V012[1]]	
1.00Vn	0.01Vn ... 2.00Vn	P.2
	<i>Negative Phase Sequence Overvoltage</i>	

V012[1] . %(V2/V1)	[Protection Para / Set 1...4 / V-Prot / V012[1]]	
inactive	inactive, active  Mode.	P.2
	<i>The %(V2/V1) setting is the unbalance trip pickup setting. It is defined by the ratio of negative sequence voltage to positive sequence voltage (% Unbalance=V2/V1). Phase sequence will be taken into account automatically.</i>	

V012[1] . %(V2/V1)	[Protection Para / Set 1...4 / V-Prot / V012[1]]	
20%	2% ... 40%	P.2
	<i>The %(V2/V1) setting is the unbalance trip pickup setting. It is defined by the ratio of negative sequence voltage to positive sequence voltage (% Unbalance=V2/V1). Phase sequence will be taken into account automatically.</i>	

V012[1] . t	[Protection Para / Set 1...4 / V-Prot / V012[1]]	
0.00s	0.00s ... 300.00s	P.2
	<i>Tripping delay</i>	

V012[1] . Meas Circuit Superv	[Protection Para / Set 1...4 / V-Prot / V012[1]]	
Sys . inactive	Sys . inactive, LOP . active  VTS Block.	P.2
	<i>Activates the use of the measuring circuit supervision. In this case the module will be blocked if a measuring circuit supervision module (e.g. LOP, VTS) signals a disturbed measuring circuit (e.g. caused by a fuse failure).</i>	

9.24.4 V012[1]: Input States

V012[1] . ExBlo1-I	[Operation / Status Display / V-Prot / V012[1]]	
	<i>Module input state: External blocking1</i>	

V012[1] . ExBlo2-I	[Operation / Status Display / V-Prot / V012[1]]	
	<i>Module input state: External blocking2</i>	

V012[1] . ExBlo TripCmd-I	[Operation / Status Display / V-Prot / V012[1]]
⬇	<i>Module input state: External Blocking of the Trip Command</i>

9.24.5 V012[1]: Signals (Output States)

V012[1] . active	[Operation / Status Display / All Actives] [Operation / Status Display / V-Prot / V012[1]]
⬇	<i>Signal: active</i>

V012[1] . Alarm	[Operation / Status Display / Alarms] [Operation / Status Display / V-Prot / V012[1]]
⬇	<i>Signal: Alarm voltage asymmetry</i>

V012[1] . Trip	[Operation / Status Display / Trips] [Operation / Status Display / V-Prot / V012[1]]
⬇	<i>Signal: Trip</i>

V012[1] . TripCmd	[Operation / Status Display / TripCmds] [Operation / Status Display / V-Prot / V012[1]]
⬇	<i>Signal: Trip Command</i>

V012[1] . ExBlo	[Operation / Status Display / V-Prot / V012[1]]
⬇	<i>Signal: External Blocking</i>

V012[1] . Blo TripCmd	[Operation / Status Display / V-Prot / V012[1]]
⬇	<i>Signal: Trip Command blocked</i>

V012[1] . ExBlo TripCmd	[Operation / Status Display / V-Prot / V012[1]]
⬇	<i>Signal: External Blocking of the Trip Command</i>

9.25 f[1] ... f[6]

Frequency Protection Module

9.25.1 f[1]: Device Planning Parameters

f[1] . Mode	[Device planning]	
f<	"-" ... delta phi ↳ Device planning.	S.3
	Frequency Protection Module, general operation mode	



9.25.2 f[1]: Global Parameters



f[1] . ExBlo1	[Protection Para / Global Prot Para / f-Prot / f[1]]	
f[1] . ExBlo2		
"_"	"_" ... Sys . Internal test state ↳ 1..n, Assignment List.	P.2
	External blocking of the module, if blocking is activated (allowed) within a parameter set and if the state of the assigned signal is true.	



f[1] . ExBlo TripCmd	[Protection Para / Global Prot Para / f-Prot / f[1]]	
"_"	"_" ... Sys . Internal test state ↳ 1..n, Assignment List.	P.2
	External blocking of the Trip Command of the module/the stage, if blocking is activated (allowed) within a parameter set and if the state of the assigned signal is true.	

9.25.3 f[1]: Setting Group Parameters

f[1] . Function	[Protection Para / Set 1...4 / f-Prot / f[1]]	
active	inactive, active ↳ Mode.	P.2
	Permanent activation or deactivation of module/stage.	

f[1] . ExBlo Fc	[Protection Para / Set 1...4 / f-Prot / f[1]]	
inactive	inactive, active  active/inactive.	P.2
	<i>Activate (allow) or inactivate (disallow) blocking of the module/stage. This parameter is only effective if a signal is assigned to the corresponding global protection parameter. If the signal becomes true, those modules/stages are blocked that are parameterized "ExBlo Fc=active".</i>	

f[1] . Blo TripCmd	[Protection Para / Set 1...4 / f-Prot / f[1]]	
inactive	inactive, active  Mode.	P.2
	<i>Permanent blocking of the Trip Command of the module/stage.</i>	

f[1] . ExBlo TripCmd Fc	[Protection Para / Set 1...4 / f-Prot / f[1]]	
inactive	inactive, active  active/inactive.	P.2
	<i>Activate (allow) or inactivate (disallow) blocking of the module/stage. This parameter is only effective if a signal is assigned to the corresponding global protection parameter. If the signal becomes true, those modules/stages are blocked that are parameterized "ExBlo TripCmd Fc=active".</i>	

f[1] . f>	[Protection Para / Set 1...4 / f-Prot / f[1]]	
51.00Hz	40.00Hz ... 69.00Hz	P.2
	<i>Pickup value for overfrequency.</i>	

f[1] . f<	[Protection Para / Set 1...4 / f-Prot / f[1]]	
49.00Hz	40.00Hz ... 69.00Hz	P.2
	<i>Pickup value for underfrequency.</i>	

f[1] . Freq. drop-off	[Protection Para / Set 1...4 / f-Prot / f[1]]	
0.020Hz	0.010Hz ... 0.100Hz	P.2
	<i>Drop-off for the Frequency function. This setting modifies the shape of the hysteresis that is used for the frequency protection.</i>	



f[1] . t	[Protection Para / Set 1...4 / f-Prot / f[1]]	
1.00s	0.00s ... 3600.00s	P.2
	<i>Tripping delay</i>	

f[1] . df/dt	[Protection Para / Set 1...4 / f-Prot / f[1]]	
1.000Hz/s	0.100Hz/s ... 10.000Hz/s	P.2
	<i>Measured value (calculated): Rate-of-frequency-change.</i>	

f[1] . t-df/dt	[Protection Para / Set 1...4 / f-Prot / f[1]]	
1.00s	0.00s ... 300.00s	P.2
	<i>Trip delay df/dt</i>	

f[1] . DF	[Protection Para / Set 1...4 / f-Prot / f[1]]	
1.00Hz	0.0Hz ... 10.0Hz	P.2
	<i>Frequency difference for the maximum admissible variation of the mean of the rate of frequency-change. This function is inactive if DF=0.</i>	

f[1] . DT	[Protection Para / Set 1...4 / f-Prot / f[1]]	
1.00s	0.1s ... 10.0s	P.2
	<i>Time interval of the maximum admissible rate-of-frequency-change.</i>	

f[1] . df/dt mode	[Protection Para / Set 1...4 / f-Prot / f[1]]	
absolute df/dt	absolute df/dt, positive df/dt, negative df/dt  Mode.	P.2
	<i>df/dt mode</i>	

f[1] . delta phi	[Protection Para / Set 1...4 / f-Prot / f[1]]	
10°	1° ... 30°	P.2
	<i>Measured value (calculated): Vector surge</i>	

9.25.4 f[1]: Input States

f[1] . ExBlo1-I	[Operation / Status Display / f-Prot / f[1]]	
	<i>Module input state: External blocking1</i>	

f[1] . ExBlo2-I	[Operation / Status Display / f-Prot / f[1]]	
	<i>Module input state: External blocking2</i>	

f[1] . ExBlo TripCmd-I	[Operation / Status Display / f-Prot / f[1]]
↓	<i>Module input state: External Blocking of the Trip Command</i>

9.25.5 f[1]: Signals (Output States)

f[1] . active	[Operation / Status Display / All Actives] [Operation / Status Display / f-Prot / f[1]]
↓	<i>Signal: active</i>

f[1] . Alarm	[Operation / Status Display / Alarms] [Operation / Status Display / f-Prot / f[1]]
↓	<i>Signal: Alarm Frequency Protection (collective signal)</i>

f[1] . Trip	[Operation / Status Display / Trips] [Operation / Status Display / f-Prot / f[1]]
↓	<i>Signal: Trip Frequency Protection (collective signal)</i>

f[1] . TripCmd	[Operation / Status Display / TripCmds] [Operation / Status Display / f-Prot / f[1]]
↓	<i>Signal: Trip Command</i>

f[1] . ExBlo	[Operation / Status Display / f-Prot / f[1]]
↓	<i>Signal: External Blocking</i>

f[1] . Blo by V<	[Operation / Status Display / f-Prot / f[1]]
↓	<i>Signal: Module is blocked by undervoltage.</i>

f[1] . Blo TripCmd	[Operation / Status Display / f-Prot / f[1]]
↓	<i>Signal: Trip Command blocked</i>



f[1] . ExBlo TripCmd	[Operation / Status Display / f-Prot / f[1]]
↓	<i>Signal: External Blocking of the Trip Command</i>

f[1] . Alarm f	[Operation / Status Display / f-Prot / f[1]]
⤴	<i>Signal: Alarm Frequency Protection</i>
f[1] . Alarm df/dt DF/DT	[Operation / Status Display / f-Prot / f[1]]
⤴	<i>Alarm instantaneous or average value of the rate-of-frequency-change</i>
f[1] . Alarm delta phi	[Operation / Status Display / f-Prot / f[1]]
⤴	<i>Signal: Alarm Vector Surge</i>
f[1] . Trip f	[Operation / Status Display / f-Prot / f[1]]
⤴	<i>Signal: Frequency has exceeded the limit.</i>
f[1] . Trip df/dt DF/DT	[Operation / Status Display / f-Prot / f[1]]
⤴	<i>Signal: Trip df/dt or DF/DT</i>
f[1] . Trip delta phi	[Operation / Status Display / f-Prot / f[1]]
⤴	<i>Signal: Trip Vector Surge</i>



9.26 PQS[1] ... PQS[6]



Power Protection - Module

9.26.1 PQS[1]: Device Planning Parameters



PQS[1] . Mode	[Device planning]	
P>	"-" ... S<  Mode.	S.3
	<i>Power Protection - Module, general operation mode</i>	

9.26.2 PQS[1]: Global Parameters

PQS[1] . ExBlo1	[Protection Para / Global Prot Para / P-Prot / PQS[1]]	
PQS[1] . ExBlo2		
"_"	"_" ... Sys . Internal test state  1..n, Assignment List.	P.2
	<i>External blocking of the module, if blocking is activated (allowed) within a parameter set and if the state of the assigned signal is true.</i>	

PQS[1] . ExBlo TripCmd	[Protection Para / Global Prot Para / P-Prot / PQS[1]]	
"_"	"_" ... Sys . Internal test state  1..n, Assignment List.	P.2
	<i>External blocking of the Trip Command of the module/the stage, if blocking is activated (allowed) within a parameter set and if the state of the assigned signal is true.</i>	

9.26.3 PQS[1]: Setting Group Parameters

PQS[1] . Function	[Protection Para / Set 1...4 / P-Prot / PQS[1]]	
active	inactive, active  Mode.	P.2
	<i>Permanent activation or deactivation of module/stage.</i>	

PQS[1] . ExBlo Fc		[Protection Para / Set 1...4 / P-Prot / PQS[1]]
inactive	inactive, active	P.2
	↳ active/inactive.	
	<i>Activate (allow) or inactivate (disallow) blocking of the module/stage. This parameter is only effective if a signal is assigned to the corresponding global protection parameter. If the signal becomes true, those modules/stages are blocked that are parameterized "ExBlo Fc=active".</i>	

PQS[1] . Blo TripCmd		[Protection Para / Set 1...4 / P-Prot / PQS[1]]
inactive	inactive, active	P.2
	↳ Mode.	
	<i>Permanent blocking of the Trip Command of the module/stage.</i>	

PQS[1] . ExBlo TripCmd Fc		[Protection Para / Set 1...4 / P-Prot / PQS[1]]
inactive	inactive, active	P.2
	↳ active/inactive.	
	<i>Activate (allow) or inactivate (disallow) blocking of the module/stage. This parameter is only effective if a signal is assigned to the corresponding global protection parameter. If the signal becomes true, those modules/stages are blocked that are parameterized "ExBlo TripCmd Fc=active".</i>	

PQS[1] . MeasCircSv Volt		[Protection Para / Set 1...4 / P-Prot / PQS[1]]
Sys . inactive	Sys . inactive, LOP . active	P.2
	↳ VTS Block.	
	<i>Measuring Circuit Supervision Voltage</i>	

PQS[1] . MeasCircSv Curr		[Protection Para / Set 1...4 / P-Prot / PQS[1]]
Sys . inactive	Sys . inactive, CTS . active	P.2
	↳ VTS Block.	
	<i>Measuring Circuit Supervision Current</i>	

PQS[1] . P>		[Protection Para / Set 1...4 / P-Prot / PQS[1]]
1.0Sn	0.003Sn ... 10.000Sn	P.2
	<i>Over(load) Active Power Pickup Value. Can be used for monitoring the maximum allowed forward power limits of transformers or overhead lines. Definition for Sn is as follows: Sn = 1.7321 * VT rating * CT rating. The voltage is the line-to-line voltage.</i>	

PQS[1] . P<	[Protection Para / Set 1...4 / P-Prot / PQS[1]]	
0.80Sn	0.003Sn ... 10.000Sn	P.2
	<i>Under(load) Active Power Pickup Value (e.g. caused by idling motors). Definition for Sn is as follows: $S_n = 1.7321 * VT \text{ rating} * CT \text{ rating}$. The voltage is the line-to-line voltage.</i>	

PQS[1] . Pr>	[Protection Para / Set 1...4 / P-Prot / PQS[1]]	
0.020Sn	0.003Sn ... 10.000Sn	P.2
	<i>Overload Reverse Active Power Pickup Value. Protection against reverse feeding into the power supply network. Definition for Sn is as follows: $S_n = 1.7321 * VT \text{ rating} * CT \text{ rating}$. The voltage is the line-to-line voltage.</i>	

PQS[1] . Pr<	[Protection Para / Set 1...4 / P-Prot / PQS[1]]	
0.80Sn	0.003Sn ... 10.000Sn	P.2
	<i>Under Reverse Definition for Sn is as follows: $S_n = 1.7321 * VT \text{ rating} * CT \text{ rating}$. The voltage is the line-to-line voltage.</i>	

PQS[1] . Q>	[Protection Para / Set 1...4 / P-Prot / PQS[1]]	
1.20Sn	0.003Sn ... 10.000Sn	P.2
	<i>Over(load) Reactive Power Pickup Value. Monitoring the maximum allowed reactive power of the electrical equipment like transformers or overhead lines). If the maximum value is exceeded a condenser bank could be switched off. Definition for Sn is as follows: $S_n = 1.7321 * VT \text{ rating} * CT \text{ rating}$. The voltage is the line-to-line voltage.</i>	

PQS[1] . Q<	[Protection Para / Set 1...4 / P-Prot / PQS[1]]	
0.80Sn	0.003Sn ... 10.000Sn	P.2
	<i>Under(load) Reactive Power Pickup Value. Monitoring the minimum value of the reactive power. If it falls below the set value a condenser bank could be switched on. Definition for Sn is as follows: $S_n = 1.7321 * VT \text{ rating} * CT \text{ rating}$. The voltage is the line-to-line voltage.</i>	



PQS[1] . Qr>	[Protection Para / Set 1...4 / P-Prot / PQS[1]]	
0.020Sn	0.003Sn ... 10.000Sn	P.2
	<i>Overload Reverse Reactive Power Pickup Value Definition for Sn is as follows: $S_n = 1.7321 * VT \text{ rating} * CT \text{ rating}$. The voltage is the line-to-line voltage.</i>	

PQS[1] . Qr<	[Protection Para / Set 1...4 / P-Prot / PQS[1]]	
0.80Sn	0.003Sn ... 10.000Sn	P.2
	<i>Under Reverse Definition for Sn is as follows: $S_n = 1.7321 * VT \text{ rating} * CT \text{ rating}$. The voltage is the line-to-line voltage.</i>	

PQS[1] . S>	[Protection Para / Set 1...4 / P-Prot / PQS[1]]	
1.20Sn	0.02Sn ... 10.00Sn	P.2
	<i>Over(load) Apparent Power Pickup Value Definition for Sn is as follows: $S_n = 1.7321 * VT \text{ rating} * CT \text{ rating}$. The voltage is the line-to-line voltage.</i>	

PQS[1] . S<	[Protection Para / Set 1...4 / P-Prot / PQS[1]]	
0.80Sn	0.02Sn ... 10.00Sn	P.2
	<i>Under(load) Apparent Power Pickup Value Definition for Sn is as follows: $S_n = 1.7321 * VT \text{ rating} * CT \text{ rating}$. The voltage is the line-to-line voltage.</i>	

PQS[1] . t	[Protection Para / Set 1...4 / P-Prot / PQS[1]]	
1.00s	0.00s ... 1100.00s	P.2
	<i>Tripping delay</i>	

PQS[1] . PowMeasMethod	[Protection Para / Set 1...4 / P-Prot / PQS[1]]	
Fundamental	Fundamental, True RMS  PowMeasMethod.	P.2
	<i>Determines if the active power, reactive power and apparent power are calculated on the basis of RMS or DFT.</i>	

9.26.4 PQS[1]: Input States

PQS[1] . ExBlo1-I	[Operation / Status Display / P-Prot / PQS[1]]	
PQS[1] . ExBlo2-I		
	<i>Module input state: External blocking</i>	

PQS[1] . ExBlo TripCmd-I	[Operation / Status Display / P-Prot / PQS[1]]	
	<i>Module input state: External Blocking of the Trip Command</i>	

9.26.5 PQS[1]: Signals (Output States)

PQS[1] . active	[Operation / Status Display / All Actives] [Operation / Status Display / P-Prot / PQS[1]]	
	<i>Signal: active</i>	

PQS[1] . Alarm	[Operation / Status Display / Alarms] [Operation / Status Display / P-Prot / PQS[1]]
 <i>Signal: Alarm Power Protection</i>	
PQS[1] . Trip	[Operation / Status Display / Trips] [Operation / Status Display / P-Prot / PQS[1]]
 <i>Signal: Trip Power Protection</i>	
PQS[1] . TripCmd	[Operation / Status Display / TripCmds] [Operation / Status Display / P-Prot / PQS[1]]
 <i>Signal: Trip Command</i>	
PQS[1] . ExBlo	[Operation / Status Display / P-Prot / PQS[1]]
 <i>Signal: External Blocking</i>	
PQS[1] . Blo TripCmd	[Operation / Status Display / P-Prot / PQS[1]]
 <i>Signal: Trip Command blocked</i>	
PQS[1] . ExBlo TripCmd	[Operation / Status Display / P-Prot / PQS[1]]
 <i>Signal: External Blocking of the Trip Command</i>	

9.27 PF[1] ... PF[2]

Power Factor - Module

9.27.1 PF[1]: Device Planning Parameters

PF[1] . Mode	[Device planning]	
"_"	"_" , use ↳ Mode.	S.3
 Power Factor - Module, general operation mode		

9.27.2 PF[1]: Global Parameters

PF[1] . ExBlo1 PF[1] . ExBlo2	[Protection Para / Global Prot Para / PF-Prot / PF[1]]	
"_"	"_" ... Sys . Internal test state ↳ 1..n, Assignment List.	P.2
 External blocking of the module, if blocking is activated (allowed) within a parameter set and if the state of the assigned signal is true.		

PF[1] . ExBlo TripCmd	[Protection Para / Global Prot Para / PF-Prot / PF[1]]	
"_"	"_" ... Sys . Internal test state ↳ 1..n, Assignment List.	P.2
 External blocking of the Trip Command of the module/the stage, if blocking is activated (allowed) within a parameter set and if the state of the assigned signal is true.		

9.27.3 PF[1]: Setting Group Parameters

PF[1] . Function	[Protection Para / Set 1...4 / PF-Prot / PF[1]]	
inactive	inactive, active ↳ Mode.	P.2
 Permanent activation or deactivation of module/stage.		

PF[1] . ExBlo Fc		[Protection Para / Set 1...4 / PF-Prot / PF[1]]
inactive	inactive, active	P.2
	↳ active/inactive.	
	<i>Activate (allow) or inactivate (disallow) blocking of the module/stage. This parameter is only effective if a signal is assigned to the corresponding global protection parameter. If the signal becomes true, those modules/stages are blocked that are parameterized "ExBlo Fc=active".</i>	

PF[1] . Blo TripCmd		[Protection Para / Set 1...4 / PF-Prot / PF[1]]
inactive	inactive, active	P.2
	↳ Mode.	
	<i>Permanent blocking of the Trip Command of the module/stage.</i>	

PF[1] . ExBlo TripCmd Fc		[Protection Para / Set 1...4 / PF-Prot / PF[1]]
inactive	inactive, active	P.2
	↳ active/inactive.	
	<i>Activate (allow) or inactivate (disallow) blocking of the module/stage. This parameter is only effective if a signal is assigned to the corresponding global protection parameter. If the signal becomes true, those modules/stages are blocked that are parameterized "ExBlo TripCmd Fc=active".</i>	

PF[1] . Measuring method		[Protection Para / Set 1...4 / PF-Prot / PF[1]]
Fundamental	Fundamental, True RMS	P.2
	↳ Measuring method.	
	<i>Measuring method: fundamental or rms or 3rd harmonic (only generator protection relays)</i>	

PF[1] . Trig Mode		[Protection Para / Set 1...4 / PF-Prot / PF[1]]
I lags V	I leads V, I lags V	P.2
	↳ Mode.	
	<i>Trigger Mode. Should the Module be triggered if the Current Phasor is leading to the Voltage Phasor = Lead? Or should the Module be triggered if the Current Phasor is lagging to the Voltage Phasor = Lag?</i>	

PF[1] . Trigger-PF		[Protection Para / Set 1...4 / PF-Prot / PF[1]]
0.8	0.5 ... 0.99	P.2
	<i>This is the power factor where the relay will pick-up.</i>	

PF[1] . Res Mode	[Protection Para / Set 1...4 / PF-Prot / PF[1]]	
I leads V	I leads V, I lags V ↳ Mode.	P.2
	<i>Trigger Mode. Should the Module be triggered if the Current Phasor is leading to the Voltage Phasor = Lead? Or should the Module be triggered if the Current Phasor is lagging to the Voltage Phasor = Lag?</i>	

PF[1] . Reset-PF	[Protection Para / Set 1...4 / PF-Prot / PF[1]]	
0.99	0.5 ... 0.99	P.2
	<i>This setting is the power factor, at which the relay will reset the power factor trip. It is like setting a hysteresis for the Trigger setting.</i>	

PF[1] . t	[Protection Para / Set 1...4 / PF-Prot / PF[1]]	
0.00s	0.00s ... 300.00s	P.2
	<i>Tripping delay</i>	

PF[1] . Pre-trig Comp	[Protection Para / Set 1...4 / PF-Prot / PF[1]]	
5.00s	0.00s ... 300.00s	P.2
	<i>Pickup (Pre-trigger) time for the Compensation Signal. When this timer is elapsed the compensation signal will be activated.</i>	

PF[1] . Post-trig Comp	[Protection Para / Set 1...4 / PF-Prot / PF[1]]	
5.00s	0.00s ... 300.00s	P.2
	<i>Post-trigger time of the Compensation Signal. When this timer is elapsed the compensation signal will be deactivated.</i>	

9.27.4 PF[1]: Input States

PF[1] . ExBlo1-I	[Operation / Status Display / PF-Prot / PF[1]]	
PF[1] . ExBlo2-I		
	<i>Module input state: External blocking</i>	

PF[1] . ExBlo TripCmd-I	[Operation / Status Display / PF-Prot / PF[1]]	
	<i>Module input state: External Blocking of the Trip Command</i>	



9.27.5 PF[1]: Signals (Output States)

PF[1] . active	[Operation / Status Display / All Actives] [Operation / Status Display / PF-Prot / PF[1]]
⇅ <i>Signal: active</i>	
PF[1] . Alarm	[Operation / Status Display / Alarms] [Operation / Status Display / PF-Prot / PF[1]]
⇅ <i>Signal: Alarm Power Factor</i>	
PF[1] . Trip	[Operation / Status Display / Trips] [Operation / Status Display / PF-Prot / PF[1]]
⇅ <i>Signal: Trip Power Factor</i>	
PF[1] . TripCmd	[Operation / Status Display / TripCmds] [Operation / Status Display / PF-Prot / PF[1]]
⇅ <i>Signal: Trip Command</i>	
PF[1] . ExBlo	[Operation / Status Display / PF-Prot / PF[1]]
⇅ <i>Signal: External Blocking</i>	
PF[1] . Blo TripCmd	[Operation / Status Display / PF-Prot / PF[1]]
⇅ <i>Signal: Trip Command blocked</i>	
PF[1] . ExBlo TripCmd	[Operation / Status Display / PF-Prot / PF[1]]
⇅ <i>Signal: External Blocking of the Trip Command</i>	
PF[1] . Compensator	[Operation / Status Display / PF-Prot / PF[1]]
⇅ <i>Signal: Compensation Signal</i>	
PF[1] . Impossible	[Operation / Status Display / PF-Prot / PF[1]]
⇅ <i>Signal: Alarm Power Factor Impossible</i>	



9.28 Q->&V<



Q->&V<

9.28.1 Q->&V<: Device Planning Parameters



Q->&V< . Mode	[Device planning]	
"_"	"_", use  Mode.	S.3
 <i>general operation mode</i>		

9.28.2 Q->&V<: Global Parameters

Q->&V< . ExBlo1	[Protection Para / Global Prot Para / Intercon-Prot / Q->&V<]	
Q->&V< . ExBlo2		
"_"	"_" ... Sys . Internal test state  1..n, Assignment List.	P.2
 <i>External blocking of the module, if blocking is activated (allowed) within a parameter set and if the state of the assigned signal is true.</i>		

Q->&V< . Power Trip dir	[Protection Para / Global Prot Para / Intercon-Prot / Q->&V<]	
negative	positive, negative  Power Trip dir.	P.2
 <i>By means of this parameter the trip direction of active and reactive power can be inverted within the QV-Module (sign reversal).</i>		

9.28.3 Q->&V<: Setting Group Parameters

Q->&V< . Function	[Protection Para / Set 1...4 / Intercon-Prot / Q->&V< / General Settings]	
inactive	inactive, active  Mode.	P.2
 <i>Permanent activation or deactivation of module/stage.</i>		

Q->&V< . ExBlo Fc		[Protection Para / Set 1...4 / Intercon-Prot / Q->&V< / General Settings]
inactive	inactive, active	P.2
	↳ active/inactive.	
	<i>Activate (allow) or inactivate (disallow) blocking of the module/stage. This parameter is only effective if a signal is assigned to the corresponding global protection parameter. If the signal becomes true, those modules/stages are blocked that are parameterized "ExBlo Fc=active".</i>	

Q->&V< . Meas Circuit Superv		[Protection Para / Set 1...4 / Intercon-Prot / Q->&V< / General Settings]
Sys . inactive	Sys . inactive, LOP . active	P.2
	↳ VTS Block.	
	<i>Activates the use of the measuring circuit supervision. In this case the module will be blocked if a measuring circuit supervision module (e.g. LOP, VTS) signals a disturbed measuring circuit (e.g. caused by a fuse failure).</i>	

Q->&V< . QV-Method		[Protection Para / Set 1...4 / Intercon-Prot / Q->&V< / Decoupling]
Power Angle Supervision	Power Angle Supervision, Pure Reactive Power Superv	P.2
	↳ Selection of the Q(V)-Method: Power Angle or Reactive Power Threshold.	
	<i>Selection of the Q(V)-Method: Power Angle or Reactive Power Threshold</i>	

Q->&V< . I1 Release		[Protection Para / Set 1...4 / Intercon-Prot / Q->&V< / Decoupling]
active	If: Q->&V< . QV-Method = Power Angle Supervision <ul style="list-style-type: none"> • active If: Q->&V< . QV-Method = Pure Reactive Power Superv <ul style="list-style-type: none"> • inactive, active ↳ I1 Release.	P.2
	<i>Activation of the "I1 Minimum Current"-Criterion.</i>	

Q->&V< . I1 min QV	[Protection Para / Set 1...4 / Intercon-Prot / Q->&V< / Decoupling]	
0.10In <i>Only available if:</i> • Q->&V< . I1 Release = active	0.01In ... 0.20In	P.2
 <i>Activation of an "I1 Minimum Current" of the rated current of the (distributed) energy resource can prevent faulty tripping.</i>		

Q->&V< . VLL< QV	[Protection Para / Set 1...4 / Intercon-Prot / Q->&V< / Decoupling]	
0.85Vn	0.70Vn ... 1.00Vn	P.2
 <i>Undervoltage threshold (line-to-line voltage!)</i>		

Q->&V< . Phi-Power	[Protection Para / Set 1...4 / Intercon-Prot / Q->&V< / Decoupling]	
3° <i>Only available if:</i> • Q->&V< . QV-Method = Power Angle Supervision	0° ... 10°	P.2
 <i>Trigger Phi-Power (Positive Phase Sequence System)</i>		

Q->&V< . Q min QV	[Protection Para / Set 1...4 / Intercon-Prot / Q->&V< / Decoupling]	
0.05Sn <i>Only available if:</i> • Q->&V< . QV-Method = Pure Reactive Power Superv	0.01Sn ... 0.20Sn	P.2
 <i>Trigger for the Reactive Power (Positive Phase Sequence System)</i>		

Q->&V< . t-Gen	[Protection Para / Set 1...4 / Intercon-Prot / Q->&V< / Decoupling]	
0.5s	0.00s ... 2.00s	P.2
 <i>First timer. If this timer has elapsed, a trip signal will be issued to the (local) energy resource.</i>		

Q->&V< . t-PCC	[Protection Para / Set 1...4 / Intercon-Prot / Q->&V< / Decoupling]
0.5s	0.00s ... 4.00s
	<i>Second timer. If this timer is elapsed, the an trip signal will be issued to the PCC (Point of Common Coupling)</i>

9.28.4 Q->&V<: Input States

Q->&V< . ExBlo1-I	[Operation / Status Display / Intercon-Prot / Q->&V<]
	<i>Module input state: External blocking1</i>

Q->&V< . ExBlo2-I	[Operation / Status Display / Intercon-Prot / Q->&V<]
	<i>Module input state: External blocking2</i>

9.28.5 Q->&V<: Signals (Output States)

Q->&V< . active	[Operation / Status Display / All Actives] [Operation / Status Display / Intercon-Prot / Q->&V<]
	<i>Signal: active</i>

Q->&V< . Alarm	[Operation / Status Display / Alarms] [Operation / Status Display / Intercon-Prot / Q->&V<]
	<i>Signal: Alarm Reactive Power Undervoltage Protection</i>

Q->&V< . Decoupling Distr. Generator	[Operation / Status Display / Trips] [Operation / Status Display / Intercon-Prot / Q->&V<]
	<i>Signal: Decoupling of the (local) Energy Generator/Resource</i>

Q->&V< . Decoupling PCC	[Operation / Status Display / Trips] [Operation / Status Display / Intercon-Prot / Q->&V<]
	<i>Signal: Decoupling at the Point of Common Coupling</i>

Q->&V< . ExBlo	[Operation / Status Display / Intercon-Prot / Q->&V<]
	<i>Signal: External Blocking</i>

Q->&V< . Fuse Fail VT Blo	[Operation / Status Display / Intercon-Prot / Q->&V<]
----------------------------------	---

 <i>Signal: Blocked by Fuse Failure (VT)</i>

Q->&V< . Power Angle	[Operation / Status Display / Intercon-Prot / Q->&V<]
-----------------------------	---

 <i>Signal: Admissible power angle exceeded</i>
--

Q->&V< . Reactive Power Thres	[Operation / Status Display / Intercon-Prot / Q->&V<]
--------------------------------------	---

 <i>Signal: Admissible Reactive Power Threshold exceeded</i>



Q->&V< . VLL too low	[Operation / Status Display / Intercon-Prot / Q->&V<]
-----------------------------	---

 <i>Signal: Line-to-Line voltage too low</i>



9.29 ReCon[1] ... ReCon[2]



Reconnection



9.29.1 ReCon[1]: Device Planning Parameters

ReCon[1] . Mode	[Device planning]	
"_"	"_" , use  Mode.	S.3
 <i>general operation mode</i>		

9.29.2 ReCon[1]: Global Parameters

ReCon[1] . ExBlo1 ReCon[1] . ExBlo2	[Protection Para / Global Prot Para / Intercon-Prot / ReCon[1] / General Settings]	
"_"	"_" ... Sys . Internal test state  1..n, Assignment List.	P.2
 <i>External blocking of the module, if blocking is activated (allowed) within a parameter set and if the state of the assigned signal is true.</i>		

ReCon[1] . V Ext Release PCC	[Protection Para / Global Prot Para / Intercon-Prot / ReCon[1] / General Settings]	
"_"	"_" ... Sys . Internal test state  1..n, Assignment List.	P.2
 <i>Release Signal by the Point of Common Coupling. The line-to-line voltage is greater than 95% of VN.</i>		

ReCon[1] . PCC Fuse Fail VT	[Protection Para / Global Prot Para / Intercon-Prot / ReCon[1] / General Settings]	
"_"	"_" ... DI Slot X6 . DI 8  1..n, Dig Inputs.	P.2
 <i>Blocking if the fuse of a voltage transformer has tripped at the PCC.</i>		

ReCon[1] . reconnected	[Protection Para / Global Prot Para / Intercon-Prot / ReCon[1] / General Settings]	
"_"	"_" ... Sys . Internal test state ↳ 1..n, Assignment List.	P.2
 This signal indicates the state "reconnected" (mains parallel).		

ReCon[1] . Decoupling1 ... ReCon[1] . Decoupling6	[Protection Para / Global Prot Para / Intercon-Prot / ReCon[1] / Decoupling]	
"_"	"_" ... Logics . LE80.Out inverted ↳ Decoupling Functions.	P.2
 Decoupling function, that blocks the reconnection.		

9.29.3 ReCon[1]: Setting Group Parameters

ReCon[1] . Function	[Protection Para / Set 1...4 / Intercon-Prot / ReCon[1] / General Settings]	
inactive	inactive, active ↳ Mode.	P.2
 Permanent activation or deactivation of module/stage.		

ReCon[1] . ExBlo Fc	[Protection Para / Set 1...4 / Intercon-Prot / ReCon[1] / General Settings]	
inactive	inactive, active ↳ active/inactive.	P.2
 Activate (allow) or inactivate (disallow) blocking of the module/stage. This parameter is only effective if a signal is assigned to the corresponding global protection parameter. If the signal becomes true, those modules/stages are blocked that are parameterized "ExBlo Fc=active".		

ReCon[1] . Meas Circuit Superv		[Protection Para / Set 1...4 / Intercon-Prot / ReCon[1] / General Settings]	
Sys . inactive		Sys . inactive, LOP . active ↳ VTS Block.	P.2
	<i>Activates the use of the measuring circuit supervision. In this case the module will be blocked if a measuring circuit supervision module (e.g. LOP, VTS) signals a disturbed measuring circuit (e.g. caused by a fuse failure).</i>		

ReCon[1] . V Ext Release PCC Fc		[Protection Para / Set 1...4 / Intercon-Prot / ReCon[1] / General Settings]	
inactive		inactive, active ↳ Mode.	P.2
	<i>Activate the release signal of the Point of Common Coupling. The line-to-line voltage is greater than 95% of VN.</i>		

ReCon[1] . Reconnect. Release Cond		[Protection Para / Set 1...4 / Intercon-Prot / ReCon[1] / Release Para]	
Both		V Internal Release, V Ext Release PCC, Both ↳ Reconnect. Release Cond.	P.2
	<i>This parameter ensures that the mains voltage is recovered.</i>		

ReCon[1] . PCC Fuse Fail VT Fk		[Protection Para / Set 1...4 / Intercon-Prot / ReCon[1] / Release Para]	
inactive		inactive, active ↳ Mode.	P.2
<i>Only available if:</i>			
<ul style="list-style-type: none"> • ReCon[1] . Reconnect. Release Cond = V Ext Release PCC • ReCon[1] . Reconnect. Release Cond = Both 			
	<i>Blocking if the fuse of a voltage transformer has tripped at the PCC.</i>		

ReCon[1] . Measuring method		[Protection Para / Set 1...4 / Intercon-Prot / ReCon[1] / Release Para]	
Fundamental		Fundamental, True RMS, Vavg ↳ Measuring method.	P.2
	<i>Measuring method: fundamental or rms or "sliding average supervision"</i>		

ReCon[1] . VLL< Release	[Protection Para / Set 1...4 / Intercon-Prot / ReCon[1] / Release Para]	
1.10Vn	1.00Vn ... 1.50Vn	P.2
<i>Only available if:</i> <ul style="list-style-type: none"> • ReCon[1] . Reconnect. Release Cond = V Internal Release • ReCon[1] . Reconnect. Release Cond = Both 		
 <i>Maximum voltage (line-to-line) for reclosure (Restoration Voltage)</i>		

ReCon[1] . VLL> Release	[Protection Para / Set 1...4 / Intercon-Prot / ReCon[1] / Release Para]	
0.95Vn	0.70Vn ... 1.00Vn	P.2
<i>Only available if:</i> <ul style="list-style-type: none"> • ReCon[1] . Reconnect. Release Cond = V Internal Release • ReCon[1] . Reconnect. Release Cond = Both 		
 <i>Minimum voltage (line-to-line) for reclosure (Restoration Voltage)</i>		

ReCon[1] . f>	[Protection Para / Set 1...4 / Intercon-Prot / ReCon[1] / Release Para]	
50.05Hz	40.00Hz ... 69.90Hz	P.2
 <i>Upper frequency limit for the reclosure</i>		

ReCon[1] . f<	[Protection Para / Set 1...4 / Intercon-Prot / ReCon[1] / Release Para]	
47.5Hz	40.00Hz ... 69.90Hz	P.2
 <i>Lower frequency limit for the reclosure (Restoration Voltage)</i>		

ReCon[1] . t-Release Blo	[Protection Para / Set 1...4 / Intercon-Prot / ReCon[1] / Release Para]	
600s	0.00s ... 3600.00s	P.2
 <i>Time stage (delay) for the reclosure of the energy resources. The Mains saddle time takes based on exirience approx. 10 - 15 minutes.</i>		

9.29.4 ReCon[1]: Input States

ReCon[1] . ExBlo1-I	[Operation / Status Display / Intercon-Prot / ReCon[1]]
↓	<i>Module input state: External blocking1</i>
ReCon[1] . ExBlo2-I	[Operation / Status Display / Intercon-Prot / ReCon[1]]
↓	<i>Module input state: External blocking2</i>
ReCon[1] . V Ext Release PCC-I	[Operation / Status Display / Intercon-Prot / ReCon[1]]
↓	<i>Module input state: Release signal is being generated by the PCC (External Release)</i>
ReCon[1] . PCC Fuse Fail VT-I	[Operation / Status Display / Intercon-Prot / ReCon[1]]
↓	<i>State of the module input: Blocking if the fuse of a voltage transformer has tripped at the PCC.</i>
ReCon[1] . reconnected-I	[Operation / Status Display / Intercon-Prot / ReCon[1]]
↓	<i>This signal indicates the state "reconnected" (mains parallel).</i>
ReCon[1] . Decoupling1-I ... ReCon[1] . Decoupling6-I	[Operation / Status Display / Intercon-Prot / ReCon[1]]
↓	<i>Decoupling function, that blocks the reconnection.</i>

9.29.5 ReCon[1]: Signals (Output States)

ReCon[1] . active	[Operation / Status Display / All Actives] [Operation / Status Display / Intercon-Prot / ReCon[1]]
↓	<i>Signal: active</i>
ReCon[1] . ExBlo	[Operation / Status Display / Intercon-Prot / ReCon[1]]
↓	<i>Signal: External Blocking</i>
ReCon[1] . Blo by Meas Circuit Superv	[Operation / Status Display / Intercon-Prot / ReCon[1]]
↓	<i>Signal: Module blocked by measuring cirucuit supervision</i>

ReCon[1] . Release Energy Resource



[Operation / Status Display / Intercon-Prot / ReCon[1]]

↕ *Signal: Release Energy Resource.*



9.30 Sync



Synchrocheck

9.30.1 Sync: Device Planning Parameters

Sync . Mode	[Device planning]	
"_"	"_" , use  Mode.	S.3
	<i>Synchrocheck, general operation mode</i>	

9.30.2 Sync: Global Parameters

Sync . ExBlo1	[Protection Para / Global Prot Para / Intercon-Prot / Sync]	
Sync . ExBlo2		
"_"	"_" ... Sys . Internal test state  1..n, Assignment List.	C.2
	<i>External blocking of the module, if blocking is activated (allowed) within a parameter set and if the state of the assigned signal is true.</i>	

Sync . Bypass	[Protection Para / Global Prot Para / Intercon-Prot / Sync]	
"_"	"_" ... Logics . LE80.Out inverted  1..n, DI-LogicList.	C.2
	<i>The Synchrocheck will be bypassed if the state of the assigned signal (logic input) becomes true.</i>	

Sync . CB Pos Detect	[Protection Para / Global Prot Para / Intercon-Prot / Sync]	
SG[1] . Pos	"_" , SG[1] . Pos, SG[2] . Pos, SG[3] . Pos, SG[4] . Pos, SG[5] . Pos, SG[6] . Pos  CB Manager.	C.2
	<i>Criterion by which the Circuit Breaker Switch Position is to be detected.</i>	

Sync . CBCloseInitiate	[Protection Para / Global Prot Para / Intercon-Prot / Sync]	
"_"	"_" ... Logics . LE80.Out inverted ↳ 1..n, SyncRequestList.	C.2
	<i>Breaker Close Initiate with synchronism check from any control sources (e.g. HMI / SCADA). If the state of the assigned signal becomes true, a Breaker Close will be initiated (Trigger Source).</i>	

9.30.3 Sync: Setting Group Parameters

Sync . Function	[Protection Para / Set 1...4 / Intercon-Prot / Sync / General Settings]	
inactive	inactive, active ↳ Mode.	P.2
	<i>Permanent activation or deactivation of module/stage.</i>	

Sync . ExBlo Fc	[Protection Para / Set 1...4 / Intercon-Prot / Sync / General Settings]	
inactive	inactive, active ↳ active/inactive.	P.2
	<i>Activate (allow) or inactivate (disallow) blocking of the module/stage. This parameter is only effective if a signal is assigned to the corresponding global protection parameter. If the signal becomes true, those modules/stages are blocked that are parameterized "ExBlo Fc=active".</i>	

Sync . Bypass Fc	[Protection Para / Set 1...4 / Intercon-Prot / Sync / General Settings]	
inactive	inactive, active ↳ active/inactive.	P.2
	<i>Allowing to bypass the Synchrocheck, if the state signal that is assigned to the parameter with the same name within the Global Parameters (logic input) becomes true.</i>	

Sync . SyncMode	[Protection Para / Set 1...4 / Intercon-Prot / Sync / Mode / Times]	
System2System	System2System, Generator2System ↳ SyncMode.	P.2
	<i>Synchrocheck mode: GENERATOR2SYSTEM = Synchronizing generator to system (breaker close initiate needed). SYSTEM2SYSTEM = SynchronCheck between two systems (Stand-Alone, no breaker info needed)</i>	

Sync . t-MaxCBCloseDelay	[Protection Para / Set 1...4 / Intercon-Prot / Sync / Mode / Times]	
0.05s	0.00s ... 300.00s	P.2
<i>Only available if:</i> <ul style="list-style-type: none"> • Sync . SyncMode = Generator2System 		
	<i>Maximum circuit breaker close time delay (Only used for GENERATOR-SYSTEM working mode and is critical for a correct synchronized switching)</i>	

Sync . t-MaxSyncSuperv	[Protection Para / Set 1...4 / Intercon-Prot / Sync / Mode / Times]	
30.00s	0.00s ... 3000.00s	P.2
<i>Only available if:</i> <ul style="list-style-type: none"> • Sync . SyncMode = Generator2System 		
	<i>Synchron-Run timer: Max. time allowed for synchronizing process after a close initiate. Only used for GENERATOR2SYSTEM working mode.</i>	

Sync . MinLiveBusVoltage	[Protection Para / Set 1...4 / Intercon-Prot / Sync / DeadLiveVLevels]	
0.65Vn	0.10Vn ... 2.00Vn	P.2
	<i>Minimum Live Bus voltage (Live bus detected, when all three phase bus voltages are above this limit).</i>	

Sync . MaxDeadBusVoltage	[Protection Para / Set 1...4 / Intercon-Prot / Sync / DeadLiveVLevels]	
0.03Vn	0.01Vn ... 1.00Vn	P.2
	<i>Maximum Dead Bus voltage (Dead bus detected, when all three phase bus voltages are below this limit).</i>	

Sync . MinLiveLineVoltage	[Protection Para / Set 1...4 / Intercon-Prot / Sync / DeadLiveVLevels]	
0.65Vn	0.10Vn ... 2.00Vn	P.2
	<i>Minimum Live Line voltage (Live line detected, when line voltage above this limit).</i>	



Sync . MaxDeadLineVoltage	[Protection Para / Set 1...4 / Intercon-Prot / Sync / DeadLiveVLevels]	
0.03Vn	0.01Vn ... 1.00Vn	P.2
	<i>Maximum Dead Line voltage (Dead Line detected, when line voltage below this limit).</i>	



Sync . t-VoltDead	[Protection Para / Set 1...4 / Intercon-Prot / Sync / DeadLiveVLevels]	
0.167s	0.000s ... 300.000s	P.2
	<i>Voltage dead time (A Dead Bus/Line condition will be accepted only if the voltage falls below the set dead voltage levels longer than this time setting).</i>	

Sync . MaxVoltageDiff	[Protection Para / Set 1...4 / Intercon-Prot / Sync / Conditions]	
0.24Vn	0.01Vn ... 1.00Vn	P.2
	<i>Maximum voltage difference between bus and line voltage phasors (Delta V) for synchronism (Related to bus voltage secondary rating)</i>	

Sync . MaxSlipFrequency	[Protection Para / Set 1...4 / Intercon-Prot / Sync / Conditions]	
0.20Hz	0.01Hz ... 2.00Hz	P.2
	<i>Maximum frequency difference (Slip: Delta f) between bus and line voltage allowed for synchronism</i>	

Sync . MaxAngleDiff	[Protection Para / Set 1...4 / Intercon-Prot / Sync / Conditions]	
20°	1° ... 60°	P.2
	<i>Maximum phase angle difference (Delta-Phi in degree) between bus and line voltages allowed for synchronism</i>	

Sync . DBDL	[Protection Para / Set 1...4 / Intercon-Prot / Sync / Override]	
inactive	inactive, active  active/inactive.	P.2
	<i>Enable/disable Dead-Bus AND Dead-Line synchronism overriding</i>	

Sync . DBLL	[Protection Para / Set 1...4 / Intercon-Prot / Sync / Override]	
inactive	inactive, active  active/inactive.	P.2
	<i>Enable/disable Dead-Bus AND Live-Line synchronism overriding</i>	

Sync . LBDL	[Protection Para / Set 1...4 / Intercon-Prot / Sync / Override]
inactive	inactive, active ↳ active/inactive.
 <i>Enable/disable Live-Bus AND Dead-Line synchronism overriding</i>	

9.30.4 Sync: Input States

Sync . ExBlo1-I	[Operation / Status Display / Intercon-Prot / Sync]
 <i>Module input state: External blocking1</i>	

Sync . ExBlo2-I	[Operation / Status Display / Intercon-Prot / Sync]
 <i>Module input state: External blocking2</i>	

Sync . Bypass-I	[Operation / Status Display / Intercon-Prot / Sync]
 <i>State of the module input: The Synchrocheck will be bypassed if the state of the assigned signal (logic input) becomes true.</i>	

Sync . CBCloseInitiate-I	[Operation / Status Display / Intercon-Prot / Sync]
 <i>State of the module input: Breaker Close Initiate with synchronism check from any control sources (e.g. HMI / SCADA). If the state of the assigned signal becomes true, a Breaker Close will be initiated (Trigger Source).</i>	

9.30.5 Sync: Signals (Output States)

Sync . active	[Operation / Status Display / All Actives]
	[Operation / Status Display / Intercon-Prot / Sync]
 <i>Signal: active</i>	

Sync . ExBlo	[Operation / Status Display / Intercon-Prot / Sync]
 <i>Signal: External Blocking</i>	

Sync . LiveBus	[Operation / Status Display / Intercon-Prot / Sync]
 <i>Signal: Live-Bus flag: 1=Live-Bus, 0=Voltage is below the LiveBus threshold</i>	

Sync . LiveLine	[Operation / Status Display / Intercon-Prot / Sync]
↑	<i>Signal: Live Line flag: 1=Live-Line, 0=Voltage is below the LiveLine threshold</i>
Sync . SynchronRunTiming	[Operation / Status Display / Intercon-Prot / Sync]
↑	<i>Signal: Synchron-Run-timer is timing (This timer starts when Close-Initiate is coming and stops if breaker is closed. Timeout means synchronizing failed.)</i>
Sync . SynchronFailed	[Operation / Status Display / Intercon-Prot / Sync]
↑	<i>Signal: This signal indicates a failed synchronization. It is set for 5s when the circuit breaker is still open after the Synchron-Run-timer has timed out.</i>
Sync . SyncOverriden	[Operation / Status Display / Intercon-Prot / Sync]
↑	<i>Signal:Synchronism Check is overridden because one of the Synchronism overriding conditions (DB/DL or ExtBypass) is met.</i>
Sync . VDiffTooHigh	[Operation / Status Display / Intercon-Prot / Sync]
↑	<i>Signal: Voltage difference between bus and line too high.</i>
Sync . SlipTooHigh	[Operation / Status Display / Intercon-Prot / Sync]
↑	<i>Signal: Frequency difference (slip frequency) between bus and line voltages too high.</i>
Sync . AngleDiffTooHigh	[Operation / Status Display / Intercon-Prot / Sync]
↑	<i>Signal: Phase Angle difference between bus and line voltages too high.</i>
Sync . Sys-in-Sync	[Operation / Status Display / Intercon-Prot / Sync]
↑	<i>Signal: Bus and line voltages are in synchronism according to the system synchronism criteria.</i>
Sync . Ready to Close	[Operation / Status Display / Intercon-Prot / Sync]
↑	<i>Signal: Ready to Close</i>

9.30.6 Sync: Values

Sync . Slip Freq	[Operation / Measured Values / Synchronism]
↗	<i>Slip frequency</i>
Sync . Volt Diff	[Operation / Measured Values / Synchronism]
↗	<i>Voltage difference between bus and line.</i>

Sync . Angle Diff	[Operation / Measured Values / Synchronism]
 <i>Angle difference between bus and line voltages.</i>	
Sync . f Bus	[Operation / Measured Values / Synchronism]
 <i>Bus frequency</i>	
Sync . f Line	[Operation / Measured Values / Synchronism]
 <i>Line frequency</i>	
Sync . V Bus	[Operation / Measured Values / Synchronism]
 <i>Bus Voltage</i>	
Sync . V Line	[Operation / Measured Values / Synchronism]
 <i>Line Voltage</i>	
Sync . Angle Bus	[Operation / Measured Values / Synchronism]
 <i>Bus Angle (Reference)</i>	
Sync . Angle Line	[Operation / Measured Values / Synchronism]
 <i>Line Angle</i>	

9.31 LoE-Z1[1] ... LoE-Z1[2]

Loss of Excitation

9.31.1 LoE-Z1[1]: Device Planning Parameters

LoE-Z1[1] . Mode	[Device planning]	
"_"	"_" , use ↳ Device planning.	S.3
 <i>general operation mode</i>		

9.31.2 LoE-Z1[1]: Global Parameters

LoE-Z1[1] . ExBlo1	[Protection Para / Global Prot Para / LoE-Prot / LoE-Z1[1]]	
LoE-Z1[1] . ExBlo2		
"_"	"_" ... Sys . Internal test state ↳ 1..n, Assignment List.	P.2
 <i>External blocking of the module, if blocking is activated (allowed) within a parameter set and if the state of the assigned signal is true.</i>		

LoE-Z1[1] . ExBlo TripCmd	[Protection Para / Global Prot Para / LoE-Prot / LoE-Z1[1]]	
"_"	"_" ... Sys . Internal test state ↳ 1..n, Assignment List.	P.2
 <i>External blocking of the Trip Command of the module/the stage, if blocking is activated (allowed) within a parameter set and if the state of the assigned signal is true.</i>		

9.31.3 LoE-Z1[1]: Setting Group Parameters

LoE-Z1[1] . Function	[Protection Para / Set 1...4 / LoE-Prot / LoE-Z1[1]]	
inactive	inactive, active ↳ Mode.	P.2
 <i>Permanent activation or deactivation of module/stage.</i>		

LoE-Z1[1] . ExBlo Fc		[Protection Para / Set 1...4 / LoE-Prot / LoE-Z1[1]]
inactive	inactive, active	P.2
	↳ active/inactive.	
	<i>Activate (allow) or inactivate (disallow) blocking of the module/stage. This parameter is only effective if a signal is assigned to the corresponding global protection parameter. If the signal becomes true, those modules/stages are blocked that are parameterized "ExBlo Fc=active".</i>	

LoE-Z1[1] . Blo TripCmd		[Protection Para / Set 1...4 / LoE-Prot / LoE-Z1[1]]
inactive	inactive, active	P.2
	↳ Mode.	
	<i>Permanent blocking of the Trip Command of the module/stage.</i>	



LoE-Z1[1] . ExBlo TripCmd Fc		[Protection Para / Set 1...4 / LoE-Prot / LoE-Z1[1]]
inactive	inactive, active	P.2
	↳ active/inactive.	
	<i>Activate (allow) or inactivate (disallow) blocking of the module/stage. This parameter is only effective if a signal is assigned to the corresponding global protection parameter. If the signal becomes true, those modules/stages are blocked that are parameterized "ExBlo TripCmd Fc=active".</i>	

LoE-Z1[1] . Meas Circuit Superv		[Protection Para / Set 1...4 / LoE-Prot / LoE-Z1[1]]
Sys . inactive	Sys . inactive, LOP . active	P.2
	↳ VTS Block.	
	<i>Activates the use of the measuring circuit supervision. In this case the module will be blocked if a measuring circuit supervision module (e.g. LOP, VTS) signals a disturbed measuring circuit (e.g. caused by a fuse failure).</i>	

LoE-Z1[1] . Mho Diameter		[Protection Para / Set 1...4 / LoE-Prot / LoE-Z1[1]]
13.4Ω	If: CT Ntrl . CT sec = 1A <ul style="list-style-type: none"> • 1.0Ω ... 750.0Ω If: CT Ntrl . CT sec = 5A <ul style="list-style-type: none"> • 0.2Ω ... 150.0Ω 	P.2
	<i>Mho Zone diameter in ohm (secondary value). Diameter of the impedance circle.</i>	

LoE-Z1[1] . Mho Offset	[Protection Para / Set 1...4 / LoE-Prot / LoE-Z1[1]]
-2.5Ω	If: CT Ntrl . CT sec = 1A • -250.0Ω ... +250.0Ω If: CT Ntrl . CT sec = 5A • -50.0Ω ... +50.0Ω
 <i>Mho Zone offset reactance in ohm (secondary value).</i>	

LoE-Z1[1] . t-Z	[Protection Para / Set 1...4 / LoE-Prot / LoE-Z1[1]]
0.25s	0.00s ... 400.00s
 <i>Mho Zone pickup time delay.</i>	

LoE-Z1[1] . FastTrip V<	[Protection Para / Set 1...4 / LoE-Prot / LoE-Z1[1]]
inactive	inactive, active  Mode.
 <i>Mho Zone Accelerated trip for loss of voltage active or inactive.</i>	

LoE-Z1[1] . V<	[Protection Para / Set 1...4 / LoE-Prot / LoE-Z1[1]]
0.80Vn	0.01Vn ... 2.00Vn
 <i>Mho Zone Voltage pickup level</i>	

LoE-Z1[1] . t-V<	[Protection Para / Set 1...4 / LoE-Prot / LoE-Z1[1]]
0.00s	0.00s ... 300.00s
 <i>Trip Delay for the Undervoltage</i>	

9.31.4 LoE-Z1[1]: Input States

LoE-Z1[1] . ExBlo1-I	[Operation / Status Display / LoE-Prot / LoE-Z1[1]]
 <i>Module input state: External blocking1</i>	

LoE-Z1[1] . ExBlo2-I	[Operation / Status Display / LoE-Prot / LoE-Z1[1]]
 <i>Module input state: External blocking2</i>	

LoE-Z1[1] . ExBlo TripCmd-I	[Operation / Status Display / LoE-Prot / LoE-Z1[1]]
↓	<i>Module input state: External Blocking of the Trip Command</i>

9.31.5 LoE-Z1[1]: Signals (Output States)

LoE-Z1[1] . active	[Operation / Status Display / All Actives] [Operation / Status Display / LoE-Prot / LoE-Z1[1]]
↓	<i>Signal: active</i>

LoE-Z1[1] . Alarm	[Operation / Status Display / Alarms] [Operation / Status Display / LoE-Prot / LoE-Z1[1]]
↓	<i>Signal: Alarm Loss of Excitation</i>

LoE-Z1[1] . Trip	[Operation / Status Display / Trips] [Operation / Status Display / LoE-Prot / LoE-Z1[1]]
↓	<i>Signal: Trip</i>

LoE-Z1[1] . TripCmd	[Operation / Status Display / TripCmds] [Operation / Status Display / LoE-Prot / LoE-Z1[1]]
↓	<i>Signal: Trip Command</i>

LoE-Z1[1] . ExBlo	[Operation / Status Display / LoE-Prot / LoE-Z1[1]]
↓	<i>Signal: External Blocking</i>

LoE-Z1[1] . Blo TripCmd	[Operation / Status Display / LoE-Prot / LoE-Z1[1]]
↓	<i>Signal: Trip Command blocked</i>

LoE-Z1[1] . ExBlo TripCmd	[Operation / Status Display / LoE-Prot / LoE-Z1[1]]
↓	<i>Signal: External Blocking of the Trip Command</i>

LoE-Z1[1] . FastTrip V<	[Operation / Status Display / LoE-Prot / LoE-Z1[1]]
↓	<i>Signal: FastTrip V<</i>

9 Protection Parameter

9.31 LoE-Z1[1] ... LoE-Z1[2]

LoE-Z1[1] . **Blocked by MeasCircSupv** [Operation / Status Display / LoE-Prot / LoE-Z1[1]]

⬆ *Blocked by Measuring Circuit Supervision*

9.32 LoE-Z2[1] ... LoE-Z2[2]

Loss of Excitation

9.32.1 LoE-Z2[1]: Device Planning Parameters

LoE-Z2[1] . Mode	[Device planning]	
"_"	"_" , use ↳ Device planning.	S.3
 <i>general operation mode</i>		

9.32.2 LoE-Z2[1]: Global Parameters

LoE-Z2[1] . ExBlo1	[Protection Para / Global Prot Para / LoE-Prot / LoE-Z2[1]]	
LoE-Z2[1] . ExBlo2		
"_"	"_" ... Sys . Internal test state ↳ 1..n, Assignment List.	P.2
 <i>External blocking of the module, if blocking is activated (allowed) within a parameter set and if the state of the assigned signal is true.</i>		

LoE-Z2[1] . ExBlo TripCmd	[Protection Para / Global Prot Para / LoE-Prot / LoE-Z2[1]]	
"_"	"_" ... Sys . Internal test state ↳ 1..n, Assignment List.	P.2
 <i>External blocking of the Trip Command of the module/the stage, if blocking is activated (allowed) within a parameter set and if the state of the assigned signal is true.</i>		

9.32.3 LoE-Z2[1]: Setting Group Parameters

LoE-Z2[1] . Function	[Protection Para / Set 1...4 / LoE-Prot / LoE-Z2[1]]	
inactive	inactive, active ↳ Mode.	P.2
 <i>Permanent activation or deactivation of module/stage.</i>		

LoE-Z2[1] . ExBlo Fc		[Protection Para / Set 1...4 / LoE-Prot / LoE-Z2[1]]
inactive	inactive, active	P.2
	↳ active/inactive.	
	<i>Activate (allow) or inactivate (disallow) blocking of the module/stage. This parameter is only effective if a signal is assigned to the corresponding global protection parameter. If the signal becomes true, those modules/stages are blocked that are parameterized "ExBlo Fc=active".</i>	

LoE-Z2[1] . Blo TripCmd		[Protection Para / Set 1...4 / LoE-Prot / LoE-Z2[1]]
inactive	inactive, active	P.2
	↳ Mode.	
	<i>Permanent blocking of the Trip Command of the module/stage.</i>	



LoE-Z2[1] . ExBlo TripCmd Fc		[Protection Para / Set 1...4 / LoE-Prot / LoE-Z2[1]]
inactive	inactive, active	P.2
	↳ active/inactive.	
	<i>Activate (allow) or inactivate (disallow) blocking of the module/stage. This parameter is only effective if a signal is assigned to the corresponding global protection parameter. If the signal becomes true, those modules/stages are blocked that are parameterized "ExBlo TripCmd Fc=active".</i>	

LoE-Z2[1] . Meas Circuit Superv		[Protection Para / Set 1...4 / LoE-Prot / LoE-Z2[1]]
Sys . inactive	Sys . inactive, LOP . active	P.2
	↳ VTS Block.	
	<i>Activates the use of the measuring circuit supervision. In this case the module will be blocked if a measuring circuit supervision module (e.g. LOP, VTS) signals a disturbed measuring circuit (e.g. caused by a fuse failure).</i>	



LoE-Z2[1] . Mho Diameter		[Protection Para / Set 1...4 / LoE-Prot / LoE-Z2[1]]
25.0Ω	If: CT Ntrl . CT sec = 1A <ul style="list-style-type: none"> • 1.0Ω ... 750.0Ω If: CT Ntrl . CT sec = 5A <ul style="list-style-type: none"> • 0.2Ω ... 150.0Ω 	P.2
	<i>Mho Zone diameter in ohm (secondary value). Diameter of the impedance circle.</i>	

LoE-Z2[1] . Mho Offset	[Protection Para / Set 1...4 / LoE-Prot / LoE-Z2[1]]	
-2.5Ω	If: CT Ntrl . CT sec = 1A <ul style="list-style-type: none"> -250.0Ω ... +250.0Ω If: CT Ntrl . CT sec = 5A <ul style="list-style-type: none"> -50.0Ω ... +50.0Ω 	P.2
 <i>Mho Zone offset reactance in ohm (secondary value).</i>		

LoE-Z2[1] . t-Z	[Protection Para / Set 1...4 / LoE-Prot / LoE-Z2[1]]	
60.0s	0.00s ... 400.00s	P.2
 <i>Mho Zone pickup time delay.</i>		

LoE-Z2[1] . Z directional	[Protection Para / Set 1...4 / LoE-Prot / LoE-Z2[1]]	
inactive	inactive, active  Mode.	P.2
 <i>Mho Zone Directional Supervision active or inactive.</i>		

LoE-Z2[1] . Z dir Angle	[Protection Para / Set 1...4 / LoE-Prot / LoE-Z2[1]]	
-10°	-20° ... 0°	P.2
 <i>Mho Zone Directional Supervision Angle.</i>		

LoE-Z2[1] . FastTrip V<	[Protection Para / Set 1...4 / LoE-Prot / LoE-Z2[1]]	
active	inactive, active  Mode.	P.2
 <i>Mho Zone Accelerated trip for loss of voltage active or inactive.</i>		

LoE-Z2[1] . V<	[Protection Para / Set 1...4 / LoE-Prot / LoE-Z2[1]]	
0.80Vn	0.01Vn ... 2.00Vn	P.2
 <i>Mho Zone Voltage pickup level</i>		

LoE-Z2[1] . t-V<	[Protection Para / Set 1...4 / LoE-Prot / LoE-Z2[1]]	
1.0s	0.00s ... 300.00s	P.2
 <i>Trip Delay for the Undervoltage</i>		

9.32.4 LoE-Z2[1]: Input States

LoE-Z2[1] . ExBlo1-I	[Operation / Status Display / LoE-Prot / LoE-Z2[1]]
↓	<i>Module input state: External blocking1</i>
LoE-Z2[1] . ExBlo2-I	[Operation / Status Display / LoE-Prot / LoE-Z2[1]]
↓	<i>Module input state: External blocking2</i>
LoE-Z2[1] . ExBlo TripCmd-I	[Operation / Status Display / LoE-Prot / LoE-Z2[1]]
↓	<i>Module input state: External Blocking of the Trip Command</i>

9.32.5 LoE-Z2[1]: Signals (Output States)

LoE-Z2[1] . active	[Operation / Status Display / All Actives] [Operation / Status Display / LoE-Prot / LoE-Z2[1]]
↑	<i>Signal: active</i>
LoE-Z2[1] . Alarm	[Operation / Status Display / Alarms] [Operation / Status Display / LoE-Prot / LoE-Z2[1]]
↑	<i>Signal: Alarm Loss of Excitation</i>
LoE-Z2[1] . Trip	[Operation / Status Display / Trips] [Operation / Status Display / LoE-Prot / LoE-Z2[1]]
↑	<i>Signal: Trip</i>
LoE-Z2[1] . TripCmd	[Operation / Status Display / TripCmds] [Operation / Status Display / LoE-Prot / LoE-Z2[1]]
↑	<i>Signal: Trip Command</i>
LoE-Z2[1] . ExBlo	[Operation / Status Display / LoE-Prot / LoE-Z2[1]]
↑	<i>Signal: External Blocking</i>
LoE-Z2[1] . Blo TripCmd	[Operation / Status Display / LoE-Prot / LoE-Z2[1]]
↑	<i>Signal: Trip Command blocked</i>

LoE-Z2[1] . ExBlo TripCmd	[Operation / Status Display / LoE-Prot / LoE-Z2[1]]
⬆	<i>Signal: External Blocking of the Trip Command</i>
LoE-Z2[1] . FastTrip V<	[Operation / Status Display / LoE-Prot / LoE-Z2[1]]
⬆	<i>Signal: FastTrip V<</i>
LoE-Z2[1] . Blo by MeasCircSupv	[Operation / Status Display / LoE-Prot / LoE-Z2[1]]
⬆	<i>Blocked by Measuring Circuit Supervision</i>

9.33 OST

Out of Step Tripping

9.33.1 OST: Device Planning Parameters

OST . Mode	[Device planning]	
"_"	"_" , use ↳ Device planning.	S.3
	<i>Out of Step Tripping, general operation mode</i>	



9.33.2 OST: Global Parameters



OST . ExBlo1	[Protection Para / Global Prot Para / OST]	
OST . ExBlo2		
"_"	"_" ... Sys . Internal test state ↳ 1..n, Assignment List.	P.2
	<i>External blocking of the module, if blocking is activated (allowed) within a parameter set and if the state of the assigned signal is true.</i>	



OST . ExBlo TripCmd	[Protection Para / Global Prot Para / OST]	
"_"	"_" ... Sys . Internal test state ↳ 1..n, Assignment List.	P.2
	<i>External blocking of the Trip Command of the module/the stage, if blocking is activated (allowed) within a parameter set and if the state of the assigned signal is true.</i>	



9.33.3 OST: Setting Group Parameters

OST . Function	[Protection Para / Set 1...4 / OST / General Settings]	
inactive	inactive, active ↳ Mode.	P.2
	<i>Permanent activation or deactivation of module/stage.</i>	

OST . ExBlo Fc	[Protection Para / Set 1...4 / OST / General Settings]	
inactive	inactive, active  active/inactive.	P.2
	<i>Activate (allow) or inactivate (disallow) blocking of the module/stage. This parameter is only effective if a signal is assigned to the corresponding global protection parameter. If the signal becomes true, those modules/stages are blocked that are parameterized "ExBlo Fc=active".</i>	

OST . Blo TripCmd	[Protection Para / Set 1...4 / OST / General Settings]	
inactive	inactive, active  Mode.	P.2
	<i>Permanent blocking of the Trip Command of the module/stage.</i>	

OST . ExBlo TripCmd Fc	[Protection Para / Set 1...4 / OST / General Settings]	
inactive	inactive, active  active/inactive.	P.2
	<i>Activate (allow) or inactivate (disallow) blocking of the module/stage. This parameter is only effective if a signal is assigned to the corresponding global protection parameter. If the signal becomes true, those modules/stages are blocked that are parameterized "ExBlo TripCmd Fc=active".</i>	

OST . Meas Circuit Superv	[Protection Para / Set 1...4 / OST / General Settings]	
Sys . inactive	Sys . inactive, LOP . active  VTS Block.	P.2
	<i>Activates the use of the measuring circuit supervision. In this case the module will be blocked if a measuring circuit supervision module (e.g. LOP, VTS) signals a disturbed measuring circuit (e.g. caused by a fuse failure).</i>	

OST . I1 min	[Protection Para / Set 1...4 / OST / General Settings]	
0.20In	0.02In ... 4.00In	P.2
	<i>Minimum value positive phase sequence current</i>	



OST . I2 max	[Protection Para / Set 1...4 / OST / General Settings]	
0.20In	0.02In ... 1.00In	P.2
	<i>Maximum value negative sequence current</i>	

OST . Min. dwell time	[Protection Para / Set 1...4 / OST / General Settings]	
0.100s	0.020s ... 0.200s	P.2
	<i>Minimum dwell time within the impedance zone (characteristic). This timer is essential to enable the device to distinguish between a power swing and a system fault. If the measured impedance crosses the first blinder before this timer has expired, the event will be declared as a system fault and not as power swing. This has the consequence that the function is blocked until the impedance has left the MHO circle again.</i>	

OST . Max. dwell time	[Protection Para / Set 1...4 / OST / General Settings]	
10.00s	0.20s ... 20.00s	P.2
	<i>Maximum dwell time within the impedance zone (characteristic). (Above this time the slip frequency is assumed to be implausibly low.)</i>	

OST . Max.Num.Pole Slips	[Protection Para / Set 1...4 / OST / General Settings]	
1	1 ... 20	P.2
	<i>Maximum number of pole slips that are accepted, i. e. above this number a trip decision is made. This counter is reset always after the duration »Reset Time« if there has not been a new pole slip during this time.</i>	

OST . Reset Time	[Protection Para / Set 1...4 / OST / General Settings]	
10.00s	0.20s ... 100.00s	P.2
	<i>Counting of pole slip events is reset after this time. (The timer is started with every detected event.) Note that this time should be set equal or greater than the pole slip cycle time.</i>	

OST . Blo by dZ/dt	[Protection Para / Set 1...4 / OST / General Settings]	
inactive	inactive, active  Mode.	P.2
	<i>Activate (allow) or inactivate (disallow) blocking of the module if the »dZ/dt« limit is exceeded.</i>	

OST . dZ/dt	[Protection Para / Set 1...4 / OST / General Settings]	
300Ω/s	If: CT Ntrl . CT sec = 1A <ul style="list-style-type: none"> • 10.0Ω/s ... 1000.0Ω/s If: CT Ntrl . CT sec = 5A <ul style="list-style-type: none"> • 2.0Ω/s ... 300.0Ω/s 	P.2
	<i>Rate of impedance change per time (secondary value). This setting is essential to enable the device to distinguish between a power swing and a system fault.</i>	

OST . Trip delay time	[Protection Para / Set 1...4 / OST / General Settings]	
0.00s	0.00s ... 1.00s	P.2
 <i>Trip Delay Timer</i>		

OST . Trip duration time	[Protection Para / Set 1...4 / OST / General Settings]	
0.10s	0.05s ... 1.00s	P.2
 <i>Trip duration time</i>		

OST . Mho Pos.Imp.Reach	[Protection Para / Set 1...4 / OST / Characteristic]	
10.0Ω	If: CT Ntrl . CT sec = 1A • 1.0Ω ... 750.0Ω If: CT Ntrl . CT sec = 5A • 0.2Ω ... 150.0Ω	P.2
 <i>MHO characteristic: Positive Impedance Reach (secondary value).</i>		

OST . Mho Pos.Imp.Angle	[Protection Para / Set 1...4 / OST / Characteristic]	
90°	60° ... 90°	P.2
 <i>MHO characteristic: Positive Impedance Angle</i>		

OST . Mho Offs.Imp.Reach	[Protection Para / Set 1...4 / OST / Characteristic]	
10.0Ω	If: CT Ntrl . CT sec = 1A • 1.0Ω ... 750.0Ω If: CT Ntrl . CT sec = 5A • 0.2Ω ... 150.0Ω	P.2
 <i>MHO characteristic: Offset Impedance Reach (secondary value).</i>		

OST . Mho Offs.Imp.Angle	[Protection Para / Set 1...4 / OST / Characteristic]	
270°	240° ... 270°	P.2
 <i>MHO characteristic: Offset Impedance Angle</i>		

OST . Blinder A	[Protection Para / Set 1...4 / OST / Characteristic]
-2.5Ω	If: CT Ntrl . CT sec = 1A • -375.0Ω ... 0.0Ω If: CT Ntrl . CT sec = 5A • -75.0Ω ... 0.0Ω
	<i>Blinder (left) of the impedance zone (characteristic), defined as a value on the R-axis (secondary value).</i>

OST . Blinder B	[Protection Para / Set 1...4 / OST / Characteristic]
2.5Ω	If: CT Ntrl . CT sec = 1A • 0.0Ω ... 375.0Ω If: CT Ntrl . CT sec = 5A • 0.0Ω ... 75.0Ω
	<i>Blinder (right) of the impedance zone (characteristic), defined as a value on the R-axis (secondary value).</i>

9.33.4 OST: Input States

OST . ExBlo1-I	[Operation / Status Display / OST]
	<i>Module input state: External blocking1</i>

OST . ExBlo2-I	[Operation / Status Display / OST]
	<i>Module input state: External blocking2</i>

OST . ExBlo TripCmd-I	[Operation / Status Display / OST]
	<i>Module input state: External Blocking of the Trip Command</i>

9.33.5 OST: Signals (Output States)

OST . active	[Operation / Status Display / All Actives] [Operation / Status Display / OST]
	<i>Signal: active</i>

OST . Alarm	[Operation / Status Display / Alarms] [Operation / Status Display / OST]
↑	<i>Signal that the module has started, i. e. the impedance has entered the MHO circle and crossed the first blinder. »Alarm« is reset when the measured impedance has left the MHO circle without an »Operate«, or when the »Trip« signal is reset. If »Max.Num.Pole Slips« is greater than 1, the »Alarm« signal stays active until the »Trip« signal is reset or the »Reset Time« has expired.</i>
OST . Trip	[Operation / Status Display / Trips] [Operation / Status Display / OST]
↑	<i>Signal: Trip</i>
OST . TripCmd	[Operation / Status Display / TripCmds] [Operation / Status Display / OST]
↑	<i>Signal: Trip Command</i>
OST . ExBlo	[Operation / Status Display / OST]
↑	<i>Signal: External Blocking</i>
OST . Blo TripCmd	[Operation / Status Display / OST]
↑	<i>Signal: Trip Command blocked</i>
OST . ExBlo TripCmd	[Operation / Status Display / OST]
↑	<i>Signal: External Blocking of the Trip Command</i>
OST . Blo by MeasCircSupv	[Operation / Status Display / OST]
↑	<i>Blocked by Measuring Circuit Supervision</i>
OST . Int.blocked	[Operation / Status Display / OST]
↑	<i>Signal: The module is internally blocked because the »Max. dwell time« has expired.</i>
OST . Pickup Blinder A	[Operation / Status Display / OST]
↑	<i>Signal: The impedance is within the MHO circle on the right side of Blinder A.</i>
OST . Pickup Blinder B	[Operation / Status Display / OST]
↑	<i>Signal: The impedance is within the MHO circle on the left side of Blinder B.</i>

OST . Pickup Mho	[Operation / Status Display / OST]
⬇	<i>Signal: The impedance is within the characteristic.</i>
OST . Swinging	[Operation / Status Display / OST]
⬇	<i>Signal: The impedance is within the instable swing zone (i. e. within the characteristic and inside the borders defined by Blinders A and B).</i>
OST . Start	[Operation / Status Display / OST]
⬇	<i>Signal, that a power swing (or an Out-of-step event) has been detected. The state of this signal becomes true as soon as the impedance traverses the first blinder, and it gets reset when the characteristic area is left.</i>
OST . Pole slipping	[Operation / Status Display / OST]
⬇	<i>Signal, that pole slipping has been detected. The state of this signal becomes true as soon as the impedance reaches 180°, and it gets reset when the characteristic area is left.</i>
OST . Operate	[Operation / Status Display / OST]
⬇	<i>Signal: The module is ready to send a trip command. The state of this signal becomes true as soon as the impedance traverses the second blinder, and it gets reset after the impedance has left the MHO circle.</i>
OST . Syst.is sym.	[Operation / Status Display / OST]
⬇	<i>Signal that the system state is symmetrical, i. e. the negative-sequence current is below »I2 max«, and the positive-sequence current is above »I1 min«.</i>
OST . Blo dZ/dt	[Operation / Status Display / OST]
⬇	<i>Signal: The module has detected a system fault based on the »rate of impedance change per time«, and therefore it has blocked itself.</i>
OST . Blo min.dwell time	[Operation / Status Display / OST]
⬇	<i>Signal: The module has detected a system fault based on the »minimum dwell time«, and therefore it has blocked itself.</i>

9.34 V/f>[1] ... V/f>[2]

Overexcitation

9.34.1 V/f>[1]: Device Planning Parameters

V/f>[1] . Mode	[Device planning]	
"_"	"_" , use ↳ Mode.	S.3
	<i>Overexcitation, general operation mode</i>	

9.34.2 V/f>[1]: Global Parameters

V/f>[1] . ExBlo1	[Protection Para / Global Prot Para / V/f>-Prot / V/f>[1]]	
V/f>[1] . ExBlo2		
"_"	"_" ... Sys . Internal test state ↳ 1..n, Assignment List.	P.2
	<i>External blocking of the module, if blocking is activated (allowed) within a parameter set and if the state of the assigned signal is true.</i>	

V/f>[1] . ExBlo TripCmd	[Protection Para / Global Prot Para / V/f>-Prot / V/f>[1]]	
"_"	"_" ... Sys . Internal test state ↳ 1..n, Assignment List.	P.2
	<i>External blocking of the Trip Command of the module/the stage, if blocking is activated (allowed) within a parameter set and if the state of the assigned signal is true.</i>	

9.34.3 V/f>[1]: Setting Group Parameters

V/f>[1] . Function	[Protection Para / Set 1...4 / V/f>-Prot / V/f>[1]]	
inactive	inactive, active ↳ Mode.	P.2
	<i>Permanent activation or deactivation of module/stage.</i>	

V/f>[1] . ExBlo Fc	[Protection Para / Set 1...4 / V/f>-Prot / V/f>[1]]	
inactive	inactive, active ↳ active/inactive.	P.2
	<i>Activate (allow) or inactivate (disallow) blocking of the module/stage. This parameter is only effective if a signal is assigned to the corresponding global protection parameter. If the signal becomes true, those modules/stages are blocked that are parameterized "ExBlo Fc=active".</i>	

V/f>[1] . Blo TripCmd	[Protection Para / Set 1...4 / V/f>-Prot / V/f>[1]]	
inactive	inactive, active ↳ Mode.	P.2
	<i>Permanent blocking of the Trip Command of the module/stage.</i>	

V/f>[1] . ExBlo TripCmd Fc	[Protection Para / Set 1...4 / V/f>-Prot / V/f>[1]]	
inactive	inactive, active ↳ active/inactive.	P.2
	<i>Activate (allow) or inactivate (disallow) blocking of the module/stage. This parameter is only effective if a signal is assigned to the corresponding global protection parameter. If the signal becomes true, those modules/stages are blocked that are parameterized "ExBlo TripCmd Fc=active".</i>	

V/f>[1] . V/f>	[Protection Para / Set 1...4 / V/f>-Prot / V/f>[1]]	
100.0%	80.0% ... 400.0%	P.2
	<i>If the value is exceeded, the element will be started.</i>	

V/f>[1] . Curve Shape	[Protection Para / Set 1...4 / V/f>-Prot / V/f>[1]]	
DEFT	DEFT, Inv A, Inv B, Inv C ↳ Tripping characteristics of V/f Over-Excitation protection..	P.2
	<i>Tripping characteristics of V/f Over-Excitation protection.</i>	

V/f>[1] . t	[Protection Para / Set 1...4 / V/f>-Prot / V/f>[1]]	
1.00s	0.00s ... 600.00s	P.2
	<i>Tripping delay</i>	

V/f>[1] . t-multiplier	[Protection Para / Set 1...4 / V/f>-Prot / V/f>[1]]
1.00	0.05 ... 600.00 P.2
	<i>Time Multiplier for inverse characteristics.</i>

V/f>[1] . t-reset	[Protection Para / Set 1...4 / V/f>-Prot / V/f>[1]]
1.0s	0.0s ... 1000.0s P.2
	<i>Reset time for inverse characteristics.</i>

9.34.4 V/f>[1]: Input States

V/f>[1] . ExBlo1-I	[Operation / Status Display / V/f>-Prot / V/f>[1]]
	<i>Module input state: External blocking1</i>

V/f>[1] . ExBlo2-I	[Operation / Status Display / V/f>-Prot / V/f>[1]]
	<i>Module input state: External blocking2</i>





V/f>[1] . ExBlo TripCmd-I	[Operation / Status Display / V/f>-Prot / V/f>[1]]
	<i>Module input state: External Blocking of the Trip Command</i>

9.34.5 V/f>[1]: Signals (Output States)

V/f>[1] . active	[Operation / Status Display / All Actives] [Operation / Status Display / V/f>-Prot / V/f>[1]]
	<i>Signal: active</i>

V/f>[1] . Alarm	[Operation / Status Display / Alarms] [Operation / Status Display / V/f>-Prot / V/f>[1]]
	<i>Signal: Alarm Overexcitation</i>

V/f>[1] . Trip	[Operation / Status Display / Trips] [Operation / Status Display / V/f>-Prot / V/f>[1]]
	<i>Signal: Trip</i>

V/f>[1] . TripCmd	[Operation / Status Display / TripCmds] [Operation / Status Display / V/f>-Prot / V/f>[1]]
 <i>Signal: Trip Command</i>	
V/f>[1] . ExBlo	[Operation / Status Display / V/f>-Prot / V/f>[1]]
 <i>Signal: External Blocking</i>	
V/f>[1] . Blo TripCmd	[Operation / Status Display / V/f>-Prot / V/f>[1]]
 <i>Signal: Trip Command blocked</i>	
V/f>[1] . ExBlo TripCmd	[Operation / Status Display / V/f>-Prot / V/f>[1]]
 <i>Signal: External Blocking of the Trip Command</i>	

9.35 InEn

Inadvertent Energization

9.35.1 InEn: Device Planning Parameters

InEn . Mode	[Device planning]	
"_"	"_", use ↳ Mode.	S.3
 <i>general operation mode</i>		



9.35.2 InEn: Global Parameters



InEn . ExBlo1	[Protection Para / Global Prot Para / InEn]	
InEn . ExBlo2		
"_"	"_" ... Sys . Internal test state ↳ 1..n, Assignment List.	P.2
 <i>External blocking of the module, if blocking is activated (allowed) within a parameter set and if the state of the assigned signal is true.</i>		



InEn . ExBlo TripCmd	[Protection Para / Global Prot Para / InEn]	
"_"	"_" ... Sys . Internal test state ↳ 1..n, Assignment List.	P.2
 <i>External blocking of the Trip Command of the module/the stage, if blocking is activated (allowed) within a parameter set and if the state of the assigned signal is true.</i>		



InEn . Assigned SG	[Protection Para / Global Prot Para / InEn]	
SG[1] . Pos	"_", SG[1] . Pos, SG[2] . Pos, SG[3] . Pos, SG[4] . Pos, SG[5] . Pos, SG[6] . Pos ↳ CB Manager.	P.2
 <i>Assigned Switchgear</i>		



9.35.3 InEn: Setting Group Parameters

InEn . Function	[Protection Para / Set 1...4 / InEn]
inactive	inactive, active  Mode.
	<i>Permanent activation or deactivation of module/stage.</i>

InEn . ExBlo Fc	[Protection Para / Set 1...4 / InEn]
inactive	inactive, active  active/inactive.
	<i>Activate (allow) or inactivate (disallow) blocking of the module/stage. This parameter is only effective if a signal is assigned to the corresponding global protection parameter. If the signal becomes true, those modules/stages are blocked that are parameterized "ExBlo Fc=active".</i>

InEn . Blo TripCmd	[Protection Para / Set 1...4 / InEn]
inactive	inactive, active  Mode.
	<i>Permanent blocking of the Trip Command of the module/stage.</i>

InEn . ExBlo TripCmd Fc	[Protection Para / Set 1...4 / InEn]
inactive	inactive, active  active/inactive.
	<i>Activate (allow) or inactivate (disallow) blocking of the module/stage. This parameter is only effective if a signal is assigned to the corresponding global protection parameter. If the signal becomes true, those modules/stages are blocked that are parameterized "ExBlo TripCmd Fc=active".</i>



InEn . Arming Signal	[Protection Para / Set 1...4 / InEn]
U/V and Offline	U/V and Offline, U/V or Offline  Arming Signal.
	<i>Select if the protection is going to be enabled by "U/V and offline" or "U/V or offline".</i>

InEn . O/C Pickup	[Protection Para / Set 1...4 / InEn]	
0.05In	0.05In ... 3.00In	P.2
	<i>Typical pickup setting is 0.5 amps. No coordination is required with other protection since this function is only operational when the generator is off-line.</i>	

InEn . U/V Pickup	[Protection Para / Set 1...4 / InEn]	
0.5Vn	0.20Vn ... 0.99Vn	P.2
	<i>The purpose of the undervoltage detector is to determine whether the unit is connected to the system. The voltage level during this accidental energization depends on the system strength. Typical setting is 50%-70% of rated voltage (in some cases, it may be set as low as 20%).</i>	

InEn . Pickup Delay	[Protection Para / Set 1...4 / InEn]	
5.00s	0.00s ... 300.00s	P.2
	<i>The pickup time delay is the time for the undervoltage unit to operate to arm the protection.</i>	

InEn . Dropout Delay	[Protection Para / Set 1...4 / InEn]	
0.25s	0.00s ... 300.00s	P.2
	<i>The dropout time delay is the time for the unit to operate to disarm the protection when the voltage is increased above the pickup value or the generator is brought on-line.</i>	

InEn . Meas Circuit Superv	[Protection Para / Set 1...4 / InEn]	
Sys . inactive	Sys . inactive, LOP . active  VTS Block.	P.2
	<i>Activates the use of the measuring circuit supervision. In this case the module will be blocked if a measuring circuit supervision module (e.g. LOP, VTS) signals a disturbed measuring circuit (e.g. caused by a fuse failure).</i>	

9.35.4 InEn: Input States

InEn . ExBlo1-I	[Operation / Status Display / InEn]	
	<i>Module input state: External blocking1</i>	

InEn . ExBlo2-I	[Operation / Status Display / InEn]	
	<i>Module input state: External blocking2</i>	

InEn . ExBlo TripCmd-I	[Operation / Status Display / InEn]
 <i>Module input state: External Blocking of the Trip Command</i>	

9.35.5 InEn: Signals (Output States)

InEn . active	[Operation / Status Display / All Actives] [Operation / Status Display / InEn]
 <i>Signal: active</i>	

InEn . Alarm	[Operation / Status Display / Alarms] [Operation / Status Display / InEn]
 <i>Signal: Inadvertent Energization</i>	

InEn . Trip	[Operation / Status Display / Trips] [Operation / Status Display / InEn]
 <i>Signal: Trip</i>	

InEn . TripCmd	[Operation / Status Display / TripCmds] [Operation / Status Display / InEn]
 <i>Signal: Trip Command</i>	

InEn . ExBlo	[Operation / Status Display / InEn]
 <i>Signal: External Blocking</i>	

InEn . Blo TripCmd	[Operation / Status Display / InEn]
 <i>Signal: Trip Command blocked</i>	



InEn . ExBlo TripCmd	[Operation / Status Display / InEn]
 <i>Signal: External Blocking of the Trip Command</i>	

InEn . Blo by MeasCircSupv	[Operation / Status Display / InEn]
 <i>Blocked by Measuring Circuit Supervision</i>	



9.36 Z[1] ... Z[2]



Phase Distance Protection



9.36.1 Z[1]: Device Planning Parameters

Z[1] . Mode	[Device planning]	
"_"	"_" , use  Device planning.	S.3
	Phase Distance Protection, general operation mode	

9.36.2 Z[1]: Global Parameters

Z[1] . ExBlo1	[Protection Para / Global Prot Para / Z / Z[1]]	
Z[1] . ExBlo2		
"_"	"_" ... Sys . Internal test state  1..n, Assignment List.	P.2
	External blocking of the module, if blocking is activated (allowed) within a parameter set and if the state of the assigned signal is true.	

Z[1] . ExBlo TripCmd	[Protection Para / Global Prot Para / Z / Z[1]]	
"_"	"_" ... Sys . Internal test state  1..n, Assignment List.	P.2
	External blocking of the Trip Command of the module/the stage, if blocking is activated (allowed) within a parameter set and if the state of the assigned signal is true.	



Z[1] . Blo by Power Swing	[Protection Para / Global Prot Para / Z / Z[1]]	
"_"	"_" ... Logics . LE80.Out inverted  .	P.2
	Blo by Power Swing	

Z[1] . Blo by LB		[Protection Para / Global Prot Para / Z / Z[1]]
"_"	"_" ... Logics . LE80.Out inverted ↳ .	P.2
	<i>Blocking of the distance protection module, if the state of the assigned signal (in general this is the Operate signal from the Load Blinder module) is true.</i>	

Z[1] . AdaptSet 1		[Protection Para / Global Prot Para / Z / Z[1]]
"_"	"_" ... Logics . LE80.Out inverted ↳ AdaptSet.	P.2
	<i>Assignment Adaptive Parameter 1</i>	

Z[1] . AdaptSet 2		[Protection Para / Global Prot Para / Z / Z[1]]
"_"	"_" ... Logics . LE80.Out inverted ↳ AdaptSet.	P.2
	<i>Assignment Adaptive Parameter 2</i>	

9.36.3 Z[1]: Setting Group Parameters



Z[1] . Function	[Protection Para / Set 1...4 / Z / Z[1] / General Settings]	
inactive	If: Transformer . Phase Shift = 0 <ul style="list-style-type: none"> • inactive, active If: Transformer . Phase Shift = 1 <ul style="list-style-type: none"> • inactive, active If: Transformer . Phase Shift = 2 <ul style="list-style-type: none"> • inactive, active If: Transformer . Phase Shift = 3 <ul style="list-style-type: none"> • inactive If: Transformer . Phase Shift = 4 <ul style="list-style-type: none"> • inactive, active If: Transformer . Phase Shift = 5 <ul style="list-style-type: none"> • inactive, active If: Transformer . Phase Shift = 6 <ul style="list-style-type: none"> • inactive, active If: Transformer . Phase Shift = 7 <ul style="list-style-type: none"> • inactive, active If: Transformer . Phase Shift = 8 <ul style="list-style-type: none"> • inactive, active If: Transformer . Phase Shift = 9 <ul style="list-style-type: none"> • inactive If: Transformer . Phase Shift = 10 <ul style="list-style-type: none"> • inactive, active If: Transformer . Phase Shift = 11 <ul style="list-style-type: none"> • inactive, active  Mode.	P.2
 <i>Permanent activation or deactivation of module/stage.</i>		

Z[1] . ExBlo Fc	[Protection Para / Set 1...4 / Z / Z[1] / General Settings]	
inactive	inactive, active ↳ active/inactive.	P.2
	<i>Activate (allow) or inactivate (disallow) blocking of the module/stage. This parameter is only effective if a signal is assigned to the corresponding global protection parameter. If the signal becomes true, those modules/stages are blocked that are parameterized "ExBlo Fc=active".</i>	

Z[1] . Blo TripCmd	[Protection Para / Set 1...4 / Z / Z[1] / General Settings]	
inactive	inactive, active ↳ Mode.	P.2
	<i>Permanent blocking of the Trip Command of the module/stage.</i>	

Z[1] . ExBlo TripCmd Fc	[Protection Para / Set 1...4 / Z / Z[1] / General Settings]	
inactive	inactive, active ↳ active/inactive.	P.2
	<i>Activate (allow) or inactivate (disallow) blocking of the module/stage. This parameter is only effective if a signal is assigned to the corresponding global protection parameter. If the signal becomes true, those modules/stages are blocked that are parameterized "ExBlo TripCmd Fc=active".</i>	

Z[1] . Meas Circuit Superv	[Protection Para / Set 1...4 / Z / Z[1] / General Settings]	
Sys . inactive	Sys . inactive, LOP . active ↳ VTS Block.	P.2
	<i>Activates the use of the measuring circuit supervision. In this case the module will be blocked if a measuring circuit supervision module (e.g. LOP, VTS) signals a disturbed measuring circuit (e.g. caused by a fuse failure).</i>	

Z[1] . Trip delay time	[Protection Para / Set 1...4 / Z / Z[1] / General Settings]	
0.50s	0.00s ... 300.00s	P.2
	Adapt. Param.	
	<i>This specifies the delay from pickup to CB tripping. (Note that since the phase distance protection is mainly used as a backup this time delay should be coordinated carefully with the primary tripping time and the latency of CB failure protection.)</i>	

Z[1] . Start condition	[Protection Para / Set 1...4 / Z / Z[1] / Threshold Settings]	
Overcurrent	Overcurrent, Overcur & Undervlt, Underimpedance	P.2
	↳ Start condition.	
 Select the start criterion for the measurement of the fault impedances.		

Z[1] . I > Str	[Protection Para / Set 1...4 / Z / Z[1] / Threshold Settings]	
1.00In	0.02In ... 20.00In	P.2
<i>Only available if:</i> <ul style="list-style-type: none"> • Z[1] . Start condition = Overcurrent • Z[1] . Start condition = Overcur & Undervlt 		
⊕ Adapt. Param.		
 Limit value for »Start condition« = "Overcurrent": The start criterion is fulfilled if the maximum measured phase current exceeds this value.		

Z[1] . Voltage type	[Protection Para / Set 1...4 / Z / Z[1] / Threshold Settings]	
Phase to Ground	Phase to Ground, Phase to Phase	P.2
<i>Only available if:</i> <ul style="list-style-type: none"> • Z[1] . Start condition = Overcur & Undervlt 	↳ Measuring Mode.	
⊕ Adapt. Param.		
 Option for »Start condition« = "Overcur & Undervlt": Select whether phase-to-phase or phase-to-ground voltages shall be used for the undervoltage criterion.		

Z[1] . V < Str	[Protection Para / Set 1...4 / Z / Z[1] / Threshold Settings]	
0.80Vn	0.01Vn ... 2.00Vn	P.2
<i>Only available if:</i> <ul style="list-style-type: none"> • Z[1] . Start condition = Overcur & Undervlt 		
⊕ Adapt. Param.		
 Limit value for »Start condition« = "Overcur & Undervlt": The start criterion is fulfilled if the maximum measured phase current exceeds »I > Str« and the minimum measured voltage is below this value.		

Z[1] . Z < Str	[Protection Para / Set 1...4 / Z / Z[1] / Threshold Settings]
20.0Ω <i>Only available if:</i> <ul style="list-style-type: none"> Z[1] . Start condition = Underimpedance ↻ Adapt. Param.	If: CT Ntrl . CT sec = 1A <ul style="list-style-type: none"> 1.0Ω ... 750.0Ω If: CT Ntrl . CT sec = 5A <ul style="list-style-type: none"> 0.2Ω ... 150.0Ω
ⓘ <i>Limit value for »Start condition« = "Underimpedance": The start criterion is fulfilled if the corresponding measured loop impedance (secondary value) is below this limit.</i>	

Z[1] . Type of imp. area	[Protection Para / Set 1...4 / Z / Z[1] / Characteristic]
MHO	MHO, Polygon ↳ Type of imp. area.
ⓘ <i>Select whether the impedance characteristic shall be of type MHO or polygon.</i>	

Z[1] . Mho Pos.Imp.Reach	[Protection Para / Set 1...4 / Z / Z[1] / Characteristic]
10.0Ω <i>Only available if:</i> <ul style="list-style-type: none"> Z[1] . Type of imp. area = MHO ↻ Adapt. Param.	If: CT Ntrl . CT sec = 1A <ul style="list-style-type: none"> 1.0Ω ... 750.0Ω If: CT Ntrl . CT sec = 5A <ul style="list-style-type: none"> 0.2Ω ... 150.0Ω
ⓘ <i>MHO characteristic: Positive Impedance Reach (secondary value).</i>	

Z[1] . Mho Pos.Imp.Angle	[Protection Para / Set 1...4 / Z / Z[1] / Characteristic]
60° <i>Only available if:</i> <ul style="list-style-type: none"> Z[1] . Type of imp. area = MHO ↻ Adapt. Param.	0° ... 90°
ⓘ <i>MHO characteristic: Positive Impedance Angle</i>	

Z[1] . Mho Offs.Imp.Reach	[Protection Para / Set 1...4 / Z / Z[1] / Characteristic]
1.50Ω	If: CT Ntrl . CT sec = 1A
<i>Only available if:</i>	• 0.0Ω ... 750.0Ω
• Z[1] . Type of imp. area = MHO	If: CT Ntrl . CT sec = 5A
⊕ Adapt. Param.	• 0.0Ω ... 150.0Ω
	If: CT Ntrl . CT sec = 5A
	• 0.0Ω ... 150.0Ω
 MHO characteristic: Offset Impedance Reach (secondary value).	

Z[1] . Mho Offs.Imp.Angle	[Protection Para / Set 1...4 / Z / Z[1] / Characteristic]
240°	0° ... 360°
<i>Only available if:</i>	
• Z[1] . Type of imp. area = MHO	
⊕ Adapt. Param.	
 MHO characteristic: Offset Impedance Angle	

Z[1] . Polyg.Pos.Imp.Reach	[Protection Para / Set 1...4 / Z / Z[1] / Characteristic]
10.0Ω	If: CT Ntrl . CT sec = 1A
<i>Only available if:</i>	• 1.0Ω ... 500.0Ω
• Z[1] . Type of imp. area = Polygon	If: CT Ntrl . CT sec = 5A
⊕ Adapt. Param.	• 0.2Ω ... 100.0Ω
 Polygon characteristic: The »Positive Impedance Reach« is the amplitude of the positive impedance phasor (secondary value) in the forward direction (first quadrant). This impedance phasor corresponds usually to the line impedance which is protected by distance protection.	

Z[1] . Polyg.Pos.Imp.Angle	[Protection Para / Set 1...4 / Z / Z[1] / Characteristic]	
60° Only available if: • Z[1] . Type of imp. area = Polygon ⊕ Adapt. Param.	45° ... 90°	P.2
<p> Polygon characteristic: The »Positive Impedance Angle« is the angle of the positive impedance phasor in the forward direction (first quadrant). This corresponds usually to the angle of the line impedance which is protected by distance protection.</p>		

Z[1] . Polyg.Pos.Imp.R.Ang.1	[Protection Para / Set 1...4 / Z / Z[1] / Characteristic]	
0° Only available if: • Z[1] . Type of imp. area = Polygon ⊕ Adapt. Param.	-30° ... 5°	P.2
<p> Polygon characteristic: The »Positive Impedance Reach Angle 1« is the tilt angle of the line element which is starting at the positive impedance reach tip and spreads on the right side in the first quadrant.</p>		

Z[1] . Polyg.Pos.Imp.R.Ang.2	[Protection Para / Set 1...4 / Z / Z[1] / Characteristic]	
180° Only available if: • Z[1] . Type of imp. area = Polygon ⊕ Adapt. Param.	175° ... 210°	P.2
<p> Polygon characteristic: The »Positive Impedance Reach Angle 2« is the tilt angle of the line element which is starting at the positive impedance reach tip and spreads leftwards, to the second quadrant.</p>		

Z[1] . Polyg.Pos.Resis.Reach	[Protection Para / Set 1...4 / Z / Z[1] / Characteristic]	
8.0Ω	If: CT Ntrl . CT sec = 1A	P.2
Only available if:	• 1.0Ω ... 500.0Ω	
• Z[1] . Type of imp. area = Polygon	If: CT Ntrl . CT sec = 5A	
⊕ Adapt. Param.	• 0.2Ω ... 100.0Ω	
 Polygon characteristic: The »Positive Resistive Reach« determines the reach on the positive R-axis (secondary value) and is used to limit the coverage for fault resistance and encroachment of the load impedance into the characteristics.		

Z[1] . Polyg.Pos.Resis.Ang.1	[Protection Para / Set 1...4 / Z / Z[1] / Characteristic]	
60°	50° ... 90°	P.2
Only available if:		
• Z[1] . Type of imp. area = Polygon		
⊕ Adapt. Param.		
 Polygon characteristic: The »Positive Resistive Angle 1« is a tilt angle in the first quadrant. The area right from the blinder is excluded from the operating area.		

Z[1] . Polyg.Pos.Resis.Ang.2	[Protection Para / Set 1...4 / Z / Z[1] / Characteristic]	
240°	225° ... 270°	P.2
Only available if:		
• Z[1] . Type of imp. area = Polygon		
⊕ Adapt. Param.		
 Polygon characteristic: The »Positive Resistive Angle 2« is a tilt angle in the fourth quadrant.		

Z[1] . Polyg.Neg.Imp.Reach	[Protection Para / Set 1...4 / Z / Z[1] / Characteristic]	
2Ω	If: CT Ntrl . CT sec = 1A	P.2
Only available if:	• 1.0Ω ... 500.0Ω	
• Z[1] . Type of imp. area = Polygon	If: CT Ntrl . CT sec = 5A	
⊕ Adapt. Param.	• 0.2Ω ... 100.0Ω	
 Polygon characteristic: The »Negative Impedance Reach« is the amplitude of the negative impedance phasor (secondary value) in the reverse (backward) direction (3rd quadrant).		

Z[1] . Polyg.Neg.Imp.Angle	[Protection Para / Set 1...4 / Z / Z[1] / Characteristic]	
240° Only available if: • Z[1] . Type of imp. area = Polygon ⊕ Adapt. Param.	225° ... 270°	P.2
 Polygon characteristic: The »Negative Impedance Angle« defines the impedance angle in the reverse (backward) direction (third quadrant).		



Z[1] . Polyg.Neg.Imp.R.Ang.1	[Protection Para / Set 1...4 / Z / Z[1] / Characteristic]	
0° Only available if: • Z[1] . Type of imp. area = Polygon ⊕ Adapt. Param.	-30° ... 30°	P.2
 Polygon characteristic: The »Negative Impedance Reach Angle 1« is the tilt angle of the line element which is starting at the negative impedance reach tip and spreads to the right, i.e. into the fourth quadrant.		

Z[1] . Polyg.Neg.Imp.R.Ang.2	[Protection Para / Set 1...4 / Z / Z[1] / Characteristic]	
180° Only available if: • Z[1] . Type of imp. area = Polygon ⊕ Adapt. Param.	150° ... 180°	P.2
 Polygon characteristic: The »Negative Impedance Reach Angle 2« is the tilt angle of the line element which is starting at the negative impedance reach tip and spreads on the left side in the third quadrant.		

Z[1] . Polyg.Neg.Resis.Reach	[Protection Para / Set 1...4 / Z / Z[1] / Characteristic]	
1.6Ω	If: CT Ntrl . CT sec = 1A	P.2
<i>Only available if:</i>	<ul style="list-style-type: none"> • 1.0Ω ... 500.0Ω 	
<ul style="list-style-type: none"> • Z[1] . Type of imp. area = Polygon 	If: CT Ntrl . CT sec = 5A	
⊕ Adapt. Param.	<ul style="list-style-type: none"> • 0.2Ω ... 100.0Ω 	
 <i>Polygon characteristic: The »Negative Resistive Reach« determines the reach on the negative R-axis (secondary value).</i>		

Z[1] . Polyg.Neg.Resis.Ang.1	[Protection Para / Set 1...4 / Z / Z[1] / Characteristic]	
105°	60° ... 120°	P.2
<i>Only available if:</i>		
<ul style="list-style-type: none"> • Z[1] . Type of imp. area = Polygon 		
⊕ Adapt. Param.		
 <i>Polygon characteristic: The »Negative Resistive Angle 1« is a tilt angle in the second quadrant. The area left from the blinder is excluded from the operating area.</i>		

Z[1] . Polyg.Neg.Resis.Ang.2	[Protection Para / Set 1...4 / Z / Z[1] / Characteristic]	
270°	225° ... 270°	P.2
<i>Only available if:</i>		
<ul style="list-style-type: none"> • Z[1] . Type of imp. area = Polygon 		
⊕ Adapt. Param.		
 <i>Polygon characteristic: The »Negative Resistive Angle 2« is a tilt angle in the third quadrant. The area left from the blinder is excluded from the operating area.</i>		

Z[1] . Direction enable	[Protection Para / Set 1...4 / Z / Z[1] / Characteristic]	
inactive	inactive, active	P.2
⊕ Adapt. Param.	 active/inactive.	
 <i>Direction enable</i>		

Z[1] . Direction angle 1	[Protection Para / Set 1...4 / Z / Z[1] / Characteristic]
-30° <i>Only available if:</i> • Z[1] . Direction enable = active ⊕ Adapt. Param.	-90° ... 45° P.2
 <i>Angle that confines the impedance area. (Note that the angle is always measured counter-clockwise from the positive R-axis.)</i>	

Z[1] . Direction angle 2	[Protection Para / Set 1...4 / Z / Z[1] / Characteristic]
105° <i>Only available if:</i> • Z[1] . Direction enable = active ⊕ Adapt. Param.	95° ... 180° P.2
 <i>Angle that confines the impedance area. (Note that the angle is always measured counter-clockwise from the positive R-axis.)</i>	

9.36.4 Z[1]: Input States

Z[1] . ExBlo1-I	[Operation / Status Display / Z / Z[1]]
 <i>Module input state: External blocking1</i>	

Z[1] . ExBlo2-I	[Operation / Status Display / Z / Z[1]]
 <i>Module input state: External blocking2</i>	

Z[1] . ExBlo TripCmd-I	[Operation / Status Display / Z / Z[1]]
 <i>Module input state: External Blocking of the Trip Command</i>	

Z[1] . Blo by Power Swing-I	[Operation / Status Display / Z / Z[1]]
 <i>Module input state: Blocking (of the distance protection) by Power Swing detection</i>	

Z[1] . Blo by LB-I	[Operation / Status Display / Z / Z[1]]
 <i>Module input state: Blocking (of the distance protection) by Load Blinder module</i>	

Z[1] . AdaptSet1-I	[Operation / Status Display / Z / Z[1]]
 <i>Module input state: Adaptive Parameter1</i>	

Z[1] . AdaptSet2-I	[Operation / Status Display / Z / Z[1]]
 <i>Module input state: Adaptive Parameter2</i>	

9.36.5 Z[1]: Signals (Output States)

Z[1] . active	[Operation / Status Display / All Actives] [Operation / Status Display / Z / Z[1]]
 <i>Signal: active</i>	

Z[1] . Alarm	[Operation / Status Display / Alarms] [Operation / Status Display / Z / Z[1]]
 <i>Alarm</i>	

Z[1] . Trip	[Operation / Status Display / Trips] [Operation / Status Display / Z / Z[1]]
 <i>Trip</i>	

Z[1] . TripCmd	[Operation / Status Display / TripCmds] [Operation / Status Display / Z / Z[1]]
 <i>Signal: Trip Command</i>	

Z[1] . ExBlo	[Operation / Status Display / Z / Z[1]]
 <i>Signal: External Blocking</i>	

Z[1] . Blo TripCmd	[Operation / Status Display / Z / Z[1]]
 <i>Signal: Trip Command blocked</i>	



Z[1] . ExBlo TripCmd	[Operation / Status Display / Z / Z[1]]
 <i>Signal: External Blocking of the Trip Command</i>	

Z[1] . Blo by Power Swing	[Operation / Status Display / Z / Z[1]]
⤴	<i>Signal: Distance Protection blocked by Power Swing detection</i>
Z[1] . Blo by LB	[Operation / Status Display / Z / Z[1]]
⤴	<i>Signal: Distance Protection blocked by Load Blinder module</i>
Z[1] . Blo by MeasCircSupv	[Operation / Status Display / Z / Z[1]]
⤴	<i>Blocked by Measuring Circuit Supervision</i>
Z[1] . Started	[Operation / Status Display / Z / Z[1]]
⤴	<i>Signal: Distance Protection has been started.</i>
Z[1] . Fault type L1-L2	[Operation / Status Display / Z / Z[1]]
⤴	<i>Fault type: L1-L2</i>
Z[1] . Fault type L2-L3	[Operation / Status Display / Z / Z[1]]
⤴	<i>Fault type: L2-L3</i>
Z[1] . Fault type L3-L1	[Operation / Status Display / Z / Z[1]]
⤴	<i>Fault type: L3-L1</i>
Z[1] . Fault type L1-L2-L3	[Operation / Status Display / Z / Z[1]]
⤴	<i>Fault type: L1-L2-L3</i>
Z[1] . DefaultSet	[Operation / Status Display / Z / Z[1]]
⤴	<i>Signal: Default Parameter Set</i>
Z[1] . AdaptSet 1	[Operation / Status Display / Z / Z[1]]
⤴	<i>Signal: Adaptive Parameter 1</i>
Z[1] . AdaptSet 2	[Operation / Status Display / Z / Z[1]]
⤴	<i>Signal: Adaptive Parameter 2</i>



9.37 LB

Load Blinder



9.37.1 LB: Device Planning Parameters



LB . Mode	[Device planning]	
"_"	"_" , use  Device planning.	S.3
 Load Blinder, general operation mode		







9.37.2 LB: Global Parameters

LB . ExBlo1	[Protection Para / Global Prot Para / LB]	
LB . ExBlo2		
"_"	"_" ... Sys . Internal test state  1..n, Assignment List.	P.2
 External blocking of the module, if blocking is activated (allowed) within a parameter set and if the state of the assigned signal is true.		

9.37.3 LB: Setting Group Parameters

LB . Function	[Protection Para / Set 1...4 / LB]	
inactive	inactive, active  Mode.	P.2
 Permanent activation or deactivation of module/stage.		

LB . ExBlo Fc	[Protection Para / Set 1...4 / LB]	
inactive	inactive, active  active/inactive.	P.2
 Activate (allow) or inactivate (disallow) blocking of the module/stage. This parameter is only effective if a signal is assigned to the corresponding global protection parameter. If the signal becomes true, those modules/stages are blocked that are parameterized "ExBlo Fc=active".		

LB . Meas Circuit Superv	[Protection Para / Set 1...4 / LB]	
Sys . inactive	Sys . inactive, LOP . active ↳ VTS Block.	P.2
	<i>Activates the use of the measuring circuit supervision. In this case the module will be blocked if a measuring circuit supervision module (e.g. LOP, VTS) signals a disturbed measuring circuit (e.g. caused by a fuse failure).</i>	
LB . I1 min	[Protection Para / Set 1...4 / LB]	
0.50In	0.10In ... 4.00In	P.2
	<i>Minimum value positive phase sequence current</i>	
LB . I2 max	[Protection Para / Set 1...4 / LB]	
0.20In	0.02In ... 1.00In	P.2
	<i>Maximum value negative sequence current</i>	
LB . Imp. Circ. Rd	[Protection Para / Set 1...4 / LB]	
50.0Ω	If: CT Ntrl . CT sec = 1A • 0.5Ω ... 500.0Ω If: CT Ntrl . CT sec = 5A • 0.1Ω ... 100.0Ω	P.2
	<i>The resistance where the Load Blinder area starts (secondary value), i. e. the radius of the impedance circle defining the Load Blinder area (together with the two blinder angles).</i>	
LB . Imp. Angle 1	[Protection Para / Set 1...4 / LB]	
30°	0° ... 45°	P.2
	<i>Blinder angle No. 1. This angle is measured counter-clockwise from the R-axis.</i>	
LB . Imp. Angle 2	[Protection Para / Set 1...4 / LB]	
-30°	-45° ... 0°	P.2
	<i>Blinder angle No. 2. This angle is measured clockwise from the R-axis.</i>	
LB . t-Delay	[Protection Para / Set 1...4 / LB]	
0.00s	0.00s ... 300.00s	P.2
	<i>Delay time between the signals »Pickup« and »Operate«.</i>	

9.37.4 LB: Input States

LB . ExBlo1-I	[Operation / Status Display / LB]
↓	<i>Module input state: External blocking1</i>

LB . ExBlo2-I	[Operation / Status Display / LB]
↓	<i>Module input state: External blocking2</i>

9.37.5 LB: Signals (Output States)

LB . active	[Operation / Status Display / All Actives] [Operation / Status Display / LB]
↑	<i>Signal: active</i>

LB . ExBlo	[Operation / Status Display / LB]
↑	<i>Signal: External Blocking</i>

LB . Blo by MeasCircSupv	[Operation / Status Display / LB]
↑	<i>Blocked by Measuring Circuit Supervision</i>

LB . Pickup	[Operation / Status Display / LB]
↑	<i>Signal that the measured system impedance is within the Load Blinder area.</i>

LB . Operate	[Operation / Status Display / LB]
↑	<i>Signal that the measured system impedance is within the Load Blinder area for at least the duration t-Delay.</i>

9.38 PSB

Power Swing Blocking

9.38.1 PSB: Device Planning Parameters

PSB . Mode	[Device planning]	
"_"	"_" , use ↳ Device planning.	S.3
 <i>Out of Step Tripping, general operation mode</i>		









9.38.2 PSB: Global Parameters

PSB . ExBlo1	[Protection Para / Global Prot Para / PSB]	
PSB . ExBlo2		
"_"	"_" ... Sys . Internal test state ↳ 1..n, Assignment List.	P.2
 <i>External blocking of the module, if blocking is activated (allowed) within a parameter set and if the state of the assigned signal is true.</i>		

9.38.3 PSB: Setting Group Parameters

PSB . Function	[Protection Para / Set 1...4 / PSB / General Settings]	
inactive	inactive, active ↳ Mode.	P.2
 <i>Permanent activation or deactivation of module/stage.</i>		

PSB . ExBlo Fc	[Protection Para / Set 1...4 / PSB / General Settings]	
inactive	inactive, active ↳ active/inactive.	P.2
 <i>Activate (allow) or inactivate (disallow) blocking of the module/stage. This parameter is only effective if a signal is assigned to the corresponding global protection parameter. If the signal becomes true, those modules/stages are blocked that are parameterized "ExBlo Fc=active".</i>		

PSB . Meas Circuit Superv	[Protection Para / Set 1...4 / PSB / General Settings]	
Sys . inactive	Sys . inactive, LOP . active  VTS Block.	P.2
	<i>Activates the use of the measuring circuit supervision. In this case the module will be blocked if a measuring circuit supervision module (e.g. LOP, VTS) signals a disturbed measuring circuit (e.g. caused by a fuse failure).</i>	
PSB . I1 min	[Protection Para / Set 1...4 / PSB / General Settings]	
0.20In	0.02In ... 4.00In	P.2
	<i>Minimum value positive phase sequence current</i>	
PSB . I2 max	[Protection Para / Set 1...4 / PSB / General Settings]	
0.20In	0.02In ... 1.00In	P.2
	<i>Maximum value negative sequence current</i>	
PSB . Min. dwell time	[Protection Para / Set 1...4 / PSB / General Settings]	
0.100s	0.020s ... 0.200s	P.2
	<i>Minimum dwell time within the impedance zone (characteristic). This timer is essential to enable the device to distinguish between a power swing and a system fault. If the measured impedance crosses the first blinder before this timer has expired, the event will be declared as a system fault and not as power swing. This has the consequence that the function is blocked until the impedance has left the MHO circle again.</i>	
PSB . Max. dwell time	[Protection Para / Set 1...4 / PSB / General Settings]	
10.00s	0.20s ... 20.00s	P.2
	<i>Maximum dwell time within the impedance zone (characteristic). (Above this time the slip frequency is assumed to be implausibly low.)</i>	
PSB . Blo by dZ/dt	[Protection Para / Set 1...4 / PSB / General Settings]	
active	inactive, active  Mode.	P.2
	<i>Activate (allow) or inactivate (disallow) blocking of the module if the »dZ/dt« limit is exceeded.</i>	

PSB . dZ/dt	[Protection Para / Set 1...4 / PSB / General Settings]
300Ω/s	If: CT Ntrl . CT sec = 1A • 10.0Ω/s ... 1000.0Ω/s If: CT Ntrl . CT sec = 5A • 2.0Ω/s ... 300.0Ω/s
	<i>Rate of impedance change per time (secondary value). This setting is essential to enable the device to distinguish between a power swing and a system fault.</i>

PSB . Mho Pos.Imp.Reach	[Protection Para / Set 1...4 / PSB / Characteristic]
10.0Ω	If: CT Ntrl . CT sec = 1A • 1.0Ω ... 750.0Ω If: CT Ntrl . CT sec = 5A • 0.2Ω ... 150.0Ω
	<i>MHO characteristic: Positive Impedance Reach (secondary value).</i>

PSB . Mho Pos.Imp.Angle	[Protection Para / Set 1...4 / PSB / Characteristic]
90°	60° ... 90°
	<i>MHO characteristic: Positive Impedance Angle</i>

PSB . Mho Offs.Imp.Reach	[Protection Para / Set 1...4 / PSB / Characteristic]
10.0Ω	If: CT Ntrl . CT sec = 1A • 1.0Ω ... 750.0Ω If: CT Ntrl . CT sec = 5A • 0.2Ω ... 150.0Ω
	<i>MHO characteristic: Offset Impedance Reach (secondary value).</i>

PSB . Mho Offs.Imp.Angle	[Protection Para / Set 1...4 / PSB / Characteristic]
270°	240° ... 270°
	<i>MHO characteristic: Offset Impedance Angle</i>

PSB . Blinder A	[Protection Para / Set 1...4 / PSB / Characteristic]
-2.5Ω	If: CT Ntrl . CT sec = 1A • -375.0Ω ... 0.0Ω If: CT Ntrl . CT sec = 5A • -75.0Ω ... 0.0Ω
 <i>Blinder (left) of the impedance zone (characteristic), defined as a value on the R-axis (secondary value).</i>	

PSB . Blinder B	[Protection Para / Set 1...4 / PSB / Characteristic]
2.5Ω	If: CT Ntrl . CT sec = 1A • 0.0Ω ... 375.0Ω If: CT Ntrl . CT sec = 5A • 0.0Ω ... 75.0Ω
 <i>Blinder (right) of the impedance zone (characteristic), defined as a value on the R-axis (secondary value).</i>	

9.38.4 PSB: Input States

PSB . ExBlo1-I	[Operation / Status Display / PSB]
 <i>Module input state: External blocking1</i>	

PSB . ExBlo2-I	[Operation / Status Display / PSB]
 <i>Module input state: External blocking2</i>	

9.38.5 PSB: Signals (Output States)

PSB . active	[Operation / Status Display / All Actives] [Operation / Status Display / PSB]
 <i>Signal: active</i>	

PSB . ExBlo	[Operation / Status Display / PSB]
 <i>Signal: External Blocking</i>	

PSB . Blo by MeasCircSupv	[Operation / Status Display / PSB]
⬇	<i>Blocked by Measuring Circuit Supervision</i>
PSB . Int.blocked	[Operation / Status Display / PSB]
⬇	<i>Signal: The module is internally blocked because the »Max. dwell time« has expired.</i>
PSB . Pickup Blinder A	[Operation / Status Display / PSB]
⬇	<i>Signal: The impedance is within the MHO circle on the right side of Blinder A.</i>
PSB . Pickup Blinder B	[Operation / Status Display / PSB]
⬇	<i>Signal: The impedance is within the MHO circle on the left side of Blinder B.</i>
PSB . Pickup Mho	[Operation / Status Display / PSB]
⬇	<i>Signal: The impedance is within the characteristic.</i>
PSB . Swinging	[Operation / Status Display / PSB]
⬇	<i>Signal: The impedance is within the instable swing zone (i. e. within the characteristic and inside the borders defined by Binders A and B).</i>
PSB . Start	[Operation / Status Display / PSB]
⬇	<i>Signal, that a power swing (or an Out-of-step event) has been detected. The state of this signal becomes true as soon as the impedance traverses the first blinder, and it gets reset when the characteristic area is left.</i>
PSB . Pole slipping	[Operation / Status Display / PSB]
⬇	<i>Signal, that pole slipping has been detected. The state of this signal becomes true as soon as the impedance reaches 180°, and it gets reset when the characteristic area is left.</i>
PSB . Syst.is sym.	[Operation / Status Display / PSB]
⬇	<i>Signal that the system state is symmetrical, i. e. the negative-sequence current is below »I2 max«, and the positive-sequence current is above »I1 min«.</i>
PSB . Blo dZ/dt	[Operation / Status Display / PSB]
⬇	<i>Signal: The module has detected a system fault based on the »rate of impedance change per time«, and therefore it has blocked itself.</i>

PSB . Blo min.dwell time

[Operation / Status Display / PSB]



Signal: The module has detected a system fault based on the »minimum dwell time«, and therefore it has blocked itself.

9.39 SOTF

Switch Onto Fault - Module

9.39.1 SOTF: Device Planning Parameters

SOTF . Mode	[Device planning]	
"_"	"_", use ↳ Mode.	S.3
 <i>general operation mode</i>		

9.39.2 SOTF: Global Parameters

SOTF . Mode	[Protection Para / Global Prot Para / SOTF]	
CB Pos	CB Pos, I<, CB Pos And I<, CB manual ON, Ext SOTF ↳ Mode.	P.2
 <i>general operation mode</i>		

SOTF . ExBlo1	[Protection Para / Global Prot Para / SOTF]	
SOTF . ExBlo2		
"_"	"_" ... Sys . Internal test state ↳ 1..n, Assignment List.	P.2
 <i>External blocking of the module, if blocking is activated (allowed) within a parameter set and if the state of the assigned signal is true.</i>		

SOTF . Ex rev Interl	[Protection Para / Global Prot Para / SOTF]	
"_"	"_" ... Sys . Internal test state ↳ 1..n, Assignment List.	P.2
 <i>External blocking of the module by external reverse interlocking, if blocking is activated (allowed) within a parameter set and if the state of the assigned signal is true.</i>		

SOTF . Assigned SG	[Protection Para / Global Prot Para / SOTF]	
. SG[1]	“-”, . SG[1], . SG[2], . SG[3], . SG[4], . SG[5], . SG[6]	P.2
	↳ CB List.	
 Assigned Switchgear		

SOTF . Ext SOTF	[Protection Para / Global Prot Para / SOTF]	
“-”	“-” ... Logics . LE80.Out inverted	P.2
	↳ 1..n, DI-LogicList.	
 External Switch Onto Fault		

9.39.3 SOTF: Setting Group Parameters

SOTF . Function	[Protection Para / Set 1...4 / SOTF]	
inactive	inactive, active	P.2
	↳ Mode.	
 Permanent activation or deactivation of module/stage.		

SOTF . ExBlo Fc	[Protection Para / Set 1...4 / SOTF]	
inactive	inactive, active	P.2
	↳ active/inactive.	
 Activate (allow) or inactivate (disallow) blocking of the module/stage. This parameter is only effective if a signal is assigned to the corresponding global protection parameter. If the signal becomes true, those modules/stages are blocked that are parameterized "ExBlo Fc=active".		

SOTF . Ex rev Interl Fc	[Protection Para / Set 1...4 / SOTF]	
inactive	inactive, active	P.2
	↳ active/inactive.	
 Activate (allow) or inactivate (disallow) blocking of the module/stage. This parameter is only effective if a signal is assigned to the corresponding global protection parameter. If the signal becomes true, those modules/stages are blocked that are parameterized "Ex rev Interl Fc = active".		

SOTF . I<	[Protection Para / Set 1...4 / SOTF]	
0.01In	0.01In ... 1.00In	P.2
	<i>The CB is in the OFF Position, if the measured current is less than this parameter.</i>	

SOTF . t-enable	[Protection Para / Set 1...4 / SOTF]	
2s	0.10s ... 10.00s	P.2
	<i>While this timer is running, and while the module is not blocked, the Switch Onto Fault Module is effective (SOTF is armed).</i>	

9.39.4 SOTF: Input States

SOTF . ExBlo1-I	[Operation / Status Display / SOTF]	
SOTF . ExBlo2-I		
	<i>Module input state: External blocking</i>	

SOTF . Ex rev Interl-I	[Operation / Status Display / SOTF]	
	<i>Module input state: External reverse interlocking</i>	

SOTF . Ext SOTF-I	[Operation / Status Display / SOTF]	
	<i>Module input state: External Switch Onto Fault Alarm</i>	

9.39.5 SOTF: Signals (Output States)

SOTF . active	[Operation / Status Display / All Actives]	
	[Operation / Status Display / SOTF]	
	<i>Signal: active</i>	

SOTF . ExBlo	[Operation / Status Display / SOTF]	
	<i>Signal: External Blocking</i>	

SOTF . Ex rev Interl	[Operation / Status Display / SOTF]	
	<i>Signal: External reverse Interlocking</i>	

SOTF . enabled

[Operation / Status Display / SOTF]



Signal: Switch Onto Fault enabled. This Signal can be used to modify Overcurrent Protection Settings.

SOTF . I<

[Operation / Status Display / SOTF]



Signal: No Load Current.

9.40 CLPU

Cold Load Pickup Module

9.40.1 CLPU: Device Planning Parameters

CLPU . Mode	[Device planning]	
"_"	"_", use ↳ Mode.	S.3
 <i>general operation mode</i>		

9.40.2 CLPU: Global Parameters

CLPU . Mode	[Protection Para / Global Prot Para / CLPU]	
CB Pos	CB Pos, I<, CB Pos Or I<, CB Pos And I< ↳ Mode.	P.2
 <i>general operation mode</i>		

CLPU . ExBlo1 CLPU . ExBlo2	[Protection Para / Global Prot Para / CLPU]	
"_"	"_" ... Sys . Internal test state ↳ 1..n, Assignment List.	P.2
 <i>External blocking of the module, if blocking is activated (allowed) within a parameter set and if the state of the assigned signal is true.</i>		

CLPU . Ex rev Interl	[Protection Para / Global Prot Para / CLPU]	
"_"	"_" ... Sys . Internal test state ↳ 1..n, Assignment List.	P.2
 <i>External blocking of the module by external reverse interlocking, if blocking is activated (allowed) within a parameter set and if the state of the assigned signal is true.</i>		

CLPU . CB Pos Detect	[Protection Para / Global Prot Para / CLPU]	
SG[1] . Pos	“-”, SG[1] . Pos, SG[2] . Pos, SG[3] . Pos, SG[4] . Pos, SG[5] . Pos, SG[6] . Pos ↳ CB Manager.	P.2
	<i>Criterion by which the Circuit Breaker Switch Position is to be detected.</i>	

9.40.3 CLPU: Setting Group Parameters

CLPU . Function	[Protection Para / Set 1...4 / CLPU]	
inactive	inactive, active ↳ Mode.	P.2
	<i>Permanent activation or deactivation of module/stage.</i>	

CLPU . ExBlo Fc	[Protection Para / Set 1...4 / CLPU]	
inactive	inactive, active ↳ active/inactive.	P.2
	<i>Activate (allow) or inactivate (disallow) blocking of the module/stage. This parameter is only effective if a signal is assigned to the corresponding global protection parameter. If the signal becomes true, those modules/stages are blocked that are parameterized "ExBlo Fc=active".</i>	

CLPU . Ex rev Interl Fc	[Protection Para / Set 1...4 / CLPU]	
inactive	inactive, active ↳ active/inactive.	P.2
	<i>Activate (allow) or inactivate (disallow) blocking of the module/stage. This parameter is only effective if a signal is assigned to the corresponding global protection parameter. If the signal becomes true, those modules/stages are blocked that are parameterized "Ex rev Interl Fc = active".</i>	

CLPU . t-Load Off	[Protection Para / Set 1...4 / CLPU]	
1.00s	0.00s ... 7200.00s	P.2
	<i>Select the outage time required for a load to be considered cold. If the Pickup Timer (Delay) has run out, a Cold Load Signal will be issued.</i>	

CLPU . t-Max Block	[Protection Para / Set 1...4 / CLPU]
1.00s	0.00s ... 300.00s P.2
	Select the amount of time for the cold load inrush. If the Release Time (Delay) has run out, a Warm Load Signal will be issued.

CLPU . I<	[Protection Para / Set 1...4 / CLPU]
0.01In	0.01In ... 1.00In P.2
	The CB is in the OFF Position, if the measured current is less than this parameter.

CLPU . Threshold	[Protection Para / Set 1...4 / CLPU]
1.2In	0.10In ... 4.00In P.2
	Set the load current inrush threshold.

CLPU . Settle Time	[Protection Para / Set 1...4 / CLPU]
1.00s	0.00s ... 300.00s P.2
	Select the time for the cold load inrush

9.40.4 CLPU: Input States

CLPU . ExBlo1-I	[Operation / Status Display / CLPU]
CLPU . ExBlo2-I	
	Module input state: External blocking

CLPU . Ex rev Inter-I	[Operation / Status Display / CLPU]
	Module input state: External reverse interlocking

9.40.5 CLPU: Signals (Output States)

CLPU . active	[Operation / Status Display / All Actives] [Operation / Status Display / CLPU]
	Signal: active



CLPU . ExBlo	[Operation / Status Display / CLPU]
	Signal: External Blocking

CLPU . Ex rev Interl	[Operation / Status Display / CLPU]
↕	<i>Signal: External reverse Interlocking</i>
CLPU . enabled	[Operation / Status Display / CLPU]
↕	<i>Signal: Cold Load enabled</i>
CLPU . detected	[Operation / Status Display / CLPU]
↕	<i>Signal: Cold Load detected</i>
CLPU . I<	[Operation / Status Display / CLPU]
↕	<i>Signal: No Load Current.</i>
CLPU . Load Inrush	[Operation / Status Display / CLPU]
↕	<i>Signal: Load Inrush</i>
CLPU . Settle Time	[Operation / Status Display / CLPU]
↕	<i>Signal: Settle Time</i>



9.41 ExP[1] ... ExP[4]



External Protection - Module



9.41.1 ExP[1]: Device Planning Parameters



ExP[1] . Mode	[Device planning]	
"_"	"_", use  Device planning.	S.3
	External Protection - Module, general operation mode	

9.41.2 ExP[1]: Global Parameters



ExP[1] . ExBlo1	[Protection Para / Global Prot Para / ExP / ExP[1]]	
ExP[1] . ExBlo2		
"_"	"_" ... Sys . Internal test state  1..n, Assignment List.	P.2
	External blocking of the module, if blocking is activated (allowed) within a parameter set and if the state of the assigned signal is true.	



ExP[1] . ExBlo TripCmd	[Protection Para / Global Prot Para / ExP / ExP[1]]	
"_"	"_" ... Sys . Internal test state  1..n, Assignment List.	P.2
	External blocking of the Trip Command of the module/the stage, if blocking is activated (allowed) within a parameter set and if the state of the assigned signal is true.	



ExP[1] . Alarm	[Protection Para / Global Prot Para / ExP / ExP[1]]	
"_"	"_" ... Sys . Internal test state  1..n, Assignment List.	P.2
	Assignment for External Alarm	



ExP[1] . Trip	[Protection Para / Global Prot Para / ExP / ExP[1]]	
"_"	"_" ... Sys . Internal test state  1..n, Assignment List.	P.2
	<i>External trip of the CB if the state of the assigned signal is true.</i>	

9.41.3 ExP[1]: Setting Group Parameters

ExP[1] . Function	[Protection Para / Set 1...4 / ExP / ExP[1]]	
inactive	inactive, active  Mode.	P.2
	<i>Permanent activation or deactivation of module/stage.</i>	

ExP[1] . ExBlo Fc	[Protection Para / Set 1...4 / ExP / ExP[1]]	
inactive	inactive, active  active/inactive.	P.2
	<i>Activate (allow) or inactivate (disallow) blocking of the module/stage. This parameter is only effective if a signal is assigned to the corresponding global protection parameter. If the signal becomes true, those modules/stages are blocked that are parameterized "ExBlo Fc=active".</i>	

ExP[1] . Blo TripCmd	[Protection Para / Set 1...4 / ExP / ExP[1]]	
inactive	inactive, active  Mode.	P.2
	<i>Permanent blocking of the Trip Command of the module/stage.</i>	

ExP[1] . ExBlo TripCmd Fc	[Protection Para / Set 1...4 / ExP / ExP[1]]	
inactive	inactive, active  active/inactive.	P.2
	<i>Activate (allow) or inactivate (disallow) blocking of the module/stage. This parameter is only effective if a signal is assigned to the corresponding global protection parameter. If the signal becomes true, those modules/stages are blocked that are parameterized "ExBlo TripCmd Fc=active".</i>	

9.41.4 ExP[1]: Input States

ExP[1] . ExBlo1-I	[Operation / Status Display / ExP / ExP[1]]
↓	<i>Module input state: External blocking1</i>
ExP[1] . ExBlo2-I	[Operation / Status Display / ExP / ExP[1]]
↓	<i>Module input state: External blocking2</i>
ExP[1] . ExBlo TripCmd-I	[Operation / Status Display / ExP / ExP[1]]
↓	<i>Module input state: External Blocking of the Trip Command</i>
ExP[1] . Alarm-I	[Operation / Status Display / ExP / ExP[1]]
↓	<i>Module input state: Alarm</i>
ExP[1] . Trip-I	[Operation / Status Display / ExP / ExP[1]]
↓	<i>Module input state: Trip</i>

9.41.5 ExP[1]: Signals (Output States)

ExP[1] . active	[Operation / Status Display / All Actives] [Operation / Status Display / ExP / ExP[1]]
↑	<i>Signal: active</i>
ExP[1] . Alarm	[Operation / Status Display / Alarms] [Operation / Status Display / ExP / ExP[1]]
↑	<i>Signal: Alarm</i>
ExP[1] . Trip	[Operation / Status Display / Trips] [Operation / Status Display / ExP / ExP[1]]
↑	<i>Signal: Trip</i>
ExP[1] . TripCmd	[Operation / Status Display / TripCmds] [Operation / Status Display / ExP / ExP[1]]
↑	<i>Signal: Trip Command</i>

ExP[1] . ExBlo	[Operation / Status Display / ExP / ExP[1]]
⬆	<i>Signal: External Blocking</i>
ExP[1] . Blo TripCmd	[Operation / Status Display / ExP / ExP[1]]
⬆	<i>Signal: Trip Command blocked</i>
ExP[1] . ExBlo TripCmd	[Operation / Status Display / ExP / ExP[1]]
⬆	<i>Signal: External Blocking of the Trip Command</i>

9.42 Ext Sudd Press

Sudden Pressure

9.42.1 Ext Sudd Press: Device Planning Parameters

Ext Sudd Press . Mode	[Device planning]	
"_"	"_" , use ↳ Device planning.	S.3
	External Protection - Module, general operation mode	

9.42.2 Ext Sudd Press: Global Parameters

Ext Sudd Press . ExBlo1	[Protection Para / Global Prot Para / Ext Sudd Press]	
Ext Sudd Press . ExBlo2		
"_"	"_" ... Sys . Internal test state ↳ 1..n, Assignment List.	P.2
	External blocking of the module, if blocking is activated (allowed) within a parameter set and if the state of the assigned signal is true.	

Ext Sudd Press . ExBlo TripCmd	[Protection Para / Global Prot Para / Ext Sudd Press]	
"_"	"_" ... Sys . Internal test state ↳ 1..n, Assignment List.	P.2
	External blocking of the Trip Command of the module/the stage, if blocking is activated (allowed) within a parameter set and if the state of the assigned signal is true.	

Ext Sudd Press . Alarm	[Protection Para / Global Prot Para / Ext Sudd Press]	
"_"	"_" ... Sys . Internal test state ↳ 1..n, Assignment List.	P.2
	Assignment for External Alarm	

Ext Sudd Press . Trip	[Protection Para / Global Prot Para / Ext Sudd Press]	
"_"	"_" ... Sys . Internal test state ↳ 1..n, Assignment List.	P.2
 External trip of the CB if the state of the assigned signal is true.		

9.42.3 Ext Sudd Press: Setting Group Parameters

Ext Sudd Press . Function	[Protection Para / Set 1...4 / Ext Sudd Press]	
inactive	inactive, active ↳ Mode.	P.2
 Permanent activation or deactivation of module/stage.		

Ext Sudd Press . ExBlo Fc	[Protection Para / Set 1...4 / Ext Sudd Press]	
inactive	inactive, active ↳ active/inactive.	P.2
 Activate (allow) or inactivate (disallow) blocking of the module/stage. This parameter is only effective if a signal is assigned to the corresponding global protection parameter. If the signal becomes true, those modules/stages are blocked that are parameterized "ExBlo Fc=active".		

Ext Sudd Press . Blo TripCmd	[Protection Para / Set 1...4 / Ext Sudd Press]	
inactive	inactive, active ↳ Mode.	P.2
 Permanent blocking of the Trip Command of the module/stage.		

Ext Sudd Press . ExBlo TripCmd Fc	[Protection Para / Set 1...4 / Ext Sudd Press]	
inactive	inactive, active ↳ active/inactive.	P.2
 Activate (allow) or inactivate (disallow) blocking of the module/stage. This parameter is only effective if a signal is assigned to the corresponding global protection parameter. If the signal becomes true, those modules/stages are blocked that are parameterized "ExBlo TripCmd Fc=active".		

9.42.4 Ext Sudd Press: Input States

Ext Sudd Press . ExBlo1-I	[Operation / Status Display / Ext Sudd Press]
↓	<i>Module input state: External blocking1</i>
Ext Sudd Press . ExBlo2-I	[Operation / Status Display / Ext Sudd Press]
↓	<i>Module input state: External blocking2</i>
Ext Sudd Press . ExBlo TripCmd-I	[Operation / Status Display / Ext Sudd Press]
↓	<i>Module input state: External Blocking of the Trip Command</i>
Ext Sudd Press . Alarm-I	[Operation / Status Display / Ext Sudd Press]
↓	<i>Module input state: Alarm</i>
Ext Sudd Press . Trip-I	[Operation / Status Display / Ext Sudd Press]
↓	<i>Module input state: Trip</i>

9.42.5 Ext Sudd Press: Signals (Output States)



Ext Sudd Press . active	[Operation / Status Display / All Actives] [Operation / Status Display / Ext Sudd Press]
↑	<i>Signal: active</i>
Ext Sudd Press . Alarm	[Operation / Status Display / Alarms] [Operation / Status Display / Ext Sudd Press]
↑	<i>Signal: Alarm</i>
Ext Sudd Press . Trip	[Operation / Status Display / Trips] [Operation / Status Display / Ext Sudd Press]
↑	<i>Signal: Trip</i>
Ext Sudd Press . TripCmd	[Operation / Status Display / TripCmds] [Operation / Status Display / Ext Sudd Press]
↑	<i>Signal: Trip Command</i>

Ext Sudd Press . ExBlo	[Operation / Status Display / Ext Sudd Press]
⬆	<i>Signal: External Blocking</i>
Ext Sudd Press . Blo TripCmd	[Operation / Status Display / Ext Sudd Press]
⬆	<i>Signal: Trip Command blocked</i>
Ext Sudd Press . ExBlo TripCmd	[Operation / Status Display / Ext Sudd Press]
⬆	<i>Signal: External Blocking of the Trip Command</i>



9.43 Ext Oil Temp



External Oil Temperature



9.43.1 Ext Oil Temp: Device Planning Parameters

Ext Oil Temp . Mode	[Device planning]	
"_"	"_" , use  Device planning.	S.3
	External Protection - Module, general operation mode	

9.43.2 Ext Oil Temp: Global Parameters

Ext Oil Temp . ExBlo1	[Protection Para / Global Prot Para / Temp-Prot / Ext Oil Temp]	
Ext Oil Temp . ExBlo2		
"_"	"_" ... Sys . Internal test state  1..n, Assignment List.	P.2
	External blocking of the module, if blocking is activated (allowed) within a parameter set and if the state of the assigned signal is true.	

Ext Oil Temp . ExBlo TripCmd	[Protection Para / Global Prot Para / Temp-Prot / Ext Oil Temp]	
"_"	"_" ... Sys . Internal test state  1..n, Assignment List.	P.2
	External blocking of the Trip Command of the module/the stage, if blocking is activated (allowed) within a parameter set and if the state of the assigned signal is true.	

Ext Oil Temp . Alarm	[Protection Para / Global Prot Para / Temp-Prot / Ext Oil Temp]	
"_"	"_" ... Sys . Internal test state  1..n, Assignment List.	P.2
	Assignment for External Alarm	

Ext Oil Temp . Trip	[Protection Para / Global Prot Para / Temp-Prot / Ext Oil Temp]
"_"	"_" ... Sys . Internal test state ↳ 1..n, Assignment List.
 External trip of the CB if the state of the assigned signal is true.	P.2

9.43.3 Ext Oil Temp: Setting Group Parameters

Ext Oil Temp . Function	[Protection Para / Set 1...4 / Temp-Prot / Ext Oil Temp]
inactive	inactive, active ↳ Mode.
 Permanent activation or deactivation of module/stage.	P.2

Ext Oil Temp . ExBlo Fc	[Protection Para / Set 1...4 / Temp-Prot / Ext Oil Temp]
inactive	inactive, active ↳ active/inactive.
 Activate (allow) or inactivate (disallow) blocking of the module/stage. This parameter is only effective if a signal is assigned to the corresponding global protection parameter. If the signal becomes true, those modules/stages are blocked that are parameterized "ExBlo Fc=active".	P.2

Ext Oil Temp . Blo TripCmd	[Protection Para / Set 1...4 / Temp-Prot / Ext Oil Temp]
inactive	inactive, active ↳ Mode.
 Permanent blocking of the Trip Command of the module/stage.	P.2

Ext Oil Temp . ExBlo TripCmd Fc	[Protection Para / Set 1...4 / Temp-Prot / Ext Oil Temp]
inactive	inactive, active ↳ active/inactive.
 Activate (allow) or inactivate (disallow) blocking of the module/stage. This parameter is only effective if a signal is assigned to the corresponding global protection parameter. If the signal becomes true, those modules/stages are blocked that are parameterized "ExBlo TripCmd Fc=active".	P.2

9.43.4 Ext Oil Temp: Input States

Ext Oil Temp . ExBlo1-I	[Operation / Status Display / Temp-Prot / Ext Oil Temp]
↓	<i>Module input state: External blocking1</i>
Ext Oil Temp . ExBlo2-I	[Operation / Status Display / Temp-Prot / Ext Oil Temp]
↓	<i>Module input state: External blocking2</i>
Ext Oil Temp . ExBlo TripCmd-I	[Operation / Status Display / Temp-Prot / Ext Oil Temp]
↓	<i>Module input state: External Blocking of the Trip Command</i>
Ext Oil Temp . Alarm-I	[Operation / Status Display / Temp-Prot / Ext Oil Temp]
↓	<i>Module input state: Alarm</i>
Ext Oil Temp . Trip-I	[Operation / Status Display / Temp-Prot / Ext Oil Temp]
↓	<i>Module input state: Trip</i>

9.43.5 Ext Oil Temp: Signals (Output States)

Ext Oil Temp . active	[Operation / Status Display / All Actives] [Operation / Status Display / Temp-Prot / Ext Oil Temp]
↑	<i>Signal: active</i>
Ext Oil Temp . Alarm	[Operation / Status Display / Alarms] [Operation / Status Display / Temp-Prot / Ext Oil Temp]
↑	<i>Signal: Alarm</i>
Ext Oil Temp . Trip	[Operation / Status Display / Trips] [Operation / Status Display / Temp-Prot / Ext Oil Temp]
↑	<i>Signal: Trip</i>
Ext Oil Temp . TripCmd	[Operation / Status Display / TripCmds] [Operation / Status Display / Temp-Prot / Ext Oil Temp]
↑	<i>Signal: Trip Command</i>

Ext Oil Temp . ExBlo	[Operation / Status Display / Temp-Prot / Ext Oil Temp]
-----------------------------	---

 <i>Signal: External Blocking</i>
--

Ext Oil Temp . Blo TripCmd	[Operation / Status Display / Temp-Prot / Ext Oil Temp]
-----------------------------------	---

 <i>Signal: Trip Command blocked</i>



Ext Oil Temp . ExBlo TripCmd	[Operation / Status Display / Temp-Prot / Ext Oil Temp]
-------------------------------------	---

 <i>Signal: External Blocking of the Trip Command</i>
--



9.44 Ext Temp Superv[1] ... Ext Temp Superv[3]



External Temperature Supervision



9.44.1 Ext Temp Superv[1]: Device Planning Parameters

Ext Temp Superv[1] . Mode	[Device planning]	
"_"	"_" , use  Device planning.	S.3
	External Protection - Module, general operation mode	

9.44.2 Ext Temp Superv[1]: Global Parameters

Ext Temp Superv[1] . ExBlo1 Ext Temp Superv[1] . ExBlo2	[Protection Para / Global Prot Para / Temp-Prot / Ext Temp Superv[1]]	
"_"	"_" ... Sys . Internal test state  1..n, Assignment List.	P.2
	External blocking of the module, if blocking is activated (allowed) within a parameter set and if the state of the assigned signal is true.	

Ext Temp Superv[1] . ExBlo TripCmd	[Protection Para / Global Prot Para / Temp-Prot / Ext Temp Superv[1]]	
"_"	"_" ... Sys . Internal test state  1..n, Assignment List.	P.2
	External blocking of the Trip Command of the module/the stage, if blocking is activated (allowed) within a parameter set and if the state of the assigned signal is true.	

Ext Temp Superv[1] . Alarm	[Protection Para / Global Prot Para / Temp-Prot / Ext Temp Superv[1]]	
"_"	"_" ... Sys . Internal test state  1..n, Assignment List.	P.2
	Assignment for External Alarm	

Ext Temp Superv[1] . Trip	[Protection Para / Global Prot Para / Temp-Prot / Ext Temp Superv[1]]	
"_"	"_" ... Sys . Internal test state ↳ 1..n, Assignment List.	P.2
	<i>External trip of the CB if the state of the assigned signal is true.</i>	

9.44.3 Ext Temp Superv[1]: Setting Group Parameters

Ext Temp Superv[1] . Function	[Protection Para / Set 1...4 / Temp-Prot / Ext Temp Superv[1]]	
inactive	inactive, active ↳ Mode.	P.2
	<i>Permanent activation or deactivation of module/stage.</i>	

Ext Temp Superv[1] . ExBlo Fc	[Protection Para / Set 1...4 / Temp-Prot / Ext Temp Superv[1]]	
inactive	inactive, active ↳ active/inactive.	P.2
	<i>Activate (allow) or inactivate (disallow) blocking of the module/stage. This parameter is only effective if a signal is assigned to the corresponding global protection parameter. If the signal becomes true, those modules/stages are blocked that are parameterized "ExBlo Fc=active".</i>	

Ext Temp Superv[1] . Blo TripCmd	[Protection Para / Set 1...4 / Temp-Prot / Ext Temp Superv[1]]	
inactive	inactive, active ↳ Mode.	P.2
	<i>Permanent blocking of the Trip Command of the module/stage.</i>	

Ext Temp Superv[1] . ExBlo TripCmd Fc	[Protection Para / Set 1...4 / Temp-Prot / Ext Temp Superv[1]]	
inactive	inactive, active ↳ active/inactive.	P.2
	<i>Activate (allow) or inactivate (disallow) blocking of the module/stage. This parameter is only effective if a signal is assigned to the corresponding global protection parameter. If the signal becomes true, those modules/stages are blocked that are parameterized "ExBlo TripCmd Fc=active".</i>	

9.44.4 Ext Temp Superv[1]: Input States

Ext Temp Superv[1] . ExBlo1-I	[Operation / Status Display / Temp-Prot / Ext Temp Superv[1]]
↓	<i>Module input state: External blocking1</i>
Ext Temp Superv[1] . ExBlo2-I	[Operation / Status Display / Temp-Prot / Ext Temp Superv[1]]
↓	<i>Module input state: External blocking2</i>
Ext Temp Superv[1] . ExBlo TripCmd-I	[Operation / Status Display / Temp-Prot / Ext Temp Superv[1]]
↓	<i>Module input state: External Blocking of the Trip Command</i>
Ext Temp Superv[1] . Alarm-I	[Operation / Status Display / Temp-Prot / Ext Temp Superv[1]]
↓	<i>Module input state: Alarm</i>
Ext Temp Superv[1] . Trip-I	[Operation / Status Display / Temp-Prot / Ext Temp Superv[1]]
↓	<i>Module input state: Trip</i>

9.44.5 Ext Temp Superv[1]: Signals (Output States)



Ext Temp Superv[1] . active	[Operation / Status Display / All Actives] [Operation / Status Display / Temp-Prot / Ext Temp Superv[1]]
↑	<i>Signal: active</i>
Ext Temp Superv[1] . Alarm	[Operation / Status Display / Alarms] [Operation / Status Display / Temp-Prot / Ext Temp Superv[1]]
↑	<i>Signal: Alarm</i>
Ext Temp Superv[1] . Trip	[Operation / Status Display / Trips] [Operation / Status Display / Temp-Prot / Ext Temp Superv[1]]
↑	<i>Signal: Trip</i>



Ext Temp Superv[1] . TripCmd	[Operation / Status Display / TripCmds] [Operation / Status Display / Temp-Prot / Ext Temp Superv[1]]
⤴	<i>Signal: Trip Command</i>
Ext Temp Superv[1] . ExBlo	[Operation / Status Display / Temp-Prot / Ext Temp Superv[1]]
⤴	<i>Signal: External Blocking</i>
Ext Temp Superv[1] . Blo TripCmd	[Operation / Status Display / Temp-Prot / Ext Temp Superv[1]]
⤴	<i>Signal: Trip Command blocked</i>
Ext Temp Superv[1] . ExBlo TripCmd	[Operation / Status Display / Temp-Prot / Ext Temp Superv[1]]
⤴	<i>Signal: External Blocking of the Trip Command</i>

9.45 URTD

Universal Resistance Temperature Detector



9.45.1 URTD: Global Parameters

URTD . Temperature Unit	[Device Para / Measurment Display / General Settings]	
Celsius	Celsius, Fahrenheit  Units.	P.2
 <i>Temperature Unit</i>		

URTD . Force Mode	[Service / Test (Prot inhibit) / URTD]	
permanent	permanent, timeout  Mode.	P.2
 <i>By means of this function the normal Output Relay States can be overwritten (forced) in case that the Relay is not in a disarmed state. The relays can be set from normal operation (relay works according to the assigned signals) to "force energized" or "force de-energized" state.</i>		

URTD . t-Timeout Force	[Service / Test (Prot inhibit) / URTD]	
0.03s <i>Only available if:</i> • URTD . Force Mode = timeout	0.00s ... 300.00s	P.2
 <i>The Output State will be set by force for the duration of this time. That means for the duration of this time the Output Relay does not show the state of the signals that are assigned on it.</i>		

9.45.2 URTD: Direct Controls

URTD . Function	[Service / Test (Prot inhibit) / URTD]	
inactive	inactive, active  active/inactive.	P.1
 <i>Permanent activation or deactivation of module/stage.</i>		

URTD . Force Windg1	[Service / Test (Prot inhibit) / URTD]
0	If: URTD . Temperature Unit = Fahrenheit • 32 ... 392 If: URTD . Temperature Unit = Celsius • 0 ... 200
<input checked="" type="radio"/> <i>Force Winding 1</i>	

URTD . Force Windg2	[Service / Test (Prot inhibit) / URTD]
0	If: URTD . Temperature Unit = Fahrenheit • 32 ... 392 If: URTD . Temperature Unit = Celsius • 0 ... 200
<input checked="" type="radio"/> <i>Force Winding 2</i>	

URTD . Force Windg3	[Service / Test (Prot inhibit) / URTD]
0	If: URTD . Temperature Unit = Fahrenheit • 32 ... 392 If: URTD . Temperature Unit = Celsius • 0 ... 200
<input checked="" type="radio"/> <i>Force Winding 3</i>	

URTD . Force Windg4	[Service / Test (Prot inhibit) / URTD]
0	If: URTD . Temperature Unit = Fahrenheit • 32 ... 392 If: URTD . Temperature Unit = Celsius • 0 ... 200
<input checked="" type="radio"/> <i>Force Winding 4</i>	

URTD . Force Windg5	[Service / Test (Prot inhibit) / URTD]
0	If: URTD . Temperature Unit = Fahrenheit • 32 ... 392 If: URTD . Temperature Unit = Celsius • 0 ... 200
<input checked="" type="radio"/> <i>Force Winding 5</i>	

URTD . Force Windg6	[Service / Test (Prot inhibit) / URTD]
0	If: URTD . Temperature Unit = Fahrenheit • 32 ... 392 If: URTD . Temperature Unit = Celsius • 0 ... 200
<input checked="" type="radio"/> <i>Force Winding 6</i>	

URTD . Force MotBear1	[Service / Test (Prot inhibit) / URTD]
0	If: URTD . Temperature Unit = Fahrenheit • 32 ... 392 If: URTD . Temperature Unit = Celsius • 0 ... 200
<input checked="" type="radio"/> <i>Force Motor Bearing 1</i>	

URTD . Force MotBear2	[Service / Test (Prot inhibit) / URTD]
0	If: URTD . Temperature Unit = Fahrenheit • 32 ... 392 If: URTD . Temperature Unit = Celsius • 0 ... 200
<input checked="" type="radio"/> <i>Force Motor Bearing 2</i>	

URTD . Force LoadBear1	[Service / Test (Prot inhibit) / URTD]
0	If: URTD . Temperature Unit = Fahrenheit • 32 ... 392 If: URTD . Temperature Unit = Celsius • 0 ... 200
<input checked="" type="radio"/> <i>Force Load Bearing 1</i>	

URTD . Force LoadBear2	[Service / Test (Prot inhibit) / URTD]
0	If: URTD . Temperature Unit = Fahrenheit • 32 ... 392 If: URTD . Temperature Unit = Celsius • 0 ... 200
<input checked="" type="radio"/> <i>Force Load Bearing 2</i>	

URTD . Force Aux1	[Service / Test (Prot inhibit) / URTD]
0	If: URTD . Temperature Unit = Fahrenheit • 32 ... 392 If: URTD . Temperature Unit = Celsius • 0 ... 200
<input checked="" type="radio"/> <i>Force Auxiliary1</i>	

URTD . Force Aux2	[Service / Test (Prot inhibit) / URTD]
0	If: URTD . Temperature Unit = Fahrenheit • 32 ... 392 If: URTD . Temperature Unit = Celsius • 0 ... 200
<input checked="" type="radio"/> <i>Force Auxiliary2</i>	

9.45.3 URTD: Signals (Output States)

URTD . Windg1 Superv	[Operation / Status Display / Temp-Prot / URTD]
 <i>Signal: Windg1, Channel Supervision. The value "1" reports a detected channel failure. (The value "0" means that this RTD channel is healthy.)</i>	
URTD . Windg2 Superv	[Operation / Status Display / Temp-Prot / URTD]
 <i>Signal: Windg2, Channel Supervision. The value "1" reports a detected channel failure. (The value "0" means that this RTD channel is healthy.)</i>	
URTD . Windg3 Superv	[Operation / Status Display / Temp-Prot / URTD]
 <i>Signal: Windg3, Channel Supervision. The value "1" reports a detected channel failure. (The value "0" means that this RTD channel is healthy.)</i>	
URTD . Windg4 Superv	[Operation / Status Display / Temp-Prot / URTD]
 <i>Signal: Windg4, Channel Supervision. The value "1" reports a detected channel failure. (The value "0" means that this RTD channel is healthy.)</i>	
URTD . Windg5 Superv	[Operation / Status Display / Temp-Prot / URTD]
 <i>Signal: Windg5, Channel Supervision. The value "1" reports a detected channel failure. (The value "0" means that this RTD channel is healthy.)</i>	
URTD . Windg6 Superv	[Operation / Status Display / Temp-Prot / URTD]
 <i>Signal: Windg6, Channel Supervision. The value "1" reports a detected channel failure. (The value "0" means that this RTD channel is healthy.)</i>	
URTD . MotBear1 Superv	[Operation / Status Display / Temp-Prot / URTD]
 <i>Signal: MotBear1, Channel Supervision. The value "1" reports a detected channel failure. (The value "0" means that this RTD channel is healthy.)</i>	
URTD . MotBear2 Superv	[Operation / Status Display / Temp-Prot / URTD]
 <i>Signal: MotBear2, Channel Supervision. The value "1" reports a detected channel failure. (The value "0" means that this RTD channel is healthy.)</i>	
URTD . LoadBear1 Superv	[Operation / Status Display / Temp-Prot / URTD]
 <i>Signal: LoadBear1, Channel Supervision. The value "1" reports a detected channel failure. (The value "0" means that this RTD channel is healthy.)</i>	

URTD . LoadBear2 Superv	[Operation / Status Display / Temp-Prot / URTD]
 <i>Signal: LoadBear2, Channel Supervision. The value "1" reports a detected channel failure. (The value "0" means that this RTD channel is healthy.)</i>	

URTD . Aux1 Superv	[Operation / Status Display / Temp-Prot / URTD]
 <i>Signal: Aux1, Channel Supervision. The value "1" reports a detected channel failure. (The value "0" means that this RTD channel is healthy.)</i>	

URTD . Aux2 Superv	[Operation / Status Display / Temp-Prot / URTD]
 <i>Signal: Aux2, Channel Supervision. The value "1" reports a detected channel failure. (The value "0" means that this RTD channel is healthy.)</i>	

URTD . Superv	[Operation / Status Display / Temp-Prot / URTD]
 <i>Signal: URTD Channel Supervision. The value "1" reports a detected channel failure. (The value "0" means that all RTD channels are healthy.)</i>	

URTD . Connection active	[Operation / Status Display / Temp-Prot / URTD]
 <i>Signal: There is an active connection between the Temperature Detector (URTD) and the protective relay.</i>	

URTD . Outs forced	[Operation / Status Display / Temp-Prot / URTD]
 <i>Signal: The State of at least one Relay Output has been set by force. That means that the state of at least one Relay is forced and hence does not show the state of the assigned signals.</i>	



9.45.4 URTD: Values

URTD . Windg1	[Operation / Measured Values / URTD]
 <i>Winding 1</i>	

URTD . Windg2	[Operation / Measured Values / URTD]
 <i>Winding 2</i>	

URTD . Windg3	[Operation / Measured Values / URTD]
 <i>Winding 3</i>	

URTD . Windg4	[Operation / Measured Values / URTD]
 <i>Winding 4</i>	

URTD . Windg5	[Operation / Measured Values / URTD]
 <i>Winding 5</i>	
URTD . Windg6	[Operation / Measured Values / URTD]
 <i>Winding 6</i>	
URTD . MotBear1	[Operation / Measured Values / URTD]
 <i>Motor Bearing 1</i>	
URTD . MotBear2	[Operation / Measured Values / URTD]
 <i>Motor Bearing 2</i>	
URTD . LoadBear1	[Operation / Measured Values / URTD]
 <i>Load Bearing 1</i>	
URTD . LoadBear2	[Operation / Measured Values / URTD]
 <i>Load Bearing 2</i>	
URTD . Aux1	[Operation / Measured Values / URTD]
 <i>Auxiliary1</i>	
URTD . Aux2	[Operation / Measured Values / URTD]
 <i>Auxiliary2</i>	
URTD . RTD Max	[Operation / Measured Values / URTD]
 <i>Maximum temperature of all channels.</i>	

9.45.5 URTD: Statistical Values



URTD . Windg1 max	[Operation / Statistics / Max / URTD]
<input checked="" type="checkbox"/> <i>Winding1 Maximum Value</i>	
URTD . Windg2 max	[Operation / Statistics / Max / URTD]
<input checked="" type="checkbox"/> <i>Winding2 Maximum Value</i>	

URTD . Windg3 max	[Operation / Statistics / Max / URTD]
<input checked="" type="checkbox"/> <i>Winding3 Maximum Value</i>	
URTD . Windg4 max	[Operation / Statistics / Max / URTD]
<input checked="" type="checkbox"/> <i>Winding4 Maximum Value</i>	
URTD . Windg5 max	[Operation / Statistics / Max / URTD]
<input checked="" type="checkbox"/> <i>Winding5 Maximum Value</i>	
URTD . Windg6 max	[Operation / Statistics / Max / URTD]
<input checked="" type="checkbox"/> <i>Winding6 Maximum Value</i>	
URTD . MotBear1 max	[Operation / Statistics / Max / URTD]
<input checked="" type="checkbox"/> <i>Motor Bearing1 Maximum Value</i>	
URTD . MotBear2 max	[Operation / Statistics / Max / URTD]
<input checked="" type="checkbox"/> <i>Motor Bearing2 Maximum Value</i>	
URTD . LoadBear1 max	[Operation / Statistics / Max / URTD]
<input checked="" type="checkbox"/> <i>Load Bearing1 Maximum Value</i>	
URTD . LoadBear2 max	[Operation / Statistics / Max / URTD]
<input checked="" type="checkbox"/> <i>Load Bearing2 Maximum Value</i>	
URTD . Aux1 max	[Operation / Statistics / Max / URTD]
<input checked="" type="checkbox"/> <i>Auxiliary1 Maximum Value</i>	
URTD . Aux2 max	[Operation / Statistics / Max / URTD]
<input checked="" type="checkbox"/> <i>Auxiliary2 Maximum Value</i>	



9.46 RTD



Temperature Protection Module



9.46.1 RTD: Device Planning Parameters

RTD . Mode	[Device planning]	
"_"	"_" , use  Device planning.	S.3
 <i>general operation mode</i>		

9.46.2 RTD: Global Parameters

RTD . ExBlo1	[Protection Para / Global Prot Para / Temp-Prot / RTD]	
RTD . ExBlo2		
"_"	"_" ... Sys . Internal test state  1..n, Assignment List.	P.2
 <i>External blocking of the module, if blocking is activated (allowed) within a parameter set and if the state of the assigned signal is true.</i>		

RTD . ExBlo TripCmd	[Protection Para / Global Prot Para / Temp-Prot / RTD]	
"_"	"_" ... Sys . Internal test state  1..n, Assignment List.	P.2
 <i>External blocking of the Trip Command of the module/the stage, if blocking is activated (allowed) within a parameter set and if the state of the assigned signal is true.</i>		

RTD . TripCmd Selection	[Protection Para / Global Prot Para / Temp-Prot / RTD]	
Trip	Trip, Voting Trip  TripCmd Selection.	P.2
 <i>This parameter determines if the final trip of the RTD module is issued by the default way or by the voting groups.</i>		



9.46.3 RTD: Setting Group Parameters



RTD . Function	[Protection Para / Set 1...4 / Temp-Prot / RTD / General Settings]	
	[Protection Para / Set 1...4 / Temp-Prot / RTD / Voting1]	
	[Protection Para / Set 1...4 / Temp-Prot / RTD / Voting2]	
inactive	inactive, active	P.2
	↳ Mode.	
	<i>Permanent activation or deactivation of module/stage.</i>	

RTD . ExBlo Fc	[Protection Para / Set 1...4 / Temp-Prot / RTD / General Settings]	
inactive	inactive, active	P.2
	↳ active/inactive.	
	<i>Activate (allow) or inactivate (disallow) blocking of the module/stage. This parameter is only effective if a signal is assigned to the corresponding global protection parameter. If the signal becomes true, those modules/stages are blocked that are parameterized "ExBlo Fc=active".</i>	

RTD . Blo TripCmd	[Protection Para / Set 1...4 / Temp-Prot / RTD / General Settings]	
inactive	inactive, active	P.2
	↳ Mode.	
	<i>Permanent blocking of the Trip Command of the module/stage.</i>	

RTD . ExBlo TripCmd Fc	[Protection Para / Set 1...4 / Temp-Prot / RTD / General Settings]	
inactive	inactive, active	P.2
	↳ active/inactive.	
	<i>Activate (allow) or inactivate (disallow) blocking of the module/stage. This parameter is only effective if a signal is assigned to the corresponding global protection parameter. If the signal becomes true, those modules/stages are blocked that are parameterized "ExBlo TripCmd Fc=active".</i>	



RTD . Windg 1 Alarm Function		[Protection Para / Set 1...4 / Temp-Prot / RTD / Windg 1]
active	inactive, active	P.2
		 Mode.
 <i>Winding 1 Alarm Function</i>		



RTD . Windg 1 Trip Function		[Protection Para / Set 1...4 / Temp-Prot / RTD / Windg 1]
active	inactive, active	P.2
		 Mode.
 <i>Winding 1 Trip Function</i>		

RTD . Windg 1 Alarm		[Protection Para / Set 1...4 / Temp-Prot / RTD / Windg 1]
80°C	0°C ... 200°C	P.2
 <i>Winding 1 Threshold for Temperature Alarm</i>		

RTD . Windg 1 t-Delay		[Protection Para / Set 1...4 / Temp-Prot / RTD / Windg 1]
1min	0min ... 360min	P.2
 <i>Winding 1 If this time is expired a Temperature Alarm will be generated.</i>		

RTD . Windg 1 Trip		[Protection Para / Set 1...4 / Temp-Prot / RTD / Windg 1]
100°C	0°C ... 200°C	P.2
 <i>Winding 1 Threshold for Temperature Trip</i>		



RTD . Windg 2 Alarm Function		[Protection Para / Set 1...4 / Temp-Prot / RTD / Windg 2]
active	inactive, active	P.2
		 Mode.
 <i>Winding 2 Alarm Function</i>		



RTD . Windg 2 Trip Function		[Protection Para / Set 1...4 / Temp-Prot / RTD / Windg 2]
active	inactive, active	P.2
		 Mode.
 <i>Winding 2 Trip Function</i>		

RTD . Windg 2 Alarm	[Protection Para / Set 1...4 / Temp-Prot / RTD / Windg 2]	
80°C	0°C ... 200°C	P.2
	<i>Winding 2 Threshold for Temperature Alarm</i>	

RTD . Windg 2 t-Delay	[Protection Para / Set 1...4 / Temp-Prot / RTD / Windg 2]	
1min	0min ... 360min	P.2
	<i>Winding 2 If this time is expired a Temperature Alarm will be generated.</i>	

RTD . Windg 2 Trip	[Protection Para / Set 1...4 / Temp-Prot / RTD / Windg 2]	
100°C	0°C ... 200°C	P.2
	<i>Winding 2 Threshold for Temperature Trip</i>	



RTD . Windg 3 Alarm Function	[Protection Para / Set 1...4 / Temp-Prot / RTD / Windg 3]	
active	inactive, active  Mode.	P.2
	<i>Winding 3 Alarm Function</i>	



RTD . Windg 3 Trip Function	[Protection Para / Set 1...4 / Temp-Prot / RTD / Windg 3]	
active	inactive, active  Mode.	P.2
	<i>Winding 3 Trip Function</i>	

RTD . Windg 3 Alarm	[Protection Para / Set 1...4 / Temp-Prot / RTD / Windg 3]	
80°C	0°C ... 200°C	P.2
	<i>Winding 3 Threshold for Temperature Alarm</i>	

RTD . Windg 3 t-Delay	[Protection Para / Set 1...4 / Temp-Prot / RTD / Windg 3]	
1min	0min ... 360min	P.2
	<i>Winding 3 If this time is expired a Temperature Alarm will be generated.</i>	

RTD . Windg 3 Trip	[Protection Para / Set 1...4 / Temp-Prot / RTD / Windg 3]	
100°C	0°C ... 200°C	P.2
	<i>Winding 3 Threshold for Temperature Trip</i>	



RTD . Windg 4 Alarm Function		[Protection Para / Set 1...4 / Temp-Prot / RTD / Windg 4]
active	inactive, active	P.2
		 Mode.
 <i>Winding 4 Alarm Function</i>		



RTD . Windg 4 Trip Function		[Protection Para / Set 1...4 / Temp-Prot / RTD / Windg 4]
active	inactive, active	P.2
		 Mode.
 <i>Winding 4 Trip Function</i>		

RTD . Windg 4 Alarm		[Protection Para / Set 1...4 / Temp-Prot / RTD / Windg 4]
80°C	0°C ... 200°C	P.2
 <i>Winding 4 Threshold for Temperature Alarm</i>		

RTD . Windg 4 t-Delay		[Protection Para / Set 1...4 / Temp-Prot / RTD / Windg 4]
1min	0min ... 360min	P.2
 <i>Winding 4 If this time is expired a Temperature Alarm will be generated.</i>		

RTD . Windg 4 Trip		[Protection Para / Set 1...4 / Temp-Prot / RTD / Windg 4]
100°C	0°C ... 200°C	P.2
 <i>Winding 4 Threshold for Temperature Trip</i>		



RTD . Windg 5 Alarm Function		[Protection Para / Set 1...4 / Temp-Prot / RTD / Windg 5]
active	inactive, active	P.2
		 Mode.
 <i>Winding 5 Alarm Function</i>		



RTD . Windg 5 Trip Function		[Protection Para / Set 1...4 / Temp-Prot / RTD / Windg 5]
active	inactive, active	P.2
		 Mode.
 <i>Winding 5 Trip Function</i>		

RTD . Windg 5 Alarm	[Protection Para / Set 1...4 / Temp-Prot / RTD / Windg 5]	
80°C	0°C ... 200°C	P.2
	<i>Winding 5 Threshold for Temperature Alarm</i>	

RTD . Windg 5 t-Delay	[Protection Para / Set 1...4 / Temp-Prot / RTD / Windg 5]	
1min	0min ... 360min	P.2
	<i>Winding 5 If this time is expired a Temperature Alarm will be generated.</i>	

RTD . Windg 5 Trip	[Protection Para / Set 1...4 / Temp-Prot / RTD / Windg 5]	
100°C	0°C ... 200°C	P.2
	<i>Winding 5 Threshold for Temperature Trip</i>	

RTD . Windg 6 Alarm Function	[Protection Para / Set 1...4 / Temp-Prot / RTD / Windg 6]	
active	inactive, active  Mode.	P.2
	<i>Winding 6 Alarm Function</i>	

RTD . Windg 6 Trip Function	[Protection Para / Set 1...4 / Temp-Prot / RTD / Windg 6]	
active	inactive, active  Mode.	P.2
	<i>Winding 6 Trip Function</i>	

RTD . Windg 6 Alarm	[Protection Para / Set 1...4 / Temp-Prot / RTD / Windg 6]	
80°C	0°C ... 200°C	P.2
	<i>Winding 6 Threshold for Temperature Alarm</i>	

RTD . Windg 6 t-Delay	[Protection Para / Set 1...4 / Temp-Prot / RTD / Windg 6]	
1min	0min ... 360min	P.2
	<i>Winding 6 If this time is expired a Temperature Alarm will be generated.</i>	

RTD . Windg 6 Trip	[Protection Para / Set 1...4 / Temp-Prot / RTD / Windg 6]	
100°C	0°C ... 200°C	P.2
	<i>Winding 6 Threshold for Temperature Trip</i>	

RTD . MotBear 1 Alarm Function	[Protection Para / Set 1...4 / Temp-Prot / RTD / MotBear 1]	
active	inactive, active ↳ Mode.	P.2
 <i>Motor Bearing 1 Alarm Function</i>		

RTD . MotBear 1 Trip Function	[Protection Para / Set 1...4 / Temp-Prot / RTD / MotBear 1]	
active	inactive, active ↳ Mode.	P.2
 <i>Motor Bearing 1 Trip Function</i>		

RTD . MotBear 1 Alarm	[Protection Para / Set 1...4 / Temp-Prot / RTD / MotBear 1]	
80°C	0°C ... 200°C	P.2
 <i>Motor Bearing 1 Threshold for Temperature Alarm</i>		

RTD . MotBear 1 t-Delay	[Protection Para / Set 1...4 / Temp-Prot / RTD / MotBear 1]	
1min	0min ... 360min	P.2
 <i>Motor Bearing 1 If this time is expired a Temperature Alarm will be generated.</i>		

RTD . MotBear 1 Trip	[Protection Para / Set 1...4 / Temp-Prot / RTD / MotBear 1]	
100°C	0°C ... 200°C	P.2
 <i>Motor Bearing 1 Threshold for Temperature Trip</i>		



RTD . MotBear 2 Alarm Function	[Protection Para / Set 1...4 / Temp-Prot / RTD / MotBear 2]	
active	inactive, active ↳ Mode.	P.2
 <i>Motor Bearing 2 Alarm Function</i>		



RTD . MotBear 2 Trip Function	[Protection Para / Set 1...4 / Temp-Prot / RTD / MotBear 2]	
active	inactive, active ↳ Mode.	P.2
 <i>Motor Bearing 2 Trip Function</i>		

RTD . MotBear 2 Alarm	[Protection Para / Set 1...4 / Temp-Prot / RTD / MotBear 2]	
80°C	0°C ... 200°C	P.2
	<i>Motor Bearing 2 Threshold for Temperature Alarm</i>	

RTD . MotBear 2 t-Delay	[Protection Para / Set 1...4 / Temp-Prot / RTD / MotBear 2]	
1min	0min ... 360min	P.2
	<i>Motor Bearing 2 If this time is expired a Temperature Alarm will be generated.</i>	

RTD . MotBear 2 Trip	[Protection Para / Set 1...4 / Temp-Prot / RTD / MotBear 2]	
100°C	0°C ... 200°C	P.2
	<i>Motor Bearing 2 Threshold for Temperature Trip</i>	



RTD . LoadBear 1 Alarm Function	[Protection Para / Set 1...4 / Temp-Prot / RTD / LoadBear 1]	
active	inactive, active  Mode.	P.2
	<i>Load Bearing 1 Alarm Function</i>	



RTD . LoadBear 1 Trip Function	[Protection Para / Set 1...4 / Temp-Prot / RTD / LoadBear 1]	
active	inactive, active  Mode.	P.2
	<i>Load Bearing 1 Trip Function</i>	

RTD . LoadBear 1 Alarm	[Protection Para / Set 1...4 / Temp-Prot / RTD / LoadBear 1]	
80°C	0°C ... 200°C	P.2
	<i>Load Bearing 1 Threshold for Temperature Alarm</i>	

RTD . LoadBear 1 t-Delay	[Protection Para / Set 1...4 / Temp-Prot / RTD / LoadBear 1]	
1min	0min ... 360min	P.2
	<i>Load Bearing 1 If this time is expired a Temperature Alarm will be generated.</i>	

RTD . LoadBear 1 Trip	[Protection Para / Set 1...4 / Temp-Prot / RTD / LoadBear 1]	
80°C	0°C ... 200°C	P.2
	<i>Load Bearing 1 Threshold for Temperature Trip</i>	



RTD . LoadBear 2 Alarm Function	[Protection Para / Set 1...4 / Temp-Prot / RTD / LoadBear 2]	
active	inactive, active  Mode.	P.2
	<i>Load Bearing 2 Alarm Function</i>	



RTD . LoadBear 2 Trip Function	[Protection Para / Set 1...4 / Temp-Prot / RTD / LoadBear 2]	
active	inactive, active  Mode.	P.2
	<i>Load Bearing 2 Trip Function</i>	

RTD . LoadBear 2 Alarm	[Protection Para / Set 1...4 / Temp-Prot / RTD / LoadBear 2]	
80°C	0°C ... 200°C	P.2
	<i>Load Bearing 2 Threshold for Temperature Alarm</i>	

RTD . LoadBear 2 t-Delay	[Protection Para / Set 1...4 / Temp-Prot / RTD / LoadBear 2]	
1min	0min ... 360min	P.2
	<i>Load Bearing 2 If this time is expired a Temperature Alarm will be generated.</i>	

RTD . LoadBear 2 Trip	[Protection Para / Set 1...4 / Temp-Prot / RTD / LoadBear 2]	
80°C	0°C ... 200°C	P.2
	<i>Load Bearing 2 Threshold for Temperature Trip</i>	



RTD . Aux1 Alarm Function	[Protection Para / Set 1...4 / Temp-Prot / RTD / Aux1]	
active	inactive, active  Mode.	P.2
	<i>Auxiliary 1 Alarm Function</i>	



RTD . Aux1 Trip Function	[Protection Para / Set 1...4 / Temp-Prot / RTD / Aux1]	
active	inactive, active  Mode.	P.2
	<i>Auxiliary 1 Trip Function</i>	

RTD . Aux1 Alarm	[Protection Para / Set 1...4 / Temp-Prot / RTD / Aux1]	
80°C	0°C ... 200°C	P.2
	<i>Auxiliary 1 Threshold for Temperature Alarm</i>	

RTD . Aux1 t-Delay	[Protection Para / Set 1...4 / Temp-Prot / RTD / Aux1]	
1min	0min ... 360min	P.2
	<i>Auxiliary 1 If this time is expired a Temperature Alarm will be generated.</i>	

RTD . Aux1 Trip	[Protection Para / Set 1...4 / Temp-Prot / RTD / Aux1]	
100°C	0°C ... 200°C	P.2
	<i>Auxiliary 1 Threshold for Temperature Trip</i>	



RTD . Aux2 Alarm Function	[Protection Para / Set 1...4 / Temp-Prot / RTD / Aux2]	
active	inactive, active  Mode.	P.2
	<i>Auxiliary 2 Alarm Function</i>	



RTD . Aux2 Trip Function	[Protection Para / Set 1...4 / Temp-Prot / RTD / Aux2]	
active	inactive, active  Mode.	P.2
	<i>Auxiliary 2 Trip Function</i>	

RTD . Aux2 Alarm	[Protection Para / Set 1...4 / Temp-Prot / RTD / Aux2]	
80°C	0°C ... 200°C	P.2
	<i>Auxiliary 2 Threshold for Temperature Alarm</i>	

RTD . Aux2 t-Delay	[Protection Para / Set 1...4 / Temp-Prot / RTD / Aux2]	
1min	0min ... 360min	P.2
	<i>Auxiliary 2 If this time is expired a Temperature Alarm will be generated.</i>	

RTD . Aux2 Trip	[Protection Para / Set 1...4 / Temp-Prot / RTD / Aux2]	
100°C	0°C ... 200°C	P.2
	<i>Auxiliary 2 Threshold for Temperature Trip</i>	



RTD . Windg Alarm Function	[Protection Para / Set 1...4 / Temp-Prot / RTD / Windg Group]	
inactive	inactive, active  Mode.	P.2
 <i>Winding Alarm Function</i>		



RTD . Windg Trip Function	[Protection Para / Set 1...4 / Temp-Prot / RTD / Windg Group]	
inactive	inactive, active  Mode.	P.2
 <i>Winding Trip Function</i>		

RTD . Windg Alarm	[Protection Para / Set 1...4 / Temp-Prot / RTD / Windg Group]	
80°C	0°C ... 200°C	P.2
 <i>Winding Threshold for Temperature Alarm</i>		

RTD . Windg t-Delay	[Protection Para / Set 1...4 / Temp-Prot / RTD / Windg Group]	
1min	0min ... 360min	P.2
 <i>Winding If this time is expired a Temperature Alarm will be generated.</i>		

RTD . Windg Trip	[Protection Para / Set 1...4 / Temp-Prot / RTD / Windg Group]	
100°C	0°C ... 200°C	P.2
 <i>Winding Threshold for Temperature Trip</i>		



RTD . MotBear Alarm Function	[Protection Para / Set 1...4 / Temp-Prot / RTD / MotBear Group]	
inactive	inactive, active  Mode.	P.2
 <i>Motor Bearing Alarm Function</i>		



RTD . MotBear Trip Function	[Protection Para / Set 1...4 / Temp-Prot / RTD / MotBear Group]	
inactive	inactive, active  Mode.	P.2
 <i>Motor Bearing Trip Function</i>		

RTD . MotBear Alarm	[Protection Para / Set 1...4 / Temp-Prot / RTD / MotBear Group]	
80°C	0°C ... 200°C	P.2
	<i>Motor Bearing Threshold for Temperature Alarm</i>	

RTD . MotBear t-Delay	[Protection Para / Set 1...4 / Temp-Prot / RTD / MotBear Group]	
1min	0min ... 360min	P.2
	<i>Motor Bearing If this time is expired a Temperature Alarm will be generated.</i>	

RTD . MotBear Trip	[Protection Para / Set 1...4 / Temp-Prot / RTD / MotBear Group]	
100°C	0°C ... 200°C	P.2
	<i>Motor Bearing Threshold for Temperature Trip</i>	



RTD . LoadBear Alarm Function	[Protection Para / Set 1...4 / Temp-Prot / RTD / LoadBear Group]	
inactive	inactive, active  Mode.	P.2
	<i>Load Bearing Alarm Function</i>	



RTD . LoadBear Trip Function	[Protection Para / Set 1...4 / Temp-Prot / RTD / LoadBear Group]	
inactive	inactive, active  Mode.	P.2
	<i>Load Bearing Trip Function</i>	

RTD . LoadBear Alarm	[Protection Para / Set 1...4 / Temp-Prot / RTD / LoadBear Group]	
80°C	0°C ... 200°C	P.2
	<i>Load Bearing Threshold for Temperature Alarm</i>	

RTD . LoadBear t-Delay	[Protection Para / Set 1...4 / Temp-Prot / RTD / LoadBear Group]	
1min	0min ... 360min	P.2
	<i>Load Bearing If this time is expired a Temperature Alarm will be generated.</i>	

RTD . LoadBear Trip	[Protection Para / Set 1...4 / Temp-Prot / RTD / LoadBear Group]	
80°C	0°C ... 200°C	P.2
	<i>Load Bearing Threshold for Temperature Trip</i>	

RTD . Aux Alarm Function	[Protection Para / Set 1...4 / Temp-Prot / RTD / Aux Group]	
inactive	inactive, active  Mode.	P.2
	<i>Auxiliary Alarm Function</i>	



RTD . Aux Trip Function	[Protection Para / Set 1...4 / Temp-Prot / RTD / Aux Group]	
inactive	inactive, active  Mode.	P.2
	<i>Auxiliary Trip Function</i>	



RTD . Aux Alarm	[Protection Para / Set 1...4 / Temp-Prot / RTD / Aux Group]	
80°C	0°C ... 200°C	P.2
	<i>Auxiliary Threshold for Temperature Alarm</i>	



RTD . Aux t-Delay	[Protection Para / Set 1...4 / Temp-Prot / RTD / Aux Group]	
1min	0min ... 360min	P.2
	<i>Auxiliary If this time is expired a Temperature Alarm will be generated.</i>	



RTD . Aux Trip	[Protection Para / Set 1...4 / Temp-Prot / RTD / Aux Group]	
100°C	0°C ... 200°C	P.2
	<i>Auxiliary Threshold for Temperature Trip</i>	



RTD . Voting 1	[Protection Para / Set 1...4 / Temp-Prot / RTD / Voting1]	
RTD . Voting 2	[Protection Para / Set 1...4 / Temp-Prot / RTD / Voting2]	
1	1 ... 12	P.2
	<i>Voting: This parameter defines how many of the selected channels must be over its threshold level for getting a voting trip</i>	



RTD . Windg 1		[Protection Para / Set 1...4 / Temp-Prot / RTD / Voting1] [Protection Para / Set 1...4 / Temp-Prot / RTD / Voting2]
no	no, yes  yes/no.	P.2
 <i>Winding 1</i>		



RTD . Windg 2		[Protection Para / Set 1...4 / Temp-Prot / RTD / Voting1] [Protection Para / Set 1...4 / Temp-Prot / RTD / Voting2]
no	no, yes  yes/no.	P.2
 <i>Winding 2</i>		



RTD . Windg 3		[Protection Para / Set 1...4 / Temp-Prot / RTD / Voting1] [Protection Para / Set 1...4 / Temp-Prot / RTD / Voting2]
no	no, yes  yes/no.	P.2
 <i>Winding 3</i>		



RTD . Windg 4		[Protection Para / Set 1...4 / Temp-Prot / RTD / Voting1] [Protection Para / Set 1...4 / Temp-Prot / RTD / Voting2]
no	no, yes  yes/no.	P.2
 <i>Winding 4</i>		



RTD . Windg 5		[Protection Para / Set 1...4 / Temp-Prot / RTD / Voting1] [Protection Para / Set 1...4 / Temp-Prot / RTD / Voting2]
no	no, yes  yes/no.	P.2
 <i>Winding 5</i>		

RTD . Windg 6		[Protection Para / Set 1...4 / Temp-Prot / RTD / Voting1] [Protection Para / Set 1...4 / Temp-Prot / RTD / Voting2]
no	no, yes  yes/no.	P.2
 <i>Winding 6</i>		

RTD . MotBear 1		[Protection Para / Set 1...4 / Temp-Prot / RTD / Voting1] [Protection Para / Set 1...4 / Temp-Prot / RTD / Voting2]
no	no, yes  yes/no.	P.2
 <i>Motor Bearing 1</i>		

RTD . MotBear 2		[Protection Para / Set 1...4 / Temp-Prot / RTD / Voting1] [Protection Para / Set 1...4 / Temp-Prot / RTD / Voting2]
no	no, yes  yes/no.	P.2
 <i>Motor Bearing 2</i>		

RTD . LoadBear 1		[Protection Para / Set 1...4 / Temp-Prot / RTD / Voting1] [Protection Para / Set 1...4 / Temp-Prot / RTD / Voting2]
no	no, yes  yes/no.	P.2
 <i>Load Bearing 1</i>		

RTD . LoadBear 2		[Protection Para / Set 1...4 / Temp-Prot / RTD / Voting1] [Protection Para / Set 1...4 / Temp-Prot / RTD / Voting2]
no	no, yes  yes/no.	P.2
 <i>Load Bearing 2</i>		

RTD . Aux1	[Protection Para / Set 1...4 / Temp-Prot / RTD / Voting1] [Protection Para / Set 1...4 / Temp-Prot / RTD / Voting2]
no	no, yes ↳ yes/no.
 Auxiliary1	

RTD . Aux2	[Protection Para / Set 1...4 / Temp-Prot / RTD / Voting1] [Protection Para / Set 1...4 / Temp-Prot / RTD / Voting2]
no	no, yes ↳ yes/no.
 Auxiliary2	

9.46.4 RTD: Input States

RTD . ExBlo1-I	[Operation / Status Display / Temp-Prot / RTD / General]
 Module input state: External blocking1	

RTD . ExBlo2-I	[Operation / Status Display / Temp-Prot / RTD / General]
 Module input state: External blocking2	

RTD . ExBlo TripCmd-I	[Operation / Status Display / Temp-Prot / RTD / General]
 Module input state: External Blocking of the Trip Command	

9.46.5 RTD: Signals (Output States)

RTD . active	[Operation / Status Display / All Actives] [Operation / Status Display / Temp-Prot / RTD / General]
 Signal: active	

RTD . Alarm	[Operation / Status Display / Alarms] [Operation / Status Display / Temp-Prot / RTD / General]
 Alarm RTD Temperature Protection	

RTD . Windg 1 Alarm	[Operation / Status Display / Alarms] [Operation / Status Display / Temp-Prot / RTD / Windg 1]
 <i>Winding 1 Alarm RTD Temperature Protection</i>	

RTD . Windg 1 Timeout Alarm	[Operation / Status Display / Alarms] [Operation / Status Display / Temp-Prot / RTD / Windg 1]
 <i>Winding 1 Timeout Alarm</i>	

RTD . Windg 2 Alarm	[Operation / Status Display / Alarms] [Operation / Status Display / Temp-Prot / RTD / Windg 2]
 <i>Winding 2 Alarm RTD Temperature Protection</i>	

RTD . Windg 2 Timeout Alarm	[Operation / Status Display / Alarms] [Operation / Status Display / Temp-Prot / RTD / Windg 2]
 <i>Winding 2 Timeout Alarm</i>	

RTD . Windg 3 Alarm	[Operation / Status Display / Alarms] [Operation / Status Display / Temp-Prot / RTD / Windg 3]
 <i>Winding 3 Alarm RTD Temperature Protection</i>	

RTD . Windg 3 Timeout Alarm	[Operation / Status Display / Alarms] [Operation / Status Display / Temp-Prot / RTD / Windg 3]
 <i>Winding 3 Timeout Alarm</i>	









RTD . Windg 4 Alarm	[Operation / Status Display / Alarms] [Operation / Status Display / Temp-Prot / RTD / Windg 4]
 <i>Winding 4 Alarm RTD Temperature Protection</i>	

RTD . Windg 4 Timeout Alarm	[Operation / Status Display / Alarms] [Operation / Status Display / Temp-Prot / RTD / Windg 4]
 <i>Winding 4 Timeout Alarm</i>	

RTD . Windg 5 Alarm	[Operation / Status Display / Alarms] [Operation / Status Display / Temp-Prot / RTD / Windg 5]
↑	<i>Winding 5 Alarm RTD Temperature Protection</i>
RTD . Windg 5 Timeout Alarm	[Operation / Status Display / Alarms] [Operation / Status Display / Temp-Prot / RTD / Windg 5]
↑	<i>Winding 5 Timeout Alarm</i>
RTD . Windg 6 Alarm	[Operation / Status Display / Alarms] [Operation / Status Display / Temp-Prot / RTD / Windg 6]
↑	<i>Winding 6 Alarm RTD Temperature Protection</i>
RTD . Windg 6 Timeout Alarm	[Operation / Status Display / Alarms] [Operation / Status Display / Temp-Prot / RTD / Windg 6]
↑	<i>Winding 6 Timeout Alarm</i>
RTD . MotBear 1 Alarm	[Operation / Status Display / Alarms] [Operation / Status Display / Temp-Prot / RTD / MotBear 1]
↑	<i>Motor Bearing 1 Alarm RTD Temperature Protection</i>
RTD . MotBear 1 Timeout Alarm	[Operation / Status Display / Alarms] [Operation / Status Display / Temp-Prot / RTD / MotBear 1]
↑	<i>Motor Bearing 1 Timeout Alarm</i>
RTD . MotBear 2 Alarm	[Operation / Status Display / Alarms] [Operation / Status Display / Temp-Prot / RTD / MotBear 2]
↑	<i>Motor Bearing 2 Alarm RTD Temperature Protection</i>
RTD . MotBear 2 Timeout Alarm	[Operation / Status Display / Alarms] [Operation / Status Display / Temp-Prot / RTD / MotBear 2]
↑	<i>Motor Bearing 2 Timeout Alarm</i>

RTD . LoadBear 1 Alarm	[Operation / Status Display / Alarms] [Operation / Status Display / Temp-Prot / RTD / LoadBear 1]
 <i>Load Bearing 1 Alarm RTD Temperature Protection</i>	
RTD . LoadBear 1 Timeout Alarm	[Operation / Status Display / Alarms] [Operation / Status Display / Temp-Prot / RTD / LoadBear 1]
 <i>Load Bearing 1 Timeout Alarm</i>	
RTD . LoadBear 2 Alarm	[Operation / Status Display / Alarms] [Operation / Status Display / Temp-Prot / RTD / LoadBear 2]
 <i>Load Bearing 2 Alarm RTD Temperature Protection</i>	
RTD . LoadBear 2 Timeout Alarm	[Operation / Status Display / Alarms] [Operation / Status Display / Temp-Prot / RTD / LoadBear 2]
 <i>Load Bearing 2 Timeout Alarm</i>	
RTD . Aux1 Alarm	[Operation / Status Display / Alarms] [Operation / Status Display / Temp-Prot / RTD / Aux1]
 <i>Auxiliary 1 Alarm RTD Temperature Protection</i>	
RTD . Aux1 Timeout Alarm	[Operation / Status Display / Alarms] [Operation / Status Display / Temp-Prot / RTD / Aux1]
 <i>Auxiliary 1 Timeout Alarm</i>	
RTD . Aux2 Alarm	[Operation / Status Display / Alarms] [Operation / Status Display / Temp-Prot / RTD / Aux2]
 <i>Auxiliary 2 Alarm RTD Temperature Protection</i>	
RTD . Aux2 Timeout Alarm	[Operation / Status Display / Alarms] [Operation / Status Display / Temp-Prot / RTD / Aux2]
 <i>Auxiliary 2 Timeout Alarm</i>	

RTD . Alarm WD Group	[Operation / Status Display / Alarms] [Operation / Status Display / Temp-Prot / RTD / Windg Group]
 <i>Alarm all Windings</i>	
RTD . TimeoutAlmWDGrp	[Operation / Status Display / Alarms] [Operation / Status Display / Temp-Prot / RTD / Windg Group]
 <i>Timeout Alarm all Windings</i>	
RTD . Alarm MB Group	[Operation / Status Display / Alarms] [Operation / Status Display / Temp-Prot / RTD / MotBear Group]
 <i>Alarm all Motor Bearings</i>	
RTD . TimeoutAlmMBGrp	[Operation / Status Display / Alarms] [Operation / Status Display / Temp-Prot / RTD / MotBear Group]
 <i>Timeout Alarm all Motor Bearings</i>	
RTD . Alarm LB Group	[Operation / Status Display / Alarms] [Operation / Status Display / Temp-Prot / RTD / LoadBear Group]
 <i>Alarm all Load Bearings</i>	
RTD . TimeoutAlmLBGrp	[Operation / Status Display / Alarms] [Operation / Status Display / Temp-Prot / RTD / LoadBear Group]
 <i>Timeout Alarm all Load Bearings</i>	
RTD . Alarm Aux Group	[Operation / Status Display / Alarms] [Operation / Status Display / Temp-Prot / RTD / Aux Group]
 <i>Alarm Auxiliary Group</i>	

RTD . TimeoutAlmAuxGrp	[Operation / Status Display / Alarms] [Operation / Status Display / Temp-Prot / RTD / Aux Group]
 <i>Timeout Alarm Auxiliary Group</i>	
RTD . Trip	[Operation / Status Display / Trips] [Operation / Status Display / Temp-Prot / RTD / General]
 <i>Signal: Trip</i>	
RTD . TripCmd	[Operation / Status Display / TripCmds] [Operation / Status Display / Temp-Prot / RTD / General]
 <i>Signal: Trip Command</i>	
RTD . ExBlo	[Operation / Status Display / Temp-Prot / RTD / General]
 <i>Signal: External Blocking</i>	
RTD . Blo TripCmd	[Operation / Status Display / Temp-Prot / RTD / General]
 <i>Signal: Trip Command blocked</i>	
RTD . ExBlo TripCmd	[Operation / Status Display / Temp-Prot / RTD / General]
 <i>Signal: External Blocking of the Trip Command</i>	
RTD . Timeout Alarm	[Operation / Status Display / Temp-Prot / RTD / General]
 <i>Alarm timeout expired</i>	
RTD . Windg 1 Trip	[Operation / Status Display / Temp-Prot / RTD / Windg 1]
 <i>Winding 1 Signal: Trip</i>	
RTD . Windg 1 Invalid	[Operation / Status Display / Temp-Prot / RTD / Windg 1]
 <i>Winding 1 Signal: Invalid Temperature Measurement Value (e.g caused by an defective or interrupted RTD Measurement)</i>	
RTD . Windg 2 Trip	[Operation / Status Display / Temp-Prot / RTD / Windg 2]
 <i>Winding 2 Signal: Trip</i>	

RTD . Windg 2 Invalid	[Operation / Status Display / Temp-Prot / RTD / Windg 2]
 <i>Winding 2 Signal: Invalid Temperature Measurement Value (e.g caused by an defective or interrupted RTD Measurement)</i>	
RTD . Windg 3 Trip	[Operation / Status Display / Temp-Prot / RTD / Windg 3]
 <i>Winding 3 Signal: Trip</i>	
RTD . Windg 3 Invalid	[Operation / Status Display / Temp-Prot / RTD / Windg 3]
 <i>Winding 3 Signal: Invalid Temperature Measurement Value (e.g caused by an defective or interrupted RTD Measurement)</i>	
RTD . Windg 4 Trip	[Operation / Status Display / Temp-Prot / RTD / Windg 4]
 <i>Winding 4 Signal: Trip</i>	
RTD . Windg 4 Invalid	[Operation / Status Display / Temp-Prot / RTD / Windg 4]
 <i>Winding 4 Signal: Invalid Temperature Measurement Value (e.g caused by an defective or interrupted RTD Measurement)</i>	
RTD . Windg 5 Trip	[Operation / Status Display / Temp-Prot / RTD / Windg 5]
 <i>Winding 5 Signal: Trip</i>	
RTD . Windg 5 Invalid	[Operation / Status Display / Temp-Prot / RTD / Windg 5]
 <i>Winding 5 Signal: Invalid Temperature Measurement Value (e.g caused by an defective or interrupted RTD Measurement)</i>	
RTD . Windg 6 Trip	[Operation / Status Display / Temp-Prot / RTD / Windg 6]
 <i>Winding 6 Signal: Trip</i>	
RTD . Windg 6 Invalid	[Operation / Status Display / Temp-Prot / RTD / Windg 6]
 <i>Winding 6 Signal: Invalid Temperature Measurement Value (e.g caused by an defective or interrupted RTD Measurement)</i>	
RTD . MotBear 1 Trip	[Operation / Status Display / Temp-Prot / RTD / MotBear 1]
 <i>Motor Bearing 1 Signal: Trip</i>	
RTD . MotBear 1 Invalid	[Operation / Status Display / Temp-Prot / RTD / MotBear 1]
 <i>Motor Bearing 1 Signal: Invalid Temperature Measurement Value (e.g caused by an defective or interrupted RTD Measurement)</i>	

RTD . MotBear 2 Trip	[Operation / Status Display / Temp-Prot / RTD / MotBear 2]
 <i>Motor Bearing 2 Signal: Trip</i>	
RTD . MotBear 2 Invalid	[Operation / Status Display / Temp-Prot / RTD / MotBear 2]
 <i>Motor Bearing 2 Signal: Invalid Temperature Measurement Value (e.g caused by an defective or interrupted RTD Measurement)</i>	
RTD . LoadBear 1 Trip	[Operation / Status Display / Temp-Prot / RTD / LoadBear 1]
 <i>Load Bearing 1 Signal: Trip</i>	
RTD . LoadBear 1 Invalid	[Operation / Status Display / Temp-Prot / RTD / LoadBear 1]
 <i>Load Bearing 1 Signal: Invalid Temperature Measurement Value (e.g caused by an defective or interrupted RTD Measurement)</i>	
RTD . LoadBear 2 Trip	[Operation / Status Display / Temp-Prot / RTD / LoadBear 2]
 <i>Load Bearing 2 Signal: Trip</i>	
RTD . LoadBear 2 Invalid	[Operation / Status Display / Temp-Prot / RTD / LoadBear 2]
 <i>Load Bearing 2 Signal: Invalid Temperature Measurement Value (e.g caused by an defective or interrupted RTD Measurement)</i>	
RTD . Aux1 Trip	[Operation / Status Display / Temp-Prot / RTD / Aux1]
 <i>Auxiliary 1 Signal: Trip</i>	
RTD . Aux1 Invalid	[Operation / Status Display / Temp-Prot / RTD / Aux1]
 <i>Auxiliary 1 Signal: Invalid Temperature Measurement Value (e.g caused by an defective or interrupted RTD Measurement)</i>	
RTD . Aux2 Trip	[Operation / Status Display / Temp-Prot / RTD / Aux2]
 <i>Auxiliary 2 Signal: Trip</i>	
RTD . Aux2 Invalid	[Operation / Status Display / Temp-Prot / RTD / Aux2]
 <i>Auxiliary 2 Signal: Invalid Temperature Measurement Value (e.g caused by an defective or interrupted RTD Measurement)</i>	
RTD . Trip WD Group	[Operation / Status Display / Temp-Prot / RTD / Windg Group]
 <i>Trip all Windings</i>	

RTD . Windg Group Invalid	[Operation / Status Display / Temp-Prot / RTD / Windg Group]
⤴	<i>Winding Group Signal: Invalid Temperature Measurement Value (e.g caused by an defective or interrupted RTD Measurement)</i>
RTD . Trip MB Group	[Operation / Status Display / Temp-Prot / RTD / MotBear Group]
⤴	<i>Trip all Motor Bearings</i>
RTD . MotBear Group Invalid	[Operation / Status Display / Temp-Prot / RTD / MotBear Group]
⤴	<i>Motor Bearing Group Signal: Invalid Temperature Measurement Value (e.g caused by an defective or interrupted RTD Measurement)</i>
RTD . Trip LB Group	[Operation / Status Display / Temp-Prot / RTD / LoadBear Group]
⤴	<i>Trip all Load Bearings</i>
RTD . LoadBear Group Invalid	[Operation / Status Display / Temp-Prot / RTD / LoadBear Group]
⤴	<i>Load Bearing Group Signal: Invalid Temperature Measurement Value (e.g caused by an defective or interrupted RTD Measurement)</i>
RTD . Trip Aux Group	[Operation / Status Display / Temp-Prot / RTD / Aux Group]
⤴	<i>Trip Auxiliary Group</i>
RTD . AuxGrpInvalid	[Operation / Status Display / Temp-Prot / RTD / Aux Group]
⤴	<i>Invalid Auxiliary Group</i>
RTD . Trip Any Group	[Operation / Status Display / Temp-Prot / RTD / Any Group]
⤴	<i>Trip Any Group</i>
RTD . Alarm Any Group	[Operation / Status Display / Temp-Prot / RTD / Any Group]
⤴	<i>Alarm Any Group</i>
RTD . TimeoutAlmAnyGrp	[Operation / Status Display / Temp-Prot / RTD / Any Group]
⤴	<i>Timeout Alarm Any Group</i>
RTD . Trip Group 1	[Operation / Status Display / Temp-Prot / RTD / Voting]
⤴	<i>Trip Group 1</i>

RTD . **Trip Group 2**

[Operation / Status Display / Temp-Prot / RTD / Voting]

↕ Trip Group 2

9.46.6 RTD: CountersRTD . **HottestWindingTemp**

[Operation / Measured Values / URTD]

*Hottest motor winding temperature in degrees C.*RTD . **Hottest MotBearTemp**

[Operation / Measured Values / URTD]

*Hottest motor bearing temperature in degrees C.*RTD . **Hottest LoadBearTemp**

[Operation / Measured Values / URTD]

*Hottest load bearing temperature in degrees C.*RTD . **Hottest Aux Temp**

[Operation / Measured Values / URTD]

Hottest Auxiliary temperature in degrees C.

9.47 AnaP[1] ... AnaP[4]

Analog Input Protection

9.47.1 AnaP[1]: Device Planning Parameters

AnaP[1] . Mode	[Device planning]	
use	"-", use ↳ Mode.	S.3
 Analog Inputs, general operation mode		

9.47.2 AnaP[1]: Global Parameters

AnaP[1] . ExBlo1	[Protection Para / Global Prot Para / Analog Inputs / AnaP[1]]	
AnaP[1] . ExBlo2		
"-"	"-" ... Sys . Internal test state ↳ 1..n, Assignment List.	S.3
 External blocking of the module, if blocking is activated (allowed) within a parameter set and if the state of the assigned signal is true.		

AnaP[1] . ExBlo TripCmd	[Protection Para / Global Prot Para / Analog Inputs / AnaP[1]]	
"-"	"-" ... Sys . Internal test state ↳ 1..n, Assignment List.	S.3
 External blocking of the Trip Command of the module/the stage, if blocking is activated (allowed) within a parameter set and if the state of the assigned signal is true.		

AnaP[1] . Measuring Input	[Protection Para / Global Prot Para / Analog Inputs / AnaP[1]]	
"-"	"-", AnIn[1] . Value, AnIn[2] . Value ↳ 1..n, AnalogOutputList.	S.3
 Measuring Input		

AnaP[1] . Alarm mode		[Protection Para / Global Prot Para / Analog Inputs / AnaP[1]]
Over	Over, Under	S.3
	↳ t-Alarm.	
 Alarm mode		

9.47.3 AnaP[1]: Setting Group Parameters

AnaP[1] . Function		[Protection Para / Set 1...4 / Analog Inputs / AnaP[1]]
inactive	inactive, active	S.3
	↳ Mode.	
 Permanent activation or deactivation of module/stage.		

AnaP[1] . ExBlo Fc		[Protection Para / Set 1...4 / Analog Inputs / AnaP[1]]
inactive	inactive, active	S.3
	↳ active/inactive.	
 Activate (allow) or inactivate (disallow) blocking of the module/stage. This parameter is only effective if a signal is assigned to the corresponding global protection parameter. If the signal becomes true, those modules/stages are blocked that are parameterized "ExBlo Fc=active".		

AnaP[1] . Blo TripCmd		[Protection Para / Set 1...4 / Analog Inputs / AnaP[1]]
inactive	inactive, active	S.3
	↳ Mode.	
 Permanent blocking of the Trip Command of the module/stage.		

AnaP[1] . ExBlo TripCmd Fc		[Protection Para / Set 1...4 / Analog Inputs / AnaP[1]]
inactive	inactive, active	S.3
	↳ active/inactive.	
 Activate (allow) or inactivate (disallow) blocking of the module/stage. This parameter is only effective if a signal is assigned to the corresponding global protection parameter. If the signal becomes true, those modules/stages are blocked that are parameterized "ExBlo TripCmd Fc=active".		

AnaP[1] . Threshold	[Protection Para / Set 1...4 / Analog Inputs / AnaP[1]]	
20%	If: AnaP[1] . Alarm mode = Over • 1.0% ... 99.9% If: AnaP[1] . Alarm mode = Under • 0.1% ... 97.0%	S.3
 <i>Threshold</i>		

AnaP[1] . t	[Protection Para / Set 1...4 / Analog Inputs / AnaP[1]]	
1s	0.00s ... 10.00s	S.3
 <i>Tripping delay</i>		

9.47.4 AnaP[1]: Input States

AnaP[1] . ExBlo1-I	[Operation / Status Display / Analog Inputs / AnaP[1]]	
 <i>Module input state: External blocking1</i>		

AnaP[1] . ExBlo2-I	[Operation / Status Display / Analog Inputs / AnaP[1]]	
 <i>Module input state: External blocking2</i>		

AnaP[1] . ExBlo TripCmd-I	[Operation / Status Display / Analog Inputs / AnaP[1]]	
 <i>Module input state: External Blocking of the Trip Command</i>		

9.47.5 AnaP[1]: Signals (Output States)

AnaP[1] . active	[Operation / Status Display / All Actives]	
	[Operation / Status Display / Analog Inputs / AnaP[1]]	
 <i>Signal: active</i>		

AnaP[1] . Pickup	[Operation / Status Display / Alarms]	
	[Operation / Status Display / Analog Inputs / AnaP[1]]	
 <i>Signal: Alarm Analog Input</i>		

AnaP[1] . Trip	[Operation / Status Display / Trips] [Operation / Status Display / Analog Inputs / AnaP[1]]
 <i>Signal: Trip</i>	

AnaP[1] . TripCmd	[Operation / Status Display / TripCmds] [Operation / Status Display / Analog Inputs / AnaP[1]]
 <i>Signal: Trip Command</i>	

AnaP[1] . ExBlo	[Operation / Status Display / Analog Inputs / AnaP[1]]
 <i>Signal: External Blocking</i>	

AnaP[1] . Blo TripCmd	[Operation / Status Display / Analog Inputs / AnaP[1]]
 <i>Signal: Trip Command blocked</i>	

AnaP[1] . ExBlo TripCmd	[Operation / Status Display / Analog Inputs / AnaP[1]]
 <i>Signal: External Blocking of the Trip Command</i>	

9.48 Supervision

9.48.1 CBF

Circuit breaker failure protection module

9.48.1.1 CBF: Device Planning Parameters

CBF . Mode	[Device planning]	
"_"	"-", use ↳ Device planning.	S.3
 <i>Module Circuit Breaker Failure protection, general operation mode</i>		

9.48.1.2 CBF: Global Parameters

CBF . Scheme	[Protection Para / Global Prot Para / Supervision / CBF]	
50BF	If: CBF . CB = "-" • 50BF If: CBF . CB ≠ "-" • 50BF, CB Pos, 50BF and CB Pos ↳ Scheme.	P.2
 <i>Scheme</i>		

CBF . CT Winding Side	[Protection Para / Global Prot Para / Supervision / CBF]	
. CT Mains	. CT Ntrl, . CT Mains ↳ CT Winding Side.	P.2
 <i>Measuring values will be used from this winding side</i>		

CBF . CB	[Protection Para / Global Prot Para / Supervision / CBF]	
SG[1] .	"-", SG[1] . , SG[2] . , SG[3] . , SG[4] . , SG[5] . , SG[6] . ↳ CB List.	P.2
 <i>Selection of the Circuit Breaker to be monitored.</i>		

CBF . ExBlo1	[Protection Para / Global Prot Para / Supervision / CBF]	
CBF . ExBlo2		
"_"	"_" ... Sys . Internal test state ↳ 1..n, Assignment List.	P.2
	<i>External blocking of the module, if blocking is activated (allowed) within a parameter set and if the state of the assigned signal is true.</i>	

CBF . Trigger	[Protection Para / Global Prot Para / Supervision / CBF]	
All Trips	- . -, All Trips, External Trips, Current Trips	P.2
Only available if:	↳ Trigger.	
• CBF . CB ≠ "-"		
	<i>Determining the trigger mode for the Breaker Failure.</i>	

CBF . Trigger1	[Protection Para / Global Prot Para / Supervision / CBF]	
CBF . Trigger2		
CBF . Trigger3		
"_"	"_" ... Logics . LE80.Out inverted ↳ Trigger.	P.2
	<i>Trigger that will start the CBF</i>	

9.48.1.3 CBF: Setting Group Parameters

CBF . Function	[Protection Para / Set 1...4 / Supervision / CBF]	
inactive	inactive, active ↳ Mode.	P.2
	<i>Permanent activation or deactivation of module/stage.</i>	

CBF . ExBlo Fc	[Protection Para / Set 1...4 / Supervision / CBF]	
inactive	inactive, active ↳ active/inactive.	P.2
	<i>Activate (allow) or inactivate (disallow) blocking of the module/stage. This parameter is only effective if a signal is assigned to the corresponding global protection parameter. If the signal becomes true, those modules/stages are blocked that are parameterized "ExBlo Fc=active".</i>	

CBF . I-CBF >	[Protection Para / Set 1...4 / Supervision / CBF]	
0.02In	0.02In ... 4.00In	P.2
	<i>Breaker Failure Alarm will be initiated if this threshold is still exceeded after the timer has expired (50 BF).</i>	

CBF . t-CBF	[Protection Para / Set 1...4 / Supervision / CBF]	
0.20s	0.00s ... 10.00s	P.2
	<i>If the delay time is expired, an CBF alarm is given out.</i>	

9.48.1.4 CBF: Direct Controls

CBF . Res Lockout	[Operation / Reset]	
inactive	inactive, active	P.1
	 Mode.	
<input checked="" type="radio"/>	<i>Reset Lockout</i>	

9.48.1.5 CBF: Input States







CBF . ExBlo1-I	[Operation / Status Display / Supervision / CBF]	
	<i>Module input state: External blocking1</i>	

CBF . ExBlo2-I	[Operation / Status Display / Supervision / CBF]	
	<i>Module input state: External blocking2</i>	

CBF . Trigger1-I	[Operation / Status Display / Supervision / CBF]	
CBF . Trigger2-I		
CBF . Trigger3-I		
	<i>Module Input: Trigger that will start the CBF</i>	

9.48.1.6 CBF: Signals (Output States)



CBF . active	[Operation / Status Display / All Actives]
	[Operation / Status Display / Supervision / CBF]
	<i>Signal: active</i>

CBF . Alarm	[Operation / Status Display / Alarms] [Operation / Status Display / Supervision / CBF]
 <i>Signal: Circuit Breaker Failure</i>	
CBF . ExBlo	[Operation / Status Display / Supervision / CBF]
 <i>Signal: External Blocking</i>	
CBF . Waiting for Trigger	[Operation / Status Display / Supervision / CBF]
 <i>Waiting for Trigger</i>	
CBF . running	[Operation / Status Display / Supervision / CBF]
 <i>Signal: CBF-Module started</i>	
CBF . Lockout	[Operation / Status Display / Supervision / CBF]
 <i>Signal: Lockout</i>	
CBF . Res Lockout	[Operation / Status Display / Supervision / CBF]
 <i>Signal: Reset Lockout</i>	

9.48.2 TCS



Trip circuit supervision



9.48.2.1 TCS: Device Planning Parameters

TCS . Mode	[Device planning]	
"-"	"-", use  Device planning.	S.3
	<i>Trip circuit supervision, general operation mode</i>	

9.48.2.2 TCS: Global Parameters

TCS . CB Pos Detect	[Protection Para / Global Prot Para / Supervision / TCS]	
SG[1] . Pos	"-", SG[1] . Pos, SG[2] . Pos, SG[3] . Pos, SG[4] . Pos, SG[5] . Pos, SG[6] . Pos  CB Manager.	P.2
	<i>Criterion by which the Circuit Breaker Switch Position is to be detected.</i>	

TCS . Mode	[Protection Para / Global Prot Para / Supervision / TCS]	
Closed	Closed, Either  Mode.	P.2
Only available if:		
• TCS . CB Pos Detect \neq "-"		
	<i>Select if trip circuit is going to be monitored when the breaker is closed or when the breaker is either open or close.</i>	

TCS . Input 1	[Protection Para / Global Prot Para / Supervision / TCS]	
"-"	"-" ... DI Slot X6 . DI 8  1..n, Dig Inputs.	P.2
Only available if:		
• TCS . CB Pos Detect \neq "-"		
	<i>Select the input configured to monitor the trip coil when the breaker is closed.</i>	

TCS . Input 2	[Protection Para / Global Prot Para / Supervision / TCS]	
"_"	"_" ... DI Slot X6 . DI 8	P.2
Only available if:	↳ 1..n, Dig Inputs.	
<ul style="list-style-type: none"> TCS . CB Pos Detect ≠ "-" TCS . Mode = Either 		
	Select the input configured to monitor the trip coil when the breaker is open. Only available if Mode set to "Either".	

TCS . ExBlo1	[Protection Para / Global Prot Para / Supervision / TCS]	
TCS . ExBlo2		
"_"	"_" ... Sys . Internal test state	P.2
	↳ 1..n, Assignment List.	
	External blocking of the module, if blocking is activated (allowed) within a parameter set and if the state of the assigned signal is true.	

9.48.2.3 TCS: Setting Group Parameters

TCS . Function	[Protection Para / Set 1...4 / Supervision / TCS]	
inactive	inactive, active	P.2
	↳ Mode.	
	Permanent activation or deactivation of module/stage.	

TCS . ExBlo Fc	[Protection Para / Set 1...4 / Supervision / TCS]	
inactive	inactive, active	P.2
	↳ active/inactive.	
	Activate (allow) or inactivate (disallow) blocking of the module/stage. This parameter is only effective if a signal is assigned to the corresponding global protection parameter. If the signal becomes true, those modules/stages are blocked that are parameterized "ExBlo Fc=active".	

TCS . t-TCS	[Protection Para / Set 1...4 / Supervision / TCS]	
0.2s	0.10s ... 10.00s	P.2
	Delay time of the Trip Circuit Supervision	

9.48.2.4 TCS: Input States

TCS . Aux ON-I	[Operation / Status Display / Supervision / TCS]
 <i>Module Input State: Position indicator/check-back signal of the CB (52a)</i>	

TCS . Aux OFF-I	[Operation / Status Display / Supervision / TCS]
 <i>Module input state: Position indicator/check-back signal of the CB (52b)</i>	

TCS . ExBlo1-I	[Operation / Status Display / Supervision / TCS]
 <i>Module input state: External blocking1</i>	

TCS . ExBlo2-I	[Operation / Status Display / Supervision / TCS]
 <i>Module input state: External blocking2</i>	

9.48.2.5 TCS: Signals (Output States)

TCS . active	[Operation / Status Display / All Actives] [Operation / Status Display / Supervision / TCS]
 <i>Signal: active</i>	

TCS . Alarm	[Operation / Status Display / Alarms] [Operation / Status Display / Supervision / TCS]
 <i>Signal: Alarm Trip Circuit Supervision</i>	

TCS . ExBlo	[Operation / Status Display / Supervision / TCS]
 <i>Signal: External Blocking</i>	

TCS . Not Possible	[Operation / Status Display / Supervision / TCS]
 <i>Not possible because no state indicator assigned to the breaker.</i>	

9.48.3 CTS

CT Supervision

9.48.3.1 CTS: Device Planning Parameters

CTS . Mode	[Device planning]	
"_"	"_", use ↳ Device planning.	S.3
 <i>CT Supervision, general operation mode</i>		

9.48.3.2 CTS: Global Parameters

CTS . ExBlo1	[Protection Para / Global Prot Para / Supervision / CTS]	
CTS . ExBlo2		
"_"	"_" ... Sys . Internal test state ↳ 1..n, Assignment List.	P.2
 <i>External blocking of the module, if blocking is activated (allowed) within a parameter set and if the state of the assigned signal is true.</i>		

9.48.3.3 CTS: Setting Group Parameters

CTS . Function	[Protection Para / Set 1...4 / Supervision / CTS]	
inactive	inactive, active ↳ Mode.	P.2
 <i>Permanent activation or deactivation of module/stage.</i>		

CTS . ExBlo Fc	[Protection Para / Set 1...4 / Supervision / CTS]	
inactive	inactive, active ↳ active/inactive.	P.2
 <i>Activate (allow) or inactivate (disallow) blocking of the module/stage. This parameter is only effective if a signal is assigned to the corresponding global protection parameter. If the signal becomes true, those modules/stages are blocked that are parameterized "ExBlo Fc=active".</i>		

CTS . ΔI	[Protection Para / Set 1...4 / Supervision / CTS]	
0.50In	0.10In ... 1.00In	P.2
	<i>In order to prevent faulty tripping of phase selective protection functions that use the current as tripping criterion. If the difference of the measured earth current and the calculated value I_0 is higher than the pick up value ΔI, an alarm event is generated after expiring of the excitation time. In such a case, a fuse failure, a broken wire or a faulty measuring circuit can be assumed.</i>	

CTS . Alarm delay	[Protection Para / Set 1...4 / Supervision / CTS]	
1.0s	0.0s ... 9999.0s	P.2
	<i>Alarm delay</i>	

CTS . Kd	[Protection Para / Set 1...4 / Supervision / CTS]	
0.00	0.00 ... 0.99	P.2
	<i>Dynamic correction factor for the evaluation of the difference between calculated and measured earth current. This correction factor allows transformer faults, caused by higher currents, to be compensated.</i>	

9.48.3.4 CTS: Input States

CTS . ExBlo1-I	[Operation / Status Display / Supervision / CTS]	
	<i>Module input state: External blocking1</i>	

CTS . ExBlo2-I	[Operation / Status Display / Supervision / CTS]	
	<i>Module input state: External blocking2</i>	

9.48.3.5 CTS: Signals (Output States)

CTS . active	[Operation / Status Display / All Actives]	
	[Operation / Status Display / Supervision / CTS]	
	<i>Signal: active</i>	

CTS . Alarm	[Operation / Status Display / Alarms]	
	[Operation / Status Display / Supervision / CTS]	
	<i>Signal: Alarm Current Transformer Measuring Circuit Supervision</i>	

CTS . **ExBlo**



[Operation / Status Display / Supervision / CTS]

↕ *Signal: External Blocking*



9.48.4 LOP



Loss of Potential



9.48.4.1 LOP: Device Planning Parameters

LOP . Mode	[Device planning]	
"_"	"_", use  Device planning.	S.3
 <i>general operation mode</i>		

9.48.4.2 LOP: Global Parameters

LOP . CB Pos Detect	[Protection Para / Global Prot Para / Supervision / LOP]	
"_"	"_", SG[1] . Pos, SG[2] . Pos, SG[3] . Pos, SG[4] . Pos, SG[5] . Pos, SG[6] . Pos  CB Manager.	P.2
 <i>If there is a circuit breaker assigned, LOP will be inhibited if the circuit breaker is open. The position of the breaker will not be taken into account by LOP if no breaker is assigned.</i>		

LOP . ExBlo1	[Protection Para / Global Prot Para / Supervision / LOP]	
LOP . ExBlo2		
"_"	"_" ... Sys . Internal test state  1..n, Assignment List.	P.2
 <i>External blocking of the module, if blocking is activated (allowed) within a parameter set and if the state of the assigned signal is true.</i>		

LOP . Blo Trigger1	[Protection Para / Global Prot Para / Supervision / LOP]	
...		
LOP . Blo Trigger5		
"_"	"_" ... IG[4] . Alarm  Blo Trigger.	P.2
 <i>An Alarm of this protective element will block the Loss of Potential Detection.</i>		

LOP . Ex FF VT	[Protection Para / Global Prot Para / Supervision / LOP]	
"_"	"_" ... Sys . Internal test state ↳ 1..n, Assignment List.	P.2
 Alarm Fuse Failure Voltage Transformers		

LOP . Ex FF EVT	[Protection Para / Global Prot Para / Supervision / LOP]	
"_"	"_" ... Sys . Internal test state ↳ 1..n, Assignment List.	P.2
 Alarm Fuse Failure Earth Voltage Transformers		

9.48.4.3 LOP: Setting Group Parameters



LOP . Function	[Protection Para / Set 1...4 / Supervision / LOP]	
inactive	inactive, active ↳ Mode.	P.2
 Permanent activation or deactivation of module/stage.		

LOP . ExBlo Fc	[Protection Para / Set 1...4 / Supervision / LOP]	
inactive	inactive, active ↳ active/inactive.	P.2
 Activate (allow) or inactivate (disallow) blocking of the module/stage. This parameter is only effective if a signal is assigned to the corresponding global protection parameter. If the signal becomes true, those modules/stages are blocked that are parameterized "ExBlo Fc=active".		

LOP . LOPB Enable	[Protection Para / Set 1...4 / Supervision / LOP]	
inactive	inactive, active ↳ active/inactive.	P.2
 Activate (allow) or inactivate (disallow) blocking by the module LOP.		

LOP . I<	[Protection Para / Set 1...4 / Supervision / LOP]	
2.0In	0.5In ... 4.0In	P.2
	<i>To prevent unintended operation during faults, this threshold should be used to distinguish between load current and overcurrent. A current above this threshold will be seen as overcurrent and LOP will be inhibited. If the current detector identifies load current as overcurrent (threshold too low), a LOP situation will not be detected and if the threshold is too high, a fault situation will be identified as LOP which results in blocking of protection functions.</i>	

LOP . t-Alarm	[Protection Para / Set 1...4 / Supervision / LOP]	
0.1s	0s ... 9999.0s	P.2
	<i>Pickup Delay</i>	

LOP . Dead Bus Detection	[Protection Para / Set 1...4 / Supervision / LOP]	
inactive	inactive, active  Mode.	P.2
	<i>If this detection is active, LOP will be inhibited if there is no current and voltage applied.</i>	

9.48.4.4 LOP: Input States

LOP . ExBlo1-I	[Operation / Status Display / Supervision / LOP]	
	<i>Module input state: External blocking1</i>	

LOP . ExBlo2-I	[Operation / Status Display / Supervision / LOP]	
	<i>Module input state: External blocking2</i>	

LOP . Ex FF VT-I	[Operation / Status Display / Supervision / LOP]	
	<i>State of the module input: Alarm Fuse Failure Voltage Transformers</i>	

LOP . Ex FF EVT-I	[Operation / Status Display / Supervision / LOP]	
	<i>State of the module input: Alarm Fuse Failure Earth Voltage Transformers</i>	

LOP . Blo Trigger1-I	[Operation / Status Display / Supervision / LOP]
...	
LOP . Blo Trigger5-I	
↓	<i>State of the module input: An Alarm of this protective element will block the Loss of Potential Detection.</i>

9.48.4.5 LOP: Signals (Output States)

LOP . active	[Operation / Status Display / All Actives] [Operation / Status Display / Supervision / LOP]
↑	<i>Signal: active</i>

LOP . Alarm	[Operation / Status Display / Alarms] [Operation / Status Display / Supervision / LOP]
↑	<i>Signal: Alarm Loss of Potential</i>

LOP . ExBlo	[Operation / Status Display / Supervision / LOP]
↑	<i>Signal: External Blocking</i>

LOP . LOP Blo	[Operation / Status Display / Supervision / LOP]
↑	<i>Signal: Loss of Potential blocks other elements.</i>

LOP . Ex FF VT	[Operation / Status Display / Supervision / LOP]
↑	<i>Signal: Ex FF VT</i>

LOP . Ex FF EVT	[Operation / Status Display / Supervision / LOP]
↑	<i>Signal: Alarm Fuse Failure Earth Voltage Transformers</i>



10 Control

Control



Control Page	[Control / Control Page]	
	This item represents a special dialog. (See the Technical Manual for details.)	
	<i>Control Page</i>	

10.1 Ctrl: Device Planning Parameters



10.2 Ctrl: Global Parameters



Ctrl . Res NonIL	[Control / General Settings]	
single Operation	single Operation, timeout, permanent	C.2
	 NonIL ResetMode.	
	<i>Resetmode Non-Interlocking</i>	

Ctrl . Timeout NonIL	[Control / General Settings]	
60s	2s ... 3600s	C.2
	<i>Timeout Non-Interlocking</i>	

Ctrl . NonIL Assign	[Control / General Settings]	
"_"	"_" ... Sys . Internal test state	C.2
	 1..n, Assignment List.	
	<i>Assignment Non-Interlocking</i>	

10.3 Ctrl: Direct Controls

Ctrl . Switching Authority	[Control / General Settings]	
Local	None, Local, Remote, Local and Remote	C.2
	 Switching Authority.	
	<i>Switching Authority</i>	

Ctrl . NonInterl	[Control / General Settings]	
inactive	inactive, active  Mode.	C.2
 <i>DC for Non-Interlocking</i>		

10.4 Ctrl: Input States

Ctrl . NonInterl-I	[Operation / Status Display / Control / General Control]
 <i>Non-Interlocking</i>	

10.5 Ctrl: Signals (Output States)

Ctrl . Local	[Operation / Status Display / Control / General Control]
 <i>Switching Authority: Local</i>	

Ctrl . Remote	[Operation / Status Display / Control / General Control]
 <i>Switching Authority: Remote</i>	

Ctrl . NonInterl	[Operation / Status Display / Control / General Control]
 <i>Non-Interlocking is active</i>	

Ctrl . SG Indeterm	[Operation / Status Display / Control / General Control]
 <i>(At least one) Switchgear is moving (Position cannot be determined).</i>	

Ctrl . SG Disturb	[Operation / Status Display / Control / General Control]
 <i>(At least one) Switchgear is disturbed.</i>	

Ctrl . CES SAauthority	[Operation / Status Display / Control / General Control]
 <i>Command Execution Supervision: Number of rejected Commands because of missing switching authority.</i>	

Ctrl . CES DoubleOperating	[Operation / Status Display / Control / General Control]
 <i>Command Execution Supervision: Number of rejected Commands because a second switch command is in conflict with a pending one.</i>	

10.6 Ctrl: Values

Ctrl . Switching Authority	[Operation / Security / Security States]
Local	None, Local, Remote, Local and Remote  Switching Authority.
 <i>Switching Authority</i>	

10.7 SG[1] ... SG[6]

Switchgear

10.7.1 SG[1]: Global Parameters

SG[1] . ON incl Prot ON		[Control / SG / SG[1] / General Settings]
active	inactive, active	C.2
		 Mode.
 <i>The ON Command includes the ON Command issued by the Protection module.</i>		
SG[1] . OFF incl TripCmd		[Control / SG / SG[1] / General Settings]
active	inactive, active	C.2
		 Mode.
 <i>The OFF Command includes the OFF Command issued by the Protection module.</i>		
SG[1] . t-Move ON		[Control / SG / SG[1] / General Settings]
0.1s	0.01s ... 100.00s	C.2
 <i>Time to move to the ON Position</i>		
SG[1] . t-Move OFF		[Control / SG / SG[1] / General Settings]
0.1s	0.01s ... 100.00s	C.2
 <i>Time to move to the OFF Position</i>		
SG[1] . t-Dwell		[Control / SG / SG[1] / General Settings]
0s	0s ... 100.00s	C.2
 <i>Dwell time</i>		
SG[1] . t-TripCmd		[Control / SG / SG[1] / Trip Manager]
0.2s	0s ... 300.00s	P.2
 <i>Minimum hold time of the OFF-command (circuit breaker, load break switch)</i>		

SG[1] . Latched		[Control / SG / SG[1] / Trip Manager]
inactive	inactive, active	P.2
	↳ Mode.	
 <i>Defines whether the Trip Command is latched.</i>		







SG[1] . Ack TripCmd		[Control / SG / SG[1] / Trip Manager]
"_"	"_" ... Sys . Internal test state	P.2
	↳ 1..n, Assignment List.	
 <i>Ack TripCmd</i>		

SG[1] . Off Cmd1		[Control / SG / SG[1] / Trip Manager]
Id . TripCmd	"_" ... AnaP[4] . TripCmd	P.2
	↳ 1..n, Trip Cmds.	
 <i>Off Command to the Circuit Breaker if the state of the assigned signal becomes true.</i>		

SG[1] . Off Cmd2		[Control / SG / SG[1] / Trip Manager]
IdH . TripCmd	"_" ... AnaP[4] . TripCmd	P.2
	↳ 1..n, Trip Cmds.	
 <i>Off Command to the Circuit Breaker if the state of the assigned signal becomes true.</i>		

SG[1] . Off Cmd3		[Control / SG / SG[1] / Trip Manager]
I[1] . TripCmd	"_" ... AnaP[4] . TripCmd	P.2
	↳ 1..n, Trip Cmds.	
 <i>Off Command to the Circuit Breaker if the state of the assigned signal becomes true.</i>		

SG[1] . Off Cmd4		[Control / SG / SG[1] / Trip Manager]
V[1] . TripCmd	"_" ... AnaP[4] . TripCmd	P.2
	↳ 1..n, Trip Cmds.	
 <i>Off Command to the Circuit Breaker if the state of the assigned signal becomes true.</i>		

SG[1] . Off Cmd5		[Control / SG / SG[1] / Trip Manager]	
V[2] . TripCmd	"-" ... AnaP[4] . TripCmd		P.2
	↳ 1..n, Trip Cmds.		
 Off Command to the Circuit Breaker if the state of the assigned signal becomes true.			
SG[1] . Off Cmd6		[Control / SG / SG[1] / Trip Manager]	
f[1] . TripCmd	"-" ... AnaP[4] . TripCmd		P.2
	↳ 1..n, Trip Cmds.		
 Off Command to the Circuit Breaker if the state of the assigned signal becomes true.			
SG[1] . Off Cmd7		[Control / SG / SG[1] / Trip Manager]	
f[2] . TripCmd	"-" ... AnaP[4] . TripCmd		P.2
	↳ 1..n, Trip Cmds.		
 Off Command to the Circuit Breaker if the state of the assigned signal becomes true.			
SG[1] . Off Cmd8		[Control / SG / SG[1] / Trip Manager]	
PQS[1] . TripCmd	"-" ... AnaP[4] . TripCmd		P.2
	↳ 1..n, Trip Cmds.		
 Off Command to the Circuit Breaker if the state of the assigned signal becomes true.			
SG[1] . Off Cmd9		[Control / SG / SG[1] / Trip Manager]	
...			
SG[1] . Off Cmd75			
"-"	"-" ... AnaP[4] . TripCmd		P.2
	↳ 1..n, Trip Cmds.		
 Off Command to the Circuit Breaker if the state of the assigned signal becomes true.			
SG[1] . Aux ON		[Control / SG / SG[1] / Pos Indicatr Wirng]	
DI Slot X1 . DI 1	"-" ... Logics . LE80.Out inverted		C.2
	↳ 1..n, DI-LogicList.		
 The CB is in ON-position if the state of the assigned signal is true (52a).			

SG[1] . Aux OFF	[Control / SG / SG[1] / Pos Indicatrns Wirng]	
DI Slot X1 . DI 2	"-" ... Logics . LE80.Out inverted ↳ 1..n, DI-LogicList.	C.2
	<i>The CB is in OFF-position if the state of the assigned signal is true (52b).</i>	

SG[1] . Ready	[Control / SG / SG[1] / Pos Indicatrns Wirng]	
"_"	"-" ... Logics . LE80.Out inverted ↳ 1..n, DI-LogicList.	C.2
	<i>Circuit breaker is ready for operation if the state of the assigned signal is true. This digital input can be used by some protective elements (if they are available within the device) like Auto Reclosure (AR), e.g. as a trigger signal.</i>	

SG[1] . Removed	[Control / SG / SG[1] / Pos Indicatrns Wirng]	
"_"	"-" ... Logics . LE80.Out inverted ↳ 1..n, DI-LogicList.	C.2
	<i>The withdrawable circuit breaker is Removed</i>	

SG[1] . SCmd ON	[Control / SG / SG[1] / Ex ON/OFF Cmd]	
"_"	"-" ... Logics . LE80.Out inverted ↳ 1..n, DI-LogicList.	C.2
	<i>Switching ON Command, e.g. the state of the Logics or the state of the digital input</i>	

SG[1] . SCmd OFF	[Control / SG / SG[1] / Ex ON/OFF Cmd]	
"_"	"-" ... Logics . LE80.Out inverted ↳ 1..n, DI-LogicList.	C.2
	<i>Switching OFF Command, e.g. the state of the Logics or the state of the digital input</i>	

SG[1] . Interl ON1	[Control / SG / SG[1] / Interlockings]	
SG[1] . Interl ON2		
SG[1] . Interl ON3		
"_"	"_" ... Sys . Internal test state ↳ 1..n, Assignment List.	C.2
 <i>Interlocking of the ON command</i>		



SG[1] . Interl OFF1	[Control / SG / SG[1] / Interlockings]	
SG[1] . Interl OFF2		
SG[1] . Interl OFF3		
"_"	"_" ... Sys . Internal test state ↳ 1..n, Assignment List.	C.2
 <i>Interlocking of the OFF command</i>		

SG[1] . Synchronism	[Control / SG / SG[1] / Synchron Switchg]	
"_"	"_" ... Logics . LE80.Out inverted ↳ 1..n, In-SyncList.	C.2
 <i>Synchronism</i>		

SG[1] . t-MaxSyncSuperv	[Control / SG / SG[1] / Synchron Switchg]	
0.2s	0s ... 3000.00s	C.2
 <i>Synchron-Run timer: Max. time allowed for synchronizing process after a close initiate. Only used for GENERATOR2SYSTEM working mode.</i>		

10.7.2 SG[1]: Direct Controls

SG[1] . Ack TripCmd	[Operation / Acknowledge]	
inactive	inactive, active ↳ Mode.	P.1
 <i>Acknowledge Trip Command</i>		

SG[1] . Res SGwear SI SG	[Operation / Reset]	
inactive	inactive, active  Mode.	P.1
 <i>Resetting the slow Switchgear Alarm</i>		

SG[1] . Manipulate Position	[Control / SG / SG[1] / General Settings]	
inactive	inactive, Pos OFF, Pos ON  Manipulate Position.	C.2
 <i>WARNING! Fake Position - Manual Position Manipulation</i>		

10.7.3 SG[1]: Input States

SG[1] . Interl ON1-I	[Operation / Status Display / Control / SG[1]]	
SG[1] . Interl ON2-I		
SG[1] . Interl ON3-I		
 <i>State of the module input: Interlocking of the ON command</i>		

SG[1] . Interl OFF1-I	[Operation / Status Display / Control / SG[1]]	
SG[1] . Interl OFF2-I		
SG[1] . Interl OFF3-I		
 <i>State of the module input: Interlocking of the OFF command</i>		

SG[1] . SCmd ON-I	[Operation / Status Display / Control / SG[1]]	
 <i>State of the module input: Switching ON Command, e.g. the state of the Logics or the state of the digital input</i>		

SG[1] . SCmd OFF-I	[Operation / Status Display / Control / SG[1]]	
 <i>State of the module input: Switching OFF Command, e.g. the state of the Logics or the state of the digital input</i>		

SG[1] . Aux ON-I	[Operation / Status Display / Control / SG[1]]	
 <i>Module Input State: Position indicator/check-back signal of the CB (52a)</i>		

SG[1] . Aux OFF-I	[Operation / Status Display / Control / SG[1]]
	<i>Module input state: Position indicator/check-back signal of the CB (52b)</i>

SG[1] . Ready-I	[Operation / Status Display / Control / SG[1]]
	<i>Module input state: CB ready</i>

SG[1] . Sys-in-Sync-I	[Operation / Status Display / Control / SG[1]]
	<i>State of the module input: This signals has to become true within the synchronization time. If not, switching is unsuccessful.</i>

SG[1] . Removed-I	[Operation / Status Display / Control / SG[1]]
	<i>State of the module input: The withdrawable circuit breaker is Removed</i>

SG[1] . Ack TripCmd-I	[Operation / Status Display / Control / SG[1]]
	<i>State of the module input: Acknowledgement Signal (for the Trip Command) Module input signal</i>

10.7.4 SG[1]: Signals (Output States)

SG[1] . TripCmd	[Operation / Status Display / TripCmds] [Operation / Status Display / Control / SG[1]]
	<i>Signal: Trip Command</i>











SG[1] . SI SingleContactInd	[Operation / Status Display / Control / SG[1]]
	<i>Signal: The Position of the Switchgear is detected by one auxiliary contact (pole) only. Thus indeterminate and disturbed Positions cannot be detected.</i>

SG[1] . Pos not ON	[Operation / Status Display / Control / SG[1]]
	<i>Signal: Pos not ON</i>

SG[1] . Pos ON	[Operation / Status Display / Control / SG[1]]
	<i>Signal: Circuit Breaker is in ON-Position</i>

SG[1] . Pos OFF	[Operation / Status Display / Control / SG[1]]
	<i>Signal: Circuit Breaker is in OFF-Position</i>

SG[1] . Pos Indeterm	[Operation / Status Display / Control / SG[1]]
⤴	<i>Signal: Circuit Breaker is in Indeterminate Position</i>
SG[1] . Pos Disturb	[Operation / Status Display / Control / SG[1]]
⤴	<i>Signal: Circuit Breaker Disturbed - Undefined Breaker Position. The Position Indicators contradict themselves. After expiring of a supervision timer this signal becomes true.</i>
SG[1] . Pos	[Operation / Status Display / Control / SG[1]]
⤴	<i>Signal: Circuit Breaker Position (0 = Indeterminate, 1 = OFF, 2 = ON, 3 = Disturbed)</i>
SG[1] . Ready	[Operation / Status Display / Control / SG[1]]
⤴	<i>Signal: Circuit breaker is ready for operation.</i>
SG[1] . t-Dwell	[Operation / Status Display / Control / SG[1]]
⤴	<i>Signal: Dwell time</i>
SG[1] . Removed	[Operation / Status Display / Control / SG[1]]
⤴	<i>Signal: The withdrawable circuit breaker is Removed</i>
SG[1] . Interl ON	[Operation / Status Display / Control / SG[1]]
⤴	<i>Signal: One or more IL_On inputs are active.</i>
SG[1] . Interl OFF	[Operation / Status Display / Control / SG[1]]
⤴	<i>Signal: One or more IL_Off inputs are active.</i>
SG[1] . CES succesf	[Operation / Status Display / Control / SG[1]]
⤴	<i>Signal: Command Execution Supervision: Switching command executed successfully.</i>
SG[1] . CES Disturbed	[Operation / Status Display / Control / SG[1]]
⤴	<i>Signal: Command Execution Supervision: Switching Command unsuccessful. Switchgear in disturbed position.</i>
SG[1] . CES Fail TripCmd	[Operation / Status Display / Control / SG[1]]
⤴	<i>Signal: Command Execution Supervision: Command execution failed because trip command is pending.</i>







SG[1] . CES SwitchDir	[Operation / Status Display / Control / SG[1]]
 <i>Signal: Command Execution Supervision respectively Switching Direction Control: This signal becomes true, if a switch command is issued even though the switchgear is already in the requested position. Example: A switchgear that is already OFF should be switched OFF again (doubly). The same applies to CLOSE commands.</i>	
SG[1] . CES ON d OFF	[Operation / Status Display / Control / SG[1]]
 <i>Signal: Command Execution Supervision: On Command during a pending OFF Command.</i>	
SG[1] . CES SG not ready	[Operation / Status Display / Control / SG[1]]
 <i>Signal: Command Execution Supervision: Switchgear not ready</i>	
SG[1] . CES Fiel Interl	[Operation / Status Display / Control / SG[1]]
 <i>Signal: Command Execution Supervision: Switching Command not executed because of field interlocking.</i>	
SG[1] . CES SyncTimeout	[Operation / Status Display / Control / SG[1]]
 <i>Signal: Command Execution Supervision: Switching Command not executed. No Synchronization signal while t-sync was running.</i>	
SG[1] . CES SG removed	[Operation / Status Display / Control / SG[1]]
 <i>Signal: Command Execution Supervision: Switching Command unsuccessful, Switchgear removed.</i>	
SG[1] . Prot ON	[Operation / Status Display / Control / SG[1]]
 <i>Signal: ON Command issued by the Prot module</i>	
SG[1] . Ack TripCmd	[Operation / Status Display / Control / SG[1]]
 <i>Signal: Acknowledge Trip Command</i>	
SG[1] . ON incl Prot ON	[Operation / Status Display / Control / SG[1]]
 <i>Signal: The ON Command includes the ON Command issued by the Protection module.</i>	
SG[1] . OFF incl TripCmd	[Operation / Status Display / Control / SG[1]]
 <i>Signal: The OFF Command includes the OFF Command issued by the Protection module.</i>	
SG[1] . Position Ind manipul	[Operation / Status Display / Control / SG[1]]
 <i>Signal: Position Indicators faked</i>	

SG[1] . SGwear Slow SG	[Operation / Status Display / Control / SG[1]]
⤴	<i>Signal: Alarm, the circuit breaker (load-break switch) becomes slower</i>
SG[1] . Res SGwear SI SG	[Operation / Status Display / Control / SG[1]]
⤴	<i>Signal: Resetting the slow Switchgear Alarm</i>
SG[1] . ON Cmd	[Operation / Status Display / Control / SG[1]]
⤴	<i>Signal: ON Command issued to the switchgear. Depending on the setting the signal may include the ON command of the Prot module.</i>
SG[1] . OFF Cmd	[Operation / Status Display / Control / SG[1]]
⤴	<i>Signal: OFF Command issued to the switchgear. Depending on the setting the signal may include the OFF command of the Prot module.</i>
SG[1] . ON Cmd manual	[Operation / Status Display / Control / SG[1]]
⤴	<i>Signal: ON Cmd manual</i>
SG[1] . OFF Cmd manual	[Operation / Status Display / Control / SG[1]]
⤴	<i>Signal: OFF Cmd manual</i>
SG[1] . Sync ON request	[Operation / Status Display / Control / SG[1]]
⤴	<i>Signal: Synchronous ON request</i>

10.7.5 Breaker Wear

Switchgear

10.7.5.1 SG[1]: Global Parameters

SG[1] . CT Winding Side		[Control / SG / SG[1] / SG Wear]	
. CT Ntrl	. CT Ntrl, . CT Mains		C.2
	↳ CT Winding Side.		
	<i>Measuring values will be used from this winding side</i>		
SG[1] . Operations Alarm		[Control / SG / SG[1] / SG Wear]	
9999	1 ... 100000		C.2
	<i>Maximum number of operations. If the operations counter »TripCmd Cr« exceeds this limit then the signal »Operations Alarm« is set.</i>		
SG[1] . Isum Intr Alarm		[Control / SG / SG[1] / SG Wear]	
100.00kA	0.00kA ... 2000.00kA		C.2
	<i>Alarm, the Sum (Limit) of interrupting currents has been exceeded.</i>		
SG[1] . Isum Intr ph Alm		[Control / SG / SG[1] / SG Wear]	
100.00kA	0.00kA ... 2000.00kA		C.2
	<i>Alarm, the per hour Sum (Limit) of interrupting currents has been exceeded.</i>		
SG[1] . SGwear Curve Fc		[Control / SG / SG[1] / SG Wear]	
inactive	inactive, active		C.2
	↳ active/inactive.		
	<i>The Circuit Breaker (load-break switch) Wear Curve defines the maximum allowed CLOSE/ OPEN cycles depending on the brake currents. If the circuit breaker maintenance curve is exceeded, an alarm will be issued. The breaker maintenance curve is to be taken from the technical data sheet of the breaker manufacturer. By means of the available points this curve is to be replicated.</i>		
SG[1] . WearLevel Alarm		[Control / SG / SG[1] / SG Wear]	
80.00%	0.00% ... 100.00%		C.2
	<i>Threshold for the Alarm</i>		

SG[1] . WearLevel Lockout	[Control / SG / SG[1] / SG Wear]	
95.00%	0.00% ... 100.00%	C.2
 <i>Threshold for the Lockout Level</i>		

SG[1] . Current1	[Control / SG / SG[1] / SG Wear]	
0.00kA	0.00kA ... 2000.00kA	C.2
 <i>Interrupted Current Level #1</i>		

SG[1] . Count1	[Control / SG / SG[1] / SG Wear]	
10000	1 ... 32000	C.2
 <i>Open Counts Allowed #1</i>		

SG[1] . Current2	[Control / SG / SG[1] / SG Wear]	
1.20kA	0.00kA ... 2000.00kA	C.2
 <i>Interrupted Current Level #2</i>		

SG[1] . Count2	[Control / SG / SG[1] / SG Wear]	
10000	1 ... 32000	C.2
 <i>Open Counts Allowed #2</i>		

SG[1] . Current3	[Control / SG / SG[1] / SG Wear]	
8.00kA	0.00kA ... 2000.00kA	C.2
 <i>Interrupted Current Level #3</i>		

SG[1] . Count3	[Control / SG / SG[1] / SG Wear]	
150	1 ... 32000	C.2
 <i>Open Counts Allowed #3</i>		

SG[1] . Current4	[Control / SG / SG[1] / SG Wear]	
20.00kA	0.00kA ... 2000.00kA	C.2
 <i>Interrupted Current Level #4</i>		

SG[1] . Count4	[Control / SG / SG[1] / SG Wear]	
12	1 ... 32000	C.2
 <i>Open Counts Allowed #4</i>		

SG[1] . Current5	[Control / SG / SG[1] / SG Wear]	
20.00kA	0.00kA ... 2000.00kA	C.2
	<i>Interrupted Current Level #5</i>	

SG[1] . Count5	[Control / SG / SG[1] / SG Wear]	
1	1 ... 32000	C.2
	<i>Open Counts Allowed #5</i>	

SG[1] . Current6	[Control / SG / SG[1] / SG Wear]	
20.00kA	0.00kA ... 2000.00kA	C.2
	<i>Interrupted Current Level #6</i>	

SG[1] . Count6	[Control / SG / SG[1] / SG Wear]	
1	1 ... 32000	C.2
	<i>Open Counts Allowed #6</i>	

SG[1] . Current7	[Control / SG / SG[1] / SG Wear]	
20.00kA	0.00kA ... 2000.00kA	C.2
	<i>Interrupted Current Level #7</i>	

SG[1] . Count7	[Control / SG / SG[1] / SG Wear]	
1	1 ... 32000	C.2
	<i>Open Counts Allowed #7</i>	

SG[1] . Current8	[Control / SG / SG[1] / SG Wear]	
20.00kA	0.00kA ... 2000.00kA	C.2
	<i>Interrupted Current Level #8</i>	

SG[1] . Count8	[Control / SG / SG[1] / SG Wear]	
1	1 ... 32000	C.2
	<i>Open Counts Allowed #8</i>	



SG[1] . Current9	[Control / SG / SG[1] / SG Wear]	
20.00kA	0.00kA ... 2000.00kA	C.2
	<i>Interrupted Current Level #9</i>	



SG[1] . Count9	[Control / SG / SG[1] / SG Wear]	
1	1 ... 32000	C.2
	<i>Open Counts Allowed #9</i>	



SG[1] . Current10	[Control / SG / SG[1] / SG Wear]	
20.00kA	0.00kA ... 2000.00kA	C.2
	<i>Interrupted Current Level #10</i>	

SG[1] . Count10	[Control / SG / SG[1] / SG Wear]	
1	1 ... 32000	C.2
	<i>Open Counts Allowed #10</i>	

10.7.5.2 SG[1]: Direct Controls

SG[1] . Res TripCmd Cr	[Operation / Reset]	
inactive	inactive, active  Mode.	P.1
	<i>Resetting of the Counter: Total number of trips of the switchgear</i>	

SG[1] . Res Sum trip	[Operation / Reset]	
inactive	inactive, active  Mode.	P.1
	<i>Reset summation of the tripping currents</i>	

SG[1] . Res CB OPEN capacity	[Operation / Reset]	
inactive	inactive, active  Mode.	P.1
	<i>Reset the CB OPEN capacity.</i> <i>(Remark: A »CB OPEN capacity« value of 100% means that the circuit breaker has to be maintained.)</i>	

SG[1] . Res Isum Intr per hour	[Operation / Reset]	
inactive	inactive, active ↳ Mode.	P.1
 <i>Reset of the Sum per hour of interrupting currents.</i>		

10.7.5.3 SG[1]: Signals (Output States)

SG[1] . Operations Alarm	[Operation / Status Display / Control / SG[1]]
 <i>Signal: Too many Operations. (The operations counter »TripCmd Cr« has exceeded the limit set at »Operations Alarm«.)</i>	

SG[1] . Isum Intr trip: IL1	[Operation / Status Display / Control / SG[1]]
 <i>Signal: Maximum permissible Summation of the interrupting (tripping) currents exceeded: IL1</i>	

SG[1] . Isum Intr trip: IL2	[Operation / Status Display / Control / SG[1]]
 <i>Signal: Maximum permissible Summation of the interrupting (tripping) currents exceeded: IL2</i>	

SG[1] . Isum Intr trip: IL3	[Operation / Status Display / Control / SG[1]]
 <i>Signal: Maximum permissible Summation of the interrupting (tripping) currents exceeded: IL3</i>	

SG[1] . Isum Intr trip	[Operation / Status Display / Control / SG[1]]
 <i>Signal: Maximum permissible Summation of the interrupting (tripping) currents exceeded in at least one phase.</i>	

SG[1] . Res TripCmd Cr	[Operation / Status Display / Control / SG[1]]
 <i>Signal: Resetting of the Counter: Total number of trips of the switchgear</i>	

SG[1] . Res Sum trip	[Operation / Status Display / Control / SG[1]]
 <i>Signal: Reset summation of the tripping currents</i>	

SG[1] . WearLevel Alarm	[Operation / Status Display / Control / SG[1]]
 <i>Signal: Threshold for the Alarm</i>	

SG[1] . WearLevel Lockout	[Operation / Status Display / Control / SG[1]]
 <i>Signal: Threshold for the Lockout Level</i>	

SG[1] . Res CB OPEN capacity	[Operation / Status Display / Control / SG[1]]
↓	<i>Signal: Reset of the wear maintenance curve (i. e. of the counter for the Circuit Breaker OPEN capacity).</i>

SG[1] . Isum Intr ph Alm	[Operation / Status Display / Control / SG[1]]
↓	<i>Signal: Alarm, the per hour Sum (Limit) of interrupting currents has been exceeded.</i>

SG[1] . Res Isum Intr ph Alm	[Operation / Status Display / Control / SG[1]]
↓	<i>Signal: Reset of the Alarm, "the per hour Sum (Limit) of interrupting currents has been exceeded".</i>

10.7.5.4 SG[1]: Values

SG[1] . Sum trip IL1	[Operation / Count and RevData / Control / SG[1]]
SG[1] . Sum trip IL2	
SG[1] . Sum trip IL3	
⌘	<i>Summation of the tripping currents phase</i>

SG[1] . Isum Intr per hour	[Operation / Count and RevData / Control / SG[1]]
⌘	<i>Sum per hour of interrupting currents.</i>

SG[1] . CB OPEN capacity	[Operation / Count and RevData / Control / SG[1]]
⌘	<i>Used capacity of the circuit breaker. (100% means that the circuit breaker has to be maintained.)</i>



10.7.5.5 SG[1]: Counters

SG[1] . TripCmd Cr	[Operation / Count and RevData / Control / SG[1]]
#	<i>Counter: Total number of trips of the switchgear.</i>



11 System Alarms



System Alarms



11.1 SysA: Device Planning Parameters

SysA . Mode	[Device planning]	
"_"	"_", use  Mode.	S.3
 <i>general operation mode</i>		

11.2 SysA: Global Parameters

SysA . Function	[SysA / General Settings]	
inactive	inactive, active  Mode.	P.2
 <i>Permanent activation or deactivation of module/stage.</i>		

SysA . ExBlo Fc	[SysA / General Settings]	
"_"	"_" ... Sys . Internal test state  1..n, Assignment List.	P.2
 <i>Activate (allow) or inactivate (disallow) blocking of the module/stage. This parameter is only effective if a signal is assigned to the corresponding global protection parameter. If the signal becomes true, those modules/stages are blocked that are parameterized "ExBlo Fc=active".</i>		

SysA . Alarm	[SysA / Power / Watt] ... [SysA / THD / I THD]	
inactive	inactive, active  active/inactive.	P.2
 <i>Alarm</i>		

SysA . Threshold	[SysA / Power / Watt] ... [SysA / THD / V THD]	
10000kW	1kW ... 40000000kW	P.2
 <i>Threshold (to be entered as primary value)</i>		

SysA . t-Delay	[SysA / Power / Watt] ... [SysA / THD / I THD]	
0min	0min ... 60min	P.2
 <i>Tripping Delay</i>		

SysA . Threshold	[SysA / Demand / Current Demand] [SysA / THD / I THD]	
500A	10A ... 500000A	P.2
 <i>Threshold (to be entered as primary value)</i>		

SysA . Threshold	[SysA / Demand / Power Demand / VAr Demand] [SysA / Demand / Power Demand / VA Demand]	
20000kVAr	1kVAr ... 40000000kVAr	P.2
 <i>Threshold (to be entered as primary value)</i>		

11.3 SysA: Input States

SysA . ExBlo-I	[Operation / Status Display / SysA]	
 <i>Module input state: External blocking</i>		

11.4 SysA: Signals (Output States)

SysA . active	[Operation / Status Display / SysA]	
 <i>Signal: active</i>		

11 System Alarms

11.4 SysA: Signals (Output States)

SysA . ExBlo	[Operation / Status Display / SysA]
⬆️ <i>Signal: External Blocking</i>	
SysA . Alarm Watt Power	[Operation / Status Display / SysA]
⬆️ <i>Signal: Alarm permitted Active Power exceeded</i>	
SysA . Alarm VAr Power	[Operation / Status Display / SysA]
⬆️ <i>Signal: Alarm permitted Reactive Power exceeded</i>	
SysA . Alarm VA Power	[Operation / Status Display / SysA]
⬆️ <i>Signal: Alarm permitted Apparent Power exceeded</i>	
SysA . Alarm Watt Demand	[Operation / Status Display / SysA]
⬆️ <i>Signal: Alarm averaged Active Power exceeded</i>	
SysA . Alarm VAr Demand	[Operation / Status Display / SysA]
⬆️ <i>Signal: Alarm averaged Reactive Power exceeded</i>	
SysA . Alarm VA Demand	[Operation / Status Display / SysA]
⬆️ <i>Signal: Alarm averaged Apparent Power exceeded</i>	
SysA . Alm Current Demd	[Operation / Status Display / SysA]
⬆️ <i>Signal: Alarm averaged demand current</i>	
SysA . Alarm I THD	[Operation / Status Display / SysA]
⬆️ <i>Signal: Alarm Total Harmonic Distortion Current</i>	
SysA . Alarm V THD	[Operation / Status Display / SysA]
⬆️ <i>Signal: Alarm Total Harmonic Distortion Voltage</i>	
SysA . Trip Watt Power	[Operation / Status Display / SysA]
⬆️ <i>Signal: Trip permitted Active Power exceeded</i>	
SysA . Trip VAr Power	[Operation / Status Display / SysA]
⬆️ <i>Signal: Trip permitted Reactive Power exceeded</i>	

SysA . Trip VA Power	[Operation / Status Display / SysA]
⬆️	<i>Signal: Trip permitted Apparent Power exceeded</i>
SysA . Trip Watt Demand	[Operation / Status Display / SysA]
⬆️	<i>Signal: Trip averaged Active Power exceeded</i>
SysA . Trip VA_r Demand	[Operation / Status Display / SysA]
⬆️	<i>Signal: Trip averaged Reactive Power exceeded</i>
SysA . Trip VA Demand	[Operation / Status Display / SysA]
⬆️	<i>Signal: Trip averaged Apparent Power exceeded</i>
SysA . Trip Current Demand	[Operation / Status Display / SysA]
⬆️	<i>Signal: Trip averaged demand current</i>
SysA . Trip I THD	[Operation / Status Display / SysA]
⬆️	<i>Signal: Trip Total Harmonic Distortion Current</i>
SysA . Trip V THD	[Operation / Status Display / SysA]
⬆️	<i>Signal: Trip Total Harmonic Distortion Voltage</i>



12 Records

12.1 Event rec

The event recorder logs all events like switching operations, change of parameters, alarms, trips, operating mode selections, blockings and state transitions of inputs and outputs.

Event rec	[Operation / Recorders / Event rec]
	This item represents a special dialog. (See the Technical Manual for details.) <i>The event recorder logs all events like switching operations, change of parameters, alarms, trips, operating mode selections, blockings and state transitions of inputs and outputs.</i>

12.1.1 Event rec: Direct Controls

Event rec . Res all rec	[Operation / Reset]
inactive	inactive, active  Mode.
	P.1
	Reset all records

12.1.2 Event rec: Signals (Output States)



Event rec . Res all records	[Operation / Status Display / Recorders / Event rec]
	Signal: All records are being deleted. (Remark: Immediately afterwards, this signal becomes inactive again.)



12.2 Disturb rec



After a trigger event has become true, the disturbance recorder writes analogue and digital tracks

Disturb rec	[Operation / Recorders / Disturb rec]	
	This item represents a special dialog. (See the Technical Manual for details.)	
	<i>After a trigger event has become true, the disturbance recorder writes analogue and digital tracks</i>	

12.2.1 Disturb rec: Global Parameters

Disturb rec . Start: 1	[Device Para / Recorders / Disturb rec]	
Prot . Trip	“-” ... Sys . Internal test state  1..n, Assignment List.	S.3
	<i>Start recording if the assigned signal is true.</i>	

Disturb rec . Start: 2	[Device Para / Recorders / Disturb rec]	
...		
Disturb rec . Start: 8		
“-”	“-” ... Sys . Internal test state  1..n, Assignment List.	S.3
	<i>Start recording if the assigned signal is true.</i>	

Disturb rec . Auto overwriting	[Device Para / Recorders / Disturb rec]	
active	inactive, active  Mode.	S.3
	<i>If there is no more free memory capacity left, the oldest file will be overwritten.</i>	

Disturb rec . Pre-trigger time	[Device Para / Recorders / Disturb rec]	
20%	0% ... 99%	S.3
	<i>The pre trigger time is set in percent of the »Max file size« value. It corresponds to the part of recording before the onset of the trigger event.</i>	

Disturb rec . Post-trigger time		[Device Para / Recorders / Disturb rec]
20%	0% ... 99%	S.3
	<i>The post trigger time is set in percent of the »Max file size« value. It is the remaining time of the »Max file size«, depending on the »Pre-trigger time« setting and the duration of the trigger event, but at maximum the »Post-trigger time« set here.</i>	

Disturb rec . Max file size		[Device Para / Recorders / Disturb rec]
2s	0.1s ... 15.0s	S.3
	<i>The maximum storage capacity per record, including pre-trigger and post-trigger time. The amount of records depends on the size of each record, on the max. file size (set here), and on the total storage capacity.</i>	

12.2.2 Disturb rec: Direct Controls

Disturb rec . Man Trigger		[Operation / Recorders / Man Trigger]
False	False, True	P.1
	 true or not true.	
<input checked="" type="radio"/>	<i>Manual Trigger</i>	

Disturb rec . Res all rec		[Operation / Reset]
inactive	inactive, active	P.1
	 Mode.	
<input checked="" type="radio"/>	<i>Reset all records</i>	

12.2.3 Disturb rec: Input States

Disturb rec . Start1-I		[Operation / Status Display / Recorders / Disturb rec]
...		
Disturb rec . Start8-I		
	<i>State of the module input:: Trigger event / start recording</i>	

12.2.4 Disturb rec: Signals (Output States)

Disturb rec . recording		[Operation / Status Display / Recorders / Disturb rec]
	<i>Signal: Recording</i>	

Disturb rec . memory full	[Operation / Status Display / Recorders / Disturb rec]
 <i>Signal: Memory full</i>	

Disturb rec . Clear fail	[Operation / Status Display / Recorders / Disturb rec]
 <i>Signal: Clear failure in memory</i>	



Disturb rec . Res all records	[Operation / Status Display / Recorders / Disturb rec]
 <i>Signal: All records are being deleted. (Remark: Immediately afterwards, this signal becomes inactive again.)</i>	

Disturb rec . Res all records	[Operation / Status Display / Recorders / Disturb rec]
 <i>Signal: All records are being deleted. (Remark: Immediately afterwards, this signal becomes inactive again.)</i>	

Disturb rec . Man Trigger	[Operation / Status Display / Recorders / Disturb rec]
 <i>Signal: Manual Trigger</i>	

12.2.5 Disturb rec: Values

Disturb rec . Rec state	[Operation / Status Display / Recorders / Disturb rec]
Ready	Ready, Recording, Writing file, Trigger Blo  Rec state.
 <i>Recording state</i>	

Disturb rec . Error code	[Operation / Status Display / Recorders / Disturb rec]
OK	OK, Write err, Clear fail, Calculation err, File not found, Auto overwriting off  Fault.
 <i>Error code</i>	

12.3 Fault rec

The values measured at the time of tripping are saved by the Fault Recorder.



Fault rec	[Operation / Recorders / Fault rec]	
	This item represents a special dialog. (See the Technical Manual for details.) <i>The values measured at the time of tripping are saved by the Fault Recorder.</i>	

12.3.1 Fault rec: Global Parameters

Fault rec . Record-Mode	[Device Para / Recorders / Fault rec]	
Trips only	Alarms and Trips, Trips only  Record-Mode.	S.3
	<i>Recorder Mode (Set the behaviour of the recorder)</i>	

Fault rec . t-meas-delay	[Device Para / Recorders / Fault rec]	
0ms	0ms ... 60ms	S.3
	<i>After the Trip, the measurement will be delayed for this time.</i>	

12.3.2 Fault rec: Direct Controls

Fault rec . Res all rec	[Operation / Reset]	
inactive	inactive, active  Mode.	P.1
	<i>Reset all records</i>	

12.3.3 Fault rec: Signals (Output States)



Fault rec . Res all records	[Operation / Status Display / Recorders / Fault rec]	
	<i>Signal: All records are being deleted. (Remark: Immediately afterwards, this signal becomes inactive again.)</i>	



12.4 Trend rec



Trend Recorder



Trend rec	[Operation / Recorders / Trend rec]
 This item represents a special dialog. (See the Technical Manual for details.)	
	<i>Trend Recorder</i>



12.4.1 Trend rec: Global Parameters

Trend rec . Resolution	[Device Para / Recorders / Trend rec]
15 min	60 min, 30 min, 15 min, 10 min, 5 min S.3  Resolution.
 Resolution (recording frequency)	

Trend rec . Trend1	[Device Para / Recorders / Trend rec]
CT Ntrl . IL1 RMS	"-" ... PQSCr . cos phi RMS S.3  1..n, TrendRecList.
 Observed Value1	

Trend rec . Trend2	[Device Para / Recorders / Trend rec]
CT Ntrl . IL2 RMS	"-" ... PQSCr . cos phi RMS S.3  1..n, TrendRecList.
 Observed Value2	

Trend rec . Trend3	[Device Para / Recorders / Trend rec]
CT Ntrl . IL3 RMS	"-" ... PQSCr . cos phi RMS S.3  1..n, TrendRecList.
 Observed Value3	

Trend rec . Trend4	[Device Para / Recorders / Trend rec]
CT Ntrl . IG meas RMS	"-" ... PQSCr . cos phi RMS S.3  1..n, TrendRecList.
 Observed Value4	

Trend rec . Trend5		[Device Para / Recorders / Trend rec]	
VT . VL1 RMS	"-" ... PQSCr . cos phi RMS		S.3
	↳ 1..n, TrendRecList.		
	Observed Value5		

Trend rec . Trend6		[Device Para / Recorders / Trend rec]	
VT . VL2 RMS	"-" ... PQSCr . cos phi RMS		S.3
	↳ 1..n, TrendRecList.		
	Observed Value6		

Trend rec . Trend7		[Device Para / Recorders / Trend rec]	
VT . VL3 RMS	"-" ... PQSCr . cos phi RMS		S.3
	↳ 1..n, TrendRecList.		
	Observed Value7		

Trend rec . Trend8		[Device Para / Recorders / Trend rec]	
VT . VX meas RMS	"-" ... PQSCr . cos phi RMS		S.3
	↳ 1..n, TrendRecList.		
	Observed Value8		

Trend rec . Trend9		[Device Para / Recorders / Trend rec]	
"_"	"-" ... PQSCr . cos phi RMS		S.3
	↳ 1..n, TrendRecList.		
	Observed Value9		

Trend rec . Trend10		[Device Para / Recorders / Trend rec]	
"_"	"-" ... PQSCr . cos phi RMS		S.3
	↳ 1..n, TrendRecList.		
	Observed Value10		

12.4.2 Trend rec: Direct Controls

Trend rec . Res all rec	[Operation / Reset]	
inactive	inactive, active  Mode.	P.1
<input checked="" type="radio"/> <i>Reset all records</i>		

12.4.3 Trend rec: Signals (Output States)

Trend rec . Res all records	[Operation / Status Display / Recorders / Trend rec]	
	<i>Signal: All records are being deleted. (Remark: Immediately afterwards, this signal becomes inactive again.)</i>	

12.4.4 Trend rec: Counters



Trend rec . Max avail Entries	[Operation / Count and RevData / Trend rec]	
	<i>Maximum available entries in the current configuration</i>	

13 Logic

13.1 Logics

Logic



13.1.1 Logics: Device Planning Parameters



Logics . No of Equations:	[Device planning]	
20	0, 5, 10, 20, 40, 80	S.3
	 No of Equations:.	
	Number of required Logic Equations:	



13.1.2 Logics ... Logics

Logic

13.1.2.1 Logics: Global Parameters

Logics . LE1.Gate	[Logics / LE 1]	
AND	AND, OR, NAND, NOR  LE1.Gate.	S.3
 <i>Logic gate</i>		

Logics . LE1.Input1 ... Logics . LE1.Input4	[Logics / LE 1]	
"_"	"_" ... Sys . Internal test state  1..n, Assignment List.	S.3
 <i>Assignment of the Input Signal</i>		

Logics . LE1.Inverting1 ... Logics . LE1.Inverting4	[Logics / LE 1]	
inactive	inactive, active  Mode.	S.3
 <i>Inverting the input signals.</i>		

Logics . LE1.t-On Delay	[Logics / LE 1]	
0.00s	0.00s ... 36000.00s	S.3
 <i>Switch On Delay</i>		

Logics . LE1.t-Off Delay	[Logics / LE 1]	
0.00s	0.00s ... 36000.00s	S.3
 <i>Switch Off Delay</i>		

Logics . LE1.Reset Latched		[Logics / LE 1]
"_"	"_" ... Sys . Internal test state	S.3
	↳ 1..n, Assignment List.	
 <i>Reset Signal for the Latching</i>		

Logics . LE1.Inverting Reset		[Logics / LE 1]
inactive	inactive, active	S.3
	↳ Mode.	
 <i>Inverting Reset Signal for the Latching</i>		

Logics . LE1.Inverting Set		[Logics / LE 1]
inactive	inactive, active	S.3
	↳ Mode.	
 <i>Inverting the Setting Signal for the Latching</i>		

13.1.2.2 Logics: Input States

Logics . LE1.Gate In1-I		[Operation / Status Display / Logics]
...		
Logics . LE1.Gate In4-I		
 <i>State of the module input: Assignment of the Input Signal</i>		

Logics . LE1.Reset Latch-I		[Operation / Status Display / Logics]
 <i>State of the module input: Reset Signal for the Latching</i>		

13.1.2.3 Logics: Signals (Output States)

Logics . LE1.Gate Out		[Operation / Status Display / Logics]
 <i>Signal: Output of the logic gate</i>		

Logics . LE1.Timer Out		[Operation / Status Display / Logics]
 <i>Signal: Timer Output</i>		

Logics . LE1.Out	[Operation / Status Display / Logics]
⬆	<i>Signal: Latched Output (Q)</i>



Logics . LE1.Out inverted	[Operation / Status Display / Logics]
⬆	<i>Signal: Negated Latched Output (Q NOT)</i>

14 Self-Supervision

SelfSupervision

Messages	[Operation / Self-Supervision / Messages]
<p> This item represents a special dialog. (See the Technical Manual for details.)</p> <p><i>Internal messages</i></p>	

14.1 SSV: Direct Controls

SSV . Ack System LED	[Operation / Acknowledge]	
False	False, True	P.1
	 true or not true.	
 Acknowledge System LED (red/green flashing LED)		

14.2 SSV: Signals (Output States)

SSV . System Error	[Operation / Self-Supervision / System State]
 Signal: Device Failure	

SSV . SelfSuperVision Contact	[Operation / Self-Supervision / System State]
 Signal: SelfSuperVision Contact	

SSV . New error	[Operation / Self-Supervision / System State]
 Signal: A new error message has been issued.	

SSV . New warning	[Operation / Self-Supervision / System State]
 Signal: A new warning message has been issued.	

14.3 SSV: Counters

SSV . Cr No of free sockets	[Operation / Self-Supervision / System State]
 Counter for network diagnosis. Number of free sockets.	

15 Service

- Sys . Reboot:  Tab.

15.1 Sgen

Sine wave generator

15.1.1 Sgen: Device Planning Parameters

Sgen . Mode	[Device planning]	
use	"-", use ↳ Mode.	S.3
 <i>Sine wave generator, general operation mode</i>		

15.1.2 Sgen: Global Parameters

Sgen . TripCmd Mode	[Service / Test (Prot inhibit) / Sgen / Process]	
No TripCmd	No TripCmd, With TripCmd ↳ TripCmd Mode.	S.3
 <i>Trip Command Mode: Select between two operating modes for the Fault Simulator: "cold simulation" (without tripping the circuit breaker), or "hot simulation" (i.e. the simulation is authorized to trip the circuit breaker)</i>		

Sgen . Ex Start Simulation	[Service / Test (Prot inhibit) / Sgen / Process]	
"_"	"_" ... Sys . Internal test state ↳ 1..n, Assignment List.	S.3
 <i>External Start of Fault Simulation (Using the test parameters)</i>		

Sgen . ExBlo1	[Service / Test (Prot inhibit) / Sgen / Process]	
SG[1] . Pos ON	"_" ... Sys . Internal test state ↳ 1..n, Assignment List.	S.3
 <i>External blocking of the module, if blocking is activated (allowed) within a parameter set and if the state of the assigned signal is true.1</i>		

Sgen . ExBlo2	[Service / Test (Prot inhibit) / Sgen / Process]	
"_"	"_" ... Sys . Internal test state ↳ 1..n, Assignment List.	S.3
 <i>External blocking of the module, if blocking is activated (allowed) within a parameter set and if the state of the assigned signal is true.2</i>		

Sgen . Ex ForcePost	[Service / Test (Prot inhibit) / Sgen / Process]	
"_"	"_" ... Sys . Internal test state ↳ 1..n, Assignment List.	S.3
 Force Post state. Abort simulation.		

Sgen . PreFault	[Service / Test (Prot inhibit) / Sgen / Configuration / Times]	
0.0s	0.00s ... 300.00s	S.3
 Pre Fault Duration		

Sgen . FaultSimulation	[Service / Test (Prot inhibit) / Sgen / Configuration / Times]	
0.0s	0.00s ... 10800.00s	S.3
 Duration of Fault Simulation		

Sgen . PostFault	[Service / Test (Prot inhibit) / Sgen / Configuration / Times]	
0.0s	0.00s ... 300.00s	S.3
 Post Fault Duration		

15.1.3 Sgen: Direct Controls

Sgen . Start Simulation	[Service / Test (Prot inhibit) / Sgen / Process]	
inactive	inactive, active ↳ Mode.	S.3
 Start Fault Simulation (Using the test parameters)		

Sgen . Stop Simulation	[Service / Test (Prot inhibit) / Sgen / Process]	
inactive	inactive, active ↳ Mode.	S.3
 Stopp Fault Simulation (Using the test parameters)		

15.1.4 Sgen: Input States

Sgen . Ex Start Simulation-I	[Operation / Status Display / Sgen]	
 State of the module input:External Start of Fault Simulation (Using the test parameters)		

Sgen . ExBlo1-I	[Operation / Status Display / Sgen] [Service / Test (Prot inhibit) / Sgen / State]
↓	<i>Module input state: External blocking1</i>

Sgen . ExBlo2-I	[Operation / Status Display / Sgen] [Service / Test (Prot inhibit) / Sgen / State]
↓	<i>Module input state: External blocking2</i>

Sgen . Ex ForcePost-I	[Operation / Status Display / Sgen] [Service / Test (Prot inhibit) / Sgen / State]
↓	<i>State of the module input:Force Post state. Abort simulation.</i>

15.1.5 Sgen: Signals (Output States)

Sgen . Manual Start	[Operation / Status Display / Sgen]
↓	<i>Fault Simulation has been started manually.</i>

Sgen . Manual Stop	[Operation / Status Display / Sgen]
↓	<i>Fault Simulation has been stopped manually.</i>

Sgen . Running	[Operation / Status Display / Sgen] [Service / Test (Prot inhibit) / Sgen / State]
↓	<i>Signal; Measuring value simulation is running</i>

Sgen . Started	[Operation / Status Display / Sgen]
↓	<i>Fault Simulation has been started</i>

Sgen . Stopped	[Operation / Status Display / Sgen]
↓	<i>Fault Simulation has been stopped</i>

Sgen . State	[Operation / Status Display / Sgen]
↓	<i>Signal: Wave generation states: 0=Off, 1=PreFault, 2=Fault, 3=PostFault, 4=InitReset</i>

15.1.6 Sgen: Values

Sgen . State	[Service / Test (Prot inhibit) / Sgen / State]
Off	Off, PreFault, FaultSimulation, PostFault, Init Res ↳ State.
 Wave generation states: 0=Off, 1=PreFault, 2=Fault, 3=PostFault, 4=InitReset	

15.1.7 Sgen

Sine wave generator

15.1.7.1 Sgen: Global Parameters

Sgen . VL1	[Service / Test (Prot inhibit) / Sgen / Configuration / PreFault / VT]	
0.57Vn	0.00Vn ... 2.00Vn	S.3
 Voltage Fundamental Magnitude in Pre State: phase L1		
Sgen . VL2	[Service / Test (Prot inhibit) / Sgen / Configuration / PreFault / VT]	
0.57Vn	0.00Vn ... 2.00Vn	S.3
 Voltage Fundamental Magnitude in Pre State: phase L2		
Sgen . VL3	[Service / Test (Prot inhibit) / Sgen / Configuration / PreFault / VT]	
0.57Vn	0.00Vn ... 2.00Vn	S.3
 Voltage Fundamental Magnitude in Pre State: phase L3		
Sgen . VX	[Service / Test (Prot inhibit) / Sgen / Configuration / PreFault / VT]	
0.0Vn	0.00Vn ... 2.00Vn	S.3
 Voltage Fundamental Magnitude in Pre State: VX		
Sgen . phi VL1	[Service / Test (Prot inhibit) / Sgen / Configuration / PreFault / VT]	
0°	-360° ... 360°	S.3
 Start Position respectively Start Angle of the Voltage Phasor during Pre-Phase:phase L1		
Sgen . phi VL2	[Service / Test (Prot inhibit) / Sgen / Configuration / PreFault / VT]	
240°	-360° ... 360°	S.3
 Start Position respectively Start Angle of the Voltage Phasor during Pre-Phase:phase L2		

Sgen . phi VL3	[Service / Test (Prot inhibit) / Sgen / Configuration / PreFault / VT]	
120°	-360° ... 360°	S.3
	<i>Start Position respectively Start Angle of the Voltage Phasor during Pre-Phase: phase L3</i>	

Sgen . phi VX meas	[Service / Test (Prot inhibit) / Sgen / Configuration / PreFault / VT]	
0°	-360° ... 360°	S.3
	<i>Start Position respectively Start Angle of the Voltage Phasor during Pre-Phase: VX</i>	







Sgen . VL1	[Service / Test (Prot inhibit) / Sgen / Configuration / FaultSimulation / VT]	
0.29Vn	0.00Vn ... 2.00Vn	S.3
	<i>Voltage Fundamental Magnitude in Fault State: phase L1</i>	





Sgen . VL2	[Service / Test (Prot inhibit) / Sgen / Configuration / FaultSimulation / VT]	
0.29Vn	0.00Vn ... 2.00Vn	S.3
	<i>Voltage Fundamental Magnitude in Fault State: phase L2</i>	

Sgen . VL3	[Service / Test (Prot inhibit) / Sgen / Configuration / FaultSimulation / VT]	
0.29Vn	0.00Vn ... 2.00Vn	S.3
	<i>Voltage Fundamental Magnitude in Fault State: phase L3</i>	

Sgen . VX	[Service / Test (Prot inhibit) / Sgen / Configuration / FaultSimulation / VT]	
0.29Vn	0.00Vn ... 2.00Vn	S.3
	<i>Voltage Fundamental Magnitude in Fault State: phase VX</i>	

Sgen . phi VL1	[Service / Test (Prot inhibit) / Sgen / Configuration / FaultSimulation / VT]	
0°	-360° ... 360°	S.3
	<i>Start Position respectively Start Angle of the Voltage Phasor during Fault-Phase: phase L1</i>	







Sgen . phi VL2	[Service / Test (Prot inhibit) / Sgen / Configuration / FaultSimulation / VT]	
240°	-360° ... 360°	S.3
	<i>Start Position respectively Start Angle of the Voltage Phasor during Fault-Phase: phase L2</i>	
Sgen . phi VL3	[Service / Test (Prot inhibit) / Sgen / Configuration / FaultSimulation / VT]	
120°	-360° ... 360°	S.3
	<i>Start Position respectively Start Angle of the Voltage Phasor during Fault-Phase: phase L3</i>	
Sgen . phi VX meas	[Service / Test (Prot inhibit) / Sgen / Configuration / FaultSimulation / VT]	
0°	-360° ... 360°	S.3
	<i>Start Position respectively Start Angle of the Voltage Phasor during Fault-Phase: VX</i>	
Sgen . VL1	[Service / Test (Prot inhibit) / Sgen / Configuration / PostFault / VT]	
0.57Vn	0.00Vn ... 2.00Vn	S.3
	<i>Voltage Fundamental Magnitude during Post phase: phase L1</i>	
Sgen . VL2	[Service / Test (Prot inhibit) / Sgen / Configuration / PostFault / VT]	
0.57Vn	0.00Vn ... 2.00Vn	S.3
	<i>Voltage Fundamental Magnitude during Post phase: phase L2</i>	
Sgen . VL3	[Service / Test (Prot inhibit) / Sgen / Configuration / PostFault / VT]	
0.57Vn	0.00Vn ... 2.00Vn	S.3
	<i>Voltage Fundamental Magnitude during Post phase: phase L3</i>	
Sgen . VX	[Service / Test (Prot inhibit) / Sgen / Configuration / PostFault / VT]	
0.0Vn	0.00Vn ... 2.00Vn	S.3
	<i>Voltage Fundamental Magnitude during Post phase: phase VX</i>	

Sgen . phi VL1	[Service / Test (Prot inhibit) / Sgen / Configuration / PostFault / VT]	
0°	-360° ... 360°	S.3
	<i>Start Position respectively Start Angle of the Voltage Phasor during Post phase: phase L1</i>	
Sgen . phi VL2	[Service / Test (Prot inhibit) / Sgen / Configuration / PostFault / VT]	
240°	-360° ... 360°	S.3
	<i>Start Position respectively Start Angle of the Voltage Phasor during Post phase: phase L2</i>	
Sgen . phi VL3	[Service / Test (Prot inhibit) / Sgen / Configuration / PostFault / VT]	
120°	-360° ... 360°	S.3
	<i>Start Position respectively Start Angle of the Voltage Phasor during Post phase: phase L3</i>	
Sgen . phi VX meas	[Service / Test (Prot inhibit) / Sgen / Configuration / PostFault / VT]	
0°	-360° ... 360°	S.3
	<i>Start Position respectively Start Angle of the Voltage Phasor during Post phase: phase VX</i>	

15.1.8 Sgen ... Sgen

Sine wave generator

15.1.8.1 Sgen: Global Parameters

Sgen . CT Ntrl.IL1	[Service / Test (Prot inhibit) / Sgen / Configuration / PreFault / CT Ntrl]	
0.0In	0.00In ... 40.00In	S.3
	<i>Current Fundamental Magnitude in Pre State: phase L1</i>	
Sgen . CT Ntrl.IL2	[Service / Test (Prot inhibit) / Sgen / Configuration / PreFault / CT Ntrl]	
0.0In	0.00In ... 40.00In	S.3
	<i>Current Fundamental Magnitude in Pre State: phase L2</i>	
Sgen . CT Ntrl.IL3	[Service / Test (Prot inhibit) / Sgen / Configuration / PreFault / CT Ntrl]	
0.0In	0.00In ... 40.00In	S.3
	<i>Current Fundamental Magnitude in Pre State: phase L3</i>	
Sgen . CT Ntrl.IG meas	[Service / Test (Prot inhibit) / Sgen / Configuration / PreFault / CT Ntrl]	
0.0In	If: slot 3 = Current measuring inputs2 • 0.00In ... 2.500In If: slot 3 ≠ Current measuring inputs2 • 0.00In ... 25.00In	S.3
	<i>Current Fundamental Magnitude in Pre State: IG</i>	
Sgen . CT Ntrl.phi IL1	[Service / Test (Prot inhibit) / Sgen / Configuration / PreFault / CT Ntrl]	
0°	-360° ... 360°	S.3
	<i>Start Position respectively Start Angle of the Current Phasor during Pre-Phase:phase L1</i>	
Sgen . CT Ntrl.phi IL2	[Service / Test (Prot inhibit) / Sgen / Configuration / PreFault / CT Ntrl]	
240°	-360° ... 360°	S.3
	<i>Start Position respectively Start Angle of the Current Phasor during Pre-Phase:phase L2</i>	

Sgen . CT Ntrl.phi IL3	[Service / Test (Prot inhibit) / Sgen / Configuration / PreFault / CT Ntrl]	
120°	-360° ... 360°	S.3
	<i>Start Position respectively Start Angle of the Current Phasor during Pre-Phase:phase L3</i>	

Sgen . CT Ntrl.phi IG meas	[Service / Test (Prot inhibit) / Sgen / Configuration / PreFault / CT Ntrl]	
0°	-360° ... 360°	S.3
	<i>Start Position respectively Start Angle of the Current Phasor during Pre-Phase: IG</i>	







Sgen . CT Ntrl.IL1	[Service / Test (Prot inhibit) / Sgen / Configuration / FaultSimulation / CT Ntrl]	
0.0In	0.00In ... 40.00In	S.3
	<i>Current Fundamental Magnitude in Fault State: phase L1</i>	

Sgen . CT Ntrl.IL2	[Service / Test (Prot inhibit) / Sgen / Configuration / FaultSimulation / CT Ntrl]	
0.0In	0.00In ... 40.00In	S.3
	<i>Current Fundamental Magnitude in Fault State: phase L2</i>	

Sgen . CT Ntrl.IL3	[Service / Test (Prot inhibit) / Sgen / Configuration / FaultSimulation / CT Ntrl]	
0.0In	0.00In ... 40.00In	S.3
	<i>Current Fundamental Magnitude in Fault State: phase L3</i>	

Sgen . CT Ntrl.IG meas	[Service / Test (Prot inhibit) / Sgen / Configuration / FaultSimulation / CT Ntrl]	
0.0In	If: slot 3 = Current measuring inputs2 • 0.00In ... 2.500In If: slot 3 ≠ Current measuring inputs2 • 0.00In ... 25.00In	S.3
	<i>Current Fundamental Magnitude in Fault State: IG</i>	

Sgen . CT Ntrl.phi IL1	[Service / Test (Prot inhibit) / Sgen / Configuration / FaultSimulation / CT Ntrl]	
0°	-360° ... 360°	S.3
	<i>Start Position respectively Start Angle of the Current Phasor during Fault-Phase:phase L1</i>	

Sgen . CT Ntrl.phi IL2	[Service / Test (Prot inhibit) / Sgen / Configuration / FaultSimulation / CT Ntrl]	
240°	-360° ... 360°	S.3
	<i>Start Position respectively Start Angle of the Current Phasor during Fault-Phase:phase L2</i>	
Sgen . CT Ntrl.phi IL3	[Service / Test (Prot inhibit) / Sgen / Configuration / FaultSimulation / CT Ntrl]	
120°	-360° ... 360°	S.3
	<i>Start Position respectively Start Angle of the Current Phasor during Fault-Phase:phase L3</i>	
Sgen . CT Ntrl.phi IG meas	[Service / Test (Prot inhibit) / Sgen / Configuration / FaultSimulation / CT Ntrl]	
0°	-360° ... 360°	S.3
	<i>Start Position respectively Start Angle of the Current Phasor during Fault-Phase: IG</i>	
Sgen . CT Ntrl.IL1	[Service / Test (Prot inhibit) / Sgen / Configuration / PostFault / CT Ntrl]	
0.0In	0.00In ... 40.00In	S.3
	<i>Current Fundamental Magnitude during Post phase: phase L1</i>	
Sgen . CT Ntrl.IL2	[Service / Test (Prot inhibit) / Sgen / Configuration / PostFault / CT Ntrl]	
0.0In	0.00In ... 40.00In	S.3
	<i>Current Fundamental Magnitude during Post phase: phase L2</i>	
Sgen . CT Ntrl.IL3	[Service / Test (Prot inhibit) / Sgen / Configuration / PostFault / CT Ntrl]	
0.0In	0.00In ... 40.00In	S.3
	<i>Current Fundamental Magnitude during Post phase: phase L3</i>	
Sgen . CT Ntrl.IG meas	[Service / Test (Prot inhibit) / Sgen / Configuration / PostFault / CT Ntrl]	
0.0In	If: slot 3 = Current measuring inputs2 • 0.00In ... 2.500In If: slot 3 ≠ Current measuring inputs2 • 0.00In ... 25.00In	S.3
	<i>Current Fundamental Magnitude during Post phase: IG</i>	

Sgen . CT Ntrl.phi IL1	[Service / Test (Prot inhibit) / Sgen / Configuration / PostFault / CT Ntrl]	
0°	-360° ... 360°	S.3
	<i>Start Position respectively Start Angle of the Current Phasor during Post phase: phase L1</i>	

Sgen . CT Ntrl.phi IL2	[Service / Test (Prot inhibit) / Sgen / Configuration / PostFault / CT Ntrl]	
240°	-360° ... 360°	S.3
	<i>Start Position respectively Start Angle of the Current Phasor during Post phase: phase L2</i>	

Sgen . CT Ntrl.phi IL3	[Service / Test (Prot inhibit) / Sgen / Configuration / PostFault / CT Ntrl]	
120°	-360° ... 360°	S.3
	<i>Start Position respectively Start Angle of the Current Phasor during Post phase: phase L3</i>	



Sgen . CT Ntrl.phi IG meas	[Service / Test (Prot inhibit) / Sgen / Configuration / PostFault / CT Ntrl]	
0°	-360° ... 360°	S.3
	<i>Start Position respectively Start Angle of the Current Phasor during Post phase: IG</i>	

16 Selection Lists

Direction

Direction detection

Selection list referenced by the following parameters:

-  Prot . Dir. I
-  Prot . Dir. IG meas.
-  Prot . Dir. IG calc.

Direction	Description
reverse	<i>reverse</i>
forward	<i>forward</i>
not possible	<i>not possible</i>

Rec state

Recording state

Selection list referenced by the following parameters:

-  Disturb rec . Rec state

Rec state	Description
Ready	<i>Ready</i>
Recording	<i>Recording</i>
Writing file	<i>Signal: Writing file</i>
Trigger Blo	<i>Trigger signal is still active - wait for fallback. A new record can only be started if and only the trigger signal that started the previous record has fallen back once. Therewith endless records are prevented.</i>

Fault



Selection list referenced by the following parameters:

-  Disturb rec . Error code

Fault	Description
OK	<i>OK</i>
Write err	<i>Signal: Writing error in memory</i>
Clear fail	<i>Signal: Clear failure in memory</i>
Calculation err	<i>Calculation error</i>
File not found	<i>File not found</i>
Auto overwriting off	<i>If there is no more memory available the record is being stopped.</i>

State

Selection list referenced by the following parameters:

-  IEC 61850 . GoosePublisherState
-  IEC 61850 . GooseSubscriberState
-  IEC 61850 . MmsServerState

State	Description
Off	<i>Off</i>
On	<i>On</i>
Error	<i>Error</i>

State

Selection list referenced by the following parameters:

-  Profibus . Slave State

State	Description
Baud Search	<i>No connection to the PROFIBUS-DP Master</i>
Baud Found	<i>The PROFIBUS DP Slave is connected to the bus. The Slave has not yet been addressed by the Master Device (and it was not yet addressed since the last break of the connection).</i>
PRM OK	<i>The slave was addressed by the master, the parameter setting message was received and is OK, a configuration message is expected from the master.</i>

State	Description
PRM REQ	<i>The slave is no longer addressed by the master (modified parameters within the master without having the connection stopped, master software is tuned off but lower PROFIBUS layer is still active)</i>
PRM Fault	<i>An Error in the parameter setting message (e.g. wrong PNO identification number)</i>
CFG Fault	<i>Configuration error the number of input/output bytes parameterised in the master does not match the number parametrised in the device (slave).</i>
Clear Data	<i>Master sends a General Control command to clear the data.</i>
Data exchange	<i>Master and slave exchange data.</i>

Baud rate

Selection list referenced by the following parameters:

-  Profibus . Baud rate

Baud rate	Description
12 Mb/s	<i>12 Mb/s</i>
6 Mb/s	<i>6 Mb/s</i>
3 Mb/s	<i>3 Mb/s</i>
1.5 Mb/s	<i>1.5 Mb/s</i>
0.5 Mb/s	<i>0.5 Mb/s</i>
187500 baud	<i>187500 baud</i>
93750 baud	<i>93750 baud</i>
45450 baud	<i>45450 baud</i>
19200 baud	<i>19200 baud</i>
9600 baud	<i>9600 baud</i>
--	<i>--</i>

PNO Id

PNO Identification Number. GSD Identification Number.

Selection list referenced by the following parameters:

-  Profibus . PNO Id

PNO Id	Description
0C50h	<i>PnodID for the Config file.</i>

Config status

Status of the user-defined SCADA configuration.\nPossible values:

Selection list referenced by the following parameters:

-  Profibus . Config status

Config status	Description
Changing	<i>New SCADA configuration is being loaded, but not active yet.</i>
OK	<i>The SCADA configuration is active.</i>
Config. not avail.	<i>The user-defined SCADA configuration is not available (e.g. has not been loaded into the device).</i>
Error	<i>Unexpected error. Please contact our service-team.</i>

Server State

Server State.

Selection list referenced by the following parameters:

-  SNTP . Used Server

Server State	Description
Server1	<i>Server1 used.</i>
Server2	<i>Server2 used.</i>
None	<i>No Server used.</i>

State

Selection list referenced by the following parameters:

-  SNTP . ServerQty







-  **SNTP . NetConn**

State	Description
GOOD	<i>GOOD</i>
SUFFICIENT	<i>SUFFICIENT</i>
BAD	<i>BAD</i>
"_"	<i>NO CONNECTION</i>

Mode

general operation mode



Selection list referenced by the following parameters:

-  **DI Slot X1 . Inverting 1**
-  **DI Slot X5 . Inverting 1**
-  **DI Slot X6 . Inverting 1**
-  **BO Slot X2 . Latched**
-  **BO Slot X2 . Inverting**
-  **BO Slot X2 . Inverting 1**
- *[...]*

Mode	Description
inactive	<i>inactive</i>
active	<i>active</i>

true or not true

Selection list referenced by the following parameters:

-  **Disturb rec . Man Trigger**
-  **SSV . Ack System LED**

true or not true	Description
False	<i>False</i>
True	<i>True</i>

Type of passw. def.

Type of the password definition. This value is directly related to the security-level of the access to the device.

Selection list referenced by the following parameters:

-  Sys . Passw. for USB conn.
-  Sys . Passw.remote net.conn.

Type of passw. def.	Description
disabled	<i>The password disabled.</i>
default	<i>The password is the same as the factory default, i.e. it has not been altered by the user. (However, for devices with a disabled default password the password type is displayed as “disabled”, not as “default”.)</i>
def. by user	<i>The password has been defined by the user. This corresponds to the highest security-level of the access to the device.</i>

TLS Certificate

Type of certificate that the device uses for the encrypted communication. This value is directly related to the security-level of the communication.



Selection list referenced by the following parameters:

-  Sys . TLS Certificate

TLS Certificate	Description
Device-specific	<i>The device uses a device-specific certificate for the encrypted communication. This corresponds to the highest security-level of the communication.</i>
Basic	<i>The device uses a basic certificate for the encrypted communication. Compared with a device-specific certificate, this means a slightly reduced security level.</i>
Corrupt	<i>The certificate for the encrypted communication is corrupt and therefore unusable.</i>

Switching Authority

Selection list referenced by the following parameters:

-  Ctrl . Switching Authority
-  Ctrl . Switching Authority
-  Ctrl . Switching Authority

Switching Authority	Description
None	None
Local	Local
Remote	Remote
Local and Remote	Local and Remote

Config. Device Reset

If the »C« key is pressed while the device is performing a cold restart a general Reset Dialog appears on the screen. Select which options shall be available with this dialog.

Selection list referenced by the following parameters:

-  HMI . Config. Device Reset
-  HMI . Config. Device Reset
-  HMI . Config. Device Reset
-  HMI . Config. Device Reset

Config. Device Reset	Description
"Fact.def.", "PW rst"	Two Reset Options shall be available: - "Reset to factory defaults", - "Reset passwords".
Only "Fact.defaults"	Only one Reset Option shall be available: - "Reset to factory defaults". <i>CAUTION: If this option has been chosen and the password should ever get lost then the only chance to recover control is to reset the protection device to factory defaults.</i>
Reset deact.	The Reset Options shall be deactivated.

Config. Device Reset	Description
	<i>CAUTION: If this option has been chosen and the password should ever get lost, then the protection device has to be sent to the manufacturer as a service request.</i>

Mode

general operation mode

Selection list referenced by the following parameters:

-  Transformer . Mode

Mode	Description
"_"	<i>do not use</i>
use	<i>use</i>

Mode

general operation mode

Selection list referenced by the following parameters:

-  Id . Mode

Mode	Description
"_"	<i>do not use</i>
use	<i>use</i>

Mode

general operation mode

Selection list referenced by the following parameters:

-  IdH . Mode

Mode	Description
"_"	<i>do not use</i>

Mode	Description
use	use

Mode

general operation mode

Selection list referenced by the following parameters:

-  IdG[1] . Mode

Mode	Description
"_"	do not use
use	use

Mode

general operation mode

Selection list referenced by the following parameters:

-  IdGH[1] . Mode

Mode	Description
"_"	do not use
use	use

Device planning

Selection list referenced by the following parameters:

-  IH2 . Mode

Device planning	Description
"_"	do not use
use	use

I>

If the pickup value is exceeded, the module/element starts to time out to trip.

Selection list referenced by the following parameters:

-  I[1] . Mode

I>	Description
“_”	<i>do not use</i>
non directional	<i>non directional</i>
forward	<i>forward</i>
reverse	<i>reverse</i>

Earth overcurrent







Selection list referenced by the following parameters:

-  IG[1] . Mode

Earth overcurrent	Description
“_”	<i>do not use</i>
non directional	<i>non directional</i>
forward	<i>forward</i>
reverse	<i>reverse</i>

yes/no

Selection list referenced by the following parameters:

-  Sys . Reboot
-  IG[1] . Superv. only
-  VG[1] . Superv. only
-  RTD . Windg 1
-  RTD . Windg 2
-  RTD . Windg 3

- [...]

yes/no	Description
no	no
yes	yes

Device planning

Selection list referenced by the following parameters:

-  ThR . Mode

Device planning	Description
"_"	do not use
use	use

Device planning

Selection list referenced by the following parameters:

-  I2>[1] . Mode

Device planning	Description
"_"	do not use
use	use

Device planning

Selection list referenced by the following parameters:

-  I2>G[1] . Mode

Device planning	Description
"_"	do not use
use	use

Device planning

Selection list referenced by the following parameters:

-  V[1] . Mode

Device planning	Description
"_"	<i>do not use</i>
V>	V>
V<	<i>Pickup value</i>

Device planning

Selection list referenced by the following parameters:

-  df/dt . Mode

Device planning	Description
"_"	<i>do not use</i>
use	<i>use</i>

Device planning

Selection list referenced by the following parameters:

-  delta phi . Mode

Device planning	Description
"_"	<i>do not use</i>
use	<i>use</i>

Device planning

Selection list referenced by the following parameters:

-  Intertripping . Mode

Device planning	Description
"_"	<i>do not use</i>
use	<i>use</i>

Mode

general operation mode

Selection list referenced by the following parameters:

-  P[1] . Mode

Mode	Description
"_"	<i>do not use</i>
P>	<i>Over Forward</i>
Pr>	<i>Over Reverse</i>

Mode

general operation mode

Selection list referenced by the following parameters:

-  Q . Mode

Mode	Description
"_"	<i>do not use</i>
Q>	<i>Over Forward</i>
Qr>	<i>Over Reverse</i>

Device planning

Selection list referenced by the following parameters:

-  LVRT[1] . Mode

Device planning	Description
"_"	<i>do not use</i>
use	<i>use</i>

Device planning

Selection list referenced by the following parameters:

-  VG[1] . Mode

Device planning	Description
"_"	<i>do not use</i>
V>	<i>V></i>
V<	<i>Pickup value</i>

Device planning

Selection list referenced by the following parameters:

-  V012[1] . Mode

Device planning	Description
"_"	<i>do not use</i>
V1>	<i>Positive Phase Sequence Overvoltage</i>
V1<	<i>Positive Phase Sequence Undervoltage</i>
V2>	<i>Negative Phase Sequence Overvoltage</i>

Device planning

Selection list referenced by the following parameters:

-  f[1] . Mode

Device planning	Description
"_"	<i>do not use</i>

Device planning	Description
f<	Underfrequency
f>	Overfrequency
f< and df/dt	Underfrequency and (instantaneous) rate of frequency change
f> and df/dt	Overfrequency and (instantaneous) rate of frequency change
f< and DF/DT	Underfrequency and (averaged) rate of frequency change
f> and DF/DT	Overfrequency and (averaged) rate of frequency change
df/dt	Measured value (calculated): Rate-of-frequency-change.
delta phi	Measured value (calculated): Vector surge

Mode

general operation mode

Selection list referenced by the following parameters:

-  PQS[1] . Mode

Mode	Description
“.”	do not use
P>	Over(load) Active Power Pickup Value. Can be used for monitoring the maximum allowed forward power limits of transformers or overhead lines.
P<	Under(load) Active Power Pickup Value (e.g. caused by idling motors).
Pr<	Under Reverse
Pr>	Overload Reverse Active Power Pickup Value. Protection against reverse feeding into the power supply network.
Q>	Over(load) Reactive Power Pickup Value. Monitoring the maximum allowed reactive power of the electrical equipment like transformers or overhead lines). If the maximum value is exceeded a condensator bank could be switched off.
Q<	Under(load) Reactive Power Pickup Value. Monitoring the minimum value of the reactive power. If it falls below the set value a condensator bank could be switched on.
Qr<	Under Reverse
Qr>	Overload Reverse Reactive Power Pickup Value
S>	Over(load) Apparent Power Pickup Value
S<	Under(load) Apparent Power Pickup Value

Mode

general operation mode

Selection list referenced by the following parameters:

-  PF[1] . Mode

Mode	Description
"_"	<i>do not use</i>
use	<i>use</i>

Mode

general operation mode

Selection list referenced by the following parameters:

-  Q->&V< . Mode

Mode	Description
"_"	<i>do not use</i>
use	<i>use</i>

Mode

general operation mode

Selection list referenced by the following parameters:

-  ReCon[1] . Mode

Mode	Description
"_"	<i>do not use</i>
use	<i>use</i>

Mode

general operation mode

Selection list referenced by the following parameters:

-  Sync . Mode

Mode	Description
"_"	<i>do not use</i>
use	<i>use</i>

Device planning

Selection list referenced by the following parameters:

-  LoE-Z1[1] . Mode

Device planning	Description
"_"	<i>do not use</i>
use	<i>use</i>

Device planning

Selection list referenced by the following parameters:

-  LoE-Z2[1] . Mode

Device planning	Description
"_"	<i>do not use</i>
use	<i>use</i>

Device planning

Selection list referenced by the following parameters:

-  OST . Mode

Device planning	Description
"_"	<i>do not use</i>
use	<i>use</i>

Mode

general operation mode

Selection list referenced by the following parameters:

-  V/f>[1] . Mode

Mode	Description
"_"	<i>do not use</i>
use	<i>use</i>

Mode

general operation mode

Selection list referenced by the following parameters:

-  InEn . Mode

Mode	Description
"_"	<i>do not use</i>
use	<i>use</i>

Device planning

Selection list referenced by the following parameters:

-  Z[1] . Mode

Device planning	Description
"_"	<i>do not use</i>
use	<i>use</i>

Device planning

Selection list referenced by the following parameters:

-  LB . Mode

Device planning	Description
"_"	<i>do not use</i>
use	<i>use</i>

Device planning

Selection list referenced by the following parameters:

-  PSB . Mode

Device planning	Description
"_"	<i>do not use</i>
use	<i>use</i>

Mode

general operation mode

Selection list referenced by the following parameters:

-  SOTF . Mode

Mode	Description
"_"	<i>do not use</i>
use	<i>use</i>

Mode

general operation mode

Selection list referenced by the following parameters:

-  CLPU . Mode

Mode	Description
"_"	<i>do not use</i>
use	<i>use</i>

Device planning

Selection list referenced by the following parameters:

-  Exp[1] . Mode

Device planning	Description
"_"	<i>do not use</i>
use	<i>use</i>

Device planning

Selection list referenced by the following parameters:

-  Ext Sudd Press . Mode

Device planning	Description
"_"	<i>do not use</i>
use	<i>use</i>

Device planning

Selection list referenced by the following parameters:

-  Ext Oil Temp . Mode

Device planning	Description
"_"	<i>do not use</i>
use	<i>use</i>

Device planning

Selection list referenced by the following parameters:

-  Ext Temp Superv[1] . Mode

Device planning	Description
"_"	<i>do not use</i>
use	<i>use</i>

Device planning

Selection list referenced by the following parameters:

-  RTD . Mode

Device planning	Description
"_"	<i>do not use</i>
use	<i>use</i>

Device planning

Selection list referenced by the following parameters:

-  CBF . Mode

Device planning	Description
"_"	<i>do not use</i>
use	<i>use</i>

Device planning

Selection list referenced by the following parameters:

-  TCS . Mode

Device planning	Description
"_"	<i>do not use</i>
use	<i>use</i>

Device planning

Selection list referenced by the following parameters:

-  CTS . Mode

Device planning	Description
"_"	<i>do not use</i>
use	<i>use</i>

Device planning

Selection list referenced by the following parameters:

-  LOP . Mode

Device planning	Description
"_"	<i>do not use</i>
use	<i>use</i>

Mode

general operation mode

Selection list referenced by the following parameters:

-  SysA . Mode

Mode	Description
"_"	<i>do not use</i>
use	<i>use</i>

Mode

general operation mode

Selection list referenced by the following parameters:

-  AnaP[1] . Mode

Mode	Description
“_”	<i>do not use</i>
use	<i>use</i>

Used Protocol

Used SCADA Protocol

Selection list referenced by the following parameters:

-  Scada . Protocol

Used Protocol	Description
“_”	<i>do not use</i>
Modbus RTU	<i>Modbus Protocol RTU</i>
Modbus TCP	<i>Modbus Protocol TCP</i>
Modbus TCP/RTU	<i>Modbus Protocol TCP/RTU</i>
DNP3 RTU	<i>Distributed Network Protocol RTU</i>
DNP3 TCP	<i>Distributed Network Protocol TCP</i>
DNP3 UDP	<i>Distributed Network Protocol UDP</i>
IEC 60870-5-103	<i>IEC 60870-5-103 Protocol</i>
IEC 60870-5-104	<i>IEC 60870-5-104 Protocol</i>
IEC 61850	<i>IEC 61850 communication</i>
Profibus	<i>Profibus Module</i>

Mode

general operation mode

Selection list referenced by the following parameters:

-  IRIG-B . Mode

Mode	Description
"_"	<i>do not use</i>
use	<i>use</i>

Mode

general operation mode

Selection list referenced by the following parameters:

-  SNTP . Mode

Mode	Description
"_"	<i>do not use</i>
use	<i>use</i>

No of Equations:

Number of required Logic Equations:

Selection list referenced by the following parameters:

-  Logics . No of Equations:

No of Equations:	Description
0	0
5	5
10	10
20	20
40	40
80	80

Mode

general operation mode

Selection list referenced by the following parameters:

-  Sgen . Mode

Mode	Description
"_"	<i>do not use</i>
use	<i>use</i>

Scaling

Display of the measured values as primary, secondary or per unit values

Selection list referenced by the following parameters:

-  Sys . Scaling

Scaling	Description
Per unit values	<i>Per unit values</i>
Primary values	<i>Primary values</i>
Secondary values	<i>Secondary values</i>

Scaling

Display of the measured values as primary, secondary or per unit values

Selection list referenced by the following parameters:

-  Z . Scaling Z

Scaling	Description
Primary values	<i>Primary values</i>
Secondary values	<i>Secondary values</i>

Units

Units for the measurement

Selection list referenced by the following parameters:

-  URTD . Temperature Unit

Units	Description
Celsius	Celsius
Fahrenheit	Fahrenheit

1..n Power Scaling

Selection list referenced by the following parameters:

-  PQSCr . Power Units

1..n Power Scaling	Description
Power Auto Scaling	Selects unit prefix (k, M, G) and decimal places for power values to best fit, depending on VT and CT primary settings.
kW/kVAr/kVA	Set unit prefix to k (kW, kVAr or kVA)
MW/MVAr/MVA	Set unit prefix to M (MW, MVAr or MVA)
GW/GVAr/GVA	Set unit prefix to G (GW, GVAr or GVA)

1..n Energy Scaling

Selection list referenced by the following parameters:

-  PQSCr . Energy Units

1..n Energy Scaling	Description
Energy Auto Scaling	Selects unit prefix (k, M, G) and decimal places for power values to best fit, depending on VT and CT primary settings.
kWh/kVArh/kVAh	Set unit prefix to k (kWh, kVArh or kVAh)
MWh/MVArh/MVAh	Set unit prefix to M (MWh, MVArh or MVAh)
GWh/GVArh/GVAh	Set unit prefix to G (GWh, GVArh or GVAh)

Nom voltage

Nominal voltage of the digital inputs

Selection list referenced by the following parameters:

-  DI Slot X1 . Nom voltage

Nom voltage	Description
24 VDC	24 VDC
48 VDC	48 VDC
60 VDC	60 VDC
110 VDC	110 VDC
230 VDC	230 VDC
110 VAC	110 VAC
230 VAC	230 VAC

Debouncing time

A change of the state of a digital input will only be recognized after the debouncing time has expired (become effective). Thus, transient signals will not be misinterpreted.

Selection list referenced by the following parameters:

-  DI Slot X1 . Debouncing time 1

Debouncing time	Description
no debouncing time	no debouncing time
20 ms	20 ms
50 ms	50 ms
100 ms	100 ms

Nom voltage

Nominal voltage of the digital inputs

Selection list referenced by the following parameters:

-  DI Slot X5 . Nom voltage

Nom voltage	Description
24 VDC	24 VDC
48 VDC	48 VDC
60 VDC	60 VDC
110 VDC	110 VDC
230 VDC	230 VDC
110 VAC	110 VAC
230 VAC	230 VAC

Debouncing time

A change of the state of a digital input will only be recognized after the debouncing time has expired (become effective). Thus, transient signals will not be misinterpreted.

Selection list referenced by the following parameters:

-  DI Slot X5 . Debouncing time 1

Debouncing time	Description
no debouncing time	<i>no debouncing time</i>
20 ms	20 ms
50 ms	50 ms
100 ms	100 ms

Nom voltage

Nominal voltage of the digital inputs

Selection list referenced by the following parameters:

-  DI Slot X6 . Nom voltage

Nom voltage	Description
24 VDC	24 VDC
48 VDC	48 VDC
60 VDC	60 VDC
110 VDC	110 VDC

Nom voltage	Description
230 VDC	230 VDC
110 VAC	110 VAC
230 VAC	230 VAC

Debouncing time

A change of the state of a digital input will only be recognized after the debouncing time has expired (become effective). Thus, transient signals will not be misinterpreted.







Selection list referenced by the following parameters:

-  DI Slot X6 . Debouncing time 1

Debouncing time	Description
no debouncing time	<i>no debouncing time</i>
20 ms	<i>20 ms</i>
50 ms	<i>50 ms</i>
100 ms	<i>100 ms</i>

1...n Operating Modes

Selection list referenced by the following parameters:







-  BO Slot X2 . Operating Mode
-  BO Slot X2 . Operating Mode
-  BO Slot X2 . Operating Mode
-  BO Slot X2 . Operating Mode
-  BO Slot X2 . Operating Mode
-  BO Slot X2 . Operating Mode

1...n Operating Modes	Description
Normally open (NO)	<i>The working principle of the relay corresponds to a normally open contact.</i>
Normally closed (NC)	<i>The working principle of the relay corresponds to a normally closed contact.</i>

1..n, Assignment List

Assignment List

Selection list referenced by the following parameters:

-  BO Slot X2 . Acknowledgement
-  BO Slot X2 . Assignment 1
-  BO Slot X2 . Assignment 2
-  BO Slot X2 . Acknowledgement
-  BO Slot X2 . Assignment 1
-  BO Slot X2 . Assignment 2
- [...]

1..n, Assignment List	Description
"_"	<i>No assignment</i>
Prot . available	<i>Signal: Protection is available</i>
Prot . active	<i>Signal: active</i>
Prot . ExBlo	<i>Signal: External Blocking</i>
Prot . Blo TripCmd	<i>Signal: Trip Command blocked</i>
Prot . ExBlo TripCmd	<i>Signal: External Blocking of the Trip Command</i>
Prot . Alarm L1	<i>Signal: General-Alarm L1</i>
Prot . Alarm L2	<i>Signal: General-Alarm L2</i>
Prot . Alarm L3	<i>Signal: General-Alarm L3</i>
Prot . Alarm G	<i>Signal: General-Alarm - Earth fault</i>
Prot . Alarm	<i>Signal: General Alarm</i>
Prot . Trip L1	<i>Signal: General Trip L1</i>
Prot . Trip L2	<i>Signal: General Trip L2</i>
Prot . Trip L3	<i>Signal: General Trip L3</i>
Prot . Trip G	<i>Signal: General Trip Ground fault</i>
Prot . Trip	<i>Signal: General Trip</i>
Prot . Res FaultNo a GridFaultNo	<i>Signal: Resetting of fault number and grid fault number.</i>
Prot . I dir fwd	<i>Signal: Phase current failure forward direction</i>

1..n, Assignment List	Description
Prot . I dir rev	<i>Signal: Phase current failure reverse direction</i>
Prot . I dir n poss	<i>Signal: Phase fault - missing reference voltage</i>
Prot . IG calc dir fwd	<i>Signal: Ground fault (calculated) forward</i>
Prot . IG calc dir rev	<i>Signal: Ground fault (calculated) reverse direction</i>
Prot . IG calc dir n poss	<i>Signal: Ground fault (calculated) direction detection not possible</i>
Prot . IG meas dir fwd	<i>Signal: Ground fault (measured) forward</i>
Prot . IG meas dir rev	<i>Signal: Ground fault (measured) reverse direction</i>
Prot . IG meas dir n poss	<i>Signal: Ground fault (measured) direction detection not possible</i>
Prot . f(VL123)<10Hz	<i>Frequency of the measuring channels 1-3 (VL1,VL2,VL3) is lower than 10Hz.</i>
Prot . f(VL123)>10Hz	<i>Frequency of the measuring channels 1-3 (VL1,VL2,VL3) is greater than 10Hz.</i>
Prot . f(VL123)<70Hz	<i>Frequency of the measuring channels 1-3 (VL1,VL2,VL3) is lower than 70Hz.</i>
Prot . f(VL123)>70Hz	<i>Frequency of the measuring channels 1-3 (VL1,VL2,VL3) is greater than 70Hz.</i>
Prot . DFT Invalid	<i>DFT values of fundamental and harmonics (except VX) are not valid. They depend on period time of frequency and measured channels 1-3 (VL1,VL2,VL3).</i>
Prot . DFT Valid	<i>DFT values of fundamental and harmonics (except VX) are valid. They depend on period time of frequency and measured channels 1-3 (VL1,VL2,VL3).</i>
Prot . f(VX)<10Hz	<i>Frequency of the measuring channel 4 (VX) is lower than 10Hz.</i>
Prot . f(VX)>10Hz	<i>Frequency of the measuring channel 4 (VX) is greater than 10Hz.</i>
Prot . f(VX)<70Hz	<i>Frequency of the measuring channel 4 (VX) is lower than 70Hz.</i>
Prot . f(VX)>70Hz	<i>Frequency of the measuring channel 4 (VX) is greater than 70Hz.</i>
Prot . DFT Invalid (VX)	<i>DFT values of fundamental and harmonics of VX (only) are not valid.</i>
Prot . DFT Valid (VX)	<i>DFT values of fundamental and harmonics of VX (only) are valid.</i>
Prot . ExBlo1-I	<i>Module input state: External blocking1</i>
Prot . ExBlo2-I	<i>Module input state: External blocking2</i>
Prot . ExBlo TripCmd-I	<i>Module input state: External Blocking of the Trip Command</i>
VT . Phase seq. wrong	<i>Signal that the device has detected a phase sequence (L1-L2-L3 / L1-L3-L2) that is different from the one that had been set at [Field settings / General Settings] »Phase Sequence«.</i>
CT Ntrl . Phase seq. wrong	<i>Signal that the device has detected a phase sequence (L1-L2-L3 / L1-L3-L2) that is different from the one that had been set at [Field settings / General Settings] »Phase Sequence«.</i>

1..n, Assignment List	Description
CT Mains . Phase seq. wrong	Signal that the device has detected a phase sequence (L1-L2-L3 / L1-L3-L2) that is different from the one that had been set at [Field settings / General Settings] »Phase Sequence«.
Generator . Running hours Alarm	Running hours Alarm
Generator . Res Running hours	Reset Running hours
Ctrl . Local	Switching Authority: Local
Ctrl . Remote	Switching Authority: Remote
Ctrl . NonInterl	Non-Interlocking is active
Ctrl . SG Indeterm	(At least one) Switchgear is moving (Position cannot be determined).
Ctrl . SG Disturb	(At least one) Switchgear is disturbed.
Ctrl . NonInterl-I	Non-Interlocking
SG[1] . SI SingleContactInd	Signal: The Position of the Switchgear is detected by one auxiliary contact (pole) only. Thus indeterminate and disturbed Positions cannot be detected.
SG[1] . Pos not ON	Signal: Pos not ON
SG[1] . Pos ON	Signal: Circuit Breaker is in ON-Position
SG[1] . Pos OFF	Signal: Circuit Breaker is in OFF-Position
SG[1] . Pos Indeterm	Signal: Circuit Breaker is in Indeterminate Position
SG[1] . Pos Disturb	Signal: Circuit Breaker Disturbed - Undefined Breaker Position. The Position Indicators contradict themselves. After expiring of a supervision timer this signal becomes true.
SG[1] . Ready	Signal: Circuit breaker is ready for operation.
SG[1] . t-Dwell	Signal: Dwell time
SG[1] . Removed	Signal: The withdrawable circuit breaker is Removed
SG[1] . Interl ON	Signal: One or more IL_On inputs are active.
SG[1] . Interl OFF	Signal: One or more IL_Off inputs are active.
SG[1] . CES succesf	Signal: Command Execution Supervision: Switching command executed successfully.
SG[1] . CES Disturbed	Signal: Command Execution Supervision: Switching Command unsuccessful. Switchgear in disturbed position.
SG[1] . CES Fail TripCmd	Signal: Command Execution Supervision: Command execution failed because trip command is pending.
SG[1] . CES SwitchDir	Signal: Command Execution Supervision respectively Switching Direction Control: This signal becomes true, if a switch command is issued even though the switchgear is already in the requested position.

1..n, Assignment List	Description
	<i>Example: A switchgear that is already OFF should be switched OFF again (doubly). The same applies to CLOSE commands.</i>
SG[1] . CES ON d OFF	<i>Signal: Command Execution Supervision: On Command during a pending OFF Command.</i>
SG[1] . CES SG not ready	<i>Signal: Command Execution Supervision: Switchgear not ready</i>
SG[1] . CES Fiel Interl	<i>Signal: Command Execution Supervision: Switching Command not executed because of field interlocking.</i>
SG[1] . CES SyncTimeout	<i>Signal: Command Execution Supervision: Switching Command not executed. No Synchronization signal while t-sync was running.</i>
SG[1] . CES SG removed	<i>Signal: Command Execution Supervision: Switching Command unsuccessful, Switchgear removed.</i>
SG[1] . Prot ON	<i>Signal: ON Command issued by the Prot module</i>
SG[1] . TripCmd	<i>Signal: Trip Command</i>
SG[1] . Ack TripCmd	<i>Signal: Acknowledge Trip Command</i>
SG[1] . ON incl Prot ON	<i>Signal: The ON Command includes the ON Command issued by the Protection module.</i>
SG[1] . OFF incl TripCmd	<i>Signal: The OFF Command includes the OFF Command issued by the Protection module.</i>
SG[1] . Position Ind manipul	<i>Signal: Position Indicators faked</i>
SG[1] . SGwear Slow SG	<i>Signal: Alarm, the circuit breaker (load-break switch) becomes slower</i>
SG[1] . Res SGwear SI SG	<i>Signal: Resetting the slow Switchgear Alarm</i>
SG[1] . ON Cmd	<i>Signal: ON Command issued to the switchgear. Depending on the setting the signal may include the ON command of the Prot module.</i>
SG[1] . OFF Cmd	<i>Signal: OFF Command issued to the switchgear. Depending on the setting the signal may include the OFF command of the Prot module.</i>
SG[1] . ON Cmd manual	<i>Signal: ON Cmd manual</i>
SG[1] . OFF Cmd manual	<i>Signal: OFF Cmd manual</i>
SG[1] . Sync ON request	<i>Signal: Synchronous ON request</i>
SG[1] . Aux ON-I	<i>Module Input State: Position indicator/check-back signal of the CB (52a)</i>
SG[1] . Aux OFF-I	<i>Module input state: Position indicator/check-back signal of the CB (52b)</i>
SG[1] . Ready-I	<i>Module input state: CB ready</i>
SG[1] . Sys-in-Sync-I	<i>State of the module input: This signals has to become true within the synchronization time. If not, switching is unsuccessful.</i>
SG[1] . Removed-I	<i>State of the module input: The withdrawable circuit breaker is Removed</i>

1..n, Assignment List	Description
SG[1] . Ack TripCmd-I	<i>State of the module input: Acknowledgement Signal (for the Trip Command) Module input signal</i>
SG[1] . Interl ON1-I	<i>State of the module input: Interlocking of the ON command</i>
SG[1] . Interl ON2-I	<i>State of the module input: Interlocking of the ON command</i>
SG[1] . Interl ON3-I	<i>State of the module input: Interlocking of the ON command</i>
SG[1] . Interl OFF1-I	<i>State of the module input: Interlocking of the OFF command</i>
SG[1] . Interl OFF2-I	<i>State of the module input: Interlocking of the OFF command</i>
SG[1] . Interl OFF3-I	<i>State of the module input: Interlocking of the OFF command</i>
SG[1] . SCmd ON-I	<i>State of the module input: Switching ON Command, e.g. the state of the Logics or the state of the digital input</i>
SG[1] . SCmd OFF-I	<i>State of the module input: Switching OFF Command, e.g. the state of the Logics or the state of the digital input</i>
SG[1] . Operations Alarm	<i>Signal: Too many Operations. (The operations counter »TripCmd Cr« has exceeded the limit set at »Operations Alarm«.)</i>
SG[1] . Isum Intr trip: IL1	<i>Signal: Maximum permissible Summation of the interrupting (tripping) currents exceeded: IL1</i>
SG[1] . Isum Intr trip: IL2	<i>Signal: Maximum permissible Summation of the interrupting (tripping) currents exceeded: IL2</i>
SG[1] . Isum Intr trip: IL3	<i>Signal: Maximum permissible Summation of the interrupting (tripping) currents exceeded: IL3</i>
SG[1] . Isum Intr trip	<i>Signal: Maximum permissible Summation of the interrupting (tripping) currents exceeded in at least one phase.</i>
SG[1] . Res TripCmd Cr	<i>Signal: Resetting of the Counter: Total number of trips of the switchgear</i>
SG[1] . Res Sum trip	<i>Signal: Reset summation of the tripping currents</i>
SG[1] . WearLevel Alarm	<i>Signal: Threshold for the Alarm</i>
SG[1] . WearLevel Lockout	<i>Signal: Threshold for the Lockout Level</i>
SG[1] . Res CB OPEN capacity	<i>Signal: Reset of the wear maintenance curve (i. e. of the counter for the Circuit Breaker OPEN capacity.</i>
SG[1] . Isum Intr ph Alm	<i>Signal: Alarm, the per hour Sum (Limit) of interrupting currents has been exceeded.</i>
SG[1] . Res Isum Intr ph Alm	<i>Signal: Reset of the Alarm, "the per hour Sum (Limit) of interrupting currents has been exceeded".</i>
SG[2] . SI SingleContactInd	<i>Signal: The Position of the Switchgear is detected by one auxiliary contact (pole) only. Thus indeterminate and disturbed Positions cannot be detected.</i>
SG[2] . Pos not ON	<i>Signal: Pos not ON</i>

1..n, Assignment List	Description
SG[2] . Pos ON	Signal: Circuit Breaker is in ON-Position
SG[2] . Pos OFF	Signal: Circuit Breaker is in OFF-Position
SG[2] . Pos Indeterm	Signal: Circuit Breaker is in Indeterminate Position
SG[2] . Pos Disturb	Signal: Circuit Breaker Disturbed - Undefined Breaker Position. The Position Indicators contradict themselves. After expiring of a supervision timer this signal becomes true.
SG[2] . Ready	Signal: Circuit breaker is ready for operation.
SG[2] . t-Dwell	Signal: Dwell time
SG[2] . Removed	Signal: The withdrawable circuit breaker is Removed
SG[2] . Interl ON	Signal: One or more IL_On inputs are active.
SG[2] . Interl OFF	Signal: One or more IL_Off inputs are active.
SG[2] . CES succesf	Signal: Command Execution Supervision: Switching command executed successfully.
SG[2] . CES Disturbed	Signal: Command Execution Supervision: Switching Command unsuccessful. Switchgear in disturbed position.
SG[2] . CES Fail TripCmd	Signal: Command Execution Supervision: Command execution failed because trip command is pending.
SG[2] . CES SwitchDir	Signal: Command Execution Supervision respectively Switching Direction Control: This signal becomes true, if a switch command is issued even though the switchgear is already in the requested position. Example: A switchgear that is already OFF should be switched OFF again (doubly). The same applies to CLOSE commands.
SG[2] . CES ON d OFF	Signal: Command Execution Supervision: On Command during a pending OFF Command.
SG[2] . CES SG not ready	Signal: Command Execution Supervision: Switchgear not ready
SG[2] . CES Fiel Interl	Signal: Command Execution Supervision: Switching Command not executed because of field interlocking.
SG[2] . CES SyncTimeout	Signal: Command Execution Supervision: Switching Command not executed. No Synchronization signal while t-sync was running.
SG[2] . CES SG removed	Signal: Command Execution Supervision: Switching Command unsuccessful, Switchgear removed.
SG[2] . Prot ON	Signal: ON Command issued by the Prot module
SG[2] . TripCmd	Signal: Trip Command
SG[2] . Ack TripCmd	Signal: Acknowledge Trip Command
SG[2] . ON incl Prot ON	Signal: The ON Command includes the ON Command issued by the Protection module.
SG[2] . OFF incl TripCmd	Signal: The OFF Command includes the OFF Command issued by the Protection module.

1..n, Assignment List	Description
SG[2] . Position Ind manipul	<i>Signal: Position Indicators faked</i>
SG[2] . SGwear Slow SG	<i>Signal: Alarm, the circuit breaker (load-break switch) becomes slower</i>
SG[2] . Res SGwear SI SG	<i>Signal: Resetting the slow Switchgear Alarm</i>
SG[2] . ON Cmd	<i>Signal: ON Command issued to the switchgear. Depending on the setting the signal may include the ON command of the Prot module.</i>
SG[2] . OFF Cmd	<i>Signal: OFF Command issued to the switchgear. Depending on the setting the signal may include the OFF command of the Prot module.</i>
SG[2] . ON Cmd manual	<i>Signal: ON Cmd manual</i>
SG[2] . OFF Cmd manual	<i>Signal: OFF Cmd manual</i>
SG[2] . Sync ON request	<i>Signal: Synchronous ON request</i>
SG[2] . Aux ON-I	<i>Module Input State: Position indicator/check-back signal of the CB (52a)</i>
SG[2] . Aux OFF-I	<i>Module input state: Position indicator/check-back signal of the CB (52b)</i>
SG[2] . Ready-I	<i>Module input state: CB ready</i>
SG[2] . Sys-in-Sync-I	<i>State of the module input: This signals has to become true within the synchronization time. If not, switching is unsuccessful.</i>
SG[2] . Removed-I	<i>State of the module input: The withdrawable circuit breaker is Removed</i>
SG[2] . Ack TripCmd-I	<i>State of the module input: Acknowledgement Signal (for the Trip Command) Module input signal</i>
SG[2] . Interl ON1-I	<i>State of the module input: Interlocking of the ON command</i>
SG[2] . Interl ON2-I	<i>State of the module input: Interlocking of the ON command</i>
SG[2] . Interl ON3-I	<i>State of the module input: Interlocking of the ON command</i>
SG[2] . Interl OFF1-I	<i>State of the module input: Interlocking of the OFF command</i>
SG[2] . Interl OFF2-I	<i>State of the module input: Interlocking of the OFF command</i>
SG[2] . Interl OFF3-I	<i>State of the module input: Interlocking of the OFF command</i>
SG[2] . SCmd ON-I	<i>State of the module input: Switching ON Command, e.g. the state of the Logics or the state of the digital input</i>
SG[2] . SCmd OFF-I	<i>State of the module input: Switching OFF Command, e.g. the state of the Logics or the state of the digital input</i>
SG[2] . Operations Alarm	<i>Signal: Too many Operations. (The operations counter »TripCmd Cr« has exceeded the limit set at »Operations Alarm«.)</i>
SG[2] . Isum Intr trip: IL1	<i>Signal: Maximum permissible Summation of the interrupting (tripping) currents exceeded: IL1</i>
SG[2] . Isum Intr trip: IL2	<i>Signal: Maximum permissible Summation of the interrupting (tripping) currents exceeded: IL2</i>

1..n, Assignment List	Description
SG[2] . Isum Intr trip: IL3	Signal: Maximum permissible Summation of the interrupting (tripping) currents exceeded: IL3
SG[2] . Isum Intr trip	Signal: Maximum permissible Summation of the interrupting (tripping) currents exceeded in at least one phase.
SG[2] . Res TripCmd Cr	Signal: Resetting of the Counter: Total number of trips of the switchgear
SG[2] . Res Sum trip	Signal: Reset summation of the tripping currents
SG[2] . WearLevel Alarm	Signal: Threshold for the Alarm
SG[2] . WearLevel Lockout	Signal: Threshold for the Lockout Level
SG[2] . Res CB OPEN capacity	Signal: Reset of the wear maintenance curve (i. e. of the counter for the Circuit Breaker OPEN capacity.
SG[2] . Isum Intr ph Alm	Signal: Alarm, the per hour Sum (Limit) of interrupting currents has been exceeded.
SG[2] . Res Isum Intr ph Alm	Signal: Reset of the Alarm, "the per hour Sum (Limit) of interrupting currents has been exceeded".
SG[3] . SI SingleContactInd	Signal: The Position of the Switchgear is detected by one auxiliary contact (pole) only. Thus indeterminate and disturbed Positions cannot be detected.
SG[3] . Pos not ON	Signal: Pos not ON
SG[3] . Pos ON	Signal: Circuit Breaker is in ON-Position
SG[3] . Pos OFF	Signal: Circuit Breaker is in OFF-Position
SG[3] . Pos Indeterm	Signal: Circuit Breaker is in Indeterminate Position
SG[3] . Pos Disturb	Signal: Circuit Breaker Disturbed - Undefined Breaker Position. The Position Indicators contradict themselves. After expiring of a supervision timer this signal becomes true.
SG[3] . Ready	Signal: Circuit breaker is ready for operation.
SG[3] . t-Dwell	Signal: Dwell time
SG[3] . Removed	Signal: The withdrawable circuit breaker is Removed
SG[3] . Interl ON	Signal: One or more IL_On inputs are active.
SG[3] . Interl OFF	Signal: One or more IL_Off inputs are active.
SG[3] . CES succesf	Signal: Command Execution Supervision: Switching command executed successfully.
SG[3] . CES Disturbed	Signal: Command Execution Supervision: Switching Command unsuccessful. Switchgear in disturbed position.
SG[3] . CES Fail TripCmd	Signal: Command Execution Supervision: Command execution failed because trip command is pending.
SG[3] . CES SwitchDir	Signal: Command Execution Supervision respectively Switching Direction Control: This signal becomes true, if a switch command is

1..n, Assignment List	Description
	<i>issued even though the switchgear is already in the requested position. Example: A switchgear that is already OFF should be switched OFF again (doubly). The same applies to CLOSE commands.</i>
SG[3] . CES ON d OFF	<i>Signal: Command Execution Supervision: On Command during a pending OFF Command.</i>
SG[3] . CES SG not ready	<i>Signal: Command Execution Supervision: Switchgear not ready</i>
SG[3] . CES Fiel Interl	<i>Signal: Command Execution Supervision: Switching Command not executed because of field interlocking.</i>
SG[3] . CES SyncTimeout	<i>Signal: Command Execution Supervision: Switching Command not executed. No Synchronization signal while t-sync was running.</i>
SG[3] . CES SG removed	<i>Signal: Command Execution Supervision: Switching Command unsuccessful, Switchgear removed.</i>
SG[3] . Prot ON	<i>Signal: ON Command issued by the Prot module</i>
SG[3] . TripCmd	<i>Signal: Trip Command</i>
SG[3] . Ack TripCmd	<i>Signal: Acknowledge Trip Command</i>
SG[3] . ON incl Prot ON	<i>Signal: The ON Command includes the ON Command issued by the Protection module.</i>
SG[3] . OFF incl TripCmd	<i>Signal: The OFF Command includes the OFF Command issued by the Protection module.</i>
SG[3] . Position Ind manipul	<i>Signal: Position Indicators faked</i>
SG[3] . SGwear Slow SG	<i>Signal: Alarm, the circuit breaker (load-break switch) becomes slower</i>
SG[3] . Res SGwear SI SG	<i>Signal: Resetting the slow Switchgear Alarm</i>
SG[3] . ON Cmd	<i>Signal: ON Command issued to the switchgear. Depending on the setting the signal may include the ON command of the Prot module.</i>
SG[3] . OFF Cmd	<i>Signal: OFF Command issued to the switchgear. Depending on the setting the signal may include the OFF command of the Prot module.</i>
SG[3] . ON Cmd manual	<i>Signal: ON Cmd manual</i>
SG[3] . OFF Cmd manual	<i>Signal: OFF Cmd manual</i>
SG[3] . Sync ON request	<i>Signal: Synchronous ON request</i>
SG[3] . Aux ON-I	<i>Module Input State: Position indicator/check-back signal of the CB (52a)</i>
SG[3] . Aux OFF-I	<i>Module input state: Position indicator/check-back signal of the CB (52b)</i>
SG[3] . Ready-I	<i>Module input state: CB ready</i>
SG[3] . Sys-in-Sync-I	<i>State of the module input: This signals has to become true within the synchronization time. If not, switching is unsuccessful.</i>

1..n, Assignment List	Description
SG[3] . Removed-I	<i>State of the module input: The withdrawable circuit breaker is Removed</i>
SG[3] . Ack TripCmd-I	<i>State of the module input: Acknowledgement Signal (for the Trip Command) Module input signal</i>
SG[3] . Interl ON1-I	<i>State of the module input: Interlocking of the ON command</i>
SG[3] . Interl ON2-I	<i>State of the module input: Interlocking of the ON command</i>
SG[3] . Interl ON3-I	<i>State of the module input: Interlocking of the ON command</i>
SG[3] . Interl OFF1-I	<i>State of the module input: Interlocking of the OFF command</i>
SG[3] . Interl OFF2-I	<i>State of the module input: Interlocking of the OFF command</i>
SG[3] . Interl OFF3-I	<i>State of the module input: Interlocking of the OFF command</i>
SG[3] . SCmd ON-I	<i>State of the module input: Switching ON Command, e.g. the state of the Logics or the state of the digital input</i>
SG[3] . SCmd OFF-I	<i>State of the module input: Switching OFF Command, e.g. the state of the Logics or the state of the digital input</i>
SG[3] . Operations Alarm	<i>Signal: Too many Operations. (The operations counter »TripCmd Cr« has exceeded the limit set at »Operations Alarm«.)</i>
SG[3] . Isum Intr trip: IL1	<i>Signal: Maximum permissible Summation of the interrupting (tripping) currents exceeded: IL1</i>
SG[3] . Isum Intr trip: IL2	<i>Signal: Maximum permissible Summation of the interrupting (tripping) currents exceeded: IL2</i>
SG[3] . Isum Intr trip: IL3	<i>Signal: Maximum permissible Summation of the interrupting (tripping) currents exceeded: IL3</i>
SG[3] . Isum Intr trip	<i>Signal: Maximum permissible Summation of the interrupting (tripping) currents exceeded in at least one phase.</i>
SG[3] . Res TripCmd Cr	<i>Signal: Resetting of the Counter: Total number of trips of the switchgear</i>
SG[3] . Res Sum trip	<i>Signal: Reset summation of the tripping currents</i>
SG[3] . WearLevel Alarm	<i>Signal: Threshold for the Alarm</i>
SG[3] . WearLevel Lockout	<i>Signal: Threshold for the Lockout Level</i>
SG[3] . Res CB OPEN capacity	<i>Signal: Reset of the wear maintenance curve (i. e. of the counter for the Circuit Breaker OPEN capacity.</i>
SG[3] . Isum Intr ph Alm	<i>Signal: Alarm, the per hour Sum (Limit) of interrupting currents has been exceeded.</i>
SG[3] . Res Isum Intr ph Alm	<i>Signal: Reset of the Alarm, "the per hour Sum (Limit) of interrupting currents has been exceeded".</i>
SG[4] . SI SingleContactInd	<i>Signal: The Position of the Switchgear is detected by one auxiliary contact (pole) only. Thus indeterminate and disturbed Positions cannot be detected.</i>

1..n, Assignment List	Description
SG[4] . Pos not ON	Signal: Pos not ON
SG[4] . Pos ON	Signal: Circuit Breaker is in ON-Position
SG[4] . Pos OFF	Signal: Circuit Breaker is in OFF-Position
SG[4] . Pos Indeterm	Signal: Circuit Breaker is in Indeterminate Position
SG[4] . Pos Disturb	Signal: Circuit Breaker Disturbed - Undefined Breaker Position. The Position Indicators contradict themselves. After expiring of a supervision timer this signal becomes true.
SG[4] . Ready	Signal: Circuit breaker is ready for operation.
SG[4] . t-Dwell	Signal: Dwell time
SG[4] . Removed	Signal: The withdrawable circuit breaker is Removed
SG[4] . Interl ON	Signal: One or more IL_On inputs are active.
SG[4] . Interl OFF	Signal: One or more IL_Off inputs are active.
SG[4] . CES succesf	Signal: Command Execution Supervision: Switching command executed successfully.
SG[4] . CES Disturbed	Signal: Command Execution Supervision: Switching Command unsuccessful. Switchgear in disturbed position.
SG[4] . CES Fail TripCmd	Signal: Command Execution Supervision: Command execution failed because trip command is pending.
SG[4] . CES SwitchDir	Signal: Command Execution Supervision respectively Switching Direction Control: This signal becomes true, if a switch command is issued even though the switchgear is already in the requested position. Example: A switchgear that is already OFF should be switched OFF again (doubly). The same applies to CLOSE commands.
SG[4] . CES ON d OFF	Signal: Command Execution Supervision: On Command during a pending OFF Command.
SG[4] . CES SG not ready	Signal: Command Execution Supervision: Switchgear not ready
SG[4] . CES Fiel Interl	Signal: Command Execution Supervision: Switching Command not executed because of field interlocking.
SG[4] . CES SyncTimeout	Signal: Command Execution Supervision: Switching Command not executed. No Synchronization signal while t-sync was running.
SG[4] . CES SG removed	Signal: Command Execution Supervision: Switching Command unsuccessful, Switchgear removed.
SG[4] . Prot ON	Signal: ON Command issued by the Prot module
SG[4] . TripCmd	Signal: Trip Command
SG[4] . Ack TripCmd	Signal: Acknowledge Trip Command
SG[4] . ON incl Prot ON	Signal: The ON Command includes the ON Command issued by the Protection module.

1..n, Assignment List	Description
SG[4] . OFF incl TripCmd	<i>Signal: The OFF Command includes the OFF Command issued by the Protection module.</i>
SG[4] . Position Ind manipul	<i>Signal: Position Indicators faked</i>
SG[4] . SGwear Slow SG	<i>Signal: Alarm, the circuit breaker (load-break switch) becomes slower</i>
SG[4] . Res SGwear SI SG	<i>Signal: Resetting the slow Switchgear Alarm</i>
SG[4] . ON Cmd	<i>Signal: ON Command issued to the switchgear. Depending on the setting the signal may include the ON command of the Prot module.</i>
SG[4] . OFF Cmd	<i>Signal: OFF Command issued to the switchgear. Depending on the setting the signal may include the OFF command of the Prot module.</i>
SG[4] . ON Cmd manual	<i>Signal: ON Cmd manual</i>
SG[4] . OFF Cmd manual	<i>Signal: OFF Cmd manual</i>
SG[4] . Sync ON request	<i>Signal: Synchronous ON request</i>
SG[4] . Aux ON-I	<i>Module Input State: Position indicator/check-back signal of the CB (52a)</i>
SG[4] . Aux OFF-I	<i>Module input state: Position indicator/check-back signal of the CB (52b)</i>
SG[4] . Ready-I	<i>Module input state: CB ready</i>
SG[4] . Sys-in-Sync-I	<i>State of the module input: This signals has to become true within the synchronization time. If not, switching is unsuccessful.</i>
SG[4] . Removed-I	<i>State of the module input: The withdrawable circuit breaker is Removed</i>
SG[4] . Ack TripCmd-I	<i>State of the module input: Acknowledgement Signal (for the Trip Command) Module input signal</i>
SG[4] . Interl ON1-I	<i>State of the module input: Interlocking of the ON command</i>
SG[4] . Interl ON2-I	<i>State of the module input: Interlocking of the ON command</i>
SG[4] . Interl ON3-I	<i>State of the module input: Interlocking of the ON command</i>
SG[4] . Interl OFF1-I	<i>State of the module input: Interlocking of the OFF command</i>
SG[4] . Interl OFF2-I	<i>State of the module input: Interlocking of the OFF command</i>
SG[4] . Interl OFF3-I	<i>State of the module input: Interlocking of the OFF command</i>
SG[4] . SCmd ON-I	<i>State of the module input: Switching ON Command, e.g. the state of the Logics or the state of the digital input</i>
SG[4] . SCmd OFF-I	<i>State of the module input: Switching OFF Command, e.g. the state of the Logics or the state of the digital input</i>
SG[4] . Operations Alarm	<i>Signal: Too many Operations. (The operations counter »TripCmd Cr« has exceeded the limit set at »Operations Alarm«.)</i>
SG[4] . Isum Intr trip: IL1	<i>Signal: Maximum permissible Summation of the interrupting (tripping) currents exceeded: IL1</i>

1..n, Assignment List	Description
SG[4] . Isum Intr trip: IL2	<i>Signal: Maximum permissible Summation of the interrupting (tripping) currents exceeded: IL2</i>
SG[4] . Isum Intr trip: IL3	<i>Signal: Maximum permissible Summation of the interrupting (tripping) currents exceeded: IL3</i>
SG[4] . Isum Intr trip	<i>Signal: Maximum permissible Summation of the interrupting (tripping) currents exceeded in at least one phase.</i>
SG[4] . Res TripCmd Cr	<i>Signal: Resetting of the Counter: Total number of trips of the switchgear</i>
SG[4] . Res Sum trip	<i>Signal: Reset summation of the tripping currents</i>
SG[4] . WearLevel Alarm	<i>Signal: Threshold for the Alarm</i>
SG[4] . WearLevel Lockout	<i>Signal: Threshold for the Lockout Level</i>
SG[4] . Res CB OPEN capacity	<i>Signal: Reset of the wear maintenance curve (i. e. of the counter for the Circuit Breaker OPEN capacity.</i>
SG[4] . Isum Intr ph Alm	<i>Signal: Alarm, the per hour Sum (Limit) of interrupting currents has been exceeded.</i>
SG[4] . Res Isum Intr ph Alm	<i>Signal: Reset of the Alarm, "the per hour Sum (Limit) of interrupting currents has been exceeded".</i>
SG[5] . SI SingleContactInd	<i>Signal: The Position of the Switchgear is detected by one auxiliary contact (pole) only. Thus indeterminate and disturbed Positions cannot be detected.</i>
SG[5] . Pos not ON	<i>Signal: Pos not ON</i>
SG[5] . Pos ON	<i>Signal: Circuit Breaker is in ON-Position</i>
SG[5] . Pos OFF	<i>Signal: Circuit Breaker is in OFF-Position</i>
SG[5] . Pos Indeterm	<i>Signal: Circuit Breaker is in Indeterminate Position</i>
SG[5] . Pos Disturb	<i>Signal: Circuit Breaker Disturbed - Undefined Breaker Position. The Position Indicators contradict themselves. After expiring of a supervision timer this signal becomes true.</i>
SG[5] . Ready	<i>Signal: Circuit breaker is ready for operation.</i>
SG[5] . t-Dwell	<i>Signal: Dwell time</i>
SG[5] . Removed	<i>Signal: The withdrawable circuit breaker is Removed</i>
SG[5] . Interl ON	<i>Signal: One or more IL_On inputs are active.</i>
SG[5] . Interl OFF	<i>Signal: One or more IL_Off inputs are active.</i>
SG[5] . CES succesf	<i>Signal: Command Execution Supervision: Switching command executed successfully.</i>
SG[5] . CES Disturbed	<i>Signal: Command Execution Supervision: Switching Command unsuccessful. Switchgear in disturbed position.</i>

1..n, Assignment List	Description
SG[5] . CES Fail TripCmd	<i>Signal: Command Execution Supervision: Command execution failed because trip command is pending.</i>
SG[5] . CES SwitchDir	<i>Signal: Command Execution Supervision respectively Switching Direction Control: This signal becomes true, if a switch command is issued even though the switchgear is already in the requested position. Example: A switchgear that is already OFF should be switched OFF again (doubly). The same applies to CLOSE commands.</i>
SG[5] . CES ON d OFF	<i>Signal: Command Execution Supervision: On Command during a pending OFF Command.</i>
SG[5] . CES SG not ready	<i>Signal: Command Execution Supervision: Switchgear not ready</i>
SG[5] . CES Fiel Interl	<i>Signal: Command Execution Supervision: Switching Command not executed because of field interlocking.</i>
SG[5] . CES SyncTimeout	<i>Signal: Command Execution Supervision: Switching Command not executed. No Synchronization signal while t-sync was running.</i>
SG[5] . CES SG removed	<i>Signal: Command Execution Supervision: Switching Command unsuccessful, Switchgear removed.</i>
SG[5] . Prot ON	<i>Signal: ON Command issued by the Prot module</i>
SG[5] . TripCmd	<i>Signal: Trip Command</i>
SG[5] . Ack TripCmd	<i>Signal: Acknowledge Trip Command</i>
SG[5] . ON incl Prot ON	<i>Signal: The ON Command includes the ON Command issued by the Protection module.</i>
SG[5] . OFF incl TripCmd	<i>Signal: The OFF Command includes the OFF Command issued by the Protection module.</i>
SG[5] . Position Ind manipul	<i>Signal: Position Indicators faked</i>
SG[5] . SGwear Slow SG	<i>Signal: Alarm, the circuit breaker (load-break switch) becomes slower</i>
SG[5] . Res SGwear SI SG	<i>Signal: Resetting the slow Switchgear Alarm</i>
SG[5] . ON Cmd	<i>Signal: ON Command issued to the switchgear. Depending on the setting the signal may include the ON command of the Prot module.</i>
SG[5] . OFF Cmd	<i>Signal: OFF Command issued to the switchgear. Depending on the setting the signal may include the OFF command of the Prot module.</i>
SG[5] . ON Cmd manual	<i>Signal: ON Cmd manual</i>
SG[5] . OFF Cmd manual	<i>Signal: OFF Cmd manual</i>
SG[5] . Sync ON request	<i>Signal: Synchronous ON request</i>
SG[5] . Aux ON-I	<i>Module Input State: Position indicator/check-back signal of the CB (52a)</i>
SG[5] . Aux OFF-I	<i>Module input state: Position indicator/check-back signal of the CB (52b)</i>

1..n, Assignment List	Description
SG[5] . Ready-I	<i>Module input state: CB ready</i>
SG[5] . Sys-in-Sync-I	<i>State of the module input: This signals has to become true within the synchronization time. If not, switching is unsuccessful.</i>
SG[5] . Removed-I	<i>State of the module input: The withdrawable circuit breaker is Removed</i>
SG[5] . Ack TripCmd-I	<i>State of the module input: Acknowledgement Signal (for the Trip Command) Module input signal</i>
SG[5] . Interl ON1-I	<i>State of the module input: Interlocking of the ON command</i>
SG[5] . Interl ON2-I	<i>State of the module input: Interlocking of the ON command</i>
SG[5] . Interl ON3-I	<i>State of the module input: Interlocking of the ON command</i>
SG[5] . Interl OFF1-I	<i>State of the module input: Interlocking of the OFF command</i>
SG[5] . Interl OFF2-I	<i>State of the module input: Interlocking of the OFF command</i>
SG[5] . Interl OFF3-I	<i>State of the module input: Interlocking of the OFF command</i>
SG[5] . SCmd ON-I	<i>State of the module input: Switching ON Command, e.g. the state of the Logics or the state of the digital input</i>
SG[5] . SCmd OFF-I	<i>State of the module input: Switching OFF Command, e.g. the state of the Logics or the state of the digital input</i>
SG[5] . Operations Alarm	<i>Signal: Too many Operations. (The operations counter »TripCmd Cr« has exceeded the limit set at »Operations Alarm«.)</i>
SG[5] . Isum Intr trip: IL1	<i>Signal: Maximum permissible Summation of the interrupting (tripping) currents exceeded: IL1</i>
SG[5] . Isum Intr trip: IL2	<i>Signal: Maximum permissible Summation of the interrupting (tripping) currents exceeded: IL2</i>
SG[5] . Isum Intr trip: IL3	<i>Signal: Maximum permissible Summation of the interrupting (tripping) currents exceeded: IL3</i>
SG[5] . Isum Intr trip	<i>Signal: Maximum permissible Summation of the interrupting (tripping) currents exceeded in at least one phase.</i>
SG[5] . Res TripCmd Cr	<i>Signal: Resetting of the Counter: Total number of trips of the switchgear</i>
SG[5] . Res Sum trip	<i>Signal: Reset summation of the tripping currents</i>
SG[5] . WearLevel Alarm	<i>Signal: Threshold for the Alarm</i>
SG[5] . WearLevel Lockout	<i>Signal: Threshold for the Lockout Level</i>
SG[5] . Res CB OPEN capacity	<i>Signal: Reset of the wear maintenance curve (i. e. of the counter for the Circuit Breaker OPEN capacity.</i>
SG[5] . Isum Intr ph Alm	<i>Signal: Alarm, the per hour Sum (Limit) of interrupting currents has been exceeded.</i>
SG[5] . Res Isum Intr ph Alm	<i>Signal: Reset of the Alarm, "the per hour Sum (Limit) of interrupting currents has been exceeded".</i>

1..n, Assignment List	Description
SG[6] . SI SingleContactInd	<i>Signal: The Position of the Switchgear is detected by one auxiliary contact (pole) only. Thus indeterminate and disturbed Positions cannot be detected.</i>
SG[6] . Pos not ON	<i>Signal: Pos not ON</i>
SG[6] . Pos ON	<i>Signal: Circuit Breaker is in ON-Position</i>
SG[6] . Pos OFF	<i>Signal: Circuit Breaker is in OFF-Position</i>
SG[6] . Pos Indeterm	<i>Signal: Circuit Breaker is in Indeterminate Position</i>
SG[6] . Pos Disturb	<i>Signal: Circuit Breaker Disturbed - Undefined Breaker Position. The Position Indicators contradict themselves. After expiring of a supervision timer this signal becomes true.</i>
SG[6] . Ready	<i>Signal: Circuit breaker is ready for operation.</i>
SG[6] . t-Dwell	<i>Signal: Dwell time</i>
SG[6] . Removed	<i>Signal: The withdrawable circuit breaker is Removed</i>
SG[6] . Interl ON	<i>Signal: One or more IL_On inputs are active.</i>
SG[6] . Interl OFF	<i>Signal: One or more IL_Off inputs are active.</i>
SG[6] . CES succesf	<i>Signal: Command Execution Supervision: Switching command executed successfully.</i>
SG[6] . CES Disturbed	<i>Signal: Command Execution Supervision: Switching Command unsuccessful. Switchgear in disturbed position.</i>
SG[6] . CES Fail TripCmd	<i>Signal: Command Execution Supervision: Command execution failed because trip command is pending.</i>
SG[6] . CES SwitchDir	<i>Signal: Command Execution Supervision respectively Switching Direction Control: This signal becomes true, if a switch command is issued even though the switchgear is already in the requested position. Example: A switchgear that is already OFF should be switched OFF again (doubly). The same applies to CLOSE commands.</i>
SG[6] . CES ON d OFF	<i>Signal: Command Execution Supervision: On Command during a pending OFF Command.</i>
SG[6] . CES SG not ready	<i>Signal: Command Execution Supervision: Switchgear not ready</i>
SG[6] . CES Fiel Interl	<i>Signal: Command Execution Supervision: Switching Command not executed because of field interlocking.</i>
SG[6] . CES SyncTimeout	<i>Signal: Command Execution Supervision: Switching Command not executed. No Synchronization signal while t-sync was running.</i>
SG[6] . CES SG removed	<i>Signal: Command Execution Supervision: Switching Command unsuccessful, Switchgear removed.</i>
SG[6] . Prot ON	<i>Signal: ON Command issued by the Prot module</i>
SG[6] . TripCmd	<i>Signal: Trip Command</i>
SG[6] . Ack TripCmd	<i>Signal: Acknowledge Trip Command</i>

1..n, Assignment List	Description
SG[6] . ON incl Prot ON	<i>Signal: The ON Command includes the ON Command issued by the Protection module.</i>
SG[6] . OFF incl TripCmd	<i>Signal: The OFF Command includes the OFF Command issued by the Protection module.</i>
SG[6] . Position Ind manipul	<i>Signal: Position Indicators faked</i>
SG[6] . SGwear Slow SG	<i>Signal: Alarm, the circuit breaker (load-break switch) becomes slower</i>
SG[6] . Res SGwear SI SG	<i>Signal: Resetting the slow Switchgear Alarm</i>
SG[6] . ON Cmd	<i>Signal: ON Command issued to the switchgear. Depending on the setting the signal may include the ON command of the Prot module.</i>
SG[6] . OFF Cmd	<i>Signal: OFF Command issued to the switchgear. Depending on the setting the signal may include the OFF command of the Prot module.</i>
SG[6] . ON Cmd manual	<i>Signal: ON Cmd manual</i>
SG[6] . OFF Cmd manual	<i>Signal: OFF Cmd manual</i>
SG[6] . Sync ON request	<i>Signal: Synchronous ON request</i>
SG[6] . Aux ON-I	<i>Module Input State: Position indicator/check-back signal of the CB (52a)</i>
SG[6] . Aux OFF-I	<i>Module input state: Position indicator/check-back signal of the CB (52b)</i>
SG[6] . Ready-I	<i>Module input state: CB ready</i>
SG[6] . Sys-in-Sync-I	<i>State of the module input: This signals has to become true within the synchronization time. If not, switching is unsuccessful.</i>
SG[6] . Removed-I	<i>State of the module input: The withdrawable circuit breaker is Removed</i>
SG[6] . Ack TripCmd-I	<i>State of the module input: Acknowledgement Signal (for the Trip Command) Module input signal</i>
SG[6] . Interl ON1-I	<i>State of the module input: Interlocking of the ON command</i>
SG[6] . Interl ON2-I	<i>State of the module input: Interlocking of the ON command</i>
SG[6] . Interl ON3-I	<i>State of the module input: Interlocking of the ON command</i>
SG[6] . Interl OFF1-I	<i>State of the module input: Interlocking of the OFF command</i>
SG[6] . Interl OFF2-I	<i>State of the module input: Interlocking of the OFF command</i>
SG[6] . Interl OFF3-I	<i>State of the module input: Interlocking of the OFF command</i>
SG[6] . SCmd ON-I	<i>State of the module input: Switching ON Command, e.g. the state of the Logics or the state of the digital input</i>
SG[6] . SCmd OFF-I	<i>State of the module input: Switching OFF Command, e.g. the state of the Logics or the state of the digital input</i>
SG[6] . Operations Alarm	<i>Signal: Too many Operations. (The operations counter »TripCmd Cr« has exceeded the limit set at »Operations Alarm«.)</i>

1..n, Assignment List	Description
SG[6] . Isum Intr trip: IL1	Signal: Maximum permissible Summation of the interrupting (tripping) currents exceeded: IL1
SG[6] . Isum Intr trip: IL2	Signal: Maximum permissible Summation of the interrupting (tripping) currents exceeded: IL2
SG[6] . Isum Intr trip: IL3	Signal: Maximum permissible Summation of the interrupting (tripping) currents exceeded: IL3
SG[6] . Isum Intr trip	Signal: Maximum permissible Summation of the interrupting (tripping) currents exceeded in at least one phase.
SG[6] . Res TripCmd Cr	Signal: Resetting of the Counter: Total number of trips of the switchgear
SG[6] . Res Sum trip	Signal: Reset summation of the tripping currents
SG[6] . WearLevel Alarm	Signal: Threshold for the Alarm
SG[6] . WearLevel Lockout	Signal: Threshold for the Lockout Level
SG[6] . Res CB OPEN capacity	Signal: Reset of the wear maintenance curve (i. e. of the counter for the Circuit Breaker OPEN capacity.
SG[6] . Isum Intr ph Alm	Signal: Alarm, the per hour Sum (Limit) of interrupting currents has been exceeded.
SG[6] . Res Isum Intr ph Alm	Signal: Reset of the Alarm, "the per hour Sum (Limit) of interrupting currents has been exceeded".
Id . active	Signal: active
Id . ExBlo	Signal: External Blocking
Id . Blo TripCmd	Signal: Trip Command blocked
Id . ExBlo TripCmd	Signal: External Blocking of the Trip Command
Id . Alarm L1	Signal: Alarm System Phase L1
Id . Alarm L2	Signal: Alarm System Phase L2
Id . Alarm L3	Signal: Alarm System L3
Id . Alarm	Signal: Alarm
Id . Trip L1	Signal: Trip System Phase L1
Id . Trip L2	Signal: Trip System Phase L2
Id . Trip L3	Signal: Trip System Phase L3
Id . Trip	Signal: Trip
Id . TripCmd	Signal: Trip Command
Id . Blo H2	Signal: Blocked by Harmonic:2
Id . Blo H4	Signal: Blocked by Harmonic:4
Id . Blo H5	Signal: Blocked by Harmonic:5

1..n, Assignment List	Description
Id . H2,H4,H5 Blo	<i>Signal: Blocked by Harmonics (Inhibit)</i>
Id . CT Satur.Stab. triggered	<i>Signal: Temporary restraining of the Phase Differential Protection, triggered by the detection of an external fault in case of CT saturation.</i>
Id . Transient	<i>Signal: Temporary stabilization of the differential protection afterwards the transformer is being energized.</i>
Id . Restraining	<i>Signal: Restraining of the differential protection by means of rising the tripping curve.</i>
Id . CT Satur.Stab. L1 trig.	<i>Signal: Temporary restraining of the Phase Differential Protection in phase L1, triggered by the detection of an external phase L1 fault in case of CT saturation.</i>
Id . CT Satur.Stab. L2 trig.	<i>Signal: Temporary restraining of the Phase Differential Protection in phase L2, triggered by the detection of an external phase L2 fault in case of CT saturation.</i>
Id . CT Satur.Stab. L3 trig.	<i>Signal: Temporary restraining of the Phase Differential Protection in phase L3, triggered by the detection of an external phase L3 fault in case of CT saturation.</i>
Id . Restraining: L1	<i>Restraining: L1</i>
Id . Restraining: L2	<i>Restraining: L2</i>
Id . Restraining: L3	<i>Restraining: L3</i>
Id . IH2 Blo L1	<i>Signal:Phase L1: Blocking of the Phase Differential Protection because of second Harmonic.</i>
Id . IH2 Blo L2	<i>Signal:Phase L2: Blocking of the Phase Differential Protection because of second Harmonic.</i>
Id . IH2 Blo L3	<i>Signal:Phase L3: Blocking of the Phase Differential Protection because of second Harmonic.</i>
Id . IH4 Blo L1	<i>Signal:Phase L1: Blocking of the Phase Differential Protection because of fourth Harmonic.</i>
Id . IH4 Blo L2	<i>Signal:Phase L2: Blocking of the Phase Differential Protection because of fourth Harmonic.</i>
Id . IH4 Blo L3	<i>Signal:Phase L3: Blocking of the Phase Differential Protection because of fourth Harmonic.</i>
Id . IH5 Blo L1	<i>Signal:Phase L1: Blocking of the Phase Differential Protection because of fifth Harmonic.</i>
Id . IH5 Blo L2	<i>Signal:Phase L2: Blocking of the Phase Differential Protection because of fifth Harmonic.</i>
Id . IH5 Blo L3	<i>Signal:Phase L3: Blocking of the Phase Differential Protection because of fifth Harmonic.</i>
Id . ExBlo1-I	<i>Module input state: External blocking1</i>
Id . ExBlo2-I	<i>Module input state: External blocking2</i>
Id . ExBlo TripCmd-I	<i>Module input state: External Blocking of the Trip Command</i>

1..n, Assignment List	Description
IdH . active	<i>Signal: active</i>
IdH . ExBlo	<i>Signal: External Blocking</i>
IdH . Blo TripCmd	<i>Signal: Trip Command blocked</i>
IdH . ExBlo TripCmd	<i>Signal: External Blocking of the Trip Command</i>
IdH . Alarm L1	<i>Signal: Alarm System Phase L1</i>
IdH . Alarm L2	<i>Signal: Alarm System Phase L2</i>
IdH . Alarm L3	<i>Signal: Alarm System L3</i>
IdH . Alarm	<i>Signal: Alarm</i>
IdH . Trip L1	<i>Signal: Trip System Phase L1</i>
IdH . Trip L2	<i>Signal: Trip System Phase L2</i>
IdH . Trip L3	<i>Signal: Trip System Phase L3</i>
IdH . Trip	<i>Signal: Trip</i>
IdH . TripCmd	<i>Signal: Trip Command</i>
IdH . ExBlo1-I	<i>Module input state: External blocking1</i>
IdH . ExBlo2-I	<i>Module input state: External blocking2</i>
IdH . ExBlo TripCmd-I	<i>Module input state: External Blocking of the Trip Command</i>
IdG[1] . active	<i>Signal: active</i>
IdG[1] . ExBlo	<i>Signal: External Blocking</i>
IdG[1] . Blo TripCmd	<i>Signal: Trip Command blocked</i>
IdG[1] . ExBlo TripCmd	<i>Signal: External Blocking of the Trip Command</i>
IdG[1] . Alarm	<i>Signal: Alarm</i>
IdG[1] . Trip	<i>Signal: Trip</i>
IdG[1] . TripCmd	<i>Signal: Trip Command</i>
IdG[1] . ExBlo1-I	<i>Module input state: External blocking1</i>
IdG[1] . ExBlo2-I	<i>Module input state: External blocking2</i>
IdG[1] . ExBlo TripCmd-I	<i>Module input state: External Blocking of the Trip Command</i>
IdGH[1] . active	<i>Signal: active</i>
IdGH[1] . ExBlo	<i>Signal: External Blocking</i>
IdGH[1] . Blo TripCmd	<i>Signal: Trip Command blocked</i>
IdGH[1] . ExBlo TripCmd	<i>Signal: External Blocking of the Trip Command</i>
IdGH[1] . Alarm	<i>Signal: Alarm</i>
IdGH[1] . Trip	<i>Signal: Trip</i>

1..n, Assignment List	Description
IdGH[1] . TripCmd	<i>Signal: Trip Command</i>
IdGH[1] . ExBlo1-I	<i>Module input state: External blocking1</i>
IdGH[1] . ExBlo2-I	<i>Module input state: External blocking2</i>
IdGH[1] . ExBlo TripCmd-I	<i>Module input state: External Blocking of the Trip Command</i>
IdG[2] . active	<i>Signal: active</i>
IdG[2] . ExBlo	<i>Signal: External Blocking</i>
IdG[2] . Blo TripCmd	<i>Signal: Trip Command blocked</i>
IdG[2] . ExBlo TripCmd	<i>Signal: External Blocking of the Trip Command</i>
IdG[2] . Alarm	<i>Signal: Alarm</i>
IdG[2] . Trip	<i>Signal: Trip</i>
IdG[2] . TripCmd	<i>Signal: Trip Command</i>
IdG[2] . ExBlo1-I	<i>Module input state: External blocking1</i>
IdG[2] . ExBlo2-I	<i>Module input state: External blocking2</i>
IdG[2] . ExBlo TripCmd-I	<i>Module input state: External Blocking of the Trip Command</i>
IdGH[2] . active	<i>Signal: active</i>
IdGH[2] . ExBlo	<i>Signal: External Blocking</i>
IdGH[2] . Blo TripCmd	<i>Signal: Trip Command blocked</i>
IdGH[2] . ExBlo TripCmd	<i>Signal: External Blocking of the Trip Command</i>
IdGH[2] . Alarm	<i>Signal: Alarm</i>
IdGH[2] . Trip	<i>Signal: Trip</i>
IdGH[2] . TripCmd	<i>Signal: Trip Command</i>
IdGH[2] . ExBlo1-I	<i>Module input state: External blocking1</i>
IdGH[2] . ExBlo2-I	<i>Module input state: External blocking2</i>
IdGH[2] . ExBlo TripCmd-I	<i>Module input state: External Blocking of the Trip Command</i>
IH2 . active	<i>Signal: active</i>
IH2 . ExBlo	<i>Signal: External Blocking</i>
IH2 . Blo L1	<i>Signal: Blocked L1</i>
IH2 . Blo L2	<i>Signal: Blocked L2</i>
IH2 . Blo L3	<i>Signal: Blocked L3</i>
IH2 . Blo IG meas	<i>Signal: Blocking of the ground (earth) protection module (measured ground current)</i>

1..n, Assignment List	Description
IH2 . Blo IG calc	Signal: Blocking of the ground (earth) protection module (calculated ground current)
IH2 . 3-ph Blo	Signal: Inrush was detected in at least one phase - trip command blocked.
IH2 . ExBlo1-I	Module input state: External blocking1
IH2 . ExBlo2-I	Module input state: External blocking2
I[1] . active	Signal: active
I[1] . ExBlo	Signal: External Blocking
I[1] . Ex rev Interl	Signal: External reverse Interlocking
I[1] . Blo TripCmd	Signal: Trip Command blocked
I[1] . ExBlo TripCmd	Signal: External Blocking of the Trip Command
I[1] . IH2 Blo	Signal: Blocking the trip command by an inrush
I[1] . Alarm L1	Signal: Alarm L1
I[1] . Alarm L2	Signal: Alarm L2
I[1] . Alarm L3	Signal: Alarm L3
I[1] . Alarm	Signal: Alarm
I[1] . Trip L1	Signal: General Trip Phase L1
I[1] . Trip L2	Signal: General Trip Phase L2
I[1] . Trip L3	Signal: General Trip Phase L3
I[1] . Trip	Signal: Trip
I[1] . TripCmd	Signal: Trip Command
I[1] . DefaultSet	Signal: Default Parameter Set
I[1] . AdaptSet 1	Signal: Adaptive Parameter 1
I[1] . AdaptSet 2	Signal: Adaptive Parameter 2
I[1] . AdaptSet 3	Signal: Adaptive Parameter 3
I[1] . AdaptSet 4	Signal: Adaptive Parameter 4
I[1] . ExBlo1-I	Module input state: External blocking1
I[1] . ExBlo2-I	Module input state: External blocking2
I[1] . ExBlo TripCmd-I	Module input state: External Blocking of the Trip Command
I[1] . Ex rev Interl-I	Module input state: External reverse interlocking
I[1] . AdaptSet1-I	Module input state: Adaptive Parameter1
I[1] . AdaptSet2-I	Module input state: Adaptive Parameter2
I[1] . AdaptSet3-I	Module input state: Adaptive Parameter3

1..n, Assignment List	Description
I[1] . AdaptSet4-I	<i>Module input state: Adaptive Parameter4</i>
I[2] . active	<i>Signal: active</i>
I[2] . ExBlo	<i>Signal: External Blocking</i>
I[2] . Ex rev Interl	<i>Signal: External reverse Interlocking</i>
I[2] . Blo TripCmd	<i>Signal: Trip Command blocked</i>
I[2] . ExBlo TripCmd	<i>Signal: External Blocking of the Trip Command</i>
I[2] . IH2 Blo	<i>Signal: Blocking the trip command by an inrush</i>
I[2] . Alarm L1	<i>Signal: Alarm L1</i>
I[2] . Alarm L2	<i>Signal: Alarm L2</i>
I[2] . Alarm L3	<i>Signal: Alarm L3</i>
I[2] . Alarm	<i>Signal: Alarm</i>
I[2] . Trip L1	<i>Signal: General Trip Phase L1</i>
I[2] . Trip L2	<i>Signal: General Trip Phase L2</i>
I[2] . Trip L3	<i>Signal: General Trip Phase L3</i>
I[2] . Trip	<i>Signal: Trip</i>
I[2] . TripCmd	<i>Signal: Trip Command</i>
I[2] . DefaultSet	<i>Signal: Default Parameter Set</i>
I[2] . AdaptSet 1	<i>Signal: Adaptive Parameter 1</i>
I[2] . AdaptSet 2	<i>Signal: Adaptive Parameter 2</i>
I[2] . AdaptSet 3	<i>Signal: Adaptive Parameter 3</i>
I[2] . AdaptSet 4	<i>Signal: Adaptive Parameter 4</i>
I[2] . ExBlo1-I	<i>Module input state: External blocking1</i>
I[2] . ExBlo2-I	<i>Module input state: External blocking2</i>
I[2] . ExBlo TripCmd-I	<i>Module input state: External Blocking of the Trip Command</i>
I[2] . Ex rev Interl-I	<i>Module input state: External reverse interlocking</i>
I[2] . AdaptSet1-I	<i>Module input state: Adaptive Parameter1</i>
I[2] . AdaptSet2-I	<i>Module input state: Adaptive Parameter2</i>
I[2] . AdaptSet3-I	<i>Module input state: Adaptive Parameter3</i>
I[2] . AdaptSet4-I	<i>Module input state: Adaptive Parameter4</i>
I[3] . active	<i>Signal: active</i>
I[3] . ExBlo	<i>Signal: External Blocking</i>
I[3] . Ex rev Interl	<i>Signal: External reverse Interlocking</i>

1..n, Assignment List	Description
I[3] . Blo TripCmd	Signal: Trip Command blocked
I[3] . ExBlo TripCmd	Signal: External Blocking of the Trip Command
I[3] . IH2 Blo	Signal: Blocking the trip command by an inrush
I[3] . Alarm L1	Signal: Alarm L1
I[3] . Alarm L2	Signal: Alarm L2
I[3] . Alarm L3	Signal: Alarm L3
I[3] . Alarm	Signal: Alarm
I[3] . Trip L1	Signal: General Trip Phase L1
I[3] . Trip L2	Signal: General Trip Phase L2
I[3] . Trip L3	Signal: General Trip Phase L3
I[3] . Trip	Signal: Trip
I[3] . TripCmd	Signal: Trip Command
I[3] . DefaultSet	Signal: Default Parameter Set
I[3] . AdaptSet 1	Signal: Adaptive Parameter 1
I[3] . AdaptSet 2	Signal: Adaptive Parameter 2
I[3] . AdaptSet 3	Signal: Adaptive Parameter 3
I[3] . AdaptSet 4	Signal: Adaptive Parameter 4
I[3] . ExBlo1-I	Module input state: External blocking1
I[3] . ExBlo2-I	Module input state: External blocking2
I[3] . ExBlo TripCmd-I	Module input state: External Blocking of the Trip Command
I[3] . Ex rev Interl-I	Module input state: External reverse interlocking
I[3] . AdaptSet1-I	Module input state: Adaptive Parameter1
I[3] . AdaptSet2-I	Module input state: Adaptive Parameter2
I[3] . AdaptSet3-I	Module input state: Adaptive Parameter3
I[3] . AdaptSet4-I	Module input state: Adaptive Parameter4
I[4] . active	Signal: active
I[4] . ExBlo	Signal: External Blocking
I[4] . Ex rev Interl	Signal: External reverse Interlocking
I[4] . Blo TripCmd	Signal: Trip Command blocked
I[4] . ExBlo TripCmd	Signal: External Blocking of the Trip Command
I[4] . IH2 Blo	Signal: Blocking the trip command by an inrush
I[4] . Alarm L1	Signal: Alarm L1

1..n, Assignment List	Description
I[4] . Alarm L2	Signal: Alarm L2
I[4] . Alarm L3	Signal: Alarm L3
I[4] . Alarm	Signal: Alarm
I[4] . Trip L1	Signal: General Trip Phase L1
I[4] . Trip L2	Signal: General Trip Phase L2
I[4] . Trip L3	Signal: General Trip Phase L3
I[4] . Trip	Signal: Trip
I[4] . TripCmd	Signal: Trip Command
I[4] . DefaultSet	Signal: Default Parameter Set
I[4] . AdaptSet 1	Signal: Adaptive Parameter 1
I[4] . AdaptSet 2	Signal: Adaptive Parameter 2
I[4] . AdaptSet 3	Signal: Adaptive Parameter 3
I[4] . AdaptSet 4	Signal: Adaptive Parameter 4
I[4] . ExBlo1-I	Module input state: External blocking1
I[4] . ExBlo2-I	Module input state: External blocking2
I[4] . ExBlo TripCmd-I	Module input state: External Blocking of the Trip Command
I[4] . Ex rev Interl-I	Module input state: External reverse interlocking
I[4] . AdaptSet1-I	Module input state: Adaptive Parameter1
I[4] . AdaptSet2-I	Module input state: Adaptive Parameter2
I[4] . AdaptSet3-I	Module input state: Adaptive Parameter3
I[4] . AdaptSet4-I	Module input state: Adaptive Parameter4
I[5] . active	Signal: active
I[5] . ExBlo	Signal: External Blocking
I[5] . Ex rev Interl	Signal: External reverse Interlocking
I[5] . Blo TripCmd	Signal: Trip Command blocked
I[5] . ExBlo TripCmd	Signal: External Blocking of the Trip Command
I[5] . IH2 Blo	Signal: Blocking the trip command by an inrush
I[5] . Alarm L1	Signal: Alarm L1
I[5] . Alarm L2	Signal: Alarm L2
I[5] . Alarm L3	Signal: Alarm L3
I[5] . Alarm	Signal: Alarm
I[5] . Trip L1	Signal: General Trip Phase L1

1..n, Assignment List	Description
I[5] . Trip L2	<i>Signal: General Trip Phase L2</i>
I[5] . Trip L3	<i>Signal: General Trip Phase L3</i>
I[5] . Trip	<i>Signal: Trip</i>
I[5] . TripCmd	<i>Signal: Trip Command</i>
I[5] . DefaultSet	<i>Signal: Default Parameter Set</i>
I[5] . AdaptSet 1	<i>Signal: Adaptive Parameter 1</i>
I[5] . AdaptSet 2	<i>Signal: Adaptive Parameter 2</i>
I[5] . AdaptSet 3	<i>Signal: Adaptive Parameter 3</i>
I[5] . AdaptSet 4	<i>Signal: Adaptive Parameter 4</i>
I[5] . ExBlo1-I	<i>Module input state: External blocking1</i>
I[5] . ExBlo2-I	<i>Module input state: External blocking2</i>
I[5] . ExBlo TripCmd-I	<i>Module input state: External Blocking of the Trip Command</i>
I[5] . Ex rev Interl-I	<i>Module input state: External reverse interlocking</i>
I[5] . AdaptSet1-I	<i>Module input state: Adaptive Parameter1</i>
I[5] . AdaptSet2-I	<i>Module input state: Adaptive Parameter2</i>
I[5] . AdaptSet3-I	<i>Module input state: Adaptive Parameter3</i>
I[5] . AdaptSet4-I	<i>Module input state: Adaptive Parameter4</i>
I[6] . active	<i>Signal: active</i>
I[6] . ExBlo	<i>Signal: External Blocking</i>
I[6] . Ex rev Interl	<i>Signal: External reverse Interlocking</i>
I[6] . Blo TripCmd	<i>Signal: Trip Command blocked</i>
I[6] . ExBlo TripCmd	<i>Signal: External Blocking of the Trip Command</i>
I[6] . IH2 Blo	<i>Signal: Blocking the trip command by an inrush</i>
I[6] . Alarm L1	<i>Signal: Alarm L1</i>
I[6] . Alarm L2	<i>Signal: Alarm L2</i>
I[6] . Alarm L3	<i>Signal: Alarm L3</i>
I[6] . Alarm	<i>Signal: Alarm</i>
I[6] . Trip L1	<i>Signal: General Trip Phase L1</i>
I[6] . Trip L2	<i>Signal: General Trip Phase L2</i>
I[6] . Trip L3	<i>Signal: General Trip Phase L3</i>
I[6] . Trip	<i>Signal: Trip</i>
I[6] . TripCmd	<i>Signal: Trip Command</i>

1..n, Assignment List	Description
I[6] . DefaultSet	<i>Signal: Default Parameter Set</i>
I[6] . AdaptSet 1	<i>Signal: Adaptive Parameter 1</i>
I[6] . AdaptSet 2	<i>Signal: Adaptive Parameter 2</i>
I[6] . AdaptSet 3	<i>Signal: Adaptive Parameter 3</i>
I[6] . AdaptSet 4	<i>Signal: Adaptive Parameter 4</i>
I[6] . ExBlo1-I	<i>Module input state: External blocking1</i>
I[6] . ExBlo2-I	<i>Module input state: External blocking2</i>
I[6] . ExBlo TripCmd-I	<i>Module input state: External Blocking of the Trip Command</i>
I[6] . Ex rev Interl-I	<i>Module input state: External reverse interlocking</i>
I[6] . AdaptSet1-I	<i>Module input state: Adaptive Parameter1</i>
I[6] . AdaptSet2-I	<i>Module input state: Adaptive Parameter2</i>
I[6] . AdaptSet3-I	<i>Module input state: Adaptive Parameter3</i>
I[6] . AdaptSet4-I	<i>Module input state: Adaptive Parameter4</i>
IG[1] . active	<i>Signal: active</i>
IG[1] . ExBlo	<i>Signal: External Blocking</i>
IG[1] . Ex rev Interl	<i>Signal: External reverse Interlocking</i>
IG[1] . Blo TripCmd	<i>Signal: Trip Command blocked</i>
IG[1] . ExBlo TripCmd	<i>Signal: External Blocking of the Trip Command</i>
IG[1] . Alarm	<i>Signal: Alarm IG</i>
IG[1] . Trip	<i>Signal: Trip</i>
IG[1] . TripCmd	<i>Signal: Trip Command</i>
IG[1] . IGH2 Blo	<i>Signal: blocked by an inrush</i>
IG[1] . DefaultSet	<i>Signal: Default Parameter Set</i>
IG[1] . AdaptSet 1	<i>Signal: Adaptive Parameter 1</i>
IG[1] . AdaptSet 2	<i>Signal: Adaptive Parameter 2</i>
IG[1] . AdaptSet 3	<i>Signal: Adaptive Parameter 3</i>
IG[1] . AdaptSet 4	<i>Signal: Adaptive Parameter 4</i>
IG[1] . ExBlo1-I	<i>Module input state: External blocking1</i>
IG[1] . ExBlo2-I	<i>Module input state: External blocking2</i>
IG[1] . ExBlo TripCmd-I	<i>Module input state: External Blocking of the Trip Command</i>
IG[1] . Ex rev Interl-I	<i>Module input state: External reverse interlocking</i>
IG[1] . AdaptSet1-I	<i>Module input state: Adaptive Parameter1</i>

1..n, Assignment List	Description
IG[1] . AdaptSet2-I	<i>Module input state: Adaptive Parameter2</i>
IG[1] . AdaptSet3-I	<i>Module input state: Adaptive Parameter3</i>
IG[1] . AdaptSet4-I	<i>Module input state: Adaptive Parameter4</i>
IG[2] . active	<i>Signal: active</i>
IG[2] . ExBlo	<i>Signal: External Blocking</i>
IG[2] . Ex rev Interl	<i>Signal: External reverse Interlocking</i>
IG[2] . Blo TripCmd	<i>Signal: Trip Command blocked</i>
IG[2] . ExBlo TripCmd	<i>Signal: External Blocking of the Trip Command</i>
IG[2] . Alarm	<i>Signal: Alarm IG</i>
IG[2] . Trip	<i>Signal: Trip</i>
IG[2] . TripCmd	<i>Signal: Trip Command</i>
IG[2] . IGH2 Blo	<i>Signal: blocked by an inrush</i>
IG[2] . DefaultSet	<i>Signal: Default Parameter Set</i>
IG[2] . AdaptSet 1	<i>Signal: Adaptive Parameter 1</i>
IG[2] . AdaptSet 2	<i>Signal: Adaptive Parameter 2</i>
IG[2] . AdaptSet 3	<i>Signal: Adaptive Parameter 3</i>
IG[2] . AdaptSet 4	<i>Signal: Adaptive Parameter 4</i>
IG[2] . ExBlo1-I	<i>Module input state: External blocking1</i>
IG[2] . ExBlo2-I	<i>Module input state: External blocking2</i>
IG[2] . ExBlo TripCmd-I	<i>Module input state: External Blocking of the Trip Command</i>
IG[2] . Ex rev Interl-I	<i>Module input state: External reverse interlocking</i>
IG[2] . AdaptSet1-I	<i>Module input state: Adaptive Parameter1</i>
IG[2] . AdaptSet2-I	<i>Module input state: Adaptive Parameter2</i>
IG[2] . AdaptSet3-I	<i>Module input state: Adaptive Parameter3</i>
IG[2] . AdaptSet4-I	<i>Module input state: Adaptive Parameter4</i>
IG[3] . active	<i>Signal: active</i>
IG[3] . ExBlo	<i>Signal: External Blocking</i>
IG[3] . Ex rev Interl	<i>Signal: External reverse Interlocking</i>
IG[3] . Blo TripCmd	<i>Signal: Trip Command blocked</i>
IG[3] . ExBlo TripCmd	<i>Signal: External Blocking of the Trip Command</i>
IG[3] . Alarm	<i>Signal: Alarm IG</i>
IG[3] . Trip	<i>Signal: Trip</i>

1..n, Assignment List	Description
IG[3] . TripCmd	<i>Signal: Trip Command</i>
IG[3] . IGH2 Blo	<i>Signal: blocked by an inrush</i>
IG[3] . DefaultSet	<i>Signal: Default Parameter Set</i>
IG[3] . AdaptSet 1	<i>Signal: Adaptive Parameter 1</i>
IG[3] . AdaptSet 2	<i>Signal: Adaptive Parameter 2</i>
IG[3] . AdaptSet 3	<i>Signal: Adaptive Parameter 3</i>
IG[3] . AdaptSet 4	<i>Signal: Adaptive Parameter 4</i>
IG[3] . ExBlo1-I	<i>Module input state: External blocking1</i>
IG[3] . ExBlo2-I	<i>Module input state: External blocking2</i>
IG[3] . ExBlo TripCmd-I	<i>Module input state: External Blocking of the Trip Command</i>
IG[3] . Ex rev Interl-I	<i>Module input state: External reverse interlocking</i>
IG[3] . AdaptSet1-I	<i>Module input state: Adaptive Parameter1</i>
IG[3] . AdaptSet2-I	<i>Module input state: Adaptive Parameter2</i>
IG[3] . AdaptSet3-I	<i>Module input state: Adaptive Parameter3</i>
IG[3] . AdaptSet4-I	<i>Module input state: Adaptive Parameter4</i>
IG[4] . active	<i>Signal: active</i>
IG[4] . ExBlo	<i>Signal: External Blocking</i>
IG[4] . Ex rev Interl	<i>Signal: External reverse Interlocking</i>
IG[4] . Blo TripCmd	<i>Signal: Trip Command blocked</i>
IG[4] . ExBlo TripCmd	<i>Signal: External Blocking of the Trip Command</i>
IG[4] . Alarm	<i>Signal: Alarm IG</i>
IG[4] . Trip	<i>Signal: Trip</i>
IG[4] . TripCmd	<i>Signal: Trip Command</i>
IG[4] . IGH2 Blo	<i>Signal: blocked by an inrush</i>
IG[4] . DefaultSet	<i>Signal: Default Parameter Set</i>
IG[4] . AdaptSet 1	<i>Signal: Adaptive Parameter 1</i>
IG[4] . AdaptSet 2	<i>Signal: Adaptive Parameter 2</i>
IG[4] . AdaptSet 3	<i>Signal: Adaptive Parameter 3</i>
IG[4] . AdaptSet 4	<i>Signal: Adaptive Parameter 4</i>
IG[4] . ExBlo1-I	<i>Module input state: External blocking1</i>
IG[4] . ExBlo2-I	<i>Module input state: External blocking2</i>
IG[4] . ExBlo TripCmd-I	<i>Module input state: External Blocking of the Trip Command</i>

1..n, Assignment List	Description
IG[4] . Ex rev Interl-I	<i>Module input state: External reverse interlocking</i>
IG[4] . AdaptSet1-I	<i>Module input state: Adaptive Parameter1</i>
IG[4] . AdaptSet2-I	<i>Module input state: Adaptive Parameter2</i>
IG[4] . AdaptSet3-I	<i>Module input state: Adaptive Parameter3</i>
IG[4] . AdaptSet4-I	<i>Module input state: Adaptive Parameter4</i>
ThR . active	<i>Signal: active</i>
ThR . ExBlo	<i>Signal: External Blocking</i>
ThR . Blo TripCmd	<i>Signal: Trip Command blocked</i>
ThR . ExBlo TripCmd	<i>Signal: External Blocking of the Trip Command</i>
ThR . Alarm	<i>Signal: Alarm Thermal Overload</i>
ThR . Trip	<i>Signal: Trip</i>
ThR . TripCmd	<i>Signal: Trip Command</i>
ThR . Res Thermal Cap	<i>Signal: Resetting Thermal Replica</i>
ThR . ExBlo1-I	<i>Module input state: External blocking1</i>
ThR . ExBlo2-I	<i>Module input state: External blocking2</i>
ThR . ExBlo TripCmd-I	<i>Module input state: External Blocking of the Trip Command</i>
I2>[1] . active	<i>Signal: active</i>
I2>[1] . ExBlo	<i>Signal: External Blocking</i>
I2>[1] . Blo TripCmd	<i>Signal: Trip Command blocked</i>
I2>[1] . ExBlo TripCmd	<i>Signal: External Blocking of the Trip Command</i>
I2>[1] . Alarm	<i>Signal: Alarm Negative Sequence</i>
I2>[1] . Trip	<i>Signal: Trip</i>
I2>[1] . TripCmd	<i>Signal: Trip Command</i>
I2>[1] . ExBlo1-I	<i>Module input state: External blocking1</i>
I2>[1] . ExBlo2-I	<i>Module input state: External blocking2</i>
I2>[1] . ExBlo TripCmd-I	<i>Module input state: External Blocking of the Trip Command</i>
I2>[2] . active	<i>Signal: active</i>
I2>[2] . ExBlo	<i>Signal: External Blocking</i>
I2>[2] . Blo TripCmd	<i>Signal: Trip Command blocked</i>
I2>[2] . ExBlo TripCmd	<i>Signal: External Blocking of the Trip Command</i>
I2>[2] . Alarm	<i>Signal: Alarm Negative Sequence</i>
I2>[2] . Trip	<i>Signal: Trip</i>

1..n, Assignment List	Description
I2>[2] . TripCmd	Signal: Trip Command
I2>[2] . ExBlo1-I	Module input state: External blocking1
I2>[2] . ExBlo2-I	Module input state: External blocking2
I2>[2] . ExBlo TripCmd-I	Module input state: External Blocking of the Trip Command
I2>G[1] . active	Signal: active
I2>G[1] . ExBlo	Signal: External Blocking
I2>G[1] . Blo TripCmd	Signal: Trip Command blocked
I2>G[1] . ExBlo TripCmd	Signal: External Blocking of the Trip Command
I2>G[1] . Alarm	Signal: Alarm Negative Sequence
I2>G[1] . Trip	Signal: Trip
I2>G[1] . TripCmd	Signal: Trip Command
I2>G[1] . ExBlo1-I	Module input state: External blocking1
I2>G[1] . ExBlo2-I	Module input state: External blocking2
I2>G[1] . ExBlo TripCmd-I	Module input state: External Blocking of the Trip Command
I2>G[2] . active	Signal: active
I2>G[2] . ExBlo	Signal: External Blocking
I2>G[2] . Blo TripCmd	Signal: Trip Command blocked
I2>G[2] . ExBlo TripCmd	Signal: External Blocking of the Trip Command
I2>G[2] . Alarm	Signal: Alarm Negative Sequence
I2>G[2] . Trip	Signal: Trip
I2>G[2] . TripCmd	Signal: Trip Command
I2>G[2] . ExBlo1-I	Module input state: External blocking1
I2>G[2] . ExBlo2-I	Module input state: External blocking2
I2>G[2] . ExBlo TripCmd-I	Module input state: External Blocking of the Trip Command
V[1] . active	Signal: active
V[1] . ExBlo	Signal: External Blocking
V[1] . Blo TripCmd	Signal: Trip Command blocked
V[1] . ExBlo TripCmd	Signal: External Blocking of the Trip Command
V[1] . Alarm L1	Signal: Alarm L1
V[1] . Alarm L2	Signal: Alarm L2
V[1] . Alarm L3	Signal: Alarm L3

1..n, Assignment List	Description
V[1] . Alarm	Signal: Alarm voltage stage
V[1] . Trip L1	Signal: General Trip Phase L1
V[1] . Trip L2	Signal: General Trip Phase L2
V[1] . Trip L3	Signal: General Trip Phase L3
V[1] . Trip	Signal: Trip
V[1] . TripCmd	Signal: Trip Command
V[1] . Imin release active	Signal that the Imin release (minimum current) check is enabled and does not block the undervoltage detection at the moment.
V[1] . ExBlo1-I	Module input state: External blocking1
V[1] . ExBlo2-I	Module input state: External blocking2
V[1] . ExBlo TripCmd-I	Module input state: External Blocking of the Trip Command
V[2] . active	Signal: active
V[2] . ExBlo	Signal: External Blocking
V[2] . Blo TripCmd	Signal: Trip Command blocked
V[2] . ExBlo TripCmd	Signal: External Blocking of the Trip Command
V[2] . Alarm L1	Signal: Alarm L1
V[2] . Alarm L2	Signal: Alarm L2
V[2] . Alarm L3	Signal: Alarm L3
V[2] . Alarm	Signal: Alarm voltage stage
V[2] . Trip L1	Signal: General Trip Phase L1
V[2] . Trip L2	Signal: General Trip Phase L2
V[2] . Trip L3	Signal: General Trip Phase L3
V[2] . Trip	Signal: Trip
V[2] . TripCmd	Signal: Trip Command
V[2] . Imin release active	Signal that the Imin release (minimum current) check is enabled and does not block the undervoltage detection at the moment.
V[2] . ExBlo1-I	Module input state: External blocking1
V[2] . ExBlo2-I	Module input state: External blocking2
V[2] . ExBlo TripCmd-I	Module input state: External Blocking of the Trip Command
V[3] . active	Signal: active
V[3] . ExBlo	Signal: External Blocking
V[3] . Blo TripCmd	Signal: Trip Command blocked
V[3] . ExBlo TripCmd	Signal: External Blocking of the Trip Command

1..n, Assignment List	Description
V[3] . Alarm L1	<i>Signal: Alarm L1</i>
V[3] . Alarm L2	<i>Signal: Alarm L2</i>
V[3] . Alarm L3	<i>Signal: Alarm L3</i>
V[3] . Alarm	<i>Signal: Alarm voltage stage</i>
V[3] . Trip L1	<i>Signal: General Trip Phase L1</i>
V[3] . Trip L2	<i>Signal: General Trip Phase L2</i>
V[3] . Trip L3	<i>Signal: General Trip Phase L3</i>
V[3] . Trip	<i>Signal: Trip</i>
V[3] . TripCmd	<i>Signal: Trip Command</i>
V[3] . Imin release active	<i>Signal that the Imin release (minimum current) check is enabled and does not block the undervoltage detection at the moment.</i>
V[3] . ExBlo1-I	<i>Module input state: External blocking1</i>
V[3] . ExBlo2-I	<i>Module input state: External blocking2</i>
V[3] . ExBlo TripCmd-I	<i>Module input state: External Blocking of the Trip Command</i>
V[4] . active	<i>Signal: active</i>
V[4] . ExBlo	<i>Signal: External Blocking</i>
V[4] . Blo TripCmd	<i>Signal: Trip Command blocked</i>
V[4] . ExBlo TripCmd	<i>Signal: External Blocking of the Trip Command</i>
V[4] . Alarm L1	<i>Signal: Alarm L1</i>
V[4] . Alarm L2	<i>Signal: Alarm L2</i>
V[4] . Alarm L3	<i>Signal: Alarm L3</i>
V[4] . Alarm	<i>Signal: Alarm voltage stage</i>
V[4] . Trip L1	<i>Signal: General Trip Phase L1</i>
V[4] . Trip L2	<i>Signal: General Trip Phase L2</i>
V[4] . Trip L3	<i>Signal: General Trip Phase L3</i>
V[4] . Trip	<i>Signal: Trip</i>
V[4] . TripCmd	<i>Signal: Trip Command</i>
V[4] . Imin release active	<i>Signal that the Imin release (minimum current) check is enabled and does not block the undervoltage detection at the moment.</i>
V[4] . ExBlo1-I	<i>Module input state: External blocking1</i>
V[4] . ExBlo2-I	<i>Module input state: External blocking2</i>
V[4] . ExBlo TripCmd-I	<i>Module input state: External Blocking of the Trip Command</i>
V[5] . active	<i>Signal: active</i>

1..n, Assignment List	Description
V[5] . ExBlo	Signal: External Blocking
V[5] . Blo TripCmd	Signal: Trip Command blocked
V[5] . ExBlo TripCmd	Signal: External Blocking of the Trip Command
V[5] . Alarm L1	Signal: Alarm L1
V[5] . Alarm L2	Signal: Alarm L2
V[5] . Alarm L3	Signal: Alarm L3
V[5] . Alarm	Signal: Alarm voltage stage
V[5] . Trip L1	Signal: General Trip Phase L1
V[5] . Trip L2	Signal: General Trip Phase L2
V[5] . Trip L3	Signal: General Trip Phase L3
V[5] . Trip	Signal: Trip
V[5] . TripCmd	Signal: Trip Command
V[5] . Imin release active	Signal that the Imin release (minimum current) check is enabled and does not block the undervoltage detection at the moment.
V[5] . ExBlo1-I	Module input state: External blocking1
V[5] . ExBlo2-I	Module input state: External blocking2
V[5] . ExBlo TripCmd-I	Module input state: External Blocking of the Trip Command
V[6] . active	Signal: active
V[6] . ExBlo	Signal: External Blocking
V[6] . Blo TripCmd	Signal: Trip Command blocked
V[6] . ExBlo TripCmd	Signal: External Blocking of the Trip Command
V[6] . Alarm L1	Signal: Alarm L1
V[6] . Alarm L2	Signal: Alarm L2
V[6] . Alarm L3	Signal: Alarm L3
V[6] . Alarm	Signal: Alarm voltage stage
V[6] . Trip L1	Signal: General Trip Phase L1
V[6] . Trip L2	Signal: General Trip Phase L2
V[6] . Trip L3	Signal: General Trip Phase L3
V[6] . Trip	Signal: Trip
V[6] . TripCmd	Signal: Trip Command
V[6] . Imin release active	Signal that the Imin release (minimum current) check is enabled and does not block the undervoltage detection at the moment.
V[6] . ExBlo1-I	Module input state: External blocking1

1..n, Assignment List	Description
V[6] . ExBlo2-I	<i>Module input state: External blocking2</i>
V[6] . ExBlo TripCmd-I	<i>Module input state: External Blocking of the Trip Command</i>
df/dt . active	<i>Signal: active</i>
df/dt . ExBlo	<i>Signal: External Blocking</i>
df/dt . Blo by V<	<i>Signal: Module is blocked by undervoltage.</i>
df/dt . Blo TripCmd	<i>Signal: Trip Command blocked</i>
df/dt . ExBlo TripCmd	<i>Signal: External Blocking of the Trip Command</i>
df/dt . Alarm	<i>Signal: Alarm Frequency Protection (collective signal)</i>
df/dt . Trip	<i>Signal: Trip Frequency Protection (collective signal)</i>
df/dt . TripCmd	<i>Signal: Trip Command</i>
df/dt . ExBlo1-I	<i>Module input state: External blocking1</i>
df/dt . ExBlo2-I	<i>Module input state: External blocking2</i>
df/dt . ExBlo TripCmd-I	<i>Module input state: External Blocking of the Trip Command</i>
delta phi . active	<i>Signal: active</i>
delta phi . ExBlo	<i>Signal: External Blocking</i>
delta phi . Blo by V<	<i>Signal: Module is blocked by undervoltage.</i>
delta phi . Blo TripCmd	<i>Signal: Trip Command blocked</i>
delta phi . ExBlo TripCmd	<i>Signal: External Blocking of the Trip Command</i>
delta phi . Alarm	<i>Signal: Alarm Frequency Protection (collective signal)</i>
delta phi . Trip	<i>Signal: Trip Frequency Protection (collective signal)</i>
delta phi . TripCmd	<i>Signal: Trip Command</i>
delta phi . ExBlo1-I	<i>Module input state: External blocking1</i>
delta phi . ExBlo2-I	<i>Module input state: External blocking2</i>
delta phi . ExBlo TripCmd-I	<i>Module input state: External Blocking of the Trip Command</i>
Intertripping . active	<i>Signal: active</i>
Intertripping . ExBlo	<i>Signal: External Blocking</i>
Intertripping . Blo TripCmd	<i>Signal: Trip Command blocked</i>
Intertripping . ExBlo TripCmd	<i>Signal: External Blocking of the Trip Command</i>
Intertripping . Alarm	<i>Signal: Alarm</i>

1..n, Assignment List	Description
Intertripping . Trip	<i>Signal: Trip</i>
Intertripping . TripCmd	<i>Signal: Trip Command</i>
Intertripping . ExBlo1-I	<i>Module input state: External blocking1</i>
Intertripping . ExBlo2-I	<i>Module input state: External blocking2</i>
Intertripping . ExBlo TripCmd-I	<i>Module input state: External Blocking of the Trip Command</i>
Intertripping . Alarm-I	<i>Module input state: Alarm</i>
Intertripping . Trip-I	<i>Module input state: Trip</i>
P[1] . active	<i>Signal: active</i>
P[1] . ExBlo	<i>Signal: External Blocking</i>
P[1] . Blo TripCmd	<i>Signal: Trip Command blocked</i>
P[1] . ExBlo TripCmd	<i>Signal: External Blocking of the Trip Command</i>
P[1] . Alarm	<i>Signal: Alarm Power Protection</i>
P[1] . Trip	<i>Signal: Trip Power Protection</i>
P[1] . TripCmd	<i>Signal: Trip Command</i>
P[1] . ExBlo1-I	<i>Module input state: External blocking</i>
P[1] . ExBlo2-I	<i>Module input state: External blocking</i>
P[1] . ExBlo TripCmd-I	<i>Module input state: External Blocking of the Trip Command</i>
P[2] . active	<i>Signal: active</i>
P[2] . ExBlo	<i>Signal: External Blocking</i>
P[2] . Blo TripCmd	<i>Signal: Trip Command blocked</i>
P[2] . ExBlo TripCmd	<i>Signal: External Blocking of the Trip Command</i>
P[2] . Alarm	<i>Signal: Alarm Power Protection</i>
P[2] . Trip	<i>Signal: Trip Power Protection</i>
P[2] . TripCmd	<i>Signal: Trip Command</i>
P[2] . ExBlo1-I	<i>Module input state: External blocking</i>
P[2] . ExBlo2-I	<i>Module input state: External blocking</i>
P[2] . ExBlo TripCmd-I	<i>Module input state: External Blocking of the Trip Command</i>
P[3] . active	<i>Signal: active</i>
P[3] . ExBlo	<i>Signal: External Blocking</i>
P[3] . Blo TripCmd	<i>Signal: Trip Command blocked</i>
P[3] . ExBlo TripCmd	<i>Signal: External Blocking of the Trip Command</i>

1..n, Assignment List	Description
P[3] . Alarm	<i>Signal: Alarm Power Protection</i>
P[3] . Trip	<i>Signal: Trip Power Protection</i>
P[3] . TripCmd	<i>Signal: Trip Command</i>
P[3] . ExBlo1-I	<i>Module input state: External blocking</i>
P[3] . ExBlo2-I	<i>Module input state: External blocking</i>
P[3] . ExBlo TripCmd-I	<i>Module input state: External Blocking of the Trip Command</i>
Q . active	<i>Signal: active</i>
Q . ExBlo	<i>Signal: External Blocking</i>
Q . Blo TripCmd	<i>Signal: Trip Command blocked</i>
Q . ExBlo TripCmd	<i>Signal: External Blocking of the Trip Command</i>
Q . Alarm	<i>Signal: Alarm Power Protection</i>
Q . Trip	<i>Signal: Trip Power Protection</i>
Q . TripCmd	<i>Signal: Trip Command</i>
Q . ExBlo1-I	<i>Module input state: External blocking</i>
Q . ExBlo2-I	<i>Module input state: External blocking</i>
Q . ExBlo TripCmd-I	<i>Module input state: External Blocking of the Trip Command</i>
LVRT[1] . active	<i>Signal: active</i>
LVRT[1] . ExBlo	<i>Signal: External Blocking</i>
LVRT[1] . Blo TripCmd	<i>Signal: Trip Command blocked</i>
LVRT[1] . ExBlo TripCmd	<i>Signal: External Blocking of the Trip Command</i>
LVRT[1] . Alarm L1	<i>Signal: Alarm L1</i>
LVRT[1] . Alarm L2	<i>Signal: Alarm L2</i>
LVRT[1] . Alarm L3	<i>Signal: Alarm L3</i>
LVRT[1] . Alarm	<i>Signal: Alarm voltage stage</i>
LVRT[1] . Trip L1	<i>Signal: General Trip Phase L1</i>
LVRT[1] . Trip L2	<i>Signal: General Trip Phase L2</i>
LVRT[1] . Trip L3	<i>Signal: General Trip Phase L3</i>
LVRT[1] . Trip	<i>Signal: Trip</i>
LVRT[1] . TripCmd	<i>Signal: Trip Command</i>
LVRT[1] . t-LVRT is running	<i>Signal: t-LVRT is running</i>
LVRT[1] . ExBlo1-I	<i>Module input state: External blocking1</i>

1..n, Assignment List	Description
LVRT[1] . ExBlo2-I	<i>Module input state: External blocking2</i>
LVRT[1] . ExBlo TripCmd-I	<i>Module input state: External Blocking of the Trip Command</i>
LVRT[2] . active	<i>Signal: active</i>
LVRT[2] . ExBlo	<i>Signal: External Blocking</i>
LVRT[2] . Blo TripCmd	<i>Signal: Trip Command blocked</i>
LVRT[2] . ExBlo TripCmd	<i>Signal: External Blocking of the Trip Command</i>
LVRT[2] . Alarm L1	<i>Signal: Alarm L1</i>
LVRT[2] . Alarm L2	<i>Signal: Alarm L2</i>
LVRT[2] . Alarm L3	<i>Signal: Alarm L3</i>
LVRT[2] . Alarm	<i>Signal: Alarm voltage stage</i>
LVRT[2] . Trip L1	<i>Signal: General Trip Phase L1</i>
LVRT[2] . Trip L2	<i>Signal: General Trip Phase L2</i>
LVRT[2] . Trip L3	<i>Signal: General Trip Phase L3</i>
LVRT[2] . Trip	<i>Signal: Trip</i>
LVRT[2] . TripCmd	<i>Signal: Trip Command</i>
LVRT[2] . t-LVRT is running	<i>Signal: t-LVRT is running</i>
LVRT[2] . ExBlo1-I	<i>Module input state: External blocking1</i>
LVRT[2] . ExBlo2-I	<i>Module input state: External blocking2</i>
LVRT[2] . ExBlo TripCmd-I	<i>Module input state: External Blocking of the Trip Command</i>
VG[1] . active	<i>Signal: active</i>
VG[1] . ExBlo	<i>Signal: External Blocking</i>
VG[1] . Blo TripCmd	<i>Signal: Trip Command blocked</i>
VG[1] . ExBlo TripCmd	<i>Signal: External Blocking of the Trip Command</i>
VG[1] . Alarm	<i>Signal: Alarm Residual Voltage Supervision-stage</i>
VG[1] . Trip	<i>Signal: Trip</i>
VG[1] . TripCmd	<i>Signal: Trip Command</i>
VG[1] . ExBlo1-I	<i>Module input state: External blocking1</i>
VG[1] . ExBlo2-I	<i>Module input state: External blocking2</i>
VG[1] . ExBlo TripCmd-I	<i>Module input state: External Blocking of the Trip Command</i>
VG[2] . active	<i>Signal: active</i>

1..n, Assignment List	Description
VG[2] . ExBlo	<i>Signal: External Blocking</i>
VG[2] . Blo TripCmd	<i>Signal: Trip Command blocked</i>
VG[2] . ExBlo TripCmd	<i>Signal: External Blocking of the Trip Command</i>
VG[2] . Alarm	<i>Signal: Alarm Residual Voltage Supervision-stage</i>
VG[2] . Trip	<i>Signal: Trip</i>
VG[2] . TripCmd	<i>Signal: Trip Command</i>
VG[2] . ExBlo1-I	<i>Module input state: External blocking1</i>
VG[2] . ExBlo2-I	<i>Module input state: External blocking2</i>
VG[2] . ExBlo TripCmd-I	<i>Module input state: External Blocking of the Trip Command</i>
V012[1] . active	<i>Signal: active</i>
V012[1] . ExBlo	<i>Signal: External Blocking</i>
V012[1] . Blo TripCmd	<i>Signal: Trip Command blocked</i>
V012[1] . ExBlo TripCmd	<i>Signal: External Blocking of the Trip Command</i>
V012[1] . Alarm	<i>Signal: Alarm voltage asymmetry</i>
V012[1] . Trip	<i>Signal: Trip</i>
V012[1] . TripCmd	<i>Signal: Trip Command</i>
V012[1] . ExBlo1-I	<i>Module input state: External blocking1</i>
V012[1] . ExBlo2-I	<i>Module input state: External blocking2</i>
V012[1] . ExBlo TripCmd-I	<i>Module input state: External Blocking of the Trip Command</i>
V012[2] . active	<i>Signal: active</i>
V012[2] . ExBlo	<i>Signal: External Blocking</i>
V012[2] . Blo TripCmd	<i>Signal: Trip Command blocked</i>
V012[2] . ExBlo TripCmd	<i>Signal: External Blocking of the Trip Command</i>
V012[2] . Alarm	<i>Signal: Alarm voltage asymmetry</i>
V012[2] . Trip	<i>Signal: Trip</i>
V012[2] . TripCmd	<i>Signal: Trip Command</i>
V012[2] . ExBlo1-I	<i>Module input state: External blocking1</i>
V012[2] . ExBlo2-I	<i>Module input state: External blocking2</i>
V012[2] . ExBlo TripCmd-I	<i>Module input state: External Blocking of the Trip Command</i>
V012[3] . active	<i>Signal: active</i>
V012[3] . ExBlo	<i>Signal: External Blocking</i>

1..n, Assignment List	Description
V012[3] . Blo TripCmd	<i>Signal: Trip Command blocked</i>
V012[3] . ExBlo TripCmd	<i>Signal: External Blocking of the Trip Command</i>
V012[3] . Alarm	<i>Signal: Alarm voltage asymmetry</i>
V012[3] . Trip	<i>Signal: Trip</i>
V012[3] . TripCmd	<i>Signal: Trip Command</i>
V012[3] . ExBlo1-I	<i>Module input state: External blocking1</i>
V012[3] . ExBlo2-I	<i>Module input state: External blocking2</i>
V012[3] . ExBlo TripCmd-I	<i>Module input state: External Blocking of the Trip Command</i>
V012[4] . active	<i>Signal: active</i>
V012[4] . ExBlo	<i>Signal: External Blocking</i>
V012[4] . Blo TripCmd	<i>Signal: Trip Command blocked</i>
V012[4] . ExBlo TripCmd	<i>Signal: External Blocking of the Trip Command</i>
V012[4] . Alarm	<i>Signal: Alarm voltage asymmetry</i>
V012[4] . Trip	<i>Signal: Trip</i>
V012[4] . TripCmd	<i>Signal: Trip Command</i>
V012[4] . ExBlo1-I	<i>Module input state: External blocking1</i>
V012[4] . ExBlo2-I	<i>Module input state: External blocking2</i>
V012[4] . ExBlo TripCmd-I	<i>Module input state: External Blocking of the Trip Command</i>
V012[5] . active	<i>Signal: active</i>
V012[5] . ExBlo	<i>Signal: External Blocking</i>
V012[5] . Blo TripCmd	<i>Signal: Trip Command blocked</i>
V012[5] . ExBlo TripCmd	<i>Signal: External Blocking of the Trip Command</i>
V012[5] . Alarm	<i>Signal: Alarm voltage asymmetry</i>
V012[5] . Trip	<i>Signal: Trip</i>
V012[5] . TripCmd	<i>Signal: Trip Command</i>
V012[5] . ExBlo1-I	<i>Module input state: External blocking1</i>
V012[5] . ExBlo2-I	<i>Module input state: External blocking2</i>
V012[5] . ExBlo TripCmd-I	<i>Module input state: External Blocking of the Trip Command</i>
V012[6] . active	<i>Signal: active</i>
V012[6] . ExBlo	<i>Signal: External Blocking</i>

1..n, Assignment List	Description
V012[6] . Blo TripCmd	Signal: Trip Command blocked
V012[6] . ExBlo TripCmd	Signal: External Blocking of the Trip Command
V012[6] . Alarm	Signal: Alarm voltage asymmetry
V012[6] . Trip	Signal: Trip
V012[6] . TripCmd	Signal: Trip Command
V012[6] . ExBlo1-I	Module input state: External blocking1
V012[6] . ExBlo2-I	Module input state: External blocking2
V012[6] . ExBlo TripCmd-I	Module input state: External Blocking of the Trip Command
f[1] . active	Signal: active
f[1] . ExBlo	Signal: External Blocking
f[1] . Blo by V<	Signal: Module is blocked by undervoltage.
f[1] . Blo TripCmd	Signal: Trip Command blocked
f[1] . ExBlo TripCmd	Signal: External Blocking of the Trip Command
f[1] . Alarm f	Signal: Alarm Frequency Protection
f[1] . Alarm df/dt DF/DT	Alarm instantaneous or average value of the rate-of-frequency-change
f[1] . Alarm delta phi	Signal: Alarm Vector Surge
f[1] . Alarm	Signal: Alarm Frequency Protection (collective signal)
f[1] . Trip f	Signal: Frequency has exceeded the limit.
f[1] . Trip df/dt DF/DT	Signal: Trip df/dt or DF/DT
f[1] . Trip delta phi	Signal: Trip Vector Surge
f[1] . Trip	Signal: Trip Frequency Protection (collective signal)
f[1] . TripCmd	Signal: Trip Command
f[1] . ExBlo1-I	Module input state: External blocking1
f[1] . ExBlo2-I	Module input state: External blocking2
f[1] . ExBlo TripCmd-I	Module input state: External Blocking of the Trip Command
f[2] . active	Signal: active
f[2] . ExBlo	Signal: External Blocking
f[2] . Blo by V<	Signal: Module is blocked by undervoltage.
f[2] . Blo TripCmd	Signal: Trip Command blocked
f[2] . ExBlo TripCmd	Signal: External Blocking of the Trip Command
f[2] . Alarm f	Signal: Alarm Frequency Protection

1..n, Assignment List	Description
f[2] . Alarm df/dt DF/DT	<i>Alarm instantaneous or average value of the rate-of-frequency-change</i>
f[2] . Alarm delta phi	<i>Signal: Alarm Vector Surge</i>
f[2] . Alarm	<i>Signal: Alarm Frequency Protection (collective signal)</i>
f[2] . Trip f	<i>Signal: Frequency has exceeded the limit.</i>
f[2] . Trip df/dt DF/DT	<i>Signal: Trip df/dt or DF/DT</i>
f[2] . Trip delta phi	<i>Signal: Trip Vector Surge</i>
f[2] . Trip	<i>Signal: Trip Frequency Protection (collective signal)</i>
f[2] . TripCmd	<i>Signal: Trip Command</i>
f[2] . ExBlo1-I	<i>Module input state: External blocking1</i>
f[2] . ExBlo2-I	<i>Module input state: External blocking2</i>
f[2] . ExBlo TripCmd-I	<i>Module input state: External Blocking of the Trip Command</i>
f[3] . active	<i>Signal: active</i>
f[3] . ExBlo	<i>Signal: External Blocking</i>
f[3] . Blo by V<	<i>Signal: Module is blocked by undervoltage.</i>
f[3] . Blo TripCmd	<i>Signal: Trip Command blocked</i>
f[3] . ExBlo TripCmd	<i>Signal: External Blocking of the Trip Command</i>
f[3] . Alarm f	<i>Signal: Alarm Frequency Protection</i>
f[3] . Alarm df/dt DF/DT	<i>Alarm instantaneous or average value of the rate-of-frequency-change</i>
f[3] . Alarm delta phi	<i>Signal: Alarm Vector Surge</i>
f[3] . Alarm	<i>Signal: Alarm Frequency Protection (collective signal)</i>
f[3] . Trip f	<i>Signal: Frequency has exceeded the limit.</i>
f[3] . Trip df/dt DF/DT	<i>Signal: Trip df/dt or DF/DT</i>
f[3] . Trip delta phi	<i>Signal: Trip Vector Surge</i>
f[3] . Trip	<i>Signal: Trip Frequency Protection (collective signal)</i>
f[3] . TripCmd	<i>Signal: Trip Command</i>
f[3] . ExBlo1-I	<i>Module input state: External blocking1</i>
f[3] . ExBlo2-I	<i>Module input state: External blocking2</i>
f[3] . ExBlo TripCmd-I	<i>Module input state: External Blocking of the Trip Command</i>
f[4] . active	<i>Signal: active</i>
f[4] . ExBlo	<i>Signal: External Blocking</i>
f[4] . Blo by V<	<i>Signal: Module is blocked by undervoltage.</i>

1..n, Assignment List	Description
f[4] . Blo TripCmd	Signal: Trip Command blocked
f[4] . ExBlo TripCmd	Signal: External Blocking of the Trip Command
f[4] . Alarm f	Signal: Alarm Frequency Protection
f[4] . Alarm df/dt DF/DT	Alarm instantaneous or average value of the rate-of-frequency-change
f[4] . Alarm delta phi	Signal: Alarm Vector Surge
f[4] . Alarm	Signal: Alarm Frequency Protection (collective signal)
f[4] . Trip f	Signal: Frequency has exceeded the limit.
f[4] . Trip df/dt DF/DT	Signal: Trip df/dt or DF/DT
f[4] . Trip delta phi	Signal: Trip Vector Surge
f[4] . Trip	Signal: Trip Frequency Protection (collective signal)
f[4] . TripCmd	Signal: Trip Command
f[4] . ExBlo1-I	Module input state: External blocking1
f[4] . ExBlo2-I	Module input state: External blocking2
f[4] . ExBlo TripCmd-I	Module input state: External Blocking of the Trip Command
f[5] . active	Signal: active
f[5] . ExBlo	Signal: External Blocking
f[5] . Blo by V<	Signal: Module is blocked by undervoltage.
f[5] . Blo TripCmd	Signal: Trip Command blocked
f[5] . ExBlo TripCmd	Signal: External Blocking of the Trip Command
f[5] . Alarm f	Signal: Alarm Frequency Protection
f[5] . Alarm df/dt DF/DT	Alarm instantaneous or average value of the rate-of-frequency-change
f[5] . Alarm delta phi	Signal: Alarm Vector Surge
f[5] . Alarm	Signal: Alarm Frequency Protection (collective signal)
f[5] . Trip f	Signal: Frequency has exceeded the limit.
f[5] . Trip df/dt DF/DT	Signal: Trip df/dt or DF/DT
f[5] . Trip delta phi	Signal: Trip Vector Surge
f[5] . Trip	Signal: Trip Frequency Protection (collective signal)
f[5] . TripCmd	Signal: Trip Command
f[5] . ExBlo1-I	Module input state: External blocking1
f[5] . ExBlo2-I	Module input state: External blocking2
f[5] . ExBlo TripCmd-I	Module input state: External Blocking of the Trip Command

1..n, Assignment List	Description
f[6] . active	Signal: active
f[6] . ExBlo	Signal: External Blocking
f[6] . Blo by V<	Signal: Module is blocked by undervoltage.
f[6] . Blo TripCmd	Signal: Trip Command blocked
f[6] . ExBlo TripCmd	Signal: External Blocking of the Trip Command
f[6] . Alarm f	Signal: Alarm Frequency Protection
f[6] . Alarm df/dt DF/DT	Alarm instantaneous or average value of the rate-of-frequency-change
f[6] . Alarm delta phi	Signal: Alarm Vector Surge
f[6] . Alarm	Signal: Alarm Frequency Protection (collective signal)
f[6] . Trip f	Signal: Frequency has exceeded the limit.
f[6] . Trip df/dt DF/DT	Signal: Trip df/dt or DF/DT
f[6] . Trip delta phi	Signal: Trip Vector Surge
f[6] . Trip	Signal: Trip Frequency Protection (collective signal)
f[6] . TripCmd	Signal: Trip Command
f[6] . ExBlo1-I	Module input state: External blocking1
f[6] . ExBlo2-I	Module input state: External blocking2
f[6] . ExBlo TripCmd-I	Module input state: External Blocking of the Trip Command
PQS[1] . active	Signal: active
PQS[1] . ExBlo	Signal: External Blocking
PQS[1] . Blo TripCmd	Signal: Trip Command blocked
PQS[1] . ExBlo TripCmd	Signal: External Blocking of the Trip Command
PQS[1] . Alarm	Signal: Alarm Power Protection
PQS[1] . Trip	Signal: Trip Power Protection
PQS[1] . TripCmd	Signal: Trip Command
PQS[1] . ExBlo1-I	Module input state: External blocking
PQS[1] . ExBlo2-I	Module input state: External blocking
PQS[1] . ExBlo TripCmd-I	Module input state: External Blocking of the Trip Command
PQS[2] . active	Signal: active
PQS[2] . ExBlo	Signal: External Blocking
PQS[2] . Blo TripCmd	Signal: Trip Command blocked
PQS[2] . ExBlo TripCmd	Signal: External Blocking of the Trip Command

1..n, Assignment List	Description
PQS[2] . Alarm	<i>Signal: Alarm Power Protection</i>
PQS[2] . Trip	<i>Signal: Trip Power Protection</i>
PQS[2] . TripCmd	<i>Signal: Trip Command</i>
PQS[2] . ExBlo1-I	<i>Module input state: External blocking</i>
PQS[2] . ExBlo2-I	<i>Module input state: External blocking</i>
PQS[2] . ExBlo TripCmd-I	<i>Module input state: External Blocking of the Trip Command</i>
PQS[3] . active	<i>Signal: active</i>
PQS[3] . ExBlo	<i>Signal: External Blocking</i>
PQS[3] . Blo TripCmd	<i>Signal: Trip Command blocked</i>
PQS[3] . ExBlo TripCmd	<i>Signal: External Blocking of the Trip Command</i>
PQS[3] . Alarm	<i>Signal: Alarm Power Protection</i>
PQS[3] . Trip	<i>Signal: Trip Power Protection</i>
PQS[3] . TripCmd	<i>Signal: Trip Command</i>
PQS[3] . ExBlo1-I	<i>Module input state: External blocking</i>
PQS[3] . ExBlo2-I	<i>Module input state: External blocking</i>
PQS[3] . ExBlo TripCmd-I	<i>Module input state: External Blocking of the Trip Command</i>
PQS[4] . active	<i>Signal: active</i>
PQS[4] . ExBlo	<i>Signal: External Blocking</i>
PQS[4] . Blo TripCmd	<i>Signal: Trip Command blocked</i>
PQS[4] . ExBlo TripCmd	<i>Signal: External Blocking of the Trip Command</i>
PQS[4] . Alarm	<i>Signal: Alarm Power Protection</i>
PQS[4] . Trip	<i>Signal: Trip Power Protection</i>
PQS[4] . TripCmd	<i>Signal: Trip Command</i>
PQS[4] . ExBlo1-I	<i>Module input state: External blocking</i>
PQS[4] . ExBlo2-I	<i>Module input state: External blocking</i>
PQS[4] . ExBlo TripCmd-I	<i>Module input state: External Blocking of the Trip Command</i>
PQS[5] . active	<i>Signal: active</i>
PQS[5] . ExBlo	<i>Signal: External Blocking</i>
PQS[5] . Blo TripCmd	<i>Signal: Trip Command blocked</i>
PQS[5] . ExBlo TripCmd	<i>Signal: External Blocking of the Trip Command</i>

1..n, Assignment List	Description
PQS[5] . Alarm	<i>Signal: Alarm Power Protection</i>
PQS[5] . Trip	<i>Signal: Trip Power Protection</i>
PQS[5] . TripCmd	<i>Signal: Trip Command</i>
PQS[5] . ExBlo1-I	<i>Module input state: External blocking</i>
PQS[5] . ExBlo2-I	<i>Module input state: External blocking</i>
PQS[5] . ExBlo TripCmd-I	<i>Module input state: External Blocking of the Trip Command</i>
PQS[6] . active	<i>Signal: active</i>
PQS[6] . ExBlo	<i>Signal: External Blocking</i>
PQS[6] . Blo TripCmd	<i>Signal: Trip Command blocked</i>
PQS[6] . ExBlo TripCmd	<i>Signal: External Blocking of the Trip Command</i>
PQS[6] . Alarm	<i>Signal: Alarm Power Protection</i>
PQS[6] . Trip	<i>Signal: Trip Power Protection</i>
PQS[6] . TripCmd	<i>Signal: Trip Command</i>
PQS[6] . ExBlo1-I	<i>Module input state: External blocking</i>
PQS[6] . ExBlo2-I	<i>Module input state: External blocking</i>
PQS[6] . ExBlo TripCmd-I	<i>Module input state: External Blocking of the Trip Command</i>
PF[1] . active	<i>Signal: active</i>
PF[1] . ExBlo	<i>Signal: External Blocking</i>
PF[1] . Blo TripCmd	<i>Signal: Trip Command blocked</i>
PF[1] . ExBlo TripCmd	<i>Signal: External Blocking of the Trip Command</i>
PF[1] . Alarm	<i>Signal: Alarm Power Factor</i>
PF[1] . Trip	<i>Signal: Trip Power Factor</i>
PF[1] . TripCmd	<i>Signal: Trip Command</i>
PF[1] . Compensator	<i>Signal: Compensation Signal</i>
PF[1] . Impossible	<i>Signal: Alarm Power Factor Impossible</i>
PF[1] . ExBlo1-I	<i>Module input state: External blocking</i>
PF[1] . ExBlo2-I	<i>Module input state: External blocking</i>
PF[1] . ExBlo TripCmd-I	<i>Module input state: External Blocking of the Trip Command</i>
PF[2] . active	<i>Signal: active</i>
PF[2] . ExBlo	<i>Signal: External Blocking</i>
PF[2] . Blo TripCmd	<i>Signal: Trip Command blocked</i>

1..n, Assignment List	Description
PF[2] . ExBlo TripCmd	<i>Signal: External Blocking of the Trip Command</i>
PF[2] . Alarm	<i>Signal: Alarm Power Factor</i>
PF[2] . Trip	<i>Signal: Trip Power Factor</i>
PF[2] . TripCmd	<i>Signal: Trip Command</i>
PF[2] . Compensator	<i>Signal: Compensation Signal</i>
PF[2] . Impossible	<i>Signal: Alarm Power Factor Impossible</i>
PF[2] . ExBlo1-I	<i>Module input state: External blocking</i>
PF[2] . ExBlo2-I	<i>Module input state: External blocking</i>
PF[2] . ExBlo TripCmd-I	<i>Module input state: External Blocking of the Trip Command</i>
Q->&V< . active	<i>Signal: active</i>
Q->&V< . ExBlo	<i>Signal: External Blocking</i>
Q->&V< . Fuse Fail VT Blo	<i>Signal: Blocked by Fuse Failure (VT)</i>
Q->&V< . Alarm	<i>Signal: Alarm Reactive Power Undervoltage Protection</i>
Q->&V< . Decoupling Distr. Generator	<i>Signal: Decoupling of the (local) Energy Generator/Resource</i>
Q->&V< . Decoupling PCC	<i>Signal: Decoupling at the Point of Common Coupling</i>
Q->&V< . Power Angle	<i>Signal: Admissible power angle exceeded</i>
Q->&V< . Reactive Power Thres	<i>Signal: Admissible Reactive Power Threshold exceeded</i>
Q->&V< . VLL too low	<i>Signal: Line-to-Line voltage too low</i>
Q->&V< . ExBlo1-I	<i>Module input state: External blocking1</i>
Q->&V< . ExBlo2-I	<i>Module input state: External blocking2</i>
ReCon[1] . active	<i>Signal: active</i>
ReCon[1] . ExBlo	<i>Signal: External Blocking</i>
ReCon[1] . Blo by Meas Circuit Superv	<i>Signal: Module blocked by measuring cirucuit supervision</i>
ReCon[1] . Release Energy Resource	<i>Signal: Release Energy Resource.</i>
ReCon[1] . ExBlo1-I	<i>Module input state: External blocking1</i>
ReCon[1] . ExBlo2-I	<i>Module input state: External blocking2</i>
ReCon[1] . V Ext Release PCC-I	<i>Module input state: Release signal is being generated by the PCC (External Release)</i>

1..n, Assignment List	Description
ReCon[1] . PCC Fuse Fail VT-I	<i>State of the module input: Blocking if the fuse of a voltage transformer has tripped at the PCC.</i>
ReCon[1] . reconnected-I	<i>This signal indicates the state "reconnected" (mains parallel).</i>
ReCon[1] . Decoupling1-I	<i>Decoupling function, that blocks the reconnection.</i>
ReCon[1] . Decoupling2-I	<i>Decoupling function, that blocks the reconnection.</i>
ReCon[1] . Decoupling3-I	<i>Decoupling function, that blocks the reconnection.</i>
ReCon[1] . Decoupling4-I	<i>Decoupling function, that blocks the reconnection.</i>
ReCon[1] . Decoupling5-I	<i>Decoupling function, that blocks the reconnection.</i>
ReCon[1] . Decoupling6-I	<i>Decoupling function, that blocks the reconnection.</i>
ReCon[2] . active	<i>Signal: active</i>
ReCon[2] . ExBlo	<i>Signal: External Blocking</i>
ReCon[2] . Blo by Meas Circuit Superv	<i>Signal: Module blocked by measuring circuit supervision</i>
ReCon[2] . Release Energy Resource	<i>Signal: Release Energy Resource.</i>
ReCon[2] . ExBlo1-I	<i>Module input state: External blocking1</i>
ReCon[2] . ExBlo2-I	<i>Module input state: External blocking2</i>
ReCon[2] . V Ext Release PCC-I	<i>Module input state: Release signal is being generated by the PCC (External Release)</i>
ReCon[2] . PCC Fuse Fail VT-I	<i>State of the module input: Blocking if the fuse of a voltage transformer has tripped at the PCC.</i>
ReCon[2] . reconnected-I	<i>This signal indicates the state "reconnected" (mains parallel).</i>
ReCon[2] . Decoupling1-I	<i>Decoupling function, that blocks the reconnection.</i>
ReCon[2] . Decoupling2-I	<i>Decoupling function, that blocks the reconnection.</i>
ReCon[2] . Decoupling3-I	<i>Decoupling function, that blocks the reconnection.</i>
ReCon[2] . Decoupling4-I	<i>Decoupling function, that blocks the reconnection.</i>
ReCon[2] . Decoupling5-I	<i>Decoupling function, that blocks the reconnection.</i>

1..n, Assignment List	Description
ReCon[2] . Decoupling6-I	<i>Decoupling function, that blocks the reconnection.</i>
Sync . active	<i>Signal: active</i>
Sync . ExBlo	<i>Signal: External Blocking</i>
Sync . LiveBus	<i>Signal: Live-Bus flag: 1=Live-Bus, 0=Voltage is below the LiveBus threshold</i>
Sync . LiveLine	<i>Signal: Live Line flag: 1=Live-Line, 0=Voltage is below the LiveLine threshold</i>
Sync . SynchronRunTiming	<i>Signal: Synchron-Run-timer is timing (This timer starts when Close-Initiate is coming and stops if breaker is closed. Timeout means synchronizing failed.)</i>
Sync . SynchronFailed	<i>Signal: This signal indicates a failed synchronization. It is set for 5s when the circuit breaker is still open after the Synchron-Run-timer has timed out.</i>
Sync . SyncOverridden	<i>Signal:Synchronism Check is overridden because one of the Synchronism overriding conditions (DB/DL or ExtBypass) is met.</i>
Sync . VDiffTooHigh	<i>Signal: Voltage difference between bus and line too high.</i>
Sync . SlipTooHigh	<i>Signal: Frequency difference (slip frequency) between bus and line voltages too high.</i>
Sync . AngleDiffTooHigh	<i>Signal: Phase Angle difference between bus and line voltages too high.</i>
Sync . Sys-in-Sync	<i>Signal: Bus and line voltages are in synchronism according to the system synchronism criteria.</i>
Sync . Ready to Close	<i>Signal: Ready to Close</i>
Sync . ExBlo1-I	<i>Module input state: External blocking1</i>
Sync . ExBlo2-I	<i>Module input state: External blocking2</i>
Sync . Bypass-I	<i>State of the module input: The Synchrocheck will be bypassed if the state of the assigned signal (logic input) becomes true.</i>
Sync . CBCloseInitiate-I	<i>State of the module input: Breaker Close Initiate with synchronism check from any control sources (e.g. HMI / SCADA). If the state of the assigned signal becomes true, a Breaker Close will be initiated (Trigger Source).</i>
LoE-Z1[1] . active	<i>Signal: active</i>
LoE-Z1[1] . ExBlo	<i>Signal: External Blocking</i>
LoE-Z1[1] . Blo TripCmd	<i>Signal: Trip Command blocked</i>
LoE-Z1[1] . ExBlo TripCmd	<i>Signal: External Blocking of the Trip Command</i>
LoE-Z1[1] . Alarm	<i>Signal: Alarm Loss of Excitation</i>
LoE-Z1[1] . Trip	<i>Signal: Trip</i>

1..n, Assignment List	Description
LoE-Z1[1] . TripCmd	<i>Signal: Trip Command</i>
LoE-Z1[1] . FastTrip V<	<i>Signal: FastTrip V<</i>
LoE-Z1[1] . Blo by MeasCircSupv	<i>Blocked by Measuring Circuit Supervision</i>
LoE-Z1[1] . ExBlo1-I	<i>Module input state: External blocking1</i>
LoE-Z1[1] . ExBlo2-I	<i>Module input state: External blocking2</i>
LoE-Z1[1] . ExBlo TripCmd-I	<i>Module input state: External Blocking of the Trip Command</i>
LoE-Z2[1] . active	<i>Signal: active</i>
LoE-Z2[1] . ExBlo	<i>Signal: External Blocking</i>
LoE-Z2[1] . Blo TripCmd	<i>Signal: Trip Command blocked</i>
LoE-Z2[1] . ExBlo TripCmd	<i>Signal: External Blocking of the Trip Command</i>
LoE-Z2[1] . Alarm	<i>Signal: Alarm Loss of Excitation</i>
LoE-Z2[1] . Trip	<i>Signal: Trip</i>
LoE-Z2[1] . TripCmd	<i>Signal: Trip Command</i>
LoE-Z2[1] . FastTrip V<	<i>Signal: FastTrip V<</i>
LoE-Z2[1] . Blo by MeasCircSupv	<i>Blocked by Measuring Circuit Supervision</i>
LoE-Z2[1] . ExBlo1-I	<i>Module input state: External blocking1</i>
LoE-Z2[1] . ExBlo2-I	<i>Module input state: External blocking2</i>
LoE-Z2[1] . ExBlo TripCmd-I	<i>Module input state: External Blocking of the Trip Command</i>
LoE-Z1[2] . active	<i>Signal: active</i>
LoE-Z1[2] . ExBlo	<i>Signal: External Blocking</i>
LoE-Z1[2] . Blo TripCmd	<i>Signal: Trip Command blocked</i>
LoE-Z1[2] . ExBlo TripCmd	<i>Signal: External Blocking of the Trip Command</i>
LoE-Z1[2] . Alarm	<i>Signal: Alarm Loss of Excitation</i>
LoE-Z1[2] . Trip	<i>Signal: Trip</i>
LoE-Z1[2] . TripCmd	<i>Signal: Trip Command</i>
LoE-Z1[2] . FastTrip V<	<i>Signal: FastTrip V<</i>
LoE-Z1[2] . Blo by MeasCircSupv	<i>Blocked by Measuring Circuit Supervision</i>
LoE-Z1[2] . ExBlo1-I	<i>Module input state: External blocking1</i>

1..n, Assignment List	Description
LoE-Z1[2] . ExBlo2-I	<i>Module input state: External blocking2</i>
LoE-Z1[2] . ExBlo TripCmd-I	<i>Module input state: External Blocking of the Trip Command</i>
LoE-Z2[2] . active	<i>Signal: active</i>
LoE-Z2[2] . ExBlo	<i>Signal: External Blocking</i>
LoE-Z2[2] . Blo TripCmd	<i>Signal: Trip Command blocked</i>
LoE-Z2[2] . ExBlo TripCmd	<i>Signal: External Blocking of the Trip Command</i>
LoE-Z2[2] . Alarm	<i>Signal: Alarm Loss of Excitation</i>
LoE-Z2[2] . Trip	<i>Signal: Trip</i>
LoE-Z2[2] . TripCmd	<i>Signal: Trip Command</i>
LoE-Z2[2] . FastTrip V<	<i>Signal: FastTrip V<</i>
LoE-Z2[2] . Blo by MeasCircSupv	<i>Blocked by Measuring Circuit Supervision</i>
LoE-Z2[2] . ExBlo1-I	<i>Module input state: External blocking1</i>
LoE-Z2[2] . ExBlo2-I	<i>Module input state: External blocking2</i>
LoE-Z2[2] . ExBlo TripCmd-I	<i>Module input state: External Blocking of the Trip Command</i>
OST . active	<i>Signal: active</i>
OST . ExBlo	<i>Signal: External Blocking</i>
OST . Blo TripCmd	<i>Signal: Trip Command blocked</i>
OST . ExBlo TripCmd	<i>Signal: External Blocking of the Trip Command</i>
OST . Blo by MeasCircSupv	<i>Blocked by Measuring Circuit Supervision</i>
OST . Int.blocked	<i>Signal: The module is internally blocked because the »Max. dwell time« has expired.</i>
OST . Pickup Blinder A	<i>Signal: The impedance is within the MHO circle on the right side of Blinder A.</i>
OST . Pickup Blinder B	<i>Signal: The impedance is within the MHO circle on the left side of Blinder B.</i>
OST . Pickup Mho	<i>Signal: The impedance is within the characteristic.</i>
OST . Swinging	<i>Signal: The impedance is within the instable swing zone (i. e. within the characteristic and inside the borders defined by Blinders A and B).</i>
OST . Start	<i>Signal, that a power swing (or an Out-of-step event) has been detected. The state of this signal becomes true as soon as the impedance traverses the first blinder, and it gets reset when the characteristic area is left.</i>

1..n, Assignment List	Description
OST . Pole slipping	Signal, that pole slipping has been detected. The state of this signal becomes true as soon as the impedance reaches 180°, and it gets reset when the characteristic area is left.
OST . Operate	Signal: The module is ready to send a trip command. The state of this signal becomes true as soon as the impedance traverses the second blinder, and it gets reset after the impedance has left the MHO circle.
OST . Alarm	Signal that the module has started, i. e. the impedance has entered the MHO circle and crossed the first blinder. »Alarm« is reset when the measured impedance has left the MHO circle without an »Operate«, or when the »Trip« signal is reset. If »Max.Num.Pole Slips« is greater than 1, the »Alarm« signal stays active until the »Trip« signal is reset or the »Reset Time« has expired.
OST . Trip	Signal: Trip
OST . TripCmd	Signal: Trip Command
OST . Syst.is sym.	Signal that the system state is symmetrical, i. e. the negative-sequence current is below »I2 max«, and the positive-sequence current is above »I1 min«.
OST . Blo dZ/dt	Signal: The module has detected a system fault based on the »rate of impedance change per time«, and therefore it has blocked itself.
OST . Blo min.dwell time	Signal: The module has detected a system fault based on the »minimum dwell time«, and therefore it has blocked itself.
OST . ExBlo1-I	Module input state: External blocking1
OST . ExBlo2-I	Module input state: External blocking2
OST . ExBlo TripCmd-I	Module input state: External Blocking of the Trip Command
V/f>[1] . active	Signal: active
V/f>[1] . ExBlo	Signal: External Blocking
V/f>[1] . Blo TripCmd	Signal: Trip Command blocked
V/f>[1] . ExBlo TripCmd	Signal: External Blocking of the Trip Command
V/f>[1] . Alarm	Signal: Alarm Overexcitation
V/f>[1] . Trip	Signal: Trip
V/f>[1] . TripCmd	Signal: Trip Command
V/f>[1] . ExBlo1-I	Module input state: External blocking1
V/f>[1] . ExBlo2-I	Module input state: External blocking2
V/f>[1] . ExBlo TripCmd-I	Module input state: External Blocking of the Trip Command
V/f>[2] . active	Signal: active
V/f>[2] . ExBlo	Signal: External Blocking
V/f>[2] . Blo TripCmd	Signal: Trip Command blocked

1..n, Assignment List	Description
V/f>[2] . ExBlo TripCmd	Signal: External Blocking of the Trip Command
V/f>[2] . Alarm	Signal: Alarm Overexcitation
V/f>[2] . Trip	Signal: Trip
V/f>[2] . TripCmd	Signal: Trip Command
V/f>[2] . ExBlo1-I	Module input state: External blocking1
V/f>[2] . ExBlo2-I	Module input state: External blocking2
V/f>[2] . ExBlo TripCmd-I	Module input state: External Blocking of the Trip Command
InEn . active	Signal: active
InEn . ExBlo	Signal: External Blocking
InEn . Blo TripCmd	Signal: Trip Command blocked
InEn . ExBlo TripCmd	Signal: External Blocking of the Trip Command
InEn . Alarm	Signal: Inadvertent Energization
InEn . Trip	Signal: Trip
InEn . TripCmd	Signal: Trip Command
InEn . Blo by MeasCircSupv	Blocked by Measuring Circuit Supervision
InEn . ExBlo1-I	Module input state: External blocking1
InEn . ExBlo2-I	Module input state: External blocking2
InEn . ExBlo TripCmd-I	Module input state: External Blocking of the Trip Command
Z[1] . active	Signal: active
Z[1] . ExBlo	Signal: External Blocking
Z[1] . Blo TripCmd	Signal: Trip Command blocked
Z[1] . ExBlo TripCmd	Signal: External Blocking of the Trip Command
Z[1] . Blo by Power Swing	Signal: Distance Protection blocked by Power Swing detection
Z[1] . Blo by LB	Signal: Distance Protection blocked by Load Blinder module
Z[1] . Blo by MeasCircSupv	Blocked by Measuring Circuit Supervision
Z[1] . Started	Signal: Distance Protection has been started.
Z[1] . Alarm	Alarm
Z[1] . Trip	Trip
Z[1] . TripCmd	Signal: Trip Command

1..n, Assignment List	Description
Z[1] . Fault type L1-L2	<i>Fault type: L1-L2</i>
Z[1] . Fault type L2-L3	<i>Fault type: L2-L3</i>
Z[1] . Fault type L3-L1	<i>Fault type: L3-L1</i>
Z[1] . Fault type L1-L2-L3	<i>Fault type: L1-L2-L3</i>
Z[1] . DefaultSet	<i>Signal: Default Parameter Set</i>
Z[1] . AdaptSet 1	<i>Signal: Adaptive Parameter 1</i>
Z[1] . AdaptSet 2	<i>Signal: Adaptive Parameter 2</i>
Z[1] . ExBlo1-I	<i>Module input state: External blocking1</i>
Z[1] . ExBlo2-I	<i>Module input state: External blocking2</i>
Z[1] . ExBlo TripCmd-I	<i>Module input state: External Blocking of the Trip Command</i>
Z[1] . Blo by Power Swing-I	<i>Module input state: Blocking (of the distance protection) by Power Swing detection</i>
Z[1] . Blo by LB-I	<i>Module input state: Blocking (of the distance protection) by Load Blinder module</i>
Z[1] . AdaptSet1-I	<i>Module input state: Adaptive Parameter1</i>
Z[1] . AdaptSet2-I	<i>Module input state: Adaptive Parameter2</i>
Z[2] . active	<i>Signal: active</i>
Z[2] . ExBlo	<i>Signal: External Blocking</i>
Z[2] . Blo TripCmd	<i>Signal: Trip Command blocked</i>
Z[2] . ExBlo TripCmd	<i>Signal: External Blocking of the Trip Command</i>
Z[2] . Blo by Power Swing	<i>Signal: Distance Protection blocked by Power Swing detection</i>
Z[2] . Blo by LB	<i>Signal: Distance Protection blocked by Load Blinder module</i>
Z[2] . Blo by MeasCircSupv	<i>Blocked by Measuring Circuit Supervision</i>
Z[2] . Started	<i>Signal: Distance Protection has been started.</i>
Z[2] . Alarm	<i>Alarm</i>
Z[2] . Trip	<i>Trip</i>
Z[2] . TripCmd	<i>Signal: Trip Command</i>
Z[2] . Fault type L1-L2	<i>Fault type: L1-L2</i>
Z[2] . Fault type L2-L3	<i>Fault type: L2-L3</i>
Z[2] . Fault type L3-L1	<i>Fault type: L3-L1</i>

1..n, Assignment List	Description
Z[2] . Fault type L1-L2-L3	<i>Fault type: L1-L2-L3</i>
Z[2] . DefaultSet	<i>Signal: Default Parameter Set</i>
Z[2] . AdaptSet 1	<i>Signal: Adaptive Parameter 1</i>
Z[2] . AdaptSet 2	<i>Signal: Adaptive Parameter 2</i>
Z[2] . ExBlo1-I	<i>Module input state: External blocking1</i>
Z[2] . ExBlo2-I	<i>Module input state: External blocking2</i>
Z[2] . ExBlo TripCmd-I	<i>Module input state: External Blocking of the Trip Command</i>
Z[2] . Blo by Power Swing-I	<i>Module input state: Blocking (of the distance protection) by Power Swing detection</i>
Z[2] . Blo by LB-I	<i>Module input state: Blocking (of the distance protection) by Load Blinder module</i>
Z[2] . AdaptSet1-I	<i>Module input state: Adaptive Parameter1</i>
Z[2] . AdaptSet2-I	<i>Module input state: Adaptive Parameter2</i>
LB . active	<i>Signal: active</i>
LB . ExBlo	<i>Signal: External Blocking</i>
LB . Blo by MeasCircSupv	<i>Blocked by Measuring Circuit Supervision</i>
LB . Pickup	<i>Signal that the measured system impedance is within the Load Blinder area.</i>
LB . Operate	<i>Signal that the measured system impedance is within the Load Blinder area for at least the duration t-Delay.</i>
LB . ExBlo1-I	<i>Module input state: External blocking1</i>
LB . ExBlo2-I	<i>Module input state: External blocking2</i>
PSB . active	<i>Signal: active</i>
PSB . ExBlo	<i>Signal: External Blocking</i>
PSB . Blo by MeasCircSupv	<i>Blocked by Measuring Circuit Supervision</i>
PSB . Int.blocked	<i>Signal: The module is internally blocked because the »Max. dwell time« has expired.</i>
PSB . Pickup Blinder A	<i>Signal: The impedance is within the MHO circle on the right side of Blinder A.</i>
PSB . Pickup Blinder B	<i>Signal: The impedance is within the MHO circle on the left side of Blinder B.</i>
PSB . Pickup Mho	<i>Signal: The impedance is within the characteristic.</i>
PSB . Swinging	<i>Signal: The impedance is within the instable swing zone (i. e. within the characteristic and inside the borders defined by Blinders A and B).</i>

1..n, Assignment List	Description
PSB . Start	<i>Signal, that a power swing (or an Out-of-step event) has been detected. The state of this signal becomes true as soon as the impedance traverses the first blinder, and it gets reset when the characteristic area is left.</i>
PSB . Pole slipping	<i>Signal, that pole slipping has been detected. The state of this signal becomes true as soon as the impedance reaches 180°, and it gets reset when the characteristic area is left.</i>
PSB . Syst.is sym.	<i>Signal that the system state is symmetrical, i. e. the negative-sequence current is below »I2 max«, and the positive-sequence current is above »I1 min«.</i>
PSB . Blo dZ/dt	<i>Signal: The module has detected a system fault based on the »rate of impedance change per time«, and therefore it has blocked itself.</i>
PSB . Blo min.dwell time	<i>Signal: The module has detected a system fault based on the »minimum dwell time«, and therefore it has blocked itself.</i>
PSB . ExBlo1-I	<i>Module input state: External blocking1</i>
PSB . ExBlo2-I	<i>Module input state: External blocking2</i>
SOTF . active	<i>Signal: active</i>
SOTF . ExBlo	<i>Signal: External Blocking</i>
SOTF . Ex rev Interl	<i>Signal: External reverse Interlocking</i>
SOTF . enabled	<i>Signal: Switch Onto Fault enabled. This Signal can be used to modify Overcurrent Protection Settings.</i>
SOTF . I<	<i>Signal: No Load Current.</i>
SOTF . ExBlo1-I	<i>Module input state: External blocking</i>
SOTF . ExBlo2-I	<i>Module input state: External blocking</i>
SOTF . Ex rev Interl-I	<i>Module input state: External reverse interlocking</i>
SOTF . Ext SOTF-I	<i>Module input state: External Switch Onto Fault Alarm</i>
CLPU . active	<i>Signal: active</i>
CLPU . ExBlo	<i>Signal: External Blocking</i>
CLPU . Ex rev Interl	<i>Signal: External reverse Interlocking</i>
CLPU . enabled	<i>Signal: Cold Load enabled</i>
CLPU . detected	<i>Signal: Cold Load detected</i>
CLPU . I<	<i>Signal: No Load Current.</i>
CLPU . Load Inrush	<i>Signal: Load Inrush</i>
CLPU . Settle Time	<i>Signal: Settle Time</i>
CLPU . ExBlo1-I	<i>Module input state: External blocking</i>
CLPU . ExBlo2-I	<i>Module input state: External blocking</i>

1..n, Assignment List	Description
CLPU . Ex rev Interl-I	<i>Module input state: External reverse interlocking</i>
ExP[1] . active	<i>Signal: active</i>
ExP[1] . ExBlo	<i>Signal: External Blocking</i>
ExP[1] . Blo TripCmd	<i>Signal: Trip Command blocked</i>
ExP[1] . ExBlo TripCmd	<i>Signal: External Blocking of the Trip Command</i>
ExP[1] . Alarm	<i>Signal: Alarm</i>
ExP[1] . Trip	<i>Signal: Trip</i>
ExP[1] . TripCmd	<i>Signal: Trip Command</i>
ExP[1] . ExBlo1-I	<i>Module input state: External blocking1</i>
ExP[1] . ExBlo2-I	<i>Module input state: External blocking2</i>
ExP[1] . ExBlo TripCmd-I	<i>Module input state: External Blocking of the Trip Command</i>
ExP[1] . Alarm-I	<i>Module input state: Alarm</i>
ExP[1] . Trip-I	<i>Module input state: Trip</i>
ExP[2] . active	<i>Signal: active</i>
ExP[2] . ExBlo	<i>Signal: External Blocking</i>
ExP[2] . Blo TripCmd	<i>Signal: Trip Command blocked</i>
ExP[2] . ExBlo TripCmd	<i>Signal: External Blocking of the Trip Command</i>
ExP[2] . Alarm	<i>Signal: Alarm</i>
ExP[2] . Trip	<i>Signal: Trip</i>
ExP[2] . TripCmd	<i>Signal: Trip Command</i>
ExP[2] . ExBlo1-I	<i>Module input state: External blocking1</i>
ExP[2] . ExBlo2-I	<i>Module input state: External blocking2</i>
ExP[2] . ExBlo TripCmd-I	<i>Module input state: External Blocking of the Trip Command</i>
ExP[2] . Alarm-I	<i>Module input state: Alarm</i>
ExP[2] . Trip-I	<i>Module input state: Trip</i>
ExP[3] . active	<i>Signal: active</i>
ExP[3] . ExBlo	<i>Signal: External Blocking</i>
ExP[3] . Blo TripCmd	<i>Signal: Trip Command blocked</i>
ExP[3] . ExBlo TripCmd	<i>Signal: External Blocking of the Trip Command</i>
ExP[3] . Alarm	<i>Signal: Alarm</i>
ExP[3] . Trip	<i>Signal: Trip</i>
ExP[3] . TripCmd	<i>Signal: Trip Command</i>

1..n, Assignment List	Description
Exp[3] . ExBlo1-I	<i>Module input state: External blocking1</i>
Exp[3] . ExBlo2-I	<i>Module input state: External blocking2</i>
Exp[3] . ExBlo TripCmd-I	<i>Module input state: External Blocking of the Trip Command</i>
Exp[3] . Alarm-I	<i>Module input state: Alarm</i>
Exp[3] . Trip-I	<i>Module input state: Trip</i>
Exp[4] . active	<i>Signal: active</i>
Exp[4] . ExBlo	<i>Signal: External Blocking</i>
Exp[4] . Blo TripCmd	<i>Signal: Trip Command blocked</i>
Exp[4] . ExBlo TripCmd	<i>Signal: External Blocking of the Trip Command</i>
Exp[4] . Alarm	<i>Signal: Alarm</i>
Exp[4] . Trip	<i>Signal: Trip</i>
Exp[4] . TripCmd	<i>Signal: Trip Command</i>
Exp[4] . ExBlo1-I	<i>Module input state: External blocking1</i>
Exp[4] . ExBlo2-I	<i>Module input state: External blocking2</i>
Exp[4] . ExBlo TripCmd-I	<i>Module input state: External Blocking of the Trip Command</i>
Exp[4] . Alarm-I	<i>Module input state: Alarm</i>
Exp[4] . Trip-I	<i>Module input state: Trip</i>
Ext Sudd Press . active	<i>Signal: active</i>
Ext Sudd Press . ExBlo	<i>Signal: External Blocking</i>
Ext Sudd Press . Blo TripCmd	<i>Signal: Trip Command blocked</i>
Ext Sudd Press . ExBlo TripCmd	<i>Signal: External Blocking of the Trip Command</i>
Ext Sudd Press . Alarm	<i>Signal: Alarm</i>
Ext Sudd Press . Trip	<i>Signal: Trip</i>
Ext Sudd Press . TripCmd	<i>Signal: Trip Command</i>
Ext Sudd Press . ExBlo1-I	<i>Module input state: External blocking1</i>
Ext Sudd Press . ExBlo2-I	<i>Module input state: External blocking2</i>
Ext Sudd Press . ExBlo TripCmd-I	<i>Module input state: External Blocking of the Trip Command</i>
Ext Sudd Press . Alarm-I	<i>Module input state: Alarm</i>
Ext Sudd Press . Trip-I	<i>Module input state: Trip</i>
Ext Oil Temp . active	<i>Signal: active</i>

1..n, Assignment List	Description
Ext Oil Temp . ExBlo	<i>Signal: External Blocking</i>
Ext Oil Temp . Blo TripCmd	<i>Signal: Trip Command blocked</i>
Ext Oil Temp . ExBlo TripCmd	<i>Signal: External Blocking of the Trip Command</i>
Ext Oil Temp . Alarm	<i>Signal: Alarm</i>
Ext Oil Temp . Trip	<i>Signal: Trip</i>
Ext Oil Temp . TripCmd	<i>Signal: Trip Command</i>
Ext Oil Temp . ExBlo1-I	<i>Module input state: External blocking1</i>
Ext Oil Temp . ExBlo2-I	<i>Module input state: External blocking2</i>
Ext Oil Temp . ExBlo TripCmd-I	<i>Module input state: External Blocking of the Trip Command</i>
Ext Oil Temp . Alarm-I	<i>Module input state: Alarm</i>
Ext Oil Temp . Trip-I	<i>Module input state: Trip</i>
Ext Temp Superv[1] . active	<i>Signal: active</i>
Ext Temp Superv[1] . ExBlo	<i>Signal: External Blocking</i>
Ext Temp Superv[1] . Blo TripCmd	<i>Signal: Trip Command blocked</i>
Ext Temp Superv[1] . ExBlo TripCmd	<i>Signal: External Blocking of the Trip Command</i>
Ext Temp Superv[1] . Alarm	<i>Signal: Alarm</i>
Ext Temp Superv[1] . Trip	<i>Signal: Trip</i>
Ext Temp Superv[1] . TripCmd	<i>Signal: Trip Command</i>
Ext Temp Superv[1] . ExBlo1-I	<i>Module input state: External blocking1</i>
Ext Temp Superv[1] . ExBlo2-I	<i>Module input state: External blocking2</i>
Ext Temp Superv[1] . ExBlo TripCmd-I	<i>Module input state: External Blocking of the Trip Command</i>
Ext Temp Superv[1] . Alarm-I	<i>Module input state: Alarm</i>
Ext Temp Superv[1] . Trip-I	<i>Module input state: Trip</i>

1..n, Assignment List	Description
Ext Temp Superv[2] . active	<i>Signal: active</i>
Ext Temp Superv[2] . ExBlo	<i>Signal: External Blocking</i>
Ext Temp Superv[2] . Blo TripCmd	<i>Signal: Trip Command blocked</i>
Ext Temp Superv[2] . ExBlo TripCmd	<i>Signal: External Blocking of the Trip Command</i>
Ext Temp Superv[2] . Alarm	<i>Signal: Alarm</i>
Ext Temp Superv[2] . Trip	<i>Signal: Trip</i>
Ext Temp Superv[2] . TripCmd	<i>Signal: Trip Command</i>
Ext Temp Superv[2] . ExBlo1-I	<i>Module input state: External blocking1</i>
Ext Temp Superv[2] . ExBlo2-I	<i>Module input state: External blocking2</i>
Ext Temp Superv[2] . ExBlo TripCmd-I	<i>Module input state: External Blocking of the Trip Command</i>
Ext Temp Superv[2] . Alarm-I	<i>Module input state: Alarm</i>
Ext Temp Superv[2] . Trip-I	<i>Module input state: Trip</i>
Ext Temp Superv[3] . active	<i>Signal: active</i>
Ext Temp Superv[3] . ExBlo	<i>Signal: External Blocking</i>
Ext Temp Superv[3] . Blo TripCmd	<i>Signal: Trip Command blocked</i>
Ext Temp Superv[3] . ExBlo TripCmd	<i>Signal: External Blocking of the Trip Command</i>
Ext Temp Superv[3] . Alarm	<i>Signal: Alarm</i>
Ext Temp Superv[3] . Trip	<i>Signal: Trip</i>
Ext Temp Superv[3] . TripCmd	<i>Signal: Trip Command</i>
Ext Temp Superv[3] . ExBlo1-I	<i>Module input state: External blocking1</i>
Ext Temp Superv[3] . ExBlo2-I	<i>Module input state: External blocking2</i>

1..n, Assignment List	Description
Ext Temp Superv[3] . ExBlo TripCmd-I	<i>Module input state: External Blocking of the Trip Command</i>
Ext Temp Superv[3] . Alarm-I	<i>Module input state: Alarm</i>
Ext Temp Superv[3] . Trip-I	<i>Module input state: Trip</i>
URTD . Windg1 Superv	<i>Signal: Windg1, Channel Supervision. The value "1" reports a detected channel failure. (The value "0" means that this RTD channel is healthy.)</i>
URTD . Windg2 Superv	<i>Signal: Windg2, Channel Supervision. The value "1" reports a detected channel failure. (The value "0" means that this RTD channel is healthy.)</i>
URTD . Windg3 Superv	<i>Signal: Windg3, Channel Supervision. The value "1" reports a detected channel failure. (The value "0" means that this RTD channel is healthy.)</i>
URTD . Windg4 Superv	<i>Signal: Windg4, Channel Supervision. The value "1" reports a detected channel failure. (The value "0" means that this RTD channel is healthy.)</i>
URTD . Windg5 Superv	<i>Signal: Windg5, Channel Supervision. The value "1" reports a detected channel failure. (The value "0" means that this RTD channel is healthy.)</i>
URTD . Windg6 Superv	<i>Signal: Windg6, Channel Supervision. The value "1" reports a detected channel failure. (The value "0" means that this RTD channel is healthy.)</i>
URTD . MotBear1 Superv	<i>Signal: MotBear1, Channel Supervision. The value "1" reports a detected channel failure. (The value "0" means that this RTD channel is healthy.)</i>
URTD . MotBear2 Superv	<i>Signal: MotBear2, Channel Supervision. The value "1" reports a detected channel failure. (The value "0" means that this RTD channel is healthy.)</i>
URTD . LoadBear1 Superv	<i>Signal: LoadBear1, Channel Supervision. The value "1" reports a detected channel failure. (The value "0" means that this RTD channel is healthy.)</i>
URTD . LoadBear2 Superv	<i>Signal: LoadBear2, Channel Supervision. The value "1" reports a detected channel failure. (The value "0" means that this RTD channel is healthy.)</i>
URTD . Aux1 Superv	<i>Signal: Aux1, Channel Supervision. The value "1" reports a detected channel failure. (The value "0" means that this RTD channel is healthy.)</i>
URTD . Aux2 Superv	<i>Signal: Aux2, Channel Supervision. The value "1" reports a detected channel failure. (The value "0" means that this RTD channel is healthy.)</i>
URTD . Superv	<i>Signal: URTD Channel Supervision. The value "1" reports a detected channel failure. (The value "0" means that all RTD channels are healthy.)</i>
URTD . Connection active	<i>Signal: There is an active connection between the Temperature Detector (URTD) and the protective relay.</i>
URTD . Outs forced	<i>Signal: The State of at least one Relay Output has been set by force. That means that the state of at least one Relay is forced and hence does not show the state of the assigned signals.</i>
RTD . active	<i>Signal: active</i>

1..n, Assignment List	Description
RTD . ExBlo	<i>Signal: External Blocking</i>
RTD . Blo TripCmd	<i>Signal: Trip Command blocked</i>
RTD . ExBlo TripCmd	<i>Signal: External Blocking of the Trip Command</i>
RTD . Alarm	<i>Alarm RTD Temperature Protection</i>
RTD . Trip	<i>Signal: Trip</i>
RTD . TripCmd	<i>Signal: Trip Command</i>
RTD . Windg 1 Trip	<i>Winding 1 Signal: Trip</i>
RTD . Windg 1 Alarm	<i>Winding 1 Alarm RTD Temperature Protection</i>
RTD . Windg 1 Timeout Alarm	<i>Winding 1 Timeout Alarm</i>
RTD . Windg 1 Invalid	<i>Winding 1 Signal: Invalid Temperature Measurement Value (e.g caused by an defective or interrupted RTD Measurement)</i>
RTD . Windg 2 Trip	<i>Winding 2 Signal: Trip</i>
RTD . Windg 2 Alarm	<i>Winding 2 Alarm RTD Temperature Protection</i>
RTD . Windg 2 Timeout Alarm	<i>Winding 2 Timeout Alarm</i>
RTD . Windg 2 Invalid	<i>Winding 2 Signal: Invalid Temperature Measurement Value (e.g caused by an defective or interrupted RTD Measurement)</i>
RTD . Windg 3 Trip	<i>Winding 3 Signal: Trip</i>
RTD . Windg 3 Alarm	<i>Winding 3 Alarm RTD Temperature Protection</i>
RTD . Windg 3 Timeout Alarm	<i>Winding 3 Timeout Alarm</i>
RTD . Windg 3 Invalid	<i>Winding 3 Signal: Invalid Temperature Measurement Value (e.g caused by an defective or interrupted RTD Measurement)</i>
RTD . Windg 4 Trip	<i>Winding 4 Signal: Trip</i>
RTD . Windg 4 Alarm	<i>Winding 4 Alarm RTD Temperature Protection</i>
RTD . Windg 4 Timeout Alarm	<i>Winding 4 Timeout Alarm</i>
RTD . Windg 4 Invalid	<i>Winding 4 Signal: Invalid Temperature Measurement Value (e.g caused by an defective or interrupted RTD Measurement)</i>
RTD . Windg 5 Trip	<i>Winding 5 Signal: Trip</i>
RTD . Windg 5 Alarm	<i>Winding 5 Alarm RTD Temperature Protection</i>
RTD . Windg 5 Timeout Alarm	<i>Winding 5 Timeout Alarm</i>
RTD . Windg 5 Invalid	<i>Winding 5 Signal: Invalid Temperature Measurement Value (e.g caused by an defective or interrupted RTD Measurement)</i>

1..n, Assignment List	Description
RTD . Windg 6 Trip	<i>Winding 6 Signal: Trip</i>
RTD . Windg 6 Alarm	<i>Winding 6 Alarm RTD Temperature Protection</i>
RTD . Windg 6 Timeout Alarm	<i>Winding 6 Timeout Alarm</i>
RTD . Windg 6 Invalid	<i>Winding 6 Signal: Invalid Temperature Measurement Value (e.g caused by an defective or interrupted RTD Measurement)</i>
RTD . MotBear 1 Trip	<i>Motor Bearing 1 Signal: Trip</i>
RTD . MotBear 1 Alarm	<i>Motor Bearing 1 Alarm RTD Temperature Protection</i>
RTD . MotBear 1 Timeout Alarm	<i>Motor Bearing 1 Timeout Alarm</i>
RTD . MotBear 1 Invalid	<i>Motor Bearing 1 Signal: Invalid Temperature Measurement Value (e.g caused by an defective or interrupted RTD Measurement)</i>
RTD . MotBear 2 Trip	<i>Motor Bearing 2 Signal: Trip</i>
RTD . MotBear 2 Alarm	<i>Motor Bearing 2 Alarm RTD Temperature Protection</i>
RTD . MotBear 2 Timeout Alarm	<i>Motor Bearing 2 Timeout Alarm</i>
RTD . MotBear 2 Invalid	<i>Motor Bearing 2 Signal: Invalid Temperature Measurement Value (e.g caused by an defective or interrupted RTD Measurement)</i>
RTD . LoadBear 1 Trip	<i>Load Bearing 1 Signal: Trip</i>
RTD . LoadBear 1 Alarm	<i>Load Bearing 1 Alarm RTD Temperature Protection</i>
RTD . LoadBear 1 Timeout Alarm	<i>Load Bearing 1 Timeout Alarm</i>
RTD . LoadBear 1 Invalid	<i>Load Bearing 1 Signal: Invalid Temperature Measurement Value (e.g caused by an defective or interrupted RTD Measurement)</i>
RTD . LoadBear 2 Trip	<i>Load Bearing 2 Signal: Trip</i>
RTD . LoadBear 2 Alarm	<i>Load Bearing 2 Alarm RTD Temperature Protection</i>
RTD . LoadBear 2 Timeout Alarm	<i>Load Bearing 2 Timeout Alarm</i>
RTD . LoadBear 2 Invalid	<i>Load Bearing 2 Signal: Invalid Temperature Measurement Value (e.g caused by an defective or interrupted RTD Measurement)</i>
RTD . Aux1 Trip	<i>Auxiliary 1 Signal: Trip</i>
RTD . Aux1 Alarm	<i>Auxiliary 1 Alarm RTD Temperature Protection</i>
RTD . Aux1 Timeout Alarm	<i>Auxiliary 1 Timeout Alarm</i>
RTD . Aux1 Invalid	<i>Auxiliary 1 Signal: Invalid Temperature Measurement Value (e.g caused by an defective or interrupted RTD Measurement)</i>
RTD . Aux2 Trip	<i>Auxiliary 2 Signal: Trip</i>

1..n, Assignment List	Description
RTD . Aux2 Alarm	<i>Auxiliary 2 Alarm RTD Temperature Protection</i>
RTD . Aux2 Timeout Alarm	<i>Auxiliary 2 Timeout Alarm</i>
RTD . Aux2 Invalid	<i>Auxiliary 2 Signal: Invalid Temperature Measurement Value (e.g caused by an defective or interrupted RTD Measurement)</i>
RTD . Trip WD Group	<i>Trip all Windings</i>
RTD . Alarm WD Group	<i>Alarm all Windings</i>
RTD . TimeoutAlmWDGrp	<i>Timeout Alarm all Windings</i>
RTD . Windg Group Invalid	<i>Winding Group Signal: Invalid Temperature Measurement Value (e.g caused by an defective or interrupted RTD Measurement)</i>
RTD . Trip MB Group	<i>Trip all Motor Bearings</i>
RTD . Alarm MB Group	<i>Alarm all Motor Bearings</i>
RTD . TimeoutAlmMBGrp	<i>Timeout Alarm all Motor Bearings</i>
RTD . MotBear Group Invalid	<i>Motor Bearing Group Signal: Invalid Temperature Measurement Value (e.g caused by an defective or interrupted RTD Measurement)</i>
RTD . Trip LB Group	<i>Trip all Load Bearings</i>
RTD . Alarm LB Group	<i>Alarm all Load Bearings</i>
RTD . TimeoutAlmLBGrp	<i>Timeout Alarm all Load Bearings</i>
RTD . LoadBear Group Invalid	<i>Load Bearing Group Signal: Invalid Temperature Measurement Value (e.g caused by an defective or interrupted RTD Measurement)</i>
RTD . Trip Any Group	<i>Trip Any Group</i>
RTD . Alarm Any Group	<i>Alarm Any Group</i>
RTD . TimeoutAlmAnyGrp	<i>Timeout Alarm Any Group</i>
RTD . Trip Group 1	<i>Trip Group 1</i>
RTD . Trip Group 2	<i>Trip Group 2</i>
RTD . Timeout Alarm	<i>Alarm timeout expired</i>
RTD . Trip Aux Group	<i>Trip Auxiliary Group</i>
RTD . Alarm Aux Group	<i>Alarm Auxiliary Group</i>
RTD . TimeoutAlmAuxGrp	<i>Timeout Alarm Auxiliary Group</i>
RTD . AuxGrpInvalid	<i>Invalid Auxiliary Group</i>
RTD . ExBlo1-I	<i>Module input state: External blocking1</i>
RTD . ExBlo2-I	<i>Module input state: External blocking2</i>

1..n, Assignment List	Description
RTD . ExBlo TripCmd-I	<i>Module input state: External Blocking of the Trip Command</i>
CBF . active	<i>Signal: active</i>
CBF . ExBlo	<i>Signal: External Blocking</i>
CBF . Waiting for Trigger	<i>Waiting for Trigger</i>
CBF . running	<i>Signal: CBF-Module started</i>
CBF . Alarm	<i>Signal: Circuit Breaker Failure</i>
CBF . Lockout	<i>Signal: Lockout</i>
CBF . Res Lockout	<i>Signal: Reset Lockout</i>
CBF . ExBlo1-I	<i>Module input state: External blocking1</i>
CBF . ExBlo2-I	<i>Module input state: External blocking2</i>
CBF . Trigger1-I	<i>Module Input: Trigger that will start the CBF</i>
CBF . Trigger2-I	<i>Module Input: Trigger that will start the CBF</i>
CBF . Trigger3-I	<i>Module Input: Trigger that will start the CBF</i>
TCS . active	<i>Signal: active</i>
TCS . ExBlo	<i>Signal: External Blocking</i>
TCS . Alarm	<i>Signal: Alarm Trip Circuit Supervision</i>
TCS . Not Possible	<i>Not possible because no state indicator assigned to the breaker.</i>
TCS . Aux ON-I	<i>Module Input State: Position indicator/check-back signal of the CB (52a)</i>
TCS . Aux OFF-I	<i>Module input state: Position indicator/check-back signal of the CB (52b)</i>
TCS . ExBlo1-I	<i>Module input state: External blocking1</i>
TCS . ExBlo2-I	<i>Module input state: External blocking2</i>
CTS . active	<i>Signal: active</i>
CTS . ExBlo	<i>Signal: External Blocking</i>
CTS . Alarm	<i>Signal: Alarm Current Transformer Measuring Circuit Supervision</i>
CTS . ExBlo1-I	<i>Module input state: External blocking1</i>
CTS . ExBlo2-I	<i>Module input state: External blocking2</i>
LOP . active	<i>Signal: active</i>
LOP . ExBlo	<i>Signal: External Blocking</i>
LOP . Alarm	<i>Signal: Alarm Loss of Potential</i>
LOP . LOP Blo	<i>Signal: Loss of Potential blocks other elements.</i>
LOP . Ex FF VT	<i>Signal: Ex FF VT</i>

1..n, Assignment List	Description
LOP . Ex FF EVT	<i>Signal: Alarm Fuse Failure Earth Voltage Transformers</i>
LOP . ExBlo1-I	<i>Module input state: External blocking1</i>
LOP . ExBlo2-I	<i>Module input state: External blocking2</i>
LOP . Ex FF VT-I	<i>State of the module input: Alarm Fuse Failure Voltage Transformers</i>
LOP . Ex FF EVT-I	<i>State of the module input: Alarm Fuse Failure Earth Voltage Transformers</i>
LOP . Blo Trigger1-I	<i>State of the module input: An Alarm of this protective element will block the Loss of Potential Detection.</i>
LOP . Blo Trigger2-I	<i>State of the module input: An Alarm of this protective element will block the Loss of Potential Detection.</i>
LOP . Blo Trigger3-I	<i>State of the module input: An Alarm of this protective element will block the Loss of Potential Detection.</i>
LOP . Blo Trigger4-I	<i>State of the module input: An Alarm of this protective element will block the Loss of Potential Detection.</i>
LOP . Blo Trigger5-I	<i>State of the module input: An Alarm of this protective element will block the Loss of Potential Detection.</i>
PQSCr . Cr Oflw Ws Net	<i>Signal: Counter Overflow Ws Net</i>
PQSCr . Cr Oflw Wp Net	<i>Signal: Counter Overflow Wp Net</i>
PQSCr . Cr Oflw Wp+	<i>Signal: Counter Overflow Wp+</i>
PQSCr . Cr Oflw Wp-	<i>Signal: Counter Overflow Wp-</i>
PQSCr . Cr Oflw Wq Net	<i>Signal: Counter Overflow Wq Net</i>
PQSCr . Cr Oflw Wq+	<i>Signal: Counter Overflow Wq+</i>
PQSCr . Cr Oflw Wq-	<i>Signal: Counter Overflow Wq-</i>
PQSCr . Ws Net Res Cr	<i>Signal: Ws Net Reset Counter</i>
PQSCr . Wp Net Res Cr	<i>Signal: Wp Net Reset Counter</i>
PQSCr . Wp+ Res Cr	<i>Signal: Wp+ Reset Counter</i>
PQSCr . Wp- Res Cr	<i>Signal: Wp- Reset Counter</i>
PQSCr . Wq Net Res Cr	<i>Signal: Wq Net Reset Counter</i>
PQSCr . Wq+ Res Cr	<i>Signal: Wq+ Reset Counter</i>
PQSCr . Wq- Res Cr	<i>Signal: Wq- Reset Counter</i>
PQSCr . Res all Energy Cr	<i>Signal: Reset of all Energy Counters</i>
PQSCr . Cr OflwW Ws Net	<i>Signal: Counter Ws Net will overflow soon</i>
PQSCr . Cr OflwW Wp Net	<i>Signal: Counter Wp Net will overflow soon</i>

1..n, Assignment List	Description
PQSCr . Cr OflwW Wp+	<i>Signal: Counter Wp+ will overflow soon</i>
PQSCr . Cr OflwW Wp-	<i>Signal: Counter Wp- will overflow soon</i>
PQSCr . Cr OflwW Wq Net	<i>Signal: Counter Wq Net will overflow soon</i>
PQSCr . Cr OflwW Wq+	<i>Signal: Counter Wq+ will overflow soon</i>
PQSCr . Cr OflwW Wq-	<i>Signal: Counter Wq- will overflow soon</i>
SysA . active	<i>Signal: active</i>
SysA . ExBlo	<i>Signal: External Blocking</i>
SysA . Alarm Watt Power	<i>Signal: Alarm permitted Active Power exceeded</i>
SysA . Alarm VAr Power	<i>Signal: Alarm permitted Reactive Power exceeded</i>
SysA . Alarm VA Power	<i>Signal: Alarm permitted Apparent Power exceeded</i>
SysA . Alarm Watt Demand	<i>Signal: Alarm averaged Active Power exceeded</i>
SysA . Alarm VAr Demand	<i>Signal: Alarm averaged Reactive Power exceeded</i>
SysA . Alarm VA Demand	<i>Signal: Alarm averaged Apparent Power exceeded</i>
SysA . Alm Current Demd	<i>Signal: Alarm averaged demand current</i>
SysA . Alarm I THD	<i>Signal: Alarm Total Harmonic Distortion Current</i>
SysA . Alarm V THD	<i>Signal: Alarm Total Harmonic Distortion Voltage</i>
SysA . Trip Watt Power	<i>Signal: Trip permitted Active Power exceeded</i>
SysA . Trip VAr Power	<i>Signal: Trip permitted Reactive Power exceeded</i>
SysA . Trip VA Power	<i>Signal: Trip permitted Apparent Power exceeded</i>
SysA . Trip Watt Demand	<i>Signal: Trip averaged Active Power exceeded</i>
SysA . Trip VAr Demand	<i>Signal: Trip averaged Reactive Power exceeded</i>
SysA . Trip VA Demand	<i>Signal: Trip averaged Apparent Power exceeded</i>
SysA . Trip Current Demand	<i>Signal: Trip averaged demand current</i>
SysA . Trip I THD	<i>Signal: Trip Total Harmonic Distortion Current</i>
SysA . Trip V THD	<i>Signal: Trip Total Harmonic Distortion Voltage</i>
SysA . ExBlo-I	<i>Module input state: External blocking</i>
DI Slot X1 . DI 1	<i>Signal: Digital Input</i>

1..n, Assignment List	Description
DI Slot X1 . DI 2	<i>Signal: Digital Input</i>
DI Slot X1 . DI 3	<i>Signal: Digital Input</i>
DI Slot X1 . DI 4	<i>Signal: Digital Input</i>
DI Slot X1 . DI 5	<i>Signal: Digital Input</i>
DI Slot X1 . DI 6	<i>Signal: Digital Input</i>
DI Slot X1 . DI 7	<i>Signal: Digital Input</i>
DI Slot X1 . DI 8	<i>Signal: Digital Input</i>
DI Slot X5 . DI 1	<i>Signal: Digital Input</i>
DI Slot X5 . DI 2	<i>Signal: Digital Input</i>
DI Slot X5 . DI 3	<i>Signal: Digital Input</i>
DI Slot X5 . DI 4	<i>Signal: Digital Input</i>
DI Slot X5 . DI 5	<i>Signal: Digital Input</i>
DI Slot X5 . DI 6	<i>Signal: Digital Input</i>
DI Slot X5 . DI 7	<i>Signal: Digital Input</i>
DI Slot X5 . DI 8	<i>Signal: Digital Input</i>
DI Slot X6 . DI 1	<i>Signal: Digital Input</i>
DI Slot X6 . DI 2	<i>Signal: Digital Input</i>
DI Slot X6 . DI 3	<i>Signal: Digital Input</i>
DI Slot X6 . DI 4	<i>Signal: Digital Input</i>
DI Slot X6 . DI 5	<i>Signal: Digital Input</i>
DI Slot X6 . DI 6	<i>Signal: Digital Input</i>
DI Slot X6 . DI 7	<i>Signal: Digital Input</i>
DI Slot X6 . DI 8	<i>Signal: Digital Input</i>
BO Slot X2 . BO 1	<i>Signal: Binary Output Relay</i>
BO Slot X2 . BO 2	<i>Signal: Binary Output Relay</i>
BO Slot X2 . BO 3	<i>Signal: Binary Output Relay</i>
BO Slot X2 . BO 4	<i>Signal: Binary Output Relay</i>
BO Slot X2 . BO 5	<i>Signal: Binary Output Relay</i>
BO Slot X2 . BO 6	<i>Signal: Binary Output Relay</i>
BO Slot X2 . DISARMED!	<i>Signal: CAUTION! RELAYS DISARMED in order to safely perform maintenance while eliminating the risk of taking an entire process off-line. (Note: The Self Supervision Contact cannot be disarmed). YOU MUST ENSURE that the relays are ARMED AGAIN after maintenance</i>

1..n, Assignment List	Description
BO Slot X2 . Outs forced	<i>Signal: The State of at least one Relay Output has been set by force. That means that the state of at least one Relay is forced and hence does not show the state of the assigned signals.</i>
BO Slot X5 . BO 1	<i>Signal: Binary Output Relay</i>
BO Slot X5 . BO 2	<i>Signal: Binary Output Relay</i>
BO Slot X5 . BO 3	<i>Signal: Binary Output Relay</i>
BO Slot X5 . BO 4	<i>Signal: Binary Output Relay</i>
BO Slot X5 . DISARMED!	<i>Signal: CAUTION! RELAYS DISARMED in order to safely perform maintenance while eliminating the risk of taking an entire process off-line. (Note: The Self Supervision Contact cannot be disarmed). YOU MUST ENSURE that the relays are ARMED AGAIN after maintenance</i>
BO Slot X5 . Outs forced	<i>Signal: The State of at least one Relay Output has been set by force. That means that the state of at least one Relay is forced and hence does not show the state of the assigned signals.</i>
BO Slot X6 . BO 1	<i>Signal: Binary Output Relay</i>
BO Slot X6 . BO 2	<i>Signal: Binary Output Relay</i>
BO Slot X6 . BO 3	<i>Signal: Binary Output Relay</i>
BO Slot X6 . BO 4	<i>Signal: Binary Output Relay</i>
BO Slot X6 . BO 5	<i>Signal: Binary Output Relay</i>
BO Slot X6 . DISARMED!	<i>Signal: CAUTION! RELAYS DISARMED in order to safely perform maintenance while eliminating the risk of taking an entire process off-line. (Note: The Self Supervision Contact cannot be disarmed). YOU MUST ENSURE that the relays are ARMED AGAIN after maintenance</i>
BO Slot X6 . Outs forced	<i>Signal: The State of at least one Relay Output has been set by force. That means that the state of at least one Relay is forced and hence does not show the state of the assigned signals.</i>
AnIn[1] . Broken wire	<i>Signal: Broken wire. This signal is only valid, if the analog input is used in the 4...20 mA mode.</i>
AnIn[1] . Input forced	<i>The value of analog Input has been set by force. That means that the value of the analog Input is forced and does not represent the real measured value.</i>
AnIn[2] . Broken wire	<i>Signal: Broken wire. This signal is only valid, if the analog input is used in the 4...20 mA mode.</i>
AnIn[2] . Input forced	<i>The value of analog Input has been set by force. That means that the value of the analog Input is forced and does not represent the real measured value.</i>
AnaP[1] . active	<i>Signal: active</i>
AnaP[1] . ExBlo	<i>Signal: External Blocking</i>
AnaP[1] . Blo TripCmd	<i>Signal: Trip Command blocked</i>
AnaP[1] . ExBlo TripCmd	<i>Signal: External Blocking of the Trip Command</i>

1..n, Assignment List	Description
AnaP[1] . Pickup	<i>Signal: Alarm Analog Input</i>
AnaP[1] . Trip	<i>Signal: Trip</i>
AnaP[1] . TripCmd	<i>Signal: Trip Command</i>
AnaP[1] . ExBlo1-I	<i>Module input state: External blocking1</i>
AnaP[1] . ExBlo2-I	<i>Module input state: External blocking2</i>
AnaP[1] . ExBlo TripCmd-I	<i>Module input state: External Blocking of the Trip Command</i>
AnaP[2] . active	<i>Signal: active</i>
AnaP[2] . ExBlo	<i>Signal: External Blocking</i>
AnaP[2] . Blo TripCmd	<i>Signal: Trip Command blocked</i>
AnaP[2] . ExBlo TripCmd	<i>Signal: External Blocking of the Trip Command</i>
AnaP[2] . Pickup	<i>Signal: Alarm Analog Input</i>
AnaP[2] . Trip	<i>Signal: Trip</i>
AnaP[2] . TripCmd	<i>Signal: Trip Command</i>
AnaP[2] . ExBlo1-I	<i>Module input state: External blocking1</i>
AnaP[2] . ExBlo2-I	<i>Module input state: External blocking2</i>
AnaP[2] . ExBlo TripCmd-I	<i>Module input state: External Blocking of the Trip Command</i>
AnaP[3] . active	<i>Signal: active</i>
AnaP[3] . ExBlo	<i>Signal: External Blocking</i>
AnaP[3] . Blo TripCmd	<i>Signal: Trip Command blocked</i>
AnaP[3] . ExBlo TripCmd	<i>Signal: External Blocking of the Trip Command</i>
AnaP[3] . Pickup	<i>Signal: Alarm Analog Input</i>
AnaP[3] . Trip	<i>Signal: Trip</i>
AnaP[3] . TripCmd	<i>Signal: Trip Command</i>
AnaP[3] . ExBlo1-I	<i>Module input state: External blocking1</i>
AnaP[3] . ExBlo2-I	<i>Module input state: External blocking2</i>
AnaP[3] . ExBlo TripCmd-I	<i>Module input state: External Blocking of the Trip Command</i>
AnaP[4] . active	<i>Signal: active</i>
AnaP[4] . ExBlo	<i>Signal: External Blocking</i>
AnaP[4] . Blo TripCmd	<i>Signal: Trip Command blocked</i>
AnaP[4] . ExBlo TripCmd	<i>Signal: External Blocking of the Trip Command</i>

1..n, Assignment List	Description
AnaP[4] . Pickup	<i>Signal: Alarm Analog Input</i>
AnaP[4] . Trip	<i>Signal: Trip</i>
AnaP[4] . TripCmd	<i>Signal: Trip Command</i>
AnaP[4] . ExBlo1-I	<i>Module input state: External blocking1</i>
AnaP[4] . ExBlo2-I	<i>Module input state: External blocking2</i>
AnaP[4] . ExBlo TripCmd-I	<i>Module input state: External Blocking of the Trip Command</i>
AnOut[1] . Force Mode	<i>For commissioning purposes or for maintenance, Analog Outputs can be set by force. By means of this function the normal Analog Outputs can be overwritten (forced).</i>
AnOut[2] . Force Mode	<i>For commissioning purposes or for maintenance, Analog Outputs can be set by force. By means of this function the normal Analog Outputs can be overwritten (forced).</i>
Event rec . Res all records	<i>Signal: All records are being deleted. (Remark: Immediately afterwards, this signal becomes inactive again.)</i>
Disturb rec . recording	<i>Signal: Recording</i>
Disturb rec . memory full	<i>Signal: Memory full</i>
Disturb rec . Clear fail	<i>Signal: Clear failure in memory</i>
Disturb rec . Res all records	<i>Signal: All records are being deleted. (Remark: Immediately afterwards, this signal becomes inactive again.)</i>
Disturb rec . Res all records	<i>Signal: All records are being deleted. (Remark: Immediately afterwards, this signal becomes inactive again.)</i>
Disturb rec . Man Trigger	<i>Signal: Manual Trigger</i>
Disturb rec . Start1-I	<i>State of the module input:: Trigger event / start recording</i>
Disturb rec . Start2-I	<i>State of the module input:: Trigger event / start recording</i>
Disturb rec . Start3-I	<i>State of the module input:: Trigger event / start recording</i>
Disturb rec . Start4-I	<i>State of the module input:: Trigger event / start recording</i>
Disturb rec . Start5-I	<i>State of the module input:: Trigger event / start recording</i>
Disturb rec . Start6-I	<i>State of the module input:: Trigger event / start recording</i>
Disturb rec . Start7-I	<i>State of the module input:: Trigger event / start recording</i>
Disturb rec . Start8-I	<i>State of the module input:: Trigger event / start recording</i>
Fault rec . Res all records	<i>Signal: All records are being deleted. (Remark: Immediately afterwards, this signal becomes inactive again.)</i>
Trend rec . Res all records	<i>Signal: All records are being deleted. (Remark: Immediately afterwards, this signal becomes inactive again.)</i>

1..n, Assignment List	Description
SSV . System Error	<i>Signal: Device Failure</i>
SSV . SelfSuperVision Contact	<i>Signal: SelfSuperVision Contact</i>
SSV . New error	<i>Signal: A new error message has been issued.</i>
SSV . New warning	<i>Signal: A new warning message has been issued.</i>
Syslog . active	<i>Signal: active</i>
Sys . Smart view via USB	<i>Information whether or not the Smart view access via the USB interface is activated (allowed).</i>
Sys . Smart view via Eth	<i>Information whether or not the Smart view access via the Ethernet interface is activated (allowed).</i>
Scada . SCADA connected	<i>At least one SCADA System is connected to the device.</i>
Scada . SCADA not connected	<i>No SCADA System is connected to the device</i>
DNP3 . busy	<i>This message is set if the protocol is started. It will be reset if the protocol is shut down.</i>
DNP3 . ready	<i>The message will be set if the protocol is successfully started and ready for data exchange.</i>
DNP3 . active	<i>The communication with the Master (SCADA) is active.</i> <i>Note that for TCP/UDP, this state is permanently "Low" unless »DataLink confirm« is set to "Always".</i>
DNP3 . BinaryOutput0	<i>Virtual Digital Output (DNP). This corresponds to a virtual binary input of the protective device.</i>
DNP3 . BinaryOutput1	<i>Virtual Digital Output (DNP). This corresponds to a virtual binary input of the protective device.</i>
DNP3 . BinaryOutput2	<i>Virtual Digital Output (DNP). This corresponds to a virtual binary input of the protective device.</i>
DNP3 . BinaryOutput3	<i>Virtual Digital Output (DNP). This corresponds to a virtual binary input of the protective device.</i>
DNP3 . BinaryOutput4	<i>Virtual Digital Output (DNP). This corresponds to a virtual binary input of the protective device.</i>
DNP3 . BinaryOutput5	<i>Virtual Digital Output (DNP). This corresponds to a virtual binary input of the protective device.</i>
DNP3 . BinaryOutput6	<i>Virtual Digital Output (DNP). This corresponds to a virtual binary input of the protective device.</i>
DNP3 . BinaryOutput7	<i>Virtual Digital Output (DNP). This corresponds to a virtual binary input of the protective device.</i>
DNP3 . BinaryOutput8	<i>Virtual Digital Output (DNP). This corresponds to a virtual binary input of the protective device.</i>

1..n, Assignment List	Description
DNP3 . BinaryOutput9	<i>Virtual Digital Output (DNP). This corresponds to a virtual binary input of the protective device.</i>
DNP3 . BinaryOutput10	<i>Virtual Digital Output (DNP). This corresponds to a virtual binary input of the protective device.</i>
DNP3 . BinaryOutput11	<i>Virtual Digital Output (DNP). This corresponds to a virtual binary input of the protective device.</i>
DNP3 . BinaryOutput12	<i>Virtual Digital Output (DNP). This corresponds to a virtual binary input of the protective device.</i>
DNP3 . BinaryOutput13	<i>Virtual Digital Output (DNP). This corresponds to a virtual binary input of the protective device.</i>
DNP3 . BinaryOutput14	<i>Virtual Digital Output (DNP). This corresponds to a virtual binary input of the protective device.</i>
DNP3 . BinaryOutput15	<i>Virtual Digital Output (DNP). This corresponds to a virtual binary input of the protective device.</i>
DNP3 . BinaryOutput16	<i>Virtual Digital Output (DNP). This corresponds to a virtual binary input of the protective device.</i>
DNP3 . BinaryOutput17	<i>Virtual Digital Output (DNP). This corresponds to a virtual binary input of the protective device.</i>
DNP3 . BinaryOutput18	<i>Virtual Digital Output (DNP). This corresponds to a virtual binary input of the protective device.</i>
DNP3 . BinaryOutput19	<i>Virtual Digital Output (DNP). This corresponds to a virtual binary input of the protective device.</i>
DNP3 . BinaryOutput20	<i>Virtual Digital Output (DNP). This corresponds to a virtual binary input of the protective device.</i>
DNP3 . BinaryOutput21	<i>Virtual Digital Output (DNP). This corresponds to a virtual binary input of the protective device.</i>
DNP3 . BinaryOutput22	<i>Virtual Digital Output (DNP). This corresponds to a virtual binary input of the protective device.</i>
DNP3 . BinaryOutput23	<i>Virtual Digital Output (DNP). This corresponds to a virtual binary input of the protective device.</i>
DNP3 . BinaryOutput24	<i>Virtual Digital Output (DNP). This corresponds to a virtual binary input of the protective device.</i>
DNP3 . BinaryOutput25	<i>Virtual Digital Output (DNP). This corresponds to a virtual binary input of the protective device.</i>
DNP3 . BinaryOutput26	<i>Virtual Digital Output (DNP). This corresponds to a virtual binary input of the protective device.</i>
DNP3 . BinaryOutput27	<i>Virtual Digital Output (DNP). This corresponds to a virtual binary input of the protective device.</i>
DNP3 . BinaryOutput28	<i>Virtual Digital Output (DNP). This corresponds to a virtual binary input of the protective device.</i>

1..n, Assignment List	Description
DNP3 . BinaryOutput29	<i>Virtual Digital Output (DNP). This corresponds to a virtual binary input of the protective device.</i>
DNP3 . BinaryOutput30	<i>Virtual Digital Output (DNP). This corresponds to a virtual binary input of the protective device.</i>
DNP3 . BinaryOutput31	<i>Virtual Digital Output (DNP). This corresponds to a virtual binary input of the protective device.</i>
DNP3 . BinaryInput0-I	<i>Virtual Digital Input (DNP). This corresponds to a virtual binary output of the protective device.</i>
DNP3 . BinaryInput1-I	<i>Virtual Digital Input (DNP). This corresponds to a virtual binary output of the protective device.</i>
DNP3 . BinaryInput2-I	<i>Virtual Digital Input (DNP). This corresponds to a virtual binary output of the protective device.</i>
DNP3 . BinaryInput3-I	<i>Virtual Digital Input (DNP). This corresponds to a virtual binary output of the protective device.</i>
DNP3 . BinaryInput4-I	<i>Virtual Digital Input (DNP). This corresponds to a virtual binary output of the protective device.</i>
DNP3 . BinaryInput5-I	<i>Virtual Digital Input (DNP). This corresponds to a virtual binary output of the protective device.</i>
DNP3 . BinaryInput6-I	<i>Virtual Digital Input (DNP). This corresponds to a virtual binary output of the protective device.</i>
DNP3 . BinaryInput7-I	<i>Virtual Digital Input (DNP). This corresponds to a virtual binary output of the protective device.</i>
DNP3 . BinaryInput8-I	<i>Virtual Digital Input (DNP). This corresponds to a virtual binary output of the protective device.</i>
DNP3 . BinaryInput9-I	<i>Virtual Digital Input (DNP). This corresponds to a virtual binary output of the protective device.</i>
DNP3 . BinaryInput10-I	<i>Virtual Digital Input (DNP). This corresponds to a virtual binary output of the protective device.</i>
DNP3 . BinaryInput11-I	<i>Virtual Digital Input (DNP). This corresponds to a virtual binary output of the protective device.</i>
DNP3 . BinaryInput12-I	<i>Virtual Digital Input (DNP). This corresponds to a virtual binary output of the protective device.</i>
DNP3 . BinaryInput13-I	<i>Virtual Digital Input (DNP). This corresponds to a virtual binary output of the protective device.</i>
DNP3 . BinaryInput14-I	<i>Virtual Digital Input (DNP). This corresponds to a virtual binary output of the protective device.</i>
DNP3 . BinaryInput15-I	<i>Virtual Digital Input (DNP). This corresponds to a virtual binary output of the protective device.</i>
DNP3 . BinaryInput16-I	<i>Virtual Digital Input (DNP). This corresponds to a virtual binary output of the protective device.</i>

1..n, Assignment List	Description
DNP3 . BinaryInput17-I	<i>Virtual Digital Input (DNP). This corresponds to a virtual binary output of the protective device.</i>
DNP3 . BinaryInput18-I	<i>Virtual Digital Input (DNP). This corresponds to a virtual binary output of the protective device.</i>
DNP3 . BinaryInput19-I	<i>Virtual Digital Input (DNP). This corresponds to a virtual binary output of the protective device.</i>
DNP3 . BinaryInput20-I	<i>Virtual Digital Input (DNP). This corresponds to a virtual binary output of the protective device.</i>
DNP3 . BinaryInput21-I	<i>Virtual Digital Input (DNP). This corresponds to a virtual binary output of the protective device.</i>
DNP3 . BinaryInput22-I	<i>Virtual Digital Input (DNP). This corresponds to a virtual binary output of the protective device.</i>
DNP3 . BinaryInput23-I	<i>Virtual Digital Input (DNP). This corresponds to a virtual binary output of the protective device.</i>
DNP3 . BinaryInput24-I	<i>Virtual Digital Input (DNP). This corresponds to a virtual binary output of the protective device.</i>
DNP3 . BinaryInput25-I	<i>Virtual Digital Input (DNP). This corresponds to a virtual binary output of the protective device.</i>
DNP3 . BinaryInput26-I	<i>Virtual Digital Input (DNP). This corresponds to a virtual binary output of the protective device.</i>
DNP3 . BinaryInput27-I	<i>Virtual Digital Input (DNP). This corresponds to a virtual binary output of the protective device.</i>
DNP3 . BinaryInput28-I	<i>Virtual Digital Input (DNP). This corresponds to a virtual binary output of the protective device.</i>
DNP3 . BinaryInput29-I	<i>Virtual Digital Input (DNP). This corresponds to a virtual binary output of the protective device.</i>
DNP3 . BinaryInput30-I	<i>Virtual Digital Input (DNP). This corresponds to a virtual binary output of the protective device.</i>
DNP3 . BinaryInput31-I	<i>Virtual Digital Input (DNP). This corresponds to a virtual binary output of the protective device.</i>
DNP3 . BinaryInput32-I	<i>Virtual Digital Input (DNP). This corresponds to a virtual binary output of the protective device.</i>
DNP3 . BinaryInput33-I	<i>Virtual Digital Input (DNP). This corresponds to a virtual binary output of the protective device.</i>
DNP3 . BinaryInput34-I	<i>Virtual Digital Input (DNP). This corresponds to a virtual binary output of the protective device.</i>
DNP3 . BinaryInput35-I	<i>Virtual Digital Input (DNP). This corresponds to a virtual binary output of the protective device.</i>
DNP3 . BinaryInput36-I	<i>Virtual Digital Input (DNP). This corresponds to a virtual binary output of the protective device.</i>

1..n, Assignment List	Description
DNP3 . BinaryInput37-I	<i>Virtual Digital Input (DNP). This corresponds to a virtual binary output of the protective device.</i>
DNP3 . BinaryInput38-I	<i>Virtual Digital Input (DNP). This corresponds to a virtual binary output of the protective device.</i>
DNP3 . BinaryInput39-I	<i>Virtual Digital Input (DNP). This corresponds to a virtual binary output of the protective device.</i>
DNP3 . BinaryInput40-I	<i>Virtual Digital Input (DNP). This corresponds to a virtual binary output of the protective device.</i>
DNP3 . BinaryInput41-I	<i>Virtual Digital Input (DNP). This corresponds to a virtual binary output of the protective device.</i>
DNP3 . BinaryInput42-I	<i>Virtual Digital Input (DNP). This corresponds to a virtual binary output of the protective device.</i>
DNP3 . BinaryInput43-I	<i>Virtual Digital Input (DNP). This corresponds to a virtual binary output of the protective device.</i>
DNP3 . BinaryInput44-I	<i>Virtual Digital Input (DNP). This corresponds to a virtual binary output of the protective device.</i>
DNP3 . BinaryInput45-I	<i>Virtual Digital Input (DNP). This corresponds to a virtual binary output of the protective device.</i>
DNP3 . BinaryInput46-I	<i>Virtual Digital Input (DNP). This corresponds to a virtual binary output of the protective device.</i>
DNP3 . BinaryInput47-I	<i>Virtual Digital Input (DNP). This corresponds to a virtual binary output of the protective device.</i>
DNP3 . BinaryInput48-I	<i>Virtual Digital Input (DNP). This corresponds to a virtual binary output of the protective device.</i>
DNP3 . BinaryInput49-I	<i>Virtual Digital Input (DNP). This corresponds to a virtual binary output of the protective device.</i>
DNP3 . BinaryInput50-I	<i>Virtual Digital Input (DNP). This corresponds to a virtual binary output of the protective device.</i>
DNP3 . BinaryInput51-I	<i>Virtual Digital Input (DNP). This corresponds to a virtual binary output of the protective device.</i>
DNP3 . BinaryInput52-I	<i>Virtual Digital Input (DNP). This corresponds to a virtual binary output of the protective device.</i>
DNP3 . BinaryInput53-I	<i>Virtual Digital Input (DNP). This corresponds to a virtual binary output of the protective device.</i>
DNP3 . BinaryInput54-I	<i>Virtual Digital Input (DNP). This corresponds to a virtual binary output of the protective device.</i>
DNP3 . BinaryInput55-I	<i>Virtual Digital Input (DNP). This corresponds to a virtual binary output of the protective device.</i>
DNP3 . BinaryInput56-I	<i>Virtual Digital Input (DNP). This corresponds to a virtual binary output of the protective device.</i>

1..n, Assignment List	Description
DNP3 . BinaryInput57-I	<i>Virtual Digital Input (DNP). This corresponds to a virtual binary output of the protective device.</i>
DNP3 . BinaryInput58-I	<i>Virtual Digital Input (DNP). This corresponds to a virtual binary output of the protective device.</i>
DNP3 . BinaryInput59-I	<i>Virtual Digital Input (DNP). This corresponds to a virtual binary output of the protective device.</i>
DNP3 . BinaryInput60-I	<i>Virtual Digital Input (DNP). This corresponds to a virtual binary output of the protective device.</i>
DNP3 . BinaryInput61-I	<i>Virtual Digital Input (DNP). This corresponds to a virtual binary output of the protective device.</i>
DNP3 . BinaryInput62-I	<i>Virtual Digital Input (DNP). This corresponds to a virtual binary output of the protective device.</i>
DNP3 . BinaryInput63-I	<i>Virtual Digital Input (DNP). This corresponds to a virtual binary output of the protective device.</i>
Modbus . Transmission RTU	<i>Signal: SCADA active</i>
Modbus . Transmission TCP	<i>Signal: SCADA active</i>
Modbus . Scada Cmd 1	<i>Scada Command</i>
Modbus . Scada Cmd 2	<i>Scada Command</i>
Modbus . Scada Cmd 3	<i>Scada Command</i>
Modbus . Scada Cmd 4	<i>Scada Command</i>
Modbus . Scada Cmd 5	<i>Scada Command</i>
Modbus . Scada Cmd 6	<i>Scada Command</i>
Modbus . Scada Cmd 7	<i>Scada Command</i>
Modbus . Scada Cmd 8	<i>Scada Command</i>
Modbus . Scada Cmd 9	<i>Scada Command</i>
Modbus . Scada Cmd 10	<i>Scada Command</i>
Modbus . Scada Cmd 11	<i>Scada Command</i>
Modbus . Scada Cmd 12	<i>Scada Command</i>
Modbus . Scada Cmd 13	<i>Scada Command</i>
Modbus . Scada Cmd 14	<i>Scada Command</i>
Modbus . Scada Cmd 15	<i>Scada Command</i>
Modbus . Scada Cmd 16	<i>Scada Command</i>
Modbus . Config Bin Inp1-I	<i>State of the module input: Config Bin Inp</i>

1..n, Assignment List	Description
Modbus . Config Bin Inp2-I	<i>State of the module input: Config Bin Inp</i>
Modbus . Config Bin Inp3-I	<i>State of the module input: Config Bin Inp</i>
Modbus . Config Bin Inp4-I	<i>State of the module input: Config Bin Inp</i>
Modbus . Config Bin Inp5-I	<i>State of the module input: Config Bin Inp</i>
Modbus . Config Bin Inp6-I	<i>State of the module input: Config Bin Inp</i>
Modbus . Config Bin Inp7-I	<i>State of the module input: Config Bin Inp</i>
Modbus . Config Bin Inp8-I	<i>State of the module input: Config Bin Inp</i>
Modbus . Config Bin Inp9-I	<i>State of the module input: Config Bin Inp</i>
Modbus . Config Bin Inp10-I	<i>State of the module input: Config Bin Inp</i>
Modbus . Config Bin Inp11-I	<i>State of the module input: Config Bin Inp</i>
Modbus . Config Bin Inp12-I	<i>State of the module input: Config Bin Inp</i>
Modbus . Config Bin Inp13-I	<i>State of the module input: Config Bin Inp</i>
Modbus . Config Bin Inp14-I	<i>State of the module input: Config Bin Inp</i>
Modbus . Config Bin Inp15-I	<i>State of the module input: Config Bin Inp</i>
Modbus . Config Bin Inp16-I	<i>State of the module input: Config Bin Inp</i>
Modbus . Config Bin Inp17-I	<i>State of the module input: Config Bin Inp</i>
Modbus . Config Bin Inp18-I	<i>State of the module input: Config Bin Inp</i>
Modbus . Config Bin Inp19-I	<i>State of the module input: Config Bin Inp</i>
Modbus . Config Bin Inp20-I	<i>State of the module input: Config Bin Inp</i>
Modbus . Config Bin Inp21-I	<i>State of the module input: Config Bin Inp</i>

1..n, Assignment List	Description
Modbus . Config Bin Inp22-I	<i>State of the module input: Config Bin Inp</i>
Modbus . Config Bin Inp23-I	<i>State of the module input: Config Bin Inp</i>
Modbus . Config Bin Inp24-I	<i>State of the module input: Config Bin Inp</i>
Modbus . Config Bin Inp25-I	<i>State of the module input: Config Bin Inp</i>
Modbus . Config Bin Inp26-I	<i>State of the module input: Config Bin Inp</i>
Modbus . Config Bin Inp27-I	<i>State of the module input: Config Bin Inp</i>
Modbus . Config Bin Inp28-I	<i>State of the module input: Config Bin Inp</i>
Modbus . Config Bin Inp29-I	<i>State of the module input: Config Bin Inp</i>
Modbus . Config Bin Inp30-I	<i>State of the module input: Config Bin Inp</i>
Modbus . Config Bin Inp31-I	<i>State of the module input: Config Bin Inp</i>
Modbus . Config Bin Inp32-I	<i>State of the module input: Config Bin Inp</i>
IEC 61850 . MMS Client connected	<i>At least one MMS client is connected to the device</i>
IEC 61850 . All Goose Subscriber active	<i>All Goose subscriber in the device are working</i>
IEC 61850 . GOSINGGIO1.Ind1.stVal	<i>Signal: Virtual Input (IEC61850 GGIO Ind): State</i>
IEC 61850 . GOSINGGIO1.Ind2.stVal	<i>Signal: Virtual Input (IEC61850 GGIO Ind): State</i>
IEC 61850 . GOSINGGIO1.Ind3.stVal	<i>Signal: Virtual Input (IEC61850 GGIO Ind): State</i>
IEC 61850 . GOSINGGIO1.Ind4.stVal	<i>Signal: Virtual Input (IEC61850 GGIO Ind): State</i>
IEC 61850 . GOSINGGIO1.Ind5.stVal	<i>Signal: Virtual Input (IEC61850 GGIO Ind): State</i>
IEC 61850 . GOSINGGIO1.Ind6.stVal	<i>Signal: Virtual Input (IEC61850 GGIO Ind): State</i>
IEC 61850 . GOSINGGIO1.Ind7.stVal	<i>Signal: Virtual Input (IEC61850 GGIO Ind): State</i>

1..n, Assignment List	Description
IEC 61850 . GOSINGGIO1.Ind8.stVal	<i>Signal: Virtual Input (IEC61850 GGIO Ind): State</i>
IEC 61850 . GOSINGGIO1.Ind9.stVal	<i>Signal: Virtual Input (IEC61850 GGIO Ind): State</i>
IEC 61850 . GOSINGGIO1.Ind10.stVal	<i>Signal: Virtual Input (IEC61850 GGIO Ind): State</i>
IEC 61850 . GOSINGGIO1.Ind11.stVal	<i>Signal: Virtual Input (IEC61850 GGIO Ind): State</i>
IEC 61850 . GOSINGGIO1.Ind12.stVal	<i>Signal: Virtual Input (IEC61850 GGIO Ind): State</i>
IEC 61850 . GOSINGGIO1.Ind13.stVal	<i>Signal: Virtual Input (IEC61850 GGIO Ind): State</i>
IEC 61850 . GOSINGGIO1.Ind14.stVal	<i>Signal: Virtual Input (IEC61850 GGIO Ind): State</i>
IEC 61850 . GOSINGGIO1.Ind15.stVal	<i>Signal: Virtual Input (IEC61850 GGIO Ind): State</i>
IEC 61850 . GOSINGGIO1.Ind16.stVal	<i>Signal: Virtual Input (IEC61850 GGIO Ind): State</i>
IEC 61850 . GOSINGGIO1.Ind17.stVal	<i>Signal: Virtual Input (IEC61850 GGIO Ind): State</i>
IEC 61850 . GOSINGGIO1.Ind18.stVal	<i>Signal: Virtual Input (IEC61850 GGIO Ind): State</i>
IEC 61850 . GOSINGGIO1.Ind19.stVal	<i>Signal: Virtual Input (IEC61850 GGIO Ind): State</i>
IEC 61850 . GOSINGGIO1.Ind20.stVal	<i>Signal: Virtual Input (IEC61850 GGIO Ind): State</i>
IEC 61850 . GOSINGGIO1.Ind21.stVal	<i>Signal: Virtual Input (IEC61850 GGIO Ind): State</i>
IEC 61850 . GOSINGGIO1.Ind22.stVal	<i>Signal: Virtual Input (IEC61850 GGIO Ind): State</i>
IEC 61850 . GOSINGGIO1.Ind23.stVal	<i>Signal: Virtual Input (IEC61850 GGIO Ind): State</i>
IEC 61850 . GOSINGGIO1.Ind24.stVal	<i>Signal: Virtual Input (IEC61850 GGIO Ind): State</i>
IEC 61850 . GOSINGGIO1.Ind25.stVal	<i>Signal: Virtual Input (IEC61850 GGIO Ind): State</i>
IEC 61850 . GOSINGGIO1.Ind26.stVal	<i>Signal: Virtual Input (IEC61850 GGIO Ind): State</i>
IEC 61850 . GOSINGGIO1.Ind27.stVal	<i>Signal: Virtual Input (IEC61850 GGIO Ind): State</i>

1..n, Assignment List	Description
IEC 61850 . GOSINGGIO1.Ind28.stVal	<i>Signal: Virtual Input (IEC61850 GGIO Ind): State</i>
IEC 61850 . GOSINGGIO1.Ind29.stVal	<i>Signal: Virtual Input (IEC61850 GGIO Ind): State</i>
IEC 61850 . GOSINGGIO1.Ind30.stVal	<i>Signal: Virtual Input (IEC61850 GGIO Ind): State</i>
IEC 61850 . GOSINGGIO1.Ind31.stVal	<i>Signal: Virtual Input (IEC61850 GGIO Ind): State</i>
IEC 61850 . GOSINGGIO1.Ind32.stVal	<i>Signal: Virtual Input (IEC61850 GGIO Ind): State</i>
IEC 61850 . GOSINGGIO2.Ind1.stVal	<i>Signal: Virtual Input (IEC61850 GGIO Ind): State</i>
IEC 61850 . GOSINGGIO2.Ind2.stVal	<i>Signal: Virtual Input (IEC61850 GGIO Ind): State</i>
IEC 61850 . GOSINGGIO2.Ind3.stVal	<i>Signal: Virtual Input (IEC61850 GGIO Ind): State</i>
IEC 61850 . GOSINGGIO2.Ind4.stVal	<i>Signal: Virtual Input (IEC61850 GGIO Ind): State</i>
IEC 61850 . GOSINGGIO2.Ind5.stVal	<i>Signal: Virtual Input (IEC61850 GGIO Ind): State</i>
IEC 61850 . GOSINGGIO2.Ind6.stVal	<i>Signal: Virtual Input (IEC61850 GGIO Ind): State</i>
IEC 61850 . GOSINGGIO2.Ind7.stVal	<i>Signal: Virtual Input (IEC61850 GGIO Ind): State</i>
IEC 61850 . GOSINGGIO2.Ind8.stVal	<i>Signal: Virtual Input (IEC61850 GGIO Ind): State</i>
IEC 61850 . GOSINGGIO2.Ind9.stVal	<i>Signal: Virtual Input (IEC61850 GGIO Ind): State</i>
IEC 61850 . GOSINGGIO2.Ind10.stVal	<i>Signal: Virtual Input (IEC61850 GGIO Ind): State</i>
IEC 61850 . GOSINGGIO2.Ind11.stVal	<i>Signal: Virtual Input (IEC61850 GGIO Ind): State</i>
IEC 61850 . GOSINGGIO2.Ind12.stVal	<i>Signal: Virtual Input (IEC61850 GGIO Ind): State</i>
IEC 61850 . GOSINGGIO2.Ind13.stVal	<i>Signal: Virtual Input (IEC61850 GGIO Ind): State</i>
IEC 61850 . GOSINGGIO2.Ind14.stVal	<i>Signal: Virtual Input (IEC61850 GGIO Ind): State</i>
IEC 61850 . GOSINGGIO2.Ind15.stVal	<i>Signal: Virtual Input (IEC61850 GGIO Ind): State</i>

1..n, Assignment List	Description
IEC 61850 . GOSINGGIO2.Ind16.stVal	<i>Signal: Virtual Input (IEC61850 GGIO Ind): State</i>
IEC 61850 . GOSINGGIO2.Ind17.stVal	<i>Signal: Virtual Input (IEC61850 GGIO Ind): State</i>
IEC 61850 . GOSINGGIO2.Ind18.stVal	<i>Signal: Virtual Input (IEC61850 GGIO Ind): State</i>
IEC 61850 . GOSINGGIO2.Ind19.stVal	<i>Signal: Virtual Input (IEC61850 GGIO Ind): State</i>
IEC 61850 . GOSINGGIO2.Ind20.stVal	<i>Signal: Virtual Input (IEC61850 GGIO Ind): State</i>
IEC 61850 . GOSINGGIO2.Ind21.stVal	<i>Signal: Virtual Input (IEC61850 GGIO Ind): State</i>
IEC 61850 . GOSINGGIO2.Ind22.stVal	<i>Signal: Virtual Input (IEC61850 GGIO Ind): State</i>
IEC 61850 . GOSINGGIO2.Ind23.stVal	<i>Signal: Virtual Input (IEC61850 GGIO Ind): State</i>
IEC 61850 . GOSINGGIO2.Ind24.stVal	<i>Signal: Virtual Input (IEC61850 GGIO Ind): State</i>
IEC 61850 . GOSINGGIO2.Ind25.stVal	<i>Signal: Virtual Input (IEC61850 GGIO Ind): State</i>
IEC 61850 . GOSINGGIO2.Ind26.stVal	<i>Signal: Virtual Input (IEC61850 GGIO Ind): State</i>
IEC 61850 . GOSINGGIO2.Ind27.stVal	<i>Signal: Virtual Input (IEC61850 GGIO Ind): State</i>
IEC 61850 . GOSINGGIO2.Ind28.stVal	<i>Signal: Virtual Input (IEC61850 GGIO Ind): State</i>
IEC 61850 . GOSINGGIO2.Ind29.stVal	<i>Signal: Virtual Input (IEC61850 GGIO Ind): State</i>
IEC 61850 . GOSINGGIO2.Ind30.stVal	<i>Signal: Virtual Input (IEC61850 GGIO Ind): State</i>
IEC 61850 . GOSINGGIO2.Ind31.stVal	<i>Signal: Virtual Input (IEC61850 GGIO Ind): State</i>
IEC 61850 . GOSINGGIO2.Ind32.stVal	<i>Signal: Virtual Input (IEC61850 GGIO Ind): State</i>
IEC 61850 . GOSINGGIO1.Ind1.q	<i>Signal: Virtual Input (IEC61850 GGIO Ind): Self-Supervision of the GGIO Input</i>
IEC 61850 . GOSINGGIO1.Ind2.q	<i>Signal: Virtual Input (IEC61850 GGIO Ind): Self-Supervision of the GGIO Input</i>
IEC 61850 . GOSINGGIO1.Ind3.q	<i>Signal: Virtual Input (IEC61850 GGIO Ind): Self-Supervision of the GGIO Input</i>

1..n, Assignment List	Description
IEC 61850 . GOSINGGIO1.Ind4.q	<i>Signal: Virtual Input (IEC61850 GGIO Ind): Self-Supervision of the GGIO Input</i>
IEC 61850 . GOSINGGIO1.Ind5.q	<i>Signal: Virtual Input (IEC61850 GGIO Ind): Self-Supervision of the GGIO Input</i>
IEC 61850 . GOSINGGIO1.Ind6.q	<i>Signal: Virtual Input (IEC61850 GGIO Ind): Self-Supervision of the GGIO Input</i>
IEC 61850 . GOSINGGIO1.Ind7.q	<i>Signal: Virtual Input (IEC61850 GGIO Ind): Self-Supervision of the GGIO Input</i>
IEC 61850 . GOSINGGIO1.Ind8.q	<i>Signal: Virtual Input (IEC61850 GGIO Ind): Self-Supervision of the GGIO Input</i>
IEC 61850 . GOSINGGIO1.Ind9.q	<i>Signal: Virtual Input (IEC61850 GGIO Ind): Self-Supervision of the GGIO Input</i>
IEC 61850 . GOSINGGIO1.Ind10.q	<i>Signal: Virtual Input (IEC61850 GGIO Ind): Self-Supervision of the GGIO Input</i>
IEC 61850 . GOSINGGIO1.Ind11.q	<i>Signal: Virtual Input (IEC61850 GGIO Ind): Self-Supervision of the GGIO Input</i>
IEC 61850 . GOSINGGIO1.Ind12.q	<i>Signal: Virtual Input (IEC61850 GGIO Ind): Self-Supervision of the GGIO Input</i>
IEC 61850 . GOSINGGIO1.Ind13.q	<i>Signal: Virtual Input (IEC61850 GGIO Ind): Self-Supervision of the GGIO Input</i>
IEC 61850 . GOSINGGIO1.Ind14.q	<i>Signal: Virtual Input (IEC61850 GGIO Ind): Self-Supervision of the GGIO Input</i>
IEC 61850 . GOSINGGIO1.Ind15.q	<i>Signal: Virtual Input (IEC61850 GGIO Ind): Self-Supervision of the GGIO Input</i>
IEC 61850 . GOSINGGIO1.Ind16.q	<i>Signal: Virtual Input (IEC61850 GGIO Ind): Self-Supervision of the GGIO Input</i>
IEC 61850 . GOSINGGIO1.Ind17.q	<i>Signal: Virtual Input (IEC61850 GGIO Ind): Self-Supervision of the GGIO Input</i>
IEC 61850 . GOSINGGIO1.Ind18.q	<i>Signal: Virtual Input (IEC61850 GGIO Ind): Self-Supervision of the GGIO Input</i>
IEC 61850 . GOSINGGIO1.Ind19.q	<i>Signal: Virtual Input (IEC61850 GGIO Ind): Self-Supervision of the GGIO Input</i>
IEC 61850 . GOSINGGIO1.Ind20.q	<i>Signal: Virtual Input (IEC61850 GGIO Ind): Self-Supervision of the GGIO Input</i>
IEC 61850 . GOSINGGIO1.Ind21.q	<i>Signal: Virtual Input (IEC61850 GGIO Ind): Self-Supervision of the GGIO Input</i>
IEC 61850 . GOSINGGIO1.Ind22.q	<i>Signal: Virtual Input (IEC61850 GGIO Ind): Self-Supervision of the GGIO Input</i>
IEC 61850 . GOSINGGIO1.Ind23.q	<i>Signal: Virtual Input (IEC61850 GGIO Ind): Self-Supervision of the GGIO Input</i>

1..n, Assignment List	Description
IEC 61850 . GOSINGGIO1.Ind24.q	<i>Signal: Virtual Input (IEC61850 GGIO Ind): Self-Supervision of the GGIO Input</i>
IEC 61850 . GOSINGGIO1.Ind25.q	<i>Signal: Virtual Input (IEC61850 GGIO Ind): Self-Supervision of the GGIO Input</i>
IEC 61850 . GOSINGGIO1.Ind26.q	<i>Signal: Virtual Input (IEC61850 GGIO Ind): Self-Supervision of the GGIO Input</i>
IEC 61850 . GOSINGGIO1.Ind27.q	<i>Signal: Virtual Input (IEC61850 GGIO Ind): Self-Supervision of the GGIO Input</i>
IEC 61850 . GOSINGGIO1.Ind28.q	<i>Signal: Virtual Input (IEC61850 GGIO Ind): Self-Supervision of the GGIO Input</i>
IEC 61850 . GOSINGGIO1.Ind29.q	<i>Signal: Virtual Input (IEC61850 GGIO Ind): Self-Supervision of the GGIO Input</i>
IEC 61850 . GOSINGGIO1.Ind30.q	<i>Signal: Virtual Input (IEC61850 GGIO Ind): Self-Supervision of the GGIO Input</i>
IEC 61850 . GOSINGGIO1.Ind31.q	<i>Signal: Virtual Input (IEC61850 GGIO Ind): Self-Supervision of the GGIO Input</i>
IEC 61850 . GOSINGGIO1.Ind32.q	<i>Signal: Virtual Input (IEC61850 GGIO Ind): Self-Supervision of the GGIO Input</i>
IEC 61850 . GOSINGGIO2.Ind1.q	<i>Signal: Virtual Input (IEC61850 GGIO Ind): Self-Supervision of the GGIO Input</i>
IEC 61850 . GOSINGGIO2.Ind2.q	<i>Signal: Virtual Input (IEC61850 GGIO Ind): Self-Supervision of the GGIO Input</i>
IEC 61850 . GOSINGGIO2.Ind3.q	<i>Signal: Virtual Input (IEC61850 GGIO Ind): Self-Supervision of the GGIO Input</i>
IEC 61850 . GOSINGGIO2.Ind4.q	<i>Signal: Virtual Input (IEC61850 GGIO Ind): Self-Supervision of the GGIO Input</i>
IEC 61850 . GOSINGGIO2.Ind5.q	<i>Signal: Virtual Input (IEC61850 GGIO Ind): Self-Supervision of the GGIO Input</i>
IEC 61850 . GOSINGGIO2.Ind6.q	<i>Signal: Virtual Input (IEC61850 GGIO Ind): Self-Supervision of the GGIO Input</i>
IEC 61850 . GOSINGGIO2.Ind7.q	<i>Signal: Virtual Input (IEC61850 GGIO Ind): Self-Supervision of the GGIO Input</i>
IEC 61850 . GOSINGGIO2.Ind8.q	<i>Signal: Virtual Input (IEC61850 GGIO Ind): Self-Supervision of the GGIO Input</i>
IEC 61850 . GOSINGGIO2.Ind9.q	<i>Signal: Virtual Input (IEC61850 GGIO Ind): Self-Supervision of the GGIO Input</i>
IEC 61850 . GOSINGGIO2.Ind10.q	<i>Signal: Virtual Input (IEC61850 GGIO Ind): Self-Supervision of the GGIO Input</i>
IEC 61850 . GOSINGGIO2.Ind11.q	<i>Signal: Virtual Input (IEC61850 GGIO Ind): Self-Supervision of the GGIO Input</i>

1..n, Assignment List	Description
IEC 61850 . GOSINGGIO2.Ind12.q	<i>Signal: Virtual Input (IEC61850 GGIO Ind): Self-Supervision of the GGIO Input</i>
IEC 61850 . GOSINGGIO2.Ind13.q	<i>Signal: Virtual Input (IEC61850 GGIO Ind): Self-Supervision of the GGIO Input</i>
IEC 61850 . GOSINGGIO2.Ind14.q	<i>Signal: Virtual Input (IEC61850 GGIO Ind): Self-Supervision of the GGIO Input</i>
IEC 61850 . GOSINGGIO2.Ind15.q	<i>Signal: Virtual Input (IEC61850 GGIO Ind): Self-Supervision of the GGIO Input</i>
IEC 61850 . GOSINGGIO2.Ind16.q	<i>Signal: Virtual Input (IEC61850 GGIO Ind): Self-Supervision of the GGIO Input</i>
IEC 61850 . GOSINGGIO2.Ind17.q	<i>Signal: Virtual Input (IEC61850 GGIO Ind): Self-Supervision of the GGIO Input</i>
IEC 61850 . GOSINGGIO2.Ind18.q	<i>Signal: Virtual Input (IEC61850 GGIO Ind): Self-Supervision of the GGIO Input</i>
IEC 61850 . GOSINGGIO2.Ind19.q	<i>Signal: Virtual Input (IEC61850 GGIO Ind): Self-Supervision of the GGIO Input</i>
IEC 61850 . GOSINGGIO2.Ind20.q	<i>Signal: Virtual Input (IEC61850 GGIO Ind): Self-Supervision of the GGIO Input</i>
IEC 61850 . GOSINGGIO2.Ind21.q	<i>Signal: Virtual Input (IEC61850 GGIO Ind): Self-Supervision of the GGIO Input</i>
IEC 61850 . GOSINGGIO2.Ind22.q	<i>Signal: Virtual Input (IEC61850 GGIO Ind): Self-Supervision of the GGIO Input</i>
IEC 61850 . GOSINGGIO2.Ind23.q	<i>Signal: Virtual Input (IEC61850 GGIO Ind): Self-Supervision of the GGIO Input</i>
IEC 61850 . GOSINGGIO2.Ind24.q	<i>Signal: Virtual Input (IEC61850 GGIO Ind): Self-Supervision of the GGIO Input</i>
IEC 61850 . GOSINGGIO2.Ind25.q	<i>Signal: Virtual Input (IEC61850 GGIO Ind): Self-Supervision of the GGIO Input</i>
IEC 61850 . GOSINGGIO2.Ind26.q	<i>Signal: Virtual Input (IEC61850 GGIO Ind): Self-Supervision of the GGIO Input</i>
IEC 61850 . GOSINGGIO2.Ind27.q	<i>Signal: Virtual Input (IEC61850 GGIO Ind): Self-Supervision of the GGIO Input</i>
IEC 61850 . GOSINGGIO2.Ind28.q	<i>Signal: Virtual Input (IEC61850 GGIO Ind): Self-Supervision of the GGIO Input</i>
IEC 61850 . GOSINGGIO2.Ind29.q	<i>Signal: Virtual Input (IEC61850 GGIO Ind): Self-Supervision of the GGIO Input</i>
IEC 61850 . GOSINGGIO2.Ind30.q	<i>Signal: Virtual Input (IEC61850 GGIO Ind): Self-Supervision of the GGIO Input</i>
IEC 61850 . GOSINGGIO2.Ind31.q	<i>Signal: Virtual Input (IEC61850 GGIO Ind): Self-Supervision of the GGIO Input</i>

1..n, Assignment List	Description
IEC 61850 . GOSINGGIO2.Ind32.q	<i>Signal: Virtual Input (IEC61850 GGIO Ind): Self-Supervision of the GGIO Input</i>
IEC 61850 . SPCSO1	<i>Status bit that can be set by clients like e.g. SCADA (Single Point Controllable Status Output).</i>
IEC 61850 . SPCSO2	<i>Status bit that can be set by clients like e.g. SCADA (Single Point Controllable Status Output).</i>
IEC 61850 . SPCSO3	<i>Status bit that can be set by clients like e.g. SCADA (Single Point Controllable Status Output).</i>
IEC 61850 . SPCSO4	<i>Status bit that can be set by clients like e.g. SCADA (Single Point Controllable Status Output).</i>
IEC 61850 . SPCSO5	<i>Status bit that can be set by clients like e.g. SCADA (Single Point Controllable Status Output).</i>
IEC 61850 . SPCSO6	<i>Status bit that can be set by clients like e.g. SCADA (Single Point Controllable Status Output).</i>
IEC 61850 . SPCSO7	<i>Status bit that can be set by clients like e.g. SCADA (Single Point Controllable Status Output).</i>
IEC 61850 . SPCSO8	<i>Status bit that can be set by clients like e.g. SCADA (Single Point Controllable Status Output).</i>
IEC 61850 . SPCSO9	<i>Status bit that can be set by clients like e.g. SCADA (Single Point Controllable Status Output).</i>
IEC 61850 . SPCSO10	<i>Status bit that can be set by clients like e.g. SCADA (Single Point Controllable Status Output).</i>
IEC 61850 . SPCSO11	<i>Status bit that can be set by clients like e.g. SCADA (Single Point Controllable Status Output).</i>
IEC 61850 . SPCSO12	<i>Status bit that can be set by clients like e.g. SCADA (Single Point Controllable Status Output).</i>
IEC 61850 . SPCSO13	<i>Status bit that can be set by clients like e.g. SCADA (Single Point Controllable Status Output).</i>
IEC 61850 . SPCSO14	<i>Status bit that can be set by clients like e.g. SCADA (Single Point Controllable Status Output).</i>
IEC 61850 . SPCSO15	<i>Status bit that can be set by clients like e.g. SCADA (Single Point Controllable Status Output).</i>
IEC 61850 . SPCSO16	<i>Status bit that can be set by clients like e.g. SCADA (Single Point Controllable Status Output).</i>
IEC 61850 . SPCSO17	<i>Status bit that can be set by clients like e.g. SCADA (Single Point Controllable Status Output).</i>
IEC 61850 . SPCSO18	<i>Status bit that can be set by clients like e.g. SCADA (Single Point Controllable Status Output).</i>
IEC 61850 . SPCSO19	<i>Status bit that can be set by clients like e.g. SCADA (Single Point Controllable Status Output).</i>

1..n, Assignment List	Description
IEC 61850 . SPCSO20	<i>Status bit that can be set by clients like e.g. SCADA (Single Point Controllable Status Output).</i>
IEC 61850 . SPCSO21	<i>Status bit that can be set by clients like e.g. SCADA (Single Point Controllable Status Output).</i>
IEC 61850 . SPCSO22	<i>Status bit that can be set by clients like e.g. SCADA (Single Point Controllable Status Output).</i>
IEC 61850 . SPCSO23	<i>Status bit that can be set by clients like e.g. SCADA (Single Point Controllable Status Output).</i>
IEC 61850 . SPCSO24	<i>Status bit that can be set by clients like e.g. SCADA (Single Point Controllable Status Output).</i>
IEC 61850 . SPCSO25	<i>Status bit that can be set by clients like e.g. SCADA (Single Point Controllable Status Output).</i>
IEC 61850 . SPCSO26	<i>Status bit that can be set by clients like e.g. SCADA (Single Point Controllable Status Output).</i>
IEC 61850 . SPCSO27	<i>Status bit that can be set by clients like e.g. SCADA (Single Point Controllable Status Output).</i>
IEC 61850 . SPCSO28	<i>Status bit that can be set by clients like e.g. SCADA (Single Point Controllable Status Output).</i>
IEC 61850 . SPCSO29	<i>Status bit that can be set by clients like e.g. SCADA (Single Point Controllable Status Output).</i>
IEC 61850 . SPCSO30	<i>Status bit that can be set by clients like e.g. SCADA (Single Point Controllable Status Output).</i>
IEC 61850 . SPCSO31	<i>Status bit that can be set by clients like e.g. SCADA (Single Point Controllable Status Output).</i>
IEC 61850 . SPCSO32	<i>Status bit that can be set by clients like e.g. SCADA (Single Point Controllable Status Output).</i>
IEC103 . Scada Cmd 1	<i>Scada Command</i>
IEC103 . Scada Cmd 2	<i>Scada Command</i>
IEC103 . Scada Cmd 3	<i>Scada Command</i>
IEC103 . Scada Cmd 4	<i>Scada Command</i>
IEC103 . Scada Cmd 5	<i>Scada Command</i>
IEC103 . Scada Cmd 6	<i>Scada Command</i>
IEC103 . Scada Cmd 7	<i>Scada Command</i>
IEC103 . Scada Cmd 8	<i>Scada Command</i>
IEC103 . Scada Cmd 9	<i>Scada Command</i>
IEC103 . Scada Cmd 10	<i>Scada Command</i>
IEC103 . Transmission	<i>Signal: SCADA active</i>

1..n, Assignment List	Description
IEC103 . Failure Event lost	<i>Failure event lost</i>
IEC103 . Test mode active	<i>Signal: IEC103 communication has been switched over into Test Mode.</i>
IEC103 . Block MD active	<i>Signal: The blocking of IEC103 transmission in monitor direction has been activated.</i>
IEC103 . Ex activate test mode-I	<i>Module input state: Test Mode of the IEC103 communication.</i>
IEC103 . Ex activate Block MD-I	<i>Module input state: Activation of the blocking of IEC103 transmission in monitor direction.</i>
IEC104 . busy	<i>This message is set if the protocol is started. It will be reset if the protocol is shut down.</i>
IEC104 . ready	<i>The message will be set if the protocol is successfully started and ready for data exchange.</i>
IEC104 . Transmission	<i>Signal: SCADA active</i>
IEC104 . Failure Event lost	<i>Failure event lost</i>
IEC104 . Scada Cmd 1	<i>Scada Command</i>
IEC104 . Scada Cmd 2	<i>Scada Command</i>
IEC104 . Scada Cmd 3	<i>Scada Command</i>
IEC104 . Scada Cmd 4	<i>Scada Command</i>
IEC104 . Scada Cmd 5	<i>Scada Command</i>
IEC104 . Scada Cmd 6	<i>Scada Command</i>
IEC104 . Scada Cmd 7	<i>Scada Command</i>
IEC104 . Scada Cmd 8	<i>Scada Command</i>
IEC104 . Scada Cmd 9	<i>Scada Command</i>
IEC104 . Scada Cmd 10	<i>Scada Command</i>
IEC104 . Scada Cmd 11	<i>Scada Command</i>
IEC104 . Scada Cmd 12	<i>Scada Command</i>
IEC104 . Scada Cmd 13	<i>Scada Command</i>
IEC104 . Scada Cmd 14	<i>Scada Command</i>
IEC104 . Scada Cmd 15	<i>Scada Command</i>
IEC104 . Scada Cmd 16	<i>Scada Command</i>
Profibus . Data OK	<i>Data within the Input field are OK (Yes=1)</i>
Profibus . SubModul Err	<i>Assignable Signal, Failure in Sub-Module, Communication Failure.</i>

1..n, Assignment List	Description
Profibus . Connection active	<i>Connection active</i>
Profibus . Scada Cmd 1	<i>Scada Command</i>
Profibus . Scada Cmd 2	<i>Scada Command</i>
Profibus . Scada Cmd 3	<i>Scada Command</i>
Profibus . Scada Cmd 4	<i>Scada Command</i>
Profibus . Scada Cmd 5	<i>Scada Command</i>
Profibus . Scada Cmd 6	<i>Scada Command</i>
Profibus . Scada Cmd 7	<i>Scada Command</i>
Profibus . Scada Cmd 8	<i>Scada Command</i>
Profibus . Scada Cmd 9	<i>Scada Command</i>
Profibus . Scada Cmd 10	<i>Scada Command</i>
Profibus . Scada Cmd 11	<i>Scada Command</i>
Profibus . Scada Cmd 12	<i>Scada Command</i>
Profibus . Scada Cmd 13	<i>Scada Command</i>
Profibus . Scada Cmd 14	<i>Scada Command</i>
Profibus . Scada Cmd 15	<i>Scada Command</i>
Profibus . Scada Cmd 16	<i>Scada Command</i>
IRIG-B . IRIG-B active	<i>Signal: If there is no valid IRIG-B signal for 60 sec, IRIG-B is regarded as inactive.</i>
IRIG-B . High-Low Invert	<i>Signal: The High and Low signals of the IRIG-B are inverted. This does NOT mean that the wiring is faulty. If the wiring is faulty no IRIG-B signal will be detected.</i>
IRIG-B . Control Signal1	<i>Signal: IRIG-B Control Signal. The external IRIG-B generator can set these signals. They can be used for further control procedures inside the device (e.g. logic funtions).</i>
IRIG-B . Control Signal2	<i>Signal: IRIG-B Control Signal. The external IRIG-B generator can set these signals. They can be used for further control procedures inside the device (e.g. logic funtions).</i>
IRIG-B . Control Signal3	<i>Signal: IRIG-B Control Signal. The external IRIG-B generator can set these signals. They can be used for further control procedures inside the device (e.g. logic funtions).</i>
IRIG-B . Control Signal4	<i>Signal: IRIG-B Control Signal. The external IRIG-B generator can set these signals. They can be used for further control procedures inside the device (e.g. logic funtions).</i>
IRIG-B . Control Signal5	<i>Signal: IRIG-B Control Signal. The external IRIG-B generator can set these signals. They can be used for further control procedures inside the device (e.g. logic funtions).</i>

1..n, Assignment List	Description
IRIG-B . Control Signal6	<i>Signal: IRIG-B Control Signal. The external IRIG-B generator can set these signals. They can be used for further control procedures inside the device (e.g. logic funtions).</i>
IRIG-B . Control Signal7	<i>Signal: IRIG-B Control Signal. The external IRIG-B generator can set these signals. They can be used for further control procedures inside the device (e.g. logic funtions).</i>
IRIG-B . Control Signal8	<i>Signal: IRIG-B Control Signal. The external IRIG-B generator can set these signals. They can be used for further control procedures inside the device (e.g. logic funtions).</i>
IRIG-B . Control Signal9	<i>Signal: IRIG-B Control Signal. The external IRIG-B generator can set these signals. They can be used for further control procedures inside the device (e.g. logic funtions).</i>
IRIG-B . Control Signal10	<i>Signal: IRIG-B Control Signal. The external IRIG-B generator can set these signals. They can be used for further control procedures inside the device (e.g. logic funtions).</i>
IRIG-B . Control Signal11	<i>Signal: IRIG-B Control Signal. The external IRIG-B generator can set these signals. They can be used for further control procedures inside the device (e.g. logic funtions).</i>
IRIG-B . Control Signal12	<i>Signal: IRIG-B Control Signal. The external IRIG-B generator can set these signals. They can be used for further control procedures inside the device (e.g. logic funtions).</i>
IRIG-B . Control Signal13	<i>Signal: IRIG-B Control Signal. The external IRIG-B generator can set these signals. They can be used for further control procedures inside the device (e.g. logic funtions).</i>
IRIG-B . Control Signal14	<i>Signal: IRIG-B Control Signal. The external IRIG-B generator can set these signals. They can be used for further control procedures inside the device (e.g. logic funtions).</i>
IRIG-B . Control Signal15	<i>Signal: IRIG-B Control Signal. The external IRIG-B generator can set these signals. They can be used for further control procedures inside the device (e.g. logic funtions).</i>
IRIG-B . Control Signal16	<i>Signal: IRIG-B Control Signal. The external IRIG-B generator can set these signals. They can be used for further control procedures inside the device (e.g. logic funtions).</i>
IRIG-B . Control Signal17	<i>Signal: IRIG-B Control Signal. The external IRIG-B generator can set these signals. They can be used for further control procedures inside the device (e.g. logic funtions).</i>
IRIG-B . Control Signal18	<i>Signal: IRIG-B Control Signal. The external IRIG-B generator can set these signals. They can be used for further control procedures inside the device (e.g. logic funtions).</i>
SNTP . SNTP active	<i>Signal: If there is no valid SNTP signal for 120 sec, SNTP is regarded as inactive.</i>
TimeSync . synchronized	<i>Clock is synchronized.</i>
Statistics . ResFc all	<i>Signal: Resetting of all Statistic values (Current Demand, Power Demand, Min, Max)</i>

1..n, Assignment List	Description
Statistics . ResFc Vavg	<i>Signal: Resetting of the sliding average calculation.</i>
Statistics . ResFc I Demand	<i>Signal: Resetting of Statistics - Current Demand (avg, peak avg)</i>
Statistics . ResFc P Demand	<i>Signal: Resetting of Statistics - Power Demand (avg, peak avg)</i>
Statistics . ResFc Max	<i>Signal: Resetting of all Maximum values</i>
Statistics . ResFc Min	<i>Signal: Resetting of all Minimum values</i>
Statistics . StartFc Vavg-I	<i>State of the module input: Start of Statistics Average Voltage</i>
Statistics . StartFc I Demand-I	<i>State of the module input: Start of the Statistics of the Current Demand</i>
Statistics . StartFc P Demand-I	<i>State of the module input: Start of the Statistics of the Active Power Demand</i>
Logics . LE1.Gate Out	<i>Signal: Output of the logic gate</i>
Logics . LE1.Timer Out	<i>Signal: Timer Output</i>
Logics . LE1.Out	<i>Signal: Latched Output (Q)</i>
Logics . LE1.Out inverted	<i>Signal: Negated Latched Output (Q NOT)</i>
Logics . LE1.Gate In1-I	<i>State of the module input: Assignment of the Input Signal</i>
Logics . LE1.Gate In2-I	<i>State of the module input: Assignment of the Input Signal</i>
Logics . LE1.Gate In3-I	<i>State of the module input: Assignment of the Input Signal</i>
Logics . LE1.Gate In4-I	<i>State of the module input: Assignment of the Input Signal</i>
Logics . LE1.Reset Latch-I	<i>State of the module input: Reset Signal for the Latching</i>
Logics . LE2.Gate Out	<i>Signal: Output of the logic gate</i>
Logics . LE2.Timer Out	<i>Signal: Timer Output</i>
Logics . LE2.Out	<i>Signal: Latched Output (Q)</i>
Logics . LE2.Out inverted	<i>Signal: Negated Latched Output (Q NOT)</i>
Logics . LE2.Gate In1-I	<i>State of the module input: Assignment of the Input Signal</i>
Logics . LE2.Gate In2-I	<i>State of the module input: Assignment of the Input Signal</i>
Logics . LE2.Gate In3-I	<i>State of the module input: Assignment of the Input Signal</i>
Logics . LE2.Gate In4-I	<i>State of the module input: Assignment of the Input Signal</i>
Logics . LE2.Reset Latch-I	<i>State of the module input: Reset Signal for the Latching</i>
Logics . LE3.Gate Out	<i>Signal: Output of the logic gate</i>

1..n, Assignment List	Description
Logics . LE3.Timer Out	<i>Signal: Timer Output</i>
Logics . LE3.Out	<i>Signal: Latched Output (Q)</i>
Logics . LE3.Out inverted	<i>Signal: Negated Latched Output (Q NOT)</i>
Logics . LE3.Gate In1-I	<i>State of the module input: Assignment of the Input Signal</i>
Logics . LE3.Gate In2-I	<i>State of the module input: Assignment of the Input Signal</i>
Logics . LE3.Gate In3-I	<i>State of the module input: Assignment of the Input Signal</i>
Logics . LE3.Gate In4-I	<i>State of the module input: Assignment of the Input Signal</i>
Logics . LE3.Reset Latch-I	<i>State of the module input: Reset Signal for the Latching</i>
Logics . LE4.Gate Out	<i>Signal: Output of the logic gate</i>
Logics . LE4.Timer Out	<i>Signal: Timer Output</i>
Logics . LE4.Out	<i>Signal: Latched Output (Q)</i>
Logics . LE4.Out inverted	<i>Signal: Negated Latched Output (Q NOT)</i>
Logics . LE4.Gate In1-I	<i>State of the module input: Assignment of the Input Signal</i>
Logics . LE4.Gate In2-I	<i>State of the module input: Assignment of the Input Signal</i>
Logics . LE4.Gate In3-I	<i>State of the module input: Assignment of the Input Signal</i>
Logics . LE4.Gate In4-I	<i>State of the module input: Assignment of the Input Signal</i>
Logics . LE4.Reset Latch-I	<i>State of the module input: Reset Signal for the Latching</i>
Logics . LE5.Gate Out	<i>Signal: Output of the logic gate</i>
Logics . LE5.Timer Out	<i>Signal: Timer Output</i>
Logics . LE5.Out	<i>Signal: Latched Output (Q)</i>
Logics . LE5.Out inverted	<i>Signal: Negated Latched Output (Q NOT)</i>
Logics . LE5.Gate In1-I	<i>State of the module input: Assignment of the Input Signal</i>
Logics . LE5.Gate In2-I	<i>State of the module input: Assignment of the Input Signal</i>
Logics . LE5.Gate In3-I	<i>State of the module input: Assignment of the Input Signal</i>
Logics . LE5.Gate In4-I	<i>State of the module input: Assignment of the Input Signal</i>
Logics . LE5.Reset Latch-I	<i>State of the module input: Reset Signal for the Latching</i>
Logics . LE6.Gate Out	<i>Signal: Output of the logic gate</i>
Logics . LE6.Timer Out	<i>Signal: Timer Output</i>

1..n, Assignment List	Description
Logics . LE6.Out	<i>Signal: Latched Output (Q)</i>
Logics . LE6.Out inverted	<i>Signal: Negated Latched Output (Q NOT)</i>
Logics . LE6.Gate In1-I	<i>State of the module input: Assignment of the Input Signal</i>
Logics . LE6.Gate In2-I	<i>State of the module input: Assignment of the Input Signal</i>
Logics . LE6.Gate In3-I	<i>State of the module input: Assignment of the Input Signal</i>
Logics . LE6.Gate In4-I	<i>State of the module input: Assignment of the Input Signal</i>
Logics . LE6.Reset Latch-I	<i>State of the module input: Reset Signal for the Latching</i>
Logics . LE7.Gate Out	<i>Signal: Output of the logic gate</i>
Logics . LE7.Timer Out	<i>Signal: Timer Output</i>
Logics . LE7.Out	<i>Signal: Latched Output (Q)</i>
Logics . LE7.Out inverted	<i>Signal: Negated Latched Output (Q NOT)</i>
Logics . LE7.Gate In1-I	<i>State of the module input: Assignment of the Input Signal</i>
Logics . LE7.Gate In2-I	<i>State of the module input: Assignment of the Input Signal</i>
Logics . LE7.Gate In3-I	<i>State of the module input: Assignment of the Input Signal</i>
Logics . LE7.Gate In4-I	<i>State of the module input: Assignment of the Input Signal</i>
Logics . LE7.Reset Latch-I	<i>State of the module input: Reset Signal for the Latching</i>
Logics . LE8.Gate Out	<i>Signal: Output of the logic gate</i>
Logics . LE8.Timer Out	<i>Signal: Timer Output</i>
Logics . LE8.Out	<i>Signal: Latched Output (Q)</i>
Logics . LE8.Out inverted	<i>Signal: Negated Latched Output (Q NOT)</i>
Logics . LE8.Gate In1-I	<i>State of the module input: Assignment of the Input Signal</i>
Logics . LE8.Gate In2-I	<i>State of the module input: Assignment of the Input Signal</i>
Logics . LE8.Gate In3-I	<i>State of the module input: Assignment of the Input Signal</i>
Logics . LE8.Gate In4-I	<i>State of the module input: Assignment of the Input Signal</i>
Logics . LE8.Reset Latch-I	<i>State of the module input: Reset Signal for the Latching</i>
Logics . LE9.Gate Out	<i>Signal: Output of the logic gate</i>
Logics . LE9.Timer Out	<i>Signal: Timer Output</i>
Logics . LE9.Out	<i>Signal: Latched Output (Q)</i>

1..n, Assignment List	Description
Logics . LE9.Out inverted	<i>Signal: Negated Latched Output (Q NOT)</i>
Logics . LE9.Gate In1-I	<i>State of the module input: Assignment of the Input Signal</i>
Logics . LE9.Gate In2-I	<i>State of the module input: Assignment of the Input Signal</i>
Logics . LE9.Gate In3-I	<i>State of the module input: Assignment of the Input Signal</i>
Logics . LE9.Gate In4-I	<i>State of the module input: Assignment of the Input Signal</i>
Logics . LE9.Reset Latch-I	<i>State of the module input: Reset Signal for the Latching</i>
Logics . LE10.Gate Out	<i>Signal: Output of the logic gate</i>
Logics . LE10.Timer Out	<i>Signal: Timer Output</i>
Logics . LE10.Out	<i>Signal: Latched Output (Q)</i>
Logics . LE10.Out inverted	<i>Signal: Negated Latched Output (Q NOT)</i>
Logics . LE10.Gate In1-I	<i>State of the module input: Assignment of the Input Signal</i>
Logics . LE10.Gate In2-I	<i>State of the module input: Assignment of the Input Signal</i>
Logics . LE10.Gate In3-I	<i>State of the module input: Assignment of the Input Signal</i>
Logics . LE10.Gate In4-I	<i>State of the module input: Assignment of the Input Signal</i>
Logics . LE10.Reset Latch-I	<i>State of the module input: Reset Signal for the Latching</i>
Logics . LE11.Gate Out	<i>Signal: Output of the logic gate</i>
Logics . LE11.Timer Out	<i>Signal: Timer Output</i>
Logics . LE11.Out	<i>Signal: Latched Output (Q)</i>
Logics . LE11.Out inverted	<i>Signal: Negated Latched Output (Q NOT)</i>
Logics . LE11.Gate In1-I	<i>State of the module input: Assignment of the Input Signal</i>
Logics . LE11.Gate In2-I	<i>State of the module input: Assignment of the Input Signal</i>
Logics . LE11.Gate In3-I	<i>State of the module input: Assignment of the Input Signal</i>
Logics . LE11.Gate In4-I	<i>State of the module input: Assignment of the Input Signal</i>
Logics . LE11.Reset Latch-I	<i>State of the module input: Reset Signal for the Latching</i>
Logics . LE12.Gate Out	<i>Signal: Output of the logic gate</i>
Logics . LE12.Timer Out	<i>Signal: Timer Output</i>
Logics . LE12.Out	<i>Signal: Latched Output (Q)</i>
Logics . LE12.Out inverted	<i>Signal: Negated Latched Output (Q NOT)</i>

1..n, Assignment List	Description
Logics . LE12.Gate In1-I	<i>State of the module input: Assignment of the Input Signal</i>
Logics . LE12.Gate In2-I	<i>State of the module input: Assignment of the Input Signal</i>
Logics . LE12.Gate In3-I	<i>State of the module input: Assignment of the Input Signal</i>
Logics . LE12.Gate In4-I	<i>State of the module input: Assignment of the Input Signal</i>
Logics . LE12.Reset Latch-I	<i>State of the module input: Reset Signal for the Latching</i>
Logics . LE13.Gate Out	<i>Signal: Output of the logic gate</i>
Logics . LE13.Timer Out	<i>Signal: Timer Output</i>
Logics . LE13.Out	<i>Signal: Latched Output (Q)</i>
Logics . LE13.Out inverted	<i>Signal: Negated Latched Output (Q NOT)</i>
Logics . LE13.Gate In1-I	<i>State of the module input: Assignment of the Input Signal</i>
Logics . LE13.Gate In2-I	<i>State of the module input: Assignment of the Input Signal</i>
Logics . LE13.Gate In3-I	<i>State of the module input: Assignment of the Input Signal</i>
Logics . LE13.Gate In4-I	<i>State of the module input: Assignment of the Input Signal</i>
Logics . LE13.Reset Latch-I	<i>State of the module input: Reset Signal for the Latching</i>
Logics . LE14.Gate Out	<i>Signal: Output of the logic gate</i>
Logics . LE14.Timer Out	<i>Signal: Timer Output</i>
Logics . LE14.Out	<i>Signal: Latched Output (Q)</i>
Logics . LE14.Out inverted	<i>Signal: Negated Latched Output (Q NOT)</i>
Logics . LE14.Gate In1-I	<i>State of the module input: Assignment of the Input Signal</i>
Logics . LE14.Gate In2-I	<i>State of the module input: Assignment of the Input Signal</i>
Logics . LE14.Gate In3-I	<i>State of the module input: Assignment of the Input Signal</i>
Logics . LE14.Gate In4-I	<i>State of the module input: Assignment of the Input Signal</i>
Logics . LE14.Reset Latch-I	<i>State of the module input: Reset Signal for the Latching</i>
Logics . LE15.Gate Out	<i>Signal: Output of the logic gate</i>
Logics . LE15.Timer Out	<i>Signal: Timer Output</i>
Logics . LE15.Out	<i>Signal: Latched Output (Q)</i>
Logics . LE15.Out inverted	<i>Signal: Negated Latched Output (Q NOT)</i>
Logics . LE15.Gate In1-I	<i>State of the module input: Assignment of the Input Signal</i>

1..n, Assignment List	Description
Logics . LE15.Gate In2-I	<i>State of the module input: Assignment of the Input Signal</i>
Logics . LE15.Gate In3-I	<i>State of the module input: Assignment of the Input Signal</i>
Logics . LE15.Gate In4-I	<i>State of the module input: Assignment of the Input Signal</i>
Logics . LE15.Reset Latch-I	<i>State of the module input: Reset Signal for the Latching</i>
Logics . LE16.Gate Out	<i>Signal: Output of the logic gate</i>
Logics . LE16.Timer Out	<i>Signal: Timer Output</i>
Logics . LE16.Out	<i>Signal: Latched Output (Q)</i>
Logics . LE16.Out inverted	<i>Signal: Negated Latched Output (Q NOT)</i>
Logics . LE16.Gate In1-I	<i>State of the module input: Assignment of the Input Signal</i>
Logics . LE16.Gate In2-I	<i>State of the module input: Assignment of the Input Signal</i>
Logics . LE16.Gate In3-I	<i>State of the module input: Assignment of the Input Signal</i>
Logics . LE16.Gate In4-I	<i>State of the module input: Assignment of the Input Signal</i>
Logics . LE16.Reset Latch-I	<i>State of the module input: Reset Signal for the Latching</i>
Logics . LE17.Gate Out	<i>Signal: Output of the logic gate</i>
Logics . LE17.Timer Out	<i>Signal: Timer Output</i>
Logics . LE17.Out	<i>Signal: Latched Output (Q)</i>
Logics . LE17.Out inverted	<i>Signal: Negated Latched Output (Q NOT)</i>
Logics . LE17.Gate In1-I	<i>State of the module input: Assignment of the Input Signal</i>
Logics . LE17.Gate In2-I	<i>State of the module input: Assignment of the Input Signal</i>
Logics . LE17.Gate In3-I	<i>State of the module input: Assignment of the Input Signal</i>
Logics . LE17.Gate In4-I	<i>State of the module input: Assignment of the Input Signal</i>
Logics . LE17.Reset Latch-I	<i>State of the module input: Reset Signal for the Latching</i>
Logics . LE18.Gate Out	<i>Signal: Output of the logic gate</i>
Logics . LE18.Timer Out	<i>Signal: Timer Output</i>
Logics . LE18.Out	<i>Signal: Latched Output (Q)</i>
Logics . LE18.Out inverted	<i>Signal: Negated Latched Output (Q NOT)</i>
Logics . LE18.Gate In1-I	<i>State of the module input: Assignment of the Input Signal</i>
Logics . LE18.Gate In2-I	<i>State of the module input: Assignment of the Input Signal</i>

1..n, Assignment List	Description
Logics . LE18.Gate In3-I	<i>State of the module input: Assignment of the Input Signal</i>
Logics . LE18.Gate In4-I	<i>State of the module input: Assignment of the Input Signal</i>
Logics . LE18.Reset Latch-I	<i>State of the module input: Reset Signal for the Latching</i>
Logics . LE19.Gate Out	<i>Signal: Output of the logic gate</i>
Logics . LE19.Timer Out	<i>Signal: Timer Output</i>
Logics . LE19.Out	<i>Signal: Latched Output (Q)</i>
Logics . LE19.Out inverted	<i>Signal: Negated Latched Output (Q NOT)</i>
Logics . LE19.Gate In1-I	<i>State of the module input: Assignment of the Input Signal</i>
Logics . LE19.Gate In2-I	<i>State of the module input: Assignment of the Input Signal</i>
Logics . LE19.Gate In3-I	<i>State of the module input: Assignment of the Input Signal</i>
Logics . LE19.Gate In4-I	<i>State of the module input: Assignment of the Input Signal</i>
Logics . LE19.Reset Latch-I	<i>State of the module input: Reset Signal for the Latching</i>
Logics . LE20.Gate Out	<i>Signal: Output of the logic gate</i>
Logics . LE20.Timer Out	<i>Signal: Timer Output</i>
Logics . LE20.Out	<i>Signal: Latched Output (Q)</i>
Logics . LE20.Out inverted	<i>Signal: Negated Latched Output (Q NOT)</i>
Logics . LE20.Gate In1-I	<i>State of the module input: Assignment of the Input Signal</i>
Logics . LE20.Gate In2-I	<i>State of the module input: Assignment of the Input Signal</i>
Logics . LE20.Gate In3-I	<i>State of the module input: Assignment of the Input Signal</i>
Logics . LE20.Gate In4-I	<i>State of the module input: Assignment of the Input Signal</i>
Logics . LE20.Reset Latch-I	<i>State of the module input: Reset Signal for the Latching</i>
Logics . LE21.Gate Out	<i>Signal: Output of the logic gate</i>
Logics . LE21.Timer Out	<i>Signal: Timer Output</i>
Logics . LE21.Out	<i>Signal: Latched Output (Q)</i>
Logics . LE21.Out inverted	<i>Signal: Negated Latched Output (Q NOT)</i>
Logics . LE21.Gate In1-I	<i>State of the module input: Assignment of the Input Signal</i>
Logics . LE21.Gate In2-I	<i>State of the module input: Assignment of the Input Signal</i>
Logics . LE21.Gate In3-I	<i>State of the module input: Assignment of the Input Signal</i>

1..n, Assignment List	Description
Logics . LE21.Gate In4-I	<i>State of the module input: Assignment of the Input Signal</i>
Logics . LE21.Reset Latch-I	<i>State of the module input: Reset Signal for the Latching</i>
Logics . LE22.Gate Out	<i>Signal: Output of the logic gate</i>
Logics . LE22.Timer Out	<i>Signal: Timer Output</i>
Logics . LE22.Out	<i>Signal: Latched Output (Q)</i>
Logics . LE22.Out inverted	<i>Signal: Negated Latched Output (Q NOT)</i>
Logics . LE22.Gate In1-I	<i>State of the module input: Assignment of the Input Signal</i>
Logics . LE22.Gate In2-I	<i>State of the module input: Assignment of the Input Signal</i>
Logics . LE22.Gate In3-I	<i>State of the module input: Assignment of the Input Signal</i>
Logics . LE22.Gate In4-I	<i>State of the module input: Assignment of the Input Signal</i>
Logics . LE22.Reset Latch-I	<i>State of the module input: Reset Signal for the Latching</i>
Logics . LE23.Gate Out	<i>Signal: Output of the logic gate</i>
Logics . LE23.Timer Out	<i>Signal: Timer Output</i>
Logics . LE23.Out	<i>Signal: Latched Output (Q)</i>
Logics . LE23.Out inverted	<i>Signal: Negated Latched Output (Q NOT)</i>
Logics . LE23.Gate In1-I	<i>State of the module input: Assignment of the Input Signal</i>
Logics . LE23.Gate In2-I	<i>State of the module input: Assignment of the Input Signal</i>
Logics . LE23.Gate In3-I	<i>State of the module input: Assignment of the Input Signal</i>
Logics . LE23.Gate In4-I	<i>State of the module input: Assignment of the Input Signal</i>
Logics . LE23.Reset Latch-I	<i>State of the module input: Reset Signal for the Latching</i>
Logics . LE24.Gate Out	<i>Signal: Output of the logic gate</i>
Logics . LE24.Timer Out	<i>Signal: Timer Output</i>
Logics . LE24.Out	<i>Signal: Latched Output (Q)</i>
Logics . LE24.Out inverted	<i>Signal: Negated Latched Output (Q NOT)</i>
Logics . LE24.Gate In1-I	<i>State of the module input: Assignment of the Input Signal</i>
Logics . LE24.Gate In2-I	<i>State of the module input: Assignment of the Input Signal</i>
Logics . LE24.Gate In3-I	<i>State of the module input: Assignment of the Input Signal</i>
Logics . LE24.Gate In4-I	<i>State of the module input: Assignment of the Input Signal</i>

1..n, Assignment List	Description
Logics . LE24.Reset Latch-I	<i>State of the module input: Reset Signal for the Latching</i>
Logics . LE25.Gate Out	<i>Signal: Output of the logic gate</i>
Logics . LE25.Timer Out	<i>Signal: Timer Output</i>
Logics . LE25.Out	<i>Signal: Latched Output (Q)</i>
Logics . LE25.Out inverted	<i>Signal: Negated Latched Output (Q NOT)</i>
Logics . LE25.Gate In1-I	<i>State of the module input: Assignment of the Input Signal</i>
Logics . LE25.Gate In2-I	<i>State of the module input: Assignment of the Input Signal</i>
Logics . LE25.Gate In3-I	<i>State of the module input: Assignment of the Input Signal</i>
Logics . LE25.Gate In4-I	<i>State of the module input: Assignment of the Input Signal</i>
Logics . LE25.Reset Latch-I	<i>State of the module input: Reset Signal for the Latching</i>
Logics . LE26.Gate Out	<i>Signal: Output of the logic gate</i>
Logics . LE26.Timer Out	<i>Signal: Timer Output</i>
Logics . LE26.Out	<i>Signal: Latched Output (Q)</i>
Logics . LE26.Out inverted	<i>Signal: Negated Latched Output (Q NOT)</i>
Logics . LE26.Gate In1-I	<i>State of the module input: Assignment of the Input Signal</i>
Logics . LE26.Gate In2-I	<i>State of the module input: Assignment of the Input Signal</i>
Logics . LE26.Gate In3-I	<i>State of the module input: Assignment of the Input Signal</i>
Logics . LE26.Gate In4-I	<i>State of the module input: Assignment of the Input Signal</i>
Logics . LE26.Reset Latch-I	<i>State of the module input: Reset Signal for the Latching</i>
Logics . LE27.Gate Out	<i>Signal: Output of the logic gate</i>
Logics . LE27.Timer Out	<i>Signal: Timer Output</i>
Logics . LE27.Out	<i>Signal: Latched Output (Q)</i>
Logics . LE27.Out inverted	<i>Signal: Negated Latched Output (Q NOT)</i>
Logics . LE27.Gate In1-I	<i>State of the module input: Assignment of the Input Signal</i>
Logics . LE27.Gate In2-I	<i>State of the module input: Assignment of the Input Signal</i>
Logics . LE27.Gate In3-I	<i>State of the module input: Assignment of the Input Signal</i>
Logics . LE27.Gate In4-I	<i>State of the module input: Assignment of the Input Signal</i>
Logics . LE27.Reset Latch-I	<i>State of the module input: Reset Signal for the Latching</i>

1..n, Assignment List	Description
Logics . LE28.Gate Out	<i>Signal: Output of the logic gate</i>
Logics . LE28.Timer Out	<i>Signal: Timer Output</i>
Logics . LE28.Out	<i>Signal: Latched Output (Q)</i>
Logics . LE28.Out inverted	<i>Signal: Negated Latched Output (Q NOT)</i>
Logics . LE28.Gate In1-I	<i>State of the module input: Assignment of the Input Signal</i>
Logics . LE28.Gate In2-I	<i>State of the module input: Assignment of the Input Signal</i>
Logics . LE28.Gate In3-I	<i>State of the module input: Assignment of the Input Signal</i>
Logics . LE28.Gate In4-I	<i>State of the module input: Assignment of the Input Signal</i>
Logics . LE28.Reset Latch-I	<i>State of the module input: Reset Signal for the Latching</i>
Logics . LE29.Gate Out	<i>Signal: Output of the logic gate</i>
Logics . LE29.Timer Out	<i>Signal: Timer Output</i>
Logics . LE29.Out	<i>Signal: Latched Output (Q)</i>
Logics . LE29.Out inverted	<i>Signal: Negated Latched Output (Q NOT)</i>
Logics . LE29.Gate In1-I	<i>State of the module input: Assignment of the Input Signal</i>
Logics . LE29.Gate In2-I	<i>State of the module input: Assignment of the Input Signal</i>
Logics . LE29.Gate In3-I	<i>State of the module input: Assignment of the Input Signal</i>
Logics . LE29.Gate In4-I	<i>State of the module input: Assignment of the Input Signal</i>
Logics . LE29.Reset Latch-I	<i>State of the module input: Reset Signal for the Latching</i>
Logics . LE30.Gate Out	<i>Signal: Output of the logic gate</i>
Logics . LE30.Timer Out	<i>Signal: Timer Output</i>
Logics . LE30.Out	<i>Signal: Latched Output (Q)</i>
Logics . LE30.Out inverted	<i>Signal: Negated Latched Output (Q NOT)</i>
Logics . LE30.Gate In1-I	<i>State of the module input: Assignment of the Input Signal</i>
Logics . LE30.Gate In2-I	<i>State of the module input: Assignment of the Input Signal</i>
Logics . LE30.Gate In3-I	<i>State of the module input: Assignment of the Input Signal</i>
Logics . LE30.Gate In4-I	<i>State of the module input: Assignment of the Input Signal</i>
Logics . LE30.Reset Latch-I	<i>State of the module input: Reset Signal for the Latching</i>
Logics . LE31.Gate Out	<i>Signal: Output of the logic gate</i>

1..n, Assignment List	Description
Logics . LE31.Timer Out	<i>Signal: Timer Output</i>
Logics . LE31.Out	<i>Signal: Latched Output (Q)</i>
Logics . LE31.Out inverted	<i>Signal: Negated Latched Output (Q NOT)</i>
Logics . LE31.Gate In1-I	<i>State of the module input: Assignment of the Input Signal</i>
Logics . LE31.Gate In2-I	<i>State of the module input: Assignment of the Input Signal</i>
Logics . LE31.Gate In3-I	<i>State of the module input: Assignment of the Input Signal</i>
Logics . LE31.Gate In4-I	<i>State of the module input: Assignment of the Input Signal</i>
Logics . LE31.Reset Latch-I	<i>State of the module input: Reset Signal for the Latching</i>
Logics . LE32.Gate Out	<i>Signal: Output of the logic gate</i>
Logics . LE32.Timer Out	<i>Signal: Timer Output</i>
Logics . LE32.Out	<i>Signal: Latched Output (Q)</i>
Logics . LE32.Out inverted	<i>Signal: Negated Latched Output (Q NOT)</i>
Logics . LE32.Gate In1-I	<i>State of the module input: Assignment of the Input Signal</i>
Logics . LE32.Gate In2-I	<i>State of the module input: Assignment of the Input Signal</i>
Logics . LE32.Gate In3-I	<i>State of the module input: Assignment of the Input Signal</i>
Logics . LE32.Gate In4-I	<i>State of the module input: Assignment of the Input Signal</i>
Logics . LE32.Reset Latch-I	<i>State of the module input: Reset Signal for the Latching</i>
Logics . LE33.Gate Out	<i>Signal: Output of the logic gate</i>
Logics . LE33.Timer Out	<i>Signal: Timer Output</i>
Logics . LE33.Out	<i>Signal: Latched Output (Q)</i>
Logics . LE33.Out inverted	<i>Signal: Negated Latched Output (Q NOT)</i>
Logics . LE33.Gate In1-I	<i>State of the module input: Assignment of the Input Signal</i>
Logics . LE33.Gate In2-I	<i>State of the module input: Assignment of the Input Signal</i>
Logics . LE33.Gate In3-I	<i>State of the module input: Assignment of the Input Signal</i>
Logics . LE33.Gate In4-I	<i>State of the module input: Assignment of the Input Signal</i>
Logics . LE33.Reset Latch-I	<i>State of the module input: Reset Signal for the Latching</i>
Logics . LE34.Gate Out	<i>Signal: Output of the logic gate</i>
Logics . LE34.Timer Out	<i>Signal: Timer Output</i>

1..n, Assignment List	Description
Logics . LE34.Out	<i>Signal: Latched Output (Q)</i>
Logics . LE34.Out inverted	<i>Signal: Negated Latched Output (Q NOT)</i>
Logics . LE34.Gate In1-I	<i>State of the module input: Assignment of the Input Signal</i>
Logics . LE34.Gate In2-I	<i>State of the module input: Assignment of the Input Signal</i>
Logics . LE34.Gate In3-I	<i>State of the module input: Assignment of the Input Signal</i>
Logics . LE34.Gate In4-I	<i>State of the module input: Assignment of the Input Signal</i>
Logics . LE34.Reset Latch-I	<i>State of the module input: Reset Signal for the Latching</i>
Logics . LE35.Gate Out	<i>Signal: Output of the logic gate</i>
Logics . LE35.Timer Out	<i>Signal: Timer Output</i>
Logics . LE35.Out	<i>Signal: Latched Output (Q)</i>
Logics . LE35.Out inverted	<i>Signal: Negated Latched Output (Q NOT)</i>
Logics . LE35.Gate In1-I	<i>State of the module input: Assignment of the Input Signal</i>
Logics . LE35.Gate In2-I	<i>State of the module input: Assignment of the Input Signal</i>
Logics . LE35.Gate In3-I	<i>State of the module input: Assignment of the Input Signal</i>
Logics . LE35.Gate In4-I	<i>State of the module input: Assignment of the Input Signal</i>
Logics . LE35.Reset Latch-I	<i>State of the module input: Reset Signal for the Latching</i>
Logics . LE36.Gate Out	<i>Signal: Output of the logic gate</i>
Logics . LE36.Timer Out	<i>Signal: Timer Output</i>
Logics . LE36.Out	<i>Signal: Latched Output (Q)</i>
Logics . LE36.Out inverted	<i>Signal: Negated Latched Output (Q NOT)</i>
Logics . LE36.Gate In1-I	<i>State of the module input: Assignment of the Input Signal</i>
Logics . LE36.Gate In2-I	<i>State of the module input: Assignment of the Input Signal</i>
Logics . LE36.Gate In3-I	<i>State of the module input: Assignment of the Input Signal</i>
Logics . LE36.Gate In4-I	<i>State of the module input: Assignment of the Input Signal</i>
Logics . LE36.Reset Latch-I	<i>State of the module input: Reset Signal for the Latching</i>
Logics . LE37.Gate Out	<i>Signal: Output of the logic gate</i>
Logics . LE37.Timer Out	<i>Signal: Timer Output</i>
Logics . LE37.Out	<i>Signal: Latched Output (Q)</i>

1..n, Assignment List	Description
Logics . LE37.Out inverted	<i>Signal: Negated Latched Output (Q NOT)</i>
Logics . LE37.Gate In1-I	<i>State of the module input: Assignment of the Input Signal</i>
Logics . LE37.Gate In2-I	<i>State of the module input: Assignment of the Input Signal</i>
Logics . LE37.Gate In3-I	<i>State of the module input: Assignment of the Input Signal</i>
Logics . LE37.Gate In4-I	<i>State of the module input: Assignment of the Input Signal</i>
Logics . LE37.Reset Latch-I	<i>State of the module input: Reset Signal for the Latching</i>
Logics . LE38.Gate Out	<i>Signal: Output of the logic gate</i>
Logics . LE38.Timer Out	<i>Signal: Timer Output</i>
Logics . LE38.Out	<i>Signal: Latched Output (Q)</i>
Logics . LE38.Out inverted	<i>Signal: Negated Latched Output (Q NOT)</i>
Logics . LE38.Gate In1-I	<i>State of the module input: Assignment of the Input Signal</i>
Logics . LE38.Gate In2-I	<i>State of the module input: Assignment of the Input Signal</i>
Logics . LE38.Gate In3-I	<i>State of the module input: Assignment of the Input Signal</i>
Logics . LE38.Gate In4-I	<i>State of the module input: Assignment of the Input Signal</i>
Logics . LE38.Reset Latch-I	<i>State of the module input: Reset Signal for the Latching</i>
Logics . LE39.Gate Out	<i>Signal: Output of the logic gate</i>
Logics . LE39.Timer Out	<i>Signal: Timer Output</i>
Logics . LE39.Out	<i>Signal: Latched Output (Q)</i>
Logics . LE39.Out inverted	<i>Signal: Negated Latched Output (Q NOT)</i>
Logics . LE39.Gate In1-I	<i>State of the module input: Assignment of the Input Signal</i>
Logics . LE39.Gate In2-I	<i>State of the module input: Assignment of the Input Signal</i>
Logics . LE39.Gate In3-I	<i>State of the module input: Assignment of the Input Signal</i>
Logics . LE39.Gate In4-I	<i>State of the module input: Assignment of the Input Signal</i>
Logics . LE39.Reset Latch-I	<i>State of the module input: Reset Signal for the Latching</i>
Logics . LE40.Gate Out	<i>Signal: Output of the logic gate</i>
Logics . LE40.Timer Out	<i>Signal: Timer Output</i>
Logics . LE40.Out	<i>Signal: Latched Output (Q)</i>
Logics . LE40.Out inverted	<i>Signal: Negated Latched Output (Q NOT)</i>

1..n, Assignment List	Description
Logics . LE40.Gate In1-I	<i>State of the module input: Assignment of the Input Signal</i>
Logics . LE40.Gate In2-I	<i>State of the module input: Assignment of the Input Signal</i>
Logics . LE40.Gate In3-I	<i>State of the module input: Assignment of the Input Signal</i>
Logics . LE40.Gate In4-I	<i>State of the module input: Assignment of the Input Signal</i>
Logics . LE40.Reset Latch-I	<i>State of the module input: Reset Signal for the Latching</i>
Logics . LE41.Gate Out	<i>Signal: Output of the logic gate</i>
Logics . LE41.Timer Out	<i>Signal: Timer Output</i>
Logics . LE41.Out	<i>Signal: Latched Output (Q)</i>
Logics . LE41.Out inverted	<i>Signal: Negated Latched Output (Q NOT)</i>
Logics . LE41.Gate In1-I	<i>State of the module input: Assignment of the Input Signal</i>
Logics . LE41.Gate In2-I	<i>State of the module input: Assignment of the Input Signal</i>
Logics . LE41.Gate In3-I	<i>State of the module input: Assignment of the Input Signal</i>
Logics . LE41.Gate In4-I	<i>State of the module input: Assignment of the Input Signal</i>
Logics . LE41.Reset Latch-I	<i>State of the module input: Reset Signal for the Latching</i>
Logics . LE42.Gate Out	<i>Signal: Output of the logic gate</i>
Logics . LE42.Timer Out	<i>Signal: Timer Output</i>
Logics . LE42.Out	<i>Signal: Latched Output (Q)</i>
Logics . LE42.Out inverted	<i>Signal: Negated Latched Output (Q NOT)</i>
Logics . LE42.Gate In1-I	<i>State of the module input: Assignment of the Input Signal</i>
Logics . LE42.Gate In2-I	<i>State of the module input: Assignment of the Input Signal</i>
Logics . LE42.Gate In3-I	<i>State of the module input: Assignment of the Input Signal</i>
Logics . LE42.Gate In4-I	<i>State of the module input: Assignment of the Input Signal</i>
Logics . LE42.Reset Latch-I	<i>State of the module input: Reset Signal for the Latching</i>
Logics . LE43.Gate Out	<i>Signal: Output of the logic gate</i>
Logics . LE43.Timer Out	<i>Signal: Timer Output</i>
Logics . LE43.Out	<i>Signal: Latched Output (Q)</i>
Logics . LE43.Out inverted	<i>Signal: Negated Latched Output (Q NOT)</i>
Logics . LE43.Gate In1-I	<i>State of the module input: Assignment of the Input Signal</i>

1..n, Assignment List	Description
Logics . LE43.Gate In2-I	<i>State of the module input: Assignment of the Input Signal</i>
Logics . LE43.Gate In3-I	<i>State of the module input: Assignment of the Input Signal</i>
Logics . LE43.Gate In4-I	<i>State of the module input: Assignment of the Input Signal</i>
Logics . LE43.Reset Latch-I	<i>State of the module input: Reset Signal for the Latching</i>
Logics . LE44.Gate Out	<i>Signal: Output of the logic gate</i>
Logics . LE44.Timer Out	<i>Signal: Timer Output</i>
Logics . LE44.Out	<i>Signal: Latched Output (Q)</i>
Logics . LE44.Out inverted	<i>Signal: Negated Latched Output (Q NOT)</i>
Logics . LE44.Gate In1-I	<i>State of the module input: Assignment of the Input Signal</i>
Logics . LE44.Gate In2-I	<i>State of the module input: Assignment of the Input Signal</i>
Logics . LE44.Gate In3-I	<i>State of the module input: Assignment of the Input Signal</i>
Logics . LE44.Gate In4-I	<i>State of the module input: Assignment of the Input Signal</i>
Logics . LE44.Reset Latch-I	<i>State of the module input: Reset Signal for the Latching</i>
Logics . LE45.Gate Out	<i>Signal: Output of the logic gate</i>
Logics . LE45.Timer Out	<i>Signal: Timer Output</i>
Logics . LE45.Out	<i>Signal: Latched Output (Q)</i>
Logics . LE45.Out inverted	<i>Signal: Negated Latched Output (Q NOT)</i>
Logics . LE45.Gate In1-I	<i>State of the module input: Assignment of the Input Signal</i>
Logics . LE45.Gate In2-I	<i>State of the module input: Assignment of the Input Signal</i>
Logics . LE45.Gate In3-I	<i>State of the module input: Assignment of the Input Signal</i>
Logics . LE45.Gate In4-I	<i>State of the module input: Assignment of the Input Signal</i>
Logics . LE45.Reset Latch-I	<i>State of the module input: Reset Signal for the Latching</i>
Logics . LE46.Gate Out	<i>Signal: Output of the logic gate</i>
Logics . LE46.Timer Out	<i>Signal: Timer Output</i>
Logics . LE46.Out	<i>Signal: Latched Output (Q)</i>
Logics . LE46.Out inverted	<i>Signal: Negated Latched Output (Q NOT)</i>
Logics . LE46.Gate In1-I	<i>State of the module input: Assignment of the Input Signal</i>
Logics . LE46.Gate In2-I	<i>State of the module input: Assignment of the Input Signal</i>

1..n, Assignment List	Description
Logics . LE46.Gate In3-I	<i>State of the module input: Assignment of the Input Signal</i>
Logics . LE46.Gate In4-I	<i>State of the module input: Assignment of the Input Signal</i>
Logics . LE46.Reset Latch-I	<i>State of the module input: Reset Signal for the Latching</i>
Logics . LE47.Gate Out	<i>Signal: Output of the logic gate</i>
Logics . LE47.Timer Out	<i>Signal: Timer Output</i>
Logics . LE47.Out	<i>Signal: Latched Output (Q)</i>
Logics . LE47.Out inverted	<i>Signal: Negated Latched Output (Q NOT)</i>
Logics . LE47.Gate In1-I	<i>State of the module input: Assignment of the Input Signal</i>
Logics . LE47.Gate In2-I	<i>State of the module input: Assignment of the Input Signal</i>
Logics . LE47.Gate In3-I	<i>State of the module input: Assignment of the Input Signal</i>
Logics . LE47.Gate In4-I	<i>State of the module input: Assignment of the Input Signal</i>
Logics . LE47.Reset Latch-I	<i>State of the module input: Reset Signal for the Latching</i>
Logics . LE48.Gate Out	<i>Signal: Output of the logic gate</i>
Logics . LE48.Timer Out	<i>Signal: Timer Output</i>
Logics . LE48.Out	<i>Signal: Latched Output (Q)</i>
Logics . LE48.Out inverted	<i>Signal: Negated Latched Output (Q NOT)</i>
Logics . LE48.Gate In1-I	<i>State of the module input: Assignment of the Input Signal</i>
Logics . LE48.Gate In2-I	<i>State of the module input: Assignment of the Input Signal</i>
Logics . LE48.Gate In3-I	<i>State of the module input: Assignment of the Input Signal</i>
Logics . LE48.Gate In4-I	<i>State of the module input: Assignment of the Input Signal</i>
Logics . LE48.Reset Latch-I	<i>State of the module input: Reset Signal for the Latching</i>
Logics . LE49.Gate Out	<i>Signal: Output of the logic gate</i>
Logics . LE49.Timer Out	<i>Signal: Timer Output</i>
Logics . LE49.Out	<i>Signal: Latched Output (Q)</i>
Logics . LE49.Out inverted	<i>Signal: Negated Latched Output (Q NOT)</i>
Logics . LE49.Gate In1-I	<i>State of the module input: Assignment of the Input Signal</i>
Logics . LE49.Gate In2-I	<i>State of the module input: Assignment of the Input Signal</i>
Logics . LE49.Gate In3-I	<i>State of the module input: Assignment of the Input Signal</i>

1..n, Assignment List	Description
Logics . LE49.Gate In4-I	<i>State of the module input: Assignment of the Input Signal</i>
Logics . LE49.Reset Latch-I	<i>State of the module input: Reset Signal for the Latching</i>
Logics . LE50.Gate Out	<i>Signal: Output of the logic gate</i>
Logics . LE50.Timer Out	<i>Signal: Timer Output</i>
Logics . LE50.Out	<i>Signal: Latched Output (Q)</i>
Logics . LE50.Out inverted	<i>Signal: Negated Latched Output (Q NOT)</i>
Logics . LE50.Gate In1-I	<i>State of the module input: Assignment of the Input Signal</i>
Logics . LE50.Gate In2-I	<i>State of the module input: Assignment of the Input Signal</i>
Logics . LE50.Gate In3-I	<i>State of the module input: Assignment of the Input Signal</i>
Logics . LE50.Gate In4-I	<i>State of the module input: Assignment of the Input Signal</i>
Logics . LE50.Reset Latch-I	<i>State of the module input: Reset Signal for the Latching</i>
Logics . LE51.Gate Out	<i>Signal: Output of the logic gate</i>
Logics . LE51.Timer Out	<i>Signal: Timer Output</i>
Logics . LE51.Out	<i>Signal: Latched Output (Q)</i>
Logics . LE51.Out inverted	<i>Signal: Negated Latched Output (Q NOT)</i>
Logics . LE51.Gate In1-I	<i>State of the module input: Assignment of the Input Signal</i>
Logics . LE51.Gate In2-I	<i>State of the module input: Assignment of the Input Signal</i>
Logics . LE51.Gate In3-I	<i>State of the module input: Assignment of the Input Signal</i>
Logics . LE51.Gate In4-I	<i>State of the module input: Assignment of the Input Signal</i>
Logics . LE51.Reset Latch-I	<i>State of the module input: Reset Signal for the Latching</i>
Logics . LE52.Gate Out	<i>Signal: Output of the logic gate</i>
Logics . LE52.Timer Out	<i>Signal: Timer Output</i>
Logics . LE52.Out	<i>Signal: Latched Output (Q)</i>
Logics . LE52.Out inverted	<i>Signal: Negated Latched Output (Q NOT)</i>
Logics . LE52.Gate In1-I	<i>State of the module input: Assignment of the Input Signal</i>
Logics . LE52.Gate In2-I	<i>State of the module input: Assignment of the Input Signal</i>
Logics . LE52.Gate In3-I	<i>State of the module input: Assignment of the Input Signal</i>
Logics . LE52.Gate In4-I	<i>State of the module input: Assignment of the Input Signal</i>

1..n, Assignment List	Description
Logics . LE52.Reset Latch-I	<i>State of the module input: Reset Signal for the Latching</i>
Logics . LE53.Gate Out	<i>Signal: Output of the logic gate</i>
Logics . LE53.Timer Out	<i>Signal: Timer Output</i>
Logics . LE53.Out	<i>Signal: Latched Output (Q)</i>
Logics . LE53.Out inverted	<i>Signal: Negated Latched Output (Q NOT)</i>
Logics . LE53.Gate In1-I	<i>State of the module input: Assignment of the Input Signal</i>
Logics . LE53.Gate In2-I	<i>State of the module input: Assignment of the Input Signal</i>
Logics . LE53.Gate In3-I	<i>State of the module input: Assignment of the Input Signal</i>
Logics . LE53.Gate In4-I	<i>State of the module input: Assignment of the Input Signal</i>
Logics . LE53.Reset Latch-I	<i>State of the module input: Reset Signal for the Latching</i>
Logics . LE54.Gate Out	<i>Signal: Output of the logic gate</i>
Logics . LE54.Timer Out	<i>Signal: Timer Output</i>
Logics . LE54.Out	<i>Signal: Latched Output (Q)</i>
Logics . LE54.Out inverted	<i>Signal: Negated Latched Output (Q NOT)</i>
Logics . LE54.Gate In1-I	<i>State of the module input: Assignment of the Input Signal</i>
Logics . LE54.Gate In2-I	<i>State of the module input: Assignment of the Input Signal</i>
Logics . LE54.Gate In3-I	<i>State of the module input: Assignment of the Input Signal</i>
Logics . LE54.Gate In4-I	<i>State of the module input: Assignment of the Input Signal</i>
Logics . LE54.Reset Latch-I	<i>State of the module input: Reset Signal for the Latching</i>
Logics . LE55.Gate Out	<i>Signal: Output of the logic gate</i>
Logics . LE55.Timer Out	<i>Signal: Timer Output</i>
Logics . LE55.Out	<i>Signal: Latched Output (Q)</i>
Logics . LE55.Out inverted	<i>Signal: Negated Latched Output (Q NOT)</i>
Logics . LE55.Gate In1-I	<i>State of the module input: Assignment of the Input Signal</i>
Logics . LE55.Gate In2-I	<i>State of the module input: Assignment of the Input Signal</i>
Logics . LE55.Gate In3-I	<i>State of the module input: Assignment of the Input Signal</i>
Logics . LE55.Gate In4-I	<i>State of the module input: Assignment of the Input Signal</i>
Logics . LE55.Reset Latch-I	<i>State of the module input: Reset Signal for the Latching</i>

1..n, Assignment List	Description
Logics . LE56.Gate Out	<i>Signal: Output of the logic gate</i>
Logics . LE56.Timer Out	<i>Signal: Timer Output</i>
Logics . LE56.Out	<i>Signal: Latched Output (Q)</i>
Logics . LE56.Out inverted	<i>Signal: Negated Latched Output (Q NOT)</i>
Logics . LE56.Gate In1-I	<i>State of the module input: Assignment of the Input Signal</i>
Logics . LE56.Gate In2-I	<i>State of the module input: Assignment of the Input Signal</i>
Logics . LE56.Gate In3-I	<i>State of the module input: Assignment of the Input Signal</i>
Logics . LE56.Gate In4-I	<i>State of the module input: Assignment of the Input Signal</i>
Logics . LE56.Reset Latch-I	<i>State of the module input: Reset Signal for the Latching</i>
Logics . LE57.Gate Out	<i>Signal: Output of the logic gate</i>
Logics . LE57.Timer Out	<i>Signal: Timer Output</i>
Logics . LE57.Out	<i>Signal: Latched Output (Q)</i>
Logics . LE57.Out inverted	<i>Signal: Negated Latched Output (Q NOT)</i>
Logics . LE57.Gate In1-I	<i>State of the module input: Assignment of the Input Signal</i>
Logics . LE57.Gate In2-I	<i>State of the module input: Assignment of the Input Signal</i>
Logics . LE57.Gate In3-I	<i>State of the module input: Assignment of the Input Signal</i>
Logics . LE57.Gate In4-I	<i>State of the module input: Assignment of the Input Signal</i>
Logics . LE57.Reset Latch-I	<i>State of the module input: Reset Signal for the Latching</i>
Logics . LE58.Gate Out	<i>Signal: Output of the logic gate</i>
Logics . LE58.Timer Out	<i>Signal: Timer Output</i>
Logics . LE58.Out	<i>Signal: Latched Output (Q)</i>
Logics . LE58.Out inverted	<i>Signal: Negated Latched Output (Q NOT)</i>
Logics . LE58.Gate In1-I	<i>State of the module input: Assignment of the Input Signal</i>
Logics . LE58.Gate In2-I	<i>State of the module input: Assignment of the Input Signal</i>
Logics . LE58.Gate In3-I	<i>State of the module input: Assignment of the Input Signal</i>
Logics . LE58.Gate In4-I	<i>State of the module input: Assignment of the Input Signal</i>
Logics . LE58.Reset Latch-I	<i>State of the module input: Reset Signal for the Latching</i>
Logics . LE59.Gate Out	<i>Signal: Output of the logic gate</i>

1..n, Assignment List	Description
Logics . LE59.Timer Out	<i>Signal: Timer Output</i>
Logics . LE59.Out	<i>Signal: Latched Output (Q)</i>
Logics . LE59.Out inverted	<i>Signal: Negated Latched Output (Q NOT)</i>
Logics . LE59.Gate In1-I	<i>State of the module input: Assignment of the Input Signal</i>
Logics . LE59.Gate In2-I	<i>State of the module input: Assignment of the Input Signal</i>
Logics . LE59.Gate In3-I	<i>State of the module input: Assignment of the Input Signal</i>
Logics . LE59.Gate In4-I	<i>State of the module input: Assignment of the Input Signal</i>
Logics . LE59.Reset Latch-I	<i>State of the module input: Reset Signal for the Latching</i>
Logics . LE60.Gate Out	<i>Signal: Output of the logic gate</i>
Logics . LE60.Timer Out	<i>Signal: Timer Output</i>
Logics . LE60.Out	<i>Signal: Latched Output (Q)</i>
Logics . LE60.Out inverted	<i>Signal: Negated Latched Output (Q NOT)</i>
Logics . LE60.Gate In1-I	<i>State of the module input: Assignment of the Input Signal</i>
Logics . LE60.Gate In2-I	<i>State of the module input: Assignment of the Input Signal</i>
Logics . LE60.Gate In3-I	<i>State of the module input: Assignment of the Input Signal</i>
Logics . LE60.Gate In4-I	<i>State of the module input: Assignment of the Input Signal</i>
Logics . LE60.Reset Latch-I	<i>State of the module input: Reset Signal for the Latching</i>
Logics . LE61.Gate Out	<i>Signal: Output of the logic gate</i>
Logics . LE61.Timer Out	<i>Signal: Timer Output</i>
Logics . LE61.Out	<i>Signal: Latched Output (Q)</i>
Logics . LE61.Out inverted	<i>Signal: Negated Latched Output (Q NOT)</i>
Logics . LE61.Gate In1-I	<i>State of the module input: Assignment of the Input Signal</i>
Logics . LE61.Gate In2-I	<i>State of the module input: Assignment of the Input Signal</i>
Logics . LE61.Gate In3-I	<i>State of the module input: Assignment of the Input Signal</i>
Logics . LE61.Gate In4-I	<i>State of the module input: Assignment of the Input Signal</i>
Logics . LE61.Reset Latch-I	<i>State of the module input: Reset Signal for the Latching</i>
Logics . LE62.Gate Out	<i>Signal: Output of the logic gate</i>
Logics . LE62.Timer Out	<i>Signal: Timer Output</i>

1..n, Assignment List	Description
Logics . LE62.Out	<i>Signal: Latched Output (Q)</i>
Logics . LE62.Out inverted	<i>Signal: Negated Latched Output (Q NOT)</i>
Logics . LE62.Gate In1-I	<i>State of the module input: Assignment of the Input Signal</i>
Logics . LE62.Gate In2-I	<i>State of the module input: Assignment of the Input Signal</i>
Logics . LE62.Gate In3-I	<i>State of the module input: Assignment of the Input Signal</i>
Logics . LE62.Gate In4-I	<i>State of the module input: Assignment of the Input Signal</i>
Logics . LE62.Reset Latch-I	<i>State of the module input: Reset Signal for the Latching</i>
Logics . LE63.Gate Out	<i>Signal: Output of the logic gate</i>
Logics . LE63.Timer Out	<i>Signal: Timer Output</i>
Logics . LE63.Out	<i>Signal: Latched Output (Q)</i>
Logics . LE63.Out inverted	<i>Signal: Negated Latched Output (Q NOT)</i>
Logics . LE63.Gate In1-I	<i>State of the module input: Assignment of the Input Signal</i>
Logics . LE63.Gate In2-I	<i>State of the module input: Assignment of the Input Signal</i>
Logics . LE63.Gate In3-I	<i>State of the module input: Assignment of the Input Signal</i>
Logics . LE63.Gate In4-I	<i>State of the module input: Assignment of the Input Signal</i>
Logics . LE63.Reset Latch-I	<i>State of the module input: Reset Signal for the Latching</i>
Logics . LE64.Gate Out	<i>Signal: Output of the logic gate</i>
Logics . LE64.Timer Out	<i>Signal: Timer Output</i>
Logics . LE64.Out	<i>Signal: Latched Output (Q)</i>
Logics . LE64.Out inverted	<i>Signal: Negated Latched Output (Q NOT)</i>
Logics . LE64.Gate In1-I	<i>State of the module input: Assignment of the Input Signal</i>
Logics . LE64.Gate In2-I	<i>State of the module input: Assignment of the Input Signal</i>
Logics . LE64.Gate In3-I	<i>State of the module input: Assignment of the Input Signal</i>
Logics . LE64.Gate In4-I	<i>State of the module input: Assignment of the Input Signal</i>
Logics . LE64.Reset Latch-I	<i>State of the module input: Reset Signal for the Latching</i>
Logics . LE65.Gate Out	<i>Signal: Output of the logic gate</i>
Logics . LE65.Timer Out	<i>Signal: Timer Output</i>
Logics . LE65.Out	<i>Signal: Latched Output (Q)</i>

1..n, Assignment List	Description
Logics . LE65.Out inverted	<i>Signal: Negated Latched Output (Q NOT)</i>
Logics . LE65.Gate In1-I	<i>State of the module input: Assignment of the Input Signal</i>
Logics . LE65.Gate In2-I	<i>State of the module input: Assignment of the Input Signal</i>
Logics . LE65.Gate In3-I	<i>State of the module input: Assignment of the Input Signal</i>
Logics . LE65.Gate In4-I	<i>State of the module input: Assignment of the Input Signal</i>
Logics . LE65.Reset Latch-I	<i>State of the module input: Reset Signal for the Latching</i>
Logics . LE66.Gate Out	<i>Signal: Output of the logic gate</i>
Logics . LE66.Timer Out	<i>Signal: Timer Output</i>
Logics . LE66.Out	<i>Signal: Latched Output (Q)</i>
Logics . LE66.Out inverted	<i>Signal: Negated Latched Output (Q NOT)</i>
Logics . LE66.Gate In1-I	<i>State of the module input: Assignment of the Input Signal</i>
Logics . LE66.Gate In2-I	<i>State of the module input: Assignment of the Input Signal</i>
Logics . LE66.Gate In3-I	<i>State of the module input: Assignment of the Input Signal</i>
Logics . LE66.Gate In4-I	<i>State of the module input: Assignment of the Input Signal</i>
Logics . LE66.Reset Latch-I	<i>State of the module input: Reset Signal for the Latching</i>
Logics . LE67.Gate Out	<i>Signal: Output of the logic gate</i>
Logics . LE67.Timer Out	<i>Signal: Timer Output</i>
Logics . LE67.Out	<i>Signal: Latched Output (Q)</i>
Logics . LE67.Out inverted	<i>Signal: Negated Latched Output (Q NOT)</i>
Logics . LE67.Gate In1-I	<i>State of the module input: Assignment of the Input Signal</i>
Logics . LE67.Gate In2-I	<i>State of the module input: Assignment of the Input Signal</i>
Logics . LE67.Gate In3-I	<i>State of the module input: Assignment of the Input Signal</i>
Logics . LE67.Gate In4-I	<i>State of the module input: Assignment of the Input Signal</i>
Logics . LE67.Reset Latch-I	<i>State of the module input: Reset Signal for the Latching</i>
Logics . LE68.Gate Out	<i>Signal: Output of the logic gate</i>
Logics . LE68.Timer Out	<i>Signal: Timer Output</i>
Logics . LE68.Out	<i>Signal: Latched Output (Q)</i>
Logics . LE68.Out inverted	<i>Signal: Negated Latched Output (Q NOT)</i>

1..n, Assignment List	Description
Logics . LE68.Gate In1-I	<i>State of the module input: Assignment of the Input Signal</i>
Logics . LE68.Gate In2-I	<i>State of the module input: Assignment of the Input Signal</i>
Logics . LE68.Gate In3-I	<i>State of the module input: Assignment of the Input Signal</i>
Logics . LE68.Gate In4-I	<i>State of the module input: Assignment of the Input Signal</i>
Logics . LE68.Reset Latch-I	<i>State of the module input: Reset Signal for the Latching</i>
Logics . LE69.Gate Out	<i>Signal: Output of the logic gate</i>
Logics . LE69.Timer Out	<i>Signal: Timer Output</i>
Logics . LE69.Out	<i>Signal: Latched Output (Q)</i>
Logics . LE69.Out inverted	<i>Signal: Negated Latched Output (Q NOT)</i>
Logics . LE69.Gate In1-I	<i>State of the module input: Assignment of the Input Signal</i>
Logics . LE69.Gate In2-I	<i>State of the module input: Assignment of the Input Signal</i>
Logics . LE69.Gate In3-I	<i>State of the module input: Assignment of the Input Signal</i>
Logics . LE69.Gate In4-I	<i>State of the module input: Assignment of the Input Signal</i>
Logics . LE69.Reset Latch-I	<i>State of the module input: Reset Signal for the Latching</i>
Logics . LE70.Gate Out	<i>Signal: Output of the logic gate</i>
Logics . LE70.Timer Out	<i>Signal: Timer Output</i>
Logics . LE70.Out	<i>Signal: Latched Output (Q)</i>
Logics . LE70.Out inverted	<i>Signal: Negated Latched Output (Q NOT)</i>
Logics . LE70.Gate In1-I	<i>State of the module input: Assignment of the Input Signal</i>
Logics . LE70.Gate In2-I	<i>State of the module input: Assignment of the Input Signal</i>
Logics . LE70.Gate In3-I	<i>State of the module input: Assignment of the Input Signal</i>
Logics . LE70.Gate In4-I	<i>State of the module input: Assignment of the Input Signal</i>
Logics . LE70.Reset Latch-I	<i>State of the module input: Reset Signal for the Latching</i>
Logics . LE71.Gate Out	<i>Signal: Output of the logic gate</i>
Logics . LE71.Timer Out	<i>Signal: Timer Output</i>
Logics . LE71.Out	<i>Signal: Latched Output (Q)</i>
Logics . LE71.Out inverted	<i>Signal: Negated Latched Output (Q NOT)</i>
Logics . LE71.Gate In1-I	<i>State of the module input: Assignment of the Input Signal</i>

1..n, Assignment List	Description
Logics . LE71.Gate In2-I	<i>State of the module input: Assignment of the Input Signal</i>
Logics . LE71.Gate In3-I	<i>State of the module input: Assignment of the Input Signal</i>
Logics . LE71.Gate In4-I	<i>State of the module input: Assignment of the Input Signal</i>
Logics . LE71.Reset Latch-I	<i>State of the module input: Reset Signal for the Latching</i>
Logics . LE72.Gate Out	<i>Signal: Output of the logic gate</i>
Logics . LE72.Timer Out	<i>Signal: Timer Output</i>
Logics . LE72.Out	<i>Signal: Latched Output (Q)</i>
Logics . LE72.Out inverted	<i>Signal: Negated Latched Output (Q NOT)</i>
Logics . LE72.Gate In1-I	<i>State of the module input: Assignment of the Input Signal</i>
Logics . LE72.Gate In2-I	<i>State of the module input: Assignment of the Input Signal</i>
Logics . LE72.Gate In3-I	<i>State of the module input: Assignment of the Input Signal</i>
Logics . LE72.Gate In4-I	<i>State of the module input: Assignment of the Input Signal</i>
Logics . LE72.Reset Latch-I	<i>State of the module input: Reset Signal for the Latching</i>
Logics . LE73.Gate Out	<i>Signal: Output of the logic gate</i>
Logics . LE73.Timer Out	<i>Signal: Timer Output</i>
Logics . LE73.Out	<i>Signal: Latched Output (Q)</i>
Logics . LE73.Out inverted	<i>Signal: Negated Latched Output (Q NOT)</i>
Logics . LE73.Gate In1-I	<i>State of the module input: Assignment of the Input Signal</i>
Logics . LE73.Gate In2-I	<i>State of the module input: Assignment of the Input Signal</i>
Logics . LE73.Gate In3-I	<i>State of the module input: Assignment of the Input Signal</i>
Logics . LE73.Gate In4-I	<i>State of the module input: Assignment of the Input Signal</i>
Logics . LE73.Reset Latch-I	<i>State of the module input: Reset Signal for the Latching</i>
Logics . LE74.Gate Out	<i>Signal: Output of the logic gate</i>
Logics . LE74.Timer Out	<i>Signal: Timer Output</i>
Logics . LE74.Out	<i>Signal: Latched Output (Q)</i>
Logics . LE74.Out inverted	<i>Signal: Negated Latched Output (Q NOT)</i>
Logics . LE74.Gate In1-I	<i>State of the module input: Assignment of the Input Signal</i>
Logics . LE74.Gate In2-I	<i>State of the module input: Assignment of the Input Signal</i>

1..n, Assignment List	Description
Logics . LE74.Gate In3-I	<i>State of the module input: Assignment of the Input Signal</i>
Logics . LE74.Gate In4-I	<i>State of the module input: Assignment of the Input Signal</i>
Logics . LE74.Reset Latch-I	<i>State of the module input: Reset Signal for the Latching</i>
Logics . LE75.Gate Out	<i>Signal: Output of the logic gate</i>
Logics . LE75.Timer Out	<i>Signal: Timer Output</i>
Logics . LE75.Out	<i>Signal: Latched Output (Q)</i>
Logics . LE75.Out inverted	<i>Signal: Negated Latched Output (Q NOT)</i>
Logics . LE75.Gate In1-I	<i>State of the module input: Assignment of the Input Signal</i>
Logics . LE75.Gate In2-I	<i>State of the module input: Assignment of the Input Signal</i>
Logics . LE75.Gate In3-I	<i>State of the module input: Assignment of the Input Signal</i>
Logics . LE75.Gate In4-I	<i>State of the module input: Assignment of the Input Signal</i>
Logics . LE75.Reset Latch-I	<i>State of the module input: Reset Signal for the Latching</i>
Logics . LE76.Gate Out	<i>Signal: Output of the logic gate</i>
Logics . LE76.Timer Out	<i>Signal: Timer Output</i>
Logics . LE76.Out	<i>Signal: Latched Output (Q)</i>
Logics . LE76.Out inverted	<i>Signal: Negated Latched Output (Q NOT)</i>
Logics . LE76.Gate In1-I	<i>State of the module input: Assignment of the Input Signal</i>
Logics . LE76.Gate In2-I	<i>State of the module input: Assignment of the Input Signal</i>
Logics . LE76.Gate In3-I	<i>State of the module input: Assignment of the Input Signal</i>
Logics . LE76.Gate In4-I	<i>State of the module input: Assignment of the Input Signal</i>
Logics . LE76.Reset Latch-I	<i>State of the module input: Reset Signal for the Latching</i>
Logics . LE77.Gate Out	<i>Signal: Output of the logic gate</i>
Logics . LE77.Timer Out	<i>Signal: Timer Output</i>
Logics . LE77.Out	<i>Signal: Latched Output (Q)</i>
Logics . LE77.Out inverted	<i>Signal: Negated Latched Output (Q NOT)</i>
Logics . LE77.Gate In1-I	<i>State of the module input: Assignment of the Input Signal</i>
Logics . LE77.Gate In2-I	<i>State of the module input: Assignment of the Input Signal</i>
Logics . LE77.Gate In3-I	<i>State of the module input: Assignment of the Input Signal</i>





1..n, Assignment List	Description
Logics . LE77.Gate In4-I	<i>State of the module input: Assignment of the Input Signal</i>
Logics . LE77.Reset Latch-I	<i>State of the module input: Reset Signal for the Latching</i>
Logics . LE78.Gate Out	<i>Signal: Output of the logic gate</i>
Logics . LE78.Timer Out	<i>Signal: Timer Output</i>
Logics . LE78.Out	<i>Signal: Latched Output (Q)</i>
Logics . LE78.Out inverted	<i>Signal: Negated Latched Output (Q NOT)</i>
Logics . LE78.Gate In1-I	<i>State of the module input: Assignment of the Input Signal</i>
Logics . LE78.Gate In2-I	<i>State of the module input: Assignment of the Input Signal</i>
Logics . LE78.Gate In3-I	<i>State of the module input: Assignment of the Input Signal</i>
Logics . LE78.Gate In4-I	<i>State of the module input: Assignment of the Input Signal</i>
Logics . LE78.Reset Latch-I	<i>State of the module input: Reset Signal for the Latching</i>
Logics . LE79.Gate Out	<i>Signal: Output of the logic gate</i>
Logics . LE79.Timer Out	<i>Signal: Timer Output</i>
Logics . LE79.Out	<i>Signal: Latched Output (Q)</i>
Logics . LE79.Out inverted	<i>Signal: Negated Latched Output (Q NOT)</i>
Logics . LE79.Gate In1-I	<i>State of the module input: Assignment of the Input Signal</i>
Logics . LE79.Gate In2-I	<i>State of the module input: Assignment of the Input Signal</i>
Logics . LE79.Gate In3-I	<i>State of the module input: Assignment of the Input Signal</i>
Logics . LE79.Gate In4-I	<i>State of the module input: Assignment of the Input Signal</i>
Logics . LE79.Reset Latch-I	<i>State of the module input: Reset Signal for the Latching</i>
Logics . LE80.Gate Out	<i>Signal: Output of the logic gate</i>
Logics . LE80.Timer Out	<i>Signal: Timer Output</i>
Logics . LE80.Out	<i>Signal: Latched Output (Q)</i>
Logics . LE80.Out inverted	<i>Signal: Negated Latched Output (Q NOT)</i>
Logics . LE80.Gate In1-I	<i>State of the module input: Assignment of the Input Signal</i>
Logics . LE80.Gate In2-I	<i>State of the module input: Assignment of the Input Signal</i>
Logics . LE80.Gate In3-I	<i>State of the module input: Assignment of the Input Signal</i>
Logics . LE80.Gate In4-I	<i>State of the module input: Assignment of the Input Signal</i>

1..n, Assignment List	Description
Logics . LE80.Reset Latch-I	<i>State of the module input: Reset Signal for the Latching</i>
Sgen . Manual Start	<i>Fault Simulation has been started manually.</i>
Sgen . Manual Stop	<i>Fault Simulation has been stopped manually.</i>
Sgen . Running	<i>Signal; Measuring value simulation is running</i>
Sgen . Started	<i>Fault Simulation has been started</i>
Sgen . Stopped	<i>Fault Simulation has been stopped</i>
Sgen . Ex Start Simulation-I	<i>State of the module input:External Start of Fault Simulation (Using the test parameters)</i>
Sgen . ExBlo1-I	<i>Module input state: External blocking1</i>
Sgen . ExBlo2-I	<i>Module input state: External blocking2</i>
Sgen . Ex ForcePost-I	<i>State of the module input:Force Post state. Abort simulation.</i>
Sys . PS 1	<i>Signal: The currently active Parameter Set is PS 1</i>
Sys . PS 2	<i>Signal: The currently active Parameter Set is PS 2</i>
Sys . PS 3	<i>Signal: The currently active Parameter Set is PS 3</i>
Sys . PS 4	<i>Signal: The currently active Parameter Set is PS 4</i>
Sys . PSS manual	<i>Signal: Manual Switch over of a Parameter Set</i>
Sys . PSS via Scada	<i>Signal: Parameter Set Switch via Scada. Write into this output byte the integer of the parameter set that should become active (e.g. 4 => Switch onto parameter set 4).</i>
Sys . PSS via Inp fct	<i>Signal: Parameter Set Switch via input function</i>
Sys . min 1 param changed	<i>Signal: At least one parameter has been changed</i>
Sys . Setting Lock Bypass	<i>Signal: Short-period unlock of the Setting Lock</i>
Sys . Ack LED	<i>Signal: LEDs acknowledgement</i>
Sys . Ack BO	<i>Signal: Acknowledgement of the Binary Outputs</i>
Sys . Ack Scada	<i>Signal: Acknowledge latched SCADA signals</i>
Sys . Ack TripCmd	<i>Signal: Reset Trip Command</i>
Sys . Ack LED-HMI	<i>Signal: LEDs acknowledgement :HMI</i>
Sys . Ack BO-HMI	<i>Signal: Acknowledgement of the Binary Outputs :HMI</i>
Sys . Ack Scada-HMI	<i>Signal: Acknowledge latched SCADA signals :HMI</i>
Sys . Ack TripCmd-HMI	<i>Signal: Reset Trip Command :HMI</i>
Sys . Ack LED-Sca	<i>Signal: LEDs acknowledgement :SCADA</i>

1..n, Assignment List	Description
Sys . Ack BO-Sca	<i>Signal: Acknowledgement of the Binary Outputs :SCADA</i>
Sys . Ack Counter-Sca	<i>Signal: Reset of all Counters :SCADA</i>
Sys . Ack Scada-Sca	<i>Signal: Acknowledge latched SCADA signals :SCADA</i>
Sys . Ack TripCmd-Sca	<i>Signal: Reset Trip Command :SCADA</i>
Sys . Res OperationsCr	<i>Signal:: Res OperationsCr</i>
Sys . Res AlarmCr	<i>Signal:: Res AlarmCr</i>
Sys . Res TripCmdCr	<i>Signal:: Res TripCmdCr</i>
Sys . Res TotalCr	<i>Signal:: Res TotalCr</i>
Sys . Ack LED-I	<i>Module input state: LEDs acknowledgement by digital input</i>
Sys . Ack BO-I	<i>Module input state: Acknowledgement of the binary Output Relays</i>
Sys . Ack Scada-I	<i>Module input state: Acknowledge latched SCADA signals.</i>
Sys . PS1-I	<i>State of the module input respectively of the signal, that should activate this Parameter Setting Group.</i>
Sys . PS2-I	<i>State of the module input respectively of the signal, that should activate this Parameter Setting Group.</i>
Sys . PS3-I	<i>State of the module input respectively of the signal, that should activate this Parameter Setting Group.</i>
Sys . PS4-I	<i>State of the module input respectively of the signal, that should activate this Parameter Setting Group.</i>
Sys . Setting Lock-I	<i>State of the module input: No parameters can be changed as long as this input is true. The parameter settings are locked.</i>
Sys . Internal test state	<i>Auxiliary state for testing purposes.</i>

1...n Operating Modes

Selection list referenced by the following parameters:





-  BO Slot X5 . Operating Mode
-  BO Slot X5 . Operating Mode
-  BO Slot X5 . Operating Mode
-  BO Slot X5 . Operating Mode

1...n Operating Modes	Description
Normally open (NO)	<i>The working principle of the relay corresponds to a normally open contact.</i>

1...n Operating Modes	Description
Normally closed (NC)	<i>The working principle of the relay corresponds to a normally closed contact.</i>

1...n Operating Modes

Selection list referenced by the following parameters:

-  BO Slot X6 . Operating Mode
-  BO Slot X6 . Operating Mode
-  BO Slot X6 . Operating Mode
-  BO Slot X6 . Operating Mode
-  BO Slot X6 . Operating Mode

1...n Operating Modes	Description
Normally open (NO)	<i>The working principle of the relay corresponds to a normally open contact.</i>
Normally closed (NC)	<i>The working principle of the relay corresponds to a normally closed contact.</i>

Type of Input

Type of Input: Select the input range and type

Selection list referenced by the following parameters:

-  AnIn[1] . Mode

Type of Input	Description
0...20 mA	<i>0...20 mA</i>
4...20 mA	<i>4...20 mA</i>
0...10V	<i>0...10V</i>

Type of Input

Type of Input: Select the input range and type



Selection list referenced by the following parameters:

-  AnIn[2] . Mode

Type of Input	Description
0...20 mA	<i>0...20 mA</i>
4...20 mA	<i>4...20 mA</i>
0...10V	<i>0...10V</i>

1..n, AnalogOutputList

Selection list referenced by the following parameters:

-  AnOut[1] . Assignment
-  AnOut[2] . Assignment

1..n, AnalogOutputList	Description
"_"	<i>No assignment</i>
VT . f	<i>Measured value: Frequency</i>
VT . VL12 RMS	<i>Measured value: Phase-to-phase voltage (RMS)</i>
VT . VL23 RMS	<i>Measured value: Phase-to-phase voltage (RMS)</i>
VT . VL31 RMS	<i>Measured value: Phase-to-phase voltage (RMS)</i>
VT . VL1 RMS	<i>Measured value: Phase-to-neutral voltage (RMS)</i>
VT . VL2 RMS	<i>Measured value: Phase-to-neutral voltage (RMS)</i>
VT . VL3 RMS	<i>Measured value: Phase-to-neutral voltage (RMS)</i>
VT . VX meas RMS	<i>Measured value (measured): VX measured (RMS)</i>
VT . VG calc RMS	<i>Measured value (calculated): VG (RMS)</i>
VT . VL12 THD	<i>Measured value (calculated): V12 Total Harmonic Distortion</i>
VT . VL23 THD	<i>Measured value (calculated): V23 Total Harmonic Distortion</i>
VT . VL31 THD	<i>Measured value (calculated): V31 Total Harmonic Distortion</i>
VT . VL1 THD	<i>Measured value (calculated): VL1 Total Harmonic Distortion</i>
VT . VL2 THD	<i>Measured value (calculated): VL2 Total Harmonic Distortion</i>
VT . VL3 THD	<i>Measured value (calculated): VL3 Total Harmonic Distortion</i>
CT Ntrl . IL1 RMS	<i>Measured value: Phase current (RMS)</i>
CT Ntrl . IL2 RMS	<i>Measured value: Phase current (RMS)</i>

1..n, AnalogOutputList	Description
CT Ntrl . IL3 RMS	<i>Measured value: Phase current (RMS)</i>
CT Ntrl . IG meas RMS	<i>Measured value (measured): IG (RMS)</i>
CT Ntrl . IG calc RMS	<i>Measured value (calculated): IG (RMS)</i>
CT Ntrl . IL1 THD	<i>Measured value (calculated): IL1 Total Harmonic Current</i>
CT Ntrl . IL2 THD	<i>Measured value (calculated): IL2 Total Harmonic Current</i>
CT Ntrl . IL3 THD	<i>Measured value (calculated): IL3 Total Harmonic Current</i>
ThR . Thermal Cap Used	<i>Measured value: Thermal Capacity Used</i>
Sync . Slip Freq	<i>Slip frequency</i>
Sync . Volt Diff	<i>Voltage difference between bus and line.</i>
Sync . Angle Diff	<i>Angle difference between bus and line voltages.</i>
Sync . f Bus	<i>Bus frequency</i>
Sync . f Line	<i>Line frequency</i>
Sync . V Bus	<i>Bus Voltage</i>
Sync . V Line	<i>Line Voltage</i>
Sync . Angle Bus	<i>Bus Angle (Reference)</i>
Sync . Angle Line	<i>Line Angle</i>
URTD . Windg1	<i>Winding 1</i>
URTD . Windg2	<i>Winding 2</i>
URTD . Windg3	<i>Winding 3</i>
URTD . Windg4	<i>Winding 4</i>
URTD . Windg5	<i>Winding 5</i>
URTD . Windg6	<i>Winding 6</i>
URTD . MotBear1	<i>Motor Bearing 1</i>
URTD . MotBear2	<i>Motor Bearing 2</i>
URTD . LoadBear1	<i>Load Bearing 1</i>
URTD . LoadBear2	<i>Load Bearing 2</i>
URTD . Aux1	<i>Auxiliary1</i>
URTD . Aux2	<i>Auxiliary2</i>
URTD . RTD Max	<i>Maximum temperature of all channels.</i>
RTD . HottestWindingTemp	<i>Hottest motor winding temperature in degrees C.</i>
RTD . Hottest MotBearTemp	<i>Hottest motor bearing temperature in degrees C.</i>

1..n, AnalogOutputList	Description
PQSCr . S RMS	<i>Measured Value (Calculated): Apparent power (RMS)</i>
PQSCr . P RMS	<i>Measured value (calculated): Active power (P- = Fed Active Power, P+ = Consumpted Active Power) (RMS)</i>
PQSCr . Q	<i>Measured value (calculated): Reactive power (Q- = Fed Reactive Power, Q+ = Consumpted Reactive Power) (fundamental)</i>
PQSCr . cos phi (±)	<i>Measured value (calculated): Power factor: Sign Convention: (+)PF:I lags V (-)PF:I leads V</i>
PQSCr . cos phi RMS(±)	<i>Measured value (calculated): Power factor: Sign Convention: (+)PF:I lags V (-)PF:I leads V</i>
PQSCr . Ws Net	<i>Absolute Apparent Power Hours</i>
PQSCr . Wp Net	<i>Absolute Active Power Hours</i>
PQSCr . Wp+	<i>Positive Active Power is consumed active energy</i>
PQSCr . Wp-	<i>Negative Active Power (Fed Energy)</i>
PQSCr . Wq Net	<i>Absolute Reactive Power Hours</i>
PQSCr . Wq+	<i>Positive Reactive Power is consumed Reactive Energy</i>
PQSCr . Wq-	<i>Negative Reactive Power (Fed Energy)</i>

Type of Output

Type of Output: Select the output range and type

Selection list referenced by the following parameters:

-  AnOut[1] . Range

Type of Output	Description
0...20mA	<i>0...20mA</i>
4...20mA	<i>4...20mA</i>
0...10V	<i>0...10V</i>

Type of Output

Type of Output: Select the output range and type

Selection list referenced by the following parameters:

-  AnOut[2] . Range

Type of Output	Description
0...20mA	0...20mA
4...20mA	4...20mA
0...10V	0...10V

Mode

general operation mode

Selection list referenced by the following parameters:

-  LEDs group A . Latched
-  LEDs group A . Latched
-  LEDs group A . Latched
-  LEDs group A . Latched
-  LEDs group A . Latched
-  LEDs group A . Latched
- [...]

Mode	Description
inactive	<i>inactive</i>
active	<i>active</i>
active, ack. by alarm	<i>Latching of LEDs is active, but will be acknowledged (reset) automatically (by a protection function) in case of a new alarm.</i>

LED active color

Selection list referenced by the following parameters:

-  LEDs group A . LED active color
-  LEDs group A . LED inactive color
-  LEDs group A . LED active color
-  LEDs group A . LED inactive color
-  LEDs group A . LED active color
-  LEDs group A . LED inactive color

- [...]

LED active color	Description
green	<i>green</i>
red	<i>red</i>
red flash	<i>red flashing</i>
green flash	<i>green blinking</i>
"_"	<i>No assignment</i>

Mode

general operation mode

Selection list referenced by the following parameters:



- ↪ LEDs group B . Latched
- ↪ LEDs group B . Latched
- ↪ LEDs group B . Latched
- ↪ LEDs group B . Latched
- ↪ LEDs group B . Latched
- ↪ LEDs group B . Latched
- ↪ LEDs group B . Latched
- [...]

Mode	Description
inactive	<i>inactive</i>
active	<i>active</i>
active, ack. by alarm	<i>Latching of LEDs is active, but will be acknowledged (reset) automatically (by a protection function) in case of a new alarm.</i>

LED active color

Selection list referenced by the following parameters:

- ↪ LEDs group B . LED active color
- ↪ LEDs group B . LED inactive color
- ↪ LEDs group B . LED active color

-  LEDs group B . LED inactive color
-  LEDs group B . LED active color
-  LEDs group B . LED inactive color
- [...]

LED active color	Description
green	green
red	red
red flash	red flashing
green flash	green blinking
“_”	No assignment

Ack via »C« key

Select which acknowledgeable elements can be reset via pressing the »C« key.

Selection list referenced by the following parameters:

-  Sys . Ack via »C« key

Ack via »C« key	Description
Nothing	<i>No elements can be simply reset via pressing the »C« key for a long time (ca. 1 second). This has the consequence that pressing the »C« key is only a shortcut to the Acknowledge menu, from which the user has to select the elements to be reset.</i>
Ack LEDs w/o passw.	<i>All LEDs are acknowledged (reset) via pressing the »C« key for ca. 1 second. No password has to be entered for this. The reset activity can be recognized from the fact that it always includes an LED test, i.e. all LEDs flash in red color for a second, then flash in green color for a second.</i>
Ack LEDs	<i>All LEDs are reset via pressing the »C« key (for ca. 1 second). The reset activity can be recognized from the fact that it always includes an LED test, i.e. all LEDs flash in red color for a second, then flash in green color for a second.</i>
Ack LEDs and relays	<i>All LEDs and all acknowledgeable binary output relays are reset via pressing the »C« key (for ca. 1 second). The reset activity can be recognized from the fact that it always includes an LED test, i.e. all LEDs flash in red color for a second, then flash in green color for a second.</i>
Ack Everything	<i>All acknowledgeable elements are reset via pressing the »C« key (for ca. 1 second):</i> - All LEDs, and

Ack via »C« key	Description
	<p>- all binary output relays, and</p> <p>- all latched SCADA signals, and</p> <p>- the Trip command.</p> <p>The reset activity can be recognized from the fact that it always includes an LED test, i.e. all LEDs flash in red color for a second, then flash in green color for a second.</p>

Duration

Recording time

Selection list referenced by the following parameters:



-  Statistics . Start I Demand via:
-  Statistics . Start P Demand via:
-  Statistics . Start Vavg via:

Duration	Description
Duration	Recording time
StartFct	Start function

Duration

Recording time

Selection list referenced by the following parameters:

-  Statistics . Duration I Demand
-  Statistics . Duration P Demand
-  Statistics . Duration Vavg

Duration	Description
2 s	s
5 s	s
10 s	s
15 s	seconds

Duration	Description
30 s	<i>seconds</i>
1 min	<i>minute</i>
5 min	<i>minute</i>
10 min	<i>minute</i>
15 min	<i>minute</i>
30 min	<i>minute</i>
1 h	<i>Hours</i>
2 h	<i>Hours</i>
6 h	<i>Hours</i>
12 h	<i>Hours</i>
1 d	<i>days</i>
2 d	<i>days</i>
5 d	<i>days</i>
7 d	<i>days</i>
10 d	<i>days</i>
30 d	<i>days</i>

Window configuration

Selection list referenced by the following parameters:

-  Statistics . Window I Demand
-  Statistics . Window P Demand
-  Statistics . Window Vavg

Window configuration	Description
sliding	<i>Moving mean: Continuously the newest measuring value is added and the oldest measuring value is removed from the moving mean (average value).</i>
fixed	<i>The average value is calculated for a fixed window.</i>

Selection

Selection list referenced by the following parameters:

-  HMI . Menu language

Selection	Description
English	English
German	German
Russian	Russian
Polish	Polish
French	French
Portuguese	Portuguese
Spanish	Spanish
Romanian	Romanian

Record-Mode

Recorder Mode (Set the behaviour of the recorder)

Selection list referenced by the following parameters:

-  Fault rec . Record-Mode

Record-Mode	Description
Alarms and Trips	A recording is started in case of an alarm or a trip.
Trips only	A recording is started only in case of a trip.

Resolution

Resolution (recording frequency)

Selection list referenced by the following parameters:

-  Trend rec . Resolution

Resolution	Description
60 min	Add next entry: 60 min
30 min	Add next entry: 30 min

Resolution	Description
15 min	Add next entry: 15 min
10 min	Add next entry: 10 min
5 min	Add next entry: 5 min

1..n, TrendRecList

Selection list referenced by the following parameters:

- ↪ DNP3 . Analog value 0
- ↪ Modbus . Mapped Meas 1
- ↪ Trend rec . Trend1
- ↪ Trend rec . Trend2
- ↪ Trend rec . Trend3
- ↪ Trend rec . Trend4
- [...]

1..n, TrendRecList	Description
“_”	No assignment
VT . VL1	Measured value: Phase-to-neutral voltage (fundamental)
VT . VL2	Measured value: Phase-to-neutral voltage (fundamental)
VT . VL3	Measured value: Phase-to-neutral voltage (fundamental)
VT . VX meas	Measured value (measured): VX measured (fundamental)
VT . VG calc	Measured value (calculated): VG (fundamental)
VT . VL12	Measured value: Phase-to-phase voltage (fundamental)
VT . VL23	Measured value: Phase-to-phase voltage (fundamental)
VT . VL31	Measured value: Phase-to-phase voltage (fundamental)
VT . VL1 RMS	Measured value: Phase-to-neutral voltage (RMS)
VT . VL2 RMS	Measured value: Phase-to-neutral voltage (RMS)
VT . VL3 RMS	Measured value: Phase-to-neutral voltage (RMS)
VT . VX meas RMS	Measured value (measured): VX measured (RMS)
VT . VG calc RMS	Measured value (calculated): VG (RMS)
VT . VL12 RMS	Measured value: Phase-to-phase voltage (RMS)

1..n, TrendRecList	Description
VT . VL23 RMS	<i>Measured value: Phase-to-phase voltage (RMS)</i>
VT . VL31 RMS	<i>Measured value: Phase-to-phase voltage (RMS)</i>
VT . V/f	<i>Ratio Volts/Hertz in relation to nominal values.</i>
VT . V0	<i>Measured value (calculated): Symmetrical components Zero voltage(fundamental)</i>
VT . V1	<i>Measured value (calculated): Symmetrical components positive phase sequence voltage(fundamental)</i>
VT . V2	<i>Measured value (calculated): Symmetrical components negative phase sequence voltage(fundamental)</i>
VT . %(V2/V1)	<i>Measured value (calculated): V2/V1, phase sequence will be taken into account automatically.</i>
VT . VX meas H3	<i>Third harmonic of measured neutral voltage used to detect generator stator ground faults.</i>
VT . VL1 avg RMS	<i>VL1 average value (RMS)</i>
VT . VL2 avg RMS	<i>VL2 average value (RMS)</i>
VT . VL3 avg RMS	<i>VL3 average value (RMS)</i>
VT . VL12 avg RMS	<i>VL12 average value (RMS)</i>
VT . VL23 avg RMS	<i>VL23 average value (RMS)</i>
VT . VL31 avg RMS	<i>VL31 average value (RMS)</i>
VT . f	<i>Measured value: Frequency</i>
VT . VL1 THD	<i>Measured value (calculated): VL1 Total Harmonic Distortion</i>
VT . VL2 THD	<i>Measured value (calculated): VL2 Total Harmonic Distortion</i>
VT . VL3 THD	<i>Measured value (calculated): VL3 Total Harmonic Distortion</i>
VT . VL12 THD	<i>Measured value (calculated): V12 Total Harmonic Distortion</i>
VT . VL23 THD	<i>Measured value (calculated): V23 Total Harmonic Distortion</i>
VT . VL31 THD	<i>Measured value (calculated): V31 Total Harmonic Distortion</i>
CT Ntrl . IL1	<i>Measured value: Phase current (fundamental)</i>
CT Ntrl . IL2	<i>Measured value: Phase current (fundamental)</i>
CT Ntrl . IL3	<i>Measured value: Phase current (fundamental)</i>
CT Ntrl . IG meas	<i>Measured value (measured): IG (fundamental)</i>
CT Ntrl . IG calc	<i>Measured value (calculated): IG (fundamental)</i>
CT Ntrl . IL1 RMS	<i>Measured value: Phase current (RMS)</i>
CT Ntrl . IL2 RMS	<i>Measured value: Phase current (RMS)</i>
CT Ntrl . IL3 RMS	<i>Measured value: Phase current (RMS)</i>

1..n, TrendRecList	Description
CT Ntrl . IG meas RMS	<i>Measured value (measured): IG (RMS)</i>
CT Ntrl . IG calc RMS	<i>Measured value (calculated): IG (RMS)</i>
CT Ntrl . I0	<i>Measured value (calculated): Zero current (fundamental)</i>
CT Ntrl . I1	<i>Measured value (calculated): Positive phase sequence current (fundamental)</i>
CT Ntrl . I2	<i>Measured value (calculated): Unbalanced load current (fundamental)</i>
CT Ntrl . %(I2/I1)	<i>Measured value (calculated): I2/I1, phase sequence will be taken into account automatically.</i>
CT Ntrl . IL1 avg RMS	<i>IL1 average value (RMS)</i>
CT Ntrl . IL2 avg RMS	<i>IL2 average value (RMS)</i>
CT Ntrl . IL3 avg RMS	<i>IL3 average value (RMS)</i>
CT Ntrl . IL1 THD	<i>Measured value (calculated): IL1 Total Harmonic Current</i>
CT Ntrl . IL2 THD	<i>Measured value (calculated): IL2 Total Harmonic Current</i>
CT Ntrl . IL3 THD	<i>Measured value (calculated): IL3 Total Harmonic Current</i>
ThR . Thermal Cap Used	<i>Measured value: Thermal Capacity Used</i>
URTD . Windg1	<i>Winding 1</i>
URTD . Windg1 max	<i>Winding1 Maximum Value</i>
URTD . Windg2	<i>Winding 2</i>
URTD . Windg2 max	<i>Winding2 Maximum Value</i>
URTD . Windg3	<i>Winding 3</i>
URTD . Windg3 max	<i>Winding3 Maximum Value</i>
URTD . Windg4	<i>Winding 4</i>
URTD . Windg4 max	<i>Winding4 Maximum Value</i>
URTD . Windg5	<i>Winding 5</i>
URTD . Windg5 max	<i>Winding5 Maximum Value</i>
URTD . Windg6	<i>Winding 6</i>
URTD . Windg6 max	<i>Winding6 Maximum Value</i>
URTD . MotBear1	<i>Motor Bearing 1</i>
URTD . MotBear1 max	<i>Motor Bearing1 Maximum Value</i>
URTD . MotBear2	<i>Motor Bearing 2</i>
URTD . MotBear2 max	<i>Motor Bearing2 Maximum Value</i>
URTD . LoadBear1	<i>Load Bearing 1</i>
URTD . LoadBear1 max	<i>Load Bearing1 Maximum Value</i>

1..n, TrendRecList	Description
URTD . LoadBear2	<i>Load Bearing 2</i>
URTD . LoadBear2 max	<i>Load Bearing2 Maximum Value</i>
URTD . Aux1	<i>Auxiliary1</i>
URTD . Aux1 max	<i>Auxiliary1 Maximum Value</i>
URTD . Aux2	<i>Auxiliary2</i>
URTD . Aux2 max	<i>Auxiliary2 Maximum Value</i>
URTD . RTD Max	<i>Maximum temperature of all channels.</i>
RTD . HottestWindingTemp	<i>Hottest motor winding temperature in degrees C.</i>
RTD . Hottest MotBearTemp	<i>Hottest motor bearing temperature in degrees C.</i>
RTD . Hottest LoadBearTemp	<i>Hottest load bearing temperature in degrees C.</i>
RTD . Hottest Aux Temp	<i>Hottest Auxiliary temperature in degrees C.</i>
PQSCr . S	<i>Measured Value (Calculated): Apparent power (fundamental)</i>
PQSCr . P	<i>Measured value (calculated): Active power (P- = Fed Active Power, P+ = Consumpted Active Power) (fundamental)</i>
PQSCr . Q	<i>Measured value (calculated): Reactive power (Q- = Fed Reactive Power, Q+ = Consumpted Reactive Power) (fundamental)</i>
PQSCr . P 1	<i>Measured value (calculated): Active power in positive sequence system (P- = Fed Active Power, P+ = Consumpted Active Power)</i>
PQSCr . Q 1	<i>Measured value (calculated): Reactive power in positive sequence system (Q- = Fed Reactive Power, Q+ = Consumpted Reactive Power)</i>
PQSCr . S RMS	<i>Measured Value (Calculated): Apparent power (RMS)</i>
PQSCr . P RMS	<i>Measured value (calculated): Active power (P- = Fed Active Power, P+ = Consumpted Active Power) (RMS)</i>
PQSCr . cos phi	<i>Measured value (calculated): Power factor: Sign Convention: sign(PF) = sign(P)</i>
PQSCr . cos phi RMS	<i>Measured value (calculated): Power factor: Sign Convention: sign(PF) = sign(P)</i>
PQSCr . Ws Net	<i>Absolute Apparent Power Hours</i>
PQSCr . Wp Net	<i>Absolute Active Power Hours</i>
PQSCr . Wq Net	<i>Absolute Reactive Power Hours</i>
PQSCr . Wp+	<i>Positive Active Power is consumed active energy</i>
PQSCr . Wp-	<i>Negative Active Power (Fed Energy)</i>
PQSCr . Wq+	<i>Positive Reactive Power is consumed Reactive Energy</i>

1..n, TrendRecList	Description
PQSCr . Wq-	<i>Negative Reactive Power (Fed Energy)</i>
AnIn[1] . Value	<i>Measured value of the Input in percent</i>
AnIn[2] . Value	<i>Measured value of the Input in percent</i>

1..n, OnOffList

Selection list referenced by the following parameters:

-  IEC 61850 . Function

1..n, OnOffList	Description
inactive	<i>inactive</i>
active	<i>active</i>

Baud rate

Selection list referenced by the following parameters:

-  DNP3 . Baud rate

Baud rate	Description
1200	<i>1200</i>
2400	<i>2400</i>
4800	<i>4800</i>
9600	<i>9600</i>
19200	<i>19200</i>
38400	<i>38400</i>
57600	<i>57600</i>
115200	<i>115200</i>

Byte Frame

Selection list referenced by the following parameters:

-  DNP3 . Frame Layout

Byte Frame	Description
8E1	<i>8 data bits, even parity, 1 stopbit.</i>
8O1	<i>8 data bits, odd, 1 stopbit.</i>
8N1	<i>8 data bits, no parity, 1 stopbit.</i>
8N2	<i>8 data bits, no parity, 2 stopbits.</i>

Optical rest position

Selection list referenced by the following parameters:

-  DNP3 . Optical rest position

Optical rest position	Description
Light off	<i>Light off</i>
Light on	<i>Light on</i>

Communication Start Variants

Selection list referenced by the following parameters:

-  DNP3 . DataLink confirm

Communication Start Variants	Description
Never	<i>Option Never is recommended</i>
Always	<i>If this variable is set to Always then LinkLayer needs to establish a connection before sending any Frame.</i>
On_Large	<i>If set to On_Large then a connection needs to be established before sending the first Frame of a multi Term Message</i>

_AL_ResponseType_k

_AL_ResponseType_h

Selection list referenced by the following parameters:

-  DNP3 . AppLink confirm

_AL_ResponseType_k	Description
Never	<i>Never</i>
Always	<i>Always</i>
Event	<i>Event</i>

1..n, Assignment List

Assignment List

Selection list referenced by the following parameters:

-  DNP3 . DoubleBitInput 0

1..n, Assignment List	Description
"_"	<i>No assignment</i>
SG[1] . Pos	<i>Signal: Circuit Breaker Position (0 = Indeterminate, 1 = OFF, 2 = ON, 3 = Disturbed)</i>
SG[2] . Pos	<i>Signal: Circuit Breaker Position (0 = Indeterminate, 1 = OFF, 2 = ON, 3 = Disturbed)</i>
SG[3] . Pos	<i>Signal: Circuit Breaker Position (0 = Indeterminate, 1 = OFF, 2 = ON, 3 = Disturbed)</i>
SG[4] . Pos	<i>Signal: Circuit Breaker Position (0 = Indeterminate, 1 = OFF, 2 = ON, 3 = Disturbed)</i>
SG[5] . Pos	<i>Signal: Circuit Breaker Position (0 = Indeterminate, 1 = OFF, 2 = ON, 3 = Disturbed)</i>
SG[6] . Pos	<i>Signal: Circuit Breaker Position (0 = Indeterminate, 1 = OFF, 2 = ON, 3 = Disturbed)</i>

1..n, Assignment List

Assignment List

Selection list referenced by the following parameters:

-  DNP3 . BinaryCounter 0

1..n, Assignment List	Description
"_"	<i>No assignment</i>

1..n, Assignment List	Description
Prot . FaultNo	<i>Fault number</i>
Prot . No. of Grid Fault	<i>Number of grid fault: A grid fault, e.g. a short circuit, might cause several faults with trip and autoreclosing; in this case, the fault number counts each fault, but the grid fault number remains the same.</i>
Generator . Gen Op Hours	<i>Generator running hours</i>
SG[1] . TripCmd Cr	<i>Counter: Total number of trips of the switchgear.</i>
SG[2] . TripCmd Cr	<i>Counter: Total number of trips of the switchgear.</i>
SG[3] . TripCmd Cr	<i>Counter: Total number of trips of the switchgear.</i>
SG[4] . TripCmd Cr	<i>Counter: Total number of trips of the switchgear.</i>
SG[5] . TripCmd Cr	<i>Counter: Total number of trips of the switchgear.</i>
SG[6] . TripCmd Cr	<i>Counter: Total number of trips of the switchgear.</i>
LVRT[1] . NumOf Vdips in t-LVRT	<i>Number of Voltage dips during t-LVRT</i>
LVRT[1] . Cr Tot Numb of Vdips	<i>Counter Total number of voltage dips.</i>
LVRT[1] . Cr Tot Numb of Vdips to Trip	<i>Counter Total number of voltage dips that caused a Trip.</i>
LVRT[2] . NumOf Vdips in t-LVRT	<i>Number of Voltage dips during t-LVRT</i>
LVRT[2] . Cr Tot Numb of Vdips	<i>Counter Total number of voltage dips.</i>
LVRT[2] . Cr Tot Numb of Vdips to Trip	<i>Counter Total number of voltage dips that caused a Trip.</i>
PQSCr . Wp+	<i>Positive Active Power is consumed active energy</i>
PQSCr . Wp-	<i>Negative Active Power (Fed Energy)</i>
PQSCr . Wq+	<i>Positive Reactive Power is consumed Reactive Energy</i>
PQSCr . Wq-	<i>Negative Reactive Power (Fed Energy)</i>
Sys . Operating hours Cr	<i>Operating hours counter of the protective device</i>

Scale Factor

Multiplier in order to convert float values into integer.

Selection list referenced by the following parameters:

-  DNP3 . Scale Factor 0

Scale Factor	Description
0.001	<i>0.001</i>
0.01	<i>0.01</i>
0.1	<i>0.1</i>
1	<i>1</i>
10	<i>10</i>
100	<i>100</i>
1000	<i>1000</i>
10000	<i>10000</i>
100000	<i>100000</i>
1000000	<i>1000000</i>

Optical rest position

Selection list referenced by the following parameters:

-  Modbus . Optical rest position

Optical rest position	Description
Light off	<i>Light off</i>
Light on	<i>Light on</i>

Port selection

Selection list referenced by the following parameters:

-  Modbus . TCP Port Config

Port selection	Description
Default	<i>Default Port</i>
Private	<i>Private Port</i>

Baud rate

Selection list referenced by the following parameters:

-  Modbus . Baud rate

Baud rate	Description
1200	1200
2400	2400
4800	4800
9600	9600
19200	19200
38400	38400

Byte Frame

Selection list referenced by the following parameters:

-  Modbus . Physical Settings

Byte Frame	Description
8E1	8 data bits, even parity, 1 stopbit.
8O1	8 data bits, odd, 1 stopbit.
8N1	8 data bits, no parity, 1 stopbit.
8N2	8 data bits, no parity, 2 stopbits.

Type of SCADA mapping

This setting decides whether the communication protocol shall use the default mapping of data objects, or some user-defined mapping that has been loaded from a *.HptSMap file.

Selection list referenced by the following parameters:

-  Modbus . Type of SCADA mapping

Type of SCADA mapping	Description
Standard	Default mapping of data objects

Type of SCADA mapping	Description
User-defined	User-defined mapping of data objects

Config status

Status of the user-defined SCADA configuration.\nPossible values:

Selection list referenced by the following parameters:

-  Modbus . Config status

Config status	Description
Changing	New SCADA configuration is being loaded, but not active yet.
OK	The SCADA configuration is active.
Config. not avail.	The user-defined SCADA configuration is not available (e.g. has not been loaded into the device).
Error	Unexpected error. Please contact our service-team.

Baud rate

Selection list referenced by the following parameters:

-  IEC103 . Baud rate

Baud rate	Description
1200	1200
2400	2400
4800	4800
9600	9600
19200	19200
38400	38400
57600	57600

Byte Frame

Selection list referenced by the following parameters:

-  IEC103 . Physical Settings

Byte Frame	Description
8E1	<i>8 data bits, even parity, 1 stopbit.</i>
8O1	<i>8 data bits, odd, 1 stopbit.</i>
8N1	<i>8 data bits, no parity, 1 stopbit.</i>
8N2	<i>8 data bits, no parity, 2 stopbits.</i>

Timezone

Selection whether the timestamps in IEC103 messages shall be given as UTC or local time. (“Local time” always includes the actual daylight saving settings.)

Selection list referenced by the following parameters:

-  IEC103 . Timezone

Timezone	Description
UTC	<i>UTC</i>
Local Time	<i>Local time according to the »Time Zones« setting (in Device Parameters) (incl. daylight saving settings).</i>

Optical rest position

Selection list referenced by the following parameters:

-  IEC103 . Optical rest position

Optical rest position	Description
Light off	<i>Light off</i>
Light on	<i>Light on</i>

Port selection

Selection list referenced by the following parameters:

-  IEC104 . TCP Port Config

Port selection	Description
Default	<i>Default Port</i>
Private	<i>Private Port</i>

Timezone

Selection whether the timestamps in the transmitted communication telegrams shall be given as UTC or local time. (“Local time” always includes the actual daylight saving settings.)

Selection list referenced by the following parameters:

-  IEC104 . Timezone

Timezone	Description
UTC	<i>UTC</i>
Local Time	<i>Local time according to the »Time Zones« setting (in Device Parameters) (incl. daylight saving settings).</i>

Type of SCADA mapping

This setting decides whether the communication protocol shall use the default mapping of data objects, or some user-defined mapping that has been loaded from a *.HptSMap file.

Selection list referenced by the following parameters:

-  IEC104 . Type of SCADA mapping

Type of SCADA mapping	Description
Standard	<i>Default mapping of data objects</i>
User-defined	<i>User-defined mapping of data objects</i>

Config status

Status of the user-defined SCADA configuration.\nPossible values:

Selection list referenced by the following parameters:

-  IEC104 . Config status

Config status	Description
Changing	<i>New SCADA configuration is being loaded, but not active yet.</i>
OK	<i>The SCADA configuration is active.</i>
Config. not avail.	<i>The user-defined SCADA configuration is not available (e.g. has not been loaded into the device).</i>
Error	<i>Unexpected error. Please contact our service-team.</i>

Type of SCADA mapping

This setting decides whether the communication protocol shall use the default mapping of data objects, or some user-defined mapping that has been loaded from a *.HptSMap file.

Selection list referenced by the following parameters:

-  Profibus . Type of SCADA mapping

Type of SCADA mapping	Description
Standard	<i>Default mapping of data objects</i>
User-defined	<i>User-defined mapping of data objects</i>

Time Zones

Selection list referenced by the following parameters:

-  TimeSync . Time Zones



Time Zones	Description
UTC+14 Kiritimati	<i>UTC+14 Kiritimati</i>
UTC+13 Rawaki	<i>UTC+13 Rawaki</i>
UTC+12.75 Chatham Island	<i>UTC+12.75 Chatham Island</i>
UTC+12 Wellington	<i>UTC+12 Wellington</i>
UTC+11.5 Kingston	<i>UTC+11.5 Kingston</i>

Time Zones	Description
UTC+11 Port Vila	<i>UTC+11 Port Vila</i>
UTC+10.5 Lord Howe Island	<i>UTC+10.5 Lord Howe Island</i>
UTC+10 Sydney	<i>UTC+10 Sydney</i>
UTC+9.5 Adelaide	<i>UTC+9.5 Adelaide</i>
UTC+9 Tokyo	<i>UTC+9 Tokyo</i>
UTC+8 Hong Kong	<i>UTC+8 Hong Kong</i>
UTC+7 Bangkok	<i>UTC+7 Bangkok</i>
UTC+6.5 Rangoon	<i>UTC+6.5 Rangoon</i>
UTC+6 Colombo	<i>UTC+6 Colombo</i>
UTC+5.75 Kathmandu	<i>UTC+5.75 Kathmandu</i>
UTC+5.5 New Delhi	<i>UTC+5.5 New Delhi</i>
UTC+5 Islamabad	<i>UTC+5 Islamabad</i>
UTC+4.5 Kabul	<i>UTC+4.5 Kabul</i>
UTC+4 Abu Dhabi	<i>UTC+4 Abu Dhabi</i>
UTC+3.5 Tehran	<i>UTC+3.5 Tehran</i>
UTC+3 Moscow	<i>UTC+3 Moscow</i>
UTC+2 Athens	<i>UTC+2 Athens</i>
UTC+1 Berlin	<i>UTC+1 Berlin</i>
UTC+0 London	<i>UTC+0 London</i>
UTC-1 Azores	<i>UTC-1 Azores</i>
UTC-2 Fern. d. Noronha	<i>UTC-2 Fern. d. Noronha</i>
UTC-3 Buenos Aires	<i>UTC-3 Buenos Aires</i>
UTC-3.5 St. John's	<i>UTC-3.5 St. John's</i>
UTC-4 Santiago	<i>UTC-4 Santiago</i>
UTC-5 New York	<i>UTC-5 New York</i>
UTC-6 Chicago	<i>UTC-6 Chicago</i>
UTC-7 Salt Lake City	<i>UTC-7 Salt Lake City</i>
UTC-8 Los Angeles	<i>UTC-8 Los Angeles</i>
UTC-9 Anchorage	<i>UTC-9 Anchorage</i>
UTC-9.5 Taiohae	<i>UTC-9.5 Taiohae</i>
UTC-10 Honolulu	<i>UTC-10 Honolulu</i>

Time Zones	Description
UTC-11 Midway Islands	<i>UTC-11 Midway Islands</i>

Month of clock change



Selection list referenced by the following parameters:

-  TimeSync . Summertime m
-  TimeSync . Wintertime m

Month of clock change	Description
January	<i>January</i>
February	<i>February</i>
March	<i>March</i>
April	<i>April</i>
May	<i>May</i>
June	<i>June</i>
July	<i>July</i>
August	<i>August</i>
September	<i>September</i>
October	<i>October</i>
November	<i>November</i>
December	<i>December</i>

Date

Selection list referenced by the following parameters:

-  TimeSync . Summertime d
-  TimeSync . Wintertime d



Date	Description
Sunday	<i>Sunday</i>
Monday	<i>Monday</i>

Date	Description
Tuesday	<i>Tuesday</i>
Wednesday	<i>Wednesday</i>
Thursday	<i>Thursday</i>
Friday	<i>Friday</i>
Saturday	<i>Saturday</i>
General day	<i>General day: Examples: first day of month, last day of month</i>

Day of clock change

Day of Time Saving change

Selection list referenced by the following parameters:

-  TimeSync . Summertime w
-  TimeSync . Wintertime w

Day of clock change	Description
First	<i>First week of the month</i>
Second	<i>Second week of the month</i>
Third	<i>Third week of the month</i>
Fourth	<i>Fourth week of the month</i>
Last	<i>Last week of the month</i>

Used Protocol

Selection list referenced by the following parameters:

-  TimeSync . TimeSync

Used Protocol	Description
"_"	-
IRIG-B . IRIG-B	<i>IRIG-B-Module</i>
SNTP . SNTP	<i>SNTP-Module</i>
Modbus . Modbus	<i>Modbus Protocol</i>

Used Protocol	Description
IEC103 . IEC 60870-5-103	<i>IEC 60870-5-103 Protocol</i>
IEC104 . IEC104	<i>IEC 60870-5-104 communication</i>
DNP3 . DNP3	<i>Distributed Network Protocol</i>

IRIG-B00X

Determination of the Type: IRIG-B00X. IRIG-B types differ in types of included “Coded Expressions” (year, control-functions, straight-binary-seconds).

Selection list referenced by the following parameters:

-  IRIG-B . IRIG-B00X

IRIG-B00X	Description
IRIGB-000	<i>Please refer to: IRIG STANDARD 200-04</i>
IRIGB-001	<i>Please refer to: IRIG STANDARD 200-04</i>
IRIGB-002	<i>Please refer to: IRIG STANDARD 200-04</i>
IRIGB-003	<i>Please refer to: IRIG STANDARD 200-04</i>
IRIGB-004	<i>Please refer to: IRIG STANDARD 200-04</i>
IRIGB-005	<i>Please refer to: IRIG STANDARD 200-04</i>
IRIGB-006	<i>Please refer to: IRIG STANDARD 200-04</i>
IRIGB-007	<i>Please refer to: IRIG STANDARD 200-04</i>

Selection list referenced by the following parameters:

-  Sys . DM version

	Description
3.6.b	<i>Version</i>

Phase Sequence

Phase Sequence direction

Selection list referenced by the following parameters:

-  Field Para . Phase Sequence

Phase Sequence	Description
ABC	<i>rotating clockwise</i>
ACB	<i>Counter-clockwise phase sequence. Positive and negative phase sequence are exchanged and MTA is turned for 180°.</i>

fN

Selection list referenced by the following parameters:

-  Field Para . f

fN	Description
50	<i>Rated frequency</i>
60	<i>Rated frequency</i>

W1 Connection/Grounding

Note: The zero current will be removed in order to prevent faulty tripping of the differential protection. If a star point is connected to ground according to the winding connection, the zero current (symmetrical components) will be removed.

Selection list referenced by the following parameters:

-  Transformer . W1 Connection/Grounding

W1 Connection/ Grounding	Description
Y	<i>Star (connection group winding on primary side)</i>
D	<i>Delta (connection group winding on primary side)</i>
Z	<i>Zig-Zag (connection group winding on primary side)</i>
YN	<i>Star grounded (connection group winding on primary side)</i>
ZN	<i>Zig-Zag with ground connection (connection group winding on primary side)</i>

W2 Connection/Grounding

Note: The zero current will be removed in order to prevent faulty tripping of the differential protection. If a star point is connected to ground according to the winding connection, the zero current (symmetrical components) will be removed.

Selection list referenced by the following parameters:

-  Transformer . W2 Connection/Grounding

W2 Connection/ Grounding	Description
y	<i>Star (connection group winding on secondary side)</i>
d	<i>Delta (connection group winding on secondary side)</i>
z	<i>Zig-Zag (connection group winding on secondary side)</i>
yn	<i>Star grounded (connection group winding on secondary side)</i>
zn	<i>Zig-Zag with ground connection (connection group winding on secondary side)</i>

Generator side

Defines which winding of the transformer is connected to the generator.\n\nIn general, the W2 (low voltage) winding of a step-up transformer is connected to the generator.

Selection list referenced by the following parameters:

-  Transformer . Generator side

Generator side	Description
W2	<i>The W2 (low voltage) transformer settings are related to the generator side. If the generator is used in combination with a step-up transformer then this setting is the default.</i>
W1	<i>The W1 (high voltage) transformer settings are related to the generator side. For compatibility with a HighPROTEC device before Release 3.6, the data on the transformer nameplate may be “inverted”.</i>

VT con

This parameter has to be set in order to ensure the correct assignment of the voltage measurement channels in the device.

Selection list referenced by the following parameters:

-  VT . VT con

VT con	Description
Phase to Phase	<i>The phase voltage measuring inputs are feed with "Phase-to-Phase" voltages (Delta-Connection)</i>
Phase to Ground	<i>The phase voltage measuring inputs are feed with "Phase-to-Ground" voltages (Star-Connection)</i>

Voltages to be synchronized

Selection list referenced by the following parameters:



-  VT . V Sync

Voltages to be synchronized	Description
L1	<i>Phase L1</i>
L2	<i>Phase L2</i>
L3	<i>Phase L3</i>
L12	<i>L12</i>
L23	<i>L23</i>
L31	<i>L31</i>

Ratio prim/sec

w_prim/w_sec



Selection list referenced by the following parameters:

-  CT Ntrl . CT sec
-  CT Ntrl . ECT sec

Ratio prim/sec	Description
1	<i>Rated value of the secondary side of the current transformers.</i>
5	<i>Rated value of the secondary side of the current transformers.</i>

Polarity

Selection list referenced by the following parameters:

-  CT Ntrl . CT dir
-  CT Ntrl . ECT dir

Polarity	Description
0	0
180	180 degree polarity correction (wiring faults)

Ratio prim/sec

w_prim/w_sec



Selection list referenced by the following parameters:

-  CT Mains . CT sec
-  CT Mains . ECT sec

Ratio prim/sec	Description
1	Rated value of the secondary side of the current transformers.
5	Rated value of the secondary side of the current transformers.

Polarity

Selection list referenced by the following parameters:

-  CT Mains . CT dir
-  CT Mains . ECT dir

Polarity	Description
0	0
180	180 degree polarity correction (wiring faults)

3V0 Source

Earth overcurrent protection elements take into account this parameter for direction decisions. You have to ensure, that this parameter is set to "Measured" only if the residual voltage is fed to the fourth measuring input of the voltage measuring card.

Selection list referenced by the following parameters:

-  VT . 3V0 Source

3V0 Source	Description
measured	<i>measured</i>
calculated	<i>calculated</i>

IG meas dir control

Options for direction detection. IGmeas is used as operating quantity.

Selection list referenced by the following parameters:

-  VT . IG meas dir control

IG meas dir control	Description
IG meas 3V0	<i>Direction detection mode IG meas 3V0 (Angle between measured ground current and residual voltage (measured or calculated))</i>
I2,V2	<i>IG meas Direction Unit polarizing mode: Neg (Use IG meas as operating quantity but use V2/I2 to detect the direction)</i>
Dual	<i>IG meas Direction Unit polarizing mode: Dual (Use V2/I2 to detect the direction (preferred, if available), else use measured ground current and neutral voltage.</i>
cos(ϕ)	<i>Direction detection mode: This method is used for ground fault direction detection in compensated grids. 3V0 is the polarizing quantity and IG meas is the operating quantity.</i>
sin(ϕ)	<i>Direction detection mode: This method is used for ground fault direction detection in isolated grids. 3V0 is the polarizing quantity and IG meas is the operating quantity.</i>

IG calc dir control

Options for direction detection. IGcalc is used as operating quantity.

Selection list referenced by the following parameters:

-  VT . IG calc dir control

IG calc dir control	Description
IG calc 3V0	<i>Direction detection mode IG calc 3V0 (Angle between calculated ground current and residual voltage (measured or calculated))</i>
IG calc IPol (IG meas)	<i>Direction detection: Angle between calculated and measured ground current.</i>
Dual	<i>Direction detection mode: Dual (The angle between residual current and measured ground current (preferred, if possible) is evaluated. Alternatively the angle between residual current and neutral voltage is evaluated.</i>
I2,V2	<i>Direction Unit polarizing mode: Use the angle between V2/I2 to detect the direction</i>
cos(ϕ)	<i>Direction detection mode: This method is used for ground fault direction detection in compensated grids. 3V0 is the polarizing quantity and IG calc is the operating quantity.</i>
sin(ϕ)	<i>Direction detection mode: This method is used for ground fault direction detection in isolated grids. 3V0 is the polarizing quantity and IG calc is the operating quantity.</i>

delta phi - Mode

The delta phi element (vector surge) trips, if the permissible voltage angle shift (delta phi) of the three measured voltages (phase-ground or phase-phase) in: one phase, two phases or within all phases is exceeded.



Selection list referenced by the following parameters:



-  VT . delta phi - Mode

delta phi - Mode	Description
one phase	<i>one phase</i>
two phases	<i>two phases</i>
three phases	<i>three phases</i>

active/inactive

Selection list referenced by the following parameters:

-  BO Slot X2 . DISARMED Ctrl
-  BO Slot X5 . DISARMED Ctrl
-  BO Slot X6 . DISARMED Ctrl

-  Prot . ExBlo Fc
-  Prot . ExBlo TripCmd Fc
-  Id . ExBlo Fc
- [...]]

active/inactive	Description
inactive	<i>inactive</i>
active	<i>active</i>

CT Winding Side

Measuring values will be used from this winding side

Selection list referenced by the following parameters:

-  I[1] . CT Winding Side
-  IG[1] . CT Winding Side
-  ThR . CT Winding Side
-  I2>[1] . CT Winding Side
-  CBF . CT Winding Side
-  SG[1] . CT Winding Side



CT Winding Side	Description
. CT Ntrl	<i>Current transformers on the neutral side</i>
. CT Mains	<i>Current Transformer Main Side</i>

AdaptSet

Adaptive Parameters

Selection list referenced by the following parameters:

-  I[1] . AdaptSet 1
-  I[1] . AdaptSet 2
-  I[1] . AdaptSet 3
-  I[1] . AdaptSet 4

-  IG[1] . AdaptSet 1
-  IG[1] . AdaptSet 2
- [...]

AdaptSet	Description
"_"	<i>No assignment</i>
IH2 . Blo L1	<i>Signal: Blocked L1</i>
IH2 . Blo L2	<i>Signal: Blocked L2</i>
IH2 . Blo L3	<i>Signal: Blocked L3</i>
IH2 . Blo IG meas	<i>Signal: Blocking of the ground (earth) protection module (measured ground current)</i>
IH2 . Blo IG calc	<i>Signal: Blocking of the ground (earth) protection module (calculated ground current)</i>
IH2 . 3-ph Blo	<i>Signal: Inrush was detected in at least one phase - trip command blocked.</i>
V[1] . Alarm	<i>Signal: Alarm voltage stage</i>
V[2] . Alarm	<i>Signal: Alarm voltage stage</i>
V[3] . Alarm	<i>Signal: Alarm voltage stage</i>
V[4] . Alarm	<i>Signal: Alarm voltage stage</i>
V[5] . Alarm	<i>Signal: Alarm voltage stage</i>
V[6] . Alarm	<i>Signal: Alarm voltage stage</i>
Intertripping . Alarm	<i>Signal: Alarm</i>
LVRT[1] . Alarm	<i>Signal: Alarm voltage stage</i>
LVRT[1] . t-LVRT is running	<i>Signal: t-LVRT is running</i>
LVRT[2] . Alarm	<i>Signal: Alarm voltage stage</i>
LVRT[2] . t-LVRT is running	<i>Signal: t-LVRT is running</i>
VG[1] . Alarm	<i>Signal: Alarm Residual Voltage Supervision-stage</i>
VG[2] . Alarm	<i>Signal: Alarm Residual Voltage Supervision-stage</i>
V012[1] . Alarm	<i>Signal: Alarm voltage asymmetry</i>
V012[2] . Alarm	<i>Signal: Alarm voltage asymmetry</i>
V012[3] . Alarm	<i>Signal: Alarm voltage asymmetry</i>
V012[4] . Alarm	<i>Signal: Alarm voltage asymmetry</i>
V012[5] . Alarm	<i>Signal: Alarm voltage asymmetry</i>
V012[6] . Alarm	<i>Signal: Alarm voltage asymmetry</i>

AdaptSet	Description
SOTF . enabled	<i>Signal: Switch Onto Fault enabled. This Signal can be used to modify Overcurrent Protection Settings.</i>
CLPU . enabled	<i>Signal: Cold Load enabled</i>
Exp[1] . Alarm	<i>Signal: Alarm</i>
Exp[2] . Alarm	<i>Signal: Alarm</i>
Exp[3] . Alarm	<i>Signal: Alarm</i>
Exp[4] . Alarm	<i>Signal: Alarm</i>
Ext Sudd Press . Alarm	<i>Signal: Alarm</i>
Ext Oil Temp . Alarm	<i>Signal: Alarm</i>
Ext Temp Superv[1] . Alarm	<i>Signal: Alarm</i>
Ext Temp Superv[2] . Alarm	<i>Signal: Alarm</i>
Ext Temp Superv[3] . Alarm	<i>Signal: Alarm</i>
CTS . Alarm	<i>Signal: Alarm Current Transformer Measuring Circuit Supervision</i>
LOP . Alarm	<i>Signal: Alarm Loss of Potential</i>
DI Slot X1 . DI 1	<i>Signal: Digital Input</i>
DI Slot X1 . DI 2	<i>Signal: Digital Input</i>
DI Slot X1 . DI 3	<i>Signal: Digital Input</i>
DI Slot X1 . DI 4	<i>Signal: Digital Input</i>
DI Slot X1 . DI 5	<i>Signal: Digital Input</i>
DI Slot X1 . DI 6	<i>Signal: Digital Input</i>
DI Slot X1 . DI 7	<i>Signal: Digital Input</i>
DI Slot X1 . DI 8	<i>Signal: Digital Input</i>
DI Slot X5 . DI 1	<i>Signal: Digital Input</i>
DI Slot X5 . DI 2	<i>Signal: Digital Input</i>
DI Slot X5 . DI 3	<i>Signal: Digital Input</i>
DI Slot X5 . DI 4	<i>Signal: Digital Input</i>
DI Slot X5 . DI 5	<i>Signal: Digital Input</i>
DI Slot X5 . DI 6	<i>Signal: Digital Input</i>
DI Slot X5 . DI 7	<i>Signal: Digital Input</i>
DI Slot X5 . DI 8	<i>Signal: Digital Input</i>

AdaptSet	Description
DI Slot X6 . DI 1	<i>Signal: Digital Input</i>
DI Slot X6 . DI 2	<i>Signal: Digital Input</i>
DI Slot X6 . DI 3	<i>Signal: Digital Input</i>
DI Slot X6 . DI 4	<i>Signal: Digital Input</i>
DI Slot X6 . DI 5	<i>Signal: Digital Input</i>
DI Slot X6 . DI 6	<i>Signal: Digital Input</i>
DI Slot X6 . DI 7	<i>Signal: Digital Input</i>
DI Slot X6 . DI 8	<i>Signal: Digital Input</i>
Modbus . Scada Cmd 1	<i>Scada Command</i>
Modbus . Scada Cmd 2	<i>Scada Command</i>
Modbus . Scada Cmd 3	<i>Scada Command</i>
Modbus . Scada Cmd 4	<i>Scada Command</i>
Modbus . Scada Cmd 5	<i>Scada Command</i>
Modbus . Scada Cmd 6	<i>Scada Command</i>
Modbus . Scada Cmd 7	<i>Scada Command</i>
Modbus . Scada Cmd 8	<i>Scada Command</i>
Modbus . Scada Cmd 9	<i>Scada Command</i>
Modbus . Scada Cmd 10	<i>Scada Command</i>
Modbus . Scada Cmd 11	<i>Scada Command</i>
Modbus . Scada Cmd 12	<i>Scada Command</i>
Modbus . Scada Cmd 13	<i>Scada Command</i>
Modbus . Scada Cmd 14	<i>Scada Command</i>
Modbus . Scada Cmd 15	<i>Scada Command</i>
Modbus . Scada Cmd 16	<i>Scada Command</i>
IEC 61850 . GOSINGGIO1.Ind1.stVal	<i>Signal: Virtual Input (IEC61850 GGIO Ind): State</i>
IEC 61850 . GOSINGGIO1.Ind2.stVal	<i>Signal: Virtual Input (IEC61850 GGIO Ind): State</i>
IEC 61850 . GOSINGGIO1.Ind3.stVal	<i>Signal: Virtual Input (IEC61850 GGIO Ind): State</i>
IEC 61850 . GOSINGGIO1.Ind4.stVal	<i>Signal: Virtual Input (IEC61850 GGIO Ind): State</i>
IEC 61850 . GOSINGGIO1.Ind5.stVal	<i>Signal: Virtual Input (IEC61850 GGIO Ind): State</i>

AdaptSet	Description
IEC 61850 . GOSINGGIO1.Ind6.stVal	<i>Signal: Virtual Input (IEC61850 GGIO Ind): State</i>
IEC 61850 . GOSINGGIO1.Ind7.stVal	<i>Signal: Virtual Input (IEC61850 GGIO Ind): State</i>
IEC 61850 . GOSINGGIO1.Ind8.stVal	<i>Signal: Virtual Input (IEC61850 GGIO Ind): State</i>
IEC 61850 . GOSINGGIO1.Ind9.stVal	<i>Signal: Virtual Input (IEC61850 GGIO Ind): State</i>
IEC 61850 . GOSINGGIO1.Ind10.stVal	<i>Signal: Virtual Input (IEC61850 GGIO Ind): State</i>
IEC 61850 . GOSINGGIO1.Ind11.stVal	<i>Signal: Virtual Input (IEC61850 GGIO Ind): State</i>
IEC 61850 . GOSINGGIO1.Ind12.stVal	<i>Signal: Virtual Input (IEC61850 GGIO Ind): State</i>
IEC 61850 . GOSINGGIO1.Ind13.stVal	<i>Signal: Virtual Input (IEC61850 GGIO Ind): State</i>
IEC 61850 . GOSINGGIO1.Ind14.stVal	<i>Signal: Virtual Input (IEC61850 GGIO Ind): State</i>
IEC 61850 . GOSINGGIO1.Ind15.stVal	<i>Signal: Virtual Input (IEC61850 GGIO Ind): State</i>
IEC 61850 . GOSINGGIO1.Ind16.stVal	<i>Signal: Virtual Input (IEC61850 GGIO Ind): State</i>
IEC 61850 . GOSINGGIO1.Ind17.stVal	<i>Signal: Virtual Input (IEC61850 GGIO Ind): State</i>
IEC 61850 . GOSINGGIO1.Ind18.stVal	<i>Signal: Virtual Input (IEC61850 GGIO Ind): State</i>
IEC 61850 . GOSINGGIO1.Ind19.stVal	<i>Signal: Virtual Input (IEC61850 GGIO Ind): State</i>
IEC 61850 . GOSINGGIO1.Ind20.stVal	<i>Signal: Virtual Input (IEC61850 GGIO Ind): State</i>
IEC 61850 . GOSINGGIO1.Ind21.stVal	<i>Signal: Virtual Input (IEC61850 GGIO Ind): State</i>
IEC 61850 . GOSINGGIO1.Ind22.stVal	<i>Signal: Virtual Input (IEC61850 GGIO Ind): State</i>
IEC 61850 . GOSINGGIO1.Ind23.stVal	<i>Signal: Virtual Input (IEC61850 GGIO Ind): State</i>
IEC 61850 . GOSINGGIO1.Ind24.stVal	<i>Signal: Virtual Input (IEC61850 GGIO Ind): State</i>
IEC 61850 . GOSINGGIO1.Ind25.stVal	<i>Signal: Virtual Input (IEC61850 GGIO Ind): State</i>

AdaptSet	Description
IEC 61850 . GOSINGGIO1.Ind26.stVal	<i>Signal: Virtual Input (IEC61850 GGIO Ind): State</i>
IEC 61850 . GOSINGGIO1.Ind27.stVal	<i>Signal: Virtual Input (IEC61850 GGIO Ind): State</i>
IEC 61850 . GOSINGGIO1.Ind28.stVal	<i>Signal: Virtual Input (IEC61850 GGIO Ind): State</i>
IEC 61850 . GOSINGGIO1.Ind29.stVal	<i>Signal: Virtual Input (IEC61850 GGIO Ind): State</i>
IEC 61850 . GOSINGGIO1.Ind30.stVal	<i>Signal: Virtual Input (IEC61850 GGIO Ind): State</i>
IEC 61850 . GOSINGGIO1.Ind31.stVal	<i>Signal: Virtual Input (IEC61850 GGIO Ind): State</i>
IEC 61850 . GOSINGGIO1.Ind32.stVal	<i>Signal: Virtual Input (IEC61850 GGIO Ind): State</i>
IEC 61850 . SPCSO1	<i>Status bit that can be set by clients like e.g. SCADA (Single Point Controllable Status Output).</i>
IEC 61850 . SPCSO2	<i>Status bit that can be set by clients like e.g. SCADA (Single Point Controllable Status Output).</i>
IEC 61850 . SPCSO3	<i>Status bit that can be set by clients like e.g. SCADA (Single Point Controllable Status Output).</i>
IEC 61850 . SPCSO4	<i>Status bit that can be set by clients like e.g. SCADA (Single Point Controllable Status Output).</i>
IEC 61850 . SPCSO5	<i>Status bit that can be set by clients like e.g. SCADA (Single Point Controllable Status Output).</i>
IEC 61850 . SPCSO6	<i>Status bit that can be set by clients like e.g. SCADA (Single Point Controllable Status Output).</i>
IEC 61850 . SPCSO7	<i>Status bit that can be set by clients like e.g. SCADA (Single Point Controllable Status Output).</i>
IEC 61850 . SPCSO8	<i>Status bit that can be set by clients like e.g. SCADA (Single Point Controllable Status Output).</i>
IEC 61850 . SPCSO9	<i>Status bit that can be set by clients like e.g. SCADA (Single Point Controllable Status Output).</i>
IEC 61850 . SPCSO10	<i>Status bit that can be set by clients like e.g. SCADA (Single Point Controllable Status Output).</i>
IEC 61850 . SPCSO11	<i>Status bit that can be set by clients like e.g. SCADA (Single Point Controllable Status Output).</i>
IEC 61850 . SPCSO12	<i>Status bit that can be set by clients like e.g. SCADA (Single Point Controllable Status Output).</i>
IEC 61850 . SPCSO13	<i>Status bit that can be set by clients like e.g. SCADA (Single Point Controllable Status Output).</i>

AdaptSet	Description
IEC 61850 . SPCSO14	<i>Status bit that can be set by clients like e.g. SCADA (Single Point Controllable Status Output).</i>
IEC 61850 . SPCSO15	<i>Status bit that can be set by clients like e.g. SCADA (Single Point Controllable Status Output).</i>
IEC 61850 . SPCSO16	<i>Status bit that can be set by clients like e.g. SCADA (Single Point Controllable Status Output).</i>
IEC103 . Scada Cmd 1	<i>Scada Command</i>
IEC103 . Scada Cmd 2	<i>Scada Command</i>
IEC103 . Scada Cmd 3	<i>Scada Command</i>
IEC103 . Scada Cmd 4	<i>Scada Command</i>
IEC103 . Scada Cmd 5	<i>Scada Command</i>
IEC103 . Scada Cmd 6	<i>Scada Command</i>
IEC103 . Scada Cmd 7	<i>Scada Command</i>
IEC103 . Scada Cmd 8	<i>Scada Command</i>
IEC103 . Scada Cmd 9	<i>Scada Command</i>
IEC103 . Scada Cmd 10	<i>Scada Command</i>
IEC104 . Scada Cmd 1	<i>Scada Command</i>
IEC104 . Scada Cmd 2	<i>Scada Command</i>
IEC104 . Scada Cmd 3	<i>Scada Command</i>
IEC104 . Scada Cmd 4	<i>Scada Command</i>
IEC104 . Scada Cmd 5	<i>Scada Command</i>
IEC104 . Scada Cmd 6	<i>Scada Command</i>
IEC104 . Scada Cmd 7	<i>Scada Command</i>
IEC104 . Scada Cmd 8	<i>Scada Command</i>
IEC104 . Scada Cmd 9	<i>Scada Command</i>
IEC104 . Scada Cmd 10	<i>Scada Command</i>
IEC104 . Scada Cmd 11	<i>Scada Command</i>
IEC104 . Scada Cmd 12	<i>Scada Command</i>
IEC104 . Scada Cmd 13	<i>Scada Command</i>
IEC104 . Scada Cmd 14	<i>Scada Command</i>
IEC104 . Scada Cmd 15	<i>Scada Command</i>
IEC104 . Scada Cmd 16	<i>Scada Command</i>
Profibus . Scada Cmd 1	<i>Scada Command</i>

AdaptSet	Description
Profibus . Scada Cmd 2	<i>Scada Command</i>
Profibus . Scada Cmd 3	<i>Scada Command</i>
Profibus . Scada Cmd 4	<i>Scada Command</i>
Profibus . Scada Cmd 5	<i>Scada Command</i>
Profibus . Scada Cmd 6	<i>Scada Command</i>
Profibus . Scada Cmd 7	<i>Scada Command</i>
Profibus . Scada Cmd 8	<i>Scada Command</i>
Profibus . Scada Cmd 9	<i>Scada Command</i>
Profibus . Scada Cmd 10	<i>Scada Command</i>
Profibus . Scada Cmd 11	<i>Scada Command</i>
Profibus . Scada Cmd 12	<i>Scada Command</i>
Profibus . Scada Cmd 13	<i>Scada Command</i>
Profibus . Scada Cmd 14	<i>Scada Command</i>
Profibus . Scada Cmd 15	<i>Scada Command</i>
Profibus . Scada Cmd 16	<i>Scada Command</i>
Logics . LE1.Gate Out	<i>Signal: Output of the logic gate</i>
Logics . LE1.Timer Out	<i>Signal: Timer Output</i>
Logics . LE1.Out	<i>Signal: Latched Output (Q)</i>
Logics . LE1.Out inverted	<i>Signal: Negated Latched Output (Q NOT)</i>
Logics . LE2.Gate Out	<i>Signal: Output of the logic gate</i>
Logics . LE2.Timer Out	<i>Signal: Timer Output</i>
Logics . LE2.Out	<i>Signal: Latched Output (Q)</i>
Logics . LE2.Out inverted	<i>Signal: Negated Latched Output (Q NOT)</i>
Logics . LE3.Gate Out	<i>Signal: Output of the logic gate</i>
Logics . LE3.Timer Out	<i>Signal: Timer Output</i>
Logics . LE3.Out	<i>Signal: Latched Output (Q)</i>
Logics . LE3.Out inverted	<i>Signal: Negated Latched Output (Q NOT)</i>
Logics . LE4.Gate Out	<i>Signal: Output of the logic gate</i>
Logics . LE4.Timer Out	<i>Signal: Timer Output</i>
Logics . LE4.Out	<i>Signal: Latched Output (Q)</i>

AdaptSet	Description
Logics . LE4.Out inverted	<i>Signal: Negated Latched Output (Q NOT)</i>
Logics . LE5.Gate Out	<i>Signal: Output of the logic gate</i>
Logics . LE5.Timer Out	<i>Signal: Timer Output</i>
Logics . LE5.Out	<i>Signal: Latched Output (Q)</i>
Logics . LE5.Out inverted	<i>Signal: Negated Latched Output (Q NOT)</i>
Logics . LE6.Gate Out	<i>Signal: Output of the logic gate</i>
Logics . LE6.Timer Out	<i>Signal: Timer Output</i>
Logics . LE6.Out	<i>Signal: Latched Output (Q)</i>
Logics . LE6.Out inverted	<i>Signal: Negated Latched Output (Q NOT)</i>
Logics . LE7.Gate Out	<i>Signal: Output of the logic gate</i>
Logics . LE7.Timer Out	<i>Signal: Timer Output</i>
Logics . LE7.Out	<i>Signal: Latched Output (Q)</i>
Logics . LE7.Out inverted	<i>Signal: Negated Latched Output (Q NOT)</i>
Logics . LE8.Gate Out	<i>Signal: Output of the logic gate</i>
Logics . LE8.Timer Out	<i>Signal: Timer Output</i>
Logics . LE8.Out	<i>Signal: Latched Output (Q)</i>
Logics . LE8.Out inverted	<i>Signal: Negated Latched Output (Q NOT)</i>
Logics . LE9.Gate Out	<i>Signal: Output of the logic gate</i>
Logics . LE9.Timer Out	<i>Signal: Timer Output</i>
Logics . LE9.Out	<i>Signal: Latched Output (Q)</i>
Logics . LE9.Out inverted	<i>Signal: Negated Latched Output (Q NOT)</i>
Logics . LE10.Gate Out	<i>Signal: Output of the logic gate</i>
Logics . LE10.Timer Out	<i>Signal: Timer Output</i>
Logics . LE10.Out	<i>Signal: Latched Output (Q)</i>
Logics . LE10.Out inverted	<i>Signal: Negated Latched Output (Q NOT)</i>
Logics . LE11.Gate Out	<i>Signal: Output of the logic gate</i>
Logics . LE11.Timer Out	<i>Signal: Timer Output</i>
Logics . LE11.Out	<i>Signal: Latched Output (Q)</i>

AdaptSet	Description
Logics . LE11.Out inverted	<i>Signal: Negated Latched Output (Q NOT)</i>
Logics . LE12.Gate Out	<i>Signal: Output of the logic gate</i>
Logics . LE12.Timer Out	<i>Signal: Timer Output</i>
Logics . LE12.Out	<i>Signal: Latched Output (Q)</i>
Logics . LE12.Out inverted	<i>Signal: Negated Latched Output (Q NOT)</i>
Logics . LE13.Gate Out	<i>Signal: Output of the logic gate</i>
Logics . LE13.Timer Out	<i>Signal: Timer Output</i>
Logics . LE13.Out	<i>Signal: Latched Output (Q)</i>
Logics . LE13.Out inverted	<i>Signal: Negated Latched Output (Q NOT)</i>
Logics . LE14.Gate Out	<i>Signal: Output of the logic gate</i>
Logics . LE14.Timer Out	<i>Signal: Timer Output</i>
Logics . LE14.Out	<i>Signal: Latched Output (Q)</i>
Logics . LE14.Out inverted	<i>Signal: Negated Latched Output (Q NOT)</i>
Logics . LE15.Gate Out	<i>Signal: Output of the logic gate</i>
Logics . LE15.Timer Out	<i>Signal: Timer Output</i>
Logics . LE15.Out	<i>Signal: Latched Output (Q)</i>
Logics . LE15.Out inverted	<i>Signal: Negated Latched Output (Q NOT)</i>
Logics . LE16.Gate Out	<i>Signal: Output of the logic gate</i>
Logics . LE16.Timer Out	<i>Signal: Timer Output</i>
Logics . LE16.Out	<i>Signal: Latched Output (Q)</i>
Logics . LE16.Out inverted	<i>Signal: Negated Latched Output (Q NOT)</i>
Logics . LE17.Gate Out	<i>Signal: Output of the logic gate</i>
Logics . LE17.Timer Out	<i>Signal: Timer Output</i>
Logics . LE17.Out	<i>Signal: Latched Output (Q)</i>
Logics . LE17.Out inverted	<i>Signal: Negated Latched Output (Q NOT)</i>
Logics . LE18.Gate Out	<i>Signal: Output of the logic gate</i>
Logics . LE18.Timer Out	<i>Signal: Timer Output</i>
Logics . LE18.Out	<i>Signal: Latched Output (Q)</i>

AdaptSet	Description
Logics . LE18.Out inverted	<i>Signal: Negated Latched Output (Q NOT)</i>
Logics . LE19.Gate Out	<i>Signal: Output of the logic gate</i>
Logics . LE19.Timer Out	<i>Signal: Timer Output</i>
Logics . LE19.Out	<i>Signal: Latched Output (Q)</i>
Logics . LE19.Out inverted	<i>Signal: Negated Latched Output (Q NOT)</i>
Logics . LE20.Gate Out	<i>Signal: Output of the logic gate</i>
Logics . LE20.Timer Out	<i>Signal: Timer Output</i>
Logics . LE20.Out	<i>Signal: Latched Output (Q)</i>
Logics . LE20.Out inverted	<i>Signal: Negated Latched Output (Q NOT)</i>
Logics . LE21.Gate Out	<i>Signal: Output of the logic gate</i>
Logics . LE21.Timer Out	<i>Signal: Timer Output</i>
Logics . LE21.Out	<i>Signal: Latched Output (Q)</i>
Logics . LE21.Out inverted	<i>Signal: Negated Latched Output (Q NOT)</i>
Logics . LE22.Gate Out	<i>Signal: Output of the logic gate</i>
Logics . LE22.Timer Out	<i>Signal: Timer Output</i>
Logics . LE22.Out	<i>Signal: Latched Output (Q)</i>
Logics . LE22.Out inverted	<i>Signal: Negated Latched Output (Q NOT)</i>
Logics . LE23.Gate Out	<i>Signal: Output of the logic gate</i>
Logics . LE23.Timer Out	<i>Signal: Timer Output</i>
Logics . LE23.Out	<i>Signal: Latched Output (Q)</i>
Logics . LE23.Out inverted	<i>Signal: Negated Latched Output (Q NOT)</i>
Logics . LE24.Gate Out	<i>Signal: Output of the logic gate</i>
Logics . LE24.Timer Out	<i>Signal: Timer Output</i>
Logics . LE24.Out	<i>Signal: Latched Output (Q)</i>
Logics . LE24.Out inverted	<i>Signal: Negated Latched Output (Q NOT)</i>
Logics . LE25.Gate Out	<i>Signal: Output of the logic gate</i>
Logics . LE25.Timer Out	<i>Signal: Timer Output</i>
Logics . LE25.Out	<i>Signal: Latched Output (Q)</i>

AdaptSet	Description
Logics . LE25.Out inverted	<i>Signal: Negated Latched Output (Q NOT)</i>
Logics . LE26.Gate Out	<i>Signal: Output of the logic gate</i>
Logics . LE26.Timer Out	<i>Signal: Timer Output</i>
Logics . LE26.Out	<i>Signal: Latched Output (Q)</i>
Logics . LE26.Out inverted	<i>Signal: Negated Latched Output (Q NOT)</i>
Logics . LE27.Gate Out	<i>Signal: Output of the logic gate</i>
Logics . LE27.Timer Out	<i>Signal: Timer Output</i>
Logics . LE27.Out	<i>Signal: Latched Output (Q)</i>
Logics . LE27.Out inverted	<i>Signal: Negated Latched Output (Q NOT)</i>
Logics . LE28.Gate Out	<i>Signal: Output of the logic gate</i>
Logics . LE28.Timer Out	<i>Signal: Timer Output</i>
Logics . LE28.Out	<i>Signal: Latched Output (Q)</i>
Logics . LE28.Out inverted	<i>Signal: Negated Latched Output (Q NOT)</i>
Logics . LE29.Gate Out	<i>Signal: Output of the logic gate</i>
Logics . LE29.Timer Out	<i>Signal: Timer Output</i>
Logics . LE29.Out	<i>Signal: Latched Output (Q)</i>
Logics . LE29.Out inverted	<i>Signal: Negated Latched Output (Q NOT)</i>
Logics . LE30.Gate Out	<i>Signal: Output of the logic gate</i>
Logics . LE30.Timer Out	<i>Signal: Timer Output</i>
Logics . LE30.Out	<i>Signal: Latched Output (Q)</i>
Logics . LE30.Out inverted	<i>Signal: Negated Latched Output (Q NOT)</i>
Logics . LE31.Gate Out	<i>Signal: Output of the logic gate</i>
Logics . LE31.Timer Out	<i>Signal: Timer Output</i>
Logics . LE31.Out	<i>Signal: Latched Output (Q)</i>
Logics . LE31.Out inverted	<i>Signal: Negated Latched Output (Q NOT)</i>
Logics . LE32.Gate Out	<i>Signal: Output of the logic gate</i>
Logics . LE32.Timer Out	<i>Signal: Timer Output</i>
Logics . LE32.Out	<i>Signal: Latched Output (Q)</i>

AdaptSet	Description
Logics . LE32.Out inverted	<i>Signal: Negated Latched Output (Q NOT)</i>
Logics . LE33.Gate Out	<i>Signal: Output of the logic gate</i>
Logics . LE33.Timer Out	<i>Signal: Timer Output</i>
Logics . LE33.Out	<i>Signal: Latched Output (Q)</i>
Logics . LE33.Out inverted	<i>Signal: Negated Latched Output (Q NOT)</i>
Logics . LE34.Gate Out	<i>Signal: Output of the logic gate</i>
Logics . LE34.Timer Out	<i>Signal: Timer Output</i>
Logics . LE34.Out	<i>Signal: Latched Output (Q)</i>
Logics . LE34.Out inverted	<i>Signal: Negated Latched Output (Q NOT)</i>
Logics . LE35.Gate Out	<i>Signal: Output of the logic gate</i>
Logics . LE35.Timer Out	<i>Signal: Timer Output</i>
Logics . LE35.Out	<i>Signal: Latched Output (Q)</i>
Logics . LE35.Out inverted	<i>Signal: Negated Latched Output (Q NOT)</i>
Logics . LE36.Gate Out	<i>Signal: Output of the logic gate</i>
Logics . LE36.Timer Out	<i>Signal: Timer Output</i>
Logics . LE36.Out	<i>Signal: Latched Output (Q)</i>
Logics . LE36.Out inverted	<i>Signal: Negated Latched Output (Q NOT)</i>
Logics . LE37.Gate Out	<i>Signal: Output of the logic gate</i>
Logics . LE37.Timer Out	<i>Signal: Timer Output</i>
Logics . LE37.Out	<i>Signal: Latched Output (Q)</i>
Logics . LE37.Out inverted	<i>Signal: Negated Latched Output (Q NOT)</i>
Logics . LE38.Gate Out	<i>Signal: Output of the logic gate</i>
Logics . LE38.Timer Out	<i>Signal: Timer Output</i>
Logics . LE38.Out	<i>Signal: Latched Output (Q)</i>
Logics . LE38.Out inverted	<i>Signal: Negated Latched Output (Q NOT)</i>
Logics . LE39.Gate Out	<i>Signal: Output of the logic gate</i>
Logics . LE39.Timer Out	<i>Signal: Timer Output</i>
Logics . LE39.Out	<i>Signal: Latched Output (Q)</i>

AdaptSet	Description
Logics . LE39.Out inverted	<i>Signal: Negated Latched Output (Q NOT)</i>
Logics . LE40.Gate Out	<i>Signal: Output of the logic gate</i>
Logics . LE40.Timer Out	<i>Signal: Timer Output</i>
Logics . LE40.Out	<i>Signal: Latched Output (Q)</i>
Logics . LE40.Out inverted	<i>Signal: Negated Latched Output (Q NOT)</i>
Logics . LE41.Gate Out	<i>Signal: Output of the logic gate</i>
Logics . LE41.Timer Out	<i>Signal: Timer Output</i>
Logics . LE41.Out	<i>Signal: Latched Output (Q)</i>
Logics . LE41.Out inverted	<i>Signal: Negated Latched Output (Q NOT)</i>
Logics . LE42.Gate Out	<i>Signal: Output of the logic gate</i>
Logics . LE42.Timer Out	<i>Signal: Timer Output</i>
Logics . LE42.Out	<i>Signal: Latched Output (Q)</i>
Logics . LE42.Out inverted	<i>Signal: Negated Latched Output (Q NOT)</i>
Logics . LE43.Gate Out	<i>Signal: Output of the logic gate</i>
Logics . LE43.Timer Out	<i>Signal: Timer Output</i>
Logics . LE43.Out	<i>Signal: Latched Output (Q)</i>
Logics . LE43.Out inverted	<i>Signal: Negated Latched Output (Q NOT)</i>
Logics . LE44.Gate Out	<i>Signal: Output of the logic gate</i>
Logics . LE44.Timer Out	<i>Signal: Timer Output</i>
Logics . LE44.Out	<i>Signal: Latched Output (Q)</i>
Logics . LE44.Out inverted	<i>Signal: Negated Latched Output (Q NOT)</i>
Logics . LE45.Gate Out	<i>Signal: Output of the logic gate</i>
Logics . LE45.Timer Out	<i>Signal: Timer Output</i>
Logics . LE45.Out	<i>Signal: Latched Output (Q)</i>
Logics . LE45.Out inverted	<i>Signal: Negated Latched Output (Q NOT)</i>
Logics . LE46.Gate Out	<i>Signal: Output of the logic gate</i>
Logics . LE46.Timer Out	<i>Signal: Timer Output</i>
Logics . LE46.Out	<i>Signal: Latched Output (Q)</i>

AdaptSet	Description
Logics . LE46.Out inverted	<i>Signal: Negated Latched Output (Q NOT)</i>
Logics . LE47.Gate Out	<i>Signal: Output of the logic gate</i>
Logics . LE47.Timer Out	<i>Signal: Timer Output</i>
Logics . LE47.Out	<i>Signal: Latched Output (Q)</i>
Logics . LE47.Out inverted	<i>Signal: Negated Latched Output (Q NOT)</i>
Logics . LE48.Gate Out	<i>Signal: Output of the logic gate</i>
Logics . LE48.Timer Out	<i>Signal: Timer Output</i>
Logics . LE48.Out	<i>Signal: Latched Output (Q)</i>
Logics . LE48.Out inverted	<i>Signal: Negated Latched Output (Q NOT)</i>
Logics . LE49.Gate Out	<i>Signal: Output of the logic gate</i>
Logics . LE49.Timer Out	<i>Signal: Timer Output</i>
Logics . LE49.Out	<i>Signal: Latched Output (Q)</i>
Logics . LE49.Out inverted	<i>Signal: Negated Latched Output (Q NOT)</i>
Logics . LE50.Gate Out	<i>Signal: Output of the logic gate</i>
Logics . LE50.Timer Out	<i>Signal: Timer Output</i>
Logics . LE50.Out	<i>Signal: Latched Output (Q)</i>
Logics . LE50.Out inverted	<i>Signal: Negated Latched Output (Q NOT)</i>
Logics . LE51.Gate Out	<i>Signal: Output of the logic gate</i>
Logics . LE51.Timer Out	<i>Signal: Timer Output</i>
Logics . LE51.Out	<i>Signal: Latched Output (Q)</i>
Logics . LE51.Out inverted	<i>Signal: Negated Latched Output (Q NOT)</i>
Logics . LE52.Gate Out	<i>Signal: Output of the logic gate</i>
Logics . LE52.Timer Out	<i>Signal: Timer Output</i>
Logics . LE52.Out	<i>Signal: Latched Output (Q)</i>
Logics . LE52.Out inverted	<i>Signal: Negated Latched Output (Q NOT)</i>
Logics . LE53.Gate Out	<i>Signal: Output of the logic gate</i>
Logics . LE53.Timer Out	<i>Signal: Timer Output</i>
Logics . LE53.Out	<i>Signal: Latched Output (Q)</i>

AdaptSet	Description
Logics . LE53.Out inverted	<i>Signal: Negated Latched Output (Q NOT)</i>
Logics . LE54.Gate Out	<i>Signal: Output of the logic gate</i>
Logics . LE54.Timer Out	<i>Signal: Timer Output</i>
Logics . LE54.Out	<i>Signal: Latched Output (Q)</i>
Logics . LE54.Out inverted	<i>Signal: Negated Latched Output (Q NOT)</i>
Logics . LE55.Gate Out	<i>Signal: Output of the logic gate</i>
Logics . LE55.Timer Out	<i>Signal: Timer Output</i>
Logics . LE55.Out	<i>Signal: Latched Output (Q)</i>
Logics . LE55.Out inverted	<i>Signal: Negated Latched Output (Q NOT)</i>
Logics . LE56.Gate Out	<i>Signal: Output of the logic gate</i>
Logics . LE56.Timer Out	<i>Signal: Timer Output</i>
Logics . LE56.Out	<i>Signal: Latched Output (Q)</i>
Logics . LE56.Out inverted	<i>Signal: Negated Latched Output (Q NOT)</i>
Logics . LE57.Gate Out	<i>Signal: Output of the logic gate</i>
Logics . LE57.Timer Out	<i>Signal: Timer Output</i>
Logics . LE57.Out	<i>Signal: Latched Output (Q)</i>
Logics . LE57.Out inverted	<i>Signal: Negated Latched Output (Q NOT)</i>
Logics . LE58.Gate Out	<i>Signal: Output of the logic gate</i>
Logics . LE58.Timer Out	<i>Signal: Timer Output</i>
Logics . LE58.Out	<i>Signal: Latched Output (Q)</i>
Logics . LE58.Out inverted	<i>Signal: Negated Latched Output (Q NOT)</i>
Logics . LE59.Gate Out	<i>Signal: Output of the logic gate</i>
Logics . LE59.Timer Out	<i>Signal: Timer Output</i>
Logics . LE59.Out	<i>Signal: Latched Output (Q)</i>
Logics . LE59.Out inverted	<i>Signal: Negated Latched Output (Q NOT)</i>
Logics . LE60.Gate Out	<i>Signal: Output of the logic gate</i>
Logics . LE60.Timer Out	<i>Signal: Timer Output</i>
Logics . LE60.Out	<i>Signal: Latched Output (Q)</i>

AdaptSet	Description
Logics . LE60.Out inverted	<i>Signal: Negated Latched Output (Q NOT)</i>
Logics . LE61.Gate Out	<i>Signal: Output of the logic gate</i>
Logics . LE61.Timer Out	<i>Signal: Timer Output</i>
Logics . LE61.Out	<i>Signal: Latched Output (Q)</i>
Logics . LE61.Out inverted	<i>Signal: Negated Latched Output (Q NOT)</i>
Logics . LE62.Gate Out	<i>Signal: Output of the logic gate</i>
Logics . LE62.Timer Out	<i>Signal: Timer Output</i>
Logics . LE62.Out	<i>Signal: Latched Output (Q)</i>
Logics . LE62.Out inverted	<i>Signal: Negated Latched Output (Q NOT)</i>
Logics . LE63.Gate Out	<i>Signal: Output of the logic gate</i>
Logics . LE63.Timer Out	<i>Signal: Timer Output</i>
Logics . LE63.Out	<i>Signal: Latched Output (Q)</i>
Logics . LE63.Out inverted	<i>Signal: Negated Latched Output (Q NOT)</i>
Logics . LE64.Gate Out	<i>Signal: Output of the logic gate</i>
Logics . LE64.Timer Out	<i>Signal: Timer Output</i>
Logics . LE64.Out	<i>Signal: Latched Output (Q)</i>
Logics . LE64.Out inverted	<i>Signal: Negated Latched Output (Q NOT)</i>
Logics . LE65.Gate Out	<i>Signal: Output of the logic gate</i>
Logics . LE65.Timer Out	<i>Signal: Timer Output</i>
Logics . LE65.Out	<i>Signal: Latched Output (Q)</i>
Logics . LE65.Out inverted	<i>Signal: Negated Latched Output (Q NOT)</i>
Logics . LE66.Gate Out	<i>Signal: Output of the logic gate</i>
Logics . LE66.Timer Out	<i>Signal: Timer Output</i>
Logics . LE66.Out	<i>Signal: Latched Output (Q)</i>
Logics . LE66.Out inverted	<i>Signal: Negated Latched Output (Q NOT)</i>
Logics . LE67.Gate Out	<i>Signal: Output of the logic gate</i>
Logics . LE67.Timer Out	<i>Signal: Timer Output</i>
Logics . LE67.Out	<i>Signal: Latched Output (Q)</i>

AdaptSet	Description
Logics . LE67.Out inverted	<i>Signal: Negated Latched Output (Q NOT)</i>
Logics . LE68.Gate Out	<i>Signal: Output of the logic gate</i>
Logics . LE68.Timer Out	<i>Signal: Timer Output</i>
Logics . LE68.Out	<i>Signal: Latched Output (Q)</i>
Logics . LE68.Out inverted	<i>Signal: Negated Latched Output (Q NOT)</i>
Logics . LE69.Gate Out	<i>Signal: Output of the logic gate</i>
Logics . LE69.Timer Out	<i>Signal: Timer Output</i>
Logics . LE69.Out	<i>Signal: Latched Output (Q)</i>
Logics . LE69.Out inverted	<i>Signal: Negated Latched Output (Q NOT)</i>
Logics . LE70.Gate Out	<i>Signal: Output of the logic gate</i>
Logics . LE70.Timer Out	<i>Signal: Timer Output</i>
Logics . LE70.Out	<i>Signal: Latched Output (Q)</i>
Logics . LE70.Out inverted	<i>Signal: Negated Latched Output (Q NOT)</i>
Logics . LE71.Gate Out	<i>Signal: Output of the logic gate</i>
Logics . LE71.Timer Out	<i>Signal: Timer Output</i>
Logics . LE71.Out	<i>Signal: Latched Output (Q)</i>
Logics . LE71.Out inverted	<i>Signal: Negated Latched Output (Q NOT)</i>
Logics . LE72.Gate Out	<i>Signal: Output of the logic gate</i>
Logics . LE72.Timer Out	<i>Signal: Timer Output</i>
Logics . LE72.Out	<i>Signal: Latched Output (Q)</i>
Logics . LE72.Out inverted	<i>Signal: Negated Latched Output (Q NOT)</i>
Logics . LE73.Gate Out	<i>Signal: Output of the logic gate</i>
Logics . LE73.Timer Out	<i>Signal: Timer Output</i>
Logics . LE73.Out	<i>Signal: Latched Output (Q)</i>
Logics . LE73.Out inverted	<i>Signal: Negated Latched Output (Q NOT)</i>
Logics . LE74.Gate Out	<i>Signal: Output of the logic gate</i>
Logics . LE74.Timer Out	<i>Signal: Timer Output</i>
Logics . LE74.Out	<i>Signal: Latched Output (Q)</i>

AdaptSet	Description
Logics . LE74.Out inverted	<i>Signal: Negated Latched Output (Q NOT)</i>
Logics . LE75.Gate Out	<i>Signal: Output of the logic gate</i>
Logics . LE75.Timer Out	<i>Signal: Timer Output</i>
Logics . LE75.Out	<i>Signal: Latched Output (Q)</i>
Logics . LE75.Out inverted	<i>Signal: Negated Latched Output (Q NOT)</i>
Logics . LE76.Gate Out	<i>Signal: Output of the logic gate</i>
Logics . LE76.Timer Out	<i>Signal: Timer Output</i>
Logics . LE76.Out	<i>Signal: Latched Output (Q)</i>
Logics . LE76.Out inverted	<i>Signal: Negated Latched Output (Q NOT)</i>
Logics . LE77.Gate Out	<i>Signal: Output of the logic gate</i>
Logics . LE77.Timer Out	<i>Signal: Timer Output</i>
Logics . LE77.Out	<i>Signal: Latched Output (Q)</i>
Logics . LE77.Out inverted	<i>Signal: Negated Latched Output (Q NOT)</i>
Logics . LE78.Gate Out	<i>Signal: Output of the logic gate</i>
Logics . LE78.Timer Out	<i>Signal: Timer Output</i>
Logics . LE78.Out	<i>Signal: Latched Output (Q)</i>
Logics . LE78.Out inverted	<i>Signal: Negated Latched Output (Q NOT)</i>
Logics . LE79.Gate Out	<i>Signal: Output of the logic gate</i>
Logics . LE79.Timer Out	<i>Signal: Timer Output</i>
Logics . LE79.Out	<i>Signal: Latched Output (Q)</i>
Logics . LE79.Out inverted	<i>Signal: Negated Latched Output (Q NOT)</i>
Logics . LE80.Gate Out	<i>Signal: Output of the logic gate</i>
Logics . LE80.Timer Out	<i>Signal: Timer Output</i>
Logics . LE80.Out	<i>Signal: Latched Output (Q)</i>
Logics . LE80.Out inverted	<i>Signal: Negated Latched Output (Q NOT)</i>

CurrentBase

Base Current Selection (based on Device Rating (1A/5A)/Protected Object Rating).

Selection list referenced by the following parameters:





-  I2>[1] . CurrentBase

CurrentBase	Description
Device Rating	Device Rating
Protected Object Rating	Protected Object Rating

CB Manager

Circuit Breaker States

Selection list referenced by the following parameters:

-  Sync . CB Pos Detect
-  InEn . Assigned SG
-  CLPU . CB Pos Detect
-  TCS . CB Pos Detect
-  LOP . CB Pos Detect

CB Manager	Description
"_"	No assignment
SG[1] . Pos	Signal: Circuit Breaker Position (0 = Indeterminate, 1 = OFF, 2 = ON, 3 = Disturbed)
SG[2] . Pos	Signal: Circuit Breaker Position (0 = Indeterminate, 1 = OFF, 2 = ON, 3 = Disturbed)
SG[3] . Pos	Signal: Circuit Breaker Position (0 = Indeterminate, 1 = OFF, 2 = ON, 3 = Disturbed)
SG[4] . Pos	Signal: Circuit Breaker Position (0 = Indeterminate, 1 = OFF, 2 = ON, 3 = Disturbed)
SG[5] . Pos	Signal: Circuit Breaker Position (0 = Indeterminate, 1 = OFF, 2 = ON, 3 = Disturbed)
SG[6] . Pos	Signal: Circuit Breaker Position (0 = Indeterminate, 1 = OFF, 2 = ON, 3 = Disturbed)

Selection list referenced by the following parameters:

-  Z[1] . Blo by Power Swing

	Description
“_”	No assignment
PSB . Start	Signal, that a power swing (or an Out-of-step event) has been detected. The state of this signal becomes true as soon as the impedance traverses the first blinder, and it gets reset when the characteristic area is left.
DI Slot X1 . DI 1	Signal: Digital Input
DI Slot X1 . DI 2	Signal: Digital Input
DI Slot X1 . DI 3	Signal: Digital Input
DI Slot X1 . DI 4	Signal: Digital Input
DI Slot X1 . DI 5	Signal: Digital Input
DI Slot X1 . DI 6	Signal: Digital Input
DI Slot X1 . DI 7	Signal: Digital Input
DI Slot X1 . DI 8	Signal: Digital Input
DI Slot X5 . DI 1	Signal: Digital Input
DI Slot X5 . DI 2	Signal: Digital Input
DI Slot X5 . DI 3	Signal: Digital Input
DI Slot X5 . DI 4	Signal: Digital Input
DI Slot X5 . DI 5	Signal: Digital Input
DI Slot X5 . DI 6	Signal: Digital Input
DI Slot X5 . DI 7	Signal: Digital Input
DI Slot X5 . DI 8	Signal: Digital Input
DI Slot X6 . DI 1	Signal: Digital Input
DI Slot X6 . DI 2	Signal: Digital Input
DI Slot X6 . DI 3	Signal: Digital Input
DI Slot X6 . DI 4	Signal: Digital Input
DI Slot X6 . DI 5	Signal: Digital Input
DI Slot X6 . DI 6	Signal: Digital Input
DI Slot X6 . DI 7	Signal: Digital Input
DI Slot X6 . DI 8	Signal: Digital Input
Logics . LE1.Gate Out	Signal: Output of the logic gate
Logics . LE1.Timer Out	Signal: Timer Output

	Description
Logics . LE1.Out	<i>Signal: Latched Output (Q)</i>
Logics . LE1.Out inverted	<i>Signal: Negated Latched Output (Q NOT)</i>
Logics . LE2.Gate Out	<i>Signal: Output of the logic gate</i>
Logics . LE2.Timer Out	<i>Signal: Timer Output</i>
Logics . LE2.Out	<i>Signal: Latched Output (Q)</i>
Logics . LE2.Out inverted	<i>Signal: Negated Latched Output (Q NOT)</i>
Logics . LE3.Gate Out	<i>Signal: Output of the logic gate</i>
Logics . LE3.Timer Out	<i>Signal: Timer Output</i>
Logics . LE3.Out	<i>Signal: Latched Output (Q)</i>
Logics . LE3.Out inverted	<i>Signal: Negated Latched Output (Q NOT)</i>
Logics . LE4.Gate Out	<i>Signal: Output of the logic gate</i>
Logics . LE4.Timer Out	<i>Signal: Timer Output</i>
Logics . LE4.Out	<i>Signal: Latched Output (Q)</i>
Logics . LE4.Out inverted	<i>Signal: Negated Latched Output (Q NOT)</i>
Logics . LE5.Gate Out	<i>Signal: Output of the logic gate</i>
Logics . LE5.Timer Out	<i>Signal: Timer Output</i>
Logics . LE5.Out	<i>Signal: Latched Output (Q)</i>
Logics . LE5.Out inverted	<i>Signal: Negated Latched Output (Q NOT)</i>
Logics . LE6.Gate Out	<i>Signal: Output of the logic gate</i>
Logics . LE6.Timer Out	<i>Signal: Timer Output</i>
Logics . LE6.Out	<i>Signal: Latched Output (Q)</i>
Logics . LE6.Out inverted	<i>Signal: Negated Latched Output (Q NOT)</i>
Logics . LE7.Gate Out	<i>Signal: Output of the logic gate</i>
Logics . LE7.Timer Out	<i>Signal: Timer Output</i>
Logics . LE7.Out	<i>Signal: Latched Output (Q)</i>
Logics . LE7.Out inverted	<i>Signal: Negated Latched Output (Q NOT)</i>
Logics . LE8.Gate Out	<i>Signal: Output of the logic gate</i>
Logics . LE8.Timer Out	<i>Signal: Timer Output</i>

	Description
Logics . LE8.Out	<i>Signal: Latched Output (Q)</i>
Logics . LE8.Out inverted	<i>Signal: Negated Latched Output (Q NOT)</i>
Logics . LE9.Gate Out	<i>Signal: Output of the logic gate</i>
Logics . LE9.Timer Out	<i>Signal: Timer Output</i>
Logics . LE9.Out	<i>Signal: Latched Output (Q)</i>
Logics . LE9.Out inverted	<i>Signal: Negated Latched Output (Q NOT)</i>
Logics . LE10.Gate Out	<i>Signal: Output of the logic gate</i>
Logics . LE10.Timer Out	<i>Signal: Timer Output</i>
Logics . LE10.Out	<i>Signal: Latched Output (Q)</i>
Logics . LE10.Out inverted	<i>Signal: Negated Latched Output (Q NOT)</i>
Logics . LE11.Gate Out	<i>Signal: Output of the logic gate</i>
Logics . LE11.Timer Out	<i>Signal: Timer Output</i>
Logics . LE11.Out	<i>Signal: Latched Output (Q)</i>
Logics . LE11.Out inverted	<i>Signal: Negated Latched Output (Q NOT)</i>
Logics . LE12.Gate Out	<i>Signal: Output of the logic gate</i>
Logics . LE12.Timer Out	<i>Signal: Timer Output</i>
Logics . LE12.Out	<i>Signal: Latched Output (Q)</i>
Logics . LE12.Out inverted	<i>Signal: Negated Latched Output (Q NOT)</i>
Logics . LE13.Gate Out	<i>Signal: Output of the logic gate</i>
Logics . LE13.Timer Out	<i>Signal: Timer Output</i>
Logics . LE13.Out	<i>Signal: Latched Output (Q)</i>
Logics . LE13.Out inverted	<i>Signal: Negated Latched Output (Q NOT)</i>
Logics . LE14.Gate Out	<i>Signal: Output of the logic gate</i>
Logics . LE14.Timer Out	<i>Signal: Timer Output</i>
Logics . LE14.Out	<i>Signal: Latched Output (Q)</i>
Logics . LE14.Out inverted	<i>Signal: Negated Latched Output (Q NOT)</i>
Logics . LE15.Gate Out	<i>Signal: Output of the logic gate</i>
Logics . LE15.Timer Out	<i>Signal: Timer Output</i>

	Description
Logics . LE15.Out	<i>Signal: Latched Output (Q)</i>
Logics . LE15.Out inverted	<i>Signal: Negated Latched Output (Q NOT)</i>
Logics . LE16.Gate Out	<i>Signal: Output of the logic gate</i>
Logics . LE16.Timer Out	<i>Signal: Timer Output</i>
Logics . LE16.Out	<i>Signal: Latched Output (Q)</i>
Logics . LE16.Out inverted	<i>Signal: Negated Latched Output (Q NOT)</i>
Logics . LE17.Gate Out	<i>Signal: Output of the logic gate</i>
Logics . LE17.Timer Out	<i>Signal: Timer Output</i>
Logics . LE17.Out	<i>Signal: Latched Output (Q)</i>
Logics . LE17.Out inverted	<i>Signal: Negated Latched Output (Q NOT)</i>
Logics . LE18.Gate Out	<i>Signal: Output of the logic gate</i>
Logics . LE18.Timer Out	<i>Signal: Timer Output</i>
Logics . LE18.Out	<i>Signal: Latched Output (Q)</i>
Logics . LE18.Out inverted	<i>Signal: Negated Latched Output (Q NOT)</i>
Logics . LE19.Gate Out	<i>Signal: Output of the logic gate</i>
Logics . LE19.Timer Out	<i>Signal: Timer Output</i>
Logics . LE19.Out	<i>Signal: Latched Output (Q)</i>
Logics . LE19.Out inverted	<i>Signal: Negated Latched Output (Q NOT)</i>
Logics . LE20.Gate Out	<i>Signal: Output of the logic gate</i>
Logics . LE20.Timer Out	<i>Signal: Timer Output</i>
Logics . LE20.Out	<i>Signal: Latched Output (Q)</i>
Logics . LE20.Out inverted	<i>Signal: Negated Latched Output (Q NOT)</i>
Logics . LE21.Gate Out	<i>Signal: Output of the logic gate</i>
Logics . LE21.Timer Out	<i>Signal: Timer Output</i>
Logics . LE21.Out	<i>Signal: Latched Output (Q)</i>
Logics . LE21.Out inverted	<i>Signal: Negated Latched Output (Q NOT)</i>
Logics . LE22.Gate Out	<i>Signal: Output of the logic gate</i>
Logics . LE22.Timer Out	<i>Signal: Timer Output</i>

	Description
Logics . LE22.Out	<i>Signal: Latched Output (Q)</i>
Logics . LE22.Out inverted	<i>Signal: Negated Latched Output (Q NOT)</i>
Logics . LE23.Gate Out	<i>Signal: Output of the logic gate</i>
Logics . LE23.Timer Out	<i>Signal: Timer Output</i>
Logics . LE23.Out	<i>Signal: Latched Output (Q)</i>
Logics . LE23.Out inverted	<i>Signal: Negated Latched Output (Q NOT)</i>
Logics . LE24.Gate Out	<i>Signal: Output of the logic gate</i>
Logics . LE24.Timer Out	<i>Signal: Timer Output</i>
Logics . LE24.Out	<i>Signal: Latched Output (Q)</i>
Logics . LE24.Out inverted	<i>Signal: Negated Latched Output (Q NOT)</i>
Logics . LE25.Gate Out	<i>Signal: Output of the logic gate</i>
Logics . LE25.Timer Out	<i>Signal: Timer Output</i>
Logics . LE25.Out	<i>Signal: Latched Output (Q)</i>
Logics . LE25.Out inverted	<i>Signal: Negated Latched Output (Q NOT)</i>
Logics . LE26.Gate Out	<i>Signal: Output of the logic gate</i>
Logics . LE26.Timer Out	<i>Signal: Timer Output</i>
Logics . LE26.Out	<i>Signal: Latched Output (Q)</i>
Logics . LE26.Out inverted	<i>Signal: Negated Latched Output (Q NOT)</i>
Logics . LE27.Gate Out	<i>Signal: Output of the logic gate</i>
Logics . LE27.Timer Out	<i>Signal: Timer Output</i>
Logics . LE27.Out	<i>Signal: Latched Output (Q)</i>
Logics . LE27.Out inverted	<i>Signal: Negated Latched Output (Q NOT)</i>
Logics . LE28.Gate Out	<i>Signal: Output of the logic gate</i>
Logics . LE28.Timer Out	<i>Signal: Timer Output</i>
Logics . LE28.Out	<i>Signal: Latched Output (Q)</i>
Logics . LE28.Out inverted	<i>Signal: Negated Latched Output (Q NOT)</i>
Logics . LE29.Gate Out	<i>Signal: Output of the logic gate</i>
Logics . LE29.Timer Out	<i>Signal: Timer Output</i>

	Description
Logics . LE29.Out	<i>Signal: Latched Output (Q)</i>
Logics . LE29.Out inverted	<i>Signal: Negated Latched Output (Q NOT)</i>
Logics . LE30.Gate Out	<i>Signal: Output of the logic gate</i>
Logics . LE30.Timer Out	<i>Signal: Timer Output</i>
Logics . LE30.Out	<i>Signal: Latched Output (Q)</i>
Logics . LE30.Out inverted	<i>Signal: Negated Latched Output (Q NOT)</i>
Logics . LE31.Gate Out	<i>Signal: Output of the logic gate</i>
Logics . LE31.Timer Out	<i>Signal: Timer Output</i>
Logics . LE31.Out	<i>Signal: Latched Output (Q)</i>
Logics . LE31.Out inverted	<i>Signal: Negated Latched Output (Q NOT)</i>
Logics . LE32.Gate Out	<i>Signal: Output of the logic gate</i>
Logics . LE32.Timer Out	<i>Signal: Timer Output</i>
Logics . LE32.Out	<i>Signal: Latched Output (Q)</i>
Logics . LE32.Out inverted	<i>Signal: Negated Latched Output (Q NOT)</i>
Logics . LE33.Gate Out	<i>Signal: Output of the logic gate</i>
Logics . LE33.Timer Out	<i>Signal: Timer Output</i>
Logics . LE33.Out	<i>Signal: Latched Output (Q)</i>
Logics . LE33.Out inverted	<i>Signal: Negated Latched Output (Q NOT)</i>
Logics . LE34.Gate Out	<i>Signal: Output of the logic gate</i>
Logics . LE34.Timer Out	<i>Signal: Timer Output</i>
Logics . LE34.Out	<i>Signal: Latched Output (Q)</i>
Logics . LE34.Out inverted	<i>Signal: Negated Latched Output (Q NOT)</i>
Logics . LE35.Gate Out	<i>Signal: Output of the logic gate</i>
Logics . LE35.Timer Out	<i>Signal: Timer Output</i>
Logics . LE35.Out	<i>Signal: Latched Output (Q)</i>
Logics . LE35.Out inverted	<i>Signal: Negated Latched Output (Q NOT)</i>
Logics . LE36.Gate Out	<i>Signal: Output of the logic gate</i>
Logics . LE36.Timer Out	<i>Signal: Timer Output</i>

	Description
Logics . LE36.Out	<i>Signal: Latched Output (Q)</i>
Logics . LE36.Out inverted	<i>Signal: Negated Latched Output (Q NOT)</i>
Logics . LE37.Gate Out	<i>Signal: Output of the logic gate</i>
Logics . LE37.Timer Out	<i>Signal: Timer Output</i>
Logics . LE37.Out	<i>Signal: Latched Output (Q)</i>
Logics . LE37.Out inverted	<i>Signal: Negated Latched Output (Q NOT)</i>
Logics . LE38.Gate Out	<i>Signal: Output of the logic gate</i>
Logics . LE38.Timer Out	<i>Signal: Timer Output</i>
Logics . LE38.Out	<i>Signal: Latched Output (Q)</i>
Logics . LE38.Out inverted	<i>Signal: Negated Latched Output (Q NOT)</i>
Logics . LE39.Gate Out	<i>Signal: Output of the logic gate</i>
Logics . LE39.Timer Out	<i>Signal: Timer Output</i>
Logics . LE39.Out	<i>Signal: Latched Output (Q)</i>
Logics . LE39.Out inverted	<i>Signal: Negated Latched Output (Q NOT)</i>
Logics . LE40.Gate Out	<i>Signal: Output of the logic gate</i>
Logics . LE40.Timer Out	<i>Signal: Timer Output</i>
Logics . LE40.Out	<i>Signal: Latched Output (Q)</i>
Logics . LE40.Out inverted	<i>Signal: Negated Latched Output (Q NOT)</i>
Logics . LE41.Gate Out	<i>Signal: Output of the logic gate</i>
Logics . LE41.Timer Out	<i>Signal: Timer Output</i>
Logics . LE41.Out	<i>Signal: Latched Output (Q)</i>
Logics . LE41.Out inverted	<i>Signal: Negated Latched Output (Q NOT)</i>
Logics . LE42.Gate Out	<i>Signal: Output of the logic gate</i>
Logics . LE42.Timer Out	<i>Signal: Timer Output</i>
Logics . LE42.Out	<i>Signal: Latched Output (Q)</i>
Logics . LE42.Out inverted	<i>Signal: Negated Latched Output (Q NOT)</i>
Logics . LE43.Gate Out	<i>Signal: Output of the logic gate</i>
Logics . LE43.Timer Out	<i>Signal: Timer Output</i>

	Description
Logics . LE43.Out	<i>Signal: Latched Output (Q)</i>
Logics . LE43.Out inverted	<i>Signal: Negated Latched Output (Q NOT)</i>
Logics . LE44.Gate Out	<i>Signal: Output of the logic gate</i>
Logics . LE44.Timer Out	<i>Signal: Timer Output</i>
Logics . LE44.Out	<i>Signal: Latched Output (Q)</i>
Logics . LE44.Out inverted	<i>Signal: Negated Latched Output (Q NOT)</i>
Logics . LE45.Gate Out	<i>Signal: Output of the logic gate</i>
Logics . LE45.Timer Out	<i>Signal: Timer Output</i>
Logics . LE45.Out	<i>Signal: Latched Output (Q)</i>
Logics . LE45.Out inverted	<i>Signal: Negated Latched Output (Q NOT)</i>
Logics . LE46.Gate Out	<i>Signal: Output of the logic gate</i>
Logics . LE46.Timer Out	<i>Signal: Timer Output</i>
Logics . LE46.Out	<i>Signal: Latched Output (Q)</i>
Logics . LE46.Out inverted	<i>Signal: Negated Latched Output (Q NOT)</i>
Logics . LE47.Gate Out	<i>Signal: Output of the logic gate</i>
Logics . LE47.Timer Out	<i>Signal: Timer Output</i>
Logics . LE47.Out	<i>Signal: Latched Output (Q)</i>
Logics . LE47.Out inverted	<i>Signal: Negated Latched Output (Q NOT)</i>
Logics . LE48.Gate Out	<i>Signal: Output of the logic gate</i>
Logics . LE48.Timer Out	<i>Signal: Timer Output</i>
Logics . LE48.Out	<i>Signal: Latched Output (Q)</i>
Logics . LE48.Out inverted	<i>Signal: Negated Latched Output (Q NOT)</i>
Logics . LE49.Gate Out	<i>Signal: Output of the logic gate</i>
Logics . LE49.Timer Out	<i>Signal: Timer Output</i>
Logics . LE49.Out	<i>Signal: Latched Output (Q)</i>
Logics . LE49.Out inverted	<i>Signal: Negated Latched Output (Q NOT)</i>
Logics . LE50.Gate Out	<i>Signal: Output of the logic gate</i>
Logics . LE50.Timer Out	<i>Signal: Timer Output</i>

	Description
Logics . LE50.Out	<i>Signal: Latched Output (Q)</i>
Logics . LE50.Out inverted	<i>Signal: Negated Latched Output (Q NOT)</i>
Logics . LE51.Gate Out	<i>Signal: Output of the logic gate</i>
Logics . LE51.Timer Out	<i>Signal: Timer Output</i>
Logics . LE51.Out	<i>Signal: Latched Output (Q)</i>
Logics . LE51.Out inverted	<i>Signal: Negated Latched Output (Q NOT)</i>
Logics . LE52.Gate Out	<i>Signal: Output of the logic gate</i>
Logics . LE52.Timer Out	<i>Signal: Timer Output</i>
Logics . LE52.Out	<i>Signal: Latched Output (Q)</i>
Logics . LE52.Out inverted	<i>Signal: Negated Latched Output (Q NOT)</i>
Logics . LE53.Gate Out	<i>Signal: Output of the logic gate</i>
Logics . LE53.Timer Out	<i>Signal: Timer Output</i>
Logics . LE53.Out	<i>Signal: Latched Output (Q)</i>
Logics . LE53.Out inverted	<i>Signal: Negated Latched Output (Q NOT)</i>
Logics . LE54.Gate Out	<i>Signal: Output of the logic gate</i>
Logics . LE54.Timer Out	<i>Signal: Timer Output</i>
Logics . LE54.Out	<i>Signal: Latched Output (Q)</i>
Logics . LE54.Out inverted	<i>Signal: Negated Latched Output (Q NOT)</i>
Logics . LE55.Gate Out	<i>Signal: Output of the logic gate</i>
Logics . LE55.Timer Out	<i>Signal: Timer Output</i>
Logics . LE55.Out	<i>Signal: Latched Output (Q)</i>
Logics . LE55.Out inverted	<i>Signal: Negated Latched Output (Q NOT)</i>
Logics . LE56.Gate Out	<i>Signal: Output of the logic gate</i>
Logics . LE56.Timer Out	<i>Signal: Timer Output</i>
Logics . LE56.Out	<i>Signal: Latched Output (Q)</i>
Logics . LE56.Out inverted	<i>Signal: Negated Latched Output (Q NOT)</i>
Logics . LE57.Gate Out	<i>Signal: Output of the logic gate</i>
Logics . LE57.Timer Out	<i>Signal: Timer Output</i>

	Description
Logics . LE57.Out	<i>Signal: Latched Output (Q)</i>
Logics . LE57.Out inverted	<i>Signal: Negated Latched Output (Q NOT)</i>
Logics . LE58.Gate Out	<i>Signal: Output of the logic gate</i>
Logics . LE58.Timer Out	<i>Signal: Timer Output</i>
Logics . LE58.Out	<i>Signal: Latched Output (Q)</i>
Logics . LE58.Out inverted	<i>Signal: Negated Latched Output (Q NOT)</i>
Logics . LE59.Gate Out	<i>Signal: Output of the logic gate</i>
Logics . LE59.Timer Out	<i>Signal: Timer Output</i>
Logics . LE59.Out	<i>Signal: Latched Output (Q)</i>
Logics . LE59.Out inverted	<i>Signal: Negated Latched Output (Q NOT)</i>
Logics . LE60.Gate Out	<i>Signal: Output of the logic gate</i>
Logics . LE60.Timer Out	<i>Signal: Timer Output</i>
Logics . LE60.Out	<i>Signal: Latched Output (Q)</i>
Logics . LE60.Out inverted	<i>Signal: Negated Latched Output (Q NOT)</i>
Logics . LE61.Gate Out	<i>Signal: Output of the logic gate</i>
Logics . LE61.Timer Out	<i>Signal: Timer Output</i>
Logics . LE61.Out	<i>Signal: Latched Output (Q)</i>
Logics . LE61.Out inverted	<i>Signal: Negated Latched Output (Q NOT)</i>
Logics . LE62.Gate Out	<i>Signal: Output of the logic gate</i>
Logics . LE62.Timer Out	<i>Signal: Timer Output</i>
Logics . LE62.Out	<i>Signal: Latched Output (Q)</i>
Logics . LE62.Out inverted	<i>Signal: Negated Latched Output (Q NOT)</i>
Logics . LE63.Gate Out	<i>Signal: Output of the logic gate</i>
Logics . LE63.Timer Out	<i>Signal: Timer Output</i>
Logics . LE63.Out	<i>Signal: Latched Output (Q)</i>
Logics . LE63.Out inverted	<i>Signal: Negated Latched Output (Q NOT)</i>
Logics . LE64.Gate Out	<i>Signal: Output of the logic gate</i>
Logics . LE64.Timer Out	<i>Signal: Timer Output</i>

	Description
Logics . LE64.Out	<i>Signal: Latched Output (Q)</i>
Logics . LE64.Out inverted	<i>Signal: Negated Latched Output (Q NOT)</i>
Logics . LE65.Gate Out	<i>Signal: Output of the logic gate</i>
Logics . LE65.Timer Out	<i>Signal: Timer Output</i>
Logics . LE65.Out	<i>Signal: Latched Output (Q)</i>
Logics . LE65.Out inverted	<i>Signal: Negated Latched Output (Q NOT)</i>
Logics . LE66.Gate Out	<i>Signal: Output of the logic gate</i>
Logics . LE66.Timer Out	<i>Signal: Timer Output</i>
Logics . LE66.Out	<i>Signal: Latched Output (Q)</i>
Logics . LE66.Out inverted	<i>Signal: Negated Latched Output (Q NOT)</i>
Logics . LE67.Gate Out	<i>Signal: Output of the logic gate</i>
Logics . LE67.Timer Out	<i>Signal: Timer Output</i>
Logics . LE67.Out	<i>Signal: Latched Output (Q)</i>
Logics . LE67.Out inverted	<i>Signal: Negated Latched Output (Q NOT)</i>
Logics . LE68.Gate Out	<i>Signal: Output of the logic gate</i>
Logics . LE68.Timer Out	<i>Signal: Timer Output</i>
Logics . LE68.Out	<i>Signal: Latched Output (Q)</i>
Logics . LE68.Out inverted	<i>Signal: Negated Latched Output (Q NOT)</i>
Logics . LE69.Gate Out	<i>Signal: Output of the logic gate</i>
Logics . LE69.Timer Out	<i>Signal: Timer Output</i>
Logics . LE69.Out	<i>Signal: Latched Output (Q)</i>
Logics . LE69.Out inverted	<i>Signal: Negated Latched Output (Q NOT)</i>
Logics . LE70.Gate Out	<i>Signal: Output of the logic gate</i>
Logics . LE70.Timer Out	<i>Signal: Timer Output</i>
Logics . LE70.Out	<i>Signal: Latched Output (Q)</i>
Logics . LE70.Out inverted	<i>Signal: Negated Latched Output (Q NOT)</i>
Logics . LE71.Gate Out	<i>Signal: Output of the logic gate</i>
Logics . LE71.Timer Out	<i>Signal: Timer Output</i>

	Description
Logics . LE71.Out	<i>Signal: Latched Output (Q)</i>
Logics . LE71.Out inverted	<i>Signal: Negated Latched Output (Q NOT)</i>
Logics . LE72.Gate Out	<i>Signal: Output of the logic gate</i>
Logics . LE72.Timer Out	<i>Signal: Timer Output</i>
Logics . LE72.Out	<i>Signal: Latched Output (Q)</i>
Logics . LE72.Out inverted	<i>Signal: Negated Latched Output (Q NOT)</i>
Logics . LE73.Gate Out	<i>Signal: Output of the logic gate</i>
Logics . LE73.Timer Out	<i>Signal: Timer Output</i>
Logics . LE73.Out	<i>Signal: Latched Output (Q)</i>
Logics . LE73.Out inverted	<i>Signal: Negated Latched Output (Q NOT)</i>
Logics . LE74.Gate Out	<i>Signal: Output of the logic gate</i>
Logics . LE74.Timer Out	<i>Signal: Timer Output</i>
Logics . LE74.Out	<i>Signal: Latched Output (Q)</i>
Logics . LE74.Out inverted	<i>Signal: Negated Latched Output (Q NOT)</i>
Logics . LE75.Gate Out	<i>Signal: Output of the logic gate</i>
Logics . LE75.Timer Out	<i>Signal: Timer Output</i>
Logics . LE75.Out	<i>Signal: Latched Output (Q)</i>
Logics . LE75.Out inverted	<i>Signal: Negated Latched Output (Q NOT)</i>
Logics . LE76.Gate Out	<i>Signal: Output of the logic gate</i>
Logics . LE76.Timer Out	<i>Signal: Timer Output</i>
Logics . LE76.Out	<i>Signal: Latched Output (Q)</i>
Logics . LE76.Out inverted	<i>Signal: Negated Latched Output (Q NOT)</i>
Logics . LE77.Gate Out	<i>Signal: Output of the logic gate</i>
Logics . LE77.Timer Out	<i>Signal: Timer Output</i>
Logics . LE77.Out	<i>Signal: Latched Output (Q)</i>
Logics . LE77.Out inverted	<i>Signal: Negated Latched Output (Q NOT)</i>
Logics . LE78.Gate Out	<i>Signal: Output of the logic gate</i>
Logics . LE78.Timer Out	<i>Signal: Timer Output</i>

	Description
Logics . LE78.Out	Signal: Latched Output (Q)
Logics . LE78.Out inverted	Signal: Negated Latched Output (Q NOT)
Logics . LE79.Gate Out	Signal: Output of the logic gate
Logics . LE79.Timer Out	Signal: Timer Output
Logics . LE79.Out	Signal: Latched Output (Q)
Logics . LE79.Out inverted	Signal: Negated Latched Output (Q NOT)
Logics . LE80.Gate Out	Signal: Output of the logic gate
Logics . LE80.Timer Out	Signal: Timer Output
Logics . LE80.Out	Signal: Latched Output (Q)
Logics . LE80.Out inverted	Signal: Negated Latched Output (Q NOT)

Selection list referenced by the following parameters:

-  Z[1] . Blo by LB

	Description
"_"	No assignment
LB . Operate	Signal that the measured system impedance is within the Load Blinder area for at least the duration t-Delay.
DI Slot X1 . DI 1	Signal: Digital Input
DI Slot X1 . DI 2	Signal: Digital Input
DI Slot X1 . DI 3	Signal: Digital Input
DI Slot X1 . DI 4	Signal: Digital Input
DI Slot X1 . DI 5	Signal: Digital Input
DI Slot X1 . DI 6	Signal: Digital Input
DI Slot X1 . DI 7	Signal: Digital Input
DI Slot X1 . DI 8	Signal: Digital Input
DI Slot X5 . DI 1	Signal: Digital Input
DI Slot X5 . DI 2	Signal: Digital Input
DI Slot X5 . DI 3	Signal: Digital Input

	Description
DI Slot X5 . DI 4	<i>Signal: Digital Input</i>
DI Slot X5 . DI 5	<i>Signal: Digital Input</i>
DI Slot X5 . DI 6	<i>Signal: Digital Input</i>
DI Slot X5 . DI 7	<i>Signal: Digital Input</i>
DI Slot X5 . DI 8	<i>Signal: Digital Input</i>
DI Slot X6 . DI 1	<i>Signal: Digital Input</i>
DI Slot X6 . DI 2	<i>Signal: Digital Input</i>
DI Slot X6 . DI 3	<i>Signal: Digital Input</i>
DI Slot X6 . DI 4	<i>Signal: Digital Input</i>
DI Slot X6 . DI 5	<i>Signal: Digital Input</i>
DI Slot X6 . DI 6	<i>Signal: Digital Input</i>
DI Slot X6 . DI 7	<i>Signal: Digital Input</i>
DI Slot X6 . DI 8	<i>Signal: Digital Input</i>
Logics . LE1.Gate Out	<i>Signal: Output of the logic gate</i>
Logics . LE1.Timer Out	<i>Signal: Timer Output</i>
Logics . LE1.Out	<i>Signal: Latched Output (Q)</i>
Logics . LE1.Out inverted	<i>Signal: Negated Latched Output (Q NOT)</i>
Logics . LE2.Gate Out	<i>Signal: Output of the logic gate</i>
Logics . LE2.Timer Out	<i>Signal: Timer Output</i>
Logics . LE2.Out	<i>Signal: Latched Output (Q)</i>
Logics . LE2.Out inverted	<i>Signal: Negated Latched Output (Q NOT)</i>
Logics . LE3.Gate Out	<i>Signal: Output of the logic gate</i>
Logics . LE3.Timer Out	<i>Signal: Timer Output</i>
Logics . LE3.Out	<i>Signal: Latched Output (Q)</i>
Logics . LE3.Out inverted	<i>Signal: Negated Latched Output (Q NOT)</i>
Logics . LE4.Gate Out	<i>Signal: Output of the logic gate</i>
Logics . LE4.Timer Out	<i>Signal: Timer Output</i>
Logics . LE4.Out	<i>Signal: Latched Output (Q)</i>
Logics . LE4.Out inverted	<i>Signal: Negated Latched Output (Q NOT)</i>

	Description
Logics . LE5.Gate Out	<i>Signal: Output of the logic gate</i>
Logics . LE5.Timer Out	<i>Signal: Timer Output</i>
Logics . LE5.Out	<i>Signal: Latched Output (Q)</i>
Logics . LE5.Out inverted	<i>Signal: Negated Latched Output (Q NOT)</i>
Logics . LE6.Gate Out	<i>Signal: Output of the logic gate</i>
Logics . LE6.Timer Out	<i>Signal: Timer Output</i>
Logics . LE6.Out	<i>Signal: Latched Output (Q)</i>
Logics . LE6.Out inverted	<i>Signal: Negated Latched Output (Q NOT)</i>
Logics . LE7.Gate Out	<i>Signal: Output of the logic gate</i>
Logics . LE7.Timer Out	<i>Signal: Timer Output</i>
Logics . LE7.Out	<i>Signal: Latched Output (Q)</i>
Logics . LE7.Out inverted	<i>Signal: Negated Latched Output (Q NOT)</i>
Logics . LE8.Gate Out	<i>Signal: Output of the logic gate</i>
Logics . LE8.Timer Out	<i>Signal: Timer Output</i>
Logics . LE8.Out	<i>Signal: Latched Output (Q)</i>
Logics . LE8.Out inverted	<i>Signal: Negated Latched Output (Q NOT)</i>
Logics . LE9.Gate Out	<i>Signal: Output of the logic gate</i>
Logics . LE9.Timer Out	<i>Signal: Timer Output</i>
Logics . LE9.Out	<i>Signal: Latched Output (Q)</i>
Logics . LE9.Out inverted	<i>Signal: Negated Latched Output (Q NOT)</i>
Logics . LE10.Gate Out	<i>Signal: Output of the logic gate</i>
Logics . LE10.Timer Out	<i>Signal: Timer Output</i>
Logics . LE10.Out	<i>Signal: Latched Output (Q)</i>
Logics . LE10.Out inverted	<i>Signal: Negated Latched Output (Q NOT)</i>
Logics . LE11.Gate Out	<i>Signal: Output of the logic gate</i>
Logics . LE11.Timer Out	<i>Signal: Timer Output</i>
Logics . LE11.Out	<i>Signal: Latched Output (Q)</i>
Logics . LE11.Out inverted	<i>Signal: Negated Latched Output (Q NOT)</i>

	Description
Logics . LE12.Gate Out	<i>Signal: Output of the logic gate</i>
Logics . LE12.Timer Out	<i>Signal: Timer Output</i>
Logics . LE12.Out	<i>Signal: Latched Output (Q)</i>
Logics . LE12.Out inverted	<i>Signal: Negated Latched Output (Q NOT)</i>
Logics . LE13.Gate Out	<i>Signal: Output of the logic gate</i>
Logics . LE13.Timer Out	<i>Signal: Timer Output</i>
Logics . LE13.Out	<i>Signal: Latched Output (Q)</i>
Logics . LE13.Out inverted	<i>Signal: Negated Latched Output (Q NOT)</i>
Logics . LE14.Gate Out	<i>Signal: Output of the logic gate</i>
Logics . LE14.Timer Out	<i>Signal: Timer Output</i>
Logics . LE14.Out	<i>Signal: Latched Output (Q)</i>
Logics . LE14.Out inverted	<i>Signal: Negated Latched Output (Q NOT)</i>
Logics . LE15.Gate Out	<i>Signal: Output of the logic gate</i>
Logics . LE15.Timer Out	<i>Signal: Timer Output</i>
Logics . LE15.Out	<i>Signal: Latched Output (Q)</i>
Logics . LE15.Out inverted	<i>Signal: Negated Latched Output (Q NOT)</i>
Logics . LE16.Gate Out	<i>Signal: Output of the logic gate</i>
Logics . LE16.Timer Out	<i>Signal: Timer Output</i>
Logics . LE16.Out	<i>Signal: Latched Output (Q)</i>
Logics . LE16.Out inverted	<i>Signal: Negated Latched Output (Q NOT)</i>
Logics . LE17.Gate Out	<i>Signal: Output of the logic gate</i>
Logics . LE17.Timer Out	<i>Signal: Timer Output</i>
Logics . LE17.Out	<i>Signal: Latched Output (Q)</i>
Logics . LE17.Out inverted	<i>Signal: Negated Latched Output (Q NOT)</i>
Logics . LE18.Gate Out	<i>Signal: Output of the logic gate</i>
Logics . LE18.Timer Out	<i>Signal: Timer Output</i>
Logics . LE18.Out	<i>Signal: Latched Output (Q)</i>
Logics . LE18.Out inverted	<i>Signal: Negated Latched Output (Q NOT)</i>

	Description
Logics . LE19.Gate Out	<i>Signal: Output of the logic gate</i>
Logics . LE19.Timer Out	<i>Signal: Timer Output</i>
Logics . LE19.Out	<i>Signal: Latched Output (Q)</i>
Logics . LE19.Out inverted	<i>Signal: Negated Latched Output (Q NOT)</i>
Logics . LE20.Gate Out	<i>Signal: Output of the logic gate</i>
Logics . LE20.Timer Out	<i>Signal: Timer Output</i>
Logics . LE20.Out	<i>Signal: Latched Output (Q)</i>
Logics . LE20.Out inverted	<i>Signal: Negated Latched Output (Q NOT)</i>
Logics . LE21.Gate Out	<i>Signal: Output of the logic gate</i>
Logics . LE21.Timer Out	<i>Signal: Timer Output</i>
Logics . LE21.Out	<i>Signal: Latched Output (Q)</i>
Logics . LE21.Out inverted	<i>Signal: Negated Latched Output (Q NOT)</i>
Logics . LE22.Gate Out	<i>Signal: Output of the logic gate</i>
Logics . LE22.Timer Out	<i>Signal: Timer Output</i>
Logics . LE22.Out	<i>Signal: Latched Output (Q)</i>
Logics . LE22.Out inverted	<i>Signal: Negated Latched Output (Q NOT)</i>
Logics . LE23.Gate Out	<i>Signal: Output of the logic gate</i>
Logics . LE23.Timer Out	<i>Signal: Timer Output</i>
Logics . LE23.Out	<i>Signal: Latched Output (Q)</i>
Logics . LE23.Out inverted	<i>Signal: Negated Latched Output (Q NOT)</i>
Logics . LE24.Gate Out	<i>Signal: Output of the logic gate</i>
Logics . LE24.Timer Out	<i>Signal: Timer Output</i>
Logics . LE24.Out	<i>Signal: Latched Output (Q)</i>
Logics . LE24.Out inverted	<i>Signal: Negated Latched Output (Q NOT)</i>
Logics . LE25.Gate Out	<i>Signal: Output of the logic gate</i>
Logics . LE25.Timer Out	<i>Signal: Timer Output</i>
Logics . LE25.Out	<i>Signal: Latched Output (Q)</i>
Logics . LE25.Out inverted	<i>Signal: Negated Latched Output (Q NOT)</i>

	Description
Logics . LE26.Gate Out	<i>Signal: Output of the logic gate</i>
Logics . LE26.Timer Out	<i>Signal: Timer Output</i>
Logics . LE26.Out	<i>Signal: Latched Output (Q)</i>
Logics . LE26.Out inverted	<i>Signal: Negated Latched Output (Q NOT)</i>
Logics . LE27.Gate Out	<i>Signal: Output of the logic gate</i>
Logics . LE27.Timer Out	<i>Signal: Timer Output</i>
Logics . LE27.Out	<i>Signal: Latched Output (Q)</i>
Logics . LE27.Out inverted	<i>Signal: Negated Latched Output (Q NOT)</i>
Logics . LE28.Gate Out	<i>Signal: Output of the logic gate</i>
Logics . LE28.Timer Out	<i>Signal: Timer Output</i>
Logics . LE28.Out	<i>Signal: Latched Output (Q)</i>
Logics . LE28.Out inverted	<i>Signal: Negated Latched Output (Q NOT)</i>
Logics . LE29.Gate Out	<i>Signal: Output of the logic gate</i>
Logics . LE29.Timer Out	<i>Signal: Timer Output</i>
Logics . LE29.Out	<i>Signal: Latched Output (Q)</i>
Logics . LE29.Out inverted	<i>Signal: Negated Latched Output (Q NOT)</i>
Logics . LE30.Gate Out	<i>Signal: Output of the logic gate</i>
Logics . LE30.Timer Out	<i>Signal: Timer Output</i>
Logics . LE30.Out	<i>Signal: Latched Output (Q)</i>
Logics . LE30.Out inverted	<i>Signal: Negated Latched Output (Q NOT)</i>
Logics . LE31.Gate Out	<i>Signal: Output of the logic gate</i>
Logics . LE31.Timer Out	<i>Signal: Timer Output</i>
Logics . LE31.Out	<i>Signal: Latched Output (Q)</i>
Logics . LE31.Out inverted	<i>Signal: Negated Latched Output (Q NOT)</i>
Logics . LE32.Gate Out	<i>Signal: Output of the logic gate</i>
Logics . LE32.Timer Out	<i>Signal: Timer Output</i>
Logics . LE32.Out	<i>Signal: Latched Output (Q)</i>
Logics . LE32.Out inverted	<i>Signal: Negated Latched Output (Q NOT)</i>

	Description
Logics . LE33.Gate Out	<i>Signal: Output of the logic gate</i>
Logics . LE33.Timer Out	<i>Signal: Timer Output</i>
Logics . LE33.Out	<i>Signal: Latched Output (Q)</i>
Logics . LE33.Out inverted	<i>Signal: Negated Latched Output (Q NOT)</i>
Logics . LE34.Gate Out	<i>Signal: Output of the logic gate</i>
Logics . LE34.Timer Out	<i>Signal: Timer Output</i>
Logics . LE34.Out	<i>Signal: Latched Output (Q)</i>
Logics . LE34.Out inverted	<i>Signal: Negated Latched Output (Q NOT)</i>
Logics . LE35.Gate Out	<i>Signal: Output of the logic gate</i>
Logics . LE35.Timer Out	<i>Signal: Timer Output</i>
Logics . LE35.Out	<i>Signal: Latched Output (Q)</i>
Logics . LE35.Out inverted	<i>Signal: Negated Latched Output (Q NOT)</i>
Logics . LE36.Gate Out	<i>Signal: Output of the logic gate</i>
Logics . LE36.Timer Out	<i>Signal: Timer Output</i>
Logics . LE36.Out	<i>Signal: Latched Output (Q)</i>
Logics . LE36.Out inverted	<i>Signal: Negated Latched Output (Q NOT)</i>
Logics . LE37.Gate Out	<i>Signal: Output of the logic gate</i>
Logics . LE37.Timer Out	<i>Signal: Timer Output</i>
Logics . LE37.Out	<i>Signal: Latched Output (Q)</i>
Logics . LE37.Out inverted	<i>Signal: Negated Latched Output (Q NOT)</i>
Logics . LE38.Gate Out	<i>Signal: Output of the logic gate</i>
Logics . LE38.Timer Out	<i>Signal: Timer Output</i>
Logics . LE38.Out	<i>Signal: Latched Output (Q)</i>
Logics . LE38.Out inverted	<i>Signal: Negated Latched Output (Q NOT)</i>
Logics . LE39.Gate Out	<i>Signal: Output of the logic gate</i>
Logics . LE39.Timer Out	<i>Signal: Timer Output</i>
Logics . LE39.Out	<i>Signal: Latched Output (Q)</i>
Logics . LE39.Out inverted	<i>Signal: Negated Latched Output (Q NOT)</i>

	Description
Logics . LE40.Gate Out	<i>Signal: Output of the logic gate</i>
Logics . LE40.Timer Out	<i>Signal: Timer Output</i>
Logics . LE40.Out	<i>Signal: Latched Output (Q)</i>
Logics . LE40.Out inverted	<i>Signal: Negated Latched Output (Q NOT)</i>
Logics . LE41.Gate Out	<i>Signal: Output of the logic gate</i>
Logics . LE41.Timer Out	<i>Signal: Timer Output</i>
Logics . LE41.Out	<i>Signal: Latched Output (Q)</i>
Logics . LE41.Out inverted	<i>Signal: Negated Latched Output (Q NOT)</i>
Logics . LE42.Gate Out	<i>Signal: Output of the logic gate</i>
Logics . LE42.Timer Out	<i>Signal: Timer Output</i>
Logics . LE42.Out	<i>Signal: Latched Output (Q)</i>
Logics . LE42.Out inverted	<i>Signal: Negated Latched Output (Q NOT)</i>
Logics . LE43.Gate Out	<i>Signal: Output of the logic gate</i>
Logics . LE43.Timer Out	<i>Signal: Timer Output</i>
Logics . LE43.Out	<i>Signal: Latched Output (Q)</i>
Logics . LE43.Out inverted	<i>Signal: Negated Latched Output (Q NOT)</i>
Logics . LE44.Gate Out	<i>Signal: Output of the logic gate</i>
Logics . LE44.Timer Out	<i>Signal: Timer Output</i>
Logics . LE44.Out	<i>Signal: Latched Output (Q)</i>
Logics . LE44.Out inverted	<i>Signal: Negated Latched Output (Q NOT)</i>
Logics . LE45.Gate Out	<i>Signal: Output of the logic gate</i>
Logics . LE45.Timer Out	<i>Signal: Timer Output</i>
Logics . LE45.Out	<i>Signal: Latched Output (Q)</i>
Logics . LE45.Out inverted	<i>Signal: Negated Latched Output (Q NOT)</i>
Logics . LE46.Gate Out	<i>Signal: Output of the logic gate</i>
Logics . LE46.Timer Out	<i>Signal: Timer Output</i>
Logics . LE46.Out	<i>Signal: Latched Output (Q)</i>
Logics . LE46.Out inverted	<i>Signal: Negated Latched Output (Q NOT)</i>

	Description
Logics . LE47.Gate Out	<i>Signal: Output of the logic gate</i>
Logics . LE47.Timer Out	<i>Signal: Timer Output</i>
Logics . LE47.Out	<i>Signal: Latched Output (Q)</i>
Logics . LE47.Out inverted	<i>Signal: Negated Latched Output (Q NOT)</i>
Logics . LE48.Gate Out	<i>Signal: Output of the logic gate</i>
Logics . LE48.Timer Out	<i>Signal: Timer Output</i>
Logics . LE48.Out	<i>Signal: Latched Output (Q)</i>
Logics . LE48.Out inverted	<i>Signal: Negated Latched Output (Q NOT)</i>
Logics . LE49.Gate Out	<i>Signal: Output of the logic gate</i>
Logics . LE49.Timer Out	<i>Signal: Timer Output</i>
Logics . LE49.Out	<i>Signal: Latched Output (Q)</i>
Logics . LE49.Out inverted	<i>Signal: Negated Latched Output (Q NOT)</i>
Logics . LE50.Gate Out	<i>Signal: Output of the logic gate</i>
Logics . LE50.Timer Out	<i>Signal: Timer Output</i>
Logics . LE50.Out	<i>Signal: Latched Output (Q)</i>
Logics . LE50.Out inverted	<i>Signal: Negated Latched Output (Q NOT)</i>
Logics . LE51.Gate Out	<i>Signal: Output of the logic gate</i>
Logics . LE51.Timer Out	<i>Signal: Timer Output</i>
Logics . LE51.Out	<i>Signal: Latched Output (Q)</i>
Logics . LE51.Out inverted	<i>Signal: Negated Latched Output (Q NOT)</i>
Logics . LE52.Gate Out	<i>Signal: Output of the logic gate</i>
Logics . LE52.Timer Out	<i>Signal: Timer Output</i>
Logics . LE52.Out	<i>Signal: Latched Output (Q)</i>
Logics . LE52.Out inverted	<i>Signal: Negated Latched Output (Q NOT)</i>
Logics . LE53.Gate Out	<i>Signal: Output of the logic gate</i>
Logics . LE53.Timer Out	<i>Signal: Timer Output</i>
Logics . LE53.Out	<i>Signal: Latched Output (Q)</i>
Logics . LE53.Out inverted	<i>Signal: Negated Latched Output (Q NOT)</i>

	Description
Logics . LE54.Gate Out	<i>Signal: Output of the logic gate</i>
Logics . LE54.Timer Out	<i>Signal: Timer Output</i>
Logics . LE54.Out	<i>Signal: Latched Output (Q)</i>
Logics . LE54.Out inverted	<i>Signal: Negated Latched Output (Q NOT)</i>
Logics . LE55.Gate Out	<i>Signal: Output of the logic gate</i>
Logics . LE55.Timer Out	<i>Signal: Timer Output</i>
Logics . LE55.Out	<i>Signal: Latched Output (Q)</i>
Logics . LE55.Out inverted	<i>Signal: Negated Latched Output (Q NOT)</i>
Logics . LE56.Gate Out	<i>Signal: Output of the logic gate</i>
Logics . LE56.Timer Out	<i>Signal: Timer Output</i>
Logics . LE56.Out	<i>Signal: Latched Output (Q)</i>
Logics . LE56.Out inverted	<i>Signal: Negated Latched Output (Q NOT)</i>
Logics . LE57.Gate Out	<i>Signal: Output of the logic gate</i>
Logics . LE57.Timer Out	<i>Signal: Timer Output</i>
Logics . LE57.Out	<i>Signal: Latched Output (Q)</i>
Logics . LE57.Out inverted	<i>Signal: Negated Latched Output (Q NOT)</i>
Logics . LE58.Gate Out	<i>Signal: Output of the logic gate</i>
Logics . LE58.Timer Out	<i>Signal: Timer Output</i>
Logics . LE58.Out	<i>Signal: Latched Output (Q)</i>
Logics . LE58.Out inverted	<i>Signal: Negated Latched Output (Q NOT)</i>
Logics . LE59.Gate Out	<i>Signal: Output of the logic gate</i>
Logics . LE59.Timer Out	<i>Signal: Timer Output</i>
Logics . LE59.Out	<i>Signal: Latched Output (Q)</i>
Logics . LE59.Out inverted	<i>Signal: Negated Latched Output (Q NOT)</i>
Logics . LE60.Gate Out	<i>Signal: Output of the logic gate</i>
Logics . LE60.Timer Out	<i>Signal: Timer Output</i>
Logics . LE60.Out	<i>Signal: Latched Output (Q)</i>
Logics . LE60.Out inverted	<i>Signal: Negated Latched Output (Q NOT)</i>

	Description
Logics . LE61.Gate Out	<i>Signal: Output of the logic gate</i>
Logics . LE61.Timer Out	<i>Signal: Timer Output</i>
Logics . LE61.Out	<i>Signal: Latched Output (Q)</i>
Logics . LE61.Out inverted	<i>Signal: Negated Latched Output (Q NOT)</i>
Logics . LE62.Gate Out	<i>Signal: Output of the logic gate</i>
Logics . LE62.Timer Out	<i>Signal: Timer Output</i>
Logics . LE62.Out	<i>Signal: Latched Output (Q)</i>
Logics . LE62.Out inverted	<i>Signal: Negated Latched Output (Q NOT)</i>
Logics . LE63.Gate Out	<i>Signal: Output of the logic gate</i>
Logics . LE63.Timer Out	<i>Signal: Timer Output</i>
Logics . LE63.Out	<i>Signal: Latched Output (Q)</i>
Logics . LE63.Out inverted	<i>Signal: Negated Latched Output (Q NOT)</i>
Logics . LE64.Gate Out	<i>Signal: Output of the logic gate</i>
Logics . LE64.Timer Out	<i>Signal: Timer Output</i>
Logics . LE64.Out	<i>Signal: Latched Output (Q)</i>
Logics . LE64.Out inverted	<i>Signal: Negated Latched Output (Q NOT)</i>
Logics . LE65.Gate Out	<i>Signal: Output of the logic gate</i>
Logics . LE65.Timer Out	<i>Signal: Timer Output</i>
Logics . LE65.Out	<i>Signal: Latched Output (Q)</i>
Logics . LE65.Out inverted	<i>Signal: Negated Latched Output (Q NOT)</i>
Logics . LE66.Gate Out	<i>Signal: Output of the logic gate</i>
Logics . LE66.Timer Out	<i>Signal: Timer Output</i>
Logics . LE66.Out	<i>Signal: Latched Output (Q)</i>
Logics . LE66.Out inverted	<i>Signal: Negated Latched Output (Q NOT)</i>
Logics . LE67.Gate Out	<i>Signal: Output of the logic gate</i>
Logics . LE67.Timer Out	<i>Signal: Timer Output</i>
Logics . LE67.Out	<i>Signal: Latched Output (Q)</i>
Logics . LE67.Out inverted	<i>Signal: Negated Latched Output (Q NOT)</i>

	Description
Logics . LE68.Gate Out	<i>Signal: Output of the logic gate</i>
Logics . LE68.Timer Out	<i>Signal: Timer Output</i>
Logics . LE68.Out	<i>Signal: Latched Output (Q)</i>
Logics . LE68.Out inverted	<i>Signal: Negated Latched Output (Q NOT)</i>
Logics . LE69.Gate Out	<i>Signal: Output of the logic gate</i>
Logics . LE69.Timer Out	<i>Signal: Timer Output</i>
Logics . LE69.Out	<i>Signal: Latched Output (Q)</i>
Logics . LE69.Out inverted	<i>Signal: Negated Latched Output (Q NOT)</i>
Logics . LE70.Gate Out	<i>Signal: Output of the logic gate</i>
Logics . LE70.Timer Out	<i>Signal: Timer Output</i>
Logics . LE70.Out	<i>Signal: Latched Output (Q)</i>
Logics . LE70.Out inverted	<i>Signal: Negated Latched Output (Q NOT)</i>
Logics . LE71.Gate Out	<i>Signal: Output of the logic gate</i>
Logics . LE71.Timer Out	<i>Signal: Timer Output</i>
Logics . LE71.Out	<i>Signal: Latched Output (Q)</i>
Logics . LE71.Out inverted	<i>Signal: Negated Latched Output (Q NOT)</i>
Logics . LE72.Gate Out	<i>Signal: Output of the logic gate</i>
Logics . LE72.Timer Out	<i>Signal: Timer Output</i>
Logics . LE72.Out	<i>Signal: Latched Output (Q)</i>
Logics . LE72.Out inverted	<i>Signal: Negated Latched Output (Q NOT)</i>
Logics . LE73.Gate Out	<i>Signal: Output of the logic gate</i>
Logics . LE73.Timer Out	<i>Signal: Timer Output</i>
Logics . LE73.Out	<i>Signal: Latched Output (Q)</i>
Logics . LE73.Out inverted	<i>Signal: Negated Latched Output (Q NOT)</i>
Logics . LE74.Gate Out	<i>Signal: Output of the logic gate</i>
Logics . LE74.Timer Out	<i>Signal: Timer Output</i>
Logics . LE74.Out	<i>Signal: Latched Output (Q)</i>
Logics . LE74.Out inverted	<i>Signal: Negated Latched Output (Q NOT)</i>

	Description
Logics . LE75.Gate Out	<i>Signal: Output of the logic gate</i>
Logics . LE75.Timer Out	<i>Signal: Timer Output</i>
Logics . LE75.Out	<i>Signal: Latched Output (Q)</i>
Logics . LE75.Out inverted	<i>Signal: Negated Latched Output (Q NOT)</i>
Logics . LE76.Gate Out	<i>Signal: Output of the logic gate</i>
Logics . LE76.Timer Out	<i>Signal: Timer Output</i>
Logics . LE76.Out	<i>Signal: Latched Output (Q)</i>
Logics . LE76.Out inverted	<i>Signal: Negated Latched Output (Q NOT)</i>
Logics . LE77.Gate Out	<i>Signal: Output of the logic gate</i>
Logics . LE77.Timer Out	<i>Signal: Timer Output</i>
Logics . LE77.Out	<i>Signal: Latched Output (Q)</i>
Logics . LE77.Out inverted	<i>Signal: Negated Latched Output (Q NOT)</i>
Logics . LE78.Gate Out	<i>Signal: Output of the logic gate</i>
Logics . LE78.Timer Out	<i>Signal: Timer Output</i>
Logics . LE78.Out	<i>Signal: Latched Output (Q)</i>
Logics . LE78.Out inverted	<i>Signal: Negated Latched Output (Q NOT)</i>
Logics . LE79.Gate Out	<i>Signal: Output of the logic gate</i>
Logics . LE79.Timer Out	<i>Signal: Timer Output</i>
Logics . LE79.Out	<i>Signal: Latched Output (Q)</i>
Logics . LE79.Out inverted	<i>Signal: Negated Latched Output (Q NOT)</i>
Logics . LE80.Gate Out	<i>Signal: Output of the logic gate</i>
Logics . LE80.Timer Out	<i>Signal: Timer Output</i>
Logics . LE80.Out	<i>Signal: Latched Output (Q)</i>
Logics . LE80.Out inverted	<i>Signal: Negated Latched Output (Q NOT)</i>

Power Trip dir

By means of this parameter the trip direction of active and reactive power can be inverted within the QV-Module (sign reversal).

Selection list referenced by the following parameters:



-  Q->&V< . Power Trip dir

Power Trip dir	Description
positive	<i>Positive P/Q (active/reactive power) Trip</i>
negative	<i>Negative P/Q (active/reactive power) Trip</i>

1..n, Dig Inputs

List of Digital Inputs that are available for the detection of the Circuit Breaker Position.

Selection list referenced by the following parameters:

-  ReCon[1] . PCC Fuse Fail VT
-  TCS . Input 1
-  TCS . Input 2

1..n, Dig Inputs	Description
"_"	<i>No assignment</i>
DI Slot X1 . DI 1	<i>Signal: Digital Input</i>
DI Slot X1 . DI 2	<i>Signal: Digital Input</i>
DI Slot X1 . DI 3	<i>Signal: Digital Input</i>
DI Slot X1 . DI 4	<i>Signal: Digital Input</i>
DI Slot X1 . DI 5	<i>Signal: Digital Input</i>
DI Slot X1 . DI 6	<i>Signal: Digital Input</i>
DI Slot X1 . DI 7	<i>Signal: Digital Input</i>
DI Slot X1 . DI 8	<i>Signal: Digital Input</i>
DI Slot X5 . DI 1	<i>Signal: Digital Input</i>
DI Slot X5 . DI 2	<i>Signal: Digital Input</i>
DI Slot X5 . DI 3	<i>Signal: Digital Input</i>
DI Slot X5 . DI 4	<i>Signal: Digital Input</i>
DI Slot X5 . DI 5	<i>Signal: Digital Input</i>
DI Slot X5 . DI 6	<i>Signal: Digital Input</i>

1..n, Dig Inputs	Description
DI Slot X5 . DI 7	<i>Signal: Digital Input</i>
DI Slot X5 . DI 8	<i>Signal: Digital Input</i>
DI Slot X6 . DI 1	<i>Signal: Digital Input</i>
DI Slot X6 . DI 2	<i>Signal: Digital Input</i>
DI Slot X6 . DI 3	<i>Signal: Digital Input</i>
DI Slot X6 . DI 4	<i>Signal: Digital Input</i>
DI Slot X6 . DI 5	<i>Signal: Digital Input</i>
DI Slot X6 . DI 6	<i>Signal: Digital Input</i>
DI Slot X6 . DI 7	<i>Signal: Digital Input</i>
DI Slot X6 . DI 8	<i>Signal: Digital Input</i>

Decoupling Functions

Selection list referenced by the following parameters:

-  ReCon[1] . Decoupling1

Decoupling Functions	Description
"_"	<i>No assignment</i>
Id . TripCmd	<i>Signal: Trip Command</i>
IdH . TripCmd	<i>Signal: Trip Command</i>
IdG[1] . TripCmd	<i>Signal: Trip Command</i>
IdGH[1] . TripCmd	<i>Signal: Trip Command</i>
IdG[2] . TripCmd	<i>Signal: Trip Command</i>
IdGH[2] . TripCmd	<i>Signal: Trip Command</i>
I[1] . TripCmd	<i>Signal: Trip Command</i>
I[2] . TripCmd	<i>Signal: Trip Command</i>
I[3] . TripCmd	<i>Signal: Trip Command</i>
I[4] . TripCmd	<i>Signal: Trip Command</i>
I[5] . TripCmd	<i>Signal: Trip Command</i>
I[6] . TripCmd	<i>Signal: Trip Command</i>
IG[1] . TripCmd	<i>Signal: Trip Command</i>
IG[2] . TripCmd	<i>Signal: Trip Command</i>

Decoupling Functions	Description
IG[3] . TripCmd	<i>Signal: Trip Command</i>
IG[4] . TripCmd	<i>Signal: Trip Command</i>
ThR . TripCmd	<i>Signal: Trip Command</i>
I2>[1] . TripCmd	<i>Signal: Trip Command</i>
I2>[2] . TripCmd	<i>Signal: Trip Command</i>
I2>G[1] . TripCmd	<i>Signal: Trip Command</i>
I2>G[2] . TripCmd	<i>Signal: Trip Command</i>
V[1] . TripCmd	<i>Signal: Trip Command</i>
V[2] . TripCmd	<i>Signal: Trip Command</i>
V[3] . TripCmd	<i>Signal: Trip Command</i>
V[4] . TripCmd	<i>Signal: Trip Command</i>
V[5] . TripCmd	<i>Signal: Trip Command</i>
V[6] . TripCmd	<i>Signal: Trip Command</i>
df/dt . TripCmd	<i>Signal: Trip Command</i>
delta phi . TripCmd	<i>Signal: Trip Command</i>
Intertripping . TripCmd	<i>Signal: Trip Command</i>
P[1] . TripCmd	<i>Signal: Trip Command</i>
P[2] . TripCmd	<i>Signal: Trip Command</i>
P[3] . TripCmd	<i>Signal: Trip Command</i>
Q . TripCmd	<i>Signal: Trip Command</i>
LVRT[1] . TripCmd	<i>Signal: Trip Command</i>
LVRT[2] . TripCmd	<i>Signal: Trip Command</i>
VG[1] . TripCmd	<i>Signal: Trip Command</i>
VG[2] . TripCmd	<i>Signal: Trip Command</i>
V012[1] . TripCmd	<i>Signal: Trip Command</i>
V012[2] . TripCmd	<i>Signal: Trip Command</i>
V012[3] . TripCmd	<i>Signal: Trip Command</i>
V012[4] . TripCmd	<i>Signal: Trip Command</i>
V012[5] . TripCmd	<i>Signal: Trip Command</i>
V012[6] . TripCmd	<i>Signal: Trip Command</i>
f[1] . TripCmd	<i>Signal: Trip Command</i>
f[2] . TripCmd	<i>Signal: Trip Command</i>

Decoupling Functions	Description
f[3] . TripCmd	<i>Signal: Trip Command</i>
f[4] . TripCmd	<i>Signal: Trip Command</i>
f[5] . TripCmd	<i>Signal: Trip Command</i>
f[6] . TripCmd	<i>Signal: Trip Command</i>
PQS[1] . TripCmd	<i>Signal: Trip Command</i>
PQS[2] . TripCmd	<i>Signal: Trip Command</i>
PQS[3] . TripCmd	<i>Signal: Trip Command</i>
PQS[4] . TripCmd	<i>Signal: Trip Command</i>
PQS[5] . TripCmd	<i>Signal: Trip Command</i>
PQS[6] . TripCmd	<i>Signal: Trip Command</i>
PF[1] . TripCmd	<i>Signal: Trip Command</i>
PF[2] . TripCmd	<i>Signal: Trip Command</i>
Q->&V< . Decoupling Distr. Generator	<i>Signal: Decoupling of the (local) Energy Generator/Resource</i>
Q->&V< . Decoupling PCC	<i>Signal: Decoupling at the Point of Common Coupling</i>
LoE-Z1[1] . TripCmd	<i>Signal: Trip Command</i>
LoE-Z2[1] . TripCmd	<i>Signal: Trip Command</i>
LoE-Z1[2] . TripCmd	<i>Signal: Trip Command</i>
LoE-Z2[2] . TripCmd	<i>Signal: Trip Command</i>
OST . TripCmd	<i>Signal: Trip Command</i>
V/f>[1] . TripCmd	<i>Signal: Trip Command</i>
V/f>[2] . TripCmd	<i>Signal: Trip Command</i>
InEn . TripCmd	<i>Signal: Trip Command</i>
Z[1] . TripCmd	<i>Signal: Trip Command</i>
Z[2] . TripCmd	<i>Signal: Trip Command</i>
ExP[1] . TripCmd	<i>Signal: Trip Command</i>
ExP[2] . TripCmd	<i>Signal: Trip Command</i>
ExP[3] . TripCmd	<i>Signal: Trip Command</i>
ExP[4] . TripCmd	<i>Signal: Trip Command</i>
Ext Sudd Press . TripCmd	<i>Signal: Trip Command</i>
Ext Oil Temp . TripCmd	<i>Signal: Trip Command</i>

Decoupling Functions	Description
Ext Temp Superv[1] . TripCmd	<i>Signal: Trip Command</i>
Ext Temp Superv[2] . TripCmd	<i>Signal: Trip Command</i>
Ext Temp Superv[3] . TripCmd	<i>Signal: Trip Command</i>
RTD . TripCmd	<i>Signal: Trip Command</i>
DI Slot X1 . DI 1	<i>Signal: Digital Input</i>
DI Slot X1 . DI 2	<i>Signal: Digital Input</i>
DI Slot X1 . DI 3	<i>Signal: Digital Input</i>
DI Slot X1 . DI 4	<i>Signal: Digital Input</i>
DI Slot X1 . DI 5	<i>Signal: Digital Input</i>
DI Slot X1 . DI 6	<i>Signal: Digital Input</i>
DI Slot X1 . DI 7	<i>Signal: Digital Input</i>
DI Slot X1 . DI 8	<i>Signal: Digital Input</i>
DI Slot X5 . DI 1	<i>Signal: Digital Input</i>
DI Slot X5 . DI 2	<i>Signal: Digital Input</i>
DI Slot X5 . DI 3	<i>Signal: Digital Input</i>
DI Slot X5 . DI 4	<i>Signal: Digital Input</i>
DI Slot X5 . DI 5	<i>Signal: Digital Input</i>
DI Slot X5 . DI 6	<i>Signal: Digital Input</i>
DI Slot X5 . DI 7	<i>Signal: Digital Input</i>
DI Slot X5 . DI 8	<i>Signal: Digital Input</i>
DI Slot X6 . DI 1	<i>Signal: Digital Input</i>
DI Slot X6 . DI 2	<i>Signal: Digital Input</i>
DI Slot X6 . DI 3	<i>Signal: Digital Input</i>
DI Slot X6 . DI 4	<i>Signal: Digital Input</i>
DI Slot X6 . DI 5	<i>Signal: Digital Input</i>
DI Slot X6 . DI 6	<i>Signal: Digital Input</i>
DI Slot X6 . DI 7	<i>Signal: Digital Input</i>
DI Slot X6 . DI 8	<i>Signal: Digital Input</i>
AnaP[1] . TripCmd	<i>Signal: Trip Command</i>
AnaP[2] . TripCmd	<i>Signal: Trip Command</i>

Decoupling Functions	Description
AnaP[3] . TripCmd	<i>Signal: Trip Command</i>
AnaP[4] . TripCmd	<i>Signal: Trip Command</i>
DNP3 . BinaryOutput0	<i>Virtual Digital Output (DNP). This corresponds to a virtual binary input of the protective device.</i>
DNP3 . BinaryOutput1	<i>Virtual Digital Output (DNP). This corresponds to a virtual binary input of the protective device.</i>
DNP3 . BinaryOutput2	<i>Virtual Digital Output (DNP). This corresponds to a virtual binary input of the protective device.</i>
DNP3 . BinaryOutput3	<i>Virtual Digital Output (DNP). This corresponds to a virtual binary input of the protective device.</i>
DNP3 . BinaryOutput4	<i>Virtual Digital Output (DNP). This corresponds to a virtual binary input of the protective device.</i>
DNP3 . BinaryOutput5	<i>Virtual Digital Output (DNP). This corresponds to a virtual binary input of the protective device.</i>
DNP3 . BinaryOutput6	<i>Virtual Digital Output (DNP). This corresponds to a virtual binary input of the protective device.</i>
DNP3 . BinaryOutput7	<i>Virtual Digital Output (DNP). This corresponds to a virtual binary input of the protective device.</i>
DNP3 . BinaryOutput8	<i>Virtual Digital Output (DNP). This corresponds to a virtual binary input of the protective device.</i>
DNP3 . BinaryOutput9	<i>Virtual Digital Output (DNP). This corresponds to a virtual binary input of the protective device.</i>
DNP3 . BinaryOutput10	<i>Virtual Digital Output (DNP). This corresponds to a virtual binary input of the protective device.</i>
DNP3 . BinaryOutput11	<i>Virtual Digital Output (DNP). This corresponds to a virtual binary input of the protective device.</i>
DNP3 . BinaryOutput12	<i>Virtual Digital Output (DNP). This corresponds to a virtual binary input of the protective device.</i>
DNP3 . BinaryOutput13	<i>Virtual Digital Output (DNP). This corresponds to a virtual binary input of the protective device.</i>
DNP3 . BinaryOutput14	<i>Virtual Digital Output (DNP). This corresponds to a virtual binary input of the protective device.</i>
DNP3 . BinaryOutput15	<i>Virtual Digital Output (DNP). This corresponds to a virtual binary input of the protective device.</i>
DNP3 . BinaryOutput16	<i>Virtual Digital Output (DNP). This corresponds to a virtual binary input of the protective device.</i>
DNP3 . BinaryOutput17	<i>Virtual Digital Output (DNP). This corresponds to a virtual binary input of the protective device.</i>
DNP3 . BinaryOutput18	<i>Virtual Digital Output (DNP). This corresponds to a virtual binary input of the protective device.</i>

Decoupling Functions	Description
DNP3 . BinaryOutput19	<i>Virtual Digital Output (DNP). This corresponds to a virtual binary input of the protective device.</i>
DNP3 . BinaryOutput20	<i>Virtual Digital Output (DNP). This corresponds to a virtual binary input of the protective device.</i>
DNP3 . BinaryOutput21	<i>Virtual Digital Output (DNP). This corresponds to a virtual binary input of the protective device.</i>
DNP3 . BinaryOutput22	<i>Virtual Digital Output (DNP). This corresponds to a virtual binary input of the protective device.</i>
DNP3 . BinaryOutput23	<i>Virtual Digital Output (DNP). This corresponds to a virtual binary input of the protective device.</i>
DNP3 . BinaryOutput24	<i>Virtual Digital Output (DNP). This corresponds to a virtual binary input of the protective device.</i>
DNP3 . BinaryOutput25	<i>Virtual Digital Output (DNP). This corresponds to a virtual binary input of the protective device.</i>
DNP3 . BinaryOutput26	<i>Virtual Digital Output (DNP). This corresponds to a virtual binary input of the protective device.</i>
DNP3 . BinaryOutput27	<i>Virtual Digital Output (DNP). This corresponds to a virtual binary input of the protective device.</i>
DNP3 . BinaryOutput28	<i>Virtual Digital Output (DNP). This corresponds to a virtual binary input of the protective device.</i>
DNP3 . BinaryOutput29	<i>Virtual Digital Output (DNP). This corresponds to a virtual binary input of the protective device.</i>
DNP3 . BinaryOutput30	<i>Virtual Digital Output (DNP). This corresponds to a virtual binary input of the protective device.</i>
DNP3 . BinaryOutput31	<i>Virtual Digital Output (DNP). This corresponds to a virtual binary input of the protective device.</i>
Modbus . Scada Cmd 1	<i>Scada Command</i>
Modbus . Scada Cmd 2	<i>Scada Command</i>
Modbus . Scada Cmd 3	<i>Scada Command</i>
Modbus . Scada Cmd 4	<i>Scada Command</i>
Modbus . Scada Cmd 5	<i>Scada Command</i>
Modbus . Scada Cmd 6	<i>Scada Command</i>
Modbus . Scada Cmd 7	<i>Scada Command</i>
Modbus . Scada Cmd 8	<i>Scada Command</i>
Modbus . Scada Cmd 9	<i>Scada Command</i>
Modbus . Scada Cmd 10	<i>Scada Command</i>
Modbus . Scada Cmd 11	<i>Scada Command</i>
Modbus . Scada Cmd 12	<i>Scada Command</i>

Decoupling Functions	Description
Modbus . Scada Cmd 13	<i>Scada Command</i>
Modbus . Scada Cmd 14	<i>Scada Command</i>
Modbus . Scada Cmd 15	<i>Scada Command</i>
Modbus . Scada Cmd 16	<i>Scada Command</i>
IEC 61850 . GOSINGGIO1.Ind1.stVal	<i>Signal: Virtual Input (IEC61850 GGIO Ind): State</i>
IEC 61850 . GOSINGGIO1.Ind2.stVal	<i>Signal: Virtual Input (IEC61850 GGIO Ind): State</i>
IEC 61850 . GOSINGGIO1.Ind3.stVal	<i>Signal: Virtual Input (IEC61850 GGIO Ind): State</i>
IEC 61850 . GOSINGGIO1.Ind4.stVal	<i>Signal: Virtual Input (IEC61850 GGIO Ind): State</i>
IEC 61850 . GOSINGGIO1.Ind5.stVal	<i>Signal: Virtual Input (IEC61850 GGIO Ind): State</i>
IEC 61850 . GOSINGGIO1.Ind6.stVal	<i>Signal: Virtual Input (IEC61850 GGIO Ind): State</i>
IEC 61850 . GOSINGGIO1.Ind7.stVal	<i>Signal: Virtual Input (IEC61850 GGIO Ind): State</i>
IEC 61850 . GOSINGGIO1.Ind8.stVal	<i>Signal: Virtual Input (IEC61850 GGIO Ind): State</i>
IEC 61850 . GOSINGGIO1.Ind9.stVal	<i>Signal: Virtual Input (IEC61850 GGIO Ind): State</i>
IEC 61850 . GOSINGGIO1.Ind10.stVal	<i>Signal: Virtual Input (IEC61850 GGIO Ind): State</i>
IEC 61850 . GOSINGGIO1.Ind11.stVal	<i>Signal: Virtual Input (IEC61850 GGIO Ind): State</i>
IEC 61850 . GOSINGGIO1.Ind12.stVal	<i>Signal: Virtual Input (IEC61850 GGIO Ind): State</i>
IEC 61850 . GOSINGGIO1.Ind13.stVal	<i>Signal: Virtual Input (IEC61850 GGIO Ind): State</i>
IEC 61850 . GOSINGGIO1.Ind14.stVal	<i>Signal: Virtual Input (IEC61850 GGIO Ind): State</i>
IEC 61850 . GOSINGGIO1.Ind15.stVal	<i>Signal: Virtual Input (IEC61850 GGIO Ind): State</i>
IEC 61850 . GOSINGGIO1.Ind16.stVal	<i>Signal: Virtual Input (IEC61850 GGIO Ind): State</i>
IEC 61850 . GOSINGGIO1.Ind17.stVal	<i>Signal: Virtual Input (IEC61850 GGIO Ind): State</i>
IEC 61850 . GOSINGGIO1.Ind18.stVal	<i>Signal: Virtual Input (IEC61850 GGIO Ind): State</i>

Decoupling Functions	Description
IEC 61850 . GOSINGGIO1.Ind19.stVal	<i>Signal: Virtual Input (IEC61850 GGIO Ind): State</i>
IEC 61850 . GOSINGGIO1.Ind20.stVal	<i>Signal: Virtual Input (IEC61850 GGIO Ind): State</i>
IEC 61850 . GOSINGGIO1.Ind21.stVal	<i>Signal: Virtual Input (IEC61850 GGIO Ind): State</i>
IEC 61850 . GOSINGGIO1.Ind22.stVal	<i>Signal: Virtual Input (IEC61850 GGIO Ind): State</i>
IEC 61850 . GOSINGGIO1.Ind23.stVal	<i>Signal: Virtual Input (IEC61850 GGIO Ind): State</i>
IEC 61850 . GOSINGGIO1.Ind24.stVal	<i>Signal: Virtual Input (IEC61850 GGIO Ind): State</i>
IEC 61850 . GOSINGGIO1.Ind25.stVal	<i>Signal: Virtual Input (IEC61850 GGIO Ind): State</i>
IEC 61850 . GOSINGGIO1.Ind26.stVal	<i>Signal: Virtual Input (IEC61850 GGIO Ind): State</i>
IEC 61850 . GOSINGGIO1.Ind27.stVal	<i>Signal: Virtual Input (IEC61850 GGIO Ind): State</i>
IEC 61850 . GOSINGGIO1.Ind28.stVal	<i>Signal: Virtual Input (IEC61850 GGIO Ind): State</i>
IEC 61850 . GOSINGGIO1.Ind29.stVal	<i>Signal: Virtual Input (IEC61850 GGIO Ind): State</i>
IEC 61850 . GOSINGGIO1.Ind30.stVal	<i>Signal: Virtual Input (IEC61850 GGIO Ind): State</i>
IEC 61850 . GOSINGGIO1.Ind31.stVal	<i>Signal: Virtual Input (IEC61850 GGIO Ind): State</i>
IEC 61850 . GOSINGGIO1.Ind32.stVal	<i>Signal: Virtual Input (IEC61850 GGIO Ind): State</i>
IEC 61850 . SPCSO1	<i>Status bit that can be set by clients like e.g. SCADA (Single Point Controllable Status Output).</i>
IEC 61850 . SPCSO2	<i>Status bit that can be set by clients like e.g. SCADA (Single Point Controllable Status Output).</i>
IEC 61850 . SPCSO3	<i>Status bit that can be set by clients like e.g. SCADA (Single Point Controllable Status Output).</i>
IEC 61850 . SPCSO4	<i>Status bit that can be set by clients like e.g. SCADA (Single Point Controllable Status Output).</i>
IEC 61850 . SPCSO5	<i>Status bit that can be set by clients like e.g. SCADA (Single Point Controllable Status Output).</i>
IEC 61850 . SPCSO6	<i>Status bit that can be set by clients like e.g. SCADA (Single Point Controllable Status Output).</i>

Decoupling Functions	Description
IEC 61850 . SPCSO7	<i>Status bit that can be set by clients like e.g. SCADA (Single Point Controllable Status Output).</i>
IEC 61850 . SPCSO8	<i>Status bit that can be set by clients like e.g. SCADA (Single Point Controllable Status Output).</i>
IEC 61850 . SPCSO9	<i>Status bit that can be set by clients like e.g. SCADA (Single Point Controllable Status Output).</i>
IEC 61850 . SPCSO10	<i>Status bit that can be set by clients like e.g. SCADA (Single Point Controllable Status Output).</i>
IEC 61850 . SPCSO11	<i>Status bit that can be set by clients like e.g. SCADA (Single Point Controllable Status Output).</i>
IEC 61850 . SPCSO12	<i>Status bit that can be set by clients like e.g. SCADA (Single Point Controllable Status Output).</i>
IEC 61850 . SPCSO13	<i>Status bit that can be set by clients like e.g. SCADA (Single Point Controllable Status Output).</i>
IEC 61850 . SPCSO14	<i>Status bit that can be set by clients like e.g. SCADA (Single Point Controllable Status Output).</i>
IEC 61850 . SPCSO15	<i>Status bit that can be set by clients like e.g. SCADA (Single Point Controllable Status Output).</i>
IEC 61850 . SPCSO16	<i>Status bit that can be set by clients like e.g. SCADA (Single Point Controllable Status Output).</i>
IEC103 . Scada Cmd 1	<i>Scada Command</i>
IEC103 . Scada Cmd 2	<i>Scada Command</i>
IEC103 . Scada Cmd 3	<i>Scada Command</i>
IEC103 . Scada Cmd 4	<i>Scada Command</i>
IEC103 . Scada Cmd 5	<i>Scada Command</i>
IEC103 . Scada Cmd 6	<i>Scada Command</i>
IEC103 . Scada Cmd 7	<i>Scada Command</i>
IEC103 . Scada Cmd 8	<i>Scada Command</i>
IEC103 . Scada Cmd 9	<i>Scada Command</i>
IEC103 . Scada Cmd 10	<i>Scada Command</i>
IEC104 . Scada Cmd 1	<i>Scada Command</i>
IEC104 . Scada Cmd 2	<i>Scada Command</i>
IEC104 . Scada Cmd 3	<i>Scada Command</i>
IEC104 . Scada Cmd 4	<i>Scada Command</i>
IEC104 . Scada Cmd 5	<i>Scada Command</i>
IEC104 . Scada Cmd 6	<i>Scada Command</i>

Decoupling Functions	Description
IEC104 . Scada Cmd 7	<i>Scada Command</i>
IEC104 . Scada Cmd 8	<i>Scada Command</i>
IEC104 . Scada Cmd 9	<i>Scada Command</i>
IEC104 . Scada Cmd 10	<i>Scada Command</i>
IEC104 . Scada Cmd 11	<i>Scada Command</i>
IEC104 . Scada Cmd 12	<i>Scada Command</i>
IEC104 . Scada Cmd 13	<i>Scada Command</i>
IEC104 . Scada Cmd 14	<i>Scada Command</i>
IEC104 . Scada Cmd 15	<i>Scada Command</i>
IEC104 . Scada Cmd 16	<i>Scada Command</i>
Profibus . Scada Cmd 1	<i>Scada Command</i>
Profibus . Scada Cmd 2	<i>Scada Command</i>
Profibus . Scada Cmd 3	<i>Scada Command</i>
Profibus . Scada Cmd 4	<i>Scada Command</i>
Profibus . Scada Cmd 5	<i>Scada Command</i>
Profibus . Scada Cmd 6	<i>Scada Command</i>
Profibus . Scada Cmd 7	<i>Scada Command</i>
Profibus . Scada Cmd 8	<i>Scada Command</i>
Profibus . Scada Cmd 9	<i>Scada Command</i>
Profibus . Scada Cmd 10	<i>Scada Command</i>
Profibus . Scada Cmd 11	<i>Scada Command</i>
Profibus . Scada Cmd 12	<i>Scada Command</i>
Profibus . Scada Cmd 13	<i>Scada Command</i>
Profibus . Scada Cmd 14	<i>Scada Command</i>
Profibus . Scada Cmd 15	<i>Scada Command</i>
Profibus . Scada Cmd 16	<i>Scada Command</i>
Logics . LE1.Gate Out	<i>Signal: Output of the logic gate</i>
Logics . LE1.Timer Out	<i>Signal: Timer Output</i>
Logics . LE1.Out	<i>Signal: Latched Output (Q)</i>
Logics . LE1.Out inverted	<i>Signal: Negated Latched Output (Q NOT)</i>
Logics . LE2.Gate Out	<i>Signal: Output of the logic gate</i>

Decoupling Functions	Description
Logics . LE2.Timer Out	<i>Signal: Timer Output</i>
Logics . LE2.Out	<i>Signal: Latched Output (Q)</i>
Logics . LE2.Out inverted	<i>Signal: Negated Latched Output (Q NOT)</i>
Logics . LE3.Gate Out	<i>Signal: Output of the logic gate</i>
Logics . LE3.Timer Out	<i>Signal: Timer Output</i>
Logics . LE3.Out	<i>Signal: Latched Output (Q)</i>
Logics . LE3.Out inverted	<i>Signal: Negated Latched Output (Q NOT)</i>
Logics . LE4.Gate Out	<i>Signal: Output of the logic gate</i>
Logics . LE4.Timer Out	<i>Signal: Timer Output</i>
Logics . LE4.Out	<i>Signal: Latched Output (Q)</i>
Logics . LE4.Out inverted	<i>Signal: Negated Latched Output (Q NOT)</i>
Logics . LE5.Gate Out	<i>Signal: Output of the logic gate</i>
Logics . LE5.Timer Out	<i>Signal: Timer Output</i>
Logics . LE5.Out	<i>Signal: Latched Output (Q)</i>
Logics . LE5.Out inverted	<i>Signal: Negated Latched Output (Q NOT)</i>
Logics . LE6.Gate Out	<i>Signal: Output of the logic gate</i>
Logics . LE6.Timer Out	<i>Signal: Timer Output</i>
Logics . LE6.Out	<i>Signal: Latched Output (Q)</i>
Logics . LE6.Out inverted	<i>Signal: Negated Latched Output (Q NOT)</i>
Logics . LE7.Gate Out	<i>Signal: Output of the logic gate</i>
Logics . LE7.Timer Out	<i>Signal: Timer Output</i>
Logics . LE7.Out	<i>Signal: Latched Output (Q)</i>
Logics . LE7.Out inverted	<i>Signal: Negated Latched Output (Q NOT)</i>
Logics . LE8.Gate Out	<i>Signal: Output of the logic gate</i>
Logics . LE8.Timer Out	<i>Signal: Timer Output</i>
Logics . LE8.Out	<i>Signal: Latched Output (Q)</i>
Logics . LE8.Out inverted	<i>Signal: Negated Latched Output (Q NOT)</i>
Logics . LE9.Gate Out	<i>Signal: Output of the logic gate</i>

Decoupling Functions	Description
Logics . LE9.Timer Out	<i>Signal: Timer Output</i>
Logics . LE9.Out	<i>Signal: Latched Output (Q)</i>
Logics . LE9.Out inverted	<i>Signal: Negated Latched Output (Q NOT)</i>
Logics . LE10.Gate Out	<i>Signal: Output of the logic gate</i>
Logics . LE10.Timer Out	<i>Signal: Timer Output</i>
Logics . LE10.Out	<i>Signal: Latched Output (Q)</i>
Logics . LE10.Out inverted	<i>Signal: Negated Latched Output (Q NOT)</i>
Logics . LE11.Gate Out	<i>Signal: Output of the logic gate</i>
Logics . LE11.Timer Out	<i>Signal: Timer Output</i>
Logics . LE11.Out	<i>Signal: Latched Output (Q)</i>
Logics . LE11.Out inverted	<i>Signal: Negated Latched Output (Q NOT)</i>
Logics . LE12.Gate Out	<i>Signal: Output of the logic gate</i>
Logics . LE12.Timer Out	<i>Signal: Timer Output</i>
Logics . LE12.Out	<i>Signal: Latched Output (Q)</i>
Logics . LE12.Out inverted	<i>Signal: Negated Latched Output (Q NOT)</i>
Logics . LE13.Gate Out	<i>Signal: Output of the logic gate</i>
Logics . LE13.Timer Out	<i>Signal: Timer Output</i>
Logics . LE13.Out	<i>Signal: Latched Output (Q)</i>
Logics . LE13.Out inverted	<i>Signal: Negated Latched Output (Q NOT)</i>
Logics . LE14.Gate Out	<i>Signal: Output of the logic gate</i>
Logics . LE14.Timer Out	<i>Signal: Timer Output</i>
Logics . LE14.Out	<i>Signal: Latched Output (Q)</i>
Logics . LE14.Out inverted	<i>Signal: Negated Latched Output (Q NOT)</i>
Logics . LE15.Gate Out	<i>Signal: Output of the logic gate</i>
Logics . LE15.Timer Out	<i>Signal: Timer Output</i>
Logics . LE15.Out	<i>Signal: Latched Output (Q)</i>
Logics . LE15.Out inverted	<i>Signal: Negated Latched Output (Q NOT)</i>
Logics . LE16.Gate Out	<i>Signal: Output of the logic gate</i>

Decoupling Functions	Description
Logics . LE16.Timer Out	<i>Signal: Timer Output</i>
Logics . LE16.Out	<i>Signal: Latched Output (Q)</i>
Logics . LE16.Out inverted	<i>Signal: Negated Latched Output (Q NOT)</i>
Logics . LE17.Gate Out	<i>Signal: Output of the logic gate</i>
Logics . LE17.Timer Out	<i>Signal: Timer Output</i>
Logics . LE17.Out	<i>Signal: Latched Output (Q)</i>
Logics . LE17.Out inverted	<i>Signal: Negated Latched Output (Q NOT)</i>
Logics . LE18.Gate Out	<i>Signal: Output of the logic gate</i>
Logics . LE18.Timer Out	<i>Signal: Timer Output</i>
Logics . LE18.Out	<i>Signal: Latched Output (Q)</i>
Logics . LE18.Out inverted	<i>Signal: Negated Latched Output (Q NOT)</i>
Logics . LE19.Gate Out	<i>Signal: Output of the logic gate</i>
Logics . LE19.Timer Out	<i>Signal: Timer Output</i>
Logics . LE19.Out	<i>Signal: Latched Output (Q)</i>
Logics . LE19.Out inverted	<i>Signal: Negated Latched Output (Q NOT)</i>
Logics . LE20.Gate Out	<i>Signal: Output of the logic gate</i>
Logics . LE20.Timer Out	<i>Signal: Timer Output</i>
Logics . LE20.Out	<i>Signal: Latched Output (Q)</i>
Logics . LE20.Out inverted	<i>Signal: Negated Latched Output (Q NOT)</i>
Logics . LE21.Gate Out	<i>Signal: Output of the logic gate</i>
Logics . LE21.Timer Out	<i>Signal: Timer Output</i>
Logics . LE21.Out	<i>Signal: Latched Output (Q)</i>
Logics . LE21.Out inverted	<i>Signal: Negated Latched Output (Q NOT)</i>
Logics . LE22.Gate Out	<i>Signal: Output of the logic gate</i>
Logics . LE22.Timer Out	<i>Signal: Timer Output</i>
Logics . LE22.Out	<i>Signal: Latched Output (Q)</i>
Logics . LE22.Out inverted	<i>Signal: Negated Latched Output (Q NOT)</i>
Logics . LE23.Gate Out	<i>Signal: Output of the logic gate</i>

Decoupling Functions	Description
Logics . LE23.Timer Out	<i>Signal: Timer Output</i>
Logics . LE23.Out	<i>Signal: Latched Output (Q)</i>
Logics . LE23.Out inverted	<i>Signal: Negated Latched Output (Q NOT)</i>
Logics . LE24.Gate Out	<i>Signal: Output of the logic gate</i>
Logics . LE24.Timer Out	<i>Signal: Timer Output</i>
Logics . LE24.Out	<i>Signal: Latched Output (Q)</i>
Logics . LE24.Out inverted	<i>Signal: Negated Latched Output (Q NOT)</i>
Logics . LE25.Gate Out	<i>Signal: Output of the logic gate</i>
Logics . LE25.Timer Out	<i>Signal: Timer Output</i>
Logics . LE25.Out	<i>Signal: Latched Output (Q)</i>
Logics . LE25.Out inverted	<i>Signal: Negated Latched Output (Q NOT)</i>
Logics . LE26.Gate Out	<i>Signal: Output of the logic gate</i>
Logics . LE26.Timer Out	<i>Signal: Timer Output</i>
Logics . LE26.Out	<i>Signal: Latched Output (Q)</i>
Logics . LE26.Out inverted	<i>Signal: Negated Latched Output (Q NOT)</i>
Logics . LE27.Gate Out	<i>Signal: Output of the logic gate</i>
Logics . LE27.Timer Out	<i>Signal: Timer Output</i>
Logics . LE27.Out	<i>Signal: Latched Output (Q)</i>
Logics . LE27.Out inverted	<i>Signal: Negated Latched Output (Q NOT)</i>
Logics . LE28.Gate Out	<i>Signal: Output of the logic gate</i>
Logics . LE28.Timer Out	<i>Signal: Timer Output</i>
Logics . LE28.Out	<i>Signal: Latched Output (Q)</i>
Logics . LE28.Out inverted	<i>Signal: Negated Latched Output (Q NOT)</i>
Logics . LE29.Gate Out	<i>Signal: Output of the logic gate</i>
Logics . LE29.Timer Out	<i>Signal: Timer Output</i>
Logics . LE29.Out	<i>Signal: Latched Output (Q)</i>
Logics . LE29.Out inverted	<i>Signal: Negated Latched Output (Q NOT)</i>
Logics . LE30.Gate Out	<i>Signal: Output of the logic gate</i>

Decoupling Functions	Description
Logics . LE30.Timer Out	<i>Signal: Timer Output</i>
Logics . LE30.Out	<i>Signal: Latched Output (Q)</i>
Logics . LE30.Out inverted	<i>Signal: Negated Latched Output (Q NOT)</i>
Logics . LE31.Gate Out	<i>Signal: Output of the logic gate</i>
Logics . LE31.Timer Out	<i>Signal: Timer Output</i>
Logics . LE31.Out	<i>Signal: Latched Output (Q)</i>
Logics . LE31.Out inverted	<i>Signal: Negated Latched Output (Q NOT)</i>
Logics . LE32.Gate Out	<i>Signal: Output of the logic gate</i>
Logics . LE32.Timer Out	<i>Signal: Timer Output</i>
Logics . LE32.Out	<i>Signal: Latched Output (Q)</i>
Logics . LE32.Out inverted	<i>Signal: Negated Latched Output (Q NOT)</i>
Logics . LE33.Gate Out	<i>Signal: Output of the logic gate</i>
Logics . LE33.Timer Out	<i>Signal: Timer Output</i>
Logics . LE33.Out	<i>Signal: Latched Output (Q)</i>
Logics . LE33.Out inverted	<i>Signal: Negated Latched Output (Q NOT)</i>
Logics . LE34.Gate Out	<i>Signal: Output of the logic gate</i>
Logics . LE34.Timer Out	<i>Signal: Timer Output</i>
Logics . LE34.Out	<i>Signal: Latched Output (Q)</i>
Logics . LE34.Out inverted	<i>Signal: Negated Latched Output (Q NOT)</i>
Logics . LE35.Gate Out	<i>Signal: Output of the logic gate</i>
Logics . LE35.Timer Out	<i>Signal: Timer Output</i>
Logics . LE35.Out	<i>Signal: Latched Output (Q)</i>
Logics . LE35.Out inverted	<i>Signal: Negated Latched Output (Q NOT)</i>
Logics . LE36.Gate Out	<i>Signal: Output of the logic gate</i>
Logics . LE36.Timer Out	<i>Signal: Timer Output</i>
Logics . LE36.Out	<i>Signal: Latched Output (Q)</i>
Logics . LE36.Out inverted	<i>Signal: Negated Latched Output (Q NOT)</i>
Logics . LE37.Gate Out	<i>Signal: Output of the logic gate</i>

Decoupling Functions	Description
Logics . LE37.Timer Out	<i>Signal: Timer Output</i>
Logics . LE37.Out	<i>Signal: Latched Output (Q)</i>
Logics . LE37.Out inverted	<i>Signal: Negated Latched Output (Q NOT)</i>
Logics . LE38.Gate Out	<i>Signal: Output of the logic gate</i>
Logics . LE38.Timer Out	<i>Signal: Timer Output</i>
Logics . LE38.Out	<i>Signal: Latched Output (Q)</i>
Logics . LE38.Out inverted	<i>Signal: Negated Latched Output (Q NOT)</i>
Logics . LE39.Gate Out	<i>Signal: Output of the logic gate</i>
Logics . LE39.Timer Out	<i>Signal: Timer Output</i>
Logics . LE39.Out	<i>Signal: Latched Output (Q)</i>
Logics . LE39.Out inverted	<i>Signal: Negated Latched Output (Q NOT)</i>
Logics . LE40.Gate Out	<i>Signal: Output of the logic gate</i>
Logics . LE40.Timer Out	<i>Signal: Timer Output</i>
Logics . LE40.Out	<i>Signal: Latched Output (Q)</i>
Logics . LE40.Out inverted	<i>Signal: Negated Latched Output (Q NOT)</i>
Logics . LE41.Gate Out	<i>Signal: Output of the logic gate</i>
Logics . LE41.Timer Out	<i>Signal: Timer Output</i>
Logics . LE41.Out	<i>Signal: Latched Output (Q)</i>
Logics . LE41.Out inverted	<i>Signal: Negated Latched Output (Q NOT)</i>
Logics . LE42.Gate Out	<i>Signal: Output of the logic gate</i>
Logics . LE42.Timer Out	<i>Signal: Timer Output</i>
Logics . LE42.Out	<i>Signal: Latched Output (Q)</i>
Logics . LE42.Out inverted	<i>Signal: Negated Latched Output (Q NOT)</i>
Logics . LE43.Gate Out	<i>Signal: Output of the logic gate</i>
Logics . LE43.Timer Out	<i>Signal: Timer Output</i>
Logics . LE43.Out	<i>Signal: Latched Output (Q)</i>
Logics . LE43.Out inverted	<i>Signal: Negated Latched Output (Q NOT)</i>
Logics . LE44.Gate Out	<i>Signal: Output of the logic gate</i>

Decoupling Functions	Description
Logics . LE44.Timer Out	<i>Signal: Timer Output</i>
Logics . LE44.Out	<i>Signal: Latched Output (Q)</i>
Logics . LE44.Out inverted	<i>Signal: Negated Latched Output (Q NOT)</i>
Logics . LE45.Gate Out	<i>Signal: Output of the logic gate</i>
Logics . LE45.Timer Out	<i>Signal: Timer Output</i>
Logics . LE45.Out	<i>Signal: Latched Output (Q)</i>
Logics . LE45.Out inverted	<i>Signal: Negated Latched Output (Q NOT)</i>
Logics . LE46.Gate Out	<i>Signal: Output of the logic gate</i>
Logics . LE46.Timer Out	<i>Signal: Timer Output</i>
Logics . LE46.Out	<i>Signal: Latched Output (Q)</i>
Logics . LE46.Out inverted	<i>Signal: Negated Latched Output (Q NOT)</i>
Logics . LE47.Gate Out	<i>Signal: Output of the logic gate</i>
Logics . LE47.Timer Out	<i>Signal: Timer Output</i>
Logics . LE47.Out	<i>Signal: Latched Output (Q)</i>
Logics . LE47.Out inverted	<i>Signal: Negated Latched Output (Q NOT)</i>
Logics . LE48.Gate Out	<i>Signal: Output of the logic gate</i>
Logics . LE48.Timer Out	<i>Signal: Timer Output</i>
Logics . LE48.Out	<i>Signal: Latched Output (Q)</i>
Logics . LE48.Out inverted	<i>Signal: Negated Latched Output (Q NOT)</i>
Logics . LE49.Gate Out	<i>Signal: Output of the logic gate</i>
Logics . LE49.Timer Out	<i>Signal: Timer Output</i>
Logics . LE49.Out	<i>Signal: Latched Output (Q)</i>
Logics . LE49.Out inverted	<i>Signal: Negated Latched Output (Q NOT)</i>
Logics . LE50.Gate Out	<i>Signal: Output of the logic gate</i>
Logics . LE50.Timer Out	<i>Signal: Timer Output</i>
Logics . LE50.Out	<i>Signal: Latched Output (Q)</i>
Logics . LE50.Out inverted	<i>Signal: Negated Latched Output (Q NOT)</i>
Logics . LE51.Gate Out	<i>Signal: Output of the logic gate</i>

Decoupling Functions	Description
Logics . LE51.Timer Out	<i>Signal: Timer Output</i>
Logics . LE51.Out	<i>Signal: Latched Output (Q)</i>
Logics . LE51.Out inverted	<i>Signal: Negated Latched Output (Q NOT)</i>
Logics . LE52.Gate Out	<i>Signal: Output of the logic gate</i>
Logics . LE52.Timer Out	<i>Signal: Timer Output</i>
Logics . LE52.Out	<i>Signal: Latched Output (Q)</i>
Logics . LE52.Out inverted	<i>Signal: Negated Latched Output (Q NOT)</i>
Logics . LE53.Gate Out	<i>Signal: Output of the logic gate</i>
Logics . LE53.Timer Out	<i>Signal: Timer Output</i>
Logics . LE53.Out	<i>Signal: Latched Output (Q)</i>
Logics . LE53.Out inverted	<i>Signal: Negated Latched Output (Q NOT)</i>
Logics . LE54.Gate Out	<i>Signal: Output of the logic gate</i>
Logics . LE54.Timer Out	<i>Signal: Timer Output</i>
Logics . LE54.Out	<i>Signal: Latched Output (Q)</i>
Logics . LE54.Out inverted	<i>Signal: Negated Latched Output (Q NOT)</i>
Logics . LE55.Gate Out	<i>Signal: Output of the logic gate</i>
Logics . LE55.Timer Out	<i>Signal: Timer Output</i>
Logics . LE55.Out	<i>Signal: Latched Output (Q)</i>
Logics . LE55.Out inverted	<i>Signal: Negated Latched Output (Q NOT)</i>
Logics . LE56.Gate Out	<i>Signal: Output of the logic gate</i>
Logics . LE56.Timer Out	<i>Signal: Timer Output</i>
Logics . LE56.Out	<i>Signal: Latched Output (Q)</i>
Logics . LE56.Out inverted	<i>Signal: Negated Latched Output (Q NOT)</i>
Logics . LE57.Gate Out	<i>Signal: Output of the logic gate</i>
Logics . LE57.Timer Out	<i>Signal: Timer Output</i>
Logics . LE57.Out	<i>Signal: Latched Output (Q)</i>
Logics . LE57.Out inverted	<i>Signal: Negated Latched Output (Q NOT)</i>
Logics . LE58.Gate Out	<i>Signal: Output of the logic gate</i>

Decoupling Functions	Description
Logics . LE58.Timer Out	<i>Signal: Timer Output</i>
Logics . LE58.Out	<i>Signal: Latched Output (Q)</i>
Logics . LE58.Out inverted	<i>Signal: Negated Latched Output (Q NOT)</i>
Logics . LE59.Gate Out	<i>Signal: Output of the logic gate</i>
Logics . LE59.Timer Out	<i>Signal: Timer Output</i>
Logics . LE59.Out	<i>Signal: Latched Output (Q)</i>
Logics . LE59.Out inverted	<i>Signal: Negated Latched Output (Q NOT)</i>
Logics . LE60.Gate Out	<i>Signal: Output of the logic gate</i>
Logics . LE60.Timer Out	<i>Signal: Timer Output</i>
Logics . LE60.Out	<i>Signal: Latched Output (Q)</i>
Logics . LE60.Out inverted	<i>Signal: Negated Latched Output (Q NOT)</i>
Logics . LE61.Gate Out	<i>Signal: Output of the logic gate</i>
Logics . LE61.Timer Out	<i>Signal: Timer Output</i>
Logics . LE61.Out	<i>Signal: Latched Output (Q)</i>
Logics . LE61.Out inverted	<i>Signal: Negated Latched Output (Q NOT)</i>
Logics . LE62.Gate Out	<i>Signal: Output of the logic gate</i>
Logics . LE62.Timer Out	<i>Signal: Timer Output</i>
Logics . LE62.Out	<i>Signal: Latched Output (Q)</i>
Logics . LE62.Out inverted	<i>Signal: Negated Latched Output (Q NOT)</i>
Logics . LE63.Gate Out	<i>Signal: Output of the logic gate</i>
Logics . LE63.Timer Out	<i>Signal: Timer Output</i>
Logics . LE63.Out	<i>Signal: Latched Output (Q)</i>
Logics . LE63.Out inverted	<i>Signal: Negated Latched Output (Q NOT)</i>
Logics . LE64.Gate Out	<i>Signal: Output of the logic gate</i>
Logics . LE64.Timer Out	<i>Signal: Timer Output</i>
Logics . LE64.Out	<i>Signal: Latched Output (Q)</i>
Logics . LE64.Out inverted	<i>Signal: Negated Latched Output (Q NOT)</i>
Logics . LE65.Gate Out	<i>Signal: Output of the logic gate</i>

Decoupling Functions	Description
Logics . LE65.Timer Out	<i>Signal: Timer Output</i>
Logics . LE65.Out	<i>Signal: Latched Output (Q)</i>
Logics . LE65.Out inverted	<i>Signal: Negated Latched Output (Q NOT)</i>
Logics . LE66.Gate Out	<i>Signal: Output of the logic gate</i>
Logics . LE66.Timer Out	<i>Signal: Timer Output</i>
Logics . LE66.Out	<i>Signal: Latched Output (Q)</i>
Logics . LE66.Out inverted	<i>Signal: Negated Latched Output (Q NOT)</i>
Logics . LE67.Gate Out	<i>Signal: Output of the logic gate</i>
Logics . LE67.Timer Out	<i>Signal: Timer Output</i>
Logics . LE67.Out	<i>Signal: Latched Output (Q)</i>
Logics . LE67.Out inverted	<i>Signal: Negated Latched Output (Q NOT)</i>
Logics . LE68.Gate Out	<i>Signal: Output of the logic gate</i>
Logics . LE68.Timer Out	<i>Signal: Timer Output</i>
Logics . LE68.Out	<i>Signal: Latched Output (Q)</i>
Logics . LE68.Out inverted	<i>Signal: Negated Latched Output (Q NOT)</i>
Logics . LE69.Gate Out	<i>Signal: Output of the logic gate</i>
Logics . LE69.Timer Out	<i>Signal: Timer Output</i>
Logics . LE69.Out	<i>Signal: Latched Output (Q)</i>
Logics . LE69.Out inverted	<i>Signal: Negated Latched Output (Q NOT)</i>
Logics . LE70.Gate Out	<i>Signal: Output of the logic gate</i>
Logics . LE70.Timer Out	<i>Signal: Timer Output</i>
Logics . LE70.Out	<i>Signal: Latched Output (Q)</i>
Logics . LE70.Out inverted	<i>Signal: Negated Latched Output (Q NOT)</i>
Logics . LE71.Gate Out	<i>Signal: Output of the logic gate</i>
Logics . LE71.Timer Out	<i>Signal: Timer Output</i>
Logics . LE71.Out	<i>Signal: Latched Output (Q)</i>
Logics . LE71.Out inverted	<i>Signal: Negated Latched Output (Q NOT)</i>
Logics . LE72.Gate Out	<i>Signal: Output of the logic gate</i>

Decoupling Functions	Description
Logics . LE72.Timer Out	<i>Signal: Timer Output</i>
Logics . LE72.Out	<i>Signal: Latched Output (Q)</i>
Logics . LE72.Out inverted	<i>Signal: Negated Latched Output (Q NOT)</i>
Logics . LE73.Gate Out	<i>Signal: Output of the logic gate</i>
Logics . LE73.Timer Out	<i>Signal: Timer Output</i>
Logics . LE73.Out	<i>Signal: Latched Output (Q)</i>
Logics . LE73.Out inverted	<i>Signal: Negated Latched Output (Q NOT)</i>
Logics . LE74.Gate Out	<i>Signal: Output of the logic gate</i>
Logics . LE74.Timer Out	<i>Signal: Timer Output</i>
Logics . LE74.Out	<i>Signal: Latched Output (Q)</i>
Logics . LE74.Out inverted	<i>Signal: Negated Latched Output (Q NOT)</i>
Logics . LE75.Gate Out	<i>Signal: Output of the logic gate</i>
Logics . LE75.Timer Out	<i>Signal: Timer Output</i>
Logics . LE75.Out	<i>Signal: Latched Output (Q)</i>
Logics . LE75.Out inverted	<i>Signal: Negated Latched Output (Q NOT)</i>
Logics . LE76.Gate Out	<i>Signal: Output of the logic gate</i>
Logics . LE76.Timer Out	<i>Signal: Timer Output</i>
Logics . LE76.Out	<i>Signal: Latched Output (Q)</i>
Logics . LE76.Out inverted	<i>Signal: Negated Latched Output (Q NOT)</i>
Logics . LE77.Gate Out	<i>Signal: Output of the logic gate</i>
Logics . LE77.Timer Out	<i>Signal: Timer Output</i>
Logics . LE77.Out	<i>Signal: Latched Output (Q)</i>
Logics . LE77.Out inverted	<i>Signal: Negated Latched Output (Q NOT)</i>
Logics . LE78.Gate Out	<i>Signal: Output of the logic gate</i>
Logics . LE78.Timer Out	<i>Signal: Timer Output</i>
Logics . LE78.Out	<i>Signal: Latched Output (Q)</i>
Logics . LE78.Out inverted	<i>Signal: Negated Latched Output (Q NOT)</i>
Logics . LE79.Gate Out	<i>Signal: Output of the logic gate</i>

Decoupling Functions	Description
Logics . LE79.Timer Out	<i>Signal: Timer Output</i>
Logics . LE79.Out	<i>Signal: Latched Output (Q)</i>
Logics . LE79.Out inverted	<i>Signal: Negated Latched Output (Q NOT)</i>
Logics . LE80.Gate Out	<i>Signal: Output of the logic gate</i>
Logics . LE80.Timer Out	<i>Signal: Timer Output</i>
Logics . LE80.Out	<i>Signal: Latched Output (Q)</i>
Logics . LE80.Out inverted	<i>Signal: Negated Latched Output (Q NOT)</i>

1..n, DI-LogicList

Selection list referenced by the following parameters:

-  Sync . Bypass
-  SOTF . Ext SOTF
-  SG[1] . Aux ON
-  SG[1] . Aux OFF
-  SG[1] . Ready
-  SG[1] . Removed
- [...]

1..n, DI-LogicList	Description
"_"	<i>No assignment</i>
DI Slot X1 . DI 1	<i>Signal: Digital Input</i>
DI Slot X1 . DI 2	<i>Signal: Digital Input</i>
DI Slot X1 . DI 3	<i>Signal: Digital Input</i>
DI Slot X1 . DI 4	<i>Signal: Digital Input</i>
DI Slot X1 . DI 5	<i>Signal: Digital Input</i>
DI Slot X1 . DI 6	<i>Signal: Digital Input</i>
DI Slot X1 . DI 7	<i>Signal: Digital Input</i>
DI Slot X1 . DI 8	<i>Signal: Digital Input</i>
DI Slot X5 . DI 1	<i>Signal: Digital Input</i>

1..n, DI-LogicList	Description
DI Slot X5 . DI 2	<i>Signal: Digital Input</i>
DI Slot X5 . DI 3	<i>Signal: Digital Input</i>
DI Slot X5 . DI 4	<i>Signal: Digital Input</i>
DI Slot X5 . DI 5	<i>Signal: Digital Input</i>
DI Slot X5 . DI 6	<i>Signal: Digital Input</i>
DI Slot X5 . DI 7	<i>Signal: Digital Input</i>
DI Slot X5 . DI 8	<i>Signal: Digital Input</i>
DI Slot X6 . DI 1	<i>Signal: Digital Input</i>
DI Slot X6 . DI 2	<i>Signal: Digital Input</i>
DI Slot X6 . DI 3	<i>Signal: Digital Input</i>
DI Slot X6 . DI 4	<i>Signal: Digital Input</i>
DI Slot X6 . DI 5	<i>Signal: Digital Input</i>
DI Slot X6 . DI 6	<i>Signal: Digital Input</i>
DI Slot X6 . DI 7	<i>Signal: Digital Input</i>
DI Slot X6 . DI 8	<i>Signal: Digital Input</i>
DNP3 . BinaryOutput0	<i>Virtual Digital Output (DNP). This corresponds to a virtual binary input of the protective device.</i>
DNP3 . BinaryOutput1	<i>Virtual Digital Output (DNP). This corresponds to a virtual binary input of the protective device.</i>
DNP3 . BinaryOutput2	<i>Virtual Digital Output (DNP). This corresponds to a virtual binary input of the protective device.</i>
DNP3 . BinaryOutput3	<i>Virtual Digital Output (DNP). This corresponds to a virtual binary input of the protective device.</i>
DNP3 . BinaryOutput4	<i>Virtual Digital Output (DNP). This corresponds to a virtual binary input of the protective device.</i>
DNP3 . BinaryOutput5	<i>Virtual Digital Output (DNP). This corresponds to a virtual binary input of the protective device.</i>
DNP3 . BinaryOutput6	<i>Virtual Digital Output (DNP). This corresponds to a virtual binary input of the protective device.</i>
DNP3 . BinaryOutput7	<i>Virtual Digital Output (DNP). This corresponds to a virtual binary input of the protective device.</i>
DNP3 . BinaryOutput8	<i>Virtual Digital Output (DNP). This corresponds to a virtual binary input of the protective device.</i>
DNP3 . BinaryOutput9	<i>Virtual Digital Output (DNP). This corresponds to a virtual binary input of the protective device.</i>
DNP3 . BinaryOutput10	<i>Virtual Digital Output (DNP). This corresponds to a virtual binary input of the protective device.</i>

1..n, DI-LogicList	Description
DNP3 . BinaryOutput11	<i>Virtual Digital Output (DNP). This corresponds to a virtual binary input of the protective device.</i>
DNP3 . BinaryOutput12	<i>Virtual Digital Output (DNP). This corresponds to a virtual binary input of the protective device.</i>
DNP3 . BinaryOutput13	<i>Virtual Digital Output (DNP). This corresponds to a virtual binary input of the protective device.</i>
DNP3 . BinaryOutput14	<i>Virtual Digital Output (DNP). This corresponds to a virtual binary input of the protective device.</i>
DNP3 . BinaryOutput15	<i>Virtual Digital Output (DNP). This corresponds to a virtual binary input of the protective device.</i>
DNP3 . BinaryOutput16	<i>Virtual Digital Output (DNP). This corresponds to a virtual binary input of the protective device.</i>
DNP3 . BinaryOutput17	<i>Virtual Digital Output (DNP). This corresponds to a virtual binary input of the protective device.</i>
DNP3 . BinaryOutput18	<i>Virtual Digital Output (DNP). This corresponds to a virtual binary input of the protective device.</i>
DNP3 . BinaryOutput19	<i>Virtual Digital Output (DNP). This corresponds to a virtual binary input of the protective device.</i>
DNP3 . BinaryOutput20	<i>Virtual Digital Output (DNP). This corresponds to a virtual binary input of the protective device.</i>
DNP3 . BinaryOutput21	<i>Virtual Digital Output (DNP). This corresponds to a virtual binary input of the protective device.</i>
DNP3 . BinaryOutput22	<i>Virtual Digital Output (DNP). This corresponds to a virtual binary input of the protective device.</i>
DNP3 . BinaryOutput23	<i>Virtual Digital Output (DNP). This corresponds to a virtual binary input of the protective device.</i>
DNP3 . BinaryOutput24	<i>Virtual Digital Output (DNP). This corresponds to a virtual binary input of the protective device.</i>
DNP3 . BinaryOutput25	<i>Virtual Digital Output (DNP). This corresponds to a virtual binary input of the protective device.</i>
DNP3 . BinaryOutput26	<i>Virtual Digital Output (DNP). This corresponds to a virtual binary input of the protective device.</i>
DNP3 . BinaryOutput27	<i>Virtual Digital Output (DNP). This corresponds to a virtual binary input of the protective device.</i>
DNP3 . BinaryOutput28	<i>Virtual Digital Output (DNP). This corresponds to a virtual binary input of the protective device.</i>
DNP3 . BinaryOutput29	<i>Virtual Digital Output (DNP). This corresponds to a virtual binary input of the protective device.</i>
DNP3 . BinaryOutput30	<i>Virtual Digital Output (DNP). This corresponds to a virtual binary input of the protective device.</i>

1..n, DI-LogicList	Description
DNP3 . BinaryOutput31	<i>Virtual Digital Output (DNP). This corresponds to a virtual binary input of the protective device.</i>
IEC104 . Scada Cmd 1	<i>Scada Command</i>
IEC104 . Scada Cmd 2	<i>Scada Command</i>
IEC104 . Scada Cmd 3	<i>Scada Command</i>
IEC104 . Scada Cmd 4	<i>Scada Command</i>
IEC104 . Scada Cmd 5	<i>Scada Command</i>
IEC104 . Scada Cmd 6	<i>Scada Command</i>
IEC104 . Scada Cmd 7	<i>Scada Command</i>
IEC104 . Scada Cmd 8	<i>Scada Command</i>
IEC104 . Scada Cmd 9	<i>Scada Command</i>
IEC104 . Scada Cmd 10	<i>Scada Command</i>
IEC104 . Scada Cmd 11	<i>Scada Command</i>
IEC104 . Scada Cmd 12	<i>Scada Command</i>
IEC104 . Scada Cmd 13	<i>Scada Command</i>
IEC104 . Scada Cmd 14	<i>Scada Command</i>
IEC104 . Scada Cmd 15	<i>Scada Command</i>
IEC104 . Scada Cmd 16	<i>Scada Command</i>
Logics . LE1.Gate Out	<i>Signal: Output of the logic gate</i>
Logics . LE1.Timer Out	<i>Signal: Timer Output</i>
Logics . LE1.Out	<i>Signal: Latched Output (Q)</i>
Logics . LE1.Out inverted	<i>Signal: Negated Latched Output (Q NOT)</i>
Logics . LE2.Gate Out	<i>Signal: Output of the logic gate</i>
Logics . LE2.Timer Out	<i>Signal: Timer Output</i>
Logics . LE2.Out	<i>Signal: Latched Output (Q)</i>
Logics . LE2.Out inverted	<i>Signal: Negated Latched Output (Q NOT)</i>
Logics . LE3.Gate Out	<i>Signal: Output of the logic gate</i>
Logics . LE3.Timer Out	<i>Signal: Timer Output</i>
Logics . LE3.Out	<i>Signal: Latched Output (Q)</i>
Logics . LE3.Out inverted	<i>Signal: Negated Latched Output (Q NOT)</i>

1..n, DI-LogicList	Description
Logics . LE4.Gate Out	<i>Signal: Output of the logic gate</i>
Logics . LE4.Timer Out	<i>Signal: Timer Output</i>
Logics . LE4.Out	<i>Signal: Latched Output (Q)</i>
Logics . LE4.Out inverted	<i>Signal: Negated Latched Output (Q NOT)</i>
Logics . LE5.Gate Out	<i>Signal: Output of the logic gate</i>
Logics . LE5.Timer Out	<i>Signal: Timer Output</i>
Logics . LE5.Out	<i>Signal: Latched Output (Q)</i>
Logics . LE5.Out inverted	<i>Signal: Negated Latched Output (Q NOT)</i>
Logics . LE6.Gate Out	<i>Signal: Output of the logic gate</i>
Logics . LE6.Timer Out	<i>Signal: Timer Output</i>
Logics . LE6.Out	<i>Signal: Latched Output (Q)</i>
Logics . LE6.Out inverted	<i>Signal: Negated Latched Output (Q NOT)</i>
Logics . LE7.Gate Out	<i>Signal: Output of the logic gate</i>
Logics . LE7.Timer Out	<i>Signal: Timer Output</i>
Logics . LE7.Out	<i>Signal: Latched Output (Q)</i>
Logics . LE7.Out inverted	<i>Signal: Negated Latched Output (Q NOT)</i>
Logics . LE8.Gate Out	<i>Signal: Output of the logic gate</i>
Logics . LE8.Timer Out	<i>Signal: Timer Output</i>
Logics . LE8.Out	<i>Signal: Latched Output (Q)</i>
Logics . LE8.Out inverted	<i>Signal: Negated Latched Output (Q NOT)</i>
Logics . LE9.Gate Out	<i>Signal: Output of the logic gate</i>
Logics . LE9.Timer Out	<i>Signal: Timer Output</i>
Logics . LE9.Out	<i>Signal: Latched Output (Q)</i>
Logics . LE9.Out inverted	<i>Signal: Negated Latched Output (Q NOT)</i>
Logics . LE10.Gate Out	<i>Signal: Output of the logic gate</i>
Logics . LE10.Timer Out	<i>Signal: Timer Output</i>
Logics . LE10.Out	<i>Signal: Latched Output (Q)</i>
Logics . LE10.Out inverted	<i>Signal: Negated Latched Output (Q NOT)</i>

1..n, DI-LogicList	Description
Logics . LE11.Gate Out	<i>Signal: Output of the logic gate</i>
Logics . LE11.Timer Out	<i>Signal: Timer Output</i>
Logics . LE11.Out	<i>Signal: Latched Output (Q)</i>
Logics . LE11.Out inverted	<i>Signal: Negated Latched Output (Q NOT)</i>
Logics . LE12.Gate Out	<i>Signal: Output of the logic gate</i>
Logics . LE12.Timer Out	<i>Signal: Timer Output</i>
Logics . LE12.Out	<i>Signal: Latched Output (Q)</i>
Logics . LE12.Out inverted	<i>Signal: Negated Latched Output (Q NOT)</i>
Logics . LE13.Gate Out	<i>Signal: Output of the logic gate</i>
Logics . LE13.Timer Out	<i>Signal: Timer Output</i>
Logics . LE13.Out	<i>Signal: Latched Output (Q)</i>
Logics . LE13.Out inverted	<i>Signal: Negated Latched Output (Q NOT)</i>
Logics . LE14.Gate Out	<i>Signal: Output of the logic gate</i>
Logics . LE14.Timer Out	<i>Signal: Timer Output</i>
Logics . LE14.Out	<i>Signal: Latched Output (Q)</i>
Logics . LE14.Out inverted	<i>Signal: Negated Latched Output (Q NOT)</i>
Logics . LE15.Gate Out	<i>Signal: Output of the logic gate</i>
Logics . LE15.Timer Out	<i>Signal: Timer Output</i>
Logics . LE15.Out	<i>Signal: Latched Output (Q)</i>
Logics . LE15.Out inverted	<i>Signal: Negated Latched Output (Q NOT)</i>
Logics . LE16.Gate Out	<i>Signal: Output of the logic gate</i>
Logics . LE16.Timer Out	<i>Signal: Timer Output</i>
Logics . LE16.Out	<i>Signal: Latched Output (Q)</i>
Logics . LE16.Out inverted	<i>Signal: Negated Latched Output (Q NOT)</i>
Logics . LE17.Gate Out	<i>Signal: Output of the logic gate</i>
Logics . LE17.Timer Out	<i>Signal: Timer Output</i>
Logics . LE17.Out	<i>Signal: Latched Output (Q)</i>
Logics . LE17.Out inverted	<i>Signal: Negated Latched Output (Q NOT)</i>

1..n, DI-LogicList	Description
Logics . LE18.Gate Out	<i>Signal: Output of the logic gate</i>
Logics . LE18.Timer Out	<i>Signal: Timer Output</i>
Logics . LE18.Out	<i>Signal: Latched Output (Q)</i>
Logics . LE18.Out inverted	<i>Signal: Negated Latched Output (Q NOT)</i>
Logics . LE19.Gate Out	<i>Signal: Output of the logic gate</i>
Logics . LE19.Timer Out	<i>Signal: Timer Output</i>
Logics . LE19.Out	<i>Signal: Latched Output (Q)</i>
Logics . LE19.Out inverted	<i>Signal: Negated Latched Output (Q NOT)</i>
Logics . LE20.Gate Out	<i>Signal: Output of the logic gate</i>
Logics . LE20.Timer Out	<i>Signal: Timer Output</i>
Logics . LE20.Out	<i>Signal: Latched Output (Q)</i>
Logics . LE20.Out inverted	<i>Signal: Negated Latched Output (Q NOT)</i>
Logics . LE21.Gate Out	<i>Signal: Output of the logic gate</i>
Logics . LE21.Timer Out	<i>Signal: Timer Output</i>
Logics . LE21.Out	<i>Signal: Latched Output (Q)</i>
Logics . LE21.Out inverted	<i>Signal: Negated Latched Output (Q NOT)</i>
Logics . LE22.Gate Out	<i>Signal: Output of the logic gate</i>
Logics . LE22.Timer Out	<i>Signal: Timer Output</i>
Logics . LE22.Out	<i>Signal: Latched Output (Q)</i>
Logics . LE22.Out inverted	<i>Signal: Negated Latched Output (Q NOT)</i>
Logics . LE23.Gate Out	<i>Signal: Output of the logic gate</i>
Logics . LE23.Timer Out	<i>Signal: Timer Output</i>
Logics . LE23.Out	<i>Signal: Latched Output (Q)</i>
Logics . LE23.Out inverted	<i>Signal: Negated Latched Output (Q NOT)</i>
Logics . LE24.Gate Out	<i>Signal: Output of the logic gate</i>
Logics . LE24.Timer Out	<i>Signal: Timer Output</i>
Logics . LE24.Out	<i>Signal: Latched Output (Q)</i>
Logics . LE24.Out inverted	<i>Signal: Negated Latched Output (Q NOT)</i>

1..n, DI-LogicList	Description
Logics . LE25.Gate Out	<i>Signal: Output of the logic gate</i>
Logics . LE25.Timer Out	<i>Signal: Timer Output</i>
Logics . LE25.Out	<i>Signal: Latched Output (Q)</i>
Logics . LE25.Out inverted	<i>Signal: Negated Latched Output (Q NOT)</i>
Logics . LE26.Gate Out	<i>Signal: Output of the logic gate</i>
Logics . LE26.Timer Out	<i>Signal: Timer Output</i>
Logics . LE26.Out	<i>Signal: Latched Output (Q)</i>
Logics . LE26.Out inverted	<i>Signal: Negated Latched Output (Q NOT)</i>
Logics . LE27.Gate Out	<i>Signal: Output of the logic gate</i>
Logics . LE27.Timer Out	<i>Signal: Timer Output</i>
Logics . LE27.Out	<i>Signal: Latched Output (Q)</i>
Logics . LE27.Out inverted	<i>Signal: Negated Latched Output (Q NOT)</i>
Logics . LE28.Gate Out	<i>Signal: Output of the logic gate</i>
Logics . LE28.Timer Out	<i>Signal: Timer Output</i>
Logics . LE28.Out	<i>Signal: Latched Output (Q)</i>
Logics . LE28.Out inverted	<i>Signal: Negated Latched Output (Q NOT)</i>
Logics . LE29.Gate Out	<i>Signal: Output of the logic gate</i>
Logics . LE29.Timer Out	<i>Signal: Timer Output</i>
Logics . LE29.Out	<i>Signal: Latched Output (Q)</i>
Logics . LE29.Out inverted	<i>Signal: Negated Latched Output (Q NOT)</i>
Logics . LE30.Gate Out	<i>Signal: Output of the logic gate</i>
Logics . LE30.Timer Out	<i>Signal: Timer Output</i>
Logics . LE30.Out	<i>Signal: Latched Output (Q)</i>
Logics . LE30.Out inverted	<i>Signal: Negated Latched Output (Q NOT)</i>
Logics . LE31.Gate Out	<i>Signal: Output of the logic gate</i>
Logics . LE31.Timer Out	<i>Signal: Timer Output</i>
Logics . LE31.Out	<i>Signal: Latched Output (Q)</i>
Logics . LE31.Out inverted	<i>Signal: Negated Latched Output (Q NOT)</i>

1..n, DI-LogicList	Description
Logics . LE32.Gate Out	<i>Signal: Output of the logic gate</i>
Logics . LE32.Timer Out	<i>Signal: Timer Output</i>
Logics . LE32.Out	<i>Signal: Latched Output (Q)</i>
Logics . LE32.Out inverted	<i>Signal: Negated Latched Output (Q NOT)</i>
Logics . LE33.Gate Out	<i>Signal: Output of the logic gate</i>
Logics . LE33.Timer Out	<i>Signal: Timer Output</i>
Logics . LE33.Out	<i>Signal: Latched Output (Q)</i>
Logics . LE33.Out inverted	<i>Signal: Negated Latched Output (Q NOT)</i>
Logics . LE34.Gate Out	<i>Signal: Output of the logic gate</i>
Logics . LE34.Timer Out	<i>Signal: Timer Output</i>
Logics . LE34.Out	<i>Signal: Latched Output (Q)</i>
Logics . LE34.Out inverted	<i>Signal: Negated Latched Output (Q NOT)</i>
Logics . LE35.Gate Out	<i>Signal: Output of the logic gate</i>
Logics . LE35.Timer Out	<i>Signal: Timer Output</i>
Logics . LE35.Out	<i>Signal: Latched Output (Q)</i>
Logics . LE35.Out inverted	<i>Signal: Negated Latched Output (Q NOT)</i>
Logics . LE36.Gate Out	<i>Signal: Output of the logic gate</i>
Logics . LE36.Timer Out	<i>Signal: Timer Output</i>
Logics . LE36.Out	<i>Signal: Latched Output (Q)</i>
Logics . LE36.Out inverted	<i>Signal: Negated Latched Output (Q NOT)</i>
Logics . LE37.Gate Out	<i>Signal: Output of the logic gate</i>
Logics . LE37.Timer Out	<i>Signal: Timer Output</i>
Logics . LE37.Out	<i>Signal: Latched Output (Q)</i>
Logics . LE37.Out inverted	<i>Signal: Negated Latched Output (Q NOT)</i>
Logics . LE38.Gate Out	<i>Signal: Output of the logic gate</i>
Logics . LE38.Timer Out	<i>Signal: Timer Output</i>
Logics . LE38.Out	<i>Signal: Latched Output (Q)</i>
Logics . LE38.Out inverted	<i>Signal: Negated Latched Output (Q NOT)</i>

1..n, DI-LogicList	Description
Logics . LE39.Gate Out	<i>Signal: Output of the logic gate</i>
Logics . LE39.Timer Out	<i>Signal: Timer Output</i>
Logics . LE39.Out	<i>Signal: Latched Output (Q)</i>
Logics . LE39.Out inverted	<i>Signal: Negated Latched Output (Q NOT)</i>
Logics . LE40.Gate Out	<i>Signal: Output of the logic gate</i>
Logics . LE40.Timer Out	<i>Signal: Timer Output</i>
Logics . LE40.Out	<i>Signal: Latched Output (Q)</i>
Logics . LE40.Out inverted	<i>Signal: Negated Latched Output (Q NOT)</i>
Logics . LE41.Gate Out	<i>Signal: Output of the logic gate</i>
Logics . LE41.Timer Out	<i>Signal: Timer Output</i>
Logics . LE41.Out	<i>Signal: Latched Output (Q)</i>
Logics . LE41.Out inverted	<i>Signal: Negated Latched Output (Q NOT)</i>
Logics . LE42.Gate Out	<i>Signal: Output of the logic gate</i>
Logics . LE42.Timer Out	<i>Signal: Timer Output</i>
Logics . LE42.Out	<i>Signal: Latched Output (Q)</i>
Logics . LE42.Out inverted	<i>Signal: Negated Latched Output (Q NOT)</i>
Logics . LE43.Gate Out	<i>Signal: Output of the logic gate</i>
Logics . LE43.Timer Out	<i>Signal: Timer Output</i>
Logics . LE43.Out	<i>Signal: Latched Output (Q)</i>
Logics . LE43.Out inverted	<i>Signal: Negated Latched Output (Q NOT)</i>
Logics . LE44.Gate Out	<i>Signal: Output of the logic gate</i>
Logics . LE44.Timer Out	<i>Signal: Timer Output</i>
Logics . LE44.Out	<i>Signal: Latched Output (Q)</i>
Logics . LE44.Out inverted	<i>Signal: Negated Latched Output (Q NOT)</i>
Logics . LE45.Gate Out	<i>Signal: Output of the logic gate</i>
Logics . LE45.Timer Out	<i>Signal: Timer Output</i>
Logics . LE45.Out	<i>Signal: Latched Output (Q)</i>
Logics . LE45.Out inverted	<i>Signal: Negated Latched Output (Q NOT)</i>

1..n, DI-LogicList	Description
Logics . LE46.Gate Out	<i>Signal: Output of the logic gate</i>
Logics . LE46.Timer Out	<i>Signal: Timer Output</i>
Logics . LE46.Out	<i>Signal: Latched Output (Q)</i>
Logics . LE46.Out inverted	<i>Signal: Negated Latched Output (Q NOT)</i>
Logics . LE47.Gate Out	<i>Signal: Output of the logic gate</i>
Logics . LE47.Timer Out	<i>Signal: Timer Output</i>
Logics . LE47.Out	<i>Signal: Latched Output (Q)</i>
Logics . LE47.Out inverted	<i>Signal: Negated Latched Output (Q NOT)</i>
Logics . LE48.Gate Out	<i>Signal: Output of the logic gate</i>
Logics . LE48.Timer Out	<i>Signal: Timer Output</i>
Logics . LE48.Out	<i>Signal: Latched Output (Q)</i>
Logics . LE48.Out inverted	<i>Signal: Negated Latched Output (Q NOT)</i>
Logics . LE49.Gate Out	<i>Signal: Output of the logic gate</i>
Logics . LE49.Timer Out	<i>Signal: Timer Output</i>
Logics . LE49.Out	<i>Signal: Latched Output (Q)</i>
Logics . LE49.Out inverted	<i>Signal: Negated Latched Output (Q NOT)</i>
Logics . LE50.Gate Out	<i>Signal: Output of the logic gate</i>
Logics . LE50.Timer Out	<i>Signal: Timer Output</i>
Logics . LE50.Out	<i>Signal: Latched Output (Q)</i>
Logics . LE50.Out inverted	<i>Signal: Negated Latched Output (Q NOT)</i>
Logics . LE51.Gate Out	<i>Signal: Output of the logic gate</i>
Logics . LE51.Timer Out	<i>Signal: Timer Output</i>
Logics . LE51.Out	<i>Signal: Latched Output (Q)</i>
Logics . LE51.Out inverted	<i>Signal: Negated Latched Output (Q NOT)</i>
Logics . LE52.Gate Out	<i>Signal: Output of the logic gate</i>
Logics . LE52.Timer Out	<i>Signal: Timer Output</i>
Logics . LE52.Out	<i>Signal: Latched Output (Q)</i>
Logics . LE52.Out inverted	<i>Signal: Negated Latched Output (Q NOT)</i>

1..n, DI-LogicList	Description
Logics . LE53.Gate Out	<i>Signal: Output of the logic gate</i>
Logics . LE53.Timer Out	<i>Signal: Timer Output</i>
Logics . LE53.Out	<i>Signal: Latched Output (Q)</i>
Logics . LE53.Out inverted	<i>Signal: Negated Latched Output (Q NOT)</i>
Logics . LE54.Gate Out	<i>Signal: Output of the logic gate</i>
Logics . LE54.Timer Out	<i>Signal: Timer Output</i>
Logics . LE54.Out	<i>Signal: Latched Output (Q)</i>
Logics . LE54.Out inverted	<i>Signal: Negated Latched Output (Q NOT)</i>
Logics . LE55.Gate Out	<i>Signal: Output of the logic gate</i>
Logics . LE55.Timer Out	<i>Signal: Timer Output</i>
Logics . LE55.Out	<i>Signal: Latched Output (Q)</i>
Logics . LE55.Out inverted	<i>Signal: Negated Latched Output (Q NOT)</i>
Logics . LE56.Gate Out	<i>Signal: Output of the logic gate</i>
Logics . LE56.Timer Out	<i>Signal: Timer Output</i>
Logics . LE56.Out	<i>Signal: Latched Output (Q)</i>
Logics . LE56.Out inverted	<i>Signal: Negated Latched Output (Q NOT)</i>
Logics . LE57.Gate Out	<i>Signal: Output of the logic gate</i>
Logics . LE57.Timer Out	<i>Signal: Timer Output</i>
Logics . LE57.Out	<i>Signal: Latched Output (Q)</i>
Logics . LE57.Out inverted	<i>Signal: Negated Latched Output (Q NOT)</i>
Logics . LE58.Gate Out	<i>Signal: Output of the logic gate</i>
Logics . LE58.Timer Out	<i>Signal: Timer Output</i>
Logics . LE58.Out	<i>Signal: Latched Output (Q)</i>
Logics . LE58.Out inverted	<i>Signal: Negated Latched Output (Q NOT)</i>
Logics . LE59.Gate Out	<i>Signal: Output of the logic gate</i>
Logics . LE59.Timer Out	<i>Signal: Timer Output</i>
Logics . LE59.Out	<i>Signal: Latched Output (Q)</i>
Logics . LE59.Out inverted	<i>Signal: Negated Latched Output (Q NOT)</i>

1..n, DI-LogicList	Description
Logics . LE60.Gate Out	<i>Signal: Output of the logic gate</i>
Logics . LE60.Timer Out	<i>Signal: Timer Output</i>
Logics . LE60.Out	<i>Signal: Latched Output (Q)</i>
Logics . LE60.Out inverted	<i>Signal: Negated Latched Output (Q NOT)</i>
Logics . LE61.Gate Out	<i>Signal: Output of the logic gate</i>
Logics . LE61.Timer Out	<i>Signal: Timer Output</i>
Logics . LE61.Out	<i>Signal: Latched Output (Q)</i>
Logics . LE61.Out inverted	<i>Signal: Negated Latched Output (Q NOT)</i>
Logics . LE62.Gate Out	<i>Signal: Output of the logic gate</i>
Logics . LE62.Timer Out	<i>Signal: Timer Output</i>
Logics . LE62.Out	<i>Signal: Latched Output (Q)</i>
Logics . LE62.Out inverted	<i>Signal: Negated Latched Output (Q NOT)</i>
Logics . LE63.Gate Out	<i>Signal: Output of the logic gate</i>
Logics . LE63.Timer Out	<i>Signal: Timer Output</i>
Logics . LE63.Out	<i>Signal: Latched Output (Q)</i>
Logics . LE63.Out inverted	<i>Signal: Negated Latched Output (Q NOT)</i>
Logics . LE64.Gate Out	<i>Signal: Output of the logic gate</i>
Logics . LE64.Timer Out	<i>Signal: Timer Output</i>
Logics . LE64.Out	<i>Signal: Latched Output (Q)</i>
Logics . LE64.Out inverted	<i>Signal: Negated Latched Output (Q NOT)</i>
Logics . LE65.Gate Out	<i>Signal: Output of the logic gate</i>
Logics . LE65.Timer Out	<i>Signal: Timer Output</i>
Logics . LE65.Out	<i>Signal: Latched Output (Q)</i>
Logics . LE65.Out inverted	<i>Signal: Negated Latched Output (Q NOT)</i>
Logics . LE66.Gate Out	<i>Signal: Output of the logic gate</i>
Logics . LE66.Timer Out	<i>Signal: Timer Output</i>
Logics . LE66.Out	<i>Signal: Latched Output (Q)</i>
Logics . LE66.Out inverted	<i>Signal: Negated Latched Output (Q NOT)</i>

1..n, DI-LogicList	Description
Logics . LE67.Gate Out	<i>Signal: Output of the logic gate</i>
Logics . LE67.Timer Out	<i>Signal: Timer Output</i>
Logics . LE67.Out	<i>Signal: Latched Output (Q)</i>
Logics . LE67.Out inverted	<i>Signal: Negated Latched Output (Q NOT)</i>
Logics . LE68.Gate Out	<i>Signal: Output of the logic gate</i>
Logics . LE68.Timer Out	<i>Signal: Timer Output</i>
Logics . LE68.Out	<i>Signal: Latched Output (Q)</i>
Logics . LE68.Out inverted	<i>Signal: Negated Latched Output (Q NOT)</i>
Logics . LE69.Gate Out	<i>Signal: Output of the logic gate</i>
Logics . LE69.Timer Out	<i>Signal: Timer Output</i>
Logics . LE69.Out	<i>Signal: Latched Output (Q)</i>
Logics . LE69.Out inverted	<i>Signal: Negated Latched Output (Q NOT)</i>
Logics . LE70.Gate Out	<i>Signal: Output of the logic gate</i>
Logics . LE70.Timer Out	<i>Signal: Timer Output</i>
Logics . LE70.Out	<i>Signal: Latched Output (Q)</i>
Logics . LE70.Out inverted	<i>Signal: Negated Latched Output (Q NOT)</i>
Logics . LE71.Gate Out	<i>Signal: Output of the logic gate</i>
Logics . LE71.Timer Out	<i>Signal: Timer Output</i>
Logics . LE71.Out	<i>Signal: Latched Output (Q)</i>
Logics . LE71.Out inverted	<i>Signal: Negated Latched Output (Q NOT)</i>
Logics . LE72.Gate Out	<i>Signal: Output of the logic gate</i>
Logics . LE72.Timer Out	<i>Signal: Timer Output</i>
Logics . LE72.Out	<i>Signal: Latched Output (Q)</i>
Logics . LE72.Out inverted	<i>Signal: Negated Latched Output (Q NOT)</i>
Logics . LE73.Gate Out	<i>Signal: Output of the logic gate</i>
Logics . LE73.Timer Out	<i>Signal: Timer Output</i>
Logics . LE73.Out	<i>Signal: Latched Output (Q)</i>
Logics . LE73.Out inverted	<i>Signal: Negated Latched Output (Q NOT)</i>

1..n, DI-LogicList	Description
Logics . LE74.Gate Out	<i>Signal: Output of the logic gate</i>
Logics . LE74.Timer Out	<i>Signal: Timer Output</i>
Logics . LE74.Out	<i>Signal: Latched Output (Q)</i>
Logics . LE74.Out inverted	<i>Signal: Negated Latched Output (Q NOT)</i>
Logics . LE75.Gate Out	<i>Signal: Output of the logic gate</i>
Logics . LE75.Timer Out	<i>Signal: Timer Output</i>
Logics . LE75.Out	<i>Signal: Latched Output (Q)</i>
Logics . LE75.Out inverted	<i>Signal: Negated Latched Output (Q NOT)</i>
Logics . LE76.Gate Out	<i>Signal: Output of the logic gate</i>
Logics . LE76.Timer Out	<i>Signal: Timer Output</i>
Logics . LE76.Out	<i>Signal: Latched Output (Q)</i>
Logics . LE76.Out inverted	<i>Signal: Negated Latched Output (Q NOT)</i>
Logics . LE77.Gate Out	<i>Signal: Output of the logic gate</i>
Logics . LE77.Timer Out	<i>Signal: Timer Output</i>
Logics . LE77.Out	<i>Signal: Latched Output (Q)</i>
Logics . LE77.Out inverted	<i>Signal: Negated Latched Output (Q NOT)</i>
Logics . LE78.Gate Out	<i>Signal: Output of the logic gate</i>
Logics . LE78.Timer Out	<i>Signal: Timer Output</i>
Logics . LE78.Out	<i>Signal: Latched Output (Q)</i>
Logics . LE78.Out inverted	<i>Signal: Negated Latched Output (Q NOT)</i>
Logics . LE79.Gate Out	<i>Signal: Output of the logic gate</i>
Logics . LE79.Timer Out	<i>Signal: Timer Output</i>
Logics . LE79.Out	<i>Signal: Latched Output (Q)</i>
Logics . LE79.Out inverted	<i>Signal: Negated Latched Output (Q NOT)</i>
Logics . LE80.Gate Out	<i>Signal: Output of the logic gate</i>
Logics . LE80.Timer Out	<i>Signal: Timer Output</i>
Logics . LE80.Out	<i>Signal: Latched Output (Q)</i>
Logics . LE80.Out inverted	<i>Signal: Negated Latched Output (Q NOT)</i>

1..n, SyncRequestList

Selection list referenced by the following parameters:

-  Sync . CBCloseInitiate

1..n, SyncRequestList	Description
"_"	<i>No assignment</i>
SG[1] . Sync ON request	<i>Signal: Synchronous ON request</i>
SG[2] . Sync ON request	<i>Signal: Synchronous ON request</i>
SG[3] . Sync ON request	<i>Signal: Synchronous ON request</i>
SG[4] . Sync ON request	<i>Signal: Synchronous ON request</i>
SG[5] . Sync ON request	<i>Signal: Synchronous ON request</i>
SG[6] . Sync ON request	<i>Signal: Synchronous ON request</i>
DI Slot X1 . DI 1	<i>Signal: Digital Input</i>
DI Slot X1 . DI 2	<i>Signal: Digital Input</i>
DI Slot X1 . DI 3	<i>Signal: Digital Input</i>
DI Slot X1 . DI 4	<i>Signal: Digital Input</i>
DI Slot X1 . DI 5	<i>Signal: Digital Input</i>
DI Slot X1 . DI 6	<i>Signal: Digital Input</i>
DI Slot X1 . DI 7	<i>Signal: Digital Input</i>
DI Slot X1 . DI 8	<i>Signal: Digital Input</i>
DI Slot X5 . DI 1	<i>Signal: Digital Input</i>
DI Slot X5 . DI 2	<i>Signal: Digital Input</i>
DI Slot X5 . DI 3	<i>Signal: Digital Input</i>
DI Slot X5 . DI 4	<i>Signal: Digital Input</i>
DI Slot X5 . DI 5	<i>Signal: Digital Input</i>
DI Slot X5 . DI 6	<i>Signal: Digital Input</i>
DI Slot X5 . DI 7	<i>Signal: Digital Input</i>
DI Slot X5 . DI 8	<i>Signal: Digital Input</i>

1..n, SyncRequestList	Description
DI Slot X6 . DI 1	<i>Signal: Digital Input</i>
DI Slot X6 . DI 2	<i>Signal: Digital Input</i>
DI Slot X6 . DI 3	<i>Signal: Digital Input</i>
DI Slot X6 . DI 4	<i>Signal: Digital Input</i>
DI Slot X6 . DI 5	<i>Signal: Digital Input</i>
DI Slot X6 . DI 6	<i>Signal: Digital Input</i>
DI Slot X6 . DI 7	<i>Signal: Digital Input</i>
DI Slot X6 . DI 8	<i>Signal: Digital Input</i>
Logics . LE1.Gate Out	<i>Signal: Output of the logic gate</i>
Logics . LE1.Timer Out	<i>Signal: Timer Output</i>
Logics . LE1.Out	<i>Signal: Latched Output (Q)</i>
Logics . LE1.Out inverted	<i>Signal: Negated Latched Output (Q NOT)</i>
Logics . LE2.Gate Out	<i>Signal: Output of the logic gate</i>
Logics . LE2.Timer Out	<i>Signal: Timer Output</i>
Logics . LE2.Out	<i>Signal: Latched Output (Q)</i>
Logics . LE2.Out inverted	<i>Signal: Negated Latched Output (Q NOT)</i>
Logics . LE3.Gate Out	<i>Signal: Output of the logic gate</i>
Logics . LE3.Timer Out	<i>Signal: Timer Output</i>
Logics . LE3.Out	<i>Signal: Latched Output (Q)</i>
Logics . LE3.Out inverted	<i>Signal: Negated Latched Output (Q NOT)</i>
Logics . LE4.Gate Out	<i>Signal: Output of the logic gate</i>
Logics . LE4.Timer Out	<i>Signal: Timer Output</i>
Logics . LE4.Out	<i>Signal: Latched Output (Q)</i>
Logics . LE4.Out inverted	<i>Signal: Negated Latched Output (Q NOT)</i>
Logics . LE5.Gate Out	<i>Signal: Output of the logic gate</i>
Logics . LE5.Timer Out	<i>Signal: Timer Output</i>
Logics . LE5.Out	<i>Signal: Latched Output (Q)</i>
Logics . LE5.Out inverted	<i>Signal: Negated Latched Output (Q NOT)</i>
Logics . LE6.Gate Out	<i>Signal: Output of the logic gate</i>

1..n, SyncRequestList	Description
Logics . LE6.Timer Out	<i>Signal: Timer Output</i>
Logics . LE6.Out	<i>Signal: Latched Output (Q)</i>
Logics . LE6.Out inverted	<i>Signal: Negated Latched Output (Q NOT)</i>
Logics . LE7.Gate Out	<i>Signal: Output of the logic gate</i>
Logics . LE7.Timer Out	<i>Signal: Timer Output</i>
Logics . LE7.Out	<i>Signal: Latched Output (Q)</i>
Logics . LE7.Out inverted	<i>Signal: Negated Latched Output (Q NOT)</i>
Logics . LE8.Gate Out	<i>Signal: Output of the logic gate</i>
Logics . LE8.Timer Out	<i>Signal: Timer Output</i>
Logics . LE8.Out	<i>Signal: Latched Output (Q)</i>
Logics . LE8.Out inverted	<i>Signal: Negated Latched Output (Q NOT)</i>
Logics . LE9.Gate Out	<i>Signal: Output of the logic gate</i>
Logics . LE9.Timer Out	<i>Signal: Timer Output</i>
Logics . LE9.Out	<i>Signal: Latched Output (Q)</i>
Logics . LE9.Out inverted	<i>Signal: Negated Latched Output (Q NOT)</i>
Logics . LE10.Gate Out	<i>Signal: Output of the logic gate</i>
Logics . LE10.Timer Out	<i>Signal: Timer Output</i>
Logics . LE10.Out	<i>Signal: Latched Output (Q)</i>
Logics . LE10.Out inverted	<i>Signal: Negated Latched Output (Q NOT)</i>
Logics . LE11.Gate Out	<i>Signal: Output of the logic gate</i>
Logics . LE11.Timer Out	<i>Signal: Timer Output</i>
Logics . LE11.Out	<i>Signal: Latched Output (Q)</i>
Logics . LE11.Out inverted	<i>Signal: Negated Latched Output (Q NOT)</i>
Logics . LE12.Gate Out	<i>Signal: Output of the logic gate</i>
Logics . LE12.Timer Out	<i>Signal: Timer Output</i>
Logics . LE12.Out	<i>Signal: Latched Output (Q)</i>
Logics . LE12.Out inverted	<i>Signal: Negated Latched Output (Q NOT)</i>
Logics . LE13.Gate Out	<i>Signal: Output of the logic gate</i>

1..n, SyncRequestList	Description
Logics . LE13.Timer Out	<i>Signal: Timer Output</i>
Logics . LE13.Out	<i>Signal: Latched Output (Q)</i>
Logics . LE13.Out inverted	<i>Signal: Negated Latched Output (Q NOT)</i>
Logics . LE14.Gate Out	<i>Signal: Output of the logic gate</i>
Logics . LE14.Timer Out	<i>Signal: Timer Output</i>
Logics . LE14.Out	<i>Signal: Latched Output (Q)</i>
Logics . LE14.Out inverted	<i>Signal: Negated Latched Output (Q NOT)</i>
Logics . LE15.Gate Out	<i>Signal: Output of the logic gate</i>
Logics . LE15.Timer Out	<i>Signal: Timer Output</i>
Logics . LE15.Out	<i>Signal: Latched Output (Q)</i>
Logics . LE15.Out inverted	<i>Signal: Negated Latched Output (Q NOT)</i>
Logics . LE16.Gate Out	<i>Signal: Output of the logic gate</i>
Logics . LE16.Timer Out	<i>Signal: Timer Output</i>
Logics . LE16.Out	<i>Signal: Latched Output (Q)</i>
Logics . LE16.Out inverted	<i>Signal: Negated Latched Output (Q NOT)</i>
Logics . LE17.Gate Out	<i>Signal: Output of the logic gate</i>
Logics . LE17.Timer Out	<i>Signal: Timer Output</i>
Logics . LE17.Out	<i>Signal: Latched Output (Q)</i>
Logics . LE17.Out inverted	<i>Signal: Negated Latched Output (Q NOT)</i>
Logics . LE18.Gate Out	<i>Signal: Output of the logic gate</i>
Logics . LE18.Timer Out	<i>Signal: Timer Output</i>
Logics . LE18.Out	<i>Signal: Latched Output (Q)</i>
Logics . LE18.Out inverted	<i>Signal: Negated Latched Output (Q NOT)</i>
Logics . LE19.Gate Out	<i>Signal: Output of the logic gate</i>
Logics . LE19.Timer Out	<i>Signal: Timer Output</i>
Logics . LE19.Out	<i>Signal: Latched Output (Q)</i>
Logics . LE19.Out inverted	<i>Signal: Negated Latched Output (Q NOT)</i>
Logics . LE20.Gate Out	<i>Signal: Output of the logic gate</i>

1..n, SyncRequestList	Description
Logics . LE20.Timer Out	<i>Signal: Timer Output</i>
Logics . LE20.Out	<i>Signal: Latched Output (Q)</i>
Logics . LE20.Out inverted	<i>Signal: Negated Latched Output (Q NOT)</i>
Logics . LE21.Gate Out	<i>Signal: Output of the logic gate</i>
Logics . LE21.Timer Out	<i>Signal: Timer Output</i>
Logics . LE21.Out	<i>Signal: Latched Output (Q)</i>
Logics . LE21.Out inverted	<i>Signal: Negated Latched Output (Q NOT)</i>
Logics . LE22.Gate Out	<i>Signal: Output of the logic gate</i>
Logics . LE22.Timer Out	<i>Signal: Timer Output</i>
Logics . LE22.Out	<i>Signal: Latched Output (Q)</i>
Logics . LE22.Out inverted	<i>Signal: Negated Latched Output (Q NOT)</i>
Logics . LE23.Gate Out	<i>Signal: Output of the logic gate</i>
Logics . LE23.Timer Out	<i>Signal: Timer Output</i>
Logics . LE23.Out	<i>Signal: Latched Output (Q)</i>
Logics . LE23.Out inverted	<i>Signal: Negated Latched Output (Q NOT)</i>
Logics . LE24.Gate Out	<i>Signal: Output of the logic gate</i>
Logics . LE24.Timer Out	<i>Signal: Timer Output</i>
Logics . LE24.Out	<i>Signal: Latched Output (Q)</i>
Logics . LE24.Out inverted	<i>Signal: Negated Latched Output (Q NOT)</i>
Logics . LE25.Gate Out	<i>Signal: Output of the logic gate</i>
Logics . LE25.Timer Out	<i>Signal: Timer Output</i>
Logics . LE25.Out	<i>Signal: Latched Output (Q)</i>
Logics . LE25.Out inverted	<i>Signal: Negated Latched Output (Q NOT)</i>
Logics . LE26.Gate Out	<i>Signal: Output of the logic gate</i>
Logics . LE26.Timer Out	<i>Signal: Timer Output</i>
Logics . LE26.Out	<i>Signal: Latched Output (Q)</i>
Logics . LE26.Out inverted	<i>Signal: Negated Latched Output (Q NOT)</i>
Logics . LE27.Gate Out	<i>Signal: Output of the logic gate</i>

1..n, SyncRequestList	Description
Logics . LE27.Timer Out	<i>Signal: Timer Output</i>
Logics . LE27.Out	<i>Signal: Latched Output (Q)</i>
Logics . LE27.Out inverted	<i>Signal: Negated Latched Output (Q NOT)</i>
Logics . LE28.Gate Out	<i>Signal: Output of the logic gate</i>
Logics . LE28.Timer Out	<i>Signal: Timer Output</i>
Logics . LE28.Out	<i>Signal: Latched Output (Q)</i>
Logics . LE28.Out inverted	<i>Signal: Negated Latched Output (Q NOT)</i>
Logics . LE29.Gate Out	<i>Signal: Output of the logic gate</i>
Logics . LE29.Timer Out	<i>Signal: Timer Output</i>
Logics . LE29.Out	<i>Signal: Latched Output (Q)</i>
Logics . LE29.Out inverted	<i>Signal: Negated Latched Output (Q NOT)</i>
Logics . LE30.Gate Out	<i>Signal: Output of the logic gate</i>
Logics . LE30.Timer Out	<i>Signal: Timer Output</i>
Logics . LE30.Out	<i>Signal: Latched Output (Q)</i>
Logics . LE30.Out inverted	<i>Signal: Negated Latched Output (Q NOT)</i>
Logics . LE31.Gate Out	<i>Signal: Output of the logic gate</i>
Logics . LE31.Timer Out	<i>Signal: Timer Output</i>
Logics . LE31.Out	<i>Signal: Latched Output (Q)</i>
Logics . LE31.Out inverted	<i>Signal: Negated Latched Output (Q NOT)</i>
Logics . LE32.Gate Out	<i>Signal: Output of the logic gate</i>
Logics . LE32.Timer Out	<i>Signal: Timer Output</i>
Logics . LE32.Out	<i>Signal: Latched Output (Q)</i>
Logics . LE32.Out inverted	<i>Signal: Negated Latched Output (Q NOT)</i>
Logics . LE33.Gate Out	<i>Signal: Output of the logic gate</i>
Logics . LE33.Timer Out	<i>Signal: Timer Output</i>
Logics . LE33.Out	<i>Signal: Latched Output (Q)</i>
Logics . LE33.Out inverted	<i>Signal: Negated Latched Output (Q NOT)</i>
Logics . LE34.Gate Out	<i>Signal: Output of the logic gate</i>

1..n, SyncRequestList	Description
Logics . LE34.Timer Out	<i>Signal: Timer Output</i>
Logics . LE34.Out	<i>Signal: Latched Output (Q)</i>
Logics . LE34.Out inverted	<i>Signal: Negated Latched Output (Q NOT)</i>
Logics . LE35.Gate Out	<i>Signal: Output of the logic gate</i>
Logics . LE35.Timer Out	<i>Signal: Timer Output</i>
Logics . LE35.Out	<i>Signal: Latched Output (Q)</i>
Logics . LE35.Out inverted	<i>Signal: Negated Latched Output (Q NOT)</i>
Logics . LE36.Gate Out	<i>Signal: Output of the logic gate</i>
Logics . LE36.Timer Out	<i>Signal: Timer Output</i>
Logics . LE36.Out	<i>Signal: Latched Output (Q)</i>
Logics . LE36.Out inverted	<i>Signal: Negated Latched Output (Q NOT)</i>
Logics . LE37.Gate Out	<i>Signal: Output of the logic gate</i>
Logics . LE37.Timer Out	<i>Signal: Timer Output</i>
Logics . LE37.Out	<i>Signal: Latched Output (Q)</i>
Logics . LE37.Out inverted	<i>Signal: Negated Latched Output (Q NOT)</i>
Logics . LE38.Gate Out	<i>Signal: Output of the logic gate</i>
Logics . LE38.Timer Out	<i>Signal: Timer Output</i>
Logics . LE38.Out	<i>Signal: Latched Output (Q)</i>
Logics . LE38.Out inverted	<i>Signal: Negated Latched Output (Q NOT)</i>
Logics . LE39.Gate Out	<i>Signal: Output of the logic gate</i>
Logics . LE39.Timer Out	<i>Signal: Timer Output</i>
Logics . LE39.Out	<i>Signal: Latched Output (Q)</i>
Logics . LE39.Out inverted	<i>Signal: Negated Latched Output (Q NOT)</i>
Logics . LE40.Gate Out	<i>Signal: Output of the logic gate</i>
Logics . LE40.Timer Out	<i>Signal: Timer Output</i>
Logics . LE40.Out	<i>Signal: Latched Output (Q)</i>
Logics . LE40.Out inverted	<i>Signal: Negated Latched Output (Q NOT)</i>
Logics . LE41.Gate Out	<i>Signal: Output of the logic gate</i>

1..n, SyncRequestList	Description
Logics . LE41.Timer Out	<i>Signal: Timer Output</i>
Logics . LE41.Out	<i>Signal: Latched Output (Q)</i>
Logics . LE41.Out inverted	<i>Signal: Negated Latched Output (Q NOT)</i>
Logics . LE42.Gate Out	<i>Signal: Output of the logic gate</i>
Logics . LE42.Timer Out	<i>Signal: Timer Output</i>
Logics . LE42.Out	<i>Signal: Latched Output (Q)</i>
Logics . LE42.Out inverted	<i>Signal: Negated Latched Output (Q NOT)</i>
Logics . LE43.Gate Out	<i>Signal: Output of the logic gate</i>
Logics . LE43.Timer Out	<i>Signal: Timer Output</i>
Logics . LE43.Out	<i>Signal: Latched Output (Q)</i>
Logics . LE43.Out inverted	<i>Signal: Negated Latched Output (Q NOT)</i>
Logics . LE44.Gate Out	<i>Signal: Output of the logic gate</i>
Logics . LE44.Timer Out	<i>Signal: Timer Output</i>
Logics . LE44.Out	<i>Signal: Latched Output (Q)</i>
Logics . LE44.Out inverted	<i>Signal: Negated Latched Output (Q NOT)</i>
Logics . LE45.Gate Out	<i>Signal: Output of the logic gate</i>
Logics . LE45.Timer Out	<i>Signal: Timer Output</i>
Logics . LE45.Out	<i>Signal: Latched Output (Q)</i>
Logics . LE45.Out inverted	<i>Signal: Negated Latched Output (Q NOT)</i>
Logics . LE46.Gate Out	<i>Signal: Output of the logic gate</i>
Logics . LE46.Timer Out	<i>Signal: Timer Output</i>
Logics . LE46.Out	<i>Signal: Latched Output (Q)</i>
Logics . LE46.Out inverted	<i>Signal: Negated Latched Output (Q NOT)</i>
Logics . LE47.Gate Out	<i>Signal: Output of the logic gate</i>
Logics . LE47.Timer Out	<i>Signal: Timer Output</i>
Logics . LE47.Out	<i>Signal: Latched Output (Q)</i>
Logics . LE47.Out inverted	<i>Signal: Negated Latched Output (Q NOT)</i>
Logics . LE48.Gate Out	<i>Signal: Output of the logic gate</i>

1..n, SyncRequestList	Description
Logics . LE48.Timer Out	<i>Signal: Timer Output</i>
Logics . LE48.Out	<i>Signal: Latched Output (Q)</i>
Logics . LE48.Out inverted	<i>Signal: Negated Latched Output (Q NOT)</i>
Logics . LE49.Gate Out	<i>Signal: Output of the logic gate</i>
Logics . LE49.Timer Out	<i>Signal: Timer Output</i>
Logics . LE49.Out	<i>Signal: Latched Output (Q)</i>
Logics . LE49.Out inverted	<i>Signal: Negated Latched Output (Q NOT)</i>
Logics . LE50.Gate Out	<i>Signal: Output of the logic gate</i>
Logics . LE50.Timer Out	<i>Signal: Timer Output</i>
Logics . LE50.Out	<i>Signal: Latched Output (Q)</i>
Logics . LE50.Out inverted	<i>Signal: Negated Latched Output (Q NOT)</i>
Logics . LE51.Gate Out	<i>Signal: Output of the logic gate</i>
Logics . LE51.Timer Out	<i>Signal: Timer Output</i>
Logics . LE51.Out	<i>Signal: Latched Output (Q)</i>
Logics . LE51.Out inverted	<i>Signal: Negated Latched Output (Q NOT)</i>
Logics . LE52.Gate Out	<i>Signal: Output of the logic gate</i>
Logics . LE52.Timer Out	<i>Signal: Timer Output</i>
Logics . LE52.Out	<i>Signal: Latched Output (Q)</i>
Logics . LE52.Out inverted	<i>Signal: Negated Latched Output (Q NOT)</i>
Logics . LE53.Gate Out	<i>Signal: Output of the logic gate</i>
Logics . LE53.Timer Out	<i>Signal: Timer Output</i>
Logics . LE53.Out	<i>Signal: Latched Output (Q)</i>
Logics . LE53.Out inverted	<i>Signal: Negated Latched Output (Q NOT)</i>
Logics . LE54.Gate Out	<i>Signal: Output of the logic gate</i>
Logics . LE54.Timer Out	<i>Signal: Timer Output</i>
Logics . LE54.Out	<i>Signal: Latched Output (Q)</i>
Logics . LE54.Out inverted	<i>Signal: Negated Latched Output (Q NOT)</i>
Logics . LE55.Gate Out	<i>Signal: Output of the logic gate</i>

1..n, SyncRequestList	Description
Logics . LE55.Timer Out	<i>Signal: Timer Output</i>
Logics . LE55.Out	<i>Signal: Latched Output (Q)</i>
Logics . LE55.Out inverted	<i>Signal: Negated Latched Output (Q NOT)</i>
Logics . LE56.Gate Out	<i>Signal: Output of the logic gate</i>
Logics . LE56.Timer Out	<i>Signal: Timer Output</i>
Logics . LE56.Out	<i>Signal: Latched Output (Q)</i>
Logics . LE56.Out inverted	<i>Signal: Negated Latched Output (Q NOT)</i>
Logics . LE57.Gate Out	<i>Signal: Output of the logic gate</i>
Logics . LE57.Timer Out	<i>Signal: Timer Output</i>
Logics . LE57.Out	<i>Signal: Latched Output (Q)</i>
Logics . LE57.Out inverted	<i>Signal: Negated Latched Output (Q NOT)</i>
Logics . LE58.Gate Out	<i>Signal: Output of the logic gate</i>
Logics . LE58.Timer Out	<i>Signal: Timer Output</i>
Logics . LE58.Out	<i>Signal: Latched Output (Q)</i>
Logics . LE58.Out inverted	<i>Signal: Negated Latched Output (Q NOT)</i>
Logics . LE59.Gate Out	<i>Signal: Output of the logic gate</i>
Logics . LE59.Timer Out	<i>Signal: Timer Output</i>
Logics . LE59.Out	<i>Signal: Latched Output (Q)</i>
Logics . LE59.Out inverted	<i>Signal: Negated Latched Output (Q NOT)</i>
Logics . LE60.Gate Out	<i>Signal: Output of the logic gate</i>
Logics . LE60.Timer Out	<i>Signal: Timer Output</i>
Logics . LE60.Out	<i>Signal: Latched Output (Q)</i>
Logics . LE60.Out inverted	<i>Signal: Negated Latched Output (Q NOT)</i>
Logics . LE61.Gate Out	<i>Signal: Output of the logic gate</i>
Logics . LE61.Timer Out	<i>Signal: Timer Output</i>
Logics . LE61.Out	<i>Signal: Latched Output (Q)</i>
Logics . LE61.Out inverted	<i>Signal: Negated Latched Output (Q NOT)</i>
Logics . LE62.Gate Out	<i>Signal: Output of the logic gate</i>

1..n, SyncRequestList	Description
Logics . LE62.Timer Out	<i>Signal: Timer Output</i>
Logics . LE62.Out	<i>Signal: Latched Output (Q)</i>
Logics . LE62.Out inverted	<i>Signal: Negated Latched Output (Q NOT)</i>
Logics . LE63.Gate Out	<i>Signal: Output of the logic gate</i>
Logics . LE63.Timer Out	<i>Signal: Timer Output</i>
Logics . LE63.Out	<i>Signal: Latched Output (Q)</i>
Logics . LE63.Out inverted	<i>Signal: Negated Latched Output (Q NOT)</i>
Logics . LE64.Gate Out	<i>Signal: Output of the logic gate</i>
Logics . LE64.Timer Out	<i>Signal: Timer Output</i>
Logics . LE64.Out	<i>Signal: Latched Output (Q)</i>
Logics . LE64.Out inverted	<i>Signal: Negated Latched Output (Q NOT)</i>
Logics . LE65.Gate Out	<i>Signal: Output of the logic gate</i>
Logics . LE65.Timer Out	<i>Signal: Timer Output</i>
Logics . LE65.Out	<i>Signal: Latched Output (Q)</i>
Logics . LE65.Out inverted	<i>Signal: Negated Latched Output (Q NOT)</i>
Logics . LE66.Gate Out	<i>Signal: Output of the logic gate</i>
Logics . LE66.Timer Out	<i>Signal: Timer Output</i>
Logics . LE66.Out	<i>Signal: Latched Output (Q)</i>
Logics . LE66.Out inverted	<i>Signal: Negated Latched Output (Q NOT)</i>
Logics . LE67.Gate Out	<i>Signal: Output of the logic gate</i>
Logics . LE67.Timer Out	<i>Signal: Timer Output</i>
Logics . LE67.Out	<i>Signal: Latched Output (Q)</i>
Logics . LE67.Out inverted	<i>Signal: Negated Latched Output (Q NOT)</i>
Logics . LE68.Gate Out	<i>Signal: Output of the logic gate</i>
Logics . LE68.Timer Out	<i>Signal: Timer Output</i>
Logics . LE68.Out	<i>Signal: Latched Output (Q)</i>
Logics . LE68.Out inverted	<i>Signal: Negated Latched Output (Q NOT)</i>
Logics . LE69.Gate Out	<i>Signal: Output of the logic gate</i>

1..n, SyncRequestList	Description
Logics . LE69.Timer Out	<i>Signal: Timer Output</i>
Logics . LE69.Out	<i>Signal: Latched Output (Q)</i>
Logics . LE69.Out inverted	<i>Signal: Negated Latched Output (Q NOT)</i>
Logics . LE70.Gate Out	<i>Signal: Output of the logic gate</i>
Logics . LE70.Timer Out	<i>Signal: Timer Output</i>
Logics . LE70.Out	<i>Signal: Latched Output (Q)</i>
Logics . LE70.Out inverted	<i>Signal: Negated Latched Output (Q NOT)</i>
Logics . LE71.Gate Out	<i>Signal: Output of the logic gate</i>
Logics . LE71.Timer Out	<i>Signal: Timer Output</i>
Logics . LE71.Out	<i>Signal: Latched Output (Q)</i>
Logics . LE71.Out inverted	<i>Signal: Negated Latched Output (Q NOT)</i>
Logics . LE72.Gate Out	<i>Signal: Output of the logic gate</i>
Logics . LE72.Timer Out	<i>Signal: Timer Output</i>
Logics . LE72.Out	<i>Signal: Latched Output (Q)</i>
Logics . LE72.Out inverted	<i>Signal: Negated Latched Output (Q NOT)</i>
Logics . LE73.Gate Out	<i>Signal: Output of the logic gate</i>
Logics . LE73.Timer Out	<i>Signal: Timer Output</i>
Logics . LE73.Out	<i>Signal: Latched Output (Q)</i>
Logics . LE73.Out inverted	<i>Signal: Negated Latched Output (Q NOT)</i>
Logics . LE74.Gate Out	<i>Signal: Output of the logic gate</i>
Logics . LE74.Timer Out	<i>Signal: Timer Output</i>
Logics . LE74.Out	<i>Signal: Latched Output (Q)</i>
Logics . LE74.Out inverted	<i>Signal: Negated Latched Output (Q NOT)</i>
Logics . LE75.Gate Out	<i>Signal: Output of the logic gate</i>
Logics . LE75.Timer Out	<i>Signal: Timer Output</i>
Logics . LE75.Out	<i>Signal: Latched Output (Q)</i>
Logics . LE75.Out inverted	<i>Signal: Negated Latched Output (Q NOT)</i>
Logics . LE76.Gate Out	<i>Signal: Output of the logic gate</i>

1..n, SyncRequestList	Description
Logics . LE76.Timer Out	<i>Signal: Timer Output</i>
Logics . LE76.Out	<i>Signal: Latched Output (Q)</i>
Logics . LE76.Out inverted	<i>Signal: Negated Latched Output (Q NOT)</i>
Logics . LE77.Gate Out	<i>Signal: Output of the logic gate</i>
Logics . LE77.Timer Out	<i>Signal: Timer Output</i>
Logics . LE77.Out	<i>Signal: Latched Output (Q)</i>
Logics . LE77.Out inverted	<i>Signal: Negated Latched Output (Q NOT)</i>
Logics . LE78.Gate Out	<i>Signal: Output of the logic gate</i>
Logics . LE78.Timer Out	<i>Signal: Timer Output</i>
Logics . LE78.Out	<i>Signal: Latched Output (Q)</i>
Logics . LE78.Out inverted	<i>Signal: Negated Latched Output (Q NOT)</i>
Logics . LE79.Gate Out	<i>Signal: Output of the logic gate</i>
Logics . LE79.Timer Out	<i>Signal: Timer Output</i>
Logics . LE79.Out	<i>Signal: Latched Output (Q)</i>
Logics . LE79.Out inverted	<i>Signal: Negated Latched Output (Q NOT)</i>
Logics . LE80.Gate Out	<i>Signal: Output of the logic gate</i>
Logics . LE80.Timer Out	<i>Signal: Timer Output</i>
Logics . LE80.Out	<i>Signal: Latched Output (Q)</i>
Logics . LE80.Out inverted	<i>Signal: Negated Latched Output (Q NOT)</i>

Mode

general operation mode

Selection list referenced by the following parameters:

-  SOTF . Mode

Mode	Description
CB Pos	<i>The CB Pos Indicator starts the Timer.</i>

Mode	Description
I<	The CB is in the OFF Position, if the measured current is less than this parameter.
CB Pos And I<	(The CB Pos Indicator starts the Timer.) And (The CB is in the OFF Position, if the measured current is less than this parameter.)
CB manual ON	Circuit breaker was switched on manually
Ext SOTF	External Switch Onto Fault

CB List

Selection list referenced by the following parameters:

-  SOTF . Assigned SG

CB List	Description
"_"	No assignment
. SG[1]	Switchgear
. SG[2]	Switchgear
. SG[3]	Switchgear
. SG[4]	Switchgear
. SG[5]	Switchgear
. SG[6]	Switchgear

Mode

general operation mode

Selection list referenced by the following parameters:

-  CLPU . Mode

Mode	Description
CB Pos	The CB Pos Indicator starts the Timer.
I<	The Pickup Timer will be started, if the measured current is less than parameter "I<".
CB Pos Or I<	(The CB Pos Indicator starts the Timer.) Or (The Pickup Timer will be started, if the measured current is less than parameter "I<".)

Mode	Description
CB Pos And I<	<i>(The CB Pos Indicator starts the Timer.) And (The Pickup Timer will be started, if the measured current is less than parameter "I<".)</i>

TripCmd Selection

This parameter determines if the final trip of the RTD module is issued by the default way or by the voting groups.

Selection list referenced by the following parameters:

-  RTD . TripCmd Selection

TripCmd Selection	Description
Trip	<i>Default RTD Trip</i>
Voting Trip	<i>Voting Trip. Trip if one of the voting groups has a pending/active trip.</i>

1..n, AnalogOutputList

Selection list referenced by the following parameters:

-  AnaP[1] . Measuring Input

1..n, AnalogOutputList	Description
"_"	<i>No assignment</i>
AnIn[1] . Value	<i>Measured value of the Input in percent</i>
AnIn[2] . Value	<i>Measured value of the Input in percent</i>

t-Alarm

Tripping Delay

Selection list referenced by the following parameters:

-  AnaP[1] . Alarm mode

t-Alarm	Description
Over	<i>Alarm, when the input signal exceeds the threshold.</i>

t-Alarm	Description
Under	<i>Under</i>

Scheme

Via this selection menu, the BF supervision scheme is to be selected.

Selection list referenced by the following parameters:

-  CBF . Scheme

Scheme	Description
50BF	<i>A Breaker Failure is detected, if the measured currents do not fall below a settable threshold within a settable time interval.</i>
CB Pos	<i>A Circuit Breaker Failure is detected after a CB open command, if the Position Contacts of the Circuit Breaker do not allow the conclusion that the Breaker is now in the Open Position within a settable time interval.</i>
50BF and CB Pos	<i>A Circuit Breaker Failure is detected if the evaluation of the Position Indicators or the evaluation of the current measurement indicate that the CB Off-Command was not executed. This scheme is called "Minimal Current Scheme" according to IEEEC37.119.</i>

CB List

Selection list referenced by the following parameters:

-  CBF . CB

CB List	Description
"_"	<i>No assignment</i>
SG[1] .	
SG[2] .	
SG[3] .	
SG[4] .	
SG[5] .	
SG[6] .	

Trigger

Determining the trigger mode for the Breaker Failure. The selection will pickup the Breaker Failure as well as the assignments (Trigger 1, Trigger 2, Trigger 3). They are OR connected.

Selection list referenced by the following parameters:

- ↳ CBF . Trigger

Trigger	Description
- . -	<i>no assignment</i>
All Trips	<i>All trip signals that are assigned to this breaker (within the trip manager) will start the BF module.</i>
External Trips	<i>All external trips that are assigned to this breaker (within the trip manager) will start the BF module.</i>
Current Trips	<i>All current trips that are assigned to this breaker (within the trip manager) will start the BF module.</i>

External Trips

All external trips that are assigned to this breaker (within the trip manager) will start the BF module.

External Trips	Description
"_"	<i>No assignment</i>
Intertripping . TripCmd	<i>Signal: Trip Command</i>
Exp[1] . TripCmd	<i>Signal: Trip Command</i>
Exp[2] . TripCmd	<i>Signal: Trip Command</i>
Exp[3] . TripCmd	<i>Signal: Trip Command</i>
Exp[4] . TripCmd	<i>Signal: Trip Command</i>
Ext Sudd Press . TripCmd	<i>Signal: Trip Command</i>
Ext Oil Temp . TripCmd	<i>Signal: Trip Command</i>
Ext Temp Superv[1] . TripCmd	<i>Signal: Trip Command</i>
Ext Temp Superv[2] . TripCmd	<i>Signal: Trip Command</i>
Ext Temp Superv[3] . TripCmd	<i>Signal: Trip Command</i>
AnaP[1] . TripCmd	<i>Signal: Trip Command</i>
AnaP[2] . TripCmd	<i>Signal: Trip Command</i>

External Trips	Description
AnaP[3] . TripCmd	<i>Signal: Trip Command</i>
AnaP[4] . TripCmd	<i>Signal: Trip Command</i>

Current Trips

All current trips that are assigned to this breaker (within the trip manager) will start the BF module.

Current Trips	Description
"_"	<i>No assignment</i>
Id . TripCmd	<i>Signal: Trip Command</i>
IdH . TripCmd	<i>Signal: Trip Command</i>
IdG[1] . TripCmd	<i>Signal: Trip Command</i>
IdGH[1] . TripCmd	<i>Signal: Trip Command</i>
IdG[2] . TripCmd	<i>Signal: Trip Command</i>
IdGH[2] . TripCmd	<i>Signal: Trip Command</i>
I[1] . TripCmd	<i>Signal: Trip Command</i>
I[2] . TripCmd	<i>Signal: Trip Command</i>
I[3] . TripCmd	<i>Signal: Trip Command</i>
I[4] . TripCmd	<i>Signal: Trip Command</i>
I[5] . TripCmd	<i>Signal: Trip Command</i>
I[6] . TripCmd	<i>Signal: Trip Command</i>
IG[1] . TripCmd	<i>Signal: Trip Command</i>
IG[2] . TripCmd	<i>Signal: Trip Command</i>
IG[3] . TripCmd	<i>Signal: Trip Command</i>
IG[4] . TripCmd	<i>Signal: Trip Command</i>
ThR . TripCmd	<i>Signal: Trip Command</i>
I2>[1] . TripCmd	<i>Signal: Trip Command</i>
I2>[2] . TripCmd	<i>Signal: Trip Command</i>
I2>G[1] . TripCmd	<i>Signal: Trip Command</i>
I2>G[2] . TripCmd	<i>Signal: Trip Command</i>
InEn . TripCmd	<i>Signal: Trip Command</i>

Trigger

Determining the trigger mode for the Breaker Failure. The selection will pickup the Breaker Failure as well as the assignments (Trigger 1, Trigger 2, Trigger 3). They are OR connected.

Selection list referenced by the following parameters:

- ↳ CBF . Trigger1

Trigger	Description
"_"	No assignment
Id . TripCmd	Signal: Trip Command
IdH . TripCmd	Signal: Trip Command
IdG[1] . TripCmd	Signal: Trip Command
IdGH[1] . TripCmd	Signal: Trip Command
IdG[2] . TripCmd	Signal: Trip Command
IdGH[2] . TripCmd	Signal: Trip Command
I[1] . TripCmd	Signal: Trip Command
I[2] . TripCmd	Signal: Trip Command
I[3] . TripCmd	Signal: Trip Command
I[4] . TripCmd	Signal: Trip Command
I[5] . TripCmd	Signal: Trip Command
I[6] . TripCmd	Signal: Trip Command
IG[1] . TripCmd	Signal: Trip Command
IG[2] . TripCmd	Signal: Trip Command
IG[3] . TripCmd	Signal: Trip Command
IG[4] . TripCmd	Signal: Trip Command
ThR . TripCmd	Signal: Trip Command
I2>[1] . TripCmd	Signal: Trip Command
I2>[2] . TripCmd	Signal: Trip Command
I2>G[1] . TripCmd	Signal: Trip Command
I2>G[2] . TripCmd	Signal: Trip Command
V[1] . TripCmd	Signal: Trip Command
V[2] . TripCmd	Signal: Trip Command

Trigger	Description
V[3] . TripCmd	<i>Signal: Trip Command</i>
V[4] . TripCmd	<i>Signal: Trip Command</i>
V[5] . TripCmd	<i>Signal: Trip Command</i>
V[6] . TripCmd	<i>Signal: Trip Command</i>
df/dt . TripCmd	<i>Signal: Trip Command</i>
delta phi . TripCmd	<i>Signal: Trip Command</i>
Intertripping . TripCmd	<i>Signal: Trip Command</i>
P[1] . TripCmd	<i>Signal: Trip Command</i>
P[2] . TripCmd	<i>Signal: Trip Command</i>
P[3] . TripCmd	<i>Signal: Trip Command</i>
Q . TripCmd	<i>Signal: Trip Command</i>
LVRT[1] . TripCmd	<i>Signal: Trip Command</i>
LVRT[2] . TripCmd	<i>Signal: Trip Command</i>
VG[1] . TripCmd	<i>Signal: Trip Command</i>
VG[2] . TripCmd	<i>Signal: Trip Command</i>
V012[1] . TripCmd	<i>Signal: Trip Command</i>
V012[2] . TripCmd	<i>Signal: Trip Command</i>
V012[3] . TripCmd	<i>Signal: Trip Command</i>
V012[4] . TripCmd	<i>Signal: Trip Command</i>
V012[5] . TripCmd	<i>Signal: Trip Command</i>
V012[6] . TripCmd	<i>Signal: Trip Command</i>
f[1] . TripCmd	<i>Signal: Trip Command</i>
f[2] . TripCmd	<i>Signal: Trip Command</i>
f[3] . TripCmd	<i>Signal: Trip Command</i>
f[4] . TripCmd	<i>Signal: Trip Command</i>
f[5] . TripCmd	<i>Signal: Trip Command</i>
f[6] . TripCmd	<i>Signal: Trip Command</i>
PQS[1] . TripCmd	<i>Signal: Trip Command</i>
PQS[2] . TripCmd	<i>Signal: Trip Command</i>
PQS[3] . TripCmd	<i>Signal: Trip Command</i>
PQS[4] . TripCmd	<i>Signal: Trip Command</i>
PQS[5] . TripCmd	<i>Signal: Trip Command</i>

Trigger	Description
PQS[6] . TripCmd	<i>Signal: Trip Command</i>
PF[1] . TripCmd	<i>Signal: Trip Command</i>
PF[2] . TripCmd	<i>Signal: Trip Command</i>
Q->&V< . Decoupling PCC	<i>Signal: Decoupling at the Point of Common Coupling</i>
Q->&V< . Decoupling Distr. Generator	<i>Signal: Decoupling of the (local) Energy Generator/Resource</i>
LoE-Z1[1] . TripCmd	<i>Signal: Trip Command</i>
LoE-Z2[1] . TripCmd	<i>Signal: Trip Command</i>
LoE-Z1[2] . TripCmd	<i>Signal: Trip Command</i>
LoE-Z2[2] . TripCmd	<i>Signal: Trip Command</i>
OST . TripCmd	<i>Signal: Trip Command</i>
V/f>[1] . TripCmd	<i>Signal: Trip Command</i>
V/f>[2] . TripCmd	<i>Signal: Trip Command</i>
InEn . TripCmd	<i>Signal: Trip Command</i>
Z[1] . TripCmd	<i>Signal: Trip Command</i>
Z[2] . TripCmd	<i>Signal: Trip Command</i>
ExP[1] . TripCmd	<i>Signal: Trip Command</i>
ExP[2] . TripCmd	<i>Signal: Trip Command</i>
ExP[3] . TripCmd	<i>Signal: Trip Command</i>
ExP[4] . TripCmd	<i>Signal: Trip Command</i>
Ext Sudd Press . TripCmd	<i>Signal: Trip Command</i>
Ext Oil Temp . TripCmd	<i>Signal: Trip Command</i>
Ext Temp Superv[1] . TripCmd	<i>Signal: Trip Command</i>
Ext Temp Superv[2] . TripCmd	<i>Signal: Trip Command</i>
Ext Temp Superv[3] . TripCmd	<i>Signal: Trip Command</i>
RTD . TripCmd	<i>Signal: Trip Command</i>
DI Slot X1 . DI 1	<i>Signal: Digital Input</i>
DI Slot X1 . DI 2	<i>Signal: Digital Input</i>
DI Slot X1 . DI 3	<i>Signal: Digital Input</i>
DI Slot X1 . DI 4	<i>Signal: Digital Input</i>

Trigger	Description
DI Slot X1 . DI 5	<i>Signal: Digital Input</i>
DI Slot X1 . DI 6	<i>Signal: Digital Input</i>
DI Slot X1 . DI 7	<i>Signal: Digital Input</i>
DI Slot X1 . DI 8	<i>Signal: Digital Input</i>
DI Slot X5 . DI 1	<i>Signal: Digital Input</i>
DI Slot X5 . DI 2	<i>Signal: Digital Input</i>
DI Slot X5 . DI 3	<i>Signal: Digital Input</i>
DI Slot X5 . DI 4	<i>Signal: Digital Input</i>
DI Slot X5 . DI 5	<i>Signal: Digital Input</i>
DI Slot X5 . DI 6	<i>Signal: Digital Input</i>
DI Slot X5 . DI 7	<i>Signal: Digital Input</i>
DI Slot X5 . DI 8	<i>Signal: Digital Input</i>
DI Slot X6 . DI 1	<i>Signal: Digital Input</i>
DI Slot X6 . DI 2	<i>Signal: Digital Input</i>
DI Slot X6 . DI 3	<i>Signal: Digital Input</i>
DI Slot X6 . DI 4	<i>Signal: Digital Input</i>
DI Slot X6 . DI 5	<i>Signal: Digital Input</i>
DI Slot X6 . DI 6	<i>Signal: Digital Input</i>
DI Slot X6 . DI 7	<i>Signal: Digital Input</i>
DI Slot X6 . DI 8	<i>Signal: Digital Input</i>
AnaP[1] . TripCmd	<i>Signal: Trip Command</i>
AnaP[2] . TripCmd	<i>Signal: Trip Command</i>
AnaP[3] . TripCmd	<i>Signal: Trip Command</i>
AnaP[4] . TripCmd	<i>Signal: Trip Command</i>
Logics . LE1.Gate Out	<i>Signal: Output of the logic gate</i>
Logics . LE1.Timer Out	<i>Signal: Timer Output</i>
Logics . LE1.Out	<i>Signal: Latched Output (Q)</i>
Logics . LE1.Out inverted	<i>Signal: Negated Latched Output (Q NOT)</i>
Logics . LE2.Gate Out	<i>Signal: Output of the logic gate</i>
Logics . LE2.Timer Out	<i>Signal: Timer Output</i>
Logics . LE2.Out	<i>Signal: Latched Output (Q)</i>

Trigger	Description
Logics . LE2.Out inverted	<i>Signal: Negated Latched Output (Q NOT)</i>
Logics . LE3.Gate Out	<i>Signal: Output of the logic gate</i>
Logics . LE3.Timer Out	<i>Signal: Timer Output</i>
Logics . LE3.Out	<i>Signal: Latched Output (Q)</i>
Logics . LE3.Out inverted	<i>Signal: Negated Latched Output (Q NOT)</i>
Logics . LE4.Gate Out	<i>Signal: Output of the logic gate</i>
Logics . LE4.Timer Out	<i>Signal: Timer Output</i>
Logics . LE4.Out	<i>Signal: Latched Output (Q)</i>
Logics . LE4.Out inverted	<i>Signal: Negated Latched Output (Q NOT)</i>
Logics . LE5.Gate Out	<i>Signal: Output of the logic gate</i>
Logics . LE5.Timer Out	<i>Signal: Timer Output</i>
Logics . LE5.Out	<i>Signal: Latched Output (Q)</i>
Logics . LE5.Out inverted	<i>Signal: Negated Latched Output (Q NOT)</i>
Logics . LE6.Gate Out	<i>Signal: Output of the logic gate</i>
Logics . LE6.Timer Out	<i>Signal: Timer Output</i>
Logics . LE6.Out	<i>Signal: Latched Output (Q)</i>
Logics . LE6.Out inverted	<i>Signal: Negated Latched Output (Q NOT)</i>
Logics . LE7.Gate Out	<i>Signal: Output of the logic gate</i>
Logics . LE7.Timer Out	<i>Signal: Timer Output</i>
Logics . LE7.Out	<i>Signal: Latched Output (Q)</i>
Logics . LE7.Out inverted	<i>Signal: Negated Latched Output (Q NOT)</i>
Logics . LE8.Gate Out	<i>Signal: Output of the logic gate</i>
Logics . LE8.Timer Out	<i>Signal: Timer Output</i>
Logics . LE8.Out	<i>Signal: Latched Output (Q)</i>
Logics . LE8.Out inverted	<i>Signal: Negated Latched Output (Q NOT)</i>
Logics . LE9.Gate Out	<i>Signal: Output of the logic gate</i>
Logics . LE9.Timer Out	<i>Signal: Timer Output</i>
Logics . LE9.Out	<i>Signal: Latched Output (Q)</i>

Trigger	Description
Logics . LE9.Out inverted	<i>Signal: Negated Latched Output (Q NOT)</i>
Logics . LE10.Gate Out	<i>Signal: Output of the logic gate</i>
Logics . LE10.Timer Out	<i>Signal: Timer Output</i>
Logics . LE10.Out	<i>Signal: Latched Output (Q)</i>
Logics . LE10.Out inverted	<i>Signal: Negated Latched Output (Q NOT)</i>
Logics . LE11.Gate Out	<i>Signal: Output of the logic gate</i>
Logics . LE11.Timer Out	<i>Signal: Timer Output</i>
Logics . LE11.Out	<i>Signal: Latched Output (Q)</i>
Logics . LE11.Out inverted	<i>Signal: Negated Latched Output (Q NOT)</i>
Logics . LE12.Gate Out	<i>Signal: Output of the logic gate</i>
Logics . LE12.Timer Out	<i>Signal: Timer Output</i>
Logics . LE12.Out	<i>Signal: Latched Output (Q)</i>
Logics . LE12.Out inverted	<i>Signal: Negated Latched Output (Q NOT)</i>
Logics . LE13.Gate Out	<i>Signal: Output of the logic gate</i>
Logics . LE13.Timer Out	<i>Signal: Timer Output</i>
Logics . LE13.Out	<i>Signal: Latched Output (Q)</i>
Logics . LE13.Out inverted	<i>Signal: Negated Latched Output (Q NOT)</i>
Logics . LE14.Gate Out	<i>Signal: Output of the logic gate</i>
Logics . LE14.Timer Out	<i>Signal: Timer Output</i>
Logics . LE14.Out	<i>Signal: Latched Output (Q)</i>
Logics . LE14.Out inverted	<i>Signal: Negated Latched Output (Q NOT)</i>
Logics . LE15.Gate Out	<i>Signal: Output of the logic gate</i>
Logics . LE15.Timer Out	<i>Signal: Timer Output</i>
Logics . LE15.Out	<i>Signal: Latched Output (Q)</i>
Logics . LE15.Out inverted	<i>Signal: Negated Latched Output (Q NOT)</i>
Logics . LE16.Gate Out	<i>Signal: Output of the logic gate</i>
Logics . LE16.Timer Out	<i>Signal: Timer Output</i>
Logics . LE16.Out	<i>Signal: Latched Output (Q)</i>

Trigger	Description
Logics . LE16.Out inverted	<i>Signal: Negated Latched Output (Q NOT)</i>
Logics . LE17.Gate Out	<i>Signal: Output of the logic gate</i>
Logics . LE17.Timer Out	<i>Signal: Timer Output</i>
Logics . LE17.Out	<i>Signal: Latched Output (Q)</i>
Logics . LE17.Out inverted	<i>Signal: Negated Latched Output (Q NOT)</i>
Logics . LE18.Gate Out	<i>Signal: Output of the logic gate</i>
Logics . LE18.Timer Out	<i>Signal: Timer Output</i>
Logics . LE18.Out	<i>Signal: Latched Output (Q)</i>
Logics . LE18.Out inverted	<i>Signal: Negated Latched Output (Q NOT)</i>
Logics . LE19.Gate Out	<i>Signal: Output of the logic gate</i>
Logics . LE19.Timer Out	<i>Signal: Timer Output</i>
Logics . LE19.Out	<i>Signal: Latched Output (Q)</i>
Logics . LE19.Out inverted	<i>Signal: Negated Latched Output (Q NOT)</i>
Logics . LE20.Gate Out	<i>Signal: Output of the logic gate</i>
Logics . LE20.Timer Out	<i>Signal: Timer Output</i>
Logics . LE20.Out	<i>Signal: Latched Output (Q)</i>
Logics . LE20.Out inverted	<i>Signal: Negated Latched Output (Q NOT)</i>
Logics . LE21.Gate Out	<i>Signal: Output of the logic gate</i>
Logics . LE21.Timer Out	<i>Signal: Timer Output</i>
Logics . LE21.Out	<i>Signal: Latched Output (Q)</i>
Logics . LE21.Out inverted	<i>Signal: Negated Latched Output (Q NOT)</i>
Logics . LE22.Gate Out	<i>Signal: Output of the logic gate</i>
Logics . LE22.Timer Out	<i>Signal: Timer Output</i>
Logics . LE22.Out	<i>Signal: Latched Output (Q)</i>
Logics . LE22.Out inverted	<i>Signal: Negated Latched Output (Q NOT)</i>
Logics . LE23.Gate Out	<i>Signal: Output of the logic gate</i>
Logics . LE23.Timer Out	<i>Signal: Timer Output</i>
Logics . LE23.Out	<i>Signal: Latched Output (Q)</i>

Trigger	Description
Logics . LE23.Out inverted	<i>Signal: Negated Latched Output (Q NOT)</i>
Logics . LE24.Gate Out	<i>Signal: Output of the logic gate</i>
Logics . LE24.Timer Out	<i>Signal: Timer Output</i>
Logics . LE24.Out	<i>Signal: Latched Output (Q)</i>
Logics . LE24.Out inverted	<i>Signal: Negated Latched Output (Q NOT)</i>
Logics . LE25.Gate Out	<i>Signal: Output of the logic gate</i>
Logics . LE25.Timer Out	<i>Signal: Timer Output</i>
Logics . LE25.Out	<i>Signal: Latched Output (Q)</i>
Logics . LE25.Out inverted	<i>Signal: Negated Latched Output (Q NOT)</i>
Logics . LE26.Gate Out	<i>Signal: Output of the logic gate</i>
Logics . LE26.Timer Out	<i>Signal: Timer Output</i>
Logics . LE26.Out	<i>Signal: Latched Output (Q)</i>
Logics . LE26.Out inverted	<i>Signal: Negated Latched Output (Q NOT)</i>
Logics . LE27.Gate Out	<i>Signal: Output of the logic gate</i>
Logics . LE27.Timer Out	<i>Signal: Timer Output</i>
Logics . LE27.Out	<i>Signal: Latched Output (Q)</i>
Logics . LE27.Out inverted	<i>Signal: Negated Latched Output (Q NOT)</i>
Logics . LE28.Gate Out	<i>Signal: Output of the logic gate</i>
Logics . LE28.Timer Out	<i>Signal: Timer Output</i>
Logics . LE28.Out	<i>Signal: Latched Output (Q)</i>
Logics . LE28.Out inverted	<i>Signal: Negated Latched Output (Q NOT)</i>
Logics . LE29.Gate Out	<i>Signal: Output of the logic gate</i>
Logics . LE29.Timer Out	<i>Signal: Timer Output</i>
Logics . LE29.Out	<i>Signal: Latched Output (Q)</i>
Logics . LE29.Out inverted	<i>Signal: Negated Latched Output (Q NOT)</i>
Logics . LE30.Gate Out	<i>Signal: Output of the logic gate</i>
Logics . LE30.Timer Out	<i>Signal: Timer Output</i>
Logics . LE30.Out	<i>Signal: Latched Output (Q)</i>

Trigger	Description
Logics . LE30.Out inverted	<i>Signal: Negated Latched Output (Q NOT)</i>
Logics . LE31.Gate Out	<i>Signal: Output of the logic gate</i>
Logics . LE31.Timer Out	<i>Signal: Timer Output</i>
Logics . LE31.Out	<i>Signal: Latched Output (Q)</i>
Logics . LE31.Out inverted	<i>Signal: Negated Latched Output (Q NOT)</i>
Logics . LE32.Gate Out	<i>Signal: Output of the logic gate</i>
Logics . LE32.Timer Out	<i>Signal: Timer Output</i>
Logics . LE32.Out	<i>Signal: Latched Output (Q)</i>
Logics . LE32.Out inverted	<i>Signal: Negated Latched Output (Q NOT)</i>
Logics . LE33.Gate Out	<i>Signal: Output of the logic gate</i>
Logics . LE33.Timer Out	<i>Signal: Timer Output</i>
Logics . LE33.Out	<i>Signal: Latched Output (Q)</i>
Logics . LE33.Out inverted	<i>Signal: Negated Latched Output (Q NOT)</i>
Logics . LE34.Gate Out	<i>Signal: Output of the logic gate</i>
Logics . LE34.Timer Out	<i>Signal: Timer Output</i>
Logics . LE34.Out	<i>Signal: Latched Output (Q)</i>
Logics . LE34.Out inverted	<i>Signal: Negated Latched Output (Q NOT)</i>
Logics . LE35.Gate Out	<i>Signal: Output of the logic gate</i>
Logics . LE35.Timer Out	<i>Signal: Timer Output</i>
Logics . LE35.Out	<i>Signal: Latched Output (Q)</i>
Logics . LE35.Out inverted	<i>Signal: Negated Latched Output (Q NOT)</i>
Logics . LE36.Gate Out	<i>Signal: Output of the logic gate</i>
Logics . LE36.Timer Out	<i>Signal: Timer Output</i>
Logics . LE36.Out	<i>Signal: Latched Output (Q)</i>
Logics . LE36.Out inverted	<i>Signal: Negated Latched Output (Q NOT)</i>
Logics . LE37.Gate Out	<i>Signal: Output of the logic gate</i>
Logics . LE37.Timer Out	<i>Signal: Timer Output</i>
Logics . LE37.Out	<i>Signal: Latched Output (Q)</i>

Trigger	Description
Logics . LE37.Out inverted	<i>Signal: Negated Latched Output (Q NOT)</i>
Logics . LE38.Gate Out	<i>Signal: Output of the logic gate</i>
Logics . LE38.Timer Out	<i>Signal: Timer Output</i>
Logics . LE38.Out	<i>Signal: Latched Output (Q)</i>
Logics . LE38.Out inverted	<i>Signal: Negated Latched Output (Q NOT)</i>
Logics . LE39.Gate Out	<i>Signal: Output of the logic gate</i>
Logics . LE39.Timer Out	<i>Signal: Timer Output</i>
Logics . LE39.Out	<i>Signal: Latched Output (Q)</i>
Logics . LE39.Out inverted	<i>Signal: Negated Latched Output (Q NOT)</i>
Logics . LE40.Gate Out	<i>Signal: Output of the logic gate</i>
Logics . LE40.Timer Out	<i>Signal: Timer Output</i>
Logics . LE40.Out	<i>Signal: Latched Output (Q)</i>
Logics . LE40.Out inverted	<i>Signal: Negated Latched Output (Q NOT)</i>
Logics . LE41.Gate Out	<i>Signal: Output of the logic gate</i>
Logics . LE41.Timer Out	<i>Signal: Timer Output</i>
Logics . LE41.Out	<i>Signal: Latched Output (Q)</i>
Logics . LE41.Out inverted	<i>Signal: Negated Latched Output (Q NOT)</i>
Logics . LE42.Gate Out	<i>Signal: Output of the logic gate</i>
Logics . LE42.Timer Out	<i>Signal: Timer Output</i>
Logics . LE42.Out	<i>Signal: Latched Output (Q)</i>
Logics . LE42.Out inverted	<i>Signal: Negated Latched Output (Q NOT)</i>
Logics . LE43.Gate Out	<i>Signal: Output of the logic gate</i>
Logics . LE43.Timer Out	<i>Signal: Timer Output</i>
Logics . LE43.Out	<i>Signal: Latched Output (Q)</i>
Logics . LE43.Out inverted	<i>Signal: Negated Latched Output (Q NOT)</i>
Logics . LE44.Gate Out	<i>Signal: Output of the logic gate</i>
Logics . LE44.Timer Out	<i>Signal: Timer Output</i>
Logics . LE44.Out	<i>Signal: Latched Output (Q)</i>

Trigger	Description
Logics . LE44.Out inverted	<i>Signal: Negated Latched Output (Q NOT)</i>
Logics . LE45.Gate Out	<i>Signal: Output of the logic gate</i>
Logics . LE45.Timer Out	<i>Signal: Timer Output</i>
Logics . LE45.Out	<i>Signal: Latched Output (Q)</i>
Logics . LE45.Out inverted	<i>Signal: Negated Latched Output (Q NOT)</i>
Logics . LE46.Gate Out	<i>Signal: Output of the logic gate</i>
Logics . LE46.Timer Out	<i>Signal: Timer Output</i>
Logics . LE46.Out	<i>Signal: Latched Output (Q)</i>
Logics . LE46.Out inverted	<i>Signal: Negated Latched Output (Q NOT)</i>
Logics . LE47.Gate Out	<i>Signal: Output of the logic gate</i>
Logics . LE47.Timer Out	<i>Signal: Timer Output</i>
Logics . LE47.Out	<i>Signal: Latched Output (Q)</i>
Logics . LE47.Out inverted	<i>Signal: Negated Latched Output (Q NOT)</i>
Logics . LE48.Gate Out	<i>Signal: Output of the logic gate</i>
Logics . LE48.Timer Out	<i>Signal: Timer Output</i>
Logics . LE48.Out	<i>Signal: Latched Output (Q)</i>
Logics . LE48.Out inverted	<i>Signal: Negated Latched Output (Q NOT)</i>
Logics . LE49.Gate Out	<i>Signal: Output of the logic gate</i>
Logics . LE49.Timer Out	<i>Signal: Timer Output</i>
Logics . LE49.Out	<i>Signal: Latched Output (Q)</i>
Logics . LE49.Out inverted	<i>Signal: Negated Latched Output (Q NOT)</i>
Logics . LE50.Gate Out	<i>Signal: Output of the logic gate</i>
Logics . LE50.Timer Out	<i>Signal: Timer Output</i>
Logics . LE50.Out	<i>Signal: Latched Output (Q)</i>
Logics . LE50.Out inverted	<i>Signal: Negated Latched Output (Q NOT)</i>
Logics . LE51.Gate Out	<i>Signal: Output of the logic gate</i>
Logics . LE51.Timer Out	<i>Signal: Timer Output</i>
Logics . LE51.Out	<i>Signal: Latched Output (Q)</i>

Trigger	Description
Logics . LE51.Out inverted	<i>Signal: Negated Latched Output (Q NOT)</i>
Logics . LE52.Gate Out	<i>Signal: Output of the logic gate</i>
Logics . LE52.Timer Out	<i>Signal: Timer Output</i>
Logics . LE52.Out	<i>Signal: Latched Output (Q)</i>
Logics . LE52.Out inverted	<i>Signal: Negated Latched Output (Q NOT)</i>
Logics . LE53.Gate Out	<i>Signal: Output of the logic gate</i>
Logics . LE53.Timer Out	<i>Signal: Timer Output</i>
Logics . LE53.Out	<i>Signal: Latched Output (Q)</i>
Logics . LE53.Out inverted	<i>Signal: Negated Latched Output (Q NOT)</i>
Logics . LE54.Gate Out	<i>Signal: Output of the logic gate</i>
Logics . LE54.Timer Out	<i>Signal: Timer Output</i>
Logics . LE54.Out	<i>Signal: Latched Output (Q)</i>
Logics . LE54.Out inverted	<i>Signal: Negated Latched Output (Q NOT)</i>
Logics . LE55.Gate Out	<i>Signal: Output of the logic gate</i>
Logics . LE55.Timer Out	<i>Signal: Timer Output</i>
Logics . LE55.Out	<i>Signal: Latched Output (Q)</i>
Logics . LE55.Out inverted	<i>Signal: Negated Latched Output (Q NOT)</i>
Logics . LE56.Gate Out	<i>Signal: Output of the logic gate</i>
Logics . LE56.Timer Out	<i>Signal: Timer Output</i>
Logics . LE56.Out	<i>Signal: Latched Output (Q)</i>
Logics . LE56.Out inverted	<i>Signal: Negated Latched Output (Q NOT)</i>
Logics . LE57.Gate Out	<i>Signal: Output of the logic gate</i>
Logics . LE57.Timer Out	<i>Signal: Timer Output</i>
Logics . LE57.Out	<i>Signal: Latched Output (Q)</i>
Logics . LE57.Out inverted	<i>Signal: Negated Latched Output (Q NOT)</i>
Logics . LE58.Gate Out	<i>Signal: Output of the logic gate</i>
Logics . LE58.Timer Out	<i>Signal: Timer Output</i>
Logics . LE58.Out	<i>Signal: Latched Output (Q)</i>

Trigger	Description
Logics . LE58.Out inverted	<i>Signal: Negated Latched Output (Q NOT)</i>
Logics . LE59.Gate Out	<i>Signal: Output of the logic gate</i>
Logics . LE59.Timer Out	<i>Signal: Timer Output</i>
Logics . LE59.Out	<i>Signal: Latched Output (Q)</i>
Logics . LE59.Out inverted	<i>Signal: Negated Latched Output (Q NOT)</i>
Logics . LE60.Gate Out	<i>Signal: Output of the logic gate</i>
Logics . LE60.Timer Out	<i>Signal: Timer Output</i>
Logics . LE60.Out	<i>Signal: Latched Output (Q)</i>
Logics . LE60.Out inverted	<i>Signal: Negated Latched Output (Q NOT)</i>
Logics . LE61.Gate Out	<i>Signal: Output of the logic gate</i>
Logics . LE61.Timer Out	<i>Signal: Timer Output</i>
Logics . LE61.Out	<i>Signal: Latched Output (Q)</i>
Logics . LE61.Out inverted	<i>Signal: Negated Latched Output (Q NOT)</i>
Logics . LE62.Gate Out	<i>Signal: Output of the logic gate</i>
Logics . LE62.Timer Out	<i>Signal: Timer Output</i>
Logics . LE62.Out	<i>Signal: Latched Output (Q)</i>
Logics . LE62.Out inverted	<i>Signal: Negated Latched Output (Q NOT)</i>
Logics . LE63.Gate Out	<i>Signal: Output of the logic gate</i>
Logics . LE63.Timer Out	<i>Signal: Timer Output</i>
Logics . LE63.Out	<i>Signal: Latched Output (Q)</i>
Logics . LE63.Out inverted	<i>Signal: Negated Latched Output (Q NOT)</i>
Logics . LE64.Gate Out	<i>Signal: Output of the logic gate</i>
Logics . LE64.Timer Out	<i>Signal: Timer Output</i>
Logics . LE64.Out	<i>Signal: Latched Output (Q)</i>
Logics . LE64.Out inverted	<i>Signal: Negated Latched Output (Q NOT)</i>
Logics . LE65.Gate Out	<i>Signal: Output of the logic gate</i>
Logics . LE65.Timer Out	<i>Signal: Timer Output</i>
Logics . LE65.Out	<i>Signal: Latched Output (Q)</i>

Trigger	Description
Logics . LE65.Out inverted	<i>Signal: Negated Latched Output (Q NOT)</i>
Logics . LE66.Gate Out	<i>Signal: Output of the logic gate</i>
Logics . LE66.Timer Out	<i>Signal: Timer Output</i>
Logics . LE66.Out	<i>Signal: Latched Output (Q)</i>
Logics . LE66.Out inverted	<i>Signal: Negated Latched Output (Q NOT)</i>
Logics . LE67.Gate Out	<i>Signal: Output of the logic gate</i>
Logics . LE67.Timer Out	<i>Signal: Timer Output</i>
Logics . LE67.Out	<i>Signal: Latched Output (Q)</i>
Logics . LE67.Out inverted	<i>Signal: Negated Latched Output (Q NOT)</i>
Logics . LE68.Gate Out	<i>Signal: Output of the logic gate</i>
Logics . LE68.Timer Out	<i>Signal: Timer Output</i>
Logics . LE68.Out	<i>Signal: Latched Output (Q)</i>
Logics . LE68.Out inverted	<i>Signal: Negated Latched Output (Q NOT)</i>
Logics . LE69.Gate Out	<i>Signal: Output of the logic gate</i>
Logics . LE69.Timer Out	<i>Signal: Timer Output</i>
Logics . LE69.Out	<i>Signal: Latched Output (Q)</i>
Logics . LE69.Out inverted	<i>Signal: Negated Latched Output (Q NOT)</i>
Logics . LE70.Gate Out	<i>Signal: Output of the logic gate</i>
Logics . LE70.Timer Out	<i>Signal: Timer Output</i>
Logics . LE70.Out	<i>Signal: Latched Output (Q)</i>
Logics . LE70.Out inverted	<i>Signal: Negated Latched Output (Q NOT)</i>
Logics . LE71.Gate Out	<i>Signal: Output of the logic gate</i>
Logics . LE71.Timer Out	<i>Signal: Timer Output</i>
Logics . LE71.Out	<i>Signal: Latched Output (Q)</i>
Logics . LE71.Out inverted	<i>Signal: Negated Latched Output (Q NOT)</i>
Logics . LE72.Gate Out	<i>Signal: Output of the logic gate</i>
Logics . LE72.Timer Out	<i>Signal: Timer Output</i>
Logics . LE72.Out	<i>Signal: Latched Output (Q)</i>

Trigger	Description
Logics . LE72.Out inverted	<i>Signal: Negated Latched Output (Q NOT)</i>
Logics . LE73.Gate Out	<i>Signal: Output of the logic gate</i>
Logics . LE73.Timer Out	<i>Signal: Timer Output</i>
Logics . LE73.Out	<i>Signal: Latched Output (Q)</i>
Logics . LE73.Out inverted	<i>Signal: Negated Latched Output (Q NOT)</i>
Logics . LE74.Gate Out	<i>Signal: Output of the logic gate</i>
Logics . LE74.Timer Out	<i>Signal: Timer Output</i>
Logics . LE74.Out	<i>Signal: Latched Output (Q)</i>
Logics . LE74.Out inverted	<i>Signal: Negated Latched Output (Q NOT)</i>
Logics . LE75.Gate Out	<i>Signal: Output of the logic gate</i>
Logics . LE75.Timer Out	<i>Signal: Timer Output</i>
Logics . LE75.Out	<i>Signal: Latched Output (Q)</i>
Logics . LE75.Out inverted	<i>Signal: Negated Latched Output (Q NOT)</i>
Logics . LE76.Gate Out	<i>Signal: Output of the logic gate</i>
Logics . LE76.Timer Out	<i>Signal: Timer Output</i>
Logics . LE76.Out	<i>Signal: Latched Output (Q)</i>
Logics . LE76.Out inverted	<i>Signal: Negated Latched Output (Q NOT)</i>
Logics . LE77.Gate Out	<i>Signal: Output of the logic gate</i>
Logics . LE77.Timer Out	<i>Signal: Timer Output</i>
Logics . LE77.Out	<i>Signal: Latched Output (Q)</i>
Logics . LE77.Out inverted	<i>Signal: Negated Latched Output (Q NOT)</i>
Logics . LE78.Gate Out	<i>Signal: Output of the logic gate</i>
Logics . LE78.Timer Out	<i>Signal: Timer Output</i>
Logics . LE78.Out	<i>Signal: Latched Output (Q)</i>
Logics . LE78.Out inverted	<i>Signal: Negated Latched Output (Q NOT)</i>
Logics . LE79.Gate Out	<i>Signal: Output of the logic gate</i>
Logics . LE79.Timer Out	<i>Signal: Timer Output</i>
Logics . LE79.Out	<i>Signal: Latched Output (Q)</i>

Trigger	Description
Logics . LE79.Out inverted	Signal: Negated Latched Output (Q NOT)
Logics . LE80.Gate Out	Signal: Output of the logic gate
Logics . LE80.Timer Out	Signal: Timer Output
Logics . LE80.Out	Signal: Latched Output (Q)
Logics . LE80.Out inverted	Signal: Negated Latched Output (Q NOT)

Mode

general operation mode

Selection list referenced by the following parameters:

-  TCS . Mode

Mode	Description
Closed	Selects that the breaker is going to be monitored when the breaker is closed.
Either	Selects that the breaker is going to be monitored when the breaker is either closed or open.

Blo Trigger

Determining the blockings for Loss of Potential

Selection list referenced by the following parameters:

-  LOP . Blo Trigger1

Blo Trigger	Description
"_"	No assignment
I[1] . Alarm	Signal: Alarm
I[2] . Alarm	Signal: Alarm
I[3] . Alarm	Signal: Alarm
I[4] . Alarm	Signal: Alarm
I[5] . Alarm	Signal: Alarm

Blo Trigger	Description
I[6] . Alarm	<i>Signal: Alarm</i>
IG[1] . Alarm	<i>Signal: Alarm IG</i>
IG[2] . Alarm	<i>Signal: Alarm IG</i>
IG[3] . Alarm	<i>Signal: Alarm IG</i>
IG[4] . Alarm	<i>Signal: Alarm IG</i>

PSet-Switch

Switching Parameter Set

Selection list referenced by the following parameters:

-  Sys . PSet-Switch

PSet-Switch	Description
PS1	<i>The currently active Parameter Set is PS1</i>
PS2	<i>The currently active Parameter Set is PS2</i>
PS3	<i>The currently active Parameter Set is PS3</i>
PS4	<i>The currently active Parameter Set is PS4</i>
PSS via Inp fct	<i>Parameter Set Switch via input function</i>
PSS via Scada	<i>Parameter Set Switch via Scada. Write into this output byte the integer of the parameter set that should become active (e.g. 4 => Switch onto parameter set 4).</i>

1..n, PSS

List of the available Parameter Setting Group Switching Signals

Selection list referenced by the following parameters:

-  Sys . PS1: activated by

1..n, PSS	Description
"_"	<i>No assignment</i>
Prot . DFT Invalid	<i>DFT values of fundamental and harmonics (except VX) are not valid. They depend on period time of frequency and measured channels 1-3 (VL1,VL2,VL3).</i>

1..n, PSS	Description
Prot . DFT Valid	<i>DFT values of fundamental and harmonics (except VX) are valid. They depend on period time of frequency and measured channels 1-3 (VL1,VL2,VL3).</i>
Prot . DFT Invalid (VX)	<i>DFT values of fundamental and harmonics of VX (only) are not valid.</i>
Prot . DFT Valid (VX)	<i>DFT values of fundamental and harmonics of VX (only) are valid.</i>
CTS . Alarm	<i>Signal: Alarm Current Transformer Measuring Circuit Supervision</i>
LOP . Alarm	<i>Signal: Alarm Loss of Potential</i>
DI Slot X1 . DI 1	<i>Signal: Digital Input</i>
DI Slot X1 . DI 2	<i>Signal: Digital Input</i>
DI Slot X1 . DI 3	<i>Signal: Digital Input</i>
DI Slot X1 . DI 4	<i>Signal: Digital Input</i>
DI Slot X1 . DI 5	<i>Signal: Digital Input</i>
DI Slot X1 . DI 6	<i>Signal: Digital Input</i>
DI Slot X1 . DI 7	<i>Signal: Digital Input</i>
DI Slot X1 . DI 8	<i>Signal: Digital Input</i>
DI Slot X5 . DI 1	<i>Signal: Digital Input</i>
DI Slot X5 . DI 2	<i>Signal: Digital Input</i>
DI Slot X5 . DI 3	<i>Signal: Digital Input</i>
DI Slot X5 . DI 4	<i>Signal: Digital Input</i>
DI Slot X5 . DI 5	<i>Signal: Digital Input</i>
DI Slot X5 . DI 6	<i>Signal: Digital Input</i>
DI Slot X5 . DI 7	<i>Signal: Digital Input</i>
DI Slot X5 . DI 8	<i>Signal: Digital Input</i>
DI Slot X6 . DI 1	<i>Signal: Digital Input</i>
DI Slot X6 . DI 2	<i>Signal: Digital Input</i>
DI Slot X6 . DI 3	<i>Signal: Digital Input</i>
DI Slot X6 . DI 4	<i>Signal: Digital Input</i>
DI Slot X6 . DI 5	<i>Signal: Digital Input</i>
DI Slot X6 . DI 6	<i>Signal: Digital Input</i>
DI Slot X6 . DI 7	<i>Signal: Digital Input</i>
DI Slot X6 . DI 8	<i>Signal: Digital Input</i>
Logics . LE1.Gate Out	<i>Signal: Output of the logic gate</i>
Logics . LE1.Timer Out	<i>Signal: Timer Output</i>

1..n, PSS	Description
Logics . LE1.Out	<i>Signal: Latched Output (Q)</i>
Logics . LE1.Out inverted	<i>Signal: Negated Latched Output (Q NOT)</i>
Logics . LE2.Gate Out	<i>Signal: Output of the logic gate</i>
Logics . LE2.Timer Out	<i>Signal: Timer Output</i>
Logics . LE2.Out	<i>Signal: Latched Output (Q)</i>
Logics . LE2.Out inverted	<i>Signal: Negated Latched Output (Q NOT)</i>
Logics . LE3.Gate Out	<i>Signal: Output of the logic gate</i>
Logics . LE3.Timer Out	<i>Signal: Timer Output</i>
Logics . LE3.Out	<i>Signal: Latched Output (Q)</i>
Logics . LE3.Out inverted	<i>Signal: Negated Latched Output (Q NOT)</i>
Logics . LE4.Gate Out	<i>Signal: Output of the logic gate</i>
Logics . LE4.Timer Out	<i>Signal: Timer Output</i>
Logics . LE4.Out	<i>Signal: Latched Output (Q)</i>
Logics . LE4.Out inverted	<i>Signal: Negated Latched Output (Q NOT)</i>
Logics . LE5.Gate Out	<i>Signal: Output of the logic gate</i>
Logics . LE5.Timer Out	<i>Signal: Timer Output</i>
Logics . LE5.Out	<i>Signal: Latched Output (Q)</i>
Logics . LE5.Out inverted	<i>Signal: Negated Latched Output (Q NOT)</i>
Logics . LE6.Gate Out	<i>Signal: Output of the logic gate</i>
Logics . LE6.Timer Out	<i>Signal: Timer Output</i>
Logics . LE6.Out	<i>Signal: Latched Output (Q)</i>
Logics . LE6.Out inverted	<i>Signal: Negated Latched Output (Q NOT)</i>
Logics . LE7.Gate Out	<i>Signal: Output of the logic gate</i>
Logics . LE7.Timer Out	<i>Signal: Timer Output</i>
Logics . LE7.Out	<i>Signal: Latched Output (Q)</i>
Logics . LE7.Out inverted	<i>Signal: Negated Latched Output (Q NOT)</i>
Logics . LE8.Gate Out	<i>Signal: Output of the logic gate</i>
Logics . LE8.Timer Out	<i>Signal: Timer Output</i>

1..n, PSS	Description
Logics . LE8.Out	<i>Signal: Latched Output (Q)</i>
Logics . LE8.Out inverted	<i>Signal: Negated Latched Output (Q NOT)</i>
Logics . LE9.Gate Out	<i>Signal: Output of the logic gate</i>
Logics . LE9.Timer Out	<i>Signal: Timer Output</i>
Logics . LE9.Out	<i>Signal: Latched Output (Q)</i>
Logics . LE9.Out inverted	<i>Signal: Negated Latched Output (Q NOT)</i>
Logics . LE10.Gate Out	<i>Signal: Output of the logic gate</i>
Logics . LE10.Timer Out	<i>Signal: Timer Output</i>
Logics . LE10.Out	<i>Signal: Latched Output (Q)</i>
Logics . LE10.Out inverted	<i>Signal: Negated Latched Output (Q NOT)</i>
Logics . LE11.Gate Out	<i>Signal: Output of the logic gate</i>
Logics . LE11.Timer Out	<i>Signal: Timer Output</i>
Logics . LE11.Out	<i>Signal: Latched Output (Q)</i>
Logics . LE11.Out inverted	<i>Signal: Negated Latched Output (Q NOT)</i>
Logics . LE12.Gate Out	<i>Signal: Output of the logic gate</i>
Logics . LE12.Timer Out	<i>Signal: Timer Output</i>
Logics . LE12.Out	<i>Signal: Latched Output (Q)</i>
Logics . LE12.Out inverted	<i>Signal: Negated Latched Output (Q NOT)</i>
Logics . LE13.Gate Out	<i>Signal: Output of the logic gate</i>
Logics . LE13.Timer Out	<i>Signal: Timer Output</i>
Logics . LE13.Out	<i>Signal: Latched Output (Q)</i>
Logics . LE13.Out inverted	<i>Signal: Negated Latched Output (Q NOT)</i>
Logics . LE14.Gate Out	<i>Signal: Output of the logic gate</i>
Logics . LE14.Timer Out	<i>Signal: Timer Output</i>
Logics . LE14.Out	<i>Signal: Latched Output (Q)</i>
Logics . LE14.Out inverted	<i>Signal: Negated Latched Output (Q NOT)</i>
Logics . LE15.Gate Out	<i>Signal: Output of the logic gate</i>
Logics . LE15.Timer Out	<i>Signal: Timer Output</i>

1..n, PSS	Description
Logics . LE15.Out	<i>Signal: Latched Output (Q)</i>
Logics . LE15.Out inverted	<i>Signal: Negated Latched Output (Q NOT)</i>
Logics . LE16.Gate Out	<i>Signal: Output of the logic gate</i>
Logics . LE16.Timer Out	<i>Signal: Timer Output</i>
Logics . LE16.Out	<i>Signal: Latched Output (Q)</i>
Logics . LE16.Out inverted	<i>Signal: Negated Latched Output (Q NOT)</i>
Logics . LE17.Gate Out	<i>Signal: Output of the logic gate</i>
Logics . LE17.Timer Out	<i>Signal: Timer Output</i>
Logics . LE17.Out	<i>Signal: Latched Output (Q)</i>
Logics . LE17.Out inverted	<i>Signal: Negated Latched Output (Q NOT)</i>
Logics . LE18.Gate Out	<i>Signal: Output of the logic gate</i>
Logics . LE18.Timer Out	<i>Signal: Timer Output</i>
Logics . LE18.Out	<i>Signal: Latched Output (Q)</i>
Logics . LE18.Out inverted	<i>Signal: Negated Latched Output (Q NOT)</i>
Logics . LE19.Gate Out	<i>Signal: Output of the logic gate</i>
Logics . LE19.Timer Out	<i>Signal: Timer Output</i>
Logics . LE19.Out	<i>Signal: Latched Output (Q)</i>
Logics . LE19.Out inverted	<i>Signal: Negated Latched Output (Q NOT)</i>
Logics . LE20.Gate Out	<i>Signal: Output of the logic gate</i>
Logics . LE20.Timer Out	<i>Signal: Timer Output</i>
Logics . LE20.Out	<i>Signal: Latched Output (Q)</i>
Logics . LE20.Out inverted	<i>Signal: Negated Latched Output (Q NOT)</i>
Logics . LE21.Gate Out	<i>Signal: Output of the logic gate</i>
Logics . LE21.Timer Out	<i>Signal: Timer Output</i>
Logics . LE21.Out	<i>Signal: Latched Output (Q)</i>
Logics . LE21.Out inverted	<i>Signal: Negated Latched Output (Q NOT)</i>
Logics . LE22.Gate Out	<i>Signal: Output of the logic gate</i>
Logics . LE22.Timer Out	<i>Signal: Timer Output</i>

1..n, PSS	Description
Logics . LE22.Out	<i>Signal: Latched Output (Q)</i>
Logics . LE22.Out inverted	<i>Signal: Negated Latched Output (Q NOT)</i>
Logics . LE23.Gate Out	<i>Signal: Output of the logic gate</i>
Logics . LE23.Timer Out	<i>Signal: Timer Output</i>
Logics . LE23.Out	<i>Signal: Latched Output (Q)</i>
Logics . LE23.Out inverted	<i>Signal: Negated Latched Output (Q NOT)</i>
Logics . LE24.Gate Out	<i>Signal: Output of the logic gate</i>
Logics . LE24.Timer Out	<i>Signal: Timer Output</i>
Logics . LE24.Out	<i>Signal: Latched Output (Q)</i>
Logics . LE24.Out inverted	<i>Signal: Negated Latched Output (Q NOT)</i>
Logics . LE25.Gate Out	<i>Signal: Output of the logic gate</i>
Logics . LE25.Timer Out	<i>Signal: Timer Output</i>
Logics . LE25.Out	<i>Signal: Latched Output (Q)</i>
Logics . LE25.Out inverted	<i>Signal: Negated Latched Output (Q NOT)</i>
Logics . LE26.Gate Out	<i>Signal: Output of the logic gate</i>
Logics . LE26.Timer Out	<i>Signal: Timer Output</i>
Logics . LE26.Out	<i>Signal: Latched Output (Q)</i>
Logics . LE26.Out inverted	<i>Signal: Negated Latched Output (Q NOT)</i>
Logics . LE27.Gate Out	<i>Signal: Output of the logic gate</i>
Logics . LE27.Timer Out	<i>Signal: Timer Output</i>
Logics . LE27.Out	<i>Signal: Latched Output (Q)</i>
Logics . LE27.Out inverted	<i>Signal: Negated Latched Output (Q NOT)</i>
Logics . LE28.Gate Out	<i>Signal: Output of the logic gate</i>
Logics . LE28.Timer Out	<i>Signal: Timer Output</i>
Logics . LE28.Out	<i>Signal: Latched Output (Q)</i>
Logics . LE28.Out inverted	<i>Signal: Negated Latched Output (Q NOT)</i>
Logics . LE29.Gate Out	<i>Signal: Output of the logic gate</i>
Logics . LE29.Timer Out	<i>Signal: Timer Output</i>

1..n, PSS	Description
Logics . LE29.Out	<i>Signal: Latched Output (Q)</i>
Logics . LE29.Out inverted	<i>Signal: Negated Latched Output (Q NOT)</i>
Logics . LE30.Gate Out	<i>Signal: Output of the logic gate</i>
Logics . LE30.Timer Out	<i>Signal: Timer Output</i>
Logics . LE30.Out	<i>Signal: Latched Output (Q)</i>
Logics . LE30.Out inverted	<i>Signal: Negated Latched Output (Q NOT)</i>
Logics . LE31.Gate Out	<i>Signal: Output of the logic gate</i>
Logics . LE31.Timer Out	<i>Signal: Timer Output</i>
Logics . LE31.Out	<i>Signal: Latched Output (Q)</i>
Logics . LE31.Out inverted	<i>Signal: Negated Latched Output (Q NOT)</i>
Logics . LE32.Gate Out	<i>Signal: Output of the logic gate</i>
Logics . LE32.Timer Out	<i>Signal: Timer Output</i>
Logics . LE32.Out	<i>Signal: Latched Output (Q)</i>
Logics . LE32.Out inverted	<i>Signal: Negated Latched Output (Q NOT)</i>
Logics . LE33.Gate Out	<i>Signal: Output of the logic gate</i>
Logics . LE33.Timer Out	<i>Signal: Timer Output</i>
Logics . LE33.Out	<i>Signal: Latched Output (Q)</i>
Logics . LE33.Out inverted	<i>Signal: Negated Latched Output (Q NOT)</i>
Logics . LE34.Gate Out	<i>Signal: Output of the logic gate</i>
Logics . LE34.Timer Out	<i>Signal: Timer Output</i>
Logics . LE34.Out	<i>Signal: Latched Output (Q)</i>
Logics . LE34.Out inverted	<i>Signal: Negated Latched Output (Q NOT)</i>
Logics . LE35.Gate Out	<i>Signal: Output of the logic gate</i>
Logics . LE35.Timer Out	<i>Signal: Timer Output</i>
Logics . LE35.Out	<i>Signal: Latched Output (Q)</i>
Logics . LE35.Out inverted	<i>Signal: Negated Latched Output (Q NOT)</i>
Logics . LE36.Gate Out	<i>Signal: Output of the logic gate</i>
Logics . LE36.Timer Out	<i>Signal: Timer Output</i>

1..n, PSS	Description
Logics . LE36.Out	<i>Signal: Latched Output (Q)</i>
Logics . LE36.Out inverted	<i>Signal: Negated Latched Output (Q NOT)</i>
Logics . LE37.Gate Out	<i>Signal: Output of the logic gate</i>
Logics . LE37.Timer Out	<i>Signal: Timer Output</i>
Logics . LE37.Out	<i>Signal: Latched Output (Q)</i>
Logics . LE37.Out inverted	<i>Signal: Negated Latched Output (Q NOT)</i>
Logics . LE38.Gate Out	<i>Signal: Output of the logic gate</i>
Logics . LE38.Timer Out	<i>Signal: Timer Output</i>
Logics . LE38.Out	<i>Signal: Latched Output (Q)</i>
Logics . LE38.Out inverted	<i>Signal: Negated Latched Output (Q NOT)</i>
Logics . LE39.Gate Out	<i>Signal: Output of the logic gate</i>
Logics . LE39.Timer Out	<i>Signal: Timer Output</i>
Logics . LE39.Out	<i>Signal: Latched Output (Q)</i>
Logics . LE39.Out inverted	<i>Signal: Negated Latched Output (Q NOT)</i>
Logics . LE40.Gate Out	<i>Signal: Output of the logic gate</i>
Logics . LE40.Timer Out	<i>Signal: Timer Output</i>
Logics . LE40.Out	<i>Signal: Latched Output (Q)</i>
Logics . LE40.Out inverted	<i>Signal: Negated Latched Output (Q NOT)</i>
Logics . LE41.Gate Out	<i>Signal: Output of the logic gate</i>
Logics . LE41.Timer Out	<i>Signal: Timer Output</i>
Logics . LE41.Out	<i>Signal: Latched Output (Q)</i>
Logics . LE41.Out inverted	<i>Signal: Negated Latched Output (Q NOT)</i>
Logics . LE42.Gate Out	<i>Signal: Output of the logic gate</i>
Logics . LE42.Timer Out	<i>Signal: Timer Output</i>
Logics . LE42.Out	<i>Signal: Latched Output (Q)</i>
Logics . LE42.Out inverted	<i>Signal: Negated Latched Output (Q NOT)</i>
Logics . LE43.Gate Out	<i>Signal: Output of the logic gate</i>
Logics . LE43.Timer Out	<i>Signal: Timer Output</i>

1..n, PSS	Description
Logics . LE43.Out	<i>Signal: Latched Output (Q)</i>
Logics . LE43.Out inverted	<i>Signal: Negated Latched Output (Q NOT)</i>
Logics . LE44.Gate Out	<i>Signal: Output of the logic gate</i>
Logics . LE44.Timer Out	<i>Signal: Timer Output</i>
Logics . LE44.Out	<i>Signal: Latched Output (Q)</i>
Logics . LE44.Out inverted	<i>Signal: Negated Latched Output (Q NOT)</i>
Logics . LE45.Gate Out	<i>Signal: Output of the logic gate</i>
Logics . LE45.Timer Out	<i>Signal: Timer Output</i>
Logics . LE45.Out	<i>Signal: Latched Output (Q)</i>
Logics . LE45.Out inverted	<i>Signal: Negated Latched Output (Q NOT)</i>
Logics . LE46.Gate Out	<i>Signal: Output of the logic gate</i>
Logics . LE46.Timer Out	<i>Signal: Timer Output</i>
Logics . LE46.Out	<i>Signal: Latched Output (Q)</i>
Logics . LE46.Out inverted	<i>Signal: Negated Latched Output (Q NOT)</i>
Logics . LE47.Gate Out	<i>Signal: Output of the logic gate</i>
Logics . LE47.Timer Out	<i>Signal: Timer Output</i>
Logics . LE47.Out	<i>Signal: Latched Output (Q)</i>
Logics . LE47.Out inverted	<i>Signal: Negated Latched Output (Q NOT)</i>
Logics . LE48.Gate Out	<i>Signal: Output of the logic gate</i>
Logics . LE48.Timer Out	<i>Signal: Timer Output</i>
Logics . LE48.Out	<i>Signal: Latched Output (Q)</i>
Logics . LE48.Out inverted	<i>Signal: Negated Latched Output (Q NOT)</i>
Logics . LE49.Gate Out	<i>Signal: Output of the logic gate</i>
Logics . LE49.Timer Out	<i>Signal: Timer Output</i>
Logics . LE49.Out	<i>Signal: Latched Output (Q)</i>
Logics . LE49.Out inverted	<i>Signal: Negated Latched Output (Q NOT)</i>
Logics . LE50.Gate Out	<i>Signal: Output of the logic gate</i>
Logics . LE50.Timer Out	<i>Signal: Timer Output</i>

1..n, PSS	Description
Logics . LE50.Out	<i>Signal: Latched Output (Q)</i>
Logics . LE50.Out inverted	<i>Signal: Negated Latched Output (Q NOT)</i>
Logics . LE51.Gate Out	<i>Signal: Output of the logic gate</i>
Logics . LE51.Timer Out	<i>Signal: Timer Output</i>
Logics . LE51.Out	<i>Signal: Latched Output (Q)</i>
Logics . LE51.Out inverted	<i>Signal: Negated Latched Output (Q NOT)</i>
Logics . LE52.Gate Out	<i>Signal: Output of the logic gate</i>
Logics . LE52.Timer Out	<i>Signal: Timer Output</i>
Logics . LE52.Out	<i>Signal: Latched Output (Q)</i>
Logics . LE52.Out inverted	<i>Signal: Negated Latched Output (Q NOT)</i>
Logics . LE53.Gate Out	<i>Signal: Output of the logic gate</i>
Logics . LE53.Timer Out	<i>Signal: Timer Output</i>
Logics . LE53.Out	<i>Signal: Latched Output (Q)</i>
Logics . LE53.Out inverted	<i>Signal: Negated Latched Output (Q NOT)</i>
Logics . LE54.Gate Out	<i>Signal: Output of the logic gate</i>
Logics . LE54.Timer Out	<i>Signal: Timer Output</i>
Logics . LE54.Out	<i>Signal: Latched Output (Q)</i>
Logics . LE54.Out inverted	<i>Signal: Negated Latched Output (Q NOT)</i>
Logics . LE55.Gate Out	<i>Signal: Output of the logic gate</i>
Logics . LE55.Timer Out	<i>Signal: Timer Output</i>
Logics . LE55.Out	<i>Signal: Latched Output (Q)</i>
Logics . LE55.Out inverted	<i>Signal: Negated Latched Output (Q NOT)</i>
Logics . LE56.Gate Out	<i>Signal: Output of the logic gate</i>
Logics . LE56.Timer Out	<i>Signal: Timer Output</i>
Logics . LE56.Out	<i>Signal: Latched Output (Q)</i>
Logics . LE56.Out inverted	<i>Signal: Negated Latched Output (Q NOT)</i>
Logics . LE57.Gate Out	<i>Signal: Output of the logic gate</i>
Logics . LE57.Timer Out	<i>Signal: Timer Output</i>

1..n, PSS	Description
Logics . LE57.Out	<i>Signal: Latched Output (Q)</i>
Logics . LE57.Out inverted	<i>Signal: Negated Latched Output (Q NOT)</i>
Logics . LE58.Gate Out	<i>Signal: Output of the logic gate</i>
Logics . LE58.Timer Out	<i>Signal: Timer Output</i>
Logics . LE58.Out	<i>Signal: Latched Output (Q)</i>
Logics . LE58.Out inverted	<i>Signal: Negated Latched Output (Q NOT)</i>
Logics . LE59.Gate Out	<i>Signal: Output of the logic gate</i>
Logics . LE59.Timer Out	<i>Signal: Timer Output</i>
Logics . LE59.Out	<i>Signal: Latched Output (Q)</i>
Logics . LE59.Out inverted	<i>Signal: Negated Latched Output (Q NOT)</i>
Logics . LE60.Gate Out	<i>Signal: Output of the logic gate</i>
Logics . LE60.Timer Out	<i>Signal: Timer Output</i>
Logics . LE60.Out	<i>Signal: Latched Output (Q)</i>
Logics . LE60.Out inverted	<i>Signal: Negated Latched Output (Q NOT)</i>
Logics . LE61.Gate Out	<i>Signal: Output of the logic gate</i>
Logics . LE61.Timer Out	<i>Signal: Timer Output</i>
Logics . LE61.Out	<i>Signal: Latched Output (Q)</i>
Logics . LE61.Out inverted	<i>Signal: Negated Latched Output (Q NOT)</i>
Logics . LE62.Gate Out	<i>Signal: Output of the logic gate</i>
Logics . LE62.Timer Out	<i>Signal: Timer Output</i>
Logics . LE62.Out	<i>Signal: Latched Output (Q)</i>
Logics . LE62.Out inverted	<i>Signal: Negated Latched Output (Q NOT)</i>
Logics . LE63.Gate Out	<i>Signal: Output of the logic gate</i>
Logics . LE63.Timer Out	<i>Signal: Timer Output</i>
Logics . LE63.Out	<i>Signal: Latched Output (Q)</i>
Logics . LE63.Out inverted	<i>Signal: Negated Latched Output (Q NOT)</i>
Logics . LE64.Gate Out	<i>Signal: Output of the logic gate</i>
Logics . LE64.Timer Out	<i>Signal: Timer Output</i>

1..n, PSS	Description
Logics . LE64.Out	<i>Signal: Latched Output (Q)</i>
Logics . LE64.Out inverted	<i>Signal: Negated Latched Output (Q NOT)</i>
Logics . LE65.Gate Out	<i>Signal: Output of the logic gate</i>
Logics . LE65.Timer Out	<i>Signal: Timer Output</i>
Logics . LE65.Out	<i>Signal: Latched Output (Q)</i>
Logics . LE65.Out inverted	<i>Signal: Negated Latched Output (Q NOT)</i>
Logics . LE66.Gate Out	<i>Signal: Output of the logic gate</i>
Logics . LE66.Timer Out	<i>Signal: Timer Output</i>
Logics . LE66.Out	<i>Signal: Latched Output (Q)</i>
Logics . LE66.Out inverted	<i>Signal: Negated Latched Output (Q NOT)</i>
Logics . LE67.Gate Out	<i>Signal: Output of the logic gate</i>
Logics . LE67.Timer Out	<i>Signal: Timer Output</i>
Logics . LE67.Out	<i>Signal: Latched Output (Q)</i>
Logics . LE67.Out inverted	<i>Signal: Negated Latched Output (Q NOT)</i>
Logics . LE68.Gate Out	<i>Signal: Output of the logic gate</i>
Logics . LE68.Timer Out	<i>Signal: Timer Output</i>
Logics . LE68.Out	<i>Signal: Latched Output (Q)</i>
Logics . LE68.Out inverted	<i>Signal: Negated Latched Output (Q NOT)</i>
Logics . LE69.Gate Out	<i>Signal: Output of the logic gate</i>
Logics . LE69.Timer Out	<i>Signal: Timer Output</i>
Logics . LE69.Out	<i>Signal: Latched Output (Q)</i>
Logics . LE69.Out inverted	<i>Signal: Negated Latched Output (Q NOT)</i>
Logics . LE70.Gate Out	<i>Signal: Output of the logic gate</i>
Logics . LE70.Timer Out	<i>Signal: Timer Output</i>
Logics . LE70.Out	<i>Signal: Latched Output (Q)</i>
Logics . LE70.Out inverted	<i>Signal: Negated Latched Output (Q NOT)</i>
Logics . LE71.Gate Out	<i>Signal: Output of the logic gate</i>
Logics . LE71.Timer Out	<i>Signal: Timer Output</i>

1..n, PSS	Description
Logics . LE71.Out	<i>Signal: Latched Output (Q)</i>
Logics . LE71.Out inverted	<i>Signal: Negated Latched Output (Q NOT)</i>
Logics . LE72.Gate Out	<i>Signal: Output of the logic gate</i>
Logics . LE72.Timer Out	<i>Signal: Timer Output</i>
Logics . LE72.Out	<i>Signal: Latched Output (Q)</i>
Logics . LE72.Out inverted	<i>Signal: Negated Latched Output (Q NOT)</i>
Logics . LE73.Gate Out	<i>Signal: Output of the logic gate</i>
Logics . LE73.Timer Out	<i>Signal: Timer Output</i>
Logics . LE73.Out	<i>Signal: Latched Output (Q)</i>
Logics . LE73.Out inverted	<i>Signal: Negated Latched Output (Q NOT)</i>
Logics . LE74.Gate Out	<i>Signal: Output of the logic gate</i>
Logics . LE74.Timer Out	<i>Signal: Timer Output</i>
Logics . LE74.Out	<i>Signal: Latched Output (Q)</i>
Logics . LE74.Out inverted	<i>Signal: Negated Latched Output (Q NOT)</i>
Logics . LE75.Gate Out	<i>Signal: Output of the logic gate</i>
Logics . LE75.Timer Out	<i>Signal: Timer Output</i>
Logics . LE75.Out	<i>Signal: Latched Output (Q)</i>
Logics . LE75.Out inverted	<i>Signal: Negated Latched Output (Q NOT)</i>
Logics . LE76.Gate Out	<i>Signal: Output of the logic gate</i>
Logics . LE76.Timer Out	<i>Signal: Timer Output</i>
Logics . LE76.Out	<i>Signal: Latched Output (Q)</i>
Logics . LE76.Out inverted	<i>Signal: Negated Latched Output (Q NOT)</i>
Logics . LE77.Gate Out	<i>Signal: Output of the logic gate</i>
Logics . LE77.Timer Out	<i>Signal: Timer Output</i>
Logics . LE77.Out	<i>Signal: Latched Output (Q)</i>
Logics . LE77.Out inverted	<i>Signal: Negated Latched Output (Q NOT)</i>
Logics . LE78.Gate Out	<i>Signal: Output of the logic gate</i>
Logics . LE78.Timer Out	<i>Signal: Timer Output</i>

1..n, PSS	Description
Logics . LE78.Out	<i>Signal: Latched Output (Q)</i>
Logics . LE78.Out inverted	<i>Signal: Negated Latched Output (Q NOT)</i>
Logics . LE79.Gate Out	<i>Signal: Output of the logic gate</i>
Logics . LE79.Timer Out	<i>Signal: Timer Output</i>
Logics . LE79.Out	<i>Signal: Latched Output (Q)</i>
Logics . LE79.Out inverted	<i>Signal: Negated Latched Output (Q NOT)</i>
Logics . LE80.Gate Out	<i>Signal: Output of the logic gate</i>
Logics . LE80.Timer Out	<i>Signal: Timer Output</i>
Logics . LE80.Out	<i>Signal: Latched Output (Q)</i>
Logics . LE80.Out inverted	<i>Signal: Negated Latched Output (Q NOT)</i>

Measuring method

Measuring method: fundamental or rms or 3rd harmonic (only generator protection relays)

Selection list referenced by the following parameters:

-  I[1] . Measuring method

Measuring method	Description
Fundamental	<i>Protection is based on Fundamental (1st. Harmonic)</i>
True RMS	<i>Protection is based on root-mean-square value (True RMS)</i>
I2	<i>Protection is based on negative phase sequence current</i>

Char

Characteristic

Selection list referenced by the following parameters:

-  I[1] . Char

Char	Description
DEFT	<i>DEFT</i>
IEC NINV	<i>IEC Normal Inverse</i>
IEC VINV	<i>IEC Very Inverse [VINV]</i>
IEC EINV	<i>IEC Extremely Inverse - Characteristic</i>
IEC LINV	<i>IEC Long Time Inverse - Characteristic [LINV]</i>
RINV	<i>R Inverse [RINV] - Characteristic</i>
ANSI MINV	<i>ANSI Moderately Inverse [MINV] - Characteristic</i>
ANSI VINV	<i>ANSI Very Inverse [VINV]</i>
ANSI EINV	<i>ANSI Extremely Inverse - Characteristic</i>
Therm Flat	<i>Therm Flat [TF] - Characteristic</i>
IT	<i>IT - Characteristic</i>
I2T	<i>I2T - Characteristic</i>
I4T	<i>I4T - Characteristic</i>

Reset Mode

Selection list referenced by the following parameters:

-  I[1] . Reset Mode

Reset Mode	Description
instantaneous	<i>Instantaneous reset: when the current drops below the pickup setting, the TOC time resets to zero within 2 cycles.</i>
delayed	<i>Reset after a fixed time. (Remark: This delay is then defined by the parameter »t-reset delay«.)</i>
calculated	<i>Calculated reset, which is defined by ANSI C37.112 and IEC.</i>

IH2 Blo

Blocking the trip command, if an inrush is detected.

Selection list referenced by the following parameters:

-  I[1] . IH2 Blo

-  IG[1] . IH2 Blo

IH2 Blo	Description
Sys . inactive	<i>inactive</i>
IH2 . active	<i>active</i>

Measuring Mode

Selection list referenced by the following parameters:







-  I[1] . Measuring Mode

Measuring Mode	Description
Phase to Ground	<i>Phase-to-Ground Voltage</i>
Phase to Phase	<i>The voltage transformers are connected to phase-to-phase voltages</i>

VTS Block

Blocking of the module if the voltage transformer supervision detects a fault.

Selection list referenced by the following parameters:

-  I[1] . Meas Circuit Superv
-  IG[1] . Meas Circuit Superv
-  V[1] . Meas Circuit Superv
-  P[1] . MeasCircSv Volt
-  Q . MeasCircSv Volt
-  LVRT[1] . Meas Circuit Superv
- *[...]*

VTS Block	Description
Sys . inactive	<i>inactive</i>
LOP . active	<i>active</i>

Measuring Channel

Selection list referenced by the following parameters:

-  IG[1] . IG Source

Measuring Channel	Description
CT Ntrl . sensitive measurement	<i>sensitive measurement</i>
CT Ntrl . measured	<i>measured</i>
CT Ntrl . calculated	<i>calculated</i>
CT Mains . measured (X4)	<i>measured (slot X4)</i>

Measuring method

Measuring method: fundamental or rms or 3rd harmonic (only generator protection relays)

Selection list referenced by the following parameters:

-  IG[1] . Measuring method

Measuring method	Description
Fundamental	<i>Protection is based on Fundamental (1st. Harmonic)</i>
True RMS	<i>Protection is based on root-mean-square value (True RMS)</i>

VX Source

Selection if VG is measured or calculated (neutral voltage or residual voltage)

Selection list referenced by the following parameters:

-  IG[1] . VX Source

VX Source	Description
measured	<i>measured</i>
calculated	<i>calculated</i>

Char

Characteristic

Selection list referenced by the following parameters:

-  IG[1] . Char

Char	Description
DEFT	<i>DEFT</i>
IEC NINV	<i>IEC Normal Inverse</i>
IEC VINV	<i>IEC Very Inverse [VINV]</i>
IEC EINV	<i>IEC Extremely Inverse - Characteristic</i>
IEC LINV	<i>IEC Long Time Inverse - Characteristic [LINV]</i>
RINV	<i>R Inverse [RINV] - Characteristic</i>
ANSI MINV	<i>ANSI Moderately Inverse [MINV] - Characteristic</i>
ANSI VINV	<i>ANSI Very Inverse [VINV]</i>
ANSI EINV	<i>ANSI Extremely Inverse - Characteristic</i>
Therm Flat	<i>Therm Flat [TF] - Characteristic</i>
IT	<i>IT - Characteristic</i>
I2T	<i>I2T - Characteristic</i>
I4T	<i>I4T - Characteristic</i>
RXIDG	<i>Special Overcurrent Curve</i>

Reset Mode

Selection list referenced by the following parameters:

-  IG[1] . Reset Mode

Reset Mode	Description
instantaneous	<i>Instantaneous reset: when the current drops below the pickup setting, the TOC time resets to zero within 2 cycles.</i>
delayed	<i>Reset after a fixed time. (Remark: This delay is then defined by the parameter »t-reset delay«.)</i>
calculated	<i>Calculated reset, which is defined by ANSI C37.112 and IEC.</i>

Char

Characteristic

Selection list referenced by the following parameters:

-  I2>[1] . Char

Char	Description
DEFT	DEFT
INV	INV

block mode

Selection list referenced by the following parameters:

-  IH2 . block mode

block mode	Description
1-ph Blo	1-ph Blo: If an inrush is detected in one phase, the corresponding phase of those modules will be blocked, where inrush blocking is set to active.
3-ph Blo	3-ph Blo: If an inrush is detected in at least one phase, all three phases of those modules where inrush blocking is set to active will be blocked (cross blocking).

Measuring Mode

Measuring/Supervision Mode: Determines if the phase-to-phase or phase-to-earth voltages are to be supervised

Selection list referenced by the following parameters:

-  V[1] . Measuring Mode

Measuring Mode	Description
Phase to Ground	The voltage transformers are connected to phase-to-ground voltages
Phase to Phase	The voltage transformers are connected to phase-to-phase voltages

Measuring method

Measuring method: fundamental or rms or "sliding average supervision"

Selection list referenced by the following parameters:

-  V[1] . Measuring method

Measuring method	Description
Fundamental	<i>Protection is based on Fundamental (1st. Harmonic)</i>
True RMS	<i>Protection is based on root-mean-square value (True RMS)</i>
Vavg	<i>Sliding Voltage Average Supervision. Note: The settings for the average calculation have to be made within menu [Device Para/Statistics/Vavg].</i>

Alarm Mode

Alarm criterion for the voltage protection stage.

Selection list referenced by the following parameters:

-  V[1] . Alarm Mode

Alarm Mode	Description
any one	<i>any one: Trip Command, if the tripping criterion is fulfilled within at least one phase.</i>
any two	<i>any two</i>
all	<i>all: Trip Command for 3p-faults, i.e. if the tripping criterion is fulfilled in all three phases.</i>

VX Source

Selection if VG is measured or calculated (neutral voltage or residual voltage)

Selection list referenced by the following parameters:

-  VG[1] . VX Source

VX Source	Description
measured	<i>VX/VG is measured at the 4th measuring input</i>
calculated	<i>VX/VG is measured at the 4th measuring input</i>

Measuring method

Measuring method: fundamental or rms or 3rd harmonic (only generator protection relays)

Selection list referenced by the following parameters:

-  VG[1] . Measuring method

Measuring method	Description
Fundamental	<i>Protection is based on Fundamental (1st. Harmonic)</i>
True RMS	<i>Protection is based on root-mean-square value (True RMS)</i>
VX meas H3	<i>Third harmonic of measured neutral voltage used to detect generator stator ground faults.</i>

Mode

general operation mode

Selection list referenced by the following parameters:



-  f[1] . df/dt mode

Mode	Description
absolute df/dt	<i>positive and negative rise of frequency frequency</i>
positive df/dt	<i>positive rise of frequency</i>
negative df/dt	<i>negative rise of frequency frequency</i>

VTS Block

Blocking of the module if the voltage transformer supervision detects a fault.

Selection list referenced by the following parameters:

-  P[1] . MeasCircSv Curr
-  Q . MeasCircSv Curr
-  PQS[1] . MeasCircSv Curr

VTS Block	Description
Sys . inactive	<i>inactive</i>

VTS Block	Description
CTS . active	active

PowMeasMethod

Determines if the active power, reactive power and apparent power are calculated on the basis of RMS or DFT.

Selection list referenced by the following parameters:

-  PQS[1] . PowMeasMethod

PowMeasMethod	Description
Fundamental	<i>The active power, reactive power and apparent power are calculated on the basis of DFT.</i>
True RMS	<i>The active power, reactive power and apparent power are calculated on the basis of RMS.</i>

Measuring method

Measuring method: fundamental or rms or 3rd harmonic (only generator protection relays)

Selection list referenced by the following parameters:



-  PF[1] . Measuring method

Measuring method	Description
Fundamental	<i>Protection is based on Fundamental (1st. Harmonic)</i>
True RMS	<i>Protection is based on root-mean-square value (True RMS)</i>

Mode

general operation mode

Selection list referenced by the following parameters:

-  PF[1] . Trig Mode
-  PF[1] . Res Mode

Mode	Description
I leads V	<i>At capacitive loads (capacitor bank) the current phasor is leading to the voltage phasor.</i>
I lags V	<i>At inductive loads (e.g. motors) the current phasor is lagging to the voltage phasor.</i>

Tripping characteristics of V/f Over-Excitation protection.

Selection list referenced by the following parameters:

-  V/f>[1] . Curve Shape

Tripping characteristics of V/f Over-Excitation protection.	Description
DEFT	<i>DEFT</i>
Inv A	<i>Inverse characteristic Type A</i>
Inv B	<i>Inverse characteristic Type B</i>
Inv C	<i>Inverse characteristic Type C</i>

Arming Signal

Select if the protection is going to be enabled by "U/V and offline" or "U/V or offline".

Selection list referenced by the following parameters:

-  InEn . Arming Signal

Arming Signal	Description
U/V and Offline	<i>U/V and Offline</i>
U/V or Offline	<i>U/V or Offline</i>

Start condition

Select the start criterion for the measurement of the fault impedances.

Selection list referenced by the following parameters:

-  Z[1] . Start condition

Start condition	Description
Overcurrent	<i>The start criterion is fulfilled if the maximum measured phase current exceeds the settable current limit »I> Str«.</i>
Overcur & Undervlt	<i>The start criterion is fulfilled if the maximum measured phase current exceeds the settable current limit »I> Str« and the minimum measured voltage is below the settable voltage limit »V< Str«.</i>
Underimpedance	<i>The start criterion is fulfilled if the corresponding measured loop impedance is below the settable impedance limit »Z< Str«.</i>

Measuring Mode

Selection list referenced by the following parameters:

-  Z[1] . Voltage type

Measuring Mode	Description
Phase to Ground	<i>Phase-to-Ground Voltage</i>
Phase to Phase	<i>The voltage transformers are connected to phase-to-phase voltages</i>

Type of imp. area

Select whether the impedance characteristic shall be of type MHO or polygon.

Selection list referenced by the following parameters:

-  Z[1] . Type of imp. area

Type of imp. area	Description
MHO	<i>Impedance characteristic of type Mho</i>
Polygon	<i>Impedance characteristic of type polygon</i>

Mode

general operation mode

Selection list referenced by the following parameters:

-  df/dt . df/dt mode

Mode	Description
absolute df/dt	<i>positive and negative rise of frequency frequency</i>
positive df/dt	<i>positive rise of frequency</i>
negative df/dt	<i>negative rise of frequency frequency</i>

Mode

general operation mode

Selection list referenced by the following parameters:

-  delta phi . df/dt mode

Mode	Description
absolute df/dt	<i>positive and negative rise of frequency frequency</i>
positive df/dt	<i>positive rise of frequency</i>
negative df/dt	<i>negative rise of frequency frequency</i>

PowMeasMethod

Determines if the active power, reactive power and apparent power are calculated on the basis of RMS or DFT.

Selection list referenced by the following parameters:

-  P[1] . PowMeasMethod

PowMeasMethod	Description
Fundamental	<i>The active power, reactive power and apparent power are calculated on the basis of DFT.</i>
True RMS	<i>The active power, reactive power and apparent power are calculated on the basis of RMS.</i>

Measuring Mode

Measuring/Supervision Mode: Determines if the phase-to-phase or phase-to-earth voltages are to be supervised

Selection list referenced by the following parameters:

-  LVRT[1] . Measuring Mode

Measuring Mode	Description
Phase to Ground	<i>The voltage transformers are connected to phase-to-ground voltages</i>
Phase to Phase	<i>The voltage transformers are connected to phase-to-phase voltages</i>

Measuring method

Measuring method: fundamental or rms or 3rd harmonic (only generator protection relays)

Selection list referenced by the following parameters:

-  LVRT[1] . Measuring method

Measuring method	Description
Fundamental	<i>Protection is based on Fundamental (1st. Harmonic)</i>
True RMS	<i>Protection is based on root-mean-square value (True RMS)</i>

Alarm Mode

Alarm criterion for the voltage protection stage.

Selection list referenced by the following parameters:

-  LVRT[1] . Alarm Mode

Alarm Mode	Description
any one	<i>any one: Trip Command, if the tripping criterion is fulfilled within at least one phase.</i>
any two	<i>any two: Trip Command only if the tripping criterion is fulfilled in minimum two phases.</i>
all	<i>all: Trip Command for 3p-faults, i.e. if the tripping criterion is fulfilled in all three phases.</i>
only 2	<i>only 2: Trip Command for 2p-faults, i.e. if the tripping criterion is fulfilled in exactly two phases.</i>

Selection of the Q(V)-Method: Power Angle or Reactive Power Threshold

Selection list referenced by the following parameters:

-  Q->&V< . QV-Method

Selection of the Q(V)-Method: Power Angle or Reactive Power Threshold	Description
Power Angle Supervision	<i>Power Angle Supervision</i>
Pure Reactive Power Superv	<i>Pure Reactive Power Supervision</i>

I1 Release

Activation of the "I1 Minimum Current"-Criterion.

Selection list referenced by the following parameters:

-  Q->&V< . I1 Release

I1 Release	Description
inactive	<i>inactive</i>
active	<i>active</i>

Reconnect. Release Cond

This parameter ensures that the mains voltage is recovered.

Selection list referenced by the following parameters:

-  ReCon[1] . Reconnect. Release Cond

Reconnect. Release Cond	Description
V Internal Release	<i>Release signal is being generated by internal voltage measuring values. The line-to-line voltage exceeds 95% Vn.</i>
V Ext Release PCC	<i>Release signal is being generated by the PCC (External Release). The line-to-line voltage exceeds 95% Vn.</i>
Both	<i>Both: Release signal is being generated by the PCC (External Release) and by internal voltage measuring values.</i>

Measuring method

Measuring method: fundamental or rms or "sliding average supervision"

Selection list referenced by the following parameters:

-  ReCon[1] . Measuring method

Measuring method	Description
Fundamental	<i>Protection is based on Fundamental (1st. Harmonic)</i>
True RMS	<i>Protection is based on root-mean-square value (True RMS)</i>
Vavg	<i>Sliding Voltage Average Supervision. Note: The settings for the average calculation have to be made within menu [Device Para/Statistics/Vavg].</i>

SyncMode

Synchrocheck mode: GENERATOR2SYSTEM = Synchronizing generator to system (breaker close initiate needed). SYSTEM2SYSTEM = SynchronCheck between two systems (Stand-Alone, no breaker info needed)

Selection list referenced by the following parameters:

-  Sync . SyncMode

SyncMode	Description
System2System	<i>SYSTEM2SYSTEM = SynchronCheck between two systems (Stand-Alone, no breaker info needed)</i>
Generator2System	<i>GENERATOR2SYSTEM = Synchronizing generator to system (breaker close initiate needed).</i>

NonIL ResetMode

Non-Interlocking ResetMode

Selection list referenced by the following parameters:

-  Ctrl . Res NonIL

NonIL ResetMode	Description
single Operation	<i>single Operation</i>

NonIL ResetMode	Description
timeout	<i>timeout</i>
permanent	<i>permanent</i>

Manipulate Position

WARNING! Fake Position - Manual Position Manipulation

Selection list referenced by the following parameters:







-  SG[1] . Manipulate Position

Manipulate Position	Description
inactive	<i>inactive</i>
Pos OFF	<i>Signal: Circuit Breaker is in OFF-Position</i>
Pos ON	<i>Signal: Circuit Breaker is in ON-Position</i>

1..n, Trip Cmds

List of available Trip Commands

Selection list referenced by the following parameters:

-  SG[1] . Off Cmd1
-  SG[1] . Off Cmd2
-  SG[1] . Off Cmd3
-  SG[1] . Off Cmd4
-  SG[1] . Off Cmd5
-  SG[1] . Off Cmd6
- *[...]*

1..n, Trip Cmds	Description
"_"	<i>No assignment</i>
Id . TripCmd	<i>Signal: Trip Command</i>
IdH . TripCmd	<i>Signal: Trip Command</i>
IdG[1] . TripCmd	<i>Signal: Trip Command</i>

1..n, Trip Cmds	Description
IdGH[1] . TripCmd	<i>Signal: Trip Command</i>
IdG[2] . TripCmd	<i>Signal: Trip Command</i>
IdGH[2] . TripCmd	<i>Signal: Trip Command</i>
I[1] . TripCmd	<i>Signal: Trip Command</i>
I[2] . TripCmd	<i>Signal: Trip Command</i>
I[3] . TripCmd	<i>Signal: Trip Command</i>
I[4] . TripCmd	<i>Signal: Trip Command</i>
I[5] . TripCmd	<i>Signal: Trip Command</i>
I[6] . TripCmd	<i>Signal: Trip Command</i>
IG[1] . TripCmd	<i>Signal: Trip Command</i>
IG[2] . TripCmd	<i>Signal: Trip Command</i>
IG[3] . TripCmd	<i>Signal: Trip Command</i>
IG[4] . TripCmd	<i>Signal: Trip Command</i>
ThR . TripCmd	<i>Signal: Trip Command</i>
I2>[1] . TripCmd	<i>Signal: Trip Command</i>
I2>[2] . TripCmd	<i>Signal: Trip Command</i>
I2>G[1] . TripCmd	<i>Signal: Trip Command</i>
I2>G[2] . TripCmd	<i>Signal: Trip Command</i>
V[1] . TripCmd	<i>Signal: Trip Command</i>
V[2] . TripCmd	<i>Signal: Trip Command</i>
V[3] . TripCmd	<i>Signal: Trip Command</i>
V[4] . TripCmd	<i>Signal: Trip Command</i>
V[5] . TripCmd	<i>Signal: Trip Command</i>
V[6] . TripCmd	<i>Signal: Trip Command</i>
df/dt . TripCmd	<i>Signal: Trip Command</i>
delta phi . TripCmd	<i>Signal: Trip Command</i>
Intertripping . TripCmd	<i>Signal: Trip Command</i>
P[1] . TripCmd	<i>Signal: Trip Command</i>
P[2] . TripCmd	<i>Signal: Trip Command</i>
P[3] . TripCmd	<i>Signal: Trip Command</i>
Q . TripCmd	<i>Signal: Trip Command</i>
LVRT[1] . TripCmd	<i>Signal: Trip Command</i>

1..n, Trip Cmds	Description
LVRT[2] . TripCmd	<i>Signal: Trip Command</i>
VG[1] . TripCmd	<i>Signal: Trip Command</i>
VG[2] . TripCmd	<i>Signal: Trip Command</i>
V012[1] . TripCmd	<i>Signal: Trip Command</i>
V012[2] . TripCmd	<i>Signal: Trip Command</i>
V012[3] . TripCmd	<i>Signal: Trip Command</i>
V012[4] . TripCmd	<i>Signal: Trip Command</i>
V012[5] . TripCmd	<i>Signal: Trip Command</i>
V012[6] . TripCmd	<i>Signal: Trip Command</i>
f[1] . TripCmd	<i>Signal: Trip Command</i>
f[2] . TripCmd	<i>Signal: Trip Command</i>
f[3] . TripCmd	<i>Signal: Trip Command</i>
f[4] . TripCmd	<i>Signal: Trip Command</i>
f[5] . TripCmd	<i>Signal: Trip Command</i>
f[6] . TripCmd	<i>Signal: Trip Command</i>
PQS[1] . TripCmd	<i>Signal: Trip Command</i>
PQS[2] . TripCmd	<i>Signal: Trip Command</i>
PQS[3] . TripCmd	<i>Signal: Trip Command</i>
PQS[4] . TripCmd	<i>Signal: Trip Command</i>
PQS[5] . TripCmd	<i>Signal: Trip Command</i>
PQS[6] . TripCmd	<i>Signal: Trip Command</i>
PF[1] . TripCmd	<i>Signal: Trip Command</i>
PF[2] . TripCmd	<i>Signal: Trip Command</i>
LoE-Z1[1] . TripCmd	<i>Signal: Trip Command</i>
LoE-Z2[1] . TripCmd	<i>Signal: Trip Command</i>
LoE-Z1[2] . TripCmd	<i>Signal: Trip Command</i>
LoE-Z2[2] . TripCmd	<i>Signal: Trip Command</i>
OST . TripCmd	<i>Signal: Trip Command</i>
V/f>[1] . TripCmd	<i>Signal: Trip Command</i>
V/f>[2] . TripCmd	<i>Signal: Trip Command</i>
InEn . TripCmd	<i>Signal: Trip Command</i>
Z[1] . TripCmd	<i>Signal: Trip Command</i>

1..n, Trip Cmds	Description
Z[2] . TripCmd	<i>Signal: Trip Command</i>
ExP[1] . TripCmd	<i>Signal: Trip Command</i>
ExP[2] . TripCmd	<i>Signal: Trip Command</i>
ExP[3] . TripCmd	<i>Signal: Trip Command</i>
ExP[4] . TripCmd	<i>Signal: Trip Command</i>
Ext Sudd Press . TripCmd	<i>Signal: Trip Command</i>
Ext Oil Temp . TripCmd	<i>Signal: Trip Command</i>
Ext Temp Superv[1] . TripCmd	<i>Signal: Trip Command</i>
Ext Temp Superv[2] . TripCmd	<i>Signal: Trip Command</i>
Ext Temp Superv[3] . TripCmd	<i>Signal: Trip Command</i>
RTD . TripCmd	<i>Signal: Trip Command</i>
AnaP[1] . TripCmd	<i>Signal: Trip Command</i>
AnaP[2] . TripCmd	<i>Signal: Trip Command</i>
AnaP[3] . TripCmd	<i>Signal: Trip Command</i>
AnaP[4] . TripCmd	<i>Signal: Trip Command</i>

1..n, In-SyncList

Selection list referenced by the following parameters:

-  SG[1] . Synchronism

1..n, In-SyncList	Description
"_"	<i>No assignment</i>
Sync . Ready to Close	<i>Signal: Ready to Close</i>
DI Slot X1 . DI 1	<i>Signal: Digital Input</i>
DI Slot X1 . DI 2	<i>Signal: Digital Input</i>
DI Slot X1 . DI 3	<i>Signal: Digital Input</i>
DI Slot X1 . DI 4	<i>Signal: Digital Input</i>
DI Slot X1 . DI 5	<i>Signal: Digital Input</i>
DI Slot X1 . DI 6	<i>Signal: Digital Input</i>

1..n, In-SyncList	Description
DI Slot X1 . DI 7	<i>Signal: Digital Input</i>
DI Slot X1 . DI 8	<i>Signal: Digital Input</i>
DI Slot X5 . DI 1	<i>Signal: Digital Input</i>
DI Slot X5 . DI 2	<i>Signal: Digital Input</i>
DI Slot X5 . DI 3	<i>Signal: Digital Input</i>
DI Slot X5 . DI 4	<i>Signal: Digital Input</i>
DI Slot X5 . DI 5	<i>Signal: Digital Input</i>
DI Slot X5 . DI 6	<i>Signal: Digital Input</i>
DI Slot X5 . DI 7	<i>Signal: Digital Input</i>
DI Slot X5 . DI 8	<i>Signal: Digital Input</i>
DI Slot X6 . DI 1	<i>Signal: Digital Input</i>
DI Slot X6 . DI 2	<i>Signal: Digital Input</i>
DI Slot X6 . DI 3	<i>Signal: Digital Input</i>
DI Slot X6 . DI 4	<i>Signal: Digital Input</i>
DI Slot X6 . DI 5	<i>Signal: Digital Input</i>
DI Slot X6 . DI 6	<i>Signal: Digital Input</i>
DI Slot X6 . DI 7	<i>Signal: Digital Input</i>
DI Slot X6 . DI 8	<i>Signal: Digital Input</i>
Logics . LE1.Gate Out	<i>Signal: Output of the logic gate</i>
Logics . LE1.Timer Out	<i>Signal: Timer Output</i>
Logics . LE1.Out	<i>Signal: Latched Output (Q)</i>
Logics . LE1.Out inverted	<i>Signal: Negated Latched Output (Q NOT)</i>
Logics . LE2.Gate Out	<i>Signal: Output of the logic gate</i>
Logics . LE2.Timer Out	<i>Signal: Timer Output</i>
Logics . LE2.Out	<i>Signal: Latched Output (Q)</i>
Logics . LE2.Out inverted	<i>Signal: Negated Latched Output (Q NOT)</i>
Logics . LE3.Gate Out	<i>Signal: Output of the logic gate</i>
Logics . LE3.Timer Out	<i>Signal: Timer Output</i>
Logics . LE3.Out	<i>Signal: Latched Output (Q)</i>
Logics . LE3.Out inverted	<i>Signal: Negated Latched Output (Q NOT)</i>

1..n, In-SyncList	Description
Logics . LE4.Gate Out	<i>Signal: Output of the logic gate</i>
Logics . LE4.Timer Out	<i>Signal: Timer Output</i>
Logics . LE4.Out	<i>Signal: Latched Output (Q)</i>
Logics . LE4.Out inverted	<i>Signal: Negated Latched Output (Q NOT)</i>
Logics . LE5.Gate Out	<i>Signal: Output of the logic gate</i>
Logics . LE5.Timer Out	<i>Signal: Timer Output</i>
Logics . LE5.Out	<i>Signal: Latched Output (Q)</i>
Logics . LE5.Out inverted	<i>Signal: Negated Latched Output (Q NOT)</i>
Logics . LE6.Gate Out	<i>Signal: Output of the logic gate</i>
Logics . LE6.Timer Out	<i>Signal: Timer Output</i>
Logics . LE6.Out	<i>Signal: Latched Output (Q)</i>
Logics . LE6.Out inverted	<i>Signal: Negated Latched Output (Q NOT)</i>
Logics . LE7.Gate Out	<i>Signal: Output of the logic gate</i>
Logics . LE7.Timer Out	<i>Signal: Timer Output</i>
Logics . LE7.Out	<i>Signal: Latched Output (Q)</i>
Logics . LE7.Out inverted	<i>Signal: Negated Latched Output (Q NOT)</i>
Logics . LE8.Gate Out	<i>Signal: Output of the logic gate</i>
Logics . LE8.Timer Out	<i>Signal: Timer Output</i>
Logics . LE8.Out	<i>Signal: Latched Output (Q)</i>
Logics . LE8.Out inverted	<i>Signal: Negated Latched Output (Q NOT)</i>
Logics . LE9.Gate Out	<i>Signal: Output of the logic gate</i>
Logics . LE9.Timer Out	<i>Signal: Timer Output</i>
Logics . LE9.Out	<i>Signal: Latched Output (Q)</i>
Logics . LE9.Out inverted	<i>Signal: Negated Latched Output (Q NOT)</i>
Logics . LE10.Gate Out	<i>Signal: Output of the logic gate</i>
Logics . LE10.Timer Out	<i>Signal: Timer Output</i>
Logics . LE10.Out	<i>Signal: Latched Output (Q)</i>
Logics . LE10.Out inverted	<i>Signal: Negated Latched Output (Q NOT)</i>

1..n, In-SyncList	Description
Logics . LE11.Gate Out	<i>Signal: Output of the logic gate</i>
Logics . LE11.Timer Out	<i>Signal: Timer Output</i>
Logics . LE11.Out	<i>Signal: Latched Output (Q)</i>
Logics . LE11.Out inverted	<i>Signal: Negated Latched Output (Q NOT)</i>
Logics . LE12.Gate Out	<i>Signal: Output of the logic gate</i>
Logics . LE12.Timer Out	<i>Signal: Timer Output</i>
Logics . LE12.Out	<i>Signal: Latched Output (Q)</i>
Logics . LE12.Out inverted	<i>Signal: Negated Latched Output (Q NOT)</i>
Logics . LE13.Gate Out	<i>Signal: Output of the logic gate</i>
Logics . LE13.Timer Out	<i>Signal: Timer Output</i>
Logics . LE13.Out	<i>Signal: Latched Output (Q)</i>
Logics . LE13.Out inverted	<i>Signal: Negated Latched Output (Q NOT)</i>
Logics . LE14.Gate Out	<i>Signal: Output of the logic gate</i>
Logics . LE14.Timer Out	<i>Signal: Timer Output</i>
Logics . LE14.Out	<i>Signal: Latched Output (Q)</i>
Logics . LE14.Out inverted	<i>Signal: Negated Latched Output (Q NOT)</i>
Logics . LE15.Gate Out	<i>Signal: Output of the logic gate</i>
Logics . LE15.Timer Out	<i>Signal: Timer Output</i>
Logics . LE15.Out	<i>Signal: Latched Output (Q)</i>
Logics . LE15.Out inverted	<i>Signal: Negated Latched Output (Q NOT)</i>
Logics . LE16.Gate Out	<i>Signal: Output of the logic gate</i>
Logics . LE16.Timer Out	<i>Signal: Timer Output</i>
Logics . LE16.Out	<i>Signal: Latched Output (Q)</i>
Logics . LE16.Out inverted	<i>Signal: Negated Latched Output (Q NOT)</i>
Logics . LE17.Gate Out	<i>Signal: Output of the logic gate</i>
Logics . LE17.Timer Out	<i>Signal: Timer Output</i>
Logics . LE17.Out	<i>Signal: Latched Output (Q)</i>
Logics . LE17.Out inverted	<i>Signal: Negated Latched Output (Q NOT)</i>

1..n, In-SyncList	Description
Logics . LE18.Gate Out	<i>Signal: Output of the logic gate</i>
Logics . LE18.Timer Out	<i>Signal: Timer Output</i>
Logics . LE18.Out	<i>Signal: Latched Output (Q)</i>
Logics . LE18.Out inverted	<i>Signal: Negated Latched Output (Q NOT)</i>
Logics . LE19.Gate Out	<i>Signal: Output of the logic gate</i>
Logics . LE19.Timer Out	<i>Signal: Timer Output</i>
Logics . LE19.Out	<i>Signal: Latched Output (Q)</i>
Logics . LE19.Out inverted	<i>Signal: Negated Latched Output (Q NOT)</i>
Logics . LE20.Gate Out	<i>Signal: Output of the logic gate</i>
Logics . LE20.Timer Out	<i>Signal: Timer Output</i>
Logics . LE20.Out	<i>Signal: Latched Output (Q)</i>
Logics . LE20.Out inverted	<i>Signal: Negated Latched Output (Q NOT)</i>
Logics . LE21.Gate Out	<i>Signal: Output of the logic gate</i>
Logics . LE21.Timer Out	<i>Signal: Timer Output</i>
Logics . LE21.Out	<i>Signal: Latched Output (Q)</i>
Logics . LE21.Out inverted	<i>Signal: Negated Latched Output (Q NOT)</i>
Logics . LE22.Gate Out	<i>Signal: Output of the logic gate</i>
Logics . LE22.Timer Out	<i>Signal: Timer Output</i>
Logics . LE22.Out	<i>Signal: Latched Output (Q)</i>
Logics . LE22.Out inverted	<i>Signal: Negated Latched Output (Q NOT)</i>
Logics . LE23.Gate Out	<i>Signal: Output of the logic gate</i>
Logics . LE23.Timer Out	<i>Signal: Timer Output</i>
Logics . LE23.Out	<i>Signal: Latched Output (Q)</i>
Logics . LE23.Out inverted	<i>Signal: Negated Latched Output (Q NOT)</i>
Logics . LE24.Gate Out	<i>Signal: Output of the logic gate</i>
Logics . LE24.Timer Out	<i>Signal: Timer Output</i>
Logics . LE24.Out	<i>Signal: Latched Output (Q)</i>
Logics . LE24.Out inverted	<i>Signal: Negated Latched Output (Q NOT)</i>

1..n, In-SyncList	Description
Logics . LE25.Gate Out	<i>Signal: Output of the logic gate</i>
Logics . LE25.Timer Out	<i>Signal: Timer Output</i>
Logics . LE25.Out	<i>Signal: Latched Output (Q)</i>
Logics . LE25.Out inverted	<i>Signal: Negated Latched Output (Q NOT)</i>
Logics . LE26.Gate Out	<i>Signal: Output of the logic gate</i>
Logics . LE26.Timer Out	<i>Signal: Timer Output</i>
Logics . LE26.Out	<i>Signal: Latched Output (Q)</i>
Logics . LE26.Out inverted	<i>Signal: Negated Latched Output (Q NOT)</i>
Logics . LE27.Gate Out	<i>Signal: Output of the logic gate</i>
Logics . LE27.Timer Out	<i>Signal: Timer Output</i>
Logics . LE27.Out	<i>Signal: Latched Output (Q)</i>
Logics . LE27.Out inverted	<i>Signal: Negated Latched Output (Q NOT)</i>
Logics . LE28.Gate Out	<i>Signal: Output of the logic gate</i>
Logics . LE28.Timer Out	<i>Signal: Timer Output</i>
Logics . LE28.Out	<i>Signal: Latched Output (Q)</i>
Logics . LE28.Out inverted	<i>Signal: Negated Latched Output (Q NOT)</i>
Logics . LE29.Gate Out	<i>Signal: Output of the logic gate</i>
Logics . LE29.Timer Out	<i>Signal: Timer Output</i>
Logics . LE29.Out	<i>Signal: Latched Output (Q)</i>
Logics . LE29.Out inverted	<i>Signal: Negated Latched Output (Q NOT)</i>
Logics . LE30.Gate Out	<i>Signal: Output of the logic gate</i>
Logics . LE30.Timer Out	<i>Signal: Timer Output</i>
Logics . LE30.Out	<i>Signal: Latched Output (Q)</i>
Logics . LE30.Out inverted	<i>Signal: Negated Latched Output (Q NOT)</i>
Logics . LE31.Gate Out	<i>Signal: Output of the logic gate</i>
Logics . LE31.Timer Out	<i>Signal: Timer Output</i>
Logics . LE31.Out	<i>Signal: Latched Output (Q)</i>
Logics . LE31.Out inverted	<i>Signal: Negated Latched Output (Q NOT)</i>

1..n, In-SyncList	Description
Logics . LE32.Gate Out	<i>Signal: Output of the logic gate</i>
Logics . LE32.Timer Out	<i>Signal: Timer Output</i>
Logics . LE32.Out	<i>Signal: Latched Output (Q)</i>
Logics . LE32.Out inverted	<i>Signal: Negated Latched Output (Q NOT)</i>
Logics . LE33.Gate Out	<i>Signal: Output of the logic gate</i>
Logics . LE33.Timer Out	<i>Signal: Timer Output</i>
Logics . LE33.Out	<i>Signal: Latched Output (Q)</i>
Logics . LE33.Out inverted	<i>Signal: Negated Latched Output (Q NOT)</i>
Logics . LE34.Gate Out	<i>Signal: Output of the logic gate</i>
Logics . LE34.Timer Out	<i>Signal: Timer Output</i>
Logics . LE34.Out	<i>Signal: Latched Output (Q)</i>
Logics . LE34.Out inverted	<i>Signal: Negated Latched Output (Q NOT)</i>
Logics . LE35.Gate Out	<i>Signal: Output of the logic gate</i>
Logics . LE35.Timer Out	<i>Signal: Timer Output</i>
Logics . LE35.Out	<i>Signal: Latched Output (Q)</i>
Logics . LE35.Out inverted	<i>Signal: Negated Latched Output (Q NOT)</i>
Logics . LE36.Gate Out	<i>Signal: Output of the logic gate</i>
Logics . LE36.Timer Out	<i>Signal: Timer Output</i>
Logics . LE36.Out	<i>Signal: Latched Output (Q)</i>
Logics . LE36.Out inverted	<i>Signal: Negated Latched Output (Q NOT)</i>
Logics . LE37.Gate Out	<i>Signal: Output of the logic gate</i>
Logics . LE37.Timer Out	<i>Signal: Timer Output</i>
Logics . LE37.Out	<i>Signal: Latched Output (Q)</i>
Logics . LE37.Out inverted	<i>Signal: Negated Latched Output (Q NOT)</i>
Logics . LE38.Gate Out	<i>Signal: Output of the logic gate</i>
Logics . LE38.Timer Out	<i>Signal: Timer Output</i>
Logics . LE38.Out	<i>Signal: Latched Output (Q)</i>
Logics . LE38.Out inverted	<i>Signal: Negated Latched Output (Q NOT)</i>

1..n, In-SyncList	Description
Logics . LE39.Gate Out	<i>Signal: Output of the logic gate</i>
Logics . LE39.Timer Out	<i>Signal: Timer Output</i>
Logics . LE39.Out	<i>Signal: Latched Output (Q)</i>
Logics . LE39.Out inverted	<i>Signal: Negated Latched Output (Q NOT)</i>
Logics . LE40.Gate Out	<i>Signal: Output of the logic gate</i>
Logics . LE40.Timer Out	<i>Signal: Timer Output</i>
Logics . LE40.Out	<i>Signal: Latched Output (Q)</i>
Logics . LE40.Out inverted	<i>Signal: Negated Latched Output (Q NOT)</i>
Logics . LE41.Gate Out	<i>Signal: Output of the logic gate</i>
Logics . LE41.Timer Out	<i>Signal: Timer Output</i>
Logics . LE41.Out	<i>Signal: Latched Output (Q)</i>
Logics . LE41.Out inverted	<i>Signal: Negated Latched Output (Q NOT)</i>
Logics . LE42.Gate Out	<i>Signal: Output of the logic gate</i>
Logics . LE42.Timer Out	<i>Signal: Timer Output</i>
Logics . LE42.Out	<i>Signal: Latched Output (Q)</i>
Logics . LE42.Out inverted	<i>Signal: Negated Latched Output (Q NOT)</i>
Logics . LE43.Gate Out	<i>Signal: Output of the logic gate</i>
Logics . LE43.Timer Out	<i>Signal: Timer Output</i>
Logics . LE43.Out	<i>Signal: Latched Output (Q)</i>
Logics . LE43.Out inverted	<i>Signal: Negated Latched Output (Q NOT)</i>
Logics . LE44.Gate Out	<i>Signal: Output of the logic gate</i>
Logics . LE44.Timer Out	<i>Signal: Timer Output</i>
Logics . LE44.Out	<i>Signal: Latched Output (Q)</i>
Logics . LE44.Out inverted	<i>Signal: Negated Latched Output (Q NOT)</i>
Logics . LE45.Gate Out	<i>Signal: Output of the logic gate</i>
Logics . LE45.Timer Out	<i>Signal: Timer Output</i>
Logics . LE45.Out	<i>Signal: Latched Output (Q)</i>
Logics . LE45.Out inverted	<i>Signal: Negated Latched Output (Q NOT)</i>

1..n, In-SyncList	Description
Logics . LE46.Gate Out	<i>Signal: Output of the logic gate</i>
Logics . LE46.Timer Out	<i>Signal: Timer Output</i>
Logics . LE46.Out	<i>Signal: Latched Output (Q)</i>
Logics . LE46.Out inverted	<i>Signal: Negated Latched Output (Q NOT)</i>
Logics . LE47.Gate Out	<i>Signal: Output of the logic gate</i>
Logics . LE47.Timer Out	<i>Signal: Timer Output</i>
Logics . LE47.Out	<i>Signal: Latched Output (Q)</i>
Logics . LE47.Out inverted	<i>Signal: Negated Latched Output (Q NOT)</i>
Logics . LE48.Gate Out	<i>Signal: Output of the logic gate</i>
Logics . LE48.Timer Out	<i>Signal: Timer Output</i>
Logics . LE48.Out	<i>Signal: Latched Output (Q)</i>
Logics . LE48.Out inverted	<i>Signal: Negated Latched Output (Q NOT)</i>
Logics . LE49.Gate Out	<i>Signal: Output of the logic gate</i>
Logics . LE49.Timer Out	<i>Signal: Timer Output</i>
Logics . LE49.Out	<i>Signal: Latched Output (Q)</i>
Logics . LE49.Out inverted	<i>Signal: Negated Latched Output (Q NOT)</i>
Logics . LE50.Gate Out	<i>Signal: Output of the logic gate</i>
Logics . LE50.Timer Out	<i>Signal: Timer Output</i>
Logics . LE50.Out	<i>Signal: Latched Output (Q)</i>
Logics . LE50.Out inverted	<i>Signal: Negated Latched Output (Q NOT)</i>
Logics . LE51.Gate Out	<i>Signal: Output of the logic gate</i>
Logics . LE51.Timer Out	<i>Signal: Timer Output</i>
Logics . LE51.Out	<i>Signal: Latched Output (Q)</i>
Logics . LE51.Out inverted	<i>Signal: Negated Latched Output (Q NOT)</i>
Logics . LE52.Gate Out	<i>Signal: Output of the logic gate</i>
Logics . LE52.Timer Out	<i>Signal: Timer Output</i>
Logics . LE52.Out	<i>Signal: Latched Output (Q)</i>
Logics . LE52.Out inverted	<i>Signal: Negated Latched Output (Q NOT)</i>

1..n, In-SyncList	Description
Logics . LE53.Gate Out	<i>Signal: Output of the logic gate</i>
Logics . LE53.Timer Out	<i>Signal: Timer Output</i>
Logics . LE53.Out	<i>Signal: Latched Output (Q)</i>
Logics . LE53.Out inverted	<i>Signal: Negated Latched Output (Q NOT)</i>
Logics . LE54.Gate Out	<i>Signal: Output of the logic gate</i>
Logics . LE54.Timer Out	<i>Signal: Timer Output</i>
Logics . LE54.Out	<i>Signal: Latched Output (Q)</i>
Logics . LE54.Out inverted	<i>Signal: Negated Latched Output (Q NOT)</i>
Logics . LE55.Gate Out	<i>Signal: Output of the logic gate</i>
Logics . LE55.Timer Out	<i>Signal: Timer Output</i>
Logics . LE55.Out	<i>Signal: Latched Output (Q)</i>
Logics . LE55.Out inverted	<i>Signal: Negated Latched Output (Q NOT)</i>
Logics . LE56.Gate Out	<i>Signal: Output of the logic gate</i>
Logics . LE56.Timer Out	<i>Signal: Timer Output</i>
Logics . LE56.Out	<i>Signal: Latched Output (Q)</i>
Logics . LE56.Out inverted	<i>Signal: Negated Latched Output (Q NOT)</i>
Logics . LE57.Gate Out	<i>Signal: Output of the logic gate</i>
Logics . LE57.Timer Out	<i>Signal: Timer Output</i>
Logics . LE57.Out	<i>Signal: Latched Output (Q)</i>
Logics . LE57.Out inverted	<i>Signal: Negated Latched Output (Q NOT)</i>
Logics . LE58.Gate Out	<i>Signal: Output of the logic gate</i>
Logics . LE58.Timer Out	<i>Signal: Timer Output</i>
Logics . LE58.Out	<i>Signal: Latched Output (Q)</i>
Logics . LE58.Out inverted	<i>Signal: Negated Latched Output (Q NOT)</i>
Logics . LE59.Gate Out	<i>Signal: Output of the logic gate</i>
Logics . LE59.Timer Out	<i>Signal: Timer Output</i>
Logics . LE59.Out	<i>Signal: Latched Output (Q)</i>
Logics . LE59.Out inverted	<i>Signal: Negated Latched Output (Q NOT)</i>

1..n, In-SyncList	Description
Logics . LE60.Gate Out	<i>Signal: Output of the logic gate</i>
Logics . LE60.Timer Out	<i>Signal: Timer Output</i>
Logics . LE60.Out	<i>Signal: Latched Output (Q)</i>
Logics . LE60.Out inverted	<i>Signal: Negated Latched Output (Q NOT)</i>
Logics . LE61.Gate Out	<i>Signal: Output of the logic gate</i>
Logics . LE61.Timer Out	<i>Signal: Timer Output</i>
Logics . LE61.Out	<i>Signal: Latched Output (Q)</i>
Logics . LE61.Out inverted	<i>Signal: Negated Latched Output (Q NOT)</i>
Logics . LE62.Gate Out	<i>Signal: Output of the logic gate</i>
Logics . LE62.Timer Out	<i>Signal: Timer Output</i>
Logics . LE62.Out	<i>Signal: Latched Output (Q)</i>
Logics . LE62.Out inverted	<i>Signal: Negated Latched Output (Q NOT)</i>
Logics . LE63.Gate Out	<i>Signal: Output of the logic gate</i>
Logics . LE63.Timer Out	<i>Signal: Timer Output</i>
Logics . LE63.Out	<i>Signal: Latched Output (Q)</i>
Logics . LE63.Out inverted	<i>Signal: Negated Latched Output (Q NOT)</i>
Logics . LE64.Gate Out	<i>Signal: Output of the logic gate</i>
Logics . LE64.Timer Out	<i>Signal: Timer Output</i>
Logics . LE64.Out	<i>Signal: Latched Output (Q)</i>
Logics . LE64.Out inverted	<i>Signal: Negated Latched Output (Q NOT)</i>
Logics . LE65.Gate Out	<i>Signal: Output of the logic gate</i>
Logics . LE65.Timer Out	<i>Signal: Timer Output</i>
Logics . LE65.Out	<i>Signal: Latched Output (Q)</i>
Logics . LE65.Out inverted	<i>Signal: Negated Latched Output (Q NOT)</i>
Logics . LE66.Gate Out	<i>Signal: Output of the logic gate</i>
Logics . LE66.Timer Out	<i>Signal: Timer Output</i>
Logics . LE66.Out	<i>Signal: Latched Output (Q)</i>
Logics . LE66.Out inverted	<i>Signal: Negated Latched Output (Q NOT)</i>

1..n, In-SyncList	Description
Logics . LE67.Gate Out	<i>Signal: Output of the logic gate</i>
Logics . LE67.Timer Out	<i>Signal: Timer Output</i>
Logics . LE67.Out	<i>Signal: Latched Output (Q)</i>
Logics . LE67.Out inverted	<i>Signal: Negated Latched Output (Q NOT)</i>
Logics . LE68.Gate Out	<i>Signal: Output of the logic gate</i>
Logics . LE68.Timer Out	<i>Signal: Timer Output</i>
Logics . LE68.Out	<i>Signal: Latched Output (Q)</i>
Logics . LE68.Out inverted	<i>Signal: Negated Latched Output (Q NOT)</i>
Logics . LE69.Gate Out	<i>Signal: Output of the logic gate</i>
Logics . LE69.Timer Out	<i>Signal: Timer Output</i>
Logics . LE69.Out	<i>Signal: Latched Output (Q)</i>
Logics . LE69.Out inverted	<i>Signal: Negated Latched Output (Q NOT)</i>
Logics . LE70.Gate Out	<i>Signal: Output of the logic gate</i>
Logics . LE70.Timer Out	<i>Signal: Timer Output</i>
Logics . LE70.Out	<i>Signal: Latched Output (Q)</i>
Logics . LE70.Out inverted	<i>Signal: Negated Latched Output (Q NOT)</i>
Logics . LE71.Gate Out	<i>Signal: Output of the logic gate</i>
Logics . LE71.Timer Out	<i>Signal: Timer Output</i>
Logics . LE71.Out	<i>Signal: Latched Output (Q)</i>
Logics . LE71.Out inverted	<i>Signal: Negated Latched Output (Q NOT)</i>
Logics . LE72.Gate Out	<i>Signal: Output of the logic gate</i>
Logics . LE72.Timer Out	<i>Signal: Timer Output</i>
Logics . LE72.Out	<i>Signal: Latched Output (Q)</i>
Logics . LE72.Out inverted	<i>Signal: Negated Latched Output (Q NOT)</i>
Logics . LE73.Gate Out	<i>Signal: Output of the logic gate</i>
Logics . LE73.Timer Out	<i>Signal: Timer Output</i>
Logics . LE73.Out	<i>Signal: Latched Output (Q)</i>
Logics . LE73.Out inverted	<i>Signal: Negated Latched Output (Q NOT)</i>

1..n, In-SyncList	Description
Logics . LE74.Gate Out	<i>Signal: Output of the logic gate</i>
Logics . LE74.Timer Out	<i>Signal: Timer Output</i>
Logics . LE74.Out	<i>Signal: Latched Output (Q)</i>
Logics . LE74.Out inverted	<i>Signal: Negated Latched Output (Q NOT)</i>
Logics . LE75.Gate Out	<i>Signal: Output of the logic gate</i>
Logics . LE75.Timer Out	<i>Signal: Timer Output</i>
Logics . LE75.Out	<i>Signal: Latched Output (Q)</i>
Logics . LE75.Out inverted	<i>Signal: Negated Latched Output (Q NOT)</i>
Logics . LE76.Gate Out	<i>Signal: Output of the logic gate</i>
Logics . LE76.Timer Out	<i>Signal: Timer Output</i>
Logics . LE76.Out	<i>Signal: Latched Output (Q)</i>
Logics . LE76.Out inverted	<i>Signal: Negated Latched Output (Q NOT)</i>
Logics . LE77.Gate Out	<i>Signal: Output of the logic gate</i>
Logics . LE77.Timer Out	<i>Signal: Timer Output</i>
Logics . LE77.Out	<i>Signal: Latched Output (Q)</i>
Logics . LE77.Out inverted	<i>Signal: Negated Latched Output (Q NOT)</i>
Logics . LE78.Gate Out	<i>Signal: Output of the logic gate</i>
Logics . LE78.Timer Out	<i>Signal: Timer Output</i>
Logics . LE78.Out	<i>Signal: Latched Output (Q)</i>
Logics . LE78.Out inverted	<i>Signal: Negated Latched Output (Q NOT)</i>
Logics . LE79.Gate Out	<i>Signal: Output of the logic gate</i>
Logics . LE79.Timer Out	<i>Signal: Timer Output</i>
Logics . LE79.Out	<i>Signal: Latched Output (Q)</i>
Logics . LE79.Out inverted	<i>Signal: Negated Latched Output (Q NOT)</i>
Logics . LE80.Gate Out	<i>Signal: Output of the logic gate</i>
Logics . LE80.Timer Out	<i>Signal: Timer Output</i>
Logics . LE80.Out	<i>Signal: Latched Output (Q)</i>
Logics . LE80.Out inverted	<i>Signal: Negated Latched Output (Q NOT)</i>

LE1.Gate

Logic gate

Selection list referenced by the following parameters:



-  Logics . LE1.Gate

LE1.Gate	Description
AND	AND Gate
OR	OR Gate
NAND	NAND Gate
NOR	NOR Gate

Mode

general operation mode

Selection list referenced by the following parameters:

-  BO Slot X2 . Disarm Mode
-  BO Slot X2 . Force Mode

Mode	Description
permanent	permanent
timeout	timeout

active/inactive

Selection list referenced by the following parameters:



-  BO Slot X2 . DISARMED

active/inactive	Description
inactive	inactive
active	active

Mode

general operation mode

Selection list referenced by the following parameters:

-  BO Slot X5 . Disarm Mode
-  BO Slot X5 . Force Mode

Mode	Description
permanent	<i>permanent</i>
timeout	<i>timeout</i>

active/inactive

Selection list referenced by the following parameters:



-  BO Slot X5 . DISARMED

active/inactive	Description
inactive	<i>inactive</i>
active	<i>active</i>

Mode

general operation mode

Selection list referenced by the following parameters:

-  BO Slot X6 . Disarm Mode
-  BO Slot X6 . Force Mode

Mode	Description
permanent	<i>permanent</i>
timeout	<i>timeout</i>

active/inactive



Selection list referenced by the following parameters:

-  BO Slot X6 . DISARMED

active/inactive	Description
inactive	<i>inactive</i>
active	<i>active</i>

Relay operating modes



Selection list referenced by the following parameters:

-  BO Slot X2 . Force all Outs
-  BO Slot X2 . Force OR1

Relay operating modes	Description
Normal	<i>Normal</i>
De-Energized	<i>De-Energized</i>
Energized	<i>Energized</i>

Relay operating modes



Selection list referenced by the following parameters:

-  BO Slot X5 . Force all Outs
-  BO Slot X5 . Force OR1

Relay operating modes	Description
Normal	<i>Normal</i>
De-Energized	<i>De-Energized</i>
Energized	<i>Energized</i>

Relay operating modes

Selection list referenced by the following parameters:

-  BO Slot X6 . Force all Outs
-  BO Slot X6 . Force OR1

Relay operating modes	Description
Normal	<i>Normal</i>
De-Energized	<i>De-Energized</i>
Energized	<i>Energized</i>

Mode

general operation mode

Selection list referenced by the following parameters:

-  URTD . Force Mode

Mode	Description
permanent	<i>permanent</i>
timeout	<i>timeout</i>

active/inactive

Selection list referenced by the following parameters:

-  URTD . Function

active/inactive	Description
inactive	<i>inactive</i>
active	<i>active</i>

State

Selection list referenced by the following parameters:

-  Sgen . State

State	Description
Off	Off
PreFault	Pre Fault Duration
FaultSimulation	Duration of Fault Simulation
PostFault	Post Fault Duration
Init Res	Init Reset

TripCmd Mode

Trip Command Mode: Select between two operating modes for the Fault Simulator: "cold simulation" (without tripping the circuit breaker), or "hot simulation" (i.e. the simulation is authorized to trip the circuit breaker)

Selection list referenced by the following parameters:

-  Sgen . TripCmd Mode

TripCmd Mode	Description
No TripCmd	No Trip Command: The TripCmd of all protection functions is blocked. The protection function will possibly trip but not generate a TripCmd.
With TripCmd	With Trip Command: The trip of a protection function generates a TripCmd, that can open the circuit breaker.

Index

.....	674, 701, 713
1	
1...n Operating Modes	528, 646, 647
1..n Energy Scaling	525
1..n Power Scaling	525
1..n, AnalogOutputList	648, 777
1..n, Assignment List	529, 663, 663
1..n, DI-LogicList	748
1..n, Dig Inputs	726
1..n, In-SyncList	828
1..n, OnOffList	661
1..n, PSS	797
1..n, SyncRequestList	763
1..n, TrendRecList	657
1..n, Trip Cmds	825
3	
3V0 Source	679
A	
Ack via »C« key	653
AdaptSet	681
Alarm Mode	816, 822
AnaP[1]	433, 433, 434, 435, 435
Arming Signal	819
active/inactive	680, 841, 842, 843, 844
B	
Baud rate	502, 661, 666, 667
Blo Trigger	796
Byte Frame	661, 666, 668
block mode	815
C	
CB List	776, 778
CB Manager	700
CBF	437, 437, 438, 439, 439, 439
CLPU	380, 380, 381, 382, 382
CT Mains	101, 102, 103, 106
CT Ntrl	92, 93, 94, 97

CT Winding Side	681
CTS	444, 444, 444, 445, 445
Char	810, 814, 815
Communication Start Variants	662
Config status	503, 667, 670
Config. Device Reset	506
Ctrl	451, 451, 451, 452, 452, 453
Current Trips	780
CurrentBase	700

D

DNP3	144, 149, 149, 150, 150
Date	672
Day of clock change	673
Debouncing time	526, 527, 528
Decoupling Functions	727
Device planning	508, 510, 510, 510, 511, 511, 511, 511, 512, 513, 513, 513, 516, 516, 516, 517, 518, 518, 519, 519, 519, 520, 520, 520, 520, 521, 521
Direction	500
Disturb rec	475, 476, 476, 476, 477
Duration	654, 654
delta phi	260, 260, 260, 263, 263
delta phi - Mode	680
df/dt	255, 255, 255, 258, 258

E

Earth overcurrent	509
Event rec	474, 474
Exp[1]	384, 384, 385, 386, 386
Ext Oil Temp	392, 392, 393, 394, 394
Ext Sudd Press	388, 388, 389, 390, 390
Ext Temp Superv[1]	396, 396, 397, 398, 398
External Trips	779

F

Fault	500
Fault rec	478, 478, 478
Field Para	77
fN	675
f[1]	296, 296, 296, 298, 299

G

Generator	110, 110, 110, 111
Generator side	676

H

HMI	73, 74, 74
-----------	------------

I

I1 Release	823
I2>G[1]	245, 245, 245, 247, 247
I2>[1]	240, 240, 241, 243, 243
I>	509
IEC 61850	159, 159, 159, 160, 161, 163, 163
IEC103	164, 166, 167, 167
IEC104	169, 172, 172, 172, 173
IG calc dir control	679
IG meas dir control	679
IG[1]	226, 226, 228, 231, 232
IH2	214, 214, 214, 215, 215
IH2 Blo	811
IRIG-B	178, 178, 178, 179, 179
IRIG-B00X	674
I[1]	217, 217, 218, 222, 223
Id	125, 125, 126, 193, 193, 193, 197, 197, 201, 201
IdG	127, 127, 127
IdGH[1]	211, 211, 211, 212, 213
IdG[1]	207, 207, 207, 209, 209
IdH	203, 203, 203, 204, 205
InEn	349, 349, 350, 351, 352
Intertripping	265, 265, 266, 267, 267

L

LB	367, 367, 367, 369, 369
LE1.Gate	841
LED active color	651, 652
LOP	447, 447, 448, 449, 450
LVRT[1]	279, 279, 279, 284, 284, 284, 286
LoE-Z1[1]	328, 328, 328, 330, 331
LoE-Z2[1]	333, 333, 333, 336, 336
Logics	482, 483, 484, 484

M	
Manipulate Position	825
Measuring Channel	813
Measuring Mode	812, 815, 820, 822
Measuring method	810, 813, 816, 817, 818, 822, 824
Modbus	152, 155, 155, 155, 156, 157
Mode	504, 507, 507, 507, 508, 508, 512, 512, 514, 515, 515, 515, 516, 517, 517, 518, 519, 521, 522, 523, 523, 524, 651, 652, 775, 776, 796, 817, 818, 820, 821, 841, 842, 842, 844
Month of clock change	672
N	
No of Equations:	523
Nom voltage	526, 526, 527
NonIL ResetMode	824
O	
OST	338, 338, 338, 342, 342
Optical rest position	662, 665, 668
P	
PF[1]	306, 306, 306, 308, 309
PNO Id	502
PQSCr	129, 129, 129, 131, 132
PQS[1]	301, 301, 301, 304, 304
PSB	370, 370, 370, 373, 373
PSet-Switch	797
P[1]	269, 269, 269, 272, 272
Phase Sequence	675
Polarity	678, 678
Port selection	665, 668
PowMeasMethod	818, 821
Power Trip dir	726
Profibus	174, 174, 175, 175, 176, 177
Prot	187, 188, 188, 188, 192
Q	
Q	274, 274, 274, 276, 277
Q->&V<	310, 310, 310, 313, 313
R	
RTD	408, 408, 409, 423, 423, 432

Ratio prim/sec	677, 678
ReCon[1]	315, 315, 316, 319, 319
Rec state	500
Reconnect. Release Cond.	823
Record-Mode	656
Relay operating modes	843, 843, 843
Reset Mode	811, 814
Resolution	656

S

SG[1]	454, 458, 459, 460, 464, 467, 468, 469, 469
SNTP	180, 180, 181, 181, 181, 182
SOTF	376, 376, 377, 378, 378
SSV	486, 486, 486
Scada	142, 142
Scale Factor	664
Scaling	524, 524
Scheme	778
Selection	656
Selection of the Q(V)-Method: Power Angle or Reactive Power Threshold	823
Server State	503
Sgen	488, 488, 489, 489, 490, 491, 492, 496
Start condition	819
State	501, 501, 503, 844
Statistics	135, 138, 139, 140, 140
Switching Authority	506
Sync	321, 321, 322, 325, 325, 326
SyncMode	824
Sys	114, 116, 117, 118, 120
SysA	470, 470, 471, 471

T

TCS	441, 441, 442, 443, 443
TLS Certificate	505
Tcplp	143
ThR	235, 235, 236, 237, 237, 238, 238, 239
Time Zones	670
TimeSync	184, 186
Timezone	668, 669
Transformer	112, 112
Trend rec	479, 481, 481, 481
Trigger	779, 781

TripCmd Mode	845
TripCmd Selection.	777
Tripping characteristics of V/f Over-Excitation protection.	819
Type of Input	647, 648
Type of Output	650, 650
Type of SCADA mapping.	666, 669, 670
Type of imp. area	820
Type of passw. def.	505
t-Alarm	777
true or not true.	504
U	
URTD	400, 400, 404, 405, 406
Units.	525
Used Protocol.	522, 673
V	
V/f>[1]	345, 345, 345, 347, 347
V012[1]	292, 292, 293, 294, 295
VG[1]	287, 287, 288, 289, 290
VT.	78, 83, 83, 88
VT con	677
VTS Block.	812, 817
VX Source.	813, 816
V[1]	249, 249, 249, 252, 253
Voltages to be synchronized.	677
W	
W1 Connection/Grounding	675
W2 Connection/Grounding	676
Window configuration.	655
Y	
yes/no	509
Z	
Z.	123, 123
Z[1]	353, 353, 355, 364, 365
-	
_AL_ResponseType_k	662

We appreciate your comments about the content of our publications.

Send comments to: kemp.doc@woodward.com

Please reference publication MCDGV4-3.6-EN-REF

<http://wwdmanuals.com/mcdgv4-2>

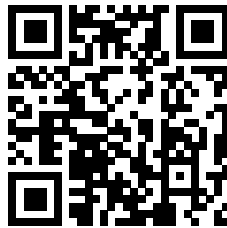

Woodward Kempen GmbH reserves the right to update any portion of this publication at any time. Information provided by Woodward Kempen GmbH is believed to be correct and reliable. However, Woodward Kempen GmbH assumes no responsibility unless otherwise expressly undertaken.



Woodward Kempen GmbH
Krefelder Weg 47 • D-47906 Kempen (Germany)
Postfach 10 07 55 (P.O.Box) • D-47884 Kempen (Germany)
Telephone: : +49 (0) 21 52 145 1

Internet: — www.woodward.com

Sales

Telephone: : +49 (0) 21 52 145 331
Fax: : +49 (0) 21 52 145 354
Email: : SalesPGD_EMEA@woodward.com

Service

Telephone: : +49 (0) 21 52 145 600
Fax: : +49 (0) 21 52 145 455
Email: : SupportPGD_Europe@woodward.com

Woodward has company-owned plants, subsidiaries, and branches, as well as authorized distributors and other authorized service and sales facilities throughout the world.

Complete address / phone / fax / email information for all locations is available on our website.