



MCDGV4

Software-Version: 3.4.b

DOK-HB-MCDGV4-2E

Revision: E

English

MCDGV4 Functional Overview

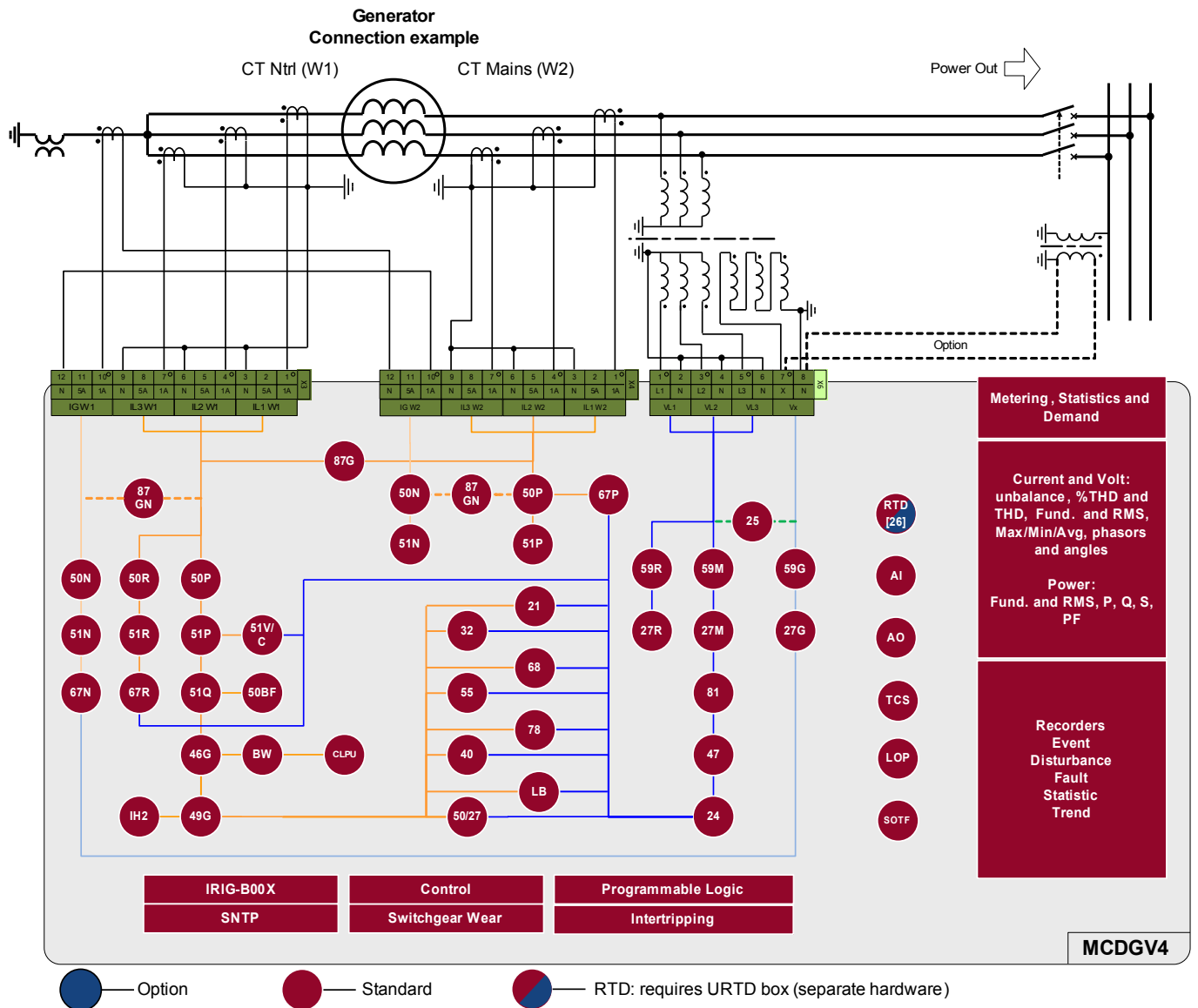

Order Code

Generator Differential Protection					MCDGV4	-2					
(Version 2 with USB, enhanced communication options and new front plate)											
Digital Inputs	Binary output relays	Analog Inputs/Outputs	Housing	Large display							
16	11	0/0	B2	X						A	
8	11	2/2	B2	X						B	
24	11	0/0	B2	X						C	
16	16	0/0	B2	X						D	
Hardware variant 2											
Phase Current 5 A/1 A, Ground Current 5 A/1 A										0	
Phase Current 5 A/1 A, Sensitive Ground Current 5 A/1 A										1	
Housing and mounting											
Door mounting											A
Door mounting 19" (flush mounting)											B
Communication protocol											
Without protocol											A
Modbus RTU, DNP3.0, IEC60870-5-103, RS485/terminals											B*
Modbus TCP, DNP3.0, Ethernet 100 MB/RJ45											C*
Profibus-DP, optic fibre											D*
Profibus-DP, RS485/D-SUB											E*
Modbus RTU, IEC60870-5-103, optic fiber											F*
Modbus RTU, IEC60870-5-103, RS485/D-SUB											G*
IEC61850, DNP3.0, Ethernet 100MB/ RJ45											H*
IEC60870-5-103, Modbus RTU, DNP3.0 RTU <i>RS485/terminals</i>											I*
Modbus TCP, DNP3.0 TCP/UDP <i>Ethernet 100 MB/RJ45</i>											
IEC61850, Modbus TCP, DNP3.0 TCP/UDP <i>Optical Ethernet 100MB/LC duplex connector</i>											K*
Modbus TCP, DNP3.0 TCP/UDP <i>Optical Ethernet 100MB/LC duplex connector</i>											L*
IEC60870-5-103, Modbus RTU, DNP3.0 RTU <i>RS485/terminals</i>											
IEC61850, Modbus TCP, DNP3.0 TCP/UDP <i>Ethernet 100 MB/RJ45</i>											T*
Harsh Environment Option											
None											A
Conformal Coating											B
Available menu languages											
Standard English/German/Spanish/Russian/Polish/Portuguese/French/Romanian											

* Within every communication option only one communication protocol is usable.
Smart view can be used in parallel via the Ethernet interface (RJ45).

The parameterizing- and disturbance analyzing software Smart view is included in the delivery of HighPROTEC devices.

All devices are equipped with an IRIG-B interface for Time Synchronization.

With control functions for up to 6 switchgears and logic up to 80 equations.

Table of Contents

MCDGV4 Functional Overview	2
Order Code	3
Table of Contents	5
Comments on the Manual	11
Information Concerning Liability and Warranty	11
IMPORTANT DEFINITIONS	12
Important Information	14
Scope of Delivery	16
Storage.....	17
Waste Disposal.....	17
Symbols.....	18
General Conventions.....	20
Load Reference Arrow System.....	25
Device	26
Device Planning.....	26
Device Configuration Parameters of the Device.....	27
Installation and Connection	29
Three-Side-View - 19".....	29
Three-Side-View - 8-Pushbutton Version.....	31
Installation Diagram 8-Pushbutton Version.....	32
Assembly Groups.....	33
Grounding.....	34
Legend for Wiring Diagrams.....	35
Slot X1: Power Supply Card with Digital Inputs.....	37
Slot X2: Relay Output Card.....	41
Slot X3: CT Ntrl - Current Transformer Measuring Inputs.....	44
Slot X4: CT Mains - Current Transformer Measuring Inputs.....	45
Slot X5: Multi Input – Output Card.....	59
Slot X6: Voltage Measuring Card with Digital In- or Outputs.....	66
DI8 X- Digital Inputs.....	69
Slot X100: Ethernet Interface.....	88
Slot X103: Data Communication.....	90
Slot X104: IRIG-B00X and Supervision Contact.....	99
Navigation - Operation	102
Basic Menu Control	107
Input, Output and LED Settings	108
Configuration of the Digital Inputs.....	108
Output Relays Settings.....	119
OR-6 X.....	123
OR-5 X.....	146
OR-4 X.....	165
Configuration of the Analog Outputs.....	182
Analog Inputs.....	190
LED configuration.....	217
Security	221
Access Authorizations (access areas).....	222
Network Access.....	227
Reset to Factory Defaults, Reset All Passwords.....	228
Smart View	230
Data visualizer	231

Wide Frequency Range	232
Measuring Values	233
Read out Measured Values.....	233
Power - Measured Values.....	247
Energy Counter	249
Global Parameters of the Energy Counter Module.....	249
Direct Commands of the Energy Counter Module	249
Signals of the Energy Counter Module (States of the Outputs).....	249
Statistics	254
Configuration of the Minimum and Maximum Values.....	254
Configuration of the Average Value Calculation.....	255
Direct Commands.....	257
Global Protection Parameters of the Statistics Module.....	257
States of the Inputs of the Statistics Module.....	261
Signals of the Statistics Module.....	262
Counters of the Module Statistics.....	262
System Alarms	275
Demand Management.....	275
Peak Values.....	278
Min. and Max. Values.....	278
THD Protection.....	279
Device Planning Parameters of the Demand Management.....	279
Signals of the Demand Management (States of the Outputs).....	279
Global Protection Parameter of the Demand Management.....	280
States of the Inputs of the Demand Management.....	284
Acknowledgments	285
Manual Acknowledgment.....	287
External Acknowledgments.....	288
Manual Resets.....	289
Status Display	290
Operating Panel (HMI)	291
Special Parameters of the Panel.....	291
Direct Commands of the Panel.....	291
Global Protection Parameters of the Panel.....	291
Recorders	293
Disturbance Recorder	293
Fault Recorder	302
Event Recorder	309
Trend Recorder.....	311
Communication Protocols	318
SCADA Interface.....	318
TCP/IP Parameter.....	318
Modbus®.....	320
Profibus.....	344
IEC60870-5-103.....	357
Direct Commands of the IEC60870-5-103.....	360
IEC60870-5-103 Input States.....	361
IEC61850.....	363
DNP3.....	379
Time Synchronization	423
SNTP.....	430
IRIG-B00X.....	437
Parameters	442

Parameter Definitions.....	442
Parameter Setting at the HMI.....	462
Setting Groups.....	466
Setting Lock.....	476
Device Parameters.....	477
Date and Time.....	477
Version.....	477
Display of ANSI-Codes.....	477
TCP/IP Settings.....	478
Direct Commands of the System Module.....	479
Global Protection Parameters of the System.....	479
System Module Input States.....	482
System Module Signals.....	483
Special Values of the System Module.....	485
Field Parameters	486
General Field Parameters.....	486
Field Parameters – Phase Differential Current.....	487
Field Parameters – Earth Differential Current.....	488
Field Parameters – Current Related.....	489
Field Parameters – Voltage Related.....	491
Field Parameters of the Generator.....	494
Field Parameters of the Transformer.....	496
Blockings.....	498
Permanent Blocking.....	498
Temporary Blocking.....	498
To Activate or Deactivate the Tripping Command of a Protection Module.....	500
Activate, Deactivate Respectively Block Temporarily Protection Functions.....	501
Module: Protection (Prot).....	507
General Alarms and General Trips.....	509
Direction Determination.....	514
Direct Commands of the Protection Module.....	515
Global Protection Parameters of the Protection Module	515
Protection Module Input States.....	516
Protection Module Signals (Output States).....	516
Protection Module Values.....	517
Directional Features of the Overcurrent Stages I[n].....	519
Directional Features for Measured Ground Fault Elements 50N/51N.....	520
Directional Features for Calculated (IG calc) Ground Fault 50N/51N.....	522
Switchgear/Breaker – Manager.....	525
Single Line Diagram.....	526
Notes on Special Switchgears.....	528
Switchgear Configuration.....	530
Switchgear Wear.....	541
Control - Example: Switching of a Circuit Breaker.....	549
Control Parameters.....	553
Controlled Circuit Breaker.....	565
Monitored Circuit Breaker.....	580
Controlled Disconnecter.....	595
Monitored Disconnecter.....	610
Protective Elements.....	625
Interconnection.....	625
id - Phase Current Differential Protection [87GP, 87UP].....	625
IdG - Ground Current Differential Protection [87GN, 87TN, 64REF].....	660

IdGh - High Set Restricted Ground Fault Protection IdGH.....	673
I - Overcurrent Protection [50, 51,51Q, 51V, 67].....	677
IH2 - Inrush.....	712
IG - Ground Fault [50N/G, 51N/G, 67N/G].....	717
I2> and %I2/I1> – Unbalanced Load [46].....	744
I2>G – Generator Unbalance Protection [46G].....	753
LoE - Loss of Excitation [40].....	763
ThR-Protection Module: Thermal Replica [49].....	777
V/f> - Volts/Hertz [24].....	786
InEn - Inadvertent Energization [50/27].....	792
OST – Out of Step Tripping [78].....	798
Z – Phase Distance Protection [21].....	815
LB – Load Blinder (Load Encroachment).....	844
PSB – Power Swing Blocking [68].....	850
SOTF - Switch Onto Fault.....	863
CLPU - Cold Load Pickup.....	870
V - Voltage Protection [27,59].....	878
VG, VX - Voltage Supervision [27A, 27TN/59N, 59A].....	891
f - Frequency [81O/U, 78, 81R].....	902
V 012 – Voltage Asymmetry [47].....	927
Sync - Synchrocheck [25].....	934
Q->&V< Reactive-Power/Undervoltage Protection.....	958
Reconnection Module.....	969
LVRT – Low Voltage Ride Through [27(t)].....	997
Intertripping (Remote).....	1013
PQS - Power [32, 37].....	1021
PF - Power Factor [55].....	1041
ExP - External Protection.....	1050
Ext Temp Superv Protection Module – External Temperature Supervision.....	1056
Ext Oil Temp Protection Module – External Oil Temperature Protection.....	1063
Sudden Pressure Protection Module – Sudden Pressure Protection.....	1069
RTD Protection Module [26].....	1075
URTDII Module Interface.....	1106
Supervision.....	1116
CBF- Circuit Breaker Failure [50BF*/62BF].....	1116
TCS - Trip Circuit Supervision [74TC].....	1141
CTS - Current Transformer Supervision [60L].....	1151
LOP - Loss of Potential.....	1157
Phase Sequence Supervision.....	1169
Self Supervision.....	1170
Programmable Logic.....	1175
General Description.....	1175
Programmable Logic at the Panel.....	1180
Commissioning	1186
Commissioning/Protection Test	1187
Putting out of Operation – Plug out the Relay.....	1188
Service and Commissioning Support.....	1189
General.....	1189
Phase Sequence.....	1189
Forcing the Relay Output Contacts.....	1190
Forcing RTDs*.....	1193
Forcing Analog Outputs*.....	1194
Forcing Analog Inputs*.....	1195

Fault Simulator (Sequencer)* 1196

Technical Data **1217**

Climatic Environmental Conditions..... 1217

Degree of Protection EN 60529..... 1217

Routine Test..... 1217

Housing..... 1218

Current and Earth Current Measurement..... 1219

Voltage and Residual Voltage Measurement..... 1220

Frequency Measurement 1220

Voltage and Residual Voltage Measurement..... 1221

Frequency Measurement 1221

Voltage Supply..... 1222

Power Consumption..... 1222

Display..... 1223

Front Interface USB..... 1223

Analog Inputs..... 1224

Analog Outputs..... 1225

Real Time Clock..... 1225

Digital Inputs..... 1226

Binary Output Relays..... 1227

Supervision Contact (SC)..... 1227

Time Synchronization IRIG..... 1228

RS485* 1228

Fiber Optic Module with ST connector* 1228

Fiber Optic Module with LC Connector for Long-distance Protection Communication** 1228

Servicing and Maintenance..... **1230**

Standards..... **1231**

Approvals..... 1231

Design Standards..... 1231

High Voltage Tests 1232

EMC Immunity Tests..... 1233

EMC Emission Tests..... 1234

Environmental Tests..... 1235

Environmental Tests..... 1236

Mechanical Tests..... 1237

General Lists..... **1238**

Assignment List 1238

List of the Digital Inputs..... 1327

Signals of the Digital Inputs and Logic..... 1328

Specifications..... **1339**

Specifications of the Real Time Clock..... 1339

Time Synchronisation Tolerances..... 1339

Specifications of the Measured Value Acquisition..... 1340

Protection Elements Accuracy..... 1342

Revision History..... **1353**

Version: 3.4.x..... 1354

Version: 3.1..... 1357

Version: 3.0.b..... 1358

Version: 3.0..... 1359

Abbreviations, and Acronyms..... **1362**

List of ANSI Codes..... **1367**

This manual applies to devices (version):

Version 3.4.b

Build: 36417

Comments on the Manual

This manual explains in general the tasks of device planning, parameter setting, installation, commissioning, operation and maintenance of the HighPROTEC devices.

The manual serves as working basis for:

- Engineers in the protection field,
- commissioning engineers,
- people dealing with setting, testing and maintenance of protection and control devices,
- as well as trained personnel for electrical installations and power stations.

All functions concerning the type code will be defined. Should there be a description of any functions, parameters or inputs/outputs which do not apply to the device in use, please ignore that information.

All details and references are explained to the best of our knowledge and are based on our experience and observations.

This manual describes the (optionally) full featured versions of the devices.

All technical information and data included in this manual reflect their state at the time this document was issued. We reserve the right to carry out technical modifications in line with further development without changing this manual and without previous notice. Hence no claim can be brought based on the information and descriptions this manual includes.

Text, graphic and formulae do not always apply to the actual delivery scope. The drawings and graphics are not true to scale. We do not accept any liability for damage and operational failures caused by operating errors or disregarding the directions of this manual.

No part of this manual is allowed to be reproduced or passed on to others in any form, unless *Woodward Kempen GmbH* have approved in writing.

This user manual is part of the delivery scope when purchasing the device. In case the device is passed on (sold) to a third party, the manual has to be handed over as well.

Any repair work carried out on the device requires skilled and competent personnel who need to be well aware especially of the local safety regulations and have the necessary experience for working on electronic protection devices and power installations (provided by evidence).

Information Concerning Liability and Warranty

Woodward does not accept any liability for damage resulting from conversions or changes carried out on the device or planning (projecting) work, parameter setting or adjustment changes done by the customer.

The warranty expires after a device has been opened by others than *Woodward* specialists.

Warranty and liability conditions stated in *Woodward* General Terms and Conditions are not supplemented by the above mentioned explanations.

IMPORTANT DEFINITIONS

The signal definitions shown below serve the safety of life and limb as well as for the appropriate operating life of the device.

 **DANGER** DANGER indicates a hazardous situation which, if not avoided, will result in death or serious injury.

 **WARNING** WARNING indicates a hazardous situation which, if not avoided, could result in death or serious injury.

 **CAUTION** CAUTION, used with the safety alert symbol, indicates a hazardous situation which, if not avoided, could result in minor or moderate injury.

 **NOTICE** NOTICE is used to address practices not related to personal injury.

 **CAUTION** CAUTION, without the safety alert symbol, is used to address practices not related to personal injury.

⚠ WARNING

FOLLOW INSTRUCTIONS

Read this entire manual and all other publications pertaining to the work to be performed before installing, operating, or servicing this equipment. Practice all plant and safety instructions and precautions. Failure to follow instructions can cause personal injury and/or property damage.

⚠ WARNING

PROPER USE

Any unauthorized modifications to or use of this equipment outside its specified mechanical, electrical, or other operating limits may cause personal injury and/or property damage, including damage to the equipment. Any such unauthorized modifications: (1) constitute "misuse" and/or "negligence" within the meaning of the product warranty thereby excluding warranty coverage for any resulting damage, and (2) invalidate product certifications or listings.

The programmable devices subject to this manual are designed for protection and also control of power installations and operational devices that are fed by voltage sources with a fixed frequency, i.e. fixed at 50 or 60 Hertz. They are not intended for use with Variable Frequency Drives. The devices are further designed for installation in low-voltage (LV) compartments of medium voltage (MV) switchgear panels or in decentralized protection panels. The programming and parameterization has to meet all requirements of the protection concept (of the equipment that is to be protected). You must ensure that the device will properly recognize and manage (e.g. switch off the circuit breaker) on the basis of your programming and parameterization all operational conditions (failures). The proper use requires a backup protection by an additional protective device. Before starting any operation and after any modification of the programming (parameterization) test make a documentary proof that your programming and parameterization meets the requirements of your protection concept.

The Self-Supervision Contact (Life-Contact) has to be wired with the substation automation system in order to supervise and monitor the state of health of the programmable protective device. It is very important that an alarm annunciation is driven from the programmable protective device self-supervision contact (Life-Contact) that requires immediate attention when tripped. The alarm indicates that the protective device is no longer protecting the circuit and the system should be serviced.

Typical applications for this product family/device line are for instance:

- Feeder protection
- Mains protection
- Machine protection
- Transformer Differential Protection

Any usage beyond these applications the devices are not designed for. This applies also to the use as a partly completed machinery. The manufacturer cannot be held liable for any resulting damage, the user alone bears the risk for this. As to the appropriate use of the device: The technical data and tolerances specified by *Woodward* have to be met.



OUT-OF-DATE PUBLICATION

This publication may have been revised or updated since this copy was produced. To verify that you have the latest revision, please visit the download section of our website:

www.woodward.com

If your publication is not there, please contact your customer service representative to get the latest copy.

Important Information



In line with the customer's requirement the devices are combined in a modular way (in compliance with the order code). The terminal assignment of the device can be found on the top of the device (wiring diagram).

CAUTION

Electrostatic Discharge Awareness

All electronic equipment is electro static-sensitive, some components more than others. To protect these components from electro static damage, you must take special precautions to minimize or eliminate electrostatic discharges. Follow these precautions when working with or near the control.

1. Before doing maintenance on the electronic control, discharge the static electricity on your body to ground by touching and holding a grounded metal object (pipes, cabinets, equipment, etc.).
2. Avoid the build-up of static electricity on your body by not wearing clothing made of synthetic materials. Wear cotton or cotton-blend materials as much as possible because these do not store static electric charges as much as synthetics.
3. Keep plastic, vinyl, and Styrofoam materials (such as plastic or Styrofoam cups, cup holders, cigarette packages, cellophane wrappers, vinyl books or folders, plastic bottles, and plastic ash trays) away from the control, the modules, and the work area as much as possible.
4. Do not remove any printed circuit board (PCB) from the control cabinet unless absolutely necessary. If you must remove the PCB from the control cabinet, follow these precautions:
 - Verify the safe isolation from supply. All connectors have to be unplugged.
 - Do not touch any part of the PCB except the edges.
 - Do not touch the electrical conductors, the connectors, or the components with conductive devices or with your hands.
 - When replacing a PCB, keep the new PCB in the plastic antistatic protective bag it comes in until you are ready to install it. Immediately after removing the old PCB from the control cabinet, place it in the antistatic protective bag.

To prevent damage to electronic components caused by improper handling, read and observe the precautions in Woodward manual 82715, Guide for Handling and Protection of Electronic Controls, Printed Circuit Boards, and Modules.

Woodward reserves the right to update any portion of this publication at any time. Information provided by Woodward is believed to be correct and reliable. However, no responsibility is assumed by Woodward unless otherwise expressly undertaken.

© Woodward 2016. All Rights Reserved.

Scope of Delivery

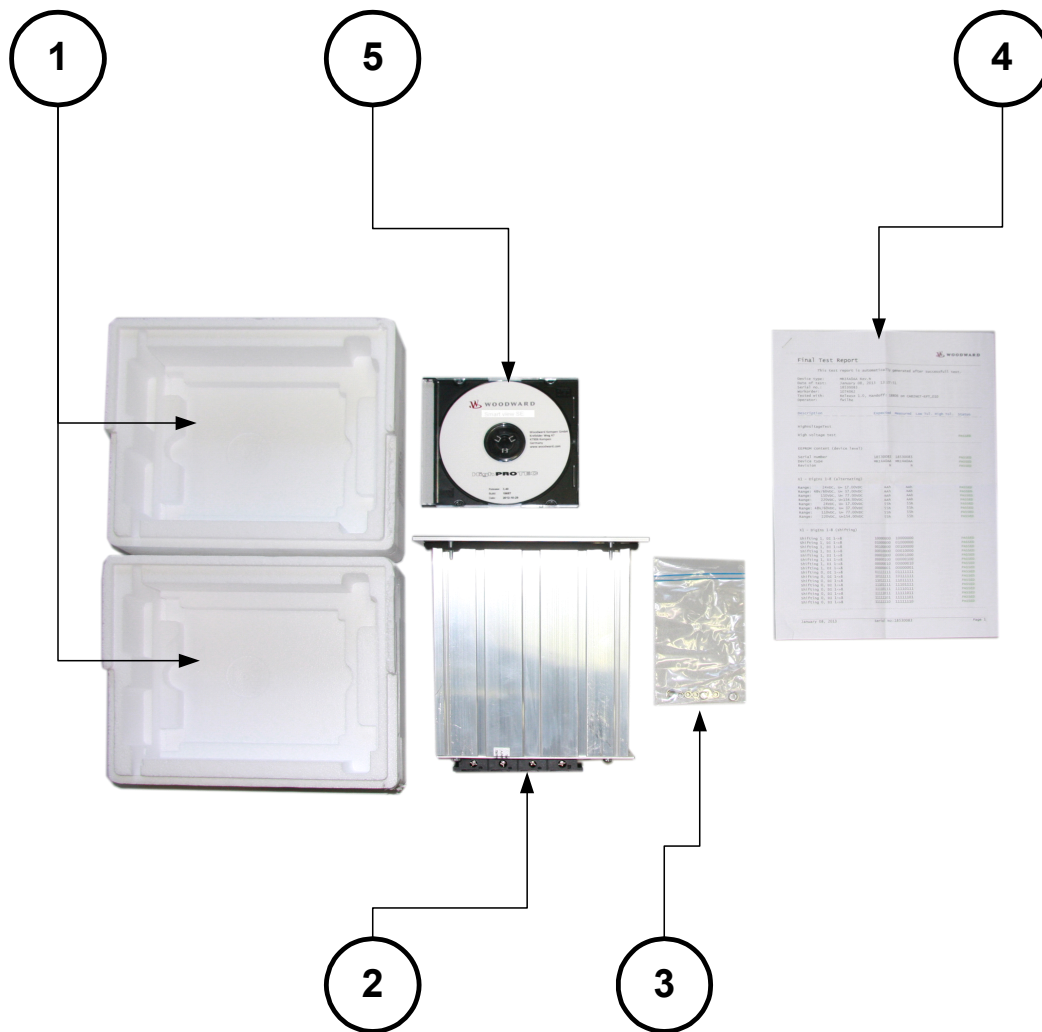

The delivery scope includes:

①	The transportation box
②	The protective device
③	The mounting nuts
④	The test report
⑤	The product DVD that includes the manuals and related documentation as well as the parameter setting and evaluation software.

Please check the consignment for completeness on arrival (delivery note).

Please ascertain whether the type plate, connection diagram, type code and description of the device tally.

If you have any doubts please contact our Service Department (contact address to be found on the reverse of the manual).

Storage

The devices must not be stored outdoors. The storing facilities have to be sufficiently ventilated and must be dry (see Technical Data).

Waste Disposal

This protective device contains a battery, and therefore it is labeled with the following symbol according to the EU Directive 2006/66/EC:



Batteries can be harmful to the environment. Damaged or unusable batteries must be disposed of in a container that is specially reserved for this purpose.

In general, appropriate local guidelines and regulations must be followed when disposing of electrical devices and batteries.

Purpose of the Battery

The purpose of the battery is to buffer the real time clock in case of an outage of the power supply of the protective device.

Removal of the Battery

The battery has to be soldered out or alternatively the contacts have to be pinched off. Please see the product safety data sheet of the battery manufacturer for further information.

Manufacturer and Type of the Battery

Panasonic, Type BR2032 (<http://panasonic.net/ec/>) or equivalent.

Symbols

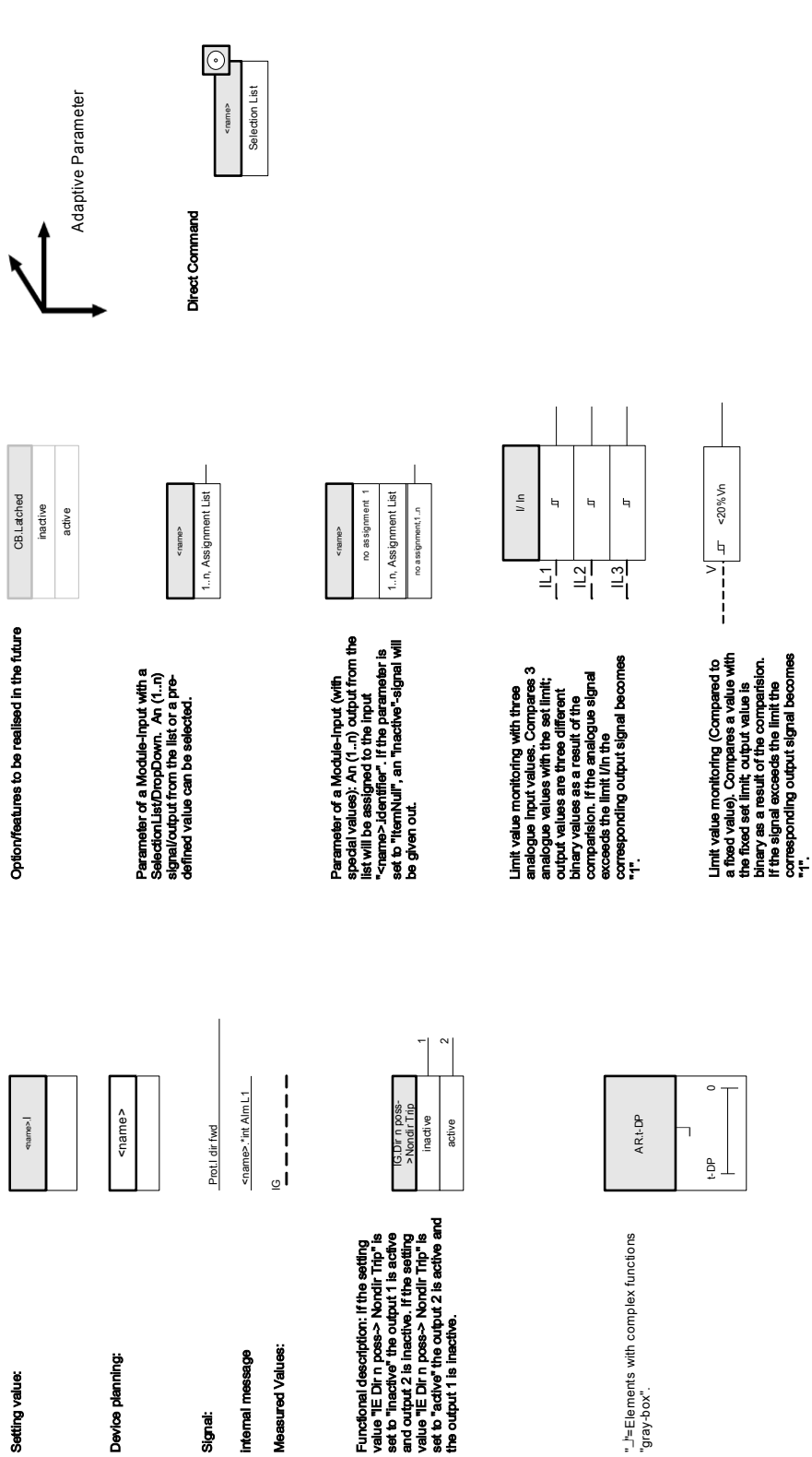

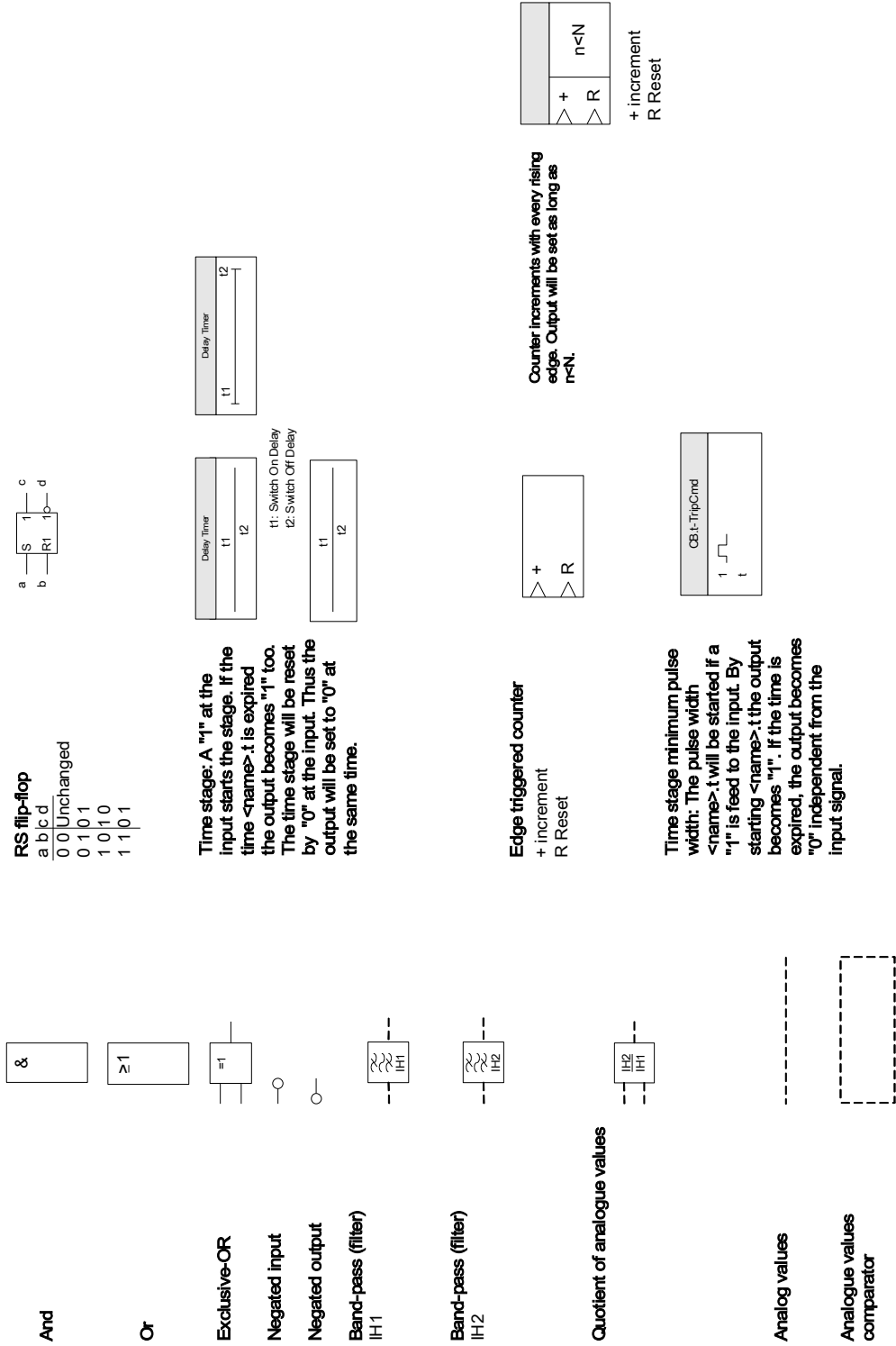

General Conventions

»Parameters are indicated by right and left double arrow heads and written in *italic* .«

»SIGNALS are indicated by right and left double arrow heads and small caps .«

[Paths are indicated by brackets.]

Software and Device names are written in italic.

Module and Instance (Element) names are displayed italic and underlined.

»Pushbuttons, Modes and Menu entries are indicated by right and left double arrow heads .«



Image References (Squares)

Output Signal























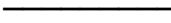
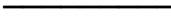
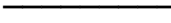

②

②

Input Signal

Output Signal	Description / Diagram	(Symbol) ②
Prot.available	Please Refer To Diagram: Prot	————— (1)
Prot.available (as a signal sent via ProtCom to the remote protective device)	Please Refer To Diagram: Prot only for line differential protection	————— (1R)
name . active	Please Refer To Diagram: Blockings	————— (2)
name . Blo TripCmd	Please Refer To Diagram: Trip blockings	————— (3)
name . active	Please Refer To Diagram: Blockings (Phase Overcurrent Stages I[1] ... [n])	————— (4)
name . active	Please Refer To Diagram: Blockings (Earth Overcurrent Stages IG[1] ... [n])	————— (4G)
name . active (as local signal)	Please Refer To Diagram: Blockings only for line differential protection	————— (4L)
name . active (as a signal sent via ProtCom to the remote protective device)	Please Refer To Diagram: Blockings only for line differential protection	————— (4R)
IH2 . Blo L1	Please Refer To Diagram: IH2	————— (5)
IH2 . Blo L2	Please Refer To Diagram: IH2	————— (6)
IH2 . Blo L3	Please Refer To Diagram: IH2	————— (7)
IH2 . Blo IG	Please Refer To Diagram: IH2	————— (8)
name . Fault in projected direction	Please Refer To Diagram: direction decision phase overcurrent	————— (9)
name . Fault in projected direction	Please Refer To Diagram: direction decision Earth fault	————— (10)
CB . Trip CB	Please Refer To Diagram: CB	————— (11)
VTS . Alarm	Please Refer To Diagram: VTS	————— (12a)
VTS . Ex FF VT-I	Please Refer To Diagram: VTS	————— (12b)
VTS . Ex FF EVT-I	Please Refer To Diagram: VTS	————— (12c)
name . Alarm	Each alarm of a module (except from supervision modules but including CBF) will lead to a general alarm (collective alarm).	————— (14)
name . Trip	Each trip of an active, trip authorized protection module will lead to a general trip.	————— (15)
name . TripCmd		————— (15a)

IMPORTANT DEFINITIONS

Output Signal	Description / Diagram	 (Symbol)
name . Trip L1	<i>Each trip of an active, trip authorized protection module will lead to a general trip.</i>	 (16)  (16a)  (16b)
name . Trip L2	<i>Each trip of an active, trip authorized protection module will lead to a general trip.</i>	 (17)  (17a)  (17b)
name . Trip L3	<i>Each trip of an active, trip authorized protection module will lead to a general trip.</i>	 (18)  (18a)  (18b)
name . TripCmd	<i>Each trip of an active, trip authorized protection module will lead to a general trip.</i>	 (19)  (19a)  (19b)  (19c)
name . TripCmd	<i>Each trip of an active, trip authorized protection module will lead to a general trip.</i>	 (19d)
name . Trip L1	<i>Each trip of an active, trip authorized protection module will lead to a general trip.</i>	 (20)
name . Trip L2	<i>Each trip of an active, trip authorized protection module will lead to a general trip.</i>	 (21)
name . Trip L3	<i>Each trip of an active, trip authorized protection module will lead to a general trip.</i>	 (22)
name . Trip	<i>Each trip of an active, trip authorized protection module will lead to a general trip.</i>	 (23)
name . Alarm L1	<i>Each phase selective alarm of a module (I, IG, V, VX depending on the device type) will lead to a phase selective general alarm (collective alarm).</i>	 (24)  (24a)  (24b)
name . Alarm L2	<i>Each phase selective alarm of a module (I, IG, V, VX depending on the device type) will lead to a phase selective general alarm (collective alarm).</i>	 (25)  (25a)  (25b)
name . Alarm L3	<i>Each phase selective alarm of a module (I, IG, V, VX depending on the device type) will lead to a phase selective general alarm (collective alarm).</i>	 (26)  (26a)  (26b)

IMPORTANT DEFINITIONS

Output Signal	Description / Diagram	② (Symbol)
name . Alarm	<i>Each phase selective alarm of a module (I, IG, V, VX depending on the device type) will lead to a phase selective general alarm (collective alarm).</i>	(27) (27a) (27b) (27c) (27d)
name . Alarm L1	<i>Each phase selective alarm of a module (I, IG, V, VX depending on the device type) will lead to a phase selective general alarm (collective alarm).</i>	(28)
name . Alarm L2	<i>Each phase selective alarm of a module (I, IG, V, VX depending on the device type) will lead to a phase selective general alarm (collective alarm).</i>	(29)
name . Alarm L3	<i>Each phase selective alarm of a module (I, IG, V, VX depending on the device type) will lead to a phase selective general alarm (collective alarm).</i>	(30)
name . Alarm	<i>Each phase selective alarm of a module (I, IG, V, VX depending on the device type) will lead to a phase selective general alarm (collective alarm).</i>	(31)
Prot . Blo TripCmd		(32)
CB . Pos	<i>Please Refer To Diagram: CB.CB Manager</i>	(33)
CB . Pos ON	<i>Please Refer To Diagram: CB.CB Manager</i>	(34)
CB . Pos OFF	<i>Please Refer To Diagram: CB.CB Manager</i>	(35)
CB . Pos Indeterm	<i>Please Refer To Diagram: CB.CB Manager</i>	(36)
CB . Pos Disturb	<i>Please Refer To Diagram: CB.CB Manager</i>	(37)
LOP . LOP Blo	<i>Please Refer To Diagram: LOP.LOP Blo</i>	(38a)
LOP . Ex FF VT-I	<i>Please Refer To Diagram: LOP.Ex FF VT</i>	(38b)
LOP . Ex FF EVT-I	<i>Please Refer To Diagram: LOP.Ex FF EVT</i>	(38c)
Q->&V< . Decoupling Distributed Generator	<i>Please Refer To Diagram: Q->&V<: "QU_Y02"</i>	(39)
CTS . Alarm	<i>Please Refer To Diagram: CTS.Alarm</i>	(40)
SG.Prot ON	<i>Please Refer To Diagram: SG.Prot ON</i>	(41)
SG . ON Cmd	<i>Please Refer To Diagram: SG.ON Cmd</i>	(42)
AnIn[1] . Value	<i>Please Refer To Diagram: Analog values</i>	(43)
AnIn[2] . Value	<i>Please Refer To Diagram: Analog values</i>	(44)
AnIn[n] . Value	<i>Please Refer To Diagram: Analog values</i>	(45)
Trip Incomplete (Motor) Start Sequence		(46)
Q->&V< . active	<i>Please refer to diagram: Blocking (Q->&V<)</i>	(47)
name . active	<i>Please refer to diagram "GeneralProt_Y06": Blocking</i>	(48)

Access Level

(Please refer to chapter [Parameter\Access Level])

Read Only-Lv0

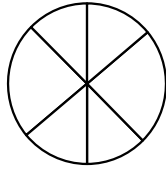

Parameters can only be read within this level.

Prot-Lv1



This level enables execution of Resets and Acknowledgements

Prot-Lv2



This level enables modification of protection settings

Control-Lv1

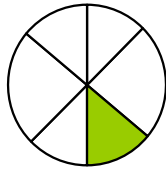

This level enables control functions

Control-Lv2

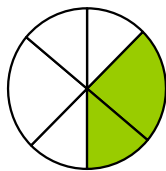

This level enables modification of switchgear settings

Supervisor-Lv3

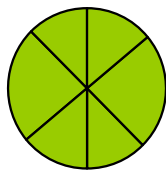

This level provides full access (not limited) to all settings

Load Reference Arrow System

Within the HighPROTEC the “Load Reference Arrow System” is used in principal. Generator protection relays are working based on the “Generator Reference System”.

Device

MCDGV4

Device Planning

Planning of a device means to reduce the functional range to a degree that suits the protection task to be fulfilled, i.e. the device shows only those functions you really need. If you, for example, deactivate the voltage protection function, all parameter branches related to this function do not appear in the parameter tree any more. All corresponding events, signals etc. will be deactivated too. By this the parameter trees become very transparent. Planning also involves adjustment of all basic system data (frequency etc.).



But it has to be taken into account that by deactivating, for instance, protective functions, you also change the functionality of the device. If you cancel the directional feature of the overcurrent protections then the device no longer trips in a directional way but merely in a non-directional way.

The manufacturer does not accept liability for any personal or material damage as a result of wrong planning.

A planning service is also offered by *Woodward Kempen GmbH*.







Beware of inadvertent deactivating protective functions/modules

If you are deactivating modules within the device planning all parameters of those modules will be set on default.

If you are activating one of these modules again all parameters of those reactivated modules will be set on default.

Device Configuration Parameters of the Device

<i>Parameter</i>	<i>Description</i>	<i>Options</i>	<i>Default</i>	<i>Menu path</i>
Hardware Variant 1 	Optional Hardware Extension	»A« 16 digital inputs 11 binary output relays, »B« 8 digital inputs 11 binary output relays 2 Analog Inputs 2 Analog Outputs, »C« 24 digital inputs 11 binary output relays, »D« 16 digital inputs 16 binary output relays	16 digital inputs 11 binary output relays	[MCDGV4]
Hardware Variant 2 	Optional Hardware Extension	»0« Phase Current 5A/1A, Ground Current 5A/1A, »1« Phase Current 5A/1A, Sensitive Ground Current 5A/1A	Phase Current 5A/1A, Ground Current 5A/1A	[MCDGV4]
Housing 	Mounting form	»A« Flush mounting, »B« 19 inch mounting (semi-flush), »H« Customized Version 1, »K« Customized Version 2	Flush mounting	[MCDGV4]

Parameter	Description	Options	Default	Menu path
Communication 	Communication	»A« Without, »B« RS 485: Modbus RTU IEC 60870-5-103 DNP RTU, »C« Ethernet: Modbus TCP DNP UDP, TCP, »D« Fiber Optics: Profibus-DP, »E« D-SUB: Profibus-DP, »F« Fiber Optics: Modbus RTU IEC 60870-5-103 DNP RTU, »G« RS 485/D-SUB: Modbus RTU IEC 60870-5-103 DNP RTU, »H« Ethernet: IEC61850 Modbus TCP DNP UDP, TCP, »I« RS 485, Ethernet: Modbus TCP, RTU IEC 60870-5-103 DNP UDP, TCP, RTU, »K« Ethernet/Fiber Optics: IEC61850 Modbus TCP DNP UDP, TCP, »L« Ethernet/Fiber Optics: Modbus TCP DNP UDP, TCP, »T« RS 485, Ethernet: IEC61850 Modbus TCP, RTU IEC 60870-5-103 DNP UDP, TCP, RTU	»A« Without	[MCDGV4]
Printed Circuit Board 	Printed Circuit Board	»A« Standard, »B« conformal coating	»A« Standard	[MCDGV4]

Installation and Connection

Three-Side-View - 19"

NOTICE

Dependent on the connection method of the SCADA system used the needed space (depth) differs. If, for instance, a D-Sub-Plug is used, it has to be added to the depth dimension.

NOTICE

The three-side-view shown in this section is exclusively valid for 19" devices.

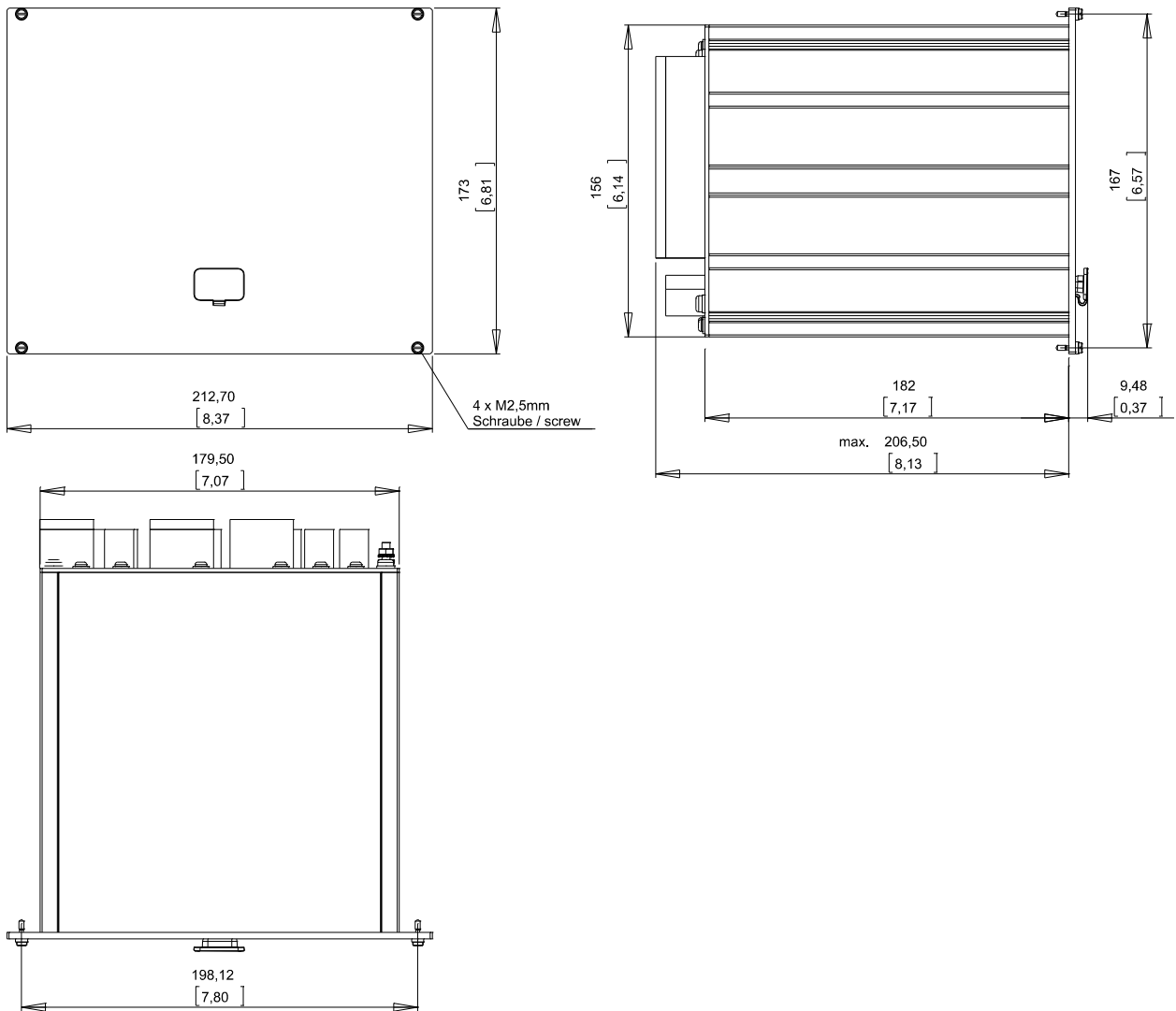

3-Side-View B2 Housing (19" Devices). (All dimensions in mm, except dimensions in brackets [inch].)

⚠ WARNING

The housing must be carefully grounded. Connect a ground cable (protective earth, 4 to 6 mm² [AWG 11–9], tightening torque 1.7 Nm [15 lb-in]) to the housing, using the screw that is marked with the ground symbol (at the rear side of the device).

Moreover, the power supply card needs a separate ground connection (functional earth, min. 2.5 mm² [≤ AWG 13], tightening torque 0,56 – 0,79 Nm [5–7 lb-in]). See the “Terminal Marking” diagram in Section “DI-4 X – Power Supply and Digital Inputs” to check for the correct terminal.

All grounding connections (i. e. protective and functional earth) must be low-inductance, i. e. as short as possible, and national standards – if applicable – must be followed.

Three-Side-View - 8-Pushbutton Version

NOTICE Dependent on the connection method of the SCADA system used the needed space (depth) differs. If, for instance, a D-Sub-Plug is used, it has to be added to the depth dimension.

NOTICE The installation diagram shown in this section is exclusively valid for devices with 8 pushbuttons at the front side of the HMI.
(INFO-, C-, OK-, CTRL-Pushbutton and 4 Softkeys (Pushbuttons)).

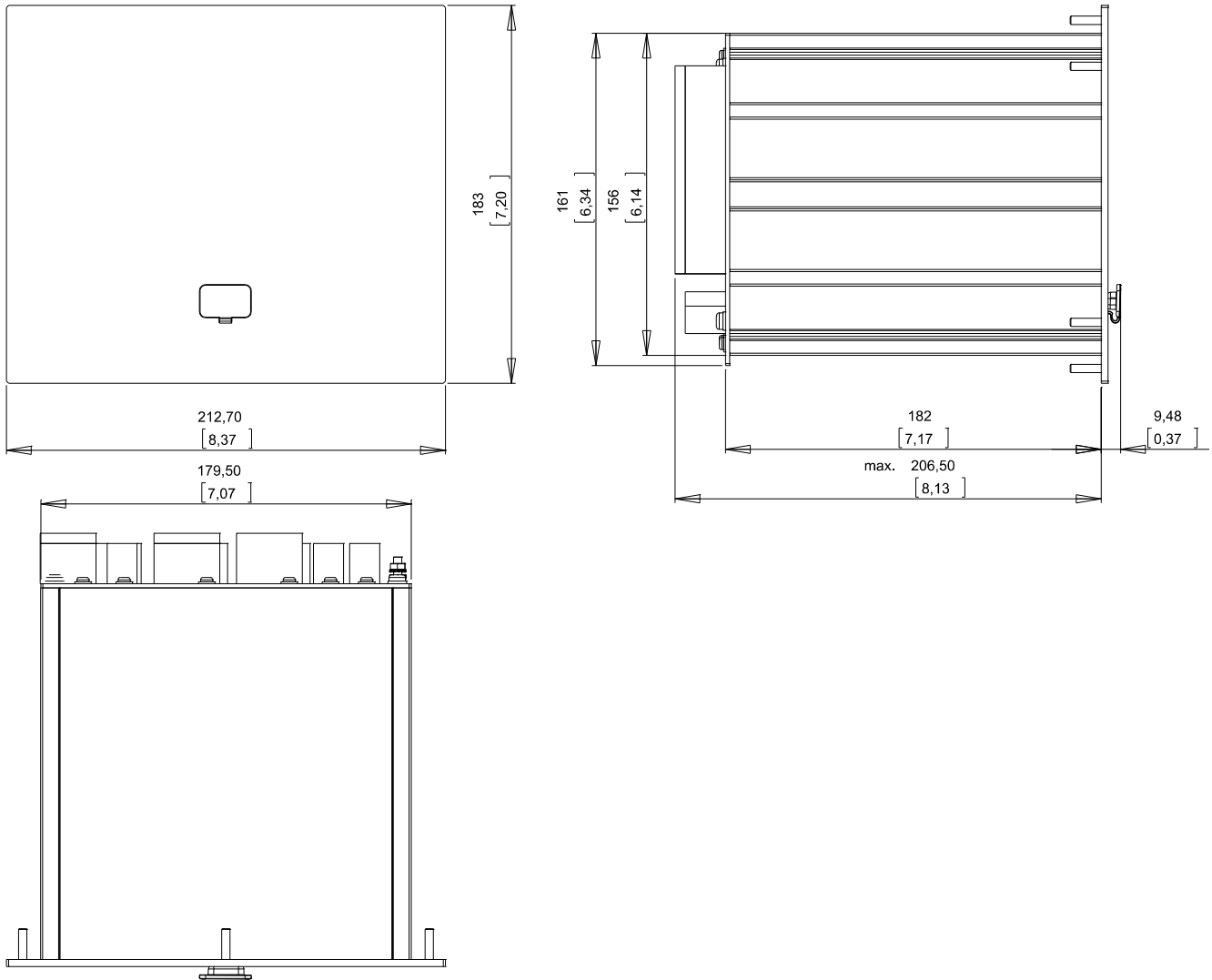

3-Side-View B2 Housing (Devices with 8 Softkeys). (All dimensions in mm, except dimensions in brackets [inch].)

WARNING The housing must be carefully grounded. Connect a ground cable (protective earth, 4 to 6 mm² [AWG 11–9], tightening torque 1.7 Nm [15 lb-in]) to the housing, using the screw that is marked with the ground symbol (at the rear side of the device). Moreover, the power supply card needs a separate ground connection (functional earth, min. 2.5 mm² [≤ AWG 13], tightening torque 0,56 – 0,79 Nm [5–7 lb-in]). See the “Terminal Marking” diagram in Section “DI-4 X” to check for the correct terminal. All grounding connections (i. e. protective and functional earth) must be low-inductance, i. e. as short as possible, and national standards – if applicable – must be followed.

Installation Diagram 8-Pushbutton Version



WARNING Even when the auxiliary voltage is switched-off, unsafe voltages might remain at the device connections.



The installation diagram shown in this section is exclusively valid for devices with 8 pushbuttons at the front side of the HMI.
(INFO-, C-, OK-, CTRL-Pushbutton and 4 Softkeys (Pushbuttons)).

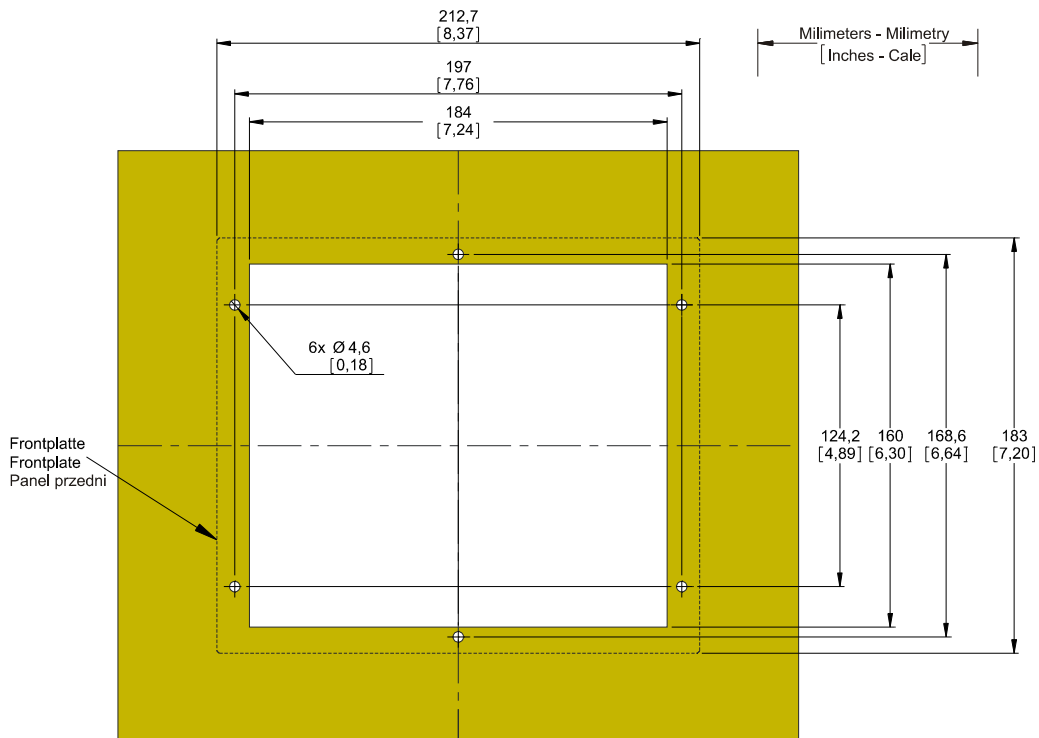

B2 Housing Door Cut-out (8-Pushbutton Version). (All dimensions in mm, except dimensions in brackets [inch].)



WARNING The housing must be carefully grounded. Connect a ground cable (protective earth, 4 to 6 mm² [AWG 11–9], tightening torque 1.7 Nm [15 lb-in]) to the housing, using the screw that is marked with the ground symbol (at the rear side of the device).

Moreover, the power supply card needs a separate ground connection (functional earth, min. 2.5 mm² [≤ AWG 13], tightening torque 0,56 – 0,79 Nm [5–7 lb-in]). See the “Terminal Marking” diagram in Section “DI-4 X – Power Supply and Digital Inputs” to check for the correct terminal.

All grounding connections (i. e. protective and functional earth) must be low-inductance, i. e. as short as possible, and national standards – if applicable – must be followed.



CAUTION Be careful. Do not overtighten the mountings nuts of the relay (M4 metric 4 mm). Check the torque by means of a torque wrench (1.7 Nm [15 In-lb]). Over-tightening the mounting nuts could cause personal injury or damage the relay.

Assembly Groups



In line with the customer's requirement the devices are combined in a modular way (in compliance with the order code). In each of the slots an assembly-group may be integrated. In the following the terminal assignment of the individual assembly-groups are shown. The exact installation place of the individual modules can be learned from the connection diagram fixed at the top of your device.

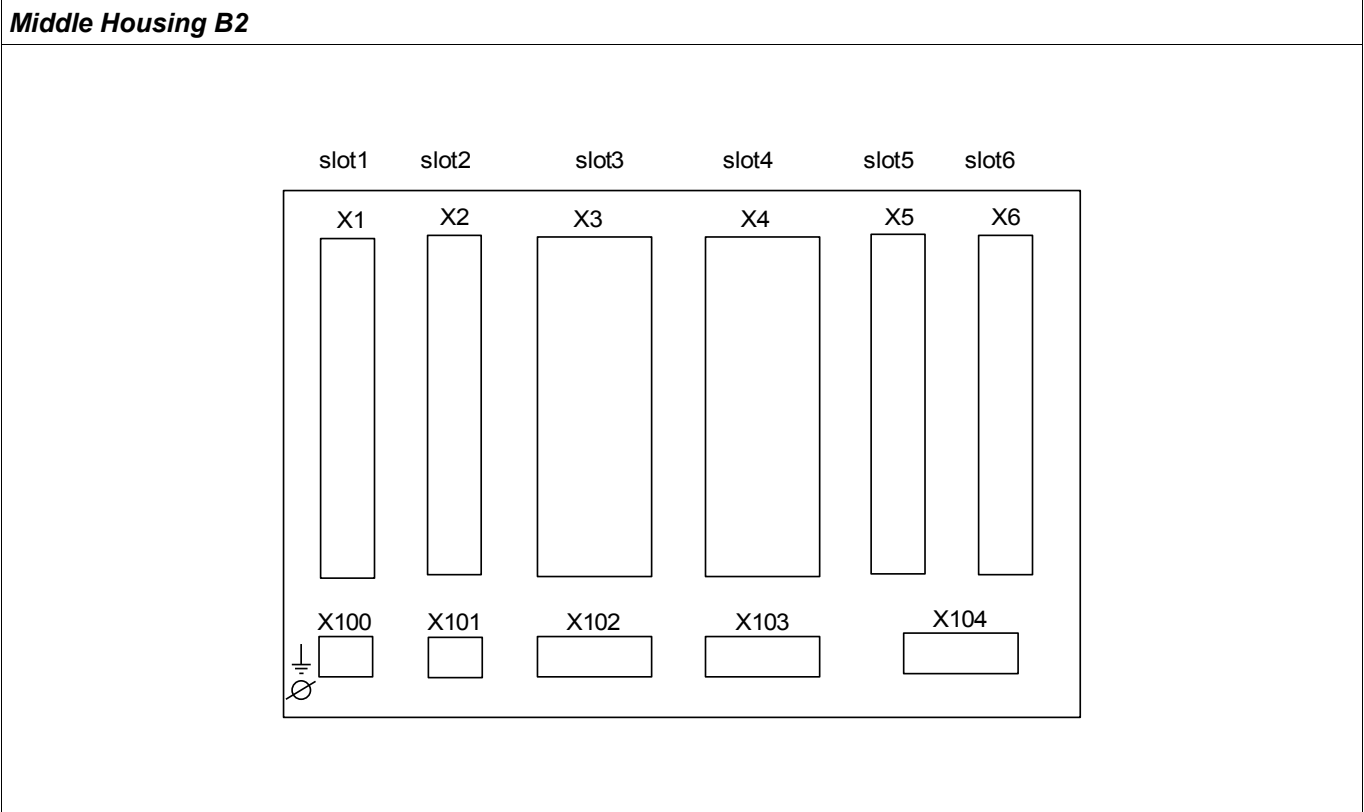

Rear view of B2 housing

Grounding

WARNING

The housing must be carefully grounded. Connect a ground cable (protective earth, 4 to 6 mm² [AWG 11–9], tightening torque 1.7 Nm [15 lb·in]) to the housing, using the screw that is marked with the ground symbol (at the rear side of the device).

Moreover, the power supply card needs a separate ground connection (functional earth, min. 2.5 mm² [≤ AWG 13], tightening torque 0,56 – 0,79 Nm [5–7 lb·in]). See the “Terminal Marking” diagram in Section “DI-4 X – Power Supply and Digital Inputs” to check for the correct terminal.

All grounding connections (i. e. protective and functional earth) must be low-inductance, i. e. as short as possible, and national standards – if applicable – must be followed.

CAUTION

The devices are very sensitive to electro-static discharges.

Legend for Wiring Diagrams

In this legend designations of various device types are listed, e. g. transformer protection, motor protection, generator protection, etc. Therefor it can occur that you will not find each designation on the wiring diagram of your device.

Designation	Meaning
FE	Connection of functional earth
Power Supply	Connection for auxiliary power supply
I L1	Phase current input L1
I L2	Phase current input L2
I L3	Phase current input L3
IG	Earth current input IG
I L1 W1	Phase current input L1, winding side 1
I L2 W1	Phase current input L2, winding side 1
I L3 W1	Phase current input L3, winding side 1
I G W1	Earth current input IG, winding side 1
I L1 W2	Phase current input L1, winding side 2
I L2 W2	Phase current input L2, winding side 2
I L3 W2	Phase current input L3, winding side 2
I G W2	Earth current input IG, winding side 2
V L1	Phase voltage L1
V L2	Phase voltage L2
V L3	Phase voltage L3
V 12	Phase to phase voltage V 12
V 23	Phase to phase voltage V 23
V 31	Phase to phase voltage V 31
V X	Forth voltage measuring input for measuring residual voltage or for Synchro-check
BO	Contact output, change over contact
NO	Contact output, normally open
DI	Digital input
COM	Common connection of digital inputs
Out+	Analog output + (0/4...20 mA or 0...10 V)
IN-	Analog input + (0/4...20 mA or 0...10 V)
N.C.	Not connected
DO NOT USE	Do not use
SC	Self supervision contact
GND	Ground

Designation	Meaning
HF SHIELD	Connection cable shield
Fibre Connection	Fibre optic connection
Only for use with external galvanic decoupled CTs. See chapter Current Transformers of the manual.	Only for use with external galvanic decoupled CTs. See chapter Current Transformers of the manual.
Caution Sensitive Current Inputs	Caution Sensitive Current Inputs
Connection Diagram see specification	Connection Diagram see specification

Slot X1: Power Supply Card with Digital Inputs

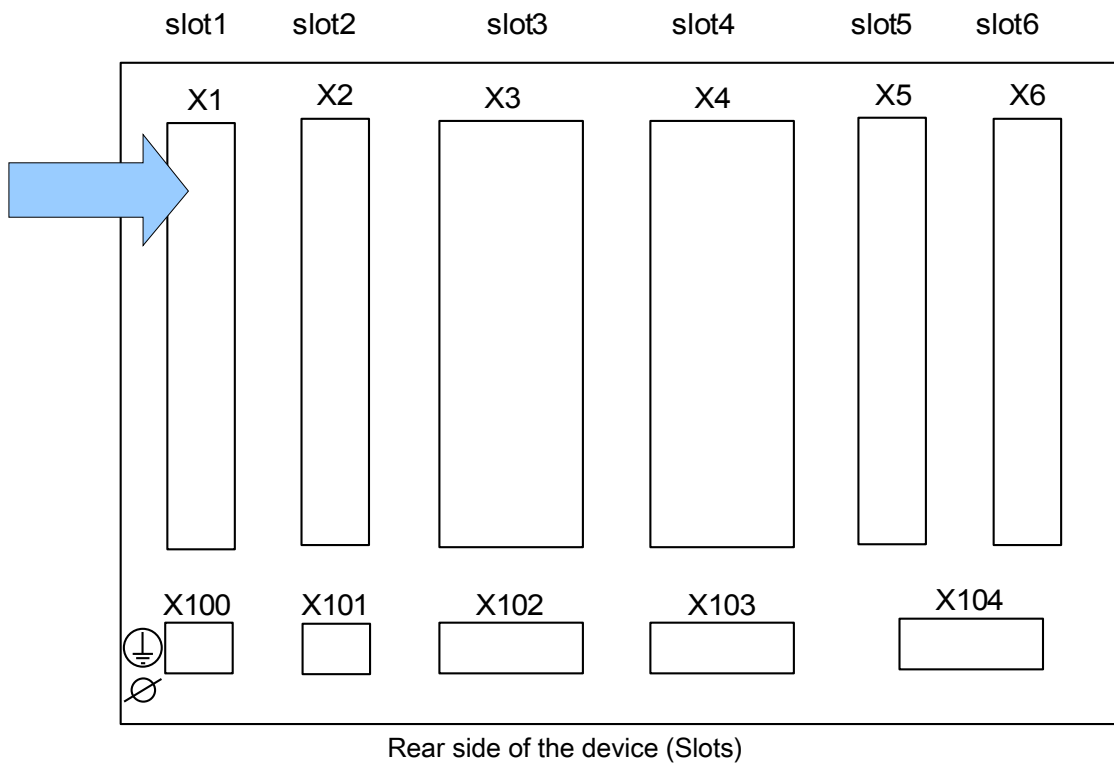

The type of power supply card and the number of digital inputs on it used in this slot is dependent on the ordered device type. The different variants have a different scope of functions.

Available assembly groups in this slot:

- **(DI8-X1):** This assembly group comprises a wide-range power supply unit; and two non-grouped digital inputs and six (6) digital inputs (grouped).

NOTICE The available combinations can be gathered from the ordering code.

DI8-X Power Supply and Digital Inputs



WARNING Ensure the correct tightening torques.

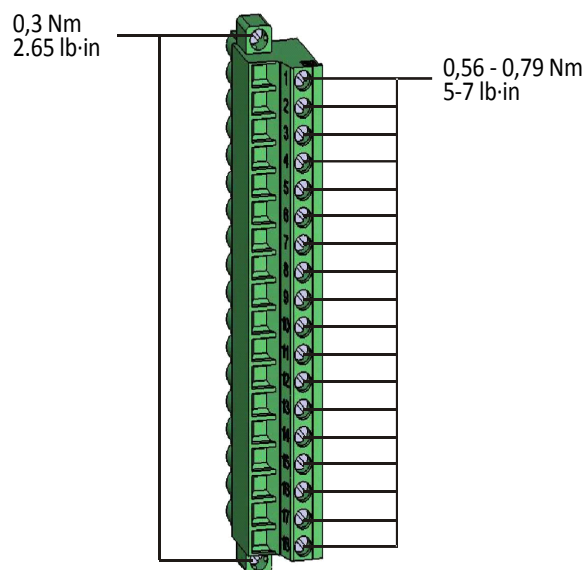

This assembly group comprises:

- a wide-range power supply unit
- 6 digital inputs, grouped
- 2 digital inputs, non-grouped
- Connector for the functional earth

Functional Earth



In addition to the grounding of the housing (protective earth, see Chapter “Installation and Wiring”) there must be an additional ground cable connected to the power supply card (functional earth, min. 2.5 mm² [≤ AWG 13], tightening torque 0,56 – 0,79 Nm [5–7 lb·in]). Connect this ground cable to terminal No. 1, see the “Terminals” diagram below.
All grounding connections (i. e. protective and functional earth) must be low-inductance, i. e. as short as possible, and national standards – if applicable – must be followed.

Auxiliary voltage supply

- The aux. voltage inputs (wide-range power supply unit) are non-polarized. The device could be provided with AC or DC voltage.

Digital inputs



For each digital input group the related voltage input range has to be parameterized. Wrong switching thresholds can result in malfunctions/wrong signal transfer times.

The digital inputs are provided with different switching thresholds (can be parameterized) (two AC and five DC input ranges). For the six grouped (connected to common potential) inputs and the two non-grouped inputs the following switching levels can be defined:

- 24V DC
- 48V DC / 60V DC
- 110 V AC/DC
- 230 V AC/DC

If a voltage >80% of the set switching threshold is applied at the digital input, the state change is recognized (physically “1”). If the voltage is below 40% of the set switching threshold, the device detects physically “0”.



When using DC supply, the negative potential has to be connected to the common terminal (COM1, COM2, COM3 - please see the terminal marking).

Terminals

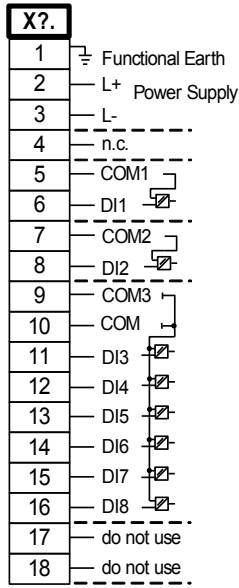

Electro-mechanical assignment

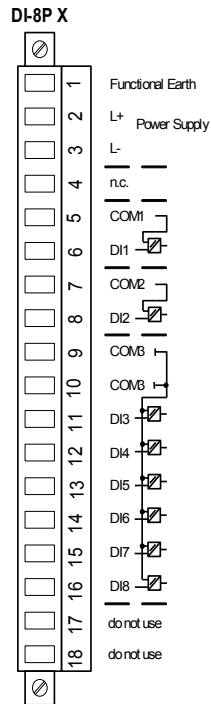

Slot X2: Relay Output Card

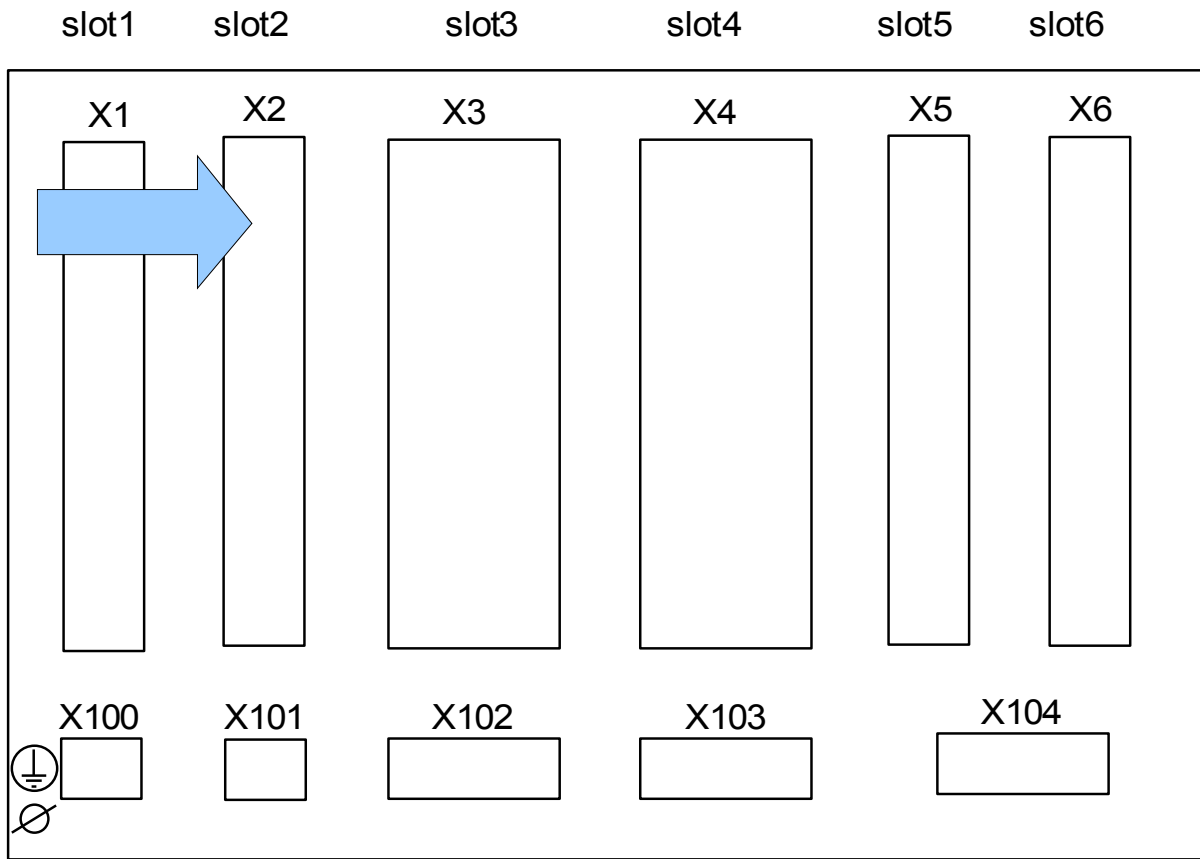

Rear side of the device (Slots)

The type of card in this slot is dependent on the ordered device type. The different variants have a different scope of functions.

Available assembly groups in this slot:

- **(RO-6 X2):** Assembly Group with 6 Relay Outputs.

NOTICE

The available combinations can be gathered from the ordering code.

Binary Output Relays

The number of the binary output relay contacts is related to the type of the device or type code. The binary output relays are potential-free change-over contacts. In chapter [Assignment/binary outputs] the assignment of the binary output relays is specified. The changeable signals are listed in the »assignment list« which can be found in the appendix.



Ensure the correct tightening torques.

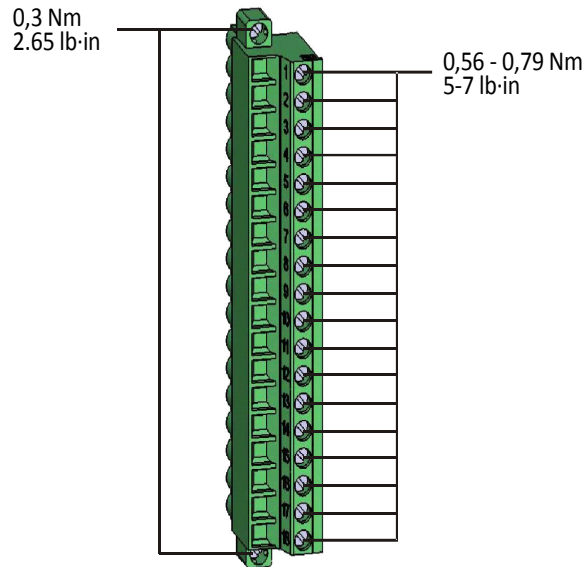

**Please duly consider the current carrying capacity of the binary output relays.
Please refer to the Technical Data.**

Terminals

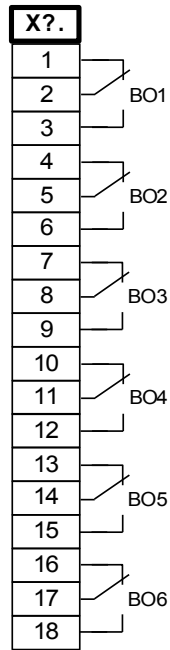

Electro-mechanical assignment

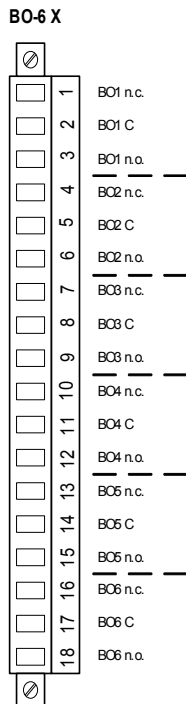

Slot X3: CT Ntrl - Current Transformer Measuring Inputs

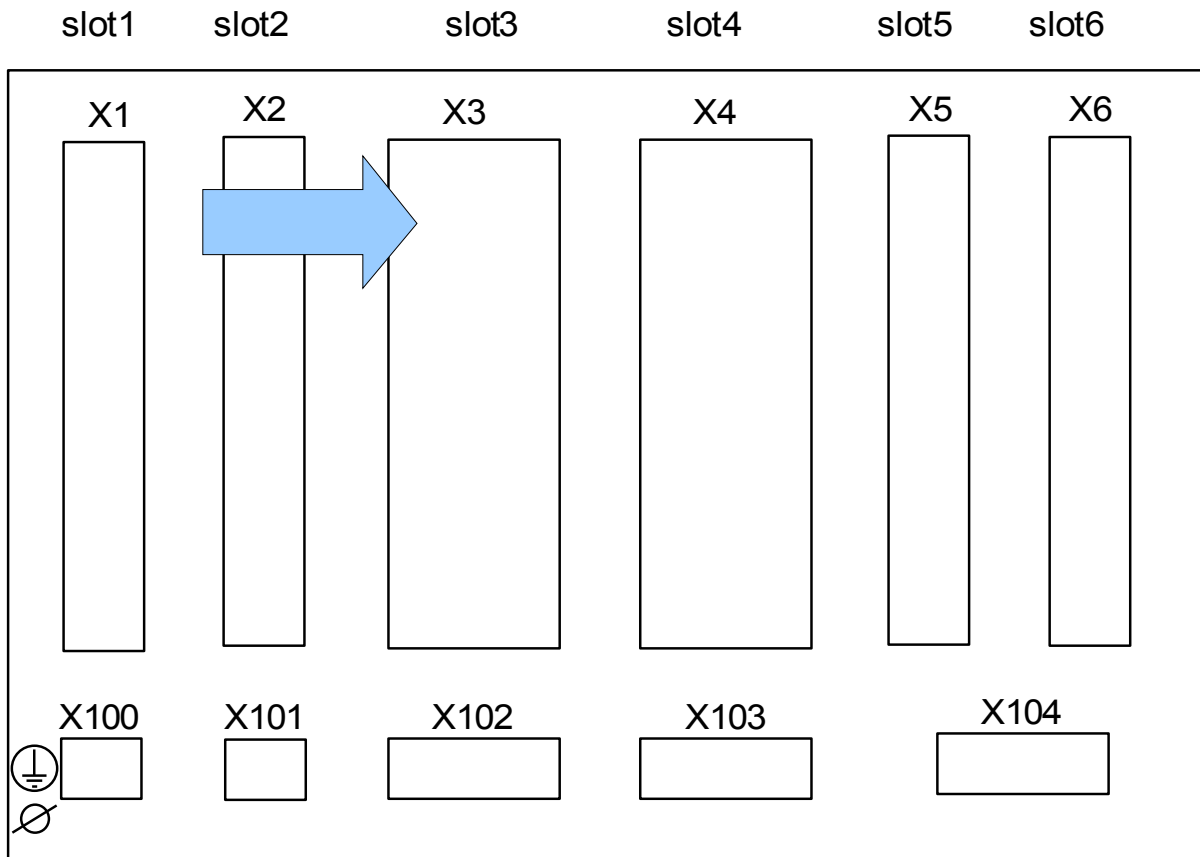

Rear side of the device (Slots)

This slot contains the current transformer measuring inputs for the neutral side of the differential protection. Depending on the order code, this might be a standard current measuring card or a sensitive ground current measuring card.

Available assembly groups in this slot:

- **(TI-4 X3):** Standard ground current measuring card.
- **(TIS-4 X3):** Sensitive Ground current measuring card. The Technical data of the sensitive ground measuring input deviate are different to the Technical Data of the phase current measuring inputs. Please refer to the Technical Data.

Slot X4: CT Mains - Current Transformer Measuring Inputs

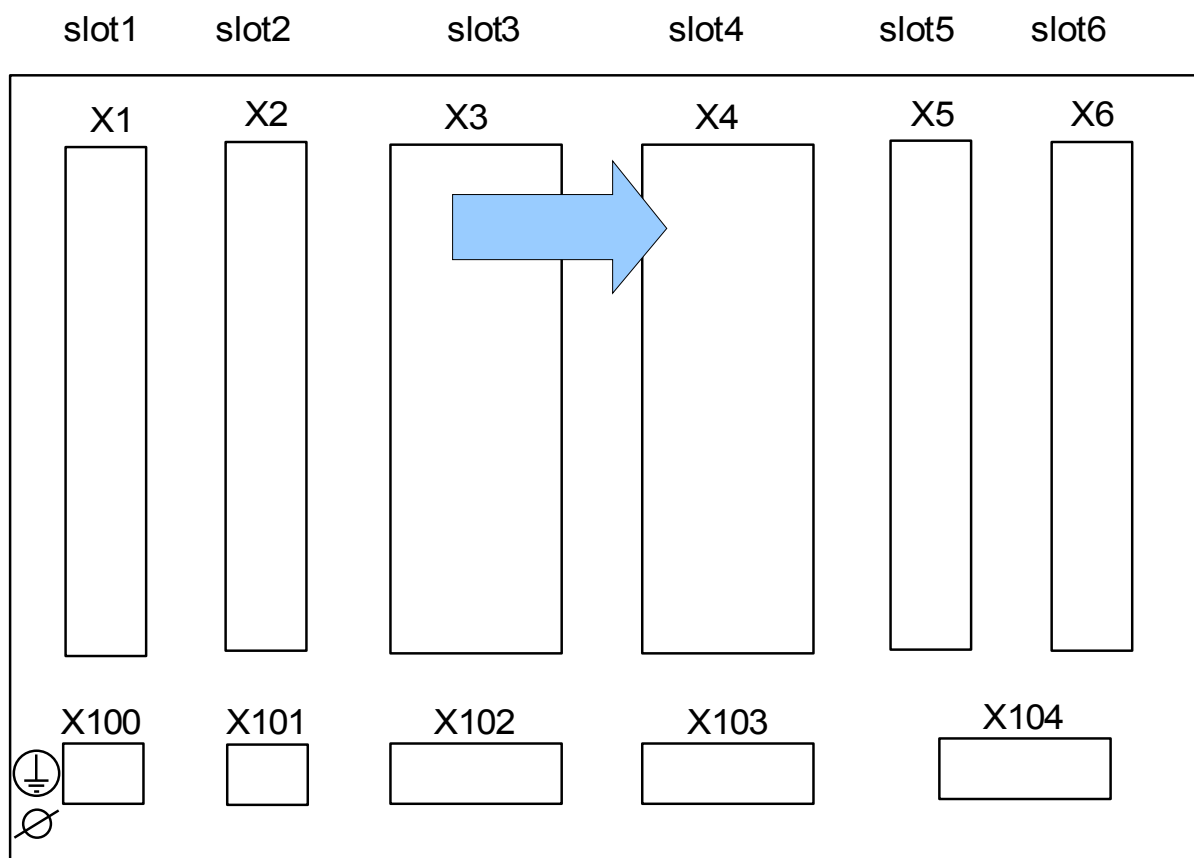

Rear side of the device (Slots)

This slot contains the current transformer measuring inputs for the line side of the differential protection.

Available assembly groups in this slot:

- (TI-4 X4): Standard ground current measuring card.

TI X- Standard Phase and Ground Current Measuring Input Card

This measuring card is provided with 4 current measuring inputs: three for measuring the phase currents and one for measuring of the earth current. Each of the current measuring inputs has a measuring input for 1 A and 5 A.

The input for earth current measuring either can be connected to a cable-type current transformer or alternatively it is possible to connect the summation current path of the phase current transformer to this input (Holmgreen connection).



DANGER Current transformers have to be earthed on their secondary side.



DANGER Interrupting the secondary circuits of current transformers causes hazardous voltages.

The secondary side of the current transformers have to be short circuited before the current circuit to the device is opened.



DANGER The current measuring inputs may exclusively be connected to current measuring transformers (with galvanic separation).



- Do not interchange the inputs (1 A/5 A)
- Make sure the transformation ratios and the power of the CTs are correctly rated. If the rating of the CTs is not right (overrated), then the normal operational conditions may not be recognized. The pickup value of the measuring unit amounts approx. 3% of the rated current of the device. Also the CTs need a current greater than approx 3% of the rated current to ensure sufficient accuracy. Example: For a 600 A CT (primary current) any currents below 18 A cannot be detected any more.
- Overloading can result in destruction of the measuring inputs or faulty signals. Overloading means that in case of a short-circuit the current-carrying capacity of the measuring inputs could be exceeded.



WARNING Ensure the correct tightening torques.

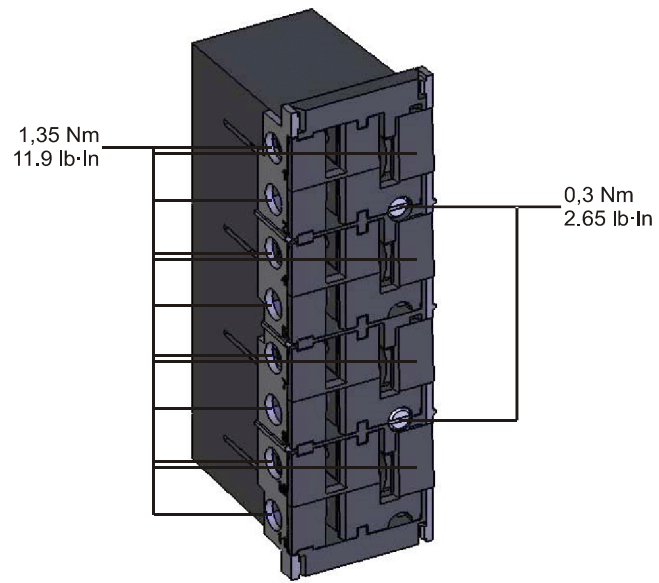

Terminals

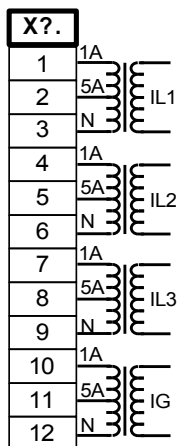

Electro-mechanical assignment

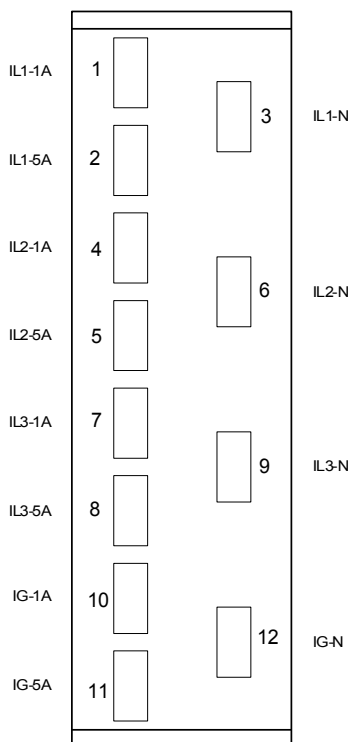

TIS X – Phase and Sensitive Ground Current Measuring Card

The measuring card is provided with 4 current measuring inputs: three for measuring the phase currents and one for measuring of the earth current. The sensitive Ground current Input has different technical data. Please refer to chapter Technical Data.

The input for earth current measuring either can be connected to a cable-type current transformer or alternatively it is possible to connect the summation current path of the phase current transformer to this input (Holmgreen connection).



Current transformers have to be earthed on their secondary side.



Interrupting the secondary circuits of current transformers causes hazardous voltages.

The secondary side of the current transformers have to be short circuited before the current circuit to the device is opened.



The current measuring inputs may exclusively be connected to current measuring transformers (with galvanic separation).



- Do not interchange the inputs (1 A/5 A)
- Make sure the transformation ratios and the power of the CTs are correctly rated. If the rating of the CTs is not right (overrated), then the normal operational conditions may not be recognized. The pickup value of the measuring unit amounts approx. 3% of the rated current of the device. Also the CTs need a current greater than approx 3% of the rated current to ensure sufficient accuracy. Example: For a 600 A CT (primary current) any currents below 18 A cannot be detected any more.
- Overloading can result in destruction of the measuring inputs or faulty signals. Overloading means that in case of a short-circuit the current-carrying capacity of the measuring inputs could be exceeded.



WARNING Ensure the correct tightening torques.

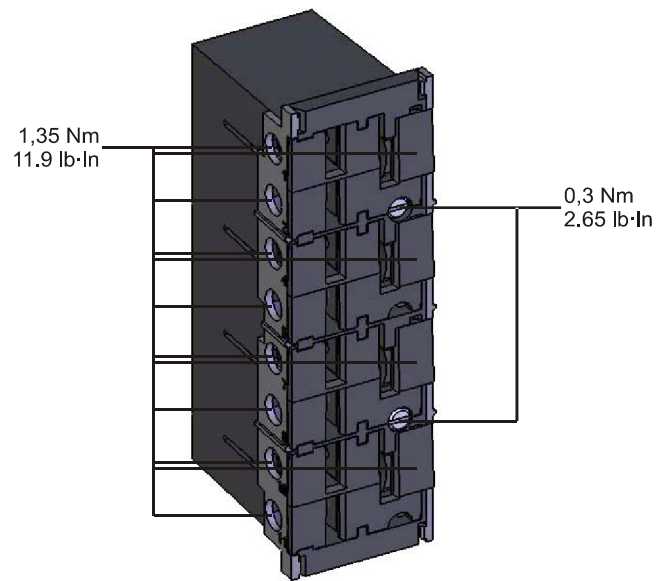

Terminals

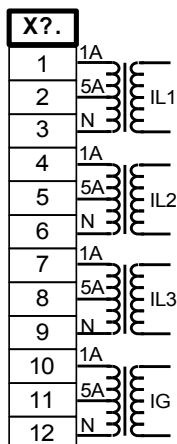

Electro-mechanical assignment

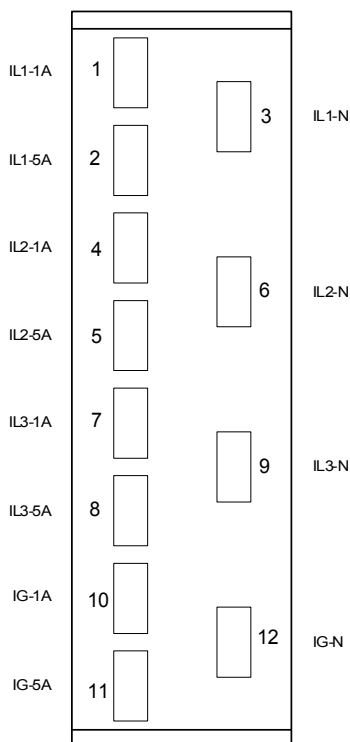

Current Transformers (CT)

Check the installation direction.



It is imperative that the secondary sides of measuring transformers be grounded.



The current measuring inputs may exclusively be connected to current measuring transformers (with galvanic separation).



CT secondary circuits must always to be low burdened or short-circuited during operation.

NOTICE

For current and voltage sensing function external wired and appropriate current and voltage transformer shall be used, based on the required input measurement ratings. Those devices provide the necessary insulation functionality.

All current measuring inputs can be provided with 1 A or 5 A nominal. Make sure that the wiring is correct.

Sensitive Ground Current Measurement

The proper use of sensitive current measuring inputs is the measurement of small currents like they could occur in isolated and high resistance grounded networks.

Due to the sensitiveness of these measuring inputs don't use them for the measurement of ground short circuit currents like they occur in solidly earthed networks.

If a sensitive measuring input should be used for the measurement of ground short circuit currents, it has to be ensured, that the measuring currents are transformed by a matching transformer according to the technical data of the protective device.

Current Transformer Connection Examples

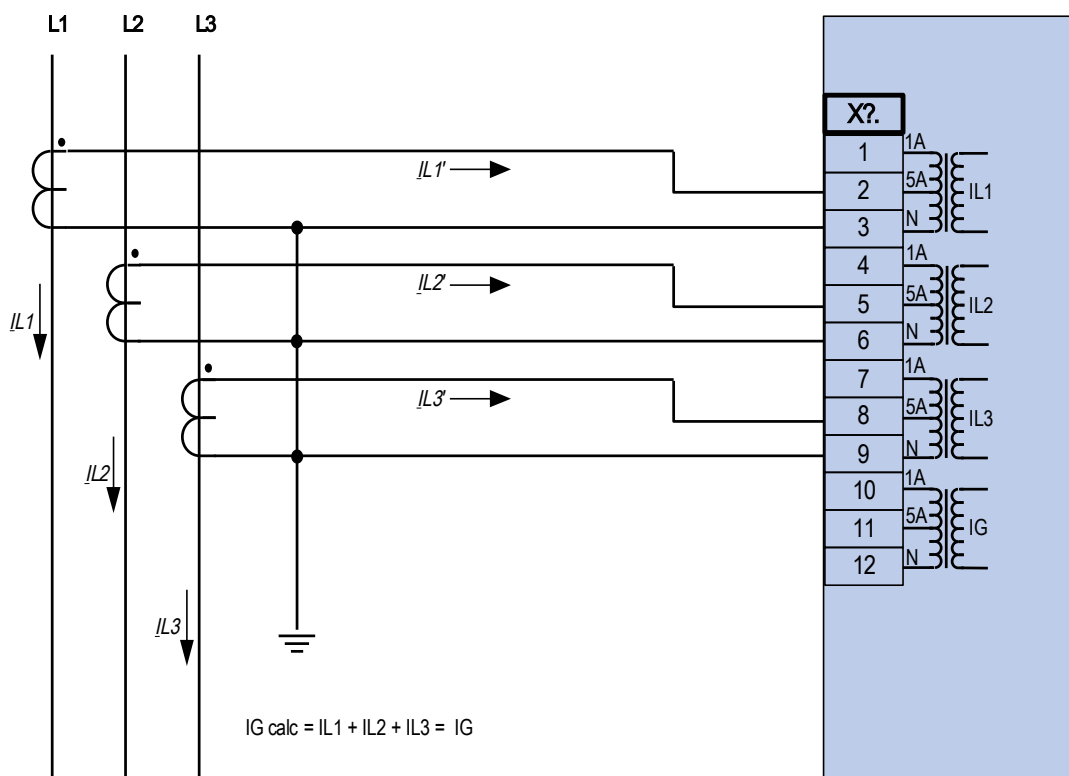

Three phase current measurement; In secondary = 5 A.

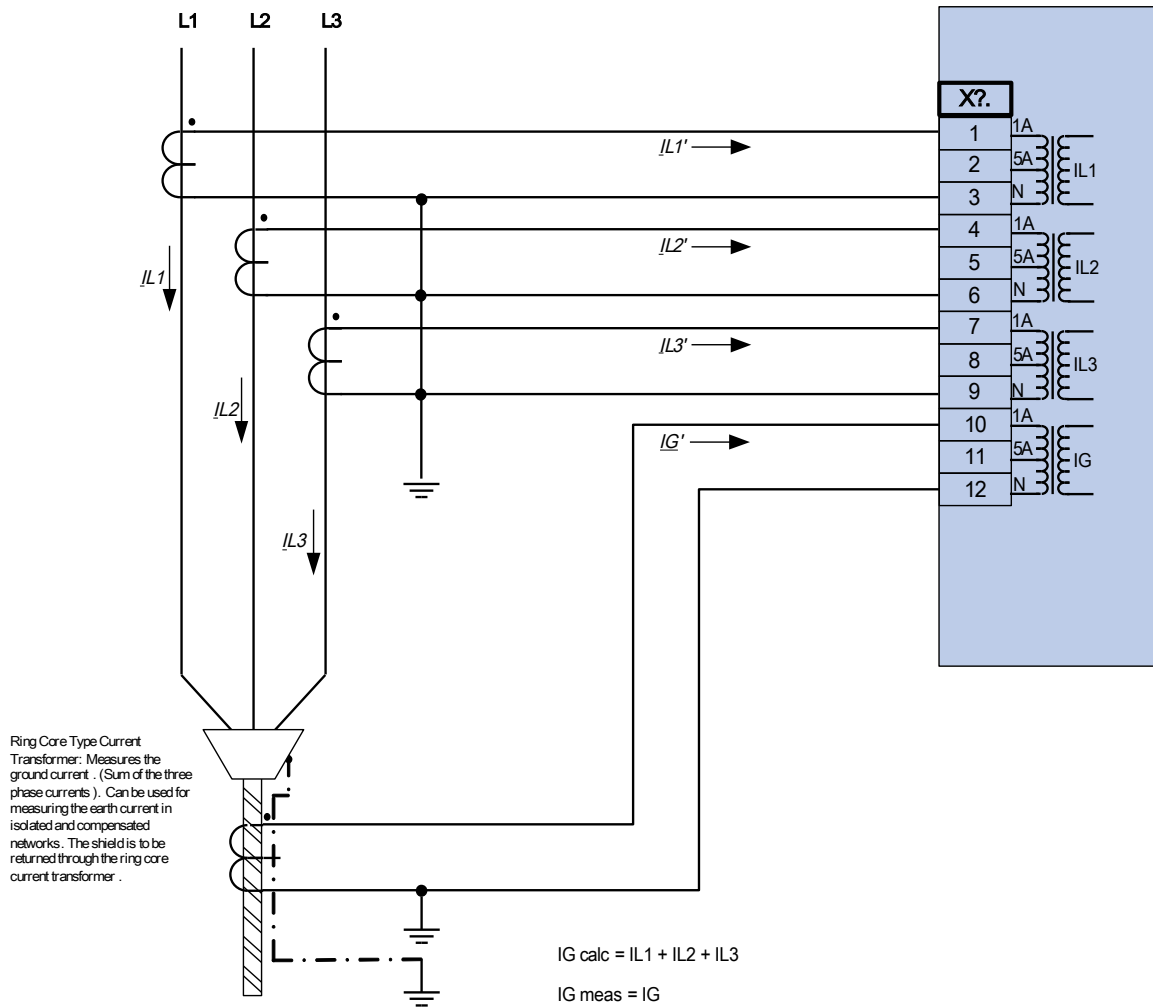

Three phase current measurement ; In secondary = 1 A.
 Earth-current measuring via cable-type current transformer ; IGnom secondary = 1 A.



Warning! The shielding at the dismantled end of the line has to be put through the cable -type current transformer and has to be grounded at the cable side .

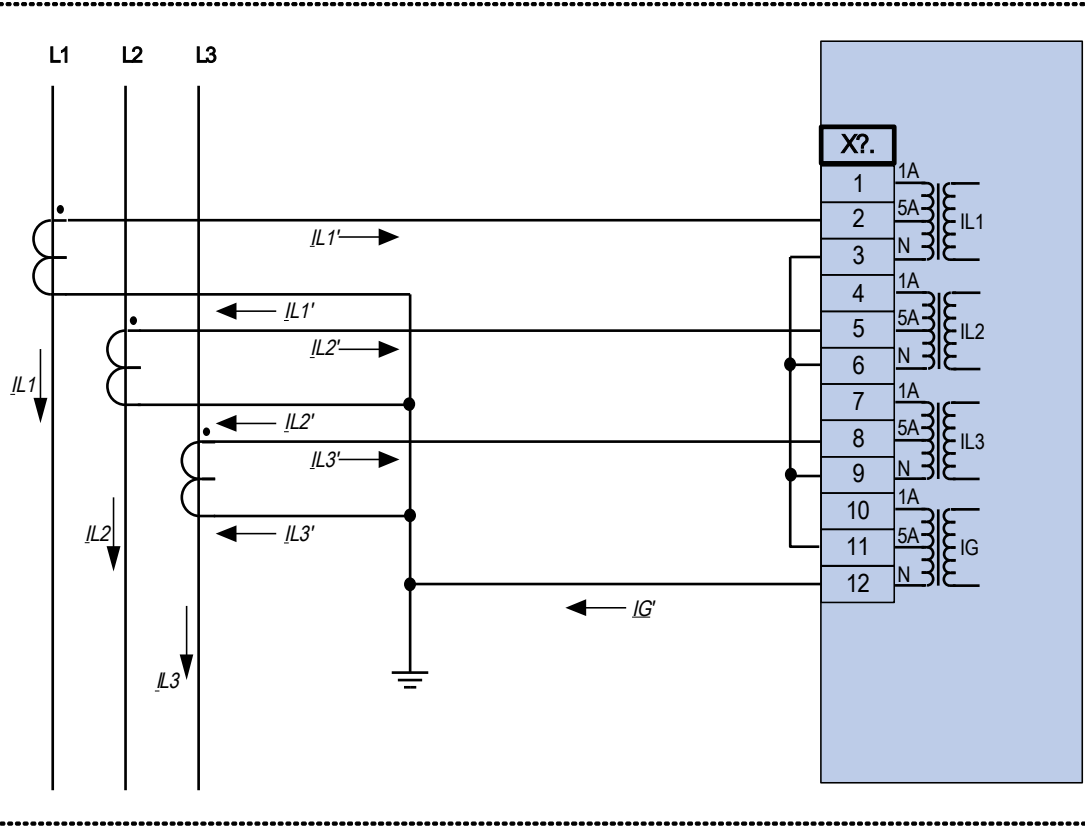

Three phase current measurement; I_n secondary = 5 A.
Earth-current measuring via Holmgreen-connection; I_{Gnom} secondary = 5 A.

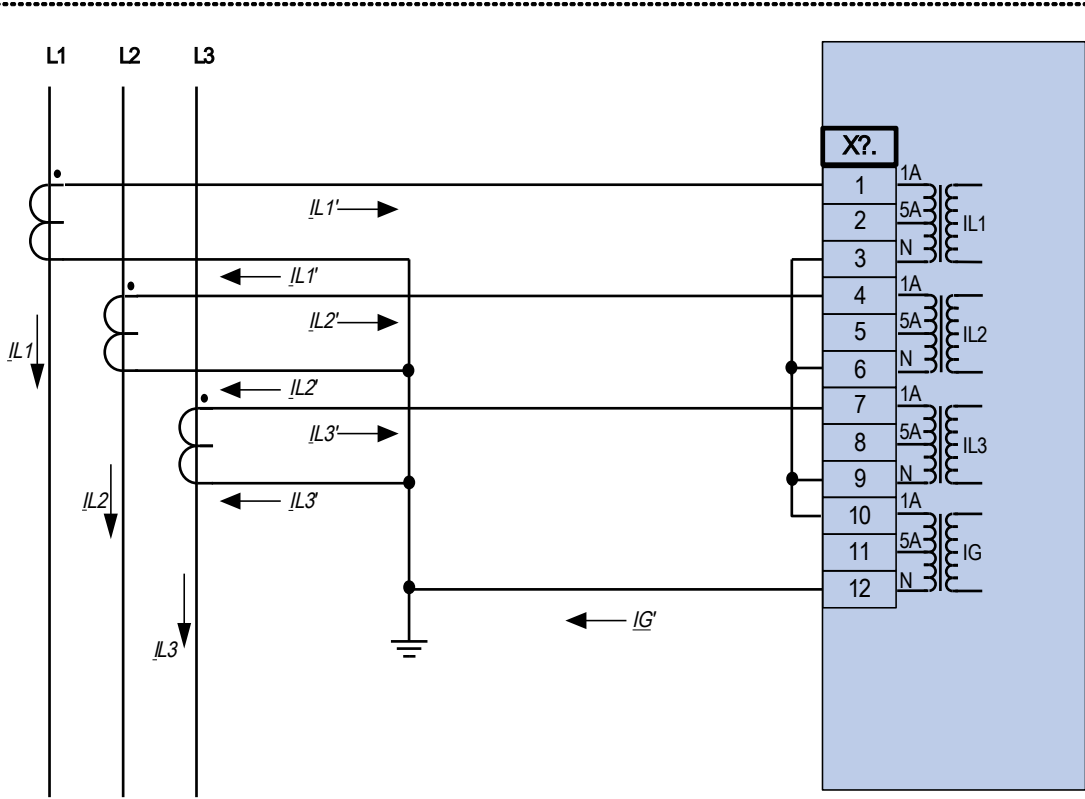

Three phase current measurement; I_n secondary = 1 A.
 Earth-current measuring via Holmgreen-connection; I_{Gnom} secondary = 1 A.

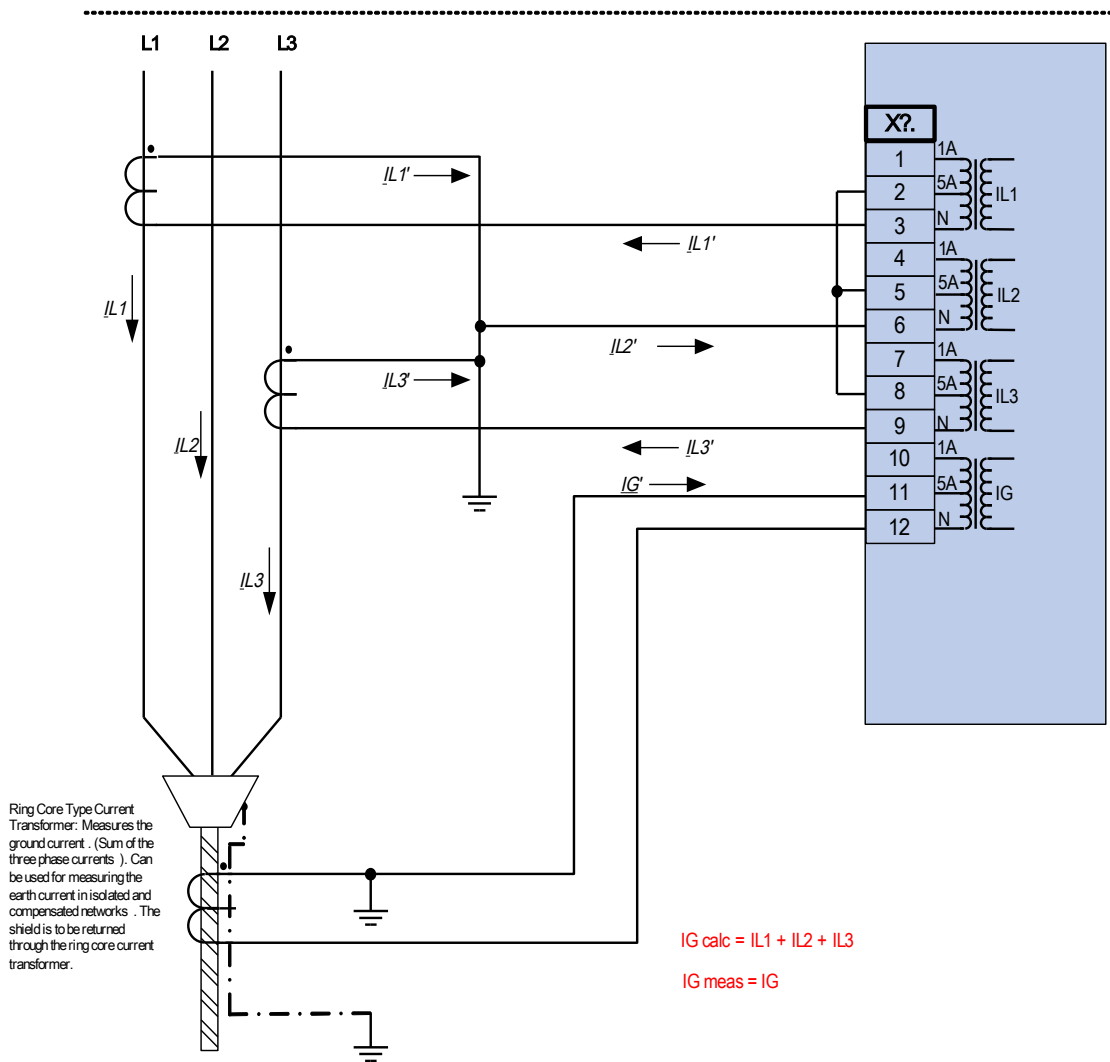

Two phase current measurement (Open Delta); In secondary = 5 A.
 Earth-current measuring via cable-type current transformer ; IGnom secondary = 5 A.



Warning! The shielding at the dismantled end of the line has to be put through the cable -type current transformer and has to be grounded at the cable side .

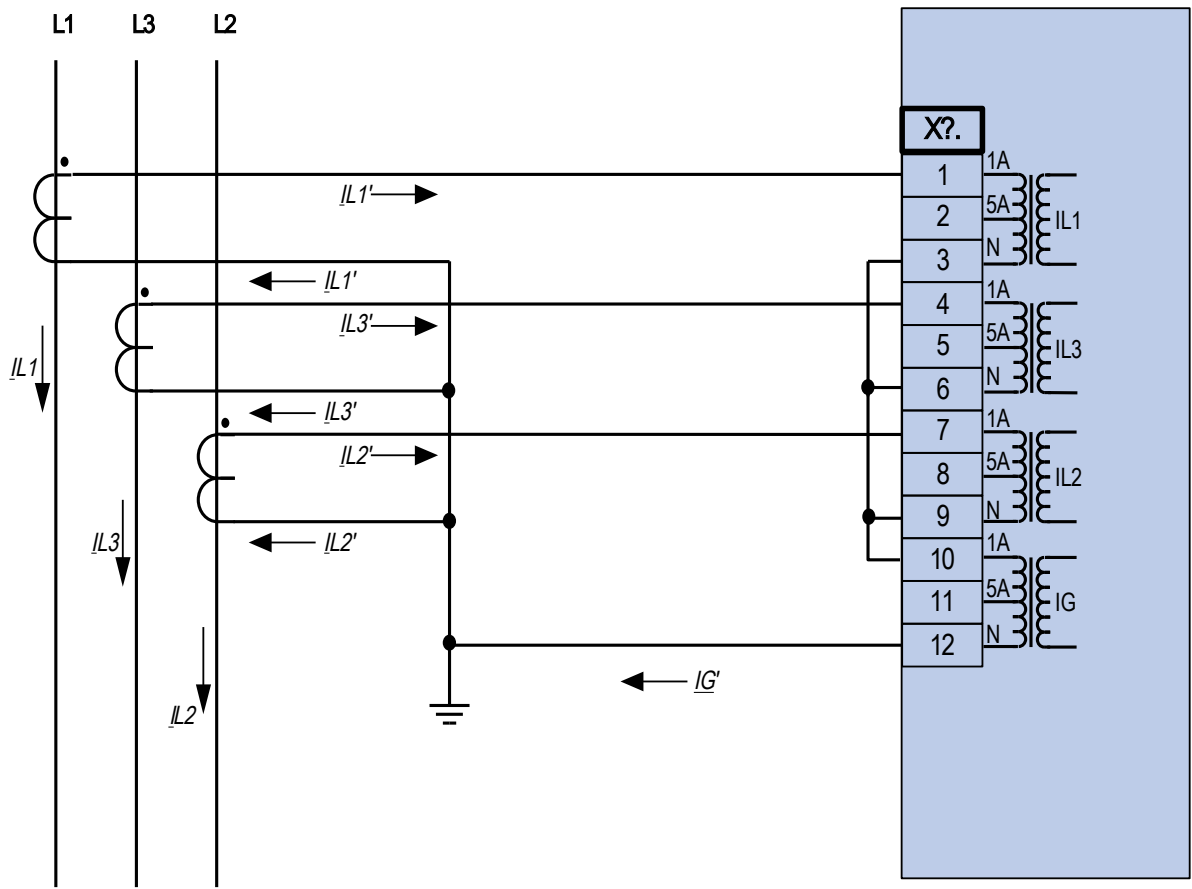

Three phase current measurement; I_n secondary = 1 A.

Earth-current measuring via Holmgreen-connection; I_{Gnom} secondary = 1 A.

Slot X5: Multi Input – Output Card

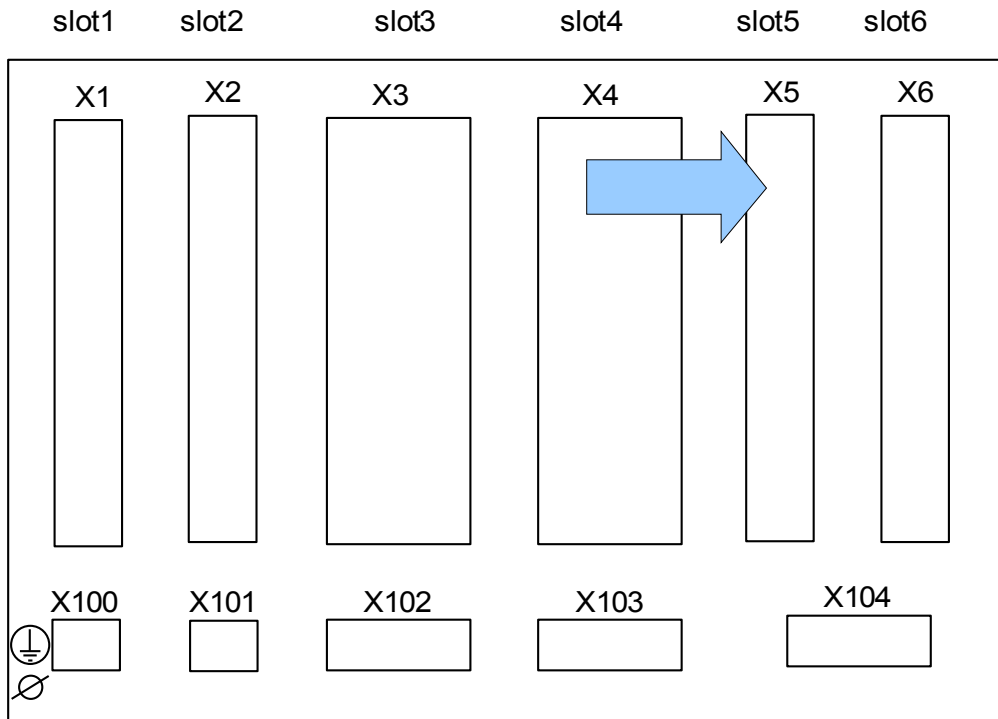

Rear side of the device (Slots)

The type of card in this slot is dependent on the ordered device type. The different variants have a different scope of functions.

Available assembly groups in this slot:

- **(DI8-OR4 X5):** Assembly Group with 8 Digital Inputs and 4 Output Relays .
- **(AN I02-OR4 X5):** Assembly Group with 2 Analog Inputs, 2 Analog Outputs and 4 Output Relays.

NOTICE

The available combinations can be gathered from the ordering code.

D18 X – Digital Inputs

This module is provided with 8 grouped digital inputs.

In chapter [Device parameter/Digital Inputs] the assignment of the digital inputs is specified.

WARNING Ensure the correct tightening torques.

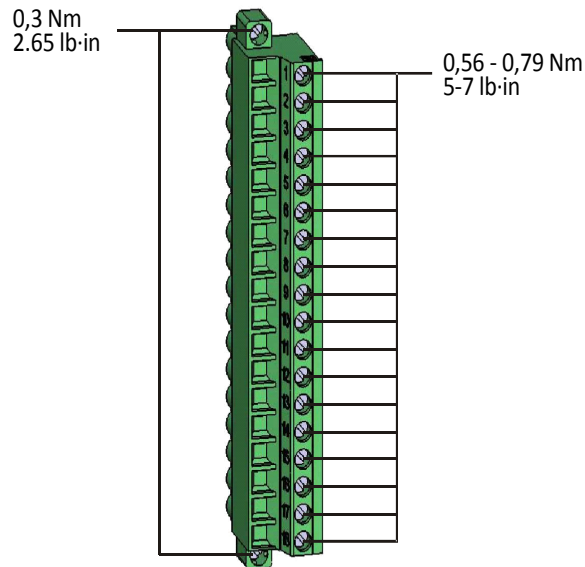

CAUTION When using DC supply, the negative potential has to be connected to the common terminal (COM1, COM2, COM3 - please see the terminal marking).

CAUTION For each digital input group the related voltage input range has to be parameterized. Wrong switching thresholds can result in malfunctions/wrong signal transfer times.

NOTICE Via the »assignment list« the states of the digital inputs are assigned to the module inputs (e.g. I[1]).

The digital inputs are provided with different switching thresholds (can be parameterized) (two AC and five DC input ranges). For each group the following switching thresholds can be defined:

- 24V DC
- 48V DC / 60V DC
- 110 V AC/DC
- 230 V AC/DC

If a voltage >80% of the set switching threshold is applied at the digital input, the state change is recognized (physically "1"). If the voltage is below 40% of the set switching threshold, the device detects physically "0".

OR-4X – Output Relays

The Output Relays are potential-free make contacts. In the Assignment / Output Relays section, the assignment of the Output Relays is specified. The changeable signals are listed in the Assignment List section.

⚠ WARNING Ensure the correct tightening torques.

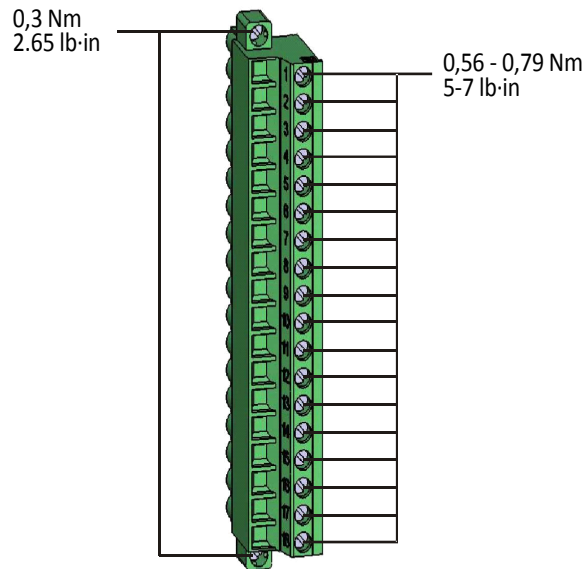

CAUTION

Please carefully consider the current carrying capacity of the Output Relays.
Please refer to the Technical Data.

Terminal Marking

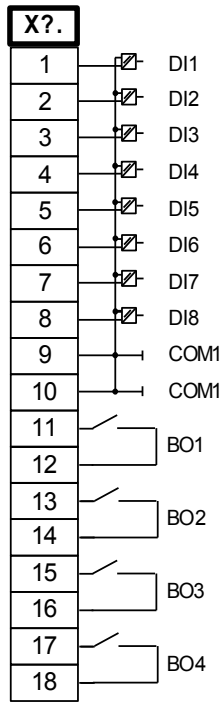

Pin Assignment

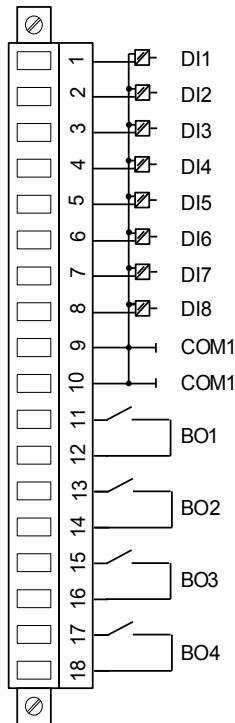

AN I02 X - Analog Inputs and Outputs

There are 2 Analog Input and 2 Analog Output channels that are configurable to either 0-20 mA, 4-20 mA, or 0-10 V. Each of the channels can be independently programmed to either of these three input/output modes.

For details on the Analog Inputs/Outputs, please refer to the Technical Data.

Wiring

- Shielded cable is recommended

HF-Shield

- The terminals of the HF shield should be used, when connecting the shield to earth on both sides of the cable is not possible. On one side of the cable the shield has to be directly connected to earth.

⚠ WARNING Ensure the correct tightening torques.

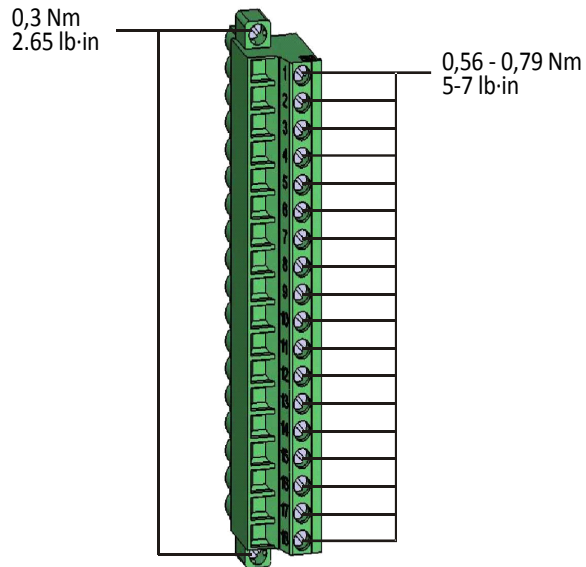

For details on the Analog Inputs or Outputs please refer to the Technical Data.

OR-4X – Output Relays

The Output Relays have potential-free contacts. In the Assignment/Output Relays section, the assignment of the Output Relays is specified. The changeable signals are listed in the Assignment List section.

⚠ WARNING Ensure the correct tightening torques.

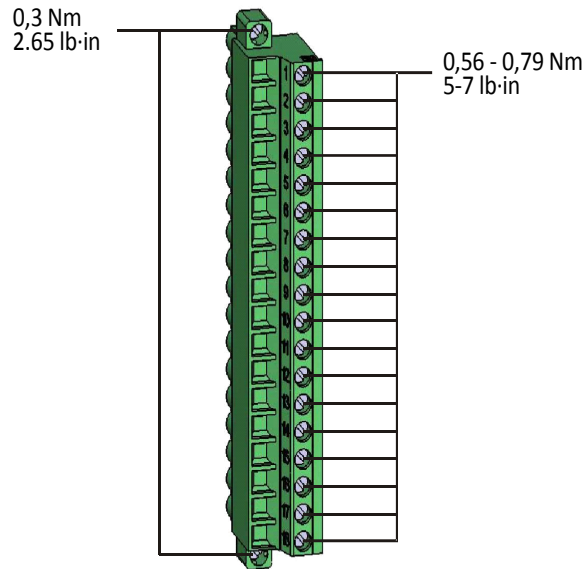

CAUTION Please carefully consider the current carrying capacity of the Output Relays. Please refer to the Technical Data.

Terminals

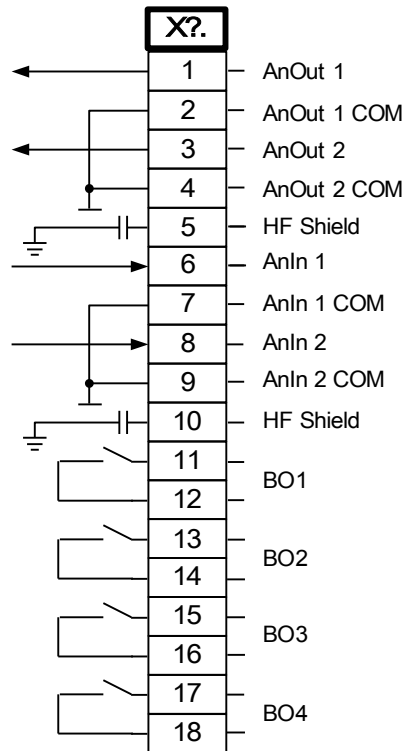

Electro-mechanical assignment

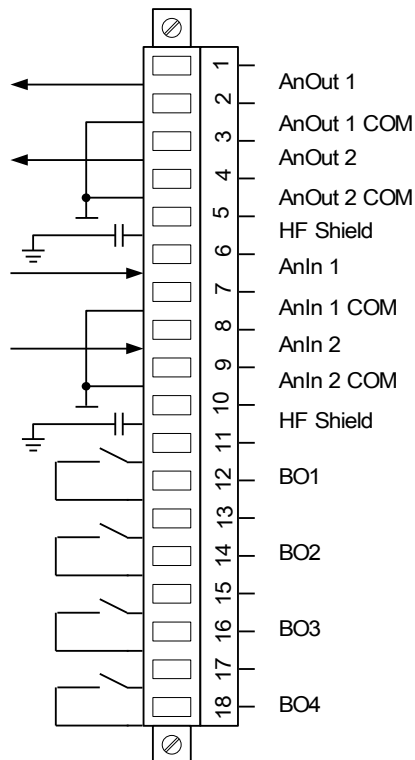

Slot X6: Voltage Measuring Card with Digital In- or Outputs

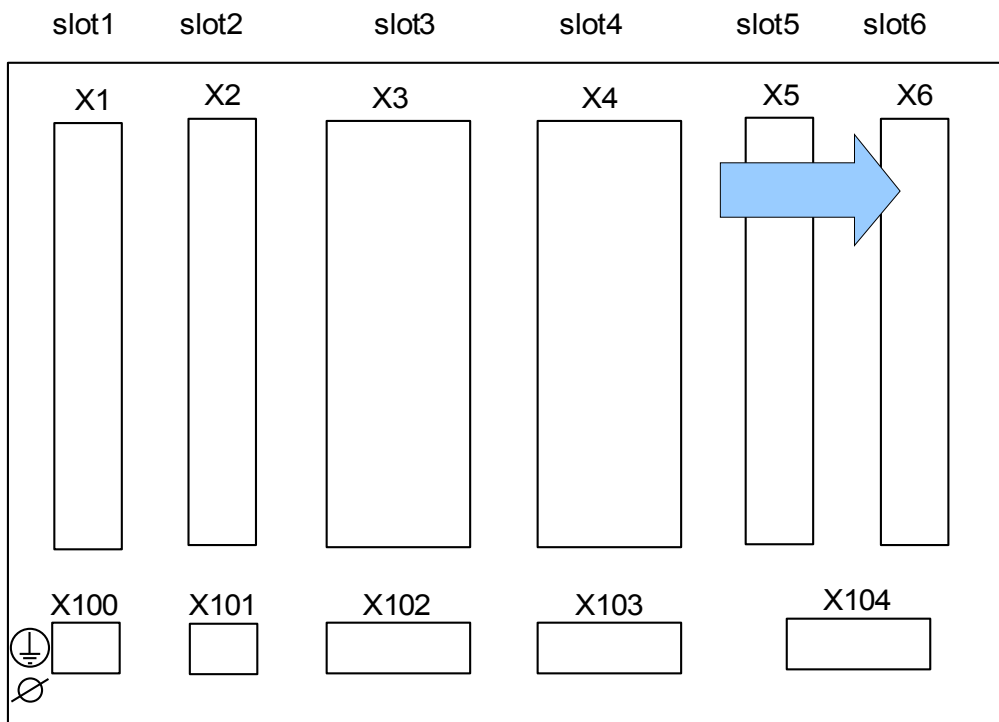

Rear side of the device (Slots)

The type of card in this slot is dependent on the ordered device type. The different variants have a different scope of functions.

Available assembly groups in this slot:

- **(UB2+ X6):** Voltage measuring assembly group
- **(U DI8 X6):** Voltage measuring assembly group with 8 Digital Inputs.
The Digital Inputs group is in principle identical with the one on Slot X1.
- **(U K4 X6):** Voltage measuring assembly group with 4 additional Relay Outputs (normally open).
The Relay Output Card is in principle identical with the one on Slot X2.

NOTICE

The available combinations can be gathered from the ordering code.

Voltage Measuring Inputs

The device is provided with 4 voltage measuring inputs: three for measuring the phase-to-phase voltages («V12«, «V23«, «V31») or phase-to-neutral voltages («VL1«, «VL2«, «VL3») and one for the measuring of the residual voltage «VE». With the field parameters the correct connection of the voltage measuring inputs has to be set:

- phase-to-neutral (star)
- phase-to-phase (Open Delta respectively V-Connection)

⚠ WARNING Ensure the correct tightening torques.

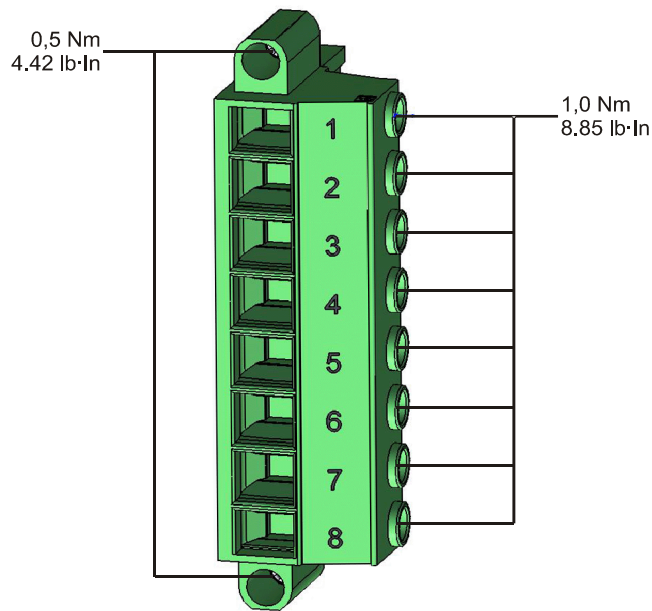

CAUTION The rotating field of your power supply system has to be taken in to account. Make sure that the transformer is wired correctly.

For the V-connection the parameter «VT con» has to be set to «phase-to-phase».

Please refer to the Technical Data.

Terminals

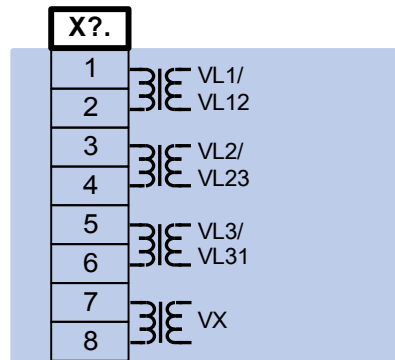

Electro-mechanical assignment

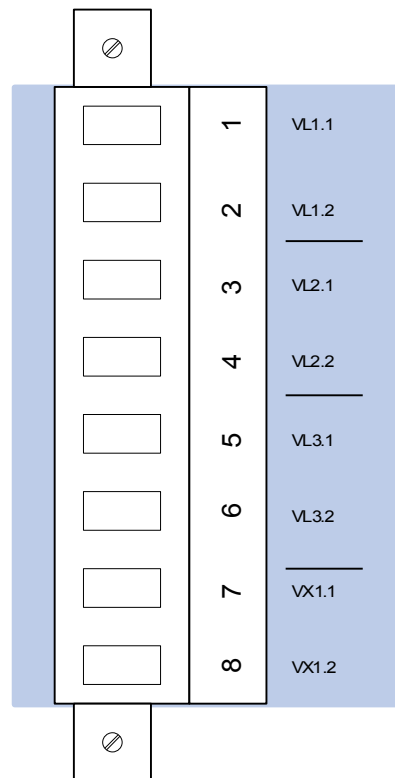

DI8 X- Digital Inputs

This module is provided with 8 grouped digital inputs.

In chapter [Device parameter/Digital Inputs] the assignment of the digital inputs is specified.

WARNING Ensure the correct tightening torques.

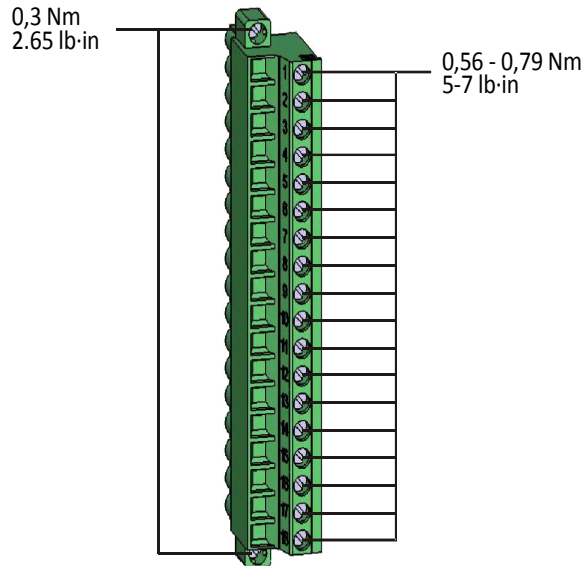

CAUTION When using DC supply, the negative potential has to be connected to the common terminal (COM1, COM2, COM3 - please see the terminal marking).

CAUTION For each digital input group the related voltage input range has to be parameterized. Wrong switching thresholds can result in malfunctions/wrong signal transfer times.

NOTICE Via the »assignment list« the states of the digital inputs are assigned to the module inputs (e.g. I[1]).

The digital inputs are provided with different switching thresholds (can be parameterized) (two AC and five DC input ranges). For each group the following switching thresholds can be defined:

- 24V DC
- 48V DC / 60V DC
- 110 V AC/DC
- 230 V AC/DC

If a voltage >80% of the set switching threshold is applied at the digital input, the state change is recognized (physically "1"). If the voltage is below 40% of the set switching threshold, the device detects physically "0".

TUr X Voltage Measuring Inputs

The device is provided with 4 voltage measuring inputs: three for measuring the phase-to-phase voltages («V12«, «V23«, «V31») or phase-to-neutral voltages («VL1«, «VL2«, «VL3») and one for the measuring of the residual voltage «VE». With the field parameters the correct connection of the voltage measuring inputs has to be set:

- phase-to-neutral (star)
- phase-to-phase (Open Delta respectively V-Connection)



Ensure the correct tightening torques.

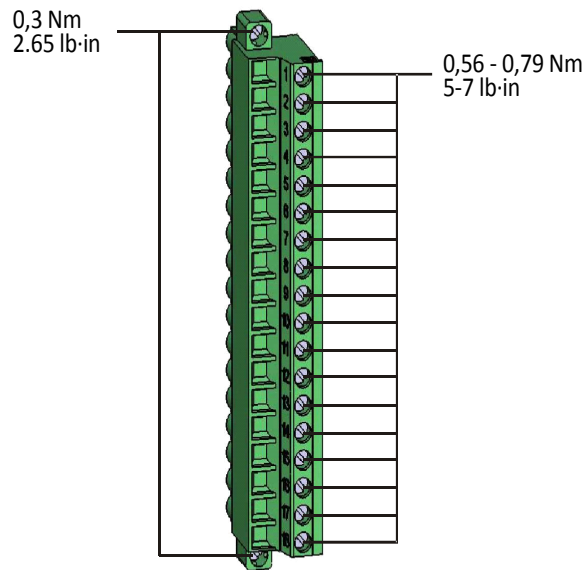

CAUTION

The rotating field of your power supply system has to be taken in to account. Make sure that the transformer is wired correctly.

For the V-connection the parameter «VT con» has to be set to «phase-to-phase».

Please refer to the Technical Data.

Terminal Marking

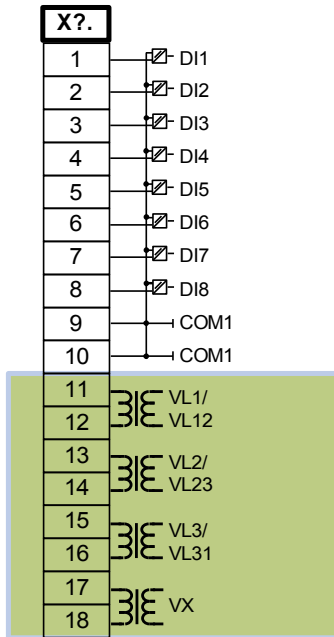

Pin Assignment

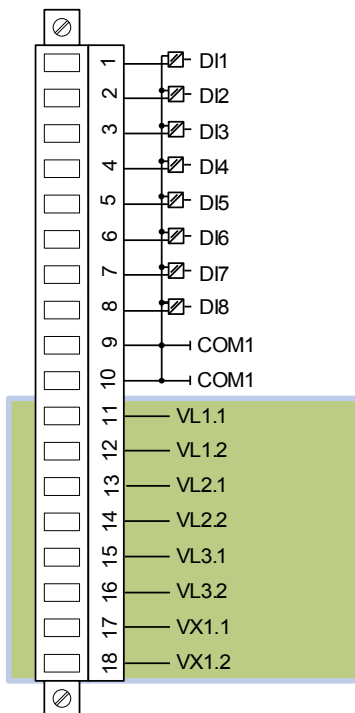

TUr X Voltage Measuring Inputs

The device is provided with 4 voltage measuring inputs: three for measuring the phase-to-phase voltages («V12«, «V23«, «V31») or phase-to-neutral voltages («VL1«, «VL2«, «VL3») and one for the measuring of the residual voltage «VE». With the field parameters the correct connection of the voltage measuring inputs has to be set:

- phase-to-neutral (star)
- phase-to-phase (Open Delta respectively V-Connection)



Ensure the correct tightening torques.

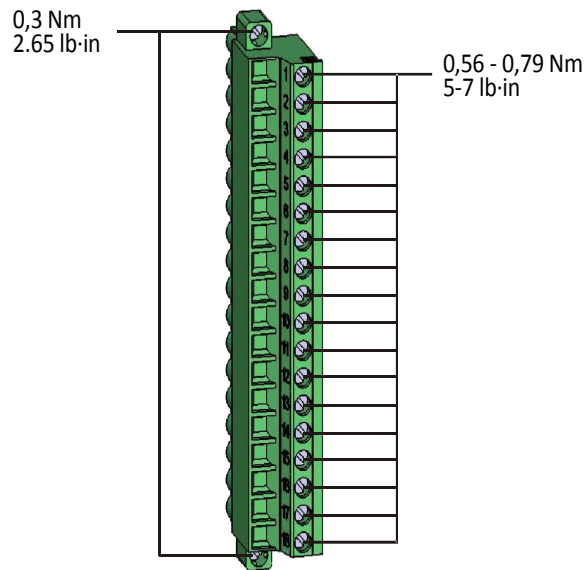

CAUTION

The rotating field of your power supply system has to be taken in to account. Make sure that the transformer is wired correctly.

For the V-connection the parameter «VT con» has to be set to «phase-to-phase».

Please refer to the Technical Data.

OR-5X – Output Relays

The Output Relays are potential-free contacts. In the Assignment/ Output Relays section, the assignment of the Output Relays is specified. The changeable signals are listed in the Assignment List section.

⚠ WARNING Ensure the correct tightening torques.

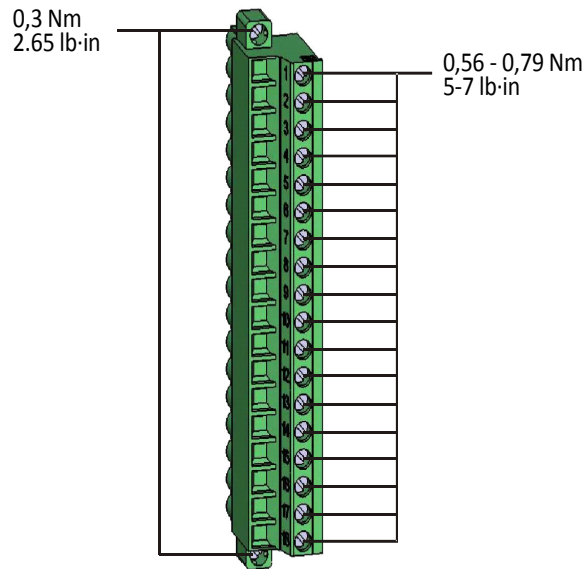

CAUTION Please carefully consider the current carrying capacity of the Output Relays. Please refer to the Technical Data.

Terminal Marking

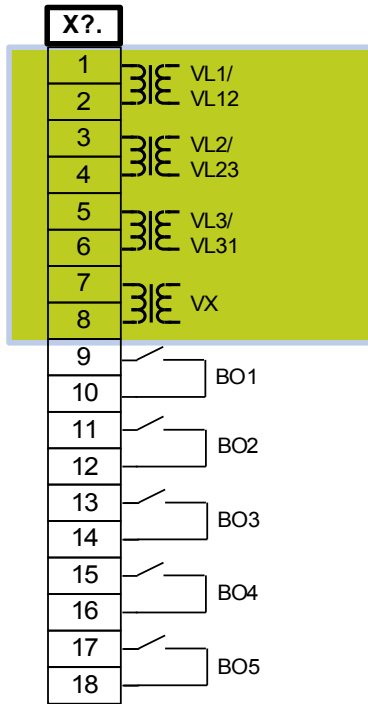

Pin Assignment

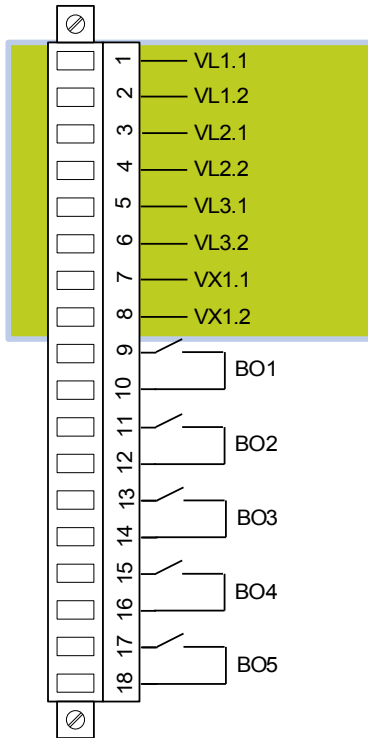

Voltage Transformers

Check the installation direction of the VTs.



It is imperative that the secondary sides of measuring transformers be grounded.

NOTICE

For current and voltage sensing function external wired and appropriate current and voltage transformer shall be used, based on the required input measurement ratings. Those devices provide the necessary insulation functionality.

Check of the Voltage Measuring Values

Connect a three-phase measuring voltage equal to the rated voltage to the relay.

NOTICE

Take connection of the measuring transformers (star connection/open delta connection) duly into account.

Now adjust voltage values in the nominal voltage range with the corresponding nominal frequency which are not likely to cause overvoltage- or undervoltage trips.

Compare the values shown in the device display with the readings of the measuring instruments. The deviation must be according to the technical data.

NOTICE

When r.m.s. value measuring instruments are used, higher deviations can arise if the fed voltage has a very high harmonic content. Since the device is provided with a filter for the harmonics, only the fundamental oscillation is evaluated (exception: thermal protection functions). If, however, a r.m.s. value forming measuring instrument is used, the harmonics are also measured.

Wiring Examples of the Voltage Transformers

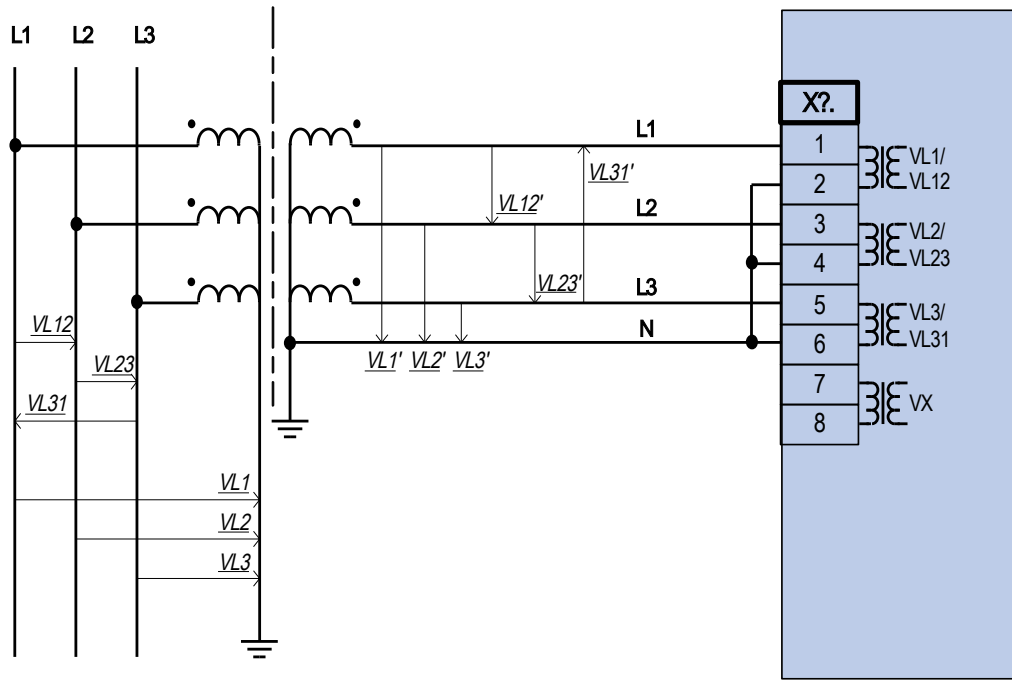

Three-phase voltage measurement - wiring of the measurement inputs: "star-connection"

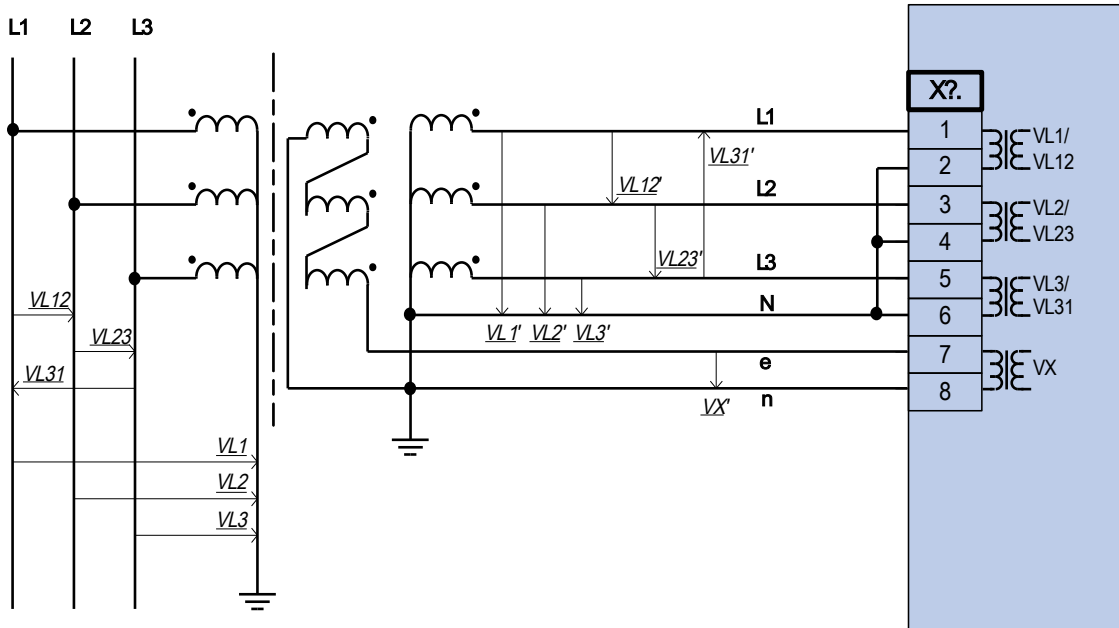

Three-phase voltage measurement - wiring of the measurement inputs: "star-connection"
 Measurement of the residual voltage VG via auxilliary windings (e-n) "broken delta"

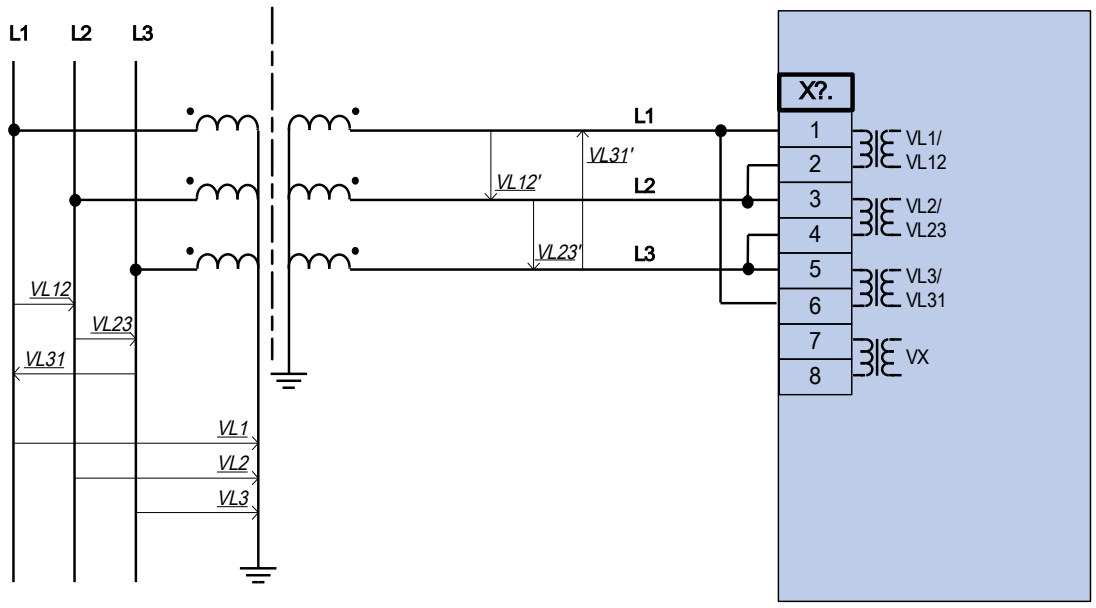

Three-phase voltage measurement - wiring of the measurement inputs: "delta-connection"



Notice!
Calculation of the residual voltage V_G is not possible

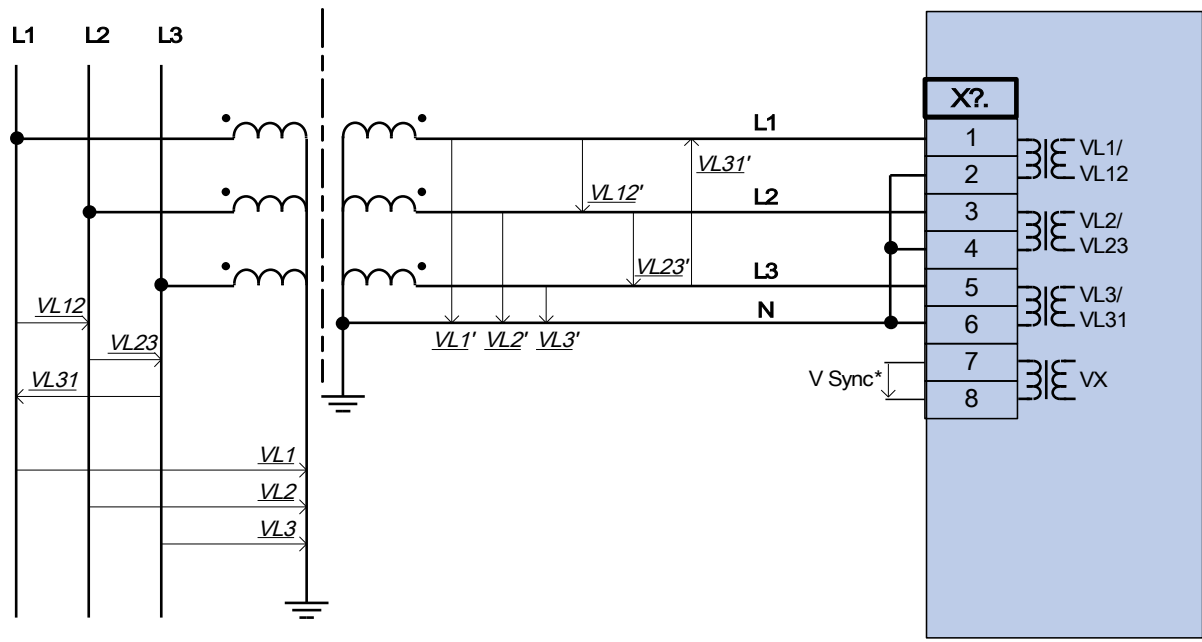

= Availability dependent on device type

Three-phase voltage measurement - wiring of the measurement inputs: "star-connection".
 Fourth measuring input for measuring a synchronisation voltage .

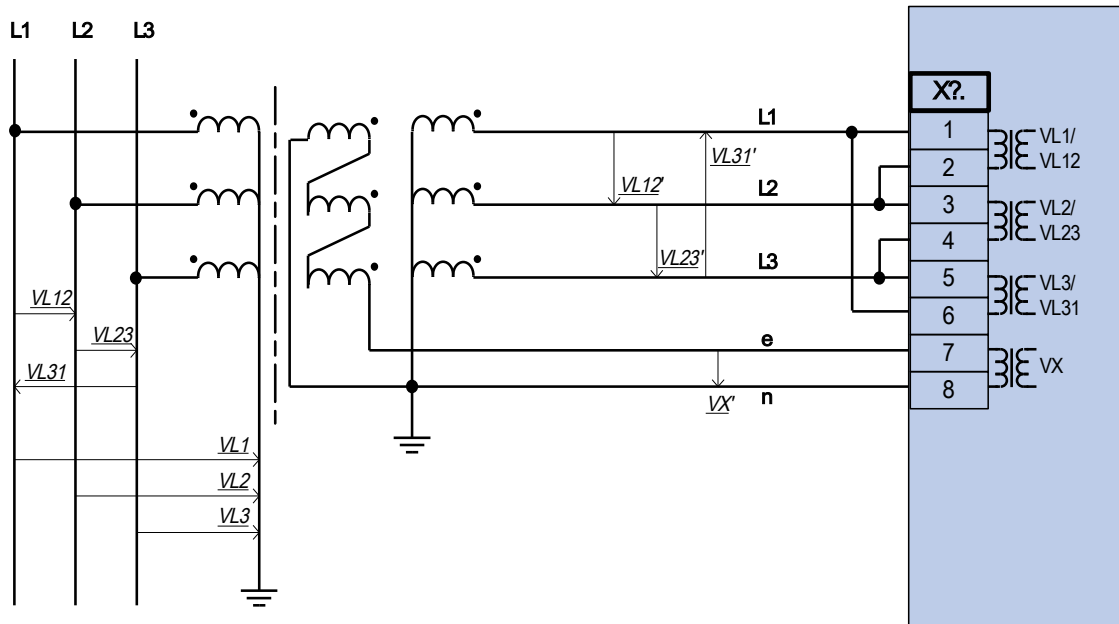

Three-phase voltage measurement - wiring of the measurement inputs: "delta-connection"
 Measurement of the residual voltage VG via auxilliary windings (e-n) "broken delta"

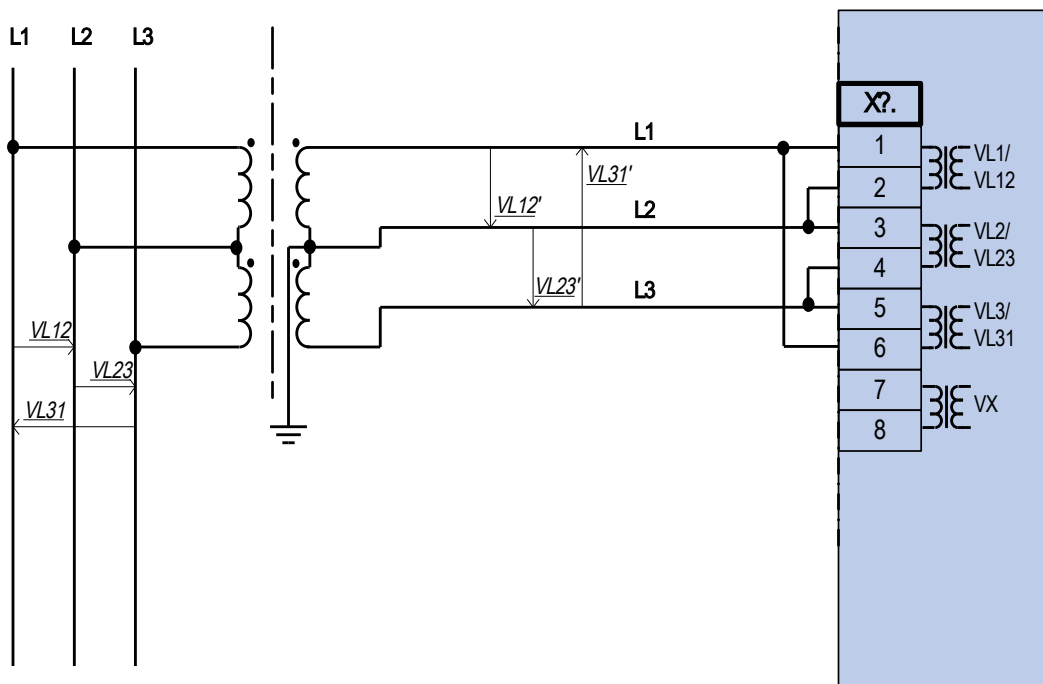

Two-phase voltage measurement - wiring of the measuring inputs: "Open Delta"

Typical External Sensing Connections

Low Resistance Grounded Generator with Phase and Ground Differential Protection

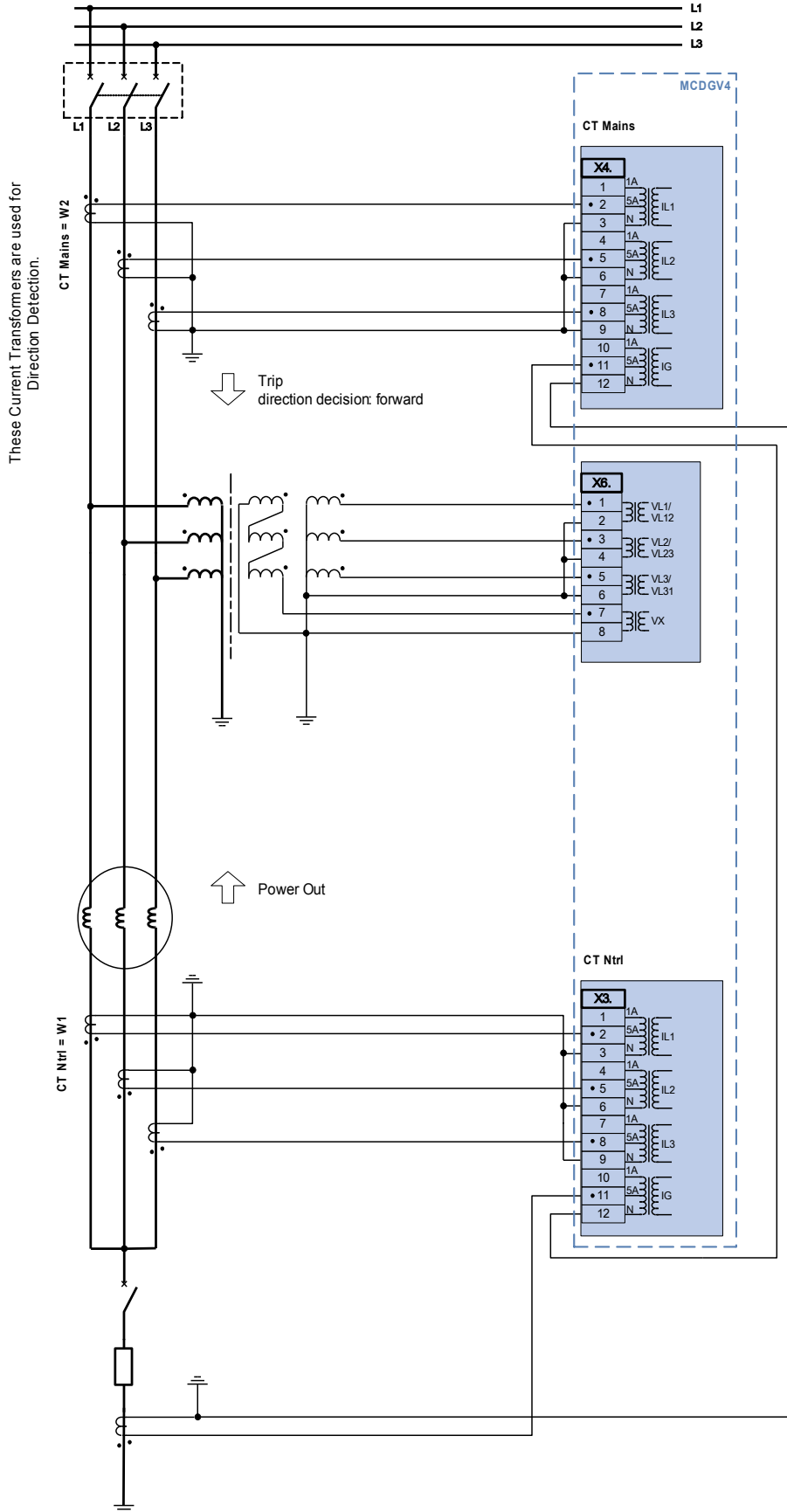

Ungrounded Generator with Phase Differential Protection and Core Balance CT

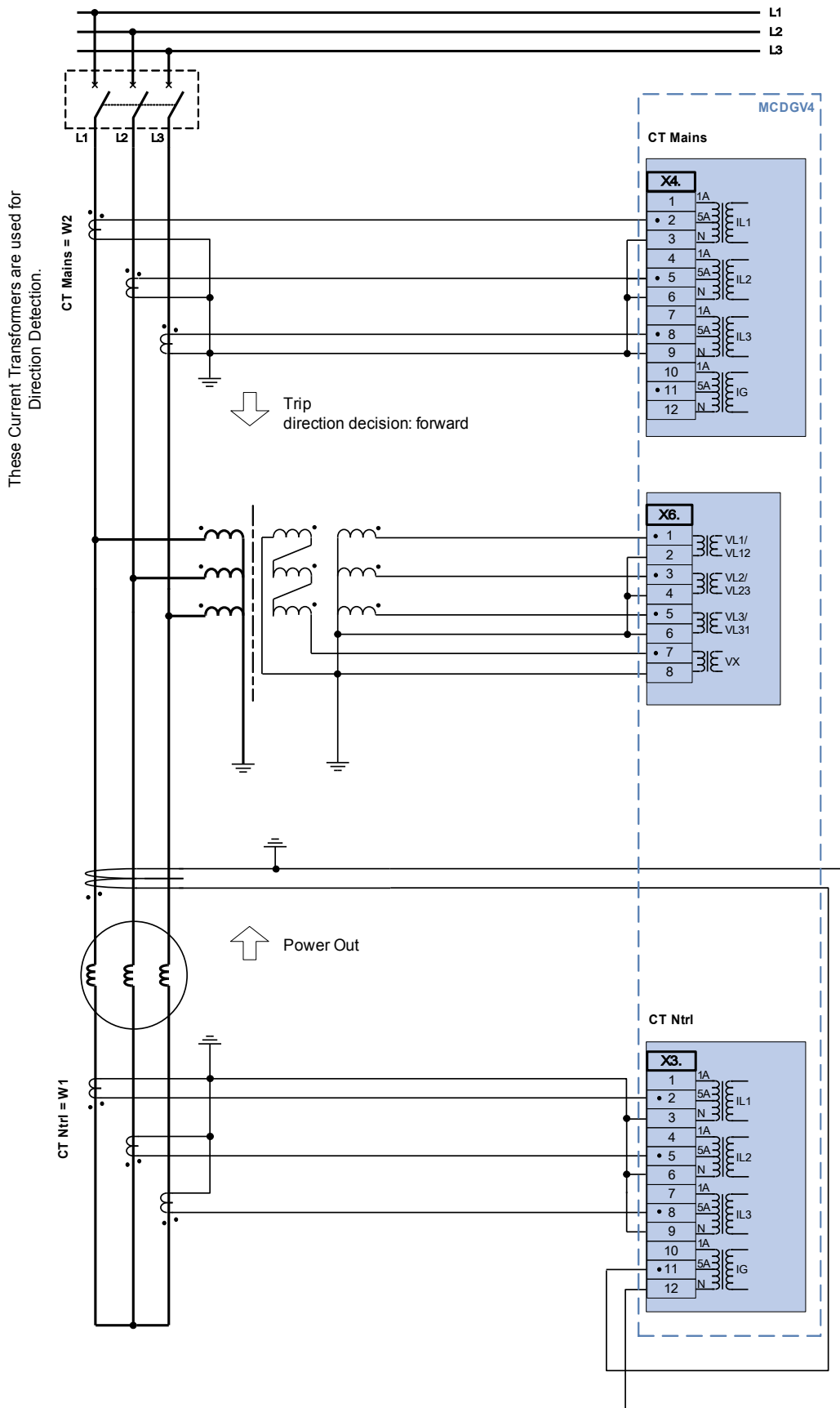

High Impedance Grounded Generator with Phase Differential and 100% Stator Ground Protection

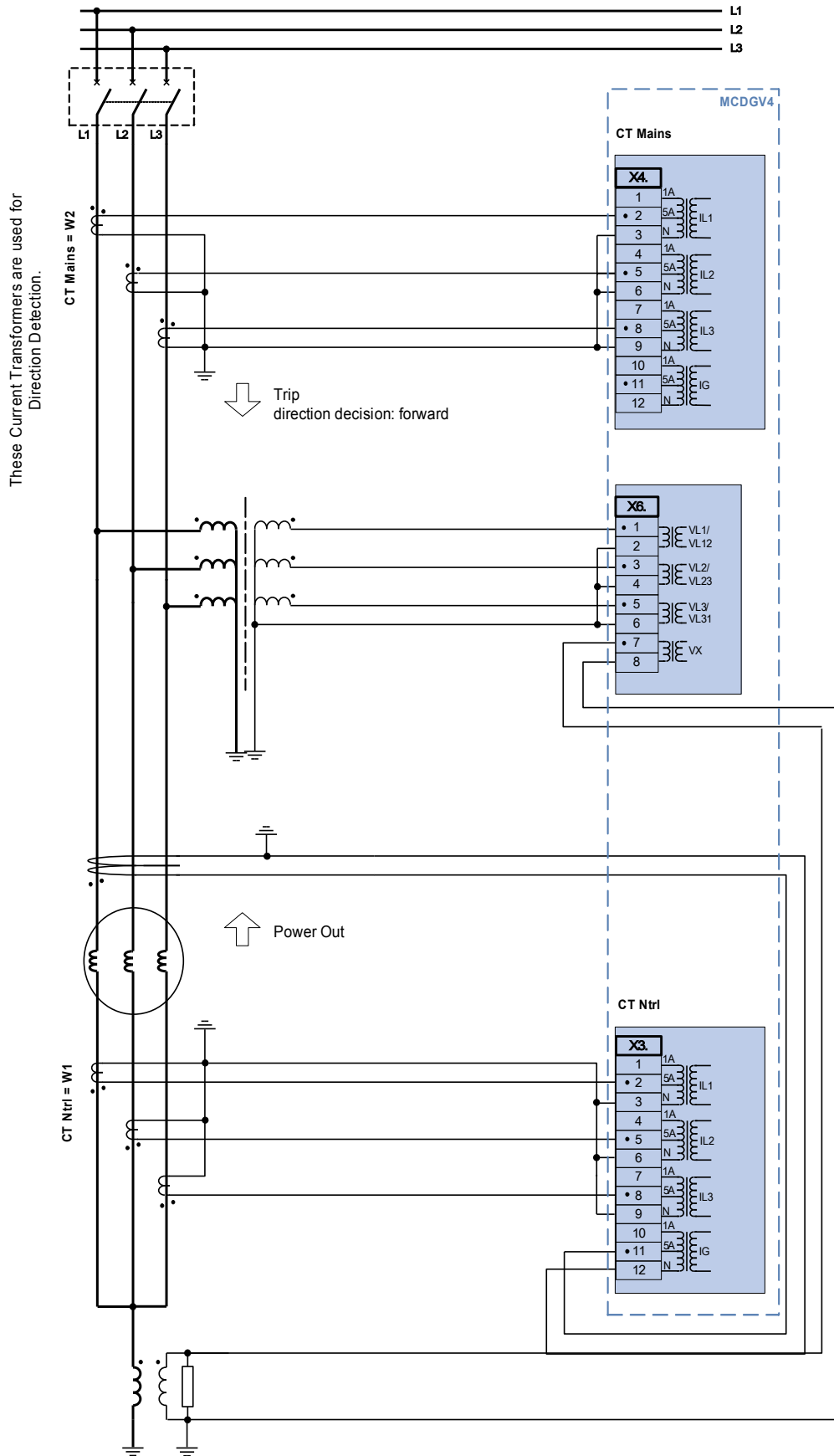

High Impedance Grounded Generator with Phase Differential and Synchronism Check

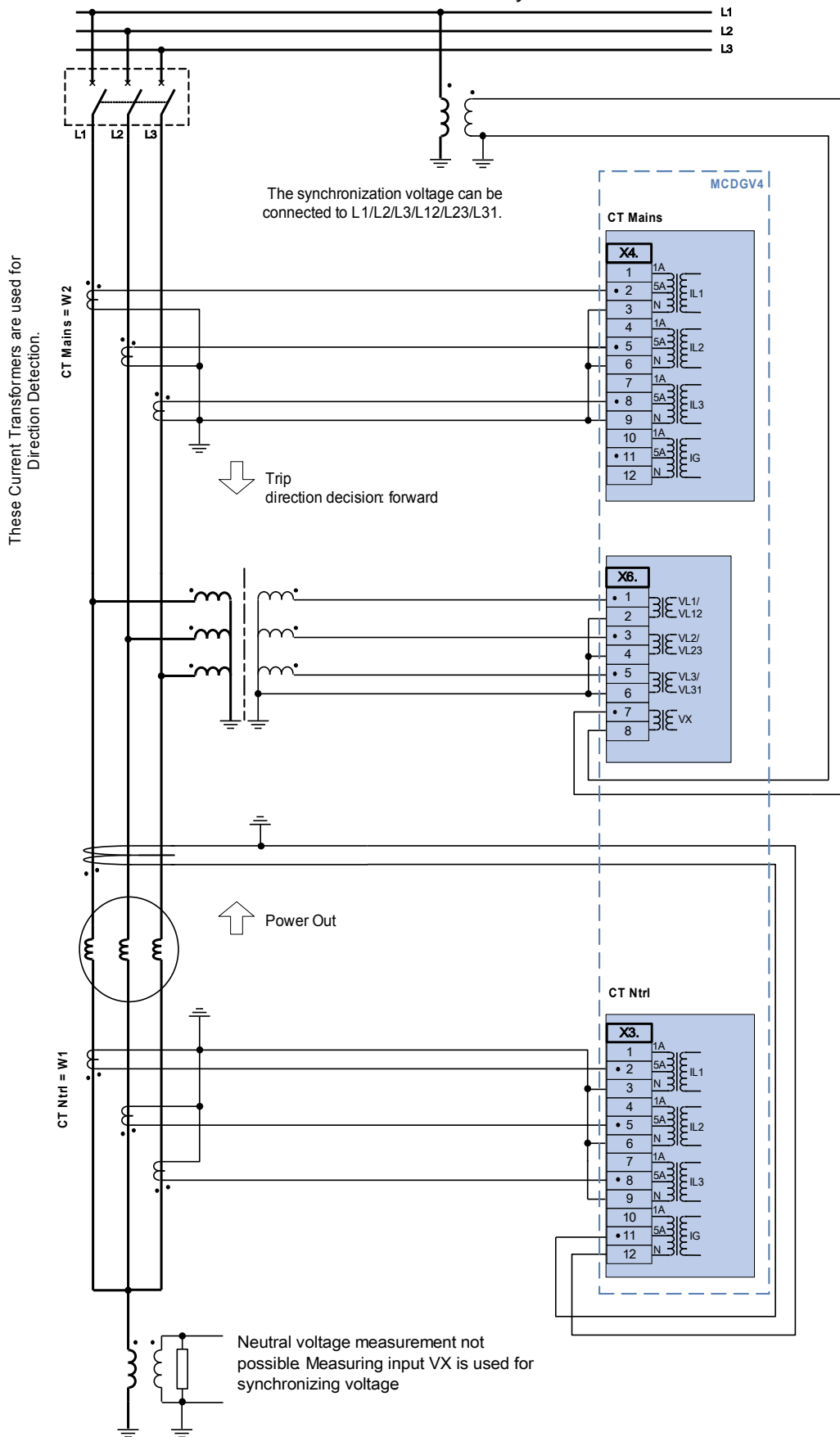

Low Resistance Grounded Generator and Stepup Transformer Unit with Generator Phase Differential Protection only

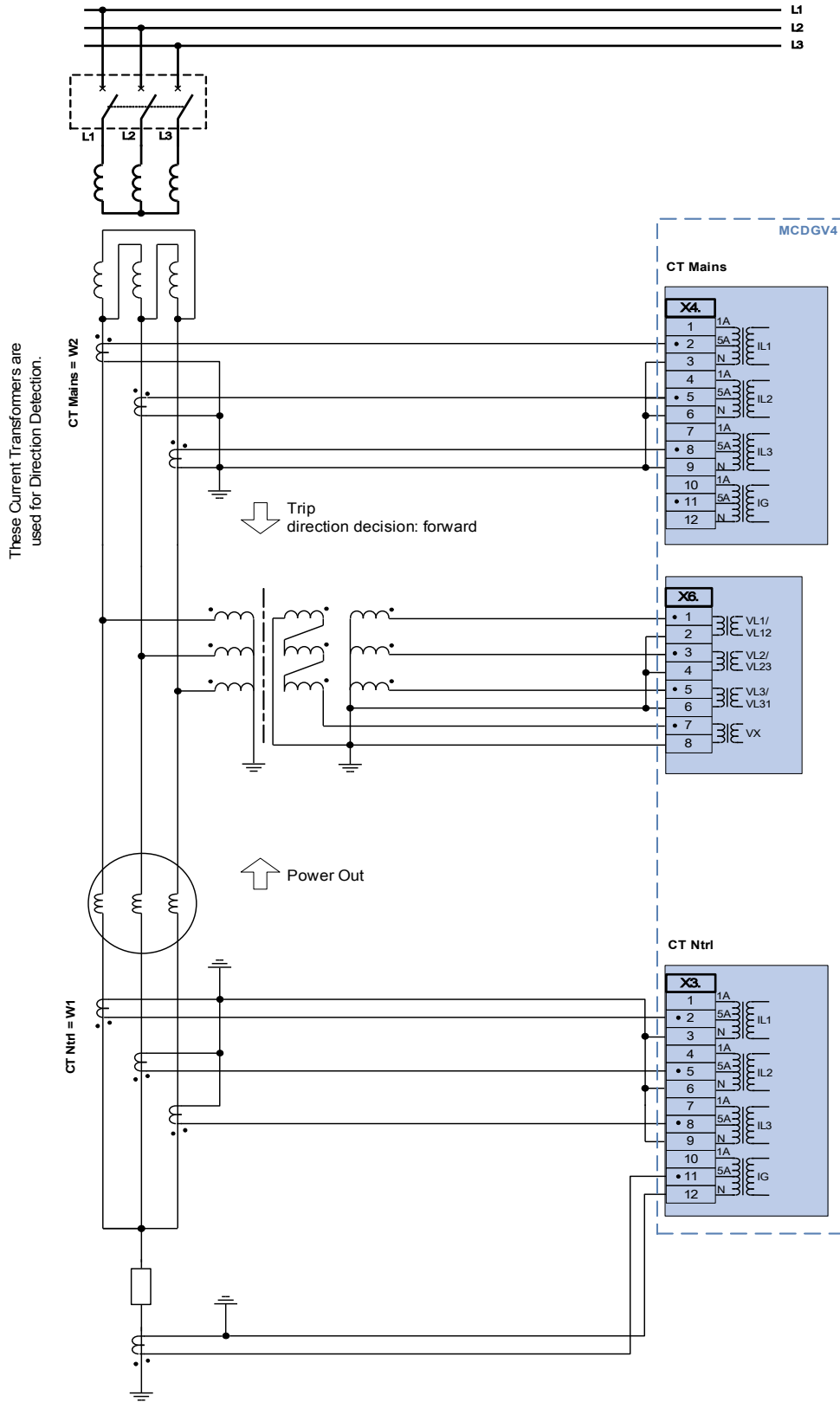

High Impedance Grounded Generator with Block Differential Protection

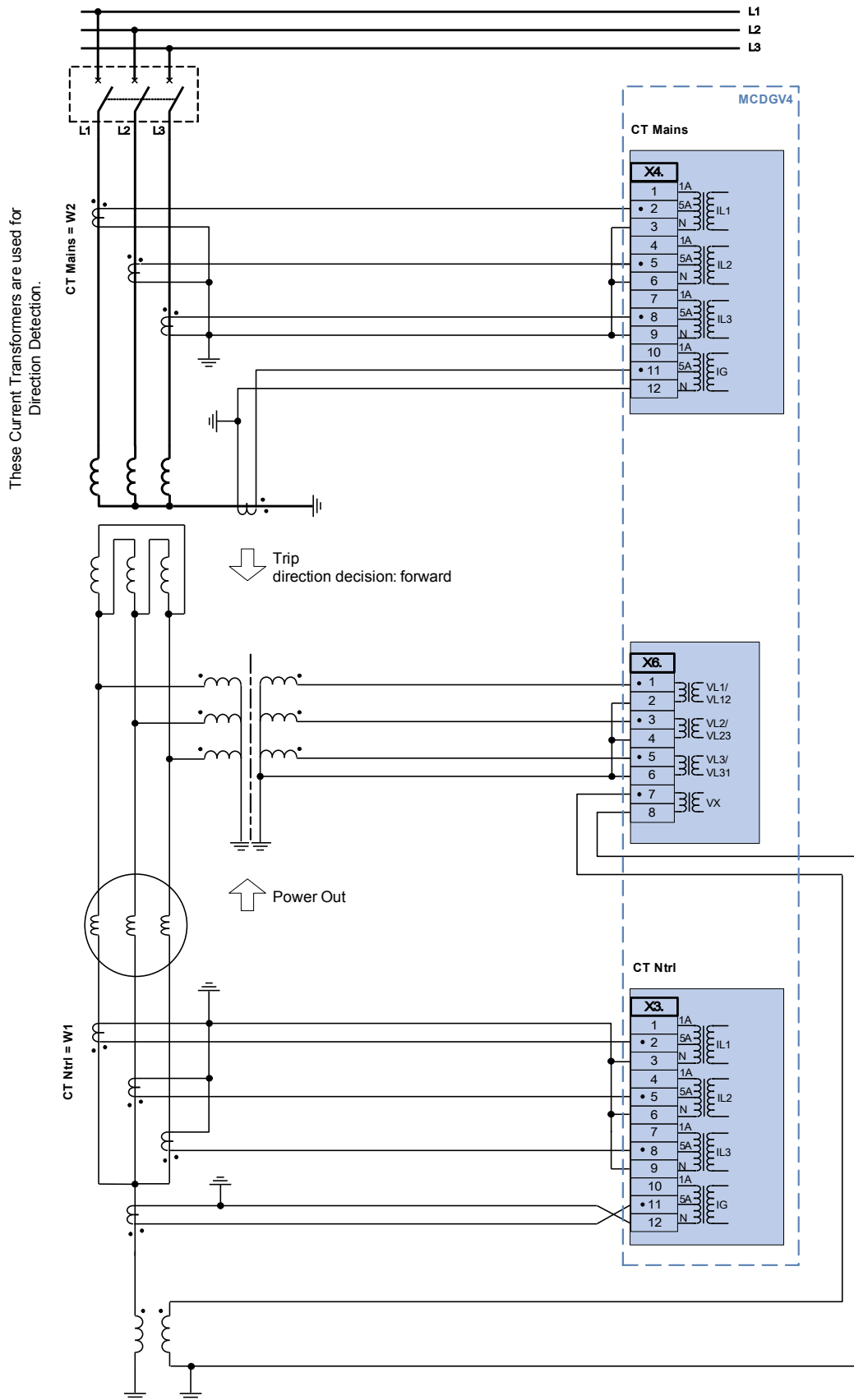

Slot X100: Ethernet Interface

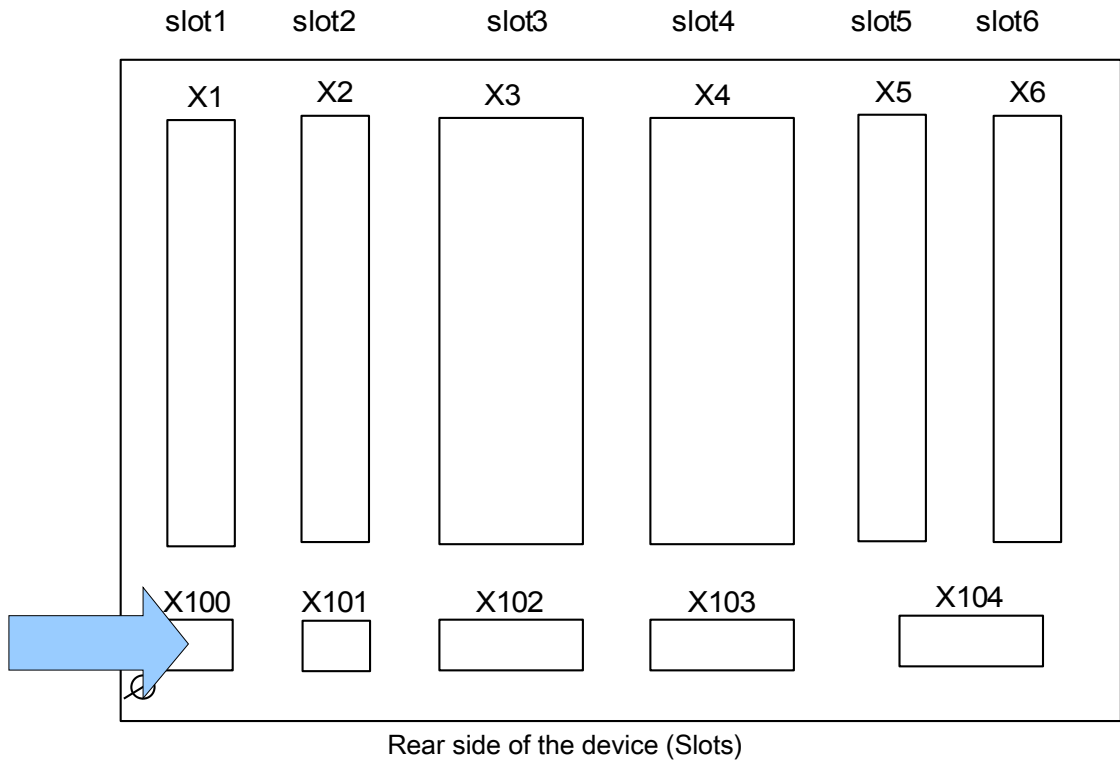

An Ethernet interface may be available depending on the device type ordered.

NOTICE

The available combinations can be gathered from the ordering code.

Ethernet - RJ45

Terminals

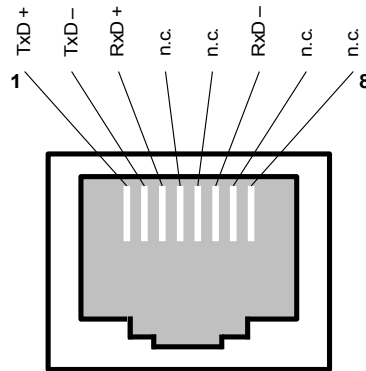

Slot X103: Data Communication

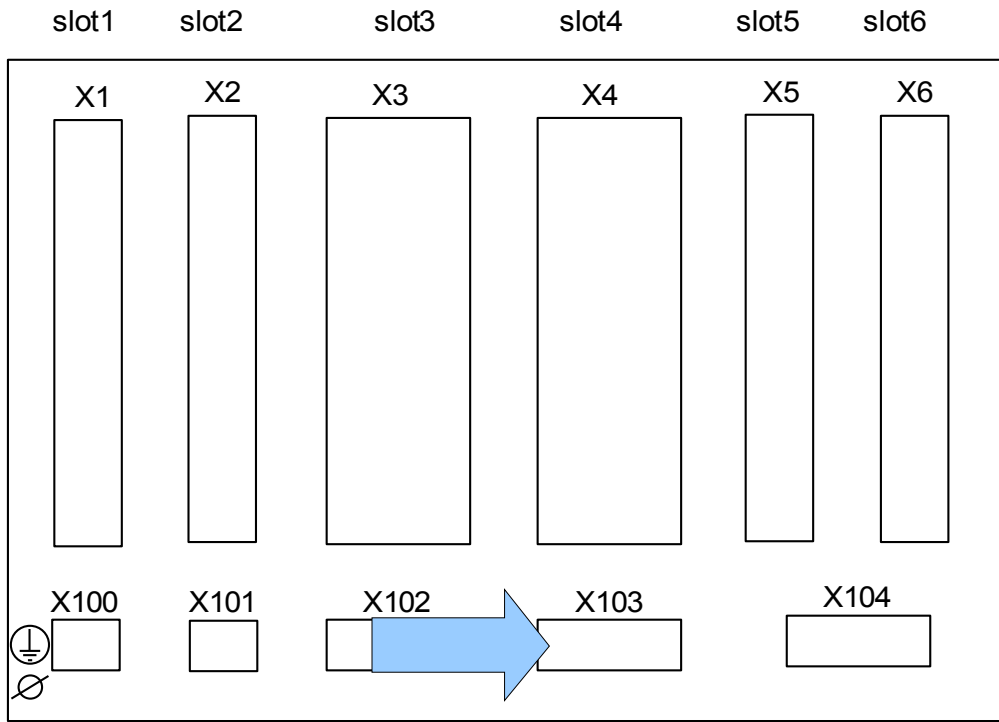

Rear side of the device (Slots)

The data communication interface in the **X103** slot is dependent on the ordered device type. The scope of functions is dependent on the type of data communication interface.

Available assembly groups in this slot:

- RS485 Terminals for Modbus, DNP and IEC
- Fiber Optics Interface for Modbus, DNP and IEC
- Fiber Optics Interface for Profibus
- D-SUB Interface for Modbus, DNP and IEC
- D-SUB Interface for Profibus
- Fiber Optics Interface for Ethernet

NOTICE The available combinations can be gathered from the ordering code.

Modbus® RTU / IEC 60870-5-103 via RS485

WARNING Ensure the correct tightening torques.

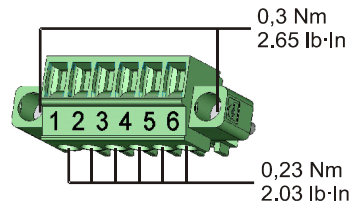

RS485

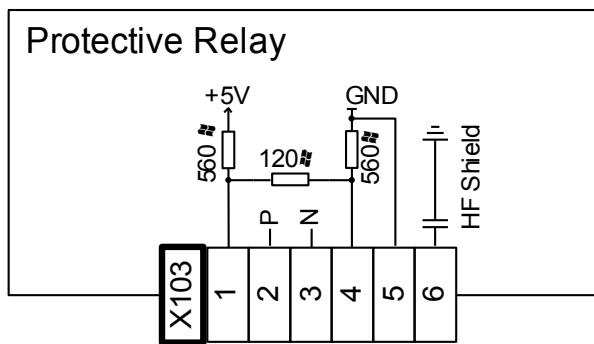

RS485 – Electro-mechanical assignment

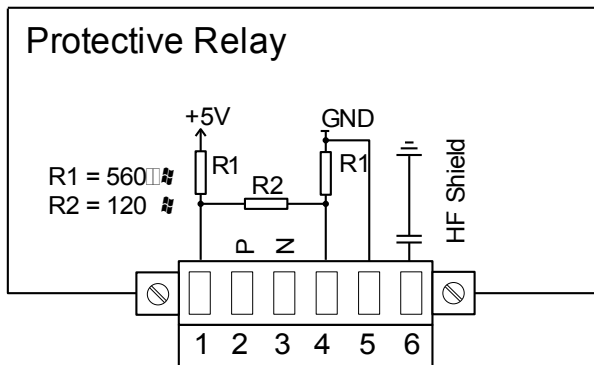

NOTICE The Modbus® / IEC 60870-5-103 connection cable must be shielded. The shielding has to be fixed at the screw beneath the interface at the rear side of the device.

The communication is halfduplex.

Wiring example, Device **in the middle** of the bus

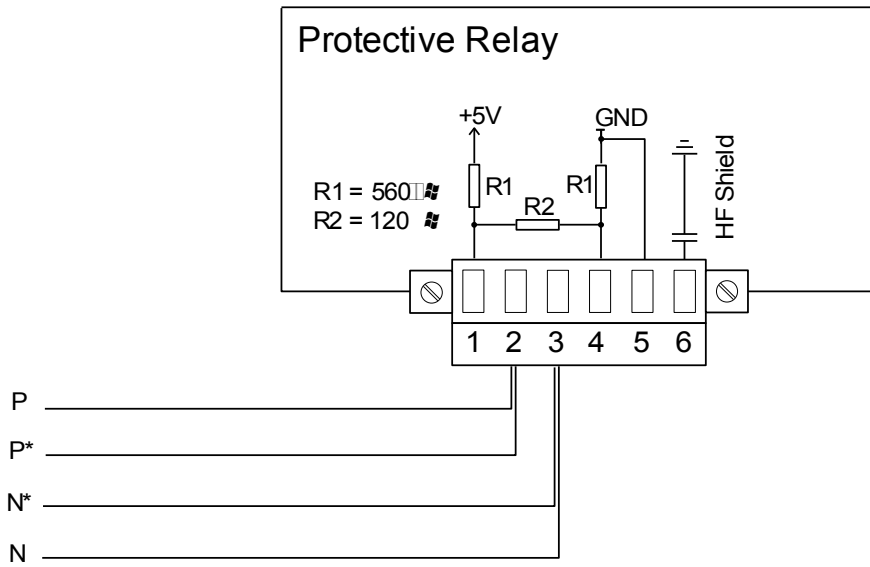

Wiring example, Device **at the end** of the bus
(setting wire jumpers to activate the integrated Terminal Resistor)

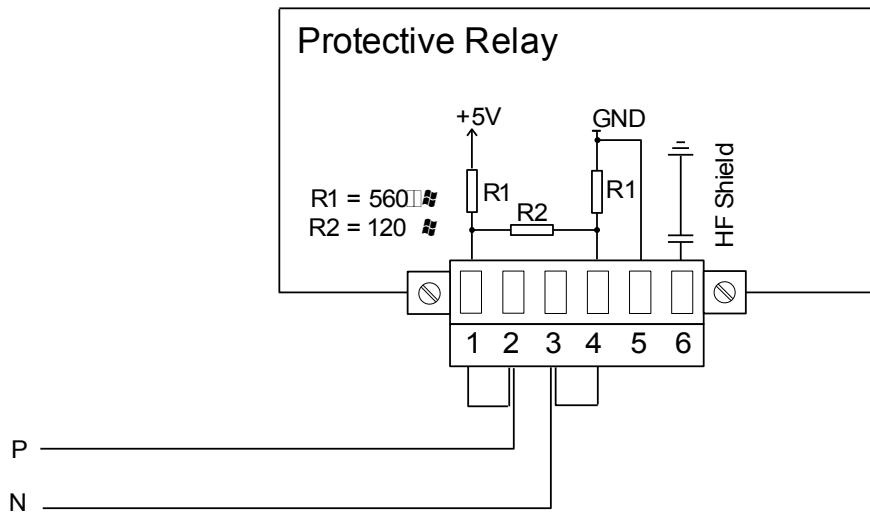

Shielding Options (2-wire + Shield)

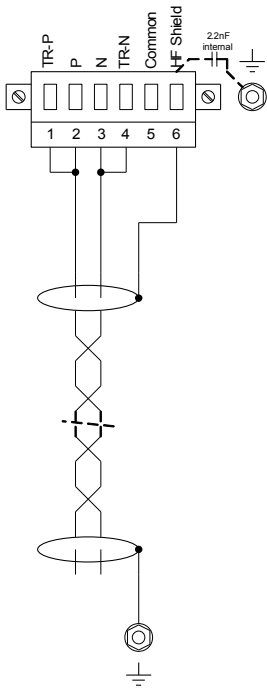

Shield at bus master side connected to earth termination resistors used

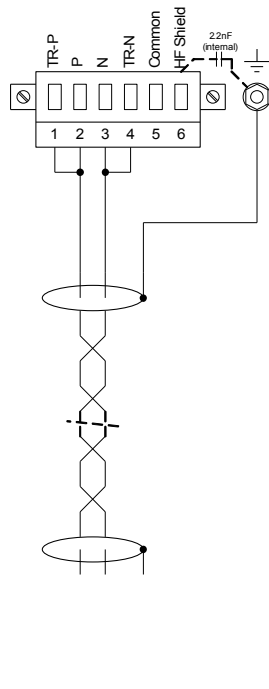

Shield at bus device side connected to earth termination resistors used

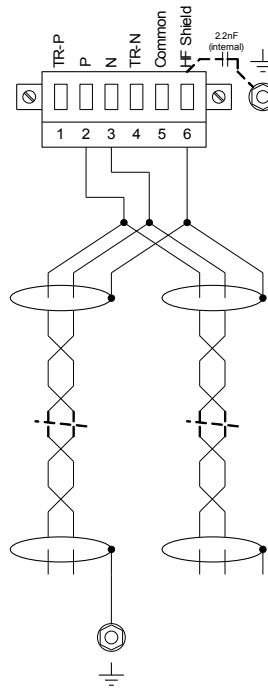

Shield at bus master side connected to earth termination resistors not used

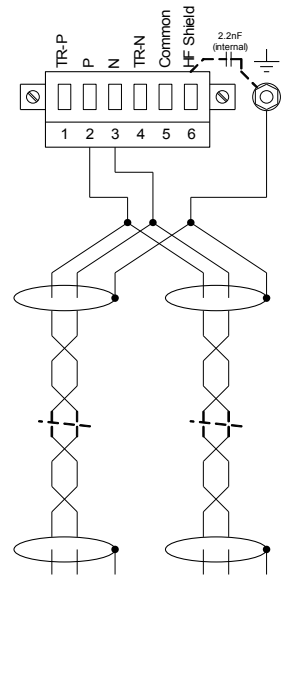

Shield at bus device side connected to earth termination resistors not used

Shielding Options (3-wire + Shield)

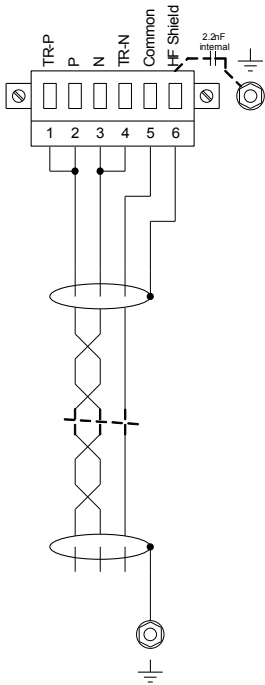

Shield at bus master side connected to earth termination resistors used

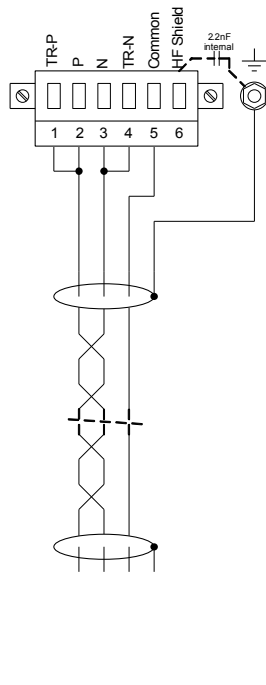

Shield at bus device side connected to earth termination resistors used

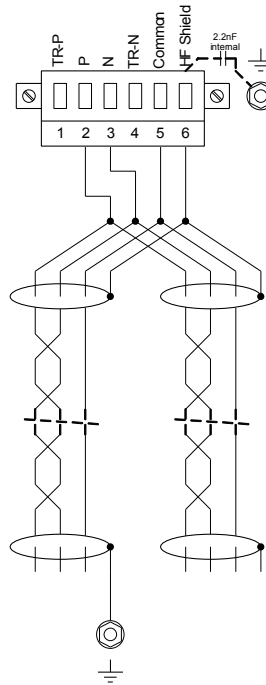

Shield at bus master side connected to earth termination resistors not used

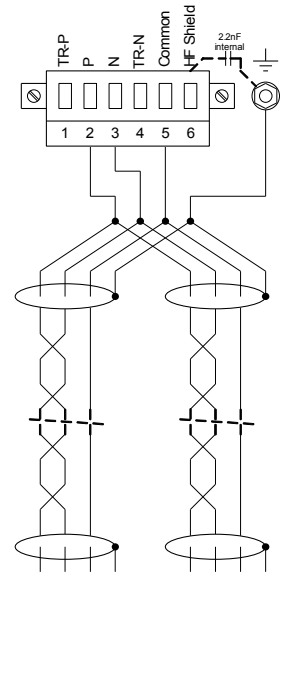

Shield at bus device side connected to earth termination resistors not used

Profibus DP/ Modbus® RTU / IEC 60870-5-103 via fibre optic

Fibre Optic

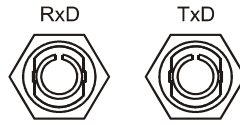

Modbus® RTU / IEC 60870-5-103 via D-SUB

D-SUB

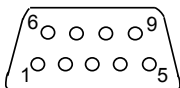

Electro-mechanical assignment

D-SUB assignment - bushing

- 1 Earthing/shielding
- 3 RxD TxD - P: High-Level
- 4 RTS-signal
- 5 DGND: Ground, neg. Potential of aux voltage supply
- 6 VP: pos. Potential of the aux voltage supply
- 8 RxD TxD - N: Low-Level

NOTICE

The connection cable must be shielded.

Profibus DP via D-SUB

D-SUB

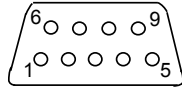

Electro-mechanical assignment

D-SUB assignment - bushing
1 Earthing/shielding
3 RxD TxD - P: High-Level
4 RTS-signal
5 DGND: Ground, neg. Potential of aux voltage supply
6 VP: pos. Potential of the aux voltage supply
8 RxD TxD - N: Low-Level

NOTICE

The connection cable must be shielded. The shielding has to be fixed at the screw which is marked with the ground symbol at the back side of the device.

Profibus DP/ Modbus[®] RTU / IEC 60870-5-103 via fibre optic

Fibre Optic

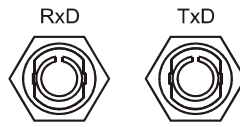

Ethernet / TCP/IP via Fiber Optics

Fiber Optics - FO

Fibre connection / LWL

RxD TxD

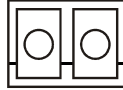

After plugging in the LC connector, fasten the metal protecting cap.

The tightening torque for the screw is 0.3 Nm [2.65 lb-in]).

Slot X104: IRIG-B00X and Supervision Contact

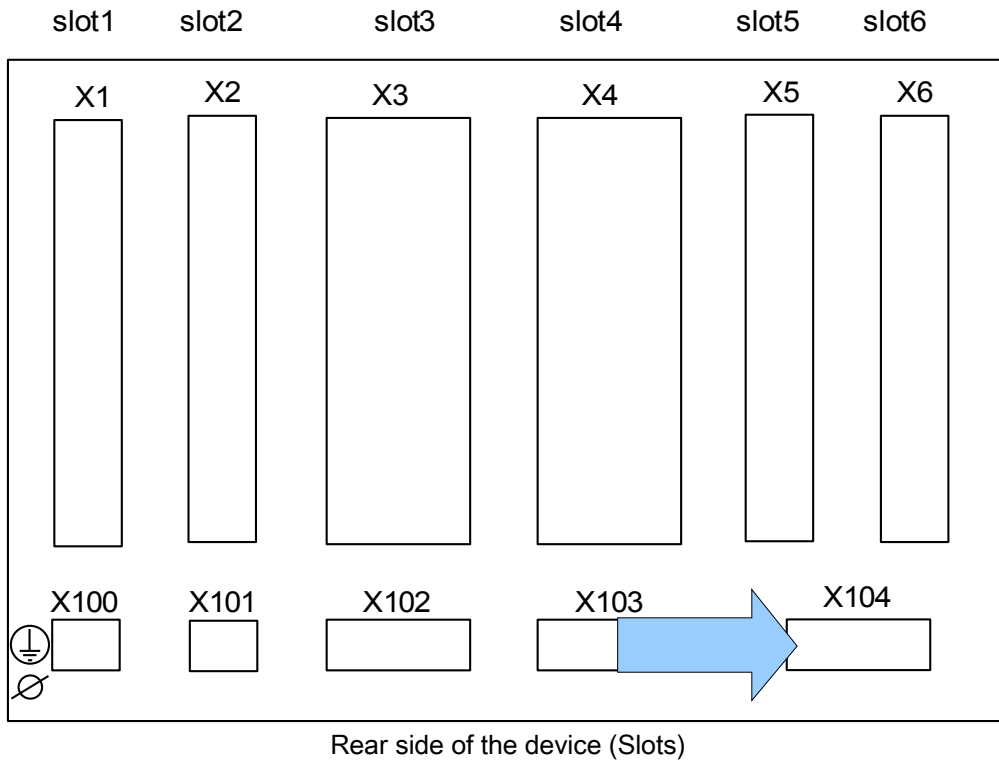

This comprises the IRIG-B00X and the System contact (Supervision Contact).

Self-Supervision Contact (SC)/Life-Contact and IRIG-B00X

WARNING Ensure the correct tightening torques.

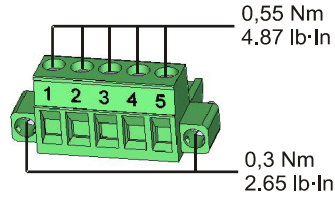

Terminal

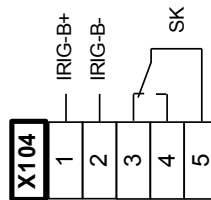

Electro-mechanical assignment

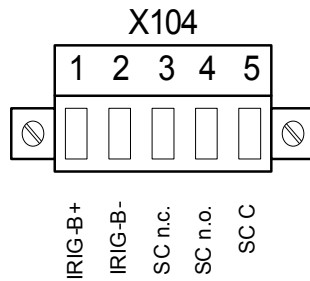

The *Self-Supervision Contact (SC relay)/Life-Contact* cannot be configured. The system contact is a changeover contact that picks up when the device is free from internal faults. While the device is booting up, the *Self-Supervision Contact (SC relay)/Life-Contact* remains dropped-off (unenergized). As soon as the system is properly started (and protection is active), the *Self-Supervision Contact (SC relay)/Life-Contact* picks up and the assigned LED (System OK) is activated accordingly (please refer to the Self Supervision chapter).

PC Interface - X120

- USB (Mini-B)

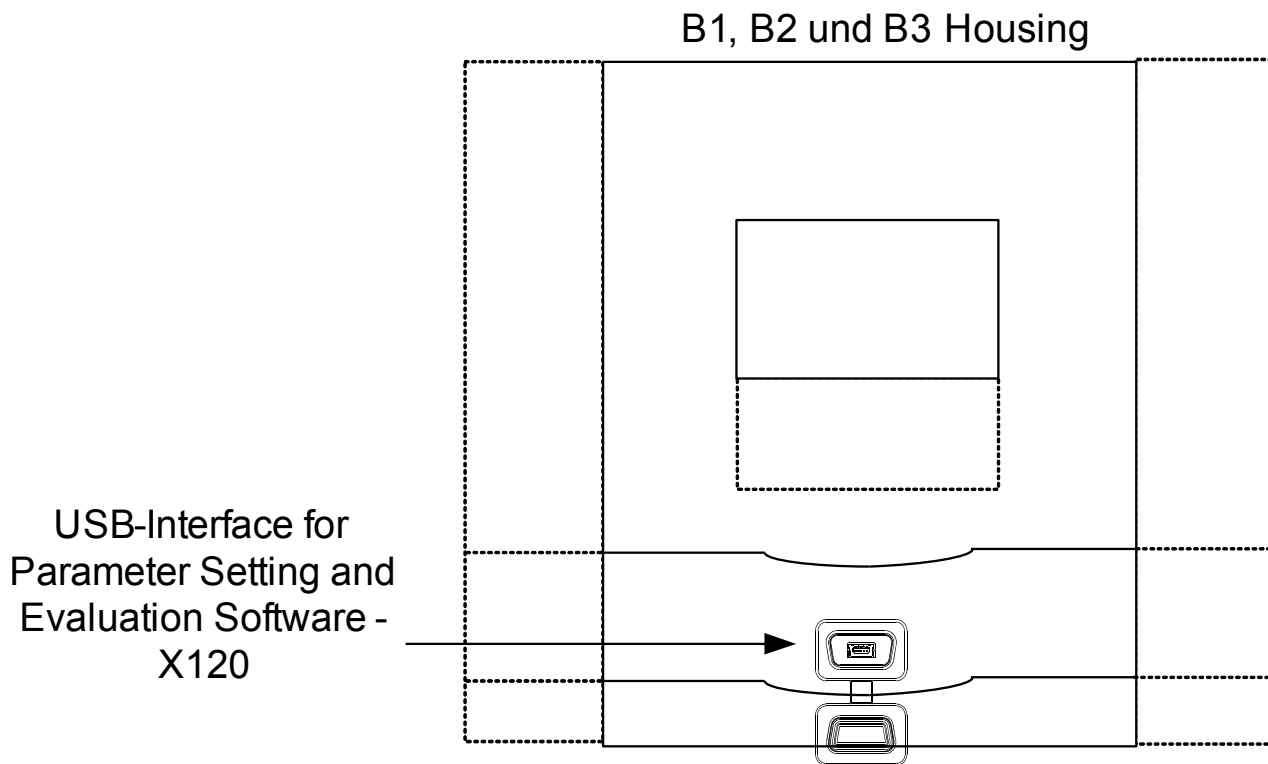



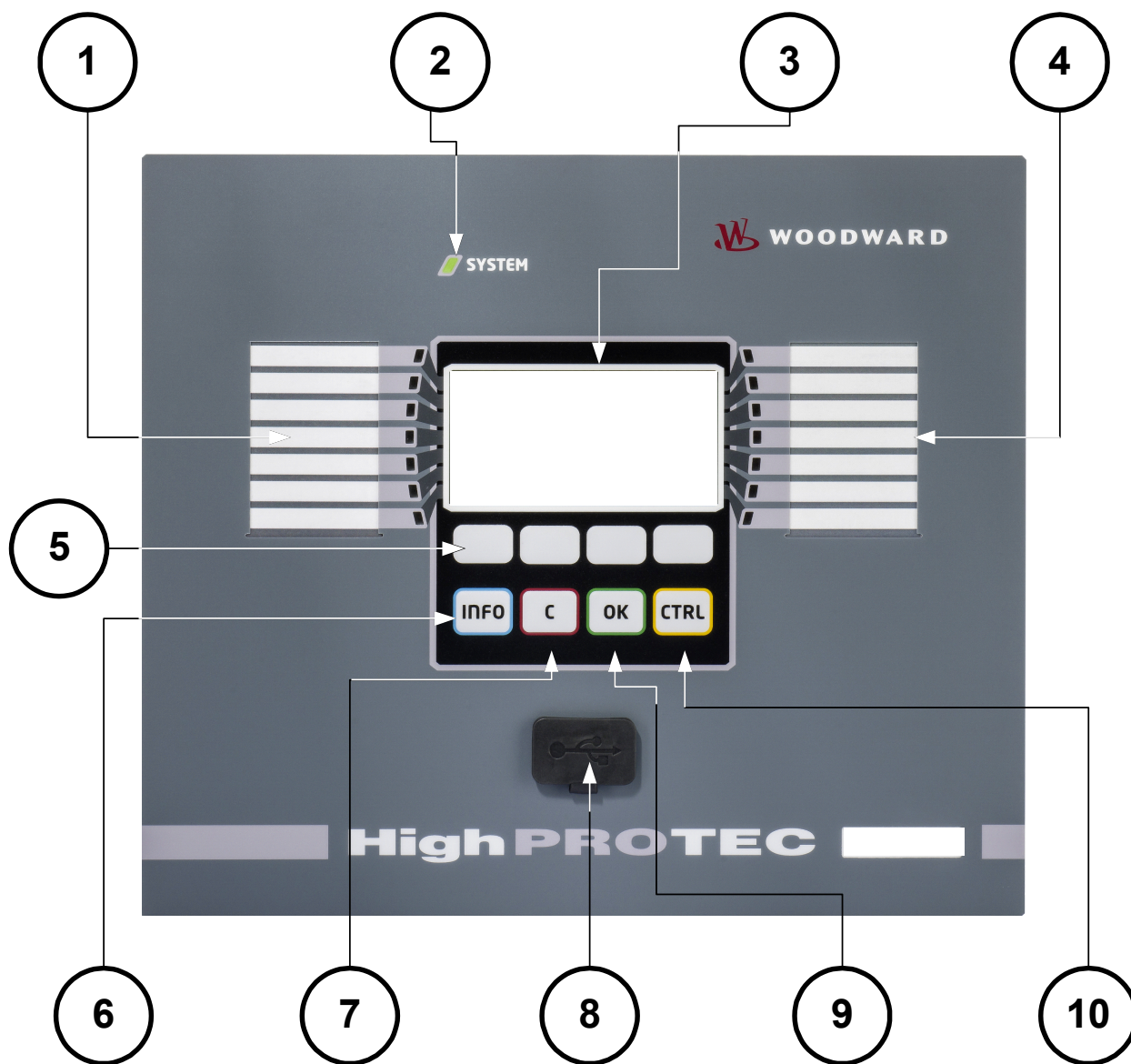

Navigation - Operation

The following illustration applies to protective devices with a small display:

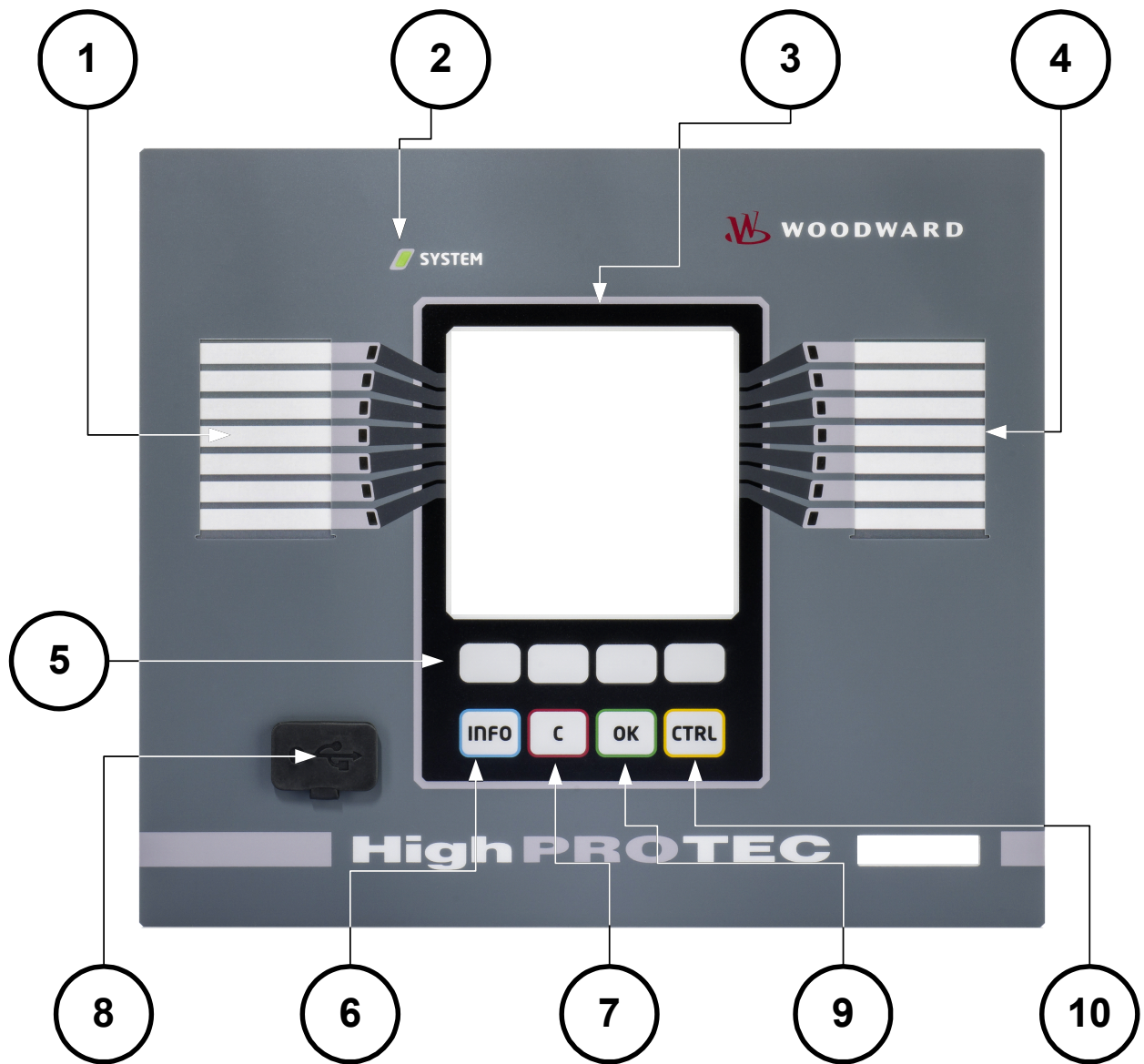

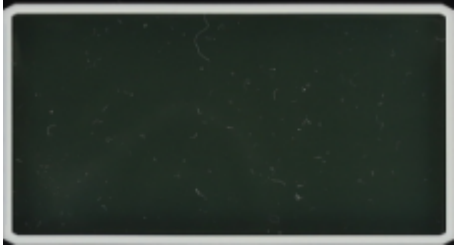
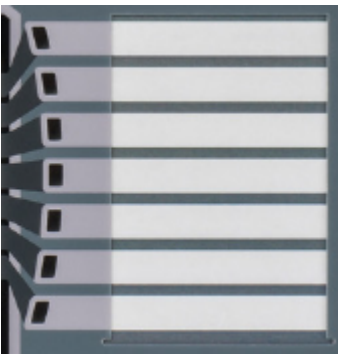

The following illustration applies to protective devices with a large display:

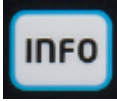

1		LEDs group A (left)	<p>Messages inform you about operational conditions, system data or other device particulars. They additionally provide you with information regarding failures and functioning of the device as well as other states of the device and the equipment.</p> <p>Alarm signals can be freely allocated to LEDs out of the »assignment list«.</p> <p>An overview about all alarm signals available in the device can be obtained from the »ASSIGNMENT LIST« which can be found in the appendix.</p>
	<p>SYSTEM </p>	LED »System OK«	Should LED »System OK« flash red during operation, contact the Service Dept. immediately.
3		Display	Via the display you can read-out operational data and edit parameters.
4		LEDs group B (right)	<p>Messages inform you about operational conditions, system data or other device particulars. They additionally provide you with information regarding failures and functioning of the device as well as other states of the device and the equipment.</p> <p>Alarm signals can be freely allocated to LEDs out of the »assignment list« .</p> <p>An overview about all alarm signals available in the device can be obtained from the »assignment list« which can be found in the appendix.</p>
5		Softkeys	<p>The function of the »SOFTKEYS« are contextual. On the bottom line of the display the present function is displayed/symbolized.</p> <p>Possible functions are:</p>



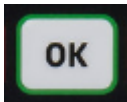
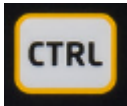











			<ul style="list-style-type: none"> ■ Navigation ■ Parameter decrement/increment. ■ Scrolling up/down a menu page ■ Moving to a digit ■ Change into the parameter setting mode »wrench symbol«.
<p>6</p>		<p>INFO Key (Signals/Messages)</p>	<p>Looking through the present LED assignment. The direct select key can be actuated at any time.</p> <p>If the INFO key is actuated once, the »LEFT LED SIGNALS« are inserted, if the INFO key is actuated again, the »RIGHT LED SIGNALS« are inserted. If the INFO key is actuated again you will leave the LED menu.</p> <p>Here only the first assignments of the LEDs will be shown. Every three seconds the »SOFTKEYS« will be shown (flashing).</p> <p><i>Displaying the multiple Assignments</i></p> <p>If the INFO-Button is pressed only the first assignments of any LED is shown. Every three seconds the »SOFTKEYS« will be shown (flashing).</p> <p>If there is more than one signal assigned to a LED (indicated by three dots) you can check the state of the multiple assignments if you proceed as follows.</p> <p>In order to show all (multiple) assignments select a LED by means of the »SOFTKEYS« »up« and »down«</p> <p>Via the »Softkey« »right« call up a Submenu of this LED that gives you detailed information on the state of all signals</p>

			<p>assigned to this LED. An arrow symbol points to the LED whose assignments are currently displayed.</p> <p>Via the »SOFTKEYS« »up« and »down« you can call up the next / previous LED.</p> <p>In order to leave the LED menu press the »SOFTKEY« »left« multiple times.</p>
7		»C Key«	<p>To abort changes and to acknowledge messages.</p> <p>In order to reset please press the Softkey »wrench« and enter the password.</p> <p>The reset menu can be left by pressing the Softkey »Arrow-left«</p>
8		USB Interface (<i>Smart view</i> Connection)	<p>Connection to software <i>Smart view</i> is done via the USB interface.</p>
9		»OK Key«	<p>When using the »OK« key parameter changes are temporarily stored. If the »OK« key is pressed again, those changes are stored definitely.</p>
10		»CTRL Key«*	<p>Direct Access to the Control Menu.</p>

*=Not for all devices available.

Basic Menu Control

The graphic user interface is equivalent to a hierarchical structured menu tree. For access to the individual submenus the »SOFTKEYS«/Navigation Keys are used. The function of the »SOFTKEYS« can be found as symbol in the footer of the display.

<i>Softkey</i>	<i>Description</i>
	■ Via »SOFTKEY« »up« you will come to the prior menu point/one parameter up by scrolling upwards.
	■ Via »SOFTKEY« »left« you will go one step back.
	■ Via »SOFTKEY« »down« you will change to the next menu point/one parameter down by scrolling downwards.
	■ Via »SOFTKEY« »right« you will come to a submenu.
	■ Via »SOFTKEY« »Top of list« you will jump directly to the top of a list.
	■ Via »SOFTKEY« »Bottom of list« you will jump directly to the end of a list.
	■ Via »SOFTKEY« »+«the related digit will be incremented. (Continuous pressure -> fast).
	■ Via »SOFTKEY« »-«the related digit will be decremented. (Continuous pressure -> fast)
	■ Via »SOFTKEY« »left« you will go one digit to the left.
	■ Via »SOFTKEY« »right« you will go one digit to the right.
	■ Via »SOFTKEY« »Parameter setting« you will call up the parameter setting mode.
	■ Via »SOFTKEY« »Parameter setting« you will call up the parameter setting mode. Password authorization required.
	■ Via »SOFTKEY« »delete« data will be deleted.
	■ Fast forward scrolling is possible via »SOFTKEY« »Fast forward«
	■ Fast backward scrolling is possible via »SOFTKEY« »Fast backward«

In order to return to the main menu, just keep pressing the Softkey »Arrow-Left« until you arrive at the »main menu«.

Input, Output and LED Settings

Configuration of the Digital Inputs

Set the following parameters for each of the digital inputs:

- »Nominal voltage«
- »Debouncing time«: A state change will only be adopted by the digital input after the debouncing time has expired.
- »Inverting« (where necessary)

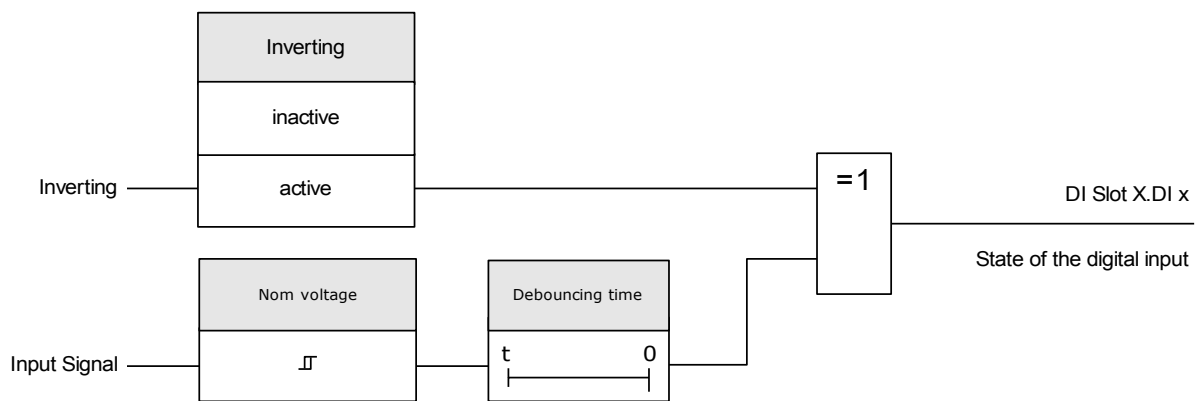

CAUTION The debouncing time will be started each time the state of the input signal alternates.

CAUTION In addition to the debouncing time that can be set via software, there is always a hardware debouncing time (approx 12 ms) that cannot be turned of.

Assignment of Digital Inputs

There are two options available in order to determine where a Digital Input should be assigned to.

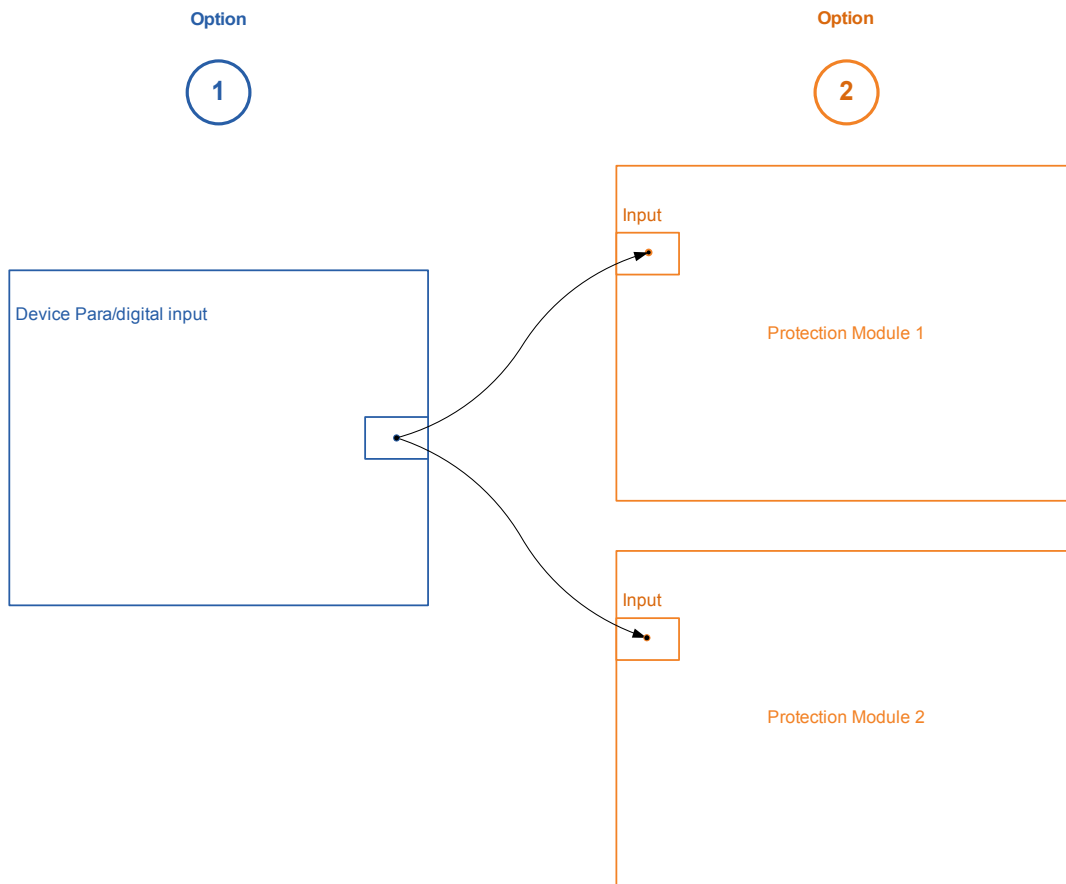

Option 1 – Assigning a Digital Input onto one or multiple modules.

Adding an assignment:

Within menu [Device Parameter\Digital Inputs] Digital Inputs can be assigned onto one or multiple targets.

Call up the Digital Input (Arrow right on the DI). Click on the Softkey »Parameter Setting/Wrench«. Click on »Add« and assign a target. Assign where required additional targets.

Deleting an assignment:

Select as described above a Digital Input that should be edited at the HMI.

Call up the assignments of the Digital Input (Arrow-right on the DI) and select the assignment that should be removed/deleted (Please note, this has to be marked with the cursor). The assignment can now be deleted at the HMI by means of the Softkey »Parameter setting« and selection of »remove«. Confirm the parameter setting update.

Option 2 – Connecting a Module Input with a Digital Input

Call a module. Within this module assign a Digital Input onto a module input. Example: A protection module should be blocked depending on the state of a Digital Input.. For this assign onto the blocking input within the Global Parameters the Digital Input (e.g. Ex Blo 1).

Checking the Assignments of a Digital Input

In order to check the targets that a Digital Input is assigned to please proceed as follows:

Call up menu [Device Parameter\Digital Inputs].

Navigate to the Digital Input that should be checked.







At the HMI:









A multiple assignment, that means if a Digital Input is used more than once (if it is assigned to multiple targets), this will be indicated by an "..." behind a Digital Input. Call up this Digital Input by Softkey »Arrow right« in order to see the list of targets of this Digital Input.





DI-8P X

DI Slot X1

Device Parameters of the Digital Inputs on DI-8P X

Parameter	Description	Setting range	Default	Menu path
 Nom voltage	Nominal voltage of the digital inputs	24 V DC, 48 V DC, 60 V DC, 110 V DC, 230 V DC, 110 V AC, 230 V AC	24 V DC	[Device Para /Digital Inputs /DI Slot X1 /Group 1]
 Inverting 1	Inverting the input signals.	inactive, active	inactive	[Device Para /Digital Inputs /DI Slot X1 /Group 1]
 Debouncing time 1	A change of the state of a digital input will only be recognized after the debouncing time has expired (become effective). Thus, transient signals will not be misinterpreted.	no debouncing time, 20 ms, 50 ms, 100 ms	no debouncing time	[Device Para /Digital Inputs /DI Slot X1 /Group 1]
 Nom voltage	Nominal voltage of the digital inputs	24 V DC, 48 V DC, 60 V DC, 110 V DC, 230 V DC, 110 V AC, 230 V AC	24 V DC	[Device Para /Digital Inputs /DI Slot X1 /Group 2]
 Inverting 2	Inverting the input signals.	inactive, active	inactive	[Device Para /Digital Inputs /DI Slot X1 /Group 2]
 Debouncing time 2	A change of the state of a digital input will only be recognized after the debouncing time has expired (become effective). Thus, transient signals will not be misinterpreted.	no debouncing time, 20 ms, 50 ms, 100 ms	no debouncing time	[Device Para /Digital Inputs /DI Slot X1 /Group 2]

<i>Parameter</i>	<i>Description</i>	<i>Setting range</i>	<i>Default</i>	<i>Menu path</i>
Nom voltage 	Nominal voltage of the digital inputs	24 V DC, 48 V DC, 60 V DC, 110 V DC, 230 V DC, 110 V AC, 230 V AC	24 V DC	[Device Para /Digital Inputs /DI Slot X1 /Group 3]
Inverting 3 	Inverting the input signals.	inactive, active	inactive	[Device Para /Digital Inputs /DI Slot X1 /Group 3]
Debouncing time 3 	A change of the state of a digital input will only be recognized after the debouncing time has expired (become effective). Thus, transient signals will not be misinterpreted.	no debouncing time, 20 ms, 50 ms, 100 ms	no debouncing time	[Device Para /Digital Inputs /DI Slot X1 /Group 3]
Inverting 4 	Inverting the input signals.	inactive, active	inactive	[Device Para /Digital Inputs /DI Slot X1 /Group 3]
Debouncing time 4 	A change of the state of a digital input will only be recognized after the debouncing time has expired (become effective). Thus, transient signals will not be misinterpreted.	no debouncing time, 20 ms, 50 ms, 100 ms	no debouncing time	[Device Para /Digital Inputs /DI Slot X1 /Group 3]
Inverting 5 	Inverting the input signals.	inactive, active	inactive	[Device Para /Digital Inputs /DI Slot X1 /Group 3]
Debouncing time 5 	A change of the state of a digital input will only be recognized after the debouncing time has expired (become effective). Thus, transient signals will not be misinterpreted.	no debouncing time, 20 ms, 50 ms, 100 ms	no debouncing time	[Device Para /Digital Inputs /DI Slot X1 /Group 3]
Inverting 6 	Inverting the input signals.	inactive, active	inactive	[Device Para /Digital Inputs /DI Slot X1 /Group 3]

<i>Parameter</i>	<i>Description</i>	<i>Setting range</i>	<i>Default</i>	<i>Menu path</i>
Debouncing time 6 	A change of the state of a digital input will only be recognized after the debouncing time has expired (become effective). Thus, transient signals will not be misinterpreted.	no debouncing time, 20 ms, 50 ms, 100 ms	no debouncing time	[Device Para /Digital Inputs /DI Slot X1 /Group 3]
Inverting 7 	Inverting the input signals.	inactive, active	inactive	[Device Para /Digital Inputs /DI Slot X1 /Group 3]
Debouncing time 7 	A change of the state of a digital input will only be recognized after the debouncing time has expired (become effective). Thus, transient signals will not be misinterpreted.	no debouncing time, 20 ms, 50 ms, 100 ms	no debouncing time	[Device Para /Digital Inputs /DI Slot X1 /Group 3]
Inverting 8 	Inverting the input signals.	inactive, active	inactive	[Device Para /Digital Inputs /DI Slot X1 /Group 3]
Debouncing time 8 	A change of the state of a digital input will only be recognized after the debouncing time has expired (become effective). Thus, transient signals will not be misinterpreted. 8	no debouncing time, 20 ms, 50 ms, 100 ms	no debouncing time	[Device Para /Digital Inputs /DI Slot X1 /Group 3]







Signals of the Digital Inputs on DI-8P X

<i>Signal</i>	<i>Description</i>
DI 1	Signal: Digital Input
DI 2	Signal: Digital Input
DI 3	Signal: Digital Input
DI 4	Signal: Digital Input
DI 5	Signal: Digital Input
DI 6	Signal: Digital Input
DI 7	Signal: Digital Input
DI 8	Signal: Digital Input

DI-8 X

DI Slot X5 ,DI Slot X6

Device Parameters of the Digital Inputs on DI-8 X

Parameter	Description	Setting range	Default	Menu path
Nom voltage 	Nominal voltage of the digital inputs	24 V DC, 48 V DC, 60 V DC, 110 V DC, 230 V DC, 110 V AC, 230 V AC	24 V DC	[Device Para /Digital Inputs /DI Slot X5 /Group 1]
Inverting 1 	Inverting the input signals.	inactive, active	inactive	[Device Para /Digital Inputs /DI Slot X5 /Group 1]
Debouncing time 1 	A change of the state of a digital input will only be recognized after the debouncing time has expired (become effective). Thus, transient signals will not be misinterpreted.	no debouncing time, 20 ms, 50 ms, 100 ms	no debouncing time	[Device Para /Digital Inputs /DI Slot X5 /Group 1]
Inverting 2 	Inverting the input signals.	inactive, active	inactive	[Device Para /Digital Inputs /DI Slot X5 /Group 1]
Debouncing time 2 	A change of the state of a digital input will only be recognized after the debouncing time has expired (become effective). Thus, transient signals will not be misinterpreted.	no debouncing time, 20 ms, 50 ms, 100 ms	no debouncing time	[Device Para /Digital Inputs /DI Slot X5 /Group 1]
Inverting 3 	Inverting the input signals.	inactive, active	inactive	[Device Para /Digital Inputs /DI Slot X5 /Group 1]
Debouncing time 3 	A change of the state of a digital input will only be recognized after the debouncing time has expired (become effective). Thus, transient signals will not be misinterpreted.	no debouncing time, 20 ms, 50 ms, 100 ms	no debouncing time	[Device Para /Digital Inputs /DI Slot X5 /Group 1]

<i>Parameter</i>	<i>Description</i>	<i>Setting range</i>	<i>Default</i>	<i>Menu path</i>
Inverting 4 	Inverting the input signals.	inactive, active	inactive	[Device Para /Digital Inputs /DI Slot X5 /Group 1]
Debouncing time 4 	A change of the state of a digital input will only be recognized after the debouncing time has expired (become effective). Thus, transient signals will not be misinterpreted.	no debouncing time, 20 ms, 50 ms, 100 ms	no debouncing time	[Device Para /Digital Inputs /DI Slot X5 /Group 1]
Inverting 5 	Inverting the input signals.	inactive, active	inactive	[Device Para /Digital Inputs /DI Slot X5 /Group 1]
Debouncing time 5 	A change of the state of a digital input will only be recognized after the debouncing time has expired (become effective). Thus, transient signals will not be misinterpreted.	no debouncing time, 20 ms, 50 ms, 100 ms	no debouncing time	[Device Para /Digital Inputs /DI Slot X5 /Group 1]
Inverting 6 	Inverting the input signals.	inactive, active	inactive	[Device Para /Digital Inputs /DI Slot X5 /Group 1]
Debouncing time 6 	A change of the state of a digital input will only be recognized after the debouncing time has expired (become effective). Thus, transient signals will not be misinterpreted.	no debouncing time, 20 ms, 50 ms, 100 ms	no debouncing time	[Device Para /Digital Inputs /DI Slot X5 /Group 1]
Inverting 7 	Inverting the input signals.	inactive, active	inactive	[Device Para /Digital Inputs /DI Slot X5 /Group 1]
Debouncing time 7 	A change of the state of a digital input will only be recognized after the debouncing time has expired (become effective). Thus, transient signals will not be misinterpreted.	no debouncing time, 20 ms, 50 ms, 100 ms	no debouncing time	[Device Para /Digital Inputs /DI Slot X5 /Group 1]
Inverting 8 	Inverting the input signals.	inactive, active	inactive	[Device Para /Digital Inputs /DI Slot X5 /Group 1]

<i>Parameter</i>	<i>Description</i>	<i>Setting range</i>	<i>Default</i>	<i>Menu path</i>
Debouncing time 8 	A change of the state of a digital input will only be recognized after the debouncing time has expired (become effective). Thus, transient signals will not be misinterpreted.	no debouncing time, 20 ms, 50 ms, 100 ms	no debouncing time	[Device Para /Digital Inputs /DI Slot X5 /Group 1]

Signals of the Digital Inputs on DI-8 X

<i>Signal</i>	<i>Description</i>
DI 1	Signal: Digital Input
DI 2	Signal: Digital Input
DI 3	Signal: Digital Input
DI 4	Signal: Digital Input
DI 5	Signal: Digital Input
DI 6	Signal: Digital Input
DI 7	Signal: Digital Input
DI 8	Signal: Digital Input

Output Relays Settings

The conditions of module outputs and signals/protective functions (such as reverse interlocking) can be passed by means of alarm relays. The alarm relays are potential-free contacts (which can be used as opening or closing contact). Each alarm relay can be assigned up to 7 functions out of the »assignment list«.

Set the following parameters for each of the binary output relays:

- Up to 7 signals from the »assignment list« (OR-connected)
- Each of the assigned signals can be inverted.
- The (collective) state of the binary output relay can be inverted (open or closed circuit current principle)
- By the Operating Mode it can be determined whether the relay output works in working current or closed-circuit principle.
- »Latched« active or inactive
 - »Latched = inactive«:
If the latching function is »inactive«, the alarm relay respectively the alarm contact will adopt the state of those alarms that were assigned.
 - »Latched = active«
If the »latching function« is »active«, the state of the alarm relay respectively alarm contact that was set by the alarms will be stored.

The alarm relay can only be acknowledged after reset of those signals that had initiated setting of the relay and after expiry of the minimum retention time.

- »Hold time«: At signal changes, the minimal latching time ensures that the relay will be maintained picked-up or released for at least this period.

CAUTION

If binary outputs are parameterized »Latched=*active*«, they will keep (return into) their position even if there is a break within the power supply.

If binary output relays are parameterized »Latched=*active*«, The binary output will also retain, if the binary output is reprogrammed in another way. This applies also if »Latched is set to *inactive*«. Resetting a binary output that has latched a signal will always require an acknowledgement.

NOTICE

The »*System OK Relay*« (watchdog) cannot be configured.

Acknowledgment options

Binary output relays can be acknowledged:

- Via the push-button »C« at the operating panel.
- Each binary output relay can be acknowledged by a signal of the »assignment list« (If »*Latched is active*«).
- Via the module »Ex Acknowledge« all binary output relays can be acknowledged at once, if the signal for external acknowledgement that was selected from the »assignment list« becomes true. (e.g the state of a digital input).
- Via SCADA, all output relays can be acknowledged at once.

⚠ WARNING

Relay output contacts can be set by force or disarmed (for commissioning support, please refer to the „Service/Disarming the Output Relay Contacts“ and „Service/Forcing the Output Relay Contacts“ sections).

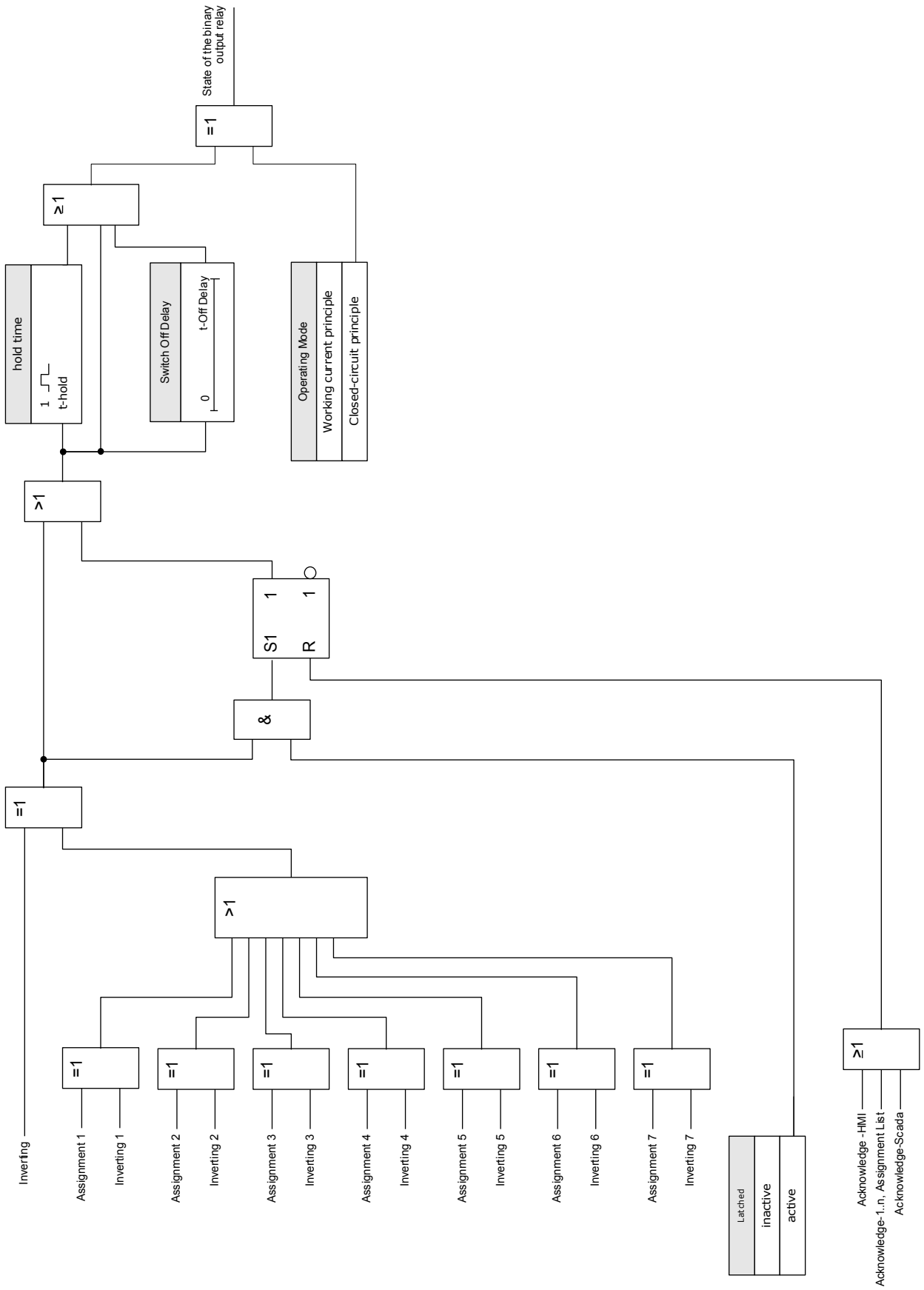

System Contact



The *System OK alarm relay (SC)* is the devices »LIFE CONTACT«. Its installation location depends on the housing type. Please refer to the wiring diagram of the device (WDC-contact).



The *System-OK relay (SC)* cannot be parameterized. The system contact is an operating current contact that picks-up, when the device is free from internal faults. While the device is booting up, the *System OK relay (SC)* remains dropped-off. As soon as the system was duly started up, the relay picks up and the assigned LED is activated accordingly (please refer to chapter Self Supervision).

OR-6 X





BO Slot X2

Direct Commands of OR-6 X

Parameter	Description	Setting range	Default	Menu path
 DISARMED	<p>This is the second step, after the "DISARMED Ctrl" has been activated, that is required to DISARM the relay outputs. This will DISARM those output relays that are currently not latched and that are not on "hold" by a pending minimum hold time. CAUTION! RELAYS DISARMED in order to safely perform maintenance while eliminating the risk of taking an entire process off-line. (Note: Zone Interlocking and Supervision Contact cannot be disarmed). YOU MUST ENSURE that the relays are ARMED AGAIN after maintenance.</p> <p>Only available if: DISARMED Ctrl = active</p>	inactive, active	inactive	[Service /Test (Prot inhibit) /DISARMED /BO Slot X2]
 Force all Outs	By means of this function the normal Output Relay State can be overwritten (forced). The relay can be set from normal operation (relay works according to the assigned signals) to "force energized" or "force de-energized" state. Forcing all outputs relays of an entire assembly group is superior to forcing a single output relay.	Normal, De-Energized, Energized	Normal	[Service /Test (Prot inhibit) /Force OR /BO Slot X2]
 Force OR1	By means of this function the normal Output Relay State can be overwritten (forced). The relay can be set from normal operation (relay works according to the assigned signals) to "force energized" or "force de-energized" state.	Normal, De-Energized, Energized	Normal	[Service /Test (Prot inhibit) /Force OR /BO Slot X2]
 Force OR2	By means of this function the normal Output Relay State can be overwritten (forced). The relay can be set from normal operation (relay works according to the assigned signals) to "force energized" or "force de-energized" state.	Normal, De-Energized, Energized	Normal	[Service /Test (Prot inhibit) /Force OR /BO Slot X2]
 Force OR3	By means of this function the normal Output Relay State can be overwritten (forced). The relay can be set from normal operation (relay works according to the assigned signals) to "force energized" or "force de-energized" state.	Normal, De-Energized, Energized	Normal	[Service /Test (Prot inhibit) /Force OR /BO Slot X2]

<i>Parameter</i>	<i>Description</i>	<i>Setting range</i>	<i>Default</i>	<i>Menu path</i>
Force OR4 	By means of this function the normal Output Relay State can be overwritten (forced). The relay can be set from normal operation (relay works according to the assigned signals) to "force energized" or "force de-energized" state.	Normal, De-Energized, Energized	Normal	[Service /Test (Prot inhibit) /Force OR /BO Slot X2]
Force OR5 	By means of this function the normal Output Relay State can be overwritten (forced). The relay can be set from normal operation (relay works according to the assigned signals) to "force energized" or "force de-energized" state.	Normal, De-Energized, Energized	Normal	[Service /Test (Prot inhibit) /Force OR /BO Slot X2]
Force OR6 	By means of this function the normal Output Relay State can be overwritten (forced). The relay can be set from normal operation (relay works according to the assigned signals) to "force energized" or "force de-energized" state.	Normal, De-Energized, Energized	Normal	[Service /Test (Prot inhibit) /Force OR /BO Slot X2]







Device Parameters of the Binary Output Relays on OR-6 X

<i>Parameter</i>	<i>Description</i>	<i>Setting range</i>	<i>Default</i>	<i>Menu path</i>
Operating Mode 	Operating Mode	Working current principle, Closed-circuit principle	Working current principle	[Device Para /Binary Outputs /BO Slot X2 /BO 1]
t-hold 	To clearly identify the state transition of a binary output relay, the "new state" is being hold, at least for the duration of the hold time.	0.00 - 300.00s	0.00s	[Device Para /Binary Outputs /BO Slot X2 /BO 1]
t-Off Delay 	Switch Off Delay	0.00 - 300.00s	0.00s	[Device Para /Binary Outputs /BO Slot X2 /BO 1]
Latched 	Defines whether the Relay Output will be latched when it picks up.	inactive, active	inactive	[Device Para /Binary Outputs /BO Slot X2 /BO 1]







Parameter	Description	Setting range	Default	Menu path
 Acknowledgement	Acknowledgement Signal - An acknowledgement signal (that acknowledges the corresponding binary output relay) can be assigned to each output relay. The acknowledgement-signal is only effective if the parameter "Latched" is set to active. Only available if: Latched = active	1..n, Assignment List	.-	[Device Para /Binary Outputs /BO Slot X2 /BO 1]
 Inverting	Inverting of the collective signal (OR-gate/disjunction). In combination with inverted input signals an AND-gate can be programmed (Conjunction).	inactive, active	inactive	[Device Para /Binary Outputs /BO Slot X2 /BO 1]
 Assignment 1	Assignment	1..n, Assignment List	SG[1].TripCmd	[Device Para /Binary Outputs /BO Slot X2 /BO 1]
 Inverting 1	Inverting of the state of the assigned signal.	inactive, active	inactive	[Device Para /Binary Outputs /BO Slot X2 /BO 1]
 Assignment 2	Assignment	1..n, Assignment List	.-	[Device Para /Binary Outputs /BO Slot X2 /BO 1]
 Inverting 2	Inverting of the state of the assigned signal.	inactive, active	inactive	[Device Para /Binary Outputs /BO Slot X2 /BO 1]
 Assignment 3	Assignment	1..n, Assignment List	.-	[Device Para /Binary Outputs /BO Slot X2 /BO 1]
 Inverting 3	Inverting of the state of the assigned signal.	inactive, active	inactive	[Device Para /Binary Outputs /BO Slot X2 /BO 1]
 Assignment 4	Assignment	1..n, Assignment List	.-	[Device Para /Binary Outputs /BO Slot X2 /BO 1]

<i>Parameter</i>	<i>Description</i>	<i>Setting range</i>	<i>Default</i>	<i>Menu path</i>
Inverting 4 	Inverting of the state of the assigned signal.	inactive, active	inactive	[Device Para /Binary Outputs /BO Slot X2 /BO 1]
Assignment 5 	Assignment	1..n, Assignment List	-.-	[Device Para /Binary Outputs /BO Slot X2 /BO 1]
Inverting 5 	Inverting of the state of the assigned signal.	inactive, active	inactive	[Device Para /Binary Outputs /BO Slot X2 /BO 1]
Assignment 6 	Assignment	1..n, Assignment List	-.-	[Device Para /Binary Outputs /BO Slot X2 /BO 1]
Inverting 6 	Inverting of the state of the assigned signal.	inactive, active	inactive	[Device Para /Binary Outputs /BO Slot X2 /BO 1]
Assignment 7 	Assignment	1..n, Assignment List	-.-	[Device Para /Binary Outputs /BO Slot X2 /BO 1]
Inverting 7 	Inverting of the state of the assigned signal.	inactive, active	inactive	[Device Para /Binary Outputs /BO Slot X2 /BO 1]
Operating Mode 	Operating Mode	Working current principle, Closed-circuit principle	Working current principle	[Device Para /Binary Outputs /BO Slot X2 /BO 2]
t-hold 	To clearly identify the state transition of a binary output relay, the "new state" is being hold, at least for the duration of the hold time.	0.00 - 300.00s	0.00s	[Device Para /Binary Outputs /BO Slot X2 /BO 2]









Parameter	Description	Setting range	Default	Menu path
 t-Off Delay	Switch Off Delay	0.00 - 300.00s	0.00s	[Device Para /Binary Outputs /BO Slot X2 /BO 2]
 Latched	Defines whether the Relay Output will be latched when it picks up.	inactive, active	inactive	[Device Para /Binary Outputs /BO Slot X2 /BO 2]
 Acknowledgement	Acknowledgement Signal - An acknowledgement signal (that acknowledges the corresponding binary output relay) can be assigned to each output relay. The acknowledgement-signal is only effective if the parameter "Latched" is set to active. Only available if: Latched = active	1..n, Assignment List	-.-	[Device Para /Binary Outputs /BO Slot X2 /BO 2]
 Inverting	Inverting of the collective signal (OR-gate/disjunction). In combination with inverted input signals an AND-gate can be programmed (Conjunction).	inactive, active	inactive	[Device Para /Binary Outputs /BO Slot X2 /BO 2]
 Assignment 1	Assignment	1..n, Assignment List	Prot.Alarm	[Device Para /Binary Outputs /BO Slot X2 /BO 2]
 Inverting 1	Inverting of the state of the assigned signal.	inactive, active	inactive	[Device Para /Binary Outputs /BO Slot X2 /BO 2]
 Assignment 2	Assignment	1..n, Assignment List	-.-	[Device Para /Binary Outputs /BO Slot X2 /BO 2]
 Inverting 2	Inverting of the state of the assigned signal.	inactive, active	inactive	[Device Para /Binary Outputs /BO Slot X2 /BO 2]
 Assignment 3	Assignment	1..n, Assignment List	-.-	[Device Para /Binary Outputs /BO Slot X2 /BO 2]

<i>Parameter</i>	<i>Description</i>	<i>Setting range</i>	<i>Default</i>	<i>Menu path</i>
Inverting 3 	Inverting of the state of the assigned signal.	inactive, active	inactive	[Device Para /Binary Outputs /BO Slot X2 /BO 2]
Assignment 4 	Assignment	1..n, Assignment List	-.-	[Device Para /Binary Outputs /BO Slot X2 /BO 2]
Inverting 4 	Inverting of the state of the assigned signal.	inactive, active	inactive	[Device Para /Binary Outputs /BO Slot X2 /BO 2]
Assignment 5 	Assignment	1..n, Assignment List	-.-	[Device Para /Binary Outputs /BO Slot X2 /BO 2]
Inverting 5 	Inverting of the state of the assigned signal.	inactive, active	inactive	[Device Para /Binary Outputs /BO Slot X2 /BO 2]
Assignment 6 	Assignment	1..n, Assignment List	-.-	[Device Para /Binary Outputs /BO Slot X2 /BO 2]
Inverting 6 	Inverting of the state of the assigned signal.	inactive, active	inactive	[Device Para /Binary Outputs /BO Slot X2 /BO 2]
Assignment 7 	Assignment	1..n, Assignment List	-.-	[Device Para /Binary Outputs /BO Slot X2 /BO 2]
Inverting 7 	Inverting of the state of the assigned signal.	inactive, active	inactive	[Device Para /Binary Outputs /BO Slot X2 /BO 2]

Parameter	Description	Setting range	Default	Menu path
 Operating Mode	Operating Mode	Working current principle, Closed-circuit principle	Working current principle	[Device Para /Binary Outputs /BO Slot X2 /BO 3]
 t-hold	To clearly identify the state transition of a binary output relay, the "new state" is being hold, at least for the duration of the hold time.	0.00 - 300.00s	0.00s	[Device Para /Binary Outputs /BO Slot X2 /BO 3]
 t-Off Delay	Switch Off Delay	0.00 - 300.00s	0.00s	[Device Para /Binary Outputs /BO Slot X2 /BO 3]
 Latched	Defines whether the Relay Output will be latched when it picks up.	inactive, active	inactive	[Device Para /Binary Outputs /BO Slot X2 /BO 3]
 Acknowledgement	Acknowledgement Signal - An acknowledgement signal (that acknowledges the corresponding binary output relay) can be assigned to each output relay. The acknowledgement-signal is only effective if the parameter "Latched" is set to active. Only available if: Latched = active	1..n, Assignment List	-.-	[Device Para /Binary Outputs /BO Slot X2 /BO 3]
 Inverting	Inverting of the collective signal (OR-gate/disjunction). In combination with inverted input signals an AND-gate can be programmed (Conjunction).	inactive, active	inactive	[Device Para /Binary Outputs /BO Slot X2 /BO 3]
 Assignment 1	Assignment	1..n, Assignment List	SG[1].ON Cmd	[Device Para /Binary Outputs /BO Slot X2 /BO 3]
 Inverting 1	Inverting of the state of the assigned signal.	inactive, active	inactive	[Device Para /Binary Outputs /BO Slot X2 /BO 3]
 Assignment 2	Assignment	1..n, Assignment List	-.-	[Device Para /Binary Outputs /BO Slot X2 /BO 3]

<i>Parameter</i>	<i>Description</i>	<i>Setting range</i>	<i>Default</i>	<i>Menu path</i>
Inverting 2 	Inverting of the state of the assigned signal.	inactive, active	inactive	[Device Para /Binary Outputs /BO Slot X2 /BO 3]
Assignment 3 	Assignment	1..n, Assignment List	-.-	[Device Para /Binary Outputs /BO Slot X2 /BO 3]
Inverting 3 	Inverting of the state of the assigned signal.	inactive, active	inactive	[Device Para /Binary Outputs /BO Slot X2 /BO 3]
Assignment 4 	Assignment	1..n, Assignment List	-.-	[Device Para /Binary Outputs /BO Slot X2 /BO 3]
Inverting 4 	Inverting of the state of the assigned signal.	inactive, active	inactive	[Device Para /Binary Outputs /BO Slot X2 /BO 3]
Assignment 5 	Assignment	1..n, Assignment List	-.-	[Device Para /Binary Outputs /BO Slot X2 /BO 3]
Inverting 5 	Inverting of the state of the assigned signal.	inactive, active	inactive	[Device Para /Binary Outputs /BO Slot X2 /BO 3]
Assignment 6 	Assignment	1..n, Assignment List	-.-	[Device Para /Binary Outputs /BO Slot X2 /BO 3]
Inverting 6 	Inverting of the state of the assigned signal.	inactive, active	inactive	[Device Para /Binary Outputs /BO Slot X2 /BO 3]

Parameter	Description	Setting range	Default	Menu path
Assignment 7 	Assignment	1..n, Assignment List	.-	[Device Para /Binary Outputs /BO Slot X2 /BO 3]
Inverting 7 	Inverting of the state of the assigned signal.	inactive, active	inactive	[Device Para /Binary Outputs /BO Slot X2 /BO 3]
Operating Mode 	Operating Mode	Working current principle, Closed-circuit principle	Working current principle	[Device Para /Binary Outputs /BO Slot X2 /BO 4]
t-hold 	To clearly identify the state transition of a binary output relay, the "new state" is being hold, at least for the duration of the hold time.	0.00 - 300.00s	0.00s	[Device Para /Binary Outputs /BO Slot X2 /BO 4]
t-Off Delay 	Switch Off Delay	0.00 - 300.00s	0.00s	[Device Para /Binary Outputs /BO Slot X2 /BO 4]
Latched 	Defines whether the Relay Output will be latched when it picks up.	inactive, active	inactive	[Device Para /Binary Outputs /BO Slot X2 /BO 4]
Acknowledgem ent 	Acknowledgement Signal - An acknowledgement signal (that acknowledges the corresponding binary output relay) can be assigned to each output relay. The acknowledgement-signal is only effective if the parameter "Latched" is set to active. Only available if: Latched = active	1..n, Assignment List	.-	[Device Para /Binary Outputs /BO Slot X2 /BO 4]
Inverting 	Inverting of the collective signal (OR-gate/disjunction). In combination with inverted input signals an AND-gate can be programmed (Conjunction).	inactive, active	inactive	[Device Para /Binary Outputs /BO Slot X2 /BO 4]
Assignment 1 	Assignment	1..n, Assignment List	SG[1].OFF Cmd	[Device Para /Binary Outputs /BO Slot X2 /BO 4]

<i>Parameter</i>	<i>Description</i>	<i>Setting range</i>	<i>Default</i>	<i>Menu path</i>
Inverting 1 	Inverting of the state of the assigned signal.	inactive, active	inactive	[Device Para /Binary Outputs /BO Slot X2 /BO 4]
Assignment 2 	Assignment	1..n, Assignment List	-.-	[Device Para /Binary Outputs /BO Slot X2 /BO 4]
Inverting 2 	Inverting of the state of the assigned signal.	inactive, active	inactive	[Device Para /Binary Outputs /BO Slot X2 /BO 4]
Assignment 3 	Assignment	1..n, Assignment List	-.-	[Device Para /Binary Outputs /BO Slot X2 /BO 4]
Inverting 3 	Inverting of the state of the assigned signal.	inactive, active	inactive	[Device Para /Binary Outputs /BO Slot X2 /BO 4]
Assignment 4 	Assignment	1..n, Assignment List	-.-	[Device Para /Binary Outputs /BO Slot X2 /BO 4]
Inverting 4 	Inverting of the state of the assigned signal.	inactive, active	inactive	[Device Para /Binary Outputs /BO Slot X2 /BO 4]
Assignment 5 	Assignment	1..n, Assignment List	-.-	[Device Para /Binary Outputs /BO Slot X2 /BO 4]
Inverting 5 	Inverting of the state of the assigned signal.	inactive, active	inactive	[Device Para /Binary Outputs /BO Slot X2 /BO 4]





Parameter	Description	Setting range	Default	Menu path
Assignment 6 	Assignment	1..n, Assignment List	-.-	[Device Para /Binary Outputs /BO Slot X2 /BO 4]
Inverting 6 	Inverting of the state of the assigned signal.	inactive, active	inactive	[Device Para /Binary Outputs /BO Slot X2 /BO 4]
Assignment 7 	Assignment	1..n, Assignment List	-.-	[Device Para /Binary Outputs /BO Slot X2 /BO 4]
Inverting 7 	Inverting of the state of the assigned signal.	inactive, active	inactive	[Device Para /Binary Outputs /BO Slot X2 /BO 4]
Operating Mode 	Operating Mode	Working current principle, Closed-circuit principle	Working current principle	[Device Para /Binary Outputs /BO Slot X2 /BO 5]
t-hold 	To clearly identify the state transition of a binary output relay, the "new state" is being hold, at least for the duration of the hold time.	0.00 - 300.00s	0.00s	[Device Para /Binary Outputs /BO Slot X2 /BO 5]
t-Off Delay 	Switch Off Delay	0.00 - 300.00s	0.00s	[Device Para /Binary Outputs /BO Slot X2 /BO 5]
Latched 	Defines whether the Relay Output will be latched when it picks up.	inactive, active	inactive	[Device Para /Binary Outputs /BO Slot X2 /BO 5]
Acknowledgem ent 	Acknowledgement Signal - An acknowledgement signal (that acknowledges the corresponding binary output relay) can be assigned to each output relay. The acknowledgement-signal is only effective if the parameter "Latched" is set to active. Only available if: Latched = active	1..n, Assignment List	-.-	[Device Para /Binary Outputs /BO Slot X2 /BO 5]

<i>Parameter</i>	<i>Description</i>	<i>Setting range</i>	<i>Default</i>	<i>Menu path</i>
 Inverting	Inverting of the collective signal (OR-gate/disjunction). In combination with inverted input signals an AND-gate can be programmed (Conjunction).	inactive, active	inactive	[Device Para /Binary Outputs /BO Slot X2 /BO 5]
 Assignment 1	Assignment	1..n, Assignment List	.-	[Device Para /Binary Outputs /BO Slot X2 /BO 5]
 Inverting 1	Inverting of the state of the assigned signal.	inactive, active	inactive	[Device Para /Binary Outputs /BO Slot X2 /BO 5]
 Assignment 2	Assignment	1..n, Assignment List	.-	[Device Para /Binary Outputs /BO Slot X2 /BO 5]
 Inverting 2	Inverting of the state of the assigned signal.	inactive, active	inactive	[Device Para /Binary Outputs /BO Slot X2 /BO 5]
 Assignment 3	Assignment	1..n, Assignment List	.-	[Device Para /Binary Outputs /BO Slot X2 /BO 5]
 Inverting 3	Inverting of the state of the assigned signal.	inactive, active	inactive	[Device Para /Binary Outputs /BO Slot X2 /BO 5]
 Assignment 4	Assignment	1..n, Assignment List	.-	[Device Para /Binary Outputs /BO Slot X2 /BO 5]
 Inverting 4	Inverting of the state of the assigned signal.	inactive, active	inactive	[Device Para /Binary Outputs /BO Slot X2 /BO 5]

<i>Parameter</i>	<i>Description</i>	<i>Setting range</i>	<i>Default</i>	<i>Menu path</i>
Assignment 5 	Assignment	1..n, Assignment List	-.-	[Device Para /Binary Outputs /BO Slot X2 /BO 5]
Inverting 5 	Inverting of the state of the assigned signal.	inactive, active	inactive	[Device Para /Binary Outputs /BO Slot X2 /BO 5]
Assignment 6 	Assignment	1..n, Assignment List	-.-	[Device Para /Binary Outputs /BO Slot X2 /BO 5]
Inverting 6 	Inverting of the state of the assigned signal.	inactive, active	inactive	[Device Para /Binary Outputs /BO Slot X2 /BO 5]
Assignment 7 	Assignment	1..n, Assignment List	-.-	[Device Para /Binary Outputs /BO Slot X2 /BO 5]
Inverting 7 	Inverting of the state of the assigned signal.	inactive, active	inactive	[Device Para /Binary Outputs /BO Slot X2 /BO 5]
Operating Mode 	Operating Mode	Working current principle, Closed-circuit principle	Working current principle	[Device Para /Binary Outputs /BO Slot X2 /BO 6]
t-hold 	To clearly identify the state transition of a binary output relay, the "new state" is being hold, at least for the duration of the hold time.	0.00 - 300.00s	0.00s	[Device Para /Binary Outputs /BO Slot X2 /BO 6]
t-Off Delay 	Switch Off Delay	0.00 - 300.00s	0.00s	[Device Para /Binary Outputs /BO Slot X2 /BO 6]

Parameter	Description	Setting range	Default	Menu path
Latched 	Defines whether the Relay Output will be latched when it picks up.	inactive, active	inactive	[Device Para /Binary Outputs /BO Slot X2 /BO 6]
Acknowledgement 	Acknowledgement Signal - An acknowledgement signal (that acknowledges the corresponding binary output relay) can be assigned to each output relay. The acknowledgement-signal is only effective if the parameter "Latched" is set to active. Only available if: Latched = active	1..n, Assignment List	-.-	[Device Para /Binary Outputs /BO Slot X2 /BO 6]
Inverting 	Inverting of the collective signal (OR-gate/disjunction). In combination with inverted input signals an AND-gate can be programmed (Conjunction).	inactive, active	inactive	[Device Para /Binary Outputs /BO Slot X2 /BO 6]
Assignment 1 	Assignment	1..n, Assignment List	-.-	[Device Para /Binary Outputs /BO Slot X2 /BO 6]
Inverting 1 	Inverting of the state of the assigned signal.	inactive, active	inactive	[Device Para /Binary Outputs /BO Slot X2 /BO 6]
Assignment 2 	Assignment	1..n, Assignment List	-.-	[Device Para /Binary Outputs /BO Slot X2 /BO 6]
Inverting 2 	Inverting of the state of the assigned signal.	inactive, active	inactive	[Device Para /Binary Outputs /BO Slot X2 /BO 6]
Assignment 3 	Assignment	1..n, Assignment List	-.-	[Device Para /Binary Outputs /BO Slot X2 /BO 6]
Inverting 3 	Inverting of the state of the assigned signal.	inactive, active	inactive	[Device Para /Binary Outputs /BO Slot X2 /BO 6]

Parameter	Description	Setting range	Default	Menu path
Assignment 4 	Assignment	1..n, Assignment List	.-	[Device Para /Binary Outputs /BO Slot X2 /BO 6]
Inverting 4 	Inverting of the state of the assigned signal.	inactive, active	inactive	[Device Para /Binary Outputs /BO Slot X2 /BO 6]
Assignment 5 	Assignment	1..n, Assignment List	.-	[Device Para /Binary Outputs /BO Slot X2 /BO 6]
Inverting 5 	Inverting of the state of the assigned signal.	inactive, active	inactive	[Device Para /Binary Outputs /BO Slot X2 /BO 6]
Assignment 6 	Assignment	1..n, Assignment List	.-	[Device Para /Binary Outputs /BO Slot X2 /BO 6]
Inverting 6 	Inverting of the state of the assigned signal.	inactive, active	inactive	[Device Para /Binary Outputs /BO Slot X2 /BO 6]
Assignment 7 	Assignment	1..n, Assignment List	.-	[Device Para /Binary Outputs /BO Slot X2 /BO 6]
Inverting 7 	Inverting of the state of the assigned signal.	inactive, active	inactive	[Device Para /Binary Outputs /BO Slot X2 /BO 6]
DISARMED Ctrl 	Enables and disables the disarming of the relay outputs. This is the first step of a two step process, to inhibit the operation or the relay outputs. Please refer to "DISARMED" for the second step.	inactive, active	inactive	[Service /Test (Prot inhibit) /DISARMED /BO Slot X2]

<i>Parameter</i>	<i>Description</i>	<i>Setting range</i>	<i>Default</i>	<i>Menu path</i>
 Disarm Mode	<p>CAUTION! RELAYS DISARMED in order to safely perform maintenance while eliminating the risk of taking an entire process off-line. (Note: The Supervision Contact cannot be disarmed). YOU MUST ENSURE that the relays are ARMED AGAIN after maintenance.</p>	permanent, timeout	permanent	[Service /Test (Prot inhibit) /DISARMED /BO Slot X2]
 t-Timeout DISARM	<p>The relays will be armed again after expiring of this time.</p> <p>Only available if: Mode = Timeout DISARM</p>	0.00 - 300.00s	0.03s	[Service /Test (Prot inhibit) /DISARMED /BO Slot X2]
 Force Mode	<p>By means of this function the normal Output Relay States can be overwritten (forced) in case that the Relay is not in a disarmed state. The relays can be set from normal operation (relay works according to the assigned signals) to "force energized" or "force de-energized" state.</p>	permanent, timeout	permanent	[Service /Test (Prot inhibit) /Force OR /BO Slot X2]
 t-Timeout Force	<p>The Output State will be set by force for the duration of this time. That means for the duration of this time the Output Relay does not show the state of the signals that are assigned on it.</p> <p>Only available if: Mode = Timeout DISARM</p>	0.00 - 300.00s	0.03s	[Service /Test (Prot inhibit) /Force OR /BO Slot X2]

Input States of the Binary Output Relays on OR-6 X

<i>Name</i>	<i>Description</i>	<i>Assignment via</i>
BO1.1	Module input state: Assignment	[Device Para /Binary Outputs /BO Slot X2 /BO 1]
BO1.2	Module input state: Assignment	[Device Para /Binary Outputs /BO Slot X2 /BO 1]
BO1.3	Module input state: Assignment	[Device Para /Binary Outputs /BO Slot X2 /BO 1]
BO1.4	Module input state: Assignment	[Device Para /Binary Outputs /BO Slot X2 /BO 1]
BO1.5	Module input state: Assignment	[Device Para /Binary Outputs /BO Slot X2 /BO 1]
BO1.6	Module input state: Assignment	[Device Para /Binary Outputs /BO Slot X2 /BO 1]
BO1.7	Module input state: Assignment	[Device Para /Binary Outputs /BO Slot X2 /BO 1]
Ack signal BO 1	Module input state: Acknowledgement signal for the binary output relay. If latching is set to active, the binary output relay can only be acknowledged if those signals that initiated the setting are fallen back and the hold time is expired.	[Device Para /Binary Outputs /BO Slot X2 /BO 1]
BO2.1	Module input state: Assignment	[Device Para /Binary Outputs /BO Slot X2 /BO 2]

Name	Description	Assignment via
BO2.2	Module input state: Assignment	[Device Para /Binary Outputs /BO Slot X2 /BO 2]
BO2.3	Module input state: Assignment	[Device Para /Binary Outputs /BO Slot X2 /BO 2]
BO2.4	Module input state: Assignment	[Device Para /Binary Outputs /BO Slot X2 /BO 2]
BO2.5	Module input state: Assignment	[Device Para /Binary Outputs /BO Slot X2 /BO 2]
BO2.6	Module input state: Assignment	[Device Para /Binary Outputs /BO Slot X2 /BO 2]
BO2.7	Module input state: Assignment	[Device Para /Binary Outputs /BO Slot X2 /BO 2]
Ack signal BO 2	Module input state: Acknowledgement signal for the binary output relay. If latching is set to active, the binary output relay can only be acknowledged if those signals that initiated the setting are fallen back and the hold time is expired.	[Device Para /Binary Outputs /BO Slot X2 /BO 2]
BO3.1	Module input state: Assignment	[Device Para /Binary Outputs /BO Slot X2 /BO 3]
BO3.2	Module input state: Assignment	[Device Para /Binary Outputs /BO Slot X2 /BO 3]

<i>Name</i>	<i>Description</i>	<i>Assignment via</i>
BO3.3	Module input state: Assignment	[Device Para /Binary Outputs /BO Slot X2 /BO 3]
BO3.4	Module input state: Assignment	[Device Para /Binary Outputs /BO Slot X2 /BO 3]
BO3.5	Module input state: Assignment	[Device Para /Binary Outputs /BO Slot X2 /BO 3]
BO3.6	Module input state: Assignment	[Device Para /Binary Outputs /BO Slot X2 /BO 3]
BO3.7	Module input state: Assignment	[Device Para /Binary Outputs /BO Slot X2 /BO 3]
Ack signal BO 3	Module input state: Acknowledgement signal for the binary output relay. If latching is set to active, the binary output relay can only be acknowledged if those signals that initiated the setting are fallen back and the hold time is expired.	[Device Para /Binary Outputs /BO Slot X2 /BO 3]
BO4.1	Module input state: Assignment	[Device Para /Binary Outputs /BO Slot X2 /BO 4]
BO4.2	Module input state: Assignment	[Device Para /Binary Outputs /BO Slot X2 /BO 4]
BO4.3	Module input state: Assignment	[Device Para /Binary Outputs /BO Slot X2 /BO 4]

Name	Description	Assignment via
BO4.4	Module input state: Assignment	[Device Para /Binary Outputs /BO Slot X2 /BO 4]
BO4.5	Module input state: Assignment	[Device Para /Binary Outputs /BO Slot X2 /BO 4]
BO4.6	Module input state: Assignment	[Device Para /Binary Outputs /BO Slot X2 /BO 4]
BO4.7	Module input state: Assignment	[Device Para /Binary Outputs /BO Slot X2 /BO 4]
Ack signal BO 4	Module input state: Acknowledgement signal for the binary output relay. If latching is set to active, the binary output relay can only be acknowledged if those signals that initiated the setting are fallen back and the hold time is expired.	[Device Para /Binary Outputs /BO Slot X2 /BO 4]
BO5.1	Module input state: Assignment	[Device Para /Binary Outputs /BO Slot X2 /BO 5]
BO5.2	Module input state: Assignment	[Device Para /Binary Outputs /BO Slot X2 /BO 5]
BO5.3	Module input state: Assignment	[Device Para /Binary Outputs /BO Slot X2 /BO 5]
BO5.4	Module input state: Assignment	[Device Para /Binary Outputs /BO Slot X2 /BO 5]

<i>Name</i>	<i>Description</i>	<i>Assignment via</i>
BO5.5	Module input state: Assignment	[Device Para /Binary Outputs /BO Slot X2 /BO 5]
BO5.6	Module input state: Assignment	[Device Para /Binary Outputs /BO Slot X2 /BO 5]
BO5.7	Module input state: Assignment	[Device Para /Binary Outputs /BO Slot X2 /BO 5]
Ack signal BO 5	Module input state: Acknowledgement signal for the binary output relay. If latching is set to active, the binary output relay can only be acknowledged if those signals that initiated the setting are fallen back and the hold time is expired.	[Device Para /Binary Outputs /BO Slot X2 /BO 5]
BO6.1	Module input state: Assignment	[Device Para /Binary Outputs /BO Slot X2 /BO 6]
BO6.2	Module input state: Assignment	[Device Para /Binary Outputs /BO Slot X2 /BO 6]
BO6.3	Module input state: Assignment	[Device Para /Binary Outputs /BO Slot X2 /BO 6]
BO6.4	Module input state: Assignment	[Device Para /Binary Outputs /BO Slot X2 /BO 6]
BO6.5	Module input state: Assignment	[Device Para /Binary Outputs /BO Slot X2 /BO 6]

<i>Name</i>	<i>Description</i>	<i>Assignment via</i>
BO6.6	Module input state: Assignment	[Device Para /Binary Outputs /BO Slot X2 /BO 6]
BO6.7	Module input state: Assignment	[Device Para /Binary Outputs /BO Slot X2 /BO 6]
Ack signal BO 6	Module input state: Acknowledgement signal for the binary output relay. If latching is set to active, the binary output relay can only be acknowledged if those signals that initiated the setting are fallen back and the hold time is expired.	[Device Para /Binary Outputs /BO Slot X2 /BO 6]



Signals of the Binary Output Relays on OR-6 X



<i>Signal</i>	<i>Description</i>
BO 1	Signal: Binary Output Relay
BO 2	Signal: Binary Output Relay
BO 3	Signal: Binary Output Relay
BO 4	Signal: Binary Output Relay
BO 5	Signal: Binary Output Relay
BO 6	Signal: Binary Output Relay
DISARMED!	Signal: CAUTION! RELAYS DISARMED in order to safely perform maintenance while eliminating the risk of taking an entire process off-line. (Note: The Self Supervision Contact cannot be disarmed). YOU MUST ENSURE that the relays are ARMED AGAIN after maintenance
Outs forced	Signal: The State of at least one Relay Output has been set by force. That means that the state of at least one Relay is forced and hence does not show the state of the assigned signals.

OR-5 X





BO Slot X6

Direct Commands of OR-5 X

Parameter	Description	Setting range	Default	Menu path
 DISARMED	This is the second step, after the "DISARMED Ctrl" has been activated, that is required to DISARM the relay outputs. This will DISARM those output relays that are currently not latched and that are not on "hold" by a pending minimum hold time. CAUTION! RELAYS DISARMED in order to safely perform maintenance while eliminating the risk of taking an entire process off-line. (Note: Zone Interlocking and Supervision Contact cannot be disarmed). YOU MUST ENSURE that the relays are ARMED AGAIN after maintenance. Only available if: DISARMED Ctrl = active	inactive, active	inactive	[Service /Test (Prot inhibit) /DISARMED /BO Slot X6]
 Force all Outs	By means of this function the normal Output Relay State can be overwritten (forced). The relay can be set from normal operation (relay works according to the assigned signals) to "force energized" or "force de-energized" state. Forcing all outputs relays of an entire assembly group is superior to forcing a single output relay.	Normal, De-Energized, Energized	Normal	[Service /Test (Prot inhibit) /Force OR /BO Slot X6]
 Force OR1	By means of this function the normal Output Relay State can be overwritten (forced). The relay can be set from normal operation (relay works according to the assigned signals) to "force energized" or "force de-energized" state.	Normal, De-Energized, Energized	Normal	[Service /Test (Prot inhibit) /Force OR /BO Slot X6]
 Force OR2	By means of this function the normal Output Relay State can be overwritten (forced). The relay can be set from normal operation (relay works according to the assigned signals) to "force energized" or "force de-energized" state.	Normal, De-Energized, Energized	Normal	[Service /Test (Prot inhibit) /Force OR /BO Slot X6]
 Force OR3	By means of this function the normal Output Relay State can be overwritten (forced). The relay can be set from normal operation (relay works according to the assigned signals) to "force energized" or "force de-energized" state.	Normal, De-Energized, Energized	Normal	[Service /Test (Prot inhibit) /Force OR /BO Slot X6]

Parameter	Description	Setting range	Default	Menu path
Force OR4 	By means of this function the normal Output Relay State can be overwritten (forced). The relay can be set from normal operation (relay works according to the assigned signals) to "force energized" or "force de-energized" state.	Normal, De-Energized, Energized	Normal	[Service /Test (Prot inhibit) /Force OR /BO Slot X6]
Force OR5 	By means of this function the normal Output Relay State can be overwritten (forced). The relay can be set from normal operation (relay works according to the assigned signals) to "force energized" or "force de-energized" state.	Normal, De-Energized, Energized	Normal	[Service /Test (Prot inhibit) /Force OR /BO Slot X6]

Device Parameters of the Binary Output Relays on OR-5 X

Parameter	Description	Setting range	Default	Menu path
Operating Mode 	Operating Mode	Working current principle, Closed-circuit principle	Working current principle	[Device Para /Binary Outputs /BO Slot X6 /BO 1]
t-hold 	To clearly identify the state transition of a binary output relay, the "new state" is being hold, at least for the duration of the hold time.	0.00 - 300.00s	0.00s	[Device Para /Binary Outputs /BO Slot X6 /BO 1]
t-Off Delay 	Switch Off Delay	0.00 - 300.00s	0.00s	[Device Para /Binary Outputs /BO Slot X6 /BO 1]
Latched 	Defines whether the Relay Output will be latched when it picks up.	inactive, active	inactive	[Device Para /Binary Outputs /BO Slot X6 /BO 1]
Acknowledgem ent 	Acknowledgement Signal - An acknowledgement signal (that acknowledges the corresponding binary output relay) can be assigned to each output relay. The acknowledgement-signal is only effective if the parameter "Latched" is set to active. Only available if: Latched = active	1..n, Assignment List	--	[Device Para /Binary Outputs /BO Slot X6 /BO 1]

<i>Parameter</i>	<i>Description</i>	<i>Setting range</i>	<i>Default</i>	<i>Menu path</i>
 Inverting	Inverting of the collective signal (OR-gate/disjunction). In combination with inverted input signals an AND-gate can be programmed (Conjunction).	inactive, active	inactive	[Device Para /Binary Outputs /BO Slot X6 /BO 1]
 Assignment 1	Assignment	1..n, Assignment List	.-	[Device Para /Binary Outputs /BO Slot X6 /BO 1]
 Inverting 1	Inverting of the state of the assigned signal.	inactive, active	inactive	[Device Para /Binary Outputs /BO Slot X6 /BO 1]
 Assignment 2	Assignment	1..n, Assignment List	.-	[Device Para /Binary Outputs /BO Slot X6 /BO 1]
 Inverting 2	Inverting of the state of the assigned signal.	inactive, active	inactive	[Device Para /Binary Outputs /BO Slot X6 /BO 1]
 Assignment 3	Assignment	1..n, Assignment List	.-	[Device Para /Binary Outputs /BO Slot X6 /BO 1]
 Inverting 3	Inverting of the state of the assigned signal.	inactive, active	inactive	[Device Para /Binary Outputs /BO Slot X6 /BO 1]
 Assignment 4	Assignment	1..n, Assignment List	.-	[Device Para /Binary Outputs /BO Slot X6 /BO 1]
 Inverting 4	Inverting of the state of the assigned signal.	inactive, active	inactive	[Device Para /Binary Outputs /BO Slot X6 /BO 1]

<i>Parameter</i>	<i>Description</i>	<i>Setting range</i>	<i>Default</i>	<i>Menu path</i>
Assignment 5 	Assignment	1..n, Assignment List	-.-	[Device Para /Binary Outputs /BO Slot X6 /BO 1]
Inverting 5 	Inverting of the state of the assigned signal.	inactive, active	inactive	[Device Para /Binary Outputs /BO Slot X6 /BO 1]
Assignment 6 	Assignment	1..n, Assignment List	-.-	[Device Para /Binary Outputs /BO Slot X6 /BO 1]
Inverting 6 	Inverting of the state of the assigned signal.	inactive, active	inactive	[Device Para /Binary Outputs /BO Slot X6 /BO 1]
Assignment 7 	Assignment	1..n, Assignment List	-.-	[Device Para /Binary Outputs /BO Slot X6 /BO 1]
Inverting 7 	Inverting of the state of the assigned signal.	inactive, active	inactive	[Device Para /Binary Outputs /BO Slot X6 /BO 1]
Operating Mode 	Operating Mode	Working current principle, Closed-circuit principle	Working current principle	[Device Para /Binary Outputs /BO Slot X6 /BO 2]
t-hold 	To clearly identify the state transition of a binary output relay, the "new state" is being hold, at least for the duration of the hold time.	0.00 - 300.00s	0.00s	[Device Para /Binary Outputs /BO Slot X6 /BO 2]
t-Off Delay 	Switch Off Delay	0.00 - 300.00s	0.00s	[Device Para /Binary Outputs /BO Slot X6 /BO 2]

Parameter	Description	Setting range	Default	Menu path
Latched 	Defines whether the Relay Output will be latched when it picks up.	inactive, active	inactive	[Device Para /Binary Outputs /BO Slot X6 /BO 2]
Acknowledgement 	Acknowledgement Signal - An acknowledgement signal (that acknowledges the corresponding binary output relay) can be assigned to each output relay. The acknowledgement-signal is only effective if the parameter "Latched" is set to active. Only available if: Latched = active	1..n, Assignment List	-.-	[Device Para /Binary Outputs /BO Slot X6 /BO 2]
Inverting 	Inverting of the collective signal (OR-gate/disjunction). In combination with inverted input signals an AND-gate can be programmed (Conjunction).	inactive, active	inactive	[Device Para /Binary Outputs /BO Slot X6 /BO 2]
Assignment 1 	Assignment	1..n, Assignment List	-.-	[Device Para /Binary Outputs /BO Slot X6 /BO 2]
Inverting 1 	Inverting of the state of the assigned signal.	inactive, active	inactive	[Device Para /Binary Outputs /BO Slot X6 /BO 2]
Assignment 2 	Assignment	1..n, Assignment List	-.-	[Device Para /Binary Outputs /BO Slot X6 /BO 2]
Inverting 2 	Inverting of the state of the assigned signal.	inactive, active	inactive	[Device Para /Binary Outputs /BO Slot X6 /BO 2]
Assignment 3 	Assignment	1..n, Assignment List	-.-	[Device Para /Binary Outputs /BO Slot X6 /BO 2]
Inverting 3 	Inverting of the state of the assigned signal.	inactive, active	inactive	[Device Para /Binary Outputs /BO Slot X6 /BO 2]









<i>Parameter</i>	<i>Description</i>	<i>Setting range</i>	<i>Default</i>	<i>Menu path</i>
Assignment 4 	Assignment	1..n, Assignment List	-.-	[Device Para /Binary Outputs /BO Slot X6 /BO 2]
Inverting 4 	Inverting of the state of the assigned signal.	inactive, active	inactive	[Device Para /Binary Outputs /BO Slot X6 /BO 2]
Assignment 5 	Assignment	1..n, Assignment List	-.-	[Device Para /Binary Outputs /BO Slot X6 /BO 2]
Inverting 5 	Inverting of the state of the assigned signal.	inactive, active	inactive	[Device Para /Binary Outputs /BO Slot X6 /BO 2]
Assignment 6 	Assignment	1..n, Assignment List	-.-	[Device Para /Binary Outputs /BO Slot X6 /BO 2]
Inverting 6 	Inverting of the state of the assigned signal.	inactive, active	inactive	[Device Para /Binary Outputs /BO Slot X6 /BO 2]
Assignment 7 	Assignment	1..n, Assignment List	-.-	[Device Para /Binary Outputs /BO Slot X6 /BO 2]
Inverting 7 	Inverting of the state of the assigned signal.	inactive, active	inactive	[Device Para /Binary Outputs /BO Slot X6 /BO 2]
Operating Mode 	Operating Mode	Working current principle, Closed-circuit principle	Working current principle	[Device Para /Binary Outputs /BO Slot X6 /BO 3]

Parameter	Description	Setting range	Default	Menu path
t-hold 	To clearly identify the state transition of a binary output relay, the "new state" is being hold, at least for the duration of the hold time.	0.00 - 300.00s	0.00s	[Device Para /Binary Outputs /BO Slot X6 /BO 3]
t-Off Delay 	Switch Off Delay	0.00 - 300.00s	0.00s	[Device Para /Binary Outputs /BO Slot X6 /BO 3]
Latched 	Defines whether the Relay Output will be latched when it picks up.	inactive, active	inactive	[Device Para /Binary Outputs /BO Slot X6 /BO 3]
Acknowledgem ent 	Acknowledgement Signal - An acknowledgement signal (that acknowledges the corresponding binary output relay) can be assigned to each output relay. The acknowledgement-signal is only effective if the parameter "Latched" is set to active. Only available if: Latched = active	1..n, Assignment List	-.-	[Device Para /Binary Outputs /BO Slot X6 /BO 3]
Inverting 	Inverting of the collective signal (OR-gate/disjunction). In combination with inverted input signals an AND-gate can be programmed (Conjunction).	inactive, active	inactive	[Device Para /Binary Outputs /BO Slot X6 /BO 3]
Assignment 1 	Assignment	1..n, Assignment List	-.-	[Device Para /Binary Outputs /BO Slot X6 /BO 3]
Inverting 1 	Inverting of the state of the assigned signal.	inactive, active	inactive	[Device Para /Binary Outputs /BO Slot X6 /BO 3]
Assignment 2 	Assignment	1..n, Assignment List	-.-	[Device Para /Binary Outputs /BO Slot X6 /BO 3]
Inverting 2 	Inverting of the state of the assigned signal.	inactive, active	inactive	[Device Para /Binary Outputs /BO Slot X6 /BO 3]

<i>Parameter</i>	<i>Description</i>	<i>Setting range</i>	<i>Default</i>	<i>Menu path</i>
Assignment 3 	Assignment	1..n, Assignment List	-.-	[Device Para /Binary Outputs /BO Slot X6 /BO 3]
Inverting 3 	Inverting of the state of the assigned signal.	inactive, active	inactive	[Device Para /Binary Outputs /BO Slot X6 /BO 3]
Assignment 4 	Assignment	1..n, Assignment List	-.-	[Device Para /Binary Outputs /BO Slot X6 /BO 3]
Inverting 4 	Inverting of the state of the assigned signal.	inactive, active	inactive	[Device Para /Binary Outputs /BO Slot X6 /BO 3]
Assignment 5 	Assignment	1..n, Assignment List	-.-	[Device Para /Binary Outputs /BO Slot X6 /BO 3]
Inverting 5 	Inverting of the state of the assigned signal.	inactive, active	inactive	[Device Para /Binary Outputs /BO Slot X6 /BO 3]
Assignment 6 	Assignment	1..n, Assignment List	-.-	[Device Para /Binary Outputs /BO Slot X6 /BO 3]
Inverting 6 	Inverting of the state of the assigned signal.	inactive, active	inactive	[Device Para /Binary Outputs /BO Slot X6 /BO 3]
Assignment 7 	Assignment	1..n, Assignment List	-.-	[Device Para /Binary Outputs /BO Slot X6 /BO 3]



Parameter	Description	Setting range	Default	Menu path
 Inverting 7	Inverting of the state of the assigned signal.	inactive, active	inactive	[Device Para /Binary Outputs /BO Slot X6 /BO 3]
 Operating Mode	Operating Mode	Working current principle, Closed-circuit principle	Working current principle	[Device Para /Binary Outputs /BO Slot X6 /BO 4]
 t-hold	To clearly identify the state transition of a binary output relay, the "new state" is being hold, at least for the duration of the hold time.	0.00 - 300.00s	0.00s	[Device Para /Binary Outputs /BO Slot X6 /BO 4]
 t-Off Delay	Switch Off Delay	0.00 - 300.00s	0.00s	[Device Para /Binary Outputs /BO Slot X6 /BO 4]
 Latched	Defines whether the Relay Output will be latched when it picks up.	inactive, active	inactive	[Device Para /Binary Outputs /BO Slot X6 /BO 4]
 Acknowledgem ent	Acknowledgement Signal - An acknowledgement signal (that acknowledges the corresponding binary output relay) can be assigned to each output relay. The acknowledgement-signal is only effective if the parameter "Latched" is set to active. Only available if: Latched = active	1..n, Assignment List	.-	[Device Para /Binary Outputs /BO Slot X6 /BO 4]
 Inverting	Inverting of the collective signal (OR-gate/disjunction). In combination with inverted input signals an AND-gate can be programmed (Conjunction).	inactive, active	inactive	[Device Para /Binary Outputs /BO Slot X6 /BO 4]
 Assignment 1	Assignment	1..n, Assignment List	.-	[Device Para /Binary Outputs /BO Slot X6 /BO 4]
 Inverting 1	Inverting of the state of the assigned signal.	inactive, active	inactive	[Device Para /Binary Outputs /BO Slot X6 /BO 4]

<i>Parameter</i>	<i>Description</i>	<i>Setting range</i>	<i>Default</i>	<i>Menu path</i>
Assignment 2 	Assignment	1..n, Assignment List	.-	[Device Para /Binary Outputs /BO Slot X6 /BO 4]
Inverting 2 	Inverting of the state of the assigned signal.	inactive, active	inactive	[Device Para /Binary Outputs /BO Slot X6 /BO 4]
Assignment 3 	Assignment	1..n, Assignment List	.-	[Device Para /Binary Outputs /BO Slot X6 /BO 4]
Inverting 3 	Inverting of the state of the assigned signal.	inactive, active	inactive	[Device Para /Binary Outputs /BO Slot X6 /BO 4]
Assignment 4 	Assignment	1..n, Assignment List	.-	[Device Para /Binary Outputs /BO Slot X6 /BO 4]
Inverting 4 	Inverting of the state of the assigned signal.	inactive, active	inactive	[Device Para /Binary Outputs /BO Slot X6 /BO 4]
Assignment 5 	Assignment	1..n, Assignment List	.-	[Device Para /Binary Outputs /BO Slot X6 /BO 4]
Inverting 5 	Inverting of the state of the assigned signal.	inactive, active	inactive	[Device Para /Binary Outputs /BO Slot X6 /BO 4]
Assignment 6 	Assignment	1..n, Assignment List	.-	[Device Para /Binary Outputs /BO Slot X6 /BO 4]

Parameter	Description	Setting range	Default	Menu path
 Inverting 6	Inverting of the state of the assigned signal.	inactive, active	inactive	[Device Para /Binary Outputs /BO Slot X6 /BO 4]
 Assignment 7	Assignment	1..n, Assignment List	-.-	[Device Para /Binary Outputs /BO Slot X6 /BO 4]
 Inverting 7	Inverting of the state of the assigned signal.	inactive, active	inactive	[Device Para /Binary Outputs /BO Slot X6 /BO 4]
 Operating Mode	Operating Mode	Working current principle, Closed-circuit principle	Working current principle	[Device Para /Binary Outputs /BO Slot X6 /BO 5]
 t-hold	To clearly identify the state transition of a binary output relay, the "new state" is being hold, at least for the duration of the hold time.	0.00 - 300.00s	0.00s	[Device Para /Binary Outputs /BO Slot X6 /BO 5]
 t-Off Delay	Switch Off Delay	0.00 - 300.00s	0.00s	[Device Para /Binary Outputs /BO Slot X6 /BO 5]
 Latched	Defines whether the Relay Output will be latched when it picks up.	inactive, active	inactive	[Device Para /Binary Outputs /BO Slot X6 /BO 5]
 Acknowledgement	Acknowledgement Signal - An acknowledgement signal (that acknowledges the corresponding binary output relay) can be assigned to each output relay. The acknowledgement-signal is only effective if the parameter "Latched" is set to active. Only available if: Latched = active	1..n, Assignment List	-.-	[Device Para /Binary Outputs /BO Slot X6 /BO 5]
 Inverting	Inverting of the collective signal (OR-gate/disjunction). In combination with inverted input signals an AND-gate can be programmed (Conjunction).	inactive, active	inactive	[Device Para /Binary Outputs /BO Slot X6 /BO 5]

<i>Parameter</i>	<i>Description</i>	<i>Setting range</i>	<i>Default</i>	<i>Menu path</i>
Assignment 1 	Assignment	1..n, Assignment List	-.-	[Device Para /Binary Outputs /BO Slot X6 /BO 5]
Inverting 1 	Inverting of the state of the assigned signal.	inactive, active	inactive	[Device Para /Binary Outputs /BO Slot X6 /BO 5]
Assignment 2 	Assignment	1..n, Assignment List	-.-	[Device Para /Binary Outputs /BO Slot X6 /BO 5]
Inverting 2 	Inverting of the state of the assigned signal.	inactive, active	inactive	[Device Para /Binary Outputs /BO Slot X6 /BO 5]
Assignment 3 	Assignment	1..n, Assignment List	-.-	[Device Para /Binary Outputs /BO Slot X6 /BO 5]
Inverting 3 	Inverting of the state of the assigned signal.	inactive, active	inactive	[Device Para /Binary Outputs /BO Slot X6 /BO 5]
Assignment 4 	Assignment	1..n, Assignment List	-.-	[Device Para /Binary Outputs /BO Slot X6 /BO 5]
Inverting 4 	Inverting of the state of the assigned signal.	inactive, active	inactive	[Device Para /Binary Outputs /BO Slot X6 /BO 5]
Assignment 5 	Assignment	1..n, Assignment List	-.-	[Device Para /Binary Outputs /BO Slot X6 /BO 5]

Parameter	Description	Setting range	Default	Menu path
 Inverting 5	Inverting of the state of the assigned signal.	inactive, active	inactive	[Device Para /Binary Outputs /BO Slot X6 /BO 5]
 Assignment 6	Assignment	1..n, Assignment List	.-	[Device Para /Binary Outputs /BO Slot X6 /BO 5]
 Inverting 6	Inverting of the state of the assigned signal.	inactive, active	inactive	[Device Para /Binary Outputs /BO Slot X6 /BO 5]
 Assignment 7	Assignment	1..n, Assignment List	.-	[Device Para /Binary Outputs /BO Slot X6 /BO 5]
 Inverting 7	Inverting of the state of the assigned signal.	inactive, active	inactive	[Device Para /Binary Outputs /BO Slot X6 /BO 5]
 DISARMED Ctrl	Enables and disables the disarming of the relay outputs. This is the first step of a two step process, to inhibit the operation or the relay outputs. Please refer to "DISARMED" for the second step.	inactive, active	inactive	[Service /Test (Prot inhibit) /DISARMED /BO Slot X6]
 Disarm Mode	CAUTION! RELAYS DISARMED in order to safely perform maintenance while eliminating the risk of taking an entire process off-line. (Note: The Supervision Contact cannot be disarmed). YOU MUST ENSURE that the relays are ARMED AGAIN after maintenance.	permanent, timeout	permanent	[Service /Test (Prot inhibit) /DISARMED /BO Slot X6]
 t-Timeout DISARM	The relays will be armed again after expiring of this time. Only available if: Mode = Timeout DISARM	0.00 - 300.00s	0.03s	[Service /Test (Prot inhibit) /DISARMED /BO Slot X6]

<i>Parameter</i>	<i>Description</i>	<i>Setting range</i>	<i>Default</i>	<i>Menu path</i>
Force Mode 	By means of this function the normal Output Relay States can be overwritten (forced) in case that the Relay is not in a disarmed state. The relays can be set from normal operation (relay works according to the assigned signals) to "force energized" or "force de-energized" state.	permanent, timeout	permanent	[Service /Test (Prot inhibit) /Force OR /BO Slot X6]
t-Timeout Force 	The Output State will be set by force for the duration of this time. That means for the duration of this time the Output Relay does not show the state of the signals that are assigned on it. Only available if: Mode = Timeout DISARM	0.00 - 300.00s	0.03s	[Service /Test (Prot inhibit) /Force OR /BO Slot X6]

Input States of the Binary Output Relays on OR-5 X

<i>Name</i>	<i>Description</i>	<i>Assignment via</i>
BO1.1	Module input state: Assignment	[Device Para /Binary Outputs /BO Slot X6 /BO 1]
BO1.2	Module input state: Assignment	[Device Para /Binary Outputs /BO Slot X6 /BO 1]
BO1.3	Module input state: Assignment	[Device Para /Binary Outputs /BO Slot X6 /BO 1]
BO1.4	Module input state: Assignment	[Device Para /Binary Outputs /BO Slot X6 /BO 1]
BO1.5	Module input state: Assignment	[Device Para /Binary Outputs /BO Slot X6 /BO 1]
BO1.6	Module input state: Assignment	[Device Para /Binary Outputs /BO Slot X6 /BO 1]

Name	Description	Assignment via
BO1.7	Module input state: Assignment	[Device Para /Binary Outputs /BO Slot X6 /BO 1]
Ack signal BO 1	Module input state: Acknowledgement signal for the binary output relay. If latching is set to active, the binary output relay can only be acknowledged if those signals that initiated the setting are fallen back and the hold time is expired.	[Device Para /Binary Outputs /BO Slot X6 /BO 1]
BO2.1	Module input state: Assignment	[Device Para /Binary Outputs /BO Slot X6 /BO 2]
BO2.2	Module input state: Assignment	[Device Para /Binary Outputs /BO Slot X6 /BO 2]
BO2.3	Module input state: Assignment	[Device Para /Binary Outputs /BO Slot X6 /BO 2]
BO2.4	Module input state: Assignment	[Device Para /Binary Outputs /BO Slot X6 /BO 2]
BO2.5	Module input state: Assignment	[Device Para /Binary Outputs /BO Slot X6 /BO 2]
BO2.6	Module input state: Assignment	[Device Para /Binary Outputs /BO Slot X6 /BO 2]
BO2.7	Module input state: Assignment	[Device Para /Binary Outputs /BO Slot X6 /BO 2]

Name	Description	Assignment via
Ack signal BO 2	Module input state: Acknowledgement signal for the binary output relay. If latching is set to active, the binary output relay can only be acknowledged if those signals that initiated the setting are fallen back and the hold time is expired.	[Device Para /Binary Outputs /BO Slot X6 /BO 2]
BO3.1	Module input state: Assignment	[Device Para /Binary Outputs /BO Slot X6 /BO 3]
BO3.2	Module input state: Assignment	[Device Para /Binary Outputs /BO Slot X6 /BO 3]
BO3.3	Module input state: Assignment	[Device Para /Binary Outputs /BO Slot X6 /BO 3]
BO3.4	Module input state: Assignment	[Device Para /Binary Outputs /BO Slot X6 /BO 3]
BO3.5	Module input state: Assignment	[Device Para /Binary Outputs /BO Slot X6 /BO 3]
BO3.6	Module input state: Assignment	[Device Para /Binary Outputs /BO Slot X6 /BO 3]
BO3.7	Module input state: Assignment	[Device Para /Binary Outputs /BO Slot X6 /BO 3]
Ack signal BO 3	Module input state: Acknowledgement signal for the binary output relay. If latching is set to active, the binary output relay can only be acknowledged if those signals that initiated the setting are fallen back and the hold time is expired.	[Device Para /Binary Outputs /BO Slot X6 /BO 3]

Name	Description	Assignment via
BO4.1	Module input state: Assignment	[Device Para /Binary Outputs /BO Slot X6 /BO 4]
BO4.2	Module input state: Assignment	[Device Para /Binary Outputs /BO Slot X6 /BO 4]
BO4.3	Module input state: Assignment	[Device Para /Binary Outputs /BO Slot X6 /BO 4]
BO4.4	Module input state: Assignment	[Device Para /Binary Outputs /BO Slot X6 /BO 4]
BO4.5	Module input state: Assignment	[Device Para /Binary Outputs /BO Slot X6 /BO 4]
BO4.6	Module input state: Assignment	[Device Para /Binary Outputs /BO Slot X6 /BO 4]
BO4.7	Module input state: Assignment	[Device Para /Binary Outputs /BO Slot X6 /BO 4]
Ack signal BO 4	Module input state: Acknowledgement signal for the binary output relay. If latching is set to active, the binary output relay can only be acknowledged if those signals that initiated the setting are fallen back and the hold time is expired.	[Device Para /Binary Outputs /BO Slot X6 /BO 4]
BO5.1	Module input state: Assignment	[Device Para /Binary Outputs /BO Slot X6 /BO 5]

<i>Name</i>	<i>Description</i>	<i>Assignment via</i>
BO5.2	Module input state: Assignment	[Device Para /Binary Outputs /BO Slot X6 /BO 5]
BO5.3	Module input state: Assignment	[Device Para /Binary Outputs /BO Slot X6 /BO 5]
BO5.4	Module input state: Assignment	[Device Para /Binary Outputs /BO Slot X6 /BO 5]
BO5.5	Module input state: Assignment	[Device Para /Binary Outputs /BO Slot X6 /BO 5]
BO5.6	Module input state: Assignment	[Device Para /Binary Outputs /BO Slot X6 /BO 5]
BO5.7	Module input state: Assignment	[Device Para /Binary Outputs /BO Slot X6 /BO 5]
Ack signal BO 5	Module input state: Acknowledgement signal for the binary output relay. If latching is set to active, the binary output relay can only be acknowledged if those signals that initiated the setting are fallen back and the hold time is expired.	[Device Para /Binary Outputs /BO Slot X6 /BO 5]

Signals of the Binary Output Relays on OR-5 X





<i>Signal</i>	<i>Description</i>
BO 1	Signal: Binary Output Relay
BO 2	Signal: Binary Output Relay
BO 3	Signal: Binary Output Relay
BO 4	Signal: Binary Output Relay
BO 5	Signal: Binary Output Relay



<i>Signal</i>	<i>Description</i>
DISARMED!	Signal: CAUTION! RELAYS DISARMED in order to safely perform maintenance while eliminating the risk of taking an entire process off-line. (Note: The Self Supervision Contact cannot be disarmed). YOU MUST ENSURE that the relays are ARMED AGAIN after maintenance
Outs forced	Signal: The State of at least one Relay Output has been set by force. That means that the state of at least one Relay is forced and hence does not show the state of the assigned signals.

OR-4 X





BO Slot X5

Direct Commands of OR- 4 X

Parameter	Description	Setting range	Default	Menu path
 DISARMED	<p>This is the second step, after the "DISARMED Ctrl" has been activated, that is required to DISARM the relay outputs. This will DISARM those output relays that are currently not latched and that are not on "hold" by a pending minimum hold time. CAUTION! RELAYS DISARMED in order to safely perform maintenance while eliminating the risk of taking an entire process off-line. (Note: Zone Interlocking and Supervision Contact cannot be disarmed). YOU MUST ENSURE that the relays are ARMED AGAIN after maintenance.</p> <p>Only available if: DISARMED Ctrl = active</p>	inactive, active	inactive	[Service /Test (Prot inhibit) /DISARMED /BO Slot X5]
 Force all Outs	By means of this function the normal Output Relay State can be overwritten (forced). The relay can be set from normal operation (relay works according to the assigned signals) to "force energized" or "force de-energized" state. Forcing all outputs relays of an entire assembly group is superior to forcing a single output relay.	Normal, De-Energized, Energized	Normal	[Service /Test (Prot inhibit) /Force OR /BO Slot X5]
 Force OR1	By means of this function the normal Output Relay State can be overwritten (forced). The relay can be set from normal operation (relay works according to the assigned signals) to "force energized" or "force de-energized" state.	Normal, De-Energized, Energized	Normal	[Service /Test (Prot inhibit) /Force OR /BO Slot X5]
 Force OR2	By means of this function the normal Output Relay State can be overwritten (forced). The relay can be set from normal operation (relay works according to the assigned signals) to "force energized" or "force de-energized" state.	Normal, De-Energized, Energized	Normal	[Service /Test (Prot inhibit) /Force OR /BO Slot X5]

<i>Parameter</i>	<i>Description</i>	<i>Setting range</i>	<i>Default</i>	<i>Menu path</i>
Force OR3 	By means of this function the normal Output Relay State can be overwritten (forced). The relay can be set from normal operation (relay works according to the assigned signals) to "force energized" or "force de-energized" state.	Normal, De-Energized, Energized	Normal	[Service /Test (Prot inhibit) /Force OR /BO Slot X5]
Force OR4 	By means of this function the normal Output Relay State can be overwritten (forced). The relay can be set from normal operation (relay works according to the assigned signals) to "force energized" or "force de-energized" state.	Normal, De-Energized, Energized	Normal	[Service /Test (Prot inhibit) /Force OR /BO Slot X5]

Device Parameters of the Binary Output Relays on OR- 4 X

<i>Parameter</i>	<i>Description</i>	<i>Setting range</i>	<i>Default</i>	<i>Menu path</i>
Operating Mode 	Operating Mode	Working current principle, Closed-circuit principle	Working current principle	[Device Para /Binary Outputs /BO Slot X5 /BO 1]
t-hold 	To clearly identify the state transition of a binary output relay, the "new state" is being hold, at least for the duration of the hold time.	0.00 - 300.00s	0.00s	[Device Para /Binary Outputs /BO Slot X5 /BO 1]
t-Off Delay 	Switch Off Delay	0.00 - 300.00s	0.00s	[Device Para /Binary Outputs /BO Slot X5 /BO 1]
Latched 	Defines whether the Relay Output will be latched when it picks up.	inactive, active	inactive	[Device Para /Binary Outputs /BO Slot X5 /BO 1]
Acknowledgem ent 	Acknowledgement Signal - An acknowledgement signal (that acknowledges the corresponding binary output relay) can be assigned to each output relay. The acknowledgement-signal is only effective if the parameter "Latched" is set to active. Only available if: Latched = active	1..n, Assignment List	-.-	[Device Para /Binary Outputs /BO Slot X5 /BO 1]

<i>Parameter</i>	<i>Description</i>	<i>Setting range</i>	<i>Default</i>	<i>Menu path</i>
 Inverting	Inverting of the collective signal (OR-gate/disjunction). In combination with inverted input signals an AND-gate can be programmed (Conjunction).	inactive, active	inactive	[Device Para /Binary Outputs /BO Slot X5 /BO 1]
 Assignment 1	Assignment	1..n, Assignment List	.-	[Device Para /Binary Outputs /BO Slot X5 /BO 1]
 Inverting 1	Inverting of the state of the assigned signal.	inactive, active	inactive	[Device Para /Binary Outputs /BO Slot X5 /BO 1]
 Assignment 2	Assignment	1..n, Assignment List	.-	[Device Para /Binary Outputs /BO Slot X5 /BO 1]
 Inverting 2	Inverting of the state of the assigned signal.	inactive, active	inactive	[Device Para /Binary Outputs /BO Slot X5 /BO 1]
 Assignment 3	Assignment	1..n, Assignment List	.-	[Device Para /Binary Outputs /BO Slot X5 /BO 1]
 Inverting 3	Inverting of the state of the assigned signal.	inactive, active	inactive	[Device Para /Binary Outputs /BO Slot X5 /BO 1]
 Assignment 4	Assignment	1..n, Assignment List	.-	[Device Para /Binary Outputs /BO Slot X5 /BO 1]
 Inverting 4	Inverting of the state of the assigned signal.	inactive, active	inactive	[Device Para /Binary Outputs /BO Slot X5 /BO 1]

<i>Parameter</i>	<i>Description</i>	<i>Setting range</i>	<i>Default</i>	<i>Menu path</i>
Assignment 5 	Assignment	1..n, Assignment List	-.-	[Device Para /Binary Outputs /BO Slot X5 /BO 1]
Inverting 5 	Inverting of the state of the assigned signal.	inactive, active	inactive	[Device Para /Binary Outputs /BO Slot X5 /BO 1]
Assignment 6 	Assignment	1..n, Assignment List	-.-	[Device Para /Binary Outputs /BO Slot X5 /BO 1]
Inverting 6 	Inverting of the state of the assigned signal.	inactive, active	inactive	[Device Para /Binary Outputs /BO Slot X5 /BO 1]
Assignment 7 	Assignment	1..n, Assignment List	-.-	[Device Para /Binary Outputs /BO Slot X5 /BO 1]
Inverting 7 	Inverting of the state of the assigned signal.	inactive, active	inactive	[Device Para /Binary Outputs /BO Slot X5 /BO 1]
Operating Mode 	Operating Mode	Working current principle, Closed-circuit principle	Working current principle	[Device Para /Binary Outputs /BO Slot X5 /BO 2]
t-hold 	To clearly identify the state transition of a binary output relay, the "new state" is being hold, at least for the duration of the hold time.	0.00 - 300.00s	0.00s	[Device Para /Binary Outputs /BO Slot X5 /BO 2]
t-Off Delay 	Switch Off Delay	0.00 - 300.00s	0.00s	[Device Para /Binary Outputs /BO Slot X5 /BO 2]

Parameter	Description	Setting range	Default	Menu path
Latched 	Defines whether the Relay Output will be latched when it picks up.	inactive, active	inactive	[Device Para /Binary Outputs /BO Slot X5 /BO 2]
Acknowledgement 	Acknowledgement Signal - An acknowledgement signal (that acknowledges the corresponding binary output relay) can be assigned to each output relay. The acknowledgement-signal is only effective if the parameter "Latched" is set to active. Only available if: Latched = active	1..n, Assignment List	-.-	[Device Para /Binary Outputs /BO Slot X5 /BO 2]
Inverting 	Inverting of the collective signal (OR-gate/disjunction). In combination with inverted input signals an AND-gate can be programmed (Conjunction).	inactive, active	inactive	[Device Para /Binary Outputs /BO Slot X5 /BO 2]
Assignment 1 	Assignment	1..n, Assignment List	-.-	[Device Para /Binary Outputs /BO Slot X5 /BO 2]
Inverting 1 	Inverting of the state of the assigned signal.	inactive, active	inactive	[Device Para /Binary Outputs /BO Slot X5 /BO 2]
Assignment 2 	Assignment	1..n, Assignment List	-.-	[Device Para /Binary Outputs /BO Slot X5 /BO 2]
Inverting 2 	Inverting of the state of the assigned signal.	inactive, active	inactive	[Device Para /Binary Outputs /BO Slot X5 /BO 2]
Assignment 3 	Assignment	1..n, Assignment List	-.-	[Device Para /Binary Outputs /BO Slot X5 /BO 2]
Inverting 3 	Inverting of the state of the assigned signal.	inactive, active	inactive	[Device Para /Binary Outputs /BO Slot X5 /BO 2]

<i>Parameter</i>	<i>Description</i>	<i>Setting range</i>	<i>Default</i>	<i>Menu path</i>
Assignment 4 	Assignment	1..n, Assignment List	-.-	[Device Para /Binary Outputs /BO Slot X5 /BO 2]
Inverting 4 	Inverting of the state of the assigned signal.	inactive, active	inactive	[Device Para /Binary Outputs /BO Slot X5 /BO 2]
Assignment 5 	Assignment	1..n, Assignment List	-.-	[Device Para /Binary Outputs /BO Slot X5 /BO 2]
Inverting 5 	Inverting of the state of the assigned signal.	inactive, active	inactive	[Device Para /Binary Outputs /BO Slot X5 /BO 2]
Assignment 6 	Assignment	1..n, Assignment List	-.-	[Device Para /Binary Outputs /BO Slot X5 /BO 2]
Inverting 6 	Inverting of the state of the assigned signal.	inactive, active	inactive	[Device Para /Binary Outputs /BO Slot X5 /BO 2]
Assignment 7 	Assignment	1..n, Assignment List	-.-	[Device Para /Binary Outputs /BO Slot X5 /BO 2]
Inverting 7 	Inverting of the state of the assigned signal.	inactive, active	inactive	[Device Para /Binary Outputs /BO Slot X5 /BO 2]
Operating Mode 	Operating Mode	Working current principle, Closed-circuit principle	Working current principle	[Device Para /Binary Outputs /BO Slot X5 /BO 3]

<i>Parameter</i>	<i>Description</i>	<i>Setting range</i>	<i>Default</i>	<i>Menu path</i>
t-hold 	To clearly identify the state transition of a binary output relay, the "new state" is being hold, at least for the duration of the hold time.	0.00 - 300.00s	0.00s	[Device Para /Binary Outputs /BO Slot X5 /BO 3]
t-Off Delay 	Switch Off Delay	0.00 - 300.00s	0.00s	[Device Para /Binary Outputs /BO Slot X5 /BO 3]
Latched 	Defines whether the Relay Output will be latched when it picks up.	inactive, active	inactive	[Device Para /Binary Outputs /BO Slot X5 /BO 3]
Acknowledgem ent 	Acknowledgement Signal - An acknowledgement signal (that acknowledges the corresponding binary output relay) can be assigned to each output relay. The acknowledgement-signal is only effective if the parameter "Latched" is set to active. Only available if: Latched = active	1..n, Assignment List	-.-	[Device Para /Binary Outputs /BO Slot X5 /BO 3]
Inverting 	Inverting of the collective signal (OR-gate/disjunction). In combination with inverted input signals an AND-gate can be programmed (Conjunction).	inactive, active	inactive	[Device Para /Binary Outputs /BO Slot X5 /BO 3]
Assignment 1 	Assignment	1..n, Assignment List	-.-	[Device Para /Binary Outputs /BO Slot X5 /BO 3]
Inverting 1 	Inverting of the state of the assigned signal.	inactive, active	inactive	[Device Para /Binary Outputs /BO Slot X5 /BO 3]
Assignment 2 	Assignment	1..n, Assignment List	-.-	[Device Para /Binary Outputs /BO Slot X5 /BO 3]
Inverting 2 	Inverting of the state of the assigned signal.	inactive, active	inactive	[Device Para /Binary Outputs /BO Slot X5 /BO 3]

<i>Parameter</i>	<i>Description</i>	<i>Setting range</i>	<i>Default</i>	<i>Menu path</i>
Assignment 3 	Assignment	1..n, Assignment List	-.-	[Device Para /Binary Outputs /BO Slot X5 /BO 3]
Inverting 3 	Inverting of the state of the assigned signal.	inactive, active	inactive	[Device Para /Binary Outputs /BO Slot X5 /BO 3]
Assignment 4 	Assignment	1..n, Assignment List	-.-	[Device Para /Binary Outputs /BO Slot X5 /BO 3]
Inverting 4 	Inverting of the state of the assigned signal.	inactive, active	inactive	[Device Para /Binary Outputs /BO Slot X5 /BO 3]
Assignment 5 	Assignment	1..n, Assignment List	-.-	[Device Para /Binary Outputs /BO Slot X5 /BO 3]
Inverting 5 	Inverting of the state of the assigned signal.	inactive, active	inactive	[Device Para /Binary Outputs /BO Slot X5 /BO 3]
Assignment 6 	Assignment	1..n, Assignment List	-.-	[Device Para /Binary Outputs /BO Slot X5 /BO 3]
Inverting 6 	Inverting of the state of the assigned signal.	inactive, active	inactive	[Device Para /Binary Outputs /BO Slot X5 /BO 3]
Assignment 7 	Assignment	1..n, Assignment List	-.-	[Device Para /Binary Outputs /BO Slot X5 /BO 3]

Parameter	Description	Setting range	Default	Menu path
 Inverting 7	Inverting of the state of the assigned signal.	inactive, active	inactive	[Device Para /Binary Outputs /BO Slot X5 /BO 3]
 Operating Mode	Operating Mode	Working current principle, Closed-circuit principle	Working current principle	[Device Para /Binary Outputs /BO Slot X5 /BO 4]
 t-hold	To clearly identify the state transition of a binary output relay, the "new state" is being hold, at least for the duration of the hold time.	0.00 - 300.00s	0.00s	[Device Para /Binary Outputs /BO Slot X5 /BO 4]
 t-Off Delay	Switch Off Delay	0.00 - 300.00s	0.00s	[Device Para /Binary Outputs /BO Slot X5 /BO 4]
 Latched	Defines whether the Relay Output will be latched when it picks up.	inactive, active	inactive	[Device Para /Binary Outputs /BO Slot X5 /BO 4]
 Acknowledgement	Acknowledgement Signal - An acknowledgement signal (that acknowledges the corresponding binary output relay) can be assigned to each output relay. The acknowledgement-signal is only effective if the parameter "Latched" is set to active. Only available if: Latched = active	1..n, Assignment List	.-	[Device Para /Binary Outputs /BO Slot X5 /BO 4]
 Inverting	Inverting of the collective signal (OR-gate/disjunction). In combination with inverted input signals an AND-gate can be programmed (Conjunction).	inactive, active	inactive	[Device Para /Binary Outputs /BO Slot X5 /BO 4]
 Assignment 1	Assignment	1..n, Assignment List	.-	[Device Para /Binary Outputs /BO Slot X5 /BO 4]
 Inverting 1	Inverting of the state of the assigned signal.	inactive, active	inactive	[Device Para /Binary Outputs /BO Slot X5 /BO 4]

<i>Parameter</i>	<i>Description</i>	<i>Setting range</i>	<i>Default</i>	<i>Menu path</i>
Assignment 2 	Assignment	1..n, Assignment List	-.-	[Device Para /Binary Outputs /BO Slot X5 /BO 4]
Inverting 2 	Inverting of the state of the assigned signal.	inactive, active	inactive	[Device Para /Binary Outputs /BO Slot X5 /BO 4]
Assignment 3 	Assignment	1..n, Assignment List	-.-	[Device Para /Binary Outputs /BO Slot X5 /BO 4]
Inverting 3 	Inverting of the state of the assigned signal.	inactive, active	inactive	[Device Para /Binary Outputs /BO Slot X5 /BO 4]
Assignment 4 	Assignment	1..n, Assignment List	-.-	[Device Para /Binary Outputs /BO Slot X5 /BO 4]
Inverting 4 	Inverting of the state of the assigned signal.	inactive, active	inactive	[Device Para /Binary Outputs /BO Slot X5 /BO 4]
Assignment 5 	Assignment	1..n, Assignment List	-.-	[Device Para /Binary Outputs /BO Slot X5 /BO 4]
Inverting 5 	Inverting of the state of the assigned signal.	inactive, active	inactive	[Device Para /Binary Outputs /BO Slot X5 /BO 4]
Assignment 6 	Assignment	1..n, Assignment List	-.-	[Device Para /Binary Outputs /BO Slot X5 /BO 4]

Parameter	Description	Setting range	Default	Menu path
 Inverting 6	Inverting of the state of the assigned signal.	inactive, active	inactive	[Device Para /Binary Outputs /BO Slot X5 /BO 4]
 Assignment 7	Assignment	1..n, Assignment List	-.-	[Device Para /Binary Outputs /BO Slot X5 /BO 4]
 Inverting 7	Inverting of the state of the assigned signal.	inactive, active	inactive	[Device Para /Binary Outputs /BO Slot X5 /BO 4]
 DISARMED Ctrl	Enables and disables the disarming of the relay outputs. This is the first step of a two step process, to inhibit the operation or the relay outputs. Please refer to "DISARMED" for the second step.	inactive, active	inactive	[Service /Test (Prot inhibit) /DISARMED /BO Slot X5]
 Disarm Mode	CAUTION! RELAYS DISARMED in order to safely perform maintenance while eliminating the risk of taking an entire process off-line. (Note: The Supervision Contact cannot be disarmed). YOU MUST ENSURE that the relays are ARMED AGAIN after maintenance.	permanent, timeout	permanent	[Service /Test (Prot inhibit) /DISARMED /BO Slot X5]
 t-Timeout DISARM	The relays will be armed again after expiring of this time. Only available if: Mode = Timeout DISARM	0.00 - 300.00s	0.03s	[Service /Test (Prot inhibit) /DISARMED /BO Slot X5]
 Force Mode	By means of this function the normal Output Relay States can be overwritten (forced) in case that the Relay is not in a disarmed state. The relays can be set from normal operation (relay works according to the assigned signals) to "force energized" or "force de-energized" state.	permanent, timeout	permanent	[Service /Test (Prot inhibit) /Force OR /BO Slot X5]
 t-Timeout Force	The Output State will be set by force for the duration of this time. That means for the duration of this time the Output Relay does not show the state of the signals that are assigned on it. Only available if: Mode = Timeout DISARM	0.00 - 300.00s	0.03s	[Service /Test (Prot inhibit) /Force OR /BO Slot X5]

Input States of the Binary Output Relays on OR- 4 X

<i>Name</i>	<i>Description</i>	<i>Assignment via</i>
BO1.1	Module input state: Assignment	[Device Para /Binary Outputs /BO Slot X5 /BO 1]
BO1.2	Module input state: Assignment	[Device Para /Binary Outputs /BO Slot X5 /BO 1]
BO1.3	Module input state: Assignment	[Device Para /Binary Outputs /BO Slot X5 /BO 1]
BO1.4	Module input state: Assignment	[Device Para /Binary Outputs /BO Slot X5 /BO 1]
BO1.5	Module input state: Assignment	[Device Para /Binary Outputs /BO Slot X5 /BO 1]
BO1.6	Module input state: Assignment	[Device Para /Binary Outputs /BO Slot X5 /BO 1]
BO1.7	Module input state: Assignment	[Device Para /Binary Outputs /BO Slot X5 /BO 1]
Ack signal BO 1	Module input state: Acknowledgement signal for the binary output relay. If latching is set to active, the binary output relay can only be acknowledged if those signals that initiated the setting are fallen back and the hold time is expired.	[Device Para /Binary Outputs /BO Slot X5 /BO 1]
BO2.1	Module input state: Assignment	[Device Para /Binary Outputs /BO Slot X5 /BO 2]

<i>Name</i>	<i>Description</i>	<i>Assignment via</i>
BO2.2	Module input state: Assignment	[Device Para /Binary Outputs /BO Slot X5 /BO 2]
BO2.3	Module input state: Assignment	[Device Para /Binary Outputs /BO Slot X5 /BO 2]
BO2.4	Module input state: Assignment	[Device Para /Binary Outputs /BO Slot X5 /BO 2]
BO2.5	Module input state: Assignment	[Device Para /Binary Outputs /BO Slot X5 /BO 2]
BO2.6	Module input state: Assignment	[Device Para /Binary Outputs /BO Slot X5 /BO 2]
BO2.7	Module input state: Assignment	[Device Para /Binary Outputs /BO Slot X5 /BO 2]
Ack signal BO 2	Module input state: Acknowledgement signal for the binary output relay. If latching is set to active, the binary output relay can only be acknowledged if those signals that initiated the setting are fallen back and the hold time is expired.	[Device Para /Binary Outputs /BO Slot X5 /BO 2]
BO3.1	Module input state: Assignment	[Device Para /Binary Outputs /BO Slot X5 /BO 3]
BO3.2	Module input state: Assignment	[Device Para /Binary Outputs /BO Slot X5 /BO 3]

Name	Description	Assignment via
BO3.3	Module input state: Assignment	[Device Para /Binary Outputs /BO Slot X5 /BO 3]
BO3.4	Module input state: Assignment	[Device Para /Binary Outputs /BO Slot X5 /BO 3]
BO3.5	Module input state: Assignment	[Device Para /Binary Outputs /BO Slot X5 /BO 3]
BO3.6	Module input state: Assignment	[Device Para /Binary Outputs /BO Slot X5 /BO 3]
BO3.7	Module input state: Assignment	[Device Para /Binary Outputs /BO Slot X5 /BO 3]
Ack signal BO 3	Module input state: Acknowledgement signal for the binary output relay. If latching is set to active, the binary output relay can only be acknowledged if those signals that initiated the setting are fallen back and the hold time is expired.	[Device Para /Binary Outputs /BO Slot X5 /BO 3]
BO4.1	Module input state: Assignment	[Device Para /Binary Outputs /BO Slot X5 /BO 4]
BO4.2	Module input state: Assignment	[Device Para /Binary Outputs /BO Slot X5 /BO 4]
BO4.3	Module input state: Assignment	[Device Para /Binary Outputs /BO Slot X5 /BO 4]

<i>Name</i>	<i>Description</i>	<i>Assignment via</i>
BO4.4	Module input state: Assignment	[Device Para /Binary Outputs /BO Slot X5 /BO 4]
BO4.5	Module input state: Assignment	[Device Para /Binary Outputs /BO Slot X5 /BO 4]
BO4.6	Module input state: Assignment	[Device Para /Binary Outputs /BO Slot X5 /BO 4]
BO4.7	Module input state: Assignment	[Device Para /Binary Outputs /BO Slot X5 /BO 4]
Ack signal BO 4	Module input state: Acknowledgement signal for the binary output relay. If latching is set to active, the binary output relay can only be acknowledged if those signals that initiated the setting are fallen back and the hold time is expired.	[Device Para /Binary Outputs /BO Slot X5 /BO 4]

Signals of the Binary Output Relays on OR- 4 X

<i>Signal</i>	<i>Description</i>
BO 1	Signal: Binary Output Relay
BO 2	Signal: Binary Output Relay
BO 3	Signal: Binary Output Relay
BO 4	Signal: Binary Output Relay
DISARMED!	Signal: CAUTION! RELAYS DISARMED in order to safely perform maintenance while eliminating the risk of taking an entire process off-line. (Note: The Self Supervision Contact cannot be disarmed). YOU MUST ENSURE that the relays are ARMED AGAIN after maintenance
Outs forced	Signal: The State of at least one Relay Output has been set by force. That means that the state of at least one Relay is forced and hence does not show the state of the assigned signals.

Configuration of the Analog Outputs

Available Elements:
AnOut[1] .AnOut[2]

The Analog Outputs can be programmed to output for three different ranges of either »0- 20mA«, »4- 20 mA«, or »0-10 Volts«.

These outputs can be configured by the User to represent the status of User programmed parameters that are available from the relay. The User will find the configuration menu for this feature under the [Device Para/ Analog Outputs] menu option. Here the User can define to which parameter the output will correlate.

Once the assignment has been made, the User can select the expected range of the parameter that will correlate to the analog output. The User will be required to enter a »Range min«, and »Range max«. The »Range min« will determine the value at which value the transmission will start. Likewise, the »Range max« value will determine the value that will result in the end value of the transmission.

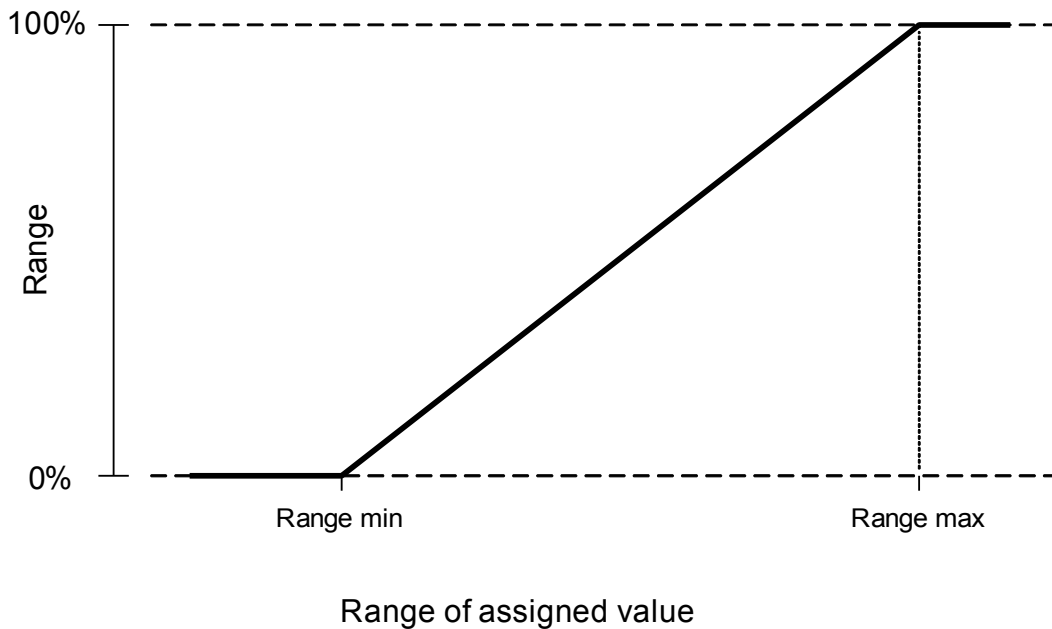

Setting Example: Analog Output with Active Power P*

*=only available in Devices that offer Power Protection

All settings/thresholds within the power module are to be set as per unit thresholds. Per definition S_n is to be used as scale basis.

$$S_n = \sqrt{3} * \text{VoltageTransformer}_{\text{Line-to-Line_Rated_Voltage}} * \text{CurrentTransformer}_{\text{Rated_Current}}$$

If thresholds should base on primary side values:

$$S_n = \sqrt{3} * \text{VoltageTransformer}_{\text{Pri_Line-to-Line_Rated_Voltage}} * \text{CurrentTransformer}_{\text{Pri_Rated_Current}}$$

If thresholds should base on secondary side values

$$S_n = \sqrt{3} * \text{VoltageTransformer}_{\text{Sec_Line-to-Line_Rated_Voltage}} * \text{CurrentTransformer}_{\text{Sec_Rated_Current}}$$

Example – Field Data

- CurrentTransformer CT pri =200 A; CT sec = 5 A
- VoltageTransformer VT pri = 10 kV; VT sec =100 V
- Active power range 1 MW to 4 MW is mapped to an Analog Outputs 0% to 100%.

Calculating setting for Range min and Range max based on primary side values

Active power range is 1 MW to 4 MW.

First S_n is to be calculated:

$$S_n = \sqrt{3} * \text{VoltageTransformer}_{\text{Pri_Line-to-Line_Rated_Voltage}} * \text{CurrentTransformer}_{\text{Pri_Rated_Current}}$$

$$S_n = 1.73 * 10000 \text{ V} * 200 \text{ A} = 3.464 \text{ MVA}$$

Calculating the range settings based to S_n :

$$\text{Range min (0\%)} = 1 \text{ MW} / 3.464 \text{ MVA} = \underline{0.29 S_n}$$

$$\text{Range max (100\%)} = 4 \text{ MW} / 3.464 \text{ MVA} = \underline{1.15 S_n}$$

Calculate the Analog Output percentage for specific value:

$$\text{AnalogOutput (InputValue)} = 100\% / (\text{Range max} - \text{Range min}) * (\text{InputValue} - \text{Range min})$$

For e.g. Input value $1 S_n$:

$$\text{AnalogOutput}(1 S_n) = 100\% / 0.86 S_n * (1 S_n - 0.29 S_n) = \underline{82.5\%}$$

The Output current for e.g. 4...20mA type is then 17.7 mA = 4mA + 82.5% * (20mA – 4mA)

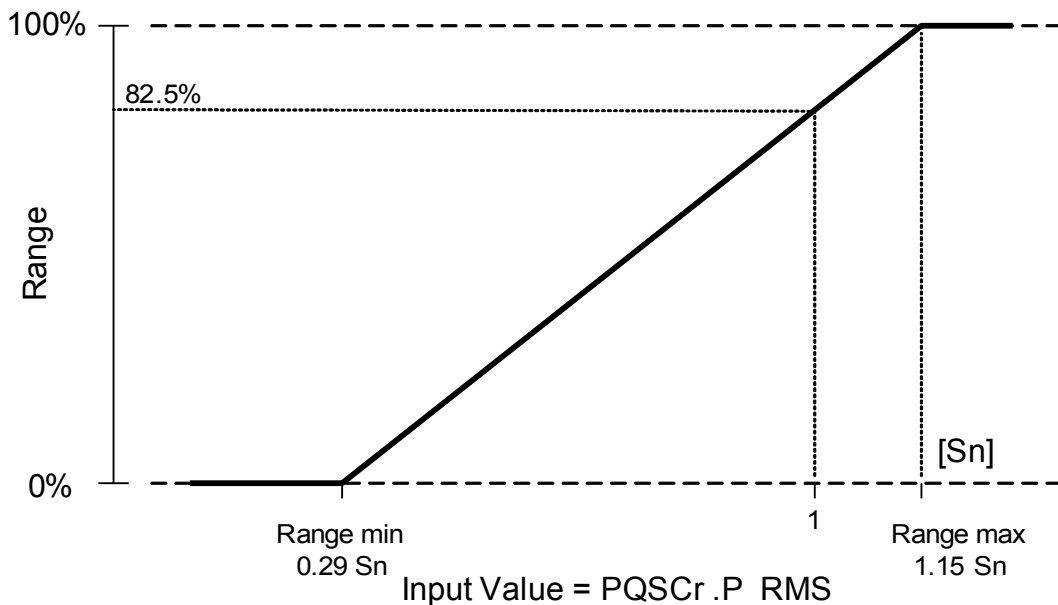

Setting Example: Analog Output with Power Factor PF*

*=only available in Devices that offer Power Protection

Since the sign of Power Factor PF follows the sign of Active Power P, there is no distinguish between capacitive and inductive Reactive Power. Hence, for Analog Output assignment the setting for PF output range uses a Power Factor with a "Sign Convention":

- a positive sign (+) PF, if Active and Reactive Power has same sign
- a negative sign (-) PF, if Active and Reactive Power has different sign

For e.g. if Active Power is flowing into the load and Current lags the voltage for a inductive load, PF with sign convention uses a positive sign. This is important to set the right range settings for Analog Ouput.

Use case for analog instrument with 4...20mA with linear scale, where scale is in range from 0.8 capacitive to 0.3 inductive, following setting should be uses:

$$\begin{aligned} \text{Range min (0\%)} &= \underline{-0.8} \\ \text{Range max (100\%)} &= \underline{+0.3} \end{aligned}$$

Calculate the Analog Output percentage for specific value for e.g. unity: $|PF|=1$ at $\phi = 0^\circ$:

First the signed PF needs to be converted into a linear range:

$$\begin{aligned} \text{Range min' (0\%)} &= -1 - (-0.8) = \underline{-0.2} \\ \text{Range max' (100\%)} &= +1 - (+0.3) = \underline{+0.7} \\ \text{InputValue'} &= +1 - (+1) = \underline{0.0} \end{aligned}$$





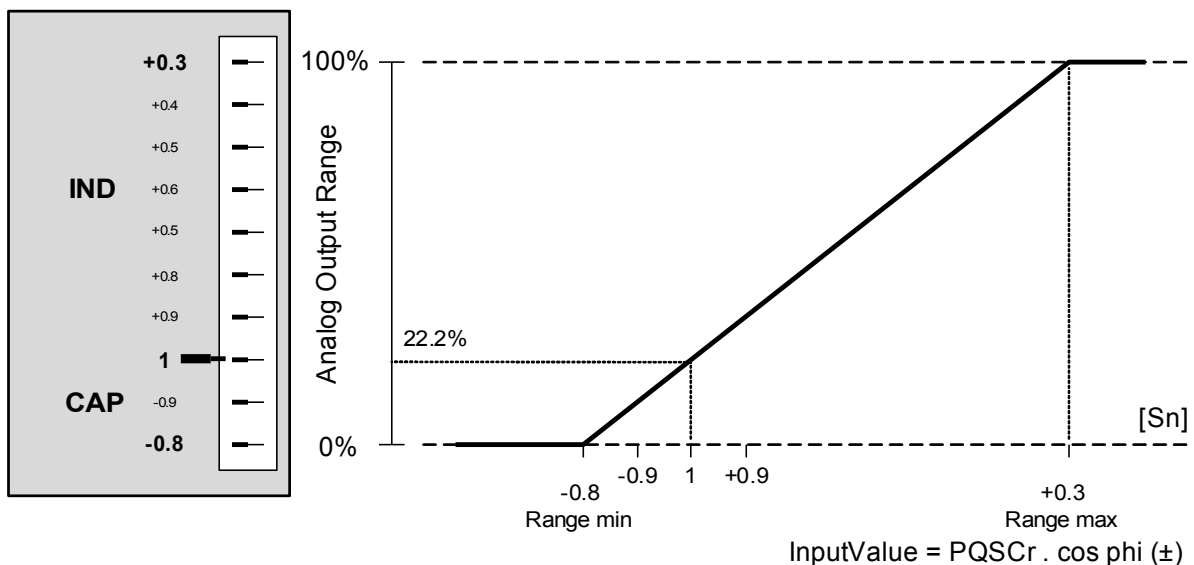

$$\text{AnalogOutput (InputValue')} = 100\% / (\text{Range max'} - \text{Range min}') * (\text{InputValue'} - \text{Range min}')$$

$$\text{AnalogOutput(0)} = 100\% / 0.9 * 0.2 = \underline{22.2\%}$$



The Output current for e.g. 4...20mA type is then $\underline{7.5 \text{ mA}} = 4\text{mA} + 22.2\% * (20\text{mA} - 4\text{mA})$



Global Protection Parameters of the Analog Outputs

Parameter	Description	Setting range	Default	Menu path
Assignment 	Assignment	1..n, AnalogOutputList	.-	[Device Para /Analog Outputs /AnOut[1]]
Range 	Adjustable range	0...20mA, 4...20mA, 0...10V	0...20mA	[Device Para /Analog Outputs /AnOut[1]]
Range max 	Adjustable range maximum.	-999999.00 - 999999.00°C	1.00°C	[Device Para /Analog Outputs /AnOut[1]]
Range min 	Adjustable range minimum.	-999999.00 - 999999.00°C	0.00°C	[Device Para /Analog Outputs /AnOut[1]]
Force Mode 	For commissioning purposes or for maintenance, Analog Outputs can be set by force. By means of this function the normal Analog Outputs can be overwritten (forced).	permanent, timeout	permanent	[Service /Test (Prot inhibit) /Analog Outputs /AnOut[1]]
t-Timeout Force 	The Analog Output Value will be set by force for the duration of this time. That means for the duration of this time the Analog Output does not show the value of the signals that are assigned on it. Only available if: Force Mode = active	0.00 - 300.00s	0.03s	[Service /Test (Prot inhibit) /Analog Outputs /AnOut[1]]

Direct Commands of the Analog Outputs

<i>Parameter</i>	<i>Description</i>	<i>Setting range</i>	<i>Default</i>	<i>Menu path</i>
Function 	Permanent activation or deactivation of module/stage.	inactive, active	inactive	[Service /Test (Prot inhibit) /Analog Outputs /AnOut[1]]
Force Value 	By means of this function the Analog Output Value can be overwritten (forced).	0.00 - 100.00%	0%	[Service /Test (Prot inhibit) /Analog Outputs /AnOut[1]]

Signals of the Analog Outputs

<i>Signal</i>	<i>Description</i>
Force Mode	For commissioning purposes or for maintenance, Analog Outputs can be set by force. By means of this function the normal Analog Outputs can be overwritten (forced).

List of the Analog Outputs

<i>Name</i>	<i>Description</i>
.-.	No assignment
VT.f	Measured value: Frequency
VT.VL12 RMS	Measured value: Phase-to-phase voltage (RMS)
VT.VL23 RMS	Measured value: Phase-to-phase voltage (RMS)
VT.VL31 RMS	Measured value: Phase-to-phase voltage (RMS)
VT.VL1 RMS	Measured value: Phase-to-neutral voltage (RMS)
VT.VL2 RMS	Measured value: Phase-to-neutral voltage (RMS)
VT.VL3 RMS	Measured value: Phase-to-neutral voltage (RMS)
VT.VX meas RMS	Measured value (measured): VX measured (RMS)
VT.VG calc RMS	Measured value (calculated): VG (RMS)
VT.VL12 THD	Measured value (calculated): V12 Total Harmonic Distortion
VT.VL23 THD	Measured value (calculated): V23 Total Harmonic Distortion
VT.VL31 THD	Measured value (calculated): V31 Total Harmonic Distortion
VT.VL1 THD	Measured value (calculated): VL1 Total Harmonic Distortion
VT.VL2 THD	Measured value (calculated): VL2 Total Harmonic Distortion
VT.VL3 THD	Measured value (calculated): VL3 Total Harmonic Distortion
CT Ntrl.IL1 RMS	Measured value: Phase current (RMS)
CT Ntrl.IL2 RMS	Measured value: Phase current (RMS)
CT Ntrl.IL3 RMS	Measured value: Phase current (RMS)
CT Ntrl.IG meas RMS	Measured value (measured): IG (RMS)
CT Ntrl.IG calc RMS	Measured value (calculated): IG (RMS)
CT Ntrl.IL1 THD	Measured value (calculated): IL1 Total Harmonic Current
CT Ntrl.IL2 THD	Measured value (calculated): IL2 Total Harmonic Current
CT Ntrl.IL3 THD	Measured value (calculated): IL3 Total Harmonic Current
ThR.Thermal Cap Used	Measured value: Thermal Capacity Used
Sync.Slip Freq	Slip frequency
Sync.Volt Diff	Voltage difference between bus and line.
Sync.Angle Diff	Angle difference between bus and line voltages.
Sync.f Bus	Bus frequency
Sync.f Line	Line frequency
Sync.V Bus	Bus Voltage
Sync.V Line	Line Voltage
Sync.Angle Bus	Bus Angle (Reference)
Sync.Angle Line	Line Angle
URTD.Windg1	Winding 1
URTD.Windg2	Winding 2
URTD.Windg3	Winding 3
URTD.Windg4	Winding 4

<i>Name</i>	<i>Description</i>
URTD.Windg5	Winding 5
URTD.Windg6	Winding 6
URTD.MotBear1	Motor Bearing 1
URTD.MotBear2	Motor Bearing 2
URTD.LoadBear1	Load Bearing 1
URTD.LoadBear2	Load Bearing 2
URTD.Aux1	Auxiliary1
URTD.Aux2	Auxiliary2
URTD.RTD Max	Maximum temperature of all channels.
RTD.HottestWindingTemp	Hottest motor winding temperature in degrees C.
RTD.Hottest MotBearTemp	Hottest motor bearing temperature in degrees C.
PQSCr.S RMS	Measured Value (Calculated): Apparent power (RMS)
PQSCr.P RMS	Measured value (calculated): Active power (P- = Fed Active Power, P+ = Consumpted Active Power) (RMS)
PQSCr.Q	Measured value (calculated): Reactive power (Q- = Fed Reactive Power, Q+ = Consumpted Reactive Power) (fundamental)
PQSCr.cos phi (±)	Measured value (calculated): Power factor: Sign Convention: (+)PF:I lags V (-)PF:I leads V
PQSCr.cos phi RMS(±)	Measured value (calculated): Power factor: Sign Convention: (+)PF:I lags V (-)PF:I leads V
PQSCr.Ws Net	Absolute Apparent Power Hours
PQSCr.Wp Net	Absolute Active Power Hours
PQSCr.Wp+	Positive Active Power is consumed active energy
PQSCr.Wp-	Negative Active Power (Fed Energy)
PQSCr.Wq Net	Absolute Reactive Power Hours
PQSCr.Wq+	Positive Reactive Power is consumed Reactive Energy
PQSCr.Wq-	Negative Reactive Power (Fed Energy)

Analog Inputs

These inputs can be configured by the User to represent the status of external analog values that are fed to the relay.

Using Analog Inputs is a two step procedure. The user has to configure the *Measuring Elements* and the *Analog Protection Elements*. Each Analog Input (hardware) is represented by one *Measuring Element* (named AnIn[x]). That means the number of *Measuring Elements* is equal to the number of analog inputs. The user can set for each *Measuring Element* the type of input (e.g. 4...20 mA). The *Measuring Element* will provide analog values based on this setting. The values being provided by the *Measuring Elements* have to be assigned onto the *Analog Protection Elements* in order to feed them. Hence one *Measuring Element* can be assigned on multiple *Analog Protection Elements*. The number and names of the *Analog Protection Elements* are depending on the ordered device.

Examples for *Analog Input Elements*.

- Generator Protection Device (Example): FldC[n] - DC Field Current.
- Motor Protection Device (Example): Spd[n] – Speed.
- Transformer Protection Device (Example) TapV[n] - Tap Voltage.

Each *Analog Input Element* is available as an *Alarm* and as a *Trip* Element.

The Configuration comprises:

Step 1 (please see section “Setting the Measuring Elements”): The first step is to set within the [Device Parameters] the type of input for each available Analog Input (Measuring Element). That means determining what kind of measuring values will be provided by each analog input (e.g. 4...20 mA).

Step 2 (please see section “Configuring the Analog Protection Elements”): Configuring an Analog Protection Element means: Activating the "Trip and/or Alarm-Element" within the [Device Planning]. After that, the Element has to be configured within the [Protection Parameters].

Step 1 - Setting the Measuring Elements

The User can set the type of input within the [Device Para/ Analog Inputs] menu option.

- 0...20 mA
- 4...20 mA
- 0...10 V

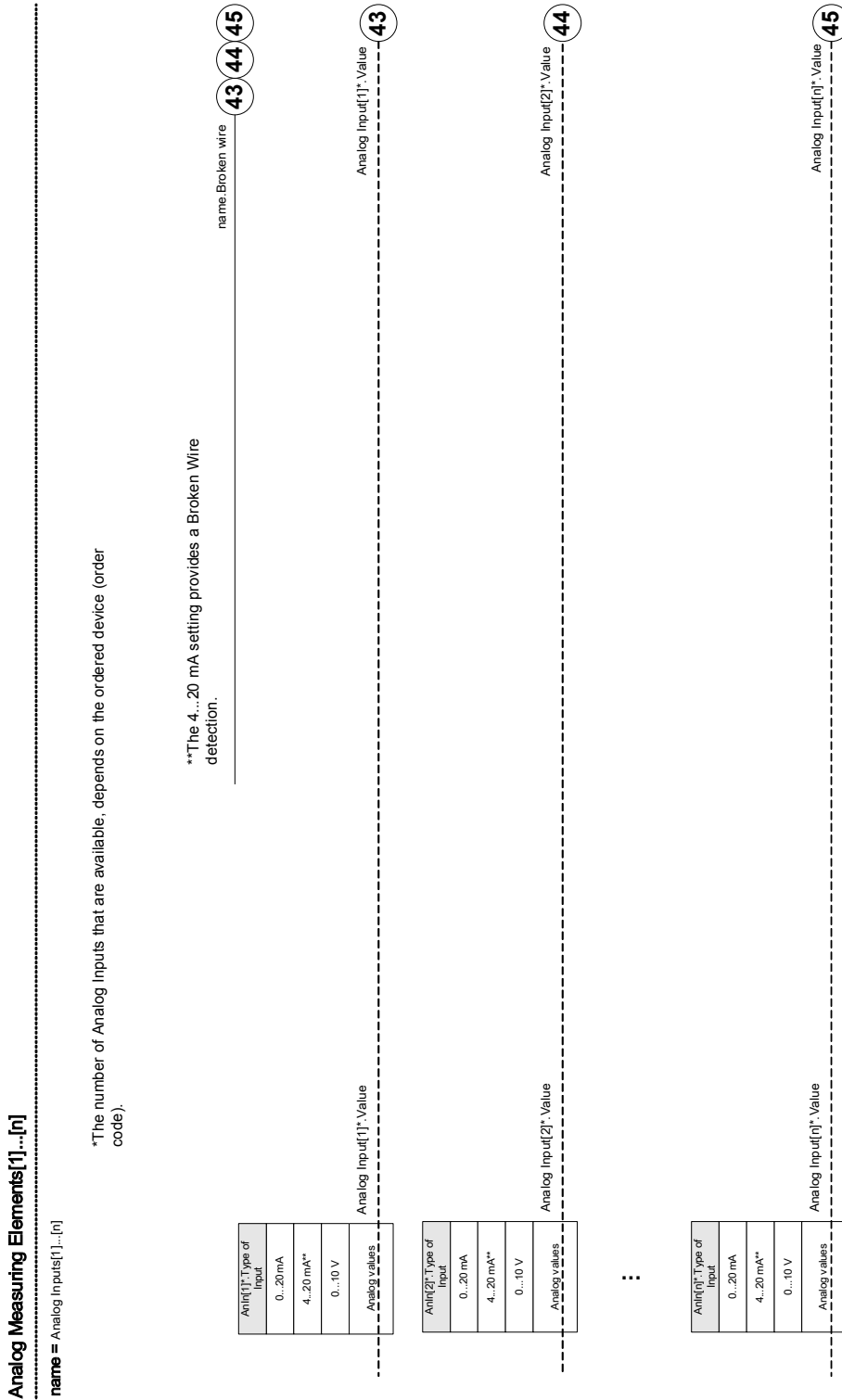

Step 2 - Configuring the Analog Protection Elements

Within the Protection Parameters [Protection Para/Global Para/Analog Inputs] the User has to select the Measuring element/Analog Input, that feeds the Analog Protection Element. The user also has to set a threshold and a tripping delay time for the Analog Protection Element. The number and Names of the Analog Input Functions that are available depend on the ordered device.

Also the Pickup Mode can be selected between »over« and »under«. The setting »over« means the relay picks up, when the analog measuring value exceeds the set threshold. The setting »under« means the relay picks up, when the analog measuring value falls below the set threshold. When the Input Type 4...20 mA is selected, the relay provides a Broken Wire Supervision. When a wire is broken, a broken wire alarm will be issued and alarm and trip commands of the Analog Protection Elements will be inhibited.

Analog Protection Trip Elements

Analog Protection Elements[1]...[n]

name = Analog Inputs[1]...[n]

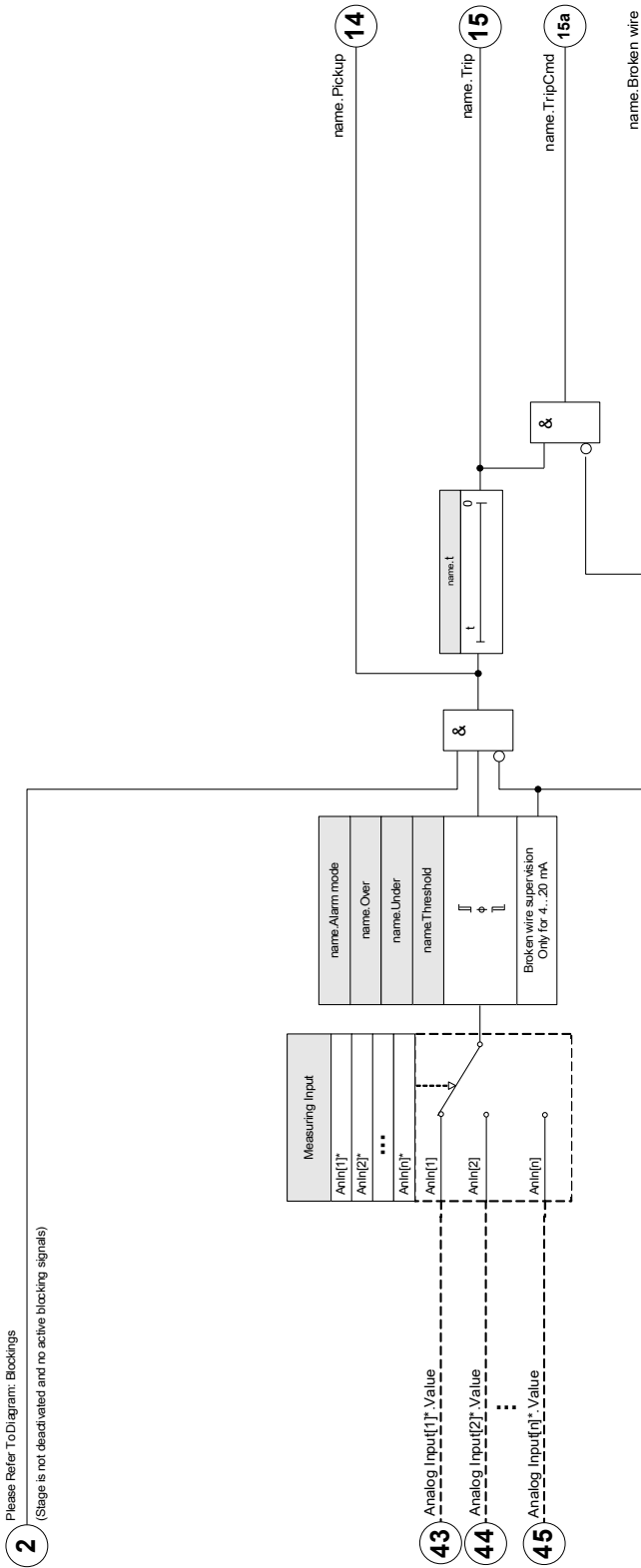

2 Please Refer To Diagram: Blockings
(Stage is not deactivated and no active blocking signals)

43 Analog Input[1]* Value
44 Analog Input[2]* Value
45 Analog Input[n]* Value

* The number of Analog Inputs that are available, depends on the ordered device (order code).

3 Please Refer To Diagram: Trip blockings
(Tripping command deactivated or blocked.)

Measuring Elements

AnIn[1] .AnIn[2]



List of available Analog Inputs

Name	Description
.-	No assignment
AnIn[1].Value	Measured value of the Input in percent
AnIn[2].Value	Measured value of the Input in percent

Signals (Output States) of the Analog Measuring Elements





Signal	Description
Broken wire	Signal: Broken wire. This signal is only valid, if the analog input is used in the 4...20 mA mode.
Input forced	The value of analog Input has been set by force. That means that the value of the analog Input is forced and does not represent the real measured value.

Direct Commands of the Analog Measuring Elements

Parameter	Description	Setting range	Default	Menu path
 Function	Permanent activation or deactivation of module/stage.	inactive, active	inactive	[Service /Test (Prot inhibit) /Analog Inputs /AnIn[1]]
 Force Value	By means of this function the Analog Input Value can be overwritten (forced).	0.0 - 100.0%	0%	[Service /Test (Prot inhibit) /Analog Inputs /AnIn[1]]

Global Protection Parameters of the Analog Measuring Elements

Parameter	Description	Setting range	Default	Menu path
 Updateinterv	Adjustable time between value updates	0.00 - 5s	0.04s	[Device Para /Analog Inputs /AnIn[1]]

<i>Parameter</i>	<i>Description</i>	<i>Setting range</i>	<i>Default</i>	<i>Menu path</i>
Mode 	The threshold depends to the mode/ mA or V	0...20 mA, 4...20 mA, 0...10V	0...20 mA	[Device Para /Analog Inputs /AnIn[1]]
Conversion Time 	Conversion time needed by the ADC to sample input values.	0.00 - 0.5s	0.01s	[Device Para /Analog Inputs /AnIn[1]]
Force Mode 	For commissioning purposes or for maintenance, Analog Inputs can be set by force. By means of this function the normal Analog Inputs can be overwritten (forced).	permanent, timeout	permanent	[Service /Test (Prot inhibit) /Analog Inputs /AnIn[1]]
t-Timeout Force 	The Analog Input Value will be set by force for the duration of this time. That means for the duration of this time the Analog Input does not show the value of the signals that are assigned on it. Only available if: Force Mode = active	0.00 - 300.00s	0.03s	[Service /Test (Prot inhibit) /Analog Inputs /AnIn[1]]

Values of the Analog Measuring Elements

<i>Value</i>	<i>Description</i>	<i>Menu path</i>
Value	Measured value of the Input in percent	[Operation /Measured Values /Analog Inputs]

Analog Trip Protection Elements

AnaP[1] ,AnaP[2] ,AnaP[3] ,AnaP[4]

Inputs of the Analog Trip Elements





Name	Description	Assignment via
ExBlo1-I	Module input state: External blocking1	[Protection Para /Global Prot Para /Analog Inputs /AnaP[1]]
ExBlo2-I	Module input state: External blocking2	[Protection Para /Global Prot Para /Analog Inputs /AnaP[1]]
ExBlo TripCmd-I	Module input state: External Blocking of the Trip Command	[Protection Para /Global Prot Para /Analog Inputs /AnaP[1]]

Signals (Output States) of the Analog Trip Elements

Signal	Description
active	Signal: active
ExBlo	Signal: External Blocking
Blo TripCmd	Signal: Trip Command blocked
ExBlo TripCmd	Signal: External Blocking of the Trip Command
Pickup	Signal: Alarm Analog Input
Trip	Signal: Trip
TripCmd	Signal: Trip Command

Setting Group Parameters of the Analog Trip Elements





Parameter	Description	Setting range	Default	Menu path
 Function	Permanent activation or deactivation of module/stage.	inactive, active	inactive	[Protection Para /<1..4> /Analog Inputs /AnaP[1]]

Parameter	Description	Setting range	Default	Menu path
ExBlo Fc 	Activate (allow) or inactivate (disallow) blocking of the module/stage. This parameter is only effective if a signal is assigned to the corresponding global protection parameter. If the signal becomes true, those modules/stages are blocked that are parameterized "ExBlo Fc=active".	inactive, active	inactive	[Protection Para /<1..4> /Analog Inputs /AnaP[1]]
Blo TripCmd 	Permanent blocking of the Trip Command of the module/stage.	inactive, active	inactive	[Protection Para /<1..4> /Analog Inputs /AnaP[1]]
ExBlo TripCmd Fc 	Activate (allow) or inactivate (disallow) blocking of the module/stage. This parameter is only effective if a signal is assigned to the corresponding global protection parameter. If the signal becomes true, those modules/stages are blocked that are parameterized "ExBlo TripCmd Fc=active".	inactive, active	inactive	[Protection Para /<1..4> /Analog Inputs /AnaP[1]]
Threshold 	Threshold	0.1 - 100.0%	20%	[Protection Para /<1..4> /Analog Inputs /AnaP[1]]
t 	Tripping delay	0.00 - 10.00s	1s	[Protection Para /<1..4> /Analog Inputs /AnaP[1]]

Device Planning Parameters of the Analog Trip Elements







<i>Parameter</i>	<i>Description</i>	<i>Options</i>	<i>Default</i>	<i>Menu path</i>
Mode 	Mode	do not use, use	AnaP[1]: use AnaP[2]: do not use AnaP[3]: do not use AnaP[4]: do not use	[Device planning]









Global Protection Parameters of the Analog Trip Elements

<i>Parameter</i>	<i>Description</i>	<i>Setting range</i>	<i>Default</i>	<i>Menu path</i>
ExBlo1 	External blocking of the module, if blocking is activated (allowed) within a parameter set and if the state of the assigned signal is true.	1..n, Assignment List	.-	[Protection Para /Global Prot Para /Analog Inputs /AnaP[1]]
ExBlo2 	External blocking of the module, if blocking is activated (allowed) within a parameter set and if the state of the assigned signal is true.	1..n, Assignment List	.-	[Protection Para /Global Prot Para /Analog Inputs /AnaP[1]]
ExBlo TripCmd 	External blocking of the Trip Command of the module/the stage, if blocking is activated (allowed) within a parameter set and if the state of the assigned signal is true.	1..n, Assignment List	.-	[Protection Para /Global Prot Para /Analog Inputs /AnaP[1]]
Measuring Input 	Measuring Input	1..n, AnalogOutputList	.-	[Protection Para /Global Prot Para /Analog Inputs /AnaP[1]]
Alarm mode 	Alarm mode	Over, Under	Over	[Protection Para /Global Prot Para /Analog Inputs /AnaP[1]]

Global Protection Parameters of the LED Module









LEDs group A ,LEDs group B

Parameter	Description	Setting range	Default	Menu path
Latched 	Defines whether the LED will be latched when it picks up.	inactive, active, active, ack. by alarm	inactive	[Device Para /LEDs /LEDs group A /LED 1]
Ack signal 	Acknowledgement signal for the LED. If latching is set to active the LED can only be acknowledged if those signals that initiated the setting are no longer present. Dependency Only available if: Latched = active	1..n, Assignment List	-.-	[Device Para /LEDs /LEDs group A /LED 1]
LED active color 	The LED lights up in this color if the state of the OR-assignment of the signals is true.	green, red, red flash, green flash, -	LEDs group A: green LEDs group B: red	[Device Para /LEDs /LEDs group A /LED 1]
LED inactive color 	The LED lights up in this color if the state of the OR-assignment of the signals is untrue.	green, red, red flash, green flash, -	-	[Device Para /LEDs /LEDs group A /LED 1]
Assignment 1 	Assignment	1..n, Assignment List	LEDs group A: Prot.active LEDs group B: -.-	[Device Para /LEDs /LEDs group A /LED 1]
Inverting 1 	Inverting of the state of the assigned signal.	inactive, active	inactive	[Device Para /LEDs /LEDs group A /LED 1]
Assignment 2 	Assignment	1..n, Assignment List	-.-	[Device Para /LEDs /LEDs group A /LED 1]
Inverting 2 	Inverting of the state of the assigned signal.	inactive, active	inactive	[Device Para /LEDs /LEDs group A /LED 1]









Parameter	Description	Setting range	Default	Menu path
Assignment 3 	Assignment	1..n, Assignment List	-.-	[Device Para /LEDs /LEDs group A /LED 1]
Inverting 3 	Inverting of the state of the assigned signal.	inactive, active	inactive	[Device Para /LEDs /LEDs group A /LED 1]
Assignment 4 	Assignment	1..n, Assignment List	-.-	[Device Para /LEDs /LEDs group A /LED 1]
Inverting 4 	Inverting of the state of the assigned signal.	inactive, active	inactive	[Device Para /LEDs /LEDs group A /LED 1]
Assignment 5 	Assignment	1..n, Assignment List	-.-	[Device Para /LEDs /LEDs group A /LED 1]
Inverting 5 	Inverting of the state of the assigned signal.	inactive, active	inactive	[Device Para /LEDs /LEDs group A /LED 1]
Latched 	Defines whether the LED will be latched when it picks up.	inactive, active, active, ack. by alarm	LEDs group A: active LEDs group B: inactive	[Device Para /LEDs /LEDs group A /LED 2]
Ack signal 	Acknowledgement signal for the LED. If latching is set to active the LED can only be acknowledged if those signals that initiated the setting are no longer present. Only available if: Latched = active	1..n, Assignment List	-.-	[Device Para /LEDs /LEDs group A /LED 2]
LED active color 	The LED lights up in this color if the state of the OR-assignment of the signals is true.	green, red, red flash, green flash, -	red	[Device Para /LEDs /LEDs group A /LED 2]

Parameter	Description	Setting range	Default	Menu path
LED inactive color 	The LED lights up in this color if the state of the OR-assignment of the signals is untrue.	green, red, red flash, green flash, -	-	[Device Para /LEDs /LEDs group A /LED 2]
Assignment 1 	Assignment	1..n, Assignment List	LEDs group A: SG[1].TripCm d LEDs group B: -.-	[Device Para /LEDs /LEDs group A /LED 2]
Inverting 1 	Inverting of the state of the assigned signal.	inactive, active	inactive	[Device Para /LEDs /LEDs group A /LED 2]
Assignment 2 	Assignment	1..n, Assignment List	-.-	[Device Para /LEDs /LEDs group A /LED 2]
Inverting 2 	Inverting of the state of the assigned signal.	inactive, active	inactive	[Device Para /LEDs /LEDs group A /LED 2]
Assignment 3 	Assignment	1..n, Assignment List	-.-	[Device Para /LEDs /LEDs group A /LED 2]
Inverting 3 	Inverting of the state of the assigned signal.	inactive, active	inactive	[Device Para /LEDs /LEDs group A /LED 2]
Assignment 4 	Assignment	1..n, Assignment List	-.-	[Device Para /LEDs /LEDs group A /LED 2]
Inverting 4 	Inverting of the state of the assigned signal.	inactive, active	inactive	[Device Para /LEDs /LEDs group A /LED 2]









Parameter	Description	Setting range	Default	Menu path
 Assignment 5	Assignment	1..n, Assignment List	-.-	[Device Para /LEDs /LEDs group A /LED 2]
 Inverting 5	Inverting of the state of the assigned signal.	inactive, active	inactive	[Device Para /LEDs /LEDs group A /LED 2]
 Latched	Defines whether the LED will be latched when it picks up.	inactive, active, active, ack. by alarm	inactive	[Device Para /LEDs /LEDs group A /LED 3]
 Ack signal	Acknowledgement signal for the LED. If latching is set to active the LED can only be acknowledged if those signals that initiated the setting are no longer present. Only available if: Latched = active	1..n, Assignment List	-.-	[Device Para /LEDs /LEDs group A /LED 3]
 LED active color	The LED lights up in this color if the state of the OR-assignment of the signals is true.	green, red, red flash, green flash, -	LEDs group A: red flash LEDs group B: red	[Device Para /LEDs /LEDs group A /LED 3]
 LED inactive color	The LED lights up in this color if the state of the OR-assignment of the signals is untrue.	green, red, red flash, green flash, -	-	[Device Para /LEDs /LEDs group A /LED 3]
 Assignment 1	Assignment	1..n, Assignment List	LEDs group A: Prot.Alarm LEDs group B: -.-	[Device Para /LEDs /LEDs group A /LED 3]
 Inverting 1	Inverting of the state of the assigned signal.	inactive, active	inactive	[Device Para /LEDs /LEDs group A /LED 3]
 Assignment 2	Assignment	1..n, Assignment List	-.-	[Device Para /LEDs /LEDs group A /LED 3]





<i>Parameter</i>	<i>Description</i>	<i>Setting range</i>	<i>Default</i>	<i>Menu path</i>
Inverting 2 	Inverting of the state of the assigned signal.	inactive, active	inactive	[Device Para /LEDs /LEDs group A /LED 3]
Assignment 3 	Assignment	1..n, Assignment List	-.-	[Device Para /LEDs /LEDs group A /LED 3]
Inverting 3 	Inverting of the state of the assigned signal.	inactive, active	inactive	[Device Para /LEDs /LEDs group A /LED 3]
Assignment 4 	Assignment	1..n, Assignment List	-.-	[Device Para /LEDs /LEDs group A /LED 3]
Inverting 4 	Inverting of the state of the assigned signal.	inactive, active	inactive	[Device Para /LEDs /LEDs group A /LED 3]
Assignment 5 	Assignment	1..n, Assignment List	-.-	[Device Para /LEDs /LEDs group A /LED 3]
Inverting 5 	Inverting of the state of the assigned signal.	inactive, active	inactive	[Device Para /LEDs /LEDs group A /LED 3]
Latched 	Defines whether the LED will be latched when it picks up.	inactive, active, active, ack. by alarm	inactive	[Device Para /LEDs /LEDs group A /LED 4]
Ack signal 	Acknowledgement signal for the LED. If latching is set to active the LED can only be acknowledged if those signals that initiated the setting are no longer present. Only available if: Latched = active	1..n, Assignment List	-.-	[Device Para /LEDs /LEDs group A /LED 4]







<i>Parameter</i>	<i>Description</i>	<i>Setting range</i>	<i>Default</i>	<i>Menu path</i>
LED active color 	The LED lights up in this color if the state of the OR-assignment of the signals is true.	green, red, red flash, green flash, -	red	[Device Para /LEDs /LEDs group A /LED 4]
LED inactive color 	The LED lights up in this color if the state of the OR-assignment of the signals is untrue.	green, red, red flash, green flash, -	-	[Device Para /LEDs /LEDs group A /LED 4]
Assignment 1 	Assignment	1..n, Assignment List	.-	[Device Para /LEDs /LEDs group A /LED 4]
Inverting 1 	Inverting of the state of the assigned signal.	inactive, active	inactive	[Device Para /LEDs /LEDs group A /LED 4]
Assignment 2 	Assignment	1..n, Assignment List	.-	[Device Para /LEDs /LEDs group A /LED 4]
Inverting 2 	Inverting of the state of the assigned signal.	inactive, active	inactive	[Device Para /LEDs /LEDs group A /LED 4]
Assignment 3 	Assignment	1..n, Assignment List	.-	[Device Para /LEDs /LEDs group A /LED 4]
Inverting 3 	Inverting of the state of the assigned signal.	inactive, active	inactive	[Device Para /LEDs /LEDs group A /LED 4]
Assignment 4 	Assignment	1..n, Assignment List	.-	[Device Para /LEDs /LEDs group A /LED 4]

Parameter	Description	Setting range	Default	Menu path
 Inverting 4	Inverting of the state of the assigned signal.	inactive, active	inactive	[Device Para /LEDs /LEDs group A /LED 4]
 Assignment 5	Assignment	1..n, Assignment List	-.-	[Device Para /LEDs /LEDs group A /LED 4]
 Inverting 5	Inverting of the state of the assigned signal.	inactive, active	inactive	[Device Para /LEDs /LEDs group A /LED 4]
 Latched	Defines whether the LED will be latched when it picks up.	inactive, active, active, ack. by alarm	inactive	[Device Para /LEDs /LEDs group A /LED 5]
 Ack signal	Acknowledgement signal for the LED. If latching is set to active the LED can only be acknowledged if those signals that initiated the setting are no longer present. Only available if: Latched = active	1..n, Assignment List	-.-	[Device Para /LEDs /LEDs group A /LED 5]
 LED active color	The LED lights up in this color if the state of the OR-assignment of the signals is true.	green, red, red flash, green flash, -	red	[Device Para /LEDs /LEDs group A /LED 5]
 LED inactive color	The LED lights up in this color if the state of the OR-assignment of the signals is untrue.	green, red, red flash, green flash, -	-	[Device Para /LEDs /LEDs group A /LED 5]
 Assignment 1	Assignment	1..n, Assignment List	-.-	[Device Para /LEDs /LEDs group A /LED 5]
 Inverting 1	Inverting of the state of the assigned signal.	inactive, active	inactive	[Device Para /LEDs /LEDs group A /LED 5]

<i>Parameter</i>	<i>Description</i>	<i>Setting range</i>	<i>Default</i>	<i>Menu path</i>
Assignment 2 	Assignment	1..n, Assignment List	.-	[Device Para /LEDs /LEDs group A /LED 5]
Inverting 2 	Inverting of the state of the assigned signal.	inactive, active	inactive	[Device Para /LEDs /LEDs group A /LED 5]
Assignment 3 	Assignment	1..n, Assignment List	.-	[Device Para /LEDs /LEDs group A /LED 5]
Inverting 3 	Inverting of the state of the assigned signal.	inactive, active	inactive	[Device Para /LEDs /LEDs group A /LED 5]
Assignment 4 	Assignment	1..n, Assignment List	.-	[Device Para /LEDs /LEDs group A /LED 5]
Inverting 4 	Inverting of the state of the assigned signal.	inactive, active	inactive	[Device Para /LEDs /LEDs group A /LED 5]
Assignment 5 	Assignment	1..n, Assignment List	.-	[Device Para /LEDs /LEDs group A /LED 5]
Inverting 5 	Inverting of the state of the assigned signal.	inactive, active	inactive	[Device Para /LEDs /LEDs group A /LED 5]
Latched 	Defines whether the LED will be latched when it picks up.	inactive, active, active, ack. by alarm	inactive	[Device Para /LEDs /LEDs group A /LED 6]

Parameter	Description	Setting range	Default	Menu path
Ack signal 	Acknowledgement signal for the LED. If latching is set to active the LED can only be acknowledged if those signals that initiated the setting are no longer present. Only available if: Latched = active	1..n, Assignment List	-.-	[Device Para /LEDs /LEDs group A /LED 6]
LED active color 	The LED lights up in this color if the state of the OR-assignment of the signals is true.	green, red, red flash, green flash, -	red	[Device Para /LEDs /LEDs group A /LED 6]
LED inactive color 	The LED lights up in this color if the state of the OR-assignment of the signals is untrue.	green, red, red flash, green flash, -	-	[Device Para /LEDs /LEDs group A /LED 6]
Assignment 1 	Assignment	1..n, Assignment List	-.-	[Device Para /LEDs /LEDs group A /LED 6]
Inverting 1 	Inverting of the state of the assigned signal.	inactive, active	inactive	[Device Para /LEDs /LEDs group A /LED 6]
Assignment 2 	Assignment	1..n, Assignment List	-.-	[Device Para /LEDs /LEDs group A /LED 6]
Inverting 2 	Inverting of the state of the assigned signal.	inactive, active	inactive	[Device Para /LEDs /LEDs group A /LED 6]
Assignment 3 	Assignment	1..n, Assignment List	-.-	[Device Para /LEDs /LEDs group A /LED 6]
Inverting 3 	Inverting of the state of the assigned signal.	inactive, active	inactive	[Device Para /LEDs /LEDs group A /LED 6]

Parameter	Description	Setting range	Default	Menu path
Assignment 4 	Assignment	1..n, Assignment List	-.-	[Device Para /LEDs /LEDs group A /LED 6]
Inverting 4 	Inverting of the state of the assigned signal.	inactive, active	inactive	[Device Para /LEDs /LEDs group A /LED 6]
Assignment 5 	Assignment	1..n, Assignment List	-.-	[Device Para /LEDs /LEDs group A /LED 6]
Inverting 5 	Inverting of the state of the assigned signal.	inactive, active	inactive	[Device Para /LEDs /LEDs group A /LED 6]
Latched 	Defines whether the LED will be latched when it picks up.	inactive, active, active, ack. by alarm	inactive	[Device Para /LEDs /LEDs group A /LED 7]
Ack signal 	Acknowledgement signal for the LED. If latching is set to active the LED can only be acknowledged if those signals that initiated the setting are no longer present. Only available if: Latched = active	1..n, Assignment List	-.-	[Device Para /LEDs /LEDs group A /LED 7]
LED active color 	The LED lights up in this color if the state of the OR-assignment of the signals is true.	green, red, red flash, green flash, -	red	[Device Para /LEDs /LEDs group A /LED 7]
LED inactive color 	The LED lights up in this color if the state of the OR-assignment of the signals is untrue.	green, red, red flash, green flash, -	-	[Device Para /LEDs /LEDs group A /LED 7]
Assignment 1 	Assignment	1..n, Assignment List	-.-	[Device Para /LEDs /LEDs group A /LED 7]

<i>Parameter</i>	<i>Description</i>	<i>Setting range</i>	<i>Default</i>	<i>Menu path</i>
Inverting 1 	Inverting of the state of the assigned signal.	inactive, active	inactive	[Device Para /LEDs /LEDs group A /LED 7]
Assignment 2 	Assignment	1..n, Assignment List	-.-	[Device Para /LEDs /LEDs group A /LED 7]
Inverting 2 	Inverting of the state of the assigned signal.	inactive, active	inactive	[Device Para /LEDs /LEDs group A /LED 7]
Assignment 3 	Assignment	1..n, Assignment List	-.-	[Device Para /LEDs /LEDs group A /LED 7]
Inverting 3 	Inverting of the state of the assigned signal.	inactive, active	inactive	[Device Para /LEDs /LEDs group A /LED 7]
Assignment 4 	Assignment	1..n, Assignment List	-.-	[Device Para /LEDs /LEDs group A /LED 7]
Inverting 4 	Inverting of the state of the assigned signal.	inactive, active	inactive	[Device Para /LEDs /LEDs group A /LED 7]
Assignment 5 	Assignment	1..n, Assignment List	-.-	[Device Para /LEDs /LEDs group A /LED 7]
Inverting 5 	Inverting of the state of the assigned signal.	inactive, active	inactive	[Device Para /LEDs /LEDs group A /LED 7]

LED Module Input States

<i>Name</i>	<i>Description</i>	<i>Assignment via</i>
LED1.1	Module input state: LED	[Device Para /LEDs /LEDs group A /LED 1]
LED1.2	Module input state: LED	[Device Para /LEDs /LEDs group A /LED 1]
LED1.3	Module input state: LED	[Device Para /LEDs /LEDs group A /LED 1]
LED1.4	Module input state: LED	[Device Para /LEDs /LEDs group A /LED 1]
LED1.5	Module input state: LED	[Device Para /LEDs /LEDs group A /LED 1]
Acknow Sig 1	Module input state: Acknowledgement Signal (only for automatic acknowledgement)	[Device Para /LEDs /LEDs group A /LED 1]
LED2.1	Module input state: LED	[Device Para /LEDs /LEDs group A /LED 2]
LED2.2	Module input state: LED	[Device Para /LEDs /LEDs group A /LED 2]
LED2.3	Module input state: LED	[Device Para /LEDs /LEDs group A /LED 2]

<i>Name</i>	<i>Description</i>	<i>Assignment via</i>
LED2.4	Module input state: LED	[Device Para /LEDs /LEDs group A /LED 2]
LED2.5	Module input state: LED	[Device Para /LEDs /LEDs group A /LED 2]
Acknow Sig 2	Module input state: Acknowledgement Signal (only for automatic acknowledgement)	[Device Para /LEDs /LEDs group A /LED 2]
LED3.1	Module input state: LED	[Device Para /LEDs /LEDs group A /LED 3]
LED3.2	Module input state: LED	[Device Para /LEDs /LEDs group A /LED 3]
LED3.3	Module input state: LED	[Device Para /LEDs /LEDs group A /LED 3]
LED3.4	Module input state: LED	[Device Para /LEDs /LEDs group A /LED 3]
LED3.5	Module input state: LED	[Device Para /LEDs /LEDs group A /LED 3]
Acknow Sig 3	Module input state: Acknowledgement Signal (only for automatic acknowledgement)	[Device Para /LEDs /LEDs group A /LED 3]

<i>Name</i>	<i>Description</i>	<i>Assignment via</i>
LED4.1	Module input state: LED	[Device Para /LEDs /LEDs group A /LED 4]
LED4.2	Module input state: LED	[Device Para /LEDs /LEDs group A /LED 4]
LED4.3	Module input state: LED	[Device Para /LEDs /LEDs group A /LED 4]
LED4.4	Module input state: LED	[Device Para /LEDs /LEDs group A /LED 4]
LED4.5	Module input state: LED	[Device Para /LEDs /LEDs group A /LED 4]
Acknow Sig 4	Module input state: Acknowledgement Signal (only for automatic acknowledgement)	[Device Para /LEDs /LEDs group A /LED 4]
LED5.1	Module input state: LED	[Device Para /LEDs /LEDs group A /LED 5]
LED5.2	Module input state: LED	[Device Para /LEDs /LEDs group A /LED 5]
LED5.3	Module input state: LED	[Device Para /LEDs /LEDs group A /LED 5]

<i>Name</i>	<i>Description</i>	<i>Assignment via</i>
LED5.4	Module input state: LED	[Device Para /LEDs /LEDs group A /LED 5]
LED5.5	Module input state: LED	[Device Para /LEDs /LEDs group A /LED 5]
Acknow Sig 5	Module input state: Acknowledgement Signal (only for automatic acknowledgement)	[Device Para /LEDs /LEDs group A /LED 5]
LED6.1	Module input state: LED	[Device Para /LEDs /LEDs group A /LED 6]
LED6.2	Module input state: LED	[Device Para /LEDs /LEDs group A /LED 6]
LED6.3	Module input state: LED	[Device Para /LEDs /LEDs group A /LED 6]
LED6.4	Module input state: LED	[Device Para /LEDs /LEDs group A /LED 6]
LED6.5	Module input state: LED	[Device Para /LEDs /LEDs group A /LED 6]
Acknow Sig 6	Module input state: Acknowledgement Signal (only for automatic acknowledgement)	[Device Para /LEDs /LEDs group A /LED 6]

<i>Name</i>	<i>Description</i>	<i>Assignment via</i>
LED7.1	Module input state: LED	[Device Para /LEDs /LEDs group A /LED 7]
LED7.2	Module input state: LED	[Device Para /LEDs /LEDs group A /LED 7]
LED7.3	Module input state: LED	[Device Para /LEDs /LEDs group A /LED 7]
LED7.4	Module input state: LED	[Device Para /LEDs /LEDs group A /LED 7]
LED7.5	Module input state: LED	[Device Para /LEDs /LEDs group A /LED 7]
Acknow Sig 7	Module input state: Acknowledgement Signal (only for automatic acknowledgement)	[Device Para /LEDs /LEDs group A /LED 7]

LED configuration

The LEDs can be configured within menu:

[Device Para/LEDs/Group X]

CAUTION

Attention must be paid that there are no overlapping functions due to double or multiple LED assignment of colors and flashing codes.

CAUTION

If LEDs are parameterized »Latched=*active*«, they will keep (return into) their blink code/color even if there is a break within the power supply.

If LEDs are parameterized »Latched=*active*«, The LED blink code will also retain, if the LED is reprogrammed in another way. This applies also if »Latched is set to *inactive*«. Resetting a LED that has latched a signal will always require an acknowledgement.

NOTICE

This chapter contains information on the LEDs that are placed on the left hand of the display (group A).

If your device is also equipped with LEDs on the right hand of the display (group B), the information in this chapter is valid analog. The only difference is "group A" and "group B" within the menu paths.

Via push button »INFO« it is always possible to display the current alarms/alarm texts that are assigned to an LED. Please refer to chapter *Navigation* (description of the »INFO-key«).

Set the following parameters for each LED:

- »Latching/self holding function«: If »Latching« is set to »*active*«, the state that is set by the alarms will be stored. If latching »Latching« is set to »*inactive*«, the LED always adopts the state of those alarms that were assigned.
- »Acknowledgment« (signal from the »assignment list«)
- »LED active color«, LED lights up in this color in case that at least one of the allocated functions is valid (red, red flashing, green, green flashing, off).
- »LED inactive color«, LED lights up in this color in case that none of the allocated functions is valid (red, red flashing, green, green flashing, off).
- Apart from the *LED for System OK*, each LED can be assigned up to five functions/alarms out of the »assignment list«.
- »Inverting« (of the signals), if necessary.

Acknowledgment options

LEDs can be acknowledged by:

- Via the push-button »C« at the operating panel.
- Each LED can be acknowledged by a signal of the »assignment list« (If »Latched = active«).
- Via the module »Ex Acknowledge« all LEDs can be acknowledged at once, if the signal for external acknowledgment that was selected from the »assignment list« becomes true (e.g. the state of a digital input).
- Via SCADA, all LEDs can be acknowledged at once.
- Automatically in case of an alarm from a protection function.
The automatic acknowledgment must be activated by setting:
[Device Para / LEDs / LEDs group A / LED 1...n] »Latched« = “active, ack. by pickup”

See also Chapter “Acknowledgments” for more information.

NOTICE

The Product-CD that is delivered with the device contains a PDF-Template in order to create and print out self adhesive films for LED assignment texts (front foil) by means of a laser printer. Recommendation: (AVERY Zweckform Art.Nr.3482)

LEDs

LED_Y01

LED = LEDs group A, . . .)

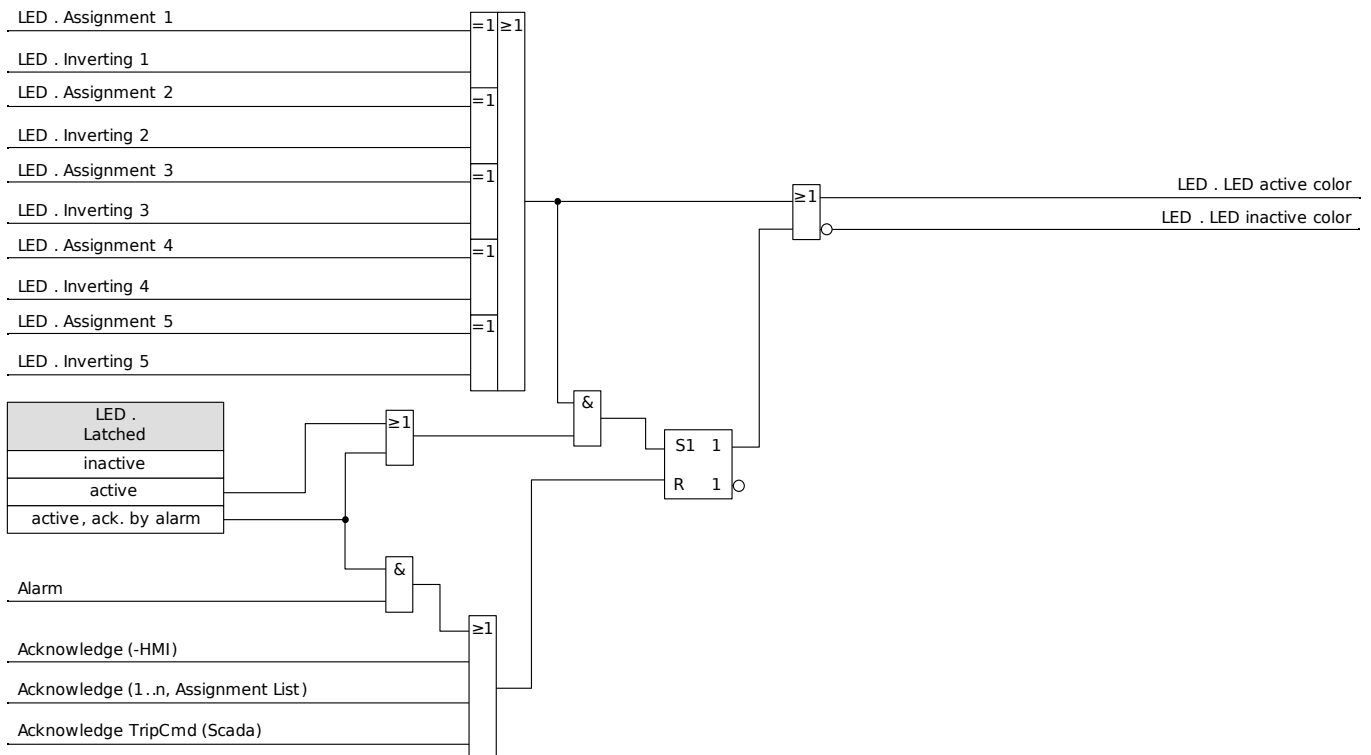

The »System OK« LED

This LED flashes green while the device is booting. After completed booting, the LED for *System OK* lights up in green thus signaling that the *protection* (function) is »*activated*«. Please refer to chapter "Self-Supervision" and to the external document "*Troubleshooting Guide*" to find out further information on blink codes of the *System OK LED*

LED System OK cannot be parameterized.

Security

CAUTION

All security settings have to be made by the user of the device!
It is strictly recommended that you adapt the security settings according to the local regulations and requirements at the end of the commissioning procedure.

The device is delivered with maximum “open” settings, i. e. all access restrictions are deactivated. This way the commissioning is not complicated unnecessarily. But afterwards, when the device is running, it is probably required to restrict the access to some extent. There are in particular the following two aspects to consider:

CAUTION

It is strictly recommended to define passwords different from the default ones. (The default password “1234” does not provide any security against unauthorized access.)

It is recommended to define (as part of the overall security concept) the rules and restrictions for accessing the device via the operating software *Smart view*.

It is recommended to define different, level-specific passwords for the different access areas / levels. This way it is possible to make sure that different user groups get their individual access permissions.

By default, all kinds of *Smart view* access to the device are permitted. Note, however, that it can be required for security reasons to block (or at least restrict) the access after commissioning (e. g. block the TCP/IP access over the network).

Access Authorizations (access areas)

Password Handling

Password Entry at the Panel

Passwords can be entered by way of the Softkeys.



Example: For password (3244) press successively:

- Softkey 3
- Softkey 2
- Softkey 4
- Softkey 4

Changing Passwords

Passwords can be changed at the device in menu [Device Para/Passwords] or by means of the *Smart view* software.

NOTICE

A password must be a user-defined combination of the numerics 1, 2, 3 and 4. All other characters and keys won't be accepted.

When you want to change a password, the existing one has to be entered firstly. The new password (up to 8 digits) is then to be confirmed twice. Please proceed as follows:

- In order to change the password please enter your old password by means of the Softkeys followed by pressing the »OK«-key.
- Enter the new password by means of the Softkeys and press the »OK«-key.
- Afterwards enter the new password once again by means of the Softkeys and press the »OK«-key.

Acknowledge without Entering a Password

If there is the need to be able to acknowledge without entering any password set an empty password for the level »Prot-Lv1«. For general information about acknowledgments see Chapter "Acknowledgments". Information about access areas / levels can be found below („Passwords – Areas”).

Deactivating Passwords during Commissioning

It is possible optionally to deactivate passwords during commissioning. It is not allowed to use this feature for other purposes than commissioning. In order to deactivate the password protection replace the existing password with an empty one for the corresponding access areas. All access authorizations (access areas) that are protected by an empty password are unlocked permanently. That means, that all parameters and settings within those areas can be modified without any further access authorization. It is no longer possible to change into the »Read Only-Lv0« level (the protective device will also not fall back into this mode if the maximum edit time is expired (t-max-Edit).

CAUTION

You have to ensure that all passwords are activated again after the commissioning. That means, that all access areas have to be protected by a password that consists of 4 digits as minimum.

Woodward will not take over any liability for any personal injuries or damages that are caused by deactivated password protection.

Password Forgotten

It is possible to reset all passwords via a general Reset dialog. See "Reset to Factory Defaults, Reset All Passwords" for details.

General Considerations

You have to ensure that the access authorizations are protected by secure passwords. These passwords have to be kept as a secret and to be known only by the authorized persons. The default password "1234" does not provide any security against unauthorized access.

A lock symbol indicates in the upper right corner of the display if there are any access authorizations active at the moment. That means, within the mode "Read Only Lv0" a closed (locked) lock symbol will be shown in the upper right corner of the display. As soon as there are any access authorizations active (above the "Read Only-Lv0" level), the upper right corner of the display will show an unlocked (open) lock symbol.

During setting parameters the C-Button can be used for canceling the parameter changes. Because of that it is not possible to acknowledge (LEDs, Output Relays...) as long as there are non-saved (cached only) parameters.











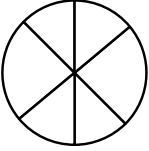

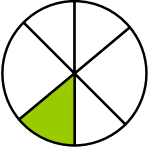
The acknowledgment menu cannot be accessed as long as the parameter modifications are not overtaken by the device (indicated by a star symbol in the upper left corner).

The passwords are part of the device (fixed assignments). That means, passwords will not be overwritten, if a parameter file is transmitted into a device.

Existing passwords are persistent (assigned to a device). If an offline created parameter file is transmitted into a device, or if a parameter file is transmitted from one device to another, this will have no impact on existing passwords within the device.

Passwords – Areas

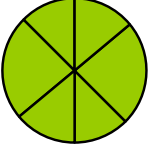
The following table shows the access areas and the authorization passwords that they require in order to access them.

<i>Area Symbol</i>	<i>Authorization Password</i>	<i>Access to:</i>
	 Read Only-Lv0	Level 0 provides Read Only access to all settings and parameters of the device. The device will fall back into this level automatically after a longer period or inactivity
	 Prot-Lv1	This password provides access to the reset- and acknowledge options. In addition to that, it permits the execution of manual trigger signals.
	 Prot-Lv2	This password provides access to the reset and acknowledge options. In addition to that it permits changing of protection settings and the configuration of the trip manager.
	 Control-Lv1	This password grants permission for switching operations (switching switchgears)
	 Control-Lv2	This password grants permission for switching operations (switching switchgears). In addition to that it gives access to the switchgear settings (switching authority, interlockings, general settings of switchgears, Breaker wear...).
	 Supervisor-Lv3	This password grants non-restricted access to all parameters and settings of the device (device configuration). This includes also the devices planning, device parameters (e.g. Date and Time), Field Parameters, Service Parameters and Logic Parameters.

Available Levels/Access Authorizations

The access authorizations are designed in form of two hierarchic strings.
 The supervisor (administrator) password provides access to all parameters and settings.

Access Level for Protection Settings

Access Level for Control Settings

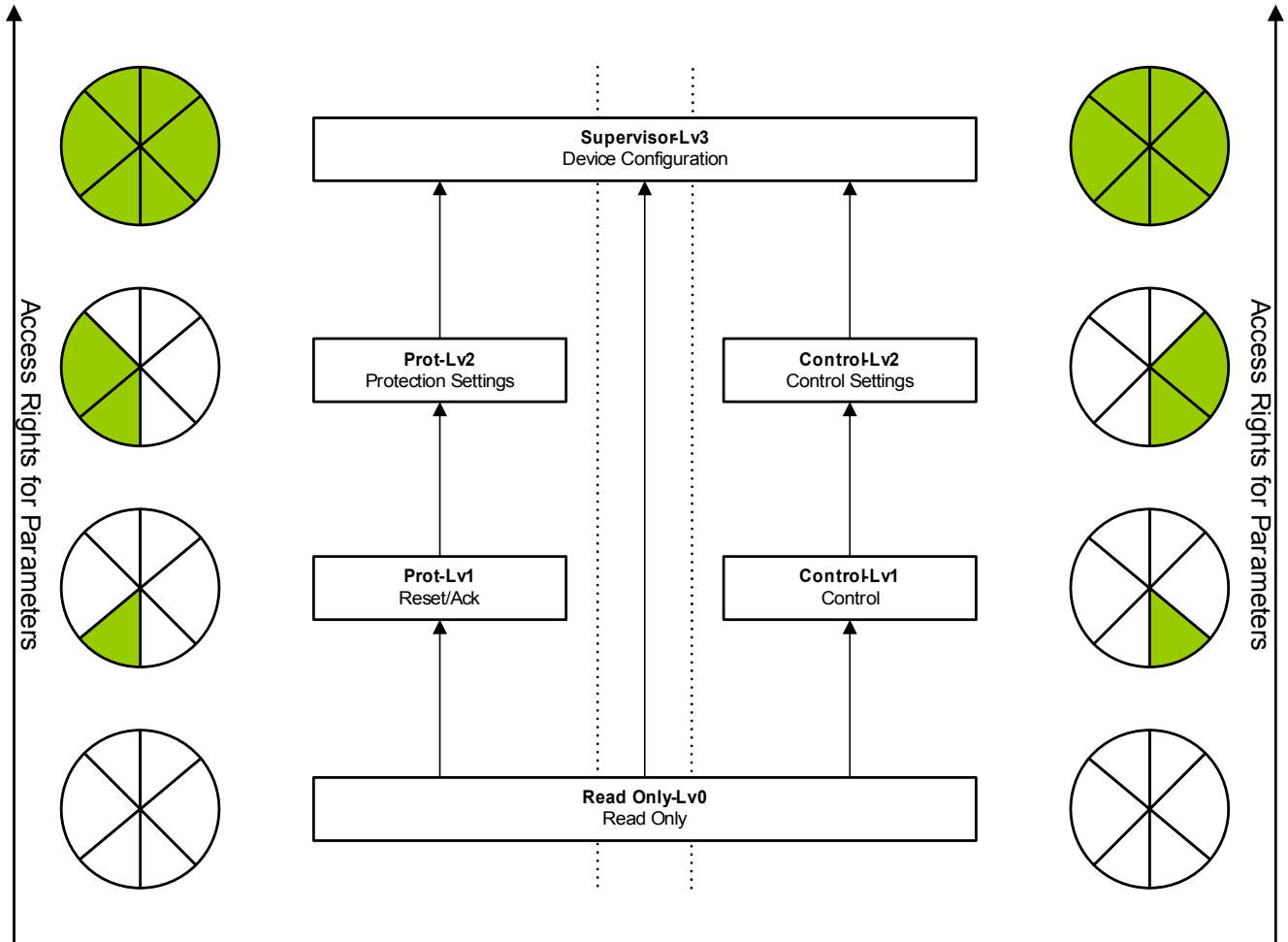

Legend : Lv = Level

◁ Parameters are read only

◀ Parameters can be modified

If the device was not active within the parameter setting mode for a longer time (can be set between 20 – 3600 seconds) it changes into »Read Only-Lv0« mode automatically. This parameter (t-max-Edit) can be modified within menu [Device Para / HMI].

How to Unlock an Access Area or Check which Ones are Unlocked?

Check for unlocked access areas:

The menu [Device Para / Access Level] provides the information, which access areas (authorizations) are currently unlocked. Within this menu it is also possible to enter (unlock) a particular area.

However, the common way during every-day-use of the device is not to use this [Access Level] menu, but to simply enter the menu path of a parameter to be changed, then start editing the parameter; at the end, immediately before the change is accepted, the user is asked for the appropriate password, which then unlocks the respective access area.

As soon as there is an unlocked access area (authorization) above »*Read Only-Lv0*«, this will be indicated by an unlocked lock symbol within the upper right corner of the device display.

If you want to explicitly set back (i. e. lock) the access area at the end (instead waiting for the »*t-max Edit/Access*« timeout) you have to enter the »*Read Only-Lv0*« mode.

Unlock an access area at the panel:

Within the menu [Device Para / Access level] it is possible to unlock or lock access areas (authorizations). After an access area has been unlocked all parameter changes or activities that are assigned to this (or a lower) level can be made without entering a password once again. However, the access permission is valid only for the panel; any access via *Smart view* has to be unlocked separately.

When no key is pressed for a time that can be specified via the [Device para / HMI / Security] »*t-max Edit/Access*« setting, the access area is reset automatically to »*Read Only-Lv0*«, and all unsaved parameter changes get canceled.

CAUTION

Do not leave the device unsupervised as long as there are still access areas (levels) unlocked (unlocked lock symbol on the display). If the access is no longer needed it is advisable to reset the permissions back to »*Read Only-Lv0*«.

Unlock an access area via Smart view:

After an access area (authorizations) has been unlocked by entering the password all parameter changes or activities that are assigned to this (or a lower) level can be made without entering a password once again. However, the access permission is valid only for this instance of *Smart view*; any access via panel or other *Smart view* instances has to be unlocked separately.

When no key is pressed for some (*Smart view*-internal) time the access area is automatically reset.

CAUTION

Do not leave the device unsupervised as long as *Smart view* still keeps some access area unlocked. Lock your PC during your absence, or at least reset the access permissions. This can be done by a double-click on the lock symbol in the status line on the bottom margin of the *Smart view* window (or, alternatively, via the menu [Device / Reset to Parameter "Read Only" Status]).

Network Access

Access via Smart view:

One of the fundamental requirements of »IT Security« is to prevent unauthorized persons from accessing the own systems, including the protective device. The device offers access via its front panel, and via the operating software *Smart view*.

Since the access via front panel is possible only for someone who is located directly in front of the device the risk should normally be rather low, compared to the risk of unauthorized access via *Smart view*, especially if the device is part of an Ethernet / TCP/IP network.

NOTICE

After commissioning of the device, it is recommended to deactivate the *Smart view* access via Ethernet; this can be done with the setting parameter [Device Para / HMI / Security] »*Smart view via Eth*«.

Independent of this, there is also the option to deactivate the *Smart view* access via the USB interface; this can be done with the setting parameter [Device Para / HMI / Security] »*Smart view via USB*«.

For Line Differential devices there is the additional option to deactivate the access to the remote device via Protection Communication; this can be done with the setting parameter [Device Para / HMI / Security] »*Sm. view via ProtCom*«.

Note: If *Smart view* is used to deactivate the Smart view access, then the current session gets automatically terminated.

SCADA Communication:

It is to be noted that there are always certain security risks related to the use of SCADA protocols. Detailed information can be found in the technical literature.

Intranet Security:

If the Ethernet interface of the device is connected to a network, it is the responsibility of the user to maintain all necessary means required for the security of the company network. In particular, it must be guaranteed that external access (i. e. out of the internet) to the device has been made impossible. Please keep yourself informed about up-to-date technology (firewalls, VPN etc.)!

Reset to Factory Defaults, Reset All Passwords

There is a dedicated Reset dialog that allows for selecting any of the following options:

- **Reset to the factory defaults**, or
- **reset all passwords**.

This Reset dialog is available at the HMI only (i. e. **not** via *Smart view*).

Press the »C« key during a cold start until the Reset dialog appears.

NOTICE

For technical reasons, this Reset dialog is available only in English language (independent of the regional language being used later, after the device has started).

Note furthermore that the dialog might not appear at all because it has been intentionally disabled (see below), or the option to reset all passwords has been disabled.

Reset to Factory Defaults

! WARNING

All records will be deleted and the measured values and counters will be reset. Exception: The operation hours counter is preserved.

- From the Reset dialog, select »Reset to factory default«.
 - ⇒ There is a confirmation dialog, asking »Reset device to factory defaults and reboot?«
- Confirm with »Yes«.
 - ⇒ The reset to factory defaults is executed, and the device restarts.

Reset All Passwords

It is possible to remove this option from the Reset dialog for security reasons (see below).

- From the Reset dialog, select »Reset all passwords «.
 - ⇒ There is a confirmation dialog, asking »Reset all passwords?«
- Confirm with »Yes«.
 - ⇒ The device starts using the standard password » **1234**« .

! WARNING

For security reasons, it is strictly recommended to change the default passwords immediately to some individual passwords. (See chapter "Changing Passwords").

Security Settings

The Reset dialog can be restricted for security reasons.

The setting parameter [Device para / HMI / Security] »Options Reset Dialog« allows for specifying which resetting options shall be available from the Reset dialog:

- *"Fact.def.", "PW rst"*: Both options –»Reset to factory default« and »Reset all passwords« – shall be available.
- *Only "Fact.defaults"*: Only the »Reset to factory default« option shall be available.
- *Dialog deact.:* The Reset dialog shall be disabled.

CAUTION

If the password should be lost and the »Reset all passwords« option has been made unavailable then the only chance to recover control is to reset the device to factory default. If this option has been deactivated, too, then the device has to be sent to Woodward as a service request.

Smart View

Smart view is a parameter setting and evaluation software. Please see separate manual (DOK-HB-SMARTVE).

- Menu-controlled parameter setting incl. validity checks
- Offline configuration of all relay types
- Reading and evaluating of statistical data and measuring values
- Setting into operation assistance
- Display of the device status
- Fault analysis via event- and fault recorder

Data visualizer

Data visualizer is an disturbance record and event viewing software. It is installed automatically with *Smart view*. It can also be used as a standard COMTRADE file viewer.

- Open and review downloaded disturbance records.
- Customize disturbance record channel layout and views including channel overlapping and zooming
- Analyze sample by sample data points and line up the displayed analog waveform channels along with the recorded internal relay logic
- Save window setups (snapshots) and print for reporting
- Open industry standard COMTRADE files from other intelligent electronic devices
- Convert downloaded waveform files to COMTRADE file format using "Export" feature

Wide Frequency Range

The frequency will be calculated based on the three phase voltages as well as the fourth voltage measuring input.

Some protective elements are using Discrete Fourier Transformation (DFT) in order to extract the fundamentals and phase angles from the measured values. Other protective elements are using True RMS values. For some protective elements, the User can specify if they should work based on DFT or True RMS values.

The calculation of measuring quantities via DFT is very fast. The values are calculated several times per cycle. For some technical reasons, the calculation of DFT values is only possible if the frequency is close to the nominal frequency ($\pm 10\% f_N$). If the frequency is out of the nominal frequency range, the DFT values are no longer precise.

That is why protective elements (and directional features), that work based on DFT values, will be blocked either because they are set fixed to DFT or they are set by the User to DFT, as soon as the frequency leaves the nominal range ($\pm 10\% f_N$).

Protective elements, that are working based on True RMS values are able to work in a wide frequency range (5–70 Hz). For technical reasons, the True RMS based calculation of measured values will be done once per cycle. The lower the frequency, the longer the cycle, the slower the calculation will become. That means that the True RMS based calculations will have longer settling times (< 2 cycles). This especially applies the lower the frequency is.

The duration of a cycle will be calculated based on the voltage measuring channels. The duration of a cycle for True RMS is possible if the voltage magnitudes exceeds 10 V. In case the cycle duration cannot be determined, the rated frequency will be assumed for DFT and True RMS calculations. As soon as a sufficient magnitude is fed to the relay, the wide frequency range will be activated a few cycles later (after the settling time) if the frequency is out of the nominal range.

$ f - f_N < 10\% \cdot f_N$	$ f - f_N > 10\% \cdot f_N$
DFT available: The measured values are calculated several times per cycle.	DFT imprecise: Protective elements will be blocked.
True RMS available: The measured values are calculated several times per cycle.	True RMS available 5-70 Hz: Measured values are updated after each cycle.

The dropout ratio is 1 Hz below 5 Hz.

Measuring Values

Read out Measured Values

In menu »Operation/Measured Values« both measured and calculated values can be viewed. The measured values are ordered by »Standard values« and »special values« (depending on the type of device).

Measurement Display

Menu [Device Para\Measurem Display] offers options to change the display of measured values.

Scaling of Measured values

By means of the parameter »Scaling« the user can determine how measured values are to be displayed within the HMI and *Smart view*.

- Primary quantities
- Secondary quantities
- Per Unit quantities

Power Units (applies only for devices with power measurement)

By means of the parameter »Power Units« the User can determine how measured values are to be displayed within the HMI and *Smart view*.

- Power Auto Scaling
- kW, kVAr or kVA
- MW, MVar or MVA
- GW, GVar or GVA

Energy Units (applies only for devices with energy measurement)

By means of the parameter »Energy Units« the User can determine how measured values are to be displayed within the HMI and *Smart view*:

- Energy Auto Scaling
- kWh, kVAh or kVAh
- MWh, MVAh or MVAh
- GWh, GVAh or GVAh

In case of an overflow of the counter, the counter will start counting again at zero. A corresponding signal will indicate the counter overflow.

Counter overflow at:

- | | |
|-----------------------|--|
| ■ Energy Auto Scaling | Depends on the settings for the current and voltage transformers |
| ■ kWh, kVAh or kVAh | 999,999.99 |
| ■ MWh, MVAh or MVAh | 999,999.99 |
| ■ GWh, GVAh or GVAh | 999,999.99 |

Temperature Unit (applies only for devices with temperature measurement)

By means of the parameter »Temperatur Unit« the User can determine how measured values are to be displayed within the HMI and *Smart view*:

- ° Celsius
- ° Fahrenheit

Cutoff level

In order to suppress noise within measured values that are close to zero the user has the option to set cutoff levels. By means of the cutoff levels, measuring quantities that are close to zero will be displayed as zero. These parameters have no impact on recorded values.

Phase Differential Current - Measured ValuesId

<i>Value</i>	<i>Description</i>	<i>Menu path</i>
Is L1	Measured value (calculated): Restraint Current Phase L1	[Operation /Measured Values /Id]
Is L2	Measured value (calculated): Restraint Current Phase L2	[Operation /Measured Values /Id]
Is L3	Measured value (calculated): Restraint Current Phase L3	[Operation /Measured Values /Id]
Id L1	Measured value (calculated): Differential Current Phase L1	[Operation /Measured Values /Id]
Id L2	Measured value (calculated): Differential Current Phase L2	[Operation /Measured Values /Id]
Id L3	Measured value (calculated): Differential Current Phase L3	[Operation /Measured Values /Id]

Earth Differential Current - Measured Values

IdG

<i>Value</i>	<i>Description</i>	<i>Menu path</i>
IsG W1	Measured value (calculated): Ground Stabilizing Current Winding 1	[Operation /Measured Values /IdG[1]]
IdG W1	Measured value (calculated): Ground Differential Current IdG Winding 1	[Operation /Measured Values /IdG[1]]
IsG W2	Measured value (calculated): Ground Stabilizing Current Winding 2	[Operation /Measured Values /IdG[2]]
IdG W2	Measured value (calculated): Ground Differential Current IdG Winding 2	[Operation /Measured Values /IdG[2]]

Current - Measured Values

CT Ntrl ,CT Mains

If the device is not equipped with an voltage measuring card the first measuring input on the first current measuring card (slot with the lowest number) will be used as the reference angle (»IL 1«).

Current Transformer Signals (Output States)

Signal	Description
Phase seq. wrong	Signal that the device has detected a phase sequence (L1-L2-L3 / L1-L3-L2) that is different from the one that had been set at [Field settings / General Settings] »Phase Sequence«.

Current Transformer Values

Value	Description	Menu path
IL1	Measured value: Phase current (fundamental)	[Operation /Measured Values /CT Ntrl /Current]
IL2	Measured value: Phase current (fundamental)	[Operation /Measured Values /CT Ntrl /Current]
IL3	Measured value: Phase current (fundamental)	[Operation /Measured Values /CT Ntrl /Current]
IG meas	Measured value (measured): IG (fundamental)	[Operation /Measured Values /CT Ntrl /Current]
IG calc	Measured value (calculated): IG (fundamental)	[Operation /Measured Values /CT Ntrl /Current]
I0	Measured value (calculated): Zero current (fundamental)	[Operation /Measured Values /CT Ntrl /Current]

Measuring Values

<i>Value</i>	<i>Description</i>	<i>Menu path</i>
I1	Measured value (calculated): Positive phase sequence current (fundamental)	[Operation /Measured Values /CT Ntrl /Current]
I2	Measured value (calculated): Unbalanced load current (fundamental)	[Operation /Measured Values /CT Ntrl /Current]
IL1 H2	Measured value: 2nd harmonic/1st harmonic of IL1	[Operation /Measured Values /CT Ntrl /Current]
IL2 H2	Measured value: 2nd harmonic/1st harmonic of IL2	[Operation /Measured Values /CT Ntrl /Current]
IL3 H2	Measured value: 2nd harmonic/1st harmonic of IL3	[Operation /Measured Values /CT Ntrl /Current]
IG H2 meas	Measured value: 2nd harmonic/1st harmonic of IG (measured)	[Operation /Measured Values /CT Ntrl /Current]
IG H2 calc	Measured value (calculated): 2nd harmonic/1st harmonic of IG (calculated)	[Operation /Measured Values /CT Ntrl /Current]
phi IL1	Measured value (calculated): Angle of Phasor IL1 Reference phasor is required to calculate the angle.	[Operation /Measured Values /CT Ntrl /Current]
phi IL2	Measured value (calculated): Angle of Phasor IL2 Reference phasor is required to calculate the angle.	[Operation /Measured Values /CT Ntrl /Current]

Measuring Values

<i>Value</i>	<i>Description</i>	<i>Menu path</i>
phi IL3	Measured value (calculated): Angle of Phasor IL3 Reference phasor is required to calculate the angle.	[Operation /Measured Values /CT Ntrl /Current]
phi IG meas	Measured value (calculated): Angle of Phasor IG meas Reference phasor is required to calculate the angle.	[Operation /Measured Values /CT Ntrl /Current]
phi IG calc	Measured value (calculated): Angle of Phasor IG calc Reference phasor is required to calculate the angle.	[Operation /Measured Values /CT Ntrl /Current]
phi I0	Measured value (calculated): Angle Zero Sequence System Reference phasor is required to calculate the angle.	[Operation /Measured Values /CT Ntrl /Current]
phi I1	Measured value (calculated): Angle of Positive Sequence System Reference phasor is required to calculate the angle.	[Operation /Measured Values /CT Ntrl /Current]
phi I2	Measured Value (calculated): Angle of Negative Sequence System Reference phasor is required to calculate the angle.	[Operation /Measured Values /CT Ntrl /Current]
phi I2-phi I1	Measured Value (calculated): Angle of Negative Sequence System - Measured value (calculated): Angle of Positive Sequence System	[Operation /Measured Values /CT Ntrl /Current]
IL1 RMS	Measured value: Phase current (RMS)	[Operation /Measured Values /CT Ntrl /Current RMS]
IL2 RMS	Measured value: Phase current (RMS)	[Operation /Measured Values /CT Ntrl /Current RMS]

Measuring Values

<i>Value</i>	<i>Description</i>	<i>Menu path</i>
IL3 RMS	Measured value: Phase current (RMS)	[Operation /Measured Values /CT Ntrl /Current RMS]
IG meas RMS	Measured value (measured): IG (RMS)	[Operation /Measured Values /CT Ntrl /Current RMS]
IG calc RMS	Measured value (calculated): IG (RMS)	[Operation /Measured Values /CT Ntrl /Current RMS]
%IL1 THD	Measured value (calculated): IL1 Total Harmonic Distortion	[Operation /Measured Values /CT Ntrl /Current RMS]
%IL2 THD	Measured value (calculated): IL2 Total Harmonic Distortion	[Operation /Measured Values /CT Ntrl /Current RMS]
%IL3 THD	Measured value (calculated): IL3 Total Harmonic Distortion	[Operation /Measured Values /CT Ntrl /Current RMS]
IL1 THD	Measured value (calculated): IL1 Total Harmonic Current	[Operation /Measured Values /CT Ntrl /Current RMS]
IL2 THD	Measured value (calculated): IL2 Total Harmonic Current	[Operation /Measured Values /CT Ntrl /Current RMS]
IL3 THD	Measured value (calculated): IL3 Total Harmonic Current	[Operation /Measured Values /CT Ntrl /Current RMS]

Measuring Values

<i>Value</i>	<i>Description</i>	<i>Menu path</i>
%(I2/I1)	Measured value (calculated): I2/I1, phase sequence will be taken into account automatically.	[Operation /Measured Values /CT Ntrl /Current]

Voltage - Measured Values

VT

In general, the first measuring input of the measuring card is used as the reference angle.

Only if the amplitude of the reference phase drops away will the next phase be used as the reference for angle calculation. For this the following order is used:

- Channel VL1, VL2, VL3, VL12, VL23, VL31, IL1, IL2, ...)

Voltage Transformer Signals (Output States)

<i>Signal</i>	<i>Description</i>
Phase seq. wrong	Signal that the device has detected a phase sequence (L1-L2-L3 / L1-L3-L2) that is different from the one that had been set at [Field settings / General Settings] »Phase Sequence«.

Voltage Transformer Values

<i>Value</i>	<i>Description</i>	<i>Menu path</i>
f	Measured value: Frequency	[Operation /Measured Values /Voltage]
VL12	Measured value: Phase-to-phase voltage (fundamental)	[Operation /Measured Values /Voltage]
VL23	Measured value: Phase-to-phase voltage (fundamental)	[Operation /Measured Values /Voltage]
VL31	Measured value: Phase-to-phase voltage (fundamental)	[Operation /Measured Values /Voltage]
VL1	Measured value: Phase-to-neutral voltage (fundamental)	[Operation /Measured Values /Voltage]
VL2	Measured value: Phase-to-neutral voltage (fundamental)	[Operation /Measured Values /Voltage]

Measuring Values

<i>Value</i>	<i>Description</i>	<i>Menu path</i>
VL3	Measured value: Phase-to-neutral voltage (fundamental)	[Operation /Measured Values /Voltage]
VX meas	Measured value (measured): VX measured (fundamental)	[Operation /Measured Values /Voltage]
VG calc	Measured value (calculated): VG (fundamental)	[Operation /Measured Values /Voltage]
V0	Measured value (calculated): Symmetrical components Zero voltage(fundamental)	[Operation /Measured Values /Voltage]
V1	Measured value (calculated): Symmetrical components positive phase sequence voltage(fundamental)	[Operation /Measured Values /Voltage]
V2	Measured value (calculated): Symmetrical components negative phase sequence voltage(fundamental)	[Operation /Measured Values /Voltage]
VL12 RMS	Measured value: Phase-to-phase voltage (RMS)	[Operation /Measured Values /Voltage RMS]
VL23 RMS	Measured value: Phase-to-phase voltage (RMS)	[Operation /Measured Values /Voltage RMS]
VL31 RMS	Measured value: Phase-to-phase voltage (RMS)	[Operation /Measured Values /Voltage RMS]
VL1 RMS	Measured value: Phase-to-neutral voltage (RMS)	[Operation /Measured Values /Voltage RMS]
VL2 RMS	Measured value: Phase-to-neutral voltage (RMS)	[Operation /Measured Values /Voltage RMS]
VL3 RMS	Measured value: Phase-to-neutral voltage (RMS)	[Operation /Measured Values /Voltage RMS]

<i>Value</i>	<i>Description</i>	<i>Menu path</i>
VX meas RMS	Measured value (measured): VX measured (RMS)	[Operation /Measured Values /Voltage RMS]
VG calc RMS	Measured value (calculated): VG (RMS)	[Operation /Measured Values /Voltage RMS]
phi VL12	Measured value (calculated): Angle of Phasor VL12 This phase is used as reference to calculate the angles of other phases. Only if:VT con!=Phase to Ground	[Operation /Measured Values /Voltage]
phi VL23	Measured value (calculated): Angle of Phasor VL23 Reference phasor is required to calculate the angle.	[Operation /Measured Values /Voltage]
phi VL31	Measured value (calculated): Angle of Phasor VL31 Reference phasor is required to calculate the angle.	[Operation /Measured Values /Voltage]
phi VL1	Measured value (calculated): Angle of Phasor VL1 This phase is used as reference to calculate the angles of other phases. Only if:VT con=Phase to Ground	[Operation /Measured Values /Voltage]
phi VL2	Measured value (calculated): Angle of Phasor VL2 Reference phasor is required to calculate the angle.	[Operation /Measured Values /Voltage]
phi VL3	Measured value (calculated): Angle of Phasor VL3 Reference phasor is required to calculate the angle.	[Operation /Measured Values /Voltage]
phi VX meas	Measured value: Angle of Phasor VX meas Reference phasor is required to calculate the angle.	[Operation /Measured Values /Voltage]
phi VG calc	Measured value (calculated): Angle of Phasor VG calc Reference phasor is required to calculate the angle.	[Operation /Measured Values /Voltage]

<i>Value</i>	<i>Description</i>	<i>Menu path</i>
phi V0	Measured value (calculated): Angle Zero Sequence System Reference phasor is required to calculate the angle.	[Operation /Measured Values /Voltage]
phi V1	Measured value (calculated): Angle of Positive Sequence System Reference phasor is required to calculate the angle.	[Operation /Measured Values /Voltage]
phi V2	Measured Value (calculated): Angle of Negative Sequence System Reference phasor is required to calculate the angle.	[Operation /Measured Values /Voltage]
%(V2/V1)	Measured value (calculated): V2/V1, phase sequence will be taken into account automatically.	[Operation /Measured Values /Voltage]
%VL12 THD	Measured value (calculated): V12 Total Harmonic Distortion / Ground wave	[Operation /Measured Values /Voltage RMS]
%VL23 THD	Measured value (calculated): V23 Total Harmonic Distortion / Ground wave	[Operation /Measured Values /Voltage RMS]
%VL31 THD	Measured value (calculated): V31 Total Harmonic Distortion / Ground wave	[Operation /Measured Values /Voltage RMS]
%VL1 THD	Measured value (calculated): VL1 Total Harmonic Distortion / Ground wave	[Operation /Measured Values /Voltage RMS]
%VL2 THD	Measured value (calculated): VL2 Total Harmonic Distortion / Ground wave	[Operation /Measured Values /Voltage RMS]
%VL3 THD	Measured value (calculated): VL3 Total Harmonic Distortion / Ground wave	[Operation /Measured Values /Voltage RMS]

Measuring Values

<i>Value</i>	<i>Description</i>	<i>Menu path</i>
VL12 THD	Measured value (calculated): V12 Total Harmonic Distortion	[Operation /Measured Values /Voltage RMS]
VL23 THD	Measured value (calculated): V23 Total Harmonic Distortion	[Operation /Measured Values /Voltage RMS]
VL31 THD	Measured value (calculated): V31 Total Harmonic Distortion	[Operation /Measured Values /Voltage RMS]
VL1 THD	Measured value (calculated): VL1 Total Harmonic Distortion	[Operation /Measured Values /Voltage RMS]
VL2 THD	Measured value (calculated): VL2 Total Harmonic Distortion	[Operation /Measured Values /Voltage RMS]
VL3 THD	Measured value (calculated): VL3 Total Harmonic Distortion	[Operation /Measured Values /Voltage RMS]
VX meas H3	Third harmonic of measured neutral voltage used to detect generator stator ground faults.	[Operation /Measured Values /Voltage]
V/f	Ratio Volts/Hertz in relation to nominal values.	[Operation /Measured Values /Voltage RMS]

Power - Measured Values

<i>Value</i>	<i>Description</i>	<i>Menu path</i>
S	Measured Value (Calculated): Apparent power (fundamental)	[Operation /Measured Values /Power]
P	Measured value (calculated): Active power (P- = Fed Active Power, P+ = Consumpted Active Power) (fundamental)	[Operation /Measured Values /Power]
Q	Measured value (calculated): Reactive power (Q- = Fed Reactive Power, Q+ = Consumpted Reactive Power) (fundamental)	[Operation /Measured Values /Power]
cos phi	Measured value (calculated): Power factor: Sign Convention: $\text{sign(PF)} = \text{sign(P)}$	[Operation /Measured Values /Power]
Wp+	Positive Active Power is consumed active energy	[Operation /Measured Values /Energy]
Wp-	Negative Active Power (Fed Energy)	[Operation /Measured Values /Energy]
Wq+	Positive Reactive Power is consumed Reactive Energy	[Operation /Measured Values /Energy]
Wq-	Negative Reactive Power (Fed Energy)	[Operation /Measured Values /Energy]
Ws Net	Absolute Apparent Power Hours	[Operation /Measured Values /Energy]
Wp Net	Absolute Active Power Hours	[Operation /Measured Values /Energy]
Wq Net	Absolute Reactive Power Hours	[Operation /Measured Values /Energy]



Measuring Values

<i>Value</i>	<i>Description</i>	<i>Menu path</i>
Start Date/Time	Energy counters run since... (Date and time of last reset)	[Operation /Measured Values /Energy]
S RMS	Measured Value (Calculated): Apparent power (RMS)	[Operation /Measured Values /Power RMS]
P RMS	Measured value (calculated): Active power (P- = Fed Active Power, P+ = Consumpted Active Power) (RMS)	[Operation /Measured Values /Power RMS]
cos phi RMS	Measured value (calculated): Power factor: Sign Convention: $\text{sign(PF)} = \text{sign(P)}$	[Operation /Measured Values /Power RMS]
P 1	Measured value (calculated): Active power in positive sequence system (P- = Fed Active Power, P+ = Consumpted Active Power)	[Operation /Measured Values /Power]
Q 1	Measured value (calculated): Reactive power in positive sequence system (Q- = Fed Reactive Power, Q+ = Consumpted Reactive Power)	[Operation /Measured Values /Power]

Energy Counter

PQSCr

Global Parameters of the Energy Counter Module

Parameter	Description	Setting range	Default	Menu path
S, P, Q Cutoff Level 	The Active/Reactive/Apparent Power shown in the Display or within the PC Software will be displayed as zero, if the absolute value of the corresponding Power falls below this Cutoff Level. This parameter has no impact on recorders.	0.0 - 0.100Sn	0.005Sn	[Device Para /Measurem Display /Power]
Power Units 	Power Units	Power Auto Scaling, kW/kVAr/kVA, MW/MVAr/MVA, GW/GVAr/GVA	Power Auto Scaling	[Device Para /Measurem Display /General Settings]
Energy Units 	Energy Units	Energy Auto Scaling, kWh/kVArh/kVAh, MWh/MVArh/MVAh, GWh/GVArh/GVAh	MWh/MVArh/MVAh	[Device Para /Measurem Display /General Settings]

Direct Commands of the Energy Counter Module

Parameter	Description	Setting range	Default	Menu path
Res all Energy Cr 	Reset of all Energy Counters	inactive, active	inactive	[Operation /Reset]

Signals of the Energy Counter Module (States of the Outputs)

Signal	Description
Cr Oflw Ws Net	Signal: Counter Overflow Ws Net
Cr Oflw Wp Net	Signal: Counter Overflow Wp Net
Cr Oflw Wp+	Signal: Counter Overflow Wp+

Energy Counter

<i>Signal</i>	<i>Description</i>
Cr Oflw Wp-	Signal: Counter Overflow Wp-
Cr Oflw Wq Net	Signal: Counter Overflow Wq Net
Cr Oflw Wq+	Signal: Counter Overflow Wq+
Cr Oflw Wq-	Signal: Counter Overflow Wq-
Ws Net Res Cr	Signal: Ws Net Reset Counter
Wp Net Res Cr	Signal: Wp Net Reset Counter
Wp+ Res Cr	Signal: Wp+ Reset Counter
Wp- Res Cr	Signal: Wp- Reset Counter
Wq Net Res Cr	Signal: Wq Net Reset Counter
Wq+ Res Cr	Signal: Wq+ Reset Counter
Wq- Res Cr	Signal: Wq- Reset Counter
Res all Energy Cr	Signal: Reset of all Energy Counters
Cr OflwW Ws Net	Signal: Counter Ws Net will overflow soon
Cr OflwW Wp Net	Signal: Counter Wp Net will overflow soon
Cr OflwW Wp+	Signal: Counter Wp+ will overflow soon
Cr OflwW Wp-	Signal: Counter Wp- will overflow soon
Cr OflwW Wq Net	Signal: Counter Wq Net will overflow soon
Cr OflwW Wq+	Signal: Counter Wq+ will overflow soon
Cr OflwW Wq-	Signal: Counter Wq- will overflow soon

Impedance – Measured Values

Z

<i>Value</i>	<i>Description</i>	<i>Menu path</i>
Z L1-L2	Impedance, phase L1-L2	[Operation /Measured Values /Impedance /Z L1-L2]
phi(Z L1-L2)	Angle of the impedance Z L1-L2	[Operation /Measured Values /Impedance /Z L1-L2]
R L1-L2	Resistance part of impedance Z L1-L2	[Operation /Measured Values /Impedance /Z L1-L2]
X L1-L2	Reactance part of impedance Z L1-L2	[Operation /Measured Values /Impedance /Z L1-L2]
Z L2-L3	Impedance, phase L2-L3	[Operation /Measured Values /Impedance /Z L2-L3]
phi(Z L2-L3)	Angle of the impedance Z L2-L3	[Operation /Measured Values /Impedance /Z L2-L3]
R L2-L3	Resistance part of impedance Z L2-L3	[Operation /Measured Values /Impedance /Z L2-L3]
X L2-L3	Reactance part of impedance Z L2-L3	[Operation /Measured Values /Impedance /Z L2-L3]

<i>Value</i>	<i>Description</i>	<i>Menu path</i>
Z L3-L1	Impedance, phase L3-L1	[Operation /Measured Values /Impedance /Z L3-L1]
phi(Z L3-L1)	Angle of the impedance Z L3-L1	[Operation /Measured Values /Impedance /Z L3-L1]
R L3-L1	Resistance part of impedance Z L3-L1	[Operation /Measured Values /Impedance /Z L3-L1]
X L3-L1	Reactance part of impedance Z L3-L1	[Operation /Measured Values /Impedance /Z L3-L1]
Z1	Measured positive-sequence impedance	[Operation /Measured Values /Impedance /Z1]
phi(Z1)	Angle of the impedance Measured positive-sequence impedance	[Operation /Measured Values /Impedance /Z1]
R1	Resistance part of impedance Measured positive-sequence impedance	[Operation /Measured Values /Impedance /Z1]
X1	Reactance part of impedance Measured positive-sequence impedance	[Operation /Measured Values /Impedance /Z1]

Global Parameters of the Impedance Measurement

<i>Parameter</i>	<i>Description</i>	<i>Setting range</i>	<i>Default</i>	<i>Menu path</i>
Scaling Z 	Display of the measured values as primary, secondary or per unit values. Note: The Disturbance Recorder and SCADA always use primary impedance values.	Primary values, Secondary values	Secondary values	[Device Para /Measurem Display /General Settings]

Statistics

Statistics

In menu »*Operation/Statistics*« the min., max. and mean values of the measured and calculated measured quantities can be found.

Configuration of the Minimum and Maximum Values

The calculation of the minimum and maximum values will be started:

- When a Reset signal becomes active (Min/Max)
- When the device is restarted
- After configuration

<i>Minimum and Maximum Values (Peak Values/Pointers)</i>		
	Time interval for the calculation of the minimum and maximum values	Reset
<i>Configuration Options</i> Where to configure? Within menu [Device Para\ Statistics\ Min/Max]	The minimum and maximum values will be reset with the rising edge of the corresponding reset signal.	Res Min Res Max (e.g. via digital Inputs). These signals will reset the minimum and maximum pointers.
<i>Display of Minimum Values</i>	Where? Within menu [Operation\Statistics\Min]	
<i>Display of Maximum Values</i>	Where? Within menu [Operation\Statistics\Max]	

Configuration of the Average Value Calculation

Configuration of the Current Based Average Value Calculation*

*=Availability depends on the ordered device code.

Current based Average Values and Peak Values			
	Time period for the calculation of the average and peak values	Start options	Reset of the average and peak values
Configuration Options Where to configure? In [Device Para\ Statistics\ Demand\ Current Demand]	sliding: (sliding: average calculation based on sliding period) fixed: (fixed: Average calculation is reset by the end of the period, that means with the next starting period)	duration: (fixed or sliding period) Start Fct: (The average values are calculated based on the time period between two rising edges of this signal)	Res Fc (e.g. via Digital Input in order to reset the average values in advance (before the next rising edge of the start signal). This applies to option „Start FC“ only.
<i>Trip (command) option to limit the average current demand: Yes</i>	Please refer to chapter „System Alarms“		
<i>View average values and peak values</i>	Where? Within menu [Operation\Statistics\Demand]		

Configuration of the Voltage Based Average Value Calculation*

*=Availability depends on the ordered device code.







Voltage based Average Values			
	Time period for the calculation of the average values	Start options	Reset of the average and peak values
Configuration Options Where to configure? In [Device Para\ Statistics\ Umit]	sliding: (sliding: average calculation based on sliding period) fixed: (fixed: Average calculation is reset by the end of the period, that means with the next starting period)	duration: (fixed or sliding period) Start Fct: (The average values are calculated based on the time period between two rising edges of this signal)	Res Fc (e.g. via Digital Input in order to reset the average values in advance (before the next rising edge of the start signal). This applies to option „Start FC“ only.
<i>View average values</i>	Where? Within menu [Operation\Statistics\Vavg]		

Configuration of the Power Based Average Value Calculation*



*=Availability depends on the ordered device code.





<i>Power based Average Values (Demand) and Peak Values</i>			
	Time period for the calculation of the average and peak values	Start options	Reset of the average and peak values
Configuration Options Where to configure? In [Device Para\ Statistics\ Bezugsmanagm\ Power Demand]	sliding: (sliding: average calculation based on sliding period) fixed: (fixed: Average calculation is reset by the end of the period, that means with the next starting period)	duration: (fixed or sliding period) Start Fct: (The average values are calculated based on the time period between two rising edges of this signal)	Res Fc (e.g. via Digital Input in order to reset the average values in advance (before the next rising edge of the start signal). This applies to option „Start FC“ only.
<i>Trip (command) option to limit the average power demand: Yes</i>	Please refer to chapter „System Alarms“		
<i>View average values and peak values</i>	Where? Within menu [Operation\Statistics\Demand]		





Direct Commands





Parameter	Description	Setting range	Default	Menu path
ResFc all 	Resetting of all Statistic values (Current Demand, Power Demand, Min, Max)	inactive, active	inactive	[Operation /Reset]
ResFc Vavg 	Resetting of the sliding average calculation.	inactive, active	inactive	[Operation /Reset]
ResFc I Demand 	Resetting of Statistics - Current Demand (avg, peak avg)	inactive, active	inactive	[Operation /Reset]
ResFc P Demand 	Resetting of Statistics - Power Demand (avg, peak avg)	inactive, active	inactive	[Operation /Reset]
ResFc Min 	Resetting of all Minimum values	inactive, active	inactive	[Operation /Reset]
ResFc Max 	Resetting of all Maximum values	inactive, active	inactive	[Operation /Reset]

Global Protection Parameters of the Statistics Module

Parameter	Description	Setting range	Default	Menu path
ResFc Max 	Resetting of all Maximum values	1..n, Assignment List	.-	[Device Para /Statistics /Min / Max]
ResFc Min 	Resetting of all Minimum values	1..n, Assignment List	.-	[Device Para /Statistics /Min / Max]
Start Vavg via: 	Start sliding average supervision by:	Duration, StartFct	Duration	[Device Para /Statistics /Vavg]

Parameter	Description	Setting range	Default	Menu path
Start Vavg Fc 	Start of the calculation, if the assigned signal becomes true. Only available if: Start P Demand via: = StartFct	1..n, Assignment List	.-	[Device Para /Statistics /Vavg]
ResFc Vavg 	Resetting of the sliding average calculation.	1..n, Assignment List	.-	[Device Para /Statistics /Vavg]
Duration Vavg 	Recording time	2 s, 5 s, 10 s, 15 s, 30 s, 1 min, 5 min, 10 min, 15 min, 30 min, 1 h, 2 h, 6 h, 12 h, 1 d, 2 d, 5 d, 7 d, 10 d, 30 d	10 min	[Device Para /Statistics /Vavg]
Window Vavg 	Window configuration	sliding, fixed	sliding	[Device Para /Statistics /Vavg]
Start I Demand via: 	Start Current demand by:	Duration, StartFct	Duration	[Device Para /Statistics /Demand /Current Demand]

<i>Parameter</i>	<i>Description</i>	<i>Setting range</i>	<i>Default</i>	<i>Menu path</i>
Start I Demand Fc 	Start of the calculation, if the assigned signal becomes true. Only available if: Start I Demand via: = StartFct	1..n, Assignment List	.-	[Device Para /Statistics /Demand /Current Demand]
ResFc I Demand 	Resetting of Statistics - Current Demand (avg, peak avg)	1..n, Assignment List	.-	[Device Para /Statistics /Demand /Current Demand]
Duration I Demand 	Recording time Only available if: Start I Demand via: = Duration	2 s, 5 s, 10 s, 15 s, 30 s, 1 min, 5 min, 10 min, 15 min, 30 min, 1 h, 2 h, 6 h, 12 h, 1 d, 2 d, 5 d, 7 d, 10 d, 30 d	15 s	[Device Para /Statistics /Demand /Current Demand]
Window I Demand 	Window configuration	sliding, fixed	sliding	[Device Para /Statistics /Demand /Current Demand]
Start P Demand via: 	Start Active Power demand by:	Duration, StartFct	Duration	[Device Para /Statistics /Demand /Power Demand]

<i>Parameter</i>	<i>Description</i>	<i>Setting range</i>	<i>Default</i>	<i>Menu path</i>
Start P Demand Fc 	Start of the calculation, if the assigned signal becomes true. Only available if: Start P Demand via: = StartFct	1..n, Assignment List	-.-	[Device Para /Statistics /Demand /Power Demand]
ResFc P Demand 	Resetting of Statistics - Power Demand (avg, peak avg)	1..n, Assignment List	-.-	[Device Para /Statistics /Demand /Power Demand]
Duration P Demand 	Recording time Only available if: Start P Demand via: = Duration	2 s, 5 s, 10 s, 15 s, 30 s, 1 min, 5 min, 10 min, 15 min, 30 min, 1 h, 2 h, 6 h, 12 h, 1 d, 2 d, 5 d, 7 d, 10 d, 30 d	15 s	[Device Para /Statistics /Demand /Power Demand]
Window P Demand 	Window configuration	sliding, fixed	sliding	[Device Para /Statistics /Demand /Power Demand]

States of the Inputs of the Statistics Module

<i>Name</i>	<i>Description</i>	<i>Assignment via</i>
StartFc Vavg-I	State of the module input: Start of Statistics Average Voltage	[Device Para /Statistics /Vavg]
StartFc I Demand-I	State of the module input: Start of the Statistics of the Current Demand	[Device Para /Statistics /Demand /Current Demand]
StartFc P Demand-I	State of the module input: Start of the Statistics of the Active Power Demand	[Device Para /Statistics /Demand /Power Demand]
ResFc Vavg-I	State of the module input: Resetting of the sliding average calculation.	[Device Para /Statistics /Vavg]
ResFc I Demand-I	State of the module input: Resetting of Statistics - Current Demand (avg, peak avg)	[Device Para /Statistics /Demand /Current Demand]
ResFc P Demand-I	State of the module input: Resetting of Statistics - Power Demand (avg, peak avg)	[Device Para /Statistics /Demand /Power Demand]
ResFc Max-I	State of the module input: Resetting of all Maximum values	[Device Para /Statistics /Min / Max]
ResFc Min-I	State of the module input: Resetting of all Minimum values	[Device Para /Statistics /Min / Max]

Signals of the Statistics Module

<i>Signal</i>	<i>Description</i>
ResFc all	Signal: Resetting of all Statistic values (Current Demand, Power Demand, Min, Max)
ResFc Vavg	Signal: Resetting of the sliding average calculation.
ResFc I Demand	Signal: Resetting of Statistics - Current Demand (avg, peak avg)
ResFc P Demand	Signal: Resetting of Statistics - Power Demand (avg, peak avg)
ResFc Max	Signal: Resetting of all Maximum values
ResFc Min	Signal: Resetting of all Minimum values

Counters of the Module Statistics

<i>Value</i>	<i>Description</i>	<i>Menu path</i>
Res Cr Vavg	Number of resets since last booting. The timestamp shows date and time of the last reset.	[Operation /Statistics /Vavg]
Res Cr I Demand	Number of resets since last booting. The timestamp shows date and time of the last reset.	[Operation /Statistics /Demand /CT Mains]
Res Cr P Demand	Number of resets since last booting. The timestamp shows date and time of the last reset.	[Operation /Statistics /Demand /Power Demand]
Res Cr Min values	Number of resets since last booting. The timestamp shows date and time of the last reset.	[Operation /Statistics /Min /Power]
Res Cr Max values	Number of resets since last booting. The timestamp shows date and time of the last reset.	[Operation /Statistics /Max /URTD]

Phase Differential Current - Statistic Values

<i>Value</i>	<i>Description</i>	<i>Menu path</i>
Is L1 max	Measured value (calculated): Restraint Current Phase L1 Maximum Value	[Operation /Statistics /Max /Id]
Is L2 max	Measured value (calculated): Restraint Current Phase L2 Maximum Value	[Operation /Statistics /Max /Id]
Is L3 max	Measured value (calculated): Restraint Current Phase L3 Maximum Value	[Operation /Statistics /Max /Id]
Id L1 max	Measured value (calculated): Differential Current Phase L1 Maximum Value	[Operation /Statistics /Max /Id]
Id L2 max	Measured value (calculated): Differential Current Phase L2 Maximum Value	[Operation /Statistics /Max /Id]
Id L3 max	Measured value (calculated): Differential Current Phase L3 Maximum Value	[Operation /Statistics /Max /Id]

Earth Differential Current - Statistic Values

<i>Value</i>	<i>Description</i>	<i>Menu path</i>
IsG W1 max	Measured value (calculated): Ground Stabilizing Current Winding 1 Maximum Value	[Operation /Statistics /Max /IdG[1]]
IdG W1 max	Measured value (calculated): Ground Differential Current IdG Winding 1 Maximum Value	[Operation /Statistics /Max /IdG[1]]
IsG W2 max	Measured value (calculated): Ground Stabilizing Current Winding 2 Maximum Value	[Operation /Statistics /Max /IdG[2]]
IdG W2 max	Measured value (calculated): Ground Differential Current IdG Winding 2 Maximum Value	[Operation /Statistics /Max /IdG[2]]

Current - Statistic Values

<i>Value</i>	<i>Description</i>	<i>Menu path</i>
I1 max	Maximum value positive phase sequence current (fundamental)	[Operation /Statistics /Max /CT Ntrl]
I1 min	Minimum value positive phase sequence current (fundamental)	[Operation /Statistics /Min /CT Ntrl]
I2 max	Maximum value negative sequence current (fundamental)	[Operation /Statistics /Max /CT Ntrl]
I2 min	Minimum value unbalanced load current (fundamental)	[Operation /Statistics /Min /CT Ntrl]
IL1 H2 max	Maximum ratio of 2nd harmonic over fundamental of IL1	[Operation /Statistics /Max /CT Ntrl]
IL1 H2 min	Minimum ratio of 2nd harmonic over fundamental of IL1	[Operation /Statistics /Min /CT Ntrl]
IL2 H2 max	Maximum ratio of 2nd harmonic over fundamental of IL2	[Operation /Statistics /Max /CT Ntrl]
IL2 H2 min	Minimum ratio of 2nd harmonic over fundamental of IL2	[Operation /Statistics /Min /CT Ntrl]
IL3 H2 max	Maximum ratio of 2nd harmonic over fundamental of IL3	[Operation /Statistics /Max /CT Ntrl]

<i>Value</i>	<i>Description</i>	<i>Menu path</i>
IL3 H2 min	Minimum ratio of 2nd harmonic/1st harmonic minimum value of IL3	[Operation /Statistics /Min /CT Ntrl]
IG H2 meas max	Measured value: Maximum ratio of 2nd harmonic over fundamental of IG (measured)	[Operation /Statistics /Max /CT Ntrl]
IG H2 meas min	Measured value: Minimum ratio of 2nd harmonic over fundamental of IG (measured)	[Operation /Statistics /Min /CT Ntrl]
IG H2 calc max	Measured value (calculated): Maximum ratio of 2nd harmonic over fundamental of IG (calculated)	[Operation /Statistics /Max /CT Ntrl]
IG H2 calc min	IG H2 calc min	[Operation /Statistics /Min /CT Ntrl]
IL1 max RMS	IL1 maximum value (RMS)	[Operation /Statistics /Max /CT Ntrl]
IL1 avg RMS	IL1 average value (RMS)	[Operation /Statistics /Demand /CT Ntrl]
IL1 min RMS	IL1 minimum value (RMS)	[Operation /Statistics /Min /CT Ntrl]
IL2 max RMS	IL2 maximum value (RMS)	[Operation /Statistics /Max /CT Ntrl]

<i>Value</i>	<i>Description</i>	<i>Menu path</i>
IL2 avg RMS	IL2 average value (RMS)	[Operation /Statistics /Demand /CT Ntrl]
IL2 min RMS	IL2 minimum value (RMS)	[Operation /Statistics /Min /CT Ntrl]
IL3 max RMS	IL3 maximum value (RMS)	[Operation /Statistics /Max /CT Ntrl]
IL3 avg RMS	IL3 average value (RMS)	[Operation /Statistics /Demand /CT Ntrl]
IL3 min RMS	IL3 minimum value (RMS)	[Operation /Statistics /Min /CT Ntrl]
IG meas max RMS	Measured value: IG maximum value (RMS)	[Operation /Statistics /Max /CT Ntrl]
IG meas min RMS	Measured value: IG minimum value (RMS)	[Operation /Statistics /Min /CT Ntrl]
IG calc max RMS	Measured value (calculated):IG maximum value (RMS)	[Operation /Statistics /Max /CT Ntrl]
IG calc min RMS	Measured value (calculated):IG minimum value (RMS)	[Operation /Statistics /Min /CT Ntrl]

<i>Value</i>	<i>Description</i>	<i>Menu path</i>
%(I2/I1) max	Measured value (calculated): I2/I1 maximum value, phase sequence will be taken into account automatically	[Operation /Statistics /Max /CT Ntrl]
%(I2/I1) min	Measured value (calculated): I2/I1 minimum value, phase sequence will be taken into account automatically	[Operation /Statistics /Min /CT Ntrl]
IL1 Peak demand	IL1 Peak value, RMS value	[Operation /Statistics /Demand /CT Ntrl]
IL2 Peak demand	IL2 Peak value, RMS value	[Operation /Statistics /Demand /CT Ntrl]
IL3 Peak demand	IL3 Peak value, RMS value	[Operation /Statistics /Demand /CT Ntrl]

Voltage - Statistic Values

<i>Value</i>	<i>Description</i>	<i>Menu path</i>
f max	Max. frequency value	[Operation /Statistics /Max /Voltage]
f min	Min. frequency value	[Operation /Statistics /Min /Voltage]
V1 max	Maximum value: Symmetrical components positive phase sequence voltage(fundamental)	[Operation /Statistics /Max /Voltage]
V1 min	Minimum value: Symmetrical components positive phase sequence voltage(fundamental)	[Operation /Statistics /Min /Voltage]
V2 max	Maximum value: Symmetrical components negative phase sequence voltage(fundamental)	[Operation /Statistics /Max /Voltage]
V2 min	Minimum value: Symmetrical components negative phase sequence voltage(fundamental)	[Operation /Statistics /Min /Voltage]
VL12 max RMS	VL12 maximum value (RMS)	[Operation /Statistics /Max /Voltage]
VL12 avg RMS	VL12 average value (RMS)	[Operation /Statistics /Avg]
VL12 min RMS	VL12 minimum value (RMS)	[Operation /Statistics /Min /Voltage]

<i>Value</i>	<i>Description</i>	<i>Menu path</i>
VL23 max RMS	VL23 maximum value (RMS)	[Operation /Statistics /Max /Voltage]
VL23 avg RMS	VL23 average value (RMS)	[Operation /Statistics /Avg]
VL23 min RMS	VL23 minimum value (RMS)	[Operation /Statistics /Min /Voltage]
VL31 max RMS	VL31 maximum value (RMS)	[Operation /Statistics /Max /Voltage]
VL31 avg RMS	VL31 average value (RMS)	[Operation /Statistics /Avg]
VL31 min RMS	VL31 minimum value (RMS)	[Operation /Statistics /Min /Voltage]
VL1 max RMS	VL1 maximum value (RMS)	[Operation /Statistics /Max /Voltage]
VL1 avg RMS	VL1 average value (RMS)	[Operation /Statistics /Avg]
VL1 min RMS	VL1 minimum value (RMS)	[Operation /Statistics /Min /Voltage]
VL2 max RMS	VL2 maximum value (RMS)	[Operation /Statistics /Max /Voltage]

<i>Value</i>	<i>Description</i>	<i>Menu path</i>
VL2 avg RMS	VL2 average value (RMS)	[Operation /Statistics /Avg]
VL2 min RMS	VL2 minimum value (RMS)	[Operation /Statistics /Min /Voltage]
VL3 max RMS	VL3 maximum value (RMS)	[Operation /Statistics /Max /Voltage]
VL3 avg RMS	VL3 average value (RMS)	[Operation /Statistics /Avg]
VL3 min RMS	VL3 minimum value (RMS)	[Operation /Statistics /Min /Voltage]
VX meas max RMS	Measured value: VX maximum value (RMS)	[Operation /Statistics /Max /Voltage]
VX meas min RMS	Measured value: VX minimum value (RMS)	[Operation /Statistics /Min /Voltage]
VG calc max RMS	Measured value (calculated):VX maximum value (RMS)	[Operation /Statistics /Max /Voltage]
VG calc min RMS	Measured value (calculated):VX minimum value (RMS)	[Operation /Statistics /Min /Voltage]
%(V2/V1) max	Measured value (calculated):V2/V1 maximum value, phase sequence will be taken into account automatically	[Operation /Statistics /Max /Voltage]

<i>Value</i>	<i>Description</i>	<i>Menu path</i>
%(V2/V1) min	Measured value (calculated):V2/V1 minimum value , phase sequence will be taken into account automatically	[Operation /Statistics /Min /Voltage]
VX meas H3 max	Maximum value: Third harmonic of measured neutral voltage used to detect generator stator ground faults.	[Operation /Statistics /Max /Voltage]
VX meas H3 min	Minimum value: Third harmonic of measured neutral voltage used to detect generator stator ground faults.	[Operation /Statistics /Min /Voltage]
V/f max	Maximum value: Ratio Volts/Hertz in relation to nominal values.	[Operation /Statistics /Max /Voltage]
V/f min	Minimum value: Ratio Volts/Hertz in relation to nominal values.	[Operation /Statistics /Min /Voltage]

Power - Statistic Values

<i>Value</i>	<i>Description</i>	<i>Menu path</i>
cos phi max	Maximum value of the power factor: Sign Convention: $\text{sign(PF)} = \text{sign(P)}$	[Operation /Statistics /Max /Power]
cos phi min	Minimum value of the power factor: Sign Convention: $\text{sign(PF)} = \text{sign(P)}$	[Operation /Statistics /Min /Power]
S max	Maximum value of the apparent power	[Operation /Statistics /Max /Power]
S avg	Average of the apparent power	[Operation /Statistics /Demand /Power Demand]
S min	Minimum value of the apparent power	[Operation /Statistics /Min /Power]
P max	Maximum value of the active power	[Operation /Statistics /Max /Power]
P avg	Average of the active power	[Operation /Statistics /Demand /Power Demand]
P min	Minimum value of the active power	[Operation /Statistics /Min /Power]
Q max	Maximum value of the reactive power	[Operation /Statistics /Max /Power]

<i>Value</i>	<i>Description</i>	<i>Menu path</i>
Q avg	Average of the reactive power	[Operation /Statistics /Demand /Power Demand]
Q min	Minimum value of the reactive power	[Operation /Statistics /Min /Power]
cos phi max RMS	Maximum value of the power factor: Sign Convention: sign(PF) = sign(P)	[Operation /Statistics /Max /Power]
cos phi min RMS	Minimum value of the power factor: Sign Convention: sign(PF) = sign(P)	[Operation /Statistics /Min /Power]
VA Peak demand	VA Peak value, RMS value	[Operation /Statistics /Demand /Power Demand]
Watt Peak demand	WATTS Peak value, RMS value	[Operation /Statistics /Demand /Power Demand]
VAr Peak demand	VARs Peak value, RMS value	[Operation /Statistics /Demand /Power Demand]

System Alarms

Available Elements:

SysA

NOTICE

Please note that Power Protection and (Active/Reactive/Apparent) Power Demand is only available within Protective Devices that offer current and voltage measurement.

Within the System Alarms menu [SysA] the User can configure:

- General Settings (activate/inactivate the Demand Management, optional assign a signal, that will block the Demand Management);
- Power Protection (Peak values);
- Demand Management (Power and Current); and
- THD Protection.

Please note, that all thresholds are to be set as primary values.

Demand Management

Demand is the average of system current or power over a time interval (window). Demand management supports the User to keep energy demand below target values bound by contract (with the energy supplier). If the contractual target values are exceeded, extra charges are to be paid to the energy supplier.

Therefore, demand management helps the User detect and avoid averaged peak loads that are taken into account for the billing. In order to reduce the demand charge respective to demand rate, peak loads, if possible, should be diversified. That means, if possible, avoiding large loads at the same time. In order to assist the User in analyzing the demand, demand management might inform the User by an alarm. The User might also use demand alarms and assign them on relays in order to perform load shedding (where applicable).

Demand management comprises:

- Power Demand
 - Watt Demand (Active Power);
 - VAr Demand (Reactive Power);
 - VA Demand (Apparent Power); and
- Current Demand.

Configuring the Demand

Configuring the demand is a two step procedure. Proceed as follows.

Step1: Configure the general settings within the [Device Para/Statistics/Demand] menu:

- Set the trigger source to »*Duration*«.
- Select a time base for the »*window*«.
- Determine if the window is »*fixed*« or »*sliding*«.
- If applicable assign a reset signal.

The interval time (window) can be set to fixed or sliding.

Example for a fixed window: If the range is set for 15 minutes, the protective device calculates the average current or power over the past 15 minutes and updates the value every 15 minutes.

Example for a sliding window: If the sliding window is selected and the interval is set to 15 minutes, the protective device calculates and updates the average current or power continuously, for the past 15 minutes (the newest measuring value replaces the oldest measuring value continuously).

Window configuration = sliding

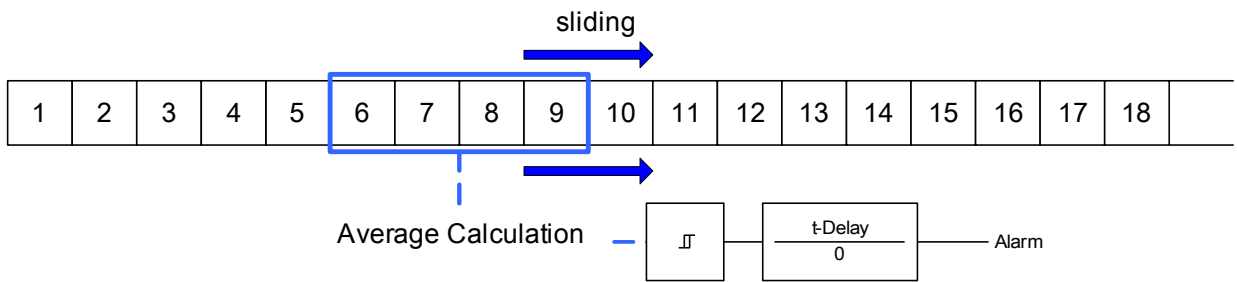
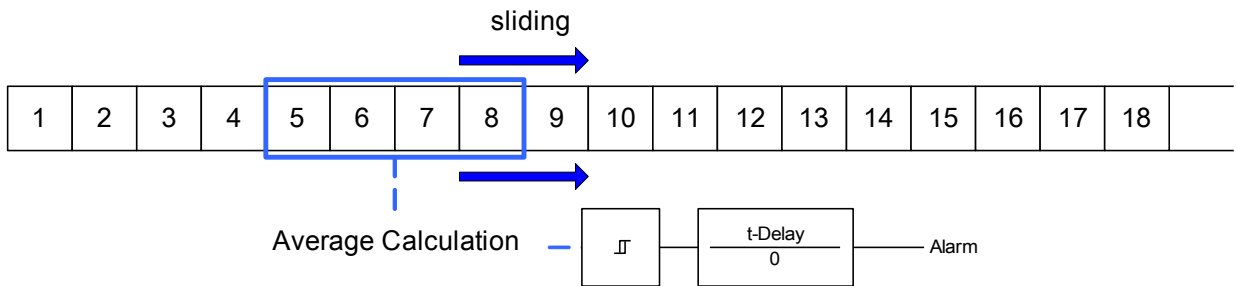
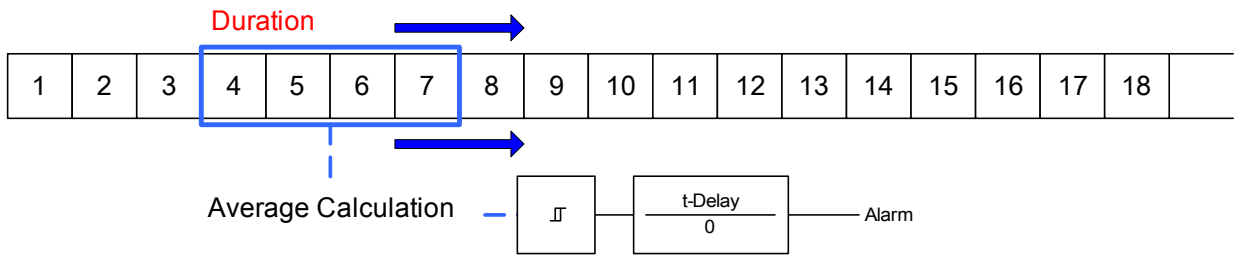

Window configuration = fixed

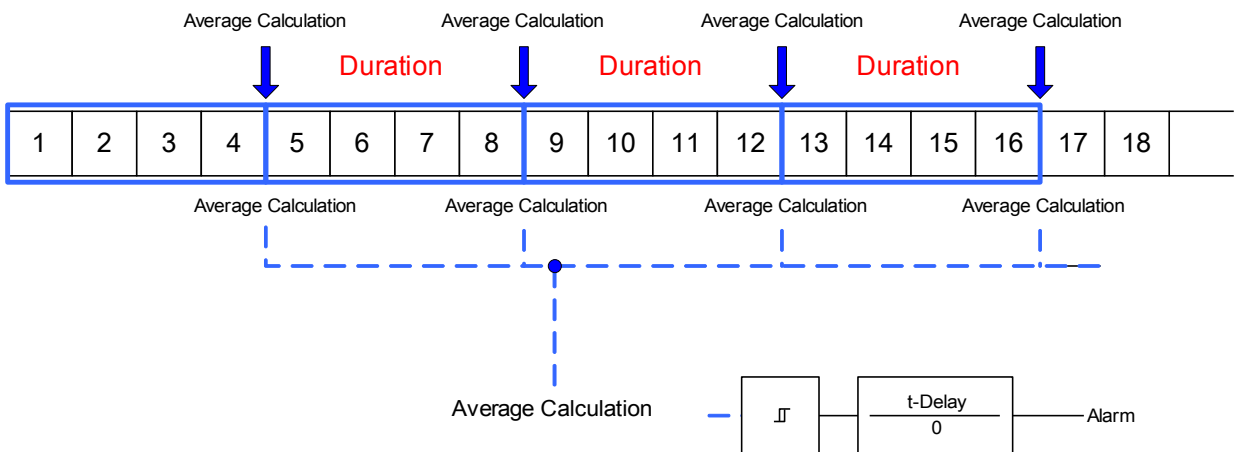

Step 2:

- In addition, the Demand specific settings have to be configured in the [SysA/Demand] menu.
- Determine if the demand should generate an alarm or if it should run in the silent mode. (Alarm active/inactive).
- Set the threshold.
- Where applicable, set a delay time for the alarm.

Peak Values

The protective device also saves the peak demand values for current and power. The quantities represent the largest demand value since the demand values were last reset. Peak demands for current and system power are date and time stamped.

Within the [Operation/Statistics] menu, the current Demand and Peak demand values can be seen.

Configuring the Peak Value Supervision

The supervision for the peak values can be configured within menu [SysA/Power] in order to monitor:

- Active Power (Watt),
- Reactive Power (VAr)
- Apparent Power (VA)

The specific settings are to be set within menu [SysA/Power].

- Determine if the peak value supervision should generate an alarm or if it should run in the silent mode. (Alarm active/inactive).
- Set the threshold.
- Where applicable, set a delay time for the alarm.

Min. and Max. Values.

Within [Operation/Statistics] menu the minimum (min.) and maximum (max.) values can be seen.

Minimum values since last reset: The minimum values are continuously compared to the last minimum value for that measuring value. If the new value is less than the last minimum, the value is updated. Within the [Device Para/Statistics/"Min / Max"] menu, a reset signal can be assigned.

Maximum values since last reset: The maximum values are continuously compared to the last maximum value for that measuring value. If the new value is greater than the last maximum, the value is updated. Within the [Device Para/Statistics/"Min / Max"] menu, a reset signal can be assigned.

THD Protection

In order to supervise power quality, the protective device can monitor the voltage (phase-to-phase) and current THDs.

Within the [SysA/THD] menu:

- Determine if an alarm is to be issued or not (Alarm active/inactive);
- Set the threshold; and
- Where applicable, set a delay time for the alarm.











Device Planning Parameters of the Demand Management

Parameter	Description	Options	Default	Menu path
Mode	Mode	do not use, use	do not use	[Device planning]
				

Signals of the Demand Management (States of the Outputs)

Signal	Description
active	Signal: active
ExBlo	Signal: External Blocking
Alarm Watt Power	Signal: Alarm permitted Active Power exceeded
Alarm VAr Power	Signal: Alarm permitted Reactive Power exceeded
Alarm VA Power	Signal: Alarm permitted Apparent Power exceeded
Alarm Watt Demand	Signal: Alarm averaged Active Power exceeded
Alarm VAr Demand	Signal: Alarm averaged Reactive Power exceeded
Alarm VA Demand	Signal: Alarm averaged Apparent Power exceeded
Alm Current Demd	Signal: Alarm averaged demand current
Alarm I THD	Signal: Alarm Total Harmonic Distortion Current
Alarm V THD	Signal: Alarm Total Harmonic Distortion Voltage
Trip Watt Power	Signal: Trip permitted Active Power exceeded
Trip VAr Power	Signal: Trip permitted Reactive Power exceeded
Trip VA Power	Signal: Trip permitted Apparent Power exceeded
Trip Watt Demand	Signal: Trip averaged Active Power exceeded
Trip VAr Demand	Signal: Trip averaged Reactive Power exceeded
Trip VA Demand	Signal: Trip averaged Apparent Power exceeded
Trip Current Demand	Signal: Trip averaged demand current
Trip I THD	Signal: Trip Total Harmonic Distortion Current
Trip V THD	Signal: Trip Total Harmonic Distortion Voltage

Global Protection Parameter of the Demand Management

Parameter	Description	Setting range	Default	Menu path
Function 	Permanent activation or deactivation of module/stage.	inactive, active	inactive	[SysA /General Settings]
ExBlo Fc 	Activate (allow) or inactivate (disallow) blocking of the module/stage. This parameter is only effective if a signal is assigned to the corresponding global protection parameter. If the signal becomes true, those modules/stages are blocked that are parameterized "ExBlo Fc=active".	1..n, Assignment List	.-	[SysA /General Settings]
Alarm 	Alarm	inactive, active	inactive	[SysA /Power /Watt]
Threshold 	Threshold (to be entered as primary value)	1 - 40000000kW	10000kW	[SysA /Power /Watt]
t-Delay 	Tripping Delay	0 - 60min	0min	[SysA /Power /Watt]
Alarm 	Alarm	inactive, active	inactive	[SysA /Power /VAr]
Threshold 	Threshold (to be entered as primary value)	1 - 40000000kVAr	10000kVAr	[SysA /Power /VAr]
t-Delay 	Tripping Delay	0 - 60min	0min	[SysA /Power /VAr]
Alarm 	Alarm	inactive, active	inactive	[SysA /Power /VA]
Threshold 	Threshold (to be entered as primary value)	1 - 40000000kVA	10000kVA	[SysA /Power /VA]

System Alarms

Parameter	Description	Setting range	Default	Menu path
t-Delay 	Tripping Delay	0 - 60min	0min	[SysA /Power /VA]
Alarm 	Alarm	inactive, active	inactive	[SysA /Demand /Power Demand /Watt Demand]
Threshold 	Threshold (to be entered as primary value)	1 - 40000000kW	10000kW	[SysA /Demand /Power Demand /Watt Demand]
t-Delay 	Tripping Delay	0 - 60min	0min	[SysA /Demand /Power Demand /Watt Demand]
Alarm 	Alarm	inactive, active	inactive	[SysA /Demand /Power Demand /VAr Demand]
Threshold 	Threshold (to be entered as primary value)	1 - 40000000kVAr	20000kVAr	[SysA /Demand /Power Demand /VAr Demand]
t-Delay 	Tripping Delay	0 - 60min	0min	[SysA /Demand /Power Demand /VAr Demand]
Alarm 	Alarm	inactive, active	inactive	[SysA /Demand /Power Demand /VA Demand]

System Alarms

Parameter	Description	Setting range	Default	Menu path
 Threshold	Threshold (to be entered as primary value)	1 - 4000000kVA	2000kVA	[SysA /Demand /Power Demand /VA Demand]
 t-Delay	Tripping Delay	0 - 60min	0min	[SysA /Demand /Power Demand /VA Demand]
 Alarm	Alarm	inactive, active	inactive	[SysA /Demand /Current Demand]
 Threshold	Threshold (to be entered as primary value)	10 - 500000A	500A	[SysA /Demand /Current Demand]
 t-Delay	Tripping Delay	0 - 60min	0min	[SysA /Demand /Current Demand]
 Alarm	Alarm	inactive, active	inactive	[SysA /THD /I THD]
 Threshold	Threshold (to be entered as primary value)	1 - 500000A	500A	[SysA /THD /I THD]
 t-Delay	Tripping Delay	0 - 3600s	0s	[SysA /THD /I THD]
 Alarm	Alarm	inactive, active	inactive	[SysA /THD /V THD]
 Threshold	Threshold (to be entered as primary value)	1 - 500000V	10000V	[SysA /THD /V THD]

System Alarms

<i>Parameter</i>	<i>Description</i>	<i>Setting range</i>	<i>Default</i>	<i>Menu path</i>
t-Delay 	Tripping Delay	0 - 3600s	0s	[SysA /THD /V THD]

States of the Inputs of the Demand Management

<i>Name</i>	<i>Description</i>	<i>Assignment via</i>
ExBlo-I	Module input state: External blocking	[SysA /General Settings]

Acknowledgments

Collective Acknowledgments for latched signals:

<i>Collective Acknowledgments</i>					
	<i>LEDs</i>	<i>Binary Output Relays</i>	<i>SCADA</i>	<i>Pending Trip Command</i>	<i>LEDs+ Binary Output Relays+ SCADA+ Pending Trip Command</i>
<p>Via Smart view or at the panel all... can be acknowledged.</p> <p>At the panel, the menu [Operation\ Acknowledge] can directly be accessed via the »C« key</p>	<p>All LEDs at once: Where? [Operation / Acknowledge]</p>	<p>All Binary Output Relays at once: Where? [Operation / Acknowledge]</p>	<p>All SCADA signals at once: Where? [Operation / Acknowledge]</p>	<p>All pending trip commands at once: Where? [Operation / Acknowledge]</p>	<p>All at once: Where? [Operation / Acknowledge]</p>
<p>External Acknowledgment*:</p> <p>Via a signal from the assignment list (e.g. a digital Input) all... can be acknowledged.</p>	<p>All LEDs at once: Where? Within the menu [Device Para / Acknowledge]</p>	<p>All Binary Output Relays at once: Where? Within the menu [Device Para / Acknowledge]</p>	<p>All SCADA signals at once: Where? Within the menu [Device Para / Acknowledge]</p>	<p>All pending trip commands at once: Where? Within the menu [Device Para / Acknowledge]</p>	
<p>Automatic Acknowledgment:</p> <p>Via a new alarm from any protection function</p>	<p>All LEDs at once, automatically in case of a protection alarm.</p>				

*The External Acknowledgment might be disabled if parameter »Ex Ack «is set to »inactive« within menu [Device Para / Acknowledge]. This blocks also the acknowledgment via Communication (e.g. Modbus).

** If the automatic acknowledgment is active all LEDs get acknowledged with a protection alarm.

The automatic acknowledgment must be activated by setting:

[Device Para / LEDs / LEDs group A / LED 1...n] »Latched« = "active, ack. by alarm"

Options for individual acknowledgments for latched signals:

<i>Individual Acknowledgment</i>			
	<i>LEDs</i>	<i>Binary Output Relays</i>	<i>Pending Trip Command</i>
Via a signal from the assignment list (e.g.: a digital Input) a single ... can be acknowledged.	<p>Single LED:</p> <p>Where? Within the configuration menu of this single LED.</p>	<p>Binary Output Relay:</p> <p>Where? Within the configuration menu of this single Binary Output Relay.</p>	<p>Pending Trip Command.</p> <p>Where? Within the module <u><i>TripControl</i></u></p>

NOTICE

As long as you are within the parameter setting mode, you cannot acknowledge.

NOTICE

In case of a fault during parameter setting via the operating panel, you must first leave the parameter mode by pressing either push-button »C« or »OK« before you may access to menu »Acknowledgments« via push-button.

Manual Acknowledgment

It is possible to acknowledge LEDs, SCADA, binary output relays and / or a pending trip command by pressing the »C« key at the panel.

There are two principles available how the »C« key shall react when being pressed:

- **(1.) *With intermediate selection step:*** After the »C« key has been pressed, you select the items to be acknowledged (LEDs, SCADA, binary output relays, trip command, or all of these) via the Softkeys. After this, you press the Softkey with the »Wrench-Symbol«.
- **(2.) *Immediate acknowledge:*** After it has been configured which items shall be assigned to the »Ack via »C« key«, these are acknowledged by simply pressing the »C« key (for ca. 1 second).

The setting parameter [Device Para / Acknowledge] »Ack via »C« key« decides about which principle described above shall be available when the »C« key is pressed:

- “Nothing” – Pressing the »C« key works as described with “principle (1.)“, i. e. you explicitly select the items to be acknowledged.
- “Ack LEDs” – Pressing the »C« key (for approx. 1 second) acknowledges all LEDs immediately (only the password will be asked for, see below).
- “Ack LEDs, relays” – Pressing the »C« key (for approx. 1 second) acknowledges all LEDs and all binary output relays immediately (only the password will be asked for, see below).
- “Ack Everything” – Pressing the »C« key (for approx. 1 second) acknowledges all (above) mentioned items immediately (only the password will be asked for, see below).

The three immediate types of acknowledgments according to “principle (2.)“ can be recognized from the fact that it always includes an LED test, i. e. all LEDs flash in red color for a second, then flash in green color for a second.

NOTICE

Independent of which acknowledgment type you have set, note that you are asked to enter the password.

If there is the need to be able to acknowledge without entering any password set an empty password for the level »Prot-Lv1«.

For general information about passwords and security-related considerations, see the „Security“ chapter.

External Acknowledgments

Within the menu [Device Parameter\Ex Acknowledge] you can assign a signal (e.g. the state of a digital input) from the assignment list that:

- acknowledges all (acknowledgeable) LEDs at once;
- acknowledges all (acknowledgeable) binary outputs at once:
- acknowledges all (acknowledgeable) SCADA-signals at once.



Manual Resets

In menu »*Operation/Reset*« you can:



- reset counters,
- delete records (e.g. disturbance records) and
- reset special things (like statistics, thermal replica...).

NOTICE

The description of the reset commands can be found within the corresponding modules.

Status Display

In the status display within the »Operation« menu, the present state of all signals can be viewed. This means the User is able to see if the individual signals are active or inactive at that moment. The User can see all signals sorted by protective elements/modules.

<i>State of the module input/signal is...</i>	<i>Is shown at the panel as...</i>
false / »0«	
true / »1«	





Operating Panel (HMI)

HMI

Special Parameters of the Panel

This menu »Device Parameter/HMI« is used to define the contrast of the display, the maximum admissible edit time and the menu language (after expiry of which, all unsaved parameter changes will be rejected).



Direct Commands of the Panel

Parameter	Description	Setting range	Default	Menu path
 Contrast	Contrast	0 - 100%	50%	[Device Para /HMI]
 Reset Options	If the »C« key is pressed while the device is performing a cold restart a general Reset Dialog appears on the screen. Select which options shall be available with this dialog.	Fact.def., "PW rst", Only "Fact.defaults", Reset deact.	Fact.def., "PW rst"	[Device Para /Security /Miscellaneous]
 Smart view via USB	Activate (allow) or inactivate (disallow) the Smart view access via the USB interface.	inactive, active	active	[Device Para /Security /Communication]
 Smart view via Eth	Activate (allow) or inactivate (disallow) the Smart view access via the Ethernet interface.	inactive, active	active	[Device Para /Security /Communication]

Global Protection Parameters of the Panel

Parameter	Description	Setting range	Default	Menu path
 t-max Edit/Access	If no other key(s) is pressed at the panel, after expiration of this time, all cached (changed) parameters are canceled. The device access will be locked by falling back into Read-only level Lv0.	20 - 3600s	180s	[Device Para /Security /Miscellaneous]

Operating Panel (HMI)

<i>Parameter</i>	<i>Description</i>	<i>Setting range</i>	<i>Default</i>	<i>Menu path</i>
Display Off 	The display back light will be turned off when this timer has expired.	20 - 3600s	180s	[Device Para /HMI]
Menu language 	Selection of the language	English, German, Russian, Polish, French, Portuguese, Spanish, Romanian	English	[Device Para /HMI]
Display ANSI Device No. 	Display ANSI Device Numbers	inactive, active	active	[Device Para /HMI]

Recorders

Disturbance Recorder

Available elements:

Disturb rec

- Disturbance records can be downloaded (read out) by means of the parameter setting and evaluation software *Smart view*.
- The disturbance records can be viewed and analyzed within *Data visualizer* (will be installed with *Smart view*).
- Disturbance records can be converted into the COMTRADE file format by means of *Data visualizers*.

The disturbance recorder works with 32 samples per cycle. The disturbance recorder can be started by any of eight start events (selection from the »assignment list« / OR-Logic). The disturbance record contains the measuring values inclusively pre-trigger-time. By means of *Smart view/Datavisualizer* (option) the oscillographic curves of the analogue (current, voltage) and digital channels/traces can be shown and evaluated in a graphical form. The disturbance recorder has a storage capacity of 120 s. The disturbance recorder is able to record up to 15 s (adjustable) per record. The amount of records depends on the size of each record.

The disturbance recorder can be configured in the menu »*Device Parameter/Recorder/Disturb rec*«.

Determine the max. recording time to register a disturbance event. This can be set via the parameter »*Max file size*«, the maximum value is 15 s (including pre-trigger and post-trigger time). The pre-trigger and post-trigger times of the disturbance recorder are set (via parameters »*Pre-trigger time*« and »*Post-trigger time*«) in percent of the »*Max file size*« value.

To trigger the disturbance recorder, up to 8 signals can be selected from the »assignment list«. The trigger events are OR-linked. If a disturbance record has been written, a new disturbance record cannot be triggered until all trigger signals that have triggered the previous disturbance record are gone.

NOTICE

If t_T is the duration of the trigger signal and t_{Max} = »*Max file size*«, t_{Pre} = (»*Pre-trigger time*« · t_{Max}), t_{Post} = (»*Post-trigger time*« · t_{Max}), then the resulting durations are as follows:

- The actual pre-trigger timer always equals t_{Pre}
- The disturbance event is recorded for the time t_{Ev} , which is:

$$t_{Ev} = \min(t_T, (t_{Max} - t_{Pre}))$$
- The actual post-trigger timer t_{Rest} is:

$$t_{Rest} = \min(t_{Post}, (t_{Max} - t_{Pre} - t_{Ev}))$$

It can obviously happen that – depending on the actual duration of the trigger signal and the setting t_{Pre} – that $t_{Ev} < t_T$, i. e. that the disturbance event does not get recorded completely. The only way to mitigate this risk (besides setting a smaller value for t_{Pre}) is to configure a larger value for t_{Max} . This, however, has the consequence that a smaller number of events can be held in memory.

In the same way it can happen that no more post-trigger time is left (i. e. $t_{Rest} = 0$). Note that the recording always gets stopped after the configured time t_{Max} = »*Max file size*« has elapsed.

Moreover, decide about the behavior of the disturbance recorder in case the storage capacity has been used up: Do you want it to automatically overwrite the oldest recordings (»*Auto overwriting*« = "active"), or do you want it to

stop making any further recordings («*Auto overwriting*»="inactive") until the memory has been cleared manually.

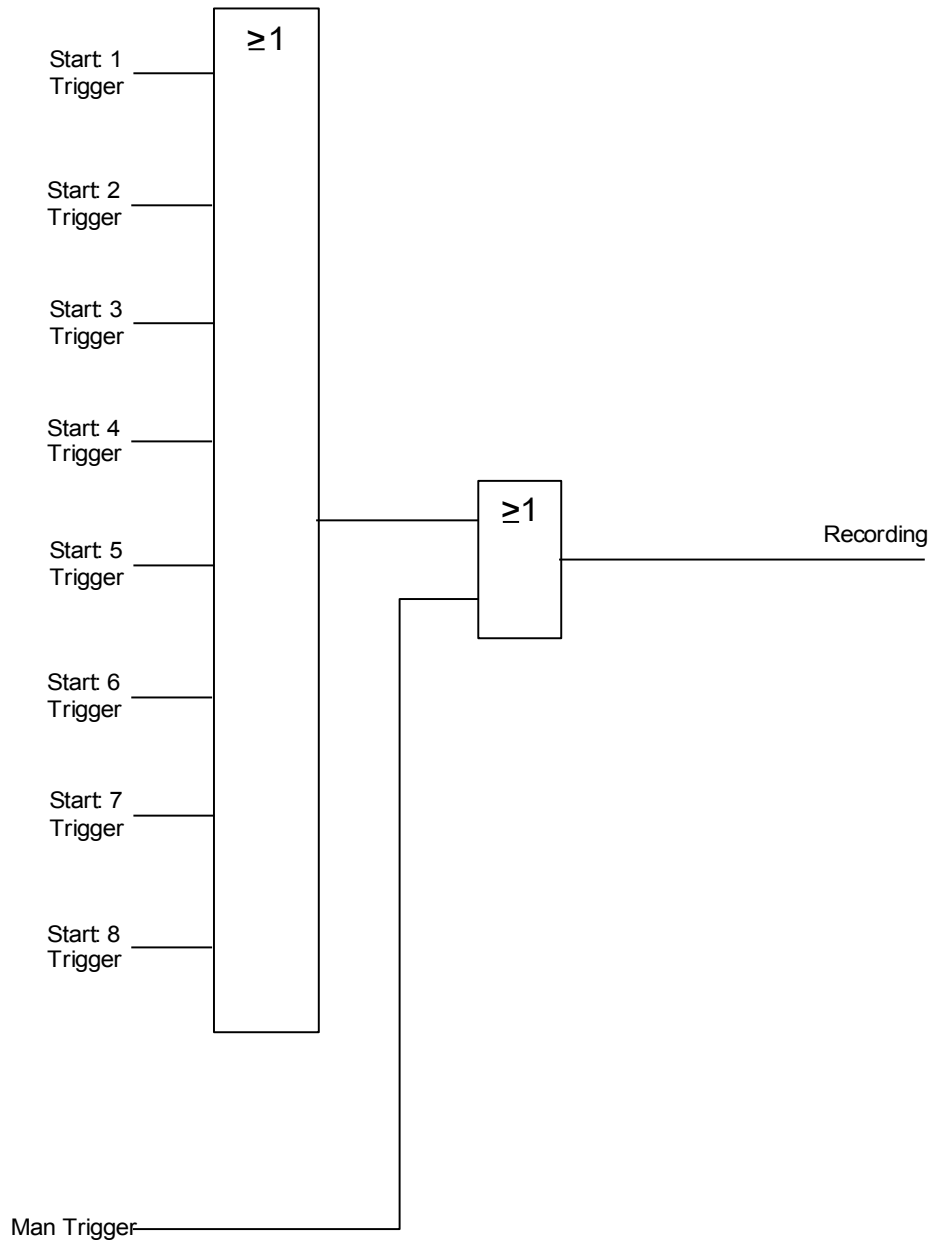

Example Disturbance Recorder Timing Chart I

- Start 1 = Prot.Trip
- Start 2 = -.-
- Start 3 = -.-
- Start 4 = -.-
- Start 5 = -.-
- Start 6 = -.-
- Start 7 = -.-
- Start 8 = -.-
- Auto overwriting = active
- Post-trigger time = 25%
- Pre-trigger time = 15%
- Max file size = 2s

t-rec < Max file size

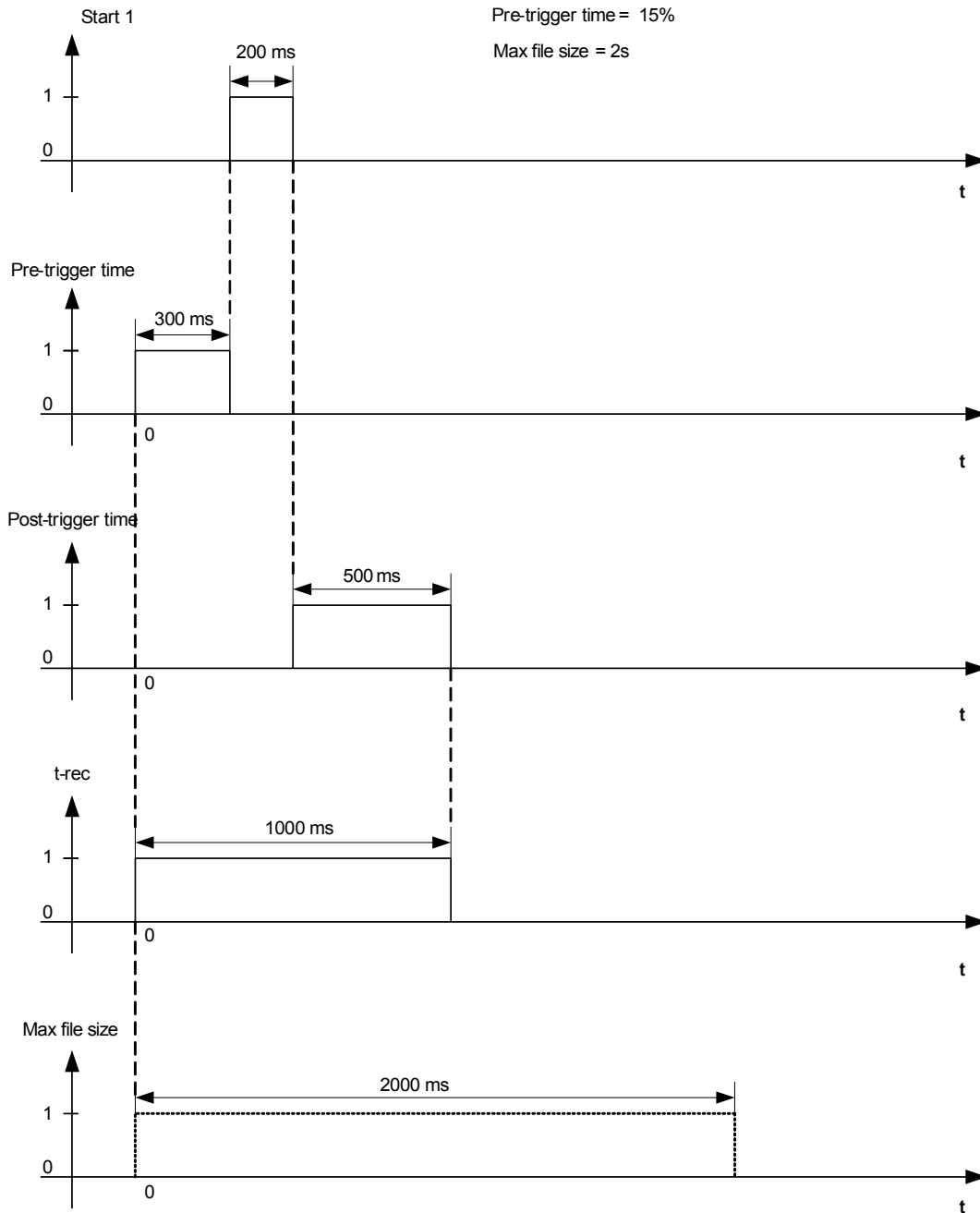

Example Disturbance Recorder Timing Chart II

- Start 1 = Prot.Alarm
- Start 2 = -.-
- Start 3 = -.-
- Start 4 = -.-
- Start 5 = -.-
- Start 6 = -.-
- Start 7 = -.-
- Start 8 = -.-
- Auto overwriting = active
- Post-trigger time = 25%
- Pre-trigger time = 15%
- Max file size = 2s

t-rec = Max file size

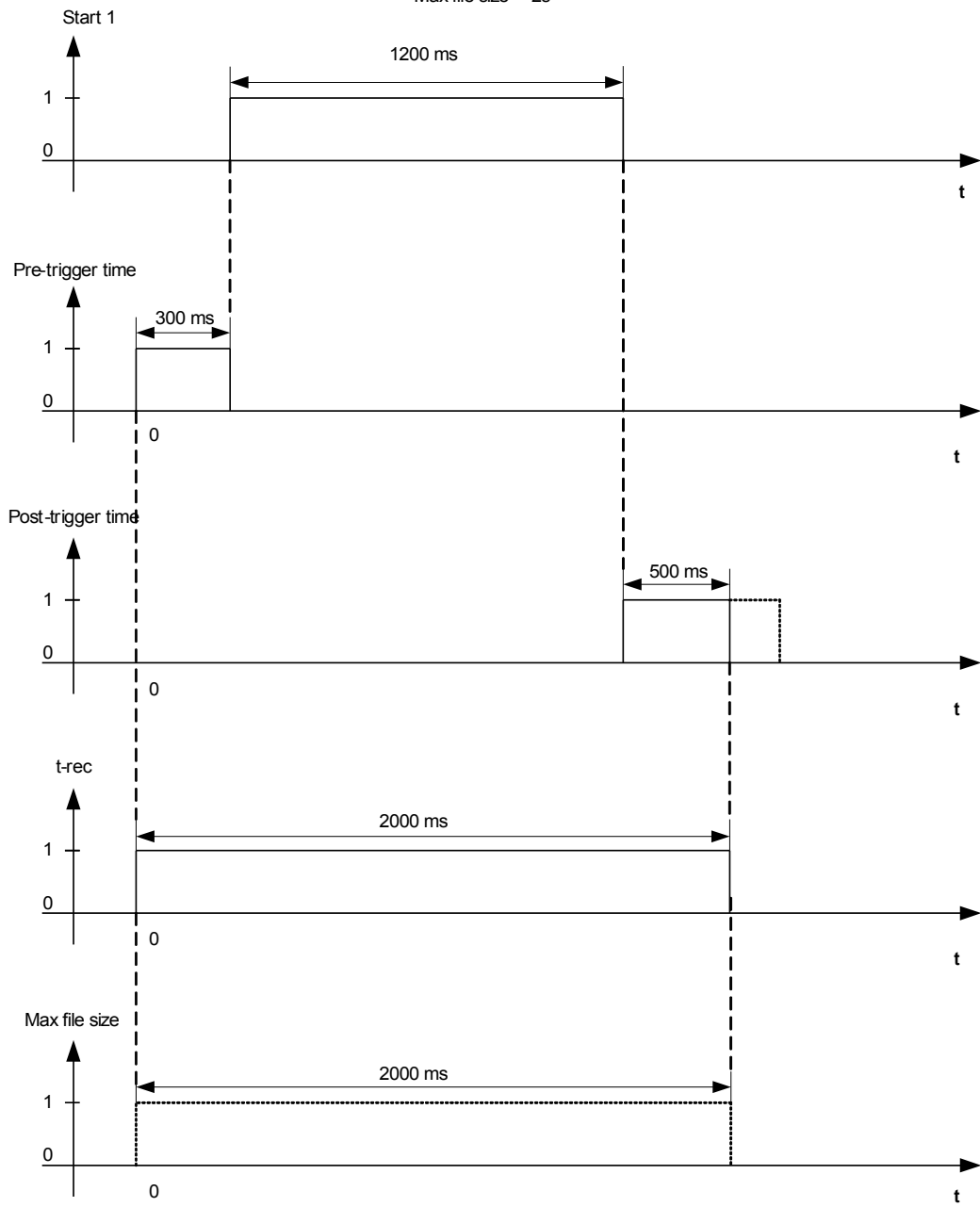

Read Out Disturbance Records

- Within the menu »Operation/Disturb rec« you can detect accumulated disturbance records.

NOTICE



Within the Menu »Operation/Recorders/Man Trigger« you can trigger the disturbance recorder manually.

Deleting Disturbance Records









Within the menu »Operation/Disturb rec« you can:





- Delete disturbance records.
- Choose via »SOFTKEY« »up« and »SOFTKEY« »down« the disturbance record that is to be deleted.
- Call up the detailed view of the disturbance record via »SOFTKEY« »right«.
- Confirm by pressing »SOFTKEY« »delete«
- Enter your password followed by pressing the key »OK«
- Choose whether only the current or whether all disturbance records should be deleted.
- Confirm by pressing »SOFTKEY« »OK«

Direct Commands of the Disturbance Recorder

Parameter	Description	Setting range	Default	Menu path
 Man Trigger	Manual Trigger	False, True	False	[Operation /Recorders /Man Trigger]
 Res all rec	Reset all records	inactive, active	inactive	[Operation /Reset]

Global Protection Parameters of the Disturbance Recorder

Parameter	Description	Setting range	Default	Menu path
 Start: 1	Start recording if the assigned signal is true.	1..n, Assignment List	Prot.Trip	[Device Para /Recorders /Disturb rec]
 Start: 2	Start recording if the assigned signal is true.	1..n, Assignment List	-.-	[Device Para /Recorders /Disturb rec]
 Start: 3	Start recording if the assigned signal is true.	1..n, Assignment List	-.-	[Device Para /Recorders /Disturb rec]
 Start: 4	Start recording if the assigned signal is true.	1..n, Assignment List	-.-	[Device Para /Recorders /Disturb rec]
 Start: 5	Start recording if the assigned signal is true.	1..n, Assignment List	-.-	[Device Para /Recorders /Disturb rec]
 Start: 6	Start recording if the assigned signal is true.	1..n, Assignment List	-.-	[Device Para /Recorders /Disturb rec]
 Start: 7	Start recording if the assigned signal is true.	1..n, Assignment List	-.-	[Device Para /Recorders /Disturb rec]
 Start: 8	Start recording if the assigned signal is true.	1..n, Assignment List	-.-	[Device Para /Recorders /Disturb rec]

Parameter	Description	Setting range	Default	Menu path
Auto overwriting 	If there is no more free memory capacity left, the oldest file will be overwritten.	inactive, active	active	[Device Para /Recorders /Disturb rec]
Pre-trigger time 	The pre trigger time is set in percent of the »Max file size« value. It corresponds to the part of recording before the onset of the trigger event.	0 - 99%	20%	[Device Para /Recorders /Disturb rec]
Post-trigger time 	The post trigger time is set in percent of the »Max file size« value. It is the remaining time of the »Max file size«, depending on the »Pre-trigger time« setting and the duration of the trigger event, but at maximum the »Post-trigger time« set here.	0 - 99%	20%	[Device Para /Recorders /Disturb rec]
Max file size 	The maximum storage capacity per record, including pre-trigger and post-trigger time. The amount of records depends on the size of each record, on the max. file size (set here), and on the total storage capacity.	0.1 - 15.0s	2s	[Device Para /Recorders /Disturb rec]

Disturbance Recorder Input States

Name	Description	Assignment via
Start1-l	State of the module input:: Trigger event / start recording if:	[Device Para /Recorders /Disturb rec]
Start2-l	State of the module input:: Trigger event / start recording if:	[Device Para /Recorders /Disturb rec]
Start3-l	State of the module input:: Trigger event / start recording if:	[Device Para /Recorders /Disturb rec]
Start4-l	State of the module input:: Trigger event / start recording if:	[Device Para /Recorders /Disturb rec]
Start5-l	State of the module input:: Trigger event / start recording if:	[Device Para /Recorders /Disturb rec]

<i>Name</i>	<i>Description</i>	<i>Assignment via</i>
Start6-l	State of the module input:: Trigger event / start recording if:	[Device Para /Recorders /Disturb rec]
Start7-l	State of the module input:: Trigger event / start recording if:	[Device Para /Recorders /Disturb rec]
Start8-l	State of the module input:: Trigger event / start recording if:	[Device Para /Recorders /Disturb rec]

Disturbance Recorder Signals

<i>Signal</i>	<i>Description</i>
recording	Signal: Recording
memory full	Signal: Memory full
Clear fail	Signal: Clear failure in memory
Res all records	Signal: All records deleted
Res rec	Signal: Delete record
Man Trigger	Signal: Manual Trigger

Special Parameters of the Disturbance Recorder

<i>Value</i>	<i>Description</i>	<i>Default</i>	<i>Size</i>	<i>Menu path</i>
Rec state	Recording state	Ready	Ready, Recording, Writing file, Trigger Blo	[Operation /Status Display /Recorders /Disturb rec]
Error code	Error code	OK	OK, Write err, Clear fail, Calculation err, File not found, Auto overwriting off	[Operation /Status Display /Recorders /Disturb rec]

Fault Recorder

Fault rec

Purpose of the Fault recorder

The *Fault Recorder* provides compressed information about faults (e.g. Trip Causes). The compressed information can be read out also at the HMI. This might be helpful for fast fault analysis already at the HMI. After a fault, a popup window will be sent onto the display in order to draw the users attention to the fault. The *Fault Recorder* will provide information on the causes of the fault. A detailed fault analysis (in oscillographic form) can be done means of the Disturbance Recorder. The reference between the Fault Records and the corresponding Disturbance Records are the »*Fault Number*« and the »*Grid Fault Number*«.

Definitions

Time to Trip: Time between *First Alarm* (Prot.Pickup) and *First Trip* (Prot.Trip) decision

Fault Duration: Time period from the rising edge of the General Pickup («PROT.PICKUP») signal up to the falling edge of the General Pickup Signal. Please note that General Pickup is an or-connection (disjunction) of all Pickup signals. General Trip is an OR-connection of all Trips.

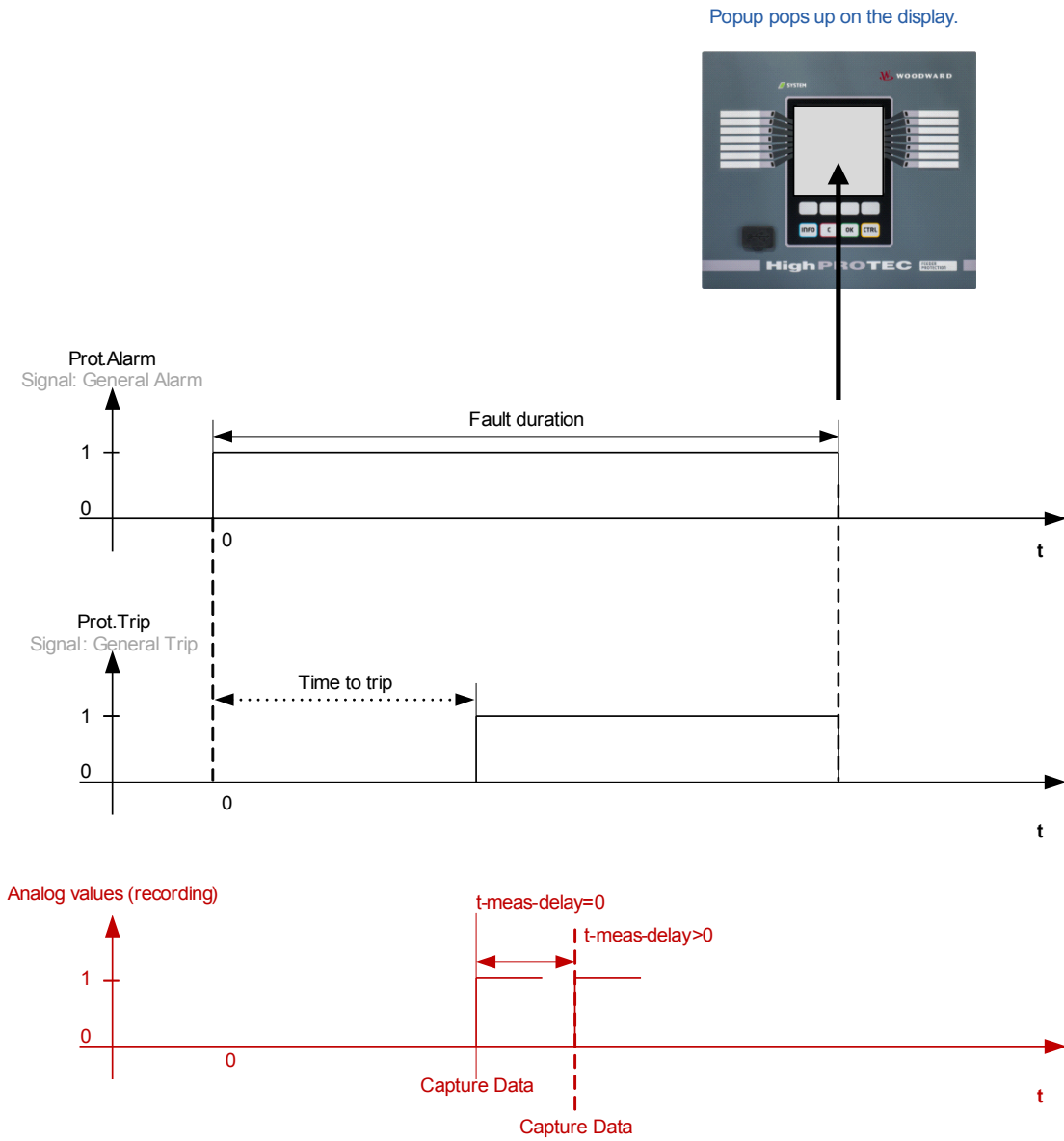

Behaviour of the Fault Recorder

Who triggers the Fault Recorder?

The *Fault Recorder* will be triggered by the rising edge of the »PROT.PICKUP« (General Pickup) signal. Please note that »PROT.PICKUP« (General Pickup) is an or-connection of all Pickup signals. The first Pickup will trigger the Fault recorder.

At which point of time will the fault measurements be captured?

The fault measurements will be captured (written) when the trip decision is taken. The point in time, when the measurements are captured (after a trip) can be delayed optionally by the parameter »*t-meas-delay*«. This might be reasonable in order to achieve more reliable measuring values (e.g. in order to avoid measuring disturbances caused by significant DC-components).

Modes

In case of a fault record should be written even if an general alarm has not lead to a trip, the parameter »*Record-Mode*« is to be set to »*Alarms and Trips*« .

Set parameter »*Record-Mode*« to »*Trips only*«, if an Alarm that is not followed by a trip decision should not lead to a trip.

When does the overlay (popup) appears on the display of the HMI?

A popup will appear on the HMI display, when the General Pickup (Prot.Pickup) disappears.

NOTICE

No time to trip will be shown if the pickup signal that triggers the fault recorder is issued by another protection module than the trip signal. This might happen if more than one protection module is involved into a fault.

NOTICE

Please note: The parameter settings (thresholds etc.) that are shown in a fault record are not part of the fault record itself. They are always read out from the current device setting. If parameters settings that are shown in a fault record could have been updated, they will be indicated with an asterisk symbol within the fault record.

To prevent this please proceed as follows:

Save any fault record that should be archived to your local network/hard disk before doing any parameter change. Delete all the fault records in your fault recorder afterwards.

Memory

The last stored fault record is saved (fail-safe) within the *Fault Recorder* (the others are saved within a memory that depends on the auxiliary power of the protective relay). If there is no more memory free, the oldest record will be overwritten (FIFO). Up to 20 records can be stored.

How to close the overlay/popup?

By using Softkey »OK«.

How to find out fast, if a fault has lead to a trip or not?

Faults that lead to a trip will be indicated by a flash icon  (right side) within the overview menu of the fault recorder.

Which fault record pops up?

The newest fault.

Content of a Fault Record





A fault record comprises information about:

Date/Time	Date and Time of the Fault			
FaultNr	The number of the fault will be incremented with each fault (General Alarm or »PROT.PICKUP«)			
Grid Fault No.	This counter will be incremented by each General Pickup (Exception AR: this applies only to devices that offer auto reclosing).			
Active Set	The active parameter set			
Time to trip	The time between pickup and trip. Please note: No time to trip will be shown if the first pickup and the first trip are issued by different protection modules.			
Alarm	Name of the module that picked up first.			
Trip	Name of the module that tripped first. The information that will be displayed depends on which protection module has tripped. That means e.g. that the thresholds are shown. In case that the trip was initiated by the MotorStart (applies to motor protection relays) protection module, additional information will be displayed.			
Adaptive Set	In case that adaptive sets are used, the number of the active set will be displayed.			
Fault type	In case of overcurrent trips, the fault type will be evaluated based on the energized phases.			
	Alarm Phase A	Alarm Phase B	Alarm Phase C	Fault Type
	x			L1G
		x		L2G
			x	L3G
	x	x		L1B
		x	x	L2L3
	x		x	L1L3
	x	x	x	L1L2L3
Direction	In case that a direction has been detected, the evaluated direction will be displayed (this applies to directional phase and ground overcurrent relays only).			
Measured Values	Various measuring values at the time of tripping (or delayed depending on parameter setting) will be displayed.			

How to set up the Fault Recorder

The »Record-Mode« will determine if trips only cause a fault record or if also Alarms without a consecutively trip should cause a fault record. This parameter is to be set within menu [Device Para\Recorders\Fault rec]

How to navigate within the Fault Recorder

<i>Navigation within the Fault recorder</i>	Softkey
Back to overview.	
Next (upper) item within this fault record.	
Previous fault record.	
Next (lower) item within this fault record.	

How to read Out the Fault Recorder

In order to read out a fault record there are two options available:

- Option 1: A Fault has popped up on the HMI (because an trip or pickup has occurred).
- Option 2: Call up manually the Fault recorder menu.

Option 1 (in case a fault record pops up on the display (overlay):

- Analyze the fault record by using Softkeys Arrow Up and Arrow Down.
- Or close the Popup by using Softkey OK



Option 2 :

- Call up the main menu;
- Call up the sub-menu »Operation/Recorders/Fault rec.«;
- Select a fault record; and
- Analyze the fault record by using Softkeys Arrow Up and Arrow Down.

Direct Commands of the Fault Recorder

<i>Parameter</i>	<i>Description</i>	<i>Setting range</i>	<i>Default</i>	<i>Menu path</i>
Res all rec 	Reset all records	inactive, active	inactive	[Operation /Reset]

Global Protection Parameters of the Fault Recorder

<i>Parameter</i>	<i>Description</i>	<i>Setting range</i>	<i>Default</i>	<i>Menu path</i>
Record-Mode 	Recorder Mode (Set the behaviour of the recorder)	Alarms and Trips, Trips only	Trips only	[Device Para /Recorders /Fault rec]
t-meas-delay 	After the Trip, the measurement will be delayed for this time.	0 - 60ms	0ms	[Device Para /Recorders /Fault rec]

Fault Recorder Signals

<i>Signal</i>	<i>Description</i>
Res rec	Signal: Delete record

Event Recorder

Event rec

The event recorder can register up to 300 events and the last (minimum) 50 saved events are recorded fail-safe. The following information is provided for any of the events:

Events are logged as follows:

<i>Record No.</i>	<i>Fault No.</i>	<i>No of grid faults</i>	<i>Date of Record</i>	<i>Module.Name</i>	<i>State</i>
Sequential Number	Number of the ongoing fault This counter will be incremented by each General Alarm (Prot.Alarm)	A grid fault No. can have several Fault No. This counter will be incremented by each General Alarm (Exception AR: this applies only to devices that offer auto reclosing)	Time stamp	What has changed?	Changed Value

There are three different classes of events:

- **Alternation of binary states are shown as:**
 - 0->1 if the signal changes physically from »0« to »1«.
 - 1->0 if the signal changes physically from »1« to »0«.

- **Counters increment is shown as:**
 - Old Counter state -> New Counter state (e.g. 3->4)

- **Alternation of multiple states are shown as:**
 - Old state -> New state (e.g. 0->2)

Read Out the Event Recorder

- Call up the »*main menu*«.
- Call up the submenu »*Operation/Recorders/Event rec*«.
- Select an event.

Direct Commands of the Event Recorder

<i>Parameter</i>	<i>Description</i>	<i>Setting range</i>	<i>Default</i>	<i>Menu path</i>
Res all rec 	Reset all records	inactive, active	inactive	[Operation /Reset]

Event Recorder Signals

<i>Signal</i>	<i>Description</i>
Res all records	Signal: All records deleted

Trend Recorder

Available Elements:

Trend_rec

Configuring the Trend Recorder

The Trend Recorder is to be configured within [Device Para/Recorders/Trend Recorder] menu.







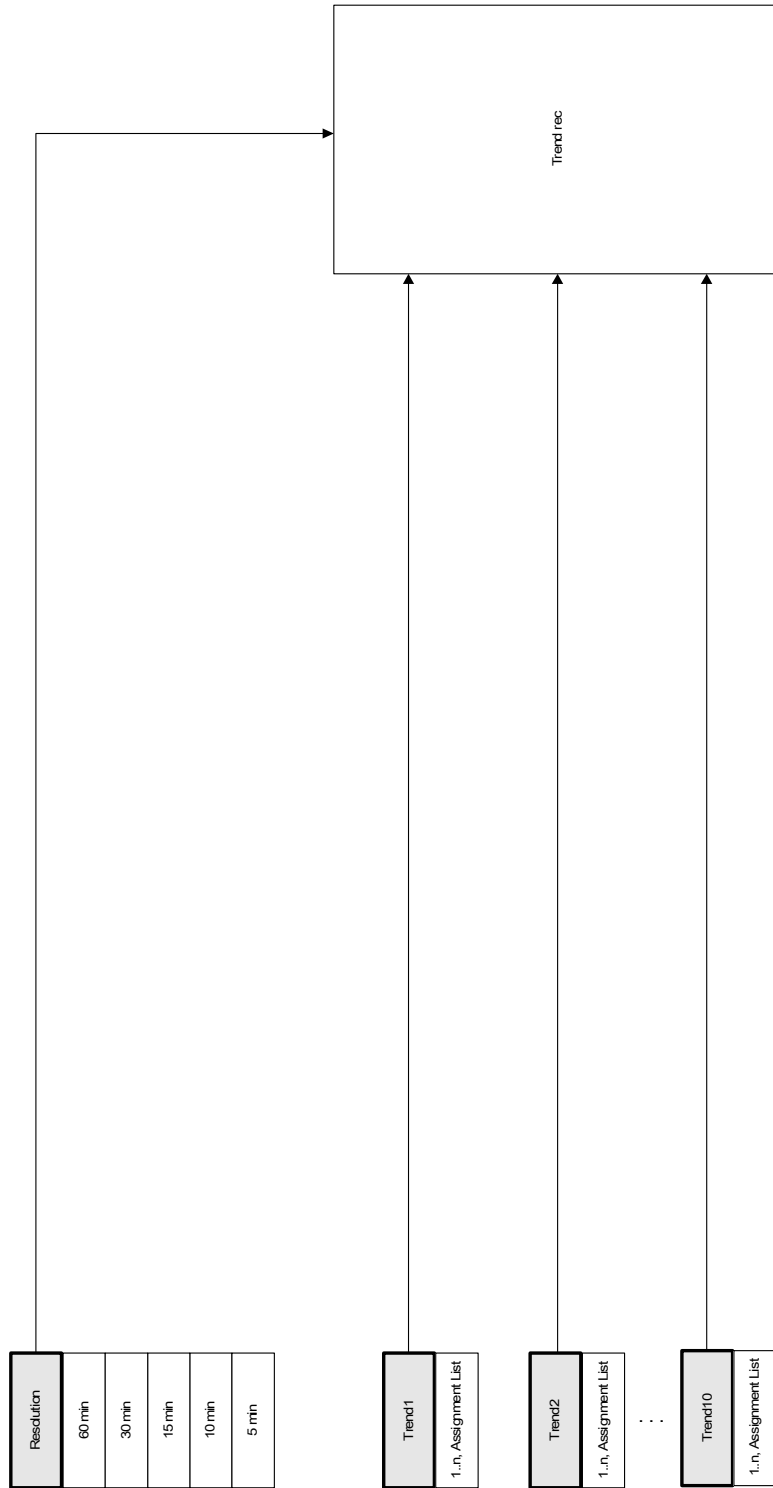



The User has to set the time interval. This defines the distance between two measuring points.

The User can select up to ten values that will be recorded.

Trend rec



Global Protection Parameters of the Trend Recorder

<i>Parameter</i>	<i>Description</i>	<i>Setting range</i>	<i>Default</i>	<i>Menu path</i>
Resolution 	Resolution (recording frequency)	60 min, 30 min, 15 min, 10 min, 5 min	15 min	[Device Para /Recorders /Trend rec]
Trend1 	Observed Value1	1..n, TrendRecList	CT Ntrl.IL1 RMS	[Device Para /Recorders /Trend rec]
Trend2 	Observed Value2	1..n, TrendRecList	CT Ntrl.IL2 RMS	[Device Para /Recorders /Trend rec]
Trend3 	Observed Value3	1..n, TrendRecList	CT Ntrl.IL3 RMS	[Device Para /Recorders /Trend rec]
Trend4 	Observed Value4	1..n, TrendRecList	CT Ntrl.IG meas RMS	[Device Para /Recorders /Trend rec]
Trend5 	Observed Value5	1..n, TrendRecList	VT.VL1 RMS	[Device Para /Recorders /Trend rec]
Trend6 	Observed Value6	1..n, TrendRecList	VT.VL2 RMS	[Device Para /Recorders /Trend rec]
Trend7 	Observed Value7	1..n, TrendRecList	VT.VL3 RMS	[Device Para /Recorders /Trend rec]
Trend8 	Observed Value8	1..n, TrendRecList	VT.VX meas RMS	[Device Para /Recorders /Trend rec]
Trend9 	Observed Value9	1..n, TrendRecList	-.-	[Device Para /Recorders /Trend rec]

Parameter	Description	Setting range	Default	Menu path
Trend10 	Observed Value10	1..n, TrendRecList	.-	[Device Para /Recorders /Trend rec]

Trend Recorder Signals (Output States)

Signal	Description
Hand Reset	Hand Reset

Direct Commands of the Trend Recorder

Parameter	Description	Setting range	Default	Menu path
Reset 	Delete all entries	inactive, active	inactive	[Operation /Reset]

General Values of the Trend Recorder

Value	Description	Default	Size	Menu path
Max avail Entries	Maximum available entries in the current configuration	0	0 - 9999999999	[Operation /Count and RevData /Trend rec]

Global Values of the Trend Recorder

The »TrendRecList« below summarizes all signals that the User can assign.

Name	Description
.-	No assignment
VT.VL1	Measured value: Phase-to-neutral voltage (fundamental)
VT.VL2	Measured value: Phase-to-neutral voltage (fundamental)
VT.VL3	Measured value: Phase-to-neutral voltage (fundamental)
VT.VX meas	Measured value (measured): VX measured (fundamental)
VT.VG calc	Measured value (calculated): VG (fundamental)
VT.VL12	Measured value: Phase-to-phase voltage (fundamental)
VT.VL23	Measured value: Phase-to-phase voltage (fundamental)
VT.VL31	Measured value: Phase-to-phase voltage (fundamental)
VT.VL1 RMS	Measured value: Phase-to-neutral voltage (RMS)
VT.VL2 RMS	Measured value: Phase-to-neutral voltage (RMS)

<i>Name</i>	<i>Description</i>
VT.VL3 RMS	Measured value: Phase-to-neutral voltage (RMS)
VT.VX meas RMS	Measured value (measured): VX measured (RMS)
VT.VG calc RMS	Measured value (calculated): VG (RMS)
VT.VL12 RMS	Measured value: Phase-to-phase voltage (RMS)
VT.VL23 RMS	Measured value: Phase-to-phase voltage (RMS)
VT.VL31 RMS	Measured value: Phase-to-phase voltage (RMS)
VT.V/f	Ratio Volts/Hertz in relation to nominal values.
VT.V0	Measured value (calculated): Symmetrical components Zero voltage(fundamental)
VT.V1	Measured value (calculated): Symmetrical components positive phase sequence voltage(fundamental)
VT.V2	Measured value (calculated): Symmetrical components negative phase sequence voltage(fundamental)
VT.%(V2/V1)	Measured value (calculated): V2/V1, phase sequence will be taken into account automatically.
VT.VX meas H3	Third harmonic of measured neutral voltage used to detect generator stator ground faults.
VT.VL1 avg RMS	VL1 average value (RMS)
VT.VL2 avg RMS	VL2 average value (RMS)
VT.VL3 avg RMS	VL3 average value (RMS)
VT.VL12 avg RMS	VL12 average value (RMS)
VT.VL23 avg RMS	VL23 average value (RMS)
VT.VL31 avg RMS	VL31 average value (RMS)
VT.f	Measured value: Frequency
VT.VL1 THD	Measured value (calculated): VL1 Total Harmonic Distortion
VT.VL2 THD	Measured value (calculated): VL2 Total Harmonic Distortion
VT.VL3 THD	Measured value (calculated): VL3 Total Harmonic Distortion
VT.VL12 THD	Measured value (calculated): V12 Total Harmonic Distortion
VT.VL23 THD	Measured value (calculated): V23 Total Harmonic Distortion
VT.VL31 THD	Measured value (calculated): V31 Total Harmonic Distortion
CT Ntrl.IL1	Measured value: Phase current (fundamental)
CT Ntrl.IL2	Measured value: Phase current (fundamental)
CT Ntrl.IL3	Measured value: Phase current (fundamental)
CT Ntrl.IG meas	Measured value (measured): IG (fundamental)
CT Ntrl.IG calc	Measured value (calculated): IG (fundamental)
CT Ntrl.IL1 RMS	Measured value: Phase current (RMS)
CT Ntrl.IL2 RMS	Measured value: Phase current (RMS)
CT Ntrl.IL3 RMS	Measured value: Phase current (RMS)
CT Ntrl.IG meas RMS	Measured value (measured): IG (RMS)
CT Ntrl.IG calc RMS	Measured value (calculated): IG (RMS)
CT Ntrl.I0	Measured value (calculated): Zero current (fundamental)
CT Ntrl.I1	Measured value (calculated): Positive phase sequence current (fundamental)

Recorders

<i>Name</i>	<i>Description</i>
CT Ntrl.I2	Measured value (calculated): Unbalanced load current (fundamental)
CT Ntrl.%(I2/I1)	Measured value (calculated): I2/I1, phase sequence will be taken into account automatically.
CT Ntrl.IL1 avg RMS	IL1 average value (RMS)
CT Ntrl.IL2 avg RMS	IL2 average value (RMS)
CT Ntrl.IL3 avg RMS	IL3 average value (RMS)
CT Ntrl.IL1 THD	Measured value (calculated): IL1 Total Harmonic Current
CT Ntrl.IL2 THD	Measured value (calculated): IL2 Total Harmonic Current
CT Ntrl.IL3 THD	Measured value (calculated): IL3 Total Harmonic Current
ThR.Thermal Cap Used	Measured value: Thermal Capacity Used
URTD.Windg1	Winding 1
URTD.Windg1 max	Winding1 Maximum Value
URTD.Windg2	Winding 2
URTD.Windg2 max	Winding2 Maximum Value
URTD.Windg3	Winding 3
URTD.Windg3 max	Winding3 Maximum Value
URTD.Windg4	Winding 4
URTD.Windg4 max	Winding4 Maximum Value
URTD.Windg5	Winding 5
URTD.Windg5 max	Winding5 Maximum Value
URTD.Windg6	Winding 6
URTD.Windg6 max	Winding6 Maximum Value
URTD.MotBear1	Motor Bearing 1
URTD.MotBear1 max	Motor Bearing1 Maximum Value
URTD.MotBear2	Motor Bearing 2
URTD.MotBear2 max	Motor Bearing2 Maximum Value
URTD.LoadBear1	Load Bearing 1
URTD.LoadBear1 max	Load Bearing1 Maximum Value
URTD.LoadBear2	Load Bearing 2
URTD.LoadBear2 max	Load Bearing2 Maximum Value
URTD.Aux1	Auxiliary1
URTD.Aux1 max	Auxiliary1 Maximum Value
URTD.Aux2	Auxiliary2
URTD.Aux2 max	Auxiliary2 Maximum Value
URTD.RTD Max	Maximum temperature of all channels.
RTD.HottestWindingTemp	Hottest motor winding temperature in degrees C.
RTD.Hottest MotBearTemp	Hottest motor bearing temperature in degrees C.
RTD.Hottest LoadBearTemp	Hottest load bearing temperature in degrees C.

Recorders

<i>Name</i>	<i>Description</i>
RTD.Hottest Aux Temp	Hottest Auxiliary temperature in degrees C.
PQSCr.S	Measured Value (Calculated): Apparent power (fundamental)
PQSCr.P	Measured value (calculated): Active power (P- = Fed Active Power, P+ = Consumpted Active Power) (fundamental)
PQSCr.Q	Measured value (calculated): Reactive power (Q- = Fed Reactive Power, Q+ = Consumpted Reactive Power) (fundamental)
PQSCr.P 1	Measured value (calculated): Active power in positive sequence system (P- = Fed Active Power, P+ = Consumpted Active Power)
PQSCr.Q 1	Measured value (calculated): Reactive power in positive sequence system (Q- = Fed Reactive Power, Q+ = Consumpted Reactive Power)
PQSCr.S RMS	Measured Value (Calculated): Apparent power (RMS)
PQSCr.P RMS	Measured value (calculated): Active power (P- = Fed Active Power, P+ = Consumpted Active Power) (RMS)
PQSCr.cos phi	Measured value (calculated): Power factor: Sign Convention: sign(PF) = sign(P)
PQSCr.cos phi RMS	Measured value (calculated): Power factor: Sign Convention: sign(PF) = sign(P)
PQSCr.Ws Net	Absolute Apparent Power Hours
PQSCr.Wp Net	Absolute Active Power Hours
PQSCr.Wq Net	Absolute Reactive Power Hours
PQSCr.Wp+	Positive Active Power is consumed active energy
PQSCr.Wp-	Negative Active Power (Fed Energy)
PQSCr.Wq+	Positive Reactive Power is consumed Reactive Energy
PQSCr.Wq-	Negative Reactive Power (Fed Energy)
AnIn[1].Value	Measured value of the Input in percent
AnIn[2].Value	Measured value of the Input in percent

Communication Protocols

SCADA Interface

Scada

Device Planning Parameters of the Serial Scada Interface

Parameter	Description	Options	Default	Menu path
 Protocol	Select the SCADA protocol to be used.	do not use, Modbus RTU, Modbus TCP, Modbus TCP/RTU, DNP3 RTU, DNP3 TCP, DNP3 UDP, IEC60870-5-103, IEC61850, Profibus	do not use	[Device planning]



Signals (Output States) of the SCADA Interface

Signal	Description
SCADA connected	At least one SCADA System is connected to the device.
SCADA not connected	No SCADA System is connected to the device

TCP/IP Parameter

Tcplp

Global TCP/IP Parameters

Parameter	Description	Setting range	Default	Menu path
 Keep Alive Time	Keep Alive Time is the duration between two keep alive transmissions in idle condition	1 - 7200s	720s	[Device Para /TCP/IP /Advanced Settings]
 Keep Alive Interval	Keep Alive Interval is the duration between two successive keep alive retransmissions, if the acknowledgement to the previous keepalive transmission was not received.	1 - 60s	15s	[Device Para /TCP/IP /Advanced Settings]

<i>Parameter</i>	<i>Description</i>	<i>Setting range</i>	<i>Default</i>	<i>Menu path</i>
Keep Alive Retry 	Keep alive retry is the number of retransmissions to be carried out before declaring that the remote end is not available.	3 - 3	3	[Device Para /TCP/IP /Advanced Settings]

Modbus®

Modbus

Modbus® Protocol Configuration

The time-controlled Modbus® protocol is based on the Master-Slave working principle. This means that the substation control and protection system sends an enquiry or instruction to a certain device (slave address) which will then be answered or carried out accordingly. If the enquiry/instruction cannot be answered/carried out (e.g. because of an invalid slave address), a failure message is returned to the master.

The Master (substation control and protection system) can query information from the device, such as:

- Type of unit version
- Measuring values/Statistical measured values
- Switch operating position
- State of device
- Time and date
- State of the device's digital inputs
- Protection-/State alarms

The Master (control system) can give commands/instructions to the device, such as:

- Control of switchgear (where applicable, i.e. each acc. to the applied device version)
- Change-over of parameter set
- Reset and acknowledgement of alarms/signals
- Adjustment of date and time
- Control of alarm relays

For detailed information on data point lists and error handling, please refer to the Modbus® documentation.

To allow configuration of the devices for Modbus® connection, some default values of the control system must be available.

Modbus RTU

Part 1: Configuration of the Devices

Call up »*Device parameter/Modbus*« and set the following communication parameters there:

- Slave-address, to allow clear identification of the device.
- Baud-Rate

Also, select below indicated RS485 interface-related parameters from there, such as:

- Number of data bits
- One of the following supported communication variants: Number of data bits, even, odd, parity or no parity, number of stop bits.
- »*t-timeout*«: communication errors are only identified after expiry of a supervision time »*t-timeout*«.
- Response time (defining the period within which an enquiry from the master has to be answered).

Part 2: Hardware Connection

- For hardware connection to the control system, there is an RS485 interface at the rear side of the device (RS485, fiber optic or terminals).
- Connect bus and device (wiring).

Error Handling - Hardware Errors

Information on physical communication errors, such as:

- Baudrate Error
- Parity Error ...

can be obtained from the event recorder.

Error Handling – Errors on protocol level

If, for example, an invalid memory address is enquired, error codes will be returned by the device that need to be interpreted.

Modbus TCP

NOTICE Establishing a connection via TCP/IP to the device is only possible if your device is equipped with an Ethernet Interface (RJ45).

Contact your IT administrator in order to establish the network connection.

Part 1: Setting the TCP/IP Parameters

Call up »Device parameter/TCP/IP« at the HMI (panel) and set the following parameters:

- TCP/IP address
- Subnetmask
- Gateway

Part 2: Configuration of the Devices

Call up »Device parameter/Modbus« and set the following communication parameters:

- Setting a Unit Identifier is only necessary if a TCP network should be coupled to a RTU network.
- If a different port than the default port 502 should be used please proceed as follows:
 - Choose “Private” within the TCP-Port-Configuration.
 - Set the port-number.
- Set the maximum accepted time of “no communication”. If this time has expired – without any communication, the device concludes a failure within the master system.
- Allow or disallow the blocking of SCADA commands.







Part 3: Hardware Connection



- There is a RJ45 interface at the rear side of the device for the hardware connection to the control system.
- Establish the connection to the device by means of a proper Ethernet cable.



Direct Commands of the Modbus®









Parameter	Description	Setting range	Default	Menu path
Res Diagn Cr 	All Modbus Diagnosis Counters will be reset.	inactive, active	inactive	[Operation /Reset]









Global Protection Parameters of the Modbus®









<i>Parameter</i>	<i>Description</i>	<i>Setting range</i>	<i>Default</i>	<i>Menu path</i>
 Slave ID	Device address (Slave ID) within the bus system. Each device address has to be unique within a bus system.	1 - 247	1	[Device Para /Modbus / Communication /RTU]
 Unit ID	The Unit Identifier is used for routing. This parameter is to be set, if a Modbus RTU and a Modbus TCP network should be coupled.	1 - 255	255	[Device Para /Modbus / Communication /TCP]
 TCP Port Config	TCP Port Configuration. This parameter is to be set only if the default Modbus TCP Port should not be used.	Default, Private	Default	[Device Para /Modbus / Communication /TCP]
 Port	IP Port Number. And Only available if: TCP Port Config = Private In general it is recommended to keep the default value. if this is not possible then select a number out of the private range 49152-52151 or 52162-65535 that is not yet in use within your network. And Only available if: TCP Port Config = Private	502 - 65535	502	[Device Para /Modbus / Communication /TCP]
 t-timeout	Within this time the answer has to be received by the SCADA system, otherwise the request will be disregarded. In that case the Scada system detects a communication failure and the Scada System has to send a new request.	0.01 - 10.00s	1s	[Device Para /Modbus / Communication /RTU]
 Baud rate	Baud rate	1200, 2400, 4800, 9600, 19200, 38400	19200	[Device Para /Modbus / Communication /RTU]









Parameter	Description	Setting range	Default	Menu path
Physical Settings 	Digit 1: Number of bits. Digit 2: E=even parity, O=odd parity, N=no parity. Digit 3: Number of stop bits. More information on the parity: It is possible that the last data bit is followed by a parity bit which is used for recognition of communication errors. The parity bit ensures that with even parity ("EVEN") always an even number of bits with valence "1" or with odd parity ("ODD") an odd number of "1" valence bits are transmitted. But it is also possible to transmit no parity bits (here the setting is "Parity = None"). More information on the stop-bits: The end of a data byte is terminated by the stop-bits.	8E1, 8O1, 8N1, 8N2	8E1	[Device Para /Modbus / Communication /RTU]
t-call 	If there is no request telegram sent from Scada to the device after expiry of this time - the device concludes a communication failure within the Scada system.	1 - 3600s	10s	[Device Para /Modbus / Communication /General Settings]
Scada CmdBlo 	Activating (allowing)/ Deactivating (disallowing) the blocking of the Scada Commands	inactive, active	inactive	[Device Para /Modbus / Communication /General Settings]
Disable Latching 	Disable Latching: If this parameter is active (true), none of the Modbus states will be latched. That means that trip signals wont be latched by Modbus.	inactive, active	inactive	[Device Para /Modbus / Communication /General Settings]
AllowGap 	If this parameter is active (True), the user can request a set of modbus register without getting an exception, because of invalid address in the requested array. The invalid addresses have a special value 0xFAFA, but the user is responsible for ignoring invalid addresses. Attention: This special value can be valid, if address is valid.	inactive, active	inactive	[Device Para /Modbus / Communication /General Settings]









<i>Parameter</i>	<i>Description</i>	<i>Setting range</i>	<i>Default</i>	<i>Menu path</i>
Optical rest position 	Optical rest position	Light off, Light on	Light on	[Device Para /Modbus / Communication /General Settings]
Config Bin Inp1 	Virtual Digital Input. This corresponds to a virtual binary output of the protective device.	1..n, Assignment List	-.-	[Device Para /Modbus /Configb Registers /States]
Latched Config Bin Inp1 	Latched Configurable Binary Input	inactive, active	inactive	[Device Para /Modbus /Configb Registers /States]
Config Bin Inp2 	Virtual Digital Input. This corresponds to a virtual binary output of the protective device.	1..n, Assignment List	-.-	[Device Para /Modbus /Configb Registers /States]
Latched Config Bin Inp2 	Latched Configurable Binary Input	inactive, active	inactive	[Device Para /Modbus /Configb Registers /States]
Config Bin Inp3 	Virtual Digital Input. This corresponds to a virtual binary output of the protective device.	1..n, Assignment List	-.-	[Device Para /Modbus /Configb Registers /States]
Latched Config Bin Inp3 	Latched Configurable Binary Input	inactive, active	inactive	[Device Para /Modbus /Configb Registers /States]
Config Bin Inp4 	Virtual Digital Input. This corresponds to a virtual binary output of the protective device.	1..n, Assignment List	-.-	[Device Para /Modbus /Configb Registers /States]









Parameter	Description	Setting range	Default	Menu path
Latched Config Bin Inp4 	Latched Configurable Binary Input	inactive, active	inactive	[Device Para /Modbus /Configb Registers /States]
Config Bin Inp5 	Virtual Digital Input. This corresponds to a virtual binary output of the protective device.	1..n, Assignment List	.-	[Device Para /Modbus /Configb Registers /States]
Latched Config Bin Inp5 	Latched Configurable Binary Input	inactive, active	inactive	[Device Para /Modbus /Configb Registers /States]
Config Bin Inp6 	Virtual Digital Input. This corresponds to a virtual binary output of the protective device.	1..n, Assignment List	.-	[Device Para /Modbus /Configb Registers /States]
Latched Config Bin Inp6 	Latched Configurable Binary Input	inactive, active	inactive	[Device Para /Modbus /Configb Registers /States]
Config Bin Inp7 	Virtual Digital Input. This corresponds to a virtual binary output of the protective device.	1..n, Assignment List	.-	[Device Para /Modbus /Configb Registers /States]
Latched Config Bin Inp7 	Latched Configurable Binary Input	inactive, active	inactive	[Device Para /Modbus /Configb Registers /States]
Config Bin Inp8 	Virtual Digital Input. This corresponds to a virtual binary output of the protective device.	1..n, Assignment List	.-	[Device Para /Modbus /Configb Registers /States]









<i>Parameter</i>	<i>Description</i>	<i>Setting range</i>	<i>Default</i>	<i>Menu path</i>
Latched Config Bin Inp8 	Latched Configurable Binary Input	inactive, active	inactive	[Device Para /Modbus /Configb Registers /States]
Config Bin Inp9 	Virtual Digital Input. This corresponds to a virtual binary output of the protective device.	1..n, Assignment List	.-	[Device Para /Modbus /Configb Registers /States]
Latched Config Bin Inp9 	Latched Configurable Binary Input	inactive, active	inactive	[Device Para /Modbus /Configb Registers /States]
Config Bin Inp10 	Virtual Digital Input. This corresponds to a virtual binary output of the protective device.	1..n, Assignment List	.-	[Device Para /Modbus /Configb Registers /States]
Latched Config Bin Inp10 	Latched Configurable Binary Input	inactive, active	inactive	[Device Para /Modbus /Configb Registers /States]
Config Bin Inp11 	Virtual Digital Input. This corresponds to a virtual binary output of the protective device.	1..n, Assignment List	.-	[Device Para /Modbus /Configb Registers /States]
Latched Config Bin Inp11 	Latched Configurable Binary Input	inactive, active	inactive	[Device Para /Modbus /Configb Registers /States]
Config Bin Inp12 	Virtual Digital Input. This corresponds to a virtual binary output of the protective device.	1..n, Assignment List	.-	[Device Para /Modbus /Configb Registers /States]







<i>Parameter</i>	<i>Description</i>	<i>Setting range</i>	<i>Default</i>	<i>Menu path</i>
Latched Config Bin Inp12 	Latched Configurable Binary Input	inactive, active	inactive	[Device Para /Modbus /Config Registers /States]
Config Bin Inp13 	Virtual Digital Input. This corresponds to a virtual binary output of the protective device.	1..n, Assignment List	.-	[Device Para /Modbus /Config Registers /States]
Latched Config Bin Inp13 	Latched Configurable Binary Input	inactive, active	inactive	[Device Para /Modbus /Config Registers /States]
Config Bin Inp14 	Virtual Digital Input. This corresponds to a virtual binary output of the protective device.	1..n, Assignment List	.-	[Device Para /Modbus /Config Registers /States]
Latched Config Bin Inp14 	Latched Configurable Binary Input	inactive, active	inactive	[Device Para /Modbus /Config Registers /States]
Config Bin Inp15 	Virtual Digital Input. This corresponds to a virtual binary output of the protective device.	1..n, Assignment List	.-	[Device Para /Modbus /Config Registers /States]
Latched Config Bin Inp15 	Latched Configurable Binary Input	inactive, active	inactive	[Device Para /Modbus /Config Registers /States]
Config Bin Inp16 	Virtual Digital Input. This corresponds to a virtual binary output of the protective device.	1..n, Assignment List	.-	[Device Para /Modbus /Config Registers /States]







<i>Parameter</i>	<i>Description</i>	<i>Setting range</i>	<i>Default</i>	<i>Menu path</i>
Latched Config Bin Inp16 	Latched Configurable Binary Input	inactive, active	inactive	[Device Para /Modbus /Config Registers /States]
Config Bin Inp17 	Virtual Digital Input. This corresponds to a virtual binary output of the protective device.	1..n, Assignment List	.-	[Device Para /Modbus /Config Registers /States]
Latched Config Bin Inp17 	Latched Configurable Binary Input	inactive, active	inactive	[Device Para /Modbus /Config Registers /States]
Config Bin Inp18 	Virtual Digital Input. This corresponds to a virtual binary output of the protective device.	1..n, Assignment List	.-	[Device Para /Modbus /Config Registers /States]
Latched Config Bin Inp18 	Latched Configurable Binary Input	inactive, active	inactive	[Device Para /Modbus /Config Registers /States]
Config Bin Inp19 	Virtual Digital Input. This corresponds to a virtual binary output of the protective device.	1..n, Assignment List	.-	[Device Para /Modbus /Config Registers /States]
Latched Config Bin Inp19 	Latched Configurable Binary Input	inactive, active	inactive	[Device Para /Modbus /Config Registers /States]
Config Bin Inp20 	Virtual Digital Input. This corresponds to a virtual binary output of the protective device.	1..n, Assignment List	.-	[Device Para /Modbus /Config Registers /States]



<i>Parameter</i>	<i>Description</i>	<i>Setting range</i>	<i>Default</i>	<i>Menu path</i>
Latched Config Bin Inp20 	Latched Configurable Binary Input	inactive, active	inactive	[Device Para /Modbus /Config Registers /States]
Config Bin Inp21 	Virtual Digital Input. This corresponds to a virtual binary output of the protective device.	1..n, Assignment List	.-	[Device Para /Modbus /Config Registers /States]
Latched Config Bin Inp21 	Latched Configurable Binary Input	inactive, active	inactive	[Device Para /Modbus /Config Registers /States]
Config Bin Inp22 	Virtual Digital Input. This corresponds to a virtual binary output of the protective device.	1..n, Assignment List	.-	[Device Para /Modbus /Config Registers /States]
Latched Config Bin Inp22 	Latched Configurable Binary Input	inactive, active	inactive	[Device Para /Modbus /Config Registers /States]
Config Bin Inp23 	Virtual Digital Input. This corresponds to a virtual binary output of the protective device.	1..n, Assignment List	.-	[Device Para /Modbus /Config Registers /States]
Latched Config Bin Inp23 	Latched Configurable Binary Input	inactive, active	inactive	[Device Para /Modbus /Config Registers /States]
Config Bin Inp24 	Virtual Digital Input. This corresponds to a virtual binary output of the protective device.	1..n, Assignment List	.-	[Device Para /Modbus /Config Registers /States]

<i>Parameter</i>	<i>Description</i>	<i>Setting range</i>	<i>Default</i>	<i>Menu path</i>
 Latched Config Bin Inp24	Latched Configurable Binary Input	inactive, active	inactive	[Device Para /Modbus /Config Registers /States]
 Config Bin Inp25	Virtual Digital Input. This corresponds to a virtual binary output of the protective device.	1..n, Assignment List	.-	[Device Para /Modbus /Config Registers /States]
 Latched Config Bin Inp25	Latched Configurable Binary Input	inactive, active	inactive	[Device Para /Modbus /Config Registers /States]
 Config Bin Inp26	Virtual Digital Input. This corresponds to a virtual binary output of the protective device.	1..n, Assignment List	.-	[Device Para /Modbus /Config Registers /States]
 Latched Config Bin Inp26	Latched Configurable Binary Input	inactive, active	inactive	[Device Para /Modbus /Config Registers /States]
 Config Bin Inp27	Virtual Digital Input. This corresponds to a virtual binary output of the protective device.	1..n, Assignment List	.-	[Device Para /Modbus /Config Registers /States]
 Latched Config Bin Inp27	Latched Configurable Binary Input	inactive, active	inactive	[Device Para /Modbus /Config Registers /States]
 Config Bin Inp28	Virtual Digital Input. This corresponds to a virtual binary output of the protective device.	1..n, Assignment List	.-	[Device Para /Modbus /Config Registers /States]

<i>Parameter</i>	<i>Description</i>	<i>Setting range</i>	<i>Default</i>	<i>Menu path</i>
Latched Config Bin Inp28 	Latched Configurable Binary Input	inactive, active	inactive	[Device Para /Modbus /Config Registers /States]
Config Bin Inp29 	Virtual Digital Input. This corresponds to a virtual binary output of the protective device.	1..n, Assignment List	.-	[Device Para /Modbus /Config Registers /States]
Latched Config Bin Inp29 	Latched Configurable Binary Input	inactive, active	inactive	[Device Para /Modbus /Config Registers /States]
Config Bin Inp30 	Virtual Digital Input. This corresponds to a virtual binary output of the protective device.	1..n, Assignment List	.-	[Device Para /Modbus /Config Registers /States]
Latched Config Bin Inp30 	Latched Configurable Binary Input	inactive, active	inactive	[Device Para /Modbus /Config Registers /States]
Config Bin Inp31 	Virtual Digital Input. This corresponds to a virtual binary output of the protective device.	1..n, Assignment List	.-	[Device Para /Modbus /Config Registers /States]
Latched Config Bin Inp31 	Latched Configurable Binary Input	inactive, active	inactive	[Device Para /Modbus /Config Registers /States]
Config Bin Inp32 	Virtual Digital Input. This corresponds to a virtual binary output of the protective device.	1..n, Assignment List	.-	[Device Para /Modbus /Config Registers /States]

<i>Parameter</i>	<i>Description</i>	<i>Setting range</i>	<i>Default</i>	<i>Menu path</i>
Latched Config Bin Inp32 	Latched Configurable Binary Input	inactive, active	inactive	[Device Para /Modbus /Config Registers /States]
Mapped Meas 1 	Mapped Measured Values. They can be used to provide measured values to the Modbus Master.	1..n, TrendRecList	-.-	[Device Para /Modbus /Config Registers /Measured Values]
Mapped Meas 2 	Mapped Measured Values. They can be used to provide measured values to the Modbus Master.	1..n, TrendRecList	-.-	[Device Para /Modbus /Config Registers /Measured Values]
Mapped Meas 3 	Mapped Measured Values. They can be used to provide measured values to the Modbus Master.	1..n, TrendRecList	-.-	[Device Para /Modbus /Config Registers /Measured Values]
Mapped Meas 4 	Mapped Measured Values. They can be used to provide measured values to the Modbus Master.	1..n, TrendRecList	-.-	[Device Para /Modbus /Config Registers /Measured Values]
Mapped Meas 5 	Mapped Measured Values. They can be used to provide measured values to the Modbus Master.	1..n, TrendRecList	-.-	[Device Para /Modbus /Config Registers /Measured Values]
Mapped Meas 6 	Mapped Measured Values. They can be used to provide measured values to the Modbus Master.	1..n, TrendRecList	-.-	[Device Para /Modbus /Config Registers /Measured Values]

Parameter	Description	Setting range	Default	Menu path
Mapped Meas 7 	Mapped Measured Values. They can be used to provide measured values to the Modbus Master.	1..n, TrendRecList	-.-	[Device Para /Modbus /Configb Registers /Measured Values]
Mapped Meas 8 	Mapped Measured Values. They can be used to provide measured values to the Modbus Master.	1..n, TrendRecList	-.-	[Device Para /Modbus /Configb Registers /Measured Values]
Mapped Meas 9 	Mapped Measured Values. They can be used to provide measured values to the Modbus Master.	1..n, TrendRecList	-.-	[Device Para /Modbus /Configb Registers /Measured Values]
Mapped Meas 10 	Mapped Measured Values. They can be used to provide measured values to the Modbus Master.	1..n, TrendRecList	-.-	[Device Para /Modbus /Configb Registers /Measured Values]
Mapped Meas 11 	Mapped Measured Values. They can be used to provide measured values to the Modbus Master.	1..n, TrendRecList	-.-	[Device Para /Modbus /Configb Registers /Measured Values]
Mapped Meas 12 	Mapped Measured Values. They can be used to provide measured values to the Modbus Master.	1..n, TrendRecList	-.-	[Device Para /Modbus /Configb Registers /Measured Values]
Mapped Meas 13 	Mapped Measured Values. They can be used to provide measured values to the Modbus Master.	1..n, TrendRecList	-.-	[Device Para /Modbus /Configb Registers /Measured Values]

Parameter	Description	Setting range	Default	Menu path
Mapped Meas 14 	Mapped Measured Values. They can be used to provide measured values to the Modbus Master.	1..n, TrendRecList	-.-	[Device Para /Modbus /Configb Registers /Measured Values]
Mapped Meas 15 	Mapped Measured Values. They can be used to provide measured values to the Modbus Master.	1..n, TrendRecList	-.-	[Device Para /Modbus /Configb Registers /Measured Values]
Mapped Meas 16 	Mapped Measured Values. They can be used to provide measured values to the Modbus Master.	1..n, TrendRecList	-.-	[Device Para /Modbus /Configb Registers /Measured Values]

States of the Module Inputs of the MODBUS® Protocol

Name	Description	Assignment via
Config Bin Inp1-l	State of the module input: Config Bin Inp	[Device Para /Modbus /Configb Registers /States]
Config Bin Inp2-l	State of the module input: Config Bin Inp	[Device Para /Modbus /Configb Registers /States]
Config Bin Inp3-l	State of the module input: Config Bin Inp	[Device Para /Modbus /Configb Registers /States]
Config Bin Inp4-l	State of the module input: Config Bin Inp	[Device Para /Modbus /Configb Registers /States]

<i>Name</i>	<i>Description</i>	<i>Assignment via</i>
Config Bin Inp5-I	State of the module input: Config Bin Inp	[Device Para /Modbus /Configb Registers /States]
Config Bin Inp6-I	State of the module input: Config Bin Inp	[Device Para /Modbus /Configb Registers /States]
Config Bin Inp7-I	State of the module input: Config Bin Inp	[Device Para /Modbus /Configb Registers /States]
Config Bin Inp8-I	State of the module input: Config Bin Inp	[Device Para /Modbus /Configb Registers /States]
Config Bin Inp9-I	State of the module input: Config Bin Inp	[Device Para /Modbus /Configb Registers /States]
Config Bin Inp10-I	State of the module input: Config Bin Inp	[Device Para /Modbus /Configb Registers /States]
Config Bin Inp11-I	State of the module input: Config Bin Inp	[Device Para /Modbus /Configb Registers /States]
Config Bin Inp12-I	State of the module input: Config Bin Inp	[Device Para /Modbus /Configb Registers /States]
Config Bin Inp13-I	State of the module input: Config Bin Inp	[Device Para /Modbus /Configb Registers /States]

Name	Description	Assignment via
Config Bin Inp14- I	State of the module input: Config Bin Inp	[Device Para /Modbus /Configb Registers /States]
Config Bin Inp15- I	State of the module input: Config Bin Inp	[Device Para /Modbus /Configb Registers /States]
Config Bin Inp16- I	State of the module input: Config Bin Inp	[Device Para /Modbus /Configb Registers /States]
Config Bin Inp17- I	State of the module input: Config Bin Inp	[Device Para /Modbus /Configb Registers /States]
Config Bin Inp18- I	State of the module input: Config Bin Inp	[Device Para /Modbus /Configb Registers /States]
Config Bin Inp19- I	State of the module input: Config Bin Inp	[Device Para /Modbus /Configb Registers /States]
Config Bin Inp20- I	State of the module input: Config Bin Inp	[Device Para /Modbus /Configb Registers /States]
Config Bin Inp21- I	State of the module input: Config Bin Inp	[Device Para /Modbus /Configb Registers /States]
Config Bin Inp22- I	State of the module input: Config Bin Inp	[Device Para /Modbus /Configb Registers /States]

Name	Description	Assignment via
Config Bin Inp23- I	State of the module input: Config Bin Inp	[Device Para /Modbus /Configb Registers /States]
Config Bin Inp24- I	State of the module input: Config Bin Inp	[Device Para /Modbus /Configb Registers /States]
Config Bin Inp25- I	State of the module input: Config Bin Inp	[Device Para /Modbus /Configb Registers /States]
Config Bin Inp26- I	State of the module input: Config Bin Inp	[Device Para /Modbus /Configb Registers /States]
Config Bin Inp27- I	State of the module input: Config Bin Inp	[Device Para /Modbus /Configb Registers /States]
Config Bin Inp28- I	State of the module input: Config Bin Inp	[Device Para /Modbus /Configb Registers /States]
Config Bin Inp29- I	State of the module input: Config Bin Inp	[Device Para /Modbus /Configb Registers /States]
Config Bin Inp30- I	State of the module input: Config Bin Inp	[Device Para /Modbus /Configb Registers /States]
Config Bin Inp31- I	State of the module input: Config Bin Inp	[Device Para /Modbus /Configb Registers /States]

<i>Name</i>	<i>Description</i>	<i>Assignment via</i>
Config Bin Inp32-1	State of the module input: Config Bin Inp	[Device Para /Modbus /Configb Registers /States]

Values of the MODBUS® Protocol

<i>Value</i>	<i>Description</i>	<i>Menu path</i>
Mapped Meas 1	Mapped Measured Values. They can be used to provide measured values to the Modbus Master.	[Operation /Count and RevData /Modbus /General Settings]
Mapped Meas 2	Mapped Measured Values. They can be used to provide measured values to the Modbus Master.	[Operation /Count and RevData /Modbus /General Settings]
Mapped Meas 3	Mapped Measured Values. They can be used to provide measured values to the Modbus Master.	[Operation /Count and RevData /Modbus /General Settings]
Mapped Meas 4	Mapped Measured Values. They can be used to provide measured values to the Modbus Master.	[Operation /Count and RevData /Modbus /General Settings]
Mapped Meas 5	Mapped Measured Values. They can be used to provide measured values to the Modbus Master.	[Operation /Count and RevData /Modbus /General Settings]
Mapped Meas 6	Mapped Measured Values. They can be used to provide measured values to the Modbus Master.	[Operation /Count and RevData /Modbus /General Settings]
Mapped Meas 7	Mapped Measured Values. They can be used to provide measured values to the Modbus Master.	[Operation /Count and RevData /Modbus /General Settings]

<i>Value</i>	<i>Description</i>	<i>Menu path</i>
Mapped Meas 8	Mapped Measured Values. They can be used to provide measured values to the Modbus Master.	[Operation /Count and RevData /Modbus /General Settings]
Mapped Meas 9	Mapped Measured Values. They can be used to provide measured values to the Modbus Master.	[Operation /Count and RevData /Modbus /General Settings]
Mapped Meas 10	Mapped Measured Values. They can be used to provide measured values to the Modbus Master.	[Operation /Count and RevData /Modbus /General Settings]
Mapped Meas 11	Mapped Measured Values. They can be used to provide measured values to the Modbus Master.	[Operation /Count and RevData /Modbus /General Settings]
Mapped Meas 12	Mapped Measured Values. They can be used to provide measured values to the Modbus Master.	[Operation /Count and RevData /Modbus /General Settings]
Mapped Meas 13	Mapped Measured Values. They can be used to provide measured values to the Modbus Master.	[Operation /Count and RevData /Modbus /General Settings]
Mapped Meas 14	Mapped Measured Values. They can be used to provide measured values to the Modbus Master.	[Operation /Count and RevData /Modbus /General Settings]
Mapped Meas 15	Mapped Measured Values. They can be used to provide measured values to the Modbus Master.	[Operation /Count and RevData /Modbus /General Settings]
Mapped Meas 16	Mapped Measured Values. They can be used to provide measured values to the Modbus Master.	[Operation /Count and RevData /Modbus /General Settings]

Counters of the MODBUS® Protocol

<i>Parameter</i>	<i>Description</i>
Device Type	Device Type: Device type code for relationship between device name and its Modbus code. Woodward: MRI4 - 1000 MRU4 - 1001 MRA4 - 1002 MCA4 - 1003 MRDT4 - 1005 MCDTV4 - 1006 MCDGV4 - 1007 MRM4 - 1009 MRMV4 - 1010 MCDLV4 - 1011
Comm Version	Modbus Communication version. This version number changes if something becomes incompatible between different Modbus releases.

Modbus® Signals (Output States)

NOTICE Some signals (that are for a short time active only) have to be acknowledged separately (e.g. Trip signals) by the Communication System.

<i>Signal</i>	<i>Description</i>
Transmission RTU	Signal: SCADA active
Transmission TCP	Signal: SCADA active
Scada Cmd 1	Scada Command
Scada Cmd 2	Scada Command
Scada Cmd 3	Scada Command
Scada Cmd 4	Scada Command
Scada Cmd 5	Scada Command
Scada Cmd 6	Scada Command
Scada Cmd 7	Scada Command
Scada Cmd 8	Scada Command
Scada Cmd 9	Scada Command
Scada Cmd 10	Scada Command
Scada Cmd 11	Scada Command
Scada Cmd 12	Scada Command
Scada Cmd 13	Scada Command
Scada Cmd 14	Scada Command

<i>Signal</i>	<i>Description</i>
Scada Cmd 15	Scada Command
Scada Cmd 16	Scada Command

Modbus® Values

<i>Value</i>	<i>Description</i>	<i>Default</i>	<i>Size</i>	<i>Menu path</i>
NoOfRequestsTotal	Total number of requests. Includes requests for other slaves.	0	0 - 9999999999	[Operation /Count and RevData /Modbus /RTU]
NoOfRequestsForMe	Total Number of requests for this slave.	0	0 - 9999999999	[Operation /Count and RevData /Modbus /RTU]
NoOfResponseOverruns	Total number of requests with exceeded response time. Physically corrupted Frame.	0	0 - 9999999999	[Operation /Count and RevData /Modbus /RTU]
NoOfOverrunErrors	Total Number of Overrun Failures. Physically corrupted Frame.	0	0 - 9999999999	[Operation /Count and RevData /Modbus /RTU]
NoOfParityErrors	Total number of parity errors. Physically corrupted Frame.	0	0 - 9999999999	[Operation /Count and RevData /Modbus /RTU]
NoOfFrameErrors	Total Number of Frame Errors. Physically corrupted Frame.	0	0 - 9999999999	[Operation /Count and RevData /Modbus /RTU]
NoOfBreaks	Number of detected communication aborts	0	0 - 9999999999	[Operation /Count and RevData /Modbus /RTU]
NoOfQueryInvalid	Total number of Request errors. Request could not be interpreted	0	0 - 9999999999	[Operation /Count and RevData /Modbus /RTU]

<i>Value</i>	<i>Description</i>	<i>Default</i>	<i>Size</i>	<i>Menu path</i>
NoOfInternalError	Total Number of Internal errors while interpreting the request.	0	0 - 9999999999	[Operation /Count and RevData /Modbus /RTU]
NoOfRequestsTotal	Total number of requests. Includes requests for other slaves.	0	0 - 9999999999	[Operation /Count and RevData /Modbus /TCP]
NoOfRequestsForMe	Total Number of requests for this slave.	0	0 - 9999999999	[Operation /Count and RevData /Modbus /TCP]
NoOfResponse	Total number of requests having been responded.	0	0 - 9999999999	[Operation /Count and RevData /Modbus /TCP]
NoOfQueryInvalid	Total number of Request errors. Request could not be interpreted	0	0 - 9999999999	[Operation /Count and RevData /Modbus /TCP]
NoOfInternalError	Total Number of Internal errors while interpreting the request.	0	0 - 9999999999	[Operation /Count and RevData /Modbus /TCP]

Profibus

Profibus

Part 1: Configuration of the Devices

Call up »*Device parameter/Profibus*« and set the following communication parameter:

- Slave-address, to allow clear identification of the device.

In addition to that the Master has to be provided with the GSD-file. The GSD-file can be taken from the Product-CD.

Part 2: Hardware Connection

- For hardware connection to the control system, there is optional an D-SUB interface at the rear side of the device.
- Connect bus and device (wiring).
- Up to 123 slaves can be connected.
- Terminate the Bus by means of an Terminate Resistor.

Error Handling

Information on physical communication errors, such as:

- Baudrate Error

This can be obtained from the event recorder or the status display.

Error Handling – Status LED at the rear side









The Profibus D-SUB interface at the rear side of the device is equipped with an status LED.











- Baud Search -> red flashing
- Baud Found -> green flashing
- Data Exchange -> green
- No Profibus/Unplugged, not connected -> red

Direct Commands of the Profibus

Parameter	Description	Setting range	Default	Menu path
Reset Comds 	All Profibus Commands will be reset.	inactive, active	inactive	[Operation /Reset]

Global Protection Parameters of the Profibus



Parameter	Description	Setting range	Default	Menu path
Config Bin Inp 1 	Virtual Digital Input. This corresponds to a virtual binary output of the protective device.	1..n, Assignment List	.-	[Device Para /Profibus /Config Bin Inp 1-16]
Latched 1 	Defines whether the Input is latched. Only available if: Latched = active	inactive, active	inactive	[Device Para /Profibus /Config Bin Inp 1-16]
Config Bin Inp 2 	Virtual Digital Input. This corresponds to a virtual binary output of the protective device.	1..n, Assignment List	.-	[Device Para /Profibus /Config Bin Inp 1-16]
Latched 2 	Defines whether the Input is latched. Only available if: Latched = active	inactive, active	inactive	[Device Para /Profibus /Config Bin Inp 1-16]
Config Bin Inp 3 	Virtual Digital Input. This corresponds to a virtual binary output of the protective device.	1..n, Assignment List	.-	[Device Para /Profibus /Config Bin Inp 1-16]
Latched 3 	Defines whether the Input is latched. Only available if: Latched = active	inactive, active	inactive	[Device Para /Profibus /Config Bin Inp 1-16]
Config Bin Inp 4 	Virtual Digital Input. This corresponds to a virtual binary output of the protective device.	1..n, Assignment List	.-	[Device Para /Profibus /Config Bin Inp 1-16]
Latched 4 	Defines whether the Input is latched. Only available if: Latched = active	inactive, active	inactive	[Device Para /Profibus /Config Bin Inp 1-16]

Parameter	Description	Setting range	Default	Menu path
 Config Bin Inp 5	Virtual Digital Input. This corresponds to a virtual binary output of the protective device.	1..n, Assignment List	.-.	[Device Para /Profibus /Config Bin Inp 1-16]
 Latched 5	Defines whether the Input is latched. Only available if: Latched = active	inactive, active	inactive	[Device Para /Profibus /Config Bin Inp 1-16]
 Config Bin Inp 6	Virtual Digital Input. This corresponds to a virtual binary output of the protective device.	1..n, Assignment List	.-.	[Device Para /Profibus /Config Bin Inp 1-16]
 Latched 6	Defines whether the Input is latched. Only available if: Latched = active	inactive, active	inactive	[Device Para /Profibus /Config Bin Inp 1-16]
 Config Bin Inp 7	Virtual Digital Input. This corresponds to a virtual binary output of the protective device.	1..n, Assignment List	.-.	[Device Para /Profibus /Config Bin Inp 1-16]
 Latched 7	Defines whether the Input is latched. Only available if: Latched = active	inactive, active	inactive	[Device Para /Profibus /Config Bin Inp 1-16]
 Config Bin Inp 8	Virtual Digital Input. This corresponds to a virtual binary output of the protective device.	1..n, Assignment List	.-.	[Device Para /Profibus /Config Bin Inp 1-16]
 Latched 8	Defines whether the Input is latched. Only available if: Latched = active	inactive, active	inactive	[Device Para /Profibus /Config Bin Inp 1-16]
 Config Bin Inp 9	Virtual Digital Input. This corresponds to a virtual binary output of the protective device.	1..n, Assignment List	.-.	[Device Para /Profibus /Config Bin Inp 1-16]
 Latched 9	Defines whether the Input is latched. Only available if: Latched = active	inactive, active	inactive	[Device Para /Profibus /Config Bin Inp 1-16]

Parameter	Description	Setting range	Default	Menu path
 Config Bin Inp 10	Virtual Digital Input. This corresponds to a virtual binary output of the protective device.	1..n, Assignment List	.-	[Device Para /Profibus /Config Bin Inp 1-16]
 Latched 10	Defines whether the Input is latched. Only available if: Latched = active	inactive, active	inactive	[Device Para /Profibus /Config Bin Inp 1-16]
 Config Bin Inp 11	Virtual Digital Input. This corresponds to a virtual binary output of the protective device.	1..n, Assignment List	.-	[Device Para /Profibus /Config Bin Inp 1-16]
 Latched 11	Defines whether the Input is latched. Only available if: Latched = active	inactive, active	inactive	[Device Para /Profibus /Config Bin Inp 1-16]
 Config Bin Inp 12	Virtual Digital Input. This corresponds to a virtual binary output of the protective device.	1..n, Assignment List	.-	[Device Para /Profibus /Config Bin Inp 1-16]
 Latched 12	Defines whether the Input is latched. Only available if: Latched = active	inactive, active	inactive	[Device Para /Profibus /Config Bin Inp 1-16]
 Config Bin Inp 13	Virtual Digital Input. This corresponds to a virtual binary output of the protective device.	1..n, Assignment List	.-	[Device Para /Profibus /Config Bin Inp 1-16]
 Latched 13	Defines whether the Input is latched. Only available if: Latched = active	inactive, active	inactive	[Device Para /Profibus /Config Bin Inp 1-16]
 Config Bin Inp 14	Virtual Digital Input. This corresponds to a virtual binary output of the protective device.	1..n, Assignment List	.-	[Device Para /Profibus /Config Bin Inp 1-16]
 Latched 14	Defines whether the Input is latched. Only available if: Latched = active	inactive, active	inactive	[Device Para /Profibus /Config Bin Inp 1-16]

Parameter	Description	Setting range	Default	Menu path
 Config Bin Inp 15	Virtual Digital Input. This corresponds to a virtual binary output of the protective device.	1..n, Assignment List	.-	[Device Para /Profibus /Config Bin Inp 1-16]
 Latched 15	Defines whether the Input is latched. Only available if: Latched = active	inactive, active	inactive	[Device Para /Profibus /Config Bin Inp 1-16]
 Config Bin Inp 16	Virtual Digital Input. This corresponds to a virtual binary output of the protective device.	1..n, Assignment List	.-	[Device Para /Profibus /Config Bin Inp 1-16]
 Latched 16	Defines whether the Input is latched. Only available if: Latched = active	inactive, active	inactive	[Device Para /Profibus /Config Bin Inp 1-16]
 Config Bin Inp 17	Virtual Digital Input. This corresponds to a virtual binary output of the protective device.	1..n, Assignment List	.-	[Device Para /Profibus /Config Bin Inp 17-32]
 Latched 17	Defines whether the Input is latched. Only available if: Latched = active	inactive, active	inactive	[Device Para /Profibus /Config Bin Inp 17-32]
 Config Bin Inp 18	Virtual Digital Input. This corresponds to a virtual binary output of the protective device.	1..n, Assignment List	.-	[Device Para /Profibus /Config Bin Inp 17-32]
 Latched 18	Defines whether the Input is latched. Only available if: Latched = active	inactive, active	inactive	[Device Para /Profibus /Config Bin Inp 17-32]
 Config Bin Inp 19	Virtual Digital Input. This corresponds to a virtual binary output of the protective device.	1..n, Assignment List	.-	[Device Para /Profibus /Config Bin Inp 17-32]
 Latched 19	Defines whether the Input is latched. Only available if: Latched = active	inactive, active	inactive	[Device Para /Profibus /Config Bin Inp 17-32]

Parameter	Description	Setting range	Default	Menu path
 Config Bin Inp 20	Virtual Digital Input. This corresponds to a virtual binary output of the protective device.	1..n, Assignment List	.-	[Device Para /Profibus /Config Bin Inp 17-32]
 Latched 20	Defines whether the Input is latched. Only available if: Latched = active	inactive, active	inactive	[Device Para /Profibus /Config Bin Inp 17-32]
 Config Bin Inp 21	Virtual Digital Input. This corresponds to a virtual binary output of the protective device.	1..n, Assignment List	.-	[Device Para /Profibus /Config Bin Inp 17-32]
 Latched 21	Defines whether the Input is latched. Only available if: Latched = active	inactive, active	inactive	[Device Para /Profibus /Config Bin Inp 17-32]
 Config Bin Inp 22	Virtual Digital Input. This corresponds to a virtual binary output of the protective device.	1..n, Assignment List	.-	[Device Para /Profibus /Config Bin Inp 17-32]
 Latched 22	Defines whether the Input is latched. Only available if: Latched = active	inactive, active	inactive	[Device Para /Profibus /Config Bin Inp 17-32]
 Config Bin Inp 23	Virtual Digital Input. This corresponds to a virtual binary output of the protective device.	1..n, Assignment List	.-	[Device Para /Profibus /Config Bin Inp 17-32]
 Latched 23	Defines whether the Input is latched. Only available if: Latched = active	inactive, active	inactive	[Device Para /Profibus /Config Bin Inp 17-32]
 Config Bin Inp 24	Virtual Digital Input. This corresponds to a virtual binary output of the protective device.	1..n, Assignment List	.-	[Device Para /Profibus /Config Bin Inp 17-32]
 Latched 24	Defines whether the Input is latched. Only available if: Latched = active	inactive, active	inactive	[Device Para /Profibus /Config Bin Inp 17-32]

Parameter	Description	Setting range	Default	Menu path
 Config Bin Inp 25	Virtual Digital Input. This corresponds to a virtual binary output of the protective device.	1..n, Assignment List	.-	[Device Para /Profibus /Config Bin Inp 17-32]
 Latched 25	Defines whether the Input is latched. Only available if: Latched = active	inactive, active	inactive	[Device Para /Profibus /Config Bin Inp 17-32]
 Config Bin Inp 26	Virtual Digital Input. This corresponds to a virtual binary output of the protective device.	1..n, Assignment List	.-	[Device Para /Profibus /Config Bin Inp 17-32]
 Latched 26	Defines whether the Input is latched. Only available if: Latched = active	inactive, active	inactive	[Device Para /Profibus /Config Bin Inp 17-32]
 Config Bin Inp 27	Virtual Digital Input. This corresponds to a virtual binary output of the protective device.	1..n, Assignment List	.-	[Device Para /Profibus /Config Bin Inp 17-32]
 Latched 27	Defines whether the Input is latched. Only available if: Latched = active	inactive, active	inactive	[Device Para /Profibus /Config Bin Inp 17-32]
 Config Bin Inp 28	Virtual Digital Input. This corresponds to a virtual binary output of the protective device.	1..n, Assignment List	.-	[Device Para /Profibus /Config Bin Inp 17-32]
 Latched 28	Defines whether the Input is latched. Only available if: Latched = active	inactive, active	inactive	[Device Para /Profibus /Config Bin Inp 17-32]
 Config Bin Inp 29	Virtual Digital Input. This corresponds to a virtual binary output of the protective device.	1..n, Assignment List	.-	[Device Para /Profibus /Config Bin Inp 17-32]
 Latched 29	Defines whether the Input is latched. Only available if: Latched = active	inactive, active	inactive	[Device Para /Profibus /Config Bin Inp 17-32]

Parameter	Description	Setting range	Default	Menu path
 Config Bin Inp 30	Virtual Digital Input. This corresponds to a virtual binary output of the protective device.	1..n, Assignment List	.-	[Device Para /Profibus /Config Bin Inp 17-32]
 Latched 30	Defines whether the Input is latched. Only available if: Latched = active	inactive, active	inactive	[Device Para /Profibus /Config Bin Inp 17-32]
 Config Bin Inp 31	Virtual Digital Input. This corresponds to a virtual binary output of the protective device.	1..n, Assignment List	.-	[Device Para /Profibus /Config Bin Inp 17-32]
 Latched 31	Defines whether the Input is latched. Only available if: Latched = active	inactive, active	inactive	[Device Para /Profibus /Config Bin Inp 17-32]
 Config Bin Inp 32	Virtual Digital Input. This corresponds to a virtual binary output of the protective device.	1..n, Assignment List	.-	[Device Para /Profibus /Config Bin Inp 17-32]
 Latched 32	Defines whether the Input is latched. Only available if: Latched = active	inactive, active	inactive	[Device Para /Profibus /Config Bin Inp 17-32]
 Slave ID	Device address (Slave ID) within the bus system. Each device address has to be unique within a bus system.	2 - 125	2	[Device Para /Profibus /Bus parameters]

Inputs of the Profibus

Name	Description	Assignment via
Assignment 1-I	Module input state: Scada Assignment	[Device Para /Profibus /Config Bin Inp 1-16]
Assignment 2-I	Module input state: Scada Assignment	[Device Para /Profibus /Config Bin Inp 1-16]
Assignment 3-I	Module input state: Scada Assignment	[Device Para /Profibus /Config Bin Inp 1-16]

<i>Name</i>	<i>Description</i>	<i>Assignment via</i>
Assignment 4-I	Module input state: Scada Assignment	[Device Para /Profibus /Config Bin Inp 1-16]
Assignment 5-I	Module input state: Scada Assignment	[Device Para /Profibus /Config Bin Inp 1-16]
Assignment 6-I	Module input state: Scada Assignment	[Device Para /Profibus /Config Bin Inp 1-16]
Assignment 7-I	Module input state: Scada Assignment	[Device Para /Profibus /Config Bin Inp 1-16]
Assignment 8-I	Module input state: Scada Assignment	[Device Para /Profibus /Config Bin Inp 1-16]
Assignment 9-I	Module input state: Scada Assignment	[Device Para /Profibus /Config Bin Inp 1-16]
Assignment 10-I	Module input state: Scada Assignment	[Device Para /Profibus /Config Bin Inp 1-16]
Assignment 11-I	Module input state: Scada Assignment	[Device Para /Profibus /Config Bin Inp 1-16]
Assignment 12-I	Module input state: Scada Assignment	[Device Para /Profibus /Config Bin Inp 1-16]
Assignment 13-I	Module input state: Scada Assignment	[Device Para /Profibus /Config Bin Inp 1-16]
Assignment 14-I	Module input state: Scada Assignment	[Device Para /Profibus /Config Bin Inp 1-16]
Assignment 15-I	Module input state: Scada Assignment	[Device Para /Profibus /Config Bin Inp 1-16]
Assignment 16-I	Module input state: Scada Assignment	[Device Para /Profibus /Config Bin Inp 1-16]

Name	Description	Assignment via
Assignment 17-I	Module input state: Scada Assignment	[Device Para /Profibus /Config Bin Inp 17-32]
Assignment 18-I	Module input state: Scada Assignment	[Device Para /Profibus /Config Bin Inp 17-32]
Assignment 19-I	Module input state: Scada Assignment	[Device Para /Profibus /Config Bin Inp 17-32]
Assignment 20-I	Module input state: Scada Assignment	[Device Para /Profibus /Config Bin Inp 17-32]
Assignment 21-I	Module input state: Scada Assignment	[Device Para /Profibus /Config Bin Inp 17-32]
Assignment 22-I	Module input state: Scada Assignment	[Device Para /Profibus /Config Bin Inp 17-32]
Assignment 23-I	Module input state: Scada Assignment	[Device Para /Profibus /Config Bin Inp 17-32]
Assignment 24-I	Module input state: Scada Assignment	[Device Para /Profibus /Config Bin Inp 17-32]
Assignment 25-I	Module input state: Scada Assignment	[Device Para /Profibus /Config Bin Inp 17-32]
Assignment 26-I	Module input state: Scada Assignment	[Device Para /Profibus /Config Bin Inp 17-32]
Assignment 27-I	Module input state: Scada Assignment	[Device Para /Profibus /Config Bin Inp 17-32]
Assignment 28-I	Module input state: Scada Assignment	[Device Para /Profibus /Config Bin Inp 17-32]
Assignment 29-I	Module input state: Scada Assignment	[Device Para /Profibus /Config Bin Inp 17-32]

<i>Name</i>	<i>Description</i>	<i>Assignment via</i>
Assignment 30-I	Module input state: Scada Assignment	[Device Para /Profibus /Config Bin Inp 17-32]
Assignment 31-I	Module input state: Scada Assignment	[Device Para /Profibus /Config Bin Inp 17-32]
Assignment 32-I	Module input state: Scada Assignment	[Device Para /Profibus /Config Bin Inp 17-32]

Profibus Signals (Output States)

<i>Signal</i>	<i>Description</i>
Data OK	Data within the Input field are OK (Yes=1)
SubModul Err	Assignable Signal, Failure in Sub-Module, Communication Failure.
Connection active	Connection active
Scada Cmd 1	Scada Command
Scada Cmd 2	Scada Command
Scada Cmd 3	Scada Command
Scada Cmd 4	Scada Command
Scada Cmd 5	Scada Command
Scada Cmd 6	Scada Command
Scada Cmd 7	Scada Command
Scada Cmd 8	Scada Command
Scada Cmd 9	Scada Command
Scada Cmd 10	Scada Command
Scada Cmd 11	Scada Command
Scada Cmd 12	Scada Command
Scada Cmd 13	Scada Command
Scada Cmd 14	Scada Command
Scada Cmd 15	Scada Command
Scada Cmd 16	Scada Command

Profibus Values

<i>Value</i>	<i>Description</i>	<i>Default</i>	<i>Size</i>	<i>Menu path</i>
Fr Sync Err	Frames, that were sent from the Master to the Slave are faulty.	1	1 - 99999999	[Operation /Count and RevData /Profibus]

<i>Value</i>	<i>Description</i>	<i>Default</i>	<i>Size</i>	<i>Menu path</i>
crcErrors	Number of CRC errors that the ss manager has recognized in received response frames from ss (each error caused a subsystem reset)	1	1 - 99999999	[Operation /Count and RevData /Profibus]
frLossErrors	Number of frame loss errors that the ss manager recognized in received response frames from ss (each error caused a subsystem reset)	1	1 - 99999999	[Operation /Count and RevData /Profibus]
ssCrcErrors	Number of CRC errors that the subsystem has recognized in received trigger frames from host	1	1 - 99999999	[Operation /Count and RevData /Profibus]
ssResets	Number of subsystem resets/restarts from ss manager	1	1 - 99999999	[Operation /Count and RevData /Profibus]
Master ID	Device address (Master ID) within the bus system. Each device address has to be unique within a bus system.	1	1 - 125	[Operation /Status Display /Profibus /State]
HO Id PSub	Handoff Id of PbSub	0	0 - 999999999	[Operation /Status Display /Profibus /State]
t-WatchDog	The Profibus Chip detects a communication issue if this timer is expired without any communication (Parameterising telegram).	0	0 - 999999999	[Operation /Status Display /Profibus /State]

<i>Value</i>	<i>Description</i>	<i>Default</i>	<i>Size</i>	<i>Menu path</i>
Slave State	Communication State between Slave and Master.	Baud Search	Baud Search, Baud Found, PRM OK, PRM REQ, PRM Fault, CFG Fault, Clear Data, Data exchange	[Operation /Status Display /Profibus /State]
Baud rate	The baud rate that has been detected lastly, will still be shown after a connection issue.	.-	12 Mb/s, 6 Mb/s, 3 Mb/s, 1.5 Mb/s, 0.5 Mb/s, 187500 baud, 93750 baud, 45450 baud, 19200 baud, 9600 baud, .-	[Operation /Status Display /Profibus /State]
PNO Id	PNO Identification Number. GSD Identification Number.	0C50h	0C50h	[Operation /Status Display /Profibus /State]

IEC60870-5-103

IEC 103

IEC60870-5-103 Protocol Configuration

In order to use the IEC60870-5-103 protocol it has to be assigned to the X103 Interface within the Device Planning. The device will reboot after setting this parameter.

Moreover, the IEC103 protocol has to be activated by setting [Device Para/ IEC 103] »Function« to “active”.

NOTICE

The parameter X103 is only available if the device is at the rear side equipped with an interface like RS485 or Fiber Optic.

NOTICE

If the device is equipped with an Fiber Optic Interface, the Optical Rest Position has to be set within the Device Parameters .

The time-controlled IEC60870-5-103 protocol is based on the Master-Slave working principle. This means that the substation control and protection system sends an enquiry or instruction to a certain device (slave address) which will then be answered or carried out accordingly.

The device meets the compatibility mode 2. Compatibility mode 3 is not supported.

The following IEC60870-5-103-functions will be supported:

- Initialization (Reset)
- Time Synchronization
- Reading out of time stamped, instantaneous signals
- General Queries
- Cyclic Signals
- General Commands
- Transmission of Disturbance Data
- Blocking of Monitor Direction
- Test Mode

Initialization

The communication has to be reset by a Reset Command each time that the device is turned on or that communication parameters have been changed. The “Reset CU” Command resets. The relay acts on both Reset Commands (Reset CU or Reset FCB).

The relay acts on the reset command by an identification signal ASDU 5 (Application Service Data Unit), as a reason (Cause Of Transmission, COT) for the transmission of the answer either a “Reset CU” or a “Reset FCB” will be sent depending on the type of the reset command. This information can be part of the data section of the ASDU-signal.

Name of the Manufacturer

The section for the identification of the software contains three digits of the device code for the identification of the device type. Beside the upper mentioned identification number the device generates a communication start event.

Time Synchronization

Time and date of the relay can be set by means of the time synchronization function of the IEC60870-5-103 protocol. If the time synchronization signal is send out with a confirmation request, the device will answer with a confirmation signal.

Spontaneous Events

The events that are generated by the device will be forwarded to the master with numbers for standard function types / standard information. The data point list comprises all events that can be generated by the device.

Cyclic Measurement

The device generates on a cyclic base measured values by means of ASDU 9. They can be read out via a class 2 query. Please take into account that the measured values will be send out as multiples (1.2 or 2.4 times the rated value). How to set 1.2 or 2.4 as multiplier for a value can be taken from the data point list.

The parameter "Transm priv meas val" defines if additional measurement values should be transmitted in the private part. Public and private measured values are transmitted by ASDU9. That means that either a "private" or a "public" ASDU9 will be transmitted. If this parameter is set, the ASDU9 will contain additional measured values that are an enhancement of the standard. The "private" ASDU9 is send with a fixed function type and information number that does not depend the type of device. Please refer to the data point list.

Commands

The data point list comprises a list of the supported commands. Any command will be responded by the device with a positive or negative confirmation. If the command is executable, the execution with the corresponding reason for the transmission (COT) will be lead in at first, and subsequently the execution will be confirmed with COT1 within a ASDU9.

Disturbance Recording

The disturbances recorded by the device can be read out by means described in standard IEC60870-5-103. The device is in compliance with the VDEW-Control System by transmission of an ASDU 23 without disturbance records at the beginning of an GI-Cycle.

A disturbance record contains the following information:

- Analog Measured Values, IL1, IL2, IL3, IN, Voltages VL1, VL2, VL3, VEN;
- Binary States, transmitted as marks, e.g. Alarms and Trips.
- The Transmission ratio will not be supported. The transmission ratio is included in the "Multiplier".

Blocking the Transmission in Monitor Direction

The relay supports the function to block the transmission in monitor direction. There are two ways to activate this blocking:







- Manual activation via Direct Control parameter »Activate Block MD«
- External activation, by assigning a signal to the setting parameter »Ex activate Block MD«



Test Mode

The relay supports the test mode (Cause of Transmission 7). There are two ways to activate the test mode:

- Manual activation via Direct Control parameter »Activate test mode«
- External activation, by assigning a signal to the setting parameter »Ex activate test mode«



Global Protection Parameters of the IEC60870-5-103

<i>Parameter</i>	<i>Description</i>	<i>Setting range</i>	<i>Default</i>	<i>Menu path</i>
Function 	Activation or deactivation of the IEC103 communication.	inactive, active	inactive	[Device Para /IEC 103]
Slave ID 	Device address (Slave ID) within the bus system. Each device address has to be unique within a bus system.	1 - 247	1	[Device Para /IEC 103]
Baud rate 	Baud rate	1200, 2400, 4800, 9600, 19200, 38400, 57600	19200	[Device Para /IEC 103]
Physical Settings 	Digit 1: Number of bits. Digit 2: E=even parity, O=odd parity, N=no parity. Digit 3: Number of stop bits. More information on the parity: It is possible that the last data bit is followed by a parity bit which is used for recognition of communication errors. The parity bit ensures that with even parity ("EVEN") always an even number of bits with valence "1" or with odd parity ("ODD") an odd number of "1" valence bits are transmitted. But it is also possible to transmit no parity bits (here the setting is "Parity = None"). More information on the stop-bits: The end of a data byte is terminated by the stop-bits.	8E1, 8O1, 8N1, 8N2	8E1	[Device Para /IEC 103]
t-call 	If there is no request telegram sent from Scada to the device after expiry of this time - the device concludes a communication failure within the Scada system.	1 - 3600s	60s	[Device Para /IEC 103]
Transm priv meas val 	Transmit additional (private) measuring values	inactive, active	inactive	[Device Para /IEC 103]
Transfer Disturb Rec 	Activates the transmission of disturbance records	inactive, active	inactive	[Device Para /IEC 103]

Parameter	Description	Setting range	Default	Menu path
 Timezone	Selection whether the timestamps in IEC103 messages shall be given as UTC or local time. ("Local time" always includes the actual daylight saving settings.)	UTC, Local Time	UTC	[Device Para /IEC 103]
 Energy Pulse Rate	The energy values are always transmitted as counter values (i.e. as integer numbers). This setting defines the unit: If "1" is set then each counter increment is 1 kWh, if "2" is set then each counter increment is 2 kWh, etc. The setting "0" has the effect that no energy values are transmitted.	0 - 100	0	[Device Para /IEC 103]
 DFC-Compat.	This setting is only required for certain substation implementations. If there should be communication problems related to the Command Response Queue this setting switches the device over to a different behavior.	inactive, active	inactive	[Device Para /IEC 103]
 Optical rest position	Optical rest position	Light off, Light on	Light on	[Device Para /IEC 103]
 Ex activate test mode	The signal assigned to this parameter switches the IEC103 communication into Test Mode.	1..n, Assignment List	Sgen.Running	[Service /Test (Prot inhibit) /Scada /IEC 103]
 Ex activate Block MD	The signal assigned to this parameter activates the blocking of IEC103 transmission in monitor direction.	1..n, Assignment List	.-	[Service /Test (Prot inhibit) /Scada /IEC 103]

Direct Commands of the IEC60870-5-103

Parameter	Description	Setting range	Default	Menu path
 Activate test mode	This Direct Control parameter switches the IEC103 communication into Test Mode (or back to normal mode).	inactive, active	inactive	[Service /Test (Prot inhibit) /Scada /IEC 103]

Parameter	Description	Setting range	Default	Menu path
 Activate Block MD	This Direct Control parameter activates (or deactivates) the blocking of IEC103 transmission in monitor direction.	inactive, active	inactive	[Service /Test (Prot inhibit) /Scada /IEC 103]
 Res all Diag Cr	Reset all diagnosis counters	inactive, active	inactive	[Operation /Reset]

IEC60870-5-103 Input States

Name	Description	Assignment via
Ex activate test mode-I	Module input state: Test Mode of the IEC103 communication.	[Service /Test (Prot inhibit) /Scada /IEC 103]
Ex activate Block MD-I	Module input state: Activation of the blocking of IEC103 transmission in monitor direction.	[Service /Test (Prot inhibit) /Scada /IEC 103]

IEC60870-5-103 Signals (Output States)

Signal	Description
Scada Cmd 1	Scada Command
Scada Cmd 2	Scada Command
Scada Cmd 3	Scada Command
Scada Cmd 4	Scada Command
Scada Cmd 5	Scada Command
Scada Cmd 6	Scada Command
Scada Cmd 7	Scada Command
Scada Cmd 8	Scada Command
Scada Cmd 9	Scada Command
Scada Cmd 10	Scada Command
Transmission	Signal: SCADA active
Failure Event lost	Failure event lost
Test mode active	Signal: IEC103 communication has been switched over into Test Mode.
Block MD active	Signal: The blocking of IEC103 transmission in monitor direction has been activated.

IEC60870-5-103 Values

<i>Value</i>	<i>Description</i>	<i>Default</i>	<i>Size</i>	<i>Menu path</i>
NReceived	Total Number of received Messages	0	0 - 9999999999	[Operation /Count and RevData /IEC 103]
NSent	Total Number of sent Messages	0	0 - 9999999999	[Operation /Count and RevData /IEC 103]
NBadFramings	Number of bad Messages	0	0 - 9999999999	[Operation /Count and RevData /IEC 103]
NBadParities	Number of Parity Errors	0	0 - 9999999999	[Operation /Count and RevData /IEC 103]
NBreakSignals	Number of Communication Interrupts	0	0 - 9999999999	[Operation /Count and RevData /IEC 103]
NInternalError	Number of Internal Errors	0	0 - 9999999999	[Operation /Count and RevData /IEC 103]
NBadCharChecksum	Number of Checksum Errors	0	0 - 9999999999	[Operation /Count and RevData /IEC 103]

IEC61850

IEC61850

Introduction

To understand the functioning and mode of operation of a substation in an IEC61850 automation environment, it is useful to compare the commissioning steps with those of a conventional substation in a Modbus TCP environment.

In a conventional substation the individual IEDs (Intelligent Electronic Devices) communicate in vertically direction with the higher level control center via SCADA. The horizontal communication is exclusively realized by wiring output relays (OR) and digital inputs (DI) among each other.

In an IEC61850 environment communication between the IEDs takes place digitally (via Ethernet) by a service called GOOSE (Generic Object Oriented Substation Event). By means of this service information about events is submitted between each IED. Therefore each IED has to know about the functional capability of all other connected IEDs.

Each IEC61850 capable device includes a description of it's own functionality and communications skills (IED Capability Description, *.ICD).

By means of a Substation Configuration Tool to describe the structure of the substation, assignment of the devices to the primary technique, etc. a virtual wiring of the IEDs among each other and with other switch gear of the substation can be done. A description of the substation configuration will be generated in form of a *.SCD file. At last this file has to be submitted to each device. Now the IEDs are able to communicate closed among each other, react to interlockings and operate switch gear.

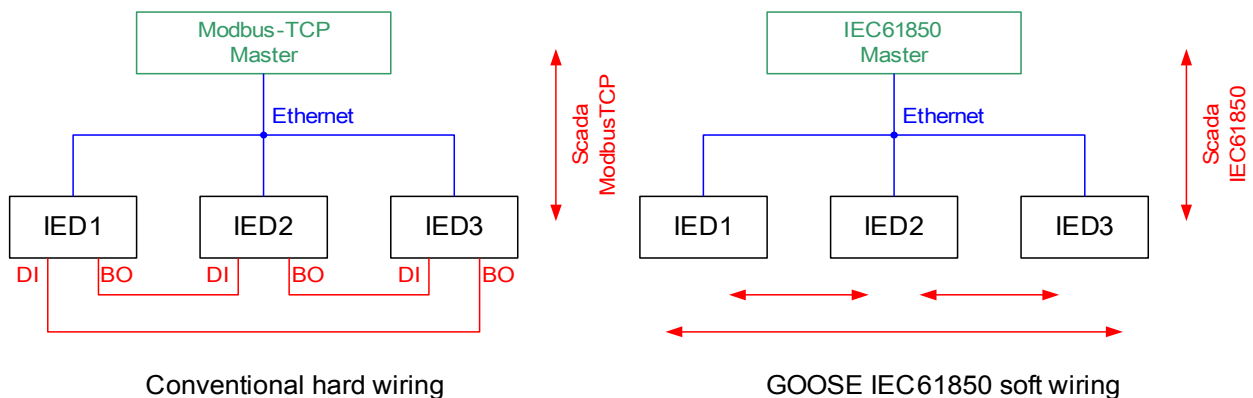

Commissioning steps for a conventional substation with modbus TCP environment:

- Parameter setting of the IEDs
- Ethernet installation
- TCP/IP settings for the IEDs
- Wiring according to wiring scheme

Commissioning steps for a substation with IEC61850 environment:

1. Parameter setting of the IEDs
Ethernet installation
TCP/IP settings for the IEDs
2. IEC61850 configuration (software wiring)
 - a) Exporting an ICD file from each device
 - b) Configuration of the substation (generating a SCD file)
 - c) Transmit SCD file to each device

Generation/Export of a device specific ICD file

Please refer to chapter "IEC61850" of the Smart view Manual.

Generation/Export of a SCD file

Please refer to chapter "IEC61850" of the Smart view Manual.

Substation configuration, Generation of .SCD file (Station Configuration Description)

The substation configuration, i. e. connection of all logical nodes of protection and control devices, as well as switch gear usually is done with a „Substation Configuration Tool“. Therefore the ICD files of all connected IEDs in the IEC61850 environment have to be available. The result of the station wide "software wiring" can be exported in the form of a SCD file (Station Configuration Description).

Suitable Substation Configuration Tools (SCT) are available by the following Companies:

H&S, Hard- & Software Technologie GmbH & Co. KG, Dortmund (Germany) (www.hstech.de).

Applied Systems Engineering Inc. (www.ase-systems.com)

Kalki Communication Technologies Limited (www.kalkitech.com)

Import of the .SCD file into the device

Please refer to chapter "IEC61850" of the Smart view Manual.



IEC 61850 Virtual Outputs

Additionally to the standardized logical node status information up to 32 free configurable status information can be assigned to 32 Virtual Outputs. This can be done in the menu [Device Para/IEC61850].





Direct Commands of the IEC 61850

Parameter	Description	Setting range	Default	Menu path
ResetStatistic 	Reset of all IEC61850 diagnostic counters	inactive, active	inactive	[Operation /Reset]

Global Parameters of the IEC 61850







Parameter	Description	Setting range	Default	Menu path
Function 	Permanent activation or deactivation of module/stage.	inactive, active	inactive	[Device Para /IEC61850]
Deadband integr time 	Deadband integration time.	0 - 300	0	[Device Para /IEC61850]

Global Parameters of the IEC 61850

Parameter	Description	Setting range	Default	Menu path
VirtualOutput1 	Virtual Output. This signal can be assigned or visualized via the SCD file to other devices within the IEC61850 substation.	1..n, Assignment List	-.-	[Device Para /IEC61850]
VirtualOutput2 	Virtual Output. This signal can be assigned or visualized via the SCD file to other devices within the IEC61850 substation.	1..n, Assignment List	-.-	[Device Para /IEC61850]
VirtualOutput3 	Virtual Output. This signal can be assigned or visualized via the SCD file to other devices within the IEC61850 substation.	1..n, Assignment List	-.-	[Device Para /IEC61850]
VirtualOutput4 	Virtual Output. This signal can be assigned or visualized via the SCD file to other devices within the IEC61850 substation.	1..n, Assignment List	-.-	[Device Para /IEC61850]
VirtualOutput5 	Virtual Output. This signal can be assigned or visualized via the SCD file to other devices within the IEC61850 substation.	1..n, Assignment List	-.-	[Device Para /IEC61850]

Parameter	Description	Setting range	Default	Menu path
VirtualOutput6 	Virtual Output. This signal can be assigned or visualized via the SCD file to other devices within the IEC61850 substation.	1..n, Assignment List	.-	[Device Para /IEC61850]
VirtualOutput7 	Virtual Output. This signal can be assigned or visualized via the SCD file to other devices within the IEC61850 substation.	1..n, Assignment List	.-	[Device Para /IEC61850]
VirtualOutput8 	Virtual Output. This signal can be assigned or visualized via the SCD file to other devices within the IEC61850 substation.	1..n, Assignment List	.-	[Device Para /IEC61850]
VirtualOutput9 	Virtual Output. This signal can be assigned or visualized via the SCD file to other devices within the IEC61850 substation.	1..n, Assignment List	.-	[Device Para /IEC61850]
VirtualOutput10 	Virtual Output. This signal can be assigned or visualized via the SCD file to other devices within the IEC61850 substation.	1..n, Assignment List	.-	[Device Para /IEC61850]
VirtualOutput11 	Virtual Output. This signal can be assigned or visualized via the SCD file to other devices within the IEC61850 substation.	1..n, Assignment List	.-	[Device Para /IEC61850]
VirtualOutput12 	Virtual Output. This signal can be assigned or visualized via the SCD file to other devices within the IEC61850 substation.	1..n, Assignment List	.-	[Device Para /IEC61850]
VirtualOutput13 	Virtual Output. This signal can be assigned or visualized via the SCD file to other devices within the IEC61850 substation.	1..n, Assignment List	.-	[Device Para /IEC61850]
VirtualOutput14 	Virtual Output. This signal can be assigned or visualized via the SCD file to other devices within the IEC61850 substation.	1..n, Assignment List	.-	[Device Para /IEC61850]
VirtualOutput15 	Virtual Output. This signal can be assigned or visualized via the SCD file to other devices within the IEC61850 substation.	1..n, Assignment List	.-	[Device Para /IEC61850]

<i>Parameter</i>	<i>Description</i>	<i>Setting range</i>	<i>Default</i>	<i>Menu path</i>
VirtualOutput16 	Virtual Output. This signal can be assigned or visualized via the SCD file to other devices within the IEC61850 substation.	1..n, Assignment List	.-	[Device Para /IEC61850]
VirtualOutput17 	Virtual Output. This signal can be assigned or visualized via the SCD file to other devices within the IEC61850 substation.	1..n, Assignment List	.-	[Device Para /IEC61850]
VirtualOutput18 	Virtual Output. This signal can be assigned or visualized via the SCD file to other devices within the IEC61850 substation.	1..n, Assignment List	.-	[Device Para /IEC61850]
VirtualOutput19 	Virtual Output. This signal can be assigned or visualized via the SCD file to other devices within the IEC61850 substation.	1..n, Assignment List	.-	[Device Para /IEC61850]
VirtualOutput20 	Virtual Output. This signal can be assigned or visualized via the SCD file to other devices within the IEC61850 substation.	1..n, Assignment List	.-	[Device Para /IEC61850]
VirtualOutput21 	Virtual Output. This signal can be assigned or visualized via the SCD file to other devices within the IEC61850 substation.	1..n, Assignment List	.-	[Device Para /IEC61850]
VirtualOutput22 	Virtual Output. This signal can be assigned or visualized via the SCD file to other devices within the IEC61850 substation.	1..n, Assignment List	.-	[Device Para /IEC61850]
VirtualOutput23 	Virtual Output. This signal can be assigned or visualized via the SCD file to other devices within the IEC61850 substation.	1..n, Assignment List	.-	[Device Para /IEC61850]
VirtualOutput24 	Virtual Output. This signal can be assigned or visualized via the SCD file to other devices within the IEC61850 substation.	1..n, Assignment List	.-	[Device Para /IEC61850]
VirtualOutput25 	Virtual Output. This signal can be assigned or visualized via the SCD file to other devices within the IEC61850 substation.	1..n, Assignment List	.-	[Device Para /IEC61850]

<i>Parameter</i>	<i>Description</i>	<i>Setting range</i>	<i>Default</i>	<i>Menu path</i>
VirtualOutput26 	Virtual Output. This signal can be assigned or visualized via the SCD file to other devices within the IEC61850 substation.	1..n, Assignment List	.-	[Device Para /IEC61850]
VirtualOutput27 	Virtual Output. This signal can be assigned or visualized via the SCD file to other devices within the IEC61850 substation.	1..n, Assignment List	.-	[Device Para /IEC61850]
VirtualOutput28 	Virtual Output. This signal can be assigned or visualized via the SCD file to other devices within the IEC61850 substation.	1..n, Assignment List	.-	[Device Para /IEC61850]
VirtualOutput29 	Virtual Output. This signal can be assigned or visualized via the SCD file to other devices within the IEC61850 substation.	1..n, Assignment List	.-	[Device Para /IEC61850]
VirtualOutput30 	Virtual Output. This signal can be assigned or visualized via the SCD file to other devices within the IEC61850 substation.	1..n, Assignment List	.-	[Device Para /IEC61850]
VirtualOutput31 	Virtual Output. This signal can be assigned or visualized via the SCD file to other devices within the IEC61850 substation.	1..n, Assignment List	.-	[Device Para /IEC61850]
VirtualOutput32 	Virtual Output. This signal can be assigned or visualized via the SCD file to other devices within the IEC61850 substation.	1..n, Assignment List	.-	[Device Para /IEC61850]

States of the Inputs of the IEC 61850

<i>Name</i>	<i>Description</i>	<i>Assignment via</i>
VirtOut1-I	Module input state: Binary state of the Virtual Output (GGIO)	[Device Para /IEC61850]
VirtOut2-I	Module input state: Binary state of the Virtual Output (GGIO)	[Device Para /IEC61850]
VirtOut3-I	Module input state: Binary state of the Virtual Output (GGIO)	[Device Para /IEC61850]
VirtOut4-I	Module input state: Binary state of the Virtual Output (GGIO)	[Device Para /IEC61850]
VirtOut5-I	Module input state: Binary state of the Virtual Output (GGIO)	[Device Para /IEC61850]
VirtOut6-I	Module input state: Binary state of the Virtual Output (GGIO)	[Device Para /IEC61850]
VirtOut7-I	Module input state: Binary state of the Virtual Output (GGIO)	[Device Para /IEC61850]
VirtOut8-I	Module input state: Binary state of the Virtual Output (GGIO)	[Device Para /IEC61850]
VirtOut9-I	Module input state: Binary state of the Virtual Output (GGIO)	[Device Para /IEC61850]
VirtOut10-I	Module input state: Binary state of the Virtual Output (GGIO)	[Device Para /IEC61850]
VirtOut11-I	Module input state: Binary state of the Virtual Output (GGIO)	[Device Para /IEC61850]
VirtOut12-I	Module input state: Binary state of the Virtual Output (GGIO)	[Device Para /IEC61850]
VirtOut13-I	Module input state: Binary state of the Virtual Output (GGIO)	[Device Para /IEC61850]
VirtOut14-I	Module input state: Binary state of the Virtual Output (GGIO)	[Device Para /IEC61850]
VirtOut15-I	Module input state: Binary state of the Virtual Output (GGIO)	[Device Para /IEC61850]
VirtOut16-I	Module input state: Binary state of the Virtual Output (GGIO)	[Device Para /IEC61850]
VirtOut17-I	Module input state: Binary state of the Virtual Output (GGIO)	[Device Para /IEC61850]
VirtOut18-I	Module input state: Binary state of the Virtual Output (GGIO)	[Device Para /IEC61850]

<i>Name</i>	<i>Description</i>	<i>Assignment via</i>
VirtOut19-I	Module input state: Binary state of the Virtual Output (GGIO)	[Device Para /IEC61850]
VirtOut20-I	Module input state: Binary state of the Virtual Output (GGIO)	[Device Para /IEC61850]
VirtOut21-I	Module input state: Binary state of the Virtual Output (GGIO)	[Device Para /IEC61850]
VirtOut22-I	Module input state: Binary state of the Virtual Output (GGIO)	[Device Para /IEC61850]
VirtOut23-I	Module input state: Binary state of the Virtual Output (GGIO)	[Device Para /IEC61850]
VirtOut24-I	Module input state: Binary state of the Virtual Output (GGIO)	[Device Para /IEC61850]
VirtOut25-I	Module input state: Binary state of the Virtual Output (GGIO)	[Device Para /IEC61850]
VirtOut26-I	Module input state: Binary state of the Virtual Output (GGIO)	[Device Para /IEC61850]
VirtOut27-I	Module input state: Binary state of the Virtual Output (GGIO)	[Device Para /IEC61850]
VirtOut28-I	Module input state: Binary state of the Virtual Output (GGIO)	[Device Para /IEC61850]
VirtOut29-I	Module input state: Binary state of the Virtual Output (GGIO)	[Device Para /IEC61850]
VirtOut30-I	Module input state: Binary state of the Virtual Output (GGIO)	[Device Para /IEC61850]
VirtOut31-I	Module input state: Binary state of the Virtual Output (GGIO)	[Device Para /IEC61850]
VirtOut32-I	Module input state: Binary state of the Virtual Output (GGIO)	[Device Para /IEC61850]

IEC 61850 Module Signals (Output States)

<i>Signal</i>	<i>Description</i>
MMS Client connected	At least one MMS client is connected to the device
All Goose Subscriber active	All Goose subscriber in the device are working
VirtInp1	Signal: Virtual Input (IEC61850 GGIO Ind)
VirtInp2	Signal: Virtual Input (IEC61850 GGIO Ind)
VirtInp3	Signal: Virtual Input (IEC61850 GGIO Ind)
VirtInp4	Signal: Virtual Input (IEC61850 GGIO Ind)
VirtInp5	Signal: Virtual Input (IEC61850 GGIO Ind)
VirtInp6	Signal: Virtual Input (IEC61850 GGIO Ind)
VirtInp7	Signal: Virtual Input (IEC61850 GGIO Ind)
VirtInp8	Signal: Virtual Input (IEC61850 GGIO Ind)
VirtInp9	Signal: Virtual Input (IEC61850 GGIO Ind)
VirtInp10	Signal: Virtual Input (IEC61850 GGIO Ind)
VirtInp11	Signal: Virtual Input (IEC61850 GGIO Ind)
VirtInp12	Signal: Virtual Input (IEC61850 GGIO Ind)
VirtInp13	Signal: Virtual Input (IEC61850 GGIO Ind)
VirtInp14	Signal: Virtual Input (IEC61850 GGIO Ind)
VirtInp15	Signal: Virtual Input (IEC61850 GGIO Ind)
VirtInp16	Signal: Virtual Input (IEC61850 GGIO Ind)
VirtInp17	Signal: Virtual Input (IEC61850 GGIO Ind)
VirtInp18	Signal: Virtual Input (IEC61850 GGIO Ind)
VirtInp19	Signal: Virtual Input (IEC61850 GGIO Ind)
VirtInp20	Signal: Virtual Input (IEC61850 GGIO Ind)
VirtInp21	Signal: Virtual Input (IEC61850 GGIO Ind)
VirtInp22	Signal: Virtual Input (IEC61850 GGIO Ind)
VirtInp23	Signal: Virtual Input (IEC61850 GGIO Ind)
VirtInp24	Signal: Virtual Input (IEC61850 GGIO Ind)
VirtInp25	Signal: Virtual Input (IEC61850 GGIO Ind)
VirtInp26	Signal: Virtual Input (IEC61850 GGIO Ind)
VirtInp27	Signal: Virtual Input (IEC61850 GGIO Ind)
VirtInp28	Signal: Virtual Input (IEC61850 GGIO Ind)
VirtInp29	Signal: Virtual Input (IEC61850 GGIO Ind)
VirtInp30	Signal: Virtual Input (IEC61850 GGIO Ind)
VirtInp31	Signal: Virtual Input (IEC61850 GGIO Ind)
VirtInp32	Signal: Virtual Input (IEC61850 GGIO Ind)
Quality of GGIO In1	Self-Supervision of the GGIO Input
Quality of GGIO In2	Self-Supervision of the GGIO Input
Quality of GGIO In3	Self-Supervision of the GGIO Input
Quality of GGIO In4	Self-Supervision of the GGIO Input

<i>Signal</i>	<i>Description</i>
Quality of GGIO In5	Self-Supervision of the GGIO Input
Quality of GGIO In6	Self-Supervision of the GGIO Input
Quality of GGIO In7	Self-Supervision of the GGIO Input
Quality of GGIO In8	Self-Supervision of the GGIO Input
Quality of GGIO In9	Self-Supervision of the GGIO Input
Quality of GGIO In10	Self-Supervision of the GGIO Input
Quality of GGIO In11	Self-Supervision of the GGIO Input
Quality of GGIO In12	Self-Supervision of the GGIO Input
Quality of GGIO In13	Self-Supervision of the GGIO Input
Quality of GGIO In14	Self-Supervision of the GGIO Input
Quality of GGIO In15	Self-Supervision of the GGIO Input
Quality of GGIO In16	Self-Supervision of the GGIO Input
Quality of GGIO In17	Self-Supervision of the GGIO Input
Quality of GGIO In18	Self-Supervision of the GGIO Input
Quality of GGIO In19	Self-Supervision of the GGIO Input
Quality of GGIO In20	Self-Supervision of the GGIO Input
Quality of GGIO In21	Self-Supervision of the GGIO Input
Quality of GGIO In22	Self-Supervision of the GGIO Input
Quality of GGIO In23	Self-Supervision of the GGIO Input
Quality of GGIO In24	Self-Supervision of the GGIO Input
Quality of GGIO In25	Self-Supervision of the GGIO Input
Quality of GGIO In26	Self-Supervision of the GGIO Input
Quality of GGIO In27	Self-Supervision of the GGIO Input
Quality of GGIO In28	Self-Supervision of the GGIO Input
Quality of GGIO In29	Self-Supervision of the GGIO Input
Quality of GGIO In30	Self-Supervision of the GGIO Input
Quality of GGIO In31	Self-Supervision of the GGIO Input
Quality of GGIO In32	Self-Supervision of the GGIO Input
SPCSO1	Status bit that can be set by clients like e.g. SCADA (Single Point Controllable Status Output).
SPCSO2	Status bit that can be set by clients like e.g. SCADA (Single Point Controllable Status Output).
SPCSO3	Status bit that can be set by clients like e.g. SCADA (Single Point Controllable Status Output).
SPCSO4	Status bit that can be set by clients like e.g. SCADA (Single Point Controllable Status Output).
SPCSO5	Status bit that can be set by clients like e.g. SCADA (Single Point Controllable Status Output).
SPCSO6	Status bit that can be set by clients like e.g. SCADA (Single Point Controllable Status Output).
SPCSO7	Status bit that can be set by clients like e.g. SCADA (Single Point Controllable Status Output).

<i>Signal</i>	<i>Description</i>
SPCSO8	Status bit that can be set by clients like e.g. SCADA (Single Point Controllable Status Output).
SPCSO9	Status bit that can be set by clients like e.g. SCADA (Single Point Controllable Status Output).
SPCSO10	Status bit that can be set by clients like e.g. SCADA (Single Point Controllable Status Output).
SPCSO11	Status bit that can be set by clients like e.g. SCADA (Single Point Controllable Status Output).
SPCSO12	Status bit that can be set by clients like e.g. SCADA (Single Point Controllable Status Output).
SPCSO13	Status bit that can be set by clients like e.g. SCADA (Single Point Controllable Status Output).
SPCSO14	Status bit that can be set by clients like e.g. SCADA (Single Point Controllable Status Output).
SPCSO15	Status bit that can be set by clients like e.g. SCADA (Single Point Controllable Status Output).
SPCSO16	Status bit that can be set by clients like e.g. SCADA (Single Point Controllable Status Output).
SPCSO17	Status bit that can be set by clients like e.g. SCADA (Single Point Controllable Status Output).
SPCSO18	Status bit that can be set by clients like e.g. SCADA (Single Point Controllable Status Output).
SPCSO19	Status bit that can be set by clients like e.g. SCADA (Single Point Controllable Status Output).
SPCSO20	Status bit that can be set by clients like e.g. SCADA (Single Point Controllable Status Output).
SPCSO21	Status bit that can be set by clients like e.g. SCADA (Single Point Controllable Status Output).
SPCSO22	Status bit that can be set by clients like e.g. SCADA (Single Point Controllable Status Output).
SPCSO23	Status bit that can be set by clients like e.g. SCADA (Single Point Controllable Status Output).
SPCSO24	Status bit that can be set by clients like e.g. SCADA (Single Point Controllable Status Output).
SPCSO25	Status bit that can be set by clients like e.g. SCADA (Single Point Controllable Status Output).
SPCSO26	Status bit that can be set by clients like e.g. SCADA (Single Point Controllable Status Output).
SPCSO27	Status bit that can be set by clients like e.g. SCADA (Single Point Controllable Status Output).
SPCSO28	Status bit that can be set by clients like e.g. SCADA (Single Point Controllable Status Output).
SPCSO29	Status bit that can be set by clients like e.g. SCADA (Single Point Controllable Status Output).
SPCSO30	Status bit that can be set by clients like e.g. SCADA (Single Point Controllable Status Output).

<i>Signal</i>	<i>Description</i>
SPCSO31	Status bit that can be set by clients like e.g. SCADA (Single Point Controllable Status Output).
SPCSO32	Status bit that can be set by clients like e.g. SCADA (Single Point Controllable Status Output).

IEC 61850 Module Values

<i>Value</i>	<i>Description</i>	<i>Default</i>	<i>Size</i>	<i>Menu path</i>
NoOfGooseRxAll	Total number of received GOOSE messages including messages for other devices (subscribed and not subscribed messages).	0	0 - 9999999999	[Operation /Count and RevData /IEC61850]
NoOfGooseRxSubscribed	Total Number of subscribed GOOSE messages including messages with incorrect content.	0	0 - 9999999999	[Operation /Count and RevData /IEC61850]
NoOfGooseRxCorrect	Total Number of subscribed and correctly received GOOSE messages.	0	0 - 9999999999	[Operation /Count and RevData /IEC61850]
NoOfGooseRxNew	Number of subscribed and correctly received GOOSE messages with new content.	0	0 - 9999999999	[Operation /Count and RevData /IEC61850]
NoOfGooseTxAll	Total Number of GOOSE messages that have been published by this device.	0	0 - 9999999999	[Operation /Count and RevData /IEC61850]
NoOfGooseTxNew	Total Number of new GOOSE messages (modified content) that have been published by this device.	0	0 - 9999999999	[Operation /Count and RevData /IEC61850]
NoOfServerRequestsAll	Total number of MMS Server requests including incorrect requests.	0	0 - 9999999999	[Operation /Count and RevData /IEC61850]
NoOfDataReadAll	Total Number of values read from this device including incorrect requests.	0	0 - 9999999999	[Operation /Count and RevData /IEC61850]
NoOfDataReadCorrect	Total Number of correctly read values from this device.	0	0 - 9999999999	[Operation /Count and RevData /IEC61850]
NoOfDataWrittenAll	Total Number of values written by this device including incorrect ones.	0	0 - 9999999999	[Operation /Count and RevData /IEC61850]

<i>Value</i>	<i>Description</i>	<i>Default</i>	<i>Size</i>	<i>Menu path</i>
NoOfDataWritten Correct	Total Number of correctly written values by this device.	0	0 - 9999999999	[Operation /Count and RevData /IEC61850]
NoOfDataChange Notification	Number of detected changes within the datasets that are published with GOOSE messages.	0	0 - 9999999999	[Operation /Count and RevData /IEC61850]
No of Client Connections	Number of active MMS client connections	0	0 - 9999999999	[Operation /Count and RevData /IEC61850]

Values of the IEC 61850

<i>Value</i>	<i>Description</i>	<i>Default</i>	<i>Size</i>	<i>Menu path</i>
GoosePublisherState	State of the GOOSE Publisher (on or off)	Off	Off, On, Error	[Operation /Status Display /IEC61850 /State]
GooseSubscriberState	State of the GOOSE Subscriber (on or off)	Off	Off, On, Error	[Operation /Status Display /IEC61850 /State]
MmsServerState	State of MMS Server (on or off)	Off	Off, On, Error	[Operation /Status Display /IEC61850 /State]

DNP3

DNP3

DNP (Distributed Network Protocol) is for data and information exchange between SCADA (Master) and IEDs (Intelligent Electronic Devices). The DNP protocol has been developed in first releases for serial communication. Due to further development of the DNP protocol, it offers now also TCP and UDP communication options via Ethernet.

DNP Device Planning

Depending on the hardware of the protective device up to three DNP communication options are available within the Device Planning.

Call up the device planning menu.

Select (depending on device code) the appropriate SCADA Protocol.

- DNP3 RTU (via serial Port)
- DNP3 TCP (via Ethernet)
- DNP3 UDP (via Ethernet)

DNP Protocol General Settings

NOTICE

Please note that unsolicited reporting is not available for serial communication, if more than one slave is connected to the serial communication (collisions). Do not use in these cases unsolicited reporting for DNP RTU.

Unsolicited reporting is available also for serial communication, if each slave is connected via a separated connection to the Master-System. That means, the master is equipped with a separate serial interface for each slave (multi serial cards).

Call up menu [Device Para/DNP3/Communication].

The Communication (General Settings) Settings have to be set according to the needs of the SCADA (Master) – System.

Self Addressing is available for DNP-TCP. That means that the Master and Slave id are auto-detected.

Point Mapping

NOTICE Please take into account that the designations of inputs and outputs are set from the Masters perspective. This way of choosing the designations is due to a definition in the DNP standard. That means for example that Binary Inputs that can be set within the Device Parameters of the DNP protocol are the “Binary Inputs” of the Master.

Call up menu [Device Para/DNP3/Point Map]. Once the general settings of the DNP protocol are done, the point mapping is to be done as a next step.

- Binary Inputs (States to be send to the master)
- Double Bit Inputs (Breaker states to be send to the master)
- Counters (Counters to be send to the master)
- Analog Inputs (e.g. measured values to be send to the master). Please take into account that floating values have to be transmitted as integers. That means they have to be scaled (multiplied) with a scaling factor in order to bring them into the integer format.

Use Binary outputs in order to control e.g. LEDs or Relays within the protective device (via Logic).

Point Mapping

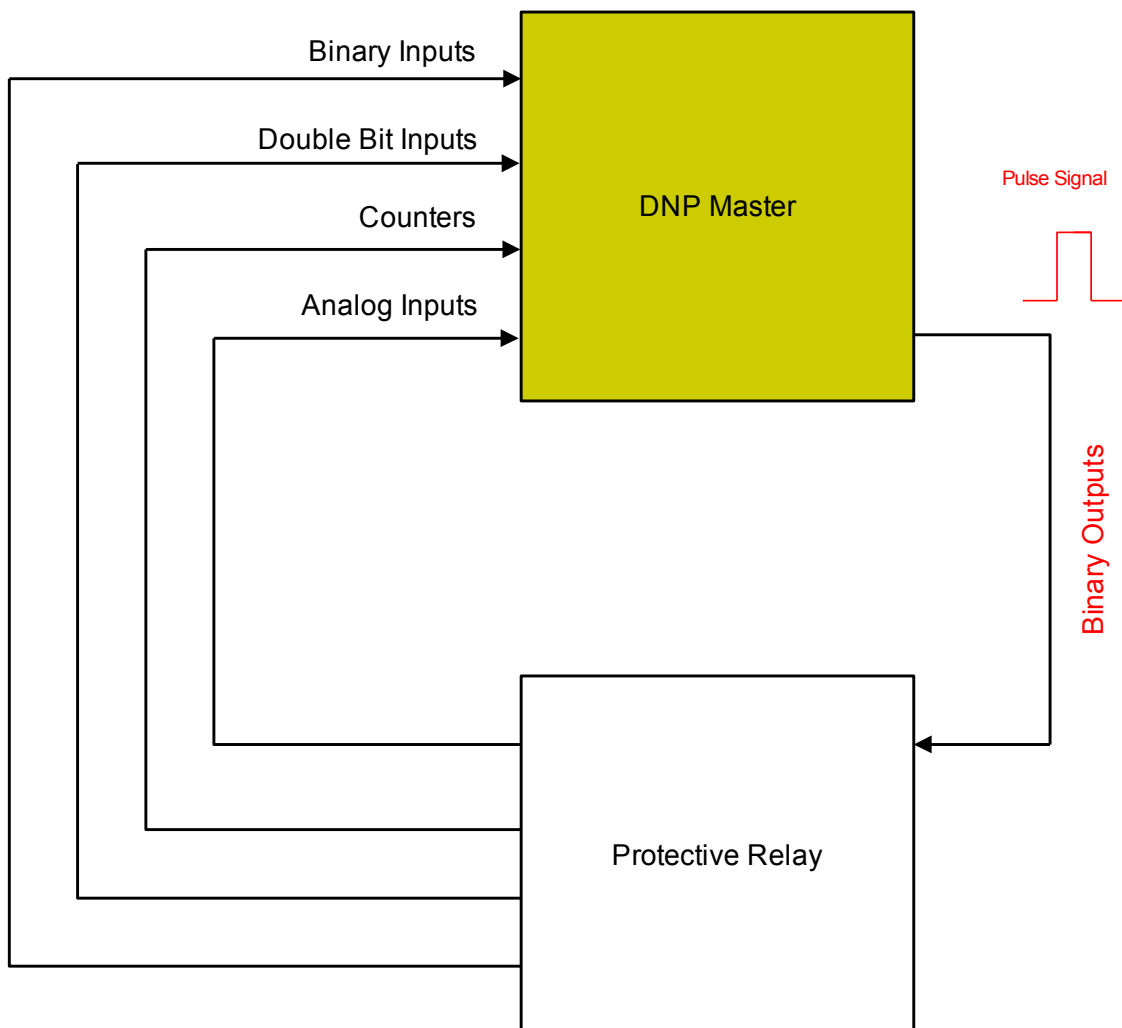

Please try to avoid gaps that will slow down the performance of the DNP communication. That means do not leave unused inputs / outputs in between used inputs / outputs (e.g. Do not use Binary Output 1 and 3 when 2 is unused).

Application Example Setting a Relay:

Binary Output signals of the DNP cannot directly be used in order to switch relays because the DNP Binary Outputs are pulse signals (by DNP definition, not steady state). Steady states can be created by means of Logic functions. The Logic Functions can be assigned onto the Relay Inputs.

Please note: You can use a Set/Reset element (Flip Flop) from Logics.

Logics

Assign Logic Functions onto Relay Inputs

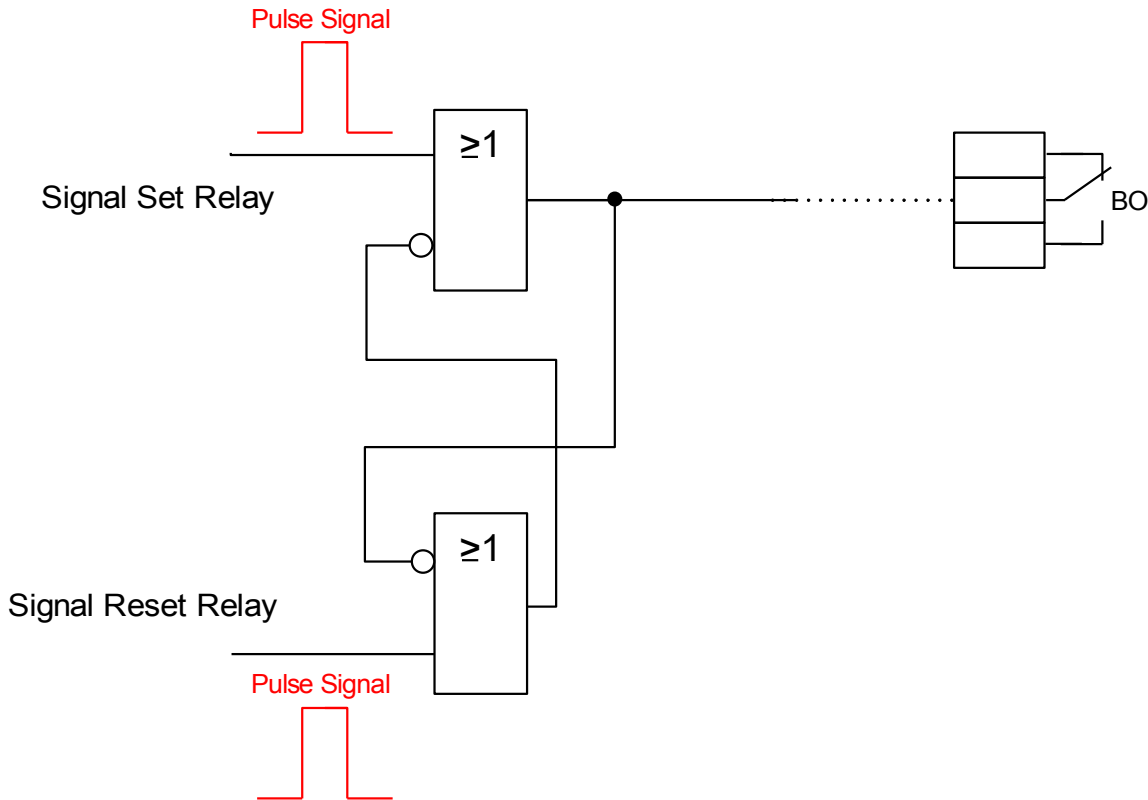





Direct Commands of the DNP

Parameter	Description	Setting range	Default	Menu path
Res all Diag Cr	Reset all diagnosis counters	inactive, active	inactive	[Operation /Reset]
Slave Id	SlaveId defines the DNP3 address of this device (Outstation)	0 - 65519	1	[Device Para /DNP3 / Communication]









Parameter	Description	Setting range	Default	Menu path
 Master Id	MasterId defines the DNP3 address of master (SCADA)	0 - 65519	65500	[Device Para /DNP3 / Communication]









Global Protection Parameters of the DNP









Parameter	Description	Setting range	Default	Menu path
 Function	Permanent activation or deactivation of module/stage.	inactive, active	inactive	[Device Para /DNP3 / Communication]
 IP Port Number	IP Port Number. In general it is recommended to keep the default value. if this is not possible then select a number out of the private range 49152-52151 or 52162-65535 that is not yet in use within your network.	0 - 65535	20000	[Device Para /DNP3 / Communication]
 Baud rate	Baud rate for communication	1200, 2400, 4800, 9600, 19200, 38400, 57600, 115200	19200	[Device Para /DNP3 / Communication]
 Frame Layout	Frame Layout	8E1, 8O1, 8N1, 8N2	8E1	[Device Para /DNP3 / Communication]
 Optical rest position	Optical rest position	Light off, Light on	Light on	[Device Para /DNP3 / Communication]









Parameter	Description	Setting range	Default	Menu path
SelfAddress 	Support of self (automatic) addresses	inactive, active	inactive	[Device Para /DNP3 / Communication]
DataLink confirm 	Enables or disables the data layer confirmation (ack).	Never, Always, On_Large	Never	[Device Para /DNP3 / Communication]
t-DataLink confirm 	Data layer confirmation timeout	0.1 - 10.0s	1s	[Device Para /DNP3 / Communication]
DataLink num retries 	Number of repetition of data link packet sending after failing	0 - 255	3	[Device Para /DNP3 / Communication]
Direction Bit 	Enables Direction Bit functionality. The Direction Bit is 0 for SlaveStation and 1 for MasterStation	inactive, active	inactive	[Device Para /DNP3 / Communication]
Max Frame Size 	This value is used to limit the net Frame Size	64 - 255	255	[Device Para /DNP3 / Communication]
Test Link Period 	This value specifies the time period when to send a Test Link-Frame	0.0 - 120.0s	0s	[Device Para /DNP3 / Communication]
AppLink confirm 	Determines if the device will request that the Application Layer response be confirmed or not	Never, Always, Event	Always	[Device Para /DNP3 / Communication]
t-AppLink confirm 	Application layer response timeout	0.1 - 10.0s	5s	[Device Para /DNP3 / Communication]









Parameter	Description	Setting range	Default	Menu path
AppLink num retries 	The number of times the device will retransmit an Application Layer fragment	0 - 255	0	[Device Para /DNP3 / Communication]
Unsol Reporting 	Enables unsolicited reporting. This is available only for DNP3 TCP connections, and for DNP3 RTU in case of a peer-to-peer connection.	inactive, active	inactive	[Device Para /DNP3 / Communication]
Unsol Reporting Timeout 	Set the amount of time that the outstation will wait for an Application Layer confirmation back from the master indicating that the master received the unsolicited response message.	1.0 - 60.0s	10s	[Device Para /DNP3 / Communication]
Unsol Reporting Retry 	Set the number of retries that an outstation transmits in each unsolicited response series if it does not receive confirmation back from the master.	0 - 255	2	[Device Para /DNP3 / Communication]
TestSeqNo 	Test if sequence number of request is incremented. If it is not correctly incremented the request will be ignored. It is recommended to have it inactive but some older DNP implementations need it activated.	inactive, active	inactive	[Device Para /DNP3 / Communication]
TestSBO 	It enables a stricter comparing of SBO and operate command. For older DNP versions it is recommended to deactivated it.	inactive, active	active	[Device Para /DNP3 / Communication]
Timeout SBO 	DNP Outputs can be controlled in a two stage procedure (SBO: Select Before Operate). These outputs are to be selected first by a select command. After this the bit is reserved for this operate request. When this timer is expired, the bit will be released.	1.0 - 60.0s	30s	[Device Para /DNP3 / Communication]
ColdRestart 	Enables support for Cold Restart function.	inactive, active	inactive	[Device Para /DNP3 / Communication]









Parameter	Description	Setting range	Default	Menu path
Deadband integr time 	Deadband integration time.	0 - 300	1	[Device Para /DNP3 / Communication]
BinaryInput 0 	Virtual Digital Input (DNP). This corresponds to a virtual binary output of the protective device.	1..n, Assignment List	-.-	[Device Para /DNP3 /Point map /Binary Inputs]
BinaryInput 1 	Virtual Digital Input (DNP). This corresponds to a virtual binary output of the protective device.	1..n, Assignment List	-.-	[Device Para /DNP3 /Point map /Binary Inputs]
BinaryInput 2 	Virtual Digital Input (DNP). This corresponds to a virtual binary output of the protective device.	1..n, Assignment List	-.-	[Device Para /DNP3 /Point map /Binary Inputs]
BinaryInput 3 	Virtual Digital Input (DNP). This corresponds to a virtual binary output of the protective device.	1..n, Assignment List	-.-	[Device Para /DNP3 /Point map /Binary Inputs]
BinaryInput 4 	Virtual Digital Input (DNP). This corresponds to a virtual binary output of the protective device.	1..n, Assignment List	-.-	[Device Para /DNP3 /Point map /Binary Inputs]
BinaryInput 5 	Virtual Digital Input (DNP). This corresponds to a virtual binary output of the protective device.	1..n, Assignment List	-.-	[Device Para /DNP3 /Point map /Binary Inputs]
BinaryInput 6 	Virtual Digital Input (DNP). This corresponds to a virtual binary output of the protective device.	1..n, Assignment List	-.-	[Device Para /DNP3 /Point map /Binary Inputs]
BinaryInput 7 	Virtual Digital Input (DNP). This corresponds to a virtual binary output of the protective device.	1..n, Assignment List	-.-	[Device Para /DNP3 /Point map /Binary Inputs]









<i>Parameter</i>	<i>Description</i>	<i>Setting range</i>	<i>Default</i>	<i>Menu path</i>
BinaryInput 8 	Virtual Digital Input (DNP). This corresponds to a virtual binary output of the protective device.	1..n, Assignment List	-.-	[Device Para /DNP3 /Point map /Binary Inputs]
BinaryInput 9 	Virtual Digital Input (DNP). This corresponds to a virtual binary output of the protective device.	1..n, Assignment List	-.-	[Device Para /DNP3 /Point map /Binary Inputs]
BinaryInput 10 	Virtual Digital Input (DNP). This corresponds to a virtual binary output of the protective device.	1..n, Assignment List	-.-	[Device Para /DNP3 /Point map /Binary Inputs]
BinaryInput 11 	Virtual Digital Input (DNP). This corresponds to a virtual binary output of the protective device.	1..n, Assignment List	-.-	[Device Para /DNP3 /Point map /Binary Inputs]
BinaryInput 12 	Virtual Digital Input (DNP). This corresponds to a virtual binary output of the protective device.	1..n, Assignment List	-.-	[Device Para /DNP3 /Point map /Binary Inputs]
BinaryInput 13 	Virtual Digital Input (DNP). This corresponds to a virtual binary output of the protective device.	1..n, Assignment List	-.-	[Device Para /DNP3 /Point map /Binary Inputs]
BinaryInput 14 	Virtual Digital Input (DNP). This corresponds to a virtual binary output of the protective device.	1..n, Assignment List	-.-	[Device Para /DNP3 /Point map /Binary Inputs]
BinaryInput 15 	Virtual Digital Input (DNP). This corresponds to a virtual binary output of the protective device.	1..n, Assignment List	-.-	[Device Para /DNP3 /Point map /Binary Inputs]
BinaryInput 16 	Virtual Digital Input (DNP). This corresponds to a virtual binary output of the protective device.	1..n, Assignment List	-.-	[Device Para /DNP3 /Point map /Binary Inputs]

<i>Parameter</i>	<i>Description</i>	<i>Setting range</i>	<i>Default</i>	<i>Menu path</i>
BinaryInput 17 	Virtual Digital Input (DNP). This corresponds to a virtual binary output of the protective device.	1..n, Assignment List	-.-	[Device Para /DNP3 /Point map /Binary Inputs]
BinaryInput 18 	Virtual Digital Input (DNP). This corresponds to a virtual binary output of the protective device.	1..n, Assignment List	-.-	[Device Para /DNP3 /Point map /Binary Inputs]
BinaryInput 19 	Virtual Digital Input (DNP). This corresponds to a virtual binary output of the protective device.	1..n, Assignment List	-.-	[Device Para /DNP3 /Point map /Binary Inputs]
BinaryInput 20 	Virtual Digital Input (DNP). This corresponds to a virtual binary output of the protective device.	1..n, Assignment List	-.-	[Device Para /DNP3 /Point map /Binary Inputs]
BinaryInput 21 	Virtual Digital Input (DNP). This corresponds to a virtual binary output of the protective device.	1..n, Assignment List	-.-	[Device Para /DNP3 /Point map /Binary Inputs]
BinaryInput 22 	Virtual Digital Input (DNP). This corresponds to a virtual binary output of the protective device.	1..n, Assignment List	-.-	[Device Para /DNP3 /Point map /Binary Inputs]
BinaryInput 23 	Virtual Digital Input (DNP). This corresponds to a virtual binary output of the protective device.	1..n, Assignment List	-.-	[Device Para /DNP3 /Point map /Binary Inputs]
BinaryInput 24 	Virtual Digital Input (DNP). This corresponds to a virtual binary output of the protective device.	1..n, Assignment List	-.-	[Device Para /DNP3 /Point map /Binary Inputs]
BinaryInput 25 	Virtual Digital Input (DNP). This corresponds to a virtual binary output of the protective device.	1..n, Assignment List	-.-	[Device Para /DNP3 /Point map /Binary Inputs]





<i>Parameter</i>	<i>Description</i>	<i>Setting range</i>	<i>Default</i>	<i>Menu path</i>
BinaryInput 26 	Virtual Digital Input (DNP). This corresponds to a virtual binary output of the protective device.	1..n, Assignment List	-.-	[Device Para /DNP3 /Point map /Binary Inputs]
BinaryInput 27 	Virtual Digital Input (DNP). This corresponds to a virtual binary output of the protective device.	1..n, Assignment List	-.-	[Device Para /DNP3 /Point map /Binary Inputs]
BinaryInput 28 	Virtual Digital Input (DNP). This corresponds to a virtual binary output of the protective device.	1..n, Assignment List	-.-	[Device Para /DNP3 /Point map /Binary Inputs]
BinaryInput 29 	Virtual Digital Input (DNP). This corresponds to a virtual binary output of the protective device.	1..n, Assignment List	-.-	[Device Para /DNP3 /Point map /Binary Inputs]
BinaryInput 30 	Virtual Digital Input (DNP). This corresponds to a virtual binary output of the protective device.	1..n, Assignment List	-.-	[Device Para /DNP3 /Point map /Binary Inputs]
BinaryInput 31 	Virtual Digital Input (DNP). This corresponds to a virtual binary output of the protective device.	1..n, Assignment List	-.-	[Device Para /DNP3 /Point map /Binary Inputs]
BinaryInput 32 	Virtual Digital Input (DNP). This corresponds to a virtual binary output of the protective device.	1..n, Assignment List	-.-	[Device Para /DNP3 /Point map /Binary Inputs]
BinaryInput 33 	Virtual Digital Input (DNP). This corresponds to a virtual binary output of the protective device.	1..n, Assignment List	-.-	[Device Para /DNP3 /Point map /Binary Inputs]
BinaryInput 34 	Virtual Digital Input (DNP). This corresponds to a virtual binary output of the protective device.	1..n, Assignment List	-.-	[Device Para /DNP3 /Point map /Binary Inputs]







<i>Parameter</i>	<i>Description</i>	<i>Setting range</i>	<i>Default</i>	<i>Menu path</i>
BinaryInput 35 	Virtual Digital Input (DNP). This corresponds to a virtual binary output of the protective device.	1..n, Assignment List	-.-	[Device Para /DNP3 /Point map /Binary Inputs]
BinaryInput 36 	Virtual Digital Input (DNP). This corresponds to a virtual binary output of the protective device.	1..n, Assignment List	-.-	[Device Para /DNP3 /Point map /Binary Inputs]
BinaryInput 37 	Virtual Digital Input (DNP). This corresponds to a virtual binary output of the protective device.	1..n, Assignment List	-.-	[Device Para /DNP3 /Point map /Binary Inputs]
BinaryInput 38 	Virtual Digital Input (DNP). This corresponds to a virtual binary output of the protective device.	1..n, Assignment List	-.-	[Device Para /DNP3 /Point map /Binary Inputs]
BinaryInput 39 	Virtual Digital Input (DNP). This corresponds to a virtual binary output of the protective device.	1..n, Assignment List	-.-	[Device Para /DNP3 /Point map /Binary Inputs]
BinaryInput 40 	Virtual Digital Input (DNP). This corresponds to a virtual binary output of the protective device.	1..n, Assignment List	-.-	[Device Para /DNP3 /Point map /Binary Inputs]
BinaryInput 41 	Virtual Digital Input (DNP). This corresponds to a virtual binary output of the protective device.	1..n, Assignment List	-.-	[Device Para /DNP3 /Point map /Binary Inputs]
BinaryInput 42 	Virtual Digital Input (DNP). This corresponds to a virtual binary output of the protective device.	1..n, Assignment List	-.-	[Device Para /DNP3 /Point map /Binary Inputs]
BinaryInput 43 	Virtual Digital Input (DNP). This corresponds to a virtual binary output of the protective device.	1..n, Assignment List	-.-	[Device Para /DNP3 /Point map /Binary Inputs]







<i>Parameter</i>	<i>Description</i>	<i>Setting range</i>	<i>Default</i>	<i>Menu path</i>
BinaryInput 44 	Virtual Digital Input (DNP). This corresponds to a virtual binary output of the protective device.	1..n, Assignment List	-.-	[Device Para /DNP3 /Point map /Binary Inputs]
BinaryInput 45 	Virtual Digital Input (DNP). This corresponds to a virtual binary output of the protective device.	1..n, Assignment List	-.-	[Device Para /DNP3 /Point map /Binary Inputs]
BinaryInput 46 	Virtual Digital Input (DNP). This corresponds to a virtual binary output of the protective device.	1..n, Assignment List	-.-	[Device Para /DNP3 /Point map /Binary Inputs]
BinaryInput 47 	Virtual Digital Input (DNP). This corresponds to a virtual binary output of the protective device.	1..n, Assignment List	-.-	[Device Para /DNP3 /Point map /Binary Inputs]
BinaryInput 48 	Virtual Digital Input (DNP). This corresponds to a virtual binary output of the protective device.	1..n, Assignment List	-.-	[Device Para /DNP3 /Point map /Binary Inputs]
BinaryInput 49 	Virtual Digital Input (DNP). This corresponds to a virtual binary output of the protective device.	1..n, Assignment List	-.-	[Device Para /DNP3 /Point map /Binary Inputs]
BinaryInput 50 	Virtual Digital Input (DNP). This corresponds to a virtual binary output of the protective device.	1..n, Assignment List	-.-	[Device Para /DNP3 /Point map /Binary Inputs]
BinaryInput 51 	Virtual Digital Input (DNP). This corresponds to a virtual binary output of the protective device.	1..n, Assignment List	-.-	[Device Para /DNP3 /Point map /Binary Inputs]
BinaryInput 52 	Virtual Digital Input (DNP). This corresponds to a virtual binary output of the protective device.	1..n, Assignment List	-.-	[Device Para /DNP3 /Point map /Binary Inputs]







<i>Parameter</i>	<i>Description</i>	<i>Setting range</i>	<i>Default</i>	<i>Menu path</i>
BinaryInput 53 	Virtual Digital Input (DNP). This corresponds to a virtual binary output of the protective device.	1..n, Assignment List	-.-	[Device Para /DNP3 /Point map /Binary Inputs]
BinaryInput 54 	Virtual Digital Input (DNP). This corresponds to a virtual binary output of the protective device.	1..n, Assignment List	-.-	[Device Para /DNP3 /Point map /Binary Inputs]
BinaryInput 55 	Virtual Digital Input (DNP). This corresponds to a virtual binary output of the protective device.	1..n, Assignment List	-.-	[Device Para /DNP3 /Point map /Binary Inputs]
BinaryInput 56 	Virtual Digital Input (DNP). This corresponds to a virtual binary output of the protective device.	1..n, Assignment List	-.-	[Device Para /DNP3 /Point map /Binary Inputs]
BinaryInput 57 	Virtual Digital Input (DNP). This corresponds to a virtual binary output of the protective device.	1..n, Assignment List	-.-	[Device Para /DNP3 /Point map /Binary Inputs]
BinaryInput 58 	Virtual Digital Input (DNP). This corresponds to a virtual binary output of the protective device.	1..n, Assignment List	-.-	[Device Para /DNP3 /Point map /Binary Inputs]
BinaryInput 59 	Virtual Digital Input (DNP). This corresponds to a virtual binary output of the protective device.	1..n, Assignment List	-.-	[Device Para /DNP3 /Point map /Binary Inputs]
BinaryInput 60 	Virtual Digital Input (DNP). This corresponds to a virtual binary output of the protective device.	1..n, Assignment List	-.-	[Device Para /DNP3 /Point map /Binary Inputs]
BinaryInput 61 	Virtual Digital Input (DNP). This corresponds to a virtual binary output of the protective device.	1..n, Assignment List	-.-	[Device Para /DNP3 /Point map /Binary Inputs]







<i>Parameter</i>	<i>Description</i>	<i>Setting range</i>	<i>Default</i>	<i>Menu path</i>
BinaryInput 62 	Virtual Digital Input (DNP). This corresponds to a virtual binary output of the protective device.	1..n, Assignment List	-.-	[Device Para /DNP3 /Point map /Binary Inputs]
BinaryInput 63 	Virtual Digital Input (DNP). This corresponds to a virtual binary output of the protective device.	1..n, Assignment List	-.-	[Device Para /DNP3 /Point map /Binary Inputs]
DoubleBitInput 0 	Double Bit Digital Input (DNP). This corresponds to a double bit binary output of the protective device.	1..n, Assignment List	-.-	[Device Para /DNP3 /Point map /Double Bit Inputs]
DoubleBitInput 1 	Double Bit Digital Input (DNP). This corresponds to a double bit binary output of the protective device.	1..n, Assignment List	-.-	[Device Para /DNP3 /Point map /Double Bit Inputs]
DoubleBitInput 2 	Double Bit Digital Input (DNP). This corresponds to a double bit binary output of the protective device.	1..n, Assignment List	-.-	[Device Para /DNP3 /Point map /Double Bit Inputs]
DoubleBitInput 3 	Double Bit Digital Input (DNP). This corresponds to a double bit binary output of the protective device.	1..n, Assignment List	-.-	[Device Para /DNP3 /Point map /Double Bit Inputs]
DoubleBitInput 4 	Double Bit Digital Input (DNP). This corresponds to a double bit binary output of the protective device.	1..n, Assignment List	-.-	[Device Para /DNP3 /Point map /Double Bit Inputs]
DoubleBitInput 5 	Double Bit Digital Input (DNP). This corresponds to a double bit binary output of the protective device.	1..n, Assignment List	-.-	[Device Para /DNP3 /Point map /Double Bit Inputs]







<i>Parameter</i>	<i>Description</i>	<i>Setting range</i>	<i>Default</i>	<i>Menu path</i>
BinaryCounter 0 	Counter can be used to report counter values to the DNP master.	1..n, Assignment List	-.-	[Device Para /DNP3 /Point map /BinaryCounter]
BinaryCounter 1 	Counter can be used to report counter values to the DNP master.	1..n, Assignment List	-.-	[Device Para /DNP3 /Point map /BinaryCounter]
BinaryCounter 2 	Counter can be used to report counter values to the DNP master.	1..n, Assignment List	-.-	[Device Para /DNP3 /Point map /BinaryCounter]
BinaryCounter 3 	Counter can be used to report counter values to the DNP master.	1..n, Assignment List	-.-	[Device Para /DNP3 /Point map /BinaryCounter]
BinaryCounter 4 	Counter can be used to report counter values to the DNP master.	1..n, Assignment List	-.-	[Device Para /DNP3 /Point map /BinaryCounter]
BinaryCounter 5 	Counter can be used to report counter values to the DNP master.	1..n, Assignment List	-.-	[Device Para /DNP3 /Point map /BinaryCounter]
BinaryCounter 6 	Counter can be used to report counter values to the DNP master.	1..n, Assignment List	-.-	[Device Para /DNP3 /Point map /BinaryCounter]
BinaryCounter 7 	Counter can be used to report counter values to the DNP master.	1..n, Assignment List	-.-	[Device Para /DNP3 /Point map /BinaryCounter]
Analog value 0 	Analog value can be used to report values to the master (DNP)	1..n, TrendRecList	-.-	[Device Para /DNP3 /Point map /Analog Input]







Parameter	Description	Setting range	Default	Menu path
Scale Factor 0 	The scale factor is used to convert the measured value in an integer format	0.001, 0.01, 0.1, 1, 10, 100, 1000, 10000, 100000, 1000000	1	[Device Para /DNP3 /Point map /Analog Input]
Dead Band 0 	If a change of measured value is greater than the deadband value it will be reported to the master.	0.01 - 100.00%	1%	[Device Para /DNP3 /Point map /Analog Input]
Analog value 1 	Analog value can be used to report values to the master (DNP)	1..n, TrendRecList	.-	[Device Para /DNP3 /Point map /Analog Input]
Scale Factor 1 	The scale factor is used to convert the measured value in an integer format	0.001, 0.01, 0.1, 1, 10, 100, 1000, 10000, 100000, 1000000	1	[Device Para /DNP3 /Point map /Analog Input]
Dead Band 1 	If a change of measured value is greater than the deadband value it will be reported to the master.	0.01 - 100.00%	1%	[Device Para /DNP3 /Point map /Analog Input]
Analog value 2 	Analog value can be used to report values to the master (DNP)	1..n, TrendRecList	.-	[Device Para /DNP3 /Point map /Analog Input]







Parameter	Description	Setting range	Default	Menu path
Scale Factor 2 	The scale factor is used to convert the measured value in an integer format	0.001, 0.01, 0.1, 1, 10, 100, 1000, 10000, 100000, 1000000	1	[Device Para /DNP3 /Point map /Analog Input]
Dead Band 2 	If a change of measured value is greater than the deadband value it will be reported to the master.	0.01 - 100.00%	1%	[Device Para /DNP3 /Point map /Analog Input]
Analog value 3 	Analog value can be used to report values to the master (DNP)	1..n, TrendRecList	.-	[Device Para /DNP3 /Point map /Analog Input]
Scale Factor 3 	The scale factor is used to convert the measured value in an integer format	0.001, 0.01, 0.1, 1, 10, 100, 1000, 10000, 100000, 1000000	1	[Device Para /DNP3 /Point map /Analog Input]
Dead Band 3 	If a change of measured value is greater than the deadband value it will be reported to the master.	0.01 - 100.00%	1%	[Device Para /DNP3 /Point map /Analog Input]
Analog value 4 	Analog value can be used to report values to the master (DNP)	1..n, TrendRecList	.-	[Device Para /DNP3 /Point map /Analog Input]







Parameter	Description	Setting range	Default	Menu path
Scale Factor 4 	The scale factor is used to convert the measured value in an integer format	0.001, 0.01, 0.1, 1, 10, 100, 1000, 10000, 100000, 1000000	1	[Device Para /DNP3 /Point map /Analog Input]
Dead Band 4 	If a change of measured value is greater than the deadband value it will be reported to the master.	0.01 - 100.00%	1%	[Device Para /DNP3 /Point map /Analog Input]
Analog value 5 	Analog value can be used to report values to the master (DNP)	1..n, TrendRecList	-.-	[Device Para /DNP3 /Point map /Analog Input]
Scale Factor 5 	The scale factor is used to convert the measured value in an integer format	0.001, 0.01, 0.1, 1, 10, 100, 1000, 10000, 100000, 1000000	1	[Device Para /DNP3 /Point map /Analog Input]
Dead Band 5 	If a change of measured value is greater than the deadband value it will be reported to the master.	0.01 - 100.00%	1%	[Device Para /DNP3 /Point map /Analog Input]
Analog value 6 	Analog value can be used to report values to the master (DNP)	1..n, TrendRecList	-.-	[Device Para /DNP3 /Point map /Analog Input]







Parameter	Description	Setting range	Default	Menu path
Scale Factor 6 	The scale factor is used to convert the measured value in an integer format	0.001, 0.01, 0.1, 1, 10, 100, 1000, 10000, 100000, 1000000	1	[Device Para /DNP3 /Point map /Analog Input]
Dead Band 6 	If a change of measured value is greater than the deadband value it will be reported to the master.	0.01 - 100.00%	1%	[Device Para /DNP3 /Point map /Analog Input]
Analog value 7 	Analog value can be used to report values to the master (DNP)	1..n, TrendRecList	-.-	[Device Para /DNP3 /Point map /Analog Input]
Scale Factor 7 	The scale factor is used to convert the measured value in an integer format	0.001, 0.01, 0.1, 1, 10, 100, 1000, 10000, 100000, 1000000	1	[Device Para /DNP3 /Point map /Analog Input]
Dead Band 7 	If a change of measured value is greater than the deadband value it will be reported to the master.	0.01 - 100.00%	1%	[Device Para /DNP3 /Point map /Analog Input]
Analog value 8 	Analog value can be used to report values to the master (DNP)	1..n, TrendRecList	-.-	[Device Para /DNP3 /Point map /Analog Input]







Parameter	Description	Setting range	Default	Menu path
Scale Factor 8 	The scale factor is used to convert the measured value in an integer format	0.001, 0.01, 0.1, 1, 10, 100, 1000, 10000, 100000, 1000000	1	[Device Para /DNP3 /Point map /Analog Input]
Dead Band 8 	If a change of measured value is greater than the deadband value it will be reported to the master.	0.01 - 100.00%	1%	[Device Para /DNP3 /Point map /Analog Input]
Analog value 9 	Analog value can be used to report values to the master (DNP)	1..n, TrendRecList	.-	[Device Para /DNP3 /Point map /Analog Input]
Scale Factor 9 	The scale factor is used to convert the measured value in an integer format	0.001, 0.01, 0.1, 1, 10, 100, 1000, 10000, 100000, 1000000	1	[Device Para /DNP3 /Point map /Analog Input]
Dead Band 9 	If a change of measured value is greater than the deadband value it will be reported to the master.	0.01 - 100.00%	1%	[Device Para /DNP3 /Point map /Analog Input]
Analog value 10 	Analog value can be used to report values to the master (DNP)	1..n, TrendRecList	.-	[Device Para /DNP3 /Point map /Analog Input]







Parameter	Description	Setting range	Default	Menu path
Scale Factor 10 	The scale factor is used to convert the measured value in an integer format	0.001, 0.01, 0.1, 1, 10, 100, 1000, 10000, 100000, 1000000	1	[Device Para /DNP3 /Point map /Analog Input]
Dead Band 10 	If a change of measured value is greater than the deadband value it will be reported to the master.	0.01 - 100.00%	1%	[Device Para /DNP3 /Point map /Analog Input]
Analog value 11 	Analog value can be used to report values to the master (DNP)	1..n, TrendRecList	.-	[Device Para /DNP3 /Point map /Analog Input]
Scale Factor 11 	The scale factor is used to convert the measured value in an integer format	0.001, 0.01, 0.1, 1, 10, 100, 1000, 10000, 100000, 1000000	1	[Device Para /DNP3 /Point map /Analog Input]
Dead Band 11 	If a change of measured value is greater than the deadband value it will be reported to the master.	0.01 - 100.00%	1%	[Device Para /DNP3 /Point map /Analog Input]
Analog value 12 	Analog value can be used to report values to the master (DNP)	1..n, TrendRecList	.-	[Device Para /DNP3 /Point map /Analog Input]







Parameter	Description	Setting range	Default	Menu path
Scale Factor 12 	The scale factor is used to convert the measured value in an integer format	0.001, 0.01, 0.1, 1, 10, 100, 1000, 10000, 100000, 1000000	1	[Device Para /DNP3 /Point map /Analog Input]
Dead Band 12 	If a change of measured value is greater than the deadband value it will be reported to the master.	0.01 - 100.00%	1%	[Device Para /DNP3 /Point map /Analog Input]
Analog value 13 	Analog value can be used to report values to the master (DNP)	1..n, TrendRecList	.-	[Device Para /DNP3 /Point map /Analog Input]
Scale Factor 13 	The scale factor is used to convert the measured value in an integer format	0.001, 0.01, 0.1, 1, 10, 100, 1000, 10000, 100000, 1000000	1	[Device Para /DNP3 /Point map /Analog Input]
Dead Band 13 	If a change of measured value is greater than the deadband value it will be reported to the master.	0.01 - 100.00%	1%	[Device Para /DNP3 /Point map /Analog Input]
Analog value 14 	Analog value can be used to report values to the master (DNP)	1..n, TrendRecList	.-	[Device Para /DNP3 /Point map /Analog Input]







Parameter	Description	Setting range	Default	Menu path
Scale Factor 14 	The scale factor is used to convert the measured value in an integer format	0.001, 0.01, 0.1, 1, 10, 100, 1000, 10000, 100000, 1000000	1	[Device Para /DNP3 /Point map /Analog Input]
Dead Band 14 	If a change of measured value is greater than the deadband value it will be reported to the master.	0.01 - 100.00%	1%	[Device Para /DNP3 /Point map /Analog Input]
Analog value 15 	Analog value can be used to report values to the master (DNP)	1..n, TrendRecList	.-	[Device Para /DNP3 /Point map /Analog Input]
Scale Factor 15 	The scale factor is used to convert the measured value in an integer format	0.001, 0.01, 0.1, 1, 10, 100, 1000, 10000, 100000, 1000000	1	[Device Para /DNP3 /Point map /Analog Input]
Dead Band 15 	If a change of measured value is greater than the deadband value it will be reported to the master.	0.01 - 100.00%	1%	[Device Para /DNP3 /Point map /Analog Input]
Analog value 16 	Analog value can be used to report values to the master (DNP)	1..n, TrendRecList	.-	[Device Para /DNP3 /Point map /Analog Input]







Parameter	Description	Setting range	Default	Menu path
 Scale Factor 16	The scale factor is used to convert the measured value in an integer format	0.001, 0.01, 0.1, 1, 10, 100, 1000, 10000, 100000, 1000000	1	[Device Para /DNP3 /Point map /Analog Input]
 Dead Band 16	If a change of measured value is greater than the deadband value it will be reported to the master.	0.01 - 100.00%	1%	[Device Para /DNP3 /Point map /Analog Input]
 Analog value 17	Analog value can be used to report values to the master (DNP)	1..n, TrendRecList	.-	[Device Para /DNP3 /Point map /Analog Input]
 Scale Factor 17	The scale factor is used to convert the measured value in an integer format	0.001, 0.01, 0.1, 1, 10, 100, 1000, 10000, 100000, 1000000	1	[Device Para /DNP3 /Point map /Analog Input]
 Dead Band 17	If a change of measured value is greater than the deadband value it will be reported to the master.	0.01 - 100.00%	1%	[Device Para /DNP3 /Point map /Analog Input]
 Analog value 18	Analog value can be used to report values to the master (DNP)	1..n, TrendRecList	.-	[Device Para /DNP3 /Point map /Analog Input]







Parameter	Description	Setting range	Default	Menu path
Scale Factor 18 	The scale factor is used to convert the measured value in an integer format	0.001, 0.01, 0.1, 1, 10, 100, 1000, 10000, 100000, 1000000	1	[Device Para /DNP3 /Point map /Analog Input]
Dead Band 18 	If a change of measured value is greater than the deadband value it will be reported to the master.	0.01 - 100.00%	1%	[Device Para /DNP3 /Point map /Analog Input]
Analog value 19 	Analog value can be used to report values to the master (DNP)	1..n, TrendRecList	-.-	[Device Para /DNP3 /Point map /Analog Input]
Scale Factor 19 	The scale factor is used to convert the measured value in an integer format	0.001, 0.01, 0.1, 1, 10, 100, 1000, 10000, 100000, 1000000	1	[Device Para /DNP3 /Point map /Analog Input]
Dead Band 19 	If a change of measured value is greater than the deadband value it will be reported to the master.	0.01 - 100.00%	1%	[Device Para /DNP3 /Point map /Analog Input]
Analog value 20 	Analog value can be used to report values to the master (DNP)	1..n, TrendRecList	-.-	[Device Para /DNP3 /Point map /Analog Input]





Parameter	Description	Setting range	Default	Menu path
 Scale Factor 20	The scale factor is used to convert the measured value in an integer format	0.001, 0.01, 0.1, 1, 10, 100, 1000, 10000, 100000, 1000000	1	[Device Para /DNP3 /Point map /Analog Input]
 Dead Band 20	If a change of measured value is greater than the deadband value it will be reported to the master.	0.01 - 100.00%	1%	[Device Para /DNP3 /Point map /Analog Input]
 Analog value 21	Analog value can be used to report values to the master (DNP)	1..n, TrendRecList	.-	[Device Para /DNP3 /Point map /Analog Input]
 Scale Factor 21	The scale factor is used to convert the measured value in an integer format	0.001, 0.01, 0.1, 1, 10, 100, 1000, 10000, 100000, 1000000	1	[Device Para /DNP3 /Point map /Analog Input]
 Dead Band 21	If a change of measured value is greater than the deadband value it will be reported to the master.	0.01 - 100.00%	1%	[Device Para /DNP3 /Point map /Analog Input]
 Analog value 22	Analog value can be used to report values to the master (DNP)	1..n, TrendRecList	.-	[Device Para /DNP3 /Point map /Analog Input]

Parameter	Description	Setting range	Default	Menu path
 Scale Factor 22	The scale factor is used to convert the measured value in an integer format	0.001, 0.01, 0.1, 1, 10, 100, 1000, 10000, 100000, 1000000	1	[Device Para /DNP3 /Point map /Analog Input]
 Dead Band 22	If a change of measured value is greater than the deadband value it will be reported to the master.	0.01 - 100.00%	1%	[Device Para /DNP3 /Point map /Analog Input]
 Analog value 23	Analog value can be used to report values to the master (DNP)	1..n, TrendRecList	.-	[Device Para /DNP3 /Point map /Analog Input]
 Scale Factor 23	The scale factor is used to convert the measured value in an integer format	0.001, 0.01, 0.1, 1, 10, 100, 1000, 10000, 100000, 1000000	1	[Device Para /DNP3 /Point map /Analog Input]
 Dead Band 23	If a change of measured value is greater than the deadband value it will be reported to the master.	0.01 - 100.00%	1%	[Device Para /DNP3 /Point map /Analog Input]
 Analog value 24	Analog value can be used to report values to the master (DNP)	1..n, TrendRecList	.-	[Device Para /DNP3 /Point map /Analog Input]

Parameter	Description	Setting range	Default	Menu path
Scale Factor 24 	The scale factor is used to convert the measured value in an integer format	0.001, 0.01, 0.1, 1, 10, 100, 1000, 10000, 100000, 1000000	1	[Device Para /DNP3 /Point map /Analog Input]
Dead Band 24 	If a change of measured value is greater than the deadband value it will be reported to the master.	0.01 - 100.00%	1%	[Device Para /DNP3 /Point map /Analog Input]
Analog value 25 	Analog value can be used to report values to the master (DNP)	1..n, TrendRecList	.-	[Device Para /DNP3 /Point map /Analog Input]
Scale Factor 25 	The scale factor is used to convert the measured value in an integer format	0.001, 0.01, 0.1, 1, 10, 100, 1000, 10000, 100000, 1000000	1	[Device Para /DNP3 /Point map /Analog Input]
Dead Band 25 	If a change of measured value is greater than the deadband value it will be reported to the master.	0.01 - 100.00%	1%	[Device Para /DNP3 /Point map /Analog Input]
Analog value 26 	Analog value can be used to report values to the master (DNP)	1..n, TrendRecList	.-	[Device Para /DNP3 /Point map /Analog Input]

Parameter	Description	Setting range	Default	Menu path
Scale Factor 26 	The scale factor is used to convert the measured value in an integer format	0.001, 0.01, 0.1, 1, 10, 100, 1000, 10000, 100000, 1000000	1	[Device Para /DNP3 /Point map /Analog Input]
Dead Band 26 	If a change of measured value is greater than the deadband value it will be reported to the master.	0.01 - 100.00%	1%	[Device Para /DNP3 /Point map /Analog Input]
Analog value 27 	Analog value can be used to report values to the master (DNP)	1..n, TrendRecList	.-	[Device Para /DNP3 /Point map /Analog Input]
Scale Factor 27 	The scale factor is used to convert the measured value in an integer format	0.001, 0.01, 0.1, 1, 10, 100, 1000, 10000, 100000, 1000000	1	[Device Para /DNP3 /Point map /Analog Input]
Dead Band 27 	If a change of measured value is greater than the deadband value it will be reported to the master.	0.01 - 100.00%	1%	[Device Para /DNP3 /Point map /Analog Input]
Analog value 28 	Analog value can be used to report values to the master (DNP)	1..n, TrendRecList	.-	[Device Para /DNP3 /Point map /Analog Input]

Parameter	Description	Setting range	Default	Menu path
 Scale Factor 28	The scale factor is used to convert the measured value in an integer format	0.001, 0.01, 0.1, 1, 10, 100, 1000, 10000, 100000, 1000000	1	[Device Para /DNP3 /Point map /Analog Input]
 Dead Band 28	If a change of measured value is greater than the deadband value it will be reported to the master.	0.01 - 100.00%	1%	[Device Para /DNP3 /Point map /Analog Input]
 Analog value 29	Analog value can be used to report values to the master (DNP)	1..n, TrendRecList	-.-	[Device Para /DNP3 /Point map /Analog Input]
 Scale Factor 29	The scale factor is used to convert the measured value in an integer format	0.001, 0.01, 0.1, 1, 10, 100, 1000, 10000, 100000, 1000000	1	[Device Para /DNP3 /Point map /Analog Input]
 Dead Band 29	If a change of measured value is greater than the deadband value it will be reported to the master.	0.01 - 100.00%	1%	[Device Para /DNP3 /Point map /Analog Input]
 Analog value 30	Analog value can be used to report values to the master (DNP)	1..n, TrendRecList	-.-	[Device Para /DNP3 /Point map /Analog Input]

Parameter	Description	Setting range	Default	Menu path
Scale Factor 30 	The scale factor is used to convert the measured value in an integer format	0.001, 0.01, 0.1, 1, 10, 100, 1000, 10000, 100000, 1000000	1	[Device Para /DNP3 /Point map /Analog Input]
Dead Band 30 	If a change of measured value is greater than the deadband value it will be reported to the master.	0.01 - 100.00%	1%	[Device Para /DNP3 /Point map /Analog Input]
Analog value 31 	Analog value can be used to report values to the master (DNP)	1..n, TrendRecList	.-	[Device Para /DNP3 /Point map /Analog Input]
Scale Factor 31 	The scale factor is used to convert the measured value in an integer format	0.001, 0.01, 0.1, 1, 10, 100, 1000, 10000, 100000, 1000000	1	[Device Para /DNP3 /Point map /Analog Input]
Dead Band 31 	If a change of measured value is greater than the deadband value it will be reported to the master.	0.01 - 100.00%	1%	[Device Para /DNP3 /Point map /Analog Input]

Inputs of the DNP

Name	Description	Assignment via
BinaryInput0-I	Virtual Digital Input (DNP). This corresponds to a virtual binary output of the protective device.	[Device Para /DNP3 /Point map /Binary Inputs]
BinaryInput1-I	Virtual Digital Input (DNP). This corresponds to a virtual binary output of the protective device.	[Device Para /DNP3 /Point map /Binary Inputs]
BinaryInput2-I	Virtual Digital Input (DNP). This corresponds to a virtual binary output of the protective device.	[Device Para /DNP3 /Point map /Binary Inputs]
BinaryInput3-I	Virtual Digital Input (DNP). This corresponds to a virtual binary output of the protective device.	[Device Para /DNP3 /Point map /Binary Inputs]
BinaryInput4-I	Virtual Digital Input (DNP). This corresponds to a virtual binary output of the protective device.	[Device Para /DNP3 /Point map /Binary Inputs]
BinaryInput5-I	Virtual Digital Input (DNP). This corresponds to a virtual binary output of the protective device.	[Device Para /DNP3 /Point map /Binary Inputs]
BinaryInput6-I	Virtual Digital Input (DNP). This corresponds to a virtual binary output of the protective device.	[Device Para /DNP3 /Point map /Binary Inputs]
BinaryInput7-I	Virtual Digital Input (DNP). This corresponds to a virtual binary output of the protective device.	[Device Para /DNP3 /Point map /Binary Inputs]
BinaryInput8-I	Virtual Digital Input (DNP). This corresponds to a virtual binary output of the protective device.	[Device Para /DNP3 /Point map /Binary Inputs]

Name	Description	Assignment via
BinaryInput9-I	Virtual Digital Input (DNP). This corresponds to a virtual binary output of the protective device.	[Device Para /DNP3 /Point map /Binary Inputs]
BinaryInput10-I	Virtual Digital Input (DNP). This corresponds to a virtual binary output of the protective device.	[Device Para /DNP3 /Point map /Binary Inputs]
BinaryInput11-I	Virtual Digital Input (DNP). This corresponds to a virtual binary output of the protective device.	[Device Para /DNP3 /Point map /Binary Inputs]
BinaryInput12-I	Virtual Digital Input (DNP). This corresponds to a virtual binary output of the protective device.	[Device Para /DNP3 /Point map /Binary Inputs]
BinaryInput13-I	Virtual Digital Input (DNP). This corresponds to a virtual binary output of the protective device.	[Device Para /DNP3 /Point map /Binary Inputs]
BinaryInput14-I	Virtual Digital Input (DNP). This corresponds to a virtual binary output of the protective device.	[Device Para /DNP3 /Point map /Binary Inputs]
BinaryInput15-I	Virtual Digital Input (DNP). This corresponds to a virtual binary output of the protective device.	[Device Para /DNP3 /Point map /Binary Inputs]
BinaryInput16-I	Virtual Digital Input (DNP). This corresponds to a virtual binary output of the protective device.	[Device Para /DNP3 /Point map /Binary Inputs]
BinaryInput17-I	Virtual Digital Input (DNP). This corresponds to a virtual binary output of the protective device.	[Device Para /DNP3 /Point map /Binary Inputs]

<i>Name</i>	<i>Description</i>	<i>Assignment via</i>
BinaryInput18-I	Virtual Digital Input (DNP). This corresponds to a virtual binary output of the protective device.	[Device Para /DNP3 /Point map /Binary Inputs]
BinaryInput19-I	Virtual Digital Input (DNP). This corresponds to a virtual binary output of the protective device.	[Device Para /DNP3 /Point map /Binary Inputs]
BinaryInput20-I	Virtual Digital Input (DNP). This corresponds to a virtual binary output of the protective device.	[Device Para /DNP3 /Point map /Binary Inputs]
BinaryInput21-I	Virtual Digital Input (DNP). This corresponds to a virtual binary output of the protective device.	[Device Para /DNP3 /Point map /Binary Inputs]
BinaryInput22-I	Virtual Digital Input (DNP). This corresponds to a virtual binary output of the protective device.	[Device Para /DNP3 /Point map /Binary Inputs]
BinaryInput23-I	Virtual Digital Input (DNP). This corresponds to a virtual binary output of the protective device.	[Device Para /DNP3 /Point map /Binary Inputs]
BinaryInput24-I	Virtual Digital Input (DNP). This corresponds to a virtual binary output of the protective device.	[Device Para /DNP3 /Point map /Binary Inputs]
BinaryInput25-I	Virtual Digital Input (DNP). This corresponds to a virtual binary output of the protective device.	[Device Para /DNP3 /Point map /Binary Inputs]
BinaryInput26-I	Virtual Digital Input (DNP). This corresponds to a virtual binary output of the protective device.	[Device Para /DNP3 /Point map /Binary Inputs]

Name	Description	Assignment via
BinaryInput27-I	Virtual Digital Input (DNP). This corresponds to a virtual binary output of the protective device.	[Device Para /DNP3 /Point map /Binary Inputs]
BinaryInput28-I	Virtual Digital Input (DNP). This corresponds to a virtual binary output of the protective device.	[Device Para /DNP3 /Point map /Binary Inputs]
BinaryInput29-I	Virtual Digital Input (DNP). This corresponds to a virtual binary output of the protective device.	[Device Para /DNP3 /Point map /Binary Inputs]
BinaryInput30-I	Virtual Digital Input (DNP). This corresponds to a virtual binary output of the protective device.	[Device Para /DNP3 /Point map /Binary Inputs]
BinaryInput31-I	Virtual Digital Input (DNP). This corresponds to a virtual binary output of the protective device.	[Device Para /DNP3 /Point map /Binary Inputs]
BinaryInput32-I	Virtual Digital Input (DNP). This corresponds to a virtual binary output of the protective device.	[Device Para /DNP3 /Point map /Binary Inputs]
BinaryInput33-I	Virtual Digital Input (DNP). This corresponds to a virtual binary output of the protective device.	[Device Para /DNP3 /Point map /Binary Inputs]
BinaryInput34-I	Virtual Digital Input (DNP). This corresponds to a virtual binary output of the protective device.	[Device Para /DNP3 /Point map /Binary Inputs]
BinaryInput35-I	Virtual Digital Input (DNP). This corresponds to a virtual binary output of the protective device.	[Device Para /DNP3 /Point map /Binary Inputs]

Name	Description	Assignment via
BinaryInput36-I	Virtual Digital Input (DNP). This corresponds to a virtual binary output of the protective device.	[Device Para /DNP3 /Point map /Binary Inputs]
BinaryInput37-I	Virtual Digital Input (DNP). This corresponds to a virtual binary output of the protective device.	[Device Para /DNP3 /Point map /Binary Inputs]
BinaryInput38-I	Virtual Digital Input (DNP). This corresponds to a virtual binary output of the protective device.	[Device Para /DNP3 /Point map /Binary Inputs]
BinaryInput39-I	Virtual Digital Input (DNP). This corresponds to a virtual binary output of the protective device.	[Device Para /DNP3 /Point map /Binary Inputs]
BinaryInput40-I	Virtual Digital Input (DNP). This corresponds to a virtual binary output of the protective device.	[Device Para /DNP3 /Point map /Binary Inputs]
BinaryInput41-I	Virtual Digital Input (DNP). This corresponds to a virtual binary output of the protective device.	[Device Para /DNP3 /Point map /Binary Inputs]
BinaryInput42-I	Virtual Digital Input (DNP). This corresponds to a virtual binary output of the protective device.	[Device Para /DNP3 /Point map /Binary Inputs]
BinaryInput43-I	Virtual Digital Input (DNP). This corresponds to a virtual binary output of the protective device.	[Device Para /DNP3 /Point map /Binary Inputs]
BinaryInput44-I	Virtual Digital Input (DNP). This corresponds to a virtual binary output of the protective device.	[Device Para /DNP3 /Point map /Binary Inputs]

Name	Description	Assignment via
BinaryInput45-I	Virtual Digital Input (DNP). This corresponds to a virtual binary output of the protective device.	[Device Para /DNP3 /Point map /Binary Inputs]
BinaryInput46-I	Virtual Digital Input (DNP). This corresponds to a virtual binary output of the protective device.	[Device Para /DNP3 /Point map /Binary Inputs]
BinaryInput47-I	Virtual Digital Input (DNP). This corresponds to a virtual binary output of the protective device.	[Device Para /DNP3 /Point map /Binary Inputs]
BinaryInput48-I	Virtual Digital Input (DNP). This corresponds to a virtual binary output of the protective device.	[Device Para /DNP3 /Point map /Binary Inputs]
BinaryInput49-I	Virtual Digital Input (DNP). This corresponds to a virtual binary output of the protective device.	[Device Para /DNP3 /Point map /Binary Inputs]
BinaryInput50-I	Virtual Digital Input (DNP). This corresponds to a virtual binary output of the protective device.	[Device Para /DNP3 /Point map /Binary Inputs]
BinaryInput51-I	Virtual Digital Input (DNP). This corresponds to a virtual binary output of the protective device.	[Device Para /DNP3 /Point map /Binary Inputs]
BinaryInput52-I	Virtual Digital Input (DNP). This corresponds to a virtual binary output of the protective device.	[Device Para /DNP3 /Point map /Binary Inputs]
BinaryInput53-I	Virtual Digital Input (DNP). This corresponds to a virtual binary output of the protective device.	[Device Para /DNP3 /Point map /Binary Inputs]

Name	Description	Assignment via
BinaryInput54-I	Virtual Digital Input (DNP). This corresponds to a virtual binary output of the protective device.	[Device Para /DNP3 /Point map /Binary Inputs]
BinaryInput55-I	Virtual Digital Input (DNP). This corresponds to a virtual binary output of the protective device.	[Device Para /DNP3 /Point map /Binary Inputs]
BinaryInput56-I	Virtual Digital Input (DNP). This corresponds to a virtual binary output of the protective device.	[Device Para /DNP3 /Point map /Binary Inputs]
BinaryInput57-I	Virtual Digital Input (DNP). This corresponds to a virtual binary output of the protective device.	[Device Para /DNP3 /Point map /Binary Inputs]
BinaryInput58-I	Virtual Digital Input (DNP). This corresponds to a virtual binary output of the protective device.	[Device Para /DNP3 /Point map /Binary Inputs]
BinaryInput59-I	Virtual Digital Input (DNP). This corresponds to a virtual binary output of the protective device.	[Device Para /DNP3 /Point map /Binary Inputs]
BinaryInput60-I	Virtual Digital Input (DNP). This corresponds to a virtual binary output of the protective device.	[Device Para /DNP3 /Point map /Binary Inputs]
BinaryInput61-I	Virtual Digital Input (DNP). This corresponds to a virtual binary output of the protective device.	[Device Para /DNP3 /Point map /Binary Inputs]
BinaryInput62-I	Virtual Digital Input (DNP). This corresponds to a virtual binary output of the protective device.	[Device Para /DNP3 /Point map /Binary Inputs]

<i>Name</i>	<i>Description</i>	<i>Assignment via</i>
BinaryInput63-I	Virtual Digital Input (DNP). This corresponds to a virtual binary output of the protective device.	[Device Para /DNP3 /Point map /Binary Inputs]
DoubleBitInput0-I	Double Bit Digital Input (DNP). This corresponds to a double bit binary output of the protective device.	[Device Para /DNP3 /Point map /Double Bit Inputs]
DoubleBitInput1-I	Double Bit Digital Input (DNP). This corresponds to a double bit binary output of the protective device.	[Device Para /DNP3 /Point map /Double Bit Inputs]
DoubleBitInput2-I	Double Bit Digital Input (DNP). This corresponds to a double bit binary output of the protective device.	[Device Para /DNP3 /Point map /Double Bit Inputs]
DoubleBitInput3-I	Double Bit Digital Input (DNP). This corresponds to a double bit binary output of the protective device.	[Device Para /DNP3 /Point map /Double Bit Inputs]
DoubleBitInput4-I	Double Bit Digital Input (DNP). This corresponds to a double bit binary output of the protective device.	[Device Para /DNP3 /Point map /Double Bit Inputs]
DoubleBitInput5-I	Double Bit Digital Input (DNP). This corresponds to a double bit binary output of the protective device.	[Device Para /DNP3 /Point map /Double Bit Inputs]

Options of the DNP

<i>Name</i>	<i>Description</i>
.-	No assignment
Prot.FaultNo	Fault number
Prot.No of GridFaults	Number of grid faults: A grid fault, e.g. a short circuit, might cause several faults with trip and autoreclosing, each fault being identified by an increased fault number. In this case, the grid fault number remains the same.
Generator.Gen Op Hours	Generator running hours
SG[1].TripCmd Cr	Counter: Total number of trips of the switchgear (circuit breaker, load break switch...). Resettable with Total or All.

<i>Name</i>	<i>Description</i>
SG[2].TripCmd Cr	Counter: Total number of trips of the switchgear (circuit breaker, load break switch...). Resettable with Total or All.
SG[3].TripCmd Cr	Counter: Total number of trips of the switchgear (circuit breaker, load break switch...). Resettable with Total or All.
SG[4].TripCmd Cr	Counter: Total number of trips of the switchgear (circuit breaker, load break switch...). Resettable with Total or All.
SG[5].TripCmd Cr	Counter: Total number of trips of the switchgear (circuit breaker, load break switch...). Resettable with Total or All.
SG[6].TripCmd Cr	Counter: Total number of trips of the switchgear (circuit breaker, load break switch...). Resettable with Total or All.
LVRT[1].NumOf Vdips in t-LVRT	Number of Voltage dips during t-LVRT
LVRT[1].Cr Tot Numb of Vdips	Counter Total number of voltage dips.
LVRT[1].Cr Tot Numb of Vdips to Trip	Counter Total number of voltage dips that caused a Trip.
LVRT[2].NumOf Vdips in t-LVRT	Number of Voltage dips during t-LVRT
LVRT[2].Cr Tot Numb of Vdips	Counter Total number of voltage dips.
LVRT[2].Cr Tot Numb of Vdips to Trip	Counter Total number of voltage dips that caused a Trip.
PQScr.Wp+	Positive Active Power is consumed active energy
PQScr.Wp-	Negative Active Power (Fed Energy)
PQScr.Wq+	Positive Reactive Power is consumed Reactive Energy
PQScr.Wq-	Negative Reactive Power (Fed Energy)
Sys.Operating hours Cr	Operating hours counter of the protective device

Selectable Switchgears of the DNP

<i>Name</i>	<i>Description</i>
.-	No assignment
SG[1].Pos	Signal: Circuit Breaker Position (0 = Indeterminate, 1 = OFF, 2 = ON, 3 = Disturbed)
SG[2].Pos	Signal: Circuit Breaker Position (0 = Indeterminate, 1 = OFF, 2 = ON, 3 = Disturbed)
SG[3].Pos	Signal: Circuit Breaker Position (0 = Indeterminate, 1 = OFF, 2 = ON, 3 = Disturbed)
SG[4].Pos	Signal: Circuit Breaker Position (0 = Indeterminate, 1 = OFF, 2 = ON, 3 = Disturbed)
SG[5].Pos	Signal: Circuit Breaker Position (0 = Indeterminate, 1 = OFF, 2 = ON, 3 = Disturbed)
SG[6].Pos	Signal: Circuit Breaker Position (0 = Indeterminate, 1 = OFF, 2 = ON, 3 = Disturbed)

DNP Signals (Output States)

NOTICE

Some signals (that are for a short time active only) have to be acknowledged separately (e.g. Trip signals) by the Communication System.

<i>Signal</i>	<i>Description</i>
busy	This message is set if the protocol is started. It will be reset if the protocol is shut down.
ready	The message will be set if the protocol is successfully started and ready for data exchange.
active	The communication with the Master (SCADA) is active. Note that for TCP/UDP, this state is permanently "Low" unless »DataLink confirm« is set to "Always".
BinaryOutput0	Virtual Digital Output (DNP). This corresponds to a virtual binary input of the protective device.
BinaryOutput1	Virtual Digital Output (DNP). This corresponds to a virtual binary input of the protective device.
BinaryOutput2	Virtual Digital Output (DNP). This corresponds to a virtual binary input of the protective device.
BinaryOutput3	Virtual Digital Output (DNP). This corresponds to a virtual binary input of the protective device.
BinaryOutput4	Virtual Digital Output (DNP). This corresponds to a virtual binary input of the protective device.
BinaryOutput5	Virtual Digital Output (DNP). This corresponds to a virtual binary input of the protective device.
BinaryOutput6	Virtual Digital Output (DNP). This corresponds to a virtual binary input of the protective device.
BinaryOutput7	Virtual Digital Output (DNP). This corresponds to a virtual binary input of the protective device.
BinaryOutput8	Virtual Digital Output (DNP). This corresponds to a virtual binary input of the protective device.
BinaryOutput9	Virtual Digital Output (DNP). This corresponds to a virtual binary input of the protective device.
BinaryOutput10	Virtual Digital Output (DNP). This corresponds to a virtual binary input of the protective device.
BinaryOutput11	Virtual Digital Output (DNP). This corresponds to a virtual binary input of the protective device.
BinaryOutput12	Virtual Digital Output (DNP). This corresponds to a virtual binary input of the protective device.
BinaryOutput13	Virtual Digital Output (DNP). This corresponds to a virtual binary input of the protective device.
BinaryOutput14	Virtual Digital Output (DNP). This corresponds to a virtual binary input of the protective device.
BinaryOutput15	Virtual Digital Output (DNP). This corresponds to a virtual binary input of the protective device.
BinaryOutput16	Virtual Digital Output (DNP). This corresponds to a virtual binary input of the protective device.

<i>Signal</i>	<i>Description</i>
BinaryOutput17	Virtual Digital Output (DNP). This corresponds to a virtual binary input of the protective device.
BinaryOutput18	Virtual Digital Output (DNP). This corresponds to a virtual binary input of the protective device.
BinaryOutput19	Virtual Digital Output (DNP). This corresponds to a virtual binary input of the protective device.
BinaryOutput20	Virtual Digital Output (DNP). This corresponds to a virtual binary input of the protective device.
BinaryOutput21	Virtual Digital Output (DNP). This corresponds to a virtual binary input of the protective device.
BinaryOutput22	Virtual Digital Output (DNP). This corresponds to a virtual binary input of the protective device.
BinaryOutput23	Virtual Digital Output (DNP). This corresponds to a virtual binary input of the protective device.
BinaryOutput24	Virtual Digital Output (DNP). This corresponds to a virtual binary input of the protective device.
BinaryOutput25	Virtual Digital Output (DNP). This corresponds to a virtual binary input of the protective device.
BinaryOutput26	Virtual Digital Output (DNP). This corresponds to a virtual binary input of the protective device.
BinaryOutput27	Virtual Digital Output (DNP). This corresponds to a virtual binary input of the protective device.
BinaryOutput28	Virtual Digital Output (DNP). This corresponds to a virtual binary input of the protective device.
BinaryOutput29	Virtual Digital Output (DNP). This corresponds to a virtual binary input of the protective device.
BinaryOutput30	Virtual Digital Output (DNP). This corresponds to a virtual binary input of the protective device.
BinaryOutput31	Virtual Digital Output (DNP). This corresponds to a virtual binary input of the protective device.

DNP Values

<i>Value</i>	<i>Description</i>	<i>Default</i>	<i>Size</i>	<i>Menu path</i>
NReceived	Diagnostic counter: Number of received characters	0	0 - 9999999999	[Operation /Count and RevData /DNP3]
NSent	Diagnostic counter: Number of sent characters	0	0 - 9999999999	[Operation /Count and RevData /DNP3]
NBadFramings	Diagnostic counter: Number of bad framings. A large number indicates a disturbed serial connection.	0	0 - 9999999999	[Operation /Count and RevData /DNP3]
NBadParities	Diagnostic counter: Number of parity errors. A large number indicates a disturbed serial connection.	0	0 - 9999999999	[Operation /Count and RevData /DNP3]
NBreakSignals	Diagnostic counter: Number of break signals. A large number indicates a disturbed serial connection.	0	0 - 9999999999	[Operation /Count and RevData /DNP3]
NBadChecksum	Diagnostic counter: Number of frames received with bad checksum.	0	0 - 9999999999	[Operation /Count and RevData /DNP3]

Time Synchronization

TimeSync

The user has the possibility to synchronize the device with a central time generator. This offers the following advantages:

- The time does not drift off from the reference time. A continuously accumulating deviation from the reference time thereby will be balanced. Also refer to the chapter Specifications (Tolerances Real Time Clock).
- All time synchronized devices operate with the same time. Thus logged events of the individual devices can be compared exactly and be evaluated in conjunction (single events of the event recorder, disturbance records).

The device's time can be synchronized via the following protocols:

- IRIG-B
- SNTP
- Communication protocol Modbus (RTU or TCP)
- Communication protocol IEC60870-5-103
- Communication protocol DNP3
- Protection communication (only for line differential devices and only for one of the two interconnected devices).

The provided protocols use different hardware interfaces and differ also in their achieved time accuracy. Further information can be found in the chapter Specifications.

<i>Used Protocol</i>	<i>Hardware-Interface</i>	<i>Recommended Application</i>
Without time synchronization	—	Not recommended
IRIG-B	IRIG-B Terminal	Recommended, if interface available
SNTP	RJ45 (Ethernet)	Recommended alternative to IRIG-B, especially when using IEC 61850 or Modbus TCP
Modbus RTU	RS485, D-SUB or Fiber Optic	Recommended when using the Modbus RTU communication protocol and when no IRIG-B code generator is available
Modbus TCP	RJ45 (Ethernet)	Limited recommendation when the Modbus TCP communication protocol is used and no IRIG-B code generator or an SNTP server is available
IEC 60870-5-103	RS485, D-SUB or Fiber Optic	Recommended when using the IEC 10870-5-103 communication protocol and no IRIG-B code generator is available
DNP3	RS485 or RJ45 (Ethernet)	Limited recommendation when using the DNP3 communication protocol and no IRIG-B code generator or an SNTP server is available
ProtCom	X102 (Fiber Optic)	The "ProtCom" Protection Communication is available only with line differential devices, and it connects two devices with each other. Time Synchronization via "ProtCom" is recommended for only one of these two devices. (Time Synchronization of the other device should be done via another protocol, e. g. IRIG-B or SNTP.)

Accuracy of Time Synchronization

The accuracy of the device's synchronized system time depends on several factors:

- accuracy of the connected time generator
- used synchronization protocol
- when using Modbus TCP, SNTP or DNP3 TCP/UDP: Network load and data package transmission times

NOTICE

Please consider the accuracy of the used time generator. Fluctuations of the time generator's time will cause the same fluctuations of the protection relay's system time.

Selection of Timezone and Synchronization Protocol

The protection relay masters both UTC and local time. This means that the device can be synchronized with UTC time while using local time for user display.

Time Synchronization with UTC time (recommended):

Time synchronization is usually done using UTC time. This means for example that an IRIG-B time generator is sending UTC time information to the protection relay. This is the recommended use case, since here a continuous time synchronization can be ensured. There are no “leaps in time” through change of summer- and wintertime.

To achieve that the device shows the current local time, the timezone and the change between summer- and wintertime can be configured.

Please carry out the following setting steps under [Device Para/ Time]:

1. Select your local timezone in the timezone menu.
2. There also configure the switching of daylight saving time.
3. Select the used time synchronization protocol in the TimeSync menu (e.g. “IRIG-B”).
4. Set the parameters of the synchronization protocol (refer to the according chapter).

Time Synchronization with local time:

Should the time synchronization however be done using local time, then please leave the timezone to »UTC+0 London« and do not use switching of daylight saving time.

NOTICE

The synchronization of the relay's system time is exclusively done by the synchronization protocol selected in the menu [Device Para/ Time/ TimeSync/ Used Protocol].







Without Time Synchronization:







To achieve that the device shows the current local time, the timezone and the change between summer- and wintertime can be configured.

Please carry out the following setting steps under [Device Para/ Time]:

1. Select your local timezone in the timezone menu.
2. There also configure the switching of daylight saving time.
3. Select »manual« as your used protocol in the TimeSync menu.
4. Set date and time.

Global Protection Parameters of the Time Synchronization

<i>Parameter</i>	<i>Description</i>	<i>Setting range</i>	<i>Default</i>	<i>Menu path</i>
 DST offset	Difference to wintertime	-180 - 180min	60min	[Device Para /Time /Timezone]
 DST manual	Manual setting of the Daylight Saving Time	inactive, active	active	[Device Para /Time /Timezone]
 Summertime	Daylight Saving Time Only available if: DST manual = active	inactive, active	inactive	[Device Para /Time /Timezone]
 Summertime m	Month of clock change summertime Only available if: DST manual = inactive	January, February, March, April, May, June, July, August, September, October, November, December	March	[Device Para /Time /Timezone]
 Summertime d	Day of clock change summertime Only available if: DST manual = inactive	Sunday, Monday, Tuesday, Wednesday, Thursday, Friday, Saturday, General day	Sunday	[Device Para /Time /Timezone]
 Summertime w	Place of selected day in month (for clock change summertime) Only available if: DST manual = inactive	First, Second, Third, Fourth, Last	Last	[Device Para /Time /Timezone]

<i>Parameter</i>	<i>Description</i>	<i>Setting range</i>	<i>Default</i>	<i>Menu path</i>
Summertime h 	Hour of clock change summertime Only available if: DST manual = inactive	0 - 23h	2h	[Device Para /Time /Timezone]
Summertime min 	Minute of clock change summertime Only available if: DST manual = inactive	0 - 59min	0min	[Device Para /Time /Timezone]
Wintertime m 	Month of clock change wintertime Only available if: DST manual = inactive	January, February, March, April, May, June, July, August, September, October, November, December	October	[Device Para /Time /Timezone]
Wintertime d 	Day of clock change wintertime Only available if: DST manual = inactive	Sunday, Monday, Tuesday, Wednesday, Thursday, Friday, Saturday, General day	Sunday	[Device Para /Time /Timezone]
Wintertime w 	Place of selected day in month (for clock change wintertime) Only available if: DST manual = inactive	First, Second, Third, Fourth, Last	Last	[Device Para /Time /Timezone]
Wintertime h 	Hour of clock change wintertime Only available if: DST manual = inactive	0 - 23h	3h	[Device Para /Time /Timezone]
Wintertime min 	Minute of clock change wintertime Only available if: DST manual = inactive	0 - 59min	0min	[Device Para /Time /Timezone]

Parameter	Description	Setting range	Default	Menu path
Time Zones 	Time Zones	UTC+14 Kiritimati, UTC+13 Rawaki, UTC+12.75 Chatham Island, UTC+12 Wellington, UTC+11.5 Kingston, UTC+11 Port Vila, UTC+10.5 Lord Howe Island, UTC+10 Sydney, UTC+9.5 Adelaide, UTC+9 Tokyo, UTC+8 Hong Kong, UTC+7 Bangkok, UTC+6.5 Rangoon, UTC+6 Colombo, UTC+5.75 Kathmandu, UTC+5.5 New Delhi, UTC+5 Islamabad, UTC+4.5 Kabul, UTC+4 Abu Dhabi, UTC+3.5 Tehran, UTC+3 Moscow, UTC+2 Athens, UTC+1 Berlin, UTC+0 London, UTC-1 Azores, UTC-2 Fern. d. Noronha,	UTC+0 London	[Device Para /Time /Timezone]

<i>Parameter</i>	<i>Description</i>	<i>Setting range</i>	<i>Default</i>	<i>Menu path</i>
TimeSync 	Time synchronisation	-, IRIG-B, SNTP, Modbus, IEC60870-5- 103, DNP3	-	[Device Para /Time /TimeSync /TimeSync]

Signals (Output States) of the Time Synchronization

<i>Signal</i>	<i>Description</i>
synchronized	Clock is synchronized.

SNTP

SNTP

NOTICE Important pre-condition: The protective relay needs to have access to an SNTP server via the connected network. This server preferably should be installed locally.

Principle – General Use

SNTP is a standard protocol for time synchronisation via a network. For this at least one SNTP server has to be available within the network. The device can be configured for one or two SNTP servers.

The protection relay's system time will be synchronised with the connected SNTP server 1-4 times per minute. In turn the SNTP server synchronises its time via NTP with other NTP servers. This is the normal case. Alternatively it can synchronise its time via GPS, radio controlled clock or the like.

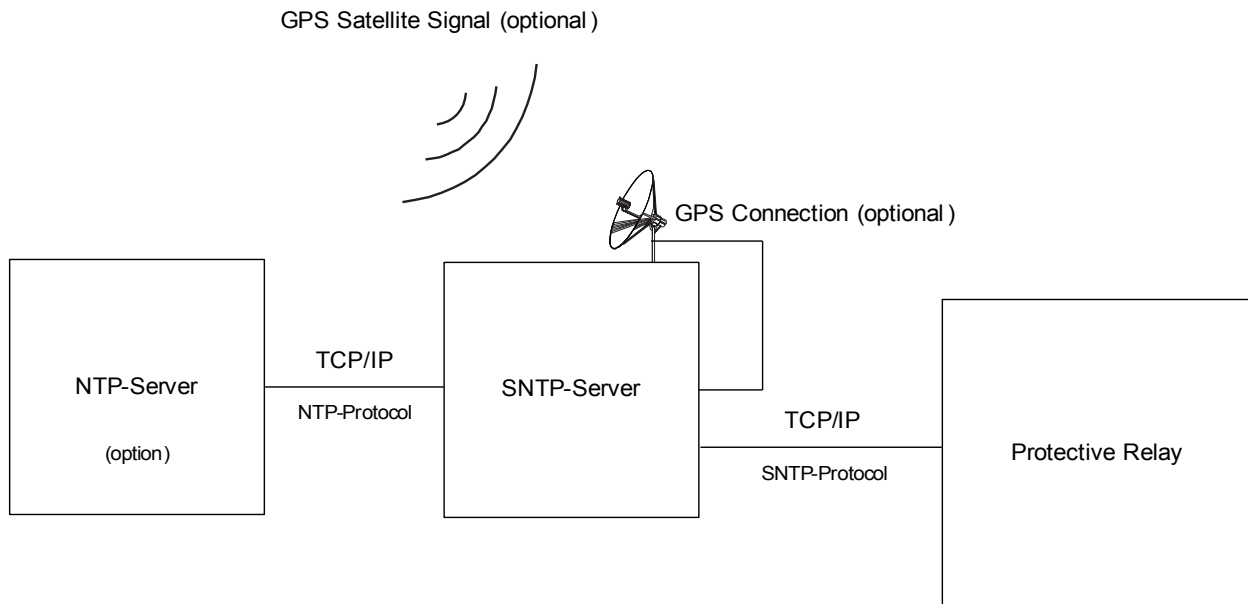

Accuracy

The accuracy of the used SNTP server and the excellence of its reference clock influences the accuracy of the protection relay's clock.

For further information about accuracy refer to the chapter "Specifications".

With each transmitted time information, the SNTP server also sends information about its accuracy:

- **Stratum:** The stratum indicates over how many interacting NTP-Servers the used SNTP server is connected to an atomic or radio controlled clock.
- **Precision:** This indicates the accuracy of the system time provided by the SNTP server.

Additionally the performance of the connected network (traffic and data package transmission times) has an influence on the accuracy of the time synchronisation.

Recommended is a locally installed SNTP server with an accuracy of $\leq 200 \mu\text{sec}$. If this cannot be realised, the connected server's excellence can be checked in the menu [Operation/Status Display/TimeSync]:

- The server quality gives information about the accuracy of the used server. The quality should be GOOD or SUFFICIENT. A server with BAD quality should not be used, because this could cause fluctuations in time synchronisation.
- The network quality gives information about the network's load and data package transmission time. The quality should be GOOD or SUFFICIENT. A network with BAD quality should not be used, because this could cause fluctuations in time synchronisation.

Using two SNTP Servers

When configuring two SNTP servers, the device always synchronizes to server 1 by default.

If server 1 fails, the device automatically switches to server 2.

When (after a failure) server 1 recovers, the device switches back to server 1.

SNTP Commissioning

Activate the SNTP time synchronisation by means of the menu [Device Para/ Time/ TimeSync]:

- Select »SNTP« in the time synchronisation menu.
- Set the IP address of the first server in the SNTP menu.
- Set the IP address of the second server, if available.
- Set all configured servers to "active".

Fault Analysis

If there is no SNTP signal for more than 120 sec, the SNTP status changes from “active” to “inactive” and an entry in the Event Recorder will be created.

The SNTP functionality can be checked in the menu [Operation/Status Display/TimeSync/Sntp]:

If the SNTP status is not indicated as being “active”, please proceed as follows:

- Check if the wiring is correct (Ethernet-cable connected).
- Check if a valid IP address is set in the device (Device Para/TCP/IP).
- Check if the IP address of the SNTP server is set in the device (Device Para/ Time/ TimeSync/ SNTP).
- Check if SNTP is used for time synchronization (Device Para/ Time/ TimeSync/ TimeSync).
- Check if the Ethernet connection is active (Device Para/TCP/IP/Link = Up?).
- Check if both the SNTP server and the protection device answer to a Ping.
- Check if the SNTP server is up and working.





Device Planning Parameters of the SNTP





Parameter	Description	Options	Default	Menu path
Mode 	Mode	do not use, use	do not use	[Device planning]

Direct Commands of the SNTP

Parameter	Description	Setting range	Default	Menu path
Res Counter 	Reset all Counters.	inactive, active	inactive	[Operation /Reset]

Global Protection Parameters of the SNTP

Parameter	Description	Setting range	Default	Menu path
Server1 	Server 1	inactive, active	inactive	[Device Para /Time /TimeSync /SNTP]
IP Byte1 	IP1.IP2.IP3.IP4	0 - 255	0	[Device Para /Time /TimeSync /SNTP]
IP Byte2 	IP1.IP2.IP3.IP4	0 - 255	0	[Device Para /Time /TimeSync /SNTP]
IP Byte3 	IP1.IP2.IP3.IP4	0 - 255	0	[Device Para /Time /TimeSync /SNTP]
IP Byte4 	IP1.IP2.IP3.IP4	0 - 255	0	[Device Para /Time /TimeSync /SNTP]

Parameter	Description	Setting range	Default	Menu path
Server2 	Server 2	inactive, active	inactive	[Device Para /Time /TimeSync /SNTP]
IP Byte1 	IP1.IP2.IP3.IP4	0 - 255	0	[Device Para /Time /TimeSync /SNTP]
IP Byte2 	IP1.IP2.IP3.IP4	0 - 255	0	[Device Para /Time /TimeSync /SNTP]
IP Byte3 	IP1.IP2.IP3.IP4	0 - 255	0	[Device Para /Time /TimeSync /SNTP]
IP Byte4 	IP1.IP2.IP3.IP4	0 - 255	0	[Device Para /Time /TimeSync /SNTP]

Signals of the SNTP

Signal	Description
SNTP active	Signal: If there is no valid SNTP signal for 120 sec, SNTP is regarded as inactive.

SNTP Counters

Value	Description	Default	Size	Menu path
NoOfSyncs	Total Number of Synchronizations.	0	0 - 9999999999	[Operation /Count and RevData /TimeSync /SNTP]
NoOfConnectLost	Total Number of lost SNTP Connections (no sync for 120 sec).	0	0 - 9999999999	[Operation /Count and RevData /TimeSync /SNTP]

<i>Value</i>	<i>Description</i>	<i>Default</i>	<i>Size</i>	<i>Menu path</i>
NoOfSmallSyncs	Service counter: Total Number of very small Time Corrections.	0	0 - 9999999999	[Operation /Count and RevData /TimeSync /SNTP]
NoOfNormSyncs	Service counter: Total Number of normal Time Corrections	0	0 - 9999999999	[Operation /Count and RevData /TimeSync /SNTP]
NoOfBigSyncs	Service counter: Total Number of big Time Corrections	0	0 - 9999999999	[Operation /Count and RevData /TimeSync /SNTP]
NoOfFiltSyncs	Service counter: Total Number of filtered Time Corrections	0	0 - 9999999999	[Operation /Count and RevData /TimeSync /SNTP]
NoOfSlowTrans	Service counter: Total Number of slow Transfers.	0	0 - 9999999999	[Operation /Count and RevData /TimeSync /SNTP]
NoOfHighOffs	Service counter: Total Number of high Offsets.	0	0 - 9999999999	[Operation /Count and RevData /TimeSync /SNTP]
NoOfIntTimeouts	Service counter: Total Number of internal timeouts.	0	0 - 9999999999	[Operation /Count and RevData /TimeSync /SNTP]
StratumServer1	Stratum of Server 1	0	0 - 9999999999	[Operation /Status Display /TimeSync /SNTP]
StratumServer2	Stratum of Server 2	0	0 - 9999999999	[Operation /Status Display /TimeSync /SNTP]

SNTP Values

<i>Value</i>	<i>Description</i>	<i>Default</i>	<i>Size</i>	<i>Menu path</i>
Used Server	Which Server is used for SNTP synchronization.	None	Server1, Server2, None	[Operation /Status Display /TimeSync /SNTP]
PrecServer1	Precision of Server 1	0ms	0 - 1000.00000 ms	[Operation /Status Display /TimeSync /SNTP]
PrecServer2	Precision of Server 2	0ms	0 - 1000.00000 ms	[Operation /Status Display /TimeSync /SNTP]
ServerQlty	Quality of Server used for Synchronization (GOOD, SUFFICIENT, BAD)	-	GOOD, SUFFICIENT, BAD, -	[Operation /Status Display /TimeSync /SNTP]
NetConn	Quality of Network Connection (GOOD, SUFFICIENT, BAD).	-	GOOD, SUFFICIENT, BAD, -	[Operation /Status Display /TimeSync /SNTP]

IRIG-B00X

IRIG-B

NOTICE Requirement: An IRIG-B00X time code generator is needed. IRIG-B004 and higher will support/transmit the “year information”.

If you are using an IRIG time code that does not support the “year information” (IRIG-B000, IRIG-B001, IRIG-B002, IRIG-B003), you have to set the “year” manually within the device. In these cases the correct year information is a precondition for a properly working IRIG-B.

Principle - General Use

The IRIG-B standard is the most used standard to synchronize the time of protection devices in medium voltage applications.

The protection device supports IRIG-B according to the IRIG STANDARD 200-04.

This means that all time synchronization formats IRIG-B00X (IRIG-B000 / B001 / B002 / B003 / B004 / B005 / B006 / B007) are supported. It is recommended to use IRIG-B004 and higher which also transmits the “year information”.

The system time of the protection device is being synchronized with the connected IRIG-B code generator once a second. The accuracy of the used IRIG-B code generator can be increased by connecting a GPS-receiver to it.

GPS Satellite Signal (optional)

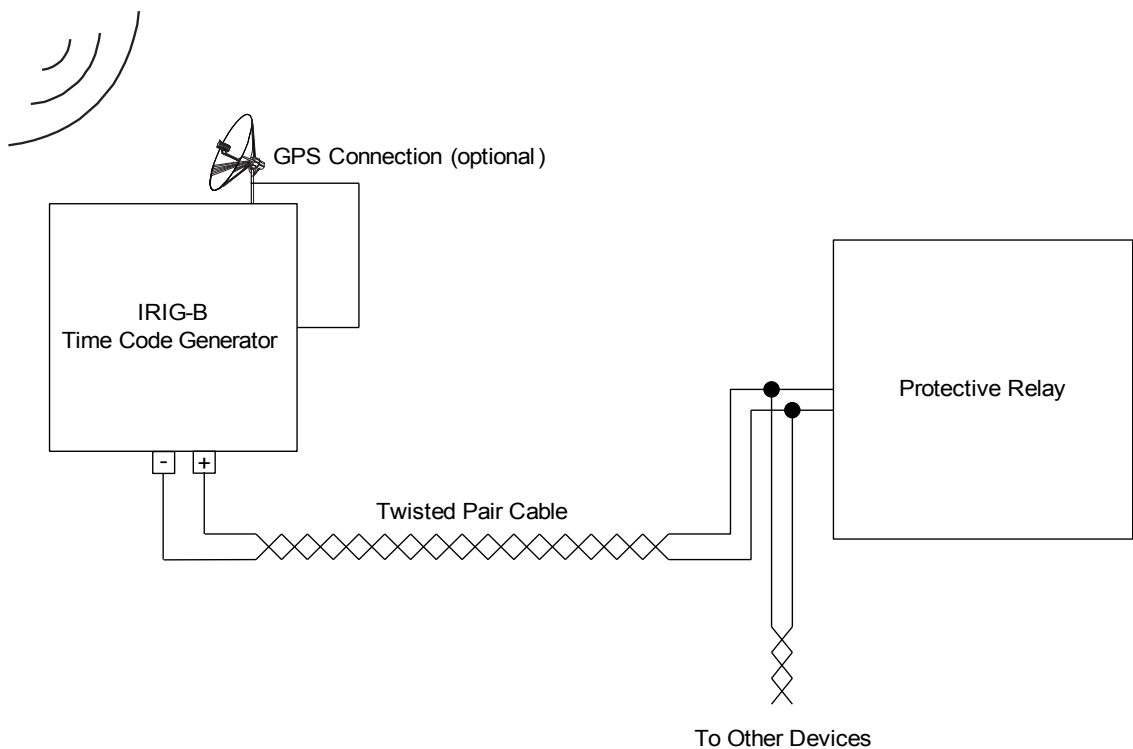

The location of the IRIG-B interface depends to the device type. Please refer to the wiring diagram supplied with the protective device.

IRIG-B Commissioning

Activate the IRIG-B synchronization within menu [Device Para/ Time/ TimeSync]:

- Select »IRIG-B« in the time synchronisation menu.
- Set the time synchronization in the IRIG-B menu to »Active«.
- Select the IRIG-B type (choose B000 through B007).

Fault Analysis

If the device does not receive any IRIG-B time code for more than 60 s, the IRIG-B status switches from »*active*« to »*inactive*« and there is created an entry within the Event Recorder.

Check the IRIG-B functionality through the menu [Operation/ Status display/ TimeSync/ IRIG-B]:

Should the IRIG-B status not be reported as being »*active*«, please proceed as follows:

- To begin with check the IRIG-B wiring.
- Check, if the correct IRIG-B00X type is configured.

IRIG-B Control Commands

In addition to the date and time information, the IRIG-B code offers the option to transmit up to 18 control commands that can be processed by the protective device. They have to be set and issued by the IRIG-B code generator.

The protective device offers up to 18 IRIG-B assignment options for those control commands in order to carry out the assigned action. If there is a control command assigned to an action, this action is being triggered as soon as the control command is transmitted as being true. As an example there can be triggered the start of statistics or the street lighting can be switched on through a relay.

NOTICE

IRIG-B control commands are not recorded by Event and Disturbance Recorders.

If it is required to have a control signal recorded the best way is to use a Logic (1 gate) equation, because the Programmable Logic always gets recorded.



Device Planning Parameters of the IRIG-B00X

Parameter	Description	Options	Default	Menu path
Mode 	Mode	do not use, use	do not use	[Device planning]

Direct Commands of the IRIG-B00X

Parameter	Description	Setting range	Default	Menu path
Res IRIG-B Cr 	Resetting of the Diagnosis Counters: IRIG-B	inactive, active	inactive	[Operation /Reset]

Global Protection Parameters of the IRIG-B00X

Parameter	Description	Setting range	Default	Menu path
Function 	Permanent activation or deactivation of module/stage.	inactive, active	inactive	[Device Para /Time /TimeSync /IRIG-B]
IRIG-B00X 	Determination of the Type: IRIG-B00X. IRIG-B types differ in types of included "Coded Expressions" (year, control-functions, straight-binary-seconds).	IRIGB-000, IRIGB-001, IRIGB-002, IRIGB-003, IRIGB-004, IRIGB-005, IRIGB-006, IRIGB-007	IRIGB-000	[Device Para /Time /TimeSync /IRIG-B]

Signals of the IRIG-B00X (Output States)

Signal	Description
IRIG-B active	Signal: If there is no valid IRIG-B signal for 60 sec, IRIG-B is regarded as inactive.
High-Low Invert	Signal: The High and Low signals of the IRIG-B are inverted. This does NOT mean that the wiring is faulty. If the wiring is faulty no IRIG-B signal will be detected.
Control Signal1	Signal: IRIG-B Control Signal. The external IRIG-B generator can set these signals. They can be used for further control procedures inside the device (e.g. logic functions).

IRIG-B00X Values

<i>Value</i>	<i>Description</i>	<i>Default</i>	<i>Size</i>	<i>Menu path</i>
NoOfFramesOK	Total Number valid Frames.	0	0 - 65535	[Operation /Count and RevData /TimeSync /IRIG-B]
NoOfFrameErrors	Total Number of Frame Errors. Physically corrupted Frame.	0	0 - 65535	[Operation /Count and RevData /TimeSync /IRIG-B]
Edges	Edges: Total number of rising and falling edges. This signal indicates if a signal is available at the IRIG-B input.	0	0 - 65535	[Operation /Count and RevData /TimeSync /IRIG-B]

Parameters

Parameter setting and planning can be done:

- directly at the device or
- by way of the *Smart view* software.

Parameter Definitions

Device Parameters

Device Parameters are part of the Parameter Tree. By means of them you can (depending on the type of device):

- Set cutoff levels,
- Configure Digital Inputs,
- Configure Output Relays,
- Assign LEDs,
- Assign Acknowledgment Signals,
- Configure Statistics,
- Configure Protocol Parameters,
- Adapt HMI Settings,
- Configure Recorders (reports),
- Set Date and Time,
- Change Passwords,
- Check the version (build) of the device.

Field Parameters

Field Parameters are part of the Parameter Tree. Field Parameters comprise the essential, basic settings of your switchboard such as rated frequency, transformer ratios.

Protection Parameters

Protection Parameters are part of the Parameter Tree. This tree comprises:

- **Global Protection Parameters are part of the Protection Parameters:** All settings and assignments that are done within the Global Parameter Tree are valid independent of the Setting Groups. They have to be set once only. In addition to that they comprise the CB Management.
- **The Parameter Setting Switch is part of the Protection Parameters:** You can either direct switch onto a certain parameter setting group or you can determine the conditions for switching onto another parameter setting group.
- **Setting Group Parameters are part of the Protection Parameters:** By means of the Parameter Setting Group Parameters you can individually adapt your protective device to the current conditions or grid conditions. They can be individually set in each Setting group.

Device Planning Parameters

Device Planning Parameters are part of the Parameter Tree.

- **Improving the Usability (clearness):** All protection modules that are currently not needed can be de-protected (switched to invisible) by means of Device Planning. In Menu Device Planning you can adapt the scope of functionality of the protective device exactly to your needs. You can improve the usability by de-projecting all modules that are currently not needed.
- **Adapting the device to your application:** For those modules that you need, determine how they should work (e.g. directional, non-directional, <, >...).

Direct Commands

Direct Commands are part of the Device Parameter Tree but they are **NOT** part of the parameter file. They will be executed directly (e.g. Resetting of a Counter).

State of the Module Inputs

Module Inputs are part of the Parameter Tree. The State of the Module Input is context-dependent.

By means of the Module Inputs influence can be taken on the Modules. You can assign Signals onto **Module Inputs**. The state of the signals that are assigned to an input can be taken from the Status Display. Module Inputs can be identified by an „-I“ at the end of the name.

Signals

Signals are part of the Parameter Tree. The state of the signal is context-dependent.

- **Signals** represent the state of your installation/equipment (e.g. Position Indicators of the Circuit Breaker).
- **Signals** are assessments of the state of the grid and the equipment (System OK, Transformer failure detected...).
- **Signals** represent decisions that are taken by the device (e.g. Trip command) based on your parameter settings.

Adaptive Parameter Sets

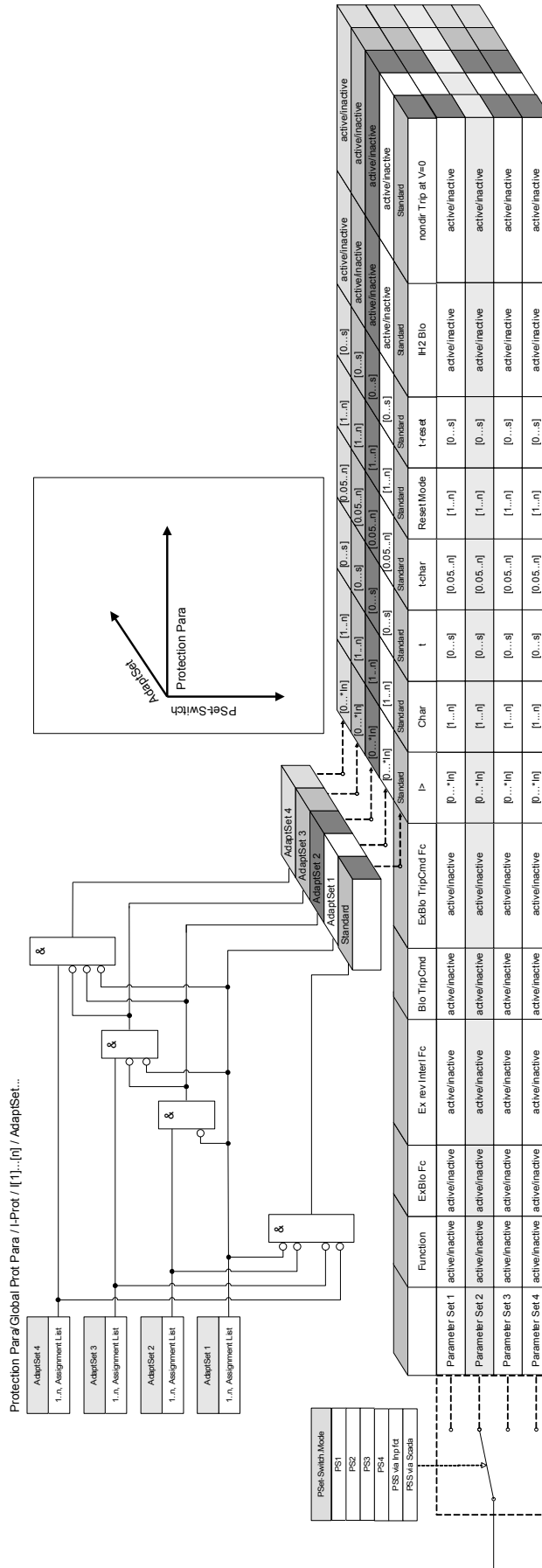

Adaptive Parameter Sets are part of the Parameter Tree.

By means of **Adaptive Parameter Sets** you can modify temporarily single parameters within the parameter setting groups.

NOTICE

Adaptive Parameters fall back automatically, if the acknowledged signal, that has activated them, has fallen back. Please take into account that Adaptive Set 1 is dominant to Adaptive Set 2. Adaptive Set 2 is dominant to Adaptive Set 3. Adaptive Set 3 is dominant to Adaptive Set 4.

NOTICE

In order to increase the usability (clearness) Adaptive Parameter Sets become visible if an corresponding activation signals has been assigned (Smart view 2.0 and higher).

Example: In order to use Adaptive Parameters within Protective Element I[1] please proceed as follows:

- Assign within the Global Parameter tree within Protective Element I[1] an activation signal for AdaptiveParameterSet 1.
- AdaptiveParameterSet 1 becomes now visible within the Protection Parameter Sets for element I[1].

By means of additional activation signals further Adaptive Parameter Sets can be used.

The functionality of the IED (relay) can be enhanced / adapted by means of **Adaptive Parameters** in order to meet the requirements of modified states of the grid or the power supply system respectively to manage unpredictable events.

Moreover, the adaptive parameter can also be used to realize various special protective functions or to expand the existing function modules in a simple way without to redesign the existing hardware or software platform costly.

The **Adaptive Parameter** feature allows, besides a standard parameter set, one of the four parameter sets labeled from 1 to 4, to be used for example in a time overcurrent element under the control of the configurable Set Control Logics. The dynamical switch-over of the adaptive parameter set is only active for a particular element when its adaptive set control logic is configured and only as long as the activation signal is true.

For some protection elements such as time overcurrent and instantaneous overcurrent (50P, 51P, 50G, 51G...), besides the "default" setting there exist another 4 "alternative" settings for pickup value, curve type, time dial, reset mode set values which can be switched-over dynamically by means of the configurable adaptive setting control logics in the single set parameter.

If the **Adaptive Parameter** feature is not used, the adaptive set control logics will not be selected (assigned). The protective elements work in this case just like a normal protection using the “Default” settings. If one of the **Adaptive Set** Control logics” is assigned to a logic function, the protective element will be “switched-over” to the corresponding adaptive settings if the assigned logic function is asserted and will fall back to the “Default” Setting if the assigned signal that has been activated the **Adaptive Set** has fallen back.

Application Example

During a Switch-OnTo-Fault condition, it is usually requested to make the embedded protective function tripping the faulted line faster, instantaneously or sometimes non-directionally.

Such a Switch-OnTo-Fault application can easily be realized using the **Adaptive Parameter** features above mentioned: The standard time overcurrent protection element (e.g. 51P) normally works with an inverse curve type (e.g. ANSI Type A), while in case of **SOTF** condition, it should trip instantaneously. If the **SOTF** logic function »SOTF_ENABLED« is detecting a manual circuit breaker close condition the relay switches to **AdaptiveSet1** if the signal »SOTF_ENABLED« is assigned to **AdaptiveSet1**. The corresponding **AdaptiveSet1** will become active and that means e.g. »curve type = DEFT« and »t = 0« sec.

Name	Value
ExBlo1	...
ExBlo2	...
ExBlo TripCmd	...
Ex rev Interf	...
AdaptSet 1	SOTF . enabled
AdaptSet 2	CLPU . enabled
AdaptSet 3	V[2] . Alarm
AdaptSet 4	V 012 [1] . Alarm

Name	DefaultSet	SOTF . enabled	CLPU . enabled	V[2] . Alarm	V 012 [1] . Alarm	Unit
Function	active					
ExBlo Fc	inactive					
Ex rev Interf Fc	inactive					
Blo TripCmd	inactive					
ExBlo TripCmd Fc	inactive					
Measuring method	Fundamental					
I>	1.5		4	1.00	1.00	In
Char	IEC NINV	DEFT	IEC NINV	IEC NINV	IEC NINV	
t	1.00	1.00	1.00	1.00	1.00	s
I-char	1	1	1	1	1	
Reset Mode	instantaneous	instantaneous	instantaneous	instantaneous	instantaneous	
I-reset	0	0	0	0	0	s
IH2 Blo	inactive	inactive	inactive	inactive	inactive	
VRestraint	inactive	inactive	inactive	inactive	inactive	
Measuring Mode	Phase to Ne...	Phase to Ne...	Phase to Ne...	Phase to Ne...	Phase to Ne...	
VRestraint max	1.00	1.00	1.00	1.00	1.00	Vn
Meas Circuit Superv	inactive	inactive	inactive	inactive	inactive	

The screenshot above shows the adaptive setting configurations following applications based on only one simple overcurrent protection element:

1. Standard Set: Default settings
2. Adaptive Set 1: *SOTF* application (Switch-Onto-Fault)
3. Adaptive Set 2: *CLPU* application (Cold Load Pickup)
4. Adaptive Set 3: Voltage-Controlled time overcurrent protection (ANSI 51V)
5. Adaptive Set 4: Negative- Phase- Sequence- Voltage-Controlled time overcurrent protection

Application Examples

- The output signal of the *Switch Onto Fault* module can be used to activate an **Adaptive Parameter Set** that sensibilizes the overcurrent protection.
- The output signal of the *Cold Load Pickup* module can be used to activate an **Adaptive Parameter Set** that desensitizes the overcurrent protection.
- By means of **Adaptive Parameter Sets** an Adaptive *Auto Reclosure* can be realized. After a reclosure attempt the tripping thresholds or tripping curves of the overcurrent protection can be adapted.
- Depending on undervoltage the overcurrent protection can be modified (Voltage Controlled).
- The earth overcurrent protection can be modified by the residual voltage.
- Matching the ground current protective settings dynamically and automatically according to the single-phase load diversity (Adaptive relay Setting – Normal Setting/Alternative Setting)

NOTICE

Adaptive Parameter Sets are only available for devices with current protection modules.

Adaptive Parameter Set Activation Signals

<i>Name</i>	<i>Description</i>
.-.	No assignment
IH2.Blo L1	Signal: Blocked L1
IH2.Blo L2	Signal: Blocked L2
IH2.Blo L3	Signal: Blocked L3
IH2.Blo IG meas	Signal: Blocking of the ground (earth) protection module (measured ground current)
IH2.Blo IG calc	Signal: Blocking of the ground (earth) protection module (calculated ground current)
IH2.3-ph Blo	Signal: Inrush was detected in at least one phase - trip command blocked.
V[1].Alarm	Signal: Alarm voltage stage
V[2].Alarm	Signal: Alarm voltage stage
V[3].Alarm	Signal: Alarm voltage stage
V[4].Alarm	Signal: Alarm voltage stage
V[5].Alarm	Signal: Alarm voltage stage
V[6].Alarm	Signal: Alarm voltage stage
Intertripping.Alarm	Signal: Alarm
LVRT[1].Alarm	Signal: Alarm voltage stage
LVRT[1].t-LVRT is running	Signal: t-LVRT is running
LVRT[2].Alarm	Signal: Alarm voltage stage
LVRT[2].t-LVRT is running	Signal: t-LVRT is running
VG[1].Alarm	Signal: Alarm Residual Voltage Supervision-stage
VG[2].Alarm	Signal: Alarm Residual Voltage Supervision-stage
V012[1].Alarm	Signal: Alarm voltage asymmetry
V012[2].Alarm	Signal: Alarm voltage asymmetry
V012[3].Alarm	Signal: Alarm voltage asymmetry
V012[4].Alarm	Signal: Alarm voltage asymmetry
V012[5].Alarm	Signal: Alarm voltage asymmetry
V012[6].Alarm	Signal: Alarm voltage asymmetry
SOTF.enabled	Signal: Switch Onto Fault enabled. This Signal can be used to modify Overcurrent Protection Settings.
CLPU.enabled	Signal: Cold Load enabled
Exp[1].Alarm	Signal: Alarm
Exp[2].Alarm	Signal: Alarm
Exp[3].Alarm	Signal: Alarm
Exp[4].Alarm	Signal: Alarm
Ext Sudd Press.Alarm	Signal: Alarm
Ext Oil Temp.Alarm	Signal: Alarm
Ext Temp Superv[1].Alarm	Signal: Alarm

Parameters

<i>Name</i>	<i>Description</i>
Ext Temp Superv[2].Alarm	Signal: Alarm
Ext Temp Superv[3].Alarm	Signal: Alarm
CTS.Alarm	Signal: Alarm Current Transformer Measuring Circuit Supervision
LOP.Alarm	Signal: Alarm Loss of Potential
DI Slot X1.DI 1	Signal: Digital Input
DI Slot X1.DI 2	Signal: Digital Input
DI Slot X1.DI 3	Signal: Digital Input
DI Slot X1.DI 4	Signal: Digital Input
DI Slot X1.DI 5	Signal: Digital Input
DI Slot X1.DI 6	Signal: Digital Input
DI Slot X1.DI 7	Signal: Digital Input
DI Slot X1.DI 8	Signal: Digital Input
DI Slot X5.DI 1	Signal: Digital Input
DI Slot X5.DI 2	Signal: Digital Input
DI Slot X5.DI 3	Signal: Digital Input
DI Slot X5.DI 4	Signal: Digital Input
DI Slot X5.DI 5	Signal: Digital Input
DI Slot X5.DI 6	Signal: Digital Input
DI Slot X5.DI 7	Signal: Digital Input
DI Slot X5.DI 8	Signal: Digital Input
DI Slot X6.DI 1	Signal: Digital Input
DI Slot X6.DI 2	Signal: Digital Input
DI Slot X6.DI 3	Signal: Digital Input
DI Slot X6.DI 4	Signal: Digital Input
DI Slot X6.DI 5	Signal: Digital Input
DI Slot X6.DI 6	Signal: Digital Input
DI Slot X6.DI 7	Signal: Digital Input
DI Slot X6.DI 8	Signal: Digital Input
Modbus.Scada Cmd 1	Scada Command
Modbus.Scada Cmd 2	Scada Command
Modbus.Scada Cmd 3	Scada Command
Modbus.Scada Cmd 4	Scada Command
Modbus.Scada Cmd 5	Scada Command
Modbus.Scada Cmd 6	Scada Command
Modbus.Scada Cmd 7	Scada Command
Modbus.Scada Cmd 8	Scada Command
Modbus.Scada Cmd 9	Scada Command
Modbus.Scada Cmd 10	Scada Command

Parameters

<i>Name</i>	<i>Description</i>
Modbus.Scada Cmd 11	Scada Command
Modbus.Scada Cmd 12	Scada Command
Modbus.Scada Cmd 13	Scada Command
Modbus.Scada Cmd 14	Scada Command
Modbus.Scada Cmd 15	Scada Command
Modbus.Scada Cmd 16	Scada Command
IEC61850.VirtInp1	Signal: Virtual Input (IEC61850 GGIO Ind)
IEC61850.VirtInp2	Signal: Virtual Input (IEC61850 GGIO Ind)
IEC61850.VirtInp3	Signal: Virtual Input (IEC61850 GGIO Ind)
IEC61850.VirtInp4	Signal: Virtual Input (IEC61850 GGIO Ind)
IEC61850.VirtInp5	Signal: Virtual Input (IEC61850 GGIO Ind)
IEC61850.VirtInp6	Signal: Virtual Input (IEC61850 GGIO Ind)
IEC61850.VirtInp7	Signal: Virtual Input (IEC61850 GGIO Ind)
IEC61850.VirtInp8	Signal: Virtual Input (IEC61850 GGIO Ind)
IEC61850.VirtInp9	Signal: Virtual Input (IEC61850 GGIO Ind)
IEC61850.VirtInp10	Signal: Virtual Input (IEC61850 GGIO Ind)
IEC61850.VirtInp11	Signal: Virtual Input (IEC61850 GGIO Ind)
IEC61850.VirtInp12	Signal: Virtual Input (IEC61850 GGIO Ind)
IEC61850.VirtInp13	Signal: Virtual Input (IEC61850 GGIO Ind)
IEC61850.VirtInp14	Signal: Virtual Input (IEC61850 GGIO Ind)
IEC61850.VirtInp15	Signal: Virtual Input (IEC61850 GGIO Ind)
IEC61850.VirtInp16	Signal: Virtual Input (IEC61850 GGIO Ind)
IEC61850.VirtInp17	Signal: Virtual Input (IEC61850 GGIO Ind)
IEC61850.VirtInp18	Signal: Virtual Input (IEC61850 GGIO Ind)
IEC61850.VirtInp19	Signal: Virtual Input (IEC61850 GGIO Ind)
IEC61850.VirtInp20	Signal: Virtual Input (IEC61850 GGIO Ind)
IEC61850.VirtInp21	Signal: Virtual Input (IEC61850 GGIO Ind)
IEC61850.VirtInp22	Signal: Virtual Input (IEC61850 GGIO Ind)
IEC61850.VirtInp23	Signal: Virtual Input (IEC61850 GGIO Ind)
IEC61850.VirtInp24	Signal: Virtual Input (IEC61850 GGIO Ind)
IEC61850.VirtInp25	Signal: Virtual Input (IEC61850 GGIO Ind)
IEC61850.VirtInp26	Signal: Virtual Input (IEC61850 GGIO Ind)
IEC61850.VirtInp27	Signal: Virtual Input (IEC61850 GGIO Ind)
IEC61850.VirtInp28	Signal: Virtual Input (IEC61850 GGIO Ind)
IEC61850.VirtInp29	Signal: Virtual Input (IEC61850 GGIO Ind)
IEC61850.VirtInp30	Signal: Virtual Input (IEC61850 GGIO Ind)
IEC61850.VirtInp31	Signal: Virtual Input (IEC61850 GGIO Ind)
IEC61850.VirtInp32	Signal: Virtual Input (IEC61850 GGIO Ind)
IEC61850.SPCSO1	Status bit that can be set by clients like e.g. SCADA (Single Point Controllable Status Output).

Parameters

<i>Name</i>	<i>Description</i>
IEC61850.SPCSO2	Status bit that can be set by clients like e.g. SCADA (Single Point Controllable Status Output).
IEC61850.SPCSO3	Status bit that can be set by clients like e.g. SCADA (Single Point Controllable Status Output).
IEC61850.SPCSO4	Status bit that can be set by clients like e.g. SCADA (Single Point Controllable Status Output).
IEC61850.SPCSO5	Status bit that can be set by clients like e.g. SCADA (Single Point Controllable Status Output).
IEC61850.SPCSO6	Status bit that can be set by clients like e.g. SCADA (Single Point Controllable Status Output).
IEC61850.SPCSO7	Status bit that can be set by clients like e.g. SCADA (Single Point Controllable Status Output).
IEC61850.SPCSO8	Status bit that can be set by clients like e.g. SCADA (Single Point Controllable Status Output).
IEC61850.SPCSO9	Status bit that can be set by clients like e.g. SCADA (Single Point Controllable Status Output).
IEC61850.SPCSO10	Status bit that can be set by clients like e.g. SCADA (Single Point Controllable Status Output).
IEC61850.SPCSO11	Status bit that can be set by clients like e.g. SCADA (Single Point Controllable Status Output).
IEC61850.SPCSO12	Status bit that can be set by clients like e.g. SCADA (Single Point Controllable Status Output).
IEC61850.SPCSO13	Status bit that can be set by clients like e.g. SCADA (Single Point Controllable Status Output).
IEC61850.SPCSO14	Status bit that can be set by clients like e.g. SCADA (Single Point Controllable Status Output).
IEC61850.SPCSO15	Status bit that can be set by clients like e.g. SCADA (Single Point Controllable Status Output).
IEC61850.SPCSO16	Status bit that can be set by clients like e.g. SCADA (Single Point Controllable Status Output).
IEC 103.Scada Cmd 1	Scada Command
IEC 103.Scada Cmd 2	Scada Command
IEC 103.Scada Cmd 3	Scada Command
IEC 103.Scada Cmd 4	Scada Command
IEC 103.Scada Cmd 5	Scada Command
IEC 103.Scada Cmd 6	Scada Command
IEC 103.Scada Cmd 7	Scada Command
IEC 103.Scada Cmd 8	Scada Command
IEC 103.Scada Cmd 9	Scada Command
IEC 103.Scada Cmd 10	Scada Command
Profibus.Scada Cmd 1	Scada Command
Profibus.Scada Cmd 2	Scada Command
Profibus.Scada Cmd 3	Scada Command
Profibus.Scada Cmd 4	Scada Command
Profibus.Scada Cmd 5	Scada Command

Parameters

<i>Name</i>	<i>Description</i>
Profibus.Scada Cmd 6	Scada Command
Profibus.Scada Cmd 7	Scada Command
Profibus.Scada Cmd 8	Scada Command
Profibus.Scada Cmd 9	Scada Command
Profibus.Scada Cmd 10	Scada Command
Profibus.Scada Cmd 11	Scada Command
Profibus.Scada Cmd 12	Scada Command
Profibus.Scada Cmd 13	Scada Command
Profibus.Scada Cmd 14	Scada Command
Profibus.Scada Cmd 15	Scada Command
Profibus.Scada Cmd 16	Scada Command
Logics.LE1.Gate Out	Signal: Output of the logic gate
Logics.LE1.Timer Out	Signal: Timer Output
Logics.LE1.Out	Signal: Latched Output (Q)
Logics.LE1.Out inverted	Signal: Negated Latched Output (Q NOT)
Logics.LE2.Gate Out	Signal: Output of the logic gate
Logics.LE2.Timer Out	Signal: Timer Output
Logics.LE2.Out	Signal: Latched Output (Q)
Logics.LE2.Out inverted	Signal: Negated Latched Output (Q NOT)
Logics.LE3.Gate Out	Signal: Output of the logic gate
Logics.LE3.Timer Out	Signal: Timer Output
Logics.LE3.Out	Signal: Latched Output (Q)
Logics.LE3.Out inverted	Signal: Negated Latched Output (Q NOT)
Logics.LE4.Gate Out	Signal: Output of the logic gate
Logics.LE4.Timer Out	Signal: Timer Output
Logics.LE4.Out	Signal: Latched Output (Q)
Logics.LE4.Out inverted	Signal: Negated Latched Output (Q NOT)
Logics.LE5.Gate Out	Signal: Output of the logic gate
Logics.LE5.Timer Out	Signal: Timer Output
Logics.LE5.Out	Signal: Latched Output (Q)
Logics.LE5.Out inverted	Signal: Negated Latched Output (Q NOT)
Logics.LE6.Gate Out	Signal: Output of the logic gate
Logics.LE6.Timer Out	Signal: Timer Output
Logics.LE6.Out	Signal: Latched Output (Q)
Logics.LE6.Out inverted	Signal: Negated Latched Output (Q NOT)
Logics.LE7.Gate Out	Signal: Output of the logic gate
Logics.LE7.Timer Out	Signal: Timer Output
Logics.LE7.Out	Signal: Latched Output (Q)
Logics.LE7.Out inverted	Signal: Negated Latched Output (Q NOT)
Logics.LE8.Gate Out	Signal: Output of the logic gate

Parameters

<i>Name</i>	<i>Description</i>
Logics.LE8.Timer Out	Signal: Timer Output
Logics.LE8.Out	Signal: Latched Output (Q)
Logics.LE8.Out inverted	Signal: Negated Latched Output (Q NOT)
Logics.LE9.Gate Out	Signal: Output of the logic gate
Logics.LE9.Timer Out	Signal: Timer Output
Logics.LE9.Out	Signal: Latched Output (Q)
Logics.LE9.Out inverted	Signal: Negated Latched Output (Q NOT)
Logics.LE10.Gate Out	Signal: Output of the logic gate
Logics.LE10.Timer Out	Signal: Timer Output
Logics.LE10.Out	Signal: Latched Output (Q)
Logics.LE10.Out inverted	Signal: Negated Latched Output (Q NOT)
Logics.LE11.Gate Out	Signal: Output of the logic gate
Logics.LE11.Timer Out	Signal: Timer Output
Logics.LE11.Out	Signal: Latched Output (Q)
Logics.LE11.Out inverted	Signal: Negated Latched Output (Q NOT)
Logics.LE12.Gate Out	Signal: Output of the logic gate
Logics.LE12.Timer Out	Signal: Timer Output
Logics.LE12.Out	Signal: Latched Output (Q)
Logics.LE12.Out inverted	Signal: Negated Latched Output (Q NOT)
Logics.LE13.Gate Out	Signal: Output of the logic gate
Logics.LE13.Timer Out	Signal: Timer Output
Logics.LE13.Out	Signal: Latched Output (Q)
Logics.LE13.Out inverted	Signal: Negated Latched Output (Q NOT)
Logics.LE14.Gate Out	Signal: Output of the logic gate
Logics.LE14.Timer Out	Signal: Timer Output
Logics.LE14.Out	Signal: Latched Output (Q)
Logics.LE14.Out inverted	Signal: Negated Latched Output (Q NOT)
Logics.LE15.Gate Out	Signal: Output of the logic gate
Logics.LE15.Timer Out	Signal: Timer Output
Logics.LE15.Out	Signal: Latched Output (Q)
Logics.LE15.Out inverted	Signal: Negated Latched Output (Q NOT)
Logics.LE16.Gate Out	Signal: Output of the logic gate
Logics.LE16.Timer Out	Signal: Timer Output
Logics.LE16.Out	Signal: Latched Output (Q)
Logics.LE16.Out inverted	Signal: Negated Latched Output (Q NOT)
Logics.LE17.Gate Out	Signal: Output of the logic gate
Logics.LE17.Timer Out	Signal: Timer Output
Logics.LE17.Out	Signal: Latched Output (Q)
Logics.LE17.Out inverted	Signal: Negated Latched Output (Q NOT)
Logics.LE18.Gate Out	Signal: Output of the logic gate

Parameters

<i>Name</i>	<i>Description</i>
Logics.LE18.Timer Out	Signal: Timer Output
Logics.LE18.Out	Signal: Latched Output (Q)
Logics.LE18.Out inverted	Signal: Negated Latched Output (Q NOT)
Logics.LE19.Gate Out	Signal: Output of the logic gate
Logics.LE19.Timer Out	Signal: Timer Output
Logics.LE19.Out	Signal: Latched Output (Q)
Logics.LE19.Out inverted	Signal: Negated Latched Output (Q NOT)
Logics.LE20.Gate Out	Signal: Output of the logic gate
Logics.LE20.Timer Out	Signal: Timer Output
Logics.LE20.Out	Signal: Latched Output (Q)
Logics.LE20.Out inverted	Signal: Negated Latched Output (Q NOT)
Logics.LE21.Gate Out	Signal: Output of the logic gate
Logics.LE21.Timer Out	Signal: Timer Output
Logics.LE21.Out	Signal: Latched Output (Q)
Logics.LE21.Out inverted	Signal: Negated Latched Output (Q NOT)
Logics.LE22.Gate Out	Signal: Output of the logic gate
Logics.LE22.Timer Out	Signal: Timer Output
Logics.LE22.Out	Signal: Latched Output (Q)
Logics.LE22.Out inverted	Signal: Negated Latched Output (Q NOT)
Logics.LE23.Gate Out	Signal: Output of the logic gate
Logics.LE23.Timer Out	Signal: Timer Output
Logics.LE23.Out	Signal: Latched Output (Q)
Logics.LE23.Out inverted	Signal: Negated Latched Output (Q NOT)
Logics.LE24.Gate Out	Signal: Output of the logic gate
Logics.LE24.Timer Out	Signal: Timer Output
Logics.LE24.Out	Signal: Latched Output (Q)
Logics.LE24.Out inverted	Signal: Negated Latched Output (Q NOT)
Logics.LE25.Gate Out	Signal: Output of the logic gate
Logics.LE25.Timer Out	Signal: Timer Output
Logics.LE25.Out	Signal: Latched Output (Q)
Logics.LE25.Out inverted	Signal: Negated Latched Output (Q NOT)
Logics.LE26.Gate Out	Signal: Output of the logic gate
Logics.LE26.Timer Out	Signal: Timer Output
Logics.LE26.Out	Signal: Latched Output (Q)
Logics.LE26.Out inverted	Signal: Negated Latched Output (Q NOT)
Logics.LE27.Gate Out	Signal: Output of the logic gate
Logics.LE27.Timer Out	Signal: Timer Output
Logics.LE27.Out	Signal: Latched Output (Q)
Logics.LE27.Out inverted	Signal: Negated Latched Output (Q NOT)
Logics.LE28.Gate Out	Signal: Output of the logic gate

Parameters

<i>Name</i>	<i>Description</i>
Logics.LE28.Timer Out	Signal: Timer Output
Logics.LE28.Out	Signal: Latched Output (Q)
Logics.LE28.Out inverted	Signal: Negated Latched Output (Q NOT)
Logics.LE29.Gate Out	Signal: Output of the logic gate
Logics.LE29.Timer Out	Signal: Timer Output
Logics.LE29.Out	Signal: Latched Output (Q)
Logics.LE29.Out inverted	Signal: Negated Latched Output (Q NOT)
Logics.LE30.Gate Out	Signal: Output of the logic gate
Logics.LE30.Timer Out	Signal: Timer Output
Logics.LE30.Out	Signal: Latched Output (Q)
Logics.LE30.Out inverted	Signal: Negated Latched Output (Q NOT)
Logics.LE31.Gate Out	Signal: Output of the logic gate
Logics.LE31.Timer Out	Signal: Timer Output
Logics.LE31.Out	Signal: Latched Output (Q)
Logics.LE31.Out inverted	Signal: Negated Latched Output (Q NOT)
Logics.LE32.Gate Out	Signal: Output of the logic gate
Logics.LE32.Timer Out	Signal: Timer Output
Logics.LE32.Out	Signal: Latched Output (Q)
Logics.LE32.Out inverted	Signal: Negated Latched Output (Q NOT)
Logics.LE33.Gate Out	Signal: Output of the logic gate
Logics.LE33.Timer Out	Signal: Timer Output
Logics.LE33.Out	Signal: Latched Output (Q)
Logics.LE33.Out inverted	Signal: Negated Latched Output (Q NOT)
Logics.LE34.Gate Out	Signal: Output of the logic gate
Logics.LE34.Timer Out	Signal: Timer Output
Logics.LE34.Out	Signal: Latched Output (Q)
Logics.LE34.Out inverted	Signal: Negated Latched Output (Q NOT)
Logics.LE35.Gate Out	Signal: Output of the logic gate
Logics.LE35.Timer Out	Signal: Timer Output
Logics.LE35.Out	Signal: Latched Output (Q)
Logics.LE35.Out inverted	Signal: Negated Latched Output (Q NOT)
Logics.LE36.Gate Out	Signal: Output of the logic gate
Logics.LE36.Timer Out	Signal: Timer Output
Logics.LE36.Out	Signal: Latched Output (Q)
Logics.LE36.Out inverted	Signal: Negated Latched Output (Q NOT)
Logics.LE37.Gate Out	Signal: Output of the logic gate
Logics.LE37.Timer Out	Signal: Timer Output
Logics.LE37.Out	Signal: Latched Output (Q)
Logics.LE37.Out inverted	Signal: Negated Latched Output (Q NOT)
Logics.LE38.Gate Out	Signal: Output of the logic gate

Parameters

<i>Name</i>	<i>Description</i>
Logics.LE38.Timer Out	Signal: Timer Output
Logics.LE38.Out	Signal: Latched Output (Q)
Logics.LE38.Out inverted	Signal: Negated Latched Output (Q NOT)
Logics.LE39.Gate Out	Signal: Output of the logic gate
Logics.LE39.Timer Out	Signal: Timer Output
Logics.LE39.Out	Signal: Latched Output (Q)
Logics.LE39.Out inverted	Signal: Negated Latched Output (Q NOT)
Logics.LE40.Gate Out	Signal: Output of the logic gate
Logics.LE40.Timer Out	Signal: Timer Output
Logics.LE40.Out	Signal: Latched Output (Q)
Logics.LE40.Out inverted	Signal: Negated Latched Output (Q NOT)
Logics.LE41.Gate Out	Signal: Output of the logic gate
Logics.LE41.Timer Out	Signal: Timer Output
Logics.LE41.Out	Signal: Latched Output (Q)
Logics.LE41.Out inverted	Signal: Negated Latched Output (Q NOT)
Logics.LE42.Gate Out	Signal: Output of the logic gate
Logics.LE42.Timer Out	Signal: Timer Output
Logics.LE42.Out	Signal: Latched Output (Q)
Logics.LE42.Out inverted	Signal: Negated Latched Output (Q NOT)
Logics.LE43.Gate Out	Signal: Output of the logic gate
Logics.LE43.Timer Out	Signal: Timer Output
Logics.LE43.Out	Signal: Latched Output (Q)
Logics.LE43.Out inverted	Signal: Negated Latched Output (Q NOT)
Logics.LE44.Gate Out	Signal: Output of the logic gate
Logics.LE44.Timer Out	Signal: Timer Output
Logics.LE44.Out	Signal: Latched Output (Q)
Logics.LE44.Out inverted	Signal: Negated Latched Output (Q NOT)
Logics.LE45.Gate Out	Signal: Output of the logic gate
Logics.LE45.Timer Out	Signal: Timer Output
Logics.LE45.Out	Signal: Latched Output (Q)
Logics.LE45.Out inverted	Signal: Negated Latched Output (Q NOT)
Logics.LE46.Gate Out	Signal: Output of the logic gate
Logics.LE46.Timer Out	Signal: Timer Output
Logics.LE46.Out	Signal: Latched Output (Q)
Logics.LE46.Out inverted	Signal: Negated Latched Output (Q NOT)
Logics.LE47.Gate Out	Signal: Output of the logic gate
Logics.LE47.Timer Out	Signal: Timer Output
Logics.LE47.Out	Signal: Latched Output (Q)
Logics.LE47.Out inverted	Signal: Negated Latched Output (Q NOT)
Logics.LE48.Gate Out	Signal: Output of the logic gate

Parameters

<i>Name</i>	<i>Description</i>
Logics.LE48.Timer Out	Signal: Timer Output
Logics.LE48.Out	Signal: Latched Output (Q)
Logics.LE48.Out inverted	Signal: Negated Latched Output (Q NOT)
Logics.LE49.Gate Out	Signal: Output of the logic gate
Logics.LE49.Timer Out	Signal: Timer Output
Logics.LE49.Out	Signal: Latched Output (Q)
Logics.LE49.Out inverted	Signal: Negated Latched Output (Q NOT)
Logics.LE50.Gate Out	Signal: Output of the logic gate
Logics.LE50.Timer Out	Signal: Timer Output
Logics.LE50.Out	Signal: Latched Output (Q)
Logics.LE50.Out inverted	Signal: Negated Latched Output (Q NOT)
Logics.LE51.Gate Out	Signal: Output of the logic gate
Logics.LE51.Timer Out	Signal: Timer Output
Logics.LE51.Out	Signal: Latched Output (Q)
Logics.LE51.Out inverted	Signal: Negated Latched Output (Q NOT)
Logics.LE52.Gate Out	Signal: Output of the logic gate
Logics.LE52.Timer Out	Signal: Timer Output
Logics.LE52.Out	Signal: Latched Output (Q)
Logics.LE52.Out inverted	Signal: Negated Latched Output (Q NOT)
Logics.LE53.Gate Out	Signal: Output of the logic gate
Logics.LE53.Timer Out	Signal: Timer Output
Logics.LE53.Out	Signal: Latched Output (Q)
Logics.LE53.Out inverted	Signal: Negated Latched Output (Q NOT)
Logics.LE54.Gate Out	Signal: Output of the logic gate
Logics.LE54.Timer Out	Signal: Timer Output
Logics.LE54.Out	Signal: Latched Output (Q)
Logics.LE54.Out inverted	Signal: Negated Latched Output (Q NOT)
Logics.LE55.Gate Out	Signal: Output of the logic gate
Logics.LE55.Timer Out	Signal: Timer Output
Logics.LE55.Out	Signal: Latched Output (Q)
Logics.LE55.Out inverted	Signal: Negated Latched Output (Q NOT)
Logics.LE56.Gate Out	Signal: Output of the logic gate
Logics.LE56.Timer Out	Signal: Timer Output
Logics.LE56.Out	Signal: Latched Output (Q)
Logics.LE56.Out inverted	Signal: Negated Latched Output (Q NOT)
Logics.LE57.Gate Out	Signal: Output of the logic gate
Logics.LE57.Timer Out	Signal: Timer Output
Logics.LE57.Out	Signal: Latched Output (Q)
Logics.LE57.Out inverted	Signal: Negated Latched Output (Q NOT)
Logics.LE58.Gate Out	Signal: Output of the logic gate

Parameters

<i>Name</i>	<i>Description</i>
Logics.LE58.Timer Out	Signal: Timer Output
Logics.LE58.Out	Signal: Latched Output (Q)
Logics.LE58.Out inverted	Signal: Negated Latched Output (Q NOT)
Logics.LE59.Gate Out	Signal: Output of the logic gate
Logics.LE59.Timer Out	Signal: Timer Output
Logics.LE59.Out	Signal: Latched Output (Q)
Logics.LE59.Out inverted	Signal: Negated Latched Output (Q NOT)
Logics.LE60.Gate Out	Signal: Output of the logic gate
Logics.LE60.Timer Out	Signal: Timer Output
Logics.LE60.Out	Signal: Latched Output (Q)
Logics.LE60.Out inverted	Signal: Negated Latched Output (Q NOT)
Logics.LE61.Gate Out	Signal: Output of the logic gate
Logics.LE61.Timer Out	Signal: Timer Output
Logics.LE61.Out	Signal: Latched Output (Q)
Logics.LE61.Out inverted	Signal: Negated Latched Output (Q NOT)
Logics.LE62.Gate Out	Signal: Output of the logic gate
Logics.LE62.Timer Out	Signal: Timer Output
Logics.LE62.Out	Signal: Latched Output (Q)
Logics.LE62.Out inverted	Signal: Negated Latched Output (Q NOT)
Logics.LE63.Gate Out	Signal: Output of the logic gate
Logics.LE63.Timer Out	Signal: Timer Output
Logics.LE63.Out	Signal: Latched Output (Q)
Logics.LE63.Out inverted	Signal: Negated Latched Output (Q NOT)
Logics.LE64.Gate Out	Signal: Output of the logic gate
Logics.LE64.Timer Out	Signal: Timer Output
Logics.LE64.Out	Signal: Latched Output (Q)
Logics.LE64.Out inverted	Signal: Negated Latched Output (Q NOT)
Logics.LE65.Gate Out	Signal: Output of the logic gate
Logics.LE65.Timer Out	Signal: Timer Output
Logics.LE65.Out	Signal: Latched Output (Q)
Logics.LE65.Out inverted	Signal: Negated Latched Output (Q NOT)
Logics.LE66.Gate Out	Signal: Output of the logic gate
Logics.LE66.Timer Out	Signal: Timer Output
Logics.LE66.Out	Signal: Latched Output (Q)
Logics.LE66.Out inverted	Signal: Negated Latched Output (Q NOT)
Logics.LE67.Gate Out	Signal: Output of the logic gate
Logics.LE67.Timer Out	Signal: Timer Output
Logics.LE67.Out	Signal: Latched Output (Q)
Logics.LE67.Out inverted	Signal: Negated Latched Output (Q NOT)
Logics.LE68.Gate Out	Signal: Output of the logic gate

Parameters

<i>Name</i>	<i>Description</i>
Logics.LE68.Timer Out	Signal: Timer Output
Logics.LE68.Out	Signal: Latched Output (Q)
Logics.LE68.Out inverted	Signal: Negated Latched Output (Q NOT)
Logics.LE69.Gate Out	Signal: Output of the logic gate
Logics.LE69.Timer Out	Signal: Timer Output
Logics.LE69.Out	Signal: Latched Output (Q)
Logics.LE69.Out inverted	Signal: Negated Latched Output (Q NOT)
Logics.LE70.Gate Out	Signal: Output of the logic gate
Logics.LE70.Timer Out	Signal: Timer Output
Logics.LE70.Out	Signal: Latched Output (Q)
Logics.LE70.Out inverted	Signal: Negated Latched Output (Q NOT)
Logics.LE71.Gate Out	Signal: Output of the logic gate
Logics.LE71.Timer Out	Signal: Timer Output
Logics.LE71.Out	Signal: Latched Output (Q)
Logics.LE71.Out inverted	Signal: Negated Latched Output (Q NOT)
Logics.LE72.Gate Out	Signal: Output of the logic gate
Logics.LE72.Timer Out	Signal: Timer Output
Logics.LE72.Out	Signal: Latched Output (Q)
Logics.LE72.Out inverted	Signal: Negated Latched Output (Q NOT)
Logics.LE73.Gate Out	Signal: Output of the logic gate
Logics.LE73.Timer Out	Signal: Timer Output
Logics.LE73.Out	Signal: Latched Output (Q)
Logics.LE73.Out inverted	Signal: Negated Latched Output (Q NOT)
Logics.LE74.Gate Out	Signal: Output of the logic gate
Logics.LE74.Timer Out	Signal: Timer Output
Logics.LE74.Out	Signal: Latched Output (Q)
Logics.LE74.Out inverted	Signal: Negated Latched Output (Q NOT)
Logics.LE75.Gate Out	Signal: Output of the logic gate
Logics.LE75.Timer Out	Signal: Timer Output
Logics.LE75.Out	Signal: Latched Output (Q)
Logics.LE75.Out inverted	Signal: Negated Latched Output (Q NOT)
Logics.LE76.Gate Out	Signal: Output of the logic gate
Logics.LE76.Timer Out	Signal: Timer Output
Logics.LE76.Out	Signal: Latched Output (Q)
Logics.LE76.Out inverted	Signal: Negated Latched Output (Q NOT)
Logics.LE77.Gate Out	Signal: Output of the logic gate
Logics.LE77.Timer Out	Signal: Timer Output
Logics.LE77.Out	Signal: Latched Output (Q)
Logics.LE77.Out inverted	Signal: Negated Latched Output (Q NOT)
Logics.LE78.Gate Out	Signal: Output of the logic gate

Parameters

<i>Name</i>	<i>Description</i>
Logics.LE78.Timer Out	Signal: Timer Output
Logics.LE78.Out	Signal: Latched Output (Q)
Logics.LE78.Out inverted	Signal: Negated Latched Output (Q NOT)
Logics.LE79.Gate Out	Signal: Output of the logic gate
Logics.LE79.Timer Out	Signal: Timer Output
Logics.LE79.Out	Signal: Latched Output (Q)
Logics.LE79.Out inverted	Signal: Negated Latched Output (Q NOT)
Logics.LE80.Gate Out	Signal: Output of the logic gate
Logics.LE80.Timer Out	Signal: Timer Output
Logics.LE80.Out	Signal: Latched Output (Q)
Logics.LE80.Out inverted	Signal: Negated Latched Output (Q NOT)

Parameter Setting at the HMI

Every parameter belongs to an access area. Editing and changing of a parameter requires a sufficient access authorization.

The User can obtain the required access authorizations by unlocking access areas in advance of parameter changes or context-dependent. In the following sections both options will be explained.

Option 1: Direct Authorization for an Access Area

Call up menu [Device Para\Access level].

Select the required access level respectively navigate to the required access authorization (level). Enter the required password. If the correct password has been entered, the required access authorization will be obtained. In order to do the parameter changes please proceed as follows:

- Move to the parameter you want to change by using the Softkeys. If the parameter is selected, the lower right corner of the display should show a »Wrench« symbol.



This symbol indicates, that the parameter is unlocked and can be edited, because the required access authorization is available. Confirm the Softkey »Wrench«, in order to edit the parameter. Change the parameter.

Now you can:

- save the change you made and have them adopted by the system or:
- change additional parameters and save finally all the altered parameters and have them adopted by the system.

To save parameter changes immediately,

- press the »OK« key for saving changed parameters directly and to have them adopted by the device. Confirm the parameter changes by pressing the »Yes« Softkey or dismiss by pressing »No«.

To change additional parameters and save afterwards,

- move to other parameters and change them

NOTICE

A star symbol in front of the changed parameters indicates that the modifications have only been saved temporarily, they are not yet finally stored and adopted by the device.

In order to make things easier to follow, especially where complex parameter changes are involved, on every superior/higher-ranking menu level the intended change of the parameter is indicated by the star symbol (star trace). This makes it possible to control or follow up from the main menu level at any time where parameter changes have been made and have not been saved finally.

In addition to the star trace to the temporary saved parameter changes, a general parameter changing symbol is faded-in at the left corner of the display,

and so it is possible from each point of the menu tree to see that there are parameter changes still not adopted by the device.

Press the »OK« key to initiate the final storage of all parameter changes. Confirm the parameter changes by pressing the »Yes« softkey or dismiss by pressing Softkey »No«.

NOTICE

If the display shows a Key Symbol instead of a Wrench-Symbol, this will indicate, that the required access authorization is not available.



In order to edit this parameter, a password is required, that provides the required authorization.

NOTICE

Plausibility check: In order to prevent obvious wrong settings the device monitors constantly all temporary saved parameter changes. If the device detects an implausibility, this is indicated by a question mark in front of the respective parameter.

In order to make things easier to follow up, especially where complex parameter changes are involved, on every superior/higher-ranking menu level, above the temporarily saved parameters an invalidity is indicated by the question mark (plausibility trace). This makes it possible to control or follow from the main menu level at any time where implausibilities are intended to be saved.

In addition to the question mark trace to the temporary saved implausible parameter changes a general implausibility symbol/question mark is faded-in at the left corner of the display, and so it is possible to see from each point of the menu tree that implausibilities have been detected by the device.

A star/parameter change indication is always overwritten by the question mark/implausibility symbol.

If a device detects an implausibility, it rejects saving and adopting of the parameters.

Option 2: Context-dependent Access Authorization

Navigate to the parameter, that is to be changed. If the parameter is selected, the lower right corner of the display shows a »Key«-Symbol.



This symbol indicates, that the device is still within the »Read Only Lv0«-Level, or that the current level does not provide sufficient access rights to allow editing of this parameter.

Press this Softkey and enter the password¹⁾ that provides access to this parameter.
Please change the parameter settings.

¹⁾ This page provides also information, which password/access authorization is required to do changes on this parameter.

Now you can:

- save the change you made and have them adopted by the system or:
- change additional parameters and save finally all the altered parameters and have them adopted by the system.

To save parameter changes immediately,

- press the »OK« key for saving changed parameters directly and to have them adopted by the device.
Confirm the parameter changes by pressing the »Yes« Softkey or dismiss by pressing »No«.

To change additional parameters and save afterwards,

- move to other parameters and change them

NOTICE

A star symbol in front of the changed parameters indicates that the modifications have only been saved temporary, they are not yet finally stored and adopted by the device.

In order to make things easier to follow up, especially where complex parameter changes are involved, on every superior/higher-ranking menu level the intended change of the parameter is indicated by the star symbol (star trace). This makes it possible to control or follow from the main menu level at any time where parameter changes have been made and have not been saved finally.

In addition to the star trace to the temporary saved parameter changes, a general parameter changing symbol is faded-in at the left corner of the display, and so it is possible from each point of the menu tree to see that there are parameter changes still not adopted by the device.

Press the »OK« key to initiate the final storage of all parameter changes. Confirm the parameter changes by pressing the »Yes« Softkey or dismiss by pressing Softkey »No«.

NOTICE

Plausibility check: In order to prevent obvious wrong settings the device monitors constantly all temporary saved parameter changes. If the device detects an implausibility, this is indicated by a question mark in front of the respective parameter.

In order to make things easier to follow up, especially where complex parameter changes are involved, on every superior/higher-ranking menu level, above the temporary saved parameters an invalidity is indicated by the question mark (plausibility trace). This makes it possible to control or follow from the main menu level at any time where implausibilities are intended to be saved.

In addition to the question mark trace to the temporary saved implausible parameter changes a general implausibility symbol/question mark is faded-in at the left corner of the display, and so it is possible to see from each point of the menu tree that implausibilities have been detected by the device.

A star/parameter change indication is always overwritten by the question mark/implausibility symbol.

If a device detects an implausibility, it rejects saving and adopting of the parameters.

Setting Groups

Within the menu »Protection Para/P-Set Switch« you have the following possibilities:

- To set one of the four setting groups active manually.
- To assign a signal to each setting group that sets this group to active.
- Scada switches the setting groups.

NOTICE

Switching over to another (already configured) setting group is done very quickly (usually within a time of approx. 10 ms).

Option	Setting Group Switch
Manual Selection	Switch over, if another setting group is chosen manually within the menu »Protection Para/P-Set Switch«
Via Input Function (e.g. Digital Input)	<p>Switch over not until the request is clear.</p> <p>That means, if there is more or less than one request signal active, no switch over will be executed.</p> <p>Example:</p> <ul style="list-style-type: none"> • DI3 is assigned onto Parameter set 1. DI3 is active "1". • DI4 is assigned onto Parameter set 2. DI4 is inactive "0". <p>Now the device should switch from parameter set 1 to parameter set 2. Therefore at first DI3 has to become inactive "0". Than DI4 has to be active "1".</p> <p>If DI4 becomes again inactive „0“, parameter set 2 will remain active "1" as long as there is no clear request (e.g. DI3 becomes active "1", all the other assignments are inactive "0")</p>
Via SCADA	<p>Switch over if there is a clear SCADA request.</p> <p>Otherwise no switch over will be executed.</p>

NOTICE

Setting group switch: Whenever another setting group gets activated, all memory-related values (e.g. timers) are reset for all protection functions.

Configuration change: Whenever changes are made to the settings of protection parameters (device planning, global parameters or setting group parameters for more than one setting group) all protection functionality is completely deactivated for a short time. This means that all protection modules are inactive for some time, so that they can be restarted with the new settings. This way it is made sure that all protection behavior is consistent with respect to the new settings.

An *exception* from this is a configuration change that is restricted to settings from only one setting group. In this case all protection functions are only reset (exactly as for a setting group switch, see above).

Signals that can be used for PSS

<i>Name</i>	<i>Description</i>
.-.	No assignment
Prot.DFT Invalid	DFT values of fundamental and harmonics (except VX) are not valid. They depend on period time of frequency and measured channels 1-3 (VL1,VL2,VL3).
Prot.DFT Valid	DFT values of fundamental and harmonics (except VX) are valid. They depend on period time of frequency and measured channels 1-3 (VL1,VL2,VL3).
Prot.DFT Invalid (VX)	DFT values of fundamental and harmonics of VX (only) are not valid.
Prot.DFT Valid (VX)	DFT values of fundamental and harmonics of VX (only) are valid.
CTS.Alarm	Signal: Alarm Current Transformer Measuring Circuit Supervision
LOP.Alarm	Signal: Alarm Loss of Potential
DI Slot X1.DI 1	Signal: Digital Input
DI Slot X1.DI 2	Signal: Digital Input
DI Slot X1.DI 3	Signal: Digital Input
DI Slot X1.DI 4	Signal: Digital Input
DI Slot X1.DI 5	Signal: Digital Input
DI Slot X1.DI 6	Signal: Digital Input
DI Slot X1.DI 7	Signal: Digital Input
DI Slot X1.DI 8	Signal: Digital Input
DI Slot X5.DI 1	Signal: Digital Input
DI Slot X5.DI 2	Signal: Digital Input
DI Slot X5.DI 3	Signal: Digital Input
DI Slot X5.DI 4	Signal: Digital Input
DI Slot X5.DI 5	Signal: Digital Input
DI Slot X5.DI 6	Signal: Digital Input
DI Slot X5.DI 7	Signal: Digital Input
DI Slot X5.DI 8	Signal: Digital Input
DI Slot X6.DI 1	Signal: Digital Input
DI Slot X6.DI 2	Signal: Digital Input
DI Slot X6.DI 3	Signal: Digital Input
DI Slot X6.DI 4	Signal: Digital Input
DI Slot X6.DI 5	Signal: Digital Input
DI Slot X6.DI 6	Signal: Digital Input
DI Slot X6.DI 7	Signal: Digital Input
DI Slot X6.DI 8	Signal: Digital Input
Logics.LE1.Gate Out	Signal: Output of the logic gate
Logics.LE1.Timer Out	Signal: Timer Output
Logics.LE1.Out	Signal: Latched Output (Q)
Logics.LE1.Out inverted	Signal: Negated Latched Output (Q NOT)
Logics.LE2.Gate Out	Signal: Output of the logic gate
Logics.LE2.Timer Out	Signal: Timer Output

Parameters

<i>Name</i>	<i>Description</i>
Logics.LE2.Out	Signal: Latched Output (Q)
Logics.LE2.Out inverted	Signal: Negated Latched Output (Q NOT)
Logics.LE3.Gate Out	Signal: Output of the logic gate
Logics.LE3.Timer Out	Signal: Timer Output
Logics.LE3.Out	Signal: Latched Output (Q)
Logics.LE3.Out inverted	Signal: Negated Latched Output (Q NOT)
Logics.LE4.Gate Out	Signal: Output of the logic gate
Logics.LE4.Timer Out	Signal: Timer Output
Logics.LE4.Out	Signal: Latched Output (Q)
Logics.LE4.Out inverted	Signal: Negated Latched Output (Q NOT)
Logics.LE5.Gate Out	Signal: Output of the logic gate
Logics.LE5.Timer Out	Signal: Timer Output
Logics.LE5.Out	Signal: Latched Output (Q)
Logics.LE5.Out inverted	Signal: Negated Latched Output (Q NOT)
Logics.LE6.Gate Out	Signal: Output of the logic gate
Logics.LE6.Timer Out	Signal: Timer Output
Logics.LE6.Out	Signal: Latched Output (Q)
Logics.LE6.Out inverted	Signal: Negated Latched Output (Q NOT)
Logics.LE7.Gate Out	Signal: Output of the logic gate
Logics.LE7.Timer Out	Signal: Timer Output
Logics.LE7.Out	Signal: Latched Output (Q)
Logics.LE7.Out inverted	Signal: Negated Latched Output (Q NOT)
Logics.LE8.Gate Out	Signal: Output of the logic gate
Logics.LE8.Timer Out	Signal: Timer Output
Logics.LE8.Out	Signal: Latched Output (Q)
Logics.LE8.Out inverted	Signal: Negated Latched Output (Q NOT)
Logics.LE9.Gate Out	Signal: Output of the logic gate
Logics.LE9.Timer Out	Signal: Timer Output
Logics.LE9.Out	Signal: Latched Output (Q)
Logics.LE9.Out inverted	Signal: Negated Latched Output (Q NOT)
Logics.LE10.Gate Out	Signal: Output of the logic gate
Logics.LE10.Timer Out	Signal: Timer Output
Logics.LE10.Out	Signal: Latched Output (Q)
Logics.LE10.Out inverted	Signal: Negated Latched Output (Q NOT)
Logics.LE11.Gate Out	Signal: Output of the logic gate
Logics.LE11.Timer Out	Signal: Timer Output
Logics.LE11.Out	Signal: Latched Output (Q)
Logics.LE11.Out inverted	Signal: Negated Latched Output (Q NOT)
Logics.LE12.Gate Out	Signal: Output of the logic gate
Logics.LE12.Timer Out	Signal: Timer Output

Parameters

<i>Name</i>	<i>Description</i>
Logics.LE12.Out	Signal: Latched Output (Q)
Logics.LE12.Out inverted	Signal: Negated Latched Output (Q NOT)
Logics.LE13.Gate Out	Signal: Output of the logic gate
Logics.LE13.Timer Out	Signal: Timer Output
Logics.LE13.Out	Signal: Latched Output (Q)
Logics.LE13.Out inverted	Signal: Negated Latched Output (Q NOT)
Logics.LE14.Gate Out	Signal: Output of the logic gate
Logics.LE14.Timer Out	Signal: Timer Output
Logics.LE14.Out	Signal: Latched Output (Q)
Logics.LE14.Out inverted	Signal: Negated Latched Output (Q NOT)
Logics.LE15.Gate Out	Signal: Output of the logic gate
Logics.LE15.Timer Out	Signal: Timer Output
Logics.LE15.Out	Signal: Latched Output (Q)
Logics.LE15.Out inverted	Signal: Negated Latched Output (Q NOT)
Logics.LE16.Gate Out	Signal: Output of the logic gate
Logics.LE16.Timer Out	Signal: Timer Output
Logics.LE16.Out	Signal: Latched Output (Q)
Logics.LE16.Out inverted	Signal: Negated Latched Output (Q NOT)
Logics.LE17.Gate Out	Signal: Output of the logic gate
Logics.LE17.Timer Out	Signal: Timer Output
Logics.LE17.Out	Signal: Latched Output (Q)
Logics.LE17.Out inverted	Signal: Negated Latched Output (Q NOT)
Logics.LE18.Gate Out	Signal: Output of the logic gate
Logics.LE18.Timer Out	Signal: Timer Output
Logics.LE18.Out	Signal: Latched Output (Q)
Logics.LE18.Out inverted	Signal: Negated Latched Output (Q NOT)
Logics.LE19.Gate Out	Signal: Output of the logic gate
Logics.LE19.Timer Out	Signal: Timer Output
Logics.LE19.Out	Signal: Latched Output (Q)
Logics.LE19.Out inverted	Signal: Negated Latched Output (Q NOT)
Logics.LE20.Gate Out	Signal: Output of the logic gate
Logics.LE20.Timer Out	Signal: Timer Output
Logics.LE20.Out	Signal: Latched Output (Q)
Logics.LE20.Out inverted	Signal: Negated Latched Output (Q NOT)
Logics.LE21.Gate Out	Signal: Output of the logic gate
Logics.LE21.Timer Out	Signal: Timer Output
Logics.LE21.Out	Signal: Latched Output (Q)
Logics.LE21.Out inverted	Signal: Negated Latched Output (Q NOT)
Logics.LE22.Gate Out	Signal: Output of the logic gate
Logics.LE22.Timer Out	Signal: Timer Output

Parameters

<i>Name</i>	<i>Description</i>
Logics.LE22.Out	Signal: Latched Output (Q)
Logics.LE22.Out inverted	Signal: Negated Latched Output (Q NOT)
Logics.LE23.Gate Out	Signal: Output of the logic gate
Logics.LE23.Timer Out	Signal: Timer Output
Logics.LE23.Out	Signal: Latched Output (Q)
Logics.LE23.Out inverted	Signal: Negated Latched Output (Q NOT)
Logics.LE24.Gate Out	Signal: Output of the logic gate
Logics.LE24.Timer Out	Signal: Timer Output
Logics.LE24.Out	Signal: Latched Output (Q)
Logics.LE24.Out inverted	Signal: Negated Latched Output (Q NOT)
Logics.LE25.Gate Out	Signal: Output of the logic gate
Logics.LE25.Timer Out	Signal: Timer Output
Logics.LE25.Out	Signal: Latched Output (Q)
Logics.LE25.Out inverted	Signal: Negated Latched Output (Q NOT)
Logics.LE26.Gate Out	Signal: Output of the logic gate
Logics.LE26.Timer Out	Signal: Timer Output
Logics.LE26.Out	Signal: Latched Output (Q)
Logics.LE26.Out inverted	Signal: Negated Latched Output (Q NOT)
Logics.LE27.Gate Out	Signal: Output of the logic gate
Logics.LE27.Timer Out	Signal: Timer Output
Logics.LE27.Out	Signal: Latched Output (Q)
Logics.LE27.Out inverted	Signal: Negated Latched Output (Q NOT)
Logics.LE28.Gate Out	Signal: Output of the logic gate
Logics.LE28.Timer Out	Signal: Timer Output
Logics.LE28.Out	Signal: Latched Output (Q)
Logics.LE28.Out inverted	Signal: Negated Latched Output (Q NOT)
Logics.LE29.Gate Out	Signal: Output of the logic gate
Logics.LE29.Timer Out	Signal: Timer Output
Logics.LE29.Out	Signal: Latched Output (Q)
Logics.LE29.Out inverted	Signal: Negated Latched Output (Q NOT)
Logics.LE30.Gate Out	Signal: Output of the logic gate
Logics.LE30.Timer Out	Signal: Timer Output
Logics.LE30.Out	Signal: Latched Output (Q)
Logics.LE30.Out inverted	Signal: Negated Latched Output (Q NOT)
Logics.LE31.Gate Out	Signal: Output of the logic gate
Logics.LE31.Timer Out	Signal: Timer Output
Logics.LE31.Out	Signal: Latched Output (Q)
Logics.LE31.Out inverted	Signal: Negated Latched Output (Q NOT)
Logics.LE32.Gate Out	Signal: Output of the logic gate
Logics.LE32.Timer Out	Signal: Timer Output

Parameters

<i>Name</i>	<i>Description</i>
Logics.LE32.Out	Signal: Latched Output (Q)
Logics.LE32.Out inverted	Signal: Negated Latched Output (Q NOT)
Logics.LE33.Gate Out	Signal: Output of the logic gate
Logics.LE33.Timer Out	Signal: Timer Output
Logics.LE33.Out	Signal: Latched Output (Q)
Logics.LE33.Out inverted	Signal: Negated Latched Output (Q NOT)
Logics.LE34.Gate Out	Signal: Output of the logic gate
Logics.LE34.Timer Out	Signal: Timer Output
Logics.LE34.Out	Signal: Latched Output (Q)
Logics.LE34.Out inverted	Signal: Negated Latched Output (Q NOT)
Logics.LE35.Gate Out	Signal: Output of the logic gate
Logics.LE35.Timer Out	Signal: Timer Output
Logics.LE35.Out	Signal: Latched Output (Q)
Logics.LE35.Out inverted	Signal: Negated Latched Output (Q NOT)
Logics.LE36.Gate Out	Signal: Output of the logic gate
Logics.LE36.Timer Out	Signal: Timer Output
Logics.LE36.Out	Signal: Latched Output (Q)
Logics.LE36.Out inverted	Signal: Negated Latched Output (Q NOT)
Logics.LE37.Gate Out	Signal: Output of the logic gate
Logics.LE37.Timer Out	Signal: Timer Output
Logics.LE37.Out	Signal: Latched Output (Q)
Logics.LE37.Out inverted	Signal: Negated Latched Output (Q NOT)
Logics.LE38.Gate Out	Signal: Output of the logic gate
Logics.LE38.Timer Out	Signal: Timer Output
Logics.LE38.Out	Signal: Latched Output (Q)
Logics.LE38.Out inverted	Signal: Negated Latched Output (Q NOT)
Logics.LE39.Gate Out	Signal: Output of the logic gate
Logics.LE39.Timer Out	Signal: Timer Output
Logics.LE39.Out	Signal: Latched Output (Q)
Logics.LE39.Out inverted	Signal: Negated Latched Output (Q NOT)
Logics.LE40.Gate Out	Signal: Output of the logic gate
Logics.LE40.Timer Out	Signal: Timer Output
Logics.LE40.Out	Signal: Latched Output (Q)
Logics.LE40.Out inverted	Signal: Negated Latched Output (Q NOT)
Logics.LE41.Gate Out	Signal: Output of the logic gate
Logics.LE41.Timer Out	Signal: Timer Output
Logics.LE41.Out	Signal: Latched Output (Q)
Logics.LE41.Out inverted	Signal: Negated Latched Output (Q NOT)
Logics.LE42.Gate Out	Signal: Output of the logic gate
Logics.LE42.Timer Out	Signal: Timer Output

Parameters

<i>Name</i>	<i>Description</i>
Logics.LE42.Out	Signal: Latched Output (Q)
Logics.LE42.Out inverted	Signal: Negated Latched Output (Q NOT)
Logics.LE43.Gate Out	Signal: Output of the logic gate
Logics.LE43.Timer Out	Signal: Timer Output
Logics.LE43.Out	Signal: Latched Output (Q)
Logics.LE43.Out inverted	Signal: Negated Latched Output (Q NOT)
Logics.LE44.Gate Out	Signal: Output of the logic gate
Logics.LE44.Timer Out	Signal: Timer Output
Logics.LE44.Out	Signal: Latched Output (Q)
Logics.LE44.Out inverted	Signal: Negated Latched Output (Q NOT)
Logics.LE45.Gate Out	Signal: Output of the logic gate
Logics.LE45.Timer Out	Signal: Timer Output
Logics.LE45.Out	Signal: Latched Output (Q)
Logics.LE45.Out inverted	Signal: Negated Latched Output (Q NOT)
Logics.LE46.Gate Out	Signal: Output of the logic gate
Logics.LE46.Timer Out	Signal: Timer Output
Logics.LE46.Out	Signal: Latched Output (Q)
Logics.LE46.Out inverted	Signal: Negated Latched Output (Q NOT)
Logics.LE47.Gate Out	Signal: Output of the logic gate
Logics.LE47.Timer Out	Signal: Timer Output
Logics.LE47.Out	Signal: Latched Output (Q)
Logics.LE47.Out inverted	Signal: Negated Latched Output (Q NOT)
Logics.LE48.Gate Out	Signal: Output of the logic gate
Logics.LE48.Timer Out	Signal: Timer Output
Logics.LE48.Out	Signal: Latched Output (Q)
Logics.LE48.Out inverted	Signal: Negated Latched Output (Q NOT)
Logics.LE49.Gate Out	Signal: Output of the logic gate
Logics.LE49.Timer Out	Signal: Timer Output
Logics.LE49.Out	Signal: Latched Output (Q)
Logics.LE49.Out inverted	Signal: Negated Latched Output (Q NOT)
Logics.LE50.Gate Out	Signal: Output of the logic gate
Logics.LE50.Timer Out	Signal: Timer Output
Logics.LE50.Out	Signal: Latched Output (Q)
Logics.LE50.Out inverted	Signal: Negated Latched Output (Q NOT)
Logics.LE51.Gate Out	Signal: Output of the logic gate
Logics.LE51.Timer Out	Signal: Timer Output
Logics.LE51.Out	Signal: Latched Output (Q)
Logics.LE51.Out inverted	Signal: Negated Latched Output (Q NOT)
Logics.LE52.Gate Out	Signal: Output of the logic gate
Logics.LE52.Timer Out	Signal: Timer Output

Parameters

<i>Name</i>	<i>Description</i>
Logics.LE52.Out	Signal: Latched Output (Q)
Logics.LE52.Out inverted	Signal: Negated Latched Output (Q NOT)
Logics.LE53.Gate Out	Signal: Output of the logic gate
Logics.LE53.Timer Out	Signal: Timer Output
Logics.LE53.Out	Signal: Latched Output (Q)
Logics.LE53.Out inverted	Signal: Negated Latched Output (Q NOT)
Logics.LE54.Gate Out	Signal: Output of the logic gate
Logics.LE54.Timer Out	Signal: Timer Output
Logics.LE54.Out	Signal: Latched Output (Q)
Logics.LE54.Out inverted	Signal: Negated Latched Output (Q NOT)
Logics.LE55.Gate Out	Signal: Output of the logic gate
Logics.LE55.Timer Out	Signal: Timer Output
Logics.LE55.Out	Signal: Latched Output (Q)
Logics.LE55.Out inverted	Signal: Negated Latched Output (Q NOT)
Logics.LE56.Gate Out	Signal: Output of the logic gate
Logics.LE56.Timer Out	Signal: Timer Output
Logics.LE56.Out	Signal: Latched Output (Q)
Logics.LE56.Out inverted	Signal: Negated Latched Output (Q NOT)
Logics.LE57.Gate Out	Signal: Output of the logic gate
Logics.LE57.Timer Out	Signal: Timer Output
Logics.LE57.Out	Signal: Latched Output (Q)
Logics.LE57.Out inverted	Signal: Negated Latched Output (Q NOT)
Logics.LE58.Gate Out	Signal: Output of the logic gate
Logics.LE58.Timer Out	Signal: Timer Output
Logics.LE58.Out	Signal: Latched Output (Q)
Logics.LE58.Out inverted	Signal: Negated Latched Output (Q NOT)
Logics.LE59.Gate Out	Signal: Output of the logic gate
Logics.LE59.Timer Out	Signal: Timer Output
Logics.LE59.Out	Signal: Latched Output (Q)
Logics.LE59.Out inverted	Signal: Negated Latched Output (Q NOT)
Logics.LE60.Gate Out	Signal: Output of the logic gate
Logics.LE60.Timer Out	Signal: Timer Output
Logics.LE60.Out	Signal: Latched Output (Q)
Logics.LE60.Out inverted	Signal: Negated Latched Output (Q NOT)
Logics.LE61.Gate Out	Signal: Output of the logic gate
Logics.LE61.Timer Out	Signal: Timer Output
Logics.LE61.Out	Signal: Latched Output (Q)
Logics.LE61.Out inverted	Signal: Negated Latched Output (Q NOT)
Logics.LE62.Gate Out	Signal: Output of the logic gate
Logics.LE62.Timer Out	Signal: Timer Output

Parameters

<i>Name</i>	<i>Description</i>
Logics.LE62.Out	Signal: Latched Output (Q)
Logics.LE62.Out inverted	Signal: Negated Latched Output (Q NOT)
Logics.LE63.Gate Out	Signal: Output of the logic gate
Logics.LE63.Timer Out	Signal: Timer Output
Logics.LE63.Out	Signal: Latched Output (Q)
Logics.LE63.Out inverted	Signal: Negated Latched Output (Q NOT)
Logics.LE64.Gate Out	Signal: Output of the logic gate
Logics.LE64.Timer Out	Signal: Timer Output
Logics.LE64.Out	Signal: Latched Output (Q)
Logics.LE64.Out inverted	Signal: Negated Latched Output (Q NOT)
Logics.LE65.Gate Out	Signal: Output of the logic gate
Logics.LE65.Timer Out	Signal: Timer Output
Logics.LE65.Out	Signal: Latched Output (Q)
Logics.LE65.Out inverted	Signal: Negated Latched Output (Q NOT)
Logics.LE66.Gate Out	Signal: Output of the logic gate
Logics.LE66.Timer Out	Signal: Timer Output
Logics.LE66.Out	Signal: Latched Output (Q)
Logics.LE66.Out inverted	Signal: Negated Latched Output (Q NOT)
Logics.LE67.Gate Out	Signal: Output of the logic gate
Logics.LE67.Timer Out	Signal: Timer Output
Logics.LE67.Out	Signal: Latched Output (Q)
Logics.LE67.Out inverted	Signal: Negated Latched Output (Q NOT)
Logics.LE68.Gate Out	Signal: Output of the logic gate
Logics.LE68.Timer Out	Signal: Timer Output
Logics.LE68.Out	Signal: Latched Output (Q)
Logics.LE68.Out inverted	Signal: Negated Latched Output (Q NOT)
Logics.LE69.Gate Out	Signal: Output of the logic gate
Logics.LE69.Timer Out	Signal: Timer Output
Logics.LE69.Out	Signal: Latched Output (Q)
Logics.LE69.Out inverted	Signal: Negated Latched Output (Q NOT)
Logics.LE70.Gate Out	Signal: Output of the logic gate
Logics.LE70.Timer Out	Signal: Timer Output
Logics.LE70.Out	Signal: Latched Output (Q)
Logics.LE70.Out inverted	Signal: Negated Latched Output (Q NOT)
Logics.LE71.Gate Out	Signal: Output of the logic gate
Logics.LE71.Timer Out	Signal: Timer Output
Logics.LE71.Out	Signal: Latched Output (Q)
Logics.LE71.Out inverted	Signal: Negated Latched Output (Q NOT)
Logics.LE72.Gate Out	Signal: Output of the logic gate
Logics.LE72.Timer Out	Signal: Timer Output

Parameters

<i>Name</i>	<i>Description</i>
Logics.LE72.Out	Signal: Latched Output (Q)
Logics.LE72.Out inverted	Signal: Negated Latched Output (Q NOT)
Logics.LE73.Gate Out	Signal: Output of the logic gate
Logics.LE73.Timer Out	Signal: Timer Output
Logics.LE73.Out	Signal: Latched Output (Q)
Logics.LE73.Out inverted	Signal: Negated Latched Output (Q NOT)
Logics.LE74.Gate Out	Signal: Output of the logic gate
Logics.LE74.Timer Out	Signal: Timer Output
Logics.LE74.Out	Signal: Latched Output (Q)
Logics.LE74.Out inverted	Signal: Negated Latched Output (Q NOT)
Logics.LE75.Gate Out	Signal: Output of the logic gate
Logics.LE75.Timer Out	Signal: Timer Output
Logics.LE75.Out	Signal: Latched Output (Q)
Logics.LE75.Out inverted	Signal: Negated Latched Output (Q NOT)
Logics.LE76.Gate Out	Signal: Output of the logic gate
Logics.LE76.Timer Out	Signal: Timer Output
Logics.LE76.Out	Signal: Latched Output (Q)
Logics.LE76.Out inverted	Signal: Negated Latched Output (Q NOT)
Logics.LE77.Gate Out	Signal: Output of the logic gate
Logics.LE77.Timer Out	Signal: Timer Output
Logics.LE77.Out	Signal: Latched Output (Q)
Logics.LE77.Out inverted	Signal: Negated Latched Output (Q NOT)
Logics.LE78.Gate Out	Signal: Output of the logic gate
Logics.LE78.Timer Out	Signal: Timer Output
Logics.LE78.Out	Signal: Latched Output (Q)
Logics.LE78.Out inverted	Signal: Negated Latched Output (Q NOT)
Logics.LE79.Gate Out	Signal: Output of the logic gate
Logics.LE79.Timer Out	Signal: Timer Output
Logics.LE79.Out	Signal: Latched Output (Q)
Logics.LE79.Out inverted	Signal: Negated Latched Output (Q NOT)
Logics.LE80.Gate Out	Signal: Output of the logic gate
Logics.LE80.Timer Out	Signal: Timer Output
Logics.LE80.Out	Signal: Latched Output (Q)
Logics.LE80.Out inverted	Signal: Negated Latched Output (Q NOT)

Setting Lock

By means of the Setting Lock, parameter settings can be locked against any changes as long as the assigned signal is true (active). The Setting Lock can be activated within menu [Field Para/General Settings/Lock Settings].

Bypass of the Setting Lock

The setting lock can be overwritten (temporarily) in case that the status of the signal that activates the setting lock cannot be modified or should not be modified (spare key).

The Setting Lock can be bypassed by means of the Direct Control Parameter »*Setting Lock Bypass*« [Field Para/General Settings/Setting Lock Bypass]. The protective device will fall back into the Setting Lock either:

- Directly after a parameter change has been saved, else
- 10 minutes after the bypass has been activated.

Device Parameters

Sys

Date and Time

In menu »*Device parameters/Date/Time*« you can set date and time.

Version

Within this menu »*Device parameters/Version*« you can obtain information on the soft- and hardware version.

Display of ANSI-Codes

The display of ANSI codes can be activated within menu »*Device parameters/HMI//Display ANSI device numbers*«

TCP/IP Settings

Within menu »*Device Para / TCP/IP/TCP/IP Config*« the TCP/IP settings have to be set.

The first-time setting of the TCP/IP Parameters can be done at the panel (HMI) only.

NOTICE

Establishing a connection via TCP/IP to the device is only possible if your device is equipped with an Ethernet Interface (RJ45).







Contact your IT administrator in order to establish the network connection.

Set the TCP/IP Parameters

Call up »*Device parameter/TCP/IP*« at the HMI (panel) and set the following parameters:

- TCP/IP address
- Subnetmask
- Gateway

Direct Commands of the System Module





Parameter	Description	Setting range	Default	Menu path
Ack BO LED Scd TCmd 	Reset the binary output relays, LEDs, SCADA and the Trip Command.	inactive, active	inactive	[Operation /Acknowledge]
Ack LED 	All acknowledgeable LEDs will be acknowledged.	inactive, active	inactive	[Operation /Acknowledge]
Ack BO 	All acknowledgeable binary output relays will be acknowledged.	inactive, active	inactive	[Operation /Acknowledge]
Ack Scada 	SCADA will be acknowledged.	inactive, active	inactive	[Operation /Acknowledge]
Reboot 	Rebooting the device.	no, yes	no	[Service /General]
Setting Lock Bypass 	Short-period unlock of the Setting Lock	inactive, active	inactive	[Field Para /General Settings]









CAUTION, rebooting the device manually will release the Supervision Contact.

Global Protection Parameters of the System

Parameter	Description	Setting range	Default	Menu path
PSet-Switch 	Switching Parameter Set	PS1, PS2, PS3, PS4, PSS via Inp fct, PSS via Scada	PS1	[Protection Para /PSet-Switch]

Parameter	Description	Setting range	Default	Menu path
 PS1: activated by	<p>This Setting Group will be the active one if: The Parameter Setting Group Switch is set to "Switch via Input" and the other three input functions are inactive at the same time. In case that there is more than one input function active, no Parameter Setting Group Switch will be executed. In case all input functions are inactive, the device will keep working with the Setting Group that was activated lastly.</p> <p>Only available if: PSet-Switch = PSS via Inp fct</p>	1..n, PSS	.-.	[Protection Para /PSet-Switch]
 PS2: activated by	<p>This Setting Group will be the active one if: The Parameter Setting Group Switch is set to "Switch via Input" and the other three input functions are inactive at the same time. In case that there is more than one input function active, no Parameter Setting Group Switch will be executed. In case all input functions are inactive, the device will keep working with the Setting Group that was activated lastly.</p> <p>Only available if: PSet-Switch = PSS via Inp fct</p>	1..n, PSS	.-.	[Protection Para /PSet-Switch]
 PS3: activated by	<p>This Setting Group will be the active one if: The Parameter Setting Group Switch is set to "Switch via Input" and the other three input functions are inactive at the same time. In case that there is more than one input function active, no Parameter Setting Group Switch will be executed. In case all input functions are inactive, the device will keep working with the Setting Group that was activated lastly.</p> <p>Only available if: PSet-Switch = PSS via Inp fct</p>	1..n, PSS	.-.	[Protection Para /PSet-Switch]
 PS4: activated by	<p>This Setting Group will be the active one if: The Parameter Setting Group Switch is set to "Switch via Input" and the other three input functions are inactive at the same time. In case that there is more than one input function active, no Parameter Setting Group Switch will be executed. In case all input functions are inactive, the device will keep working with the Setting Group that was activated lastly.</p> <p>Only available if: PSet-Switch = PSS via Inp fct</p>	1..n, PSS	.-.	[Protection Para /PSet-Switch]

Parameter	Description	Setting range	Default	Menu path
 Ack via »C« key	Select which acknowledgeable elements can be reset via pressing the »C« key.	Nothing, Ack LEDs, Ack LEDs, relays, Ack Everything	Ack LEDs	[Device Para /Acknowledge]
 Remote Reset	Enables or disables the option to acknowledge from external/remote via signals (assignments) and SCADA.	inactive, active	active	[Device Para /Acknowledge]
 Ack LED	All acknowledgeable LEDs will be acknowledged if the state of the assigned signal becomes true. Only available if: Remote Reset = active	1..n, Assignment List	.-	[Device Para /Acknowledge]
 Ack BO	All acknowledgeable binary output relays will be acknowledged if the state of the assigned signal becomes true. Only available if: Remote Reset = active	1..n, Assignment List	.-	[Device Para /Acknowledge]
 Ack Scada	SCADA will be acknowledged if the state of the assigned signal becomes true. Only available if: Remote Reset = active	1..n, Assignment List	.-	[Device Para /Acknowledge]
 Scaling	Display of the measured values as primary, secondary or per unit values	Per unit values, Primary values, Secondary values	Per unit values	[Device Para /Measurem Display /General Settings]
 Lock Settings	No parameters can be changed as long as this input is true. The parameter settings are locked.	1..n, Assignment List	.-	[Field Para /General Settings]

System Module Input States

<i>Name</i>	<i>Description</i>	<i>Assignment via</i>
Ack LED-I	Module input state: LEDs acknowledgement by digital input	[Device Para /Acknowledge]
Ack BO-I	Module input state: Acknowledgement of the binary Output Relays	[Device Para /Acknowledge]
Ack Scada-I	Module input state: Acknowledge Scada via digital input. The replica that SCADA has got from the device is to be reset.	[Device Para /Acknowledge]
PS1-I	State of the module input respectively of the signal, that should activate this Parameter Setting Group.	[Protection Para /PSet-Switch]
PS2-I	State of the module input respectively of the signal, that should activate this Parameter Setting Group.	[Protection Para /PSet-Switch]
PS3-I	State of the module input respectively of the signal, that should activate this Parameter Setting Group.	[Protection Para /PSet-Switch]
PS4-I	State of the module input respectively of the signal, that should activate this Parameter Setting Group.	[Protection Para /PSet-Switch]
Lock Settings-I	State of the module input: No parameters can be changed as long as this input is true. The parameter settings are locked.	[Field Para /General Settings]
Internal test state	Auxiliary state for testing purposes.	[]

System Module Signals

<i>Signal</i>	<i>Description</i>
Reboot	Signal: Rebooting the device: 1=Normal Start-up; 2=Reboot by the Operator; 3=Reboot by means of Super Reset; 4=outdated; 5=outdated; 6=Unknown Error Source; 7=Forced Reboot (initiated by the main processor); 8=Exceeded Time Limit of the Protection Cycle; 9= Forced Reboot (initiated by the digital signal processor); 10=Exceeded Time Limit of the Measured Value Processing; 11=Sags of the Supply Voltage; 12=Illegal Memory Access.
Act Set	Signal: Active Parameter Set
PS 1	Signal: Parameter Set 1
PS 2	Signal: Parameter Set 2
PS 3	Signal: Parameter Set 3
PS 4	Signal: Parameter Set 4
PSS manual	Signal: Manual Switch over of a Parameter Set
PSS via Scada	Signal: Parameter Set Switch via Scada. Write into this output byte the integer of the parameter set that should become active (e.g. 4 => Switch onto parameter set 4).
PSS via Inp fct	Signal: Parameter Set Switch via input function
min 1 param changed	Signal: At least one parameter has been changed
Setting Lock Bypass	Signal: Short-period unlock of the Setting Lock
Param to be saved	Number of parameters to be saved. 0 means that all parameter changes are overtaken.
Ack LED	Signal: LEDs acknowledgement
Ack BO	Signal: Acknowledgement of the Binary Outputs
Ack Counter	Signal: Reset of all Counters
Ack Scada	Signal: Acknowledge Scada
Ack TripCmd	Signal: Reset Trip Command
Ack LED-HMI	Signal: LEDs acknowledgement :HMI
Ack BO-HMI	Signal: Acknowledgement of the Binary Outputs :HMI
Ack Counter-HMI	Signal: Reset of all Counters :HMI
Ack Scada-HMI	Signal: Acknowledge Scada :HMI
Ack TripCmd-HMI	Signal: Reset Trip Command :HMI
Ack LED-Sca	Signal: LEDs acknowledgement :SCADA
Ack BO-Sca	Signal: Acknowledgement of the Binary Outputs :SCADA
Ack Counter-Sca	Signal: Reset of all Counters :SCADA
Ack Scada-Sca	Signal: Acknowledge Scada :SCADA
Ack TripCmd-Sca	Signal: Reset Trip Command :SCADA
Res OperationsCr	Signal:: Res OperationsCr
Res AlarmCr	Signal:: Res AlarmCr
Res TripCmdCr	Signal:: Res TripCmdCr
Res TotalCr	Signal:: Res TotalCr

Special Values of the System Module



<i>Value</i>	<i>Description</i>	<i>Menu path</i>
Build	Build	[Device Para /Version]
DM-Version	Version	[Device Para /Version]
Operating hours Cr	Operating hours counter of the protective device	[Operation /Count and RevData /Sys]

Field Parameters



Field Para

Within the field parameters you can set all parameters, that are relevant for the primary side and the mains operational method like frequency, primary and secondary values...



General Field Parameters

<i>Parameter</i>	<i>Description</i>	<i>Setting range</i>	<i>Default</i>	<i>Menu path</i>
Phase Sequence 	Phase Sequence direction	ABC, ACB	ABC	[Field Para /General Settings]
f 	Nominal frequency	50Hz, 60Hz	50Hz	[Field Para /General Settings]







Field Parameters – Phase Differential Current

<i>Parameter</i>	<i>Description</i>	<i>Setting range</i>	<i>Default</i>	<i>Menu path</i>
 Id Cutoff Level	The Differential Current shown in the Display or within the PC Software will be displayed as zero, if the Differential Current falls below this Cutoff Level. This parameter has no impact on recorders.	0.0 - 0.100In	0.005In	[Device Para /Measurem Display /Diff]
 IS Cutoff Level	The Restraint Current shown in the Display or within the PC Software will be displayed as zero, if the Restraint Current falls below this Cutoff Level. This parameter has no impact on recorders.	0.0 - 0.100In	0.005In	[Device Para /Measurem Display /Diff]





Field Parameters – Earth Differential Current

<i>Parameter</i>	<i>Description</i>	<i>Setting range</i>	<i>Default</i>	<i>Menu path</i>
 IdG Cutoff Level	The Ground Differential Current shown in the Display or within the PC Software will be displayed as zero, if the Ground Differential Current falls below this Cutoff Level. This parameter has no impact on recorders.	0.0 - 0.100In	0.005In	[Device Para /Measurem Display /Diff]
 ISG Cutoff Level	The GroundRestraint Current shown in the Display or within the PC Software will be displayed as zero, if the Ground Restraint Current falls below this Cutoff Level. This parameter has no impact on recorders.	0.0 - 0.100In	0.005In	[Device Para /Measurem Display /Diff]









Field Parameters – Current Related







Parameter	Description	Setting range	Default	Menu path
CT pri 	Nominal current of the primary side of the current transformers.	1 - 50000A	1000A	[Field Para /CT Ntrl]
CT sec 	Nominal current of the secondary side of the current transformers.	1A, 5A	1A	[Field Para /CT Ntrl]
CT dir 	Protection functions with directional feature can only work properly if the connection of the current transformers is free of wiring errors. If all current transformers are connected to the device with an incorrect polarity, the wiring error can be compensated by this parameter. This parameter turns the current vectors by 180 degrees.	0°, 180°	0°	[Field Para /CT Ntrl]
ECT pri 	This parameter defines the primary nominal current of the connected earth current transformer. If the earth current is measured via the Holmgreen connection, the primary value of the phase current transformer must be entered here.	1 - 50000A	1000A	[Field Para /CT Ntrl]
ECT sec 	This parameter defines the secondary nominal current of the connected earth current transformer. If the earth current is done via the Holmgreen connection, the primary value of the phase current transformer must be entered here.	1A, 5A	1A	[Field Para /CT Ntrl]
ECT dir 	Earth fault protection with directional feature depends also on the correct wiring of the earth current transformer. An incorrect polarity/wiring can be corrected by means of the settings "0°" or "180°". The operator has the possibility of turning the current vector by 180 degrees (change of sign) without modification of the wiring. This means, that - in terms of figures - the determined current indicator was turned by 180° by the device.	0°, 180°	0°	[Field Para /CT Ntrl]

Field Parameters





<i>Parameter</i>	<i>Description</i>	<i>Setting range</i>	<i>Default</i>	<i>Menu path</i>
IL1, IL2, IL3 Cutoff Level 	The Current shown in the Display or within the PC Software will be displayed as zero, if the Current falls below this Cutoff Level. This parameter has no impact on recorders.	0.0 - 0.100In	0.005In	[Device Para /Measurem Display /CT Ntrl]
IG meas Cutoff Level 	The measured Earth Current shown in the Display or within the PC Software will be displayed as zero, if the measured Earth Current falls below this Cutoff Level. This parameter has no impact on recorders.	0.0 - 0.100In	0.005In	[Device Para /Measurem Display /CT Ntrl]
IG calc Cutoff Level 	The calculated Earth Current shown in the Display or within the PC Software will be displayed as zero, if the calculated Earth Current falls below this Cutoff Level. This parameter has no impact on recorders.	0.0 - 0.100In	0.005In	[Device Para /Measurem Display /CT Ntrl]
I012 Cutoff Level 	The Symmetrical Component shown in the Display or within the PC Software will be displayed as zero, if the Symmetrical Component falls below this Cutoff Level. This parameter has no impact on recorders.	0.0 - 0.100In	0.005In	[Device Para /Measurem Display /CT Ntrl]

Field Parameters – Voltage Related

Parameter	Description	Setting range	Default	Menu path
VT pri 	Nominal voltage of the Voltage Transformers at the primary side. The phase to phase voltage is to be entered even if the load is in delta connection.	60 - 500000V	10500V	[Field Para /VT]
VT sec 	Nominal voltage of the Voltage Transformers at the secondary side. The phase to phase voltage is to be entered even if the load is in delta connection.	60.00 - 600.00V	100V	[Field Para /VT]
VT con 	This parameter has to be set in order to ensure the correct assignment of the voltage measurement channels in the device.	Phase to Phase, Phase to Ground	Phase to Ground	[Field Para /VT]
EVT pri 	Primary nominal voltage of the e-n winding of the voltage transformers, which is only taken into account in the direct measurement of the residual voltage (GVT con=measured/broken delta).	60 - 500000V	10500V	[Field Para /VT]
EVT sec 	Secondary nominal voltage of the e-n winding of the voltage transformers, which is only taken into account in the direct measurement of the residual voltage.	35.00 - 600.00V	100V	[Field Para /VT]
V Block f 	Threshold for the release of the frequency stages	0.15 - 1.00Vn	0.5Vn	[Field Para /General Settings]
V Sync 	The fourth measuring input of the voltage measuring card measures the voltage that is to be synchronized.	L1, L2, L3, L12, L23, L31	L12	[Field Para /VT]
delta phi - Mode 	The delta phi element (vector surge) trips, if the permissible voltage angle shift (delta phi) of the three measured voltages (phase-ground or phase-phase) in: one phase, two phases or within all phases is exceeded.	one phase, two phases, three phases	two phases	[Field Para /VT]

Parameter	Description	Setting range	Default	Menu path
 Phase MTA	Maximum Torque Angle: Angle between phase current and reference voltage in case of a short circuit. This angle is needed to determine the fault direction in case of short circuits.	0 - 360°	45°	[Field Para /Direction]
 IG calc dir ctrl	Options for direction detection. IGcalc is used as operating quantity.	IG calc 3V0, IG calc IPol (IG meas), Dual, I2,V2	IG calc 3V0	[Field Para /Direction]
 IG meas dir ctrl	Options for direction detection. IGmeas is used as operating quantity.	IG meas 3V0, I2,V2, Dual	IG meas 3V0	[Field Para /Direction]
 3V0 Source	Earth overcurrent protection elements take into account this parameter for direction decisions. You have to ensure, that this parameter is set to "Measured" only if the residual voltage is fed to the fourth measuring input of the voltage measuring card.	measured, calculated	measured	[Field Para /Direction]
 Ground MTA	Ground Maximum Torque Angle: Angle between chosen operating quantity and chosen reference quantity in case of a ground fault. This angle is needed to determine the ground fault direction in case of a short circuit. Depending on the selected ground direction option, different MTA values are used: IGcalc 3V0, IGmeas 3V0 : Ground MTA; IGcalc Neg, IGmeas Neg : 90° + Phase MTA; IGcalc IPol : 0°; IGcalc Dual : 0° (if I2 and V2 available) or Ground MTA; IGmeas Dual : 90° + Phase MTA (if I2 and V2 available) or Ground MTA.	0 - 360°	110°	[Field Para /Direction]
 ECT Angle Cor	Fine adjustment of the measuring angle of the earth current transformers. By means of the Angle Correction, faults of the earth voltage transformers can be taken into account.	-45 - 45°	0°	[Field Para /Direction]

Field Parameters

<i>Parameter</i>	<i>Description</i>	<i>Setting range</i>	<i>Default</i>	<i>Menu path</i>
 V Cutoff Level	The Phase Voltage shown in the Display or within the PC Software will be displayed as zero, if the Phase Voltage falls below this Cutoff Level. This parameter has no impact on recorders. This parameter is related to the voltage that is connected to the device (phase-to-phase or phase-to-earth).	0.0 - 0.100Vn	0.005Vn	[Device Para /Measurem Display /Voltage]
 VG meas Cutoff Level	The measured Residual Voltage shown in the Display or within the PC Software will be displayed as zero, if the measured Residual Voltage falls below this Cutoff Level. This parameter has no impact on recorders.	0.0 - 0.100Vn	0.005Vn	[Device Para /Measurem Display /Voltage]
 VG calc Cutoff Level	The calculated Residual Voltage shown in the Display or within the PC Software will be displayed as zero, if the calculated Residual Voltage falls below this Cutoff Level. This parameter has no impact on recorders.	0.0 - 0.100Vn	0.005Vn	[Device Para /Measurem Display /Voltage]
 V012 Comp Cutoff Level	The Symmetrical Component shown in the Display or within the PC Software will be displayed as zero, if the Symmetrical Component falls below this Cutoff Level. This parameter has no impact on recorders.	0.0 - 0.100Vn	0.005Vn	[Device Para /Measurem Display /Voltage]

Field Parameters of the Generator

Generator





Signals (Output States) of the Generator

<i>Signal</i>	<i>Description</i>
Running hours Alarm	Running hours Alarm
Res Running hours	Reset Running hours

Direct Commands of the Generator

<i>Parameter</i>	<i>Description</i>	<i>Setting range</i>	<i>Default</i>	<i>Menu path</i>
t - Res Gen Op Hours 	Resettable Generator running hours	inactive, active	inactive	[Operation /Reset]

Global Protection Parameters of the Generator

<i>Parameter</i>	<i>Description</i>	<i>Setting range</i>	<i>Default</i>	<i>Menu path</i>
SN 	Rated Power of the Generator in MVA	0.001 - 2000.000MVA	11MVA	[Field Para /Generator]
Rated Voltage 	Rated Voltage of the Generator (Phase-Phase)	60 - 60000V	10500V	[Field Para /Generator]
Power Factor 	Power Factor	0.05 - 0.99	0.95	[Field Para /Generator]
Running hours Limit 	Running hours Limit	1.00 - 1000000.00h	1000.00h	[Field Para /Generator]
Running hours Initial 	Running hours Initial	0.00 - 999999.00h	0.00h	[Field Para /Generator]

Values of the Generator

<i>Value</i>	<i>Description</i>	<i>Menu path</i>
Gen Op Hours	Generator running hours	[Operation /Measured Values /Generator]







Field Parameters of the Transformer

Transformer

Device Planning Parameters of the Transformer

Parameter	Description	Options	Default	Menu path
 Mode	Mode selects, if power transformer is used in protection-zone. Note! For linediff application, setting for local and remote device must be equal.	do not use, use	do not use	[Device planning]

Global Protection Parameters of the Transformer

Parameter	Description	Setting range	Default	Menu path
 SN	Rated Power of the Transformer in MVA	0.001 - 2000.000MVA	11MVA	[Field Para /Transformer]
 Rated Voltage (W1)	Transformer rated voltage (phase to phase) at current measuring input W1 (slot X3).	60 - 500000V	10500V	[Field Para /Transformer]
 Rated Voltage (W2)	Transformer rated voltage (phase to phase) at current measuring input W2 (slot X4).	60 - 500000V	10000V	[Field Para /Transformer]
 W1 Connection/Grounding	Note: The zero current will be removed in order to prevent faulty tripping of the differential protection. If a star point is connected to ground according to the winding connection, the zero current (symmetrical components) will be removed.	Y, D, Z, YN, ZN	D	[Field Para /Transformer]
 W2 Connection/Grounding	Note: The zero current will be removed in order to prevent faulty tripping of the differential protection. If a star point is connected to ground according to the winding connection, the zero current (symmetrical components) will be removed.	y, d, z, yn, zn	yn	[Field Para /Transformer]
 Phase Shift	Phase Shift between W1 side and W2 side. The phase shift angle is a factor (1, 2, 3,..., 11) multiplied with 30 degrees.	0 - 11	1	[Field Para /Transformer]

Field Parameters

<i>Parameter</i>	<i>Description</i>	<i>Setting range</i>	<i>Default</i>	<i>Menu path</i>
Tap changer 	Tap changer (referring to the W1 side)	-15 - 15%	0%	[Field Para /Transformer]

Blockings

The device provides a function for temporary and permanent blocking of the complete protection functionality or of single protection stages.



WARNING Make absolutely sure that no illogical or even life-threatening blockings are allocated.

Make sure that you do not carelessly deactivate protection functions which have to be available according to the protection concept.

Permanent Blocking

Switching ON or OFF the complete protection functionality

In module »*Protection*« the complete protection of the device can be switched on or off. Set the parameter *Function* to »*active*« or »*inactive*« in module »*Prot*«.



WARNING Only if in module »*Prot*« the parameter »*Function*« is = »*active*«, the protection is activated; i.e. with »*Function*« = »*inactive*«, no protection function is operating. Then the device cannot protect any components.

Switching modules ON or OFF

Each of the modules can be switched on or off (permanently). This is achieved when the parameter »*Function*« is set to »*active*« or »*inactive*« in the respective module.

Activating or deactivating the tripping command of a protection stage permanently

In each of the protection stages the tripping command to the CB can be permanently blocked. For this purpose the parameter »*TripCmd Blo*« has to be set to »*active*«.

Temporary Blocking

To block the complete protection of the device temporarily by a signal

In module »*Prot*« the complete protection of the device can be blocked temporarily by a signal. On condition that a module-external blocking is permitted »*ExBlo Fc=active*«. In addition to this, a related blocking signal from the »assignment list« must have been assigned. For the time the allocated blocking signal is active, the module is blocked.



WARNING If the module »*Prot*« is blocked, the complete protection function does not work. As long as the blocking signal is active, the device cannot protect any components.

To block a complete protection module temporarily by an active assignment

- In order to establish a temporary blockage of a protection module, the parameter »*ExBlo Fc*« of the module has to be set to »*active*«. This gives the permission: »This module can be blocked«.
- Within the general protection parameters a signal has to be additionally chosen from the »ASSIGNMENT LIST«. The blocking only becomes active when the assigned signal is active.

To block the tripping command of a protection stage temporarily by an active assignment.

The tripping command of any of the protection modules can be blocked from external. In this case, external does not only mean from outside the device, but also from outside the module. Not only real external signals are permitted to be used as blocking signals, as for example, the state of a digital input, but you can also choose any other signal from the »assignment list«.

- In order to establish a temporary blockage of a protection stage, the parameter »*ExBlo TripCmd Fc*« of the module has to be set to »*active*«. This gives the permission: »The tripping command of this stage can be blocked«.
- Within the general protection parameters, a signal has to be chosen additionally and assigned to the parameter »*ExBlo*« from the »assignment list«. If the selected signal is activated, the temporary blockage becomes effective.

To Activate or Deactivate the Tripping Command of a Protection Module

Trip blockings

GeneralProt_Y02

name = all modules that are blockable

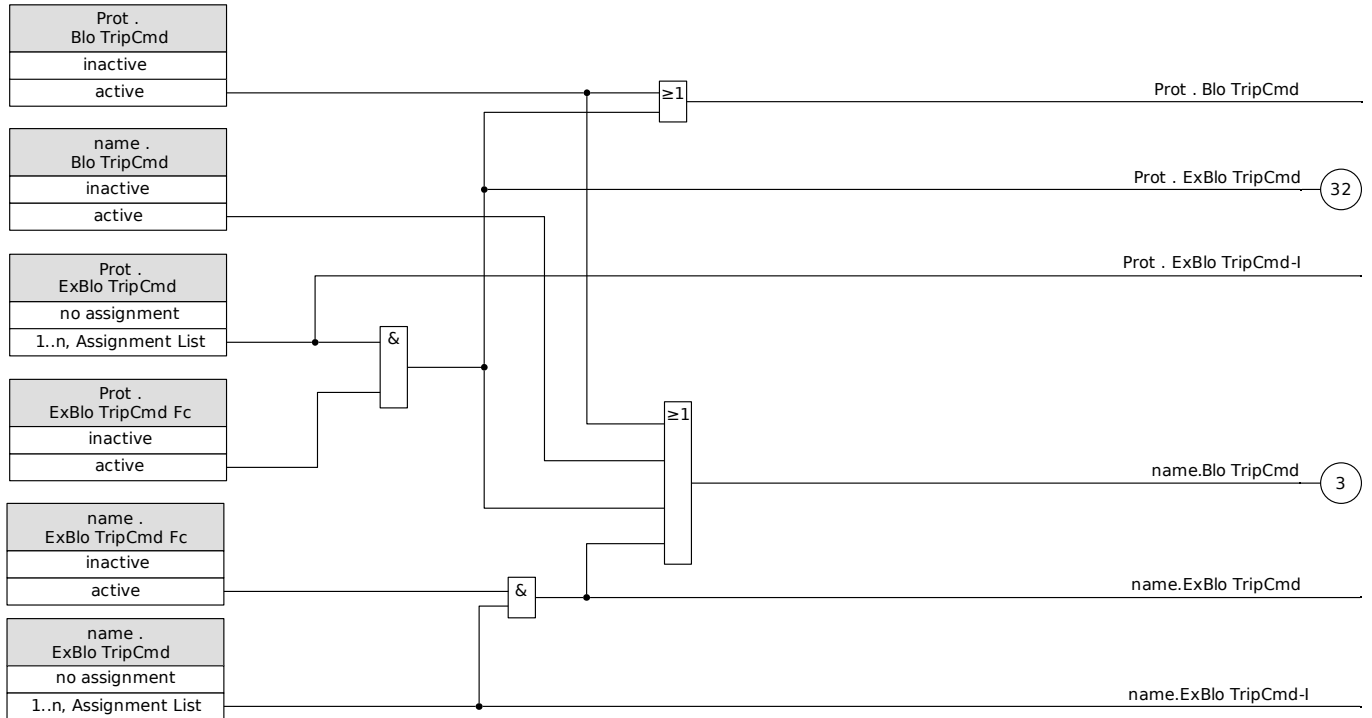

Activate, Deactivate Respectively Block Temporarily Protection Functions

The following diagram applies to all protective elements except: Phase current, Earth current, Z[1/2], OST, PSB, LB and Q->&V< protection elements.

Blockings

GeneralProt_Y03

name = all modules that are blockable

Frequency is within the nominal frequency range(*)(**)

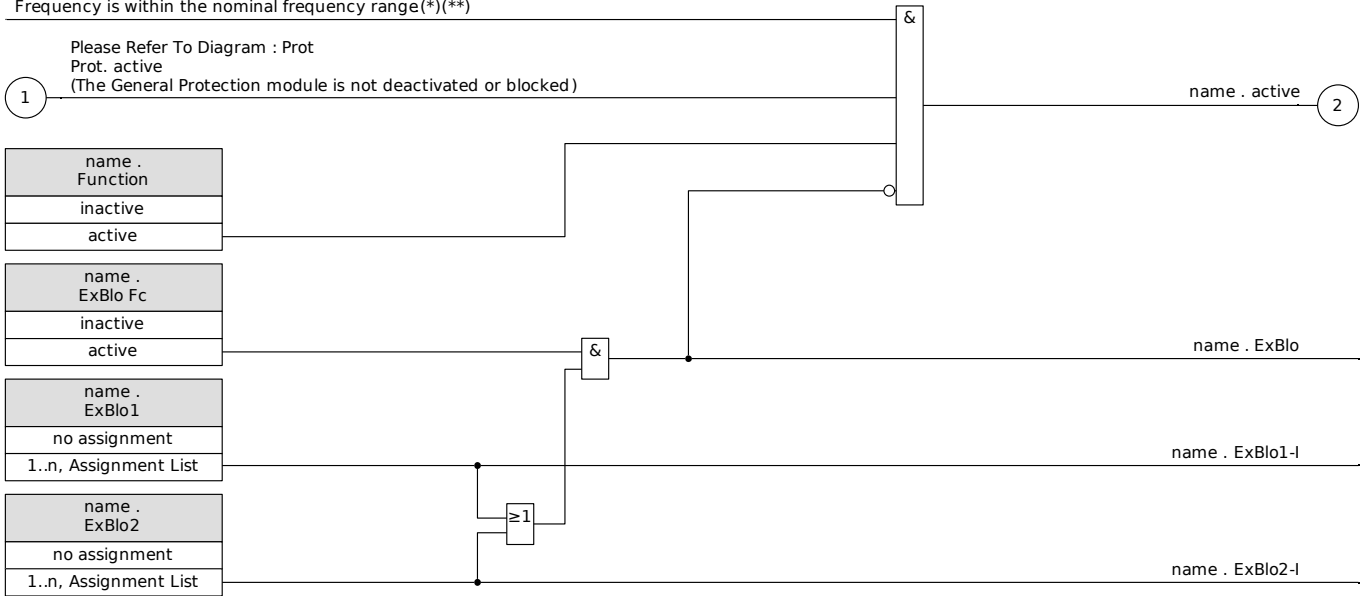

(*) All protective elements will be blocked that are using fundamental or harmonics measured values, if the frequency leaves the nominal frequency range. Protective elements that are using RMS values will remain active. See chapter "Wide frequency range".

(**) This applies to devices that offer wide frequency range measurement only.

The following diagram is applies to the Q->&V< Protection:

Blockings Q->&V< ()**

QU_Y01

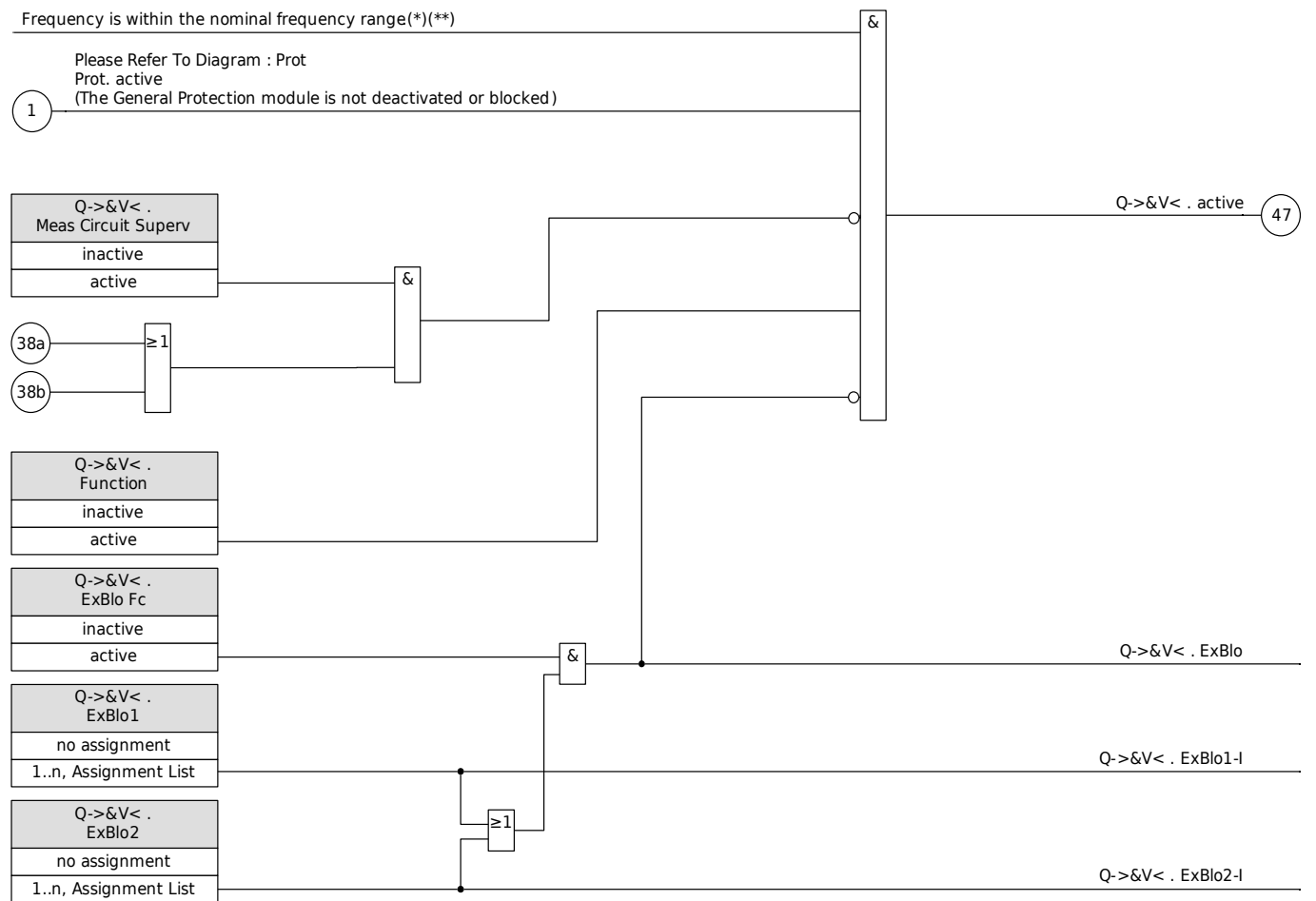

(*) All protective elements will be blocked that are using fundamental or harmonics measured values, if the frequency leaves the nominal frequency range. Protective elements that are using RMS values will remain active. See chapter "Wide frequency range".

(**) This applies to devices that offer wide frequency range measurement only.

The following diagram is applies to the Z[1/2], OST, PSB, LB Protection:

[name = Z[1/2], OST, PSB, LB]
Blockings

GeneralProt_Y06

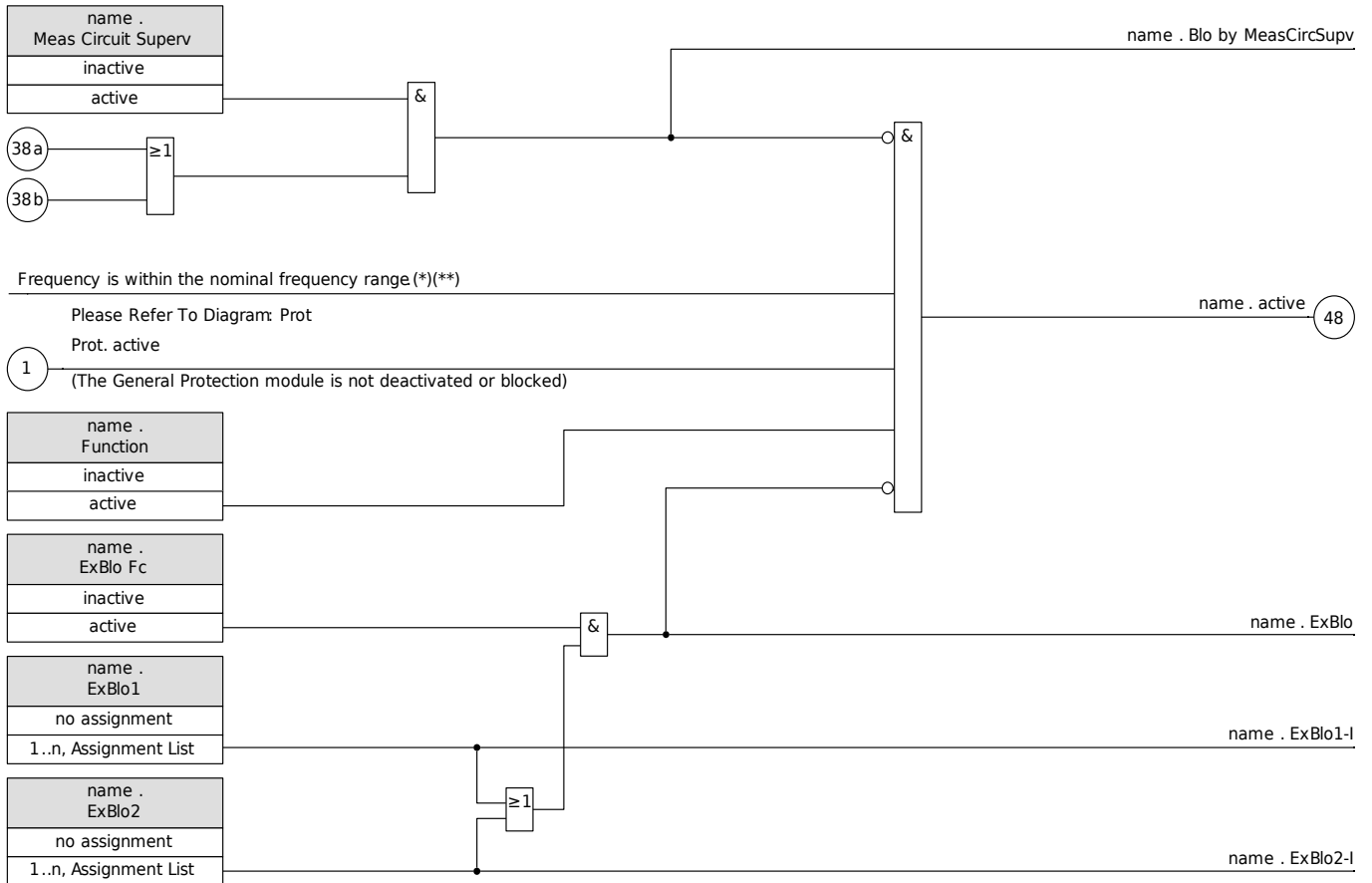

(*) All protective elements will be blocked that are using fundamental or harmonics measured values, if the frequency leaves the nominal frequency range. Protective elements that are using RMS values will remain active. See chapter "Wide frequency range".

(**) This applies to devices that offer wide frequency range measurement only.

Blockings

Current protective functions cannot only be blocked permanently (»function = inactive«) or temporarily by any blocking signal from the »assignment list«, but also by »reverse Interlocking«.

The following diagram applies phase current elements:

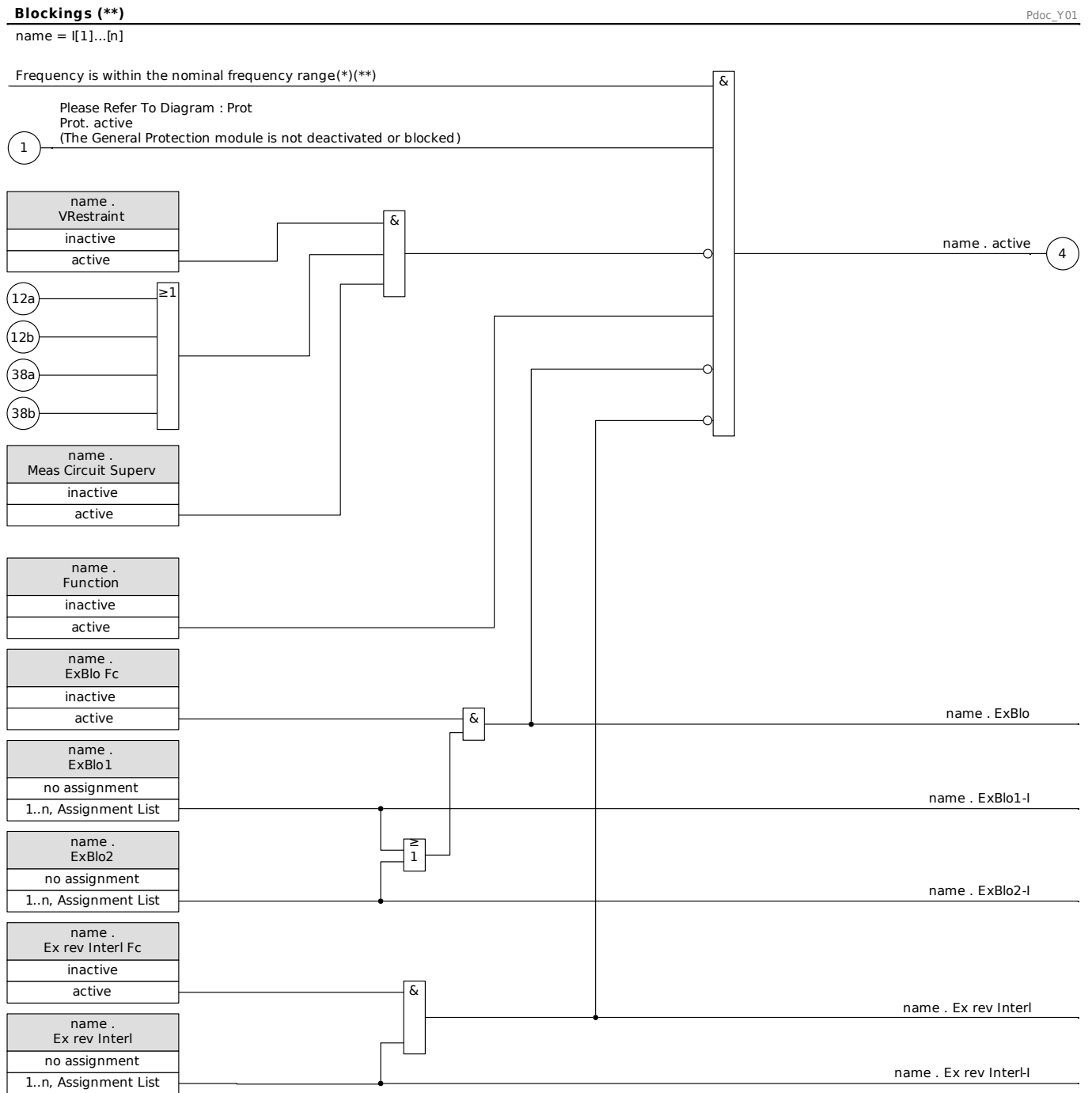

(*) All protective elements will be blocked that are using fundamental or harmonics measured values, if the frequency leaves the nominal frequency range. Protective elements that are using RMS values will remain active. See chapter "Wide frequency range".

(**) This applies to devices that offer wide frequency range measurement only.

Ground (earth) current protective functions cannot only be blocked permanently (*»function = inactive«*) or temporarily by any blocking signal from the *»assignment list«*, but also by *»reverse Interlocking«*.

The following diagram applies to earth current elements:

Blockings ()**

Edoc_Y01

name = IG[1]...[n]

Frequency is within the nominal frequency range(**)

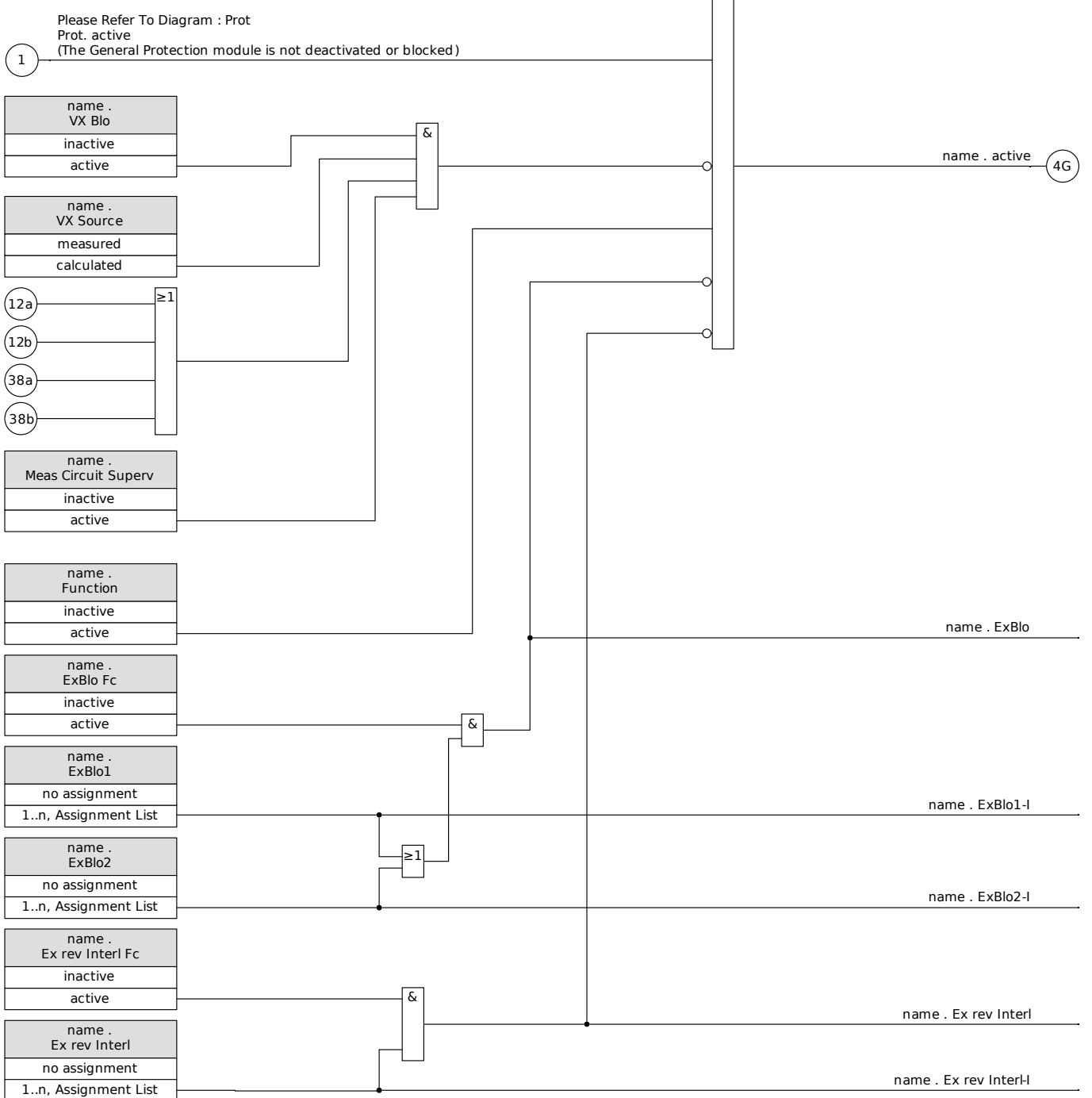

(*) All protective elements will be blocked that are using fundamental or harmonics measured values, if the frequency leaves the nominal frequency range. Protective elements that are using RMS values will remain active. See chapter "Wide frequency range".

(**) This applies to devices that offer wide frequency range measurement only.

The following diagram applies to the *Load Blinder* module:

Blockings ()**

LoadBlinder_Y02

Frequency is within the nominal frequency range(*)(**)

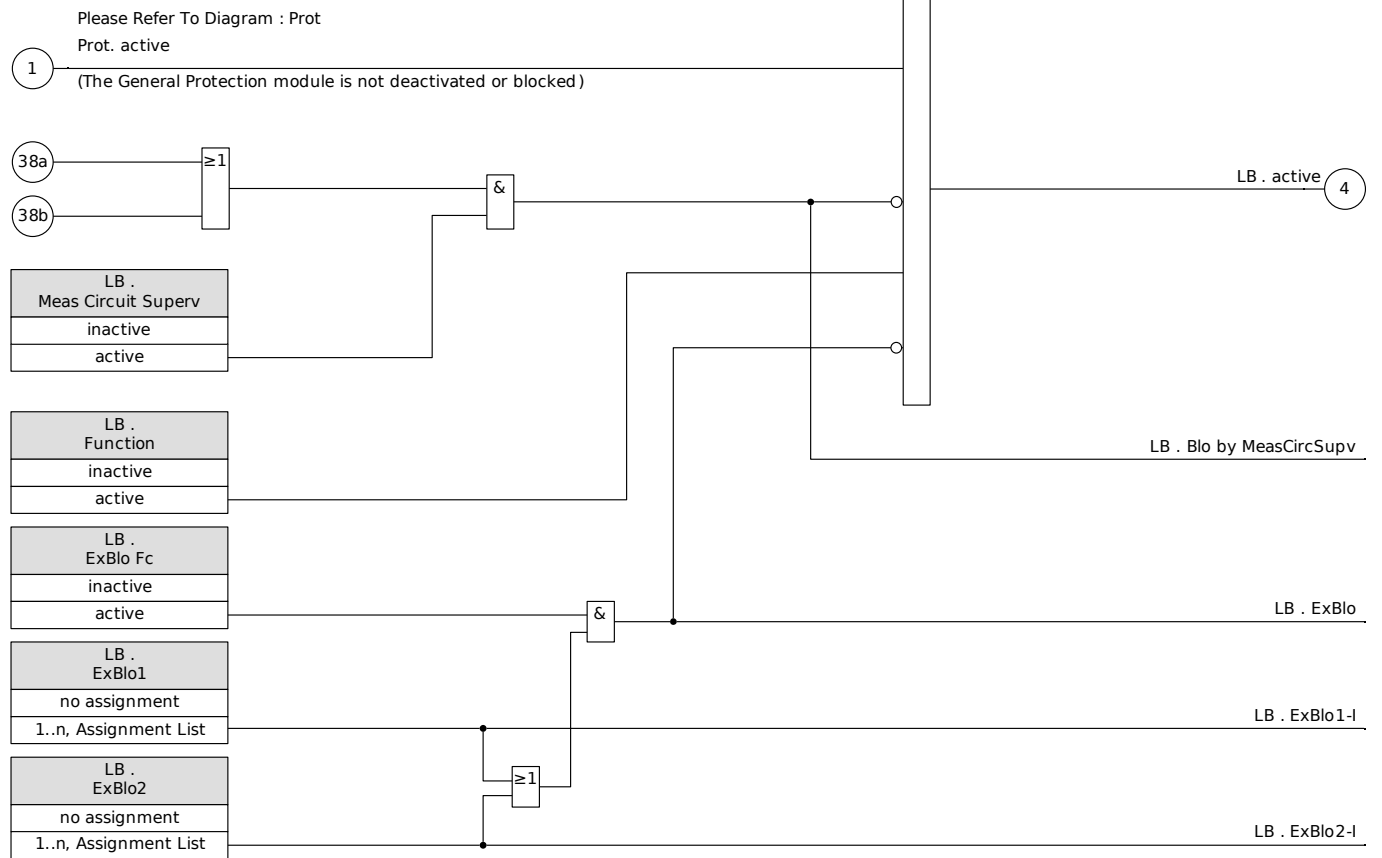

(*) All protective elements will be blocked that are using fundamental or harmonics measured values, if the frequency leaves the nominal frequency range. Protective elements that are using RMS values will remain active. See chapter "Wide frequency range".

(**) This applies to devices that offer wide frequency range measurement only.

Module: Protection (Prot)

Prot

The module »Module General Protection« (»Prot«) serves as outer frame for all other protection modules, i.e. they are all enclosed by this module.



WARNING

If in the »Prot« module the parameter [Protection Para / Global Prot Para / Prot] »Function« is set on "inactive" or in case the module is blocked, then no protective function of the device is effective.

Blocking all Protective Elements Permanently

In order to allow (the principle use) of blocking the entire protection call up the menu [Protection/Para/Global Prot Para/Prot]:

- Set the parameter »Function = inactive«.

Blocking all Protective Elements Temporarily

In order to allow (the principle use) of blocking the entire protection call up the menu [Protection/Para/Global Prot Para/Prot]:

- Set the parameter »ExBlo Fc = active«;
- Choose an assignment for »ExBlo1«; and
- Optionally choose an assignment for »ExBlo2«.

If one of the signals becomes true, then the entire protection will be blocked as long as one of these signals are true.

Blocking all Trip Commands Permanently

In order to allow (the principle use) of blocking the entire protection call up the menu [Protection/Para/Global Prot Para/Prot]:

- Set the parameter »Blo TripCmd = active«.

Blocking all Trip Commands Temporarily

In order to allow (the principle use) of blocking the entire protection, call up the menu [Protection/Para/Global Prot Para/Prot]:

- Set the parameter »ExBlo TripCmd Fc= active«.
- Choose an assignment for »ExBlo TripCmd«. All Trip commands will be blocked temporarily if this assignment becomes true.

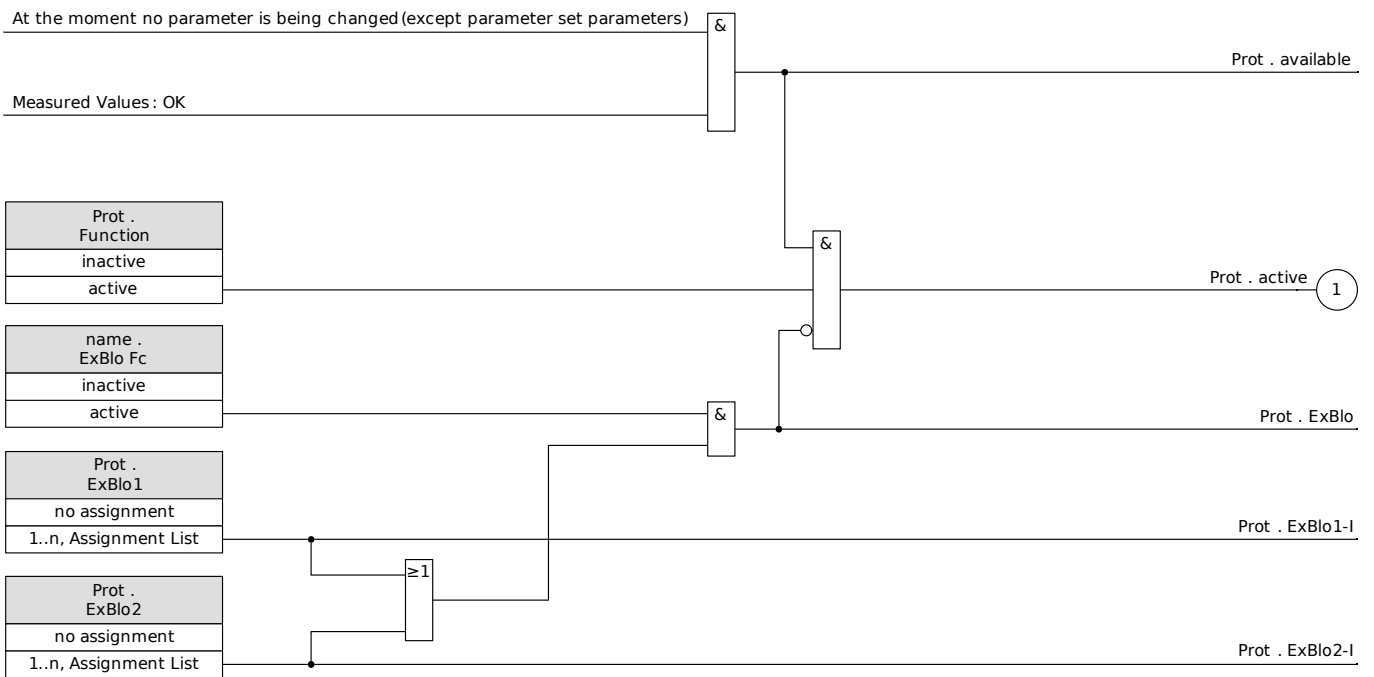

General Alarms and General Trips

Each protective element generates it's own alarm and trip signals. All alarms and trip decision are passed on to the master module *»Prot«*.

If a protective element picks up, respectively has decided about a trip, two signals will be issued:

1. The module or the protection stage issues an alarm e.g. *»I[1].ALARM«* or *»I[1].TRIP«*.
2. The master module *»Prot«* collects/summarizes the signals and issues an alarm or a trip signal *»PROT.ALARM«* *»PROT.TRIP«*.

Further examples: *»PROT.ALARM L1«* is a collective signal (OR-connected) for all alarms issued by any of the protective elements concerning Phase L1.

»PROT.TRIP L1« is a collective signal (OR-connected) for all trips issued by any of the protective elements concerning Phase L1.

»PROT.ALARM« is the collective alarm signal OR-ed from all protection elements. *»PROT.TRIP«* is the collective alarm signal OR-ed from all protection elements.

The trip commands of a the protective elements have to be assigned within the Circuit Breaker Manager *CB Manager*. Only those trip decisions that are assigned within the *CB Manager* are issued to the Circuit Breaker.



Caution: Trip commands that are not assigned within the Circuit Breaker Manager (CB Manager) are not issued to a circuit breaker.

The CB Manager issues the trip commands to a circuit breaker.

Assign within the Circuit Breaker Manager all trip commands that have to switch a circuit breaker.

Prot.Trip

name = Each trip of an active, trip authorized protection module will lead to a general trip.

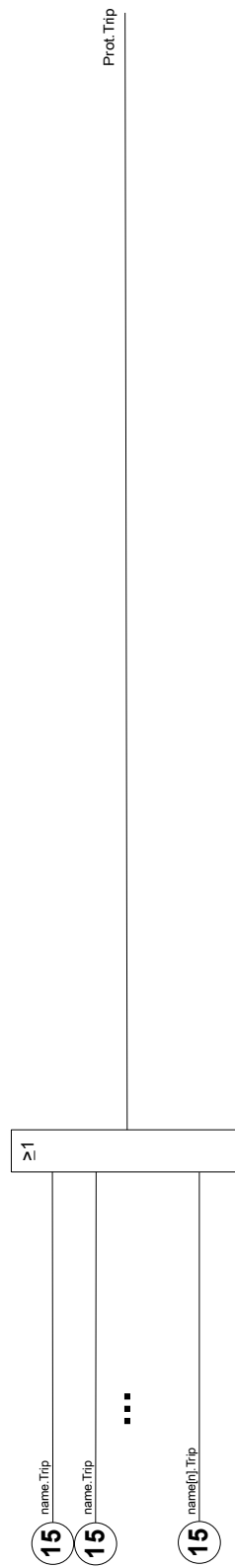

Prot.Alarm

name = Each alarm of a module (except from supervision modules but including CBF) will lead to a general alarm (collective alarm).

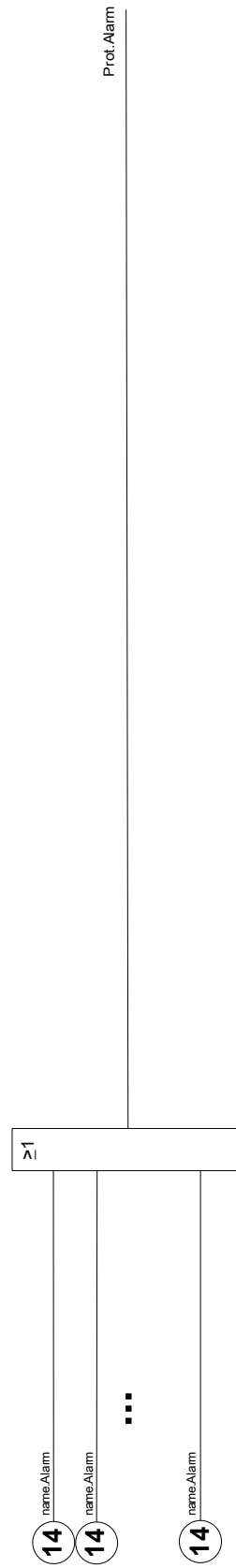

Prot. Trip

Each phase selective trip of a trip authorized module (I, IG, V, VX depending on the device type) will lead to a phase selective general trip.

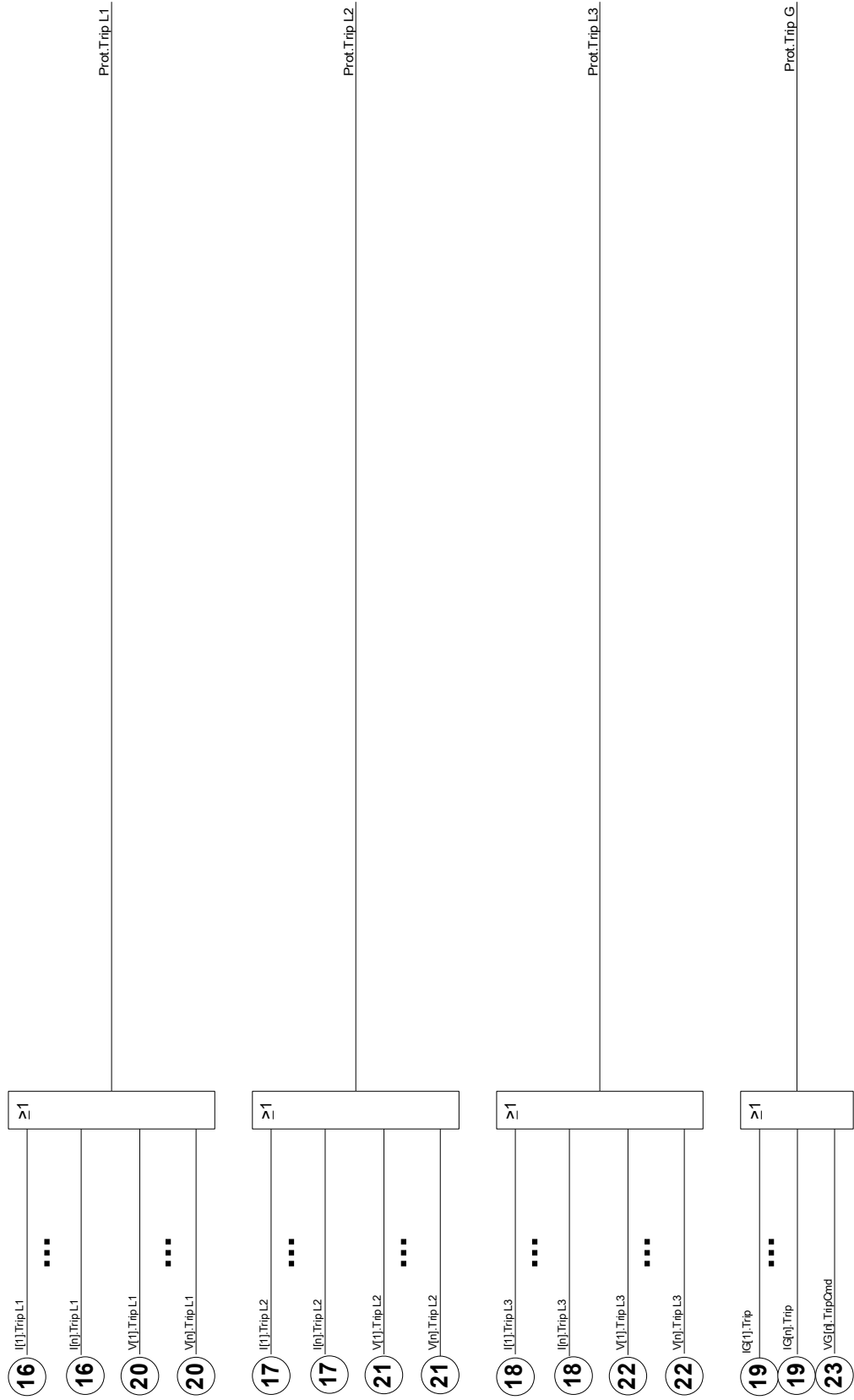

Prot.Alarm

Each phase selective alarm of a module (I, IG, V, VX depending on the device type) will lead to a phase selective general alarm (collective alarm).

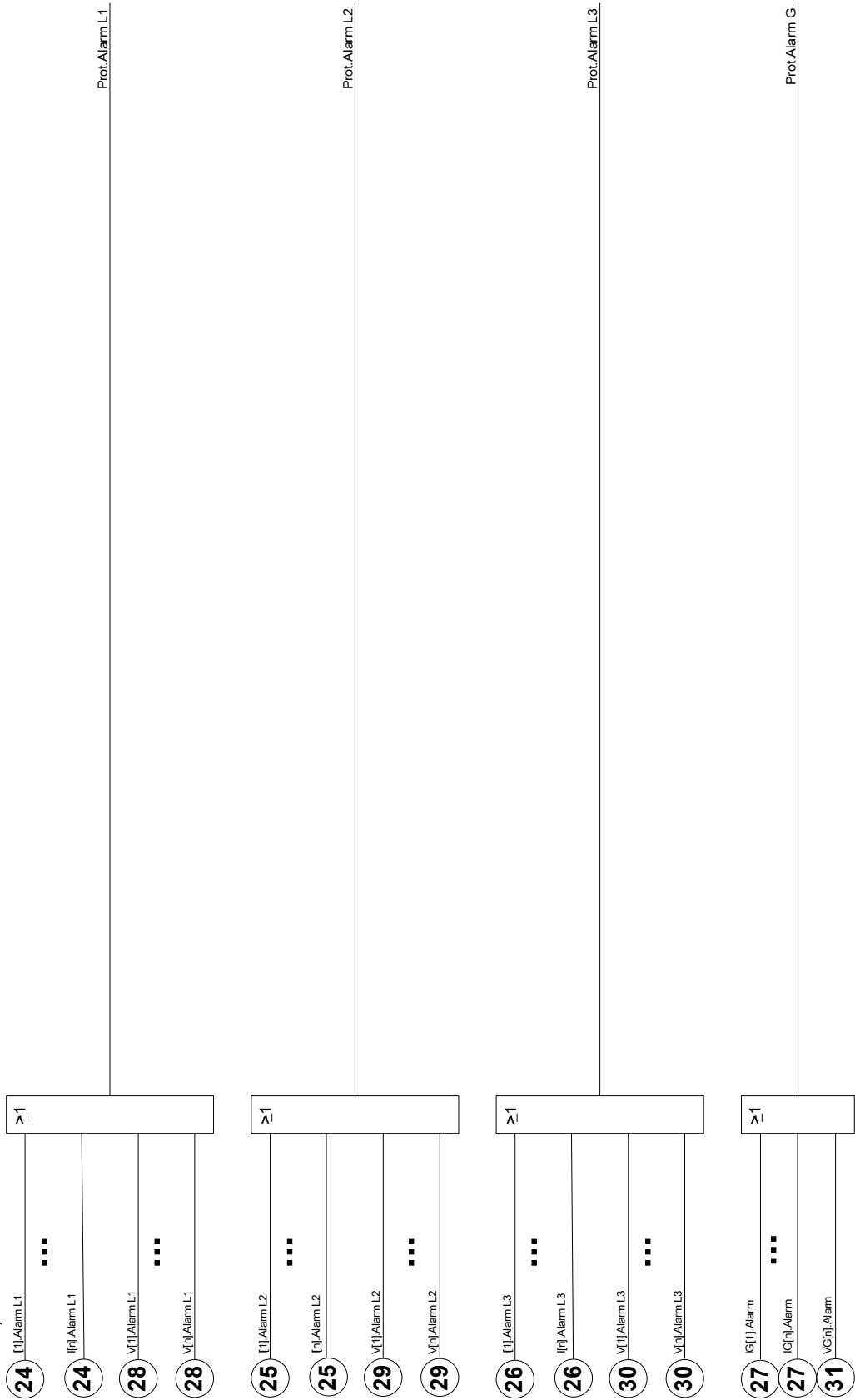

Direction Determination

The direction determination of the device is built in as part of the »Prot« module. This functionality is triggered as soon as any of the overcurrent modules I[1] ... [6] has been configured to work in directional mode (ANSI 67), and the same is true of the directional mode of the measured and calculated ground fault protection (IG[1] ... [4], ANSI 67N).

Measurement Values of the Direction Determination

Three directional values are permanently available under the menu path [Operation / Measured Values / Direction detection]:

- *»Direction I«* – Determined direction of the phase currents. (See also below, --> Directional_Feature_PhaseOvercurrent.)
- *»Direction IG meas.«* – Determined direction of the measured ground current. (See also below, --> Directional_Feature_EarthOvercurrent_IX.)
- *»Direction IG calc.«* – Determined direction of the calculated ground current. (See also below, --> Directional_Feature_EarthOvercurrent_IR.)

These values offer the same information as can be seen in case of an alarm when checking the status flags under [Operation / Status Display / Prot].







Only for the MCDGV4: As the MCDGV4 is fitted with two CT measuring inputs, the direction determination is based on the current values of the CT Ntrl input (Current transformers on the neutral side, slot X3).

Only for the MCDTV4: As the MCDTV4 is fitted with two CT measuring inputs, the direction determination is based on the current values according to the Field Parameter setting *»VX Winding Side«*.

Direct Commands of the Protection Module

Parameter	Description	Setting range	Default	Menu path
Res FaultNo a GridFaultNo 	Resetting of fault number and grid fault number.	inactive, active	inactive	[Operation /Reset]

Global Protection Parameters of the Protection Module

Parameter	Description	Setting range	Default	Menu path
Function 	Permanent activation or deactivation of module/stage.	inactive, active	active	[Protection Para /Global Prot Para /Prot]
ExBlo Fc 	Activate (allow) the external blocking of the global protection functionality of the device.	inactive, active	inactive	[Protection Para /Global Prot Para /Prot]
ExBlo1 	If external blocking of this module is activated (allowed), the global protection functionality of the device will be blocked if the state of the assigned signal becomes true.	1..n, Assignment List	.-	[Protection Para /Global Prot Para /Prot]
ExBlo2 	If external blocking of this module is activated (allowed), the global protection functionality of the device will be blocked if the state of the assigned signal becomes true.	1..n, Assignment List	.-	[Protection Para /Global Prot Para /Prot]
Blo TripCmd 	Permanent blocking of the Trip Command of the entire Protection.	inactive, active	inactive	[Protection Para /Global Prot Para /Prot]
ExBlo TripCmd Fc 	Activate (allow) the external blocking of the trip command of the entire device.	inactive, active	inactive	[Protection Para /Global Prot Para /Prot]

Parameter	Description	Setting range	Default	Menu path
 ExBlo TripCmd	If external blocking of the tripping command is activated (allowed), the tripping command of the entire device will be blocked if the state of the assigned signal becomes true.	1..n, Assignment List	.-	[Protection Para /Global Prot Para /Prot]

Protection Module Input States

Name	Description	Assignment via
ExBlo1-I	Module input state: External blocking1	[Protection Para /Global Prot Para /Prot]
ExBlo2-I	Module input state: External blocking2	[Protection Para /Global Prot Para /Prot]
ExBlo TripCmd-I	Module input state: External Blocking of the Trip Command	[Protection Para /Global Prot Para /Prot]

Protection Module Signals (Output States)

Signal	Description
available	Signal: Protection is available
active	Signal: active
ExBlo	Signal: External Blocking
Blo TripCmd	Signal: Trip Command blocked
ExBlo TripCmd	Signal: External Blocking of the Trip Command
Alarm L1	Signal: General-Alarm L1
Alarm L2	Signal: General-Alarm L2
Alarm L3	Signal: General-Alarm L3
Alarm G	Signal: General-Alarm - Earth fault
Alarm	Signal: General Alarm
Trip L1	Signal: General Trip L1
Trip L2	Signal: General Trip L2
Trip L3	Signal: General Trip L3
Trip G	Signal: General Trip Ground fault
Trip	Signal: General Trip
Res FaultNo a GridFaultNo	Signal: Resetting of fault number and grid fault number.
I dir fwd	Signal: Phase current failure forward direction

<i>Signal</i>	<i>Description</i>
I dir rev	Signal: Phase current failure reverse direction
I dir n poss	Signal: Phase fault - missing reference voltage
IG calc dir fwd	Signal: Ground fault (calculated) forward
IG calc dir rev	Signal: Ground fault (calculated) reverse direction
IG calc dir n poss	Signal: Ground fault (calculated) direction detection not possible
IG meas dir fwd	Signal: Ground fault (measured) forward
IG meas dir rev	Signal: Ground fault (measured) reverse direction
IG meas dir n poss	Signal: Ground fault (measured) direction detection not possible
f(VL123)<10Hz	Frequency of the measuring channels 1-3 (VL1,VL2,VL3) is lower than 10Hz.
f(VL123)>10Hz	Frequency of the measuring channels 1-3 (VL1,VL2,VL3) is greater than 10Hz.
f(VL123)<70Hz	Frequency of the measuring channels 1-3 (VL1,VL2,VL3) is lower than 70Hz.
f(VL123)>70Hz	Frequency of the measuring channels 1-3 (VL1,VL2,VL3) is greater than 70Hz.
DFT Invalid	DFT values of fundamental and harmonics (except VX) are not valid. They depend on period time of frequency and measured channels 1-3 (VL1,VL2,VL3).
DFT Valid	DFT values of fundamental and harmonics (except VX) are valid. They depend on period time of frequency and measured channels 1-3 (VL1,VL2,VL3).
f(VX)<10Hz	Frequency of the measuring channel 4 (VX) is lower than 10Hz.
f(VX)>10Hz	Frequency of the measuring channel 4 (VX) is greater than 10Hz.
f(VX)<70Hz	Frequency of the measuring channel 4 (VX) is lower than 70Hz.
f(VX)>70Hz	Frequency of the measuring channel 4 (VX) is greater than 70Hz.
DFT Invalid (VX)	DFT values of fundamental and harmonics of VX (only) are not valid.
DFT Valid (VX)	DFT values of fundamental and harmonics of VX (only) are valid.

Protection Module Values

<i>Parameter</i>	<i>Description</i>
FaultNo	Fault number
No of GridFaults	Number of grid faults: A grid fault, e.g. a short circuit, might cause several faults with trip and autoreclosing, each fault being identified by an increased fault number. In this case, the grid fault number remains the same.
Trip	Initial reason of trip. It is transferred as an integer value in the MODBUS register 5004 and essentially corresponds to the "Trip" entry in the fault record, i. e. to the name of the protective module that tripped first. Look up the definition of these integer values (i. e. the mapping trip code number-->module name) in the "Cause of Trip" table within the SCADA documentation.

<i>Value</i>	<i>Description</i>	<i>Menu path</i>
Direction I	The detected direction of the phase current flow.	[Operation /Measured Values /Direction detection]
Direction IG meas.	The detected direction of the current flow of the measured residual current.	[Operation /Measured Values /Direction detection]
Direction IG calc.	The detected direction of the current flow of the calculated residual current.	[Operation /Measured Values /Direction detection]

Directional Features of the Overcurrent Stages I[n]

Prot - phase failure direction detection

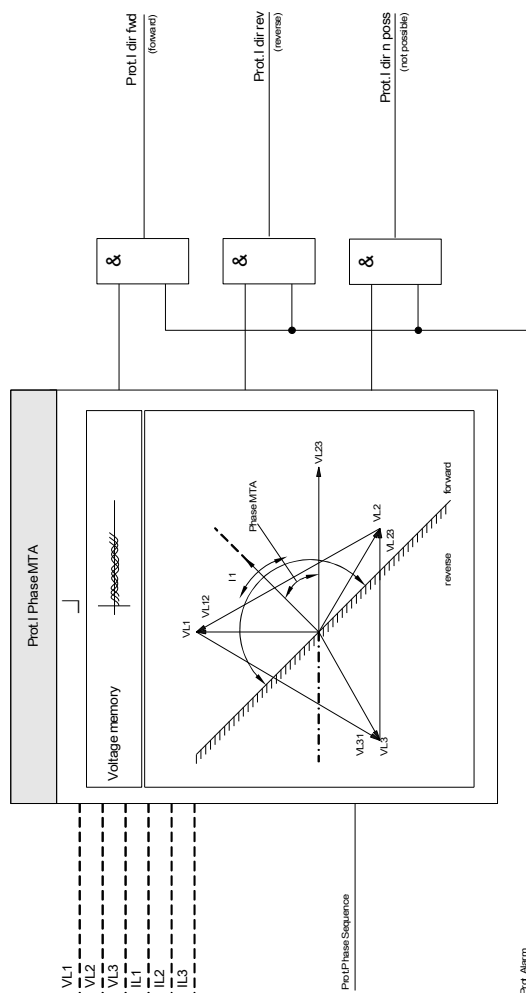

Directional Features for Measured Ground Fault Elements 50N/51N

All ground fault elements can be selected as »non-directional/forward/reverse« operated. This has to be done in the »Device Planning« menu.

Important Definitions

Polarizing Quantity: This is the quantity that is used as a reference value. The *polarizing quantity* can be selected by the parameter »IG meas dir ctrl« in the [Field Para/Direction] menu as follows:

- »IG meas 3V0«: The neutral voltage selected by the parameter »3V0 Source« will be used as the polarizing quantity. The traditional way to polarize a ground fault element is to use neutral voltage (3V0). The neutral voltage can, however, be either »measured« or »calculated«. This can be selected by the parameter »3V0 Source« in the [Field Para/Direction] menu.
- »I2, V2«: With this selection, the negative phase sequence voltage and current (Polarizing: V2/Operating: I2) will be used to detect direction. The monitored current is still the measured residual current IG meas.
- »Dual«: For this method, the negative phase sequence voltage »V2« will be used as polarizing quantity if »V2« and »I2« are available, otherwise 3V0 will be used. The operating quantity is either I2 if »V2« and »I2« are available, else IG meas.

The following table gives the User a quick overview of all possible directional settings.

50N/51N Direction Decision by Angle Between:	[Field Para/Direction] The Following Angle Has to Be Set:	[Field Para/Direction]: IG meas dir ctrl =	[Field Para/Direction]: 3V0 Source =
Measured ground current and neutral voltage: IG meas, 3V0 (measured)	Ground MTA	IG meas 3V0	measured
Measured ground current and neutral voltage: IG meas, 3V0 (calculated)	Ground MTA	IG meas 3V0	calculated
Negative sequence voltage and current I2, V2	90° + Phase MTA	I2,V2	not used
Negative phase sequence current and voltage (preferred), measured ground current and neutral voltage (alternatively): I2, V2 (if available) or else: IG meas, 3V0 (measured)	If V2 and I2 are available: 90° + Phase MTA else: Ground MTA	Dual	measured
Negative phase sequence current and voltage (preferred), measured ground current and neutral voltage (alternatively): I2, V2 (if available) or else: IG meas, 3V0 (calculated)	If V2 and I2 are available: 90° + Phase MTA else: Ground MTA	Dual	calculated

Prot - 50G/51G - direction detection

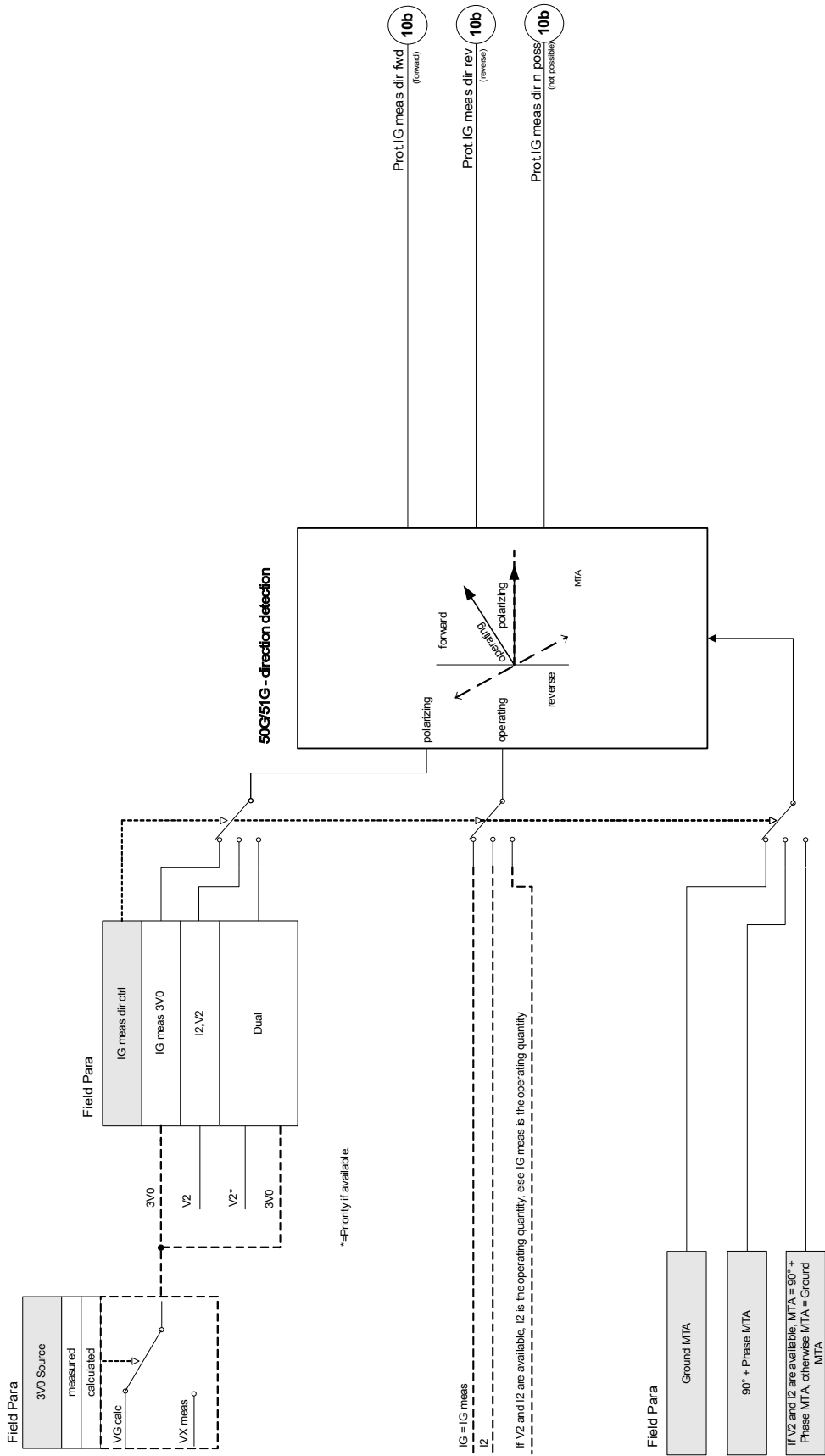

Directional Features for Calculated (IG calc) Ground Fault 50N/51N

All ground fault elements can be selected as »*non-directional/forward/reverse*« operated. This has to be done in the »*Device Planning*« menu.

Important Definitions

Polarizing Quantity: This is the quantity that is used as a reference value. The *polarizing quantity* can be selected by the parameter »*IG calc dir ctrl*« in the [Field Para/Direction] menu as follows:

- »*IG calc 3V0*«: The neutral voltage selected by the parameter »*3V0 Source*« will be used as the polarizing quantity. The traditional way to polarize a ground fault element is to use neutral voltage (3V0). The neutral voltage can, however, be either »*measured*« or »*calculated*«. This can be selected by the parameter »*3V0 Source*« in the [Field Para/Direction] menu.
- »*IG calc Ipol (IG meas)*«: The measured neutral current (usually = IG meas) will be used as polarizing quantity.
- »*Dual*«: For this method, the measured neutral current $I_{pol}=IG\ meas$ will be used as polarizing quantity, if available, otherwise 3V0 will be used.
- »*I2, V2*«: With this selection, the negative phase sequence voltage and current will be used to detect the direction. The monitored current is still the calculated residual current IG calc.

Operating Quantity: For the directional IG calc elements, the *operating quantity* is in general the *calculated neutral current IG calc* (except from »*I2, V2*« mode, where »*I2*« is the operating quantity).

The ground maximum torque angles (MTA) can be adjusted from 0° to 360°, except, if »*IG calc Ipol (IG meas)*« is selected. In this case it is set to 0° (fixed).

The MTA will also be set internally to 0° in case that $I_{pol}=IG\ meas$ is available within the Dual-Mode

The following table gives the User a quick overview of all possible directional settings.

50N/51N Direction Decision by Angle Between:	[Field Para/ Direction] The Following Angle Has to Be Set:	[Field Para/Direction]: IG calc dir ctrl =	[Field Para/Direction]: 3V0 Source =
Residual current and neutral voltage: IG calc, 3V0 (measured)	Ground MTA	<i>IG calc 3V0</i>	measured
Residual current and neutral voltage: IG calc, 3V0 (calculated)	Ground MTA	<i>IG calc 3V0</i>	calculated
Residual current and neutral/ground current IG calc, IG meas	0° (fixed)	IG calc Ipol (IG meas)	not used
Residual current and neutral/ground current (preferred), residual current and neutral voltage (alternatively): IG calc, IG meas (if available) or else: IG calc, 3V0 (measured)	If Ipol (=IG meas) is available, MTA = 0° (fixed); else MTA=Ground MTA	Dual	measured
Residual current and neutral/ground current (preferred), residual current and neutral voltage (alternatively): IG calc, IG meas (if available) or else: IG calc, 3V0 (calculated)	If Ipol (=IG meas) is available, MTA = 0° (fixed); else MTA=Ground MTA	Dual	calculated
Negative sequence voltage and current I2, V2	90° + Phase MTA	<i>I2, V2</i>	not used

Prot - 50N51N - direction detection

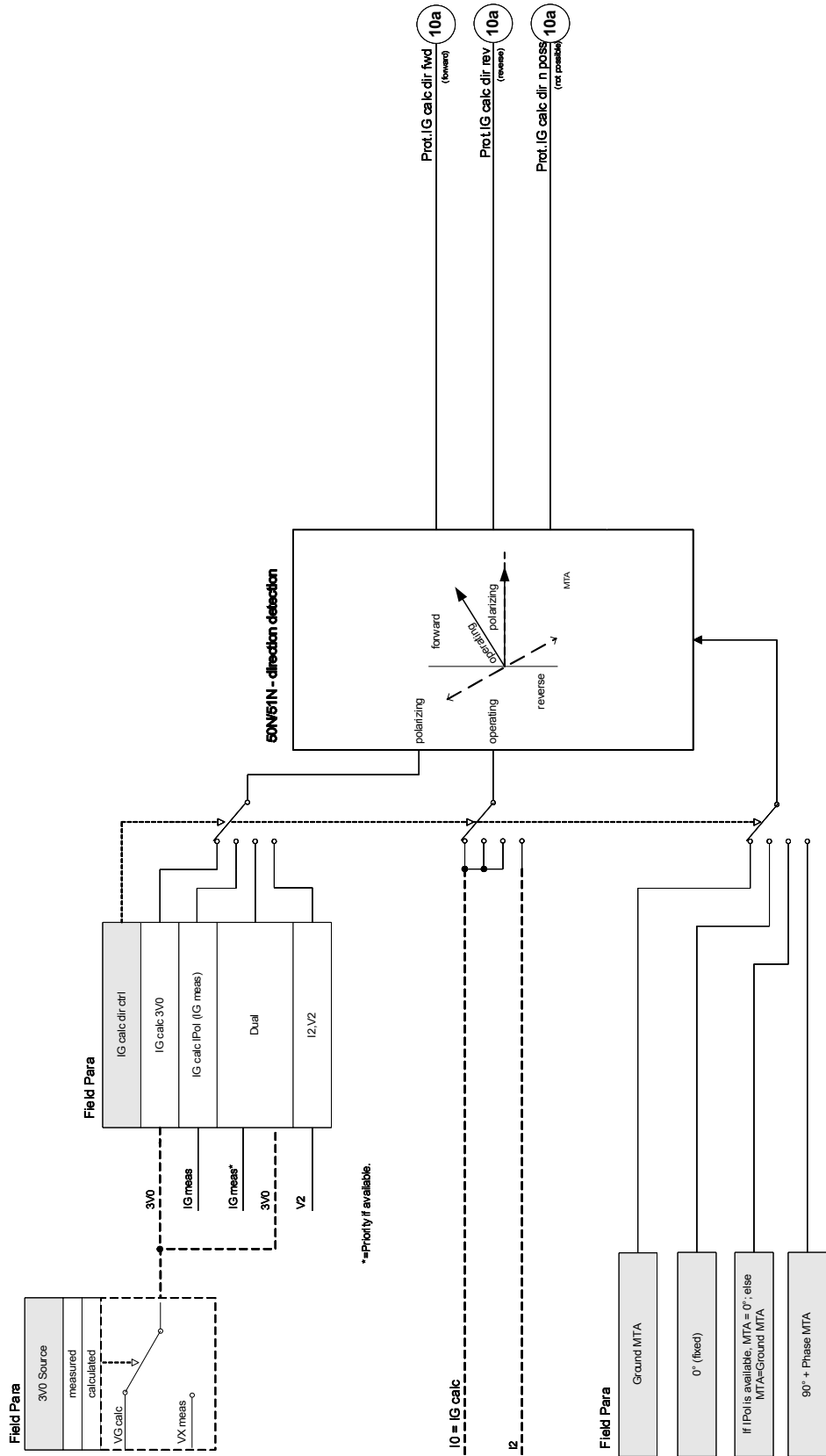

Switchgear/Breaker – Manager



WARNING Misconfiguration of switchgear could result in death or serious injury. This e. g. is the case when opening a disconnecter under load or when switching a ground connector to live parts of a system.

Beside protection functions, protective relays more and more will take care about controlling switchgear, like circuit breakers, load break switches, disconnectors and ground connectors.

A correct configuration of all switchgear is an indispensable precondition for the proper functioning of the protective device. This also is the case, when the switchgear are not controlled, but supervised only.

Single Line Diagram

The user can create and modify Single Lines (pages) by means of the *Page Editor*.

The Single Lines (Control Pages) have to be loaded into the protective device by means of *Smart view*.

For details on the creation, modification and upload of Single Lines (Control Pages) please refer to the manual “page_editor_uk.pdf” or contact the technical support. The manual can be accessed via the *Page Editors* help menu.

The single line diagram includes the graphical description of the switchgear and its designation (name) as well as its features (short circuit proof or not ...). For displaying in the devices software, the switchgears' designations (e. g. QA1, QA2, instead of SG[x]) will be taken from the single line diagram (configuration file).

The configuration file includes the single line diagram and the switchgear properties. Switchgear properties and single line diagram are coupled via the configuration file.

NOTICE

The default settings of the switchgears depend on the used Single Line. The shown default values correspond to a Single Line with two circuit breakers and to isolating switches.

After the single line diagram has been loaded, each individual switchgear has to be configured. The following table shows the required configurations dependent on the type of switchgear.

To be configured at:	Type of switchgear							
	Circuit Breaker (controlled)	Circuit Breaker (supervised)	Switch Disconnector (controlled)	Switch Disconnector (supervised)	Ground Connector (controlled)	Ground Connector (supervised)	Disconnector (controlled)	Disconnector (supervised)
Assignment of position indications (Digital inputs)	X	X	X	X	X	X	X	X
Assignment of commands (Output relays)	X	-	X	-	X	-	X	-
Setting of supervision timers	X	X	X	X	X	X	X	X
Interlockings	X	-	X	-	X	-	X	-
Trip Manager (Assignment of trip commands)	X	X	-	-	-	-	-	-
Optional: Synchronous switching	X	-	-	-	-	-	-	-
Optional: Ex ON/OFF Cmd	X	-	X	-	X	-	X	-
Optional: SGW	X	X	X	X	X	X	X	X

Notes on Special Switchgears

Combination of a Disconnecter and an Earthing Switch

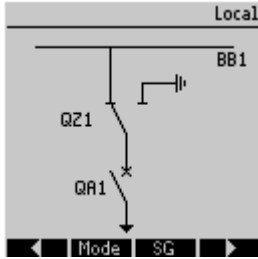

This switchgear is a combination of a disconnecter and an earthing switch. This Switch switches between the »ON-Position« (e.g. Busbar) and the »Earthing-Position«.

NOTICE The Earthing position of a „Disconnecter and Earthing“-Switchgear combination is shown as „CB POS OFF“ within the SCADA documentation (register maps).

Three Position Disconnecter

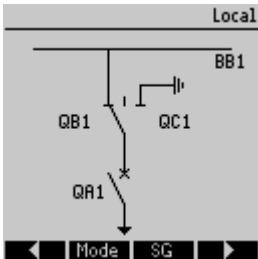

The “Three Position Disconnecter” covers functional two switchgears. One switchgear corresponds to the disconnecter of the “Three Position Disconnecter”, and the second switchgear corresponds to the earthing switch. The Single Line shows the current position of the “Three Position Disconnecter”. The separation into two switchgears prevent unintentional direct switching from the »ON«-position via the »OFF«-position into the »EARTH«-position. From security aspects there are two clear switch positions »Isolating« and »EARTH«. Thanks to this separation, individual supervision and switching timers for the earthing and isolating part can be set. In addition to that individual interlockings and device names (designations) can be set for the earthing and the isolating part.

NOTICE The Command Execution Supervision will issue the following message in case of a switching attempt from the earthing position (directly) into the isolator position and vice versa:
„CES SwitchDir“

NOTICE The “Earth” position of a „Disconnecter and Earthing“-switchgear combination is shown as „CB POS OFF“ within the SCADA documentation (register maps).

Withdrawable Circuit Breaker (Draw Out Circuit Breaker)

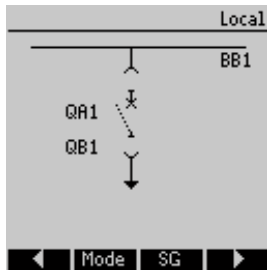

The truck of a withdrawable circuit breaker has to be managed as an individual switchgear. There is no fixed connection between the circuit breaker and the truck. An interlocking has to be set by the User because it is not allowed to withdraw the breaker as long as it is in the closed position. The circuit breaker can be switched in the withdrawn and in the non-withdrawn position.

The signals of the control circuit (low voltage) plug have to be wired and configured with(-in) the protective device.

The control (supervision) will be set to »Removed« when the control circuit plug is removed (pulled).

The circuit breaker will be set into the »CB OFF«-position as long as the »Removed«-signal is active.



It's not possible to manipulate the Position Signals of a withdrawn (removed) circuit breaker.

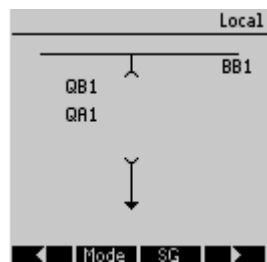

Switchgear Configuration

Wiring

At first the switchgear positioning indicators have to be connected to the digital inputs of the protection device. One of the position indicators (either the »Aux ON« or the »Aux OFF«) contact has to be connected necessarily. It is recommended also to connect the »Aux OFF« contact.

Thereafter the command outputs (relay outputs) have to be connected with the switchgear.

NOTICE

Please observe the following option: In the general settings of a circuit breaker, the ON/OFF commands of a protection element can be issued to the same output relays, where the other control commands are issued. If the commands are issued to different relays output relays the amount of wiring increases.

Assignment of Position Indications

The position indication is needed by the device to get (evaluate) the information about the current status /position of the breaker. The switchgear position indications are shown in the devices display. Each position change of a switchgear results in a change of the corresponding switchgear symbol.

NOTICE

For the detection of a switchgear's position always two separate Aux contacts are recommended! If only one Aux contact is used, no intermediate or disturbed positions can be detected. A (reduced) transition supervision (time between issue of the command and position feedback indication of the switchgear) is also possible by one Aux contact.

In the menu [Control/SG/SG [x]] the assignments for the position indications have to be set.

Detection of switchgear position with two Aux contacts – Aux ON and Aux OFF (recommended!)

For detection of their positions switchgear are provided with Aux contacts (Aux ON and Aux OFF). It is recommended to use both contacts to detect intermediate and disturbed positions too.

The protection device continuously supervises the status of the inputs »Aux ON-I« and »Aux OFF-I«.

These signals are validated based on the supervision timers »t-Move ON« and »t-Move OFF« validation functions. As a result, the switchgear position will be detected by the following signals (examples):

- Pos ON
- Pos OFF
- Pos Indeterm
- Pos Disturb.
- Pos (State=0, 1, 2 or 3)

Supervision of the ON command

When an ON command is initiated, the »*t-Move ON*« timer will be started. While the timer is running, the »POS INDETERM« State will become true. If the command is executed and properly fed back from the switchgear before the timer has run down, »POS ON« will become true. Otherwise, if the timer has expired »POS DISTURB« will become true.

Supervision of the OFF command

When an OFF command is initiated, the »*t-Move OFF*« timer will be started. While the timer is running, the »POS INDETERM« State will become true. If the command is executed and properly fed back before the timer has run down, »POS OFF« will become true. Otherwise, if the timer has expired »POS DISTURB« will become true.

The following table shows how switchgear positions are validated:

States of the Digital Inputs		Validated Breaker Positions				
<i>Aux ON-I</i>	<i>Aux OFF-I</i>	<i>POS ON</i>	<i>POS OFF</i>	<i>POS Indeterm</i>	<i>POS Disturb</i>	<i>POS State</i>
0	0	0	0	1 (while a Moving timer is running)	0 (while a Moving timer is running)	0 Intermediate
1	1	0	0	1 (while a Moving timer is running)	0 (while a Moving timer is running)	0 Intermediate
0	1	0	1	0	0	1 OFF
1	0	1	0	0	0	2 ON
0	0	0	0	0 (Moving timer elapsed)	1 (Moving timer elapsed)	3 Disturbed
1	1	0	0	0 (Moving timer elapsed)	1 (Moving timer elapsed)	3 Disturbed

Single Position Indication Aux ON or Aux OFF

If the single pole indication is used, the »SI SINGLECONTACTIND« will become true.

The moving time supervision works only in one direction. If the Aux OFF signal is connected to the device, only the “OFF command” can be supervised and if the Aux ON signal is connected to the device, only the “ON command” can be supervised.

Single Position Indication – Aux ON

If only the Aux ON signal is used for the Status Indication of an “ON command”, the switch command will also start the moving time, the position indication indicates an INTERMEDIATE position during this time interval. When the switchgear reaches the end position indicated by the signals Pos ON and CES succesf before the moving time has elapsed the signal Pos Indeterm disappears.

If the moving time elapsed before the switchgear has reached the end position, the switching operation was not successful and the Position Indication will change to POS Disturb and the signal Pos Indeterm disappears. After the moving time has elapsed, the Dwell time will be started (if set). During this time interval the Position Indication will also indicate an INTERMEDIATE state. When the Dwell time elapses the Position Indication will change to Pos ON.

The following table shows how breaker positions are validated based on **Aux ON**:

<i>States of the Digital Input</i>		<i>Validated Breaker Positions</i>				
<i>Aux ON-I</i>	<i>Aux OFF-I</i>	<i>POS ON</i>	<i>POS OFF</i>	<i>POS Indeterm</i>	<i>POS Disturb</i>	<i>POS State</i>
0	Not wired	0	0	1 (while t-Move ON is running)	0 (while t-Move ON is running)	0 Intermediate
0	Not wired	0	1	0	0	1 OFF
1	Not wired	1	0	0	0	2 ON

If there is no digital input assigned to the »Aux On« contact, the position indication will have the value 3 (disturbed).

Single Position Indication – Aux OFF

If only the Aux OFF signal is used for the monitoring of the “OFF command”, the switch command will start the moving timer. The Position Indication will indicate an INTERMEDIATE position. When the switchgear reaches its end position before the moving timer elapses, »CES succesf« will be indicated. At the same time the signal »Pos Indeterm« disappears.

If the moving time elapsed before the switchgear has reached the OFF position, the switching operation was not successful and the Position Indication will change to »Pos Disturb« and the signal »Pos Indeterm« disappears. When the moving timer has elapsed, the dwell timer will be started (if configured). During this timer elapses »Pos Disturb« will be indicated. When the dwell time has elapsed, the OFF position of the switchgear will be indicated by the »Pos OFF« signal.

The following table shows how breaker positions are validated based on **Aux OFF**:

States of the Digital Input		Validated Breaker Positions				
Aux ON-I	Aux OFF-I	POS ON	POS OFF	POS Indeterm	POS Disturb	POS State
Not wired	0	0	0	1 (while t-Move OFF is running)	0 (while t-Move OFF is running)	0 Intermediate
Not wired	1	0	1	0	0	1 OFF
Not wired	0	1	0	0	0	2 ON

If there is no digital input assigned to the »Aux OFF« contact, the position indication will have the value 3 (disturbed).

Setting of Supervision Times

In the menu [Control/SG/SG[x]/General Settings] the supervision times of the individual switchgear have to be set. Dependent on the type of switchgear it can be necessary to set further parameters, like dwell time.

Interlockings

To avoid faulty operations, interlockings have to be provided. This can be realised mechanically or electrically.

For a controllable switchgear up to three interlockings can be assigned in both switching directions (ON/OFF). These interlockings prevent switching in the corresponding direction.

The protection OFF command and the reclosing command of the AR module are always executed without interlockings. For the case, that a protection OFF command must not be issued, this must be blocked separately.

Further interlockings can be realised by means of the Logic module.

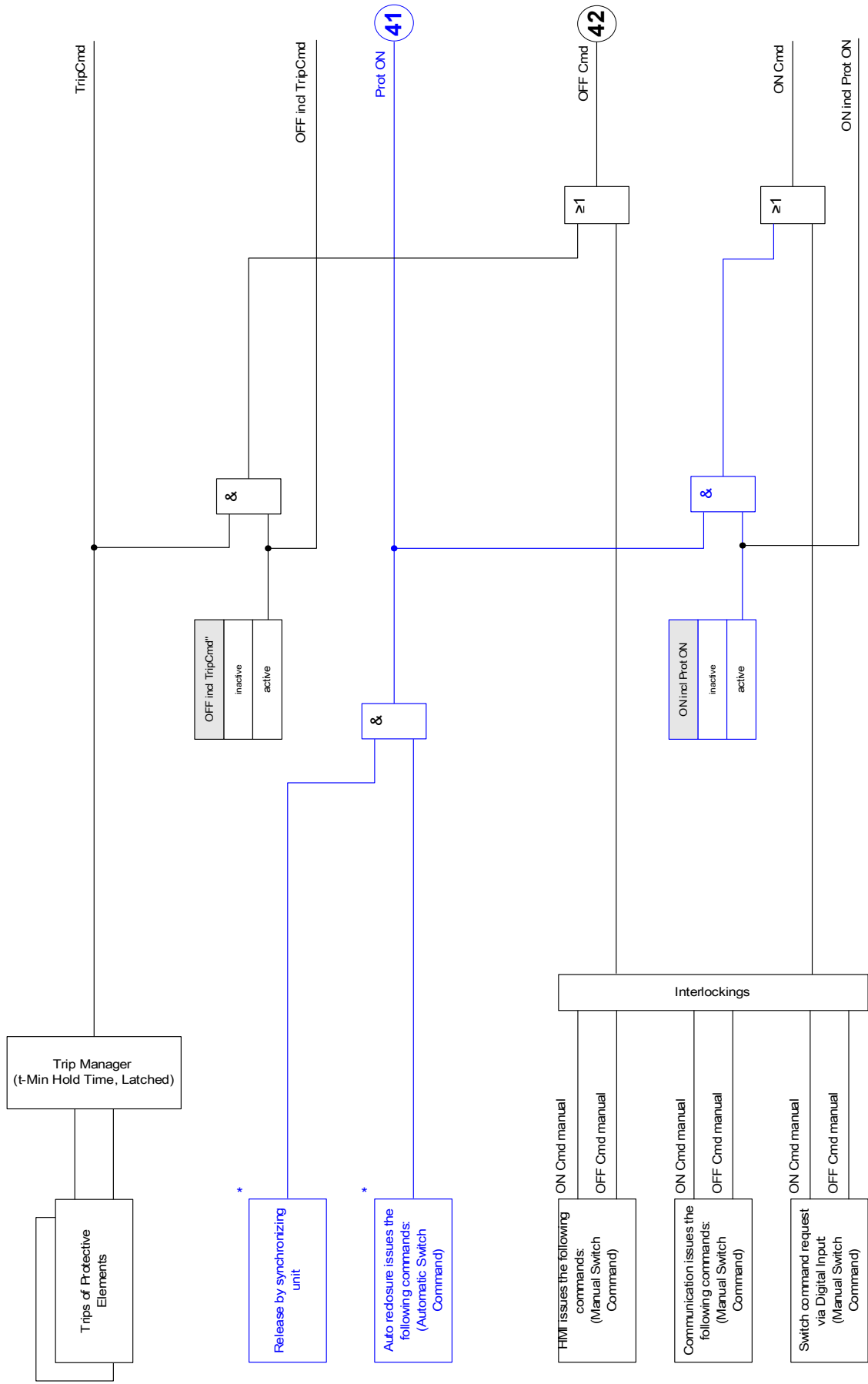

* Availability dependent on device type

Trip Manager – Assignment of commands

The trip commands of the protection elements have to be assigned to those switchgear, that are make/break capable (Circuit Breaker). For every make/break capable switchgear a Trip Manager is provided.

In the Trip Manger all tripping commands are combined by an “OR” logic. The actual tripping command to the switchgear is exclusively given by the Trip Manager. This means, that only tripping commands which are assigned in the Trip Manager lead to an operation of the switchgear. In addition to that, the User can set the minimum hold time of the tripping command within this module and define whether the tripping command is latched or not.

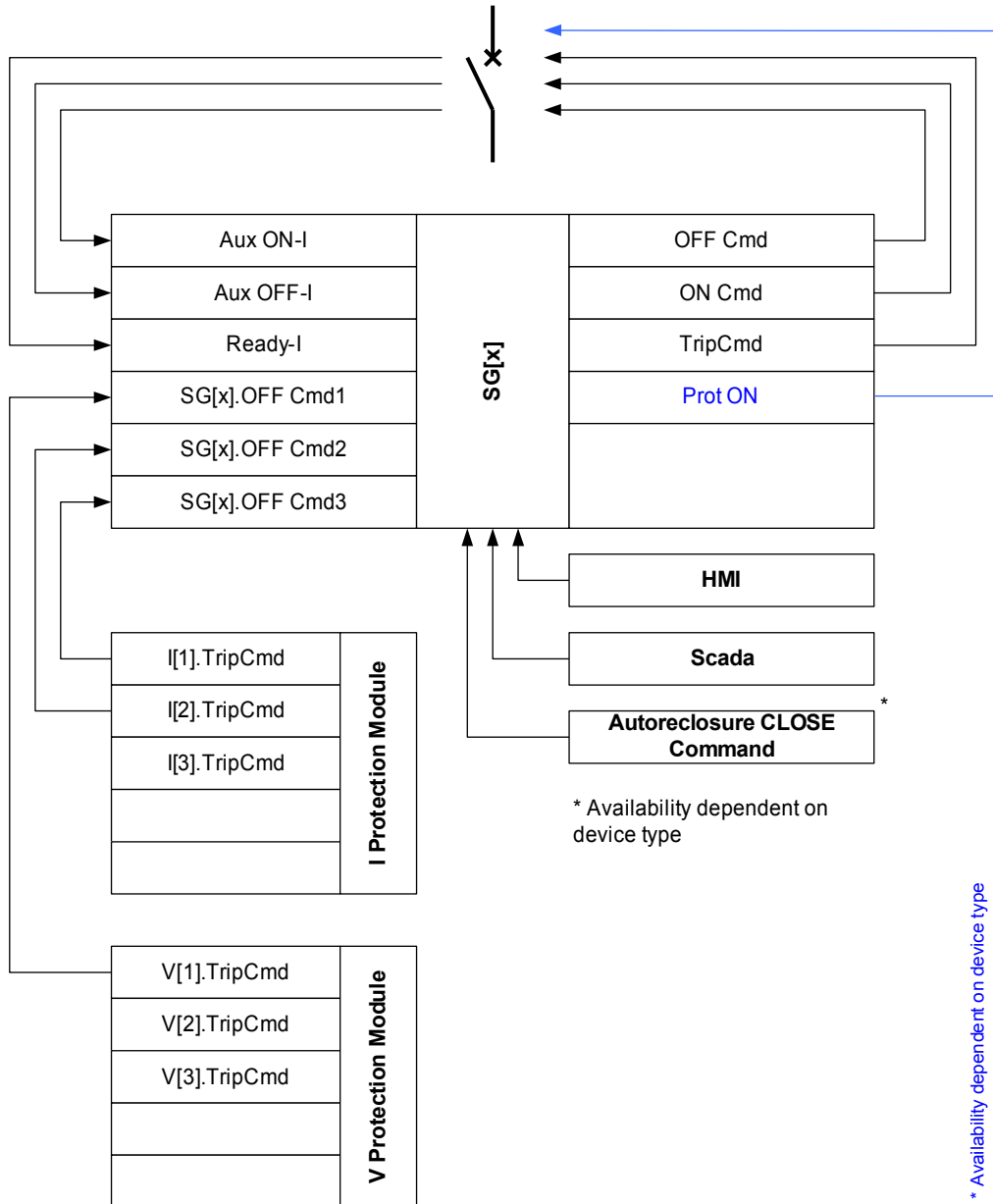

The exact name of the Switchgear is defined in the Single Line file.



SG[x].Trip CB

Switchgear_Y01

name =Module name of the assigned trip command

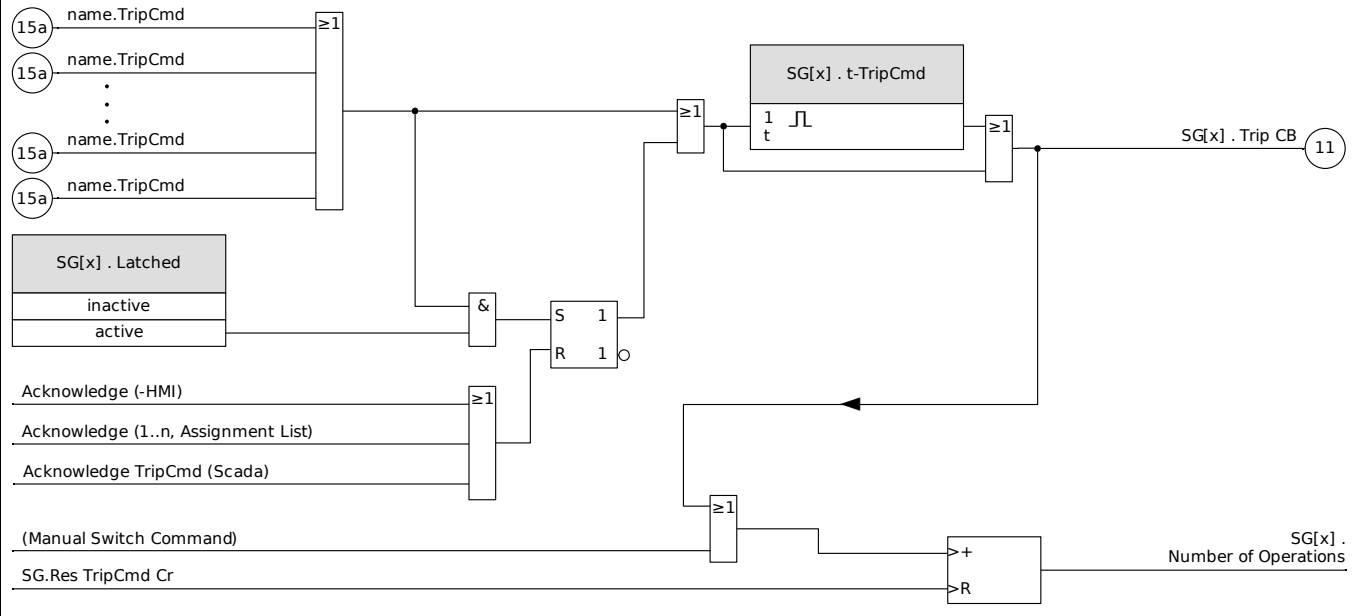

Ex ON/OFF

If the switchgear should be opened or closed by an external signal, the User can assign one signal that will trigger the ON and one signal that will trigger the OFF command (e.g. digital inputs or output signals of the Logics). An OFF command has priority. ON commands are slope oriented, OFF commands are level oriented.

Synchronised Switching*

*=availability depends on ordered device type

Before a switchgear may connect two mains sections, synchronism of these sections must be assured.

In the menu [Synchronous Switching] the parameter »Synchronism« defines which signal indicates synchronism.

If the synchronism condition shall be evaluated by the internal Synch-Check module the signal »*Sync. Ready to Close*« (release by synch-check module) has to be assigned. Alternatively a digital input or a logic output can be assigned.

In the synchronisation mode “Generator-to-System” additionally the synchronism request has to be assigned in the menu [Protection Para\Global Prot Para\Sync].

If a synchronism signal is assigned, the switching command will only be executed, when the synchronism signal will become true within the maximum supervision time »*t-MaxSyncSuperv*«. This supervision time will be started with the issued ON command. If no synchronism signal has been assigned, the synchronism release is permanently.

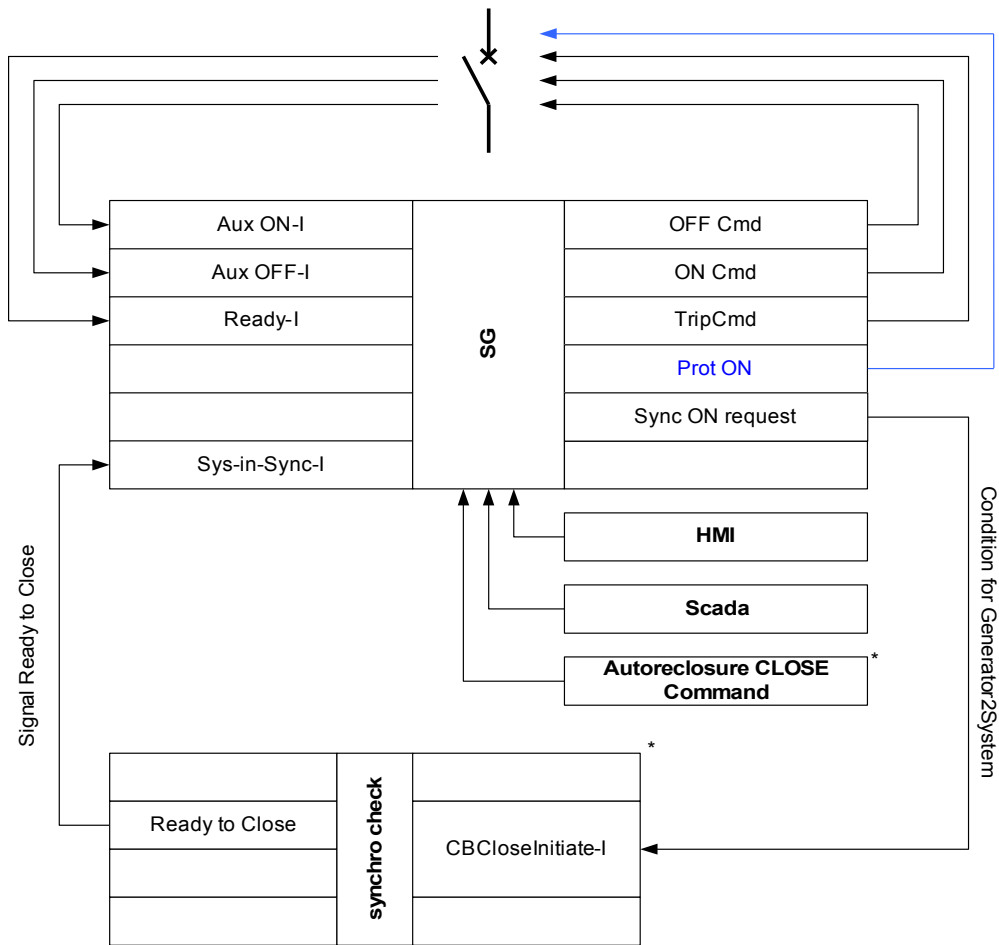

* = * Availability dependent on device type

** = * Availability dependent on device type

Switching Authority

For the Switching Authority [Control\General Settings], the following general settings are possible:

- NONE: No control function;
- LOCAL: Control only via push buttons at the panel;
- REMOTE: Control only via SCADA, digital inputs, or internal signals; and
- LOCAL&REMOTE: Control via push buttons, SCADA, digital inputs, or internal signals.

Non interlocked Switching

For test purposes, during commissioning and temporarily operations, interlockings can be disabled.

 **WARNING** WARNING: Non interlocked Switching can lead to serious injuries or death!

For non interlocked switching the menü [Control\General Settings] provides the following options:

- Non interlocked switching for one single command
- Permanent
- Non interlocked switching for a certain time
- Non interlocked switching, activated by an assigned signal

The set time for non interlocked switching applies also for the „single Operation“ mode.

Manual Manipulation of the Switchgear Position

In case of faulty position indication contacts (Aux contacts) or broken wires, the position indication resulted from the assigned signals can be manipulated (overwritten) manually, to keep the ability to switch the affected switchgear. A manipulated switchgear position will be indicated on the display by an exclamation mark “!” beside the switchgear symbol.

 **WARNING** WARNING: Manipulation of the Switchgear Position can lead to serious injuries or death!

Double Operation Locking

All control commands to any switchgear in a bay have to be processed sequentially. During a running control command no other command will be handled.

Switch Direction Control



Switching commands are validated before execution. When the switchgear is already in the desired position, the switch command will not be issued again. An opened circuit breaker cannot be opened again. This also applies for switching command at the HMI or via SCADA.

Anti Pumping

By pressing the ON command softkey only a single switching ON impulse will be issued independent, how long the softkey is actuated. The switchgear will close only once per close command.

Ctrl

Direct commands of the Switching Authority

<i>Parameter</i>	<i>Description</i>	<i>Setting range</i>	<i>Default</i>	<i>Menu path</i>
Switching Authority 	Switching Authority	None, Local, Remote, Local and Remote	Local	[Control /General Settings]
NonInterl 	DC for Non-Interlocking	inactive, active	inactive	[Control /General Settings]

Signals of the Switching Authority

<i>Signal</i>	<i>Description</i>
Local	Switching Authority: Local
Remote	Switching Authority: Remote
NonInterl	Non-Interlocking is active
SG Indeterm	Minimum one Switchgear is moving (Position cannot be determined).
SG Disturb	Minimum one Switchgear is disturbed.

Counters of the Command Execution Supervision

<i>Parameter</i>	<i>Description</i>
CES SAuthority	Command Execution Supervision: Number of rejected Commands because of missing switching authority.
CES DoubleOperating	Command Execution Supervision: Number of rejected Commands because a second switch command is in conflict with a pending one.
CES No. of rej. Com	Command Execution Supervision: Number of rejected Commands because Locked by ParaSystem

Switchgear Wear

Switchgear Wear Features

The sum of the accumulated interrupted currents.

A »SGwear Slow Switchgear« might indicate malfunction at an early stage.

The protective relay will calculate the »SG OPEN Capacity« continuously. 100% means, that switchgear maintenance is mandatory now.

The protective relay will make a alarm decision based on the curve that the user provides.

The relay will monitor the frequency of ON/OFF cycles. The User can set thresholds for the maximum allowed sum of interrupt currents and the maximum allowed sum of interrupt currents per hour. By means of this alarm, excessive switchgear operations can be detected at an early stage.

Slow Switchgear Alarm

An increase of the close or opening time of the switchgear is an indication for the maintenance need. If the measured time exceeds the time »*t-Move OFF*« or »*t-Move ON*«, the signal »SGwear Slow Switchgear« will be activated.

Switchgear Wear Curve

In order to keep the switchgear in good working condition, the switchgear needs to be monitored. The switchgear health (operation life) depends above all on:







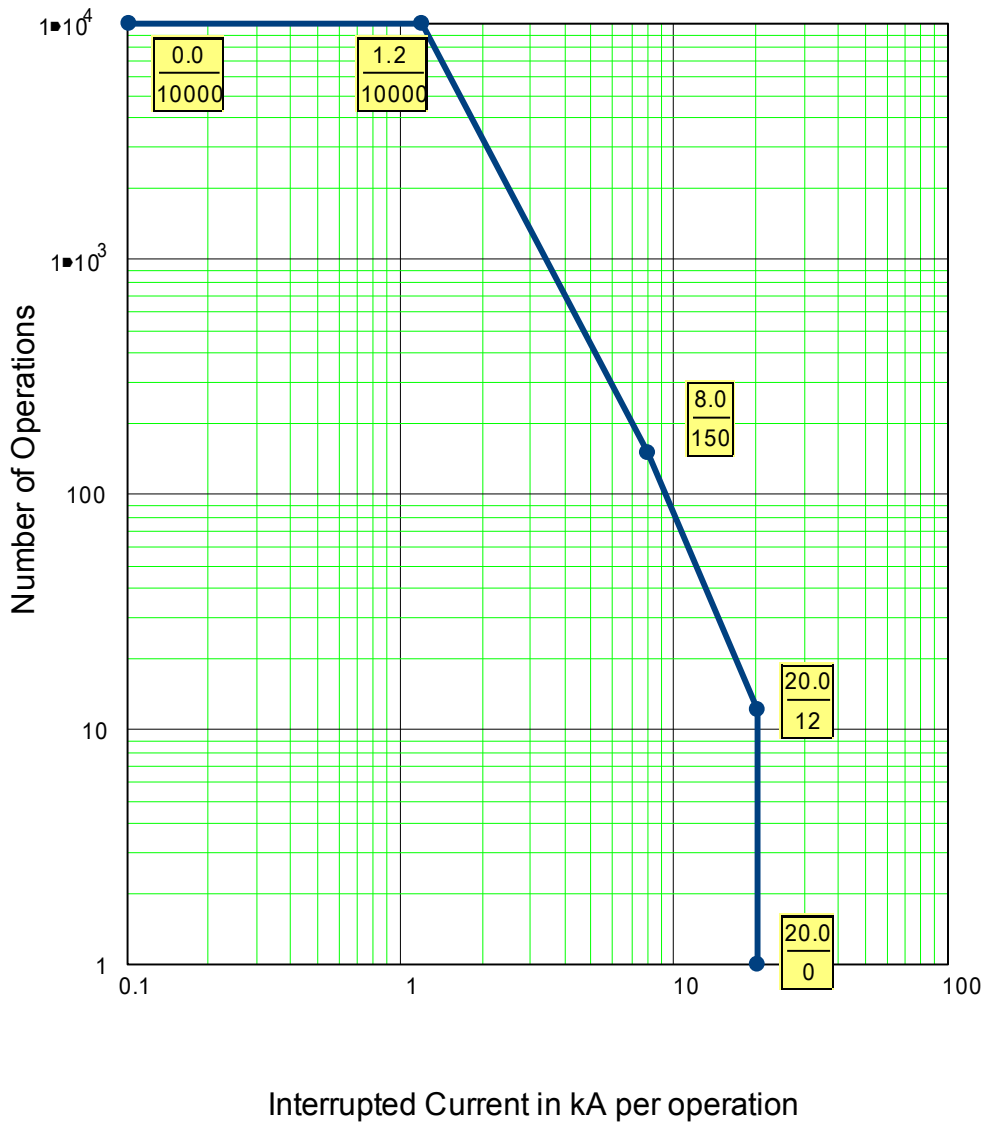

- The number of CLOSE/OPEN cycles.
- The amplitudes of the interrupting currents.
- The frequency that the switchgear operates (Operations per hour).

The User has to maintain the switchgear accordingly to the maintenance schedule that is to be provided by the manufacturer (switchgear operation statistics). By means of up to ten points that the user can replicate the switchgear wear curve within menu [Control/SG/SG[x]/SGW] . Each point has two settings: the interrupt current in kilo amperes and the allowed operation counts. No matter how many points are used, the operation counts the last point as zero. The protective relay will interpolate the allowed operations based on the switchgear wear curve. When the interrupted current is greater than the interrupt current at the last point, the protective relay will assume zero operation counts.

Breaker Maintenance Curve for a typical 25kV Circuit Breaker



Global Protection Parameters of the Breaker Wear Module

<i>Parameter</i>	<i>Description</i>	<i>Setting range</i>	<i>Default</i>	<i>Menu path</i>
CT Winding Side 	Measuring values will be used from this winding side	CT Ntrl, CT Mains	CT Ntrl	[Control /SG /SG[1] /SG Wear]
Operations Alarm 	Service Alarm, too many Operations	1 - 100000	9999	[Control /SG /SG[1] /SG Wear]
Isum Intr Alarm 	Alarm, the Sum (Limit) of interrupting currents has been exceeded.	0.00 - 2000.00kA	100.00kA	[Control /SG /SG[1] /SG Wear]
Isum Intr ph Alm 	Alarm, the per hour Sum (Limit) of interrupting currents has been exceeded.	0.00 - 2000.00kA	100.00kA	[Control /SG /SG[1] /SG Wear]
SGwear Curve Fc 	The Circuit Breaker (load-break switch) Wear Curve defines the maximum allowed CLOSE/OPEN cycles depending on the brake currents. If the circuit breaker maintenance curve is exceeded, an alarm will be issued. The breaker maintenance curve is to be taken from the technical data sheet of the breaker manufacturer. By means of the available points this curve is to be replicated.	inactive, active	inactive	[Control /SG /SG[1] /SG Wear]
WearLevel Alarm 	Threshold for the Alarm Only available if:SGwear Curve Fc = active	0.00 - 100.00%	80.00%	[Control /SG /SG[1] /SG Wear]
WearLevel Lockout 	Threshold for the Lockout Level Only available if:SGwear Curve Fc = active	0.00 - 100.00%	95.00%	[Control /SG /SG[1] /SG Wear]
Current1 	Interrupted Current Level #1 Only available if:SGwear Curve Fc = active	0.00 - 2000.00kA	0.00kA	[Control /SG /SG[1] /SG Wear]

<i>Parameter</i>	<i>Description</i>	<i>Setting range</i>	<i>Default</i>	<i>Menu path</i>
Count1 	Open Counts Allowed #1 Only available if:SGwear Curve Fc = active	1 - 32000	10000	[Control /SG /SG[1] /SG Wear]
Current2 	Interrupted Current Level #2 Only available if:SGwear Curve Fc = active	0.00 - 2000.00kA	1.20kA	[Control /SG /SG[1] /SG Wear]
Count2 	Open Counts Allowed #2 Only available if:SGwear Curve Fc = active	1 - 32000	10000	[Control /SG /SG[1] /SG Wear]
Current3 	Interrupted Current Level #3 Only available if:SGwear Curve Fc = active	0.00 - 2000.00kA	8.00kA	[Control /SG /SG[1] /SG Wear]
Count3 	Open Counts Allowed #3 Only available if:SGwear Curve Fc = active	1 - 32000	150	[Control /SG /SG[1] /SG Wear]
Current4 	Interrupted Current Level #4 Only available if:SGwear Curve Fc = active	0.00 - 2000.00kA	20.00kA	[Control /SG /SG[1] /SG Wear]
Count4 	Open Counts Allowed #4 Only available if:SGwear Curve Fc = active	1 - 32000	12	[Control /SG /SG[1] /SG Wear]
Current5 	Interrupted Current Level #5 Only available if:SGwear Curve Fc = active	0.00 - 2000.00kA	20.00kA	[Control /SG /SG[1] /SG Wear]
Count5 	Open Counts Allowed #5 Only available if:SGwear Curve Fc = active	1 - 32000	1	[Control /SG /SG[1] /SG Wear]

Parameter	Description	Setting range	Default	Menu path
 Current6	Interrupted Current Level #6 Only available if:SGwear Curve Fc = active	0.00 - 2000.00kA	20.00kA	[Control /SG /SG[1] /SG Wear]
 Count6	Open Counts Allowed #6 Only available if:SGwear Curve Fc = active	1 - 32000	1	[Control /SG /SG[1] /SG Wear]
 Current7	Interrupted Current Level #7 Only available if:SGwear Curve Fc = active	0.00 - 2000.00kA	20.00kA	[Control /SG /SG[1] /SG Wear]
 Count7	Open Counts Allowed #7 Only available if:SGwear Curve Fc = active	1 - 32000	1	[Control /SG /SG[1] /SG Wear]
 Current8	Interrupted Current Level #8 Only available if:SGwear Curve Fc = active	0.00 - 2000.00kA	20.00kA	[Control /SG /SG[1] /SG Wear]
 Count8	Open Counts Allowed #8 Only available if:SGwear Curve Fc = active	1 - 32000	1	[Control /SG /SG[1] /SG Wear]
 Current9	Interrupted Current Level #9 Only available if:SGwear Curve Fc = active	0.00 - 2000.00kA	20.00kA	[Control /SG /SG[1] /SG Wear]
 Count9	Open Counts Allowed #9 Only available if:SGwear Curve Fc = active	1 - 32000	1	[Control /SG /SG[1] /SG Wear]
 Current10	Interrupted Current Level #10 Only available if:SGwear Curve Fc = active	0.00 - 2000.00kA	20.00kA	[Control /SG /SG[1] /SG Wear]

Parameter	Description	Setting range	Default	Menu path
Count10 	Open Counts Allowed #10 Only available if:SGwear Curve Fc = active	1 - 32000	1	[Control /SG /SG[1] /SG Wear]

Breaker Wear Signals (Output States)



Signal	Description
Operations Alarm	Signal: Service Alarm, too many Operations
Isum Intr trip: IL1	Signal: Maximum permissible Summation of the interrupting (tripping) currents exceeded: IL1
Isum Intr trip: IL2	Signal: Maximum permissible Summation of the interrupting (tripping) currents exceeded: IL2
Isum Intr trip: IL3	Signal: Maximum permissible Summation of the interrupting (tripping) currents exceeded: IL3
Isum Intr trip	Signal: Maximum permissible Summation of the interrupting (tripping) currents exceeded in at least one phase.
Res TripCmd Cr	Signal: Resetting of the Counter: total number of trip commands
Res Sum trip	Signal: Reset summation of the tripping currents
WearLevel Alarm	Signal: Threshold for the Alarm
WearLevel Lockout	Signal: Threshold for the Lockout Level
Res CB OPEN capacity	Signal: Reset of the wear maintenance curve (i. e. of the counter for the Circuit Breaker OPEN capacity.
Isum Intr ph Alm	Signal: Alarm, the per hour Sum (Limit) of interrupting currents has been exceeded.
Res Isum Intr ph Alm	Signal: Reset of the Alarm, "the per hour Sum (Limit) of interrupting currents has been exceeded".

Breaker Wear Counter Values

Value	Description	Default	Size	Menu path
TripCmd Cr	Counter: Total number of trips of the switchgear (circuit breaker, load break switch...). Resettable with Total or All.	0	0 - 200000	[Operation /Count and RevData /Control /SG[1]]

<i>Value</i>	<i>Description</i>	<i>Default</i>	<i>Size</i>	<i>Menu path</i>
Sum trip IL1	Summation of the tripping currents phase	0.00A	0.00 - 1000.00A	[Operation /Count and RevData /Control /SG[1]]
Sum trip IL2	Summation of the tripping currents phase	0.00A	0.00 - 1000.00A	[Operation /Count and RevData /Control /SG[1]]
Sum trip IL3	Summation of the tripping currents phase	0.00A	0.00 - 1000.00A	[Operation /Count and RevData /Control /SG[1]]
Isum Intr per hour	Sum per hour of interrupting currents.	0.00kA	0.00 - 1000.00kA	[Operation /Count and RevData /Control /SG[1]]
CB OPEN capacity	Used capacity of the circuit breaker. (100% means that the circuit breaker has to be maintained.)	0.0%	0.0 - 100.0%	[Operation /Count and RevData /Control /SG[1]]





Direct Commands of the Breaker Wear Module

<i>Parameter</i>	<i>Description</i>	<i>Setting range</i>	<i>Default</i>	<i>Menu path</i>
Res TripCmd Cr 	Resetting of the Counter: total number of trip commands	inactive, active	inactive	[Operation /Reset]
Res Sum trip 	Reset summation of the tripping currents	inactive, active	inactive	[Operation /Reset]
Res Isum Intr per hour 	Reset of the Sum per hour of interrupting currents.	inactive, active	inactive	[Operation /Reset]

<i>Parameter</i>	<i>Description</i>	<i>Setting range</i>	<i>Default</i>	<i>Menu path</i>
Res CB OPEN capacity 	Reset the CB OPEN capacity. (Remark: A »CB OPEN capacity« value of 100% means that the circuit breaker has to be maintained.)	inactive, active	inactive	[Operation /Reset]

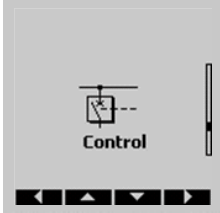
Control - Example: Switching of a Circuit Breaker

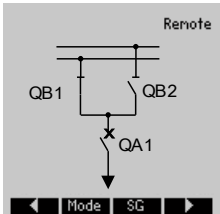
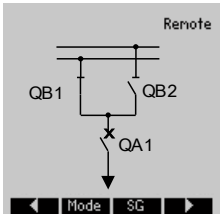
The following example shows how to switch a circuit breaker via the HMI at the device.

	<p>Change into the menu »Control« or alternatively push the »CTRL« button at the device front.</p>
	<p>Change to the control page by pushing the »right arrow« softkey.</p>
	<p>Information only: On the control page a single line diagram with the current switchgear positions is displayed. By means of the softkey »Mode« it can be switched to the menu »General Settings«. In this menu switching authority and interlockings can be set.</p> <p>By means of the softkey »SG« it can be switched to the menu »SG«. In this menu specific settings for the switch gear can be done.</p>
	<p>To execute a switching operation, change into the switching menu by pushing the right arrow softkey button.</p>
	<p>Executing a switching command via the devices HMI is only possible when the switching authority is set to »Local«. If no switching authority is given, this has to be set first to »Local« or »Local and Remote«.</p> <p>With the softkey »OK« it can be switched back to the single line diagram page.</p>

	<p>Pushing the softkey »Mode« leads to the menu »General Settings«.</p>
--	---

	<p>In this menu the switching authority can be changed.</p>
--	---

	<p>Select between »Local« or »Local and Remote«.</p>
--	--

	<p>Now it is possible to execute switching commands at the HMI.</p>
--	---

	<p>Push the »right arrow« softkey to get to the control page.</p>
--	---

	<p>To select a switchgear press the softkey »Select« as long as the desired switchgear is selected. The current selection is displayed by the edges of a rectangle. In this example the circuit breaker is selected. Switchgears that are supervised only, cannot be selected.</p>
--	--

	<p>The circuit breaker is opened, therefore it can be closed only. After pushing the softkey »ON« a confirmation window appears.</p>
--	--

	<p>When you are sure to proceed with the switching operation, press the softkey »YES«.</p>
--	--

	<p>The switching command will be given to the circuit breaker. The display shows the intermediate position of the switchgear.</p>
--	---



	<p>It will be shown on the display when the switchgear reaches the new end position. Further possible switching operations (OPEN) will be displayed by softkeys.</p>
--	--



Notice: For the case, the switchgear does not reach the new end position within the set supervision time the following Warning appears on the display.

Control Parameters

Global Protection Parameters of the Control Module

Parameter	Description	Setting range	Default	Menu path
Res NonIL 	Resetmode Non-Interlocking	single Operation, timeout, permanent	single Operation	[Control /General Settings]
Timeout NonIL 	Timeout Non-Interlocking Only available if: Res NonIL<>permanent	2 - 3600s	60s	[Control /General Settings]
NonIL Assign 	Assignment Non-Interlocking	1..n, Assignment List	.-.	[Control /General Settings]

Control Moduel Input States

Name	Description	Assignment via
NonInterl-I	Non-Interlocking	[Control /General Settings]

Synchronization inputs

Name	Description
.-.	No assignment
Sync.Ready to Close	Signal: Ready to Close
DI Slot X1.DI 1	Signal: Digital Input
DI Slot X1.DI 2	Signal: Digital Input
DI Slot X1.DI 3	Signal: Digital Input
DI Slot X1.DI 4	Signal: Digital Input
DI Slot X1.DI 5	Signal: Digital Input
DI Slot X1.DI 6	Signal: Digital Input
DI Slot X1.DI 7	Signal: Digital Input
DI Slot X1.DI 8	Signal: Digital Input
DI Slot X5.DI 1	Signal: Digital Input
DI Slot X5.DI 2	Signal: Digital Input
DI Slot X5.DI 3	Signal: Digital Input
DI Slot X5.DI 4	Signal: Digital Input
DI Slot X5.DI 5	Signal: Digital Input

<i>Name</i>	<i>Description</i>
DI Slot X5.DI 6	Signal: Digital Input
DI Slot X5.DI 7	Signal: Digital Input
DI Slot X5.DI 8	Signal: Digital Input
DI Slot X6.DI 1	Signal: Digital Input
DI Slot X6.DI 2	Signal: Digital Input
DI Slot X6.DI 3	Signal: Digital Input
DI Slot X6.DI 4	Signal: Digital Input
DI Slot X6.DI 5	Signal: Digital Input
DI Slot X6.DI 6	Signal: Digital Input
DI Slot X6.DI 7	Signal: Digital Input
DI Slot X6.DI 8	Signal: Digital Input
Logics.LE1.Gate Out	Signal: Output of the logic gate
Logics.LE1.Timer Out	Signal: Timer Output
Logics.LE1.Out	Signal: Latched Output (Q)
Logics.LE1.Out inverted	Signal: Negated Latched Output (Q NOT)
Logics.LE2.Gate Out	Signal: Output of the logic gate
Logics.LE2.Timer Out	Signal: Timer Output
Logics.LE2.Out	Signal: Latched Output (Q)
Logics.LE2.Out inverted	Signal: Negated Latched Output (Q NOT)
Logics.LE3.Gate Out	Signal: Output of the logic gate
Logics.LE3.Timer Out	Signal: Timer Output
Logics.LE3.Out	Signal: Latched Output (Q)
Logics.LE3.Out inverted	Signal: Negated Latched Output (Q NOT)
Logics.LE4.Gate Out	Signal: Output of the logic gate
Logics.LE4.Timer Out	Signal: Timer Output
Logics.LE4.Out	Signal: Latched Output (Q)
Logics.LE4.Out inverted	Signal: Negated Latched Output (Q NOT)
Logics.LE5.Gate Out	Signal: Output of the logic gate
Logics.LE5.Timer Out	Signal: Timer Output
Logics.LE5.Out	Signal: Latched Output (Q)
Logics.LE5.Out inverted	Signal: Negated Latched Output (Q NOT)
Logics.LE6.Gate Out	Signal: Output of the logic gate
Logics.LE6.Timer Out	Signal: Timer Output
Logics.LE6.Out	Signal: Latched Output (Q)
Logics.LE6.Out inverted	Signal: Negated Latched Output (Q NOT)
Logics.LE7.Gate Out	Signal: Output of the logic gate
Logics.LE7.Timer Out	Signal: Timer Output
Logics.LE7.Out	Signal: Latched Output (Q)
Logics.LE7.Out inverted	Signal: Negated Latched Output (Q NOT)
Logics.LE8.Gate Out	Signal: Output of the logic gate

<i>Name</i>	<i>Description</i>
Logics.LE8.Timer Out	Signal: Timer Output
Logics.LE8.Out	Signal: Latched Output (Q)
Logics.LE8.Out inverted	Signal: Negated Latched Output (Q NOT)
Logics.LE9.Gate Out	Signal: Output of the logic gate
Logics.LE9.Timer Out	Signal: Timer Output
Logics.LE9.Out	Signal: Latched Output (Q)
Logics.LE9.Out inverted	Signal: Negated Latched Output (Q NOT)
Logics.LE10.Gate Out	Signal: Output of the logic gate
Logics.LE10.Timer Out	Signal: Timer Output
Logics.LE10.Out	Signal: Latched Output (Q)
Logics.LE10.Out inverted	Signal: Negated Latched Output (Q NOT)
Logics.LE11.Gate Out	Signal: Output of the logic gate
Logics.LE11.Timer Out	Signal: Timer Output
Logics.LE11.Out	Signal: Latched Output (Q)
Logics.LE11.Out inverted	Signal: Negated Latched Output (Q NOT)
Logics.LE12.Gate Out	Signal: Output of the logic gate
Logics.LE12.Timer Out	Signal: Timer Output
Logics.LE12.Out	Signal: Latched Output (Q)
Logics.LE12.Out inverted	Signal: Negated Latched Output (Q NOT)
Logics.LE13.Gate Out	Signal: Output of the logic gate
Logics.LE13.Timer Out	Signal: Timer Output
Logics.LE13.Out	Signal: Latched Output (Q)
Logics.LE13.Out inverted	Signal: Negated Latched Output (Q NOT)
Logics.LE14.Gate Out	Signal: Output of the logic gate
Logics.LE14.Timer Out	Signal: Timer Output
Logics.LE14.Out	Signal: Latched Output (Q)
Logics.LE14.Out inverted	Signal: Negated Latched Output (Q NOT)
Logics.LE15.Gate Out	Signal: Output of the logic gate
Logics.LE15.Timer Out	Signal: Timer Output
Logics.LE15.Out	Signal: Latched Output (Q)
Logics.LE15.Out inverted	Signal: Negated Latched Output (Q NOT)
Logics.LE16.Gate Out	Signal: Output of the logic gate
Logics.LE16.Timer Out	Signal: Timer Output
Logics.LE16.Out	Signal: Latched Output (Q)
Logics.LE16.Out inverted	Signal: Negated Latched Output (Q NOT)
Logics.LE17.Gate Out	Signal: Output of the logic gate
Logics.LE17.Timer Out	Signal: Timer Output
Logics.LE17.Out	Signal: Latched Output (Q)
Logics.LE17.Out inverted	Signal: Negated Latched Output (Q NOT)
Logics.LE18.Gate Out	Signal: Output of the logic gate

<i>Name</i>	<i>Description</i>
Logics.LE18.Timer Out	Signal: Timer Output
Logics.LE18.Out	Signal: Latched Output (Q)
Logics.LE18.Out inverted	Signal: Negated Latched Output (Q NOT)
Logics.LE19.Gate Out	Signal: Output of the logic gate
Logics.LE19.Timer Out	Signal: Timer Output
Logics.LE19.Out	Signal: Latched Output (Q)
Logics.LE19.Out inverted	Signal: Negated Latched Output (Q NOT)
Logics.LE20.Gate Out	Signal: Output of the logic gate
Logics.LE20.Timer Out	Signal: Timer Output
Logics.LE20.Out	Signal: Latched Output (Q)
Logics.LE20.Out inverted	Signal: Negated Latched Output (Q NOT)
Logics.LE21.Gate Out	Signal: Output of the logic gate
Logics.LE21.Timer Out	Signal: Timer Output
Logics.LE21.Out	Signal: Latched Output (Q)
Logics.LE21.Out inverted	Signal: Negated Latched Output (Q NOT)
Logics.LE22.Gate Out	Signal: Output of the logic gate
Logics.LE22.Timer Out	Signal: Timer Output
Logics.LE22.Out	Signal: Latched Output (Q)
Logics.LE22.Out inverted	Signal: Negated Latched Output (Q NOT)
Logics.LE23.Gate Out	Signal: Output of the logic gate
Logics.LE23.Timer Out	Signal: Timer Output
Logics.LE23.Out	Signal: Latched Output (Q)
Logics.LE23.Out inverted	Signal: Negated Latched Output (Q NOT)
Logics.LE24.Gate Out	Signal: Output of the logic gate
Logics.LE24.Timer Out	Signal: Timer Output
Logics.LE24.Out	Signal: Latched Output (Q)
Logics.LE24.Out inverted	Signal: Negated Latched Output (Q NOT)
Logics.LE25.Gate Out	Signal: Output of the logic gate
Logics.LE25.Timer Out	Signal: Timer Output
Logics.LE25.Out	Signal: Latched Output (Q)
Logics.LE25.Out inverted	Signal: Negated Latched Output (Q NOT)
Logics.LE26.Gate Out	Signal: Output of the logic gate
Logics.LE26.Timer Out	Signal: Timer Output
Logics.LE26.Out	Signal: Latched Output (Q)
Logics.LE26.Out inverted	Signal: Negated Latched Output (Q NOT)
Logics.LE27.Gate Out	Signal: Output of the logic gate
Logics.LE27.Timer Out	Signal: Timer Output
Logics.LE27.Out	Signal: Latched Output (Q)
Logics.LE27.Out inverted	Signal: Negated Latched Output (Q NOT)
Logics.LE28.Gate Out	Signal: Output of the logic gate

<i>Name</i>	<i>Description</i>
Logics.LE28.Timer Out	Signal: Timer Output
Logics.LE28.Out	Signal: Latched Output (Q)
Logics.LE28.Out inverted	Signal: Negated Latched Output (Q NOT)
Logics.LE29.Gate Out	Signal: Output of the logic gate
Logics.LE29.Timer Out	Signal: Timer Output
Logics.LE29.Out	Signal: Latched Output (Q)
Logics.LE29.Out inverted	Signal: Negated Latched Output (Q NOT)
Logics.LE30.Gate Out	Signal: Output of the logic gate
Logics.LE30.Timer Out	Signal: Timer Output
Logics.LE30.Out	Signal: Latched Output (Q)
Logics.LE30.Out inverted	Signal: Negated Latched Output (Q NOT)
Logics.LE31.Gate Out	Signal: Output of the logic gate
Logics.LE31.Timer Out	Signal: Timer Output
Logics.LE31.Out	Signal: Latched Output (Q)
Logics.LE31.Out inverted	Signal: Negated Latched Output (Q NOT)
Logics.LE32.Gate Out	Signal: Output of the logic gate
Logics.LE32.Timer Out	Signal: Timer Output
Logics.LE32.Out	Signal: Latched Output (Q)
Logics.LE32.Out inverted	Signal: Negated Latched Output (Q NOT)
Logics.LE33.Gate Out	Signal: Output of the logic gate
Logics.LE33.Timer Out	Signal: Timer Output
Logics.LE33.Out	Signal: Latched Output (Q)
Logics.LE33.Out inverted	Signal: Negated Latched Output (Q NOT)
Logics.LE34.Gate Out	Signal: Output of the logic gate
Logics.LE34.Timer Out	Signal: Timer Output
Logics.LE34.Out	Signal: Latched Output (Q)
Logics.LE34.Out inverted	Signal: Negated Latched Output (Q NOT)
Logics.LE35.Gate Out	Signal: Output of the logic gate
Logics.LE35.Timer Out	Signal: Timer Output
Logics.LE35.Out	Signal: Latched Output (Q)
Logics.LE35.Out inverted	Signal: Negated Latched Output (Q NOT)
Logics.LE36.Gate Out	Signal: Output of the logic gate
Logics.LE36.Timer Out	Signal: Timer Output
Logics.LE36.Out	Signal: Latched Output (Q)
Logics.LE36.Out inverted	Signal: Negated Latched Output (Q NOT)
Logics.LE37.Gate Out	Signal: Output of the logic gate
Logics.LE37.Timer Out	Signal: Timer Output
Logics.LE37.Out	Signal: Latched Output (Q)
Logics.LE37.Out inverted	Signal: Negated Latched Output (Q NOT)
Logics.LE38.Gate Out	Signal: Output of the logic gate

<i>Name</i>	<i>Description</i>
Logics.LE38.Timer Out	Signal: Timer Output
Logics.LE38.Out	Signal: Latched Output (Q)
Logics.LE38.Out inverted	Signal: Negated Latched Output (Q NOT)
Logics.LE39.Gate Out	Signal: Output of the logic gate
Logics.LE39.Timer Out	Signal: Timer Output
Logics.LE39.Out	Signal: Latched Output (Q)
Logics.LE39.Out inverted	Signal: Negated Latched Output (Q NOT)
Logics.LE40.Gate Out	Signal: Output of the logic gate
Logics.LE40.Timer Out	Signal: Timer Output
Logics.LE40.Out	Signal: Latched Output (Q)
Logics.LE40.Out inverted	Signal: Negated Latched Output (Q NOT)
Logics.LE41.Gate Out	Signal: Output of the logic gate
Logics.LE41.Timer Out	Signal: Timer Output
Logics.LE41.Out	Signal: Latched Output (Q)
Logics.LE41.Out inverted	Signal: Negated Latched Output (Q NOT)
Logics.LE42.Gate Out	Signal: Output of the logic gate
Logics.LE42.Timer Out	Signal: Timer Output
Logics.LE42.Out	Signal: Latched Output (Q)
Logics.LE42.Out inverted	Signal: Negated Latched Output (Q NOT)
Logics.LE43.Gate Out	Signal: Output of the logic gate
Logics.LE43.Timer Out	Signal: Timer Output
Logics.LE43.Out	Signal: Latched Output (Q)
Logics.LE43.Out inverted	Signal: Negated Latched Output (Q NOT)
Logics.LE44.Gate Out	Signal: Output of the logic gate
Logics.LE44.Timer Out	Signal: Timer Output
Logics.LE44.Out	Signal: Latched Output (Q)
Logics.LE44.Out inverted	Signal: Negated Latched Output (Q NOT)
Logics.LE45.Gate Out	Signal: Output of the logic gate
Logics.LE45.Timer Out	Signal: Timer Output
Logics.LE45.Out	Signal: Latched Output (Q)
Logics.LE45.Out inverted	Signal: Negated Latched Output (Q NOT)
Logics.LE46.Gate Out	Signal: Output of the logic gate
Logics.LE46.Timer Out	Signal: Timer Output
Logics.LE46.Out	Signal: Latched Output (Q)
Logics.LE46.Out inverted	Signal: Negated Latched Output (Q NOT)
Logics.LE47.Gate Out	Signal: Output of the logic gate
Logics.LE47.Timer Out	Signal: Timer Output
Logics.LE47.Out	Signal: Latched Output (Q)
Logics.LE47.Out inverted	Signal: Negated Latched Output (Q NOT)
Logics.LE48.Gate Out	Signal: Output of the logic gate

<i>Name</i>	<i>Description</i>
Logics.LE48.Timer Out	Signal: Timer Output
Logics.LE48.Out	Signal: Latched Output (Q)
Logics.LE48.Out inverted	Signal: Negated Latched Output (Q NOT)
Logics.LE49.Gate Out	Signal: Output of the logic gate
Logics.LE49.Timer Out	Signal: Timer Output
Logics.LE49.Out	Signal: Latched Output (Q)
Logics.LE49.Out inverted	Signal: Negated Latched Output (Q NOT)
Logics.LE50.Gate Out	Signal: Output of the logic gate
Logics.LE50.Timer Out	Signal: Timer Output
Logics.LE50.Out	Signal: Latched Output (Q)
Logics.LE50.Out inverted	Signal: Negated Latched Output (Q NOT)
Logics.LE51.Gate Out	Signal: Output of the logic gate
Logics.LE51.Timer Out	Signal: Timer Output
Logics.LE51.Out	Signal: Latched Output (Q)
Logics.LE51.Out inverted	Signal: Negated Latched Output (Q NOT)
Logics.LE52.Gate Out	Signal: Output of the logic gate
Logics.LE52.Timer Out	Signal: Timer Output
Logics.LE52.Out	Signal: Latched Output (Q)
Logics.LE52.Out inverted	Signal: Negated Latched Output (Q NOT)
Logics.LE53.Gate Out	Signal: Output of the logic gate
Logics.LE53.Timer Out	Signal: Timer Output
Logics.LE53.Out	Signal: Latched Output (Q)
Logics.LE53.Out inverted	Signal: Negated Latched Output (Q NOT)
Logics.LE54.Gate Out	Signal: Output of the logic gate
Logics.LE54.Timer Out	Signal: Timer Output
Logics.LE54.Out	Signal: Latched Output (Q)
Logics.LE54.Out inverted	Signal: Negated Latched Output (Q NOT)
Logics.LE55.Gate Out	Signal: Output of the logic gate
Logics.LE55.Timer Out	Signal: Timer Output
Logics.LE55.Out	Signal: Latched Output (Q)
Logics.LE55.Out inverted	Signal: Negated Latched Output (Q NOT)
Logics.LE56.Gate Out	Signal: Output of the logic gate
Logics.LE56.Timer Out	Signal: Timer Output
Logics.LE56.Out	Signal: Latched Output (Q)
Logics.LE56.Out inverted	Signal: Negated Latched Output (Q NOT)
Logics.LE57.Gate Out	Signal: Output of the logic gate
Logics.LE57.Timer Out	Signal: Timer Output
Logics.LE57.Out	Signal: Latched Output (Q)
Logics.LE57.Out inverted	Signal: Negated Latched Output (Q NOT)
Logics.LE58.Gate Out	Signal: Output of the logic gate

<i>Name</i>	<i>Description</i>
Logics.LE58.Timer Out	Signal: Timer Output
Logics.LE58.Out	Signal: Latched Output (Q)
Logics.LE58.Out inverted	Signal: Negated Latched Output (Q NOT)
Logics.LE59.Gate Out	Signal: Output of the logic gate
Logics.LE59.Timer Out	Signal: Timer Output
Logics.LE59.Out	Signal: Latched Output (Q)
Logics.LE59.Out inverted	Signal: Negated Latched Output (Q NOT)
Logics.LE60.Gate Out	Signal: Output of the logic gate
Logics.LE60.Timer Out	Signal: Timer Output
Logics.LE60.Out	Signal: Latched Output (Q)
Logics.LE60.Out inverted	Signal: Negated Latched Output (Q NOT)
Logics.LE61.Gate Out	Signal: Output of the logic gate
Logics.LE61.Timer Out	Signal: Timer Output
Logics.LE61.Out	Signal: Latched Output (Q)
Logics.LE61.Out inverted	Signal: Negated Latched Output (Q NOT)
Logics.LE62.Gate Out	Signal: Output of the logic gate
Logics.LE62.Timer Out	Signal: Timer Output
Logics.LE62.Out	Signal: Latched Output (Q)
Logics.LE62.Out inverted	Signal: Negated Latched Output (Q NOT)
Logics.LE63.Gate Out	Signal: Output of the logic gate
Logics.LE63.Timer Out	Signal: Timer Output
Logics.LE63.Out	Signal: Latched Output (Q)
Logics.LE63.Out inverted	Signal: Negated Latched Output (Q NOT)
Logics.LE64.Gate Out	Signal: Output of the logic gate
Logics.LE64.Timer Out	Signal: Timer Output
Logics.LE64.Out	Signal: Latched Output (Q)
Logics.LE64.Out inverted	Signal: Negated Latched Output (Q NOT)
Logics.LE65.Gate Out	Signal: Output of the logic gate
Logics.LE65.Timer Out	Signal: Timer Output
Logics.LE65.Out	Signal: Latched Output (Q)
Logics.LE65.Out inverted	Signal: Negated Latched Output (Q NOT)
Logics.LE66.Gate Out	Signal: Output of the logic gate
Logics.LE66.Timer Out	Signal: Timer Output
Logics.LE66.Out	Signal: Latched Output (Q)
Logics.LE66.Out inverted	Signal: Negated Latched Output (Q NOT)
Logics.LE67.Gate Out	Signal: Output of the logic gate
Logics.LE67.Timer Out	Signal: Timer Output
Logics.LE67.Out	Signal: Latched Output (Q)
Logics.LE67.Out inverted	Signal: Negated Latched Output (Q NOT)
Logics.LE68.Gate Out	Signal: Output of the logic gate

<i>Name</i>	<i>Description</i>
Logics.LE68.Timer Out	Signal: Timer Output
Logics.LE68.Out	Signal: Latched Output (Q)
Logics.LE68.Out inverted	Signal: Negated Latched Output (Q NOT)
Logics.LE69.Gate Out	Signal: Output of the logic gate
Logics.LE69.Timer Out	Signal: Timer Output
Logics.LE69.Out	Signal: Latched Output (Q)
Logics.LE69.Out inverted	Signal: Negated Latched Output (Q NOT)
Logics.LE70.Gate Out	Signal: Output of the logic gate
Logics.LE70.Timer Out	Signal: Timer Output
Logics.LE70.Out	Signal: Latched Output (Q)
Logics.LE70.Out inverted	Signal: Negated Latched Output (Q NOT)
Logics.LE71.Gate Out	Signal: Output of the logic gate
Logics.LE71.Timer Out	Signal: Timer Output
Logics.LE71.Out	Signal: Latched Output (Q)
Logics.LE71.Out inverted	Signal: Negated Latched Output (Q NOT)
Logics.LE72.Gate Out	Signal: Output of the logic gate
Logics.LE72.Timer Out	Signal: Timer Output
Logics.LE72.Out	Signal: Latched Output (Q)
Logics.LE72.Out inverted	Signal: Negated Latched Output (Q NOT)
Logics.LE73.Gate Out	Signal: Output of the logic gate
Logics.LE73.Timer Out	Signal: Timer Output
Logics.LE73.Out	Signal: Latched Output (Q)
Logics.LE73.Out inverted	Signal: Negated Latched Output (Q NOT)
Logics.LE74.Gate Out	Signal: Output of the logic gate
Logics.LE74.Timer Out	Signal: Timer Output
Logics.LE74.Out	Signal: Latched Output (Q)
Logics.LE74.Out inverted	Signal: Negated Latched Output (Q NOT)
Logics.LE75.Gate Out	Signal: Output of the logic gate
Logics.LE75.Timer Out	Signal: Timer Output
Logics.LE75.Out	Signal: Latched Output (Q)
Logics.LE75.Out inverted	Signal: Negated Latched Output (Q NOT)
Logics.LE76.Gate Out	Signal: Output of the logic gate
Logics.LE76.Timer Out	Signal: Timer Output
Logics.LE76.Out	Signal: Latched Output (Q)
Logics.LE76.Out inverted	Signal: Negated Latched Output (Q NOT)
Logics.LE77.Gate Out	Signal: Output of the logic gate
Logics.LE77.Timer Out	Signal: Timer Output
Logics.LE77.Out	Signal: Latched Output (Q)
Logics.LE77.Out inverted	Signal: Negated Latched Output (Q NOT)
Logics.LE78.Gate Out	Signal: Output of the logic gate

<i>Name</i>	<i>Description</i>
Logics.LE78.Timer Out	Signal: Timer Output
Logics.LE78.Out	Signal: Latched Output (Q)
Logics.LE78.Out inverted	Signal: Negated Latched Output (Q NOT)
Logics.LE79.Gate Out	Signal: Output of the logic gate
Logics.LE79.Timer Out	Signal: Timer Output
Logics.LE79.Out	Signal: Latched Output (Q)
Logics.LE79.Out inverted	Signal: Negated Latched Output (Q NOT)
Logics.LE80.Gate Out	Signal: Output of the logic gate
Logics.LE80.Timer Out	Signal: Timer Output
Logics.LE80.Out	Signal: Latched Output (Q)
Logics.LE80.Out inverted	Signal: Negated Latched Output (Q NOT)

Assignable Trip Commands (Trip Manager)

<i>Name</i>	<i>Description</i>
.-	No assignment
Id.TripCmd	Signal: Trip Command
IdH.TripCmd	Signal: Trip Command
IdG[1].TripCmd	Signal: Trip Command
IdGH[1].TripCmd	Signal: Trip Command
IdG[2].TripCmd	Signal: Trip Command
IdGH[2].TripCmd	Signal: Trip Command
I[1].TripCmd	Signal: Trip Command
I[2].TripCmd	Signal: Trip Command
I[3].TripCmd	Signal: Trip Command
I[4].TripCmd	Signal: Trip Command
I[5].TripCmd	Signal: Trip Command
I[6].TripCmd	Signal: Trip Command
IG[1].TripCmd	Signal: Trip Command
IG[2].TripCmd	Signal: Trip Command
IG[3].TripCmd	Signal: Trip Command
IG[4].TripCmd	Signal: Trip Command
ThR.TripCmd	Signal: Trip Command
I2>[1].TripCmd	Signal: Trip Command
I2>[2].TripCmd	Signal: Trip Command
I2>G[1].TripCmd	Signal: Trip Command
I2>G[2].TripCmd	Signal: Trip Command
V[1].TripCmd	Signal: Trip Command
V[2].TripCmd	Signal: Trip Command
V[3].TripCmd	Signal: Trip Command



<i>Name</i>	<i>Description</i>
V[4].TripCmd	Signal: Trip Command
V[5].TripCmd	Signal: Trip Command
V[6].TripCmd	Signal: Trip Command
df/dt.TripCmd	Signal: Trip Command
delta phi.TripCmd	Signal: Trip Command
Intertripping.TripCmd	Signal: Trip Command
P.TripCmd	Signal: Trip Command
Q.TripCmd	Signal: Trip Command
LVRT[1].TripCmd	Signal: Trip Command
LVRT[2].TripCmd	Signal: Trip Command
VG[1].TripCmd	Signal: Trip Command
VG[2].TripCmd	Signal: Trip Command
V012[1].TripCmd	Signal: Trip Command
V012[2].TripCmd	Signal: Trip Command
V012[3].TripCmd	Signal: Trip Command
V012[4].TripCmd	Signal: Trip Command
V012[5].TripCmd	Signal: Trip Command
V012[6].TripCmd	Signal: Trip Command
f[1].TripCmd	Signal: Trip Command
f[2].TripCmd	Signal: Trip Command
f[3].TripCmd	Signal: Trip Command
f[4].TripCmd	Signal: Trip Command
f[5].TripCmd	Signal: Trip Command
f[6].TripCmd	Signal: Trip Command
PQS[1].TripCmd	Signal: Trip Command
PQS[2].TripCmd	Signal: Trip Command
PQS[3].TripCmd	Signal: Trip Command
PQS[4].TripCmd	Signal: Trip Command
PQS[5].TripCmd	Signal: Trip Command
PQS[6].TripCmd	Signal: Trip Command
PF[1].TripCmd	Signal: Trip Command
PF[2].TripCmd	Signal: Trip Command
LoE-Z1[1].TripCmd	Signal: Trip Command
LoE-Z2[1].TripCmd	Signal: Trip Command
LoE-Z1[2].TripCmd	Signal: Trip Command
LoE-Z2[2].TripCmd	Signal: Trip Command
OST.TripCmd	Signal: Trip Command
V/f>[1].TripCmd	Signal: Trip Command
V/f>[2].TripCmd	Signal: Trip Command
InEn.TripCmd	Signal: Trip Command

<i>Name</i>	<i>Description</i>
Z[1].TripCmd	Signal: Trip Command
Z[2].TripCmd	Signal: Trip Command
ExP[1].TripCmd	Signal: Trip Command
ExP[2].TripCmd	Signal: Trip Command
ExP[3].TripCmd	Signal: Trip Command
ExP[4].TripCmd	Signal: Trip Command
Ext Sudd Press.TripCmd	Signal: Trip Command
Ext Oil Temp.TripCmd	Signal: Trip Command
Ext Temp Superv[1].TripCmd	Signal: Trip Command
Ext Temp Superv[2].TripCmd	Signal: Trip Command
Ext Temp Superv[3].TripCmd	Signal: Trip Command
RTD.TripCmd	Signal: Trip Command
AnaP[1].TripCmd	Signal: Trip Command
AnaP[2].TripCmd	Signal: Trip Command
AnaP[3].TripCmd	Signal: Trip Command
AnaP[4].TripCmd	Signal: Trip Command



Controlled Circuit Breaker









SG[1]







Direct Commands of a Controlled Circuit Breaker









Parameter	Description	Setting range	Default	Menu path
Manipulate Position 	WARNING! Fake Position - Manual Position Manipulation	inactive, Pos OFF, Pos ON	inactive	[Control /SG /SG[1] /General Settings]
Res SGwear SI SG 	Resetting the slow Switchgear Alarm	inactive, active	inactive	[Operation /Reset]
Ack TripCmd 	Acknowledge Trip Command	inactive, active	inactive	[Operation /Acknowledge]







Global Protection Parameters of a Controlled Circuit Breaker









Parameter	Description	Setting range	Default	Menu path
Aux ON 	The CB is in ON-position if the state of the assigned signal is true (52a).	1..n, DI- LogicList	DI Slot X1.DI 1	[Control /SG /SG[1] /Pos Indicatr Wirng]
Aux OFF 	The CB is in OFF-position if the state of the assigned signal is true (52b).	1..n, DI- LogicList	DI Slot X1.DI 2	[Control /SG /SG[1] /Pos Indicatr Wirng]
Ready 	Circuit breaker is ready for operation if the state of the assigned signal is true. This digital input can be used by some protective elements (if they are available within the device) like Auto Reclosure (AR), e.g. as a trigger signal.	1..n, DI- LogicList	.-	[Control /SG /SG[1] /Pos Indicatr Wirng]









Parameter	Description	Setting range	Default	Menu path
Removed 	The withdrawable circuit breaker is Removed Dependency	1..n, DI-LogicList	-.-	[Control /SG /SG[1] /Pos Indicatr Wirng]
Interl ON1 	Interlocking of the ON command	1..n, Assignment List	-.-	[Control /SG /SG[1] /Interlockings]
Interl ON2 	Interlocking of the ON command	1..n, Assignment List	-.-	[Control /SG /SG[1] /Interlockings]
Interl ON3 	Interlocking of the ON command	1..n, Assignment List	-.-	[Control /SG /SG[1] /Interlockings]
Interl OFF1 	Interlocking of the OFF command	1..n, Assignment List	-.-	[Control /SG /SG[1] /Interlockings]
Interl OFF2 	Interlocking of the OFF command	1..n, Assignment List	-.-	[Control /SG /SG[1] /Interlockings]
Interl OFF3 	Interlocking of the OFF command	1..n, Assignment List	-.-	[Control /SG /SG[1] /Interlockings]
SCmd ON 	Switching ON Command, e.g. the state of the Logics or the state of the digital input	1..n, DI-LogicList	-.-	[Control /SG /SG[1] /Ex ON/OFF Cmd]
SCmd OFF 	Switching OFF Command, e.g. the state of the Logics or the state of the digital input	1..n, DI-LogicList	-.-	[Control /SG /SG[1] /Ex ON/OFF Cmd]









Parameter	Description	Setting range	Default	Menu path
t-TripCmd 	Minimum hold time of the OFF-command (circuit breaker, load break switch)	0 - 300.00s	0.2s	[Control /SG /SG[1] /Trip Manager]
Latched 	Defines whether the Binary Output Relay will be Latched when it picks up.	inactive, active	inactive	[Control /SG /SG[1] /Trip Manager]
Ack TripCmd 	Ack TripCmd	1..n, Assignment List	-.-	[Control /SG /SG[1] /Trip Manager]
Off Cmd1 	Off Command to the Circuit Breaker if the state of the assigned signal becomes true.	1..n, Trip Cmds	Id.TripCmd	[Control /SG /SG[1] /Trip Manager]
Off Cmd2 	Off Command to the Circuit Breaker if the state of the assigned signal becomes true.	1..n, Trip Cmds	IdH.TripCmd	[Control /SG /SG[1] /Trip Manager]
Off Cmd3 	Off Command to the Circuit Breaker if the state of the assigned signal becomes true.	1..n, Trip Cmds	I[1].TripCmd	[Control /SG /SG[1] /Trip Manager]
Off Cmd4 	Off Command to the Circuit Breaker if the state of the assigned signal becomes true.	1..n, Trip Cmds	V[1].TripCmd	[Control /SG /SG[1] /Trip Manager]
Off Cmd5 	Off Command to the Circuit Breaker if the state of the assigned signal becomes true.	1..n, Trip Cmds	V[2].TripCmd	[Control /SG /SG[1] /Trip Manager]
Off Cmd6 	Off Command to the Circuit Breaker if the state of the assigned signal becomes true.	1..n, Trip Cmds	f[1].TripCmd	[Control /SG /SG[1] /Trip Manager]







Parameter	Description	Setting range	Default	Menu path
Off Cmd7 	Off Command to the Circuit Breaker if the state of the assigned signal becomes true.	1..n, Trip Cmds	f[2].TripCmd	[Control /SG /SG[1] /Trip Manager]
Off Cmd8 	Off Command to the Circuit Breaker if the state of the assigned signal becomes true.	1..n, Trip Cmds	PQS[1].TripCmd	[Control /SG /SG[1] /Trip Manager]
Off Cmd9 	Off Command to the Circuit Breaker if the state of the assigned signal becomes true.	1..n, Trip Cmds	.-	[Control /SG /SG[1] /Trip Manager]
Off Cmd10 	Off Command to the Circuit Breaker if the state of the assigned signal becomes true.	1..n, Trip Cmds	.-	[Control /SG /SG[1] /Trip Manager]
Off Cmd11 	Off Command to the Circuit Breaker if the state of the assigned signal becomes true.	1..n, Trip Cmds	.-	[Control /SG /SG[1] /Trip Manager]
Off Cmd12 	Off Command to the Circuit Breaker if the state of the assigned signal becomes true.	1..n, Trip Cmds	.-	[Control /SG /SG[1] /Trip Manager]
Off Cmd13 	Off Command to the Circuit Breaker if the state of the assigned signal becomes true.	1..n, Trip Cmds	.-	[Control /SG /SG[1] /Trip Manager]
Off Cmd14 	Off Command to the Circuit Breaker if the state of the assigned signal becomes true.	1..n, Trip Cmds	.-	[Control /SG /SG[1] /Trip Manager]
Off Cmd15 	Off Command to the Circuit Breaker if the state of the assigned signal becomes true.	1..n, Trip Cmds	.-	[Control /SG /SG[1] /Trip Manager]









<i>Parameter</i>	<i>Description</i>	<i>Setting range</i>	<i>Default</i>	<i>Menu path</i>
Off Cmd16 	Off Command to the Circuit Breaker if the state of the assigned signal becomes true.	1..n, Trip Cmds	.-	[Control /SG /SG[1] /Trip Manager]
Off Cmd17 	Off Command to the Circuit Breaker if the state of the assigned signal becomes true.	1..n, Trip Cmds	.-	[Control /SG /SG[1] /Trip Manager]
Off Cmd18 	Off Command to the Circuit Breaker if the state of the assigned signal becomes true.	1..n, Trip Cmds	.-	[Control /SG /SG[1] /Trip Manager]
Off Cmd19 	Off Command to the Circuit Breaker if the state of the assigned signal becomes true.	1..n, Trip Cmds	.-	[Control /SG /SG[1] /Trip Manager]
Off Cmd20 	Off Command to the Circuit Breaker if the state of the assigned signal becomes true.	1..n, Trip Cmds	.-	[Control /SG /SG[1] /Trip Manager]
Off Cmd21 	Off Command to the Circuit Breaker if the state of the assigned signal becomes true.	1..n, Trip Cmds	.-	[Control /SG /SG[1] /Trip Manager]
Off Cmd22 	Off Command to the Circuit Breaker if the state of the assigned signal becomes true.	1..n, Trip Cmds	.-	[Control /SG /SG[1] /Trip Manager]
Off Cmd23 	Off Command to the Circuit Breaker if the state of the assigned signal becomes true.	1..n, Trip Cmds	.-	[Control /SG /SG[1] /Trip Manager]
Off Cmd24 	Off Command to the Circuit Breaker if the state of the assigned signal becomes true.	1..n, Trip Cmds	.-	[Control /SG /SG[1] /Trip Manager]

<i>Parameter</i>	<i>Description</i>	<i>Setting range</i>	<i>Default</i>	<i>Menu path</i>
Off Cmd25 	Off Command to the Circuit Breaker if the state of the assigned signal becomes true.	1..n, Trip Cmds	.-	[Control /SG /SG[1] /Trip Manager]
Off Cmd26 	Off Command to the Circuit Breaker if the state of the assigned signal becomes true.	1..n, Trip Cmds	.-	[Control /SG /SG[1] /Trip Manager]
Off Cmd27 	Off Command to the Circuit Breaker if the state of the assigned signal becomes true.	1..n, Trip Cmds	.-	[Control /SG /SG[1] /Trip Manager]
Off Cmd28 	Off Command to the Circuit Breaker if the state of the assigned signal becomes true.	1..n, Trip Cmds	.-	[Control /SG /SG[1] /Trip Manager]
Off Cmd29 	Off Command to the Circuit Breaker if the state of the assigned signal becomes true.	1..n, Trip Cmds	.-	[Control /SG /SG[1] /Trip Manager]
Off Cmd30 	Off Command to the Circuit Breaker if the state of the assigned signal becomes true.	1..n, Trip Cmds	.-	[Control /SG /SG[1] /Trip Manager]
Off Cmd31 	Off Command to the Circuit Breaker if the state of the assigned signal becomes true.	1..n, Trip Cmds	.-	[Control /SG /SG[1] /Trip Manager]
Off Cmd32 	Off Command to the Circuit Breaker if the state of the assigned signal becomes true.	1..n, Trip Cmds	.-	[Control /SG /SG[1] /Trip Manager]
Off Cmd33 	Off Command to the Circuit Breaker if the state of the assigned signal becomes true.	1..n, Trip Cmds	.-	[Control /SG /SG[1] /Trip Manager]





<i>Parameter</i>	<i>Description</i>	<i>Setting range</i>	<i>Default</i>	<i>Menu path</i>
Off Cmd34 	Off Command to the Circuit Breaker if the state of the assigned signal becomes true.	1..n, Trip Cmds	-.-	[Control /SG /SG[1] /Trip Manager]
Off Cmd35 	Off Command to the Circuit Breaker if the state of the assigned signal becomes true.	1..n, Trip Cmds	-.-	[Control /SG /SG[1] /Trip Manager]
Off Cmd36 	Off Command to the Circuit Breaker if the state of the assigned signal becomes true.	1..n, Trip Cmds	-.-	[Control /SG /SG[1] /Trip Manager]
Off Cmd37 	Off Command to the Circuit Breaker if the state of the assigned signal becomes true.	1..n, Trip Cmds	-.-	[Control /SG /SG[1] /Trip Manager]
Off Cmd38 	Off Command to the Circuit Breaker if the state of the assigned signal becomes true.	1..n, Trip Cmds	-.-	[Control /SG /SG[1] /Trip Manager]
Off Cmd39 	Off Command to the Circuit Breaker if the state of the assigned signal becomes true.	1..n, Trip Cmds	-.-	[Control /SG /SG[1] /Trip Manager]
Off Cmd40 	Off Command to the Circuit Breaker if the state of the assigned signal becomes true.	1..n, Trip Cmds	-.-	[Control /SG /SG[1] /Trip Manager]
Off Cmd41 	Off Command to the Circuit Breaker if the state of the assigned signal becomes true.	1..n, Trip Cmds	-.-	[Control /SG /SG[1] /Trip Manager]
Off Cmd42 	Off Command to the Circuit Breaker if the state of the assigned signal becomes true.	1..n, Trip Cmds	-.-	[Control /SG /SG[1] /Trip Manager]

<i>Parameter</i>	<i>Description</i>	<i>Setting range</i>	<i>Default</i>	<i>Menu path</i>
Off Cmd43 	Off Command to the Circuit Breaker if the state of the assigned signal becomes true.	1..n, Trip Cmds	.-	[Control /SG /SG[1] /Trip Manager]
Off Cmd44 	Off Command to the Circuit Breaker if the state of the assigned signal becomes true.	1..n, Trip Cmds	.-	[Control /SG /SG[1] /Trip Manager]
Off Cmd45 	Off Command to the Circuit Breaker if the state of the assigned signal becomes true.	1..n, Trip Cmds	.-	[Control /SG /SG[1] /Trip Manager]
Off Cmd46 	Off Command to the Circuit Breaker if the state of the assigned signal becomes true.	1..n, Trip Cmds	.-	[Control /SG /SG[1] /Trip Manager]
Off Cmd47 	Off Command to the Circuit Breaker if the state of the assigned signal becomes true.	1..n, Trip Cmds	.-	[Control /SG /SG[1] /Trip Manager]
Off Cmd48 	Off Command to the Circuit Breaker if the state of the assigned signal becomes true.	1..n, Trip Cmds	.-	[Control /SG /SG[1] /Trip Manager]
Off Cmd49 	Off Command to the Circuit Breaker if the state of the assigned signal becomes true.	1..n, Trip Cmds	.-	[Control /SG /SG[1] /Trip Manager]
Off Cmd50 	Off Command to the Circuit Breaker if the state of the assigned signal becomes true.	1..n, Trip Cmds	.-	[Control /SG /SG[1] /Trip Manager]
Off Cmd51 	Off Command to the Circuit Breaker if the state of the assigned signal becomes true.	1..n, Trip Cmds	.-	[Control /SG /SG[1] /Trip Manager]

<i>Parameter</i>	<i>Description</i>	<i>Setting range</i>	<i>Default</i>	<i>Menu path</i>
Off Cmd52 	Off Command to the Circuit Breaker if the state of the assigned signal becomes true.	1..n, Trip Cmds	.-	[Control /SG /SG[1] /Trip Manager]
Off Cmd53 	Off Command to the Circuit Breaker if the state of the assigned signal becomes true.	1..n, Trip Cmds	.-	[Control /SG /SG[1] /Trip Manager]
Off Cmd54 	Off Command to the Circuit Breaker if the state of the assigned signal becomes true.	1..n, Trip Cmds	.-	[Control /SG /SG[1] /Trip Manager]
Off Cmd55 	Off Command to the Circuit Breaker if the state of the assigned signal becomes true.	1..n, Trip Cmds	.-	[Control /SG /SG[1] /Trip Manager]
Off Cmd56 	Off Command to the Circuit Breaker if the state of the assigned signal becomes true.	1..n, Trip Cmds	.-	[Control /SG /SG[1] /Trip Manager]
Off Cmd57 	Off Command to the Circuit Breaker if the state of the assigned signal becomes true.	1..n, Trip Cmds	.-	[Control /SG /SG[1] /Trip Manager]
Off Cmd58 	Off Command to the Circuit Breaker if the state of the assigned signal becomes true.	1..n, Trip Cmds	.-	[Control /SG /SG[1] /Trip Manager]
Off Cmd59 	Off Command to the Circuit Breaker if the state of the assigned signal becomes true.	1..n, Trip Cmds	.-	[Control /SG /SG[1] /Trip Manager]
Off Cmd60 	Off Command to the Circuit Breaker if the state of the assigned signal becomes true.	1..n, Trip Cmds	.-	[Control /SG /SG[1] /Trip Manager]

<i>Parameter</i>	<i>Description</i>	<i>Setting range</i>	<i>Default</i>	<i>Menu path</i>
Off Cmd61 	Off Command to the Circuit Breaker if the state of the assigned signal becomes true.	1..n, Trip Cmds	.-	[Control /SG /SG[1] /Trip Manager]
Off Cmd62 	Off Command to the Circuit Breaker if the state of the assigned signal becomes true.	1..n, Trip Cmds	.-	[Control /SG /SG[1] /Trip Manager]
Off Cmd63 	Off Command to the Circuit Breaker if the state of the assigned signal becomes true.	1..n, Trip Cmds	.-	[Control /SG /SG[1] /Trip Manager]
Off Cmd64 	Off Command to the Circuit Breaker if the state of the assigned signal becomes true.	1..n, Trip Cmds	.-	[Control /SG /SG[1] /Trip Manager]
Off Cmd65 	Off Command to the Circuit Breaker if the state of the assigned signal becomes true.	1..n, Trip Cmds	.-	[Control /SG /SG[1] /Trip Manager]
Off Cmd66 	Off Command to the Circuit Breaker if the state of the assigned signal becomes true.	1..n, Trip Cmds	.-	[Control /SG /SG[1] /Trip Manager]
Off Cmd67 	Off Command to the Circuit Breaker if the state of the assigned signal becomes true.	1..n, Trip Cmds	.-	[Control /SG /SG[1] /Trip Manager]
Off Cmd68 	Off Command to the Circuit Breaker if the state of the assigned signal becomes true.	1..n, Trip Cmds	.-	[Control /SG /SG[1] /Trip Manager]
Off Cmd69 	Off Command to the Circuit Breaker if the state of the assigned signal becomes true.	1..n, Trip Cmds	.-	[Control /SG /SG[1] /Trip Manager]

Parameter	Description	Setting range	Default	Menu path
Off Cmd70 	Off Command to the Circuit Breaker if the state of the assigned signal becomes true.	1..n, Trip Cmds	.-	[Control /SG /SG[1] /Trip Manager]
Off Cmd71 	Off Command to the Circuit Breaker if the state of the assigned signal becomes true.	1..n, Trip Cmds	.-	[Control /SG /SG[1] /Trip Manager]
Off Cmd72 	Off Command to the Circuit Breaker if the state of the assigned signal becomes true.	1..n, Trip Cmds	.-	[Control /SG /SG[1] /Trip Manager]
Off Cmd73 	Off Command to the Circuit Breaker if the state of the assigned signal becomes true.	1..n, Trip Cmds	.-	[Control /SG /SG[1] /Trip Manager]
Off Cmd74 	Off Command to the Circuit Breaker if the state of the assigned signal becomes true.	1..n, Trip Cmds	.-	[Control /SG /SG[1] /Trip Manager]
Off Cmd75 	Off Command to the Circuit Breaker if the state of the assigned signal becomes true.	1..n, Trip Cmds	.-	[Control /SG /SG[1] /Trip Manager]
Synchronism 	Synchronism	1..n, In-SyncList	.-	[Control /SG /SG[1] /Synchron Switchg]
t- MaxSyncSuperv 	Synchron-Run timer: Max. time allowed for synchronizing process after a close initiate. Only used for GENERATOR2SYSTEM working mode.	0 - 3000.00s	0.2s	[Control /SG /SG[1] /Synchron Switchg]
ON incl Prot ON 	The ON Command includes the ON Command issued by the Protection module.	inactive, active	active	[Control /SG /SG[1] /General Settings]

<i>Parameter</i>	<i>Description</i>	<i>Setting range</i>	<i>Default</i>	<i>Menu path</i>
OFF incl TripCmd 	The OFF Command includes the OFF Command issued by the Protection module.	inactive, active	active	[Control /SG /SG[1] /General Settings]
t-Move ON 	Time to move to the ON Position	0.01 - 100.00s	0.1s	[Control /SG /SG[1] /General Settings]
t-Move OFF 	Time to move to the OFF Position	0.01 - 100.00s	0.1s	[Control /SG /SG[1] /General Settings]
t-Dwell 	Dwell time	0 - 100.00s	0s	[Control /SG /SG[1] /General Settings]

Controlled Circuit Breaker Input States

<i>Name</i>	<i>Description</i>	<i>Assignment via</i>
Aux ON-I	Module Input State: Position indicator/check-back signal of the CB (52a)	[Control /SG /SG[1] /Pos Indicatrs Wirng]
Aux OFF-I	Module input state: Position indicator/check-back signal of the CB (52b)	[Control /SG /SG[1] /Pos Indicatrs Wirng]
Ready-I	Module input state: CB ready	[Control /SG /SG[1] /Pos Indicatrs Wirng]
Sys-in-Sync-I	State of the module input: This signals has to become true within the synchronization time. If not, switching is unsuccessful.	[Control /SG /SG[1] /Synchron Switchg]

<i>Name</i>	<i>Description</i>	<i>Assignment via</i>
Removed-I	State of the module input: The withdrawable circuit breaker is Removed	[Control /SG /SG[1] /Pos Indicators Wirng]
Ack TripCmd-I	State of the module input: Acknowledgement Signal (only for automatic acknowledgement) Module input signal	[Control /SG /SG[1] /Trip Manager]
Interl ON1-I	State of the module input: Interlocking of the ON command	[Control /SG /SG[1] /Interlockings]
Interl ON2-I	State of the module input: Interlocking of the ON command	[Control /SG /SG[1] /Interlockings]
Interl ON3-I	State of the module input: Interlocking of the ON command	[Control /SG /SG[1] /Interlockings]
Interl OFF1-I	State of the module input: Interlocking of the OFF command	[Control /SG /SG[1] /Interlockings]
Interl OFF2-I	State of the module input: Interlocking of the OFF command	[Control /SG /SG[1] /Interlockings]
Interl OFF3-I	State of the module input: Interlocking of the OFF command	[Control /SG /SG[1] /Interlockings]
SCmd ON-I	State of the module input: Switching ON Command, e.g. the state of the Logics or the state of the digital input	[Control /SG /SG[1] /Ex ON/OFF Cmd]

Name	Description	Assignment via
SCmd OFF-I	State of the module input: Switching OFF Command, e.g. the state of the Logics or the state of the digital input	[Control /SG /SG[1] /Ex ON/OFF Cmd]

Signals of a Controlled Circuit Breaker



Signal	Description
SI SingleContactInd	Signal: The Position of the Switchgear is detected by one auxiliary contact (pole) only. Thus indeterminate and disturbed Positions cannot be detected.
Pos not ON	Signal: Pos not ON
Pos ON	Signal: Circuit Breaker is in ON-Position
Pos OFF	Signal: Circuit Breaker is in OFF-Position
Pos Indeterm	Signal: Circuit Breaker is in Indeterminate Position
Pos Disturb	Signal: Circuit Breaker Disturbed - Undefined Breaker Position. The Position Indicators contradict themselves. After expiring of a supervision timer this signal becomes true.
Pos	Signal: Circuit Breaker Position (0 = Indeterminate, 1 = OFF, 2 = ON, 3 = Disturbed)
Ready	Signal: Circuit breaker is ready for operation.
t-Dwell	Signal: Dwell time
Removed	Signal: The withdrawable circuit breaker is Removed
Interl ON	Signal: One or more IL_On inputs are active.
Interl OFF	Signal: One or more IL_Off inputs are active.
CES succesf	Signal: Command Execution Supervision: Switching command executed successfully.
CES Disturbed	Signal: Command Execution Supervision: Switching Command unsuccessful. Switchgear in disturbed position.
CES Fail TripCmd	Signal: Command Execution Supervision: Command execution failed because trip command is pending.
CES SwitchDir	Signal: Command Execution Supervision respectively Switching Direction Control: This signal becomes true, if a switch command is issued even though the switchgear is already in the requested position. Example: A switchgear that is already OFF should be switched OFF again (doubly). The same applies to CLOSE commands.
CES ON d OFF	Signal: Command Execution Supervision: On Command during a pending OFF Command.
CES SG not ready	Signal: Command Execution Supervision: Switchgear not ready
CES Fiel Interl	Signal: Command Execution Supervision: Switching Command not executed because of field interlocking.
CES SyncTimeout	Signal: Command Execution Supervision: Switching Command not executed. No Synchronization signal while t-sync was running.
CES SG removed	Signal: Command Execution Supervision: Switching Command unsuccessful, Switchgear removed.
Prot ON	Signal: ON Command issued by the Prot module

<i>Signal</i>	<i>Description</i>
TripCmd	Signal: Trip Command
Ack TripCmd	Signal: Acknowledge Trip Command
ON incl Prot ON	Signal: The ON Command includes the ON Command issued by the Protection module.
OFF incl TripCmd	Signal: The OFF Command includes the OFF Command issued by the Protection module.
Position Ind manipul	Signal: Position Indicators faked
SGwear Slow SG	Signal: Alarm, the circuit breaker (load-break switch) becomes slower
Res SGwear SI SG	Signal: Resetting the slow Switchgear Alarm
ON Cmd	Signal: ON Command issued to the switchgear. Depending on the setting the signal may include the ON command of the Prot module.
OFF Cmd	Signal: OFF Command issued to the switchgear. Depending on the setting the signal may include the OFF command of the Prot module.
ON Cmd manual	Signal: ON Cmd manual
OFF Cmd manual	Signal: OFF Cmd manual
Sync ON request	Signal: Synchronous ON request



Monitored Circuit Breaker







SG[3]



Direct Commands of a Monitored Circuit Breaker



Parameter	Description	Setting range	Default	Menu path
Manipulate Position 	WARNING! Fake Position - Manual Position Manipulation	inactive, Pos OFF, Pos ON	inactive	[Control /SG /SG[3] /General Settings]
Res SGwear SI SG 	Resetting the slow Switchgear Alarm	inactive, active	inactive	[Operation /Reset]
Ack TripCmd 	Acknowledge Trip Command	inactive, active	inactive	[Operation /Acknowledge]



Global Protection Parameters of a Monitored Circuit Breaker







Parameter	Description	Setting range	Default	Menu path
Aux ON 	The CB is in ON-position if the state of the assigned signal is true (52a).	1..n, DI- LogicList	DI Slot X1.DI 3	[Control /SG /SG[3] /Pos Indicatr Wirng]
Aux OFF 	The CB is in OFF-position if the state of the assigned signal is true (52b).	1..n, DI- LogicList	DI Slot X1.DI 4	[Control /SG /SG[3] /Pos Indicatr Wirng]
Ready 	Circuit breaker is ready for operation if the state of the assigned signal is true. This digital input can be used by some protective elements (if they are available within the device) like Auto Reclosure (AR), e.g. as a trigger signal.	1..n, DI- LogicList	.-	[Control /SG /SG[3] /Pos Indicatr Wirng]





Parameter	Description	Setting range	Default	Menu path
Removed 	The withdrawable circuit breaker is Removed Dependency	1..n, DI-LogicList	-.-	[Control /SG /SG[3] /Pos Indicatr Wirng]
Interl ON1 	Interlocking of the ON command	1..n, Assignment List	-.-	[Control /SG /SG[3] /Interlockings]
Interl ON2 	Interlocking of the ON command	1..n, Assignment List	-.-	[Control /SG /SG[3] /Interlockings]
Interl ON3 	Interlocking of the ON command	1..n, Assignment List	-.-	[Control /SG /SG[3] /Interlockings]
Interl OFF1 	Interlocking of the OFF command	1..n, Assignment List	-.-	[Control /SG /SG[3] /Interlockings]
Interl OFF2 	Interlocking of the OFF command	1..n, Assignment List	-.-	[Control /SG /SG[3] /Interlockings]
Interl OFF3 	Interlocking of the OFF command	1..n, Assignment List	-.-	[Control /SG /SG[3] /Interlockings]
SCmd ON 	Switching ON Command, e.g. the state of the Logics or the state of the digital input	1..n, DI-LogicList	-.-	[Control /SG /SG[3] /Ex ON/OFF Cmd]
SCmd OFF 	Switching OFF Command, e.g. the state of the Logics or the state of the digital input	1..n, DI-LogicList	-.-	[Control /SG /SG[3] /Ex ON/OFF Cmd]









<i>Parameter</i>	<i>Description</i>	<i>Setting range</i>	<i>Default</i>	<i>Menu path</i>
t-TripCmd 	Minimum hold time of the OFF-command (circuit breaker, load break switch)	0 - 300.00s	0.2s	[Control /SG /SG[3] /Trip Manager]
Latched 	Defines whether the Binary Output Relay will be Latched when it picks up.	inactive, active	inactive	[Control /SG /SG[3] /Trip Manager]
Ack TripCmd 	Ack TripCmd	1..n, Assignment List	-.-	[Control /SG /SG[3] /Trip Manager]
Off Cmd1 	Off Command to the Circuit Breaker if the state of the assigned signal becomes true.	1..n, Trip Cmds	-.-	[Control /SG /SG[3] /Trip Manager]
Off Cmd2 	Off Command to the Circuit Breaker if the state of the assigned signal becomes true.	1..n, Trip Cmds	-.-	[Control /SG /SG[3] /Trip Manager]
Off Cmd3 	Off Command to the Circuit Breaker if the state of the assigned signal becomes true.	1..n, Trip Cmds	-.-	[Control /SG /SG[3] /Trip Manager]
Off Cmd4 	Off Command to the Circuit Breaker if the state of the assigned signal becomes true.	1..n, Trip Cmds	-.-	[Control /SG /SG[3] /Trip Manager]
Off Cmd5 	Off Command to the Circuit Breaker if the state of the assigned signal becomes true.	1..n, Trip Cmds	-.-	[Control /SG /SG[3] /Trip Manager]
Off Cmd6 	Off Command to the Circuit Breaker if the state of the assigned signal becomes true.	1..n, Trip Cmds	-.-	[Control /SG /SG[3] /Trip Manager]









Parameter	Description	Setting range	Default	Menu path
Off Cmd7 	Off Command to the Circuit Breaker if the state of the assigned signal becomes true.	1..n, Trip Cmds	.-	[Control /SG /SG[3] /Trip Manager]
Off Cmd8 	Off Command to the Circuit Breaker if the state of the assigned signal becomes true.	1..n, Trip Cmds	.-	[Control /SG /SG[3] /Trip Manager]
Off Cmd9 	Off Command to the Circuit Breaker if the state of the assigned signal becomes true.	1..n, Trip Cmds	.-	[Control /SG /SG[3] /Trip Manager]
Off Cmd10 	Off Command to the Circuit Breaker if the state of the assigned signal becomes true.	1..n, Trip Cmds	.-	[Control /SG /SG[3] /Trip Manager]
Off Cmd11 	Off Command to the Circuit Breaker if the state of the assigned signal becomes true.	1..n, Trip Cmds	.-	[Control /SG /SG[3] /Trip Manager]
Off Cmd12 	Off Command to the Circuit Breaker if the state of the assigned signal becomes true.	1..n, Trip Cmds	.-	[Control /SG /SG[3] /Trip Manager]
Off Cmd13 	Off Command to the Circuit Breaker if the state of the assigned signal becomes true.	1..n, Trip Cmds	.-	[Control /SG /SG[3] /Trip Manager]
Off Cmd14 	Off Command to the Circuit Breaker if the state of the assigned signal becomes true.	1..n, Trip Cmds	.-	[Control /SG /SG[3] /Trip Manager]
Off Cmd15 	Off Command to the Circuit Breaker if the state of the assigned signal becomes true.	1..n, Trip Cmds	.-	[Control /SG /SG[3] /Trip Manager]









<i>Parameter</i>	<i>Description</i>	<i>Setting range</i>	<i>Default</i>	<i>Menu path</i>
Off Cmd16 	Off Command to the Circuit Breaker if the state of the assigned signal becomes true.	1..n, Trip Cmds	.-	[Control /SG /SG[3] /Trip Manager]
Off Cmd17 	Off Command to the Circuit Breaker if the state of the assigned signal becomes true.	1..n, Trip Cmds	.-	[Control /SG /SG[3] /Trip Manager]
Off Cmd18 	Off Command to the Circuit Breaker if the state of the assigned signal becomes true.	1..n, Trip Cmds	.-	[Control /SG /SG[3] /Trip Manager]
Off Cmd19 	Off Command to the Circuit Breaker if the state of the assigned signal becomes true.	1..n, Trip Cmds	.-	[Control /SG /SG[3] /Trip Manager]
Off Cmd20 	Off Command to the Circuit Breaker if the state of the assigned signal becomes true.	1..n, Trip Cmds	.-	[Control /SG /SG[3] /Trip Manager]
Off Cmd21 	Off Command to the Circuit Breaker if the state of the assigned signal becomes true.	1..n, Trip Cmds	.-	[Control /SG /SG[3] /Trip Manager]
Off Cmd22 	Off Command to the Circuit Breaker if the state of the assigned signal becomes true.	1..n, Trip Cmds	.-	[Control /SG /SG[3] /Trip Manager]
Off Cmd23 	Off Command to the Circuit Breaker if the state of the assigned signal becomes true.	1..n, Trip Cmds	.-	[Control /SG /SG[3] /Trip Manager]
Off Cmd24 	Off Command to the Circuit Breaker if the state of the assigned signal becomes true.	1..n, Trip Cmds	.-	[Control /SG /SG[3] /Trip Manager]







<i>Parameter</i>	<i>Description</i>	<i>Setting range</i>	<i>Default</i>	<i>Menu path</i>
Off Cmd25 	Off Command to the Circuit Breaker if the state of the assigned signal becomes true.	1..n, Trip Cmds	.-	[Control /SG /SG[3] /Trip Manager]
Off Cmd26 	Off Command to the Circuit Breaker if the state of the assigned signal becomes true.	1..n, Trip Cmds	.-	[Control /SG /SG[3] /Trip Manager]
Off Cmd27 	Off Command to the Circuit Breaker if the state of the assigned signal becomes true.	1..n, Trip Cmds	.-	[Control /SG /SG[3] /Trip Manager]
Off Cmd28 	Off Command to the Circuit Breaker if the state of the assigned signal becomes true.	1..n, Trip Cmds	.-	[Control /SG /SG[3] /Trip Manager]
Off Cmd29 	Off Command to the Circuit Breaker if the state of the assigned signal becomes true.	1..n, Trip Cmds	.-	[Control /SG /SG[3] /Trip Manager]
Off Cmd30 	Off Command to the Circuit Breaker if the state of the assigned signal becomes true.	1..n, Trip Cmds	.-	[Control /SG /SG[3] /Trip Manager]
Off Cmd31 	Off Command to the Circuit Breaker if the state of the assigned signal becomes true.	1..n, Trip Cmds	.-	[Control /SG /SG[3] /Trip Manager]
Off Cmd32 	Off Command to the Circuit Breaker if the state of the assigned signal becomes true.	1..n, Trip Cmds	.-	[Control /SG /SG[3] /Trip Manager]
Off Cmd33 	Off Command to the Circuit Breaker if the state of the assigned signal becomes true.	1..n, Trip Cmds	.-	[Control /SG /SG[3] /Trip Manager]





<i>Parameter</i>	<i>Description</i>	<i>Setting range</i>	<i>Default</i>	<i>Menu path</i>
Off Cmd34 	Off Command to the Circuit Breaker if the state of the assigned signal becomes true.	1..n, Trip Cmds	.-	[Control /SG /SG[3] /Trip Manager]
Off Cmd35 	Off Command to the Circuit Breaker if the state of the assigned signal becomes true.	1..n, Trip Cmds	.-	[Control /SG /SG[3] /Trip Manager]
Off Cmd36 	Off Command to the Circuit Breaker if the state of the assigned signal becomes true.	1..n, Trip Cmds	.-	[Control /SG /SG[3] /Trip Manager]
Off Cmd37 	Off Command to the Circuit Breaker if the state of the assigned signal becomes true.	1..n, Trip Cmds	.-	[Control /SG /SG[3] /Trip Manager]
Off Cmd38 	Off Command to the Circuit Breaker if the state of the assigned signal becomes true.	1..n, Trip Cmds	.-	[Control /SG /SG[3] /Trip Manager]
Off Cmd39 	Off Command to the Circuit Breaker if the state of the assigned signal becomes true.	1..n, Trip Cmds	.-	[Control /SG /SG[3] /Trip Manager]
Off Cmd40 	Off Command to the Circuit Breaker if the state of the assigned signal becomes true.	1..n, Trip Cmds	.-	[Control /SG /SG[3] /Trip Manager]
Off Cmd41 	Off Command to the Circuit Breaker if the state of the assigned signal becomes true.	1..n, Trip Cmds	.-	[Control /SG /SG[3] /Trip Manager]
Off Cmd42 	Off Command to the Circuit Breaker if the state of the assigned signal becomes true.	1..n, Trip Cmds	.-	[Control /SG /SG[3] /Trip Manager]

<i>Parameter</i>	<i>Description</i>	<i>Setting range</i>	<i>Default</i>	<i>Menu path</i>
Off Cmd43 	Off Command to the Circuit Breaker if the state of the assigned signal becomes true.	1..n, Trip Cmds	.-	[Control /SG /SG[3] /Trip Manager]
Off Cmd44 	Off Command to the Circuit Breaker if the state of the assigned signal becomes true.	1..n, Trip Cmds	.-	[Control /SG /SG[3] /Trip Manager]
Off Cmd45 	Off Command to the Circuit Breaker if the state of the assigned signal becomes true.	1..n, Trip Cmds	.-	[Control /SG /SG[3] /Trip Manager]
Off Cmd46 	Off Command to the Circuit Breaker if the state of the assigned signal becomes true.	1..n, Trip Cmds	.-	[Control /SG /SG[3] /Trip Manager]
Off Cmd47 	Off Command to the Circuit Breaker if the state of the assigned signal becomes true.	1..n, Trip Cmds	.-	[Control /SG /SG[3] /Trip Manager]
Off Cmd48 	Off Command to the Circuit Breaker if the state of the assigned signal becomes true.	1..n, Trip Cmds	.-	[Control /SG /SG[3] /Trip Manager]
Off Cmd49 	Off Command to the Circuit Breaker if the state of the assigned signal becomes true.	1..n, Trip Cmds	.-	[Control /SG /SG[3] /Trip Manager]
Off Cmd50 	Off Command to the Circuit Breaker if the state of the assigned signal becomes true.	1..n, Trip Cmds	.-	[Control /SG /SG[3] /Trip Manager]
Off Cmd51 	Off Command to the Circuit Breaker if the state of the assigned signal becomes true.	1..n, Trip Cmds	.-	[Control /SG /SG[3] /Trip Manager]

<i>Parameter</i>	<i>Description</i>	<i>Setting range</i>	<i>Default</i>	<i>Menu path</i>
Off Cmd52 	Off Command to the Circuit Breaker if the state of the assigned signal becomes true.	1..n, Trip Cmds	.-	[Control /SG /SG[3] /Trip Manager]
Off Cmd53 	Off Command to the Circuit Breaker if the state of the assigned signal becomes true.	1..n, Trip Cmds	.-	[Control /SG /SG[3] /Trip Manager]
Off Cmd54 	Off Command to the Circuit Breaker if the state of the assigned signal becomes true.	1..n, Trip Cmds	.-	[Control /SG /SG[3] /Trip Manager]
Off Cmd55 	Off Command to the Circuit Breaker if the state of the assigned signal becomes true.	1..n, Trip Cmds	.-	[Control /SG /SG[3] /Trip Manager]
Off Cmd56 	Off Command to the Circuit Breaker if the state of the assigned signal becomes true.	1..n, Trip Cmds	.-	[Control /SG /SG[3] /Trip Manager]
Off Cmd57 	Off Command to the Circuit Breaker if the state of the assigned signal becomes true.	1..n, Trip Cmds	.-	[Control /SG /SG[3] /Trip Manager]
Off Cmd58 	Off Command to the Circuit Breaker if the state of the assigned signal becomes true.	1..n, Trip Cmds	.-	[Control /SG /SG[3] /Trip Manager]
Off Cmd59 	Off Command to the Circuit Breaker if the state of the assigned signal becomes true.	1..n, Trip Cmds	.-	[Control /SG /SG[3] /Trip Manager]
Off Cmd60 	Off Command to the Circuit Breaker if the state of the assigned signal becomes true.	1..n, Trip Cmds	.-	[Control /SG /SG[3] /Trip Manager]

Parameter	Description	Setting range	Default	Menu path
Off Cmd61 	Off Command to the Circuit Breaker if the state of the assigned signal becomes true.	1..n, Trip Cmds	.-	[Control /SG /SG[3] /Trip Manager]
Off Cmd62 	Off Command to the Circuit Breaker if the state of the assigned signal becomes true.	1..n, Trip Cmds	.-	[Control /SG /SG[3] /Trip Manager]
Off Cmd63 	Off Command to the Circuit Breaker if the state of the assigned signal becomes true.	1..n, Trip Cmds	.-	[Control /SG /SG[3] /Trip Manager]
Off Cmd64 	Off Command to the Circuit Breaker if the state of the assigned signal becomes true.	1..n, Trip Cmds	.-	[Control /SG /SG[3] /Trip Manager]
Off Cmd65 	Off Command to the Circuit Breaker if the state of the assigned signal becomes true.	1..n, Trip Cmds	.-	[Control /SG /SG[3] /Trip Manager]
Off Cmd66 	Off Command to the Circuit Breaker if the state of the assigned signal becomes true.	1..n, Trip Cmds	.-	[Control /SG /SG[3] /Trip Manager]
Off Cmd67 	Off Command to the Circuit Breaker if the state of the assigned signal becomes true.	1..n, Trip Cmds	.-	[Control /SG /SG[3] /Trip Manager]
Off Cmd68 	Off Command to the Circuit Breaker if the state of the assigned signal becomes true.	1..n, Trip Cmds	.-	[Control /SG /SG[3] /Trip Manager]
Off Cmd69 	Off Command to the Circuit Breaker if the state of the assigned signal becomes true.	1..n, Trip Cmds	.-	[Control /SG /SG[3] /Trip Manager]

Parameter	Description	Setting range	Default	Menu path
Off Cmd70 	Off Command to the Circuit Breaker if the state of the assigned signal becomes true.	1..n, Trip Cmds	.-	[Control /SG /SG[3] /Trip Manager]
Off Cmd71 	Off Command to the Circuit Breaker if the state of the assigned signal becomes true.	1..n, Trip Cmds	.-	[Control /SG /SG[3] /Trip Manager]
Off Cmd72 	Off Command to the Circuit Breaker if the state of the assigned signal becomes true.	1..n, Trip Cmds	.-	[Control /SG /SG[3] /Trip Manager]
Off Cmd73 	Off Command to the Circuit Breaker if the state of the assigned signal becomes true.	1..n, Trip Cmds	.-	[Control /SG /SG[3] /Trip Manager]
Off Cmd74 	Off Command to the Circuit Breaker if the state of the assigned signal becomes true.	1..n, Trip Cmds	.-	[Control /SG /SG[3] /Trip Manager]
Off Cmd75 	Off Command to the Circuit Breaker if the state of the assigned signal becomes true.	1..n, Trip Cmds	.-	[Control /SG /SG[3] /Trip Manager]
Synchronism 	Synchronism	1..n, In-SyncList	.-	[Control /SG /SG[3] /Synchron Switchg]
t- MaxSyncSuperv 	Synchron-Run timer: Max. time allowed for synchronizing process after a close initiate. Only used for GENERATOR2SYSTEM working mode.	0 - 3000.00s	0.2s	[Control /SG /SG[3] /Synchron Switchg]
ON incl Prot ON 	The ON Command includes the ON Command issued by the Protection module.	inactive, active	active	[Control /SG /SG[3] /General Settings]

<i>Parameter</i>	<i>Description</i>	<i>Setting range</i>	<i>Default</i>	<i>Menu path</i>
OFF incl TripCmd 	The OFF Command includes the OFF Command issued by the Protection module.	inactive, active	active	[Control /SG /SG[3] /General Settings]
t-Move ON 	Time to move to the ON Position	0.01 - 100.00s	0.1s	[Control /SG /SG[3] /General Settings]
t-Move OFF 	Time to move to the OFF Position	0.01 - 100.00s	0.1s	[Control /SG /SG[3] /General Settings]
t-Dwell 	Dwell time	0 - 100.00s	0s	[Control /SG /SG[3] /General Settings]

Monitored Circuit Breaker Input States

<i>Name</i>	<i>Description</i>	<i>Assignment via</i>
Aux ON-I	Module Input State: Position indicator/check-back signal of the CB (52a)	[Control /SG /SG[3] /Pos Indicatrs Wirng]
Aux OFF-I	Module input state: Position indicator/check-back signal of the CB (52b)	[Control /SG /SG[3] /Pos Indicatrs Wirng]
Ready-I	Module input state: CB ready	[Control /SG /SG[3] /Pos Indicatrs Wirng]
Sys-in-Sync-I	State of the module input: This signals has to become true within the synchronization time. If not, switching is unsuccessful.	[Control /SG /SG[3] /Synchron Switchg]

<i>Name</i>	<i>Description</i>	<i>Assignment via</i>
Removed-I	State of the module input: The withdrawable circuit breaker is Removed	[Control /SG /SG[3] /Pos Indicators Wirng]
Ack TripCmd-I	State of the module input: Acknowledgement Signal (only for automatic acknowledgement) Module input signal	[Control /SG /SG[3] /Trip Manager]
Interl ON1-I	State of the module input: Interlocking of the ON command	[Control /SG /SG[3] /Interlockings]
Interl ON2-I	State of the module input: Interlocking of the ON command	[Control /SG /SG[3] /Interlockings]
Interl ON3-I	State of the module input: Interlocking of the ON command	[Control /SG /SG[3] /Interlockings]
Interl OFF1-I	State of the module input: Interlocking of the OFF command	[Control /SG /SG[3] /Interlockings]
Interl OFF2-I	State of the module input: Interlocking of the OFF command	[Control /SG /SG[3] /Interlockings]
Interl OFF3-I	State of the module input: Interlocking of the OFF command	[Control /SG /SG[3] /Interlockings]
SCmd ON-I	State of the module input: Switching ON Command, e.g. the state of the Logics or the state of the digital input	[Control /SG /SG[3] /Ex ON/OFF Cmd]

Name	Description	Assignment via
SCmd OFF-I	State of the module input: Switching OFF Command, e.g. the state of the Logics or the state of the digital input	[Control /SG /SG[3] /Ex ON/OFF Cmd]

Signals of a Monitored Circuit Breaker



Signal	Description
SI SingleContactInd	Signal: The Position of the Switchgear is detected by one auxiliary contact (pole) only. Thus indeterminate and disturbed Positions cannot be detected.
Pos not ON	Signal: Pos not ON
Pos ON	Signal: Circuit Breaker is in ON-Position
Pos OFF	Signal: Circuit Breaker is in OFF-Position
Pos Indeterm	Signal: Circuit Breaker is in Indeterminate Position
Pos Disturb	Signal: Circuit Breaker Disturbed - Undefined Breaker Position. The Position Indicators contradict themselves. After expiring of a supervision timer this signal becomes true.
Pos	Signal: Circuit Breaker Position (0 = Indeterminate, 1 = OFF, 2 = ON, 3 = Disturbed)
Ready	Signal: Circuit breaker is ready for operation.
t-Dwell	Signal: Dwell time
Removed	Signal: The withdrawable circuit breaker is Removed
Interl ON	Signal: One or more IL_On inputs are active.
Interl OFF	Signal: One or more IL_Off inputs are active.
CES succesf	Signal: Command Execution Supervision: Switching command executed successfully.
CES Disturbed	Signal: Command Execution Supervision: Switching Command unsuccessful. Switchgear in disturbed position.
CES Fail TripCmd	Signal: Command Execution Supervision: Command execution failed because trip command is pending.
CES SwitchDir	Signal: Command Execution Supervision respectively Switching Direction Control: This signal becomes true, if a switch command is issued even though the switchgear is already in the requested position. Example: A switchgear that is already OFF should be switched OFF again (doubly). The same applies to CLOSE commands.
CES ON d OFF	Signal: Command Execution Supervision: On Command during a pending OFF Command.
CES SG not ready	Signal: Command Execution Supervision: Switchgear not ready
CES Fiel Interl	Signal: Command Execution Supervision: Switching Command not executed because of field interlocking.
CES SyncTimeout	Signal: Command Execution Supervision: Switching Command not executed. No Synchronization signal while t-sync was running.
CES SG removed	Signal: Command Execution Supervision: Switching Command unsuccessful, Switchgear removed.
Prot ON	Signal: ON Command issued by the Prot module

<i>Signal</i>	<i>Description</i>
TripCmd	Signal: Trip Command
Ack TripCmd	Signal: Acknowledge Trip Command
ON incl Prot ON	Signal: The ON Command includes the ON Command issued by the Protection module.
OFF incl TripCmd	Signal: The OFF Command includes the OFF Command issued by the Protection module.
Position Ind manipul	Signal: Position Indicators faked
SGwear Slow SG	Signal: Alarm, the circuit breaker (load-break switch) becomes slower
Res SGwear SI SG	Signal: Resetting the slow Switchgear Alarm
ON Cmd	Signal: ON Command issued to the switchgear. Depending on the setting the signal may include the ON command of the Prot module.
OFF Cmd	Signal: OFF Command issued to the switchgear. Depending on the setting the signal may include the OFF command of the Prot module.
ON Cmd manual	Signal: ON Cmd manual
OFF Cmd manual	Signal: OFF Cmd manual
Sync ON request	Signal: Synchronous ON request



Controlled Disconnecter





SG[4]

Direct Commands of a Controlled Disconnecter









Parameter	Description	Setting range	Default	Menu path
Manipulate Position 	WARNING! Fake Position - Manual Position Manipulation	inactive, Pos OFF, Pos ON	inactive	[Control /SG /SG[4] /General Settings]
Res SGwear SI SG 	Resetting the slow Switchgear Alarm	inactive, active	inactive	[Operation /Reset]
Ack TripCmd 	Acknowledge Trip Command	inactive, active	inactive	[Operation /Acknowledge]



Global Protection Parameters of a Controlled Disconnecter









Parameter	Description	Setting range	Default	Menu path
Aux ON 	The CB is in ON-position if the state of the assigned signal is true (52a).	1..n, DI- LogicList	DI Slot X1.DI 5	[Control /SG /SG[4] /Pos Indicatr Wirng]
Aux OFF 	The CB is in OFF-position if the state of the assigned signal is true (52b).	1..n, DI- LogicList	DI Slot X1.DI 6	[Control /SG /SG[4] /Pos Indicatr Wirng]
Ready 	Circuit breaker is ready for operation if the state of the assigned signal is true. This digital input can be used by some protective elements (if they are available within the device) like Auto Reclosure (AR), e.g. as a trigger signal.	1..n, DI- LogicList	.-	[Control /SG /SG[4] /Pos Indicatr Wirng]









<i>Parameter</i>	<i>Description</i>	<i>Setting range</i>	<i>Default</i>	<i>Menu path</i>
Removed 	The withdrawable circuit breaker is Removed Dependency	1..n, DI-LogicList	.-	[Control /SG /SG[4] /Pos Indicatr Wirng]
Interl ON1 	Interlocking of the ON command	1..n, Assignment List	SG[1].Pos ON	[Control /SG /SG[4] /Interlockings]
Interl ON2 	Interlocking of the ON command	1..n, Assignment List	SG[6].Pos ON	[Control /SG /SG[4] /Interlockings]
Interl ON3 	Interlocking of the ON command	1..n, Assignment List	.-	[Control /SG /SG[4] /Interlockings]
Interl OFF1 	Interlocking of the OFF command	1..n, Assignment List	SG[1].Pos ON	[Control /SG /SG[4] /Interlockings]
Interl OFF2 	Interlocking of the OFF command	1..n, Assignment List	.-	[Control /SG /SG[4] /Interlockings]
Interl OFF3 	Interlocking of the OFF command	1..n, Assignment List	.-	[Control /SG /SG[4] /Interlockings]
SCmd ON 	Switching ON Command, e.g. the state of the Logics or the state of the digital input	1..n, DI-LogicList	.-	[Control /SG /SG[4] /Ex ON/OFF Cmd]
SCmd OFF 	Switching OFF Command, e.g. the state of the Logics or the state of the digital input	1..n, DI-LogicList	.-	[Control /SG /SG[4] /Ex ON/OFF Cmd]









Parameter	Description	Setting range	Default	Menu path
t-TripCmd 	Minimum hold time of the OFF-command (circuit breaker, load break switch)	0 - 300.00s	0.2s	[Control /SG /SG[4] /Trip Manager]
Latched 	Defines whether the Binary Output Relay will be Latched when it picks up.	inactive, active	inactive	[Control /SG /SG[4] /Trip Manager]
Ack TripCmd 	Ack TripCmd	1..n, Assignment List	-.-	[Control /SG /SG[4] /Trip Manager]
Off Cmd1 	Off Command to the Circuit Breaker if the state of the assigned signal becomes true.	1..n, Trip Cmds	-.-	[Control /SG /SG[4] /Trip Manager]
Off Cmd2 	Off Command to the Circuit Breaker if the state of the assigned signal becomes true.	1..n, Trip Cmds	-.-	[Control /SG /SG[4] /Trip Manager]
Off Cmd3 	Off Command to the Circuit Breaker if the state of the assigned signal becomes true.	1..n, Trip Cmds	-.-	[Control /SG /SG[4] /Trip Manager]
Off Cmd4 	Off Command to the Circuit Breaker if the state of the assigned signal becomes true.	1..n, Trip Cmds	-.-	[Control /SG /SG[4] /Trip Manager]
Off Cmd5 	Off Command to the Circuit Breaker if the state of the assigned signal becomes true.	1..n, Trip Cmds	-.-	[Control /SG /SG[4] /Trip Manager]
Off Cmd6 	Off Command to the Circuit Breaker if the state of the assigned signal becomes true.	1..n, Trip Cmds	-.-	[Control /SG /SG[4] /Trip Manager]









Parameter	Description	Setting range	Default	Menu path
Off Cmd7 	Off Command to the Circuit Breaker if the state of the assigned signal becomes true.	1..n, Trip Cmds	-.-	[Control /SG /SG[4] /Trip Manager]
Off Cmd8 	Off Command to the Circuit Breaker if the state of the assigned signal becomes true.	1..n, Trip Cmds	-.-	[Control /SG /SG[4] /Trip Manager]
Off Cmd9 	Off Command to the Circuit Breaker if the state of the assigned signal becomes true.	1..n, Trip Cmds	-.-	[Control /SG /SG[4] /Trip Manager]
Off Cmd10 	Off Command to the Circuit Breaker if the state of the assigned signal becomes true.	1..n, Trip Cmds	-.-	[Control /SG /SG[4] /Trip Manager]
Off Cmd11 	Off Command to the Circuit Breaker if the state of the assigned signal becomes true.	1..n, Trip Cmds	-.-	[Control /SG /SG[4] /Trip Manager]
Off Cmd12 	Off Command to the Circuit Breaker if the state of the assigned signal becomes true.	1..n, Trip Cmds	-.-	[Control /SG /SG[4] /Trip Manager]
Off Cmd13 	Off Command to the Circuit Breaker if the state of the assigned signal becomes true.	1..n, Trip Cmds	-.-	[Control /SG /SG[4] /Trip Manager]
Off Cmd14 	Off Command to the Circuit Breaker if the state of the assigned signal becomes true.	1..n, Trip Cmds	-.-	[Control /SG /SG[4] /Trip Manager]
Off Cmd15 	Off Command to the Circuit Breaker if the state of the assigned signal becomes true.	1..n, Trip Cmds	-.-	[Control /SG /SG[4] /Trip Manager]









Parameter	Description	Setting range	Default	Menu path
Off Cmd16 	Off Command to the Circuit Breaker if the state of the assigned signal becomes true.	1..n, Trip Cmds	.-	[Control /SG /SG[4] /Trip Manager]
Off Cmd17 	Off Command to the Circuit Breaker if the state of the assigned signal becomes true.	1..n, Trip Cmds	.-	[Control /SG /SG[4] /Trip Manager]
Off Cmd18 	Off Command to the Circuit Breaker if the state of the assigned signal becomes true.	1..n, Trip Cmds	.-	[Control /SG /SG[4] /Trip Manager]
Off Cmd19 	Off Command to the Circuit Breaker if the state of the assigned signal becomes true.	1..n, Trip Cmds	.-	[Control /SG /SG[4] /Trip Manager]
Off Cmd20 	Off Command to the Circuit Breaker if the state of the assigned signal becomes true.	1..n, Trip Cmds	.-	[Control /SG /SG[4] /Trip Manager]
Off Cmd21 	Off Command to the Circuit Breaker if the state of the assigned signal becomes true.	1..n, Trip Cmds	.-	[Control /SG /SG[4] /Trip Manager]
Off Cmd22 	Off Command to the Circuit Breaker if the state of the assigned signal becomes true.	1..n, Trip Cmds	.-	[Control /SG /SG[4] /Trip Manager]
Off Cmd23 	Off Command to the Circuit Breaker if the state of the assigned signal becomes true.	1..n, Trip Cmds	.-	[Control /SG /SG[4] /Trip Manager]
Off Cmd24 	Off Command to the Circuit Breaker if the state of the assigned signal becomes true.	1..n, Trip Cmds	.-	[Control /SG /SG[4] /Trip Manager]

<i>Parameter</i>	<i>Description</i>	<i>Setting range</i>	<i>Default</i>	<i>Menu path</i>
Off Cmd25 	Off Command to the Circuit Breaker if the state of the assigned signal becomes true.	1..n, Trip Cmds	.-	[Control /SG /SG[4] /Trip Manager]
Off Cmd26 	Off Command to the Circuit Breaker if the state of the assigned signal becomes true.	1..n, Trip Cmds	.-	[Control /SG /SG[4] /Trip Manager]
Off Cmd27 	Off Command to the Circuit Breaker if the state of the assigned signal becomes true.	1..n, Trip Cmds	.-	[Control /SG /SG[4] /Trip Manager]
Off Cmd28 	Off Command to the Circuit Breaker if the state of the assigned signal becomes true.	1..n, Trip Cmds	.-	[Control /SG /SG[4] /Trip Manager]
Off Cmd29 	Off Command to the Circuit Breaker if the state of the assigned signal becomes true.	1..n, Trip Cmds	.-	[Control /SG /SG[4] /Trip Manager]
Off Cmd30 	Off Command to the Circuit Breaker if the state of the assigned signal becomes true.	1..n, Trip Cmds	.-	[Control /SG /SG[4] /Trip Manager]
Off Cmd31 	Off Command to the Circuit Breaker if the state of the assigned signal becomes true.	1..n, Trip Cmds	.-	[Control /SG /SG[4] /Trip Manager]
Off Cmd32 	Off Command to the Circuit Breaker if the state of the assigned signal becomes true.	1..n, Trip Cmds	.-	[Control /SG /SG[4] /Trip Manager]
Off Cmd33 	Off Command to the Circuit Breaker if the state of the assigned signal becomes true.	1..n, Trip Cmds	.-	[Control /SG /SG[4] /Trip Manager]





<i>Parameter</i>	<i>Description</i>	<i>Setting range</i>	<i>Default</i>	<i>Menu path</i>
Off Cmd34 	Off Command to the Circuit Breaker if the state of the assigned signal becomes true.	1..n, Trip Cmds	.-	[Control /SG /SG[4] /Trip Manager]
Off Cmd35 	Off Command to the Circuit Breaker if the state of the assigned signal becomes true.	1..n, Trip Cmds	.-	[Control /SG /SG[4] /Trip Manager]
Off Cmd36 	Off Command to the Circuit Breaker if the state of the assigned signal becomes true.	1..n, Trip Cmds	.-	[Control /SG /SG[4] /Trip Manager]
Off Cmd37 	Off Command to the Circuit Breaker if the state of the assigned signal becomes true.	1..n, Trip Cmds	.-	[Control /SG /SG[4] /Trip Manager]
Off Cmd38 	Off Command to the Circuit Breaker if the state of the assigned signal becomes true.	1..n, Trip Cmds	.-	[Control /SG /SG[4] /Trip Manager]
Off Cmd39 	Off Command to the Circuit Breaker if the state of the assigned signal becomes true.	1..n, Trip Cmds	.-	[Control /SG /SG[4] /Trip Manager]
Off Cmd40 	Off Command to the Circuit Breaker if the state of the assigned signal becomes true.	1..n, Trip Cmds	.-	[Control /SG /SG[4] /Trip Manager]
Off Cmd41 	Off Command to the Circuit Breaker if the state of the assigned signal becomes true.	1..n, Trip Cmds	.-	[Control /SG /SG[4] /Trip Manager]
Off Cmd42 	Off Command to the Circuit Breaker if the state of the assigned signal becomes true.	1..n, Trip Cmds	.-	[Control /SG /SG[4] /Trip Manager]

Parameter	Description	Setting range	Default	Menu path
Off Cmd43 	Off Command to the Circuit Breaker if the state of the assigned signal becomes true.	1..n, Trip Cmds	.-	[Control /SG /SG[4] /Trip Manager]
Off Cmd44 	Off Command to the Circuit Breaker if the state of the assigned signal becomes true.	1..n, Trip Cmds	.-	[Control /SG /SG[4] /Trip Manager]
Off Cmd45 	Off Command to the Circuit Breaker if the state of the assigned signal becomes true.	1..n, Trip Cmds	.-	[Control /SG /SG[4] /Trip Manager]
Off Cmd46 	Off Command to the Circuit Breaker if the state of the assigned signal becomes true.	1..n, Trip Cmds	.-	[Control /SG /SG[4] /Trip Manager]
Off Cmd47 	Off Command to the Circuit Breaker if the state of the assigned signal becomes true.	1..n, Trip Cmds	.-	[Control /SG /SG[4] /Trip Manager]
Off Cmd48 	Off Command to the Circuit Breaker if the state of the assigned signal becomes true.	1..n, Trip Cmds	.-	[Control /SG /SG[4] /Trip Manager]
Off Cmd49 	Off Command to the Circuit Breaker if the state of the assigned signal becomes true.	1..n, Trip Cmds	.-	[Control /SG /SG[4] /Trip Manager]
Off Cmd50 	Off Command to the Circuit Breaker if the state of the assigned signal becomes true.	1..n, Trip Cmds	.-	[Control /SG /SG[4] /Trip Manager]
Off Cmd51 	Off Command to the Circuit Breaker if the state of the assigned signal becomes true.	1..n, Trip Cmds	.-	[Control /SG /SG[4] /Trip Manager]

<i>Parameter</i>	<i>Description</i>	<i>Setting range</i>	<i>Default</i>	<i>Menu path</i>
Off Cmd52 	Off Command to the Circuit Breaker if the state of the assigned signal becomes true.	1..n, Trip Cmds	.-	[Control /SG /SG[4] /Trip Manager]
Off Cmd53 	Off Command to the Circuit Breaker if the state of the assigned signal becomes true.	1..n, Trip Cmds	.-	[Control /SG /SG[4] /Trip Manager]
Off Cmd54 	Off Command to the Circuit Breaker if the state of the assigned signal becomes true.	1..n, Trip Cmds	.-	[Control /SG /SG[4] /Trip Manager]
Off Cmd55 	Off Command to the Circuit Breaker if the state of the assigned signal becomes true.	1..n, Trip Cmds	.-	[Control /SG /SG[4] /Trip Manager]
Off Cmd56 	Off Command to the Circuit Breaker if the state of the assigned signal becomes true.	1..n, Trip Cmds	.-	[Control /SG /SG[4] /Trip Manager]
Off Cmd57 	Off Command to the Circuit Breaker if the state of the assigned signal becomes true.	1..n, Trip Cmds	.-	[Control /SG /SG[4] /Trip Manager]
Off Cmd58 	Off Command to the Circuit Breaker if the state of the assigned signal becomes true.	1..n, Trip Cmds	.-	[Control /SG /SG[4] /Trip Manager]
Off Cmd59 	Off Command to the Circuit Breaker if the state of the assigned signal becomes true.	1..n, Trip Cmds	.-	[Control /SG /SG[4] /Trip Manager]
Off Cmd60 	Off Command to the Circuit Breaker if the state of the assigned signal becomes true.	1..n, Trip Cmds	.-	[Control /SG /SG[4] /Trip Manager]

<i>Parameter</i>	<i>Description</i>	<i>Setting range</i>	<i>Default</i>	<i>Menu path</i>
Off Cmd61 	Off Command to the Circuit Breaker if the state of the assigned signal becomes true.	1..n, Trip Cmds	.-	[Control /SG /SG[4] /Trip Manager]
Off Cmd62 	Off Command to the Circuit Breaker if the state of the assigned signal becomes true.	1..n, Trip Cmds	.-	[Control /SG /SG[4] /Trip Manager]
Off Cmd63 	Off Command to the Circuit Breaker if the state of the assigned signal becomes true.	1..n, Trip Cmds	.-	[Control /SG /SG[4] /Trip Manager]
Off Cmd64 	Off Command to the Circuit Breaker if the state of the assigned signal becomes true.	1..n, Trip Cmds	.-	[Control /SG /SG[4] /Trip Manager]
Off Cmd65 	Off Command to the Circuit Breaker if the state of the assigned signal becomes true.	1..n, Trip Cmds	.-	[Control /SG /SG[4] /Trip Manager]
Off Cmd66 	Off Command to the Circuit Breaker if the state of the assigned signal becomes true.	1..n, Trip Cmds	.-	[Control /SG /SG[4] /Trip Manager]
Off Cmd67 	Off Command to the Circuit Breaker if the state of the assigned signal becomes true.	1..n, Trip Cmds	.-	[Control /SG /SG[4] /Trip Manager]
Off Cmd68 	Off Command to the Circuit Breaker if the state of the assigned signal becomes true.	1..n, Trip Cmds	.-	[Control /SG /SG[4] /Trip Manager]
Off Cmd69 	Off Command to the Circuit Breaker if the state of the assigned signal becomes true.	1..n, Trip Cmds	.-	[Control /SG /SG[4] /Trip Manager]

Parameter	Description	Setting range	Default	Menu path
Off Cmd70 	Off Command to the Circuit Breaker if the state of the assigned signal becomes true.	1..n, Trip Cmds	.-	[Control /SG /SG[4] /Trip Manager]
Off Cmd71 	Off Command to the Circuit Breaker if the state of the assigned signal becomes true.	1..n, Trip Cmds	.-	[Control /SG /SG[4] /Trip Manager]
Off Cmd72 	Off Command to the Circuit Breaker if the state of the assigned signal becomes true.	1..n, Trip Cmds	.-	[Control /SG /SG[4] /Trip Manager]
Off Cmd73 	Off Command to the Circuit Breaker if the state of the assigned signal becomes true.	1..n, Trip Cmds	.-	[Control /SG /SG[4] /Trip Manager]
Off Cmd74 	Off Command to the Circuit Breaker if the state of the assigned signal becomes true.	1..n, Trip Cmds	.-	[Control /SG /SG[4] /Trip Manager]
Off Cmd75 	Off Command to the Circuit Breaker if the state of the assigned signal becomes true.	1..n, Trip Cmds	.-	[Control /SG /SG[4] /Trip Manager]
Synchronism 	Synchronism	1..n, In-SyncList	.-	[Control /SG /SG[4] /Synchron Switchg]
t- MaxSyncSuperv 	Synchron-Run timer: Max. time allowed for synchronizing process after a close initiate. Only used for GENERATOR2SYSTEM working mode.	0 - 3000.00s	0.2s	[Control /SG /SG[4] /Synchron Switchg]
ON incl Prot ON 	The ON Command includes the ON Command issued by the Protection module.	inactive, active	active	[Control /SG /SG[4] /General Settings]

<i>Parameter</i>	<i>Description</i>	<i>Setting range</i>	<i>Default</i>	<i>Menu path</i>
OFF incl TripCmd 	The OFF Command includes the OFF Command issued by the Protection module.	inactive, active	active	[Control /SG /SG[4] /General Settings]
t-Move ON 	Time to move to the ON Position	0.01 - 100.00s	0.1s	[Control /SG /SG[4] /General Settings]
t-Move OFF 	Time to move to the OFF Position	0.01 - 100.00s	0.1s	[Control /SG /SG[4] /General Settings]
t-Dwell 	Dwell time	0 - 100.00s	0s	[Control /SG /SG[4] /General Settings]

Controlled Disconnecter Input States

<i>Name</i>	<i>Description</i>	<i>Assignment via</i>
Aux ON-I	Module Input State: Position indicator/check-back signal of the CB (52a)	[Control /SG /SG[4] /Pos Indicatrs Wirng]
Aux OFF-I	Module input state: Position indicator/check-back signal of the CB (52b)	[Control /SG /SG[4] /Pos Indicatrs Wirng]
Ready-I	Module input state: CB ready	[Control /SG /SG[4] /Pos Indicatrs Wirng]
Sys-in-Sync-I	State of the module input: This signals has to become true within the synchronization time. If not, switching is unsuccessful.	[Control /SG /SG[4] /Synchron Switchg]

<i>Name</i>	<i>Description</i>	<i>Assignment via</i>
Removed-I	State of the module input: The withdrawable circuit breaker is Removed	[Control /SG /SG[4] /Pos Indicatrs Wirng]
Ack TripCmd-I	State of the module input: Acknowledgement Signal (only for automatic acknowledgement) Module input signal	[Control /SG /SG[4] /Trip Manager]
Interl ON1-I	State of the module input: Interlocking of the ON command	[Control /SG /SG[4] /Interlockings]
Interl ON2-I	State of the module input: Interlocking of the ON command	[Control /SG /SG[4] /Interlockings]
Interl ON3-I	State of the module input: Interlocking of the ON command	[Control /SG /SG[4] /Interlockings]
Interl OFF1-I	State of the module input: Interlocking of the OFF command	[Control /SG /SG[4] /Interlockings]
Interl OFF2-I	State of the module input: Interlocking of the OFF command	[Control /SG /SG[4] /Interlockings]
Interl OFF3-I	State of the module input: Interlocking of the OFF command	[Control /SG /SG[4] /Interlockings]
SCmd ON-I	State of the module input: Switching ON Command, e.g. the state of the Logics or the state of the digital input	[Control /SG /SG[4] /Ex ON/OFF Cmd]

Name	Description	Assignment via
SCmd OFF-I	State of the module input: Switching OFF Command, e.g. the state of the Logics or the state of the digital input	[Control /SG /SG[4] /Ex ON/OFF Cmd]

Signals of a Controlled Disconnecter



Signal	Description
SI SingleContactInd	Signal: The Position of the Switchgear is detected by one auxiliary contact (pole) only. Thus indeterminate and disturbed Positions cannot be detected.
Pos not ON	Signal: Pos not ON
Pos ON	Signal: Circuit Breaker is in ON-Position
Pos OFF	Signal: Circuit Breaker is in OFF-Position
Pos Indeterm	Signal: Circuit Breaker is in Indeterminate Position
Pos Disturb	Signal: Circuit Breaker Disturbed - Undefined Breaker Position. The Position Indicators contradict themselves. After expiring of a supervision timer this signal becomes true.
Pos	Signal: Circuit Breaker Position (0 = Indeterminate, 1 = OFF, 2 = ON, 3 = Disturbed)
Ready	Signal: Circuit breaker is ready for operation.
t-Dwell	Signal: Dwell time
Removed	Signal: The withdrawable circuit breaker is Removed
Interl ON	Signal: One or more IL_On inputs are active.
Interl OFF	Signal: One or more IL_Off inputs are active.
CES succesf	Signal: Command Execution Supervision: Switching command executed successfully.
CES Disturbed	Signal: Command Execution Supervision: Switching Command unsuccessful. Switchgear in disturbed position.
CES Fail TripCmd	Signal: Command Execution Supervision: Command execution failed because trip command is pending.
CES SwitchDir	Signal: Command Execution Supervision respectively Switching Direction Control: This signal becomes true, if a switch command is issued even though the switchgear is already in the requested position. Example: A switchgear that is already OFF should be switched OFF again (doubly). The same applies to CLOSE commands.
CES ON d OFF	Signal: Command Execution Supervision: On Command during a pending OFF Command.
CES SG not ready	Signal: Command Execution Supervision: Switchgear not ready
CES Fiel Interl	Signal: Command Execution Supervision: Switching Command not executed because of field interlocking.
CES SyncTimeout	Signal: Command Execution Supervision: Switching Command not executed. No Synchronization signal while t-sync was running.
CES SG removed	Signal: Command Execution Supervision: Switching Command unsuccessful, Switchgear removed.
Prot ON	Signal: ON Command issued by the Prot module

<i>Signal</i>	<i>Description</i>
TripCmd	Signal: Trip Command
Ack TripCmd	Signal: Acknowledge Trip Command
ON incl Prot ON	Signal: The ON Command includes the ON Command issued by the Protection module.
OFF incl TripCmd	Signal: The OFF Command includes the OFF Command issued by the Protection module.
Position Ind manipul	Signal: Position Indicators faked
SGwear Slow SG	Signal: Alarm, the circuit breaker (load-break switch) becomes slower
Res SGwear SI SG	Signal: Resetting the slow Switchgear Alarm
ON Cmd	Signal: ON Command issued to the switchgear. Depending on the setting the signal may include the ON command of the Prot module.
OFF Cmd	Signal: OFF Command issued to the switchgear. Depending on the setting the signal may include the OFF command of the Prot module.
ON Cmd manual	Signal: ON Cmd manual
OFF Cmd manual	Signal: OFF Cmd manual
Sync ON request	Signal: Synchronous ON request



Monitored Disconnecter









SG[2] .SG[5] .SG[6]

Direct Commands of a Monitored Disconnecter









Parameter	Description	Setting range	Default	Menu path
Manipulate Position 	WARNING! Fake Position - Manual Position Manipulation	inactive, Pos OFF, Pos ON	inactive	[Control /SG /SG[2] /General Settings]
Res SGwear SI SG 	Resetting the slow Switchgear Alarm	inactive, active	inactive	[Operation /Reset]
Ack TripCmd 	Acknowledge Trip Command	inactive, active	inactive	[Operation /Acknowledge]





Global Protection Parameters of a Monitored Disconnecter









Parameter	Description	Setting range	Default	Menu path
Aux ON 	The CB is in ON-position if the state of the assigned signal is true (52a).	1..n, DI- LogicList	SG[2]: -. SG[5]: -. SG[6]: DI Slot X1.DI 7	[Control /SG /SG[2] /Pos Indicatr Wirng]
Aux OFF 	The CB is in OFF-position if the state of the assigned signal is true (52b).	1..n, DI- LogicList	SG[2]: -. SG[5]: -. SG[6]: DI Slot X1.DI 8	[Control /SG /SG[2] /Pos Indicatr Wirng]
Ready 	Circuit breaker is ready for operation if the state of the assigned signal is true. This digital input can be used by some protective elements (if they are available within the device) like Auto Reclosure (AR), e.g. as a trigger signal.	1..n, DI- LogicList	-.	[Control /SG /SG[2] /Pos Indicatr Wirng]







Parameter	Description	Setting range	Default	Menu path
Removed 	The withdrawable circuit breaker is Removed Dependency	1..n, DI-LogicList	.-	[Control /SG /SG[2] /Pos Indicatr Wirng]
Interl ON1 	Interlocking of the ON command	1..n, Assignment List	.-	[Control /SG /SG[2] /Interlockings]
Interl ON2 	Interlocking of the ON command	1..n, Assignment List	.-	[Control /SG /SG[2] /Interlockings]
Interl ON3 	Interlocking of the ON command	1..n, Assignment List	.-	[Control /SG /SG[2] /Interlockings]
Interl OFF1 	Interlocking of the OFF command	1..n, Assignment List	.-	[Control /SG /SG[2] /Interlockings]
Interl OFF2 	Interlocking of the OFF command	1..n, Assignment List	.-	[Control /SG /SG[2] /Interlockings]
Interl OFF3 	Interlocking of the OFF command	1..n, Assignment List	.-	[Control /SG /SG[2] /Interlockings]
SCmd ON 	Switching ON Command, e.g. the state of the Logics or the state of the digital input	1..n, DI-LogicList	.-	[Control /SG /SG[2] /Ex ON/OFF Cmd]
SCmd OFF 	Switching OFF Command, e.g. the state of the Logics or the state of the digital input	1..n, DI-LogicList	.-	[Control /SG /SG[2] /Ex ON/OFF Cmd]









<i>Parameter</i>	<i>Description</i>	<i>Setting range</i>	<i>Default</i>	<i>Menu path</i>
t-TripCmd 	Minimum hold time of the OFF-command (circuit breaker, load break switch)	0 - 300.00s	0.2s	[Control /SG /SG[2] /Trip Manager]
Latched 	Defines whether the Binary Output Relay will be Latched when it picks up.	inactive, active	inactive	[Control /SG /SG[2] /Trip Manager]
Ack TripCmd 	Ack TripCmd	1..n, Assignment List	-.-	[Control /SG /SG[2] /Trip Manager]
Off Cmd1 	Off Command to the Circuit Breaker if the state of the assigned signal becomes true.	1..n, Trip Cmds	-.-	[Control /SG /SG[2] /Trip Manager]
Off Cmd2 	Off Command to the Circuit Breaker if the state of the assigned signal becomes true.	1..n, Trip Cmds	-.-	[Control /SG /SG[2] /Trip Manager]
Off Cmd3 	Off Command to the Circuit Breaker if the state of the assigned signal becomes true.	1..n, Trip Cmds	-.-	[Control /SG /SG[2] /Trip Manager]
Off Cmd4 	Off Command to the Circuit Breaker if the state of the assigned signal becomes true.	1..n, Trip Cmds	-.-	[Control /SG /SG[2] /Trip Manager]
Off Cmd5 	Off Command to the Circuit Breaker if the state of the assigned signal becomes true.	1..n, Trip Cmds	-.-	[Control /SG /SG[2] /Trip Manager]
Off Cmd6 	Off Command to the Circuit Breaker if the state of the assigned signal becomes true.	1..n, Trip Cmds	-.-	[Control /SG /SG[2] /Trip Manager]







<i>Parameter</i>	<i>Description</i>	<i>Setting range</i>	<i>Default</i>	<i>Menu path</i>
Off Cmd7 	Off Command to the Circuit Breaker if the state of the assigned signal becomes true.	1..n, Trip Cmds	.-.	[Control /SG /SG[2] /Trip Manager]
Off Cmd8 	Off Command to the Circuit Breaker if the state of the assigned signal becomes true.	1..n, Trip Cmds	.-.	[Control /SG /SG[2] /Trip Manager]
Off Cmd9 	Off Command to the Circuit Breaker if the state of the assigned signal becomes true.	1..n, Trip Cmds	.-.	[Control /SG /SG[2] /Trip Manager]
Off Cmd10 	Off Command to the Circuit Breaker if the state of the assigned signal becomes true.	1..n, Trip Cmds	.-.	[Control /SG /SG[2] /Trip Manager]
Off Cmd11 	Off Command to the Circuit Breaker if the state of the assigned signal becomes true.	1..n, Trip Cmds	.-.	[Control /SG /SG[2] /Trip Manager]
Off Cmd12 	Off Command to the Circuit Breaker if the state of the assigned signal becomes true.	1..n, Trip Cmds	.-.	[Control /SG /SG[2] /Trip Manager]
Off Cmd13 	Off Command to the Circuit Breaker if the state of the assigned signal becomes true.	1..n, Trip Cmds	.-.	[Control /SG /SG[2] /Trip Manager]
Off Cmd14 	Off Command to the Circuit Breaker if the state of the assigned signal becomes true.	1..n, Trip Cmds	.-.	[Control /SG /SG[2] /Trip Manager]
Off Cmd15 	Off Command to the Circuit Breaker if the state of the assigned signal becomes true.	1..n, Trip Cmds	.-.	[Control /SG /SG[2] /Trip Manager]









<i>Parameter</i>	<i>Description</i>	<i>Setting range</i>	<i>Default</i>	<i>Menu path</i>
Off Cmd16 	Off Command to the Circuit Breaker if the state of the assigned signal becomes true.	1..n, Trip Cmds	.-	[Control /SG /SG[2] /Trip Manager]
Off Cmd17 	Off Command to the Circuit Breaker if the state of the assigned signal becomes true.	1..n, Trip Cmds	.-	[Control /SG /SG[2] /Trip Manager]
Off Cmd18 	Off Command to the Circuit Breaker if the state of the assigned signal becomes true.	1..n, Trip Cmds	.-	[Control /SG /SG[2] /Trip Manager]
Off Cmd19 	Off Command to the Circuit Breaker if the state of the assigned signal becomes true.	1..n, Trip Cmds	.-	[Control /SG /SG[2] /Trip Manager]
Off Cmd20 	Off Command to the Circuit Breaker if the state of the assigned signal becomes true.	1..n, Trip Cmds	.-	[Control /SG /SG[2] /Trip Manager]
Off Cmd21 	Off Command to the Circuit Breaker if the state of the assigned signal becomes true.	1..n, Trip Cmds	.-	[Control /SG /SG[2] /Trip Manager]
Off Cmd22 	Off Command to the Circuit Breaker if the state of the assigned signal becomes true.	1..n, Trip Cmds	.-	[Control /SG /SG[2] /Trip Manager]
Off Cmd23 	Off Command to the Circuit Breaker if the state of the assigned signal becomes true.	1..n, Trip Cmds	.-	[Control /SG /SG[2] /Trip Manager]
Off Cmd24 	Off Command to the Circuit Breaker if the state of the assigned signal becomes true.	1..n, Trip Cmds	.-	[Control /SG /SG[2] /Trip Manager]

<i>Parameter</i>	<i>Description</i>	<i>Setting range</i>	<i>Default</i>	<i>Menu path</i>
Off Cmd25 	Off Command to the Circuit Breaker if the state of the assigned signal becomes true.	1..n, Trip Cmds	.-	[Control /SG /SG[2] /Trip Manager]
Off Cmd26 	Off Command to the Circuit Breaker if the state of the assigned signal becomes true.	1..n, Trip Cmds	.-	[Control /SG /SG[2] /Trip Manager]
Off Cmd27 	Off Command to the Circuit Breaker if the state of the assigned signal becomes true.	1..n, Trip Cmds	.-	[Control /SG /SG[2] /Trip Manager]
Off Cmd28 	Off Command to the Circuit Breaker if the state of the assigned signal becomes true.	1..n, Trip Cmds	.-	[Control /SG /SG[2] /Trip Manager]
Off Cmd29 	Off Command to the Circuit Breaker if the state of the assigned signal becomes true.	1..n, Trip Cmds	.-	[Control /SG /SG[2] /Trip Manager]
Off Cmd30 	Off Command to the Circuit Breaker if the state of the assigned signal becomes true.	1..n, Trip Cmds	.-	[Control /SG /SG[2] /Trip Manager]
Off Cmd31 	Off Command to the Circuit Breaker if the state of the assigned signal becomes true.	1..n, Trip Cmds	.-	[Control /SG /SG[2] /Trip Manager]
Off Cmd32 	Off Command to the Circuit Breaker if the state of the assigned signal becomes true.	1..n, Trip Cmds	.-	[Control /SG /SG[2] /Trip Manager]
Off Cmd33 	Off Command to the Circuit Breaker if the state of the assigned signal becomes true.	1..n, Trip Cmds	.-	[Control /SG /SG[2] /Trip Manager]





<i>Parameter</i>	<i>Description</i>	<i>Setting range</i>	<i>Default</i>	<i>Menu path</i>
Off Cmd34 	Off Command to the Circuit Breaker if the state of the assigned signal becomes true.	1..n, Trip Cmds	.-	[Control /SG /SG[2] /Trip Manager]
Off Cmd35 	Off Command to the Circuit Breaker if the state of the assigned signal becomes true.	1..n, Trip Cmds	.-	[Control /SG /SG[2] /Trip Manager]
Off Cmd36 	Off Command to the Circuit Breaker if the state of the assigned signal becomes true.	1..n, Trip Cmds	.-	[Control /SG /SG[2] /Trip Manager]
Off Cmd37 	Off Command to the Circuit Breaker if the state of the assigned signal becomes true.	1..n, Trip Cmds	.-	[Control /SG /SG[2] /Trip Manager]
Off Cmd38 	Off Command to the Circuit Breaker if the state of the assigned signal becomes true.	1..n, Trip Cmds	.-	[Control /SG /SG[2] /Trip Manager]
Off Cmd39 	Off Command to the Circuit Breaker if the state of the assigned signal becomes true.	1..n, Trip Cmds	.-	[Control /SG /SG[2] /Trip Manager]
Off Cmd40 	Off Command to the Circuit Breaker if the state of the assigned signal becomes true.	1..n, Trip Cmds	.-	[Control /SG /SG[2] /Trip Manager]
Off Cmd41 	Off Command to the Circuit Breaker if the state of the assigned signal becomes true.	1..n, Trip Cmds	.-	[Control /SG /SG[2] /Trip Manager]
Off Cmd42 	Off Command to the Circuit Breaker if the state of the assigned signal becomes true.	1..n, Trip Cmds	.-	[Control /SG /SG[2] /Trip Manager]

<i>Parameter</i>	<i>Description</i>	<i>Setting range</i>	<i>Default</i>	<i>Menu path</i>
Off Cmd43 	Off Command to the Circuit Breaker if the state of the assigned signal becomes true.	1..n, Trip Cmds	.-	[Control /SG /SG[2] /Trip Manager]
Off Cmd44 	Off Command to the Circuit Breaker if the state of the assigned signal becomes true.	1..n, Trip Cmds	.-	[Control /SG /SG[2] /Trip Manager]
Off Cmd45 	Off Command to the Circuit Breaker if the state of the assigned signal becomes true.	1..n, Trip Cmds	.-	[Control /SG /SG[2] /Trip Manager]
Off Cmd46 	Off Command to the Circuit Breaker if the state of the assigned signal becomes true.	1..n, Trip Cmds	.-	[Control /SG /SG[2] /Trip Manager]
Off Cmd47 	Off Command to the Circuit Breaker if the state of the assigned signal becomes true.	1..n, Trip Cmds	.-	[Control /SG /SG[2] /Trip Manager]
Off Cmd48 	Off Command to the Circuit Breaker if the state of the assigned signal becomes true.	1..n, Trip Cmds	.-	[Control /SG /SG[2] /Trip Manager]
Off Cmd49 	Off Command to the Circuit Breaker if the state of the assigned signal becomes true.	1..n, Trip Cmds	.-	[Control /SG /SG[2] /Trip Manager]
Off Cmd50 	Off Command to the Circuit Breaker if the state of the assigned signal becomes true.	1..n, Trip Cmds	.-	[Control /SG /SG[2] /Trip Manager]
Off Cmd51 	Off Command to the Circuit Breaker if the state of the assigned signal becomes true.	1..n, Trip Cmds	.-	[Control /SG /SG[2] /Trip Manager]

<i>Parameter</i>	<i>Description</i>	<i>Setting range</i>	<i>Default</i>	<i>Menu path</i>
Off Cmd52 	Off Command to the Circuit Breaker if the state of the assigned signal becomes true.	1..n, Trip Cmds	-.-	[Control /SG /SG[2] /Trip Manager]
Off Cmd53 	Off Command to the Circuit Breaker if the state of the assigned signal becomes true.	1..n, Trip Cmds	-.-	[Control /SG /SG[2] /Trip Manager]
Off Cmd54 	Off Command to the Circuit Breaker if the state of the assigned signal becomes true.	1..n, Trip Cmds	-.-	[Control /SG /SG[2] /Trip Manager]
Off Cmd55 	Off Command to the Circuit Breaker if the state of the assigned signal becomes true.	1..n, Trip Cmds	-.-	[Control /SG /SG[2] /Trip Manager]
Off Cmd56 	Off Command to the Circuit Breaker if the state of the assigned signal becomes true.	1..n, Trip Cmds	-.-	[Control /SG /SG[2] /Trip Manager]
Off Cmd57 	Off Command to the Circuit Breaker if the state of the assigned signal becomes true.	1..n, Trip Cmds	-.-	[Control /SG /SG[2] /Trip Manager]
Off Cmd58 	Off Command to the Circuit Breaker if the state of the assigned signal becomes true.	1..n, Trip Cmds	-.-	[Control /SG /SG[2] /Trip Manager]
Off Cmd59 	Off Command to the Circuit Breaker if the state of the assigned signal becomes true.	1..n, Trip Cmds	-.-	[Control /SG /SG[2] /Trip Manager]
Off Cmd60 	Off Command to the Circuit Breaker if the state of the assigned signal becomes true.	1..n, Trip Cmds	-.-	[Control /SG /SG[2] /Trip Manager]

<i>Parameter</i>	<i>Description</i>	<i>Setting range</i>	<i>Default</i>	<i>Menu path</i>
Off Cmd61 	Off Command to the Circuit Breaker if the state of the assigned signal becomes true.	1..n, Trip Cmds	.-	[Control /SG /SG[2] /Trip Manager]
Off Cmd62 	Off Command to the Circuit Breaker if the state of the assigned signal becomes true.	1..n, Trip Cmds	.-	[Control /SG /SG[2] /Trip Manager]
Off Cmd63 	Off Command to the Circuit Breaker if the state of the assigned signal becomes true.	1..n, Trip Cmds	.-	[Control /SG /SG[2] /Trip Manager]
Off Cmd64 	Off Command to the Circuit Breaker if the state of the assigned signal becomes true.	1..n, Trip Cmds	.-	[Control /SG /SG[2] /Trip Manager]
Off Cmd65 	Off Command to the Circuit Breaker if the state of the assigned signal becomes true.	1..n, Trip Cmds	.-	[Control /SG /SG[2] /Trip Manager]
Off Cmd66 	Off Command to the Circuit Breaker if the state of the assigned signal becomes true.	1..n, Trip Cmds	.-	[Control /SG /SG[2] /Trip Manager]
Off Cmd67 	Off Command to the Circuit Breaker if the state of the assigned signal becomes true.	1..n, Trip Cmds	.-	[Control /SG /SG[2] /Trip Manager]
Off Cmd68 	Off Command to the Circuit Breaker if the state of the assigned signal becomes true.	1..n, Trip Cmds	.-	[Control /SG /SG[2] /Trip Manager]
Off Cmd69 	Off Command to the Circuit Breaker if the state of the assigned signal becomes true.	1..n, Trip Cmds	.-	[Control /SG /SG[2] /Trip Manager]

Parameter	Description	Setting range	Default	Menu path
Off Cmd70 	Off Command to the Circuit Breaker if the state of the assigned signal becomes true.	1..n, Trip Cmds	--	[Control /SG /SG[2] /Trip Manager]
Off Cmd71 	Off Command to the Circuit Breaker if the state of the assigned signal becomes true.	1..n, Trip Cmds	--	[Control /SG /SG[2] /Trip Manager]
Off Cmd72 	Off Command to the Circuit Breaker if the state of the assigned signal becomes true.	1..n, Trip Cmds	--	[Control /SG /SG[2] /Trip Manager]
Off Cmd73 	Off Command to the Circuit Breaker if the state of the assigned signal becomes true.	1..n, Trip Cmds	--	[Control /SG /SG[2] /Trip Manager]
Off Cmd74 	Off Command to the Circuit Breaker if the state of the assigned signal becomes true.	1..n, Trip Cmds	--	[Control /SG /SG[2] /Trip Manager]
Off Cmd75 	Off Command to the Circuit Breaker if the state of the assigned signal becomes true.	1..n, Trip Cmds	--	[Control /SG /SG[2] /Trip Manager]
Synchronism 	Synchronism	1..n, In-SyncList	--	[Control /SG /SG[2] /Synchron Switchg]
t- MaxSyncSuperv 	Synchron-Run timer: Max. time allowed for synchronizing process after a close initiate. Only used for GENERATOR2SYSTEM working mode.	0 - 3000.00s	0.2s	[Control /SG /SG[2] /Synchron Switchg]
ON incl Prot ON 	The ON Command includes the ON Command issued by the Protection module.	inactive, active	active	[Control /SG /SG[2] /General Settings]

<i>Parameter</i>	<i>Description</i>	<i>Setting range</i>	<i>Default</i>	<i>Menu path</i>
OFF incl TripCmd 	The OFF Command includes the OFF Command issued by the Protection module.	inactive, active	active	[Control /SG /SG[2] /General Settings]
t-Move ON 	Time to move to the ON Position	0.01 - 100.00s	0.1s	[Control /SG /SG[2] /General Settings]
t-Move OFF 	Time to move to the OFF Position	0.01 - 100.00s	0.1s	[Control /SG /SG[2] /General Settings]
t-Dwell 	Dwell time	0 - 100.00s	0s	[Control /SG /SG[2] /General Settings]

Monitored Disconnecter Input States

<i>Name</i>	<i>Description</i>	<i>Assignment via</i>
Aux ON-I	Module Input State: Position indicator/check-back signal of the CB (52a)	[Control /SG /SG[2] /Pos Indicators Wirng]
Aux OFF-I	Module input state: Position indicator/check-back signal of the CB (52b)	[Control /SG /SG[2] /Pos Indicators Wirng]
Ready-I	Module input state: CB ready	[Control /SG /SG[2] /Pos Indicators Wirng]
Sys-in-Sync-I	State of the module input: This signal has to become true within the synchronization time. If not, switching is unsuccessful.	[Control /SG /SG[2] /Synchron Switchg]

<i>Name</i>	<i>Description</i>	<i>Assignment via</i>
Removed-I	State of the module input: The withdrawable circuit breaker is Removed	[Control /SG /SG[2] /Pos Indicatrs Wirng]
Ack TripCmd-I	State of the module input: Acknowledgement Signal (only for automatic acknowledgement) Module input signal	[Control /SG /SG[2] /Trip Manager]
Interl ON1-I	State of the module input: Interlocking of the ON command	[Control /SG /SG[2] /Interlockings]
Interl ON2-I	State of the module input: Interlocking of the ON command	[Control /SG /SG[2] /Interlockings]
Interl ON3-I	State of the module input: Interlocking of the ON command	[Control /SG /SG[2] /Interlockings]
Interl OFF1-I	State of the module input: Interlocking of the OFF command	[Control /SG /SG[2] /Interlockings]
Interl OFF2-I	State of the module input: Interlocking of the OFF command	[Control /SG /SG[2] /Interlockings]
Interl OFF3-I	State of the module input: Interlocking of the OFF command	[Control /SG /SG[2] /Interlockings]
SCmd ON-I	State of the module input: Switching ON Command, e.g. the state of the Logics or the state of the digital input	[Control /SG /SG[2] /Ex ON/OFF Cmd]

Name	Description	Assignment via
SCmd OFF-I	State of the module input: Switching OFF Command, e.g. the state of the Logics or the state of the digital input	[Control /SG /SG[2] /Ex ON/OFF Cmd]

Signals of a Monitored Disconnecter

Signal	Description
SI SingleContactInd	Signal: The Position of the Switchgear is detected by one auxiliary contact (pole) only. Thus indeterminate and disturbed Positions cannot be detected.
Pos not ON	Signal: Pos not ON
Pos ON	Signal: Circuit Breaker is in ON-Position
Pos OFF	Signal: Circuit Breaker is in OFF-Position
Pos Indeterm	Signal: Circuit Breaker is in Indeterminate Position
Pos Disturb	Signal: Circuit Breaker Disturbed - Undefined Breaker Position. The Position Indicators contradict themselves. After expiring of a supervision timer this signal becomes true.
Pos	Signal: Circuit Breaker Position (0 = Indeterminate, 1 = OFF, 2 = ON, 3 = Disturbed)
Ready	Signal: Circuit breaker is ready for operation.
t-Dwell	Signal: Dwell time
Removed	Signal: The withdrawable circuit breaker is Removed
Interl ON	Signal: One or more IL_On inputs are active.
Interl OFF	Signal: One or more IL_Off inputs are active.
CES succesf	Signal: Command Execution Supervision: Switching command executed successfully.
CES Disturbed	Signal: Command Execution Supervision: Switching Command unsuccessful. Switchgear in disturbed position.
CES Fail TripCmd	Signal: Command Execution Supervision: Command execution failed because trip command is pending.
CES SwitchDir	Signal: Command Execution Supervision respectively Switching Direction Control: This signal becomes true, if a switch command is issued even though the switchgear is already in the requested position. Example: A switchgear that is already OFF should be switched OFF again (doubly). The same applies to CLOSE commands.
CES ON d OFF	Signal: Command Execution Supervision: On Command during a pending OFF Command.
CES SG not ready	Signal: Command Execution Supervision: Switchgear not ready
CES Fiel Interl	Signal: Command Execution Supervision: Switching Command not executed because of field interlocking.
CES SyncTimeout	Signal: Command Execution Supervision: Switching Command not executed. No Synchronization signal while t-sync was running.
CES SG removed	Signal: Command Execution Supervision: Switching Command unsuccessful, Switchgear removed.
Prot ON	Signal: ON Command issued by the Prot module

<i>Signal</i>	<i>Description</i>
TripCmd	Signal: Trip Command
Ack TripCmd	Signal: Acknowledge Trip Command
ON incl Prot ON	Signal: The ON Command includes the ON Command issued by the Protection module.
OFF incl TripCmd	Signal: The OFF Command includes the OFF Command issued by the Protection module.
Position Ind manipul	Signal: Position Indicators faked
SGwear Slow SG	Signal: Alarm, the circuit breaker (load-break switch) becomes slower
Res SGwear SI SG	Signal: Resetting the slow Switchgear Alarm
ON Cmd	Signal: ON Command issued to the switchgear. Depending on the setting the signal may include the ON command of the Prot module.
OFF Cmd	Signal: OFF Command issued to the switchgear. Depending on the setting the signal may include the OFF command of the Prot module.
ON Cmd manual	Signal: ON Cmd manual
OFF Cmd manual	Signal: OFF Cmd manual
Sync ON request	Signal: Synchronous ON request

Protective Elements

Interconnection

Various state-of-the-art protective elements have been developed for the *HighPROTEC*. Due to the increasing role of distributed energy resources interconnection protection becomes more and more important. A new, sophisticated protection function package covers all protective elements for interconnection applications. This package can be found within menu [Interconnection].

These protective elements can be used flexible. They can be adapted easily by parameter settings to various international and local grid codes.

In the following an overview is given on this menu. Please refer for details on these protective elements to the corresponding chapters.

The Interconnection menu comprises:

A submenu with mains-decoupling elements. Depending on the grid codes that are to be taken into account various mains decoupling elements are mandatory (or forbidden). Within this menu, you have access to the following mains decoupling elements:

- ROCOF (df/dt) (please refer to chapter frequency protection). This element is consistent with a Frequency Protection element, that is set to „df/dt“ within the Device Planning.
- Vector shift (delta phi) (please refer to chapter frequency protection). This element is consistent with a Frequency Protection element, that is set to „delta phi“ within the Device Planning.
- Pr (please refer to chapter power protection). This element is consistent with a Power Protection element, that is set to „Pr>“ within the Device Planning.
- Qr (please refer to chapter power protection). This element is consistent with a Power Protection element, that is set to „Qr>“ within the Device Planning.
- Intertripping (please refer to chapter intertripping).

A submenu for Low Voltage Ride Through (please refer to the LVRT chapter).

A submenu for Q->&V<-Protection (please refer to the Q->&V< chapter).

A submenu for synchronization (please refer to the synchronization chapter).

NOTICE

The device offers also among other things for low voltage systems a voltage quality supervision based on the ten minutes sliding mean square measurement. (please refer to chapter Voltage Protection).

id - Phase Current Differential Protection [87GP, 87UP]

Available elements:

Id

Description

The protective device provides restrained phase differential protection function with User-configurable multiple slope

percentage restrained characteristic that allows to compensate both the static error and the dynamic error. The static error accounts for transformer static magnetizing current and current measurement circuit calibration errors. The dynamic error may be caused by Tap Changing (OLTC) and by CT saturation caused by heavy fault currents.

In addition, the static tripping characteristic can be modified temporarily at the User's choice to prevent some nuisance tripping from the harmonic inrush during energization, over-excitation, or deep CT saturation. The harmonic inrush is evaluated through 2nd, 4th harmonics and 5th harmonics transient is monitored through the CT saturation detector.

Phase Differential Protection Applications

The phase differential protection can be used for two application scenarios:

(1) Generator Phase Differential Protection - 87 GP

For this application, the phase differential protection will detect phase faults in the generator stator windings. The differential zone is between the current transformers (CT) installed at the generator neutral and mains side. For detailed application configuration, please see also the application table on the next page.

(2) Generator Phase Differential Protection with Unit Step-Up Transformer included in differential zone - 87 UP

For this application, the phase differential protection will detect phase faults both in generator and step-up transformer. The differential zone in this case is between the current transformers installed at the generator neutral and transformer main side (high voltage side). That means that all of the electrical equipment, including generator, transformer and the cable connections between them, are inside the phase differential zone (Overall Differential). For detailed application configuration, please see also the application table on the next page.

It is to note that for both above mentioned applications, the phase differential protection base current I_b , to which both the differential and restraining currents are scaled, will be calculated from the set generator ratings as follows:

$$I_b = \frac{S_N}{\sqrt{3} * V_{LL}} = \frac{\text{Rated Power}_{Generator}}{\sqrt{3} * \text{Rated Voltage}_{Generator}}$$

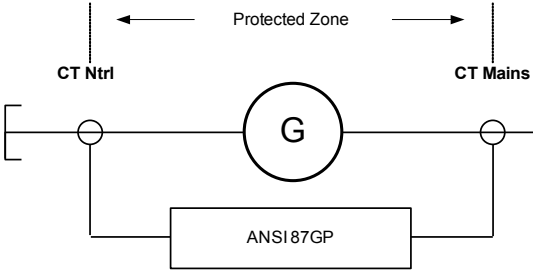
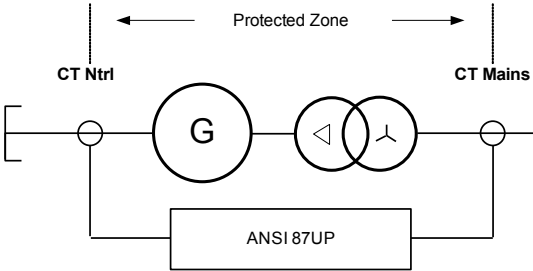
Application Options	Required Settings
<p>ANSI 87GP – Generator Differential Protection (Bus connection)</p>  <p>To be used if only the generator is to be protected by the differential protection.</p>	<p><i>Note1:</i> „CT Neutral” at generator neutral must be connected to the device current input X3 (W1) and “CT Mains” at generator terminal must be connected to device current terminal X4 (W2).</p> <p>Set the Mode within the Device Planning.</p> <p style="text-align: center;">Where? Within [Device Planning] Set „Transformer.Mode=not used“</p> <p>Set the Field Parameters of the Generator.</p> <p style="text-align: center;">Where? Within [Field Para\Generator]</p> <p>Set the Differential Protection Parameters.</p> <p style="text-align: center;">Where? Within [Protection Para\Set [x]\Diff-Prot]</p> <p><i>Note2:</i> Settings for harmonic and CT saturation detection like Stab H2/H4/H5 can be set to inactive if they are probably not used for Generator Phase Differential Protection.</p>
<p>ANSI 87UP – Unit Differential Protection</p>  <p>To be used if the generator and the step-up transformer are to be protected by one phase differential protection element.</p>	<p><i>Note1:</i> “CT Neutral” at generator neutral must be connected to the device current input X3 (W1) and “CT Mains” at transformer bus side must be connected to device current terminal X4 (W2).</p> <p>Set the Mode within the Device Planning.</p> <p style="text-align: center;">Where? Within [Device Planning] Set „Transformer.Mode=use“</p> <p>Set the Field Parameters of the Generator¹⁾.</p> <p style="text-align: center;">Where? Within [Field Para\Generator]</p> <p>Set the Field Parameters of the Transformer¹⁾ (step up).</p> <p style="text-align: center;">Where? Within [Field Para\Transformer]</p> <p>Set the Differential Protection Parameters.</p> <p style="text-align: center;">Where? Within [Protection Para\Set [x]\Diff-Prot]</p> <p><i>Note2:</i> Settings for harmonic and CT saturation detection like Stab H2/H4/H5 can be set to active if they are probably used for Unit Phase Differential Protection.</p>

¹⁾For Unit Differential Protection the Transformer Rated Voltage on the generator side (Pri V W1) should be the same as the generator Generator Rated Voltage (Ph-Ph).

Direction Definitions

The direction convention adopted here is as shown in the following drawing.

Protection Principle of the Current Differential Protection

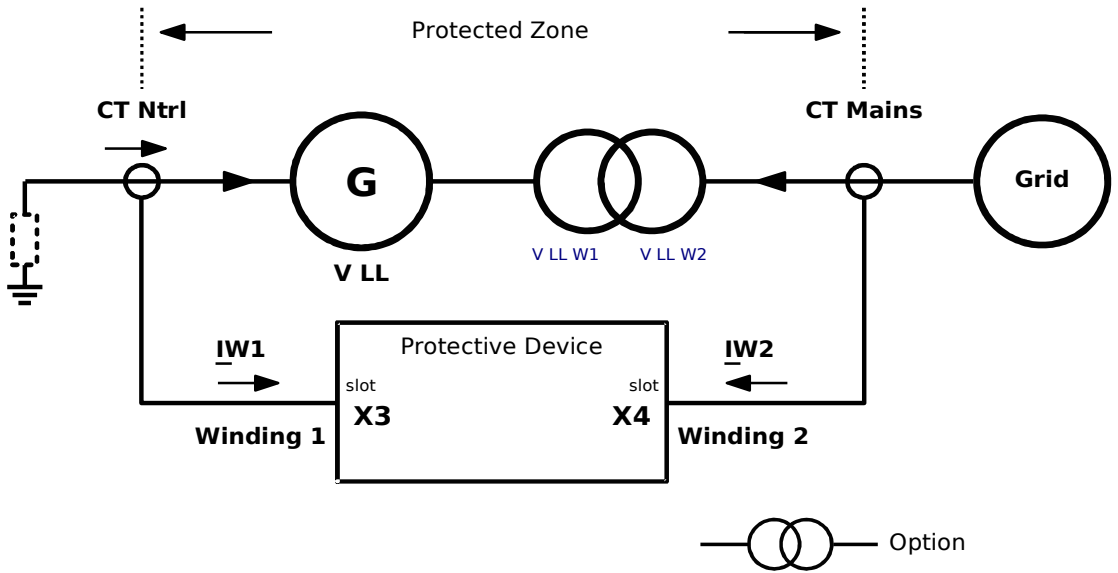

Please see also Legend on next page.

Id_Z09

Legend

Symbol	Explanation
S_N	Rated Power from Protected Object (e.g. Generator or Transformer)
V_{LL}	Rated Voltage from Protected Object (e.g. Generator)
$V_{LL,W1}$	Rated Voltage of the Transformer side W1
$V_{LL,W2}$	Rated Voltage of the Transformer side W2
$CT_{pri,W1}$	Primary Rated current of the Current Transformer on Transformer side W1
$CT_{sec,W1}$	Secondary Rated current of the Current Transformer on Transformer side W1
$CT_{pri,W2}$	Primary Rated current of Current Transformer on Transformer side W2
$CT_{sec,W2}$	Secondary Rated current of Current Transformer on Transformer side W2
I_b	Base current (is depending on the applied context, in general, it is the Rated Current of Protected Object, e.g. Generator or Transformer)
$I_{b,W1}$	Base current or Rated Current of the Transformer winding on side W1
$I_{b,W2}$	Base current or Rated Current of the Transformer winding on side W2
$I_{pri,W1}$ $I_{pri,W2}$	Uncompensated primary current phasors on the corresponding winding side (W1 or W2)
\vec{I}_{W1} \vec{I}_{W2}	Uncompensated secondary current phasors on the corresponding winding side (W1 or W2)

Tripping curve

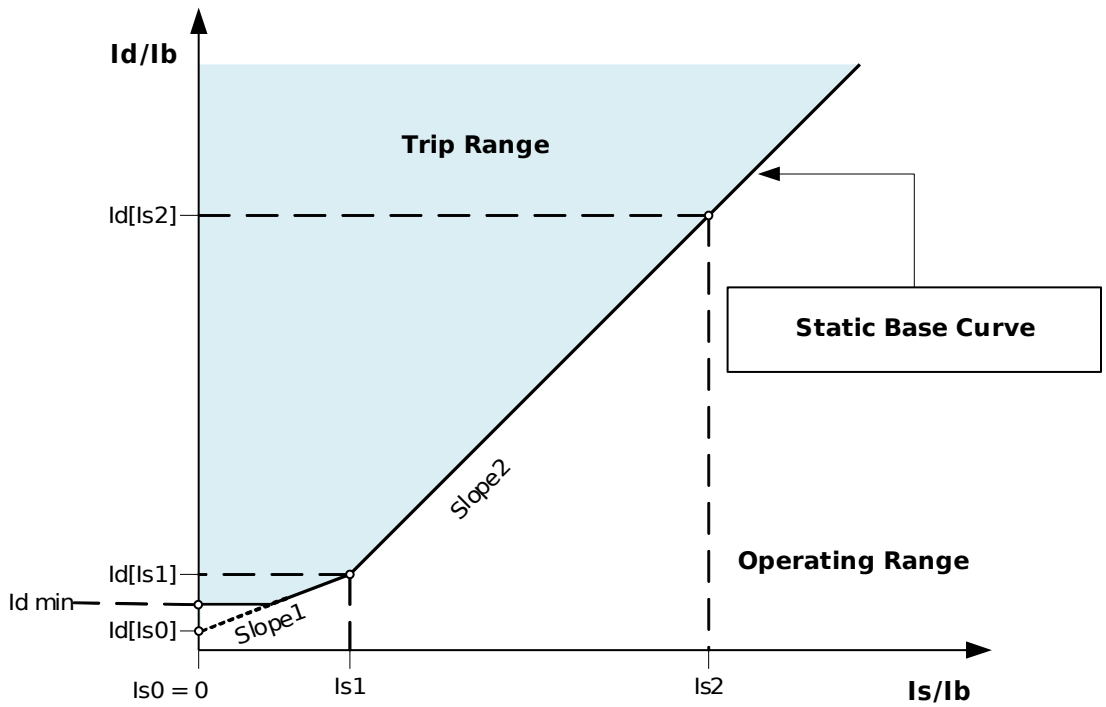

Id_Z07

The restrained percentage phase differential protection tripping characteristic can be expressed mathematically as:

$$|\vec{I}_d| \geq |\vec{I}_{dmin}| + K_1 \cdot \underbrace{|\vec{I}_s|}_{I_s > I_{s(dmin)} \text{ und } I_s < I_{s1}} + \underbrace{K_2 \cdot |\vec{I}_s|}_{I_s \geq I_{s2}} + d(H, m)$$

Where

$$|\vec{I}_d| = |\vec{I}_{W1}'''' + \vec{I}_{W2}''''| \text{ is defined as fundamental differential current.}$$

$|\vec{I}_s| = 0.5 \cdot |\vec{I}_{W1}'''' - \vec{I}_{W2}''''|$ is defined as fundamental restraining current, and it is also called the through-current for normal load and external faults.

$|\vec{I}_{dmin}|$ is the minimum differential current scaled to the base current.

K_1 and K_2 are slope factors for two slope sections on the operating curve respectively.

$d(H, m)$ is the temporary restraining current (see diagram “Temporary Dynamic Rise of the Static Tripping Characteristic”), which is a configurable multiple of the base current I_b .

\vec{I}_{W1}'''' and \vec{I}_{W2}'''' are the corresponding compensated secondary current phasors, which are scaled from the uncompensated primary phase current phasors $\vec{I}_{pri,W1}$ and $\vec{I}_{pri,W2}$ flowing into the protected object.

Under normal conditions, the differential current should be below $|\vec{I}_{dmin}|$. When an internal fault occurs, the different current will raise above the restraining current to trip. To establish a correct trip criterion, two currents flowing into the protected object must be matched by compensating their magnitudes and phases.

Setting the Tripping Curve

I_{dmin} is the minimum differential current multiple scaled to the base current to get the restrained phase differential protection to trip, which should be set based on the static error (no load error, transformer magnetizing current, and measurement circuit noise). K_1 and K_2 are the restraining slopes that will be determined with the settings $I_d(|\vec{I}_{s0}|)$, $I_d(|\vec{I}_{s1}|)$, and $I_d(|\vec{I}_{s2}|)$ as follows:

$$K_1 = |I_d(|\vec{I}_{s1}|) - I_d(|\vec{I}_{s0}|)| / I_{s1}$$

$$K_2 = |I_d(|\vec{I}_{s2}|) - I_d(|\vec{I}_{s1}|)| / (I_{s2} - I_{s1})$$

All current settings are expressed as multiples of the base current (I_b). The base current will be calculated internally from the power rating and voltage ratings of the protected object under the field parameter menu.

For generator or motor differential protection the base current is defined as:

$$I_b = \frac{S_N}{\sqrt{3} \cdot V_{LL}} = \frac{\text{Rated Power}_{Generator}}{\sqrt{3} \cdot \text{Rated Voltage}_{Generator}}$$

For step-up transformers with two windings the two base currents for each winding are defined respectively as:

$$I_{b,w1} = \frac{S_N}{\sqrt{3} \cdot V_{LL,W1}} \quad I_{b,w2} = \frac{S_N}{\sqrt{3} \cdot V_{LL,W2}}$$

NOTICE For setting the tripping characteristics of the 87 Transformer Phase Differential Protection, the base current $I_b = I_{b,w1}$ is to be used.

For the 87 (Line / Generator / Unit) Phase Differential Protection, the base current I_b is to be used.

The procedures to configure: $I_d(|\vec{I}_{s0}|)$, $I_d(|\vec{I}_{s1}|)$, and $I_d(|\vec{I}_{s2}|)$:

1. Use $I_d(|\vec{I}_{s0}|)$ as a minimum differential current to trip (starting point of the tripping characteristic is at $I_{s0} = 0$);
2. Select the slope K_1 (usually around 15%-40% [typically 25%]);
3. Calculate set value $I_d(|\vec{I}_{s1}|)$ using $I_d(|\vec{I}_{s0}|)$ and K_1 : $I_d(|\vec{I}_{s1}|) = I_d(|\vec{I}_{s0}|) + I_{s1} \cdot K_1$;
4. Select the slope K_2 (usually around 40%-90% [typically 60%]);
5. Calculate set value $I_d(|\vec{I}_{s2}|)$ using $I_d(|\vec{I}_{s1}|)$ and K_2 : $I_d(|\vec{I}_{s2}|) = I_d(|\vec{I}_{s1}|) + (I_{s2} - I_{s1}) \cdot K_2$;

Phasor Compensation

Please note: This section applies only if a transformer is part of the protected differential zone.

Please note: The reference side for the phasor compensation is the current measuring card W1.

The phase current phasor compensations are performed automatically and involve amplitude and phase adjustments based on the field parameters.

The compensated secondary current phasor on the side W2, with side W1 as reference winding, can be expressed as follows:

$$\vec{I}_{W2}' = \frac{V_{LL,W2}}{V_{LL,W1} \cdot (1 + Tap\ Changer)} \cdot \frac{CT_{pri, W2}}{CT_{pri, W1}} \cdot \vec{I}_{W2}$$
 for magnitude compensation,

and

$$\vec{I}_{W2}'' = T_{Phase\ Shift(n)} \cdot \vec{I}_{W2}'$$
 for angle compensation.

Note: $T_{Phase\ Shift(n)}$ is a complex factor due to transformer vector group setting.

CT Mismatch

Please note: This section applies only if a transformer is part of the protected differential zone.

NOTICE

None of the Amplitudes Matching factors must exceed a value of 10.

$$k_{CT1} = \frac{CT_{pri,W1}}{Ib_{W1}} \leq 10 \quad \text{and} \quad k_{CT2} = \frac{CT_{pri,W2}}{Ib_{W2}} \leq 10$$

The ratio between the maximum and second largest amplitudes matching factors must not exceed a value of 3.

Phase Compensation (ABC Phase System)

Please note: This section applies only if a step up transformer is part of the protected differential zone.

The protective device calculates the phase compensation with side W1 as reference winding. The vector group depends on the direction of observation.

The setting parameter [Field Para / Transformer] »Phase Shift« specifies the angle (as a factor of 30°) by which the W2 side is lagging the W1 side.

Transformer Type Plate:

The specifications printed on the type plate of the transformer (vector group, connection type, e.g. Yd7) always refer to the primary winding side.

For the MCDTV4 and MRDT4 it is recommended to assign the primary winding side of the transformer to the W1 side of the protective device.

Application Example for the MCDGV4: Generator and Machine Transformer in the Protection Zone:

If a generator is connected via a transformer then the generator is usually connected to the secondary side of the transformer. Since the MCDGV4 uses the W1 side as the reference side it is necessary to convert the technical data that is printed on the type plate of the transformer:

- The connection type of the primary transformer side has to be set via the parameter [Field Para / Transformer] »W2 Connection/Grounding«.
- The connection type of the secondary transformer side has to be set via the parameter [Field Para / Transformer] »W1 Connection/Grounding«.
- The vector group specified on the type plate must be subtracted from 12 (i.e. calculate “12 minus vector group”), and the result has to be set via the parameter [Field Para / Transformer] »Phase Shift«.

The following example may illustrate this:

A machine transformer with the following specification shall be connected to a 6 kV generator:

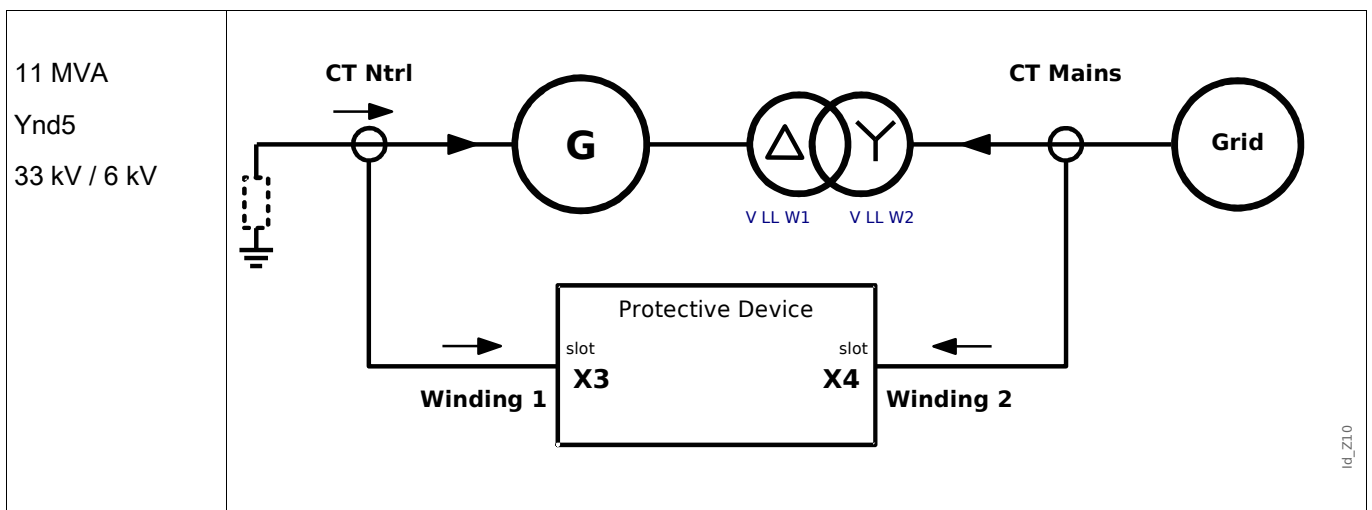

From the point of view of the MCDGV4 protection device, the following “inverted transformer” has to be set:

11 MVA

Dyn7 ("12 - 5 = 7")

6 kV / 33 kV

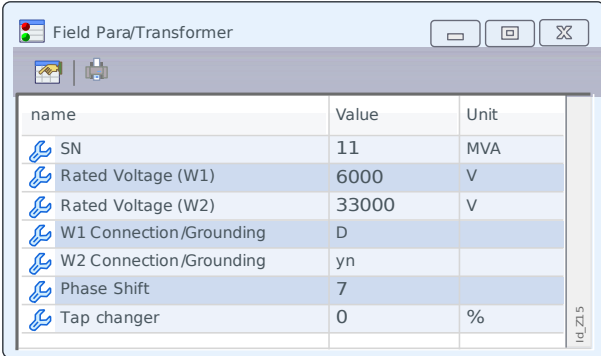

The screenshot shows a software window titled "Field Para/Transformer" with a table of parameters. The table has three columns: "name", "Value", and "Unit". The parameters listed are SN (11 MVA), Rated Voltage (W1) (6000 V), Rated Voltage (W2) (33000 V), W1 Connection/Grounding (D), W2 Connection/Grounding (yn), Phase Shift (7), and Tap changer (0 %). The window also includes standard UI elements like a title bar, a toolbar with icons for help and print, and a small vertical label "Id_Z1.5" on the right side.

name	Value	Unit
SN	11	MVA
Rated Voltage (W1)	6000	V
Rated Voltage (W2)	33000	V
W1 Connection/Grounding	D	
W2 Connection/Grounding	yn	
Phase Shift	7	
Tap changer	0	%

Zero Sequence Removal

Please note: This section applies only if a transformer is part of the protected differential zone.

Zero sequence currents must be removed to prevent the phase differential protection from tripping on external ground faults. For ground faults, the zero sequence current exits only on the transformer winding side whose neutral is grounded, but not on the ungrounded winding side. The differential current due to different groundings on two winding sides results in maloperation of phase differential function if it is not compensated (removed) before. The protective device does not require the zero sequence currents to be removed externally and they will be automatically removed internally according to the system parameters »W1 Connection/Grounding« and »W2 Connection/Grounding«.

$$\vec{I}_{W1}''' = \vec{I}_{W1}'' - \vec{I}_{0,W1}$$

$$\vec{I}_{W2}''' = \vec{I}_{W2}'' - \vec{I}_{0,W2}$$

Retrofitting – External Compensation

Please note: This section applies only if a transformer is part of the protected differential zone.

CAUTION By using the external removal approach, just like many electromechanical relays do, the relay will not see the zero sequence current (unlike other protection functions, such as residual overcurrent, ground differential, etc.)

For a retrofit project, if the user has CTs externally connected in such a way that the zero sequence currents are removed automatically, then the internal zero sequence currents compensation will not be needed. However, if the user prefers the external approach of zero sequence current removal, the user must be aware that the protective device is a multi-function, digital protection system and the phase differential function is one of them. By using the external removal approach, the relay will not see the zero sequence current on which other functions such as residual overcurrent functions, ground differential function, etc. are just based on. If the user is only interested in the phase differential function in this relay, attention must be paid to the phase shift and CT ratios. Under normal or external fault conditions, the CT secondary currents from two windings should be equal in magnitude, i. e.:

$$\left| \frac{CT_{Sec,W1}}{CT_{Pri,W1}\sqrt{3}} \cdot \vec{I}_{Pri,W1} \right| = \left| \frac{CT_{Sec,W2}}{CT_{Pri,W2}} \cdot \vec{I}_{Pri,W2} \right| \text{ if the W1 CTs are delta-connected; or}$$

$$\left| \frac{CT_{sec,W1}}{CT_{pri,W1}} \cdot \vec{I}_{Pri,W1} \right| = \left| \frac{CT_{sec,W2}}{CT_{pri,W2}\sqrt{3}} \cdot \vec{I}_{Pri,W2} \right| \text{ if the W2 CTs are delta-connected.}$$

The user must provide the relay with the modified CT primary rating to accommodate the current's effective decrease due to the CT delta connection. The CT primary rating setting on the CT delta connected side should be divided by $\sqrt{3}$.

The phase shift n for the CT delta connected case should include the phase shift from transformer winding connections and additional phase shift from CT delta connection. There are only two methods for the CT delta connection:

- DAB (dy1) or
- DAC (dy11)

Example 1: If the user has a Yd1 transformer and the neutral on the Y side is grounded, the user must have CTs on the Y side connected as DAC (Dy11), then the user has a total phase shift 1+11=12 (same as 0 in terms of phase shift).

Example 2: If the user has a Yd5 transformer and the neutral on the Y side is grounded, the user must have CTs on the Y side connected as DAB (Dy1), then the user has a total phase shift 5+1=6.

Example 3: If the user has a Yd7 transformer and the neutral on the Y side is grounded, the user must have CTs on the Y side connected as DAC (Dy11). Then the user has a total phase shift 7+11=18. This number is greater than 12, and it has to be remembered that all these numbers must be understood as multiples of 30°, so that 12 corresponds to a phase shift of 360° (which equals 0°). Therefore the number has to be set which results from subtracting 12 (i.e. 360°). In other words: Only the rest from a division of 18 by 12 is relevant, which is 6. Hence the user has to set the total phase shift to 6.

<i>Transformer Winding Connection Type</i>	<i>CT Delta Connection Type on Y or y Side of the Transformer</i>	<i>Total Phase Shift (as a Multiple of 30°)</i>
Dy1	DAC (Dy11)	0 (=1+11-12, see Example 1 above)
Dy5	DAB (Dy1)	6 (=5+1, see Example 2 above)
Dy7	DAC (Dy11)	6 (=7+11-12, see Example 3 above)
Dy11	DAB (Dy1)	0 (=11+1-12, see Example 1 above)
Yd1	DAC (Dy11)	0 (=1+11-12, see Example 1 above)
Yd5	DAB (Dy1)	6 (=5+1, see Example 2 above)
Yd7	DAC (Dy11)	6 (=7+11-12, see Example 3 above)
Yd11	DAB (Dy1)	0 (=11+1-12, see Example 1 above)

Once a correct phase shift n is selected, the phase compensation calculations are done automatically using the corresponding phase shifting matrix listed in the table.

Transient Restraining

The transient behavior can be evoked by:

1. Directly energizing the transformer (inrush effect);
2. Sympathetic inrush current sharing due to adjacent transformer energization; and/or
3. Saturation of the CT.

Temporarily restraining can be triggered by:

1. 2nd harmonic trigger is enabled and the percentage of the 2nd harmonic exceeds its threshold;
2. 4th harmonic trigger is enabled and the percentage of the 4th harmonic exceeds its threshold;
3. 5th harmonic trigger is enabled and the percentage of the 5th harmonic exceeds its threshold; or
4. CT saturation trigger is enabled and saturation is detected.

NOTICE

By means of the »Block mode« (Cross Block), the User can specify if a harmonic signal or CT saturation within one phase temporarily causes restraining within this phase only or a cross block (3 phases).

Temporarily Restraining (by monitoring of the harmonics)

The protective device also offers the temporary restraining feature for further securing phase percentage restrained differential protection against harmonics and other transients such as CT saturation. Separating the temporary restraining from the fundamental restraining can make the differential protection more sensitive to internal faults and more secure when harmonics or other transients occur. The temporary restraining, whenever effective, will essentially add a constant $d(H, m)$ to the fundamental restraining. Graphically, the static tripping curve is temporarily raised by $d(H, m)$. The amount of the temporary restraining is configured as multiple of the base current I_b . The 2nd, 4th, and 5th harmonics percentage relative to fundamental and CT saturation can trigger the temporary restraining. For each harmonic trigger function to be effective, it must be enabled and the percentage of the harmonic over fundamental must exceed its threshold.

Moreover, for the 2nd and 5th harmonics trigger functions, they can be configured independently as having different trigger levels for transient and stationary harmonics. The transient restraining will be effective for a specified t-Trans beginning with energization, which should be set according to the time duration expected for inrush (IH2) currents. For example, this can vary from around 1 second up to nearly 30 seconds for special applications like auto-transformer banks.

The stationary harmonic restraining will take place after t-Trans for time as long as one of the stationary harmonic triggers is active.

Temporarily Restraining (by CT saturation monitoring)

Beside the harmonic temporary restraining triggers, the protective device offers another trigger function - the Transients Monitor (Gradient Monitor). This monitor supervises the current transformer saturation. This monitor will be triggered by the behavior of the phase currents (their slopes, normalized derivative).

The normalized derivative is defined as:

$$m = \frac{1}{\omega * I_{peak}} \cdot \frac{di}{dt}$$

where I_{peak} is the peak value within a half cycle and ω is the system frequency.

For a purely sinusoidal waveform, the normalized derivative should be equal to 1. Under CT saturation, m will be greater than 1. The setting CT Satur Sensitvn should be set properly to identify effectively CT saturation but not to generate a nuisance trigger.

When the CT saturation monitor is active, it will trigger the temporary restraining if m exceeds an internal threshold. The temporary restraining, whenever effective, will essentially add a constant $d(H, m)$ to the fundamental restraining. Graphically, the static tripping curve is temporarily raised by $d(H, m)$ which the sensitivity of the differential protection function is reduced temporarily.

The internal threshold can be modified by means of the CT Saturation Sensitvn. The CT saturation monitor will behave more sensitively the lower the setting value is set.

Temporary Dynamic Rise of the Static Tripping Characteristic.

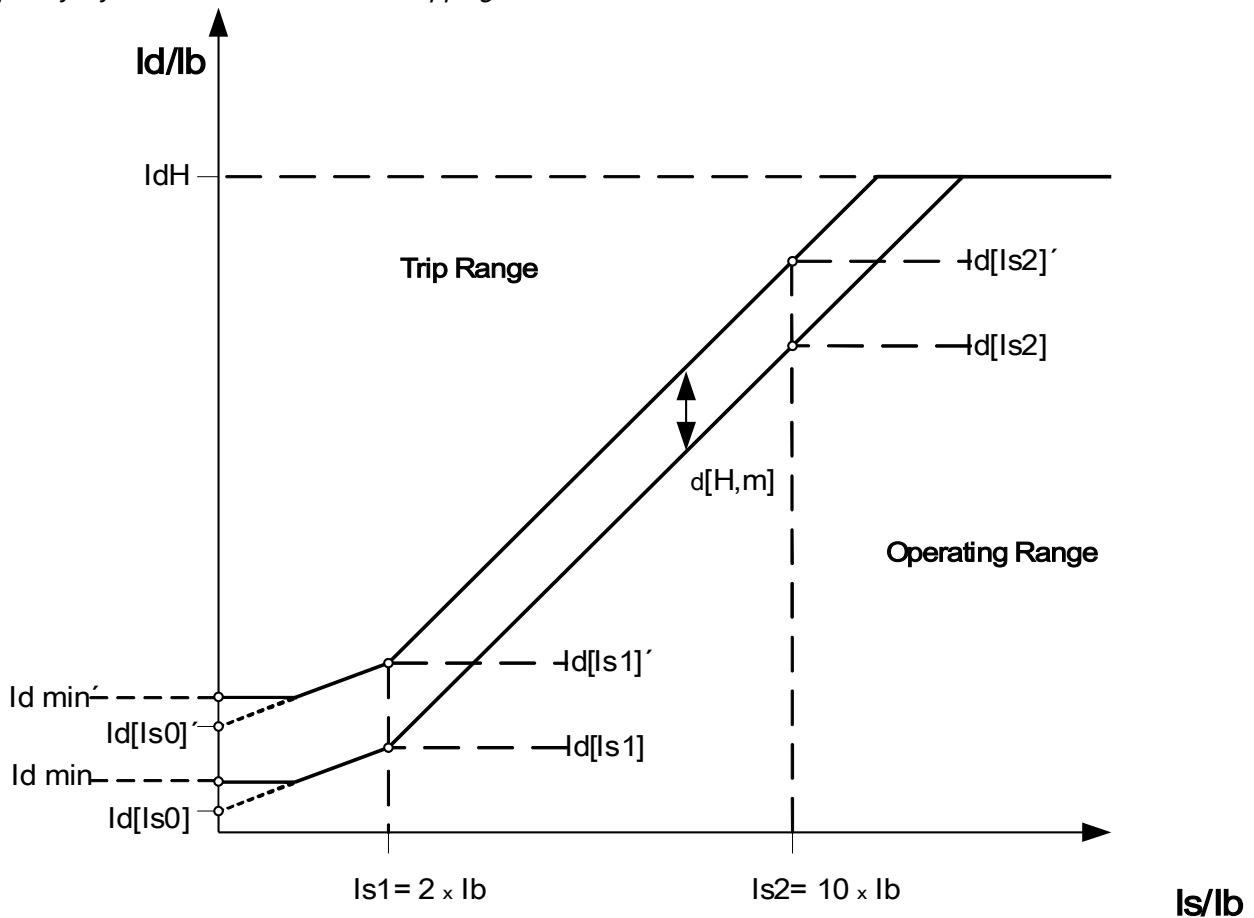

NOTICE

The following signals cannot become true if $I_d < I_{dmin}$:

- 87. Slope Blo
- 87. H2,H4,H5 Blo
- 87. Blo H2
- 87. Blo H4
- 87. Blo H5
- 87. Restraining

The signal restraining will become true if “87. Slope Blo” or “87. H2,H4,H5 Blo” is true.

Example on Setting the Differential Function for Transformer Application

Setting the differential module will be described here with focus on the differential functionality. The protective device asks for nearly all type-plate data of the transformer to allow for optimal adjustment of the differential function without the need of an auxiliary transformer and other tools like CT tapping (especially that known from non-digital relays in the past).

This results in the fact that the relay takes automatically these numeric values into account:

- CT ratio and its deviation from full load amperage at each winding of the transformer;
- Transformer ratio with respect to amplitude and transformer vector-group; and
- Ratio change by tap changer displacement.

All this is compensated internally for by numeric means.

SN:

Nominal, rated capacity of the transformer - basis for calculating the full load amperage of the transformer.

Example
78 MVA

Pri V:

Rated voltage of the transformer regarding winding 1.

Example
118 kV

Sec V:

Rated voltage of the transformer regarding winding 2.

Example
14.4 kV

By means of these three settings, the following full load amperage I_b is calculated, which is defined as the full load amperage for the maximum allowed apparent power of the transformer. There is one full load amperage for each winding, but differential protection results are always displayed in relation to I_b of the winding 1.

Example:

$$I_b = I_{b_{W1}} = I_{FLA, W1} = \frac{78000000 VA}{\sqrt{3} * 118000 V} = 381 A$$

I_b = Full load current (FLA related to the W1 side, which is – in this example – the transformer primary side)

Connection Groups

»W1 Connection/Grounding«	Allowed Settings: Y, D, Z, YN, ZN
This is the setting for the connection scheme of the winding W1 of the transformer and its grounding condition.	

»W2 Connection/Grounding«	Allowed Settings: y, d, z, yn, zn
This is the setting for the connection scheme of the winding W2 of the transformer and its grounding condition.	

The combination of »W1 Connection/Grounding« and »W2 Connection/Grounding« allows for all possible physical connection schemes of transformers. The N or n can be set whenever the neutral of the transformer is connected to ground and the grid on that side of the winding is grounded.

»Phase Shift«	Allowed Settings: 0, ..., 11
The phase shift is set in multiples of 30° and defines the angle by which the voltage on the W2 side lags the voltage on the W1 side.	

Phase shift in multiples of 0...11 * (-30) degree that the secondary voltage lags the primary voltage.

Please refer to the Phase Compensation section for a number of typical, preferred transformer types.

For (Y, y, Z, z) connections, the neutral can be connected to ground or not connected to ground. In general, there is a distinction between odd (1, 3, 5, ..., 11) and even (0, 2, 4, ..., 10) connection numbers. Together with the connection scheme (y, d, or z) and the treatment of the neutral of the transformer, the following definitions are taken.

- The three-phase symmetrical system I1 is rotated counter-clockwise when transferring from winding 1 to winding 2 (applies for ABC phase sequence).
- The three-phase symmetrical system I2 is rotated clockwise when transferring from winding 1 to winding 2. (applies for ABC phase sequence).
- The connection of the transformer to a negative rotating system (ACB) is taken into account according to the parameter.
- The transformation of the zero sequence system I0 depends on the connection of the windings:
 - Only (Y, y, Z, z) – connections provide for an external available neutral point;
 - Only when this neutral point is connected to ground (this is indicated by an appended “n” in the winding group setting (example Dyn)), and at least another ground connection is available on the grid to which the winding is connected (a zero sequence - respectively ground current can flow); and
 - Only when both windings of the transformer allow for ground current flowing, the zero sequence current can be transformed from one side of the transformer to the other without any phase shift.
- Odd connection groups are created by Dy, Yd, Yz, Zy schemes.
- Even connection groups are created by Yy, Zd, Dz, Dd.
- The primary values of winding 1 are reference values when displaying or evaluating relative values.

The transformer ratio can be modified by a tap changer.

Tap Changer:

The tap changer changes the transformer voltage ratio k_{Tap} .

$$k_{Tap} = \frac{V_{LL,W1} (1 + Tap\ Changer)}{V_{LL,W2}}$$

Principally, the following calculations need to be executed before calculating differential values and restraining values of the transformer differential protection:

- Rotating the measured values of winding 2 to the reference winding 1 count-clockwise with an angle of rotation number (0, 1,11) * 30 degrees;
- Adjustment of measured values for winding 2 with respect to CT ratio mismatch;
- Adjustment of measured values for winding 2 with respect to winding connection (y, d, z); and
- Adjustment of measured values for winding 1 and winding 2 according to neutral connection and ground treatment (zero sequence current elimination).

Automatic Calculations: Amplitudes, Vector Groups, and Zero Sequence Removal

The calculations performed can be done by matrix calculations. Three steps have to be completed.

1. Adjust the amplitude according to all transformation ratios (Stepup transformer and CTs).
2. Adjust the vector group angle by rotating the three-phase system accordingly.
3. Remove the zero sequence current where necessary (this being valid for winding 1 and winding 2).

Re. 1.: Amplitude Adjustment:

$$\vec{I}_{W2}' = \vec{I}_{W2} \cdot k_r \quad k_r = \frac{CT_{pri,W2}}{I_{B,W2}} \cdot \frac{I_{b,W1}}{CT_{pri,W1}} = \frac{CT_{pri,W2}}{CT_{pri,W1}} \cdot \frac{V_{LL,W2}}{V_{LL,W1} \cdot (1 + Tap\ Changer)}$$

Re. 2.: Vector Group Adjustment:

The vector group adjustment is calculated using the following formulas and transformation matrices:

$$\vec{I}_{W2}'' = [T_{Phase\ Shift}] * \vec{I}_{W2}' \quad [T_{Phase\ Shift}] \rightarrow [T_{0,1,2...11}]$$

Even Connection Groups	Odd Connection Groups
$T_0 = \begin{bmatrix} 1 & 0 & 0 \\ 0 & 1 & 0 \\ 0 & 0 & 1 \end{bmatrix}$	$T_1 = \frac{1}{\sqrt{3}} \cdot \begin{bmatrix} 1 & -1 & 0 \\ 0 & 1 & -1 \\ -1 & 0 & 1 \end{bmatrix}$
$T_2 = \begin{bmatrix} 0 & -1 & 0 \\ 0 & 0 & -1 \\ -1 & 0 & 0 \end{bmatrix}$	$T_3 = \frac{1}{\sqrt{3}} \cdot \begin{bmatrix} 0 & -1 & 1 \\ 1 & 0 & -1 \\ -1 & 1 & 0 \end{bmatrix}$
$T_4 = \begin{bmatrix} 0 & 0 & 1 \\ 1 & 0 & 0 \\ 0 & 1 & 0 \end{bmatrix}$	$T_5 = \frac{1}{\sqrt{3}} \cdot \begin{bmatrix} -1 & 0 & 1 \\ 1 & -1 & 0 \\ 0 & 1 & -1 \end{bmatrix}$
$T_6 = \begin{bmatrix} -1 & 0 & 0 \\ 0 & -1 & 0 \\ 0 & 0 & -1 \end{bmatrix}$	$T_7 = \frac{1}{\sqrt{3}} \cdot \begin{bmatrix} -1 & 1 & 0 \\ 0 & -1 & 1 \\ 1 & 0 & -1 \end{bmatrix}$
$T_8 = \begin{bmatrix} 0 & 1 & 0 \\ 0 & 0 & 1 \\ 1 & 0 & 0 \end{bmatrix}$	$T_9 = \frac{1}{\sqrt{3}} \cdot \begin{bmatrix} 0 & 1 & -1 \\ -1 & 0 & 1 \\ 1 & -1 & 0 \end{bmatrix}$
$T_{10} = \begin{bmatrix} 0 & 0 & -1 \\ -1 & 0 & 0 \\ 0 & -1 & 0 \end{bmatrix}$	$T_{11} = \frac{1}{\sqrt{3}} \cdot \begin{bmatrix} 1 & 0 & -1 \\ -1 & 1 & 0 \\ 0 & -1 & 1 \end{bmatrix}$

Re. 3.: Zero sequence removal (elimination of the ground current if this can only flow through one winding at the external asymmetrical faults and will not be transformed to the other winding).

Zero sequence removal will be calculated for the W1 side, if the W1con value is set to YN or ZN.

A zero sequence current can only flow:

1. If the neutral is connected to ground on the W1 side; and
2. The grid on the W1 side is grounded as well.

$$\vec{I}_{W1}''' = \vec{I}_{W1}'' - \vec{I}_{0,W1}''$$

For the W2 side:

Zero sequence removal is calculated for the W2 side, if the W2con value is set to yn or zn.

A zero sequence current can only flow:

1. If the vector group is odd;
2. If the neutral is connected to ground on the W2 side; and
3. The grid on the W2 side is grounded as well

$$\vec{I}_{W2}''' = \vec{I}_{W2}'' - \vec{I}_{0,W2}''$$

After setting the values for the percentage restrained characteristic curve, the settings for harmonic and transient restraining have to be defined. Both the harmonic and transient restraining settings depend on many parameters:

- Transformer type;
- Transformer material;
- Operational parameter of the grid; and
- Time of energizing relative to the sinusoidal phase.

Therefore it is very difficult to give “one for all” settings in this area and to find a compromise between making a differential relay extremely fast and extremely reliable in its trip decisions.

Beginning with the static characteristic curve, typical slopes of 25% and 50% for both sections are recommended. They will be obtained by the settings »Id(IS0)«, »Id(IS1)«, »Id(IS2)«.

In case of harmonic or transient restraint, the curve will be added by a static offset d(H,m)

To be able to withstand magnetizing inrush currents of typical values, the setting »d(H,m)« = 8 is recommended.

In case that harmonic restraint threshold is reached, this value will be added to the characteristic curve.

It is important to estimate the necessary harmonic threshold to obtain stability against magnetizing inrush, CT saturation, and over-excitation. The harmonics seen under different operational conditions like magnetizing inrush and CT saturation depend on many different parameters.

Magnetizing inrush:

Basically, harmonics can be observed and monitored. Due to this fact, the 2nd and 4th harmonic are monitored. Inrush currents depend on the time of energizing, the remnant magnetizing compared to phase of sinusoidal curve, the voltage (low voltage energizing produce less harmonic), the core material and the core geometry among others.

It is recommended generally to set the harmonic restraint as active. This is done (for each harmonic separately) by setting the respective parameter »Stab H2«, »Stab H4«, »Stab H5« to “active”.

To operate very stably under stationary circumstances, it can be distinguished between a stationary value of harmonic thresholds and a transient harmonic threshold directly after energizing. This transient period is always started if the differential as well the restraining current is below 5% of the base current I_b . The following values

are recommended for typical cases:

- »H2 Sta« = 30 %
- »H2 Tra« = 15 %
- »H4 Sta« = 30 %

For CT saturation, the 5th harmonic is one typical criteria. This feature also should be activated as long as CT saturation is expected due to CT dimensioning and operational current values under external faults. It has to be noted that CT saturation can only be monitored as long as there is a critical rest of the current transformed to the secondary side of the CT. For severe CT saturation, the CT can be nearly short circuited, as seen from the primary side, so that nearly no measurable current can be monitored or analyzed.

- »H5 Sta« = 30 %
- »H5 Tra« = 15 %

The so-called transient time period »*t-Trans*« directly after energizing strongly depends on the above mentioned influencing parameter. Time spans from nearly zero to more than 15 seconds are known for special auto-transformer banks. A typical setting of 2 s is recommended for commonly used transformers.

All harmonic-generating events can occur to a different degree in one, two, or all three phases. That is why there is a choice provided to restrain only those phases with harmonic content or restrain all three phases, which is recommended for typical application, as long as knowledge of the grid and modes of operation do not prove another choice.

- »*Crossblock*« = "active": Phase-overlapping stabilisation of the differential protection function.
- »*Crossblock*« = "inactive": Phase-selective stabilisation of the differential protection function.

The Transient Monitor analyzes continuously the differential current signal. If it detects saturation $|m| > 1$, it will decide whether the saturation is caused by internal or external faults.

- External Faults: the sign of differential current and of slope are equal (both "-" or both "+").
- Internal Faults: the sign of differential current and slope are different (one "-" and the other "+", or the other way round).

If the saturation is caused by an internal fault, there will be no raising/stabilizing of the tripping curve. If the saturation is caused by an external fault, the tripping curve will be raised by d(H,m).

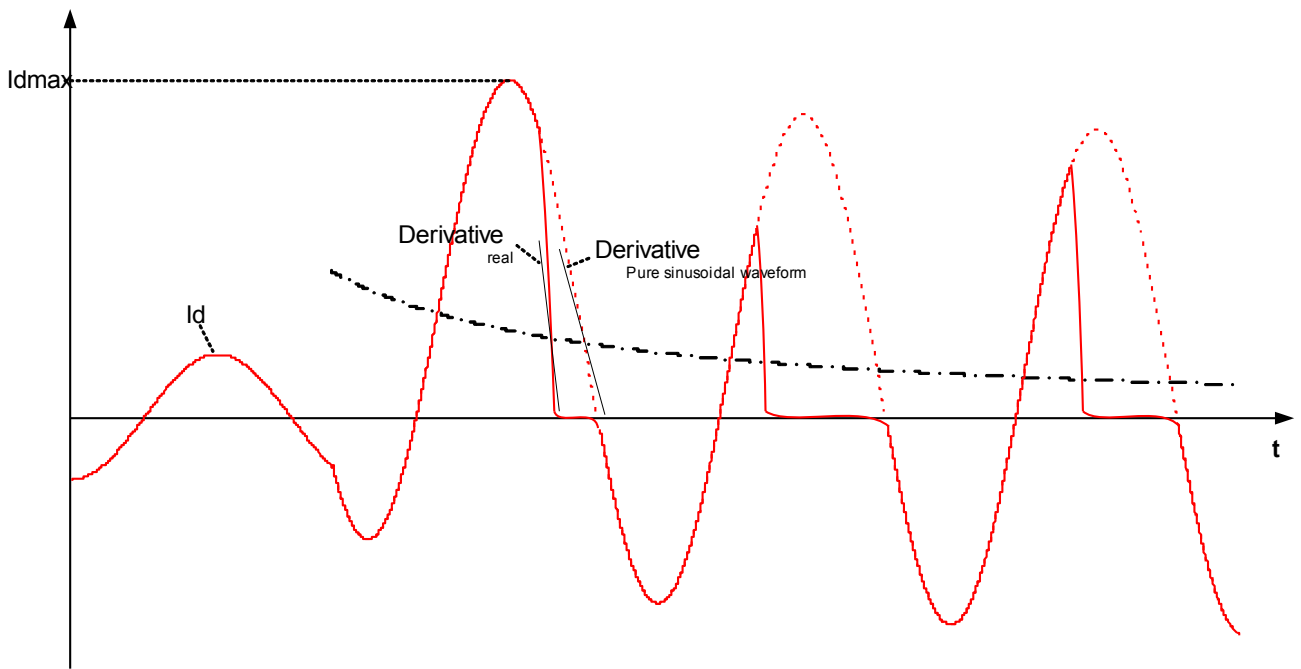

The recommended settings for the CT saturation monitor are (for usual applications):

- »CT Satur Monit« = "active"
- »CT Satur Sensitivn« = 120 % (Sensitiveness of the Current Transformer Saturation Supervision. The higher the value, the lower the sensitiveness.)

Device Planning Parameters of the Phase Current Differential Protection

Parameter	Description	Options	Default	Menu path
Mode	Mode	do not use, use	use	[Device planning]

Global Protection Parameters of the Phase Current Differential Protection







Parameter	Description	Setting range	Default	Menu path
ExBlo1	External blocking of the module, if blocking is activated (allowed) within a parameter set and if the state of the assigned signal is true.	1..n, Assignment List	-.-	[Protection Para /Global Prot Para /Diff-Prot /Id]
ExBlo2	External blocking of the module, if blocking is activated (allowed) within a parameter set and if the state of the assigned signal is true.	1..n, Assignment List	-.-	[Protection Para /Global Prot Para /Diff-Prot /Id]
ExBlo TripCmd	External blocking of the Trip Command of the module/the stage, if blocking is activated (allowed) within a parameter set and if the state of the assigned signal is true.	1..n, Assignment List	-.-	[Protection Para /Global Prot Para /Diff-Prot /Id]







Setting Group Parameters of the Phase Current Differential Protection

Parameter	Description	Setting range	Default	Menu path
Function	Permanent activation or deactivation of module/stage.	inactive, active	active	[Protection Para /<1..4> /Diff-Prot /Id]
ExBlo Fc	Activate (allow) or inactivate (disallow) blocking of the module/stage. This parameter is only effective if a signal is assigned to the corresponding global protection parameter. If the signal becomes true, those modules/stages are blocked that are parameterized "ExBlo Fc=active".	inactive, active	inactive	[Protection Para /<1..4> /Diff-Prot /Id]

Protective Elements

Parameter	Description	Setting range	Default	Menu path
 Blo TripCmd	Permanent blocking of the Trip Command of the module/stage.	inactive, active	inactive	[Protection Para /<1..4> /Diff-Prot /Id]
 ExBlo TripCmd Fc	Activate (allow) or inactivate (disallow) blocking of the module/stage. This parameter is only effective if a signal is assigned to the corresponding global protection parameter. If the signal becomes true, those modules/stages are blocked that are parameterized "ExBlo TripCmd Fc=active".	inactive, active	inactive	[Protection Para /<1..4> /Diff-Prot /Id]
 Id min	Constant minimum pickup current (differential current). Pickup value of the differential current based on the rated current Ib of the protection object.	0.05 - 1.00Ib	0.2Ib	[Protection Para /<1..4> /Diff-Prot /Id]
 Id(Is0)	Starting point of the static tripping characteristic at Is0	0.0 - 1.00Ib	0.0Ib	[Protection Para /<1..4> /Diff-Prot /Id]
 Id(Is1)	Breaking point of the static tripping characteristic at Is1	0.2 - 2.00Ib	0.6Ib	[Protection Para /<1..4> /Diff-Prot /Id]
 Id(Is2)	Value of the static tripping characteristic at Is2	1.0 - 8.0Ib	6.2Ib	[Protection Para /<1..4> /Diff-Prot /Id]
 Is1	Breaking point of the static tripping characteristic when Is1	0.5 - 4.0Ib	2.0Ib	[Protection Para /<1..4> /Diff-Prot /Id]

Parameter	Description	Setting range	Default	Menu path
Is2 	Value of the static tripping characteristic at Is2	5.0 - 10.0lb	10.0lb	[Protection Para /<1..4> /Diff-Prot /Id]
Char Reset% 	Drop Out (in percent of the setting). Settable Drop Out works only on the gradients. Id min uses a fix Drop Out.	90 - 98%	95%	[Protection Para /<1..4> /Diff-Prot /Id]
d(H,m) 	Restraining factor for rising the static tripping characteristic in case of stationary or transient harmonic components, which are ascertained by Fourier analysis (H) or transients monitor (m).	0.0 - 30.0lb	8lb	[Protection Para /<1..4> /Diff-Prot /Id]
Stab H2 	Restraining of differential protection function against stationary or transient components of the 2nd harmonic at the phase current (e.g. rush-effect).	inactive, active	inactive	[Protection Para /<1..4> /Diff-Prot /Id]
H2 Sta 	Threshold (2nd harmonic - basic wave ratio) for restraining the differential protection function against stationary 2nd harmonic. Only available if: Stab H2 = active	10 - 60%	25%	[Protection Para /<1..4> /Diff-Prot /Id]
H2 Tra 	Threshold (2nd harmonic - basic wave ratio) for temporary stabilisation of the differential protection function against transient 2nd harmonic. Only available if: Stab H2 = active	10 - 60%	10%	[Protection Para /<1..4> /Diff-Prot /Id]
Stab H4 	Restraining of differential protection function against stationary components of the 4th harmonic at the phase current.	inactive, active	inactive	[Protection Para /<1..4> /Diff-Prot /Id]
H4 Sta 	Threshold (4th harmonic - basic wave ratio) for restraining the differential protection function against stationary 4th harmonic. Only available if: Stab H4 = active	10 - 60%	20%	[Protection Para /<1..4> /Diff-Prot /Id]

Parameter	Description	Setting range	Default	Menu path
 Stab H5	Stabilisation of differential protection function against stationary or transient components of the 5th harmonic at the phase current (e.g. transformer overexcitation).	inactive, active	inactive	[Protection Para /<1..4> /Diff-Prot /Id]
 H5 Sta	Threshold (5thd harmonic - basic wave ratio) for stabilising the differential protection function against stationary 5th harmonic. Only available if: Stab H5 = active	10 - 60%	30%	[Protection Para /<1..4> /Diff-Prot /Id]
 H5 Tra	Threshold (5th harmonic - basic wave ratio) for temporary restraining of the differential protection function against transient 5th harmonic. Only available if: Stab H5 = active	10 - 60%	15%	[Protection Para /<1..4> /Diff-Prot /Id]
 t-Trans	Time of temporary stabilisation of the differential protection function when thresholds for „H2 Tra“ and „H5 Tra“ (transient harmonic) are exceeded.	0.05 - 120.00s	2s	[Protection Para /<1..4> /Diff-Prot /Id]
 Crossbl	Active = Phase overlapping stabilisation of the differential protection function. Inactive = Phase selective stabilisation of the differential protection function.	inactive, active	inactive	[Protection Para /<1..4> /Diff-Prot /Id]
 CT Satur Monit	Current Transformer Saturation Supervision	inactive, active	active	[Protection Para /<1..4> /Diff-Prot /Id]
 CT Satur Sensitvn	Sensitiveness of the Current Transformer Saturation Supervision. The higher the value, the lower the sensitiveness. Only available if: VRestraining = active	100 - 500%	100%	[Protection Para /<1..4> /Diff-Prot /Id]

Phase Current Differential Protection Module Input States

<i>Name</i>	<i>Description</i>	<i>Assignment via</i>
ExBlo1-I	Module input state: External blocking1	[Protection Para /Global Prot Para /Diff-Prot /Id]
ExBlo2-I	Module input state: External blocking2	[Protection Para /Global Prot Para /Diff-Prot /Id]
ExBlo TripCmd-I	Module input state: External Blocking of the Trip Command	[Protection Para /Global Prot Para /Diff-Prot /Id]

Phase Current Differential Protection Module Signals (Output States)

<i>Signal</i>	<i>Description</i>
active	Signal: active
ExBlo	Signal: External Blocking
Blo TripCmd	Signal: Trip Command blocked
ExBlo TripCmd	Signal: External Blocking of the Trip Command
Alarm L1	Signal: Alarm System Phase L1
Alarm L2	Signal: Alarm System Phase L2
Alarm L3	Signal: Alarm System L3
Alarm	Signal: Alarm
Trip L1	Signal: Trip System Phase L1
Trip L2	Signal: Trip System Phase L2
Trip L3	Signal: Trip System Phase L3
Trip	Signal: Trip
TripCmd	Signal: Trip Command
Blo H2	Signal: Blocked by Harmonic:2
Blo H4	Signal: Blocked by Harmonic:4
Blo H5	Signal: Blocked by Harmonic:5
H2,H4,H5 Blo	Signal: Blocked by Harmonics (Inhibit)
Slope Blo	Signal: Differential protection was blocked by current transformer saturation. The tripping characteristic was lifted because of current transformer saturation.
Transient	Signal: Temporary stabilization of the differential protection afterwards the transformer is being energized.
Restraining	Signal: Restraining of the differential protection by means of rising the tripping curve.

<i>Signal</i>	<i>Description</i>
Slope Blo: L1	Slope Blo: L1
Slope Blo: L2	Slope Blo: L2
Slope Blo: L3	Slope Blo: L3
Restraining: L1	Restraining: L1
Restraining: L2	Restraining: L2
Restraining: L3	Restraining: L3
IH2 Blo L1	Signal:Phase L1: Blocking of the Phase Differential Protection because of second Harmonic.
IH2 Blo L2	Signal:Phase L2: Blocking of the Phase Differential Protection because of second Harmonic.
IH2 Blo L3	Signal:Phase L3: Blocking of the Phase Differential Protection because of second Harmonic.
IH4 Blo L1	Signal:Phase L1: Blocking of the Phase Differential Protection because of fourth Harmonic.
IH4 Blo L2	Signal:Phase L2: Blocking of the Phase Differential Protection because of fourth Harmonic.
IH4 Blo L3	Signal:Phase L3: Blocking of the Phase Differential Protection because of fourth Harmonic.
IH5 Blo L1	Signal:Phase L1: Blocking of the Phase Differential Protection because of fifth Harmonic.
IH5 Blo L2	Signal:Phase L2: Blocking of the Phase Differential Protection because of fifth Harmonic.
IH5 Blo L3	Signal:Phase L3: Blocking of the Phase Differential Protection because of fifth Harmonic.

Phase Current Differential Protection Module Values

<i>Value</i>	<i>Description</i>	<i>Menu path</i>
Id L1 H2	Measured value (calculated): Differential Current Phase L1 Harmonic:2	[Operation /Measured Values /Id]
Id L2 H2	Measured value (calculated): Differential Current Phase L2 Harmonic:2	[Operation /Measured Values /Id]
Id L3 H2	Measured value (calculated): Differential Current Phase L3 Harmonic:2	[Operation /Measured Values /Id]
Id L1 H4	Measured value (calculated): Differential Current Phase L1 Harmonic:4	[Operation /Measured Values /Id]

<i>Value</i>	<i>Description</i>	<i>Menu path</i>
Id L2 H4	Measured value (calculated): Differential Current Phase L2 Harmonic:4	[Operation /Measured Values /Id]
Id L3 H4	Measured value (calculated): Differential Current Phase L3 Harmonic:4	[Operation /Measured Values /Id]
Id L1 H5	Measured value (calculated): Differential Current Phase L1 Harmonic:5	[Operation /Measured Values /Id]
Id L2 H5	Measured value (calculated): Differential Current Phase L2 Harmonic:5	[Operation /Measured Values /Id]
Id L3 H5	Measured value (calculated): Differential Current Phase L3 Harmonic:5	[Operation /Measured Values /Id]

Phase Current Differential Protection Module Statistics

<i>Value</i>	<i>Description</i>	<i>Menu path</i>
Id L1H2max	Maximum Value Id L1H2	[Operation /Statistics /Max /Id]
Id L2H2max	Maximum Value Id L2H2	[Operation /Statistics /Max /Id]
Id L3H2max	Maximum Value Id L3H2	[Operation /Statistics /Max /Id]
Id L1H4max	Maximum Value Id L1H4	[Operation /Statistics /Max /Id]

Protective Elements

<i>Value</i>	<i>Description</i>	<i>Menu path</i>
Id L2H4max	Maximum Value Id L2H4	[Operation /Statistics /Max /Id]
Id L3H4max	Maximum Value Id L3H4	[Operation /Statistics /Max /Id]
Id L1H5max	Maximum Value Id L1H5	[Operation /Statistics /Max /Id]
Id L2H5max	Maximum Value Id L2H5	[Operation /Statistics /Max /Id]
Id L3H5max	Maximum Value Id L3H5	[Operation /Statistics /Max /Id]

Unrestrained High-set Differential Current Protection IdH

Elements:
IdH

Irrespective of the set static tripping characteristic and restraining factors $d[H,m]$, a pickup value for a max. differential current I_{dH} can be adjusted and results in undelayed tripping when exceeded. This protection step is referred to as high-set differential step I_{dH} and only trips on faults within the protection zone.

Unrestrained High-set Differential Protection Step IdH

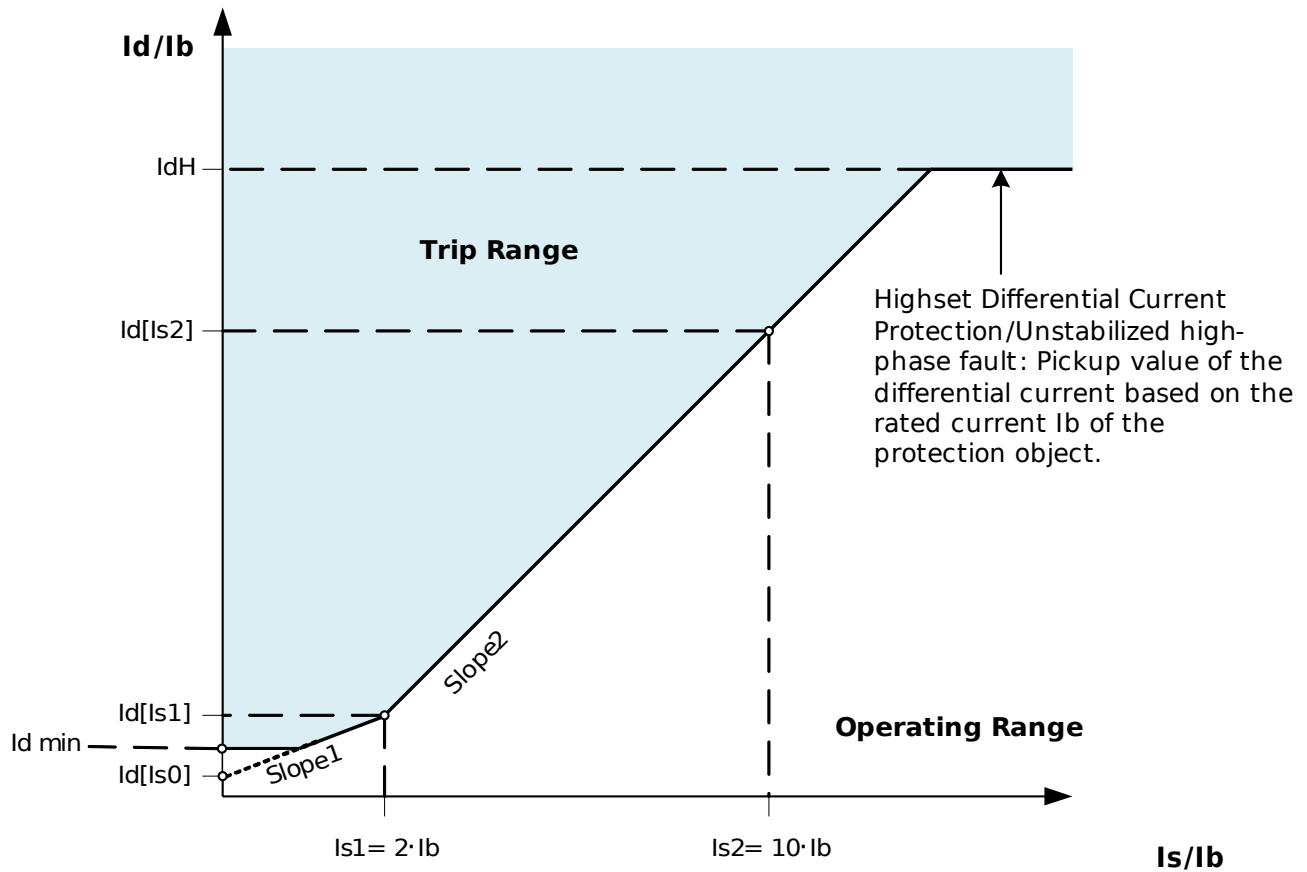



Idhigh_Z01

Device Planning Parameters of the Unrestrained High-set Differential Current Protection Module





Parameter	Description	Options	Default	Menu path
Mode 	Mode	do not use, use	use	[Device planning]

Global Protection Parameters of the Unrestrained High-set Differential Current Protection Module

Parameter	Description	Setting range	Default	Menu path
ExBlo1 	External blocking of the module, if blocking is activated (allowed) within a parameter set and if the state of the assigned signal is true.	1..n, Assignment List	-.-	[Protection Para /Global Prot Para /Diff-Prot /IdH]
ExBlo2 	External blocking of the module, if blocking is activated (allowed) within a parameter set and if the state of the assigned signal is true.	1..n, Assignment List	-.-	[Protection Para /Global Prot Para /Diff-Prot /IdH]
ExBlo TripCmd 	External blocking of the Trip Command of the module/the stage, if blocking is activated (allowed) within a parameter set and if the state of the assigned signal is true.	1..n, Assignment List	-.-	[Protection Para /Global Prot Para /Diff-Prot /IdH]

Setting Group Parameters of the Unrestrained High-set Differential Current Protection Module

Parameter	Description	Setting range	Default	Menu path
Function 	Permanent activation or deactivation of module/stage.	inactive, active	active	[Protection Para /<1..4> /Diff-Prot /IdH]

Parameter	Description	Setting range	Default	Menu path
 ExBlo Fc	Activate (allow) or inactivate (disallow) blocking of the module/stage. This parameter is only effective if a signal is assigned to the corresponding global protection parameter. If the signal becomes true, those modules/stages are blocked that are parameterized "ExBlo Fc=active".	inactive, active	inactive	[Protection Para /<1..4> /Diff-Prot /IdH]
 Blo TripCmd	Permanent blocking of the Trip Command of the module/stage.	inactive, active	inactive	[Protection Para /<1..4> /Diff-Prot /IdH]
 ExBlo TripCmd Fc	Activate (allow) or inactivate (disallow) blocking of the module/stage. This parameter is only effective if a signal is assigned to the corresponding global protection parameter. If the signal becomes true, those modules/stages are blocked that are parameterized "ExBlo TripCmd Fc=active".	inactive, active	inactive	[Protection Para /<1..4> /Diff-Prot /IdH]
 Id>>	Highset Differential Current Protection/Unstabilized high-phase fault: Pickup value of the differential current based on the rated current Ib of the protection object.	0.5 - 30.0Ib	10.0Ib	[Protection Para /<1..4> /Diff-Prot /IdH]

Unrestrained High-set Differential Current Protection Module Input States

Name	Description	Assignment via
ExBlo1-I	Module input state: External blocking1	[Protection Para /Global Prot Para /Diff-Prot /IdH]
ExBlo2-I	Module input state: External blocking2	[Protection Para /Global Prot Para /Diff-Prot /IdH]
ExBlo TripCmd-I	Module input state: External Blocking of the Trip Command	[Protection Para /Global Prot Para /Diff-Prot /IdH]

Signals of the Unrestrained High-set Differential Current Protection Signals (Output States)

<i>Signal</i>	<i>Description</i>
active	Signal: active
ExBlo	Signal: External Blocking
Blo TripCmd	Signal: Trip Command blocked
ExBlo TripCmd	Signal: External Blocking of the Trip Command
Alarm L1	Signal: Alarm System Phase L1
Alarm L2	Signal: Alarm System Phase L2
Alarm L3	Signal: Alarm System L3
Alarm	Signal: Alarm
Trip L1	Signal: Trip System Phase L1
Trip L2	Signal: Trip System Phase L2
Trip L3	Signal: Trip System Phase L3
Trip	Signal: Trip
TripCmd	Signal: Trip Command

IdG - Ground Current Differential Protection [87GN, 87TN, 64REF]

Available elements:
 IdG[1]..IdG[2]

The ground differential protective element can be used to provide:

- Sensitive detection of internal ground faults on the wye-side windings of transformers.
- Sensitive ground fault detection for solidly or low -impedance grounded generators.

Description

This protection principle is based on a restricted ground fault scheme that only can be used in systems with an earthed neutral. The ground differential current is the vector sum of the measured earth current and the calculated zero sequence current from three measured phase currents. Similarly to the phase restrained differential protection, the ground restraining current is the vector difference of the measured earth current and the calculated zero sequence current from three measured phase currents. The trip characteristic is very much similar to the phase restrained differential protection and it does not have the temporary restraining.

Protection Principle of Ground Current Differential Protection connected on wye-side winding of a transformer

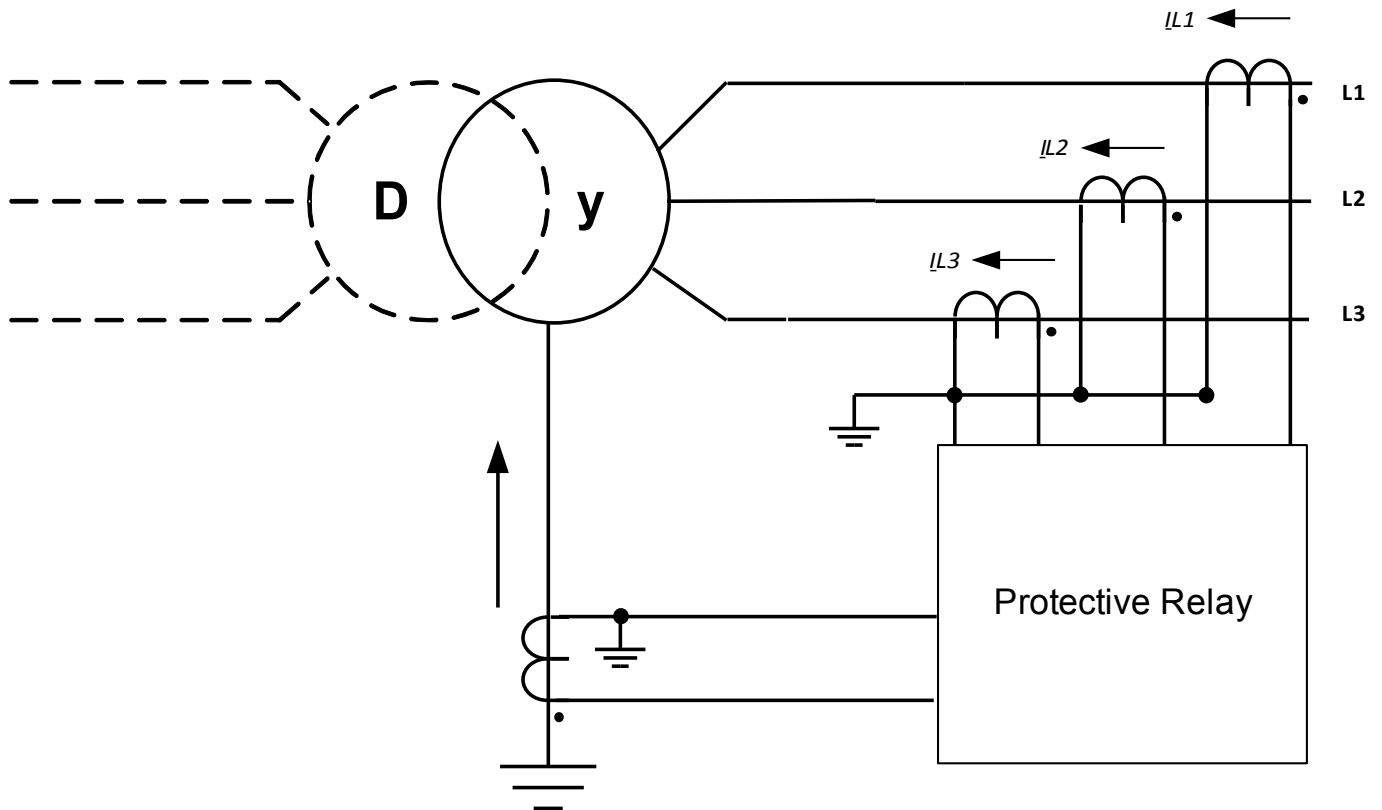

⚠ WARNING The trip commands generated by the protective function restricted ground fault IdG have to be assigned within the Breaker Manager.

NOTICE

Please be aware that the protective function Restricted Ground Fault IdG solely can be applied to the winding end which builds the earthed neutral point.

Ground Differential Protection Options

The Ground Current Differential Protection (87GG) can be used to various protected objects such as stepup transformers, generators, motors, generator-step-up-transformer (GSU) unit and etc. The following applications describe the corresponding system connections, relay current input connection, relay parameter settings and some tips for special applications accordingly.

Application ANSI 87GN (Busbar Connection)

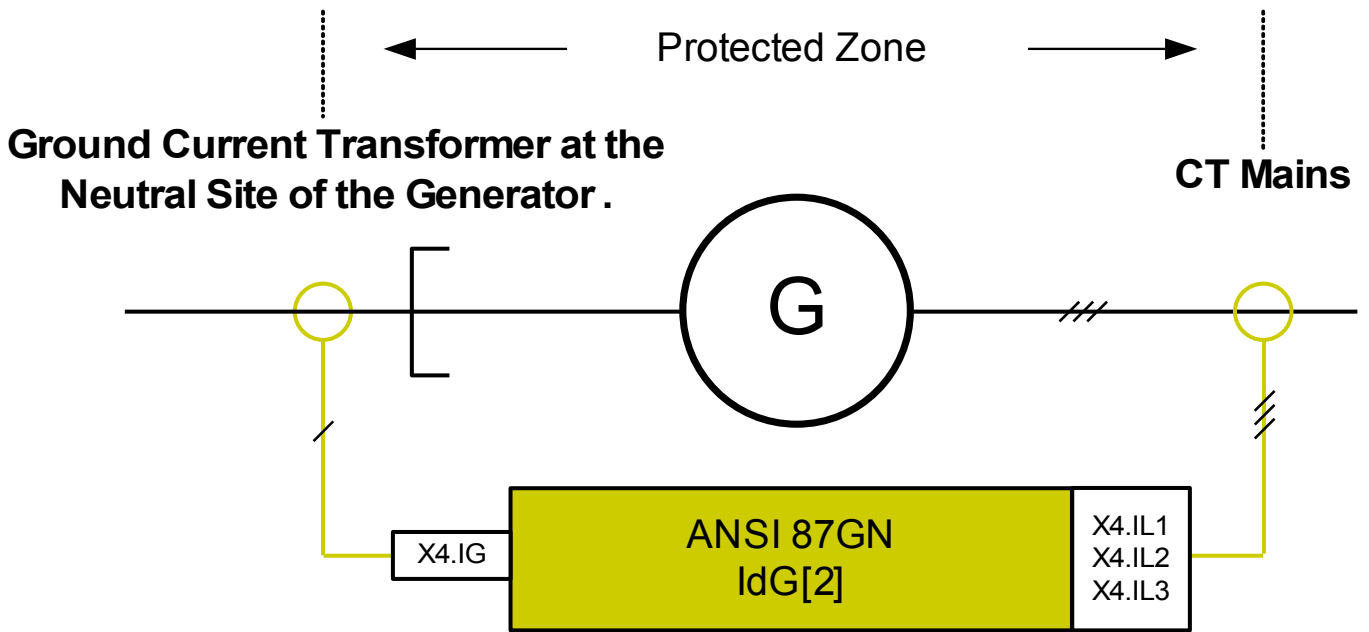

Proper Use

To be used if the generator is connected directly to a busbar and should be protected against ground faults between the phase and the neutral current transformer (within the generator).

Required type of current transformers and current transformer locations

- Phase current transformers at the mains site of the generator.
- Ring core type current transformer or ground current transformer at the neutral site of the generator.

Name of the Element that is to be used

IdG[2]

Wiring of the current transformers

- Phase current transformers to be connected to X4.IL1, X4.IL2, X4.IL3
- Ring core or ground current transformer to be connected to X4.IG

Calculated Reference Current

$$I_b = \frac{S_N}{\sqrt{3} * V_{LL}} = \frac{\text{Rated Power}_{Generator}}{\sqrt{3} * \text{Rated Voltage}_{Generator} (Ph-Ph)}$$

Required Settings

Set the Mode within the Device Planning.

Where? Within [Device Planning]
Set „Transformer.Mode=not used“

Activate the Protective Element within the Device Planning.

Where? Within [Device Planning]
Set „IdG[2].Mode=use“

Set the Field Parameters of the Generator.

Where? Within [Field Para\Generator]

Set the Differential Protection Parameters.

Where? Within [Protection Para\Set [x]\Diff-Prot]

Application ANSI 87GN (Unit Connection)

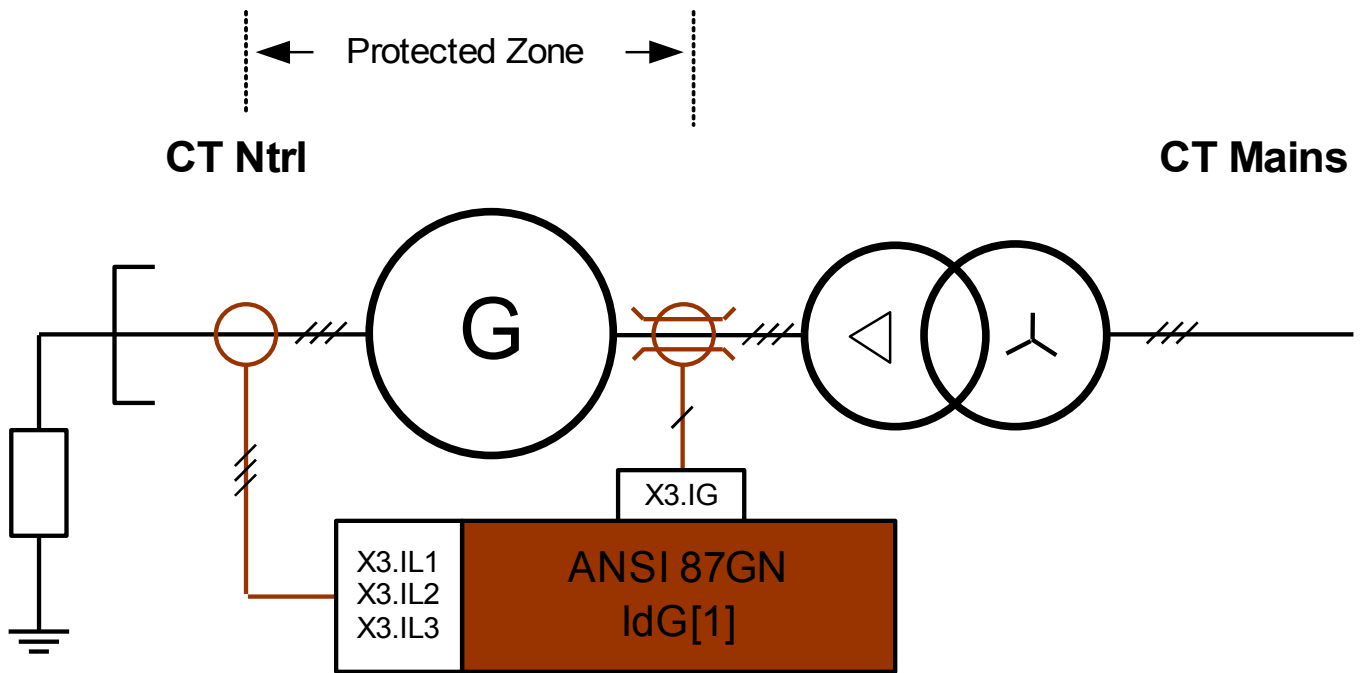

Proper Use

To be used if the generator is connected via a step up transformer to the mains and should be protected against ground faults between the phase and neutral current transformer (within the generator).

Required type of current transformers and current transformer locations

- Phase current transformers at the neutral site of the generator.
- Ring core type current transformer at the mains site of the generator.

Name of the Element that is to be used

IdG[1]

Wiring of the current transformers

- Phase current transformers to be connected to X3.IL1, X3.IL2, X3.IL3
- Ring core or ground current transformer to be connected to X3.IG

Calculated Reference Current

$$I_b = \frac{S_N}{\sqrt{3} * V_{LL}} = \frac{\text{Rated Power}_{Generator}}{\sqrt{3} * \text{Rated Voltage}_{Generator} (Ph-Ph)}$$

Required Settings

Set the Mode within the Device Planning.

Where? Within [Device Planning]
Set „Transformer.Mode=use“

Activate the Protective Element within the Device Planning.

Where? Within [Device Planning]
Set „IdG[1].Mode=use“

Set the Field Parameters of the Generator.

Where? Within [Field Para\Generator]

Set the Differential Protection Parameters.

Where? Within [Protection Para\Set [x]\Diff-Prot]

Application ANSI 87TN (Unit Connection)

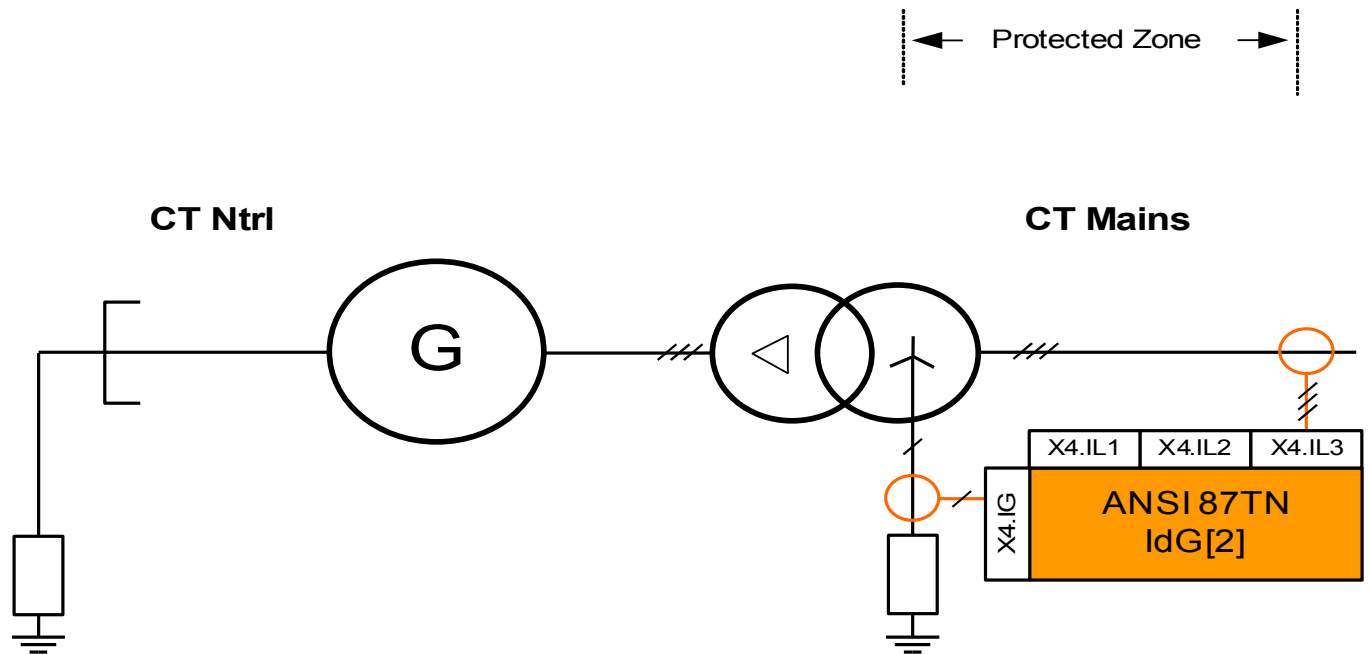

Proper Use

To be used if the generator is connected via a step up transformer to the mains and if the transformer (step up) should be protected against ground differential faults within the transformer.

Required type of current transformers and current transformer locations

- Phase current transformers at the mains site of the transformer.
- Ground current transformer at the neutral site of the transformer.

Name of the Element that is to be used
IdG[2]

Wiring of the current transformers

- Phase current transformers to be connected to X4.IL1, X4.IL2, X4.IL3
- Ring core or ground current transformer to be connected to X4.IG

Calculated Reference Current

$$I_b = I_{b, W2} = \frac{S_N}{\sqrt{3} * V_{LL, W2}} = \frac{\text{Rated Power}_{Transformer}}{\sqrt{3} * \text{Rated Voltage (W2)}_{Transformer} (Ph - Ph)}$$

Required Settings

Set the Mode within the Device Planning.

Where? Within [Device Planning]
Set „Transformer.Mode=use“

Activate the Protective Element within the Device Planning.

Where? Within [Device Planning]
Set „IdG[2].Mode=use“

Set the Field Parameters of the Transformer.

Where? Within [Field Para\Transformer]

Set the Differential Protection Parameters.

Where? Within [Protection Para\Set [x]\Diff-Prot]

Application ANSI 87 GN and ANSI 87TN (Unit Connection)

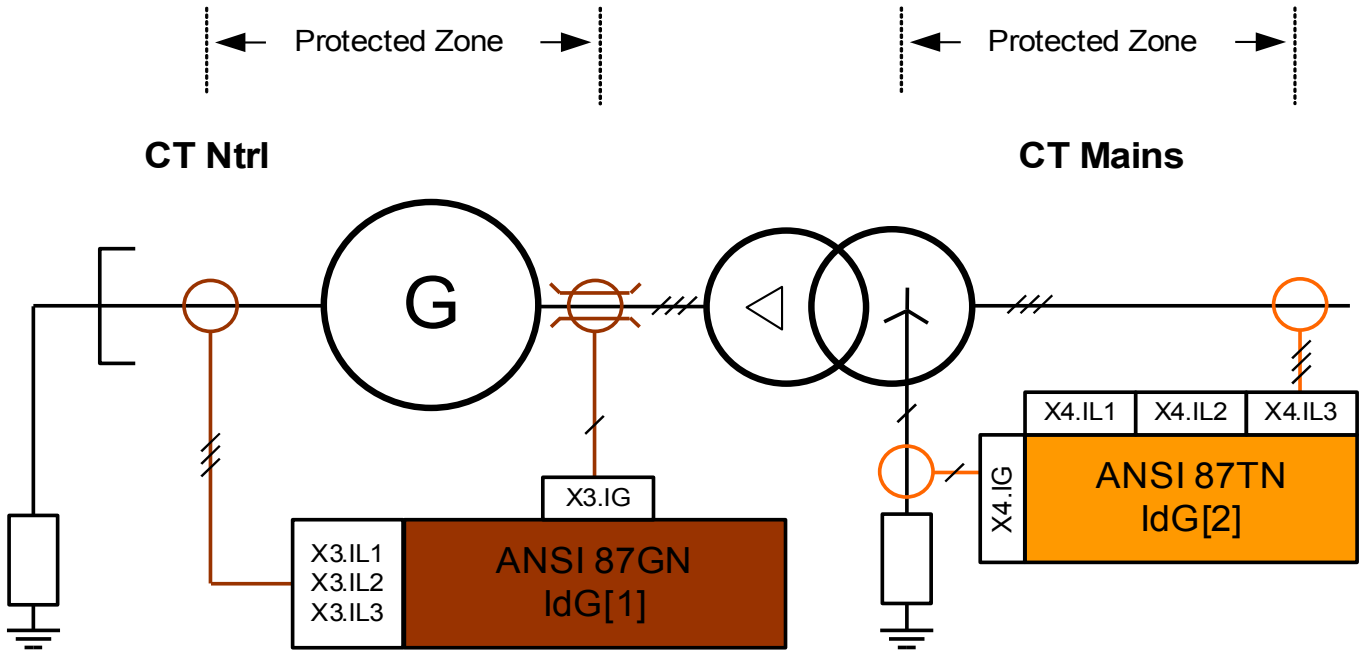

Proper Use



To be used if the generator is connected via a step up transformer to the mains and if the generator and the transformer (step up) should be protected against ground differential faults.

ANSI 87GN	ANSI 87TN
<p><i>Required type of current transformers and current transformer locations</i></p> <ul style="list-style-type: none"> ■ Phase current transformers at the neutral site of the generator. ■ Ring core type current transformer at the mains site of the generator. 	<p><i>Required type of current transformers and current transformer locations</i></p> <ul style="list-style-type: none"> ■ Phase current transformers at the mains site of the transformer. ■ Ring core type current transformer or ground current transformer at the neutral site of the transformer.
<p><i>Wiring of the current transformers</i></p> <ul style="list-style-type: none"> ■ Phase current transformers to be connected to X3.IL1, X3.IL2, X3.IL3 ■ Ring core or ground current transformer to be connected to X3.IG 	<p><i>Wiring of the current transformers</i></p> <ul style="list-style-type: none"> ■ Phase current transformers to be connected to X4.IL1, X4.IL2, X4.IL3 ■ Ground current transformer to be connected to X4.IG
<p><i>Name of the Element that is to be used</i> IdG[1]</p>	<p><i>Name of the Element that is to be used</i> IdG[2]</p>
<p><i>Calculated Reference Current</i></p> $I_b = \frac{S_N}{\sqrt{3} * V_{LL}}$ <div style="background-color: #c00000; color: white; padding: 5px; margin-top: 5px;"> $= \frac{\text{Rated Power}_{Generator}}{\sqrt{3} * \text{Rated Voltage}_{Generator} (Ph - Ph)}$ </div>	<p><i>Calculated Reference Current</i></p> $I_b = I_{b, W2} = \frac{S_N}{\sqrt{3} * V_{LL, W2}}$ <div style="background-color: #ffa500; padding: 5px; margin-top: 5px;"> $= \frac{\text{Rated Power}_{Transformer}}{\sqrt{3} * \text{Rated Voltage} (W2)_{Transformer} (Ph - Ph)}$ </div>
<p><i>Required Settings</i></p> <p>Set the Mode within the Device Planning. Where? Within [Device Planning] Set „Transformer.Mode=use“</p> <p>Activate the Protective Element within the Device Planning. Where? Within [Device Planning] Set „IdG[1].Mode=use“</p> <p>Set the Field Parameters of the Generator. Where? Within [Field Para\Generator]</p> <p>Set the Differential Protection Parameters. Where? Within [Protection Para\Set [x]\Diff-Prot]</p>	<p><i>Required Settings</i></p> <p>Set the Mode within the Device Planning. Where? Within [Device Planning] Set „Transformer.Mode=use“</p> <p>Activate the Protective Element within the Device Planning. Where? Within [Device Planning] Set „IdG[2].Mode=use“</p> <p>Set the Field Parameters of the Transformer. Where? Within [Field Para\Transformer]</p> <p>Set the Differential Protection Parameters. Where? Within [Protection Para\Set [x]\Diff-Prot]</p>

Device Planning Parameters of the Restricted Ground Fault Protection







Parameter	Description	Options	Default	Menu path
Mode 	Mode	do not use, use	do not use	[Device planning]



Global Protection Parameters of the Restricted Ground Fault Protection

Parameter	Description	Setting range	Default	Menu path
ExBlo1 	External blocking of the module, if blocking is activated (allowed) within a parameter set and if the state of the assigned signal is true.	1..n, Assignment List	-.-	[Protection Para /Global Prot Para /Diff-Prot /IdG[1]]
ExBlo2 	External blocking of the module, if blocking is activated (allowed) within a parameter set and if the state of the assigned signal is true.	1..n, Assignment List	-.-	[Protection Para /Global Prot Para /Diff-Prot /IdG[1]]
ExBlo TripCmd 	External blocking of the Trip Command of the module/the stage, if blocking is activated (allowed) within a parameter set and if the state of the assigned signal is true.	1..n, Assignment List	-.-	[Protection Para /Global Prot Para /Diff-Prot /IdG[1]]

Setting Group Parameters of the Restricted Ground Fault Protection

Parameter	Description	Setting range	Default	Menu path
Function 	Permanent activation or deactivation of module/stage.	inactive, active	inactive	[Protection Para /<1..4> /Diff-Prot /IdG[1]]

Parameter	Description	Setting range	Default	Menu path
 ExBlo Fc	Activate (allow) or inactivate (disallow) blocking of the module/stage. This parameter is only effective if a signal is assigned to the corresponding global protection parameter. If the signal becomes true, those modules/stages are blocked that are parameterized "ExBlo Fc=active".	inactive, active	inactive	[Protection Para /<1..4> /Diff-Prot /IdG[1]]
 Blo TripCmd	Permanent blocking of the Trip Command of the module/stage.	inactive, active	inactive	[Protection Para /<1..4> /Diff-Prot /IdG[1]]
 ExBlo TripCmd Fc	Activate (allow) or inactivate (disallow) blocking of the module/stage. This parameter is only effective if a signal is assigned to the corresponding global protection parameter. If the signal becomes true, those modules/stages are blocked that are parameterized "ExBlo TripCmd Fc=active".	inactive, active	inactive	[Protection Para /<1..4> /Diff-Prot /IdG[1]]
 IdG min	Constant minimum pickup current (earth differential current). Pickup value of the differential current based on the rated current Ib of the related protection object.	0.05 - 1.00Ib	0.05Ib	[Protection Para /<1..4> /Diff-Prot /IdG[1]]
 IdG(Is0)	Starting point of the static tripping characteristic at Is0	0.00 - 1.00Ib	0.1Ib	[Protection Para /<1..4> /Diff-Prot /IdG[1]]
 IdG(Is1)	Breaking point of the static tripping characteristic at Is1	0.2 - 2.00Ib	0.2Ib	[Protection Para /<1..4> /Diff-Prot /IdG[1]]
 IdG(Is2)	Value of the static tripping characteristic at Is2	1.0 - 8.0Ib	2.0Ib	[Protection Para /<1..4> /Diff-Prot /IdG[1]]

<i>Parameter</i>	<i>Description</i>	<i>Setting range</i>	<i>Default</i>	<i>Menu path</i>
Is1 	Breaking point of the static tripping characteristic when Is1	0.5 - 5.0Ib	2.0Ib	[Protection Para /<1..4> /Diff-Prot /IdG[1]]
Is2 	Value of the static tripping characteristic at Is2	5.0 - 10.0Ib	10.0Ib	[Protection Para /<1..4> /Diff-Prot /IdG[1]]

Restricted Ground Fault Protection Module Input States

<i>Name</i>	<i>Description</i>	<i>Assignment via</i>
ExBlo1-I	Module input state: External blocking1	[Protection Para /Global Prot Para /Diff-Prot /IdG[1]]
ExBlo2-I	Module input state: External blocking2	[Protection Para /Global Prot Para /Diff-Prot /IdG[1]]
ExBlo TripCmd-I	Module input state: External Blocking of the Trip Command	[Protection Para /Global Prot Para /Diff-Prot /IdG[1]]

Restricted Ground Fault Protection Module Signals (Output States)

<i>Signal</i>	<i>Description</i>
active	Signal: active
ExBlo	Signal: External Blocking
Blo TripCmd	Signal: Trip Command blocked
ExBlo TripCmd	Signal: External Blocking of the Trip Command
Alarm	Signal: Alarm
Trip	Signal: Trip
TripCmd	Signal: Trip Command

IdGh - High Set Restricted Ground Fault Protection IdGH

Elements

IdGH[1], IdGH[2]

Similar to the unrestrained phase differential protection, unrestrained ground differential protection functions are provided for a high ground differential current.

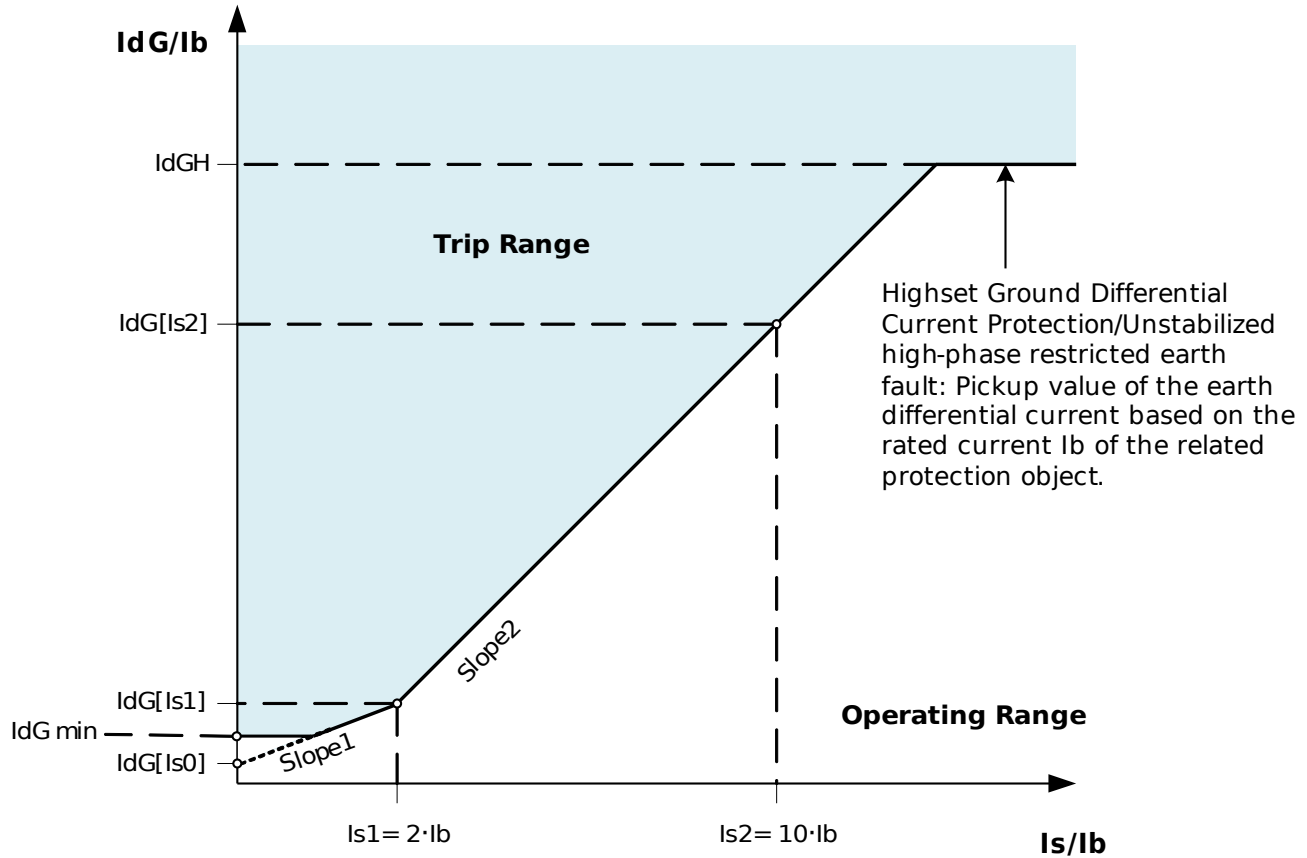



Idhigh_Z01

Unstabilized High Set Differential Protection Element IdGH

Device Planning Parameters of the High Set Restricted Ground Fault Protection Module





Parameter	Description	Options	Default	Menu path
Mode 	Mode	do not use, use	do not use	[Device planning]

Global Protection Parameters of the High Set Restricted Ground Fault Protection Module

Parameter	Description	Setting range	Default	Menu path
ExBlo1 	External blocking of the module, if blocking is activated (allowed) within a parameter set and if the state of the assigned signal is true.	1..n, Assignment List	-.-	[Protection Para /Global Prot Para /Diff-Prot /IdGH[1]]
ExBlo2 	External blocking of the module, if blocking is activated (allowed) within a parameter set and if the state of the assigned signal is true.	1..n, Assignment List	-.-	[Protection Para /Global Prot Para /Diff-Prot /IdGH[1]]
ExBlo TripCmd 	External blocking of the Trip Command of the module/the stage, if blocking is activated (allowed) within a parameter set and if the state of the assigned signal is true.	1..n, Assignment List	-.-	[Protection Para /Global Prot Para /Diff-Prot /IdGH[1]]

Setting Group Parameters of the High Set Restricted Ground Fault Protection Module

Parameter	Description	Setting range	Default	Menu path
Function 	Permanent activation or deactivation of module/stage.	inactive, active	inactive	[Protection Para /<1..4> /Diff-Prot /IdGH[1]]

Parameter	Description	Setting range	Default	Menu path
 ExBlo Fc	Activate (allow) or inactivate (disallow) blocking of the module/stage. This parameter is only effective if a signal is assigned to the corresponding global protection parameter. If the signal becomes true, those modules/stages are blocked that are parameterized "ExBlo Fc=active".	inactive, active	inactive	[Protection Para /<1..4> /Diff-Prot /IdGH[1]]
 Blo TripCmd	Permanent blocking of the Trip Command of the module/stage.	inactive, active	inactive	[Protection Para /<1..4> /Diff-Prot /IdGH[1]]
 ExBlo TripCmd Fc	Activate (allow) or inactivate (disallow) blocking of the module/stage. This parameter is only effective if a signal is assigned to the corresponding global protection parameter. If the signal becomes true, those modules/stages are blocked that are parameterized "ExBlo TripCmd Fc=active".	inactive, active	inactive	[Protection Para /<1..4> /Diff-Prot /IdGH[1]]
 IdG>>	Highset Ground Differential Current Protection/Unstabilized high-phase restricted earth fault: Pickup value of the earth differential current based on the rated current Ib of the related protection object.	0.50 - 20.00Ib	2.00Ib	[Protection Para /<1..4> /Diff-Prot /IdGH[1]]

High Set Restricted Ground Fault Protection Module Input States

Name	Description	Assignment via
ExBlo1-I	Module input state: External blocking1	[Protection Para /Global Prot Para /Diff-Prot /IdGH[1]]
ExBlo2-I	Module input state: External blocking2	[Protection Para /Global Prot Para /Diff-Prot /IdGH[1]]
ExBlo TripCmd-I	Module input state: External Blocking of the Trip Command	[Protection Para /Global Prot Para /Diff-Prot /IdGH[1]]

High Set Restricted Ground Fault Signals (Output States)

<i>Signal</i>	<i>Description</i>
active	Signal: active
ExBlo	Signal: External Blocking
Blo TripCmd	Signal: Trip Command blocked
ExBlo TripCmd	Signal: External Blocking of the Trip Command
Alarm	Signal: Alarm
Trip	Signal: Trip
TripCmd	Signal: Trip Command

I - Overcurrent Protection [50, 51,51Q, 51V, 67]

Available stages:

I[1] .I[2] .I[3] .I[4] .I[5] .I[6]

WARNING

If you are using inrush blockings the tripping delay of the current protection functions must be at least 30ms or more in order to prevent faulty trippings.

CAUTION

In order to ensure correct functioning of the directional detection after single-phase short-circuits, the following reference voltage is used: For phase current *I1* it is the line-to-line voltage *U23*, for phase current *I2* the line-to-line voltage *U31* and for phase current *I3* the line-to-line voltage *U12*.

In case the fault happens to be near the measuring location and there is no reference voltage for directional recognition available any more (neither measured or from history (voltage memory)), then the module will - depending on the parameter setting - either trip non-directional or it will be blocked.

NOTICE

All overcurrent protective elements are identically structured.

NOTICE

The setting parameter »CT Winding Side«) allows to select which CT the protective element monitors (CT Ntrl=Current transformers on the neutral side, or CT Mains=Current Transformer Main Side).

It must be noted, however, that the direction determination is available only with the setting »CT Winding Side« = CT Mains.

NOTICE

This module offers Adaptive Parameter Sets. Parameters can be modified within parameter sets dynamically by means of Adaptive Parameter Sets. Please refer to chapter Parameter / Adaptive Parameter Sets.

The following table shows the application options of the Overcurrent Protection element

Applications of the I-Protection Module	Setting in	Option
ANSI 50 – Overcurrent protection, non-directional	Device Planning menu	Measuring Mode: Fundamental/TrueRMS/negative phase sequence current (I2)
ANSI 51 – Short circuit protection, non-directional	Device Planning menu	Measuring Mode: Fundamental/TrueRMS/negative phase sequence current (I2)
ANSI 67 – Overcurrent/ Short circuit protection, directional	Device Planning menu	Measuring Mode: Fundamental/TrueRMS/negative phase sequence current (I2)
ANSI 51V – Voltage restraint overcurrent protection	Parameter Set: VRestraint = active	Measuring Mode: Fundamental/TrueRMS/negative phase sequence current (I2) Measuring Channel: Phase to Phase/Phase to Neutral
ANSI 51Q Negative Phase Sequence Overcurrent Protection	Parameter Set: Measuring Method =I2 (Negative Sequence Current)	
51C Voltage controlled overcurrent protection (Please refer to the chapter Parameter/Adaptive Parameter)	Adaptive Parameters	Measuring Mode: Fundamental/TrueRMS/negative phase sequence current (I2) Measuring Channel: (in voltage protection module) Phase to Phase/Phase to Neutral

Measuring Mode

For all protection elements it can be determined, whether the measurement is done on basis of the »*Fundamental*« or if »*TrueRMS*« measurement is used.

Alternatively the »*Measuring Mode*« can be set to »*I2*«. In this case the negative phase sequence current will be measured. This is to detect unbalanced faults.

Voltage restraint overcurrent protection 51V

When the Parameter »*VRestraint*« is set to active the overcurrent protection element works voltage restraint. That means, the overcurrent pickup threshold will be lowered during voltage drops. This results in a more sensitive overcurrent protection. For the voltage threshold »*VRestraint max*« additionally the »*Measuring Channel*« can be determined.

Measuring Channel

With the parameter »*Measuring Channel*« it can be determined, whether the »*Phase to Phase*« voltage or the »*Phase to Neutral*« voltage is measured.

With the setting »*CT Winding Side*« = "CT Mains" (Current Transformer Mains Side), all overcurrent protective elements can be planned as non-directional or optionally as directional (forward / reverse) elements.

(If »*CT Winding Side*« = "CT Ntrl" (Current transformers on the neutral side), only the non-directional mode is available.)

For each element the following characteristics are available:

- DEFT (UMZ) – *Definite Time-Overcurrent*
- NINV (IEC/AMZ) – *IEC Normal Inverse*
- VINV (IEC/AMZ) – *IEC Very Inverse*
- LINV (IEC/AMZ) – *IEC Long Time Inverse*
- EINV (IEC/AMZ) – *IEC Extremely Inverse*
- MINV (ANSI/AMZ) – *ANSI Moderately Inverse*
- VINV (ANSI/AMZ) – *ANSI Very Inverse*
- EINV (ANSI/AMZ) – *ANSI Extremely Inverse*
- RINV – *R Inverse*
- Thermal Flat
- IT
- I2T
- I4T

Explanation:

t = Tripping delay

t-char = Time multiplier/tripping characteristic factor. The setting range depends on the selected tripping curve.

I = Fault current

I> = If the pickup value is exceeded, the module/element starts to time out to trip.

By using the projecting parameters each of the overcurrent protective elements can be defined as »*forward*«, »*reverse*« or »*non-directional*«. The forward or reverse direction is based on the characteristic angle for the phase direction specified by the field parameter »*I MTA*«. No directional information will be taken into account if the current protective element is planned as »*non-directional*«

DEFT – *Definite Time-Overcurrent*

DEFT

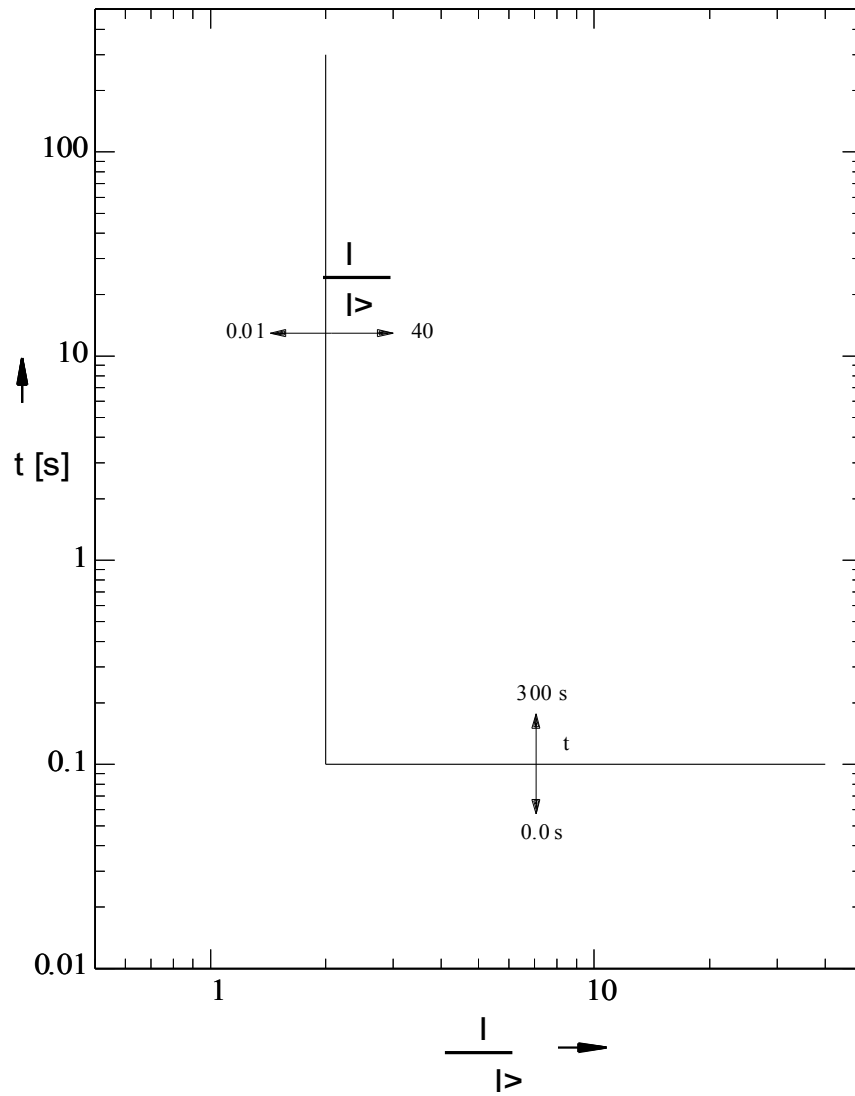

IEC Normal Inverse

NOTICE Various reset modes are available:
Resetting via characteristic, delayed and instantaneous.

Remark: For $I > 20 \cdot I_n$, the curve stops decreasing, the t-values are kept constant at the value for $I = 20 \cdot I_n$.

»Char« = IEC NINV

Reset

$$t = \frac{0.14}{1 - \left(\frac{I}{I_n}\right)^2} \cdot t_{char}$$

If: $\frac{I}{I_n} < 1$

Trip

$$t = \frac{0.14}{\left(\frac{I}{I_n}\right)^{0.02} - 1} \cdot t_{char}$$

If: $1 < \frac{I}{I_n} \leq 20$

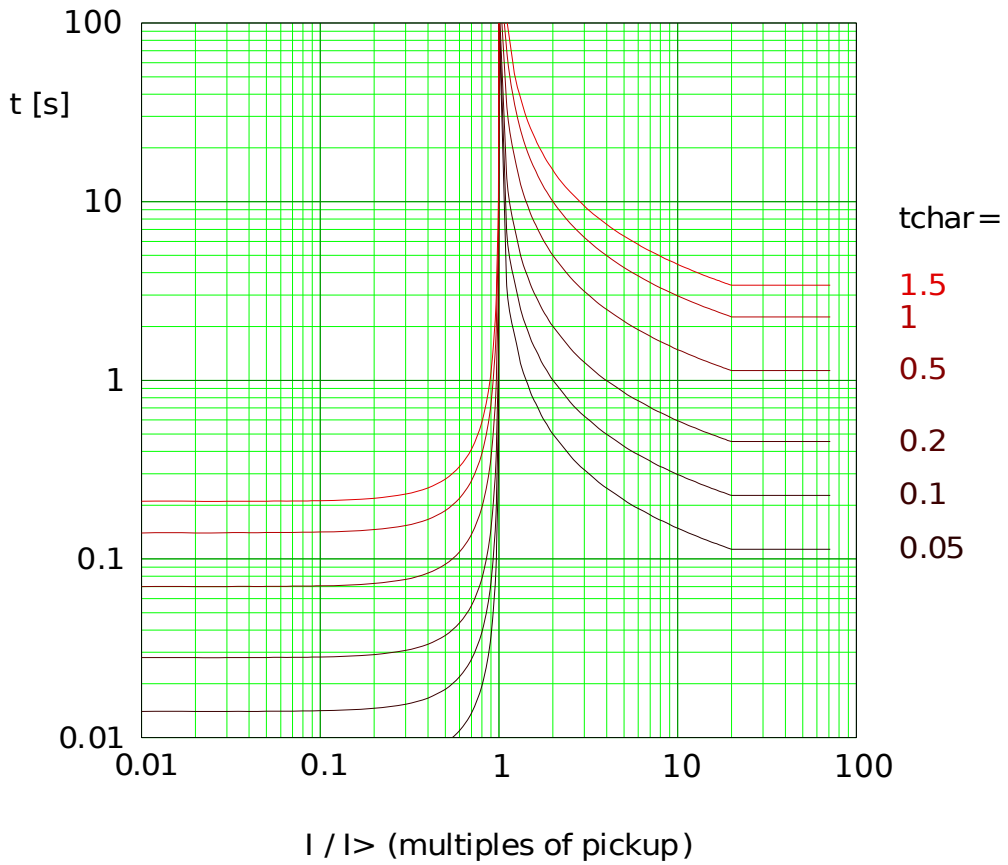

Pdloc_Z01

IEC Very Inverse

NOTICE Various reset modes are available:
Resetting via characteristic, delayed and instantaneous.

Remark: For $I > 20 \cdot I_n$, the curve stops decreasing, the t-values are kept constant at the value for $I = 20 \cdot I_n$.

»Char« = IEC VINV

Reset

$$t = \frac{13.5}{1 - \left(\frac{I}{I_n}\right)^2} \cdot t_{char}$$

If: $\frac{I}{I_n} < 1$

Trip

$$t = \frac{13.5}{\frac{I}{I_n} - 1} \cdot t_{char}$$

If: $1 < \frac{I}{I_n} \leq 20$

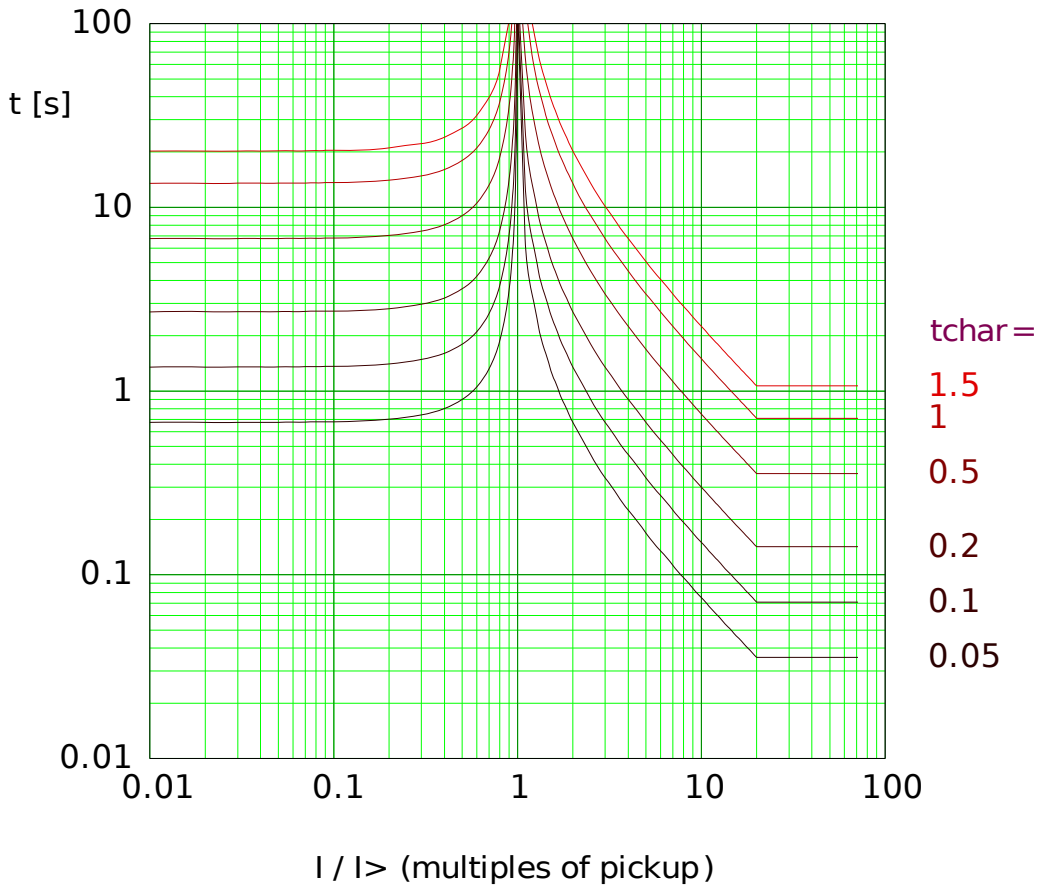

Pdloc_Z02

IEC Extremely Inverse

NOTICE Various reset modes are available:
Resetting via characteristic, delayed and instantaneous.

Remark: For $I > 20 \cdot I_n$, the curve stops decreasing, the t-values are kept constant at the value for $I = 20 \cdot I_n$.

»Char« = IEC EINV

Reset

$$t = \frac{80}{1 - \left(\frac{I}{I_n}\right)^2} \cdot t_{char}$$

If: $\frac{I}{I_n} < 1$

Trip

$$t = \frac{80}{\left(\frac{I}{I_n}\right)^2 - 1} \cdot t_{char}$$

If: $1 < \frac{I}{I_n} \leq 20$

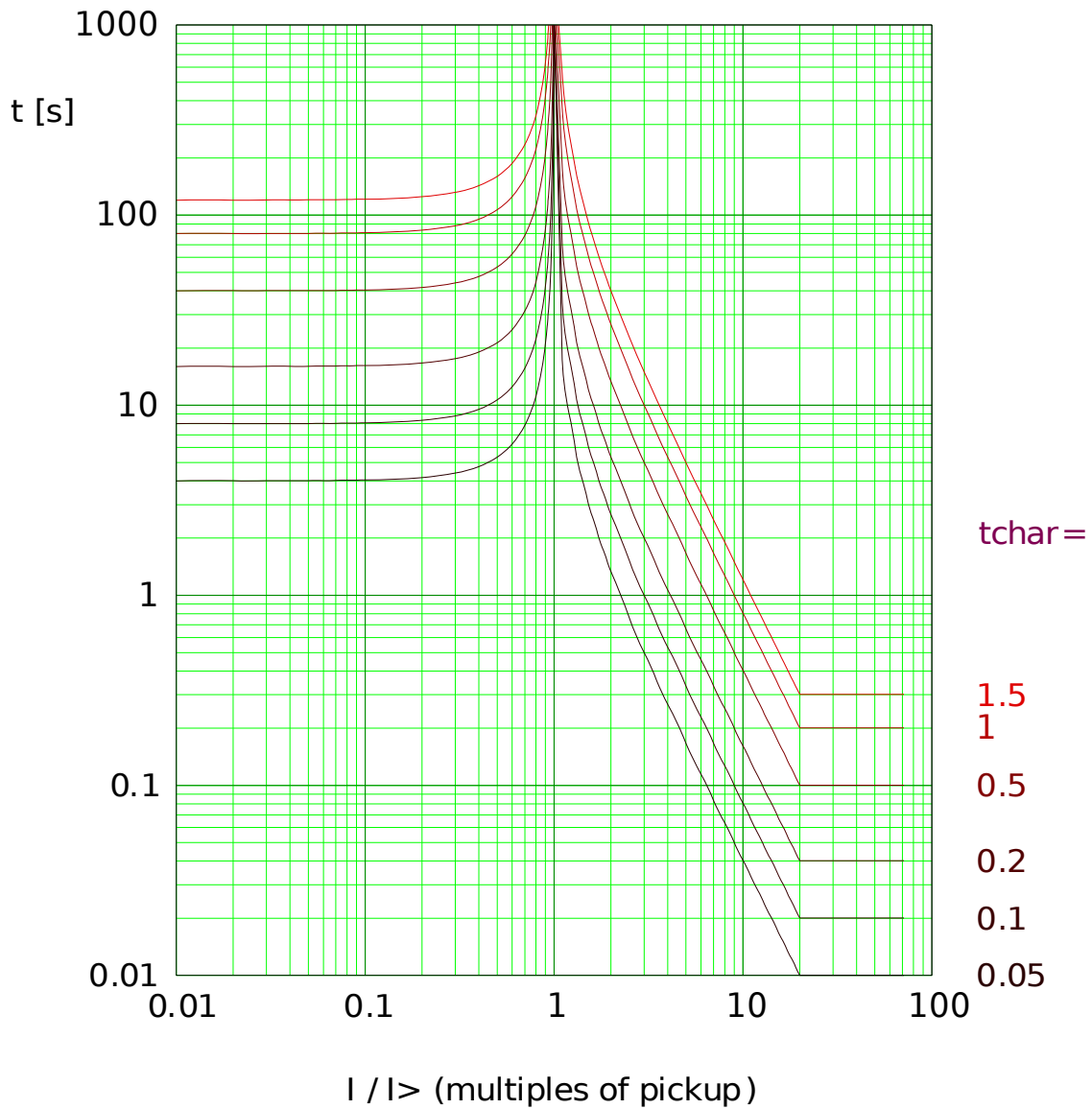

IEC Long Time Inverse

NOTICE Various reset modes are available:
Resetting via characteristic, delayed and instantaneous.

Remark: For $I > 20 \cdot I_s$, the curve stops decreasing, the t-values are kept constant at the value for $I = 20 \cdot I_s$.

»Char« = IEC LINV

Reset

$$t = \frac{120}{1 - \left(\frac{I}{I_s}\right)^2} \cdot t_{char}$$

If: $\frac{I}{I_s} < 1$

Trip

$$t = \frac{120}{\frac{I}{I_s} - 1} \cdot t_{char}$$

If: $1 < \frac{I}{I_s} \leq 20$

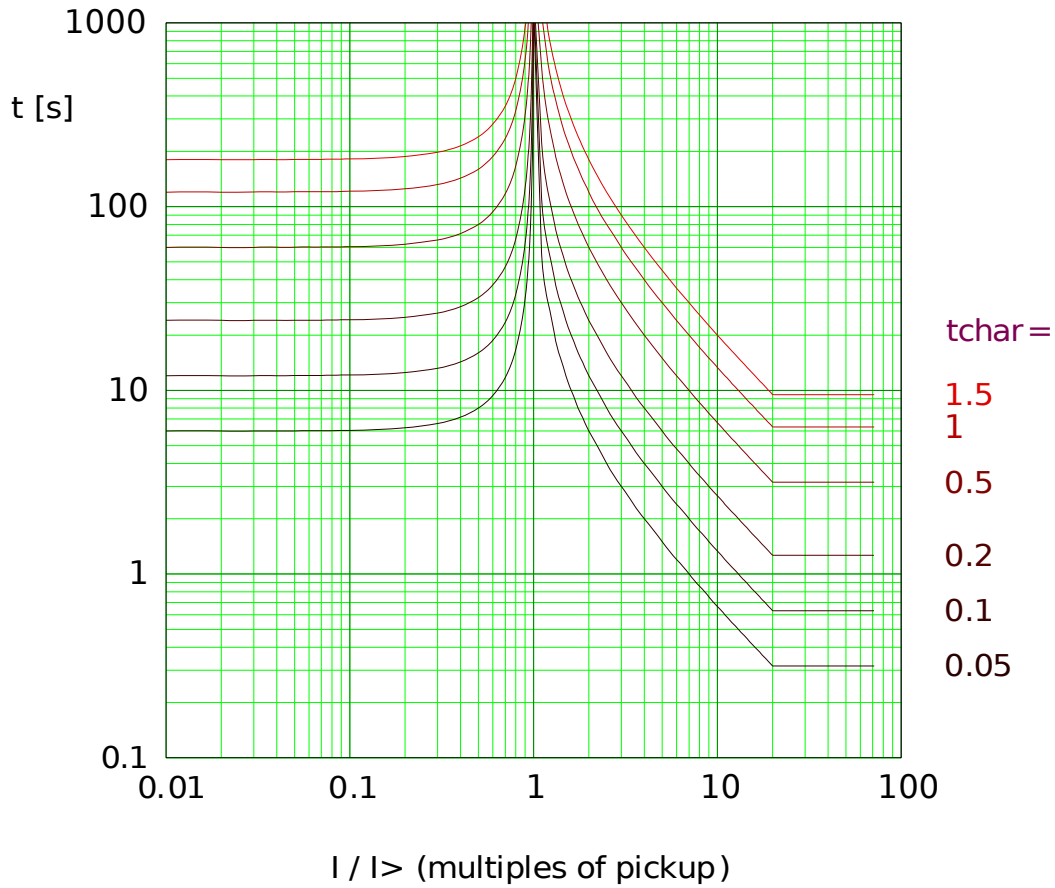

Pdoc_Z03

ANSI Moderately Inverse

NOTICE

Various reset modes are available:
Resetting via characteristic, delayed and instantaneous.

Remark: For $I > 20 \cdot I_n$, the curve stops decreasing, the t-values are kept constant at the value for $I = 20 \cdot I_n$.

»Char« = ANSI MINV

Reset

$$t = \frac{4.85}{1 - \left(\frac{I}{I_n}\right)^2} \cdot t_{char}$$

If: $\frac{I}{I_n} < 1$

Trip

$$t = \left(\frac{0.0515}{\left(\frac{I}{I_n}\right)^{0.02} - 1} + 0.1140 \right) \cdot t_{char}$$

If: $1 < \frac{I}{I_n} \leq 20$

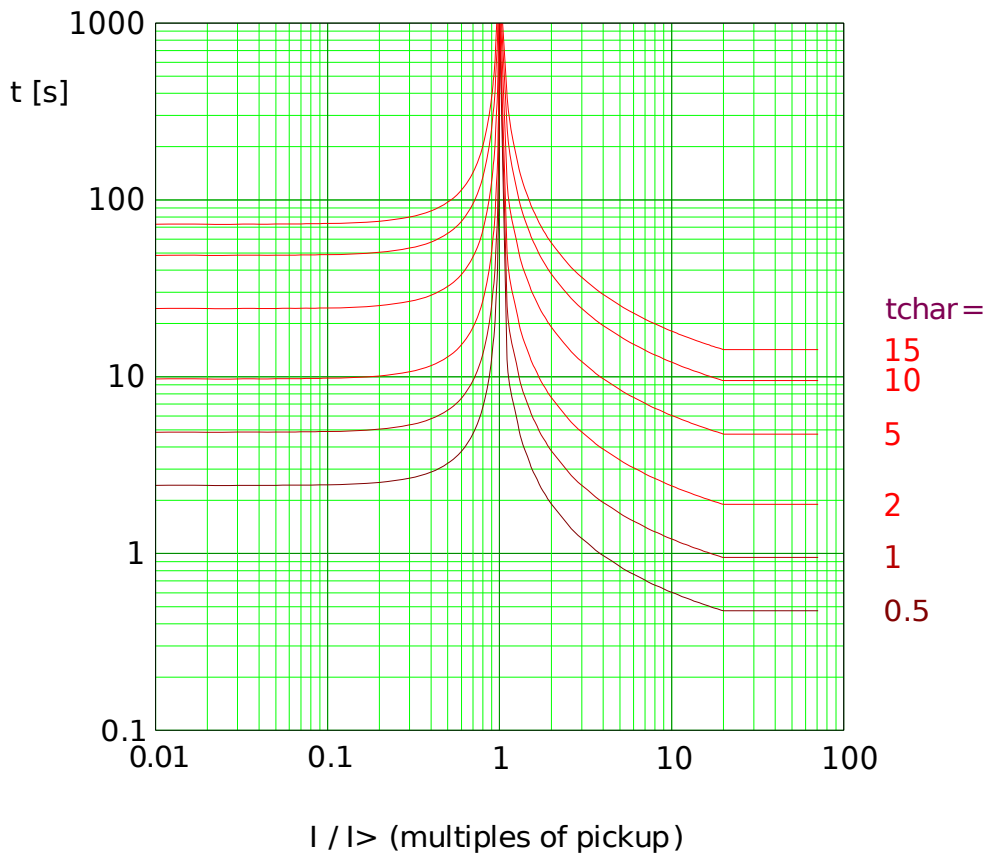

Pdoc_Z05

ANSI Very Inverse

NOTICE

Various reset modes are available:
Resetting via characteristic, delayed and instantaneous.

Remark: For $I > 20 \cdot I_s$, the curve stops decreasing, the t-values are kept constant at the value for $I = 20 \cdot I_s$.

»Char« = ANSI VINV

Reset

$$t = \frac{21.6}{1 - \left(\frac{I}{I_s}\right)^2} \cdot t_{char}$$

If: $\frac{I}{I_s} < 1$

Trip

$$t = \left(\frac{19.61}{\left(\frac{I}{I_s}\right)^2 - 1} + 0.491 \right) \cdot t_{char}$$

If: $1 < \frac{I}{I_s} \leq 20$

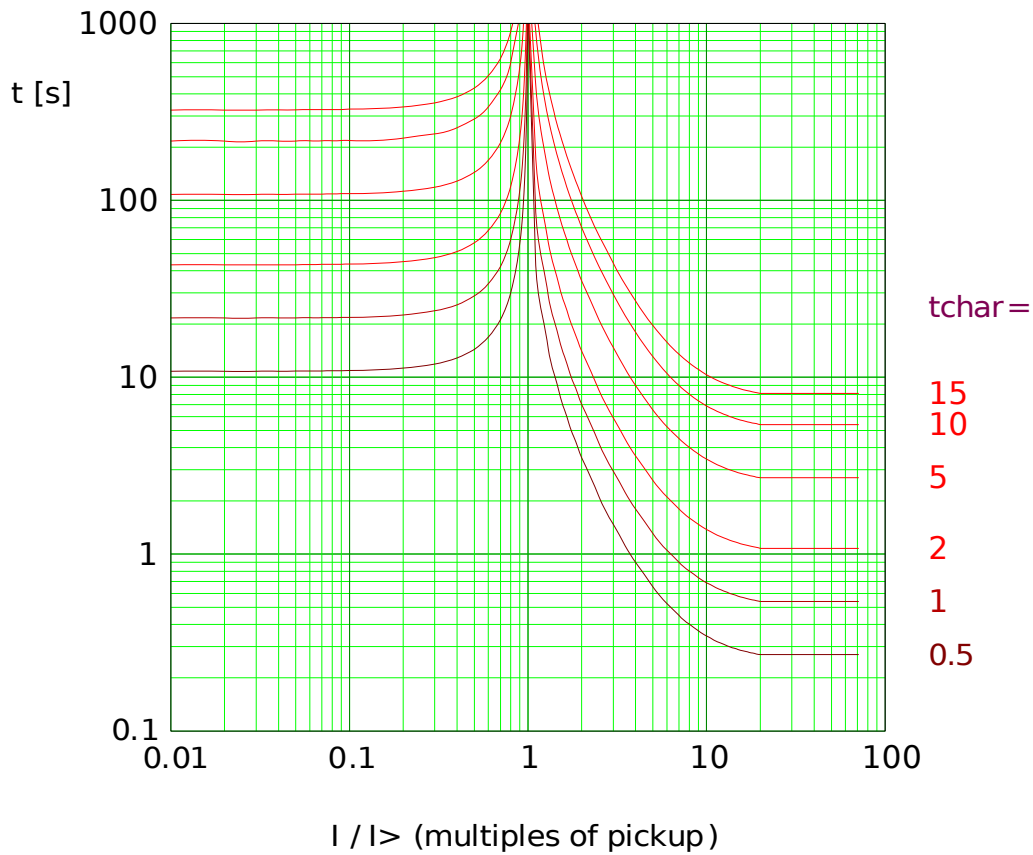

PdDoc_Z06

ANSI Extremely Inverse

NOTICE

Various reset modes are available:
Resetting via characteristic, delayed and instantaneous.

Remark: For $I > 20 \cdot I_s$, the curve stops decreasing, the t-values are kept constant at the value for $I = 20 \cdot I_s$.

»Char« = ANSI EINV

Reset

$$t = \frac{29.1}{1 - \left(\frac{I}{I_s}\right)^2} \cdot t_{char}$$

If: $\frac{I}{I_s} < 1$

Trip

$$t = \left(\frac{28.2}{\left(\frac{I}{I_s}\right)^2 - 1} + 0.1217 \right) \cdot t_{char}$$

If: $1 < \frac{I}{I_s} \leq 20$

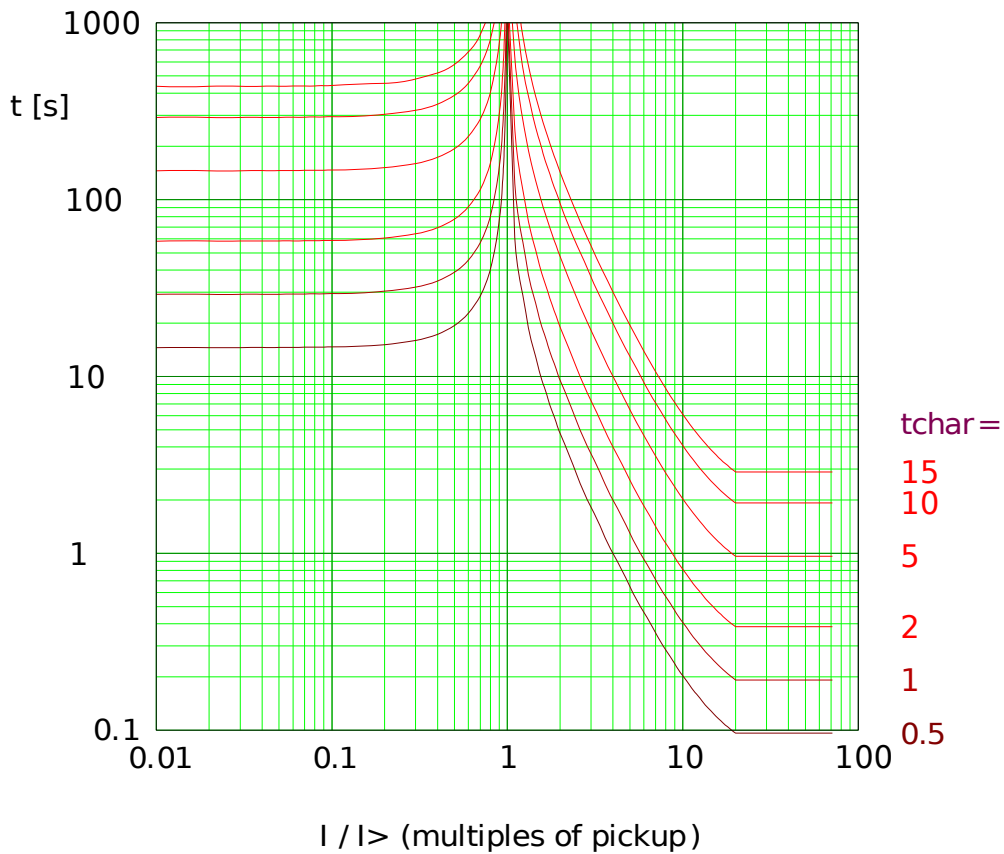

PDoc_Z07

R Inverse

NOTICE

Various reset modes are available:
Resetting via characteristic, delayed and instantaneous.

Remark: For $I > 20 \cdot I_s$, the curve stops decreasing, the t-values are kept constant at the value for $I = 20 \cdot I_s$.

»Char« = RINV

Reset

$$t = \frac{1.0}{1 - \left(\frac{I}{I_s}\right)^2} \cdot t_{char}$$

If: $\frac{I}{I_s} < 1$

Trip

$$t = \frac{1.0}{0.339 - 0.236 \cdot \left(\frac{I}{I_s}\right)^{-1}} \cdot t_{char}$$

If: $1 < \frac{I}{I_s} \leq 20$

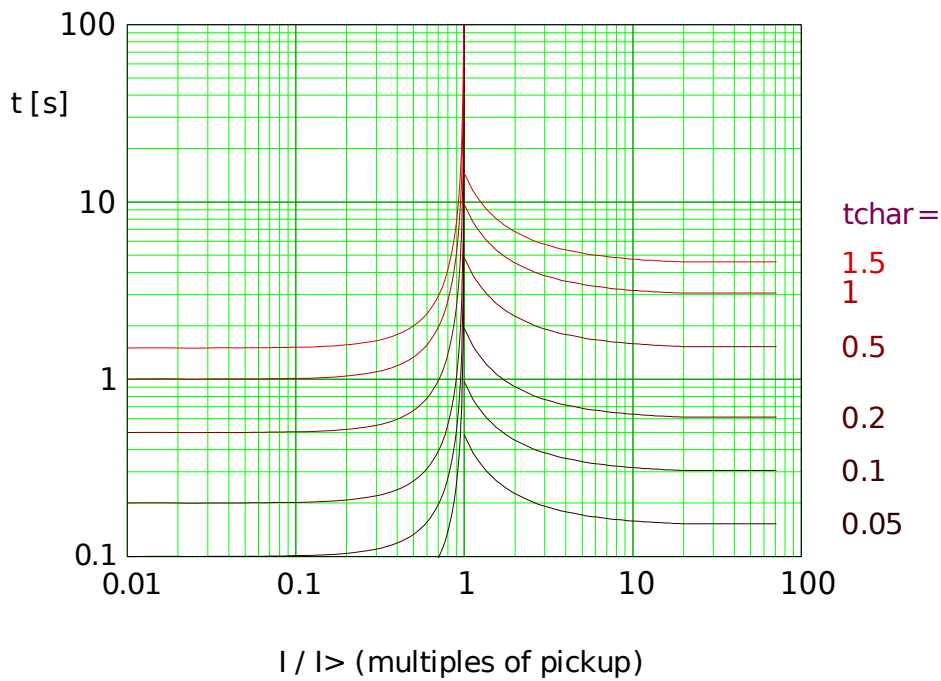

Pdoc_Z112

Thermal Flat Curve

NOTICE Various reset modes are available:
Resetting via characteristic, delayed and instantaneous.

»Char« = Therm Flat

Reset

$$t = (5 \cdot 3^2) \cdot t_{char}$$

If: $\frac{I}{I_n} < 1$

Trip

$$t = (5 \cdot 3^0) \cdot t_{char}$$

If: $1 < \frac{I}{I_n}$

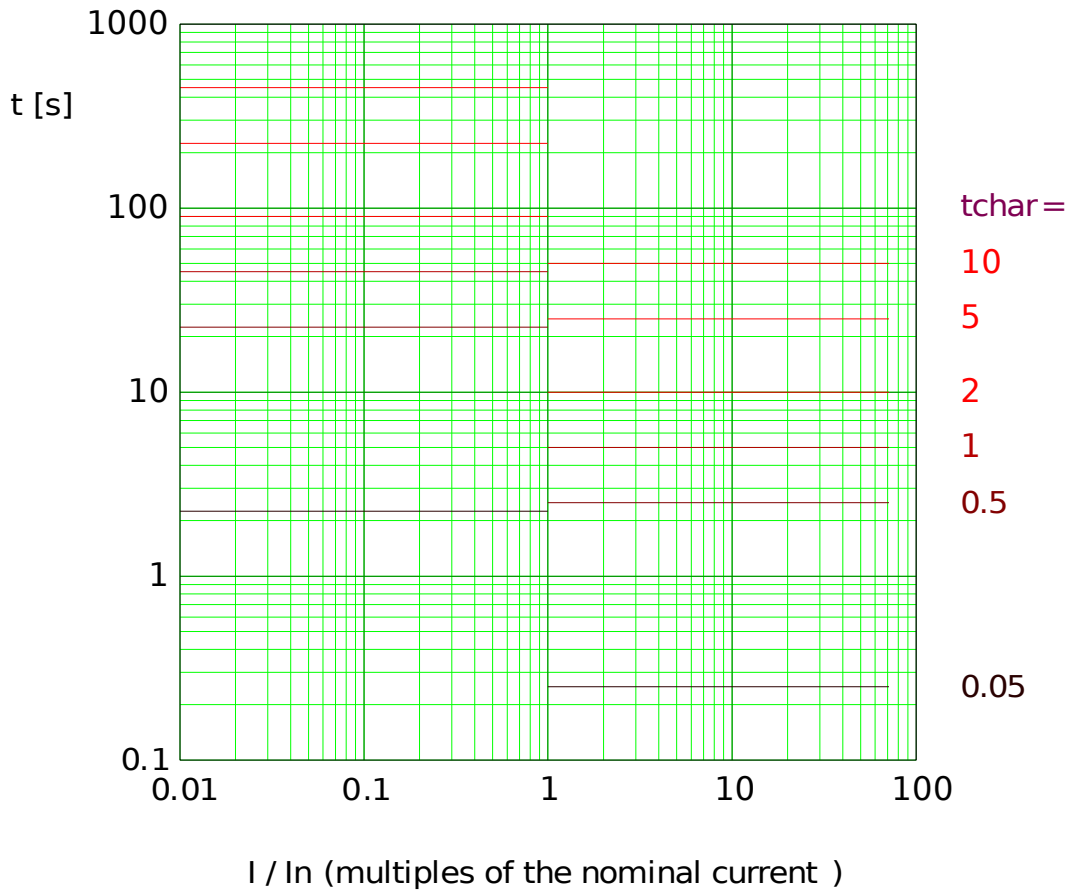

Pdoc_Z08

Thermal Curve IT

NOTICE

Various reset modes are available:
Resetting via characteristic, delayed and instantaneous.

»Char« = IT

Reset

$$t = (5 \cdot 3^2) \cdot t_{char}$$

If: $\frac{I}{I_n} < 1$

Trip

$$t = \frac{5 \cdot 3^1}{\left(\frac{I}{I_n}\right)^1} \cdot t_{char}$$

If: $1 < \frac{I}{I_n}$

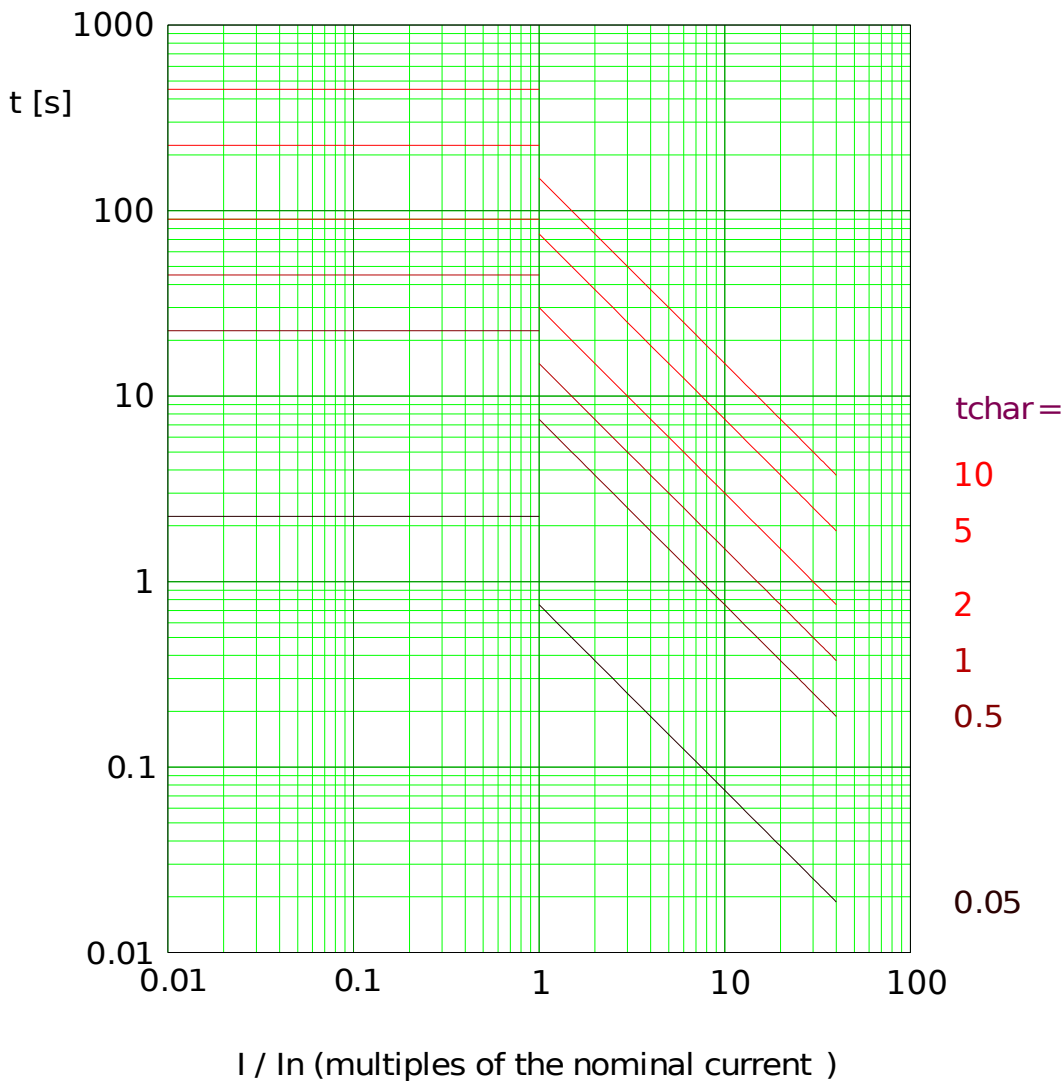

Pdoc_Z09

Thermal Curve I2T

NOTICE

Various reset modes are available:
Resetting via characteristic, delayed and instantaneous.

»Char« = I2T

Reset

$$t = (5 \cdot 3^2) \cdot t_{char}$$

If: $\frac{I}{I_n} < 1$

Trip

$$t = \frac{5 \cdot 3^2}{\left(\frac{I}{I_n}\right)^2} \cdot t_{char}$$

If: $1 < \frac{I}{I_n}$

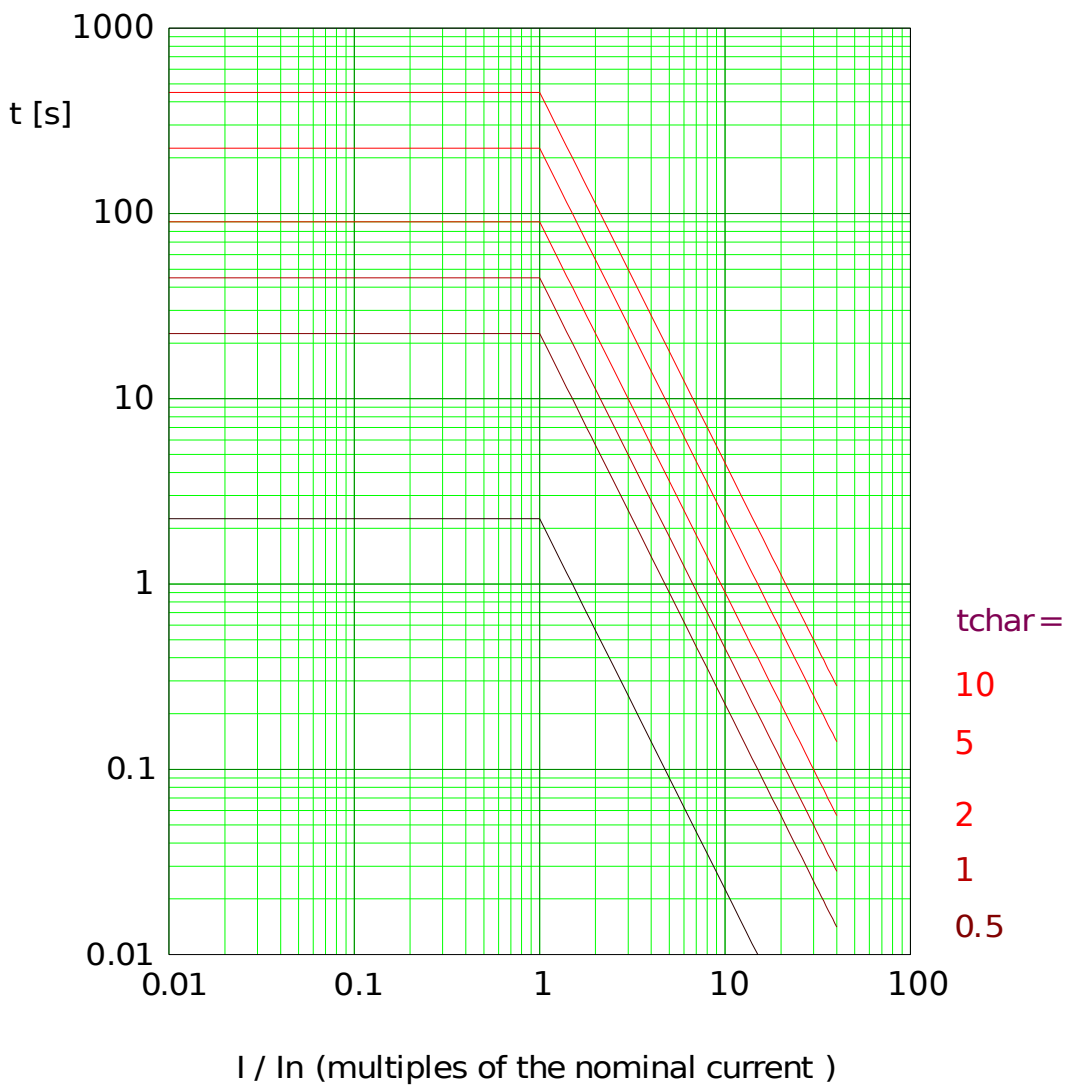

Pdoc_Z110

Thermal Curve I4T

NOTICE

Various reset modes are available:
Resetting via characteristic, delayed and instantaneous.

»Char« = I4T

Reset

$$t = (5 \cdot 3^2) \cdot tchar$$

If: $\frac{I}{In} < 1$

Trip

$$t = \frac{5 \cdot 3^4}{\left(\frac{I}{In}\right)^4} \cdot tchar$$

If: $1 < \frac{I}{In}$

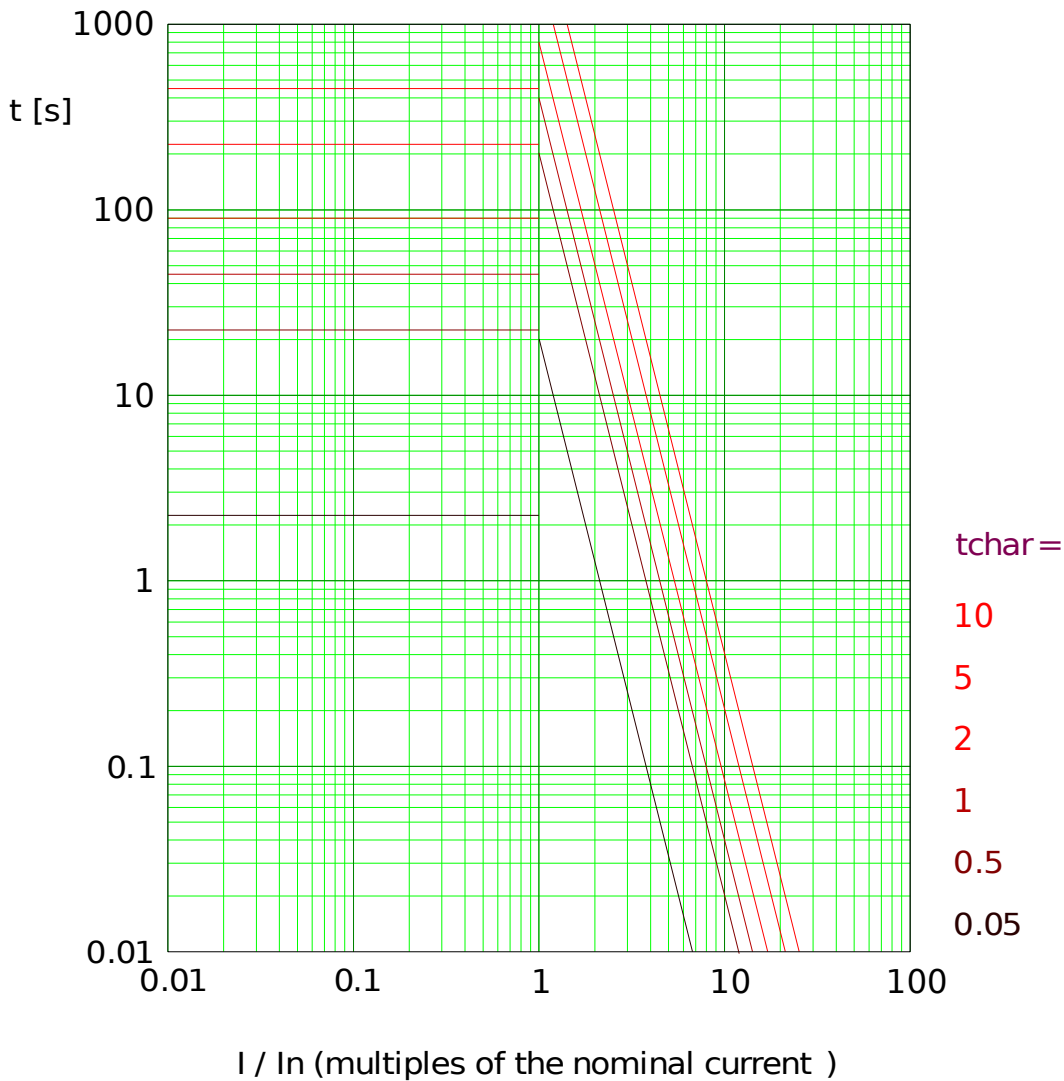

PdDoc_Z11

Prot - phase failure direction detection

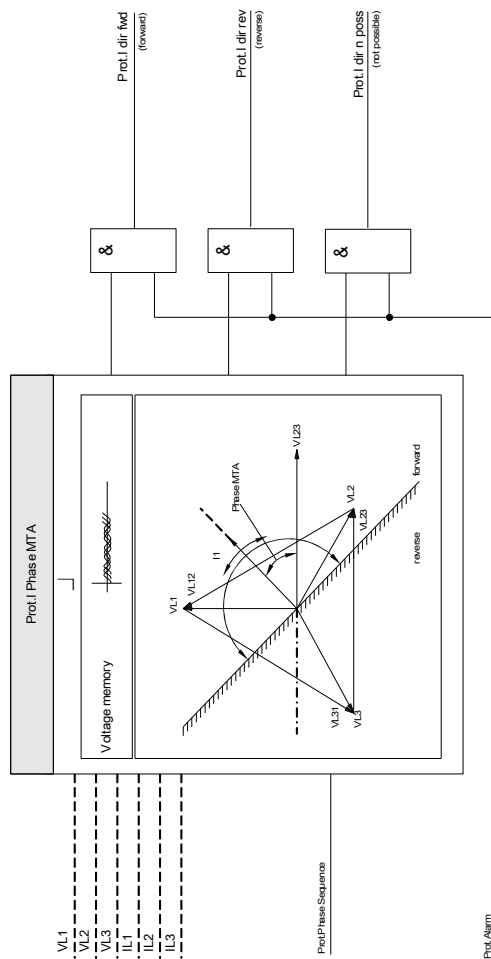

direction decision phase overcurrent

name = [1]...[n]

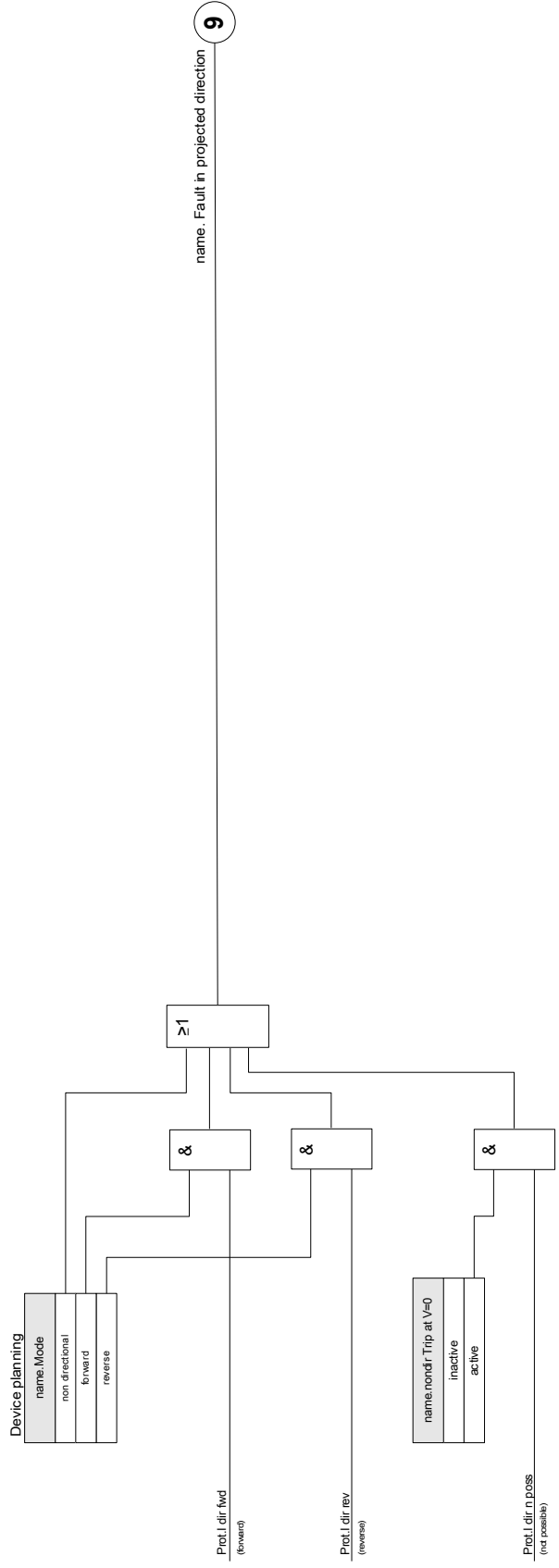

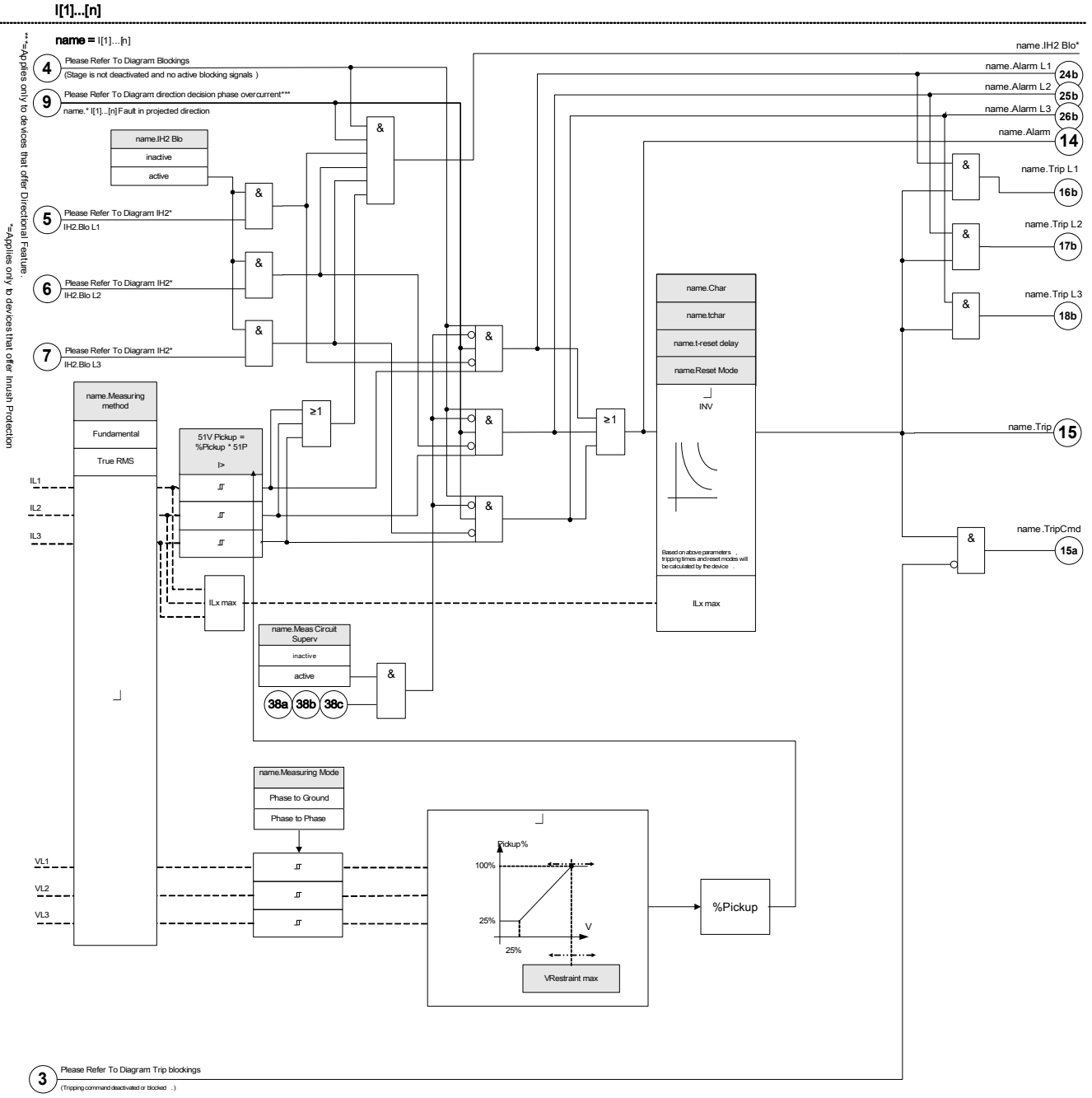









Device Planning Parameters of the I Module

Parameter	Description	Options	Default	Menu path
Mode 	Mode	do not use, non directional, forward, reverse	I[1]: non directional I[2]: do not use I[3]: do not use I[4]: do not use I[5]: do not use I[6]: do not use	[Device planning]





Global Protection Parameters of the I Module

Parameter	Description	Setting range	Default	Menu path
CT Winding Side 	Measuring values will be used from this winding side	CT Ntrl, CT Mains	CT Ntrl	[Protection Para /Global Prot Para /I-Prot /I[1]]
ExBlo1 	External blocking of the module, if blocking is activated (allowed) within a parameter set and if the state of the assigned signal is true.	1..n, Assignment List	-.-	[Protection Para /Global Prot Para /I-Prot /I[1]]
ExBlo2 	External blocking of the module, if blocking is activated (allowed) within a parameter set and if the state of the assigned signal is true.	1..n, Assignment List	-.-	[Protection Para /Global Prot Para /I-Prot /I[1]]
ExBlo TripCmd 	External blocking of the Trip Command of the module/the stage, if blocking is activated (allowed) within a parameter set and if the state of the assigned signal is true.	1..n, Assignment List	-.-	[Protection Para /Global Prot Para /I-Prot /I[1]]

<i>Parameter</i>	<i>Description</i>	<i>Setting range</i>	<i>Default</i>	<i>Menu path</i>
 Ex rev Interl	External blocking of the module by external reverse interlocking, if blocking is activated (allowed) within a parameter set and if the state of the assigned signal is true.	1..n, Assignment List	-.-	[Protection Para /Global Prot Para /I-Prot /[1]]
 AdaptSet 1	Assignment Adaptive Parameter 1	AdaptSet	-.-	[Protection Para /Global Prot Para /I-Prot /[1]]
 AdaptSet 2	Assignment Adaptive Parameter 2	AdaptSet	-.-	[Protection Para /Global Prot Para /I-Prot /[1]]
 AdaptSet 3	Assignment Adaptive Parameter 3	AdaptSet	-.-	[Protection Para /Global Prot Para /I-Prot /[1]]
 AdaptSet 4	Assignment Adaptive Parameter 4	AdaptSet	-.-	[Protection Para /Global Prot Para /I-Prot /[1]]

Setting Group Parameters of the I Module

<i>Parameter</i>	<i>Description</i>	<i>Setting range</i>	<i>Default</i>	<i>Menu path</i>
 Function	Permanent activation or deactivation of module/stage.	inactive, active	I[1]: active I[2]: inactive I[3]: inactive I[4]: inactive I[5]: inactive I[6]: inactive	[Protection Para /<1..4> /I-Prot /[1]]

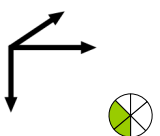
Parameter	Description	Setting range	Default	Menu path
 ExBlo Fc	Activate (allow) or inactivate (disallow) blocking of the module/stage. This parameter is only effective if a signal is assigned to the corresponding global protection parameter. If the signal becomes true, those modules/stages are blocked that are parameterized "ExBlo Fc=active".	inactive, active	inactive	[Protection Para /<1..4> /I-Prot /[1]]
 Ex rev Interl Fc	Activate (allow) or inactivate (disallow) blocking of the module/stage. This parameter is only effective if a signal is assigned to the corresponding global protection parameter. If the signal becomes true, those modules/stages are blocked that are parameterized "Ex rev Interl Fc = active".	inactive, active	inactive	[Protection Para /<1..4> /I-Prot /[1]]
 Blo TripCmd	Permanent blocking of the Trip Command of the module/stage.	inactive, active	inactive	[Protection Para /<1..4> /I-Prot /[1]]
 ExBlo TripCmd Fc	Activate (allow) or inactivate (disallow) blocking of the module/stage. This parameter is only effective if a signal is assigned to the corresponding global protection parameter. If the signal becomes true, those modules/stages are blocked that are parameterized "ExBlo TripCmd Fc=active".	inactive, active	inactive	[Protection Para /<1..4> /I-Prot /[1]]
 Measuring method	Measuring method: fundamental or rms or 3rd harmonic (only generator protection relays)	Fundamental, True RMS, I2	Fundamental	[Protection Para /<1..4> /I-Prot /[1]]
 I>	If the pickup value is exceeded, the module/element starts to time out to trip. Only available if: Characteristic = DEFT Or Characteristic = INV Minimum of the setting range If: VRestrained = active Minimum of the setting range If: VRestrained = inactive	0.02 - 40.00In	1.00In	[Protection Para /<1..4> /I-Prot /[1]]

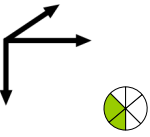
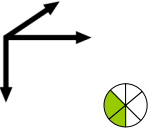
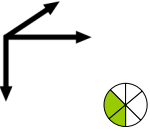
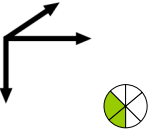
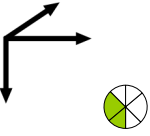
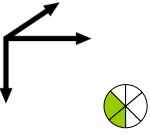
Parameter	Description	Setting range	Default	Menu path
Char 	Characteristic	DEFT, IEC NINV, IEC VINV, IEC EINV, IEC LINV, RINV, ANSI MINV, ANSI VINV, ANSI EINV, Therm Flat, IT, I2T, I4T	DEFT	[Protection Para /<1..4> /I-Prot /[1]]
t 	Tripping delay Only available if: Characteristic = DEFT	0.00 - 300.00s	1.00s	[Protection Para /<1..4> /I-Prot /[1]]
tchar 	Time multiplier/tripping characteristic factor. The setting range depends on the selected tripping curve. Only available if: Characteristic = INV Or Characteristic = Therm Flat Or Characteristic = IT Or Characteristic = I2T Or Characteristic = I4T	0.02 - 20.00	1	[Protection Para /<1..4> /I-Prot /[1]]
Reset Mode 	Reset Mode Only available if: Characteristic = INV Or Characteristic = Therm Flat Or Characteristic = IT Or Characteristic = I2T Or Characteristic = I4T	instantaneous, delayed, calculated	instantaneous	[Protection Para /<1..4> /I-Prot /[1]]
t-reset delay 	Reset delay for intermittent phase failures (INV characteristics only) Available if: Reset Mode = delayed	0.00 - 60.00s	0s	[Protection Para /<1..4> /I-Prot /[1]]
IH2 Blo 	Blocking the trip command, if an inrush is detected.	inactive, active	inactive	[Protection Para /<1..4> /I-Prot /[1]]

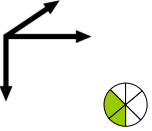
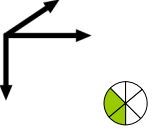
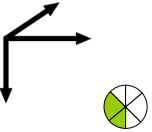
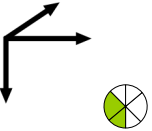
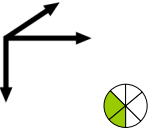
Parameter	Description	Setting range	Default	Menu path
nondir Trip at V=0 	Only relevant for current protection modules/stages with directional feature! The device will trip non directional if this parameter is set to active and no direction could be determined because no reference voltage (V=0) could be measured any more (e.g. if there is a three-phase short circuit close to the device). If this parameter is set to inactive, the protection stage will be blocked in case of V=0. Only available if: Device planning: I.Mode = directional	inactive, active	inactive	[Protection Para <1..4> /I-Prot /[1]]
VRestraint 	Voltage Restraint Protection	inactive, active	inactive	[Protection Para <1..4> /I-Prot /[1]]
Measuring Mode 	Measuring Mode Only available if: VRestraint = active	Phase to Ground, Phase to Phase	Phase to Ground	[Protection Para <1..4> /I-Prot /[1]]
VRestraint max 	Maximum voltage restraint level. Definition of Vn: Vn is dependent on the System Parameter setting of "VT con". When the System Parameters "VT con" is set to "phase-to-phase", "Vn = VT sec ". When the System Parameters "VT con" is set to "phase-to-ground", "Vn = VT sec/SQRT(3)". Only available if: VRestraint = active	0.04 - 2.00Vn	1.00Vn	[Protection Para <1..4> /I-Prot /[1]]
Meas Circuit Superv 	Activates the use of the measuring circuit supervision. In this case the module will be blocked if a measuring circuit supervision module (e.g. LOP, VTS) signals a disturbed measuring circuit (e.g. caused by a fuse failure). Only available if: VRestraint = active	inactive, active	inactive	[Protection Para <1..4> /I-Prot /[1]]

I Module Input States

<i>Name</i>	<i>Description</i>	<i>Assignment via</i>
ExBlo1-I	Module input state: External blocking1	[Protection Para /Global Prot Para /I-Prot /I[1]]
ExBlo2-I	Module input state: External blocking2	[Protection Para /Global Prot Para /I-Prot /I[1]]
ExBlo TripCmd-I	Module input state: External Blocking of the Trip Command	[Protection Para /Global Prot Para /I-Prot /I[1]]
Ex rev InterI-I	Module input state: External reverse interlocking	[Protection Para /Global Prot Para /I-Prot /I[1]]
AdaptSet1-I	Module input state: Adaptive Parameter1	[Protection Para /Global Prot Para /I-Prot /I[1]]
AdaptSet2-I	Module input state: Adaptive Parameter2	[Protection Para /Global Prot Para /I-Prot /I[1]]
AdaptSet3-I	Module input state: Adaptive Parameter3	[Protection Para /Global Prot Para /I-Prot /I[1]]
AdaptSet4-I	Module input state: Adaptive Parameter4	[Protection Para /Global Prot Para /I-Prot /I[1]]

I Module Signals (Output States)

<i>Signal</i>	<i>Description</i>
active	Signal: active
ExBlo	Signal: External Blocking

Protective Elements

<i>Signal</i>	<i>Description</i>
Ex rev Interl	Signal: External reverse Interlocking
Blo TripCmd	Signal: Trip Command blocked
ExBlo TripCmd	Signal: External Blocking of the Trip Command
IH2 Blo	Signal: Blocking the trip command by an inrush
Alarm L1	Signal: Alarm L1
Alarm L2	Signal: Alarm L2
Alarm L3	Signal: Alarm L3
Alarm	Signal: Alarm
Trip L1	Signal: General Trip Phase L1
Trip L2	Signal: General Trip Phase L2
Trip L3	Signal: General Trip Phase L3
Trip	Signal: Trip
TripCmd	Signal: Trip Command
Active AdaptSet	Active Adaptive Parameter
DefaultSet	Signal: Default Parameter Set
AdaptSet 1	Signal: Adaptive Parameter 1
AdaptSet 2	Signal: Adaptive Parameter 2
AdaptSet 3	Signal: Adaptive Parameter 3
AdaptSet 4	Signal: Adaptive Parameter 4

Commissioning: Overcurrent Protection, non-directional [50, 51]

Object to be tested

- Signals to be measured for each current protection element, the threshold values, total tripping time (recommended), or alternatively tripping delays and the fallback ratios; each time 3 x single-phase and 1 x three-phase.

NOTICE

Especially in Holmgreen connections, wiring errors can easily happen, and these are then detected safely. Measuring the total tripping time can ensure that the secondary wiring is o.k. (from the terminal on, up to the trip coil of the CB).

NOTICE

It is recommended to measure the total tripping time instead of the tripping delay. The tripping delay should be specified by the customer. The total tripping time is measured at the position signalling contact of the CB (not at the relay output!).

Total tripping time = tripping delay (please refer to the tolerances of the protection stages) + CB operating time (about 50 ms)

Please take the CB operating times from the technical data specified in the relevant documentation provided by the CB manufacturer.

Necessary means

- Current source
- May be: ampere meters
- Timer

Procedure

Testing the threshold values (3 x single-phase and 1 x three-phase)

Each time feed a current which is about 3-5% above the threshold value for activation/tripping. Then check the threshold values.

Testing the total tripping delay (recommendation)

Measure the total tripping times at the auxiliary contacts of the CB (CB tripping).

Testing the tripping delay (measuring at the relay output)

Measure the tripping times at the relay output.

Testing the fallback ratio

Reduce the current to 97% below the trip value and check the fallback ratio.

Successful test result

The measured total tripping delays or individual tripping delays, threshold values and fallback ratios correspond with those values, specified in the adjustment list. Permissible deviations/tolerances can be found under Technical Data.

Commissioning: Overcurrent Protection, directional [67]

Object to be tested

For each directional overcurrent element is to be measured: the total tripping time (recommendation) or alternatively tripping delays and the fallback ratios; each time 3 x single-phase and 1 x three-phase.

NOTICE

Especially in Holmgreen connections, wiring errors can happen easily and these are then detected safely. By measuring the total tripping time, it can be ensured that the secondary wiring is o.k. (from the terminal on, up to the trip coil of the CB).

NOTICE

It is recommended to measure the total tripping time instead of the tripping time. The tripping delay should be specified by the customer. The total tripping time is measured at the position signaling contacts of the CBs (not at the relay output!).

Total tripping time: = tripping delay (please refer to the tolerances of the protection stages) + CB operating time (about 50 ms)

Please take the CB switching times from the technical data, specified in the relevant documentation, provided by the CB manufacturer.

Necessary means

- Synchronizable current and voltage sources
- May be: ampere meters
- Timer

Procedure

Synchronize the 3-phase current and voltage sources with each other. Then simulate the tripping directions to be tested by the angle between current and voltage.

Testing the threshold values (3 x single-phase and 1 x three-phase)

Each time feed a current which is about 3-5% above the threshold value for activation/tripping. Check then the threshold values.

Testing the total tripping delay (recommendation)

Measure the total tripping times at the auxiliary contacts of the CB (CB tripping).

Testing the trip delay (measured at the relay output)

Measure the tripping times at the relay output.

Testing the fallback ratio

Reduce the current to 97% below the trip value and check the fallback ratio.

Successful test result

The measured total tripping delays or individual tripping delays, threshold values and fallback ratios correspond with those values, specified in the adjustment list. Permissible deviations/tolerances can be found under Technical Data.

51V - Voltage Restraint Overcurrent

For activating this function, the parameter »VRestraint« has to be set to *active* in the parameter set of the corresponding overcurrent element I[x].

The 51V protection function restrains operation which reduces pickup levels. This allows the User to lower the pickup value of the 51V protection function with the corresponding phase input voltage (phase-to-phase or phase-to-ground, depending on the setting of »Measuring Channel« within the current protection module). When the minimum fault phase current is close to the load current, it may make the phase time overcurrent protection coordination difficult. In this case, an undervoltage function may be used to alleviate this situation. When the voltage is low, the phase time overcurrent pickup threshold may be set low accordingly, so that the phase time overcurrent protection may achieve adequate sensitivity and better coordination. The device uses a simple linear model to determine the effective pickup by characterizing the relationship between the voltage and the phase time overcurrent pickup threshold.

Once the voltage restraint protection function is activated, the effective phase time overcurrent pickup threshold will be the calculated Pickup% times the phase time overcurrent pickup setting. The effective pickup threshold must be within the setting range allowed and, if it is less, the minimum pickup value will be used.

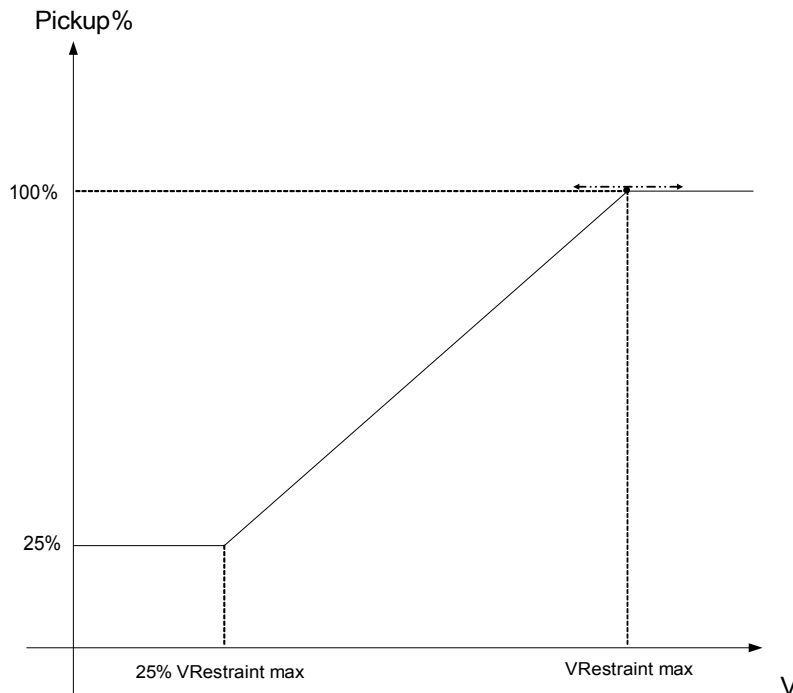

That means:

$$V_{min} = 0.25 \cdot V_{max};$$

- Pickup%_{min} = 25%;

- Pickup% = 25%, if $V \leq V_{min}$;

- $\text{Pickup\%} = \frac{1}{V_{max}} \cdot (V - V_{min}) + 25\%$, if $V_{min} < V < V_{max}$;

- Pickup% = 100%, if $V \geq V_{max}$;

The tripping curves (characteristic) will not be influenced by the voltage restraint function.

If the voltage transformer supervision is activated, the voltage restraint overcurrent protection element is blocked in case of m.c.b. trip to avoid false trippings.

NOTICE

Definition of Vn:

Vn is dependent on the »*Measuring Channel*« setting in the current protection modules.

In case that this parameter is set to "Phase to Phase":

$$V_n = \text{Main VT sec}$$

In case that this parameter is set to "Phase to Neutral":

$$V_n = \frac{\text{Main VT sec}}{\sqrt{3}}$$

If the parameter »*VT con*« within the field parameters is set to »*Phase to Phase*« the setting »*Phase to Neutral*« in the current modules is effectless.

Commissioning: Overcurrent Protection, Non-directional [ANSI 51V]

Object to be tested:

Signals to be measured for Voltage Restraint protection function: the threshold values, total tripping time (recommended), or alternatively tripping delays and the dropout ratios; each time 3 x single-phase and 1 x three-phase.

NOTICE

It is recommended to measure the total tripping time instead of the tripping time. The tripping delay should be specified by the customer. The total tripping time is measured at the position signaling contacts of the CBs (not at the relay output!).

Total tripping time: = tripping delay (please refer to the tolerances of the protection stages) + CB operating time (about 50 ms)

Please take the CB switching times from the technical data, specified in the relevant documentation, provided by the CB manufacturer.

Necessary means:

- Current source;
- Voltage Source;
- Current and Voltage meters; and
- Timer.

Procedure:

Testing the threshold values (3 x single-phase and 1 x three-phase)

Feed %Pickup voltage. For each test performed, feed a current that is about 3-5% above the threshold value for activation/tripping. Then check if the pickup values are %Pickup of the value according to the standard overcurrent protection.

Testing the total tripping delay (recommendation)

Measure the total tripping times at the auxiliary contacts of the breakers (breaker tripping).

Testing the tripping delay (measuring at the relay output contact)

Measure the tripping times at the relay output contact.

Testing the dropout ratio

Reduce the current to 97% below the trip value and check the dropout ratio.

Successful test result

The measured total tripping delays or individual tripping delays, threshold values, and dropout ratios correspond with those values specified in the adjustment list. Permissible deviations/tolerances can be found under Technical Data.

I2> - Negative-Sequence Overcurrent [51Q]

For activating this function, the parameter »Measuring Mode« has to be set to »I2« in the parameter set of the corresponding overcurrent element I[x].

The negative-sequence overcurrent protection function (I2>) is to be seen as an equivalent to the phase overcurrent protection with the exception that it uses negative-sequence current (I2>) as measured quantities instead of the three phase currents used by phase overcurrent protection function. The negative-sequence current used by I2> is derived from the following well-known symmetrical component transformation:

$$I_2 = \frac{1}{3}(I_{L1} + a^2 I_{L2} + a I_{L3})$$

The pickup set value of a I2> protection function should be set in accordance of the negative-sequence current occurrence in the protected object.

Besides that, the negative-sequence overcurrent protection function (I2>) uses the same setting parameters as the phase overcurrent protection function, like trip and reset characteristics from both IEC/ANSI standards, time multiplier, etc.

The negative-sequence overcurrent protection function (I2>) can be used for line, generator, transformer and motor protection to protect the system from unbalanced faults. Because the I2> protection function operates on the negative-sequence current component which is normally absent during load conditions, the I2> can, therefore, be set more sensitive than the phase overcurrent protection functions. On the other hand, coordination of negative-sequence overcurrent protection function in a radial system does not mean automatically very long fault clearing time for the furthest upstream protection devices, because the tripping time of concerned negative-sequence overcurrent protection function needs only be coordinate with the next downstream device with the negative-sequence overcurrent protection function. This makes the I2> in many cases as an advantageous protection concept in addition to the phase overcurrent protection function.

**WARNING**

If you are using inrush blockings, the tripping delay of the current protection functions must be at least 30 ms or more in order to prevent faulty trippings.

NOTICE

At the moment of breaker closure, negative-sequence current might be the result of transients.

I[1]...[n]: Measuring method = (I2>)

name = {I1}...[n]

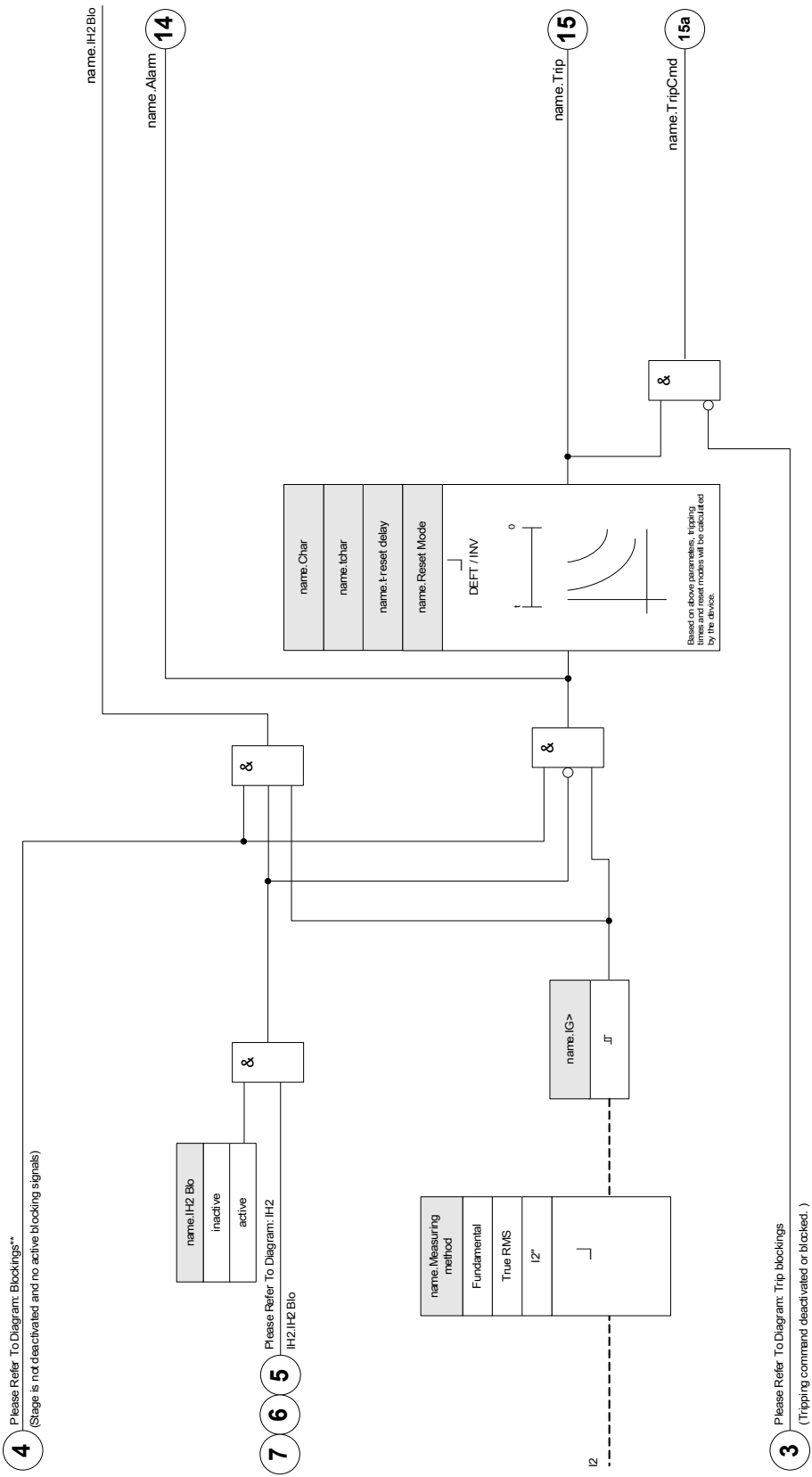

Commissioning: Negative Sequence Overcurrent

Object to be tested

Signals to be measured for each current protection function: the threshold values, total tripping time (recommended), or alternatively tripping delays and the dropout ratios.

NOTICE

It is recommended to measure the total tripping time instead of the tripping time. The tripping delay should be specified by the customer. The total tripping time is measured at the position signalling contacts of the CBs (not at the relay output!).

Total tripping time: = tripping delay (please refer to the tolerances of the protection stages) + CB operating time (about 50 ms)

Please take the CB switching times from the technical data, specified in the relevant documentation, provided by the CB manufacturer.

Necessary means:

- Current source
- Current meters
- Timer

Procedure:

Testing the threshold values

In order to get a negative-sequence current, please change the phase sequence at the terminals of the current source (in case of ABC sequence to ACB – in case of a ACB sequence to ABC).

For each test performed, feed a current that is about 3-5% above the threshold value for activation/tripping. Then check the threshold values.

Testing the total tripping delay (recommendation)

Measure the total tripping times at the auxiliary contacts of the breakers (breaker tripping).

Testing the tripping delay (measuring at the relay output contact)

Measure the tripping times at the relay output contact.

Testing the dropout ratio

Reduce the current to 97% below the trip value and check the dropout ratio.

Successful test result

The measured total tripping delays or individual tripping delays, threshold values, and dropout ratios correspond with those values specified in the adjustment list. Permissible deviations/tolerances can be found under Technical Data.

Voltage Controlled Overcurrent Protection [51C]

When a short circuit is near the generator, the voltage might drop down. By means of **Adaptive Parameters** (Please refer to chapter Parameter) the tripping times or tripping characteristics can be modified by the output signal of a voltage element (depending on a threshold). The device might change a load curve to a fault curve (taking influence on tripping time, trip curves and reset modes).

Please proceed as follows:

- Read and understand the section „Adaptive Parameters“ within the chapter Parameter.
- Do the device planning and set all required parameters for the Undervoltage element.
- Do the device planning and set all required parameters for the Overcurrent element.
- Set the **Adaptive Parameters** within the Overcurrent element in the relevant parameter sets (e.g. Curve multiplier, curve type...).
- Assign the Undervoltage alarm (pickup) within the **Global Parameters** as an activation signal for the corresponding **Adaptive Parameter set** of the overcurrent element that should be modified.
- Check the functionality by a commissioning test.

IH2 - Inrush

Available elements:
IH2

The inrush module can prevent false trips caused by switching actions of saturated inductive loads. The ratio of the 2nd harmonic to the 1st harmonic is taken into account.

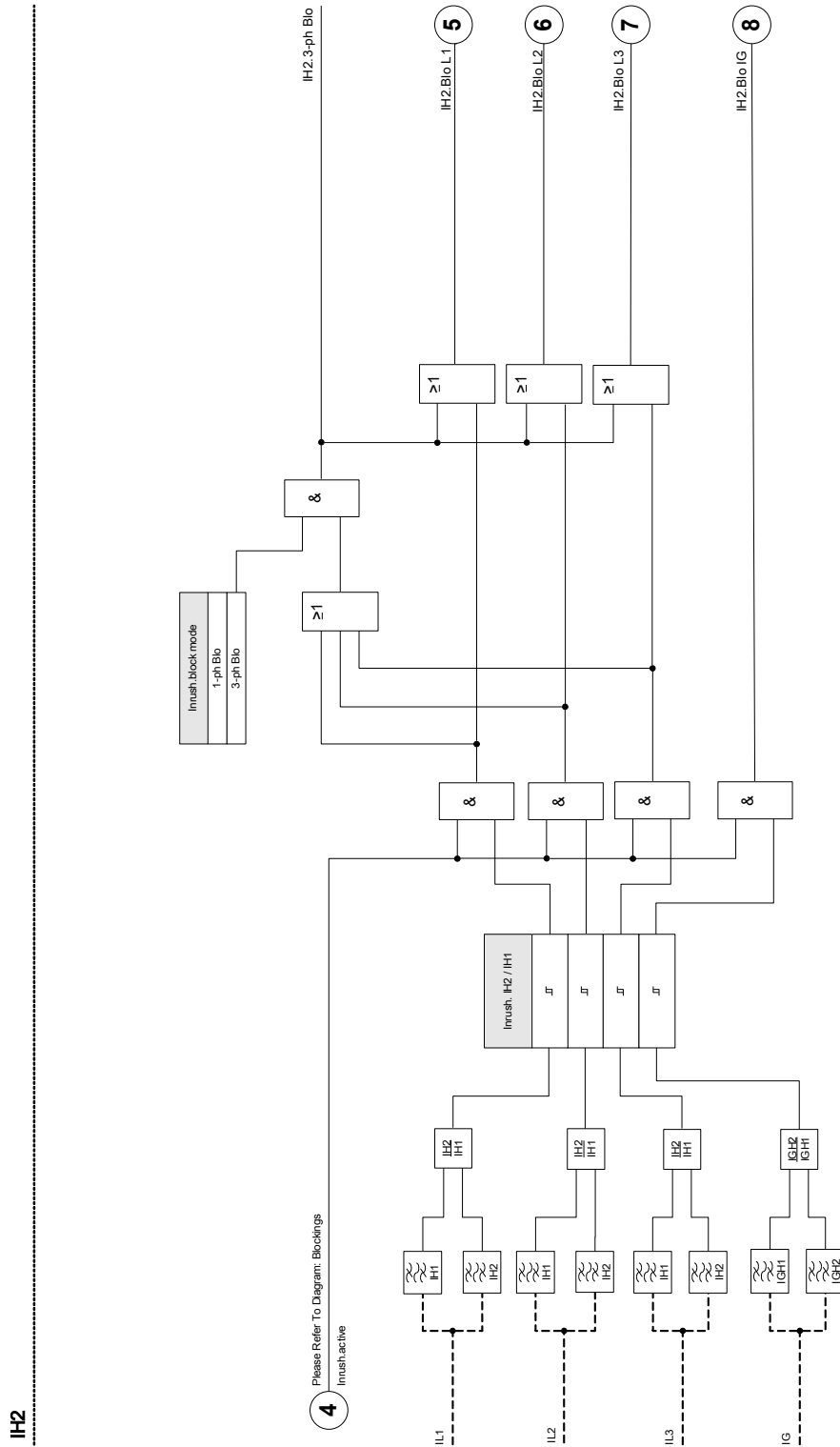



NOTICE

Do not use the Inrush element in combination with undelayed/instantaneous overcurrent protection (in order to prevent faulty tripping).



Device Planning Parameters of the Inrush Module

Parameter	Description	Options	Default	Menu path
Mode 	Mode	do not use, use	do not use	[Device planning]

Global Protection Parameters of the Inrush module

Parameter	Description	Setting range	Default	Menu path
ExBlo1 	External blocking of the module, if blocking is activated (allowed) within a parameter set and if the state of the assigned signal is true.	1..n, Assignment List	.-	[Protection Para /Global Prot Para /I-Prot /IH2]
ExBlo2 	External blocking of the module, if blocking is activated (allowed) within a parameter set and if the state of the assigned signal is true.	1..n, Assignment List	.-	[Protection Para /Global Prot Para /I-Prot /IH2]

Setting Group Parameters of the Inrush Module

Parameter	Description	Setting range	Default	Menu path
Function 	Permanent activation or deactivation of module/stage.	inactive, active	inactive	[Protection Para /<1..4> /I-Prot /IH2]
ExBlo Fc 	Activate (allow) or inactivate (disallow) blocking of the module/stage. This parameter is only effective if a signal is assigned to the corresponding global protection parameter. If the signal becomes true, those modules/stages are blocked that are parameterized "ExBlo Fc=active".	inactive, active	inactive	[Protection Para /<1..4> /I-Prot /IH2]
IH2 / IH1 	Maximum permissible percentage of the 2nd harmonic of the 1st harmonic.	10 - 40%	15%	[Protection Para /<1..4> /I-Prot /IH2]

Parameter	Description	Setting range	Default	Menu path
 block mode	1-ph Blo: If an inrush is detected in one phase, the corresponding phase of those modules will be blocked, where inrush blocking is set to active./3-ph Blo: If an inrush is detected in at least one phase, all three phases of those modules where inrush blocking is set to active will be blocked (cross blocking).	1-ph Blo, 3-ph Blo	1-ph Blo	[Protection Para /<1..4> /I-Prot /IH2]

Inrush Module Input States

Name	Description	Assignment via
ExBlo1-I	Module input state: External blocking1	[Protection Para /Global Prot Para /I-Prot /IH2]
ExBlo2-I	Module input state: External blocking2	[Protection Para /Global Prot Para /I-Prot /IH2]

Inrush Module Signals (Output States)

Signal	Description
active	Signal: active
ExBlo	Signal: External Blocking
Blo L1	Signal: Blocked L1
Blo L2	Signal: Blocked L2
Blo L3	Signal: Blocked L3
Blo IG meas	Signal: Blocking of the ground (earth) protection module (measured ground current)
Blo IG calc	Signal: Blocking of the ground (earth) protection module (calculated ground current)
3-ph Blo	Signal: Inrush was detected in at least one phase - trip command blocked.

Commissioning: Inrush

NOTICE

Dependent on the parameterized inrush-blocking-mode («*1-ph Blo* or *3-ph Blo*»), the test procedure is different.

For mode «*1-ph-Blo*» the test has to be carried out first for each individual phase and then for all three phases together.

For mode «*3-ph-Blo*» the test is a three-phase one.

Object to be tested

Test of inrush blocking.

Necessary means

- three-phase current source with adjustable frequency
- three-phase current source (for the first harmonic)

Procedure (dependent on the parameterized blocking mode)

- Feed the current to the secondary side with nominal frequency.
- Feed abruptly current to the secondary side with double nominal frequency. The amplitude must exceed the preset ratio/threshold «*I_{H2}/I_N*».
- Ascertain that the signal «*INRUSH ALARM*» is generated now.

Successful test results

The signal «*INRUSH ALARM*» is generated and the event recorder indicates the blocking of the current protection stage.

IG - Ground Fault [50N/G, 51N/G, 67N/G]

Available elements:
IG[1] .IG[2] .IG[3] .IG[4]

⚠ WARNING If you are using inrush blockings the tripping delay of the earth current protection functions must be at least 30ms or more in order to prevent faulty trippings.

NOTICE All earth current elements are identically structured.

NOTICE This module offers Adaptive Parameter Sets. Parameters can be modified within parameter sets dynamically by means of Adaptive Parameter Sets. Please refer to chapter Parameter / Adaptive Parameter Sets.

The following table shows the application options of the earth overcurrent protection element

Applications of the IE-Protection Module	Setting in	Option
ANSI 50N/G – Earth overcurrent protection, non directional	Device Planning menu Setting: non directional	Measuring Mode: Fundamental/TrueRMS
ANSI 51N/G – Earth short circuit protection, non directional	Device Planning menu Setting: non directional	Measuring Mode: Fundamental/TrueRMS
ANSI 67N/G – Earth overcurrent/Earth short circuit protection, directional	Device Planning menu Setting: directional Field parameter menu 3V0 Source: measured/calculated 3I0 Source: measured/calculated	Measuring Mode: Fundamental/TrueRMS IG Source: measured/calculated VG Source: measured/calculated

Measuring Mode

For all protection elements it can be determined, whether the measurement is done on basis of the »*Fundamental*« or if »*TrueRMS*« measurement is used.

IG Source/VG Source

Within the parameter menu, this parameter determines, whether the earth current and the residual voltage is »*measured*« or »*calculated*«.

Direction detection (3V0 Source und 3I0 Source)

In the field parameter menu it can be determined, if the earth current directional detection should be based on measured or calculated values of currents and voltages. This setting takes effect on all earth current elements.



- Calculation of the residual voltage is only possible, when phase to neutral voltage is applied to the voltage inputs.

At setting »measured« the quantities to be measured, i. e. Residual voltage and the measured earth current have to be applied to the corresponding 4th measuring input.

All earth current protective elements can be planned user defined as non-directional or as directional stages. This means, for instance, all 4 elements can be projected in forward/reverse direction. For each element the following characteristics are available:

- DEFT (UMZ) – *Definite Time-Overcurrent*
- NINV (IEC/AMZ) – *IEC Normal Inverse*
- VINV (IEC/AMZ) – *IEC Very Inverse*
- LINV (IEC/AMZ) – *IEC Long Time Inverse*
- EINV (IEC/AMZ) – *IEC Extremely Inverse*
- MINV (ANSI/AMZ) – *ANSI Moderately Inverse*
- VINV (ANSI/AMZ) – *ANSI Very Inverse*
- EINV (ANSI/AMZ) – *ANSI Extremely Inverse*
- RINV – *R Inverse*
- RXIDG
- Thermal Flat
- IT
- I2T
- I4T

Explanation:

t = Tripping delay

t-char = Time multiplier/tripping characteristic factor . The setting range depends on the selected tripping curve .

IG = Fault current

IG> = If the pickup value is exceeded , the module/element starts to time out to trip .

The earth current can be measured either directly via a cable-type transformer or detected by a Holmgreen connection. The earth current can alternatively be calculated from the phase currents; but this is only possible if the phase currents are not ascertained by a V-connection.

The device can optionally be procured with a sensitive earth current measuring input.

DEFT – *Definite Time-Overcurrent*

DEFT

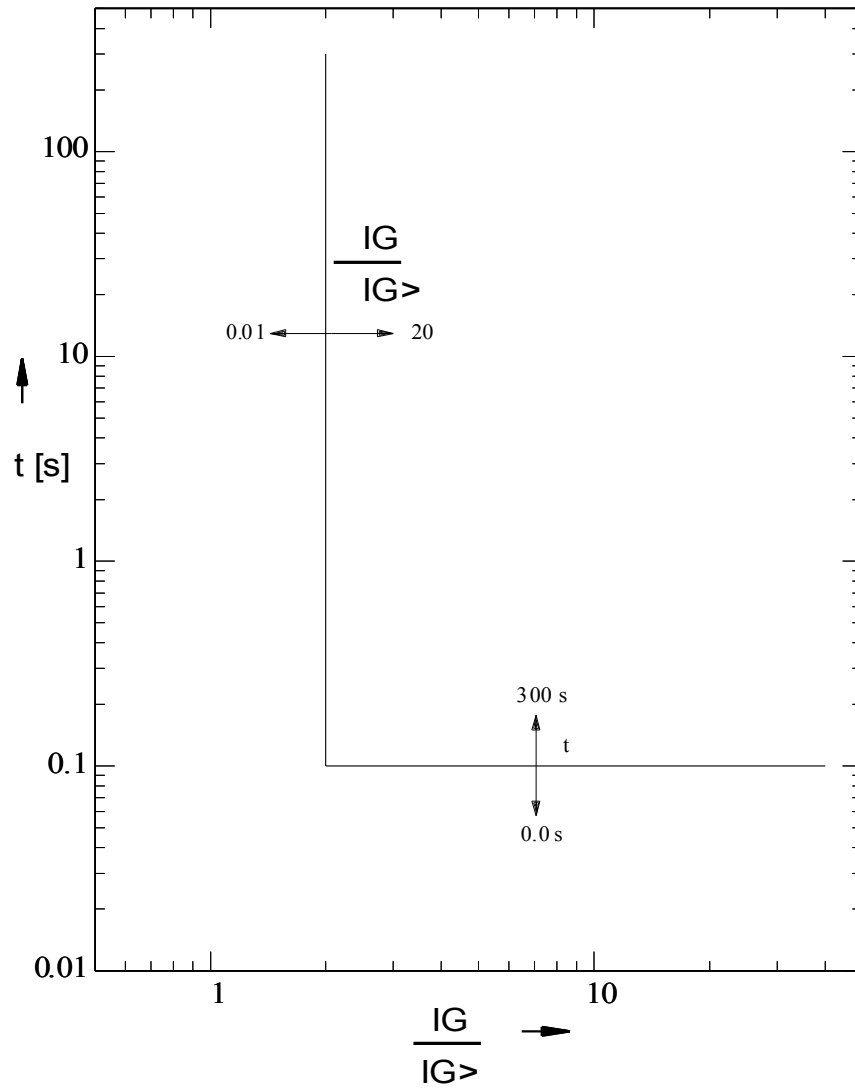

IEC Normal Inverse

NOTICE Various reset modes are available:
Resetting via characteristic, delayed and instantaneous.

Remark: For $I_G > 20 \cdot I_{G>}$, the curve stops decreasing, the t-values are kept constant at the value for $I_G = 20 \cdot I_{G>}$.

»Char« = IEC NINV

Reset

$$t = \frac{0.14}{1 - \left(\frac{I_G}{I_{G>}}\right)^2} \cdot tchar$$

If: $\frac{I_G}{I_{G>}} < 1$

Trip

$$t = \frac{0.14}{\left(\frac{I_G}{I_{G>}}\right)^{0.02} - 1} \cdot tchar$$

If: $1 < \frac{I_G}{I_{G>}} \leq 20$

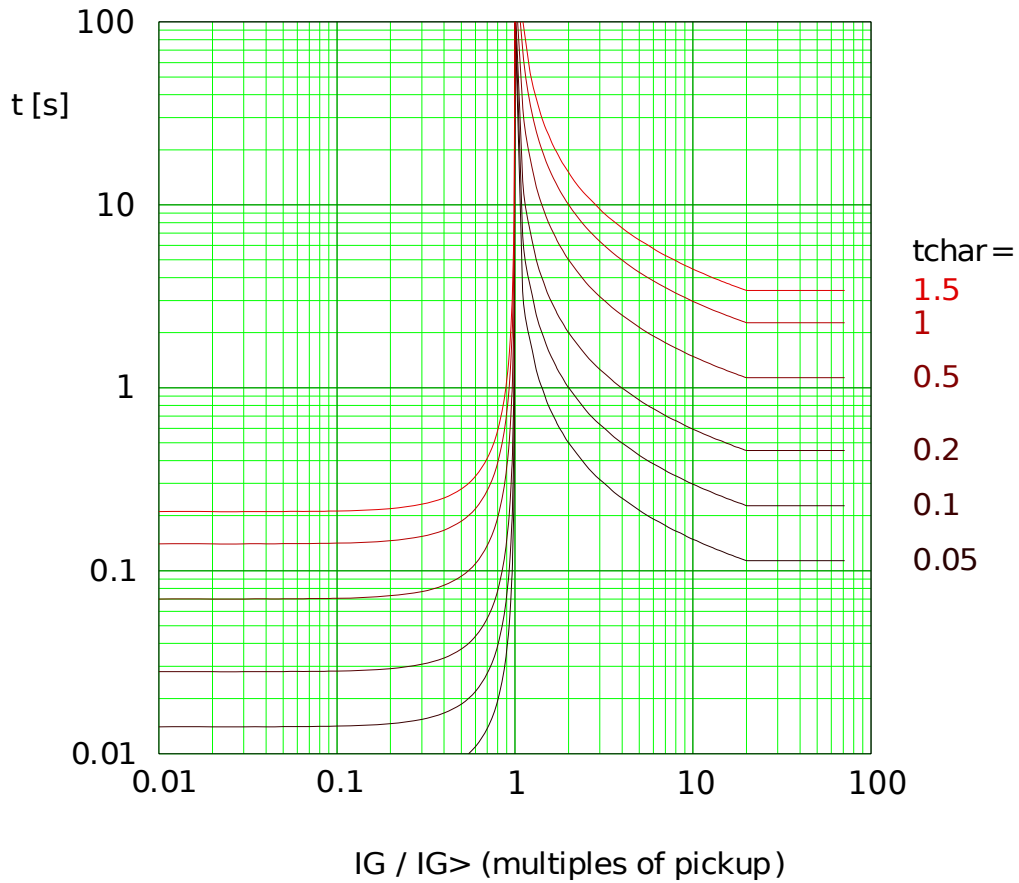

Edoc_Z01

IEC Very Inverse

NOTICE

Various reset modes are available:
Resetting via characteristic, delayed and instantaneous.

Remark: For $I_G > 20 \cdot I_{G>}$, the curve stops decreasing, the t-values are kept constant at the value for $I_G = 20 \cdot I_{G>}$.

»Char« = IEC VINV

Reset

$$t = \frac{13.5}{1 - \left(\frac{I_G}{I_{G>}}\right)^2} \cdot t_{char}$$

If: $\frac{I_G}{I_{G>}} < 1$

Trip

$$t = \frac{13.5}{\frac{I_G}{I_{G>}} - 1} \cdot t_{char}$$

If: $1 < \frac{I_G}{I_{G>}} \leq 20$

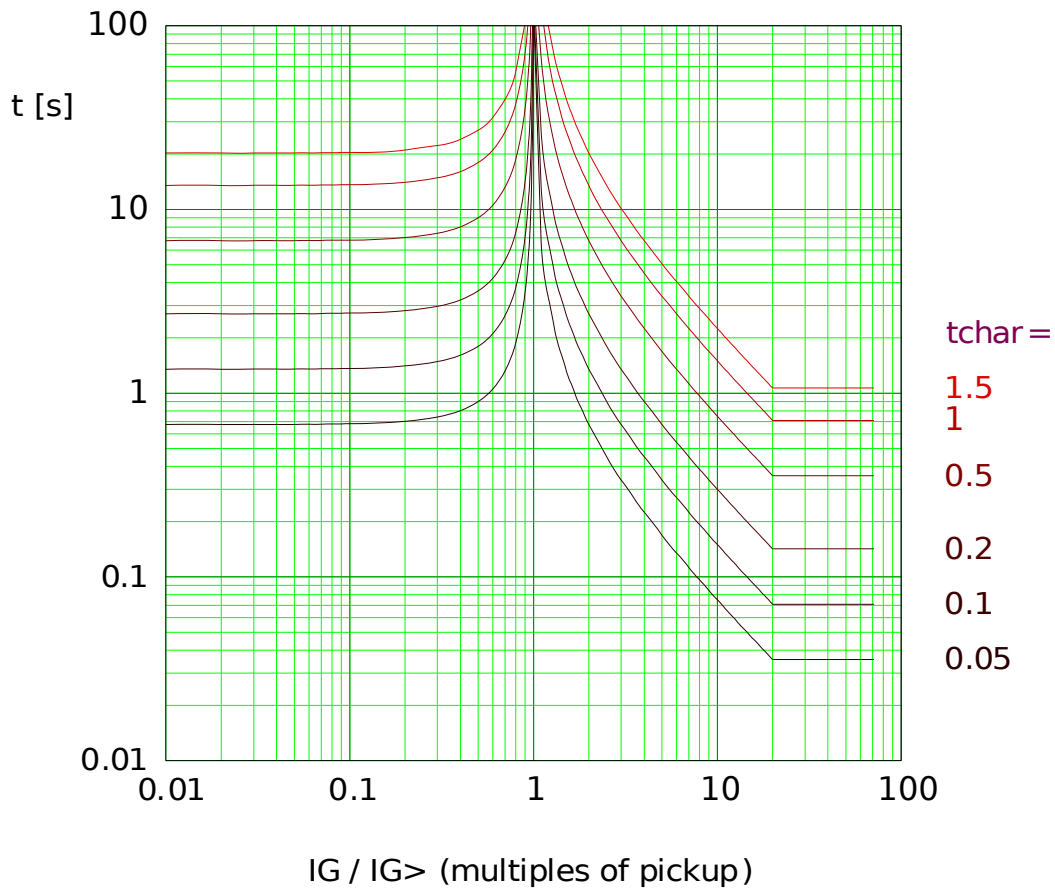

Edoc_Z02

IEC Extremely Inverse

NOTICE

Various reset modes are available:
Resetting via characteristic, delayed and instantaneous.

Remark: For $I_G > 20 \cdot I_{G>}$, the curve stops decreasing, the t-values are kept constant at the value for $I_G = 20 \cdot I_{G>}$.

»Char« = IEC EINV

Reset

$$t = \frac{80}{1 - \left(\frac{I_G}{I_{G>}}\right)^2} \cdot tchar$$

If: $\frac{I_G}{I_{G>}} < 1$

Trip

$$t = \frac{80}{\left(\frac{I_G}{I_{G>}}\right)^2 - 1} \cdot tchar$$

If: $1 < \frac{I_G}{I_{G>}} \leq 20$

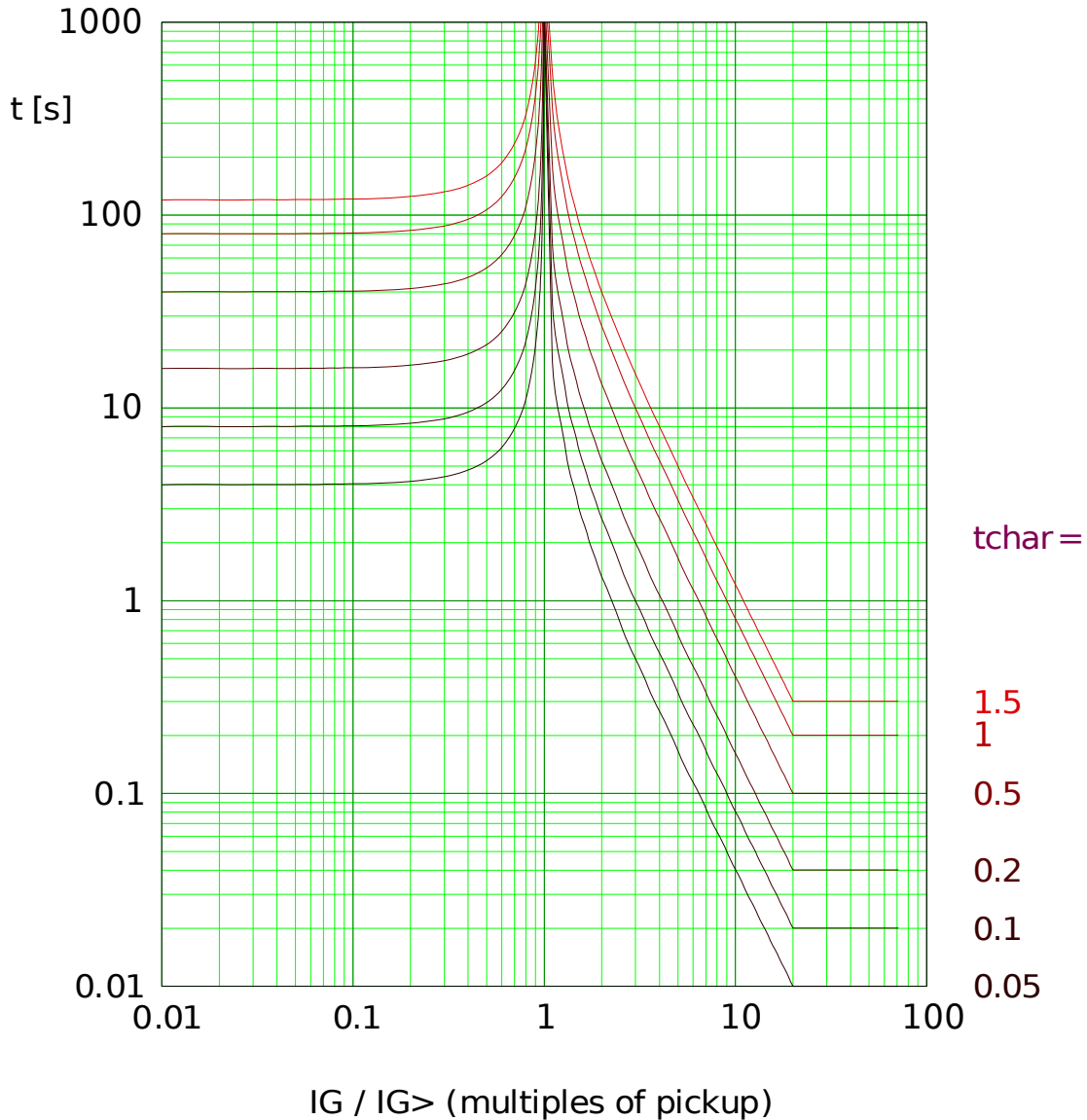

Edoc_Z04

IEC Long Time Inverse

NOTICE

Various reset modes are available:
Resetting via characteristic, delayed and instantaneous.

Remark: For $I_G > 20 \cdot I_{G>}$, the curve stops decreasing, the t-values are kept constant at the value for $I_G = 20 \cdot I_{G>}$.

»Char« = IEC LINV

Reset

$$t = \frac{120}{1 - \left(\frac{I_G}{I_{G>}}\right)^2} \cdot t_{char}$$

If: $\frac{I_G}{I_{G>}} < 1$

Trip

$$t = \frac{120}{\frac{I_G}{I_{G>}} - 1} \cdot t_{char}$$

If: $1 < \frac{I_G}{I_{G>}} \leq 20$

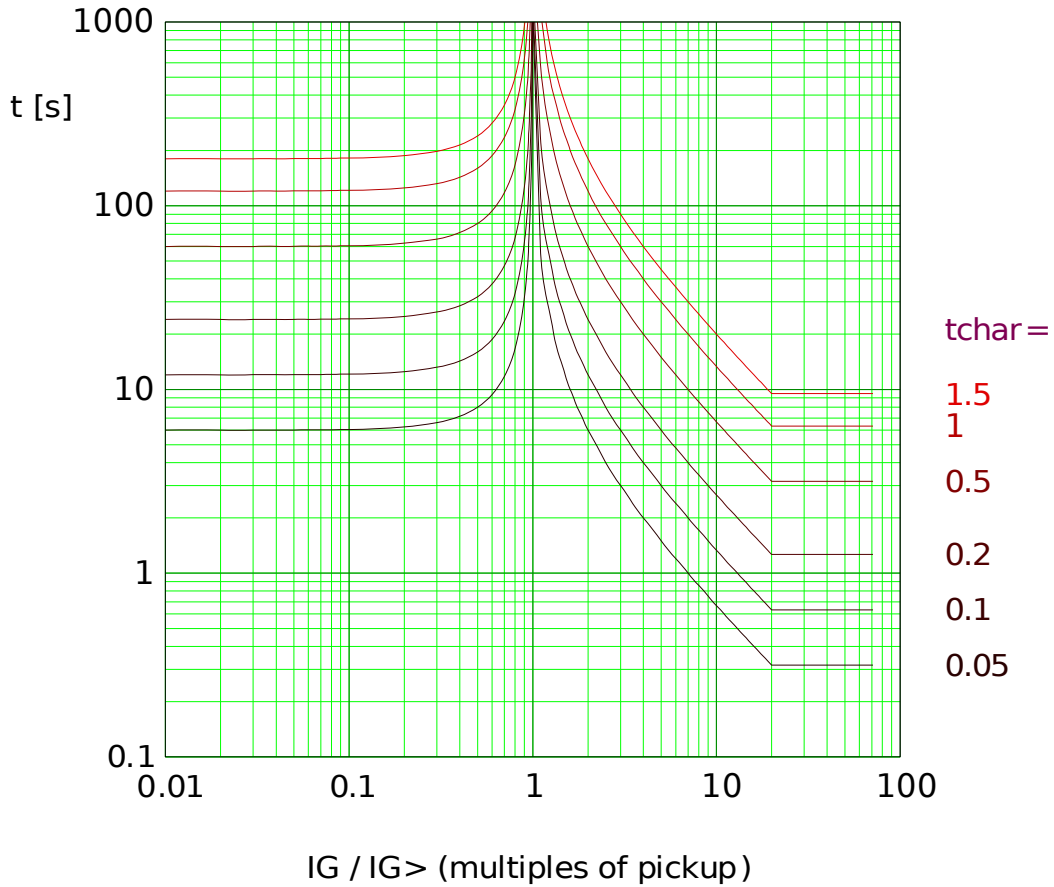

Edoc_Z03

ANSI Moderately Inverse

NOTICE

Various reset modes are available:
Resetting via characteristic, delayed and instantaneous.

Remark: For $I_G > 20 \cdot I_{G>}$, the curve stops decreasing, the t-values are kept constant at the value for $I_G = 20 \cdot I_{G>}$.

»Char« = ANSI MINV

Reset

$$t = \frac{4.85}{1 - \left(\frac{I_G}{I_{G>}}\right)^2} \cdot tchar$$

If: $\frac{I_G}{I_{G>}} < 1$

Trip

$$t = \left(\frac{0.0515}{\left(\frac{I_G}{I_{G>}}\right)^{0.02} - 1} + 0.1140 \right) \cdot tchar$$

If: $1 < \frac{I_G}{I_{G>}} \leq 20$

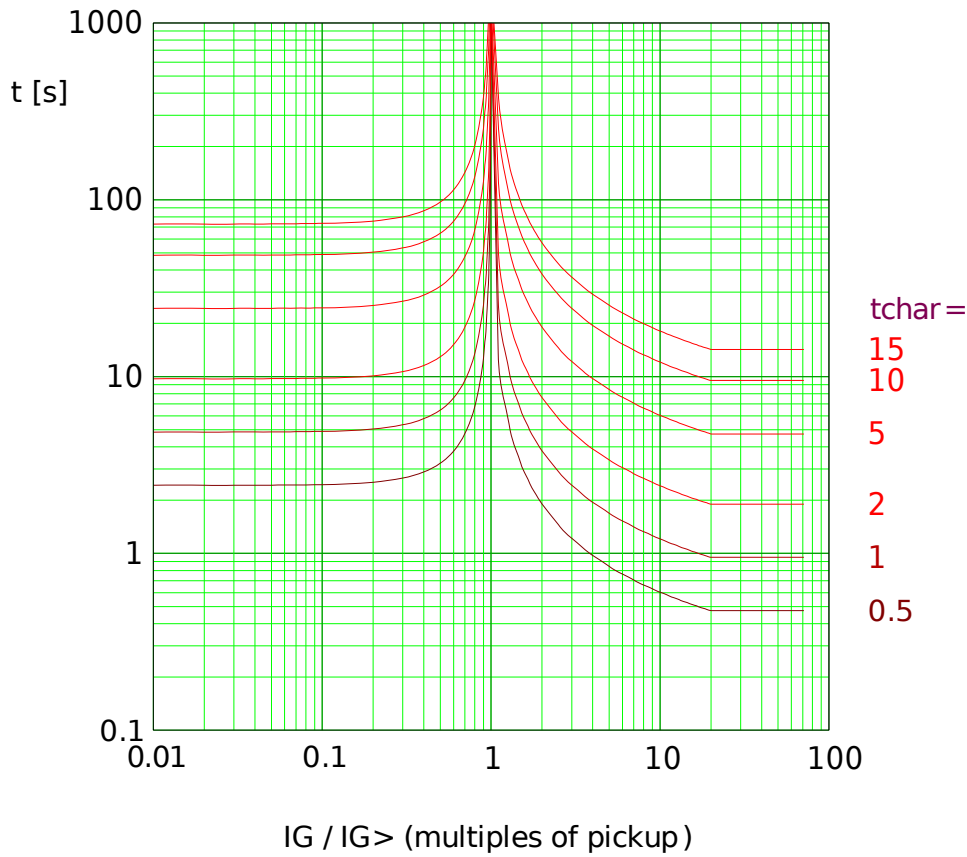

Edoc_Z05

ANSI Very Inverse

NOTICE

Various reset modes are available:
Resetting via characteristic, delayed and instantaneous.

Remark: For $I_G > 20 \cdot I_{G>}$, the curve stops decreasing, the t-values are kept constant at the value for $I_G = 20 \cdot I_{G>}$.

»Char« = ANSI VINV

Reset

$$t = \frac{21.6}{1 - \left(\frac{I_G}{I_{G>}}\right)^2} \cdot tchar$$

If: $\frac{I_G}{I_{G>}} < 1$

Trip

$$t = \left(\frac{19.61}{\left(\frac{I_G}{I_{G>}}\right)^2 - 1} + 0.491 \right) \cdot tchar$$

If: $1 < \frac{I_G}{I_{G>}} \leq 20$

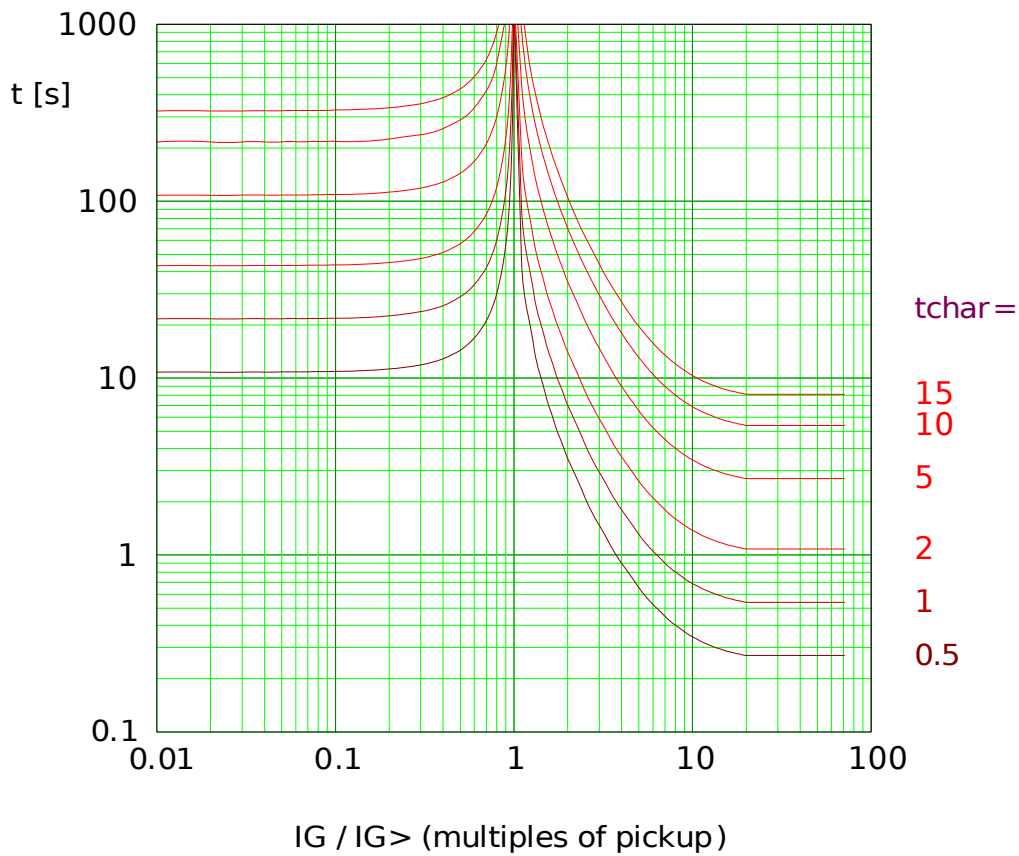

Edoc_Z06

ANSI Extremely Inverse

NOTICE

Various reset modes are available:
Resetting via characteristic, delayed and instantaneous.

Remark: For $I_G > 20 \cdot I_{G>}$, the curve stops decreasing, the t-values are kept constant at the value for $I_G = 20 \cdot I_{G>}$.

»Char« = ANSI EINV

Reset

$$t = \frac{29.1}{1 - \left(\frac{I_G}{I_{G>}}\right)^2} \cdot t_{char}$$

If: $\frac{I_G}{I_{G>}} < 1$

Trip

$$t = \left(\frac{28.2}{\left(\frac{I_G}{I_{G>}}\right)^2 - 1} + 0.1217 \right) \cdot t_{char}$$

If: $1 < \frac{I_G}{I_{G>}} \leq 20$

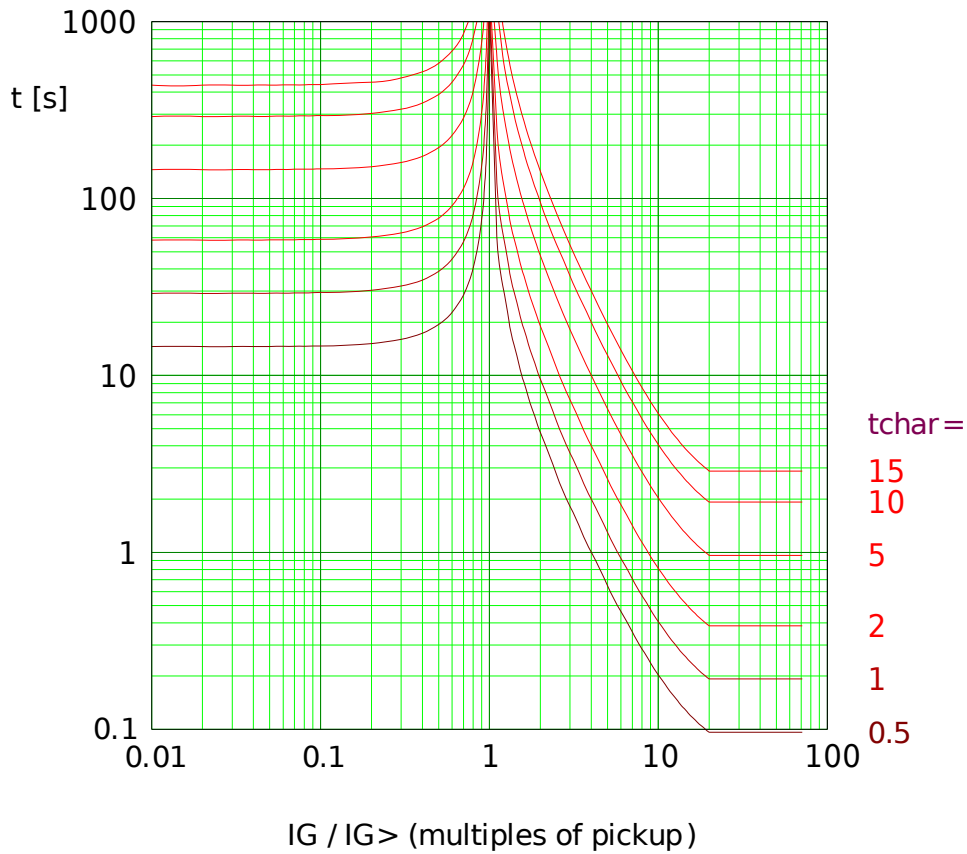

Edoc_Z07

R Inverse

NOTICE Various reset modes are available:
Resetting via characteristic, delayed and instantaneous.

Remark: For $I_G > 20 \cdot I_{G>}$, the curve stops decreasing, the t-values are kept constant at the value for $I_G = 20 \cdot I_{G>}$.

»Char« = RINV

Reset

$$t = \frac{1.0}{1 - \left(\frac{I_G}{I_{G>}}\right)^2} \cdot tchar$$

If: $\frac{I_G}{I_{G>}} < 1$

Trip

$$t = \frac{1.0}{0.339 - 0.236 \cdot \left(\frac{I_G}{I_{G>}}\right)^{-1}} \cdot tchar$$

If: $1 < \frac{I_G}{I_{G>}} \leq 20$

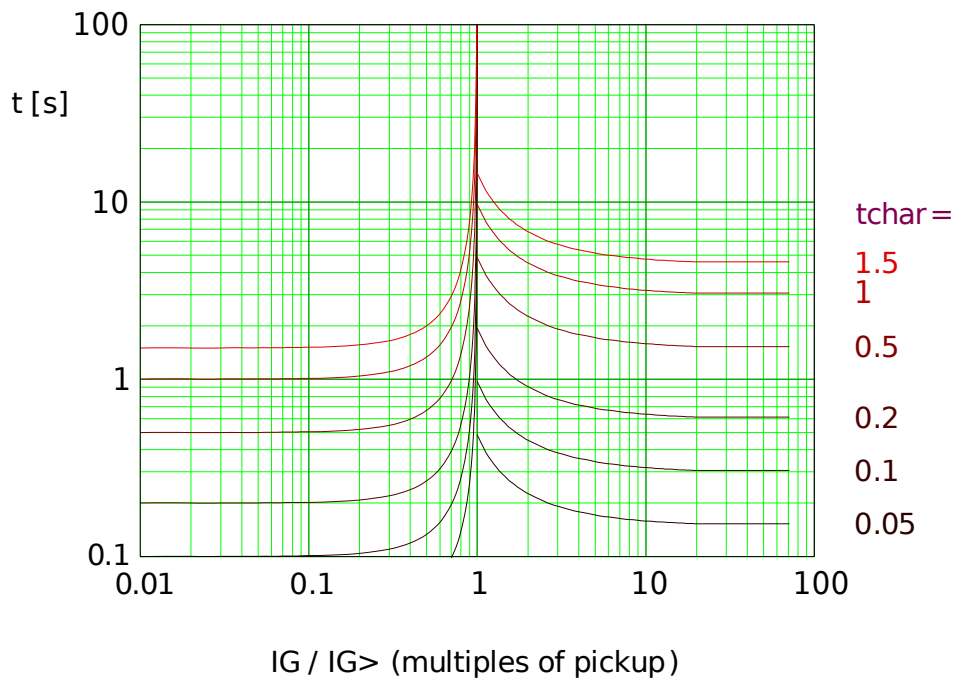

Edoc_Z112

RXIDG

NOTICE Various reset modes are available:
Resetting via characteristic, delayed and instantaneous.

Remark: The curve stops decreasing at $t = 0.02$ s and is kept constant for higher I_c values.

»Char« = RXIDG

Trip

$$t = 5.8 - 1.35 \cdot \ln \left(\frac{IG}{IG> \cdot tchar} \right)$$

If: $1 < \frac{IG}{IG>}$ AND $t \geq 0.02$ s

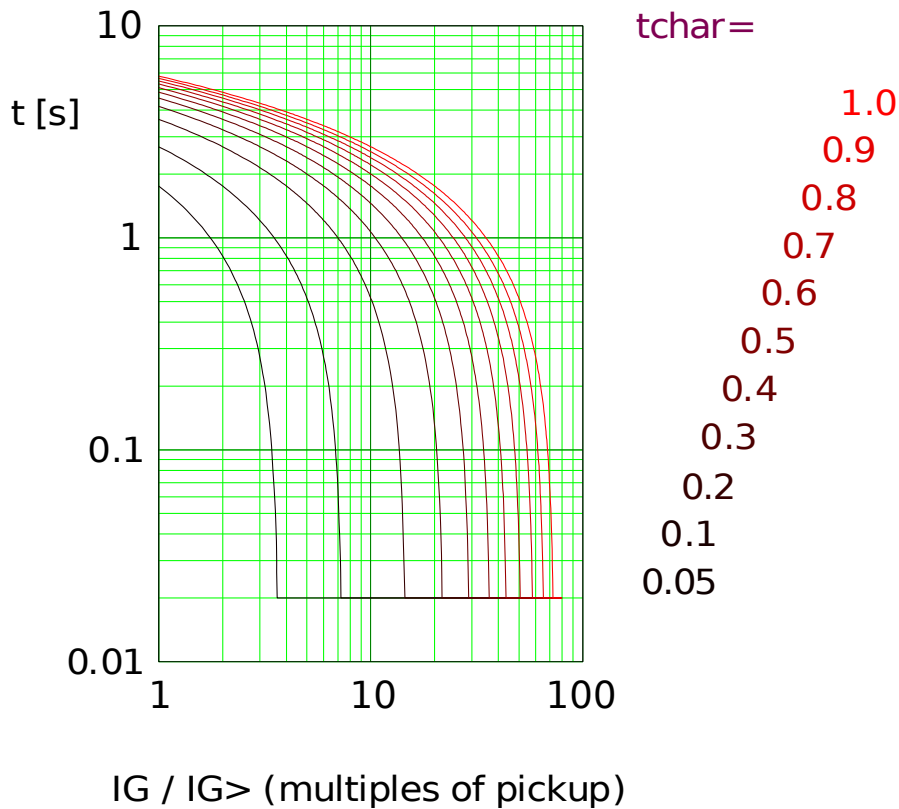

Edoc_Z13

Thermal Flat Curve

NOTICE Various reset modes are available:
Resetting via characteristic, delayed and instantaneous.

»Char« = Therm Flat

Reset

$$t = (5 \cdot 1^2) \cdot t_{char}$$

If: $\frac{IG}{IGnom} < 1$

Trip

$$t = (5 \cdot 1^0) \cdot t_{char}$$

If: $1 < \frac{IG}{IGnom}$

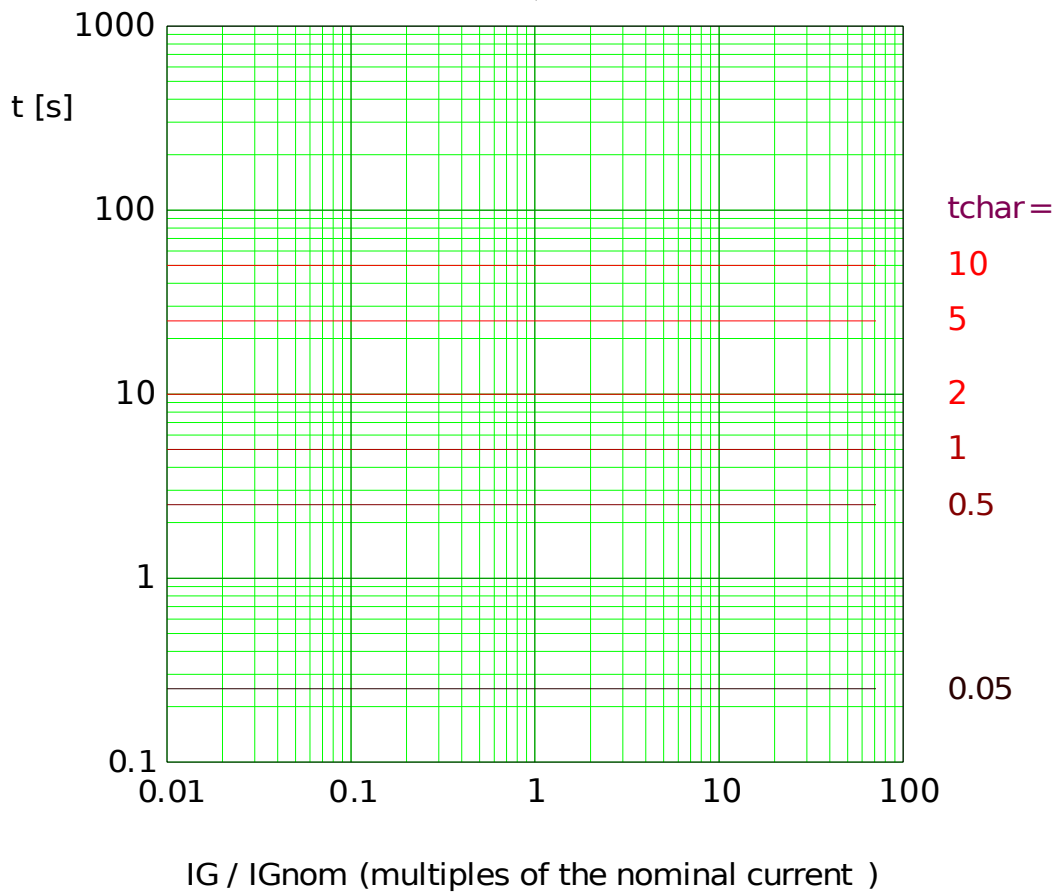

Edoc_Z08

Thermal Curve IT

NOTICE

Various reset modes are available:
Resetting via characteristic, delayed and instantaneous.

»Char« = IT

Reset

$$t = (5 \cdot 10^2) \cdot t_{char}$$

If: $\frac{I_G}{I_{Gnom}} < 1$

Trip

$$t = \frac{5 \cdot 10^1}{\left(\frac{I_G}{I_{Gnom}}\right)^1} \cdot t_{char}$$

If: $1 < \frac{I_G}{I_{Gnom}}$

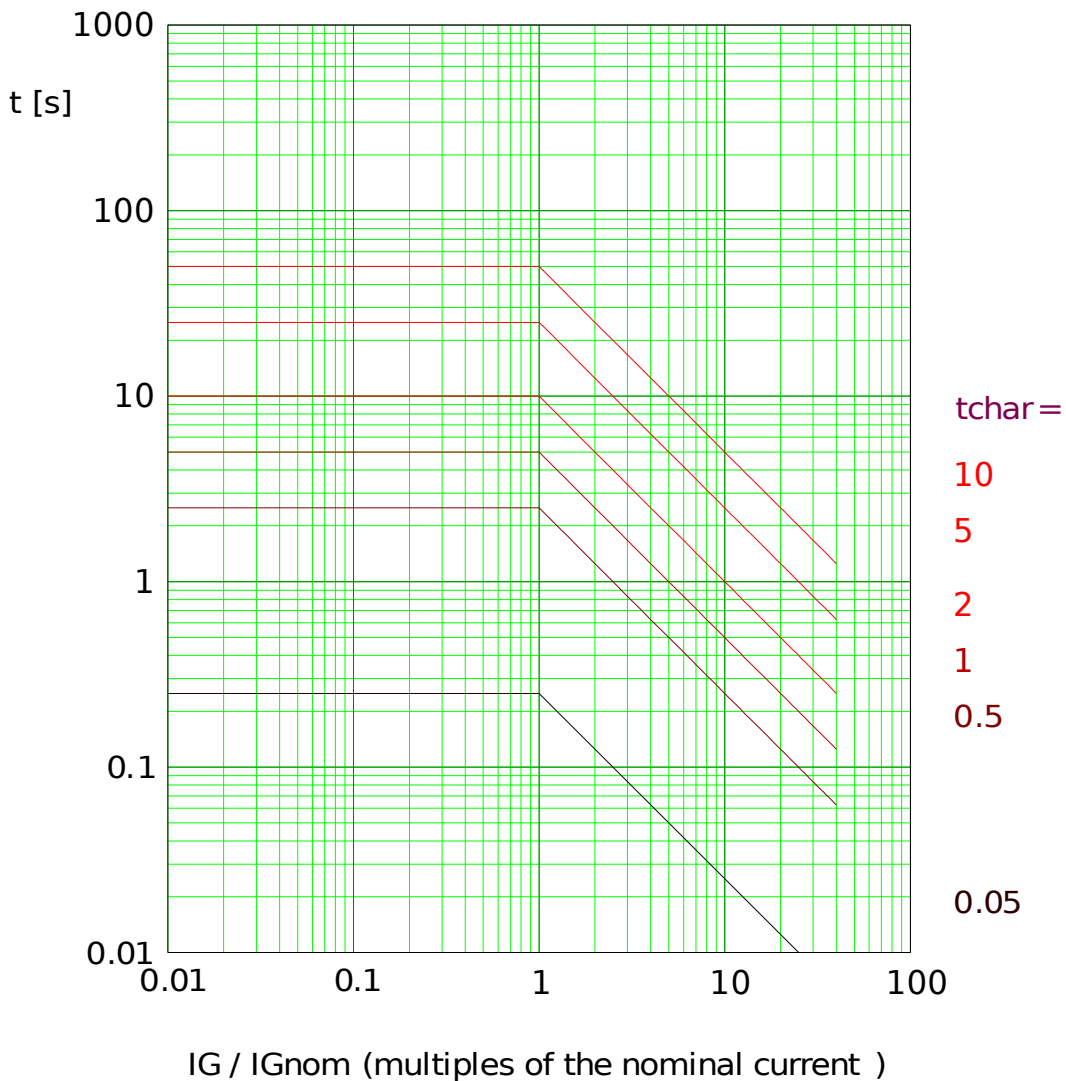

Edoc_Z09

Thermal Curve I2T

NOTICE

Various reset modes are available:
Resetting via characteristic, delayed and instantaneous.

»Char« = I2T

Reset

$$t = (5 \cdot 1^2) \cdot tchar$$

If: $\frac{IG}{IGnom} < 1$

Trip

$$t = \frac{5 \cdot 1^2}{\left(\frac{IG}{IGnom}\right)^2} \cdot tchar$$

If: $1 < \frac{IG}{IGnom}$

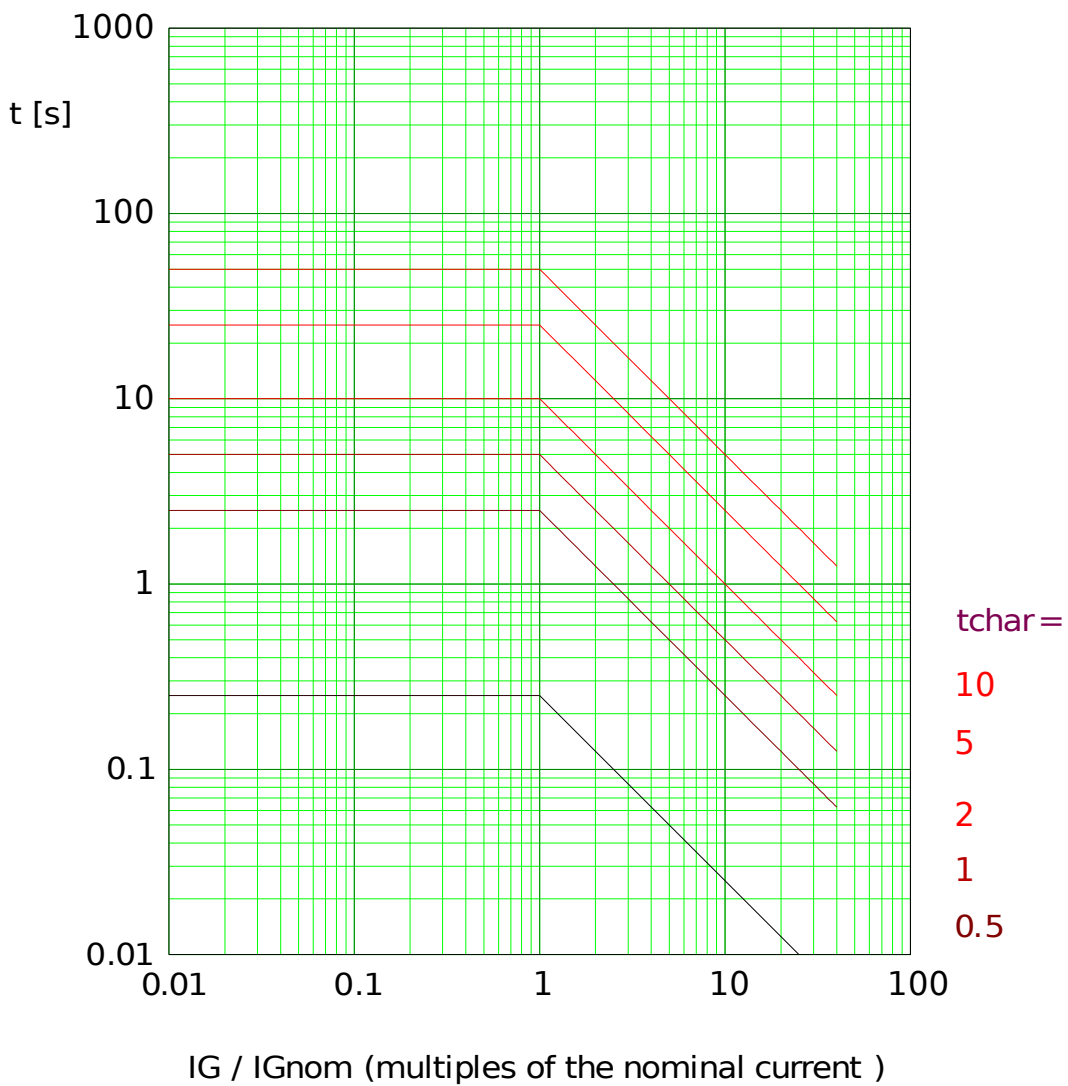

Edoc_Z10

Thermal Curve I4T

NOTICE

Various reset modes are available:
Resetting via characteristic, delayed and instantaneous.

»Char« = I4T

Reset

$$t = (5 \cdot 1^2) \cdot tchar$$

If: $\frac{IG}{IGnom} < 1$

Trip

$$t = \frac{5 \cdot 1^4}{\left(\frac{IG}{IGnom}\right)^4} \cdot tchar$$

If: $1 < \frac{IG}{IGnom}$

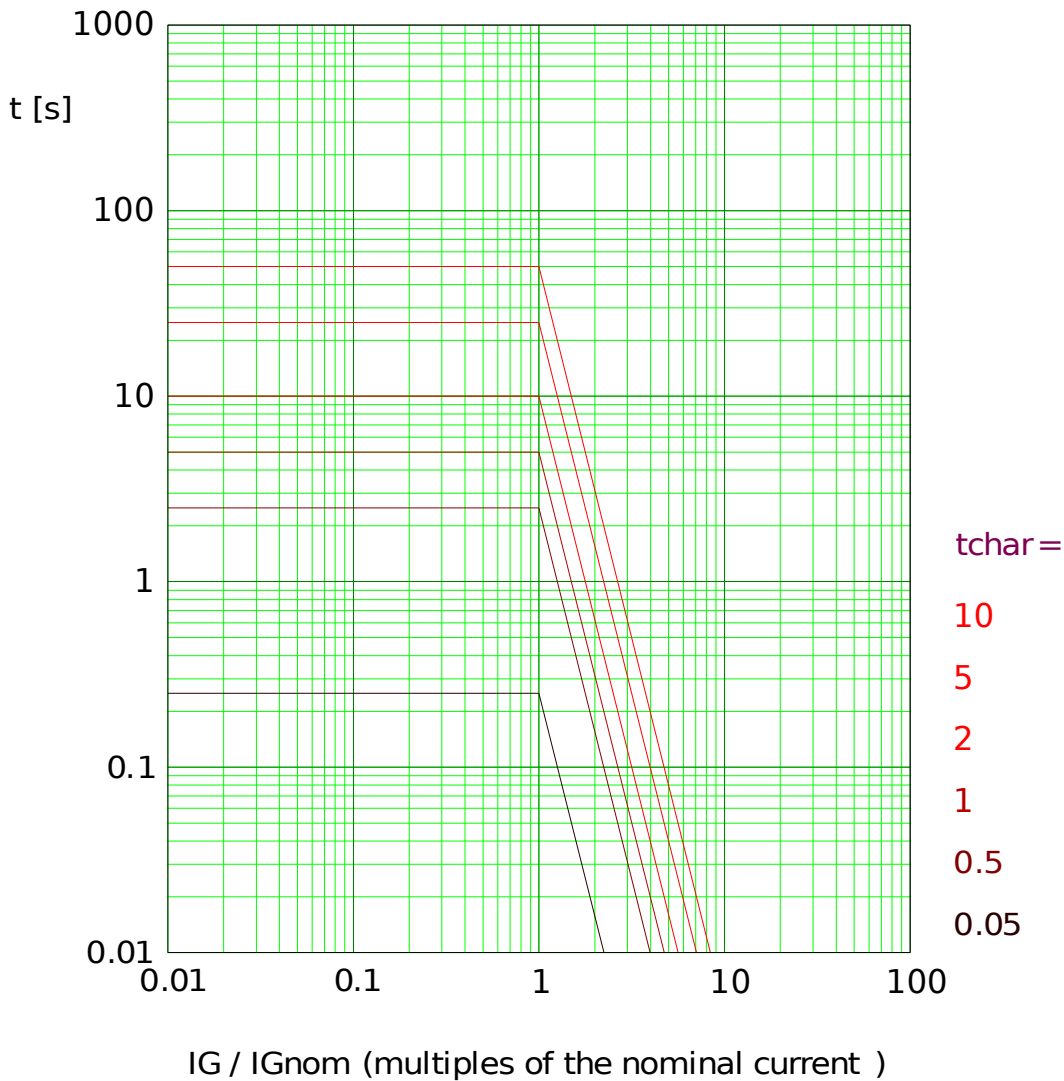

Edoc_Z11

Direction Determination

The direction determination is based on the »Prot« module. See the chapter “Module: Protection (Prot)” for more information.

Prot - Earth fault - direction detection

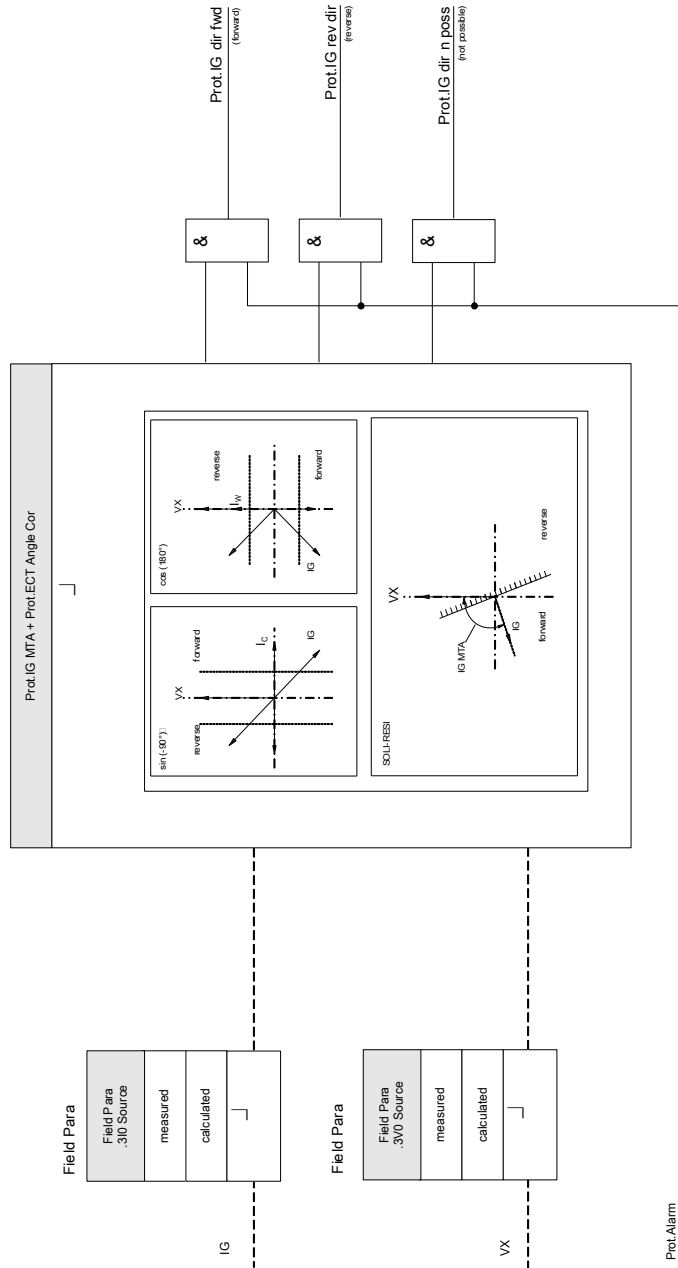

direction decision Earth fault

name = IG[1]...[n]

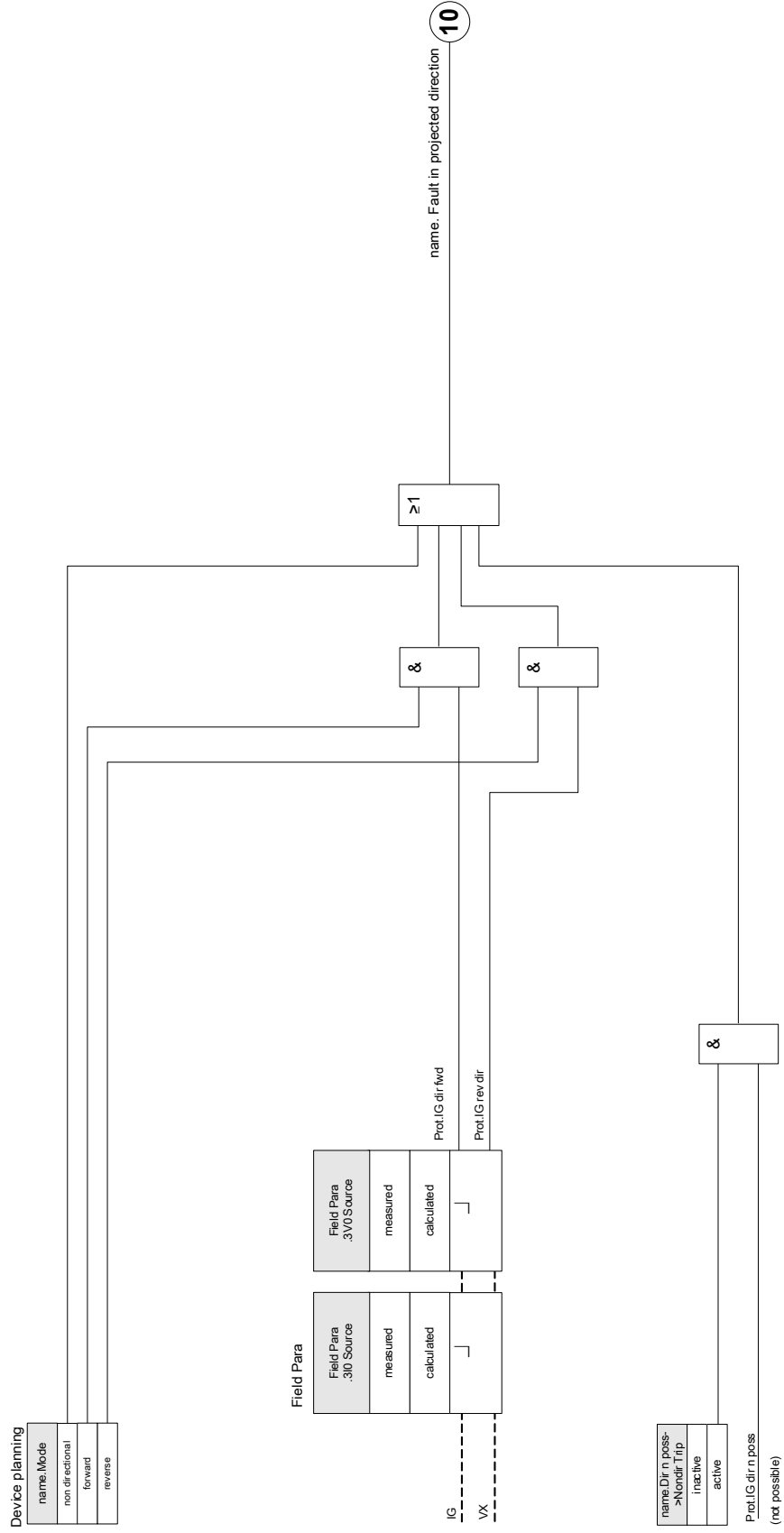

IG[1]...[n]

name = IG[1]...[n]

4G

Please Refer To Diagram: Blockings**
(Stage is not deactivated and no active blocking signals)

10

Please Refer To Diagram: direction decision Earth fault
name: * Fault in projected direction

name.IGH2 Blo

8

Please Refer To Diagram: IH2
IH2_Blo/IG

14 27

name.Alarm

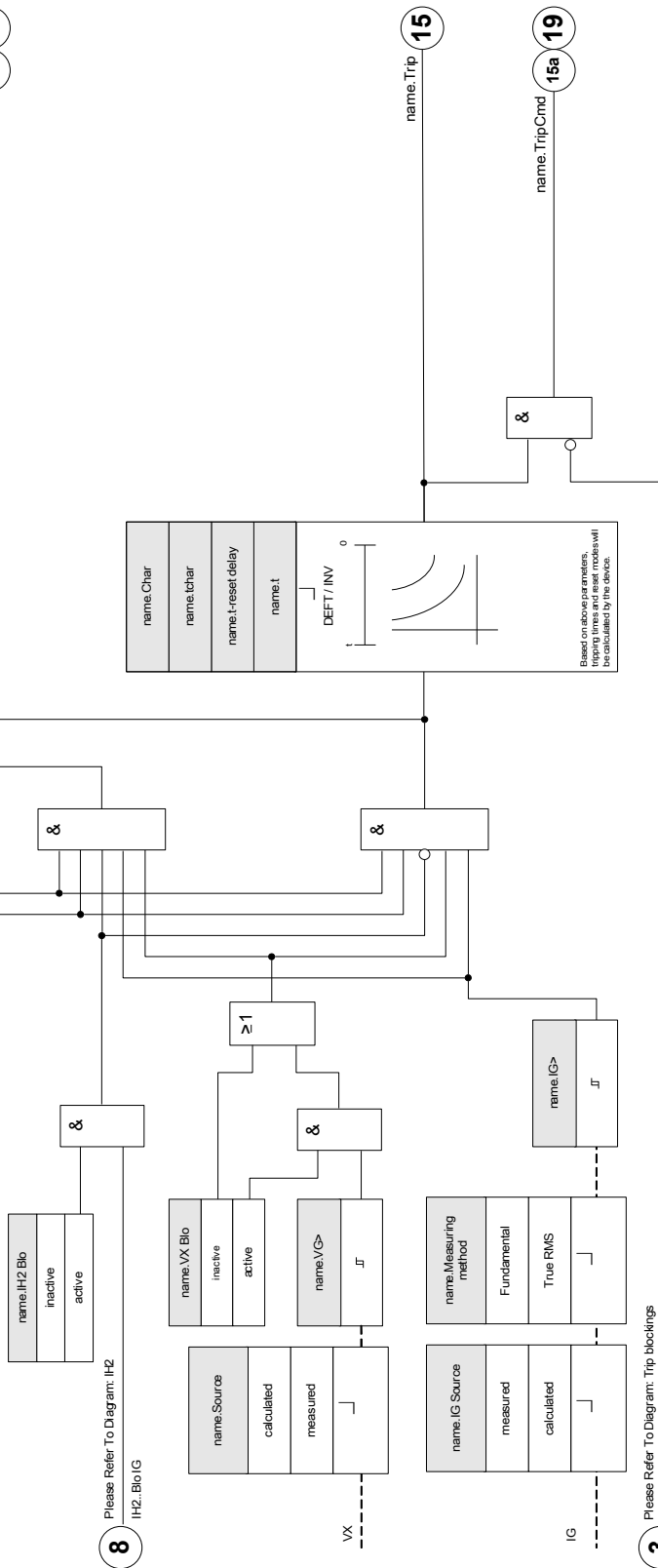





3





Please Refer To Diagram: Trip blockings
(Tripping command deactivated or blocked.)

Device Planning Parameters of the Ground Fault Protection



Parameter	Description	Options	Default	Menu path
Mode 	Mode	do not use, non directional, forward, reverse	do not use	[Device planning]







Global Protection Parameters of the Ground Fault Protection

Parameter	Description	Setting range	Default	Menu path
CT Winding Side 	Measuring values will be used from this winding side	CT Ntrl, CT Mains	CT Ntrl	[Protection Para /Global Prot Para /I-Prot /IG[1]]
ExBlo1 	External blocking of the module, if blocking is activated (allowed) within a parameter set and if the state of the assigned signal is true.	1..n, Assignment List	.-	[Protection Para /Global Prot Para /I-Prot /IG[1]]
ExBlo2 	External blocking of the module, if blocking is activated (allowed) within a parameter set and if the state of the assigned signal is true.	1..n, Assignment List	.-	[Protection Para /Global Prot Para /I-Prot /IG[1]]
ExBlo TripCmd 	External blocking of the Trip Command of the module/the stage, if blocking is activated (allowed) within a parameter set and if the state of the assigned signal is true.	1..n, Assignment List	.-	[Protection Para /Global Prot Para /I-Prot /IG[1]]
Ex rev Interl 	External blocking of the module by external reverse interlocking, if blocking is activated (allowed) within a parameter set and if the state of the assigned signal is true.	1..n, Assignment List	.-	[Protection Para /Global Prot Para /I-Prot /IG[1]]

<i>Parameter</i>	<i>Description</i>	<i>Setting range</i>	<i>Default</i>	<i>Menu path</i>
AdaptSet 1 	Assignment Adaptive Parameter 1	AdaptSet	.-	[Protection Para /Global Prot Para /I-Prot /IG[1]]
AdaptSet 2 	Assignment Adaptive Parameter 2	AdaptSet	.-	[Protection Para /Global Prot Para /I-Prot /IG[1]]
AdaptSet 3 	Assignment Adaptive Parameter 3	AdaptSet	.-	[Protection Para /Global Prot Para /I-Prot /IG[1]]
AdaptSet 4 	Assignment Adaptive Parameter 4	AdaptSet	.-	[Protection Para /Global Prot Para /I-Prot /IG[1]]

Setting Group Parameters of the Ground Fault Protection

<i>Parameter</i>	<i>Description</i>	<i>Setting range</i>	<i>Default</i>	<i>Menu path</i>
Function 	Permanent activation or deactivation of module/stage.	inactive, active	inactive	[Protection Para /<1..4> /I-Prot /IG[1]]
ExBlo Fc 	Activate (allow) or inactivate (disallow) blocking of the module/stage. This parameter is only effective if a signal is assigned to the corresponding global protection parameter. If the signal becomes true, those modules/stages are blocked that are parameterized "ExBlo Fc=active".	inactive, active	inactive	[Protection Para /<1..4> /I-Prot /IG[1]]

Parameter	Description	Setting range	Default	Menu path
 Ex rev Interl Fc	Activate (allow) or inactivate (disallow) blocking of the module/stage. This parameter is only effective if a signal is assigned to the corresponding global protection parameter. If the signal becomes true, those modules/stages are blocked that are parameterized "Ex rev Interl Fc = active".	inactive, active	inactive	[Protection Para /<1..4> /I-Prot /IG[1]]
 Blo TripCmd	Permanent blocking of the Trip Command of the module/stage.	inactive, active	inactive	[Protection Para /<1..4> /I-Prot /IG[1]]
 ExBlo TripCmd Fc	Activate (allow) or inactivate (disallow) blocking of the module/stage. This parameter is only effective if a signal is assigned to the corresponding global protection parameter. If the signal becomes true, those modules/stages are blocked that are parameterized "ExBlo TripCmd Fc=active".	inactive, active	inactive	[Protection Para /<1..4> /I-Prot /IG[1]]
 IG Source	Selection if measured or calculated ground current should be used.	sensitive measurement, measured, calculated, measured (W2)	calculated	[Protection Para /<1..4> /I-Prot /IG[1]]
 Measuring method	Measuring method: fundamental or rms or 3rd harmonic (only generator protection relays)	Fundamental, True RMS	Fundamental	[Protection Para /<1..4> /I-Prot /IG[1]]
 VX Source	Selection if VG is measured or calculated (neutral voltage or residual voltage)	measured, calculated	measured	[Protection Para /<1..4> /I-Prot /IG[1]]
 Meas Circuit Superv	Activates the use of the measuring circuit supervision. In this case the module will be blocked if a measuring circuit supervision module (e.g. LOP, VTS) signals a disturbed measuring circuit (e.g. caused by a fuse failure). Only available if "VX Source" ist set to "calculated".	inactive, active	inactive	[Protection Para /<1..4> /I-Prot /IG[1]]

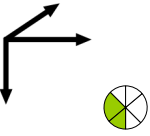
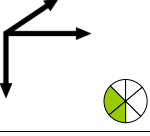
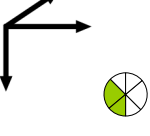
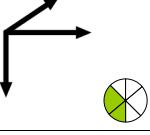
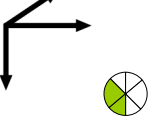
Parameter	Description	Setting range	Default	Menu path
IG> 	If the pickup value is exceeded, the module/stage will be started.	0.02 - 20.00In	0.02In	[Protection Para /<1..4> /I-Prot /IG[1]]
IGs> 	If the pickup value is exceeded, the module/stage will be started.	0.002 - 2.000In	0.02In	[Protection Para /<1..4> /I-Prot /IG[1]]
Char 	Characteristic	DEFT, IEC NINV, IEC VINV, IEC EINV, IEC LINV, RINV, ANSI MINV, ANSI VINV, ANSI EINV, Therm Flat, IT, I2T, I4T, RXIDG	DEFT	[Protection Para /<1..4> /I-Prot /IG[1]]
t 	Tripping delay Only available if: Characteristic = DEFT	0.00 - 300.00s	0.00s	[Protection Para /<1..4> /I-Prot /IG[1]]
tchar 	Time multiplier/tripping characteristic factor. The setting range depends on the selected tripping curve. Only available if: Characteristic = INV Or Characteristic = Therm Flat Or Characteristic = IT Or Characteristic = I2T Or Characteristic = I4T Or Characteristic = RXIDG	0.02 - 20.00	1	[Protection Para /<1..4> /I-Prot /IG[1]]

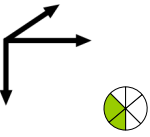
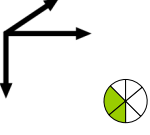
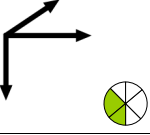
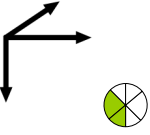
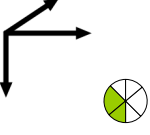
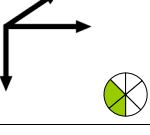
Parameter	Description	Setting range	Default	Menu path
 Reset Mode	Reset Mode Only available if: Characteristic = INV Or Characteristic = Therm Flat Or Characteristic = IT Or Characteristic = I2T Or Characteristic = I4T Or Characteristic = RXIDG	instantaneous, delayed, calculated	instantaneous	[Protection Para /<1..4> /I-Prot /IG[1]]
 t-reset delay	Reset delay for intermittent phase failures (INV characteristics only) Only available if: Characteristic = INV Or Characteristic = Therm Flat Or Characteristic = IT Or Characteristic = I2T Or Characteristic = I4T Or Characteristic = RXIDG Only available if: Reset Mode = delayed	0.00 - 60.00s	0.00s	[Protection Para /<1..4> /I-Prot /IG[1]]
 IH2 Blo	Blocking the trip command, if an inrush is detected.	inactive, active	inactive	[Protection Para /<1..4> /I-Prot /IG[1]]
 Dir n poss->Nondir Trip	Only relevant for current protection elements with directional feature! The device will trip non directional if this parameter is set to active and no direction could be determined. Direction detection is impossible e.g. if the required quantities for the direction detection cannot be measured or validated. Direction detection is also impossible if the frequency deviates significantly from the nominal frequency. Caution: If this parameter is set to inactive, the protective element will trip only if the direction can be detected. Only available if: Device planning: Earth current protection - Stage.Mode = directional	inactive, active	inactive	[Protection Para /<1..4> /I-Prot /IG[1]]
 VX Blo	VX Blo = active means that the IG-stage will only excite if a residual voltage higher than the pickup value is measured at the same time. VX Blo = inactive means that the excitation of the IG stage does not depend on any residual voltage stage.	inactive, active	inactive	[Protection Para /<1..4> /I-Prot /IG[1]]
 VG>	If the pickup value is exceeded, the module/stage will be started. Only available if: VX Blo = active	0.01 - 2.00Vn	1.00Vn	[Protection Para /<1..4> /I-Prot /IG[1]]

Ground Fault Protection Input States

<i>Name</i>	<i>Description</i>	<i>Assignment via</i>
ExBlo1-I	Module input state: External blocking1	[Protection Para /Global Prot Para /I-Prot /IG[1]]
ExBlo2-I	Module input state: External blocking2	[Protection Para /Global Prot Para /I-Prot /IG[1]]
ExBlo TripCmd-I	Module input state: External Blocking of the Trip Command	[Protection Para /Global Prot Para /I-Prot /IG[1]]
Ex rev InterI-I	Module input state: External reverse interlocking	[Protection Para /Global Prot Para /I-Prot /IG[1]]
AdaptSet1-I	Module input state: Adaptive Parameter1	[Protection Para /Global Prot Para /I-Prot /IG[1]]
AdaptSet2-I	Module input state: Adaptive Parameter2	[Protection Para /Global Prot Para /I-Prot /IG[1]]
AdaptSet3-I	Module input state: Adaptive Parameter3	[Protection Para /Global Prot Para /I-Prot /IG[1]]
AdaptSet4-I	Module input state: Adaptive Parameter4	[Protection Para /Global Prot Para /I-Prot /IG[1]]

Ground Fault Protection Signals (Output States)

<i>Signal</i>	<i>Description</i>
active	Signal: active
ExBlo	Signal: External Blocking

Protective Elements

<i>Signal</i>	<i>Description</i>
Ex rev Interl	Signal: External reverse Interlocking
Blo TripCmd	Signal: Trip Command blocked
ExBlo TripCmd	Signal: External Blocking of the Trip Command
Alarm	Signal: Alarm IG
Trip	Signal: Trip
TripCmd	Signal: Trip Command
IGH2 Blo	Signal: blocked by an inrush
Active AdaptSet	Active Adaptive Parameter
DefaultSet	Signal: Default Parameter Set
AdaptSet 1	Signal: Adaptive Parameter 1
AdaptSet 2	Signal: Adaptive Parameter 2
AdaptSet 3	Signal: Adaptive Parameter 3
AdaptSet 4	Signal: Adaptive Parameter 4

Commissioning: Ground Fault Protection – non-directional [50N/G, 51N/G]

Please test the non-directional earth overcurrent analog to the non-directional phase overcurrent protection.

Commissioning: Ground Fault Protection – directional [50N/G, 51N/G, 67N/G]

Please test the directional earth overcurrent analog to the directional phase overcurrent protection.

I2> and %I2/I1> – Unbalanced Load [46]

Elements:

I2>[1] , I2>[2]

The I2> Current Unbalance module works similar to the V 012 Voltage Unbalance module. The positive and negative sequence currents are calculated from the 3-phase currents. The threshold setting (either »I2>« or »I2/FLA«) defines a minimum operating current magnitude of I2 for the 46 function to operate, which insures that the relay has a solid basis for initiating a current unbalance trip. The »%(I2/I1)« (option) setting is the unbalance trip pickup setting. It is defined by the ratio of negative sequence current to positive sequence current »%(I2/I1)«.

NOTICE All I2> Current Unbalance modules are identically structured.

The condition for a trip of this module is that the negative sequence current I2 is above the set threshold **and** – if configured – the percentage current unbalance is above the setting »%(I2/I1)«. The module initiates a trip if this condition is fulfilled for a specific tripping delay time.

For this tripping delay time, there are two characteristics available as configuring options, a definite time characteristic (DEFT, where the tripping delay is a setting value) and an inverse characteristic (INV, where the tripping delay is calculated).

The setting of »CurrentBase« decides about whether »I2>« or »I2/FLA« is used as the threshold value. This rating value – »I2>« or »I2/FLA« – is the permitted continuous unbalanced load current, and it is specified in units of either I_n (for »CurrentBase« = "Device Rating") or I_b (for »CurrentBase« = "Protected Object Rating").

The principle of the definite time characteristic (DEFT) is as follows:

- The module trips if for the tripping delay time (which is set as the Setting Group parameter »t«) the negative sequence current I2 is above the set threshold **and** (if configured) the percentage current unbalance is above the setting »%(I2/I1)«.

The principle of the inverse time characteristic (INV) is as follows:

- The protective device permanently calculates the heat (thermal) energy θ of the object to be protected. This happens all the time, independent of any alarm or tripping decisions. The module trips if for the tripping delay time t_{trip} – which is dependent on θ – the following conditions are all fulfilled:
 1. The negative sequence current I2 is above the set threshold (»I2>« or »I2/FLA«) **and**
 2. the percentage current unbalance is above the setting »%(I2/I1)« (if »%(I2/I1)« is set to *active*) **and**
 3. the calculated thermal energy θ exceeds a maximum value θ_{max} , which is calculated based on the setting K for the thermal load capability.
- For $\theta = 0$ the tripping delay time is calculated as follows:

for »CurrentBase« = "Device Rating"	for »CurrentBase« = "Protected Object Rating"
$t_A = \frac{K \cdot I_n^2}{I_2^2 - I_{2,}^2}$	$t_A = \frac{K \cdot I_b^2}{I_2^2 - I_{2/FLA}^2}$

where

t_{trip} = tripping delay in seconds,

- K = thermal load capability of the object while running with 100% unbalanced load current. This is an intrinsic property of the object that is to be protected, and therefore it must be specified as a setting value (Setting Group parameter » K «).
- I_n = nominal current, in case of » $CurrentBase$ « = "Device Rating",
- I_b = nominal current of the protected object, in case of » $CurrentBase$ « = "Protected Object Rating".
- I_2 = unbalanced load current I_2 (calculated from measured current values),
- $I_{2>}$ = Setting value » $I_2>$ «, in case of » $CurrentBase$ « = "Device Rating",
- $I_{2/FLA}$ = Setting value » I_2/FLA «, in case of » $CurrentBase$ « = "Protected Object Rating".

- In case of a still present residual heat, $\theta > 0$, the tripping delay t_{trip} is reduced accordingly, so that an earlier tripping occurs.
- As long as the unbalanced load current I_2 is **greater** than the threshold » $I_2>$ « it is assumed that the object is *heating up*. During this phase, the heat (thermal) energy is calculated by an integration of the current value I_2 :

$$\theta(t) = \theta_{0,cool} + f \cdot \int |\vec{I}_2|^2 dt$$

- $\theta(t)$ = actual value of the thermal energy,
- $\theta_{0,cool}$ = initial value at the beginning of the heating phase,
 - i. e. the thermal energy at the end of the last cooling-down phase (or = 0, if the last cooling-down phase has ended, see below, or if there has not been any cooling-down phase yet),
- f = scaling factor.

- As long as the unbalanced load current I_2 is **less** than the threshold (» $I_2>$ « or » I_2/FLA «) it is assumed that the object is *cooling down*. During this phase, the heat (thermal) energy is calculated based on a cooling-down constant. This constant is another intrinsic property of the object that is to be protected, and therefore it must be specified as a setting value (Setting Group parameter » $T-cool$ «):

$$\theta(t) = \theta_{0,heat} \cdot e^{-\frac{t}{T_{cool}}}$$

- $\theta(t)$ = actual value of the thermal energy,
- $\theta_{0,heat}$ = initial value at the beginning of the cooling-down phase,
 - i. e. the thermal energy at the end of the last heating-up phase
- T_{cool} = object property, setting value » $T-cool$ «.

- The cooling-down phase always continues as long as I_2 is below the threshold, i. e. $\theta(t)$ is calculated continuously. (Only after $\theta(t)$ has dropped below $0.01 \cdot \theta_{max}$ the calculation ends and θ gets reset to 0, i. e. a subsequent heating-up phase will start with initial value $\theta_{0,cool} = 0$.)

NOTICE

The heat (thermal) energy is an auxiliary value that is calculated and maintained internally, i. e. it can neither be displayed at the HMI nor be retrieved via any communication protocol.

46[1]...[n]



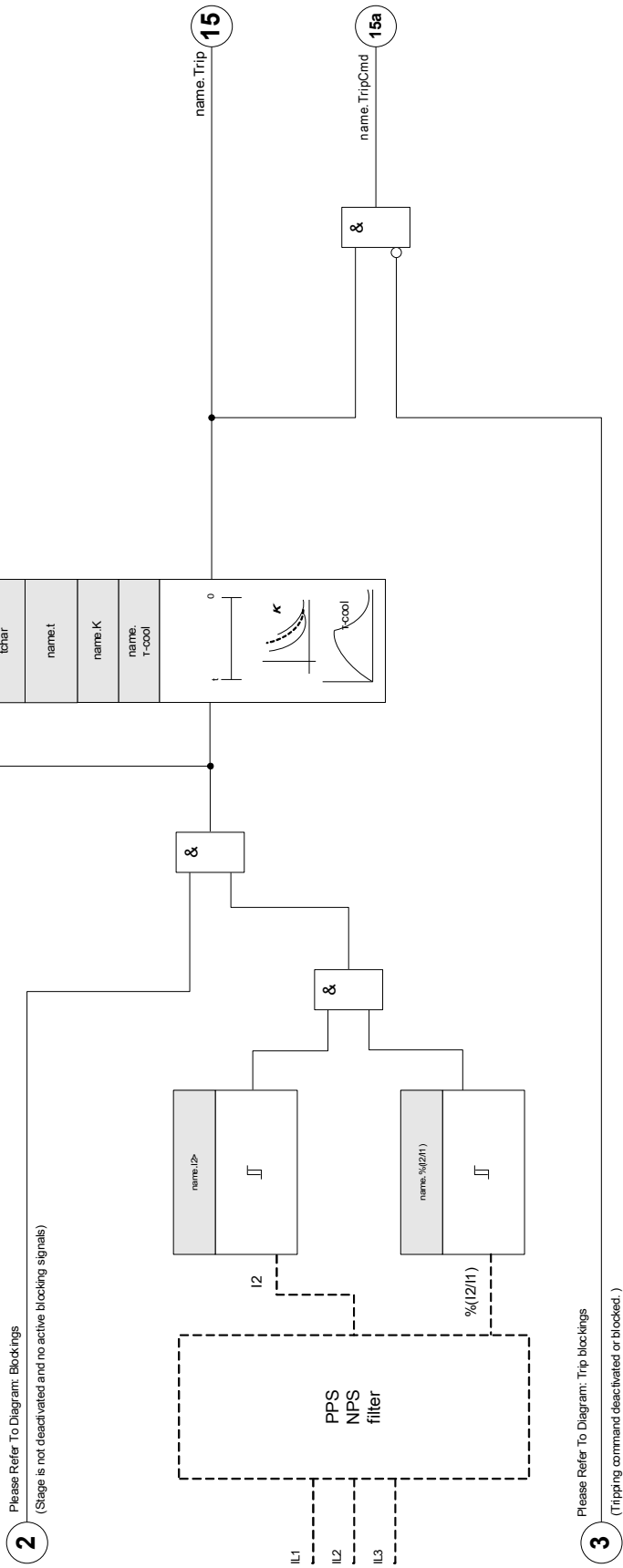

name = 46[1]...[n]









Device Planning Parameters of the Current Unbalance Module







Parameter	Description	Options	Default	Menu path
Mode 	Mode	do not use, use	do not use	[Device planning]

Global Protection Parameters of the Current Unbalance Module

Parameter	Description	Setting range	Default	Menu path
CT Winding Side 	Measuring values will be used from this winding side	CT Ntrl, CT Mains	CT Ntrl	[Protection Para /Global Prot Para /I-Prot /I2>[1]]
ExBlo1 	External blocking of the module, if blocking is activated (allowed) within a parameter set and if the state of the assigned signal is true.	1..n, Assignment List	-.-	[Protection Para /Global Prot Para /I-Prot /I2>[1]]
ExBlo2 	External blocking of the module, if blocking is activated (allowed) within a parameter set and if the state of the assigned signal is true.	1..n, Assignment List	-.-	[Protection Para /Global Prot Para /I-Prot /I2>[1]]
ExBlo TripCmd 	External blocking of the Trip Command of the module/the stage, if blocking is activated (allowed) within a parameter set and if the state of the assigned signal is true.	1..n, Assignment List	-.-	[Protection Para /Global Prot Para /I-Prot /I2>[1]]
CurrentBase 	Base Current Selection (based on Device Rating (1A/5A)/Protected Object Rating).	Device Rating, Protected Object Rating	Device Rating	[Protection Para /Global Prot Para /I-Prot /I2>[1]]

Setting Group Parameters of the Current Unbalance Module

Parameter	Description	Setting range	Default	Menu path
 Function	Permanent activation or deactivation of module/stage.	inactive, active	inactive	[Protection Para /<1..4> /I-Prot /I2>[1]]
 ExBlo Fc	Activate (allow) or inactivate (disallow) blocking of the module/stage. This parameter is only effective if a signal is assigned to the corresponding global protection parameter. If the signal becomes true, those modules/stages are blocked that are parameterized "ExBlo Fc=active".	inactive, active	inactive	[Protection Para /<1..4> /I-Prot /I2>[1]]
 Blo TripCmd	Permanent blocking of the Trip Command of the module/stage.	inactive, active	inactive	[Protection Para /<1..4> /I-Prot /I2>[1]]
 ExBlo TripCmd Fc	Activate (allow) or inactivate (disallow) blocking of the module/stage. This parameter is only effective if a signal is assigned to the corresponding global protection parameter. If the signal becomes true, those modules/stages are blocked that are parameterized "ExBlo TripCmd Fc=active".	inactive, active	inactive	[Protection Para /<1..4> /I-Prot /I2>[1]]
 I2>	The Threshold setting defines a minimum operating current magnitude of I2 for the 46 function to operate, which ensures that the relay has a solid basis for initiating a current unbalance trip. This is a supervisory function and not a trip level. Only available if: I2>.CurrentBase = Device Rating	0.01 - 4.00In	0.01In	[Protection Para /<1..4> /I-Prot /I2>[1]]
 I2/FLA	Generator/motor unbalance current pickup value based on the full load current(FLA) (Setting from Continuous Unbalance Current Capability) Only available if: I2>.CurrentBase = Protected Object Rating	0.000 - 1.000Ib	0.08Ib	[Protection Para /<1..4> /I-Prot /I2>[1]]

Parameter	Description	Setting range	Default	Menu path
 %(I2/I1)	The %(I2/I1) setting is the unbalance trip pickup setting. It is defined by the ratio of negative sequence current to positive sequence current (% Unbalance=I2/I1). Phase sequence will be taken into account automatically.	inactive, active	inactive	[Protection Para /<1..4> /I-Prot /I2>[1]]
 %(I2/I1)	The %(I2/I1) setting is the unbalance trip pickup setting. It is defined by the ratio of negative sequence current to positive sequence current (% Unbalance=I2/I1). Phase sequence will be taken into account automatically. Only available if: %(I2/I1) = use	2 - 40%	20%	[Protection Para /<1..4> /I-Prot /I2>[1]]
 Char	Characteristic	DEFT, INV	DEFT	[Protection Para /<1..4> /I-Prot /I2>[1]]
 t	Tripping delay Only available if: Characteristic = DEFT	0.00 - 300.00s	0.00s	[Protection Para /<1..4> /I-Prot /I2>[1]]
 K	This setting is the negative sequence capability constant. This value is normally provided by the generator manufacturer. Only available if: Characteristic = INV	1.00 - 200.00s	10.0s	[Protection Para /<1..4> /I-Prot /I2>[1]]
 τ-cool	If the unbalanced load current falls below the pickup value, the cooling-off time is taken into account. If the unbalanced load exceeds the pickup value again, than the saved heat within the electrical equipment will lead to an accelerated trip. Only available if: Characteristic = INV	0.0 - 60000.0s	0.0s	[Protection Para /<1..4> /I-Prot /I2>[1]]

Current Unbalance Module Input States

Name	Description	Assignment via
ExBlo1-I	Module input state: External blocking1	[Protection Para /Global Prot Para /I-Prot /I2>[1]]

<i>Name</i>	<i>Description</i>	<i>Assignment via</i>
ExBlo2-I	Module input state: External blocking2	[Protection Para /Global Prot Para /I-Prot /I2>[1]]
ExBlo TripCmd-I	Module input state: External Blocking of the Trip Command	[Protection Para /Global Prot Para /I-Prot /I2>[1]]

Current Unbalance Module Signals (Output States)

<i>Signal</i>	<i>Description</i>
active	Signal: active
ExBlo	Signal: External Blocking
Blo TripCmd	Signal: Trip Command blocked
ExBlo TripCmd	Signal: External Blocking of the Trip Command
Alarm	Signal: Alarm Negative Sequence
Trip	Signal: Trip
TripCmd	Signal: Trip Command

Commissioning: Current Unbalance Module

Object to be tested:

Test of the unbalanced load protection function.

Necessary means:

- Three-phase current source with adjustable current unbalance; and
- Timer.

Procedure:

Check the phase sequence:

- Ensure that the phase sequence is the same as that set in the field parameters.
- Feed-in a three-phase nominal current.
- Change to the »Measuring Values« menu.
- Check the measuring value for the unbalanced current »I2«. The measuring value displayed for »I2« should be zero (within the physical measuring accuracy).

NOTICE

If the displayed magnitude for I2 is the same as that for the symmetrical nominal currents fed to the relay, it implies that the phase sequence of the currents seen by the relay is reversed.

- Now turn-off phase L1.
- Again check the measuring value of the unbalanced current »I2« in the »Measuring Values« menu. The measuring value of the asymmetrical current »I2« should now be 33%.
- Turn-on phase L1, but turn-off phase L2.
- Once again check the measuring value of the asymmetrical current I2 in the »Measuring Values« menu. The measuring value of the asymmetrical current »I2« should be again 33%.
- Turn-on phase L2, but turn-off phase L3.
- Again check the measuring value of asymmetrical current »I2« in the »Measuring Values« menu. The measuring value of the asymmetrical current »I2« should still be 33%.

Testing the trip delay:

- Apply a symmetrical three-phase current system (nominal currents).
- Switch off IL1 (the threshold value »Threshold« for »I2« must be below 33%).
- Measure the tripping time.

The present current unbalance »I2« corresponds with 1/3 of the existing phase current displayed.

Testing the threshold values

- Configure minimum » $I_{2/1}$ « setting (2%) and an arbitrary threshold value » *Threshold* « (I2).
- For testing the threshold value, a current has to be fed to phase A which is lower than three times the adjusted threshold value » *Threshold* « (I2).
- Feeding only phase A results in » $I_{2/1} = 100\%$ «, so the first condition » $I_{2/1} \geq 2\%$ « is always fulfilled.
- Now increase the phase L1 current until the relay is activated.

Testing the dropout ratio of the threshold values

Having tripped the relay in the previous test, now decrease the phase A current. The dropout ratio must not be higher than 0.97 times the threshold value.

Testing $I_{2/1}$

- Configure minimum threshold value » *Threshold* « (I2) ($0.01 \times I_n$) and set » $I_{2/1}$ « greater or equal to 10%.
- Apply a symmetrical three-phase current system (nominal currents). The measuring value of » $I_{2/1}$ « should be 0%.
- Now increase the phase L1 current. With this configuration, the threshold value » *Threshold* « (I2) should be reached before the value » $I_{2/1}$ « reaches the set » $I_{2/1}$ « ratio threshold.
- Continue increasing the phase 1 current until the relay is activated.

Testing the dropout ratio of $I_{2/1}$

Having tripped the relay in the previous test, now decrease the phase L1 current. The dropout of » $I_{2/1}$ « has to be 1% below the » $I_{2/1}$ « setting.

Successful test result:

The measured trip delays, threshold values, and dropout ratios are within the permitted deviations/tolerances, specified under Technical Data.

I2>G – Generator Unbalance Protection [46G]

The 46G function has an inverse time element.

NOTICE The relation of CTprim/FLA should be less than 2.

46G – Inverse Time Generator Unbalance Protection Element

The condition for a trip of this module is that the negative sequence current I_2 is above the set threshold » I_2/FLA «. The module initiates a trip if this condition is fulfilled for a specific tripping delay time.

The rating value » I_2/FLA « is the permitted continuous unbalanced load current of the protected generator. The principle of the module is as follows:

- The protective device permanently calculates the heat (thermal) energy θ of the generator. This happens all the time, independent of any alarm or tripping decisions. The module trips if for the tripping delay time t_{trip} – which is dependent on θ – the following conditions are all fulfilled:
 1. The negative sequence current I_2 is above the set threshold » I_2/FLA « **and**
 2. the calculated thermal energy θ exceeds a maximum value θ_{max} , which is calculated based on the setting K for the thermal load capability.

- For $\theta = 0$ the tripping delay time is calculated as follows:

$$t_{trip} = \frac{K}{\left(\frac{I_2}{FLA}\right)^2}$$

t_{trip} = tripping delay in seconds

K = thermal load capability of the generator while running with 100% unbalanced load current. This is an intrinsic property of the generator, and therefore it must be specified as a setting value (Setting Group parameter » K «). It should be possible to obtain this value from the data sheet of the generator.

FLA = Full Load Amperage

I_2 = unbalanced load current I_2 (calculated from measured current values).

- In case of a still present residual heat, $\theta > 0$, the tripping delay t_{trip} is reduced accordingly, so that an earlier tripping occurs.
- As long as the unbalanced load current I_2 is **greater** than the threshold » I_2/FLA « it is assumed that the generator is *heating up*. During this phase, the heat (thermal) energy is calculated by an integration of the current value I_2 :

$$\theta(t) = \theta_{0,cool} + f \cdot \int |\vec{I}_2|^2 dt$$

$\theta(t)$ = actual value of the thermal energy,

$\theta_{0,cool}$ = initial value at the beginning of the heating phase,
 i. e. the thermal energy at the end of the last cooling-down phase
 (or = 0, if the last cooling-down phase has ended, see below,
 or if there has not been any cooling-down phase yet),

f = scaling factor.

- As long as the unbalanced load current $I2$ is **less** than the threshold » $I2/FLA$ « it is assumed that the generator is *cooling down*. During this phase, the heat (thermal) energy is calculated based on a cooling-down constant. This constant is another intrinsic property of the generator, and therefore it must be specified as a setting value (Setting Group parameter » $T-cool$ «):

$$\theta(t) = \theta_{0,heat} \cdot e^{-\frac{t}{\tau_{cool}}}$$

$\theta(t)$ = actual value of the thermal energy,

$\theta_{0,heat}$ = initial value at the beginning of the cooling-down phase,
 i. e. the thermal energy at the end of the last heating-up phase

T_{cool} = generator property, setting value » $T-cool$ «.

- The cooling-down phase always continues as long as $I2$ is below the threshold, i. e. $\theta(t)$ is calculated continuously. (Only after $\theta(t)$ has dropped below $0.01 \cdot \theta_{max}$ the calculation ends and θ gets reset to 0, i. e. a subsequent heating-up phase will start with initial value $\theta_{0,cool} = 0$.)

NOTICE The heat (thermal) energy is an auxiliary value that is calculated and maintained internally, i. e. it can neither be displayed at the HMI nor be retrieved via any communication protocol.

The parameters described above can be set in the menu [Protection Para/Set(x)/Unbalance-Prot/46G-I.Unbalance].

Moreover, the following parameters can be set:

» $Tmin$ «: This is the minimum operate time of this element. The element will not operate before this time expires. This is set to prevent false trips for faults that would be cleared normally by system protections.

» $Tmax$ «: This is the maximum operate time of this element. This setting can be applied to limit the maximum tripping time for low level unbalances.

Generator unbalance tripping curves

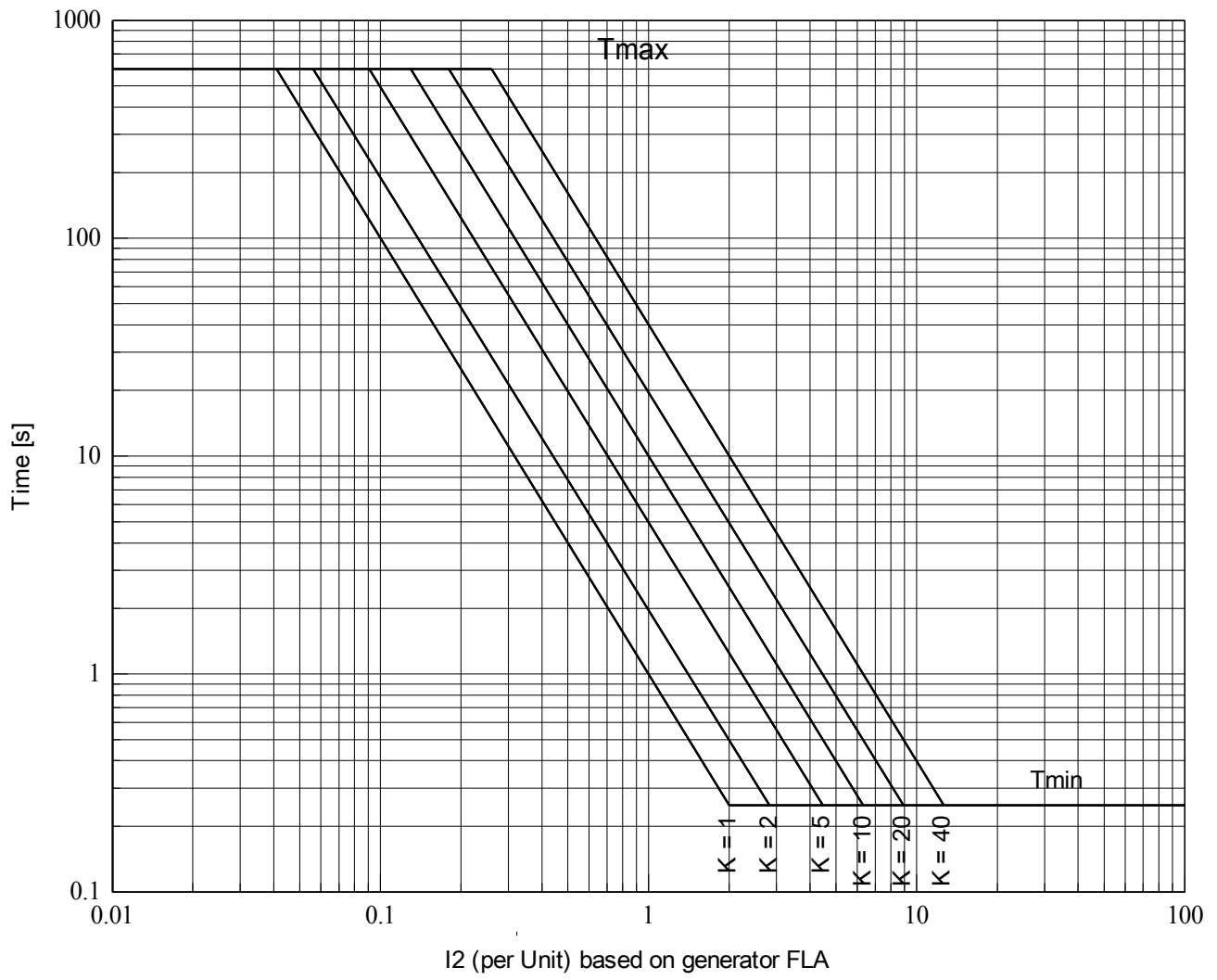

Setting example for generator unbalance 46G

Given generator data as follows:

Generator MVA rating (from Generator name plate or data sheet):	$S_{Gn} = 30 \text{ MVA}$
Generator rated voltage (from Generator name plate or data sheet):	$U_{Gn} = 4160 \text{ V}$
Generator rated current (FLA, to be calculated):	$I_{Gn} = S_{Gn} / (\sqrt{3} * U_{Gn}) = 4163.6 \text{ A}$
Generator continuous current unbalance capability: (from Generator name plate or data sheet)	8% = Pickup = <u>0.08</u>
Generator unbalance fault capability: (from Generator name plate or data sheet)	10 s (permissible $I^2 * t$) = K-value = <u>10</u>
Unbalance reset (cooling) time constant: (from Generator name plate or data sheet)	$\tau_{\text{cool}} = 240 \text{ s} = \text{K-reset} = \underline{240}$
Maximum allowed tripping time at unbalance pickup: (please see unbalance tripping curves)	$T_{\text{max}} = \underline{600 \text{ s}}$
Minimum allowed tripping time at unbalance pickup: (please see unbalance tripping curves)	$T_{\text{min}} = \underline{0.25 \text{ s}}$

NOTICE

All double underlined values have to be set in the menu [Protection Para/Set(x)/Unbalance-Prot/46G[2]-I.Unbalance]

46G[1]...[n]
 name = 46G[1]...[n]

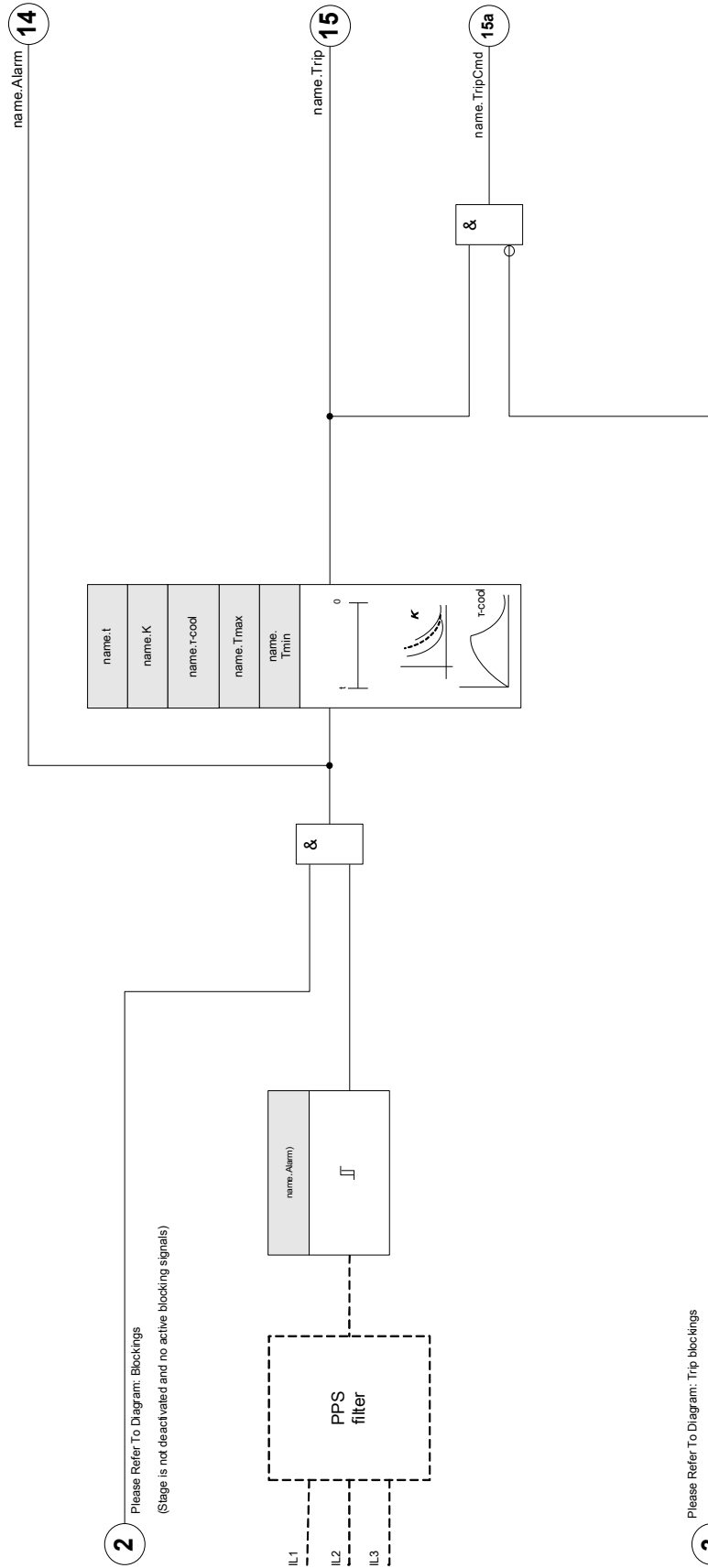



Elements:

I2>G[1] ,I2>G[2]

Device Planning Parameters of the 46G - Definite Time Element







Parameter	Description	Options	Default	Menu path
Mode 	Mode	do not use, use	do not use	[Device planning]

Global Protection Parameters of the 46G - Definite Time Element

Parameter	Description	Setting range	Default	Menu path
ExBlo1 	External blocking of the module, if blocking is activated (allowed) within a parameter set and if the state of the assigned signal is true.	1..n, Assignment List	-.-	[Protection Para /Global Prot Para /I-Prot /I2>G[1]]
ExBlo2 	External blocking of the module, if blocking is activated (allowed) within a parameter set and if the state of the assigned signal is true.	1..n, Assignment List	-.-	[Protection Para /Global Prot Para /I-Prot /I2>G[1]]
ExBlo TripCmd 	External blocking of the Trip Command of the module/the stage, if blocking is activated (allowed) within a parameter set and if the state of the assigned signal is true.	1..n, Assignment List	-.-	[Protection Para /Global Prot Para /I-Prot /I2>G[1]]

Setting Group Parameters of the 46G - Definite Time Element

Parameter	Description	Setting range	Default	Menu path
Function 	Permanent activation or deactivation of module/stage.	inactive, active	inactive	[Protection Para /<1..4> /I-Prot /I2>G[1]]

Parameter	Description	Setting range	Default	Menu path
 ExBlo Fc	Activate (allow) or inactivate (disallow) blocking of the module/stage. This parameter is only effective if a signal is assigned to the corresponding global protection parameter. If the signal becomes true, those modules/stages are blocked that are parameterized "ExBlo Fc=active".	inactive, active	inactive	[Protection Para /<1..4> /I-Prot /I2>G[1]]
 Blo TripCmd	Permanent blocking of the Trip Command of the module/stage.	inactive, active	inactive	[Protection Para /<1..4> /I-Prot /I2>G[1]]
 ExBlo TripCmd Fc	Activate (allow) or inactivate (disallow) blocking of the module/stage. This parameter is only effective if a signal is assigned to the corresponding global protection parameter. If the signal becomes true, those modules/stages are blocked that are parameterized "ExBlo TripCmd Fc=active".	inactive, active	inactive	[Protection Para /<1..4> /I-Prot /I2>G[1]]
 I2/FLA	Generator/motor unbalance current pickup value based on the full load current(FLA) (Setting from Continuous Unbalance Current Capability) Only available if: I2>.CurrentBase = Protected Object Rating	0.000 - 1.000Ib	0.08Ib	[Protection Para /<1..4> /I-Prot /I2>G[1]]
 K	This setting is the negative sequence capability constant. This value is normally provided by the generator manufacturer. Only available if: Characteristic = INV	1.00 - 200.00s	10.0s	[Protection Para /<1..4> /I-Prot /I2>G[1]]
 τ-cool	If the unbalanced load current falls below the pickup value, the cooling-off time is taken into account. If the unbalanced load exceeds the pickup value again, than the saved heat within the electrical equipment will lead to an accelerated trip. Only available if: Characteristic = INV	0.0 - 60000.0s	240.0s	[Protection Para /<1..4> /I-Prot /I2>G[1]]
 Tmax	Maximum operating time for inverse characteristics which limit the tripping time for low level unbalance. Only available if: Characteristic = INV	0.00 - 1000.00s	600.00s	[Protection Para /<1..4> /I-Prot /I2>G[1]]

Parameter	Description	Setting range	Default	Menu path
Tmin 	Minimum operating time for inverse characteristics which prevent false trips for faults that would be cleared normally by system protection. Only available if: Characteristic = INV	0.00 - 50.00s	0.25s	[Protection Para /<1..4> /I-Prot /I2>G[1]]

46G - Definite Time Element Element Input States

Name	Description	Assignment via
ExBlo1-I	Module input state: External blocking1	[Protection Para /Global Prot Para /I-Prot /I2>G[1]]
ExBlo2-I	Module input state: External blocking2	[Protection Para /Global Prot Para /I-Prot /I2>G[1]]
ExBlo TripCmd-I	Module input state: External Blocking of the Trip Command	[Protection Para /Global Prot Para /I-Prot /I2>G[1]]

46G - Definite Time Element Element Signals (Output States)

Signal	Description
active	Signal: active
ExBlo	Signal: External Blocking
Blo TripCmd	Signal: Trip Command blocked
ExBlo TripCmd	Signal: External Blocking of the Trip Command
Alarm	Signal: Alarm Negative Sequence
Trip	Signal: Trip
TripCmd	Signal: Trip Command

Commissioning: Generator Unbalance Module

Object to be tested:

Test of the generator unbalance protection function.

Necessary means:

- Three-phase current source with adjustable current unbalance; and
- Timer.

Procedure:

Check the phase sequence:

- Ensure that the phase sequence is the same as that set in the field parameters.
- Feed-in a three-phase nominal current.
- Change to the »Measuring Values« menu.
- Check the measuring value for the unbalanced current » I_2 Fund.«. The measuring value displayed for » I_2 Fund.« should be approximately zero (within the physical measuring accuracy).

NOTICE

If the displayed magnitude for I_2 Fund. is the same as that for the balanced nominal currents fed to the relay, it implies that the phase sequence of the currents seen by the relay is reversed.

- Now turn-off phase A.
- Again check the measuring value of the unbalanced current » I_2 Fund.« in the »Measuring Values« menu. The measuring value of the unbalanced current » I_2 Fund.« should now be 33%.
- Turn-on phase A, but turn-off phase B.
- Once again check the measuring value of the unbalanced current I_2 Fund. in the »Measuring Values« menu. The measuring value of the asymmetrical current » I_2 Fund.« should be again 33%.
- Turn-on phase B, but turn-off phase C.
- Again check the measuring value of unbalanced current » I_2 Fund.« in the »Measuring Values« menu. The measuring value of the unbalanced current » I_2 Fund.« should still be 33%.

Testing the trip delay inverse time element 46G:

- Set a K-value, e. g. K-value = 5
- Calculate the resulting tripping time acc. to the *Generator unbalance tripping curves* or to the following formula

$$t_{trip} = \frac{K}{\left(\frac{I_2}{FLA}\right)^2} \quad - \text{ in this example: } \quad t_{trip} = \frac{5 \text{ s}}{(0.33)^2} = 46 \text{ s}$$

- Apply a balanced three-phase current system (nominal currents).
- Switch off IA (the threshold value »*Threshold*« for »*I2 Fund.*« must be below 33%).
- The present current unbalance »*I2 Fund.*« corresponds with 1/3 of the existing phase current displayed.

Measure if the tripping time corresponds to the calculated tripping delay.

Successful test result:

The measured trip delays are within the permitted deviations/tolerances, specified under Technical Data.

LoE - Loss of Excitation [40]

NOTICE

If the loss of excitation is to be used in work two zones, the User has to use a 40-Z1 and a 40-Z2 element.

This flexible protective function detects the partial or complete loss of excitation using a pair (Z1 and Z2) of Offset mho circles. Because of balanced feature under loss-of-excitation conditions the »*positive phase sequence impedances*« are measured and used to set the Offset mho zones.

There are four protective elements available: two Z1 elements (40-Z1[1/2]) and two Z2 elements (40-Z2[1/2]), so that two independent, complete loss of excitation functions can be realized if needed.

Each of the four 40-elements offers an adjustable Offset mho characteristic with its tripping time delay »*t-Z*« and a *voltage-controlled tripping acceleration* »*V< Acc Trip*« function. The »*Mho diameter*« and »*Mho Offset*« determines the operating zone of an Offset mho characteristic. The Offset of a mho characteristic can be set from -250 Ohm to +250 Ohm which determines the location of the mho circle on the reactance axis. A negative Offset setting makes the mho characteristic on the III and IV quarters with a minus Offset to the original (ref. to Z1/Z2 mho circle in option 1), whereas a positive Offset setting makes the mho circle stretched into the I and II quarters with a plus Offset to original (ref. to Z2 mho circle in option 2). A trip for the corresponding zone occurs if the measured positive sequence impedance is inside the mho zone longer than the set time delay »*t-Z*«. The voltage controlled feature “accelerates”, if enabled, the tripping with the set time »*t-V<*« (that is usually set less than »*t-Z*«) if the positive sequence voltage is below the voltage control setting »*V<*«. The purpose of the voltage control is to have a faster tripping in case the reactive power consumption of the generator causes significant low voltage.

The two 40-Z2 elements offer additionally a directional feature that can be enabled or disabled. This “directional blinder” »*Z directional*« is provided to block the relay operation in case of slightly under-excitations by using a positive Offset mho zone (ref. to Z2 in option 2). In case of a negative Offset, the direction is implied and a directional element is not required therefore. The angle »*Dir Angle*« for determining the direction can be set in a range from -20° to 0.

The time delay for Z2 Offset mho elements has to be set long enough to prevent a malfunction (faulty tripping) e.g.: during power swing.

LoE

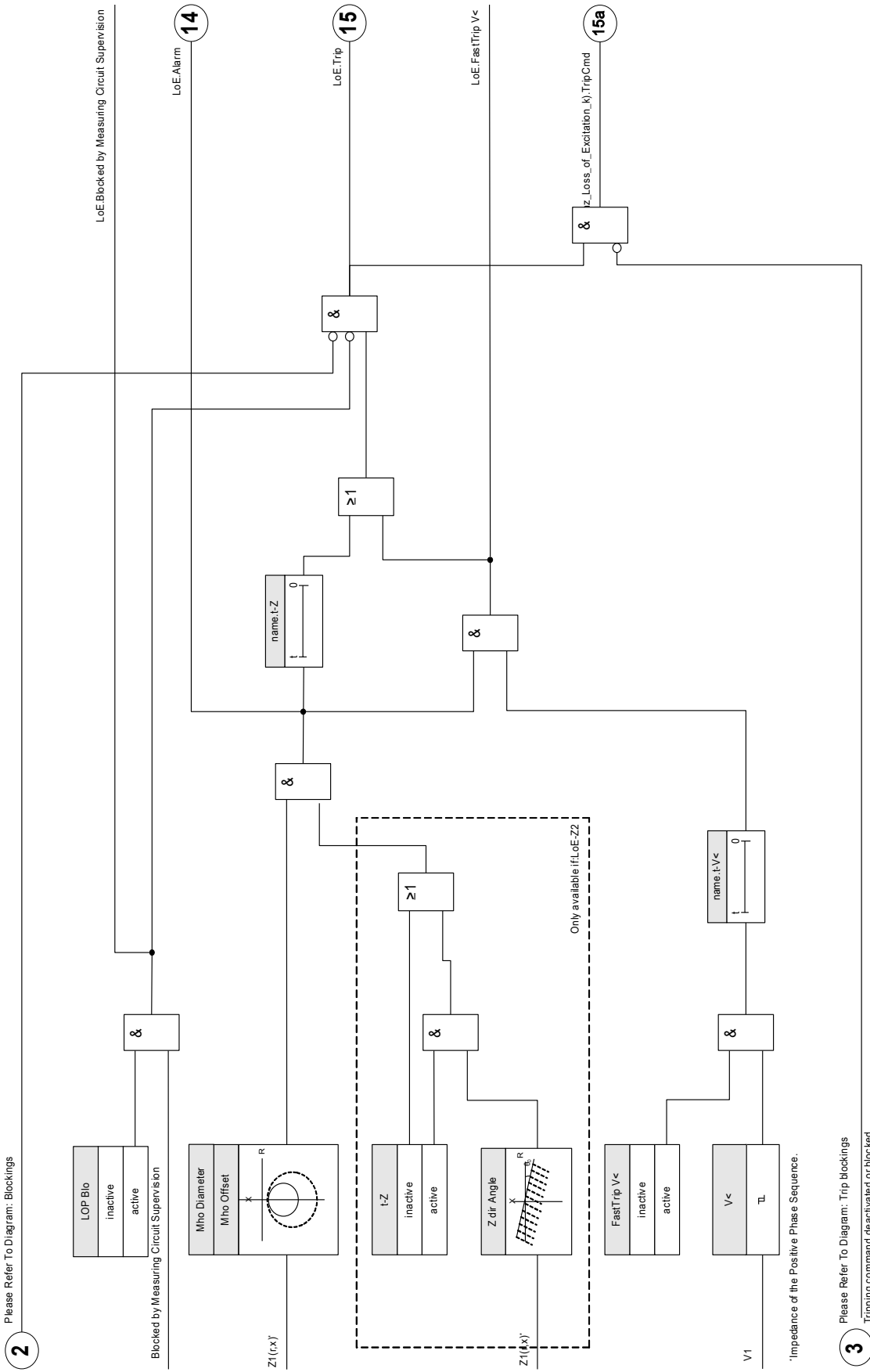

Application Notes

1. The 40 protective function provides loss-of-excitation protection in two options:
 - For generator-bus connection (option 1) and
 - For generator and unit transformer connection (option 2).
2. To set the loss of excitation function properly, the following generator and system data should be available:
 - Generator transient reactance x'_d ;
 - Generator synchronous reactance x_d ;
 - Generator rated voltage (phase-to-phase);
 - Generator rated current (FLA);
 - Current transformer (CT ratio);
 - Voltage transformer (VT ratio); and
 - Step-up transformer reactance XT(In case of option 2).
3. All impedance settings are secondary relay quantities and can be derived from the following formula:
$$Z_{SEC} = Z_{PRI} \times (RC \div RV)$$

Where:

 - Z_{SEC} = Set impedance in secondary ohms;
 - Z_{PRI} = Set impedance in primary ohms;
 - RC = Current transformer ratio; and
 - RV = Voltage transformer ratio.
4. By setting an mho circle, the diameter should be set greater than the Offset of the circle. This is usually also the case in the real applications.

Setting Example for Loss of Excitation Function

Generator Technical Data:

MVA:	200 MVA
Voltage (Ph-Ph):	15.75 kV
Generator rated current (FLA):	$200 \text{ MVA} / (\sqrt{3} * 15.75 \text{ kV}) = 7331 \text{ A}$
X'd:	0.2428 pu
Xd:	1.908 pu
CT ratio:	8000 A/1 A = 8000
PT ratio:	15800 V/100 V = 158

Setting Calculation:

Primary Base Impedance:	$Z_{b,Prim} = \text{Base kV}^2 / \text{Base MVA} = (15.75 \text{ kV})^2 / 200 \text{ MVA} = 1.24 \Omega$
Secondary Base Impedance:	$Z_{b,Sec} = Z_{b,Prim} * \text{CT/PT} = 1.24 \Omega * 8000 / 158 = 62.78 \Omega$
Transient Reactance in secondary:	$X'_{d,Sec} = X'_d * Z_{b,Sec} = 0.2408 \text{ pu} * 62.78 \Omega = 15.12 \Omega$
Synchronous Reactance in secondary:	$X_{d,Sec} = X_d * Z_{b,Sec} = 1.908 \text{ pu} * 62.78 \Omega = 119.78 \Omega$

Setting Recommendation:

Zone 1 Settings (40-Z1[1]):

Mho Offset:	$-X'_{d,Sec}/2 = -7.6 \Omega$
Mho Diameter:	$1.0 \text{ pu} = Z_{b,Sec} = 62.8 \Omega$
t-Z:	0.25 s

Zone 2 Settings (40-Z2[1]):

Mho Offset:	$-X'_{d,Sec}/2 = -7.6 \Omega$
Mho Diameter:	$X_{d,Sec} = 119.8 \Omega$
t-Z:	1.0 s

Option 1 (generator)

The Offset for both mho-elements is $-X'_d \div 2$. X'_d is the (saturated) direct axis transient reactance of the generator.

The diameter of the smaller circle (40-Z1) is set at 1.0 pu impedance on the generator base. The purpose of this element is to detect the loss of excitation in a range from full load to approx. 30%. The protection will be very fast if the delay time is set very short. The diameter of the second (larger) circle (40-Z2) is set to X_d .

X_d is the (unsaturated) direct axis synchronous reactance of the generator. The purpose of the second mho element is to detect the loss of excitation in a range from full load to nearly 0% load. A time delay of approximately 30 to 60 cycles (40-Z2) prevents malfunction on stable swings. The time delay with voltage control is to be set shorter than the other time delay.

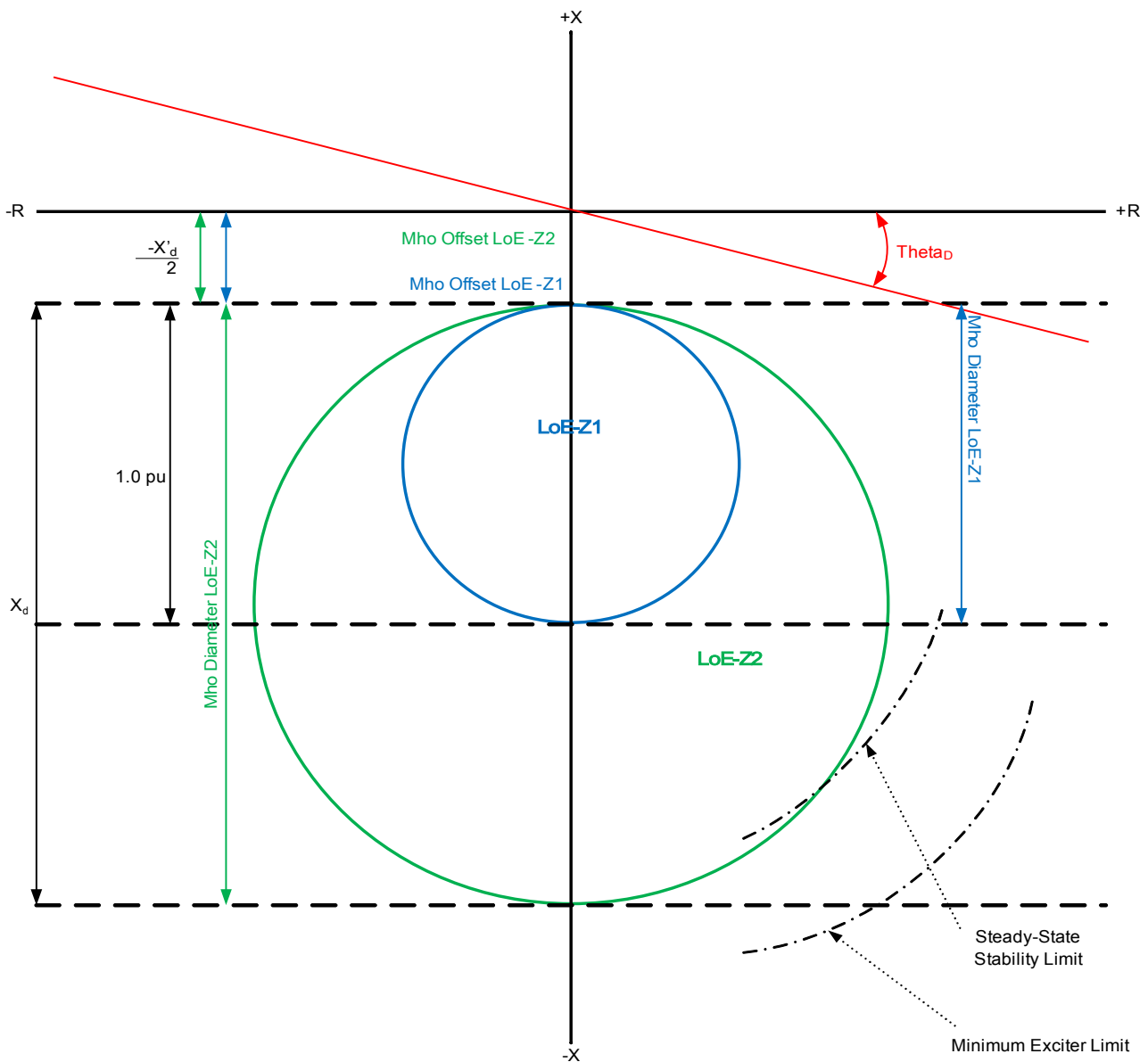

Option 2 (generator and unit transformer)

In this approach, one of the mho elements is set with an Offset of $-X'_d \div 2$, a diameter of $1.1 X_d - (X'_d \div 2)$ and a time delay of 10 to 30 cycles. The second circle (40-Z2) coordinates the minimum excitation limit of the generator with the steady state limit of the generator. The diameter of this element is nearly equal to $(1.1 X_d + X_T)$. The proper coordination requires to set the Offset of this element positive. The positive Offset is set typically equal to the reactance (XT) of the transformer unit.

A time delay of approximately 30 to 60 cycles prevents malfunction on stable swings.

If the voltage control is used, the following time settings are suggested additionally to the standard delay times.

	<u>40-Z1</u>	<u>40-Z2</u>
Voltage Control	--	80-90% of the nominal voltage
»t-Z«	250 ms	60 s
»t-V« (with accelerated trip/voltage control)	Disable	1 s

Typical setting is 13° (0.974 power factor). This setting is common to both element 40-Z1 and 40-Z2. Option1 can also be used for 40-Z1, and option2 for 40-Z1. Thus a better coordination with the limits of AVR, generator capabilities and steady state stability limits can be achieved.

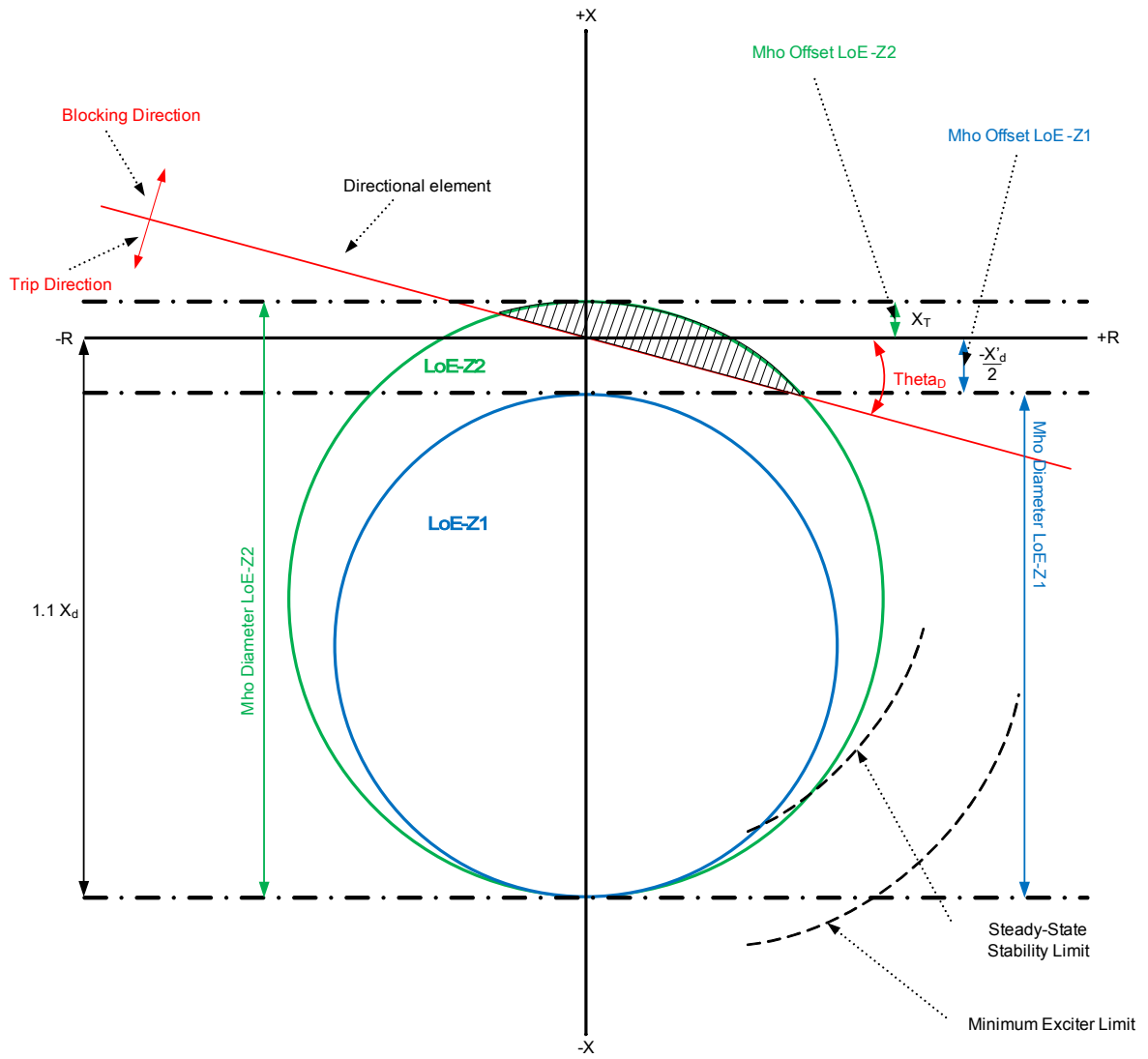



Available 40Z1 Elements
 LoE-Z1[1] ,LoE-Z1[2]

Device Planning Parameters of the 40Z1 Element





Parameter	Description	Options	Default	Menu path
Mode 	Mode	do not use, use	do not use	[Device planning]



Global Protection Parameters of the 40Z1 Element

Parameter	Description	Setting range	Default	Menu path
ExBlo1 	External blocking of the module, if blocking is activated (allowed) within a parameter set and if the state of the assigned signal is true.	1..n, Assignment List	-.-	[Protection Para /Global Prot Para /LoE-Prot /LoE-Z1[1]]
ExBlo2 	External blocking of the module, if blocking is activated (allowed) within a parameter set and if the state of the assigned signal is true.	1..n, Assignment List	-.-	[Protection Para /Global Prot Para /LoE-Prot /LoE-Z1[1]]
ExBlo TripCmd 	External blocking of the Trip Command of the module/the stage, if blocking is activated (allowed) within a parameter set and if the state of the assigned signal is true.	1..n, Assignment List	-.-	[Protection Para /Global Prot Para /LoE-Prot /LoE-Z1[1]]

Setting Group Parameters of the 40Z1 Element

Parameter	Description	Setting range	Default	Menu path
Function 	Permanent activation or deactivation of module/stage.	inactive, active	inactive	[Protection Para /<1..4> /LoE-Prot /LoE-Z1[1]]

Parameter	Description	Setting range	Default	Menu path
 ExBlo Fc	Activate (allow) or inactivate (disallow) blocking of the module/stage. This parameter is only effective if a signal is assigned to the corresponding global protection parameter. If the signal becomes true, those modules/stages are blocked that are parameterized "ExBlo Fc=active".	inactive, active	inactive	[Protection Para /<1..4> /LoE-Prot /LoE-Z1[1]]
 Blo TripCmd	Permanent blocking of the Trip Command of the module/stage.	inactive, active	inactive	[Protection Para /<1..4> /LoE-Prot /LoE-Z1[1]]
 ExBlo TripCmd Fc	Activate (allow) or inactivate (disallow) blocking of the module/stage. This parameter is only effective if a signal is assigned to the corresponding global protection parameter. If the signal becomes true, those modules/stages are blocked that are parameterized "ExBlo TripCmd Fc=active".	inactive, active	inactive	[Protection Para /<1..4> /LoE-Prot /LoE-Z1[1]]
 Meas Circuit Superv	Activates the use of the measuring circuit supervision. In this case the module will be blocked if a measuring circuit supervision module (e.g. LOP, VTS) signals a disturbed measuring circuit (e.g. caused by a fuse failure).	inactive, active	inactive	[Protection Para /<1..4> /LoE-Prot /LoE-Z1[1]]
 Mho Diameter	Mho Zone diameter in ohm (secondary value). Diameter of the impedance circle.	0.2 - 750.0Ω	13.4Ω	[Protection Para /<1..4> /LoE-Prot /LoE-Z1[1]]
 Mho Offset	Mho Zone offset reactance in ohm (secondary value).	-250.0 - +250.0Ω	-2.5Ω	[Protection Para /<1..4> /LoE-Prot /LoE-Z1[1]]
 t-Z	Mho Zone pickup time delay.	0.00 - 400.00s	0.25s	[Protection Para /<1..4> /LoE-Prot /LoE-Z1[1]]

Parameter	Description	Setting range	Default	Menu path
FastTrip V< 	Mho Zone Accelerated trip for loss of voltage active or inactive.	inactive, active	inactive	[Protection Para /<1..4> /LoE-Prot /LoE-Z1[1]]
V< 	Mho Zone Voltage pickup level Only available if: FastTrip V< = active	0.01 - 2.00Vn	0.80Vn	[Protection Para /<1..4> /LoE-Prot /LoE-Z1[1]]
t-V< 	Trip Delay for the Undervoltage Only available if: FastTrip V< = active	0.00 - 300.00s	0.00s	[Protection Para /<1..4> /LoE-Prot /LoE-Z1[1]]

40Z1 Element Input States

Name	Description	Assignment via
ExBlo1-I	Module input state: External blocking1	[Protection Para /Global Prot Para /LoE-Prot /LoE-Z1[1]]
ExBlo2-I	Module input state: External blocking2	[Protection Para /Global Prot Para /LoE-Prot /LoE-Z1[1]]
ExBlo TripCmd-I	Module input state: External Blocking of the Trip Command	[Protection Para /Global Prot Para /LoE-Prot /LoE-Z1[1]]

40Z1 Element Signals (Output States)

Signal	Description
active	Signal: active
ExBlo	Signal: External Blocking
Blo TripCmd	Signal: Trip Command blocked
ExBlo TripCmd	Signal: External Blocking of the Trip Command
Alarm	Signal: Alarm Loss of Excitation

Signal	Description
Trip	Signal: Trip
TripCmd	Signal: Trip Command
FastTrip V<	Signal: FastTrip V<
Blo by MeasCircSupv	Blocked by Measuring Circuit Supervision

Available 40Z2 Elements
 LoE-Z2[1] ,LoE-Z2[2]

Device Planning Parameters of the 40Z2 Elements

Parameter	Description	Options	Default	Menu path
Mode	Mode	do not use, use	do not use	[Device planning]



Global Protection Parameters of the 40Z2 Elements

Parameter	Description	Setting range	Default	Menu path
ExBlo1	External blocking of the module, if blocking is activated (allowed) within a parameter set and if the state of the assigned signal is true.	1..n, Assignment List	.-	[Protection Para /Global Prot Para /LoE-Prot /LoE-Z2[1]]
ExBlo2	External blocking of the module, if blocking is activated (allowed) within a parameter set and if the state of the assigned signal is true.	1..n, Assignment List	.-	[Protection Para /Global Prot Para /LoE-Prot /LoE-Z2[1]]
ExBlo TripCmd	External blocking of the Trip Command of the module/the stage, if blocking is activated (allowed) within a parameter set and if the state of the assigned signal is true.	1..n, Assignment List	.-	[Protection Para /Global Prot Para /LoE-Prot /LoE-Z2[1]]



Setting Group Parameters of the 40Z2 Elements

Parameter	Description	Setting range	Default	Menu path
Function 	Permanent activation or deactivation of module/stage.	inactive, active	inactive	[Protection Para /<1..4> /LoE-Prot /LoE-Z2[1]]
ExBlo Fc 	Activate (allow) or inactivate (disallow) blocking of the module/stage. This parameter is only effective if a signal is assigned to the corresponding global protection parameter. If the signal becomes true, those modules/stages are blocked that are parameterized "ExBlo Fc=active".	inactive, active	inactive	[Protection Para /<1..4> /LoE-Prot /LoE-Z2[1]]
Blo TripCmd 	Permanent blocking of the Trip Command of the module/stage.	inactive, active	inactive	[Protection Para /<1..4> /LoE-Prot /LoE-Z2[1]]
ExBlo TripCmd Fc 	Activate (allow) or inactivate (disallow) blocking of the module/stage. This parameter is only effective if a signal is assigned to the corresponding global protection parameter. If the signal becomes true, those modules/stages are blocked that are parameterized "ExBlo TripCmd Fc=active".	inactive, active	inactive	[Protection Para /<1..4> /LoE-Prot /LoE-Z2[1]]
Meas Circuit Superv 	Activates the use of the measuring circuit supervision. In this case the module will be blocked if a measuring circuit supervision module (e.g. LOP, VTS) signals a disturbed measuring circuit (e.g. caused by a fuse failure).	inactive, active	inactive	[Protection Para /<1..4> /LoE-Prot /LoE-Z2[1]]
Mho Diameter 	Mho Zone diameter in ohm (secondary value). Diameter of the impedance circle.	0.2 - 750.0Ω	25.0Ω	[Protection Para /<1..4> /LoE-Prot /LoE-Z2[1]]
Mho Offset 	Mho Zone offset reactance in ohm (secondary value).	-250.0 - +250.0Ω	-2.5Ω	[Protection Para /<1..4> /LoE-Prot /LoE-Z2[1]]

Parameter	Description	Setting range	Default	Menu path
t-Z 	Mho Zone pickup time delay.	0.00 - 400.00s	60.0s	[Protection Para /<1..4> /LoE-Prot /LoE-Z2[1]]
Z directional 	Mho Zone Directional Supervision active or inactive.	inactive, active	inactive	[Protection Para /<1..4> /LoE-Prot /LoE-Z2[1]]
Z dir Angle 	Mho Zone Directional Supervision Angle. Only available if: Z dir Angle = active	-20 - 0°	-10°	[Protection Para /<1..4> /LoE-Prot /LoE-Z2[1]]
FastTrip V< 	Mho Zone Accelerated trip for loss of voltage active or inactive.	inactive, active	active	[Protection Para /<1..4> /LoE-Prot /LoE-Z2[1]]
V< 	Mho Zone Voltage pickup level Only available if: FastTrip V< = active	0.01 - 2.00Vn	0.80Vn	[Protection Para /<1..4> /LoE-Prot /LoE-Z2[1]]
t-V< 	Trip Delay for the Undervoltage Only available if: FastTrip V< = active	0.00 - 300.00s	1.0s	[Protection Para /<1..4> /LoE-Prot /LoE-Z2[1]]

40Z2 Element Input States

Name	Description	Assignment via
ExBlo1-I	Module input state: External blocking1	[Protection Para /Global Prot Para /LoE-Prot /LoE-Z2[1]]

<i>Name</i>	<i>Description</i>	<i>Assignment via</i>
ExBlo2-I	Module input state: External blocking2	[Protection Para /Global Prot Para /LoE-Prot /LoE-Z2[1]]
ExBlo TripCmd-I	Module input state: External Blocking of the Trip Command	[Protection Para /Global Prot Para /LoE-Prot /LoE-Z2[1]]

40Z2 Element Signals (Output States)

<i>Signal</i>	<i>Description</i>
active	Signal: active
ExBlo	Signal: External Blocking
Blo TripCmd	Signal: Trip Command blocked
ExBlo TripCmd	Signal: External Blocking of the Trip Command
Alarm	Signal: Alarm Loss of Excitation
Trip	Signal: Trip
TripCmd	Signal: Trip Command
FastTrip V<	Signal: FastTrip V<
Blo by MeasCircSupv	Blocked by Measuring Circuit Supervision

ThR-Protection Module: Thermal Replica [49]

ThR

The maximal permissible thermal loading capacity, and consequently the tripping delay of a component, depends on the amount of the flowing current at a specific time, the »previously existing load (current)« as well as on a constant specified by the component.

The thermal overload protection is in compliance with IEC255-8 (VDE 435 T301). A complete thermal replica function is implemented in the device as Homogeneous-Body Replica of the equipment to be protected and by taking the previously existing load into account. The protection function is of one step design, provided with a warning limit.

For this the device calculates the thermal load of the equipment by using the existing measured values and the parameter settings. When knowing the thermal constants, the temperature of the equipment can be established (simulated).

The general tripping times of the overload protection can be gathered from the following equation according to IEC 255-8:

$$t = \tau\text{-warm} \ln\left(\frac{I^2 - I_p^2}{I^2 - (K \cdot I_b)^2}\right)$$

Legend:

t = Tripping delay

$\tau\text{-warm}$ = Warming-up time constant

$\tau\text{-cool}$ = Cooling time constant

I_b = Base current: Maximum permissible thermal continuous current.

K = Overload Factor: The maximum thermal limit is defined as $k \cdot I_b$, the product of the overload factor and the base current .

I = measured current (x ln)

I_p = Preload Current

Thr

name = Thr

2

Please Refer To Diagram: Blockings
(Stage is not deactivated and no active blocking signals)

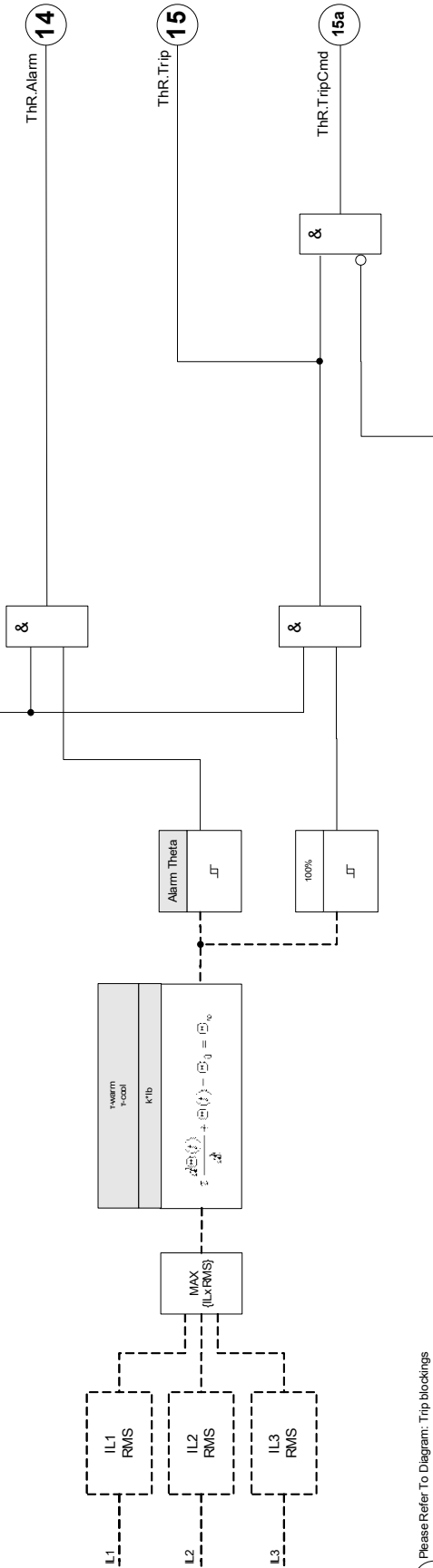

3

Please Refer To Diagram: Trip blockings
(Tripping command deactivated or blocked.)





Direct Commands of the Thermal Overload Module

<i>Parameter</i>	<i>Description</i>	<i>Setting range</i>	<i>Default</i>	<i>Menu path</i>
Reset 	Reset the Thermal Replica	inactive, active	inactive	[Operation /Reset]





Device Planning Parameters of the Thermal Overload Module

<i>Parameter</i>	<i>Description</i>	<i>Options</i>	<i>Default</i>	<i>Menu path</i>
Mode 	Mode	do not use, use	do not use	[Device planning]



Global Protection Parameters of the Thermal Overload Module

<i>Parameter</i>	<i>Description</i>	<i>Setting range</i>	<i>Default</i>	<i>Menu path</i>
CT Winding Side 	Measuring values will be used from this winding side	CT Ntrl, CT Mains	CT Ntrl	[Protection Para /Global Prot Para /I-Prot /ThR]
ExBlo1 	External blocking of the module, if blocking is activated (allowed) within a parameter set and if the state of the assigned signal is true.	1..n, Assignment List	-.-	[Protection Para /Global Prot Para /I-Prot /ThR]
ExBlo2 	External blocking of the module, if blocking is activated (allowed) within a parameter set and if the state of the assigned signal is true.	1..n, Assignment List	-.-	[Protection Para /Global Prot Para /I-Prot /ThR]
ExBlo TripCmd 	External blocking of the Trip Command of the module/the stage, if blocking is activated (allowed) within a parameter set and if the state of the assigned signal is true.	1..n, Assignment List	-.-	[Protection Para /Global Prot Para /I-Prot /ThR]

Setting Group Parameters of the Thermal Overload Module

Parameter	Description	Setting range	Default	Menu path
Function 	Permanent activation or deactivation of module/stage.	inactive, active	inactive	[Protection Para /<1..4> /I-Prot /ThR]
ExBlo Fc 	Activate (allow) or inactivate (disallow) blocking of the module/stage. This parameter is only effective if a signal is assigned to the corresponding global protection parameter. If the signal becomes true, those modules/stages are blocked that are parameterized "ExBlo Fc=active".	inactive, active	inactive	[Protection Para /<1..4> /I-Prot /ThR]
Blo TripCmd 	Permanent blocking of the Trip Command of the module/stage.	inactive, active	inactive	[Protection Para /<1..4> /I-Prot /ThR]
ExBlo TripCmd Fc 	Activate (allow) or inactivate (disallow) blocking of the module/stage. This parameter is only effective if a signal is assigned to the corresponding global protection parameter. If the signal becomes true, those modules/stages are blocked that are parameterized "ExBlo TripCmd Fc=active".	inactive, active	inactive	[Protection Para /<1..4> /I-Prot /ThR]
Ib 	Base current: Maximum permissible thermal continuous current.	0.01 - 4.00In	1.00In	[Protection Para /<1..4> /I-Prot /ThR]
K 	Overload Factor: The maximum thermal limit is defined as $k \cdot I_B$, the product of the overload factor and the base current.	0.80 - 1.50	1.00	[Protection Para /<1..4> /I-Prot /ThR]
Alarm Theta 	Pickup value	50 - 100%	80%	[Protection Para /<1..4> /I-Prot /ThR]

Protective Elements

<i>Parameter</i>	<i>Description</i>	<i>Setting range</i>	<i>Default</i>	<i>Menu path</i>
τ -warm 	Warming-up time constant	1 - 60000s	10s	[Protection Para /<1..4> /I-Prot /ThR]
τ -cool 	Cooling time constant	1 - 60000s	10s	[Protection Para /<1..4> /I-Prot /ThR]

Thermal Overload Module Input States

<i>Name</i>	<i>Description</i>	<i>Assignment via</i>
ExBlo1-I	Module input state: External blocking1	[Protection Para /Global Prot Para /I-Prot /ThR]
ExBlo2-I	Module input state: External blocking2	[Protection Para /Global Prot Para /I-Prot /ThR]
ExBlo TripCmd-I	Module input state: External Blocking of the Trip Command	[Protection Para /Global Prot Para /I-Prot /ThR]

Signals of the Thermal Overload Signals (Output States)

<i>Signal</i>	<i>Description</i>
active	Signal: active
ExBlo	Signal: External Blocking
Blo TripCmd	Signal: Trip Command blocked
ExBlo TripCmd	Signal: External Blocking of the Trip Command
Alarm	Signal: Alarm Thermal Overload
Trip	Signal: Trip
TripCmd	Signal: Trip Command
Res Thermal Cap	Signal: Resetting Thermal Replica

Thermal Overload Module Values

<i>Value</i>	<i>Description</i>	<i>Menu path</i>
Thermal Cap Used	Measured value: Thermal Capacity Used	[Operation /Measured Values /ThR]
Time To Trip	Measured value (calculated/measured): Remaining time until the thermal overload module will trip	[Operation /Measured Values /ThR]

Thermal Overload Module Statistics

<i>Value</i>	<i>Description</i>	<i>Menu path</i>
Thermal Cap max	Thermal Capacity maximum value	[Operation /Statistics /Max /ThR]

Commissioning: Thermal Replica

Object to be tested

Protective function *ThR*

Necessary means

- Three-phase current source
- Timer

Procedure

Calculate the tripping time for the current to be constantly impressed by using the formula for the thermal image.

NOTICE The parameter of the temperature rise of the component » $\Delta\theta$ « has to be known to guarantee an optimal protection.

$$t = \tau\text{-warm} \ln\left(\frac{I^2 - I_p^2}{I^2 - (K \cdot I_b)^2}\right)$$

Legend:

t = Tripping delay

τ -warm = Warming-up time constant

τ -cool = Cooling time constant

I_b = Base current: Maximum permissible thermal continuous current.

K = Overload Factor: The maximum thermal limit is defined as k * I_B, the product of the overload factor and the base current .

I = measured current (x ln)

I_p = Preload Current

Testing the threshold values

Apply the current you have based your mathematical calculation on.

Testing the trip delay

NOTICE The thermal capacity should be zero before the test is started. See »Measuring Values«.

For testing the trip delay, a timer is to be connected to the contact of the associated trip relay.

Apply the current you have based your mathematical calculation on. The timer is started as soon as the current is applied and it is stopped when the relay trips.

Successful test result

The calculated tripping time and the fallback ratio comply with the measured values. For permissible deviations/tolerances, please see Technical Data.

V/f> - Volts/Hertz [24]

Available Elements

V/f>[1], V/f>[2]

This protective element of the device provides over-excitation protection for the generator and unit connected transformers. It incorporates two elements that can be programmed to specific times and used to create traditional, two-step over-excitation protection.

In addition, the protective elements can be programmed as inverse time elements to provide advanced protection by approximating closely the combined generator/unit transformer over-excitation curve. Standard inverse time curves can be selected along with a linear reset rate that may be programmed to match the specific machine cooling characteristics.

The percent pickup is based on the Nominal Voltage and Frequency settings. The V/Hz function provides reliable measurements of V/Hz up to 200% for a frequency range of 5 - 70 Hz.

Characteristic / Curve Shape: INV A

$$t = \frac{t\text{-multiplier}}{\left(\frac{\frac{V / V_n}{f / f_N}}{V/f>} \right)^{-1}^2}$$

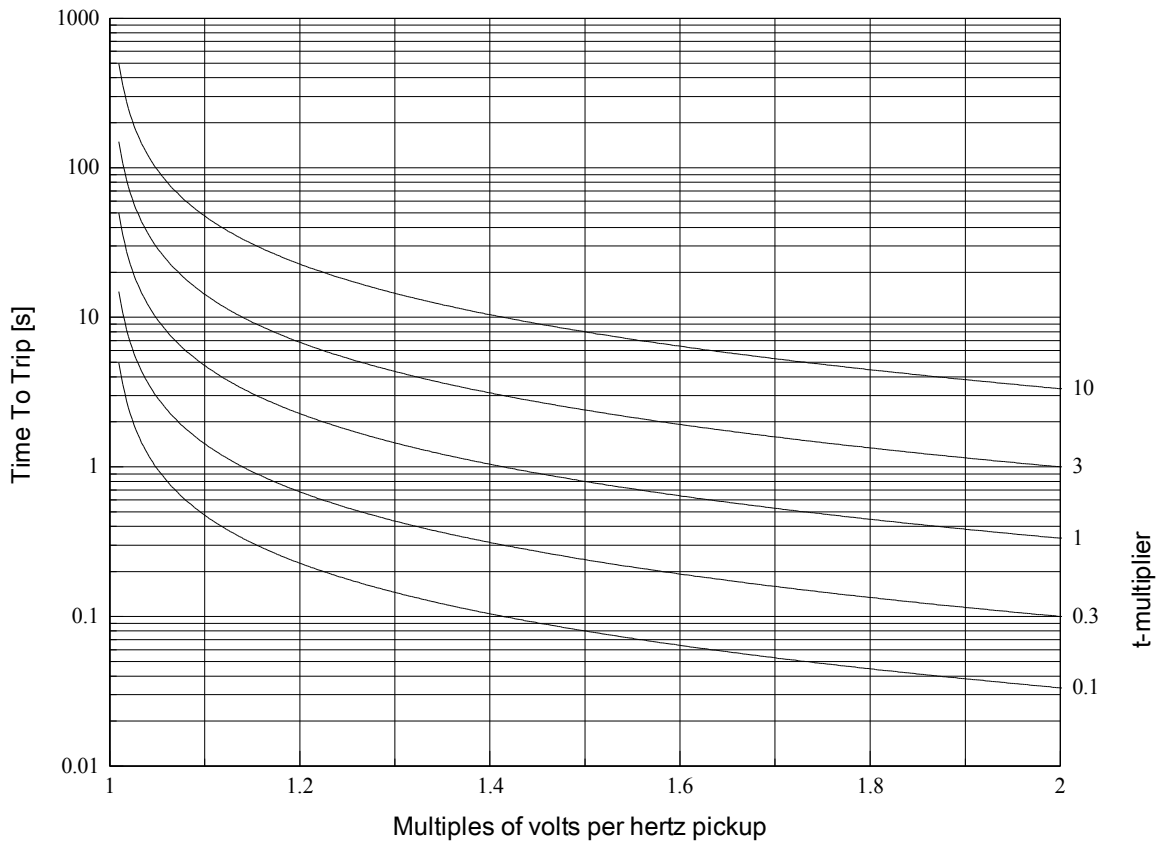

Characteristic / Curve Shape: INV B

$$t = \frac{\text{t-multiplier}}{\left(\frac{\frac{V / V_n}{f / f_N}}{V/f} \right)^{-1}}$$

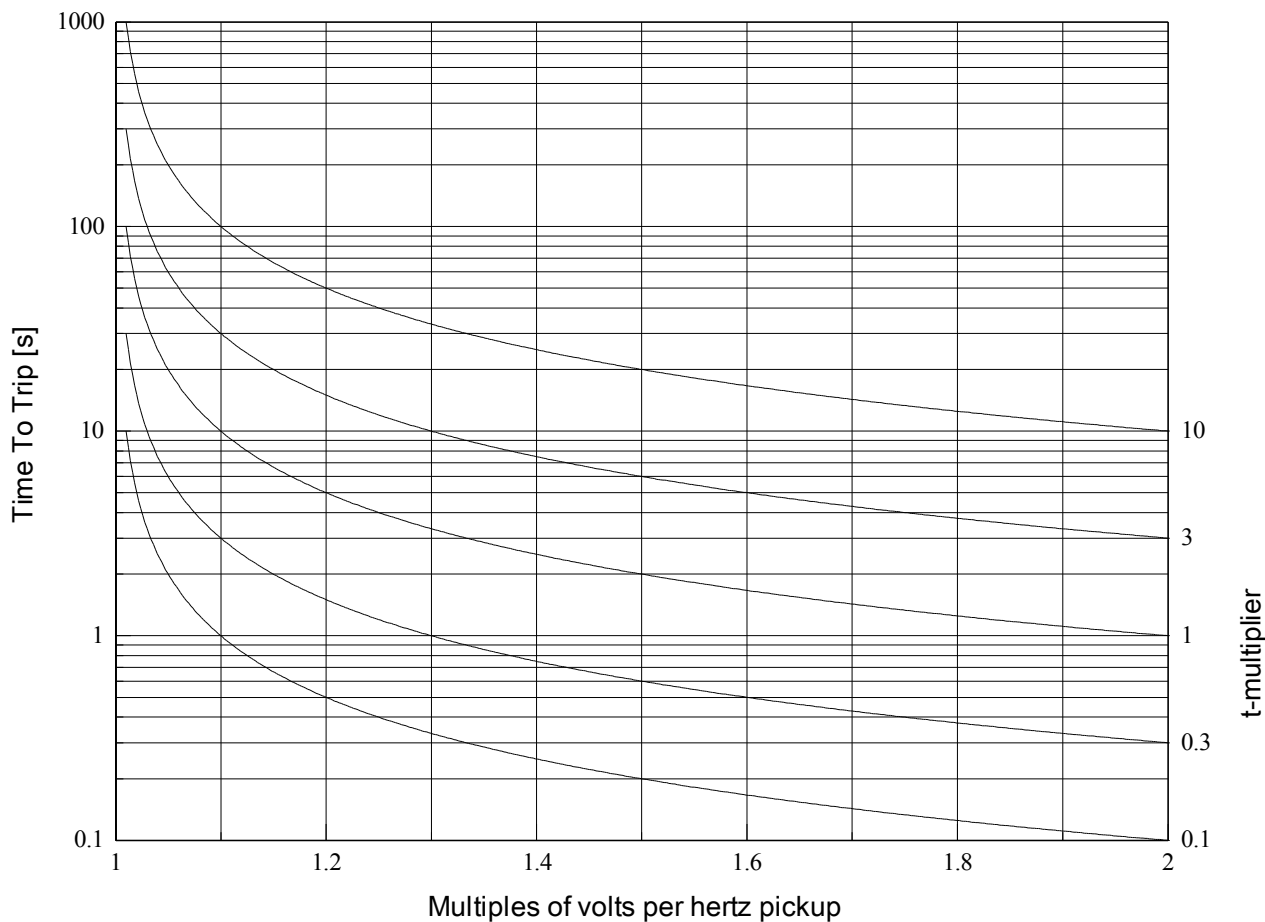

Characteristic / Curve Shape: INV C

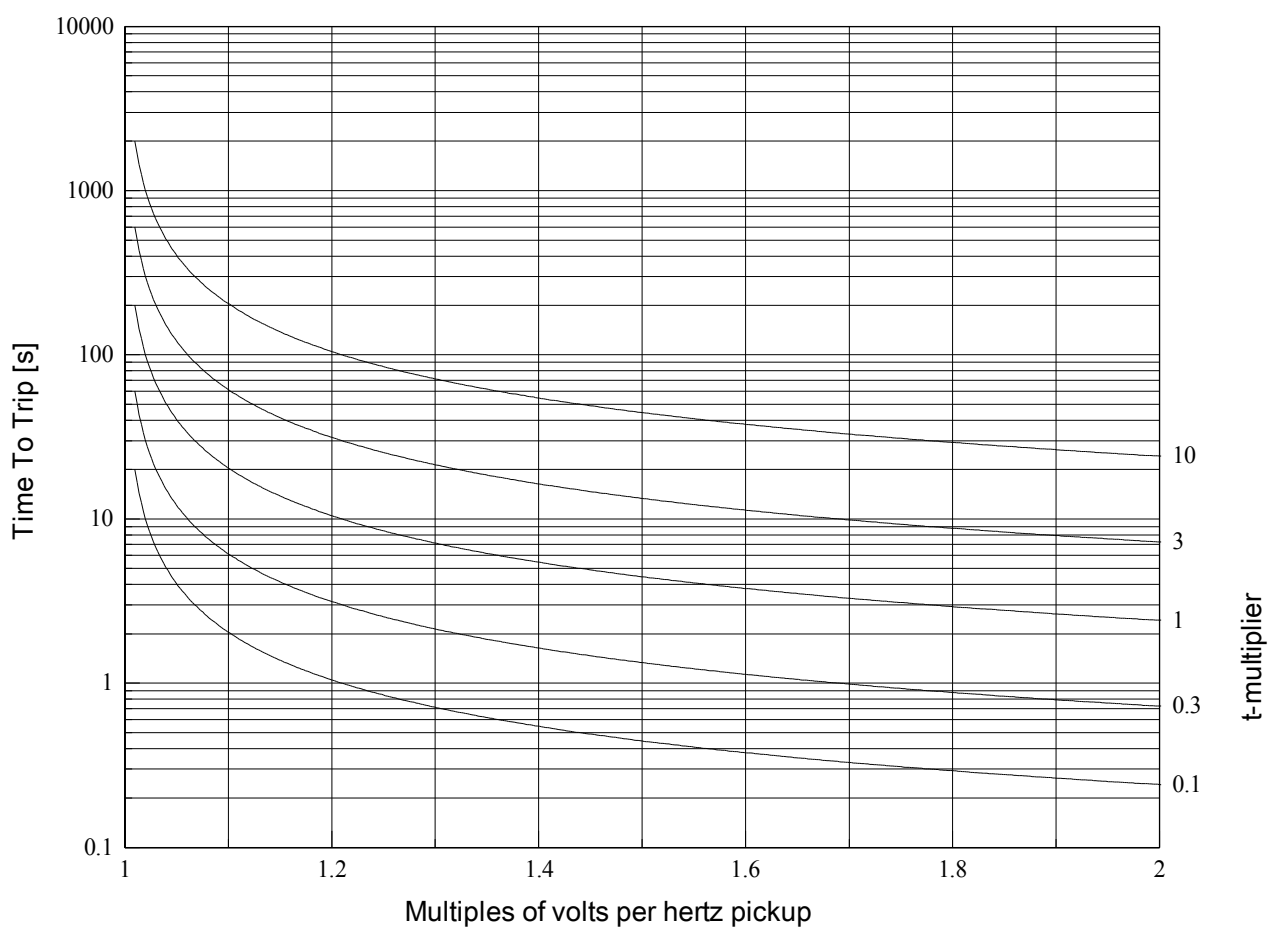

$$t = \frac{\text{t-multiplier}}{\left(\frac{\frac{V / V_n}{f / f_N}}{V/f} \right)^{-1}}^{0.5}$$



Device Planning Parameters of the Volts/Hertz Element







Parameter	Description	Options	Default	Menu path
Mode 	Mode	do not use, use	do not use	[Device planning]

Global Protection Parameters of the Volts/Hertz Element

Parameter	Description	Setting range	Default	Menu path
ExBlo1 	External blocking of the module, if blocking is activated (allowed) within a parameter set and if the state of the assigned signal is true.	1..n, Assignment List	-.-	[Protection Para /Global Prot Para /V/f>-Prot /V/f>[1]]
ExBlo2 	External blocking of the module, if blocking is activated (allowed) within a parameter set and if the state of the assigned signal is true.	1..n, Assignment List	-.-	[Protection Para /Global Prot Para /V/f>-Prot /V/f>[1]]
ExBlo TripCmd 	External blocking of the Trip Command of the module/the stage, if blocking is activated (allowed) within a parameter set and if the state of the assigned signal is true.	1..n, Assignment List	-.-	[Protection Para /Global Prot Para /V/f>-Prot /V/f>[1]]

Setting Group Parameters of the Volts/Hertz Element

Parameter	Description	Setting range	Default	Menu path
Function 	Permanent activation or deactivation of module/stage.	inactive, active	inactive	[Protection Para /<1..4> /V/f>-Prot /V/f>[1]]

Parameter	Description	Setting range	Default	Menu path
 ExBlo Fc	Activate (allow) or inactivate (disallow) blocking of the module/stage. This parameter is only effective if a signal is assigned to the corresponding global protection parameter. If the signal becomes true, those modules/stages are blocked that are parameterized "ExBlo Fc=active".	inactive, active	inactive	[Protection Para /<1..4> /V/f>-Prot /V/f>[1]]
 Blo TripCmd	Permanent blocking of the Trip Command of the module/stage.	inactive, active	inactive	[Protection Para /<1..4> /V/f>-Prot /V/f>[1]]
 ExBlo TripCmd Fc	Activate (allow) or inactivate (disallow) blocking of the module/stage. This parameter is only effective if a signal is assigned to the corresponding global protection parameter. If the signal becomes true, those modules/stages are blocked that are parameterized "ExBlo TripCmd Fc=active".	inactive, active	inactive	[Protection Para /<1..4> /V/f>-Prot /V/f>[1]]
 V/f>	If the value is exceeded, the element will be started.	80.0 - 400.0%	100.0%	[Protection Para /<1..4> /V/f>-Prot /V/f>[1]]
 Curve Shape	Tripping characteristics of V/f Over-Excitation protection.	DEFT, Inv A, Inv B, Inv C	DEFT	[Protection Para /<1..4> /V/f>-Prot /V/f>[1]]
 t	Tripping delay Only available if: Characteristic = DEFT	0.00 - 600.00s	1.00s	[Protection Para /<1..4> /V/f>-Prot /V/f>[1]]
 t-multiplier	Time Multiplier for inverse characteristics. Only available if: Characteristic = INV	0.05 - 600.00	1.00	[Protection Para /<1..4> /V/f>-Prot /V/f>[1]]

Parameter	Description	Setting range	Default	Menu path
t-reset 	Reset time for inverse characteristics. Only available if: Characteristic = INV	0.0 - 1000.0s	1.0s	[Protection Para /<1..4> /V/f>-Prot /V/f>[1]]

Input States of the Volts/Hertz Element

Name	Description	Assignment via
ExBlo1-I	Module input state: External blocking1	[Protection Para /Global Prot Para /V/f>-Prot /V/f>[1]]
ExBlo2-I	Module input state: External blocking2	[Protection Para /Global Prot Para /V/f>-Prot /V/f>[1]]
ExBlo TripCmd-I	Module input state: External Blocking of the Trip Command	[Protection Para /Global Prot Para /V/f>-Prot /V/f>[1]]

Signals of the Volts/Hertz (Output States)

Signal	Description
active	Signal: active
ExBlo	Signal: External Blocking
Blo TripCmd	Signal: Trip Command blocked
ExBlo TripCmd	Signal: External Blocking of the Trip Command
Alarm	Signal: Alarm Overexcitation
Trip	Signal: Trip
TripCmd	Signal: Trip Command

InEn - Inadvertent Energization [50/27]

InEn

What does inadvertent energization mean?

Inadvertent energization of a synchronous generator means, that the stator winding of the generator is connected to the power system accidentally/unintendedly.

Inadvertent energization may be caused by the following events:

- Malfunctions within the control circuits
- Flashovers within the breaker -especially large generators (high voltages)
- Gen-set control malfunctions
- Mistakes by operators

What are the serious consequences of inadvertent energization?

If a synchronous generator that stands still or is close to standstill is energized inadvertent, then the generator will be accelerated like an induction machine. If a synchronous generator is energized while he stands still or is close to standstill, high currents will flow, similar to starting currents of a starting induction machine. As a consequence of that the armature/rotor winding or even the entire gen-set might be damaged within seconds.

How to prevent inadvertent energization?

By means of a special logic that evaluates overcurrent, undervoltage and/or the state of the breaker. See block diagram.

The inadvertent energization is an overcurrent element that is released or blocked by a logic. The logic comprises a pickup and a dropout timer. The logic can be applied in two different variants to detect, that the generator is taken out of service:

- »Undervoltage« and »Breaker status Open« or
- »Undervoltage« or »Breaker Status«

By means of the »Arming Signal«, the user can choose between those two above mentioned options. The OR-Logic might be used if the voltage transformers are mounted on the line side.

InEn

name = InEn

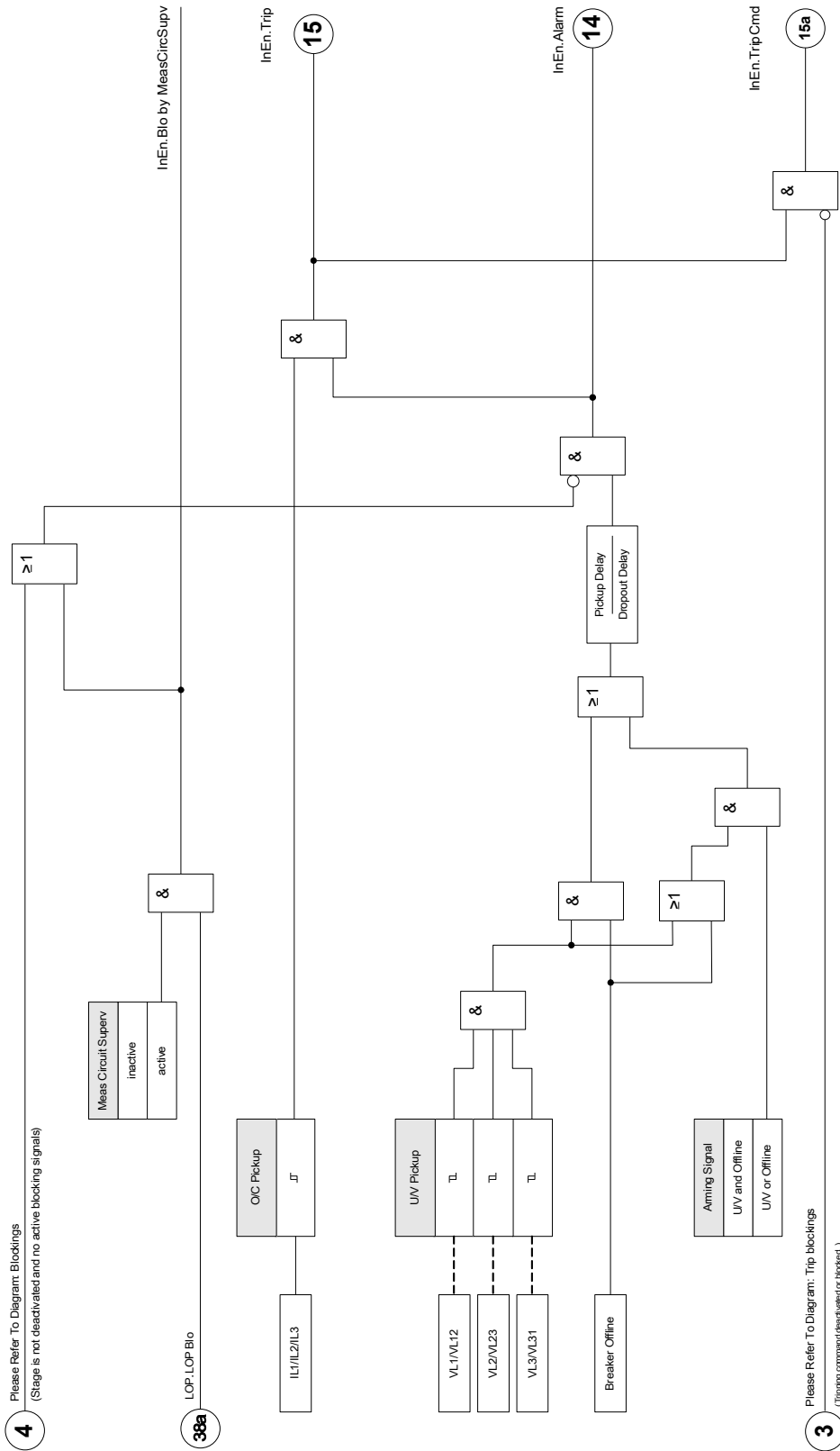

4 Please Refer To Diagram: Blockings
(Stage is not deactivated and no active blocking signals)





38a LOP, LOP Blo

3 Please Refer To Diagram: Trip blockings
(Tripping command devalued or blocked)

Device Planning Parameters of the Inadvertent Energization



Parameter	Description	Options	Default	Menu path
Mode 	Mode	do not use, use	do not use	[Device planning]

Global Protection Parameters of the Inadvertent Energization

Parameter	Description	Setting range	Default	Menu path
ExBlo1 	External blocking of the module, if blocking is activated (allowed) within a parameter set and if the state of the assigned signal is true.	1..n, Assignment List	-.-	[Protection Para /Global Prot Para /InEn]
ExBlo2 	External blocking of the module, if blocking is activated (allowed) within a parameter set and if the state of the assigned signal is true.	1..n, Assignment List	-.-	[Protection Para /Global Prot Para /InEn]
ExBlo TripCmd 	External blocking of the Trip Command of the module/the stage, if blocking is activated (allowed) within a parameter set and if the state of the assigned signal is true.	1..n, Assignment List	-.-	[Protection Para /Global Prot Para /InEn]
Assigned SG 	Assigned Switchgear	-.-, SG[1].Pos, SG[2].Pos, SG[3].Pos, SG[4].Pos, SG[5].Pos, SG[6].Pos	SG[1].Pos	[Protection Para /Global Prot Para /InEn]

Setting Group Parameters of the Inadvertent Energization

Parameter	Description	Setting range	Default	Menu path
 Function	Permanent activation or deactivation of module/stage.	inactive, active	inactive	[Protection Para /<1..4> /InEn]
 ExBlo Fc	Activate (allow) or inactivate (disallow) blocking of the module/stage. This parameter is only effective if a signal is assigned to the corresponding global protection parameter. If the signal becomes true, those modules/stages are blocked that are parameterized "ExBlo Fc=active".	inactive, active	inactive	[Protection Para /<1..4> /InEn]
 Blo TripCmd	Permanent blocking of the Trip Command of the module/stage.	inactive, active	inactive	[Protection Para /<1..4> /InEn]
 ExBlo TripCmd Fc	Activate (allow) or inactivate (disallow) blocking of the module/stage. This parameter is only effective if a signal is assigned to the corresponding global protection parameter. If the signal becomes true, those modules/stages are blocked that are parameterized "ExBlo TripCmd Fc=active".	inactive, active	inactive	[Protection Para /<1..4> /InEn]
 Arming Signal	Select if the protection is going to be enabled by "U/V and offline" or "U/V or offline".	U/V and Offline, U/V or Offline	U/V and Offline	[Protection Para /<1..4> /InEn]
 O/C Pickup	Typical pickup setting is 0.5 amps. No coordination is required with other protection since this function is only operational when the generator is off-line.	0.05 - 3.00In	0.05In	[Protection Para /<1..4> /InEn]
 U/V Pickup	The purpose of the undervoltage detector is to determine whether the unit is connected to the system. The voltage level during this accidental energization depends on the system strength. Typical setting is 50%-70% of rated voltage (in some cases, it may be set as low as 20%.)	0.20 - 0.99Vn	0.5Vn	[Protection Para /<1..4> /InEn]

Parameter	Description	Setting range	Default	Menu path
 Pickup Delay	The pickup time delay is the time for the undervoltage unit to operate to arm the protection.	0.00 - 300.00s	5.00s	[Protection Para /<1..4> /InEn]
 Dropout Delay	The dropout time delay is the time for the unit to operate to disarm the protection when the voltage is increased above the pickup value or the generator is brought on-line.	0.00 - 300.00s	0.25s	[Protection Para /<1..4> /InEn]
 Meas Circuit Superv	Activates the use of the measuring circuit supervision. In this case the module will be blocked if a measuring circuit supervision module (e.g. LOP, VTS) signals a disturbed measuring circuit (e.g. caused by a fuse failure).	inactive, active	inactive	[Protection Para /<1..4> /InEn]

Inputs of the Inadvertent Energization

Name	Description	Assignment via
ExBlo1-I	Module input state: External blocking1	[Protection Para /Global Prot Para /InEn]
ExBlo2-I	Module input state: External blocking2	[Protection Para /Global Prot Para /InEn]
ExBlo TripCmd-I	Module input state: External Blocking of the Trip Command	[Protection Para /Global Prot Para /InEn]

Signals (Output States) of the Inadvertent Energization

Signal	Description
active	Signal: active
ExBlo	Signal: External Blocking
Blo TripCmd	Signal: Trip Command blocked
ExBlo TripCmd	Signal: External Blocking of the Trip Command
Alarm	Signal: Inadvertent Energization
Trip	Signal: Trip
TripCmd	Signal: Trip Command

Protective Elements

<i>Signal</i>	<i>Description</i>
Blo by MeasCircSupv	Blocked by Measuring Circuit Supervision

OST – Out of Step Tripping [78]

Available elements:

OST

After disturbances in a power system, such as short-circuit faults and their tripping, power system oscillations (power swings) can happen between the generator concerned and the rest of the power system. Depending on the severity of system disturbances and the capability of the system reserve power a power system disturbance can either result in a controllable **stable power swing**, or extend to an **unstable power swing**. In the latter case the power transfer angle (generator rotor electrical angle δ) between the generator and the rest of the power system exceeds 180° .

A generator gets into the loss of synchronism (out of step or pole slipping) state if an unstable power swing occurs. During an unstable power swing the generator suffers from enormous voltage and current oscillations. The position of the electrical center is an indication of the severity of the event with respect to the generator. In worst cases, where the center is located in the generator step-up transformer or generator itself, the generator (and the generator step-up transformer) get under electrical and mechanical stresses almost like generator terminal three-phase short-circuit faults, and the generator is exposed to this condition during each slip cycle.

Out of step conditions should be detected as fast as possible to protect generators and turbines from potential damages due to high peak currents, pulsating torques and mechanical resonances, and the generator has to be disconnected from the power system as soon as possible.

Function

The Out of Step Tripping (“OST”, ANSI 78) module, which is available with this relay, is designed to detect such out-of-step (loss of synchronism/pole slip) conditions and to issue a tripping command in case of an unstable power swing event, to disconnect the generator from the system. Besides a well-known **blinder** characteristic, a special **dZ/dt** supervision algorithm is available to distinguish between a fault and a power swing condition. Even a fault during a power swing can be detected prior to the scheme declaring an unstable power swing condition inappropriately.

The best method for detecting out-of-step conditions of a generator is to measure and analyze the impedance trajectory at the generator terminal. Since power swing events can be characterized as symmetrical processes, only the **positive-sequence impedances** are calculated from the voltage and current positive-sequence components, and the moving trajectories of the impedance are evaluated. The OST module compares the positive-sequence impedances with a configured MHO (circle) characteristic with two blinder elements. Besides the system symmetry is monitored by evaluating the negative-phase sequence current continuously.

The general challenge for an Out of Step Tripping protection function is to distinguish an unstable power swing from the following conditions:

- Stable power swings
- Normal and heavily loaded operating conditions
- (3-phase) Short-circuit faults (including those occurring during power swings)

Impedance Location under Different System Conditions

Under normal operation conditions the load impedances dwell within a load region shown in the following diagram, and no significant impedance change rate is expected by different load conditions.

In case of a short-circuit fault in front of the generator, however, the impedances as viewed at the relay point change rapidly from the load region to a **fault region** which is located in very small range depending on the faulted distance to the relay point.

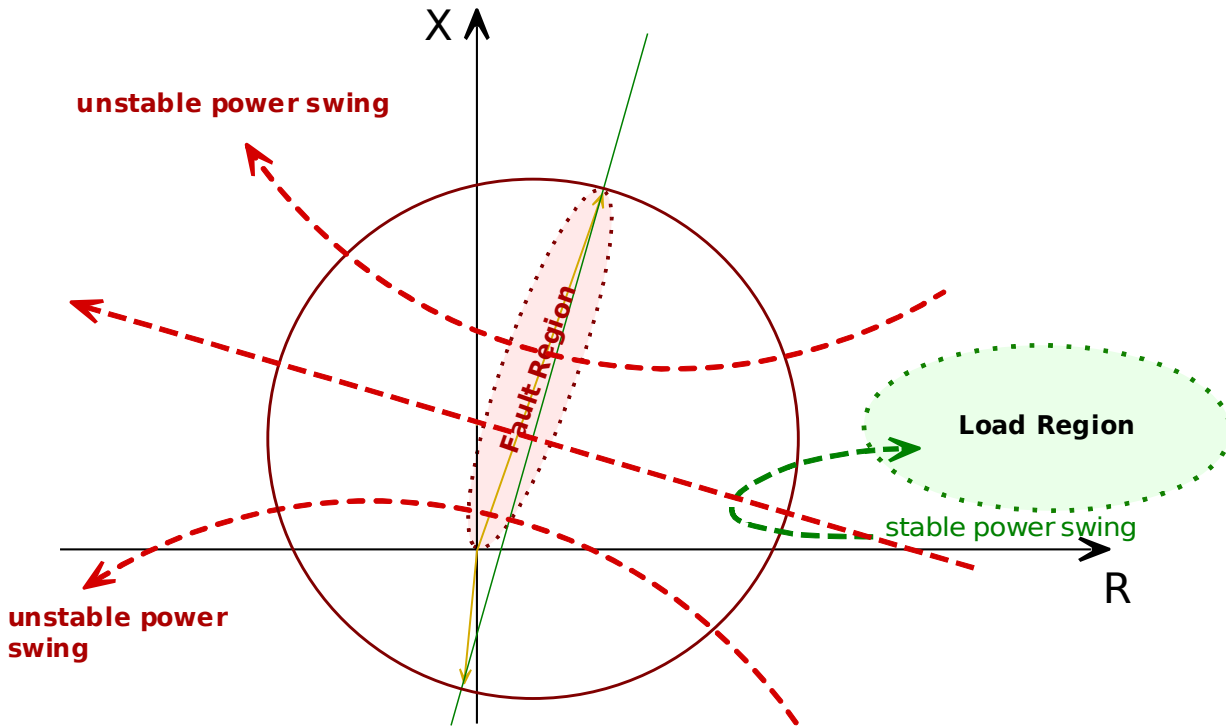

OutOfStep_Z01

Load Region and impedance trajectories.

The variation of the measured impedance during a power swing event (i. e. the swing impedance trajectory) moves as shown in the diagram above. The positive sequence impedance travels in the complex plane with rather slow speed, compared to the more or less instantaneous impedance change due to a fault. The impedance movement in case of a power swing depends on the slip frequency, the voltage variation between generator and system, the location of the system electrical center as well as the rotor angle displacement during the power swing. It is to note that the impedance trajectory during a power swing is nothing else than the power transfer angle movement. In other words: The generator rotor angle displacement (δ) can be indirectly measured by means of monitoring the moving trajectory of the positive-sequence impedance.

Stable and Unstable Power Swings

An out-of-step condition is recognized if an unstable power swing is detected. The criterion is that the rotor angle displacement (δ) exceeds 180° , or the measured impedance runs across the system impedance line on the impedance plane. A pole slipping is happening in this case.

A power swing is considered stable if a generator does not slip poles ($\delta < 180^\circ$) during power swing and the system reaches a new stable state of an acceptable operating conditions after swing fades away. No Out-Of-Step tripping is allowed for a stable power swing.

Out-of-Step Characteristic

For detecting out-of-step conditions, the two blinder elements and a supervisory MHO circle, as shown in the following diagram, work together as a double blinder scheme. The MHO circle together with the region to the right of **Blinder A** and the region to the left of **Blinder B** defines the out-of-step characteristic and should be configured carefully according to the individual application.

The MHO characteristic is usually set to be a circle with the electrical center as its middle point and with a diameter consisting of whole system impedances observed.

The two blinder elements (Blinder A and Blinder B) are two lines parallel to the system impedance line with settable distances from the system impedance line on the resistance axis.

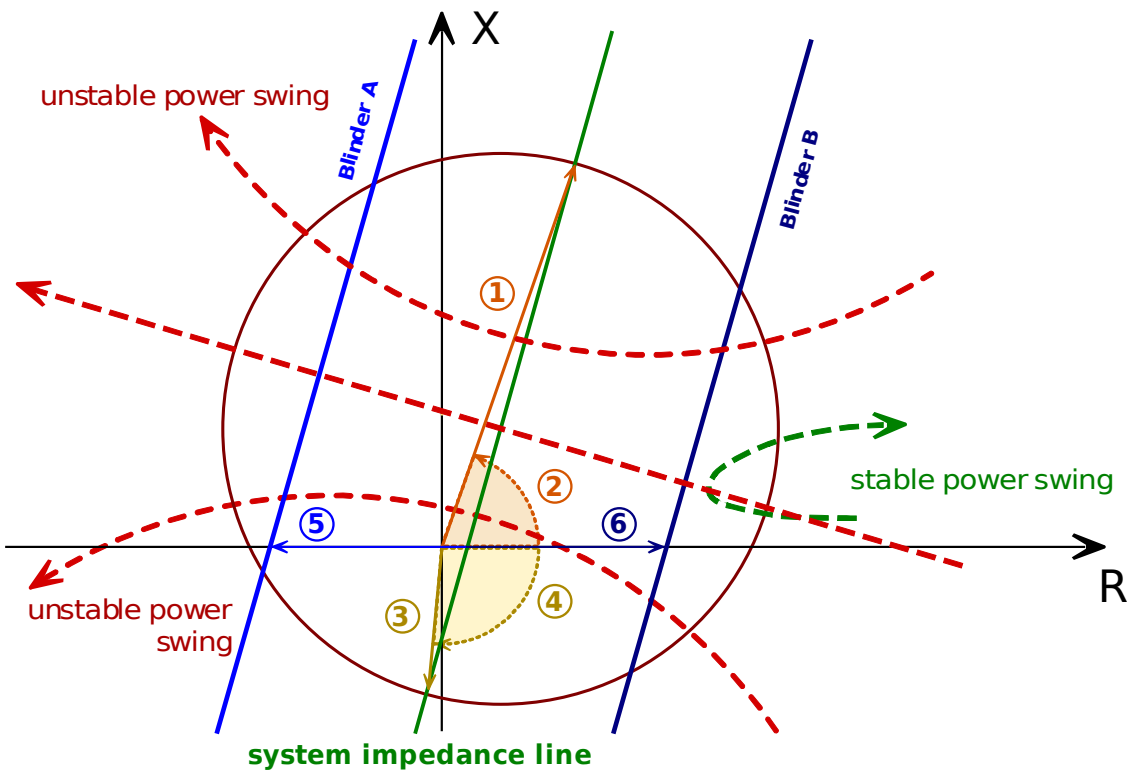

OutOfStep_Z02

Out-of-Step Characteristic and Single Blinder Scheme.

The lengths and angles marked by circled numbers are setting parameters as follows:

<i>Number in Diagram</i>	<i>Setting</i>	<i>Description</i>
[1]	<i>Mho Pos.Imp.Reach</i>	MHO characteristic: Positive Impedance Reach (secondary value).
[2]	<i>Mho Pos.Imp.Angle</i>	MHO characteristic: Positive Impedance Angle
[3]	<i>Mho Offs.Imp.Reach</i>	MHO characteristic: Offset Impedance Reach (secondary value).
[4]	<i>Mho Offs.Imp.Angle</i>	MHO characteristic: Offset Impedance Angle
[5]	<i>Blinder A</i>	Blinder (left) of the impedance zone (characteristic), defined as a value on the R-axis (secondary value).
[6]	<i>Blinder B</i>	Blinder (right) of the impedance zone (characteristic), defined as a value on the R-axis.

Detection Logic

The Out-of-Step function measures the positive sequence impedance at the generator terminal and analyzes the variation of the positive sequence impedance by an advanced logic. It tracks the development of measured impedance, evaluates the progressive change in the apparent impedance during a power swing, compares it with the preset out-of-step characteristic and finally decides whether the detected power swing is stable or unstable (out-of-step). Only unstable power swings lead to a trip.

The Case of a Typical Stable Power Swing

In case of a stable power swing, as shown (in green color) in the diagram “Out-of-Step Characteristic and Single Blinder Scheme” above, the measured impedance can enter the MHO circle from its right-hand side. This is signaled via the output signal »Swinging«. For a stable power swing, the measured impedance trajectory is experiencing a turnaround before it reaches the pole slipping line and the first blinder (stability limit), i. e. the trajectory changes its direction and travels back out of the MHO circle, on the same side as from which it had entered. The corresponding signal »Swinging« is reset when the impedance leaves the MHO circle. There is no tripping decision in this case.

The Case of a Typical Unstable Power Swing

In case of an unstable power swing, as shown (in red color) in the diagram “Out-of-Step Characteristic and Single Blinder Scheme” above, the trajectory enters the MHO circle (»Swinging« is set), then passes the first blinder (»Start« is set) and reaches the pole-slipping line of the Out of Step characteristic (»Pole slipping« indicates an unstable power swing). Some time later it passes through the second blinder element (»Operate« is set). This leads to the detection of an Out of Step condition, and a tripping command is issued. When a generator loses synchronism with the system the impedance locus is expected to travel from right to left through the Out of Step Tripping characteristic. If loss of synchronism happens while the generator is running in motoring mode, the impedance is expected to travel from left to right. Both cases can be detected with this Out of Step Tripping function. (However, in the latter case the function of the two blinders is obviously vice versa).

Operating Conditions

Power swings are not the only cause for the impedance trajectory entering the MHO circle. In case of a short-circuit fault, for instance, the trajectory can enter the MHO circle spontaneously and leave it again after a very short dwell time, whereas during a power swing the impedance travels in the impedance plane with a comparably slow pace. There are two timers that are used to distinguish between power swings and impedance changes that are due to faults or other system transients.

- The first timer measures the time that it takes the impedance trajectory to cross the distance between the border of the MHO circle and the first blinder. The OST characteristic works according to a double blinder scheme. If this time is longer than the set value of »Min. dwell time« a power swing is declared and the »Start« signal is issued. Otherwise the event is declared as a system fault which is signaled via »Blo min.dwell time«.
This principle requires that the blinders are within the MHO circle and that the »Min. dwell time« is coordinated with the impedance difference between the MHO circle and the blinder in conjunction with the maximum slip frequency.
- »Max. dwell time« supervises the maximum dwell time within the MHO circle during a slip cycle. If the timer elapses before the impedance leaves the MHO circle then the Out of Step module gets internally blocked until the impedance has left the MHO circle. This blocked state is marked by the signal »Int.blocked«.

The power swing detection works only if there is a sufficient positive sequence current. This limit is set via the parameter »I1 min«. Moreover, a negative sequence supervision avoids malfunction during unsymmetrical faults: The module is blocked if the measured negative-sequence current is above the setting »I2 max«. The default value of 20% for both »I1 min« and »I2 max« should be sufficient for most applications.

An additional method to distinguish faults from power swings is to block the OST module if the rate of change of impedance $\Delta Z/\Delta t$ is above a particular threshold »dZ/dt«. During a fault, the impedance changes very rapidly from the load impedance to the fault impedance, whereas during a power swing, the speed of the impedance trajectory is slower than in case of a fault, because it depends on the slip frequency, the rotor displacement angle and system impedances. There are two settings related to this feature:

- »Blo by dZ/dt« has to be set to “active” to activate the $\Delta Z/\Delta t$ blocking.
- »dZ/dt« is the setting for the $\Delta Z/\Delta t$ threshold value.

Short-Circuit Fault During Power Swings

It is important to distinguish between power swing events and short-circuit faults, to prevent unwanted OST tripping. This can be done by observing the change of the impedance, which is significantly faster for conventional faults than for power swings.

The impedance change during a power swing can be estimated (assuming two sources with equal magnitude, linear behavior between slip angle and slip frequency, etc.) with the following equation:

$$\frac{\Delta Z}{\Delta t} = \frac{\omega_s \cdot Z}{4 \cdot \left(\sin\left(\frac{\delta}{2}\right)\right)^2}$$

With:

- $\omega_s = 2\pi \cdot f_s$
- f_s : slip frequency
- Z : system impedance
- δ : slip angle

This shows that the impedance change depends on the slip frequency, the system impedance and the slip angle. Furthermore, it shows that the impedance change over time has a minimum at a pole slip angle of 180°. The impedance change is usually smaller than 100 Ω/s for a slip angle between 90° and 270° ($f_s = 1$ Hz, $Z = 10$ Ω).

The difference between the minimum expected load impedance and the maximum fault impedance based on $\Delta t = 20$ ms (data window length to get an impedance calculated at 50 Hz resp. $\Delta t = 16.7$ ms at 60 Hz) leads to a typical $\Delta Z/\Delta t$ for a fault:

$$\frac{\Delta Z}{\Delta t} = \frac{Z_L - Z_F}{\Delta t}$$

The OST function uses the $\Delta Z/\Delta t$ threshold (setting parameter: »dZ/dt«) to distinguish between a fault and a power swing. It can be observed that typical impedance changes are about five times higher for conventional faults than for power swings.

This means that the following settings should be sufficient for most applications:

- For $I_n = 1$ A: »dZ/dt« = $\Delta Z/\Delta t = 300$ Ω/s,
- For $I_n = 5$ A: »dZ/dt« = $\Delta Z/\Delta t = 60$ Ω/s.

This should be adapted if a transient stability study shows that the system has a different rate of change of impedance. It is also to note that the "dZ/dt" should in fact be replaced by "dR/dt" because only the resistive part of the impedance is evaluated. This is acceptable if bearing in mind that significant impedance changes by both power swings and faults are clearly represented in their resistive parts but not in their reactive parts.

This, on the other hand, shows that for the rare case of a 3-pole fault with an inception point at the same resistance on the impedance trajectory as the resistance component of the fault, it is on principle not possible to recognize this fault.

Operating and Tripping Logic

The principle implemented with this device is to issue the tripping command as soon as the second blinder is traversed; this is called the "Trip on Way out" (ToWo) scheme. The ToWo scheme traces a detected power swing and allows tripping after the first pole slipping, which results in less transient overvoltages on the breaker poles.

The positive edge of the »Operate« signal starts the trip delay timer, »*Trip delay time*«, if the set »*Max.Num.Pole Slips*« has been reached. After the trip delay timer has expired the »Trip« signal and – unless blocked – the »TripCmd« get active for the configured trip duration »*Trip duration time*«. With this additional trip delay time the tripping command can be given when the system is closer to an in-phase condition.

It is also possible to trip after more than one pole slipping cycles. The setting »*Max.Num.Pole Slips*« can be used for this. But note, however, that the reset timer »*Reset Time*« must be set for this: The timer is started when the impedance leaves the MHO circle, and if this timer expires before the impedance re-enters the MHO circle, the slip counter gets reset.

The signals »Alarm« and »Start« indicate that the OST module has started, i. e. the impedance trajectory has crossed the stability threshold (first blinder). Both are reset when the measured impedance has left the MHO circle without an »Operate« (which indicates a stable swing), or when the »Trip« signal is reset. If »*Max.Num.Pole Slips*« has been set to a number greater than 1, the »Alarm« signal stays active until the »Trip« signal is reset or the »*Reset Time*« has expired.

Functionality

OST

OutOfStep_Y01

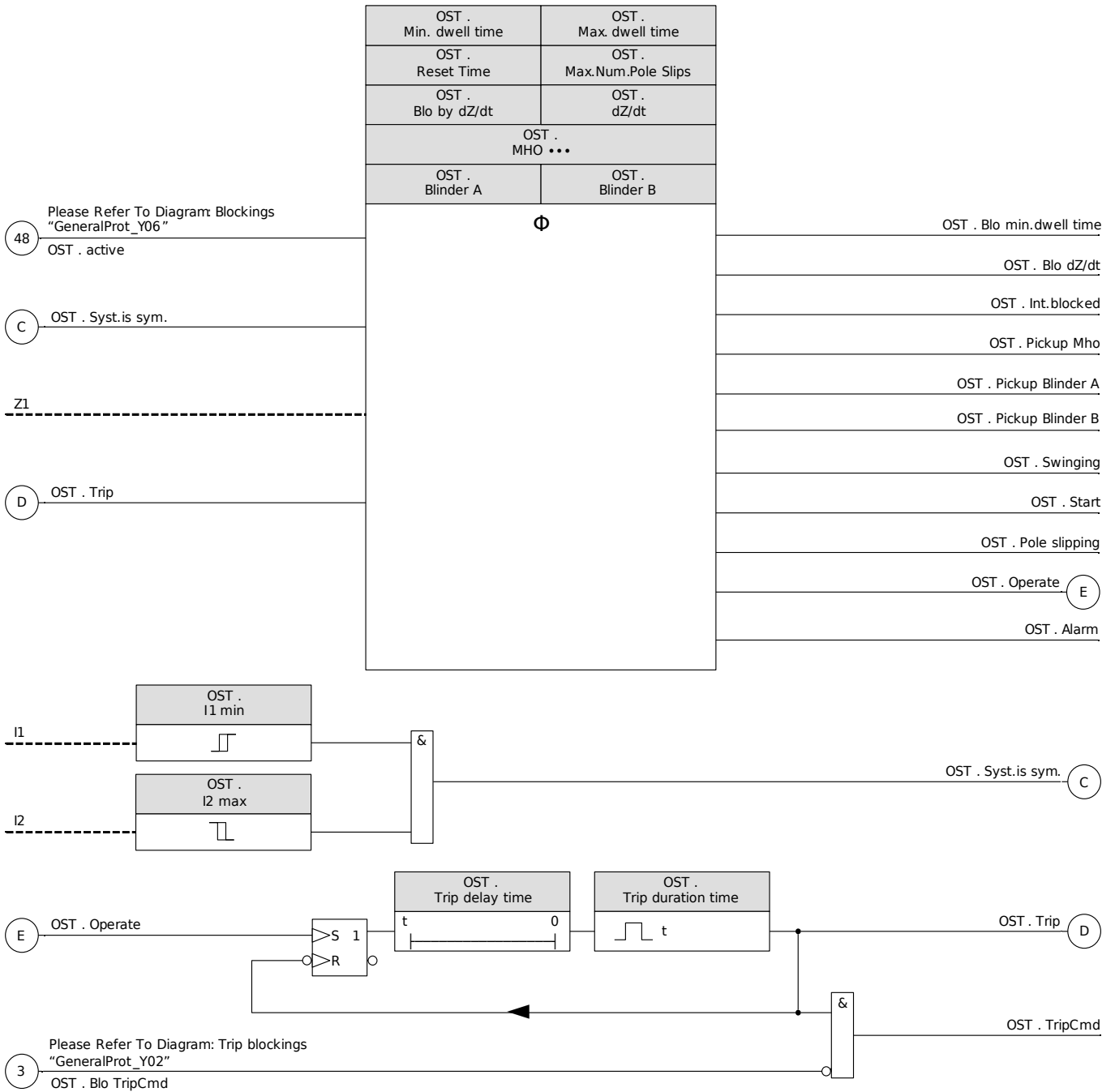

Functionality of the Out-Of-Step Tripping module.

For the temporary or permanent blocking of the phase distance protection module, see the chapter “Blocking”.

OST – Settings

Transient stability studies are surely the best way to determine the appropriate settings for Out-Of-Step tripping function. If stability studies are not available, the relay may be set using a graphical procedure and conservative settings.

The diagram below shows the relationship between a sample power system and an OST characteristic with blinders.

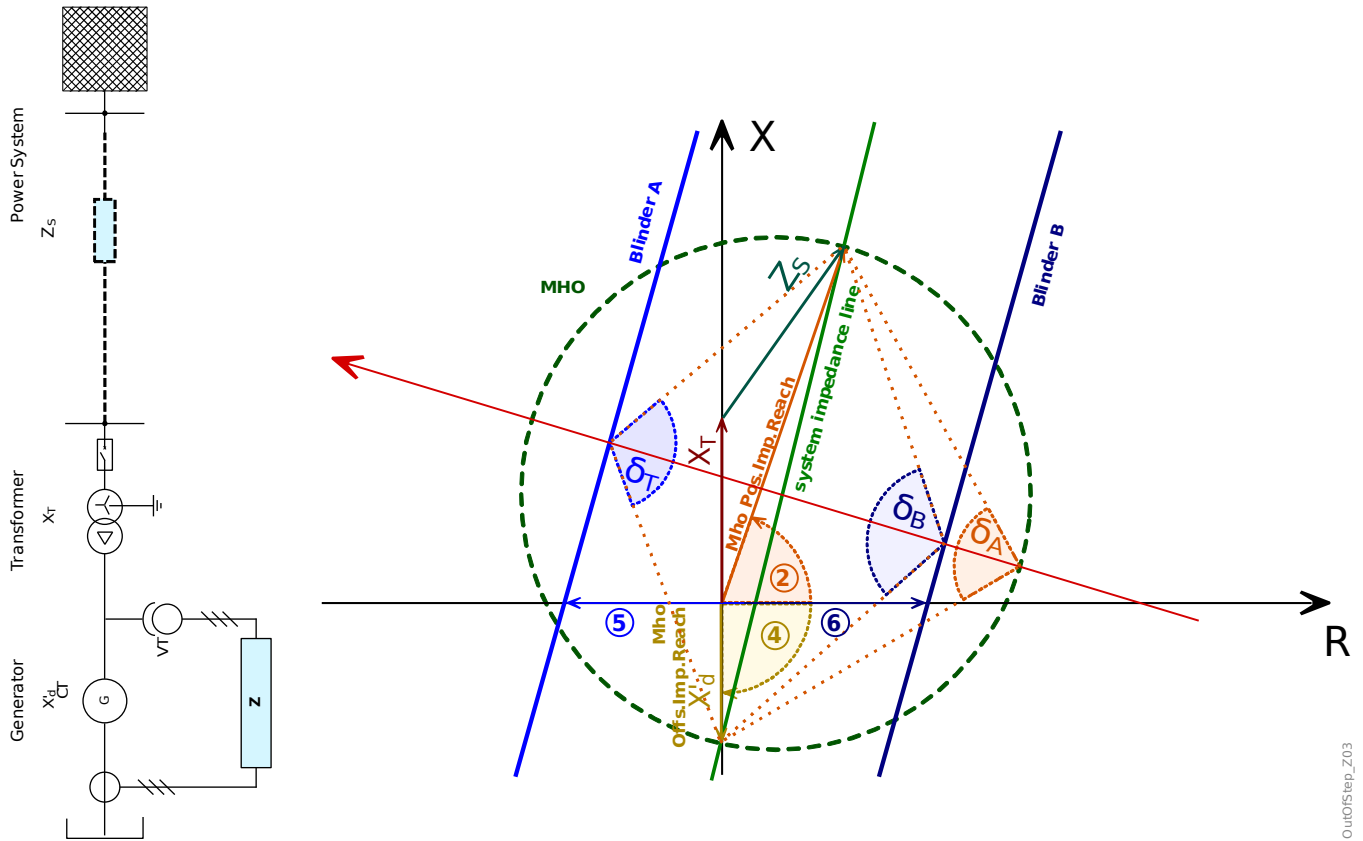

System Single-Line (left) and Out of Step characteristics (right).

- ②=»Mho Pos.Imp.Angle«
- ④=»Mho Offs.Imp.Angle«
- ⑤=»Blinder A«
- ⑥=» Blinder B«

In this context, the generator is described via the transient reactance X'_d , the transformer reactance via X_T and the impedance of the connected power system via Z_S . The system impedance line is the connection of all these three impedances, see diagram.

To simplify the setting calculations, the resistive components of some impedances are neglected and only reactive components are considered.

Based on the above system data the MHO settings can be determined:

- · »Mho Pos.Imp.Reach« = $|X_T + Z_S|$
- ② · »Mho Pos.Imp.Angle« = $\tan^{-1}(X_T + Z_S)$
- · »Mho Offs.Imp.Reach« = X'_d

- ④. »Mho Offs.Imp.Angle« = 270°

Alternatively: According to the IEEE Std. C37.102-2006 recommendation and in case of lacking of connected system data the MHO circle may be constructed with a positive impedance reach of 1.5 times the transformer impedance and an offset impedance reach of 2 times the generator transient reactance. The system impedance angle is 90° in this case, which leads to a positive impedance angle of 90° and an offset impedance angle of 270°.

The distance between the blinders and the origin is generally derived from the impedance swing position where the angular separation between the system and the generator exceeds the stability limit. If no stability study is available, the separation angle is typically set to 120°.

In the diagram above, the angle of Z_S is shown quite far away from 90° (i. e. the R-part of Z_S is quite large), because otherwise, it would be difficult to show all involved data. However, for the calculation of the blinder distances, we are going to neglect the small displacement on the R-axis, so that we set: $|Z_S| \approx X_S$

Therefore the distance of the blinders can be calculated as follows:

$$\text{Blinder B} = \frac{1}{2}(X'_d + X_T + X_S) \cdot \tan(90^\circ - \frac{1}{2}\delta_S)$$

δ_S is the pole slip angle at the stability limit (i. e. where an unstable power swing occurs).

$$\text{Blinder A} = \frac{1}{2}(X'_d + X_T + X_S) \cdot \tan(90^\circ - \frac{1}{2}\delta_O)$$

δ_O is the pole slip angle where the »Operate« signal is issued.

Via the trip delay time an additional delay between the »Operate« and the »Trip« can be defined.

For Out of Step detection with the generator running in motoring mode, the blinder values will be used vice versa, which has to be considered when calculating the above blinder settings.

Timer Settings

The minimum dwell time (measured between entering the MHO circle and crossing the first blinder) is used to differentiate power swing events from other transient events like faults:

$$\text{» Min. dwell time «} = \frac{\delta_S - \delta_A}{360^\circ} \cdot \frac{1}{f_{S,max}}$$

- δ_S = pole slip angle at stability limit (as above)
- δ_S = pole slip angle when the impedance reaches the MHO circle.
This angle is usually 90° if the Out of Step characteristic is configured according to the available system data as shown in the diagram above.
- $f_{S,max}$ = maximum slip frequency

The maximum dwell time of the impedance within the MHO circle:

$$\text{» Max. dwell time «} = \frac{\delta_{MHO}}{360^\circ} \cdot \frac{1}{f_{S,min}}$$

- δ_{MHO} = pole slip angle range which is covered by the MHO circle.
This angle range is usually 270°-90° = 180° if the Out of Step characteristic is configured according to the available system data as shown in the diagram above
- $f_{S,min}$ = minimum slip frequency

Example

Let us assume the following impedance values (each given in polar coordinates, i. e. as norm [vector length] and angle):

- · $X'_d = 3.6 \Omega \angle 90^\circ$
- · $X_T = 2.04 \Omega \angle 90^\circ$
- · $Z_S = 8.9 \Omega \angle 85^\circ$

This gives the following:

- · $Z = X_T + Z_S \approx 10.9 \Omega \angle 86^\circ$

Therefore one gets the following:

- · Mho Pos.Imp.Reach = $|Z| = 10.9 \Omega$
- · Mho Pos.Imp.Angle = $\tan^{-1}(Z) = 86^\circ$
- · Mho Offs.Imp.Reach = $X'_d = 3.6 \Omega$
- · Mho Offs.Imp.Angle = $-90^\circ = 270^\circ$

For the calculation of the blinder distances we again neglect the R-parts, i. e. we set $|Z_S| \approx X_S$.

With $\delta_S = 120^\circ$ as stability limit we get the following:

- · Blinder B = $\frac{1}{2} \cdot (X'_d + X_T + Z_S) \cdot \tan(90^\circ - \frac{1}{2}\delta_S) = \frac{1}{2}(3.6 \Omega + 2.04 \Omega + 8.9 \Omega) \cdot \tan(90^\circ - \frac{1}{2} \cdot 120^\circ) \approx 4.2 \Omega$

With $\delta_A = 240^\circ$ (to get the same stability limit 120° for power swings during motoring of the generator):

- · Blinder A = $\frac{1}{2} \cdot (X'_d + X_T + Z_S) \cdot \tan(90^\circ - \frac{1}{2}\delta_O) = \frac{1}{2}(3.6 \Omega + 2.04 \Omega + 8.9 \Omega) \cdot \tan(90^\circ - \frac{1}{2} \cdot 240^\circ) \approx -4.2 \Omega$

With $f_{S,max} = 2.0 \text{ Hz}$ it follows:

$$\gg \text{Min. dwell time} \ll = \frac{\delta_S - \delta_A}{360^\circ} \cdot \frac{1}{f_{S,max}} = \frac{120^\circ - 90^\circ}{360^\circ} \cdot \frac{1}{2 \text{ Hz}} = 0.042 \text{ s}$$

With $f_{S,min} = 0.1 \text{ Hz}$ it follows:

$$\gg \text{Max. dwell time} \ll = \frac{\delta_{MHO}}{360^\circ} \cdot \frac{1}{f_{S,min}} = \frac{270^\circ - 90^\circ}{360^\circ} \cdot \frac{1}{0.1 \text{ Hz}} = 5 \text{ s}$$

Device Planning Parameters of the Out-of-Step Tripping Module

Parameter	Description	Options	Default	Menu path
Mode	Mode	do not use, use	do not use	[Device planning]

Global Protection Parameters of the Out-of-Step Tripping n Module

Parameter	Description	Setting range	Default	Menu path
ExBlo1	External blocking of the module, if blocking is activated (allowed) within a parameter set and if the state of the assigned signal is true.	1..n, Assignment List	-.-	[Protection Para /Global Prot Para /OST]
ExBlo2	External blocking of the module, if blocking is activated (allowed) within a parameter set and if the state of the assigned signal is true.	1..n, Assignment List	-.-	[Protection Para /Global Prot Para /OST]
ExBlo TripCmd	External blocking of the Trip Command of the module/the stage, if blocking is activated (allowed) within a parameter set and if the state of the assigned signal is true.	1..n, Assignment List	-.-	[Protection Para /Global Prot Para /OST]







Setting Group Parameters of the Out-of-Step Tripping Module

NOTICE The actually available value range for all impedance settings is dependent on the Field Parameter setting »CT sec«. This dependency is not properly reflected in the parameter table below.

- For »CT sec« = 1 A the min. value from the “Setting Range” table row has to be multiplied by 5.
- For »CT sec« = 5 A the max. value from the “Setting Range” table row has to be divided by 5.

Parameter	Description	Setting range	Default	Menu path
Function	Permanent activation or deactivation of module/stage.	inactive, active	inactive	[Protection Para /<1..4> /OST /General Settings]

Parameter	Description	Setting range	Default	Menu path
 ExBlo Fc	Activate (allow) or inactivate (disallow) blocking of the module/stage. This parameter is only effective if a signal is assigned to the corresponding global protection parameter. If the signal becomes true, those modules/stages are blocked that are parameterized "ExBlo Fc=active".	inactive, active	inactive	[Protection Para /<1..4> /OST /General Settings]
 Blo TripCmd	Permanent blocking of the Trip Command of the module/stage.	inactive, active	inactive	[Protection Para /<1..4> /OST /General Settings]
 ExBlo TripCmd Fc	Activate (allow) or inactivate (disallow) blocking of the module/stage. This parameter is only effective if a signal is assigned to the corresponding global protection parameter. If the signal becomes true, those modules/stages are blocked that are parameterized "ExBlo TripCmd Fc=active".	inactive, active	inactive	[Protection Para /<1..4> /OST /General Settings]
 Meas Circuit Superv	Activates the use of the measuring circuit supervision. In this case the module will be blocked if a measuring circuit supervision module (e.g. LOP, VTS) signals a disturbed measuring circuit (e.g. caused by a fuse failure).	inactive, active	inactive	[Protection Para /<1..4> /OST /General Settings]
 I1 min	Minimum value positive phase sequence current	0.02 - 4.00In	0.20In	[Protection Para /<1..4> /OST /General Settings]
 I2 max	Maximum value negative sequence current	0.02 - 1.00In	0.20In	[Protection Para /<1..4> /OST /General Settings]

Parameter	Description	Setting range	Default	Menu path
 Min. dwell time	Minimum dwell time within the impedance zone (characteristic). This timer is essential to enable the device to distinguish between a power swing and a system fault. If the measured impedance crosses the first blinder before this timer has expired, the event will be declared as a system fault and not as power swing. This has the consequence that the function is blocked until the impedance has left the MHO circle again.	0.020 - 0.200s	0.100s	[Protection Para /<1..4> /OST /General Settings]
 Max. dwell time	Maximum dwell time within the impedance zone (characteristic). (Above this time the slip frequency is assumed to be implausibly low.)	0.20 - 20.00s	10.00s	[Protection Para /<1..4> /OST /General Settings]
 Max.Num.Pole Slips	Maximum number of pole slips that are accepted, i. e. above this number a trip decision is made. This counter is reset always after the duration »Reset Time« if there has not been a new pole slip during this time.	1 - 20	1	[Protection Para /<1..4> /OST /General Settings]
 Reset Time	Counting of pole slip events is reset after this time. (The timer is started with every detected event.) Note that this time should be set equal or greater than the pole slip cycle time.	0.20 - 100.00s	10.00s	[Protection Para /<1..4> /OST /General Settings]
 Blo by dZ/dt	Activate (allow) or inactivate (disallow) blocking of the module if the »dZ/dt« limit is exceeded.	inactive, active	inactive	[Protection Para /<1..4> /OST /General Settings]
 dZ/dt	Rate of impedance change per time (secondary value). This setting is essential to enable the device to distinguish between a power swing and a system fault.	2.0 - 1000.0Ω/s	300Ω/s	[Protection Para /<1..4> /OST /General Settings]

Parameter	Description	Setting range	Default	Menu path
 Trip delay time	Trip Delay Timer	0.00 - 1.00s	0.00s	[Protection Para /<1..4> /OST /General Settings]
 Trip duration time	Trip duration time	0.05 - 1.00s	0.10s	[Protection Para /<1..4> /OST /General Settings]
 Mho Pos.Imp.Reach	MHO characteristic: Positive Impedance Reach (secondary value).	0.2 - 750.0Ω	10.0Ω	[Protection Para /<1..4> /OST /Characteristic]
 Mho Pos.Imp.Angle	MHO characteristic: Positive Impedance Angle	60 - 90°	90°	[Protection Para /<1..4> /OST /Characteristic]
 Mho Offs.Imp.Reach	MHO characteristic: Offset Impedance Reach (secondary value).	0.0 - 750.0Ω	10.0Ω	[Protection Para /<1..4> /OST /Characteristic]
 Mho Offs.Imp.Angle	MHO characteristic: Offset Impedance Angle	240 - 270°	270°	[Protection Para /<1..4> /OST /Characteristic]
 Blinder A	Blinder (left) of the impedance zone (characteristic), defined as a value on the R-axis (secondary value).	-375.0 - 0.0Ω	-2.5Ω	[Protection Para /<1..4> /OST /Characteristic]
 Blinder B	Blinder (right) of the impedance zone (characteristic), defined as a value on the R-axis (secondary value).	0.0 - 375.0Ω	2.5Ω	[Protection Para /<1..4> /OST /Characteristic]

Input States of the Out-of-Step Tripping Module

Name	Description	Assignment via
ExBlo1-I	Module input state: External blocking1	[Protection Para /Global Prot Para /OST]
ExBlo2-I	Module input state: External blocking2	[Protection Para /Global Prot Para /OST]
ExBlo TripCmd-I	Module input state: External Blocking of the Trip Command	[Protection Para /Global Prot Para /OST]

Signals (Output States) of the Out-of-Step Tripping Module

Signal	Description
active	Signal: active
ExBlo	Signal: External Blocking
Blo TripCmd	Signal: Trip Command blocked
ExBlo TripCmd	Signal: External Blocking of the Trip Command
Blo by MeasCircSupv	Blocked by Measuring Circuit Supervision
Int.blocked	Signal: The module is internally blocked because the »Max. dwell time« has expired.
Pickup Blinder A	Signal: The impedance is within the MHO circle on the right side of Blinder A.
Pickup Blinder B	Signal: The impedance is within the MHO circle on the left side of Blinder B.
Pickup Mho	Signal: The impedance is within the characteristic.
Swinging	Signal: The impedance is within the instable swing zone (i. e. within the characteristic and inside the borders defined by Blinders A and B).
Start	Signal, that a power swing (or an Out-of-step event) has been detected. The state of this signal becomes true as soon as the impedance traverses the first blinder, and it gets reset when the characteristic area is left.
Pole slipping	Signal, that pole slipping has been detected. The state of this signal becomes true as soon as the impedance reaches 180°, and it gets reset when the characteristic area is left.
Operate	Signal: The module is ready to send a trip command. The state of this signal becomes true as soon as the impedance traverses the second blinder, and it gets reset after the impedance has left the MHO circle.
Alarm	Signal that the module has started, i. e. the impedance has entered the MHO circle and crossed the first blinder. »Alarm« is reset when the measured impedance has left the MHO circle without an »Operate«, or when the »Trip« signal is reset. If »Max.Num.Pole Slips« is greater than 1, the »Alarm« signal stays active until the »Trip« signal is reset or the »Reset Time« has expired.
Trip	Signal: Trip
TripCmd	Signal: Trip Command

Protective Elements

<i>Signal</i>	<i>Description</i>
Syst.is sym.	Signal that the system state is symmetrical, i. e. the negative-sequence current is below »I2 max«, and the positive-sequence current is above »I1 min«.
Blo dZ/dt	Signal: The module has detected a system fault based on the »rate of impedance change per time«, and therefore it has blocked itself.
Blo min.dwell time	Signal: The module has detected a system fault based on the »minimum dwell time«, and therefore it has blocked itself.

Z – Phase Distance Protection [21]

Available elements:
Z[1].Z[2]

The phase distance protection module, which is integrated in this relay, is intended to provide backup protection for phase-to-phase faults on the electrical power system to which the generator set is connected. In case of a relay failure on the power system the distance protection in the generator protection relay can work as a (remote) system backup protection, backup protection for step-up transformer faults and sometimes backup protection for generator internal faults as well.

Function

The device has two distance elements **Z[1/2]** with (independently configurable) **MHO** or **polygon** characteristics and (independently settable) tripping timers, so that a two-zone phase distance protection scheme with different zone reaches can be easily set up.

Fault Impedance Calculation

For the phase distance protection the three phase currents from the neutral (“W1”) CTs and the three voltages from the terminal VTs are used to calculate the three phase-to-phase loop impedances (ZL1-L2, ZL2-L3,ZL3-L1). However, impedance calculation is blocked as soon as the measured current drops below some (fixed device-internal) limit, so that irrelevant calculation results can be excluded.

The relay takes corrections into account with the impedance calculation if there is a step-up transformer with Delta/Star connection between generator and power system, as shown in the following diagram. These corrections get activated if the Field Parameters of the Transformer are set to »Phase Shift« = 1, 5, 7 or 11. (The fault impedance correction is not available for phase shift 3 and 9.)

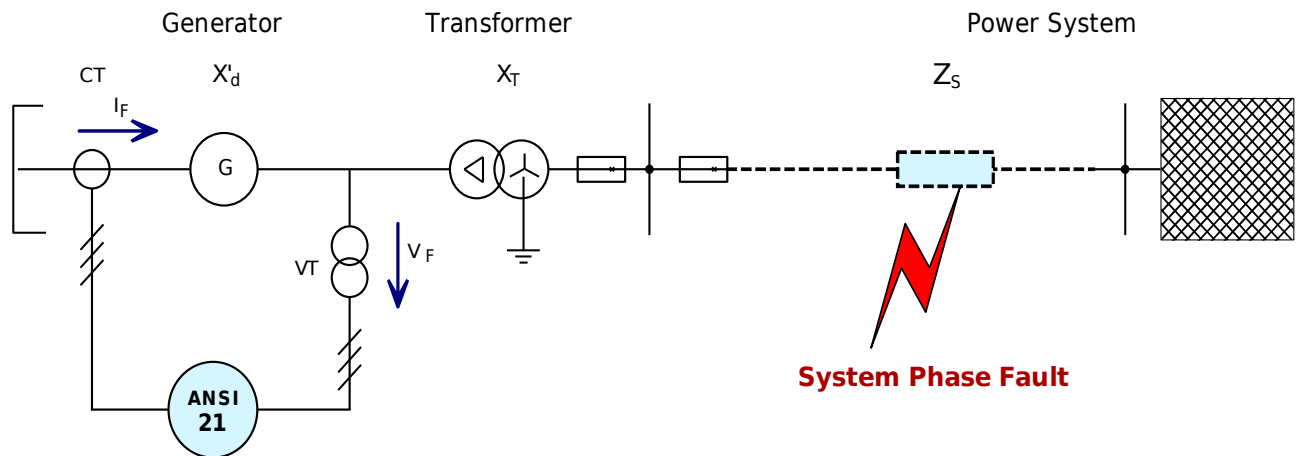

Generator connected to the power system through a Δ/Y transformer.

PD15_Z01

Identification of the Faulty Phase

The purpose of the fault type classification in the distance protection function is to provide information about the involved phases in order to select the appropriate impedance loop. The fault type classification uses the symmetrical component for the fault type classification in the following way and sequence:

- If the positive sequence current is lower than $0.01 \cdot I_n$, we decide for a non-fault situation.
- If the negative-sequence current is lower than 30% of the positive-sequence current, we decide for the symmetrical fault L1–L2–L3 and select loop L1–L2.
- Otherwise, the phase shift between positive and negative-sequence currents is used as shown in the following table.

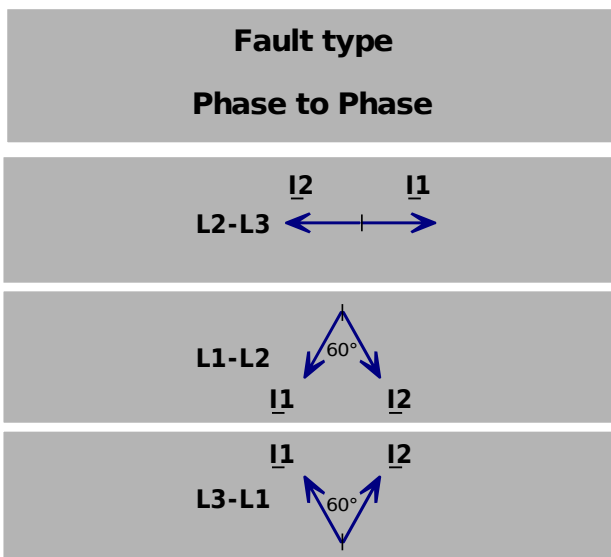

Positive and negative phase sequence current phasors for different fault types.

PDIS_2012

Starting Method

A distance protection element of the generator phase distance protection can only be started to evaluate the faulted impedances if some starting conditions are fulfilled. These conditions depend on a settable starting method:

- »Start condition« = “Overcurrent”: The starting condition is fulfilled if maximum measured phase current exceeds the settable current limit $I > I_{str}$.
- »Start condition« = “Overcur & Undervlt”: The starting condition is fulfilled if maximum measured phase current exceeds the settable current limit $I > I_{str}$ **and** the minimum measured voltage is lower than the settable limit $V < V_{str}$. The additional setting »Voltage type« selects whether phase-to-phase or phase-to-neutral voltages shall be used.
- »Start condition« = “Underimpedance”: The starting condition is fulfilled if the corresponding measured loop impedance is lower than the settable limit $Z < Z_{str}$.

Impedance Operating Characteristic

For each distance protection element an impedance operating characteristic with direction boundary can be configured.

Direction boundary: Two settable angles define two directional lines, which start at the origin of the impedance plane. These two lines define the forward and reverse (backward) areas. The area on the right side of the two direction lines is defined as forward (green color in the following diagram), whereas the remaining area (shown in yellow color) defines the reverse direction. The setting »Direction enable« = “active” enables this feature.

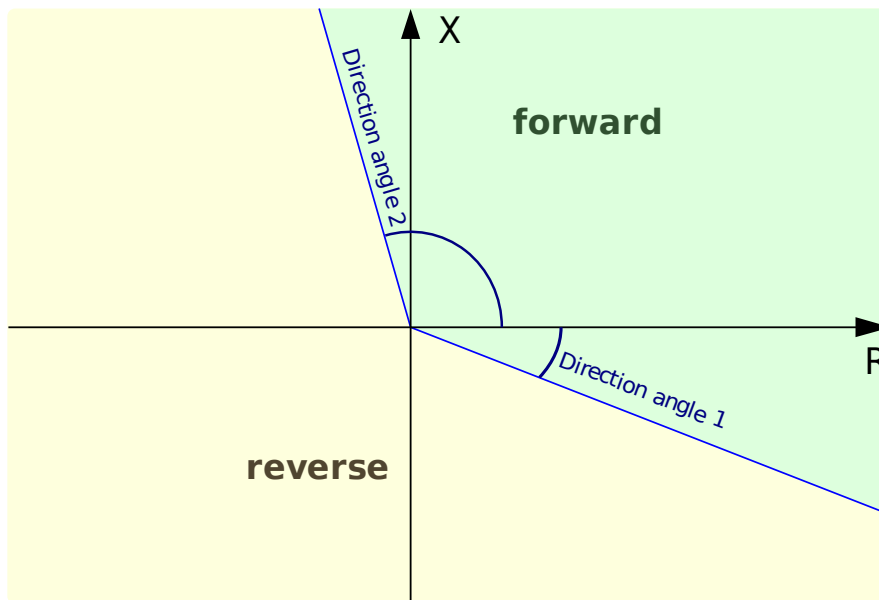

PD15_Z03

Definition of forward and reverse (backward) areas.

Type of impedance characteristic: The impedance characteristic of a distance protection element is an operating characteristic; this means the distance element shall operate if the measured impedances are inside the characteristic boundary. There are two types of characteristic available, settable via the parameter »Type of imp. area«: “MHO” (circle), or “Polygon”.

- **MHO (circle):**

The MHO characteristic can be defined with four settings (see next diagram). Note that the center of the MHO circle is defined as the point half-way between the »Mho Pos.Imp.Reach« vector and the »Mho Offs.Imp.Reach« vector. Both vectors are configured by setting their magnitude (“length”) and angle with the R-axis.

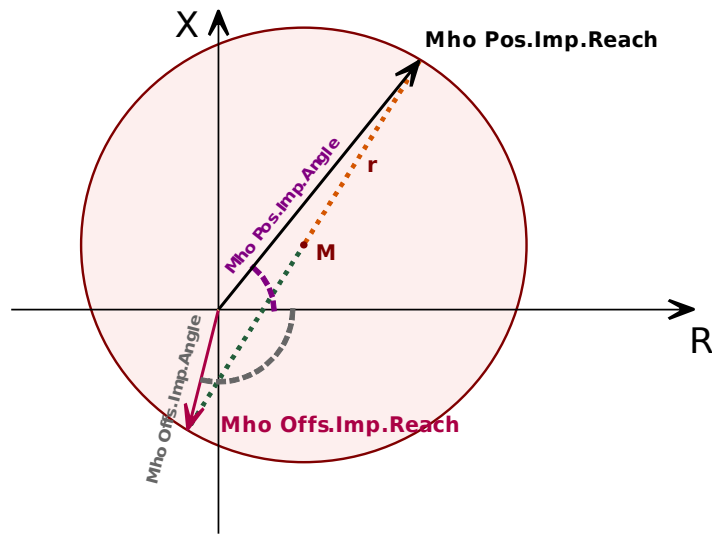

PDIS_Z04

Operating area (colored in bright red) of type MHO (circle), with »Direction enable« = “inactive”.

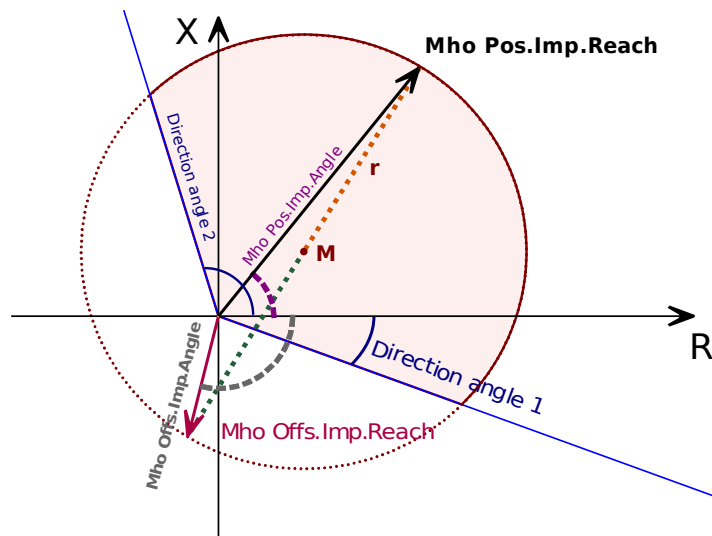

PDE_Z05

Operating area (colored in bright red) of type MHO (circle), with »Direction enable« = “active”.

Setting Parameter	Description
»Mho Pos.Imp.Reach«	MHO characteristic: Positive Impedance Reach
»Mho Pos.Imp.Angle«	MHO characteristic: Positive Impedance Angle
»Mho Offs.Imp.Reach«	MHO characteristic: Offset Impedance Reach
»Mho Offs.Imp.Angle«	MHO characteristic: Offset Impedance Angle
»Direction angle 1« »Direction angle 2«	Angles that confine the impedance area. (Note that the angles are always measured counter-clockwise from the positive R-axis.)

- Polygon:**
 Modern powerful digital protection relays allow for very sophisticated polygon characteristics, which often offers a better coverage of different fault and operating conditions. The downside of the great flexibility in shaping the operating area is that a lot of different setting parameters are involved.

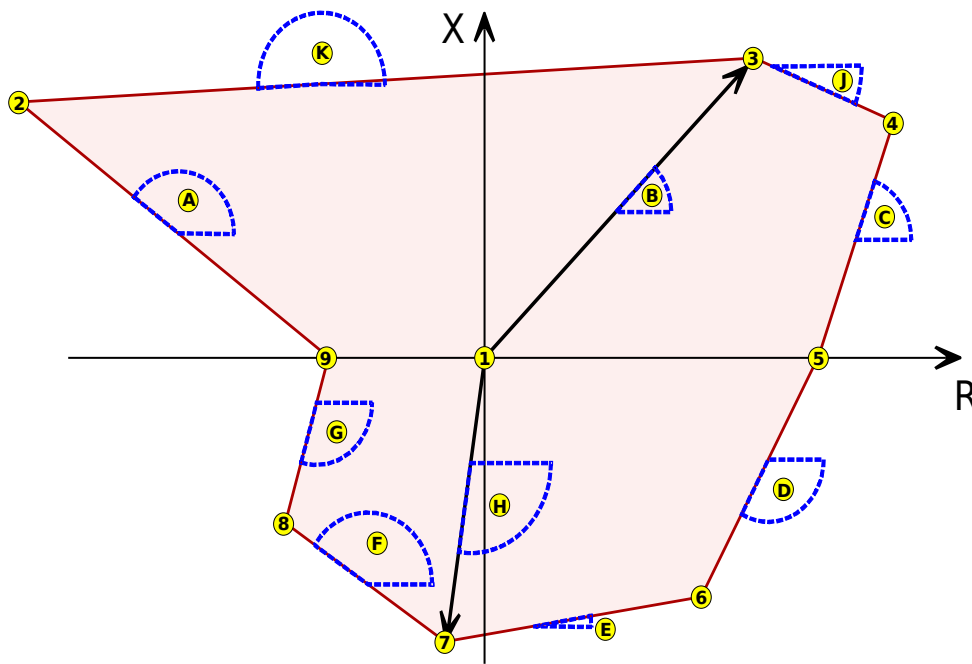

PD05_Z06

Operating area (colored in bright red) of type polygon, with »Direction enable« = "inactive".

(The table below lists which distances are referred to by the circled numbers, and which angles are referred to by the circled letters.)

NOTICE Note that all angles in this construction are always measured counter-clockwise from the R-axis.

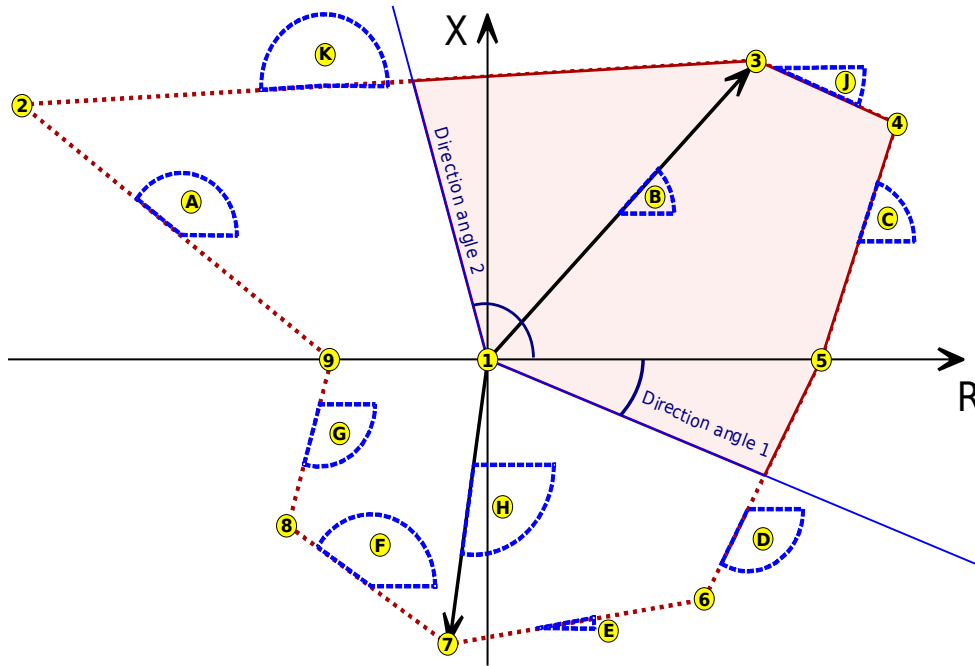

PDIS_Z07

Operating area (colored in bright red) of type polygon, with »Direction enable« = “active”.

Setting Parameter	Description
<i>Polyg.Pos.Imp.Reach</i>	Polygon characteristic: The »Positive Impedance Reach« is the amplitude of the positive impedance phasor (1) → (3) in the forward direction (first quadrant).
<i>Polyg.Pos.Imp.Angle</i>	Polygon characteristic: The »Positive Impedance Angle« is the angle (B) of the positive impedance phasor (1) → (3) in the forward direction (first quadrant).
<i>Polyg.Pos.Imp.R.Ang.1</i>	Polygon characteristic: The »Positive Impedance Reach Angle 1« is the tilt angle (J) of the line element which is starting at the positive impedance reach tip (3) and spreads on the right side (3) → (4) in the first quadrant.
<i>Polyg.Pos.Imp.R.Ang.2</i>	Polygon characteristic: The »Positive Impedance Reach Angle 2« is the tilt angle (K) of the line element which is starting at the positive impedance reach tip (3) and spreads leftwards, to the second quadrant, (3) → (2).
<i>Polyg.Pos.Resis.Reach</i>	Polygon characteristic: The »Positive Resistive Reach« determines the reach (5) on the positive R-axis and is used to limit the coverage for fault resistance and encroachment of the load impedance into the characteristics.
<i>Polyg.Pos.Resis.Ang.1</i>	Polygon characteristic: The »Positive Resistive Angle 1« is the tilt angle (C) in the first quadrant. The area right from the blinder is excluded from the operating area.
<i>Polyg.Pos.Resis.Ang.2</i>	Polygon characteristic: The »Positive Resistive Angle 2« is the tilt angle (D) in the fourth quadrant.
<i>Polyg.Neg.Imp.Reach</i>	Polygon characteristic: The »Negative Impedance Reach« is the amplitude of the negative impedance phasor (1) → (7) in the reverse (backward) direction (third quadrant).
<i>Polyg.Neg.Imp.Angle</i>	Polygon characteristic: The »Negative Impedance Angle« defines the impedance angle (1) → (7) in the reverse (backward) direction (third quadrant).
<i>Polyg.Neg.Imp.R.Ang.1</i>	Polygon characteristic: The »Negative Impedance Reach Angle 1« is the tilt angle (E) of the line element which is starting at the negative impedance reach tip (7) and spreads to the right, i.e. into the fourth quadrant, (7) → (6).

<i>Setting Parameter</i>	<i>Description</i>
<i>Polyg.Neg.Imp.R.Ang.2</i>	Polygon characteristic: The »Negative Impedance Reach Angle 2« is the tilt angle (F) of the line element which is starting at the negative impedance reach tip (7) and spreads on the left side (7) → (8) in the third quadrant.
<i>Polyg.Neg.Resis.Reach</i>	Polygon characteristic: The »Negative Resistive Reach« determines the reach (9) on the negative R-axis.
<i>Polyg.Neg.Resis.Ang.1</i>	Polygon characteristic: The »Negative Resistive Angle 1« is the tilt angle (A) in the second quadrant, (9) → (2). The area left from the blinder is excluded from the operating area.
<i>Polyg.Neg.Resis.Ang.2</i>	Polygon characteristic: The »Negative Resistive Angle 2« is the tilt angle (G) in the third quadrant, (9) → (8). The area left from the blinder is excluded from the operating area.

CAUTION

Close-in faults (faults in the region of the voltage transformer) cause a strong breakdown of the measured voltage. This results in inaccuracies in reactance and resistance values, which can lead to delayed or no tripping if the direction boundaries are active or if the borderline of the impedance characteristic intersects the coordinate origin.

If the protection zone to be defined is close to the voltage transformer, then the impedance characteristic should *enclose* the coordinate origin (i. e. »Mho Offs.Imp.Reach« > 0 for MHO, »Polyg.Neg.Imp.Reach« > 0 for polygon), and the additional direction boundaries should be inactive (i. e. »Direction enable« = "inactive").

Tripping time delay

For each of two phase distance elements there is the setting parameter »Trip delay time« that defines the time delay between pickup and trip. As the Generator Phase Distance protection is mainly applied as a backup protection in case of relay or CB failure this time delay should carefully be coordinated with the system protection tripping time delay and CB failure protection latency time.

Load Encroachment by Load Blinder (LB) Module

Load encroachment can be activated for each phase distance protection element. This is done by assigning the signal »LB . Operate« of the **Load Blinder** module to the input »Z . Blo by LB« of the respective **Phase Distance** element.

With activated LB module a load region, which is configured within the LB module, is cut out of the impedance area of the phase distance protection. Three-phase high-resistive faults within the load encroachment area are blocked.

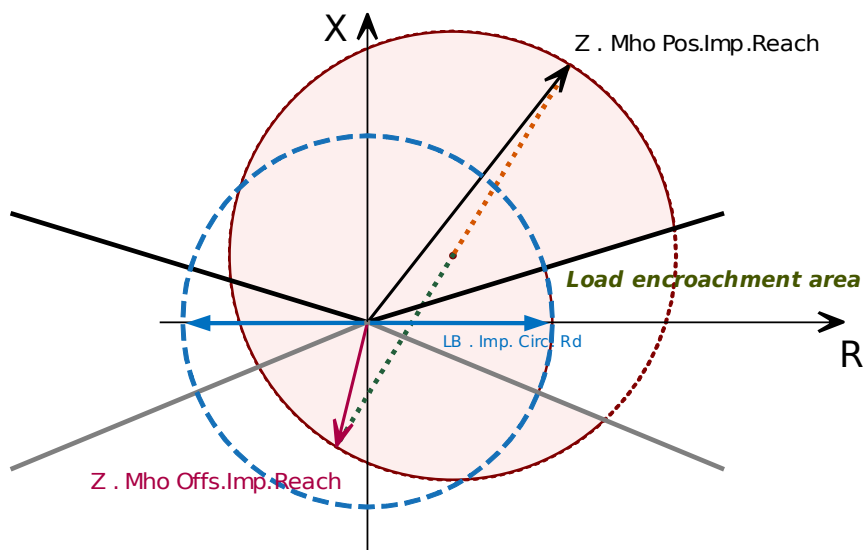

Impedance operating characteristic (colored in bright red) with active load encroachment.

Power Swing Blocking

During power swings it is possible that the measured impedance trajectory intrudes into the operating zone of the phase distance protection. This would lead to an unwanted trip.

This protective device is equipped with a Power Swing Blocking (ANSI 68) module, to detect power swing events. In case of a power swing event, a dedicated blocking signal is issued, which can be used to block the distance protection elements. In particular, it is recommended to assign the signal »PSB . Start« of the **Power Swing Blocking (PSB)** module to the input »Z . Blo by Power Swing« of the respective **Phase Distance** element. For more information, refer to the chapter about the Power Swing Blocking (PSB) module.

Measuring Circuit Failure (Fuse Failure) Blocking

If the measuring circuit supervision is active (*»Meas Circuit Superv«* = "active") the phase distance protection function is blocked in case of a disturbed measuring circuit (e. g. caused by a fuse failure).

Functionality

Z
Z = Z[1]...[2]

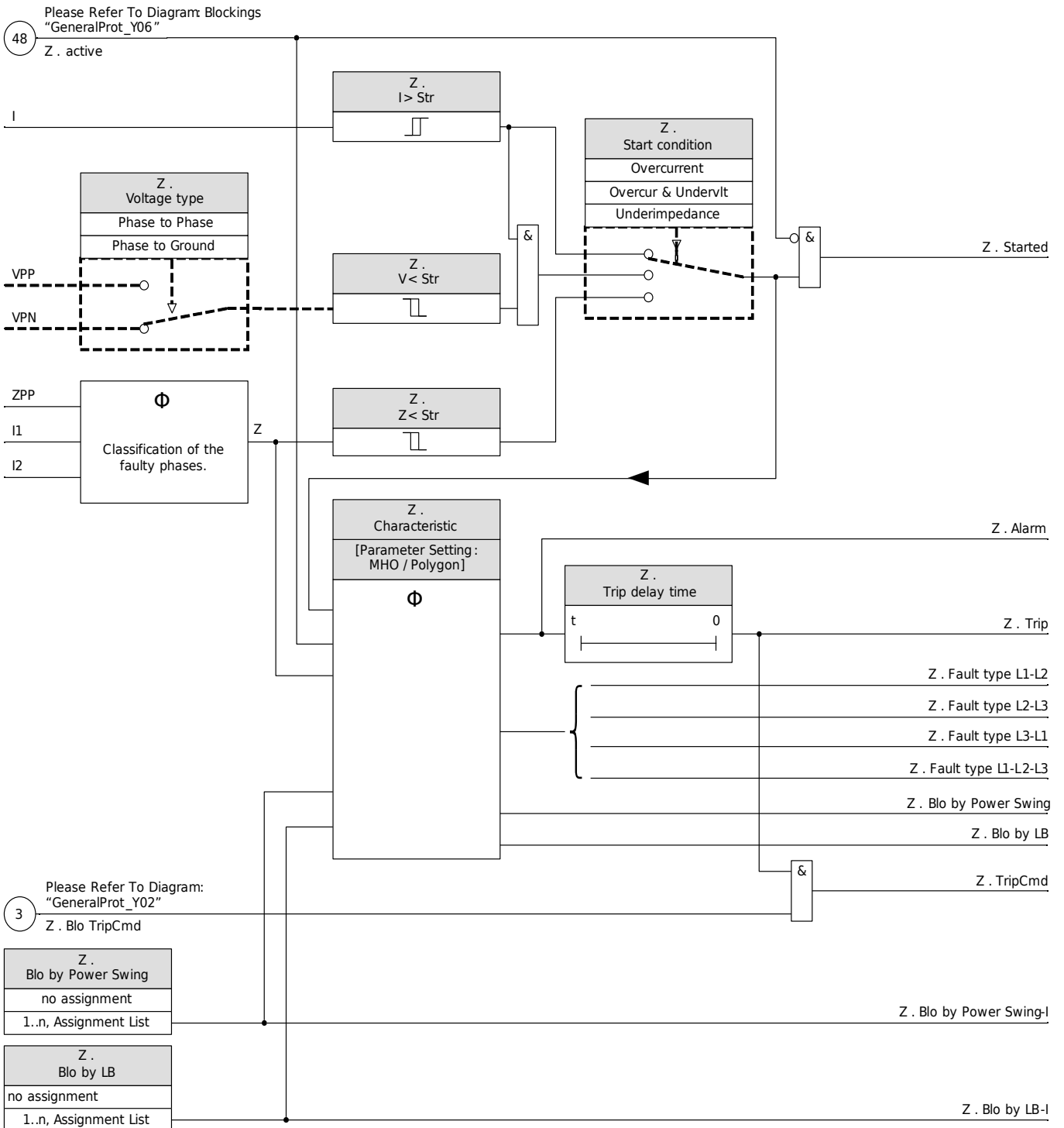

Functionality of the Z[1/2] module.

For the temporary or permanent blocking of the phase distance protection module, see the chapter "Blocking".

Setting Example

A correct setting of the Z function requires the general data and information from the Generator, Transmission and Distribution owners as listed below:

- Generator data sheet with all ratings and electrical data
- Generator impedances (saturated and unsaturated reactances that include direct and quadrature axis, negative and zero sequence impedances and their associated time constants)
- Generator operating limits
- CT and VT electrical data and limits
- Unit transformer ratings and electrical data
- Unit transformer connection group, tape position, impedance and neutral grounding
- Transmission/distribution line impedances for the shortest and the longest lines connected to the generating substation high voltage bus
- Power system base ratings during maximum and minimum generations
- Existing transmission/distribution line distance protection zone characteristic, reach and time delay settings

The following single-line diagram shows a sample generating unit protected by an MCDGV4.

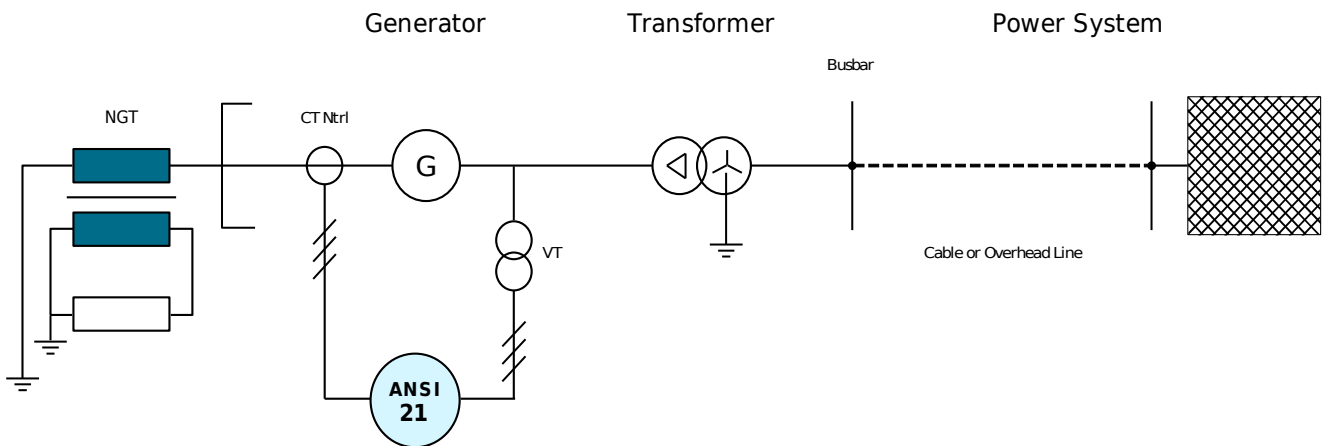

PD/S_Z09

Single-line diagram with neutral grounding transformer (NGT), generator, unit transformer and power system.

Protective Elements

Generator	Directly cooled cylindrical synchronous generator
Prime mover	Steam turbine
Power rating (S_G)	492 MVA
Rated Voltage (V_G)	20 kV
Rated Current (I_G)	14202 A
Power Factor (PF)	0.77
Rated Frequency (f_N)	60 Hz
Rated Speed	3600 RPM
Direct axis synchronous reactance (X_d)	1.1888 (pu)
Saturated direct axis transient reactance (X'_d)	0.20577 (pu) = 3.61 Ω
Saturated direct axis sub-transient reactance (X''_d)	0.17847 (pu)
Negative-sequence reactance (X_2)	0.17676 (pu)
VT location	Generator terminal
VT connection	Y-ground
VT primary rated voltage	20000 V
VT secondary rated voltage	120 V
VT ratio	20000 / 120 = 166.67
CT Ntrl primary rated current	18000 A
CT Ntrl secondary rated current	5 A
CT Ntrl ratio	18000 / 5 = 3600
CT Mains primary rated current	18000 A
CT Mains secondary rated current	5 A
CT Mains ratio	18000 / 5 = 3600
Generator Neutral Grounding Transformer (NGT)	14400 V / 240 V / 120 V
NGT secondary resistance	1.25 Ω

Transformer: Type	Two windings, 3-phase
Power rating (S_T)	425 MVA
Rated Voltage HV (V_{TH})	145 kV
Rated Voltage LV (V_{TL})	19 kV
HV/LV connection	Y0/Δ
Phase shift	1
Rated Frequency (f_N)	60 Hz
Leakage reactance (X_T)	0.111 (pu) ($X_{TG} = 0.11607$ (pu) = 2.04 Ω)

Power System	
Base MVA (S_S)	100 MVA
Base Voltage (V_S)	138 kV
Positive sequence impedance during maximum generation $Z_{max,S1}$	0.000511 + j0.010033 (pu)
Negative sequence impedance during maximum generation $Z_{max,S2}$	0.001046 + j0.017206 (pu)
Positive sequence impedance during minimum generation $Z_{min,1}$	0.00105 + j0.016463 (pu)
Positive sequence impedance of the longest transmission line connected to the unit transformer bus Z_{LL1}	0.01095 + j0.11546 (pu) = 0.77 + j8.15 Ω
Zero sequence impedance of the longest transmission line connected to the unit transformer bus Z_{LL0}	0.07370 + j0.37449 (pu)
Positive sequence impedance of the shortest transmission line connected to the unit transformer bus Z_{SL1}	0.00546 + j0.05773 (pu) = 0.39 + j4.08 Ω
Zero sequence impedance of the shortest transmission line connected to the unit transformer bus Z_{SL0}	0.03685 + j0.18725 (pu)
Distance Protection settings for the shortest transmission line: zone 1	80% Z_{SL1}
Distance Protection settings for the longest transmission line: zone 2	120% Z_{LL1}

Convert all data to generator base**Base 1:**

- Base power = S_N
- Base voltage V_N
- Base impedance X_N

Base 2:

- Base power = S_B
- Base voltage V_B
- Base impedance X_B

[1.] From this it follows:

$$X_B = X_N \cdot \frac{S_B}{S_N} \cdot \left(\frac{V_N}{V_B}\right)^2$$

[2.] Convert unit transformer impedance X_T to generator-based impedance X_{TG} using [1.]:

$$X_{TG} = X_T \cdot \frac{S_G}{S_T} \cdot \left(\frac{V_{TL}}{V_G}\right)^2 = 0.11607 (pu)$$

[3.] Convert system impedance $Z_{max,S1}$ to transformer-based impedance $Z_{max,ST1}$:

$$Z_{max,ST1} = Z_{max,S1} \cdot \frac{S_T}{S_S} \cdot \left(\frac{V_S}{V_{TH}}\right)^2 = 0.001967 + j0.038623 (pu)$$

[4.] Convert transformer-based system impedance $Z_{max,ST1}$ to generator-based impedance $Z_{max,SG1}$:

$$Z_{max,SG1} = Z_{max,ST1} \cdot \frac{S_G}{S_T} \cdot \left(\frac{V_{TL}}{V_G}\right)^2 = 0.002055 + j0.040352 (pu)$$

[5.] Convert the positive sequence system impedance at minimum generation $Z_{min,S1}$ to generator based impedance $Z_{min,SG1}$ in the same way as [3.] and [4.]:

$$Z_{min,SG1} = 0.00422 + j0.06621 (pu)$$

[6.] Convert the positive sequence impedance of the longest transmission line Z_{LL1} to generator-based impedance Z_{LLG1} in the same way as [3.] and [4.]:

$$Z_{LLG1} = 0.04404 + j0.46437 (pu)$$

[7.] Convert the positive sequence impedance of the shortest transmission line Z_{SL1} to generator-based impedance Z_{SLG1} in the same way as [3.] and [4.]:

$$Z_{SLG1} = 0.02196 + j0.23219 (pu)$$

Single-line diagram with generator-based data.

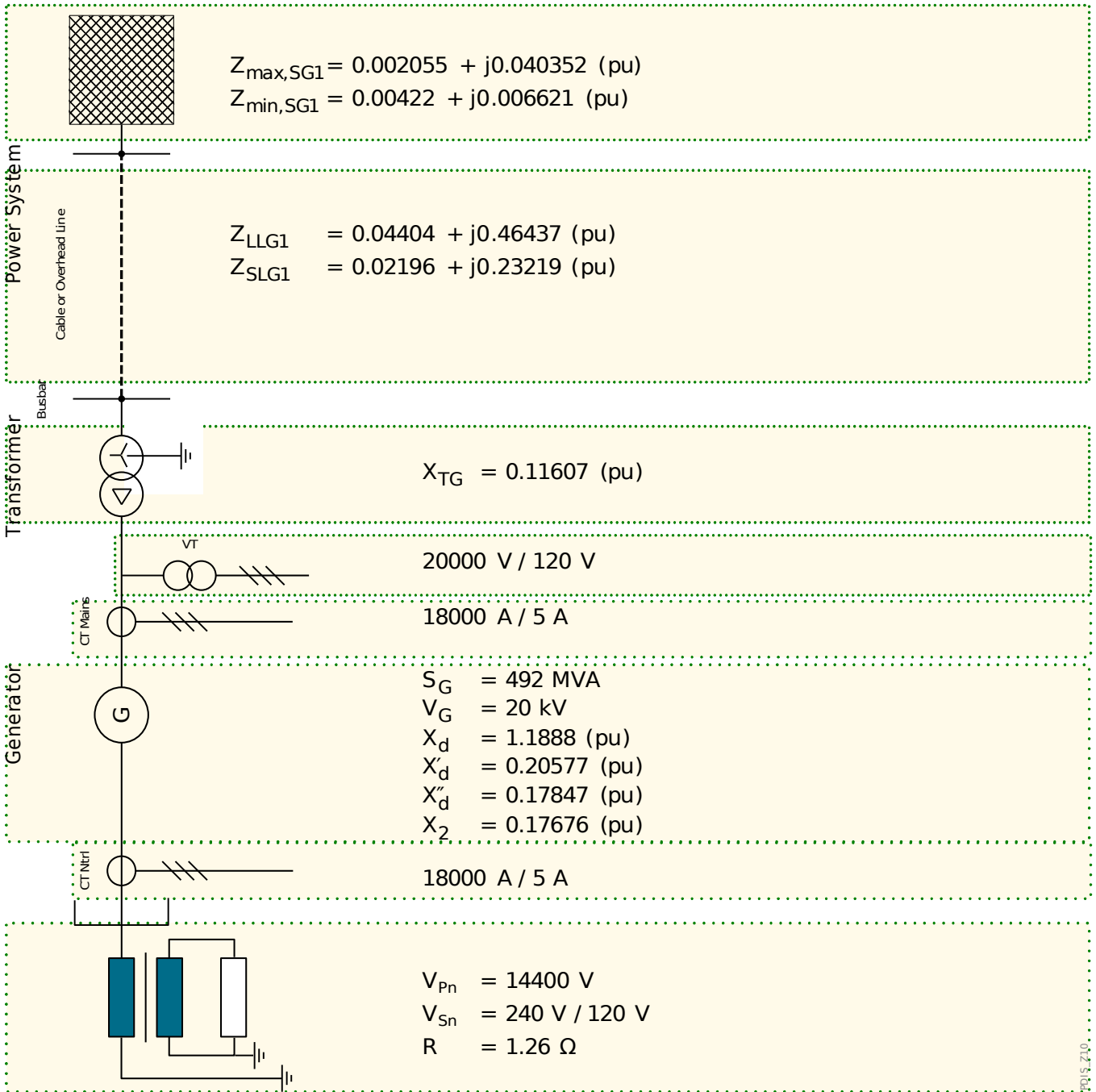

0-2-5-04

NOTICE

All impedances we have calculated or got from generator / transformer data sheets are per unit values (pu). However, all impedance setting values used by the device should be apparent impedance values in Ohm based on the relay secondary rated voltage and currents. This means that we need to convert all impedance (pu) values into impedance Ohm values.

We have to take the voltage and current transformer ratios into account. For the generator VT and CT in our example, we have:

[8.]:

$$VT_{Ratio\ prim/sec} = 166.67$$

[9.]:

$$CT_{Ratio\ prim/sec} = 3600$$

[10.] The general conversion formula is:

$$Z_{secondary} [\Omega] = Z_{primary} [\Omega] \cdot \frac{CT_{Ratio\ prim/sec}}{VT_{Ratio\ prim/sec}}$$

[11.] For the generator distance protection, all impedance-related setting values have to be converted based on the generator base impedance $Z_{B,primary}$, which can be calculated as primary Ohm value with the generator power rating S_G and the generator rated voltage V_G as follows:

$$Z_{B,primary} [\Omega] = \frac{V_G^2}{S_G} = \frac{(20\text{ kV})^2}{492\text{ MVA}} = 0.813\ \Omega$$

[12.] The generator primary base impedance $Z_{B,primary}$ can be converted to the generator secondary base impedance $Z_{B,secondary}$ using [10.]:

$$Z_{B,secondary} [\Omega] = Z_{B,primary} [\Omega] \cdot \frac{CT_{Ratio\ prim/sec}}{VT_{Ratio\ prim/sec}} = 0.813\ \Omega \cdot \frac{3600}{166.67} = 17.56\ \Omega$$

Settings for the Phase Distance Protection Z[1]

For the example described above we set one distance protection element Z[1] as local backup for transformer and high-voltage bus protection, and another element Z[2] as remote backup by relay failure in case of system phase faults. We go for an MHO characteristic, assuming that an MHO characteristic is also used for the line distance protection. The impedance reach and time delay settings needs to be coordinated with the transmission system primary and backup protection and CB failure protection to allow selectivity.

It is supposed that the generator and the transformer are protected via differential protection as primary protection, to detect faults inside the protected objects. A distance protection as local backup protection for the transformer and high-voltage bus provides additional backup protection in case that the primary protections fails to trip.

Typically, the impedance reach setting for such local backup protection is chosen as the smaller value out of the values resulting from the following criteria:

- Set impedance reach to 120% of unit transformer to get enough sensitivity by faults inside transformer and bus:

$$|Z_a| = 1.2 \cdot X_{TG} \cdot Z_{B,secondary} = 1.2 \cdot 0.11607 \cdot 17.56 \Omega = 2.45 \Omega$$

$$\varphi_a = 90^\circ$$

- 80% of zone 1 reach setting of the line distance relay on the shortest transmission line to get coordination with the connected transmission line. Then the impedance reach setting for distance protection zone 1 is equal to the unit transformer impedance plus 80% of the zone 1 line distance protection setting. Assuming the line distance protection reach on the shortest line is set at 80% of the line, then the impedance reach is calculated from the following:

$$\begin{aligned} & (X_{TG} + 0.8 \cdot (0.8 \cdot Z_{SLG1})) \cdot Z_{B,secondary} \\ &= (j0.11607 + 0.8 \cdot (0.8 \cdot (0.02196 + j0.23219))) \cdot 17.56 \Omega \\ &= (0.25 + j4.65) \Omega \end{aligned}$$

$$|Z_b| = \sqrt{0.25^2 + 4.65^2} = 4.6 \Omega$$

$$\varphi_b = \tan^{-1}\left(\frac{4.65}{0.25}\right) = 87^\circ$$

The setting parameter »Mho Pos.Imp.Reach« is set to the minimum of $|Z_a|$ and $|Z_b|$, the angle is selected as 90° (i.e. the resistive part is neglected) and no offset impedance is needed:

- »Mho Pos.Imp.Reach« = 2.5 Ω
- »Mho Pos.Imp.Angle« = 90°
- »Mho Offs.Imp.Reach« = 0 Ω
- »Mho Offs.Imp.Angle« = 0°

The time delay should be set greater than the tripping time of zone 1 of the shortest line distance protection (0.1 s) plus the tripping time of the used breaker failure function (0.1 s), as well as the CB opening time (e.g. 0.1 s). With an additional security margin of 0.1 s the resulting time setting is:

- »Trip delay time« = 0.4 s

This time delay gives the primary protection functions (generator differential 87G, transformer differential 87T and overall differential 87GT as well as bus protection) enough time to trip before the operation of generator phase distance protection function Z[1].

Settings for the Phase Distance Protection Z[2]

A remote backup protection is defined as a backup protection for faults on the remote protected object, in this case the faults on the longest transmission line connected to the generating unit high-voltage bus. A distance protection element for this usage should detect faults on whole line and isolate the generator with the faulted system (only) if faults are not tripped by line protection functions because of relay failure.

The phase distance element Z[2] is selected for this remote backup protection. The impedance reach setting should be set such that it sees at least 120% of the longest line connected to the generating station high-voltage bus:

$$\begin{aligned} Z &= (X_{TG} + 120\% \cdot Z_{LLG1}) \cdot Z_{B,secondary} \\ &= (j0.11607 + 120\% \cdot (0.04404 + j0.46437)) \cdot 17.56 \Omega \\ &= (0.93 + j11.82) \Omega \end{aligned}$$

Hence it follows:

$$|Z| = \sqrt{0.93^2 + 11.82^2} = 11.86 \Omega$$

$$\varphi = \tan^{-1}\left(\frac{11.82}{0.93}\right) = 85^\circ$$

Therefore the distance protection element Z[2] is set as follows:

- »Mho Pos.Imp.Reach« = 11.9 Ω
- »Mho Pos.Imp.Angle« = 85°
- »Mho Offs.Imp.Reach« = 0 Ω
- »Mho Offs.Imp.Angle« = 0°

The time delay for Z[2] should be set greater than the tripping time of zone 2 of the longest line distance protection (0.8 s) plus the tripping time of the used breaker failure function (0.1 s), as well as the CB opening time (e.g. 0.1 s). With an additional security margin of 0.1 s the resulting time setting is:

- »Trip delay time« = (0.8 + 0.1 + 0.1 + 0.1) s = 1.1 s

NOTICE

The setting calculation above is only an example calculation to illustrate the setting procedure in a simplified manner.



In fact, there are many more setting possibilities and relevant factors, such as in-feed effects during system faults, maximum loading conditions to be expected, stable power swings; all these may have significant impacts on the distance backup protection settings.

It is therefore recommended that the setting of these protections be evaluated between the generator protection engineers and the system protection engineers to optimize coordination while still protecting the generator. System stability studies may be necessary to help determine settings which optimize protection and coordination.

Device Planning Parameters of the Phase Distance Protection Module



Parameter	Description	Options	Default	Menu path
Mode 	Mode	do not use, use	do not use	[Device planning]

Global Protection Parameters of the Phase Distance Protection Module

Parameter	Description	Setting range	Default	Menu path
ExBlo1 	External blocking of the module, if blocking is activated (allowed) within a parameter set and if the state of the assigned signal is true.	1..n, Assignment List	-.-	[Protection Para /Global Prot Para /Z /Z[1]]
ExBlo2 	External blocking of the module, if blocking is activated (allowed) within a parameter set and if the state of the assigned signal is true.	1..n, Assignment List	-.-	[Protection Para /Global Prot Para /Z /Z[1]]
ExBlo TripCmd 	External blocking of the Trip Command of the module/the stage, if blocking is activated (allowed) within a parameter set and if the state of the assigned signal is true.	1..n, Assignment List	-.-	[Protection Para /Global Prot Para /Z /Z[1]]

Parameter	Description	Setting range	Default	Menu path
Blo by Power Swing 	Blo by Power Swing	--, PSB.Start, DI Slot X1.DI 1, DI Slot X1.DI 2, DI Slot X1.DI 3, DI Slot X1.DI 4, DI Slot X1.DI 5, DI Slot X1.DI 6, DI Slot X1.DI 7, DI Slot X1.DI 8, DI Slot X5.DI 1, DI Slot X5.DI 2, DI Slot X5.DI 3, DI Slot X5.DI 4, DI Slot X5.DI 5, DI Slot X5.DI 6, DI Slot X5.DI 7, DI Slot X5.DI 8, DI Slot X6.DI 1, DI Slot X6.DI 2, DI Slot X6.DI 3, DI Slot X6.DI 4, DI Slot X6.DI 5, DI Slot X6.DI 6, DI Slot X6.DI 7, DI Slot X6.DI 8, Logics.LE1.Gate Out, Logics.LE1.Timer Out, Logics.LE1.Out, Logics.LE1.Out inverted, Logics.LE2.Gate Out, Logics.LE2.Timer Out, Logics.LE2.Out, Logics.LE2.Out inverted, Logics.LE3.Gate Out,	--	[Protection Para /Global Prot Para /Z /Z[1]]



Parameter	Description	Setting range	Default	Menu path
Blo by LB 	Blocking of the distance protection module, if the state of the assigned signal (in general this is the Operate signal from the Load Blinder module) is true.	--, LB.Operate, DI Slot X1.DI 1, DI Slot X1.DI 2, DI Slot X1.DI 3, DI Slot X1.DI 4, DI Slot X1.DI 5, DI Slot X1.DI 6, DI Slot X1.DI 7, DI Slot X1.DI 8, DI Slot X5.DI 1, DI Slot X5.DI 2, DI Slot X5.DI 3, DI Slot X5.DI 4, DI Slot X5.DI 5, DI Slot X5.DI 6, DI Slot X5.DI 7, DI Slot X5.DI 8, DI Slot X6.DI 1, DI Slot X6.DI 2, DI Slot X6.DI 3, DI Slot X6.DI 4, DI Slot X6.DI 5, DI Slot X6.DI 6, DI Slot X6.DI 7, DI Slot X6.DI 8, Logics.LE1.Gate Out, Logics.LE1.Timer Out, Logics.LE1.Out, Logics.LE1.Out inverted, Logics.LE2.Gate Out, Logics.LE2.Timer Out, Logics.LE2.Out, Logics.LE2.Out inverted, Logics.LE3.Gate Out,	--	[Protection Para /Global Prot Para /Z /Z[1]]





Parameter	Description	Setting range	Default	Menu path
AdaptSet 1 	Assignment Adaptive Parameter 1	AdaptSet	-.-	[Protection Para /Global Prot Para /Z /Z[1]]
AdaptSet 2 	Assignment Adaptive Parameter 2	AdaptSet	-.-	[Protection Para /Global Prot Para /Z /Z[1]]



Setting Group Parameters of the Phase Distance Protection Module

NOTICE The actually available value range for all impedance settings is dependent on the Field Parameter setting »CT sec«. This dependency is not properly reflected in the parameter table below.

- For »CT sec« = 1 A the min. value from the “Setting Range” table row has to be multiplied by 5.
- For »CT sec« = 5 A the max. value from the “Setting Range” table row has to be divided by 5.

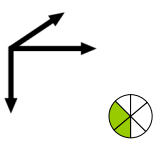
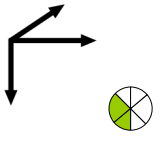
Parameter	Description	Setting range	Default	Menu path
Function 	Permanent activation or deactivation of module/stage.	inactive, active	inactive	[Protection Para /<1..4> /Z /Z[1] /General Settings]
ExBlo Fc 	Activate (allow) or inactivate (disallow) blocking of the module/stage. This parameter is only effective if a signal is assigned to the corresponding global protection parameter. If the signal becomes true, those modules/stages are blocked that are parameterized "ExBlo Fc=active".	inactive, active	inactive	[Protection Para /<1..4> /Z /Z[1] /General Settings]

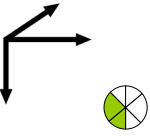
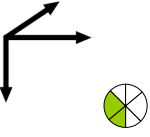
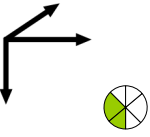
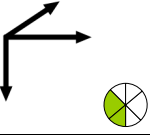
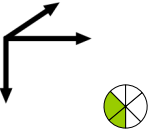
Parameter	Description	Setting range	Default	Menu path
Blo TripCmd 	Permanent blocking of the Trip Command of the module/stage.	inactive, active	inactive	[Protection Para /<1..4> /Z /Z[1] /General Settings]
ExBlo TripCmd Fc 	Activate (allow) or inactivate (disallow) blocking of the module/stage. This parameter is only effective if a signal is assigned to the corresponding global protection parameter. If the signal becomes true, those modules/stages are blocked that are parameterized "ExBlo TripCmd Fc=active".	inactive, active	inactive	[Protection Para /<1..4> /Z /Z[1] /General Settings]
Meas Circuit Superv 	Activates the use of the measuring circuit supervision. In this case the module will be blocked if a measuring circuit supervision module (e.g. LOP, VTS) signals a disturbed measuring circuit (e.g. caused by a fuse failure).	inactive, active	inactive	[Protection Para /<1..4> /Z /Z[1] /General Settings]
Start condition 	Select the start criterion for the measurement of the fault impedances.	Overcurrent, Overcur & Undervlt, Underimpedance	Overcurrent	[Protection Para /<1..4> /Z /Z[1] /Threshold Settings]
I> Str 	Limit value for »Start condition« = "Overcurrent": The start criterion is fulfilled if the maximum measured phase current exceeds this value.	0.02 - 20.00In	1.00In	[Protection Para /<1..4> /Z /Z[1] /Threshold Settings]
Voltage type 	Option for »Start condition« = "Overcur & Undervlt": Select whether phase-to-phase or phase-to-ground voltages shall be used for the undervoltage criterion.	Phase to Ground, Phase to Phase	Phase to Ground	[Protection Para /<1..4> /Z /Z[1] /Threshold Settings]

Parameter	Description	Setting range	Default	Menu path
<p>V < Str</p> 	<p>Limit value for »Start condition« = "Overcur & Undervlt": The start criterion is fulfilled if the maximum measured phase current exceeds »I> Str« and the minimum measured voltage is below this value.</p>	0.01 - 2.00Vn	0.80Vn	<p>[Protection Para /<1..4> /Z /Z[1] /Threshold Settings]</p>
<p>Z < Str</p> 	<p>Limit value for »Start condition« = "Underimpedance": The start criterion is fulfilled if the corresponding measured loop impedance (secondary value) is below this limit.</p>	0.2 - 750.0Ω	20.0Ω	<p>[Protection Para /<1..4> /Z /Z[1] /Threshold Settings]</p>
<p>Direction enable</p> 	<p>Direction enable</p>	inactive, active	inactive	<p>[Protection Para /<1..4> /Z /Z[1] /Characteristic]</p>
<p>Direction angle 1</p> 	<p>Angle that confines the impedance area. (Note that the angle is always measured counter-clockwise from the positive R-axis.)</p>	-90 - 45°	-30°	<p>[Protection Para /<1..4> /Z /Z[1] /Characteristic]</p>
<p>Direction angle 2</p> 	<p>Angle that confines the impedance area. (Note that the angle is always measured counter-clockwise from the positive R-axis.)</p>	95 - 180°	105°	<p>[Protection Para /<1..4> /Z /Z[1] /Characteristic]</p>
<p>Type of imp. area</p> 	<p>Select whether the impedance characteristic shall be of type MHO or polygon.</p>	MHO, Polygon	MHO	<p>[Protection Para /<1..4> /Z /Z[1] /Characteristic]</p>

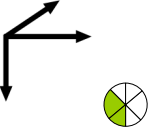
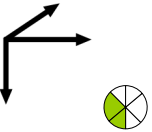
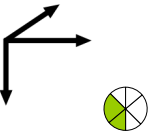
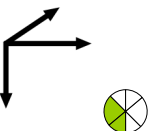
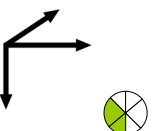
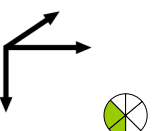
Parameter	Description	Setting range	Default	Menu path
Mho Pos.Imp.Reach 	MHO characteristic: Positive Impedance Reach (secondary value).	0.2 - 750.0Ω	10.0Ω	[Protection Para /<1..4> /Z /Z[1] /Characteristic]
Mho Pos.Imp.Angle 	MHO characteristic: Positive Impedance Angle	0 - 90°	60°	[Protection Para /<1..4> /Z /Z[1] /Characteristic]
Mho Offs.Imp.Reach 	MHO characteristic: Offset Impedance Reach (secondary value).	0.0 - 750.0Ω	1.50Ω	[Protection Para /<1..4> /Z /Z[1] /Characteristic]
Mho Offs.Imp.Angle 	MHO characteristic: Offset Impedance Angle	0 - 360°	240°	[Protection Para /<1..4> /Z /Z[1] /Characteristic]
Polyg.Pos.Imp.Reach 	Polygon characteristic: The »Positive Impedance Reach« is the amplitude of the positive impedance phasor (secondary value) in the forward direction (first quadrant). This impedance phasor corresponds usually to the line impedance which is protected by distance protection.	0.2 - 500.0Ω	10.0Ω	[Protection Para /<1..4> /Z /Z[1] /Characteristic]
Polyg.Pos.Imp.Angle 	Polygon characteristic: The »Positive Impedance Angle« is the angle of the positive impedance phasor in the forward direction (first quadrant). This corresponds usually to the angle of the line impedance which is protected by distance protection.	45 - 90°	60°	[Protection Para /<1..4> /Z /Z[1] /Characteristic]

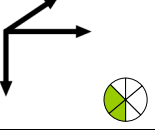
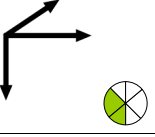
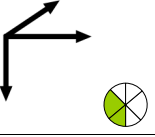
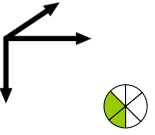
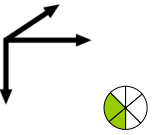
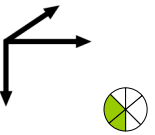
Parameter	Description	Setting range	Default	Menu path
Polyg.Pos.Imp.R.Ang.1 	Polygon characteristic: The »Positive Impedance Reach Angle 1« is the tilt angle of the line element which is starting at the positive impedance reach tip and spreads on the right side in the first quadrant.	-30 - 5°	0°	[Protection Para /<1..4> /Z /Z[1] /Characteristic]
Polyg.Pos.Imp.R.Ang.2 	Polygon characteristic: The »Positive Impedance Reach Angle 2« is the tilt angle of the line element which is starting at the positive impedance reach tip and spreads leftwards, to the second quadrant.	175 - 210°	180°	[Protection Para /<1..4> /Z /Z[1] /Characteristic]
Polyg.Pos.Resis.Reach 	Polygon characteristic: The »Positive Resistive Reach« determines the reach on the positive R-axis (secondary value) and is used to limit the coverage for fault resistance and encroachment of the load impedance into the characteristics.	0.2 - 500.0Ω	8.0Ω	[Protection Para /<1..4> /Z /Z[1] /Characteristic]
Polyg.Pos.Resis.Ang.1 	Polygon characteristic: The »Positive Resistive Angle 1« is a tilt angle in the first quadrant. The area right from the blinder is excluded from the operating area.	50 - 90°	60°	[Protection Para /<1..4> /Z /Z[1] /Characteristic]
Polyg.Pos.Resis.Ang.2 	Polygon characteristic: The »Positive Resistive Angle 2« is a tilt angle in the fourth quadrant.	225 - 270°	240°	[Protection Para /<1..4> /Z /Z[1] /Characteristic]
Polyg.Neg.Imp.Reach 	Polygon characteristic: The »Negative Impedance Reach« is the amplitude of the negative impedance phasor (secondary value) in the reverse (backward) direction (3rd quadrant).	0.2 - 500.0Ω	2Ω	[Protection Para /<1..4> /Z /Z[1] /Characteristic]

Parameter	Description	Setting range	Default	Menu path
Polyg.Neg.Imp. Angle	Polygon characteristic: The »Negative Impedance Angle« defines the impedance angle in the reverse (backward) direction (third quadrant).	225 - 270°	240°	[Protection Para /<1..4> /Z /Z[1] /Characteristic]
Polyg.Neg.Imp. R.Ang.1	Polygon characteristic: The »Negative Impedance Reach Angle 1« is the tilt angle of the line element which is starting at the negative impedance reach tip and spreads to the right, i.e. into the fourth quadrant.	-30 - 30°	0°	[Protection Para /<1..4> /Z /Z[1] /Characteristic]
Polyg.Neg.Imp. R.Ang.2	Polygon characteristic: The »Negative Impedance Reach Angle 2« is the tilt angle of the line element which is starting at the negative impedance reach tip and spreads on the left side in the third quadrant.	150 - 180°	180°	[Protection Para /<1..4> /Z /Z[1] /Characteristic]
Polyg.Neg.Resis. .Reach	Polygon characteristic: The »Negative Resistive Reach« determines the reach on the negative R-axis (secondary value).	0.2 - 500.0Ω	1.6Ω	[Protection Para /<1..4> /Z /Z[1] /Characteristic]
Polyg.Neg.Resis .Ang.1	Polygon characteristic: The »Negative Resistive Angle 1« is a tilt angle in the second quadrant. The area left from the blinder is excluded from the operating area.	60 - 120°	105°	[Protection Para /<1..4> /Z /Z[1] /Characteristic]
Polyg.Neg.Resis .Ang.2	Polygon characteristic: The »Negative Resistive Angle 2« is a tilt angle in the third quadrant. The area left from the blinder is excluded from the operating area.	225 - 270°	270°	[Protection Para /<1..4> /Z /Z[1] /Characteristic]

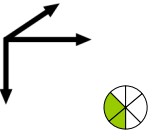
Parameter	Description	Setting range	Default	Menu path
Trip delay time 	This specifies the delay from pickup to CB tripping. (Note that since the phase distance protection is mainly used as a backup this time delay should be coordinated carefully with the primary tripping time and the latency of CB failure protection.)	0.00 - 300.00s	0.50s	[Protection Para /<1..4> /Z /Z[1] /General Settings]

Input States of the Phase Distance Protection Module

Name	Description	Assignment via
ExBlo1-I	Module input state: External blocking1	[Protection Para /Global Prot Para /Z /Z[1]]
ExBlo2-I	Module input state: External blocking2	[Protection Para /Global Prot Para /Z /Z[1]]
ExBlo TripCmd-I	Module input state: External Blocking of the Trip Command	[Protection Para /Global Prot Para /Z /Z[1]]
Blo by Power Swing-I	Module input state: Blocking (of the distance protection) by Power Swing detection	[Protection Para /Global Prot Para /Z /Z[1]]
Blo by LB-I	Module input state: Blocking (of the distance protection) by Load Blinder module	[Protection Para /Global Prot Para /Z /Z[1]]
AdaptSet1-I	Module input state: Adaptive Parameter1	[Protection Para /Global Prot Para /Z /Z[1]]
AdaptSet2-I	Module input state: Adaptive Parameter2	[Protection Para /Global Prot Para /Z /Z[1]]

Signals (Output States) of the Phase Distance Protection Module

<i>Signal</i>	<i>Description</i>
active	Signal: active
ExBlo	Signal: External Blocking
Blo TripCmd	Signal: Trip Command blocked
ExBlo TripCmd	Signal: External Blocking of the Trip Command
Blo by Power Swing	Signal: Distance Protection blocked by Power Swing detection
Blo by LB	Signal: Distance Protection blocked by Load Blinder module
Blo by MeasCircSupv	Blocked by Measuring Circuit Supervision
Started	Signal: Distance Protection has been started.
Alarm	Alarm
Trip	Trip
TripCmd	Signal: Trip Command
Fault type L1-L2	Fault type: L1-L2
Fault type L2-L3	Fault type: L2-L3
Fault type L3-L1	Fault type: L3-L1
Fault type L1-L2-L3	Fault type: L1-L2-L3
Active AdaptSet	Active Adaptive Parameter
DefaultSet	Signal: Default Parameter Set
AdaptSet 1	Signal: Adaptive Parameter 1
AdaptSet 2	Signal: Adaptive Parameter 2

LB – Load Blinder (Load Encroachment)

Available elements:
LB

An expanded operating characteristic of a distance protection function can reduce line/generator loadability. If we want to provide sufficient arc resistance coverage and at the same time avoid the possibility for tripping under maximum load conditions, we can use the Load Blinder (load encroachment) function to restrict the operating characteristic of distance protection.

The operating characteristic of the Load Blinder module is a segment of the complex impedance plane, with the exception of a circle around the origin. It is therefore defined by three settings: the two segment angles »Imp. Angle 1«, »Imp. Angle 2«, and the circle radius »Imp. Circ. Rd«:

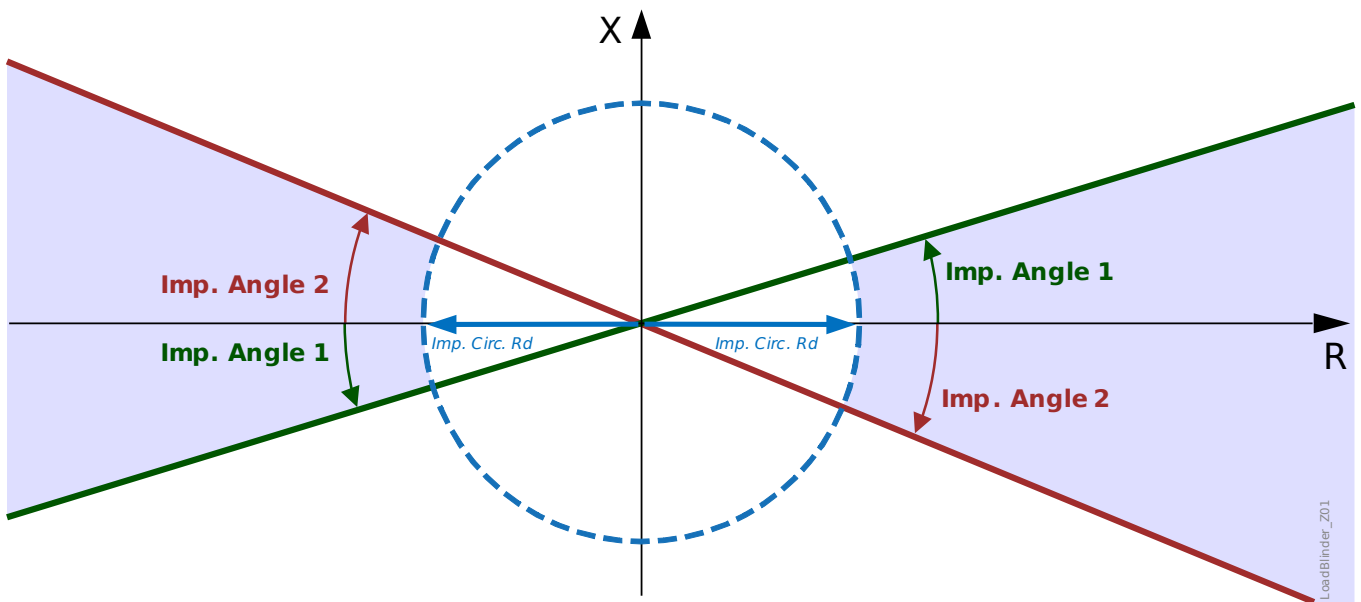

Load Blinder Characteristic (area in bright-blue color)

In other words, the load encroachment area spreads on the outside of the impedance circle, being limited by the two blinders which are defined by the impedance angles, see the light-blue area in the diagram.

If the measured impedance is within the load encroachment area the function will initiate »Pickup« and after the configured time delay (»t-Delay«) the signal »Operate«.

Interaction with Distance Protection

To inhibit the operation of the distance protection element for these high load areas, the »Operate« signal has to be assigned to the input »Z . Blo by LB« of the respective distance protection element. Thereby, the load blinder area is removed from the tripping zone of the appropriate distance protection function. The resulting tripping zone is shown in bright-red color in the following diagram.

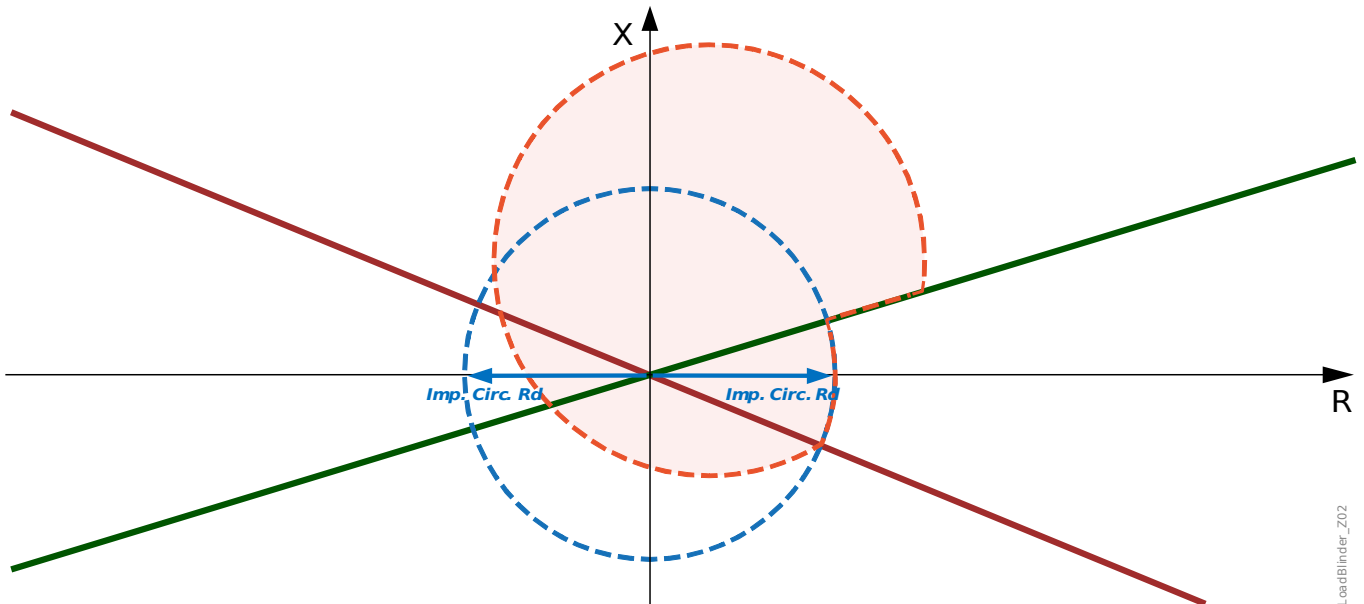

Distance Protection tripping zone (red area) with active Load Blinder.

The load blinder function should work only under overload conditions which are characterized by (almost) only the positive phase sequence component in current measurements. Vice versa, it must be disabled in case of unsymmetrical faults, which are characterized by significant negative phase sequence component. Therefore there are two more settings, a maximum value » $I_2 \text{ max}$ « for the negative sequence current, and a minimum value » $I_1 \text{ min}$ « for the positive sequence current: The Load Blinder function is active only if the positive sequence current I_1 is above » $I_1 \text{ min}$ « **and** if the negative sequence current I_2 is below » $I_2 \text{ max}$ «. The default values of » $I_1 \text{ min}$ «, » $I_2 \text{ max}$ « should already fit to typical applications; nevertheless it is recommended to check these settings during commissioning and adapt them to the local fault and load conditions if necessary.

Functionality

LB

LoadBlinder_Y01

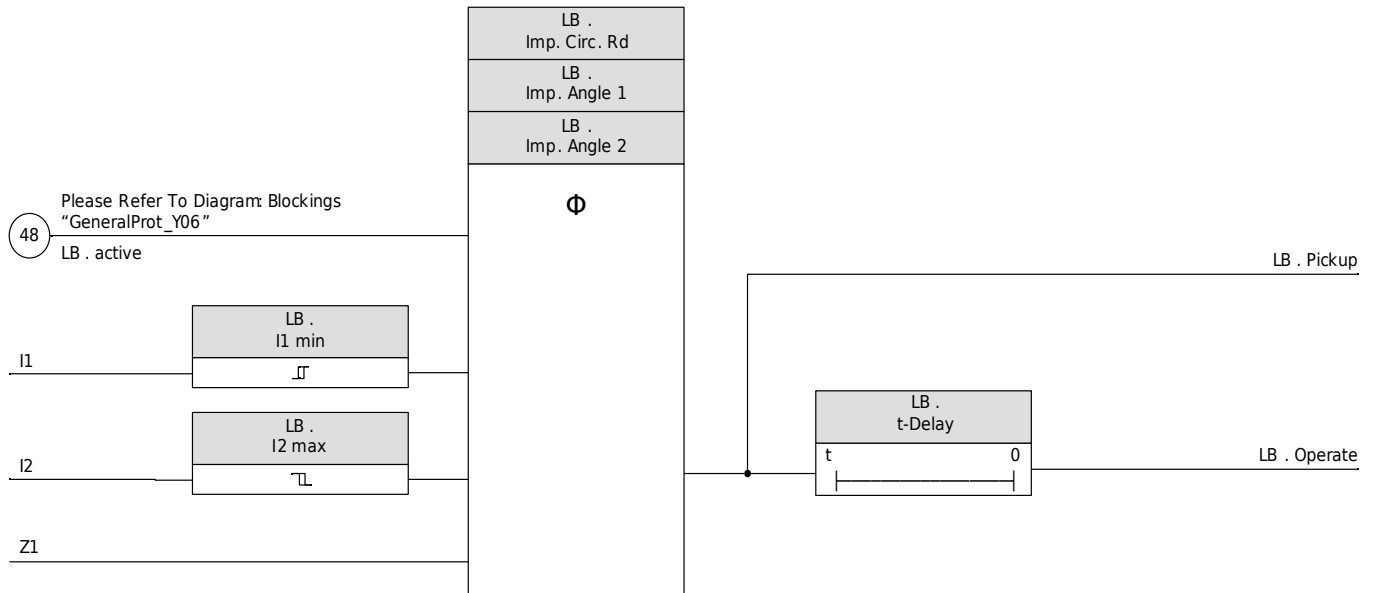

Functionality of the Load Blinder module.

For the temporary or permanent blocking of the Load Blinder module, see the chapter "Blocking".

Device Planning Parameters of the Load Blinder Module

Parameter	Description	Options	Default	Menu path
Mode	Mode	do not use, use	do not use	[Device planning]



Global Protection Parameters of the Load Blinder Module

Parameter	Description	Setting range	Default	Menu path
ExBlo1	External blocking of the module, if blocking is activated (allowed) within a parameter set and if the state of the assigned signal is true.	1..n, Assignment List	-.-	[Protection Para /Global Prot Para /LB]
ExBlo2	External blocking of the module, if blocking is activated (allowed) within a parameter set and if the state of the assigned signal is true.	1..n, Assignment List	-.-	[Protection Para /Global Prot Para /LB]









Setting Group Parameters of the Load Blinder Module

NOTICE The actually available value range for all impedance settings is dependent on the Field Parameter setting »CT sec«. This dependency is not properly reflected in the parameter table below.

- For »CT sec« = 1 A the min. value from the “Setting Range” table row has to be multiplied by 5.
- For »CT sec« = 5 A the max. value from the “Setting Range” table row has to be divided by 5.

Parameter	Description	Setting range	Default	Menu path
Function	Permanent activation or deactivation of module/stage.	inactive, active	inactive	[Protection Para /<1..4> /LB]
ExBlo Fc	Activate (allow) or inactivate (disallow) blocking of the module/stage. This parameter is only effective if a signal is assigned to the corresponding global protection parameter. If the signal becomes true, those modules/stages are blocked that are parameterized "ExBlo Fc=active".	inactive, active	inactive	[Protection Para /<1..4> /LB]



Parameter	Description	Setting range	Default	Menu path
 Meas Circuit Superv Activates the use of the measuring circuit supervision. In this case the module will be blocked if a measuring circuit supervision module (e.g. LOP, VTS) signals a disturbed measuring circuit (e.g. caused by a fuse failure).	inactive, active	inactive	[Protection Para /<1..4> /LB]	
 I1 min Minimum value positive phase sequence current	0.10 - 4.00In	0.50In	[Protection Para /<1..4> /LB]	
 I2 max Maximum value negative sequence current	0.02 - 1.00In	0.20In	[Protection Para /<1..4> /LB]	
 Imp. Circ. Rd The resistance where the Load Blinder area starts (secondary value), i. e. the radius of the impedance circle defining the Load Blinder area (together with the two blinder angles).	0.1 - 500.0Ω	50.0Ω	[Protection Para /<1..4> /LB]	
 Imp. Angle 1 Blinder angle No. 1. This angle is measured counter-clockwise from the R-axis.	0 - 45°	30°	[Protection Para /<1..4> /LB]	
 Imp. Angle 2 Blinder angle No. 2. This angle is measured clockwise from the R-axis.	-45 - 0°	-30°	[Protection Para /<1..4> /LB]	
 t-Delay Delay time between the signals »Pickup« and »Operate«.	0.00 - 300.00s	0.00s	[Protection Para /<1..4> /LB]	

Input States of the Load Blinder Module

Name	Description	Assignment via
ExBlo1-I	Module input state: External blocking1	[Protection Para /Global Prot Para /LB]
ExBlo2-I	Module input state: External blocking2	[Protection Para /Global Prot Para /LB]

Signals (Output States) of the Load Blinder Module

<i>Signal</i>	<i>Description</i>
active	Signal: active
ExBlo	Signal: External Blocking
Blo by MeasCircSupv	Blocked by Measuring Circuit Supervision
Pickup	Signal that the measured system impedance is within the Load Blinder area.
Operate	Signal that the measured system impedance is within the Load Blinder area for at least the duration t-Delay.

PSB – Power Swing Blocking [68]

Available elements:

PSB

After disturbances in a power system, such as short-circuit faults and their tripping, power system oscillations (power swings) can happen. Power swings can cause enormous voltage and current oscillations in the power system. The PSB module should be used to block protection functions that are known to make wrong decisions during a power swing. A protection function that is based on impedance measurements, e. g. distance protection, is affected by such oscillations, which can make the measured impedance move into the operating characteristics of that protection function. If the swing impedance passes through distance zones with a time longer than the set tripping time the result can be false trip decisions. It is therefore necessary to detect power swings so that the distance protection can be blocked.

Function

The PSB function uses a blinder characteristic and the associated functional logic to detect power swings. One of the challenges for power swing detection is to differentiate short-circuit faults during a power swing. In this case, an issued power swing blocking command should be withdrawn as fast as possible, so that correct fault clearance by distance protection shall not be inhibited. For this purpose, a special $\Delta Z/\Delta t$ supervision algorithm is available to distinguish between a fault and a power swing condition. Even a fault during a power swing can be detected so that false blocking of the distance protection for faults during power swings can be avoided.

The best method for detecting power swings is to measure and analyze the impedance trajectory at the generator terminal during a power swing. Since power swing events can be characterized as symmetrical processes, only the positive-sequence impedances are calculated, and the moving trajectories of the positive sequence impedance are evaluated.

The PSB module monitors the positive-sequence impedances measured at the generator terminal and compares them with a configured MHO (circle) characteristic with two blinder elements. The PSB module traces the impedance trajectory and determines if a power swing occurs. An according »Start« signal is then issued, which can be used selectively for blocking distance protection elements.

Besides the system symmetry is monitored by evaluating the negative-phase sequence current continuously.

Impedance Location under Different System Conditions

Impedance Location under Different System Conditions

Under normal operation conditions the load impedances dwell within a load region shown in the following diagram, and no significant impedance change rate is expected by different load conditions.

In case of a short-circuit fault in front of the generator, however, the impedances as viewed at the relay point change rapidly from the load region to a fault region which is located in very small range depending on the faulted distance to the relay point.

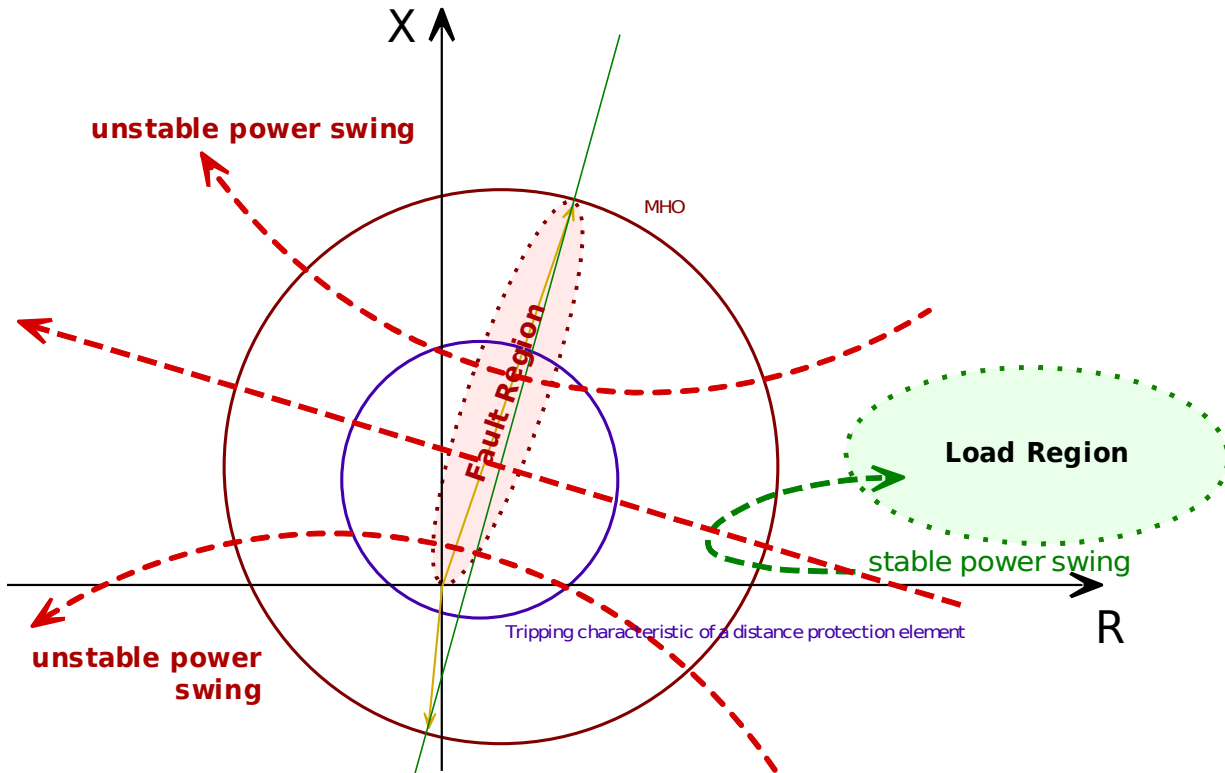

PSB_Z01

Load Region and impedance trajectories.

The variation of the measured impedance during a power swing event (i.e. the swing impedance trajectory) moves as shown in the diagram above. The positive sequence impedance travels in the complex plane with rather slow speed, compared to the more or less instantaneous impedance change due to a fault. As the impedance trajectory during a power swing can also move across a distance protection tripping zone (see diagram above), it is required to detect a power swing beforehand and block the distance function.

PSB Characteristic

For detecting power swing conditions, two blinder elements and a supervisory MHO circle, as shown in the following diagram, work together as a double blinder scheme. The MHO circle, the region to the right of Blinder A and the region to the left of Blinder B define the PSB characteristic and should be configured carefully according to the individual application.

The MHO characteristic is usually set to be a circle with the electrical center as its middle point and with a diameter consisting of whole system impedances observed.

The two blinder elements (Blinder A and Blinder B) are two lines parallel to the system impedance line with settable distances on the resistance axis.

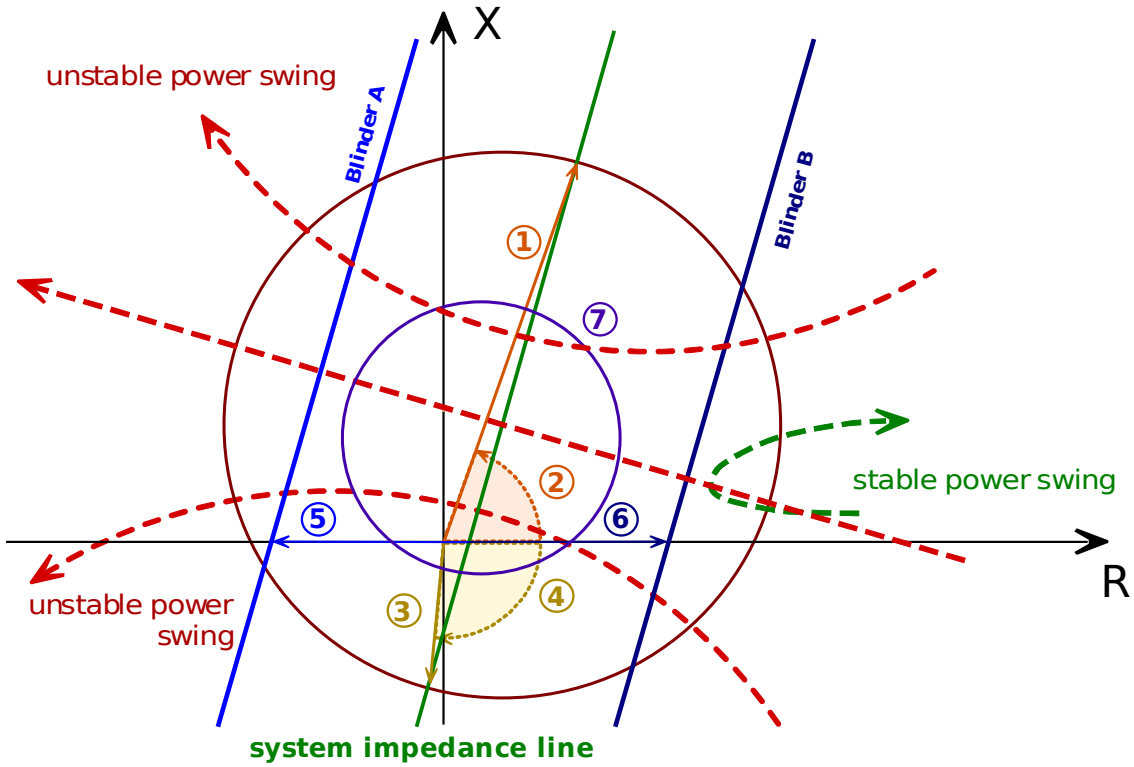

PSB_Z02

PSB Characteristic.

The lengths and angles marked by circled numbers are setting parameters as follows:

Number in Diagram	Setting	Description
[1]	<i>Mho Pos.Imp.Reach</i>	MHO characteristic: Positive Impedance Reach (secondary value).
[2]	<i>Mho Pos.Imp.Angle</i>	MHO characteristic: Positive Impedance Angle
[3]	<i>Mho Offs.Imp.Reach</i>	MHO characteristic: Offset Impedance Reach (secondary value).
[4]	<i>Mho Offs.Imp.Angle</i>	MHO characteristic: Offset Impedance Angle
[5]	<i>Blinder A</i>	Blinder (left) of the impedance zone (characteristic), defined as a value on the R-axis (secondary value).
[6]	<i>Blinder B</i>	Blinder (right) of the impedance zone (characteristic), defined as a value on the R-axis.
[7]		Tripping characteristic of a distance protection element.

Detection Logic

The PSB module measures the positive sequence impedance at the generator terminals and analyzes the variation by an advanced logic, compares it with the preset PSB characteristic and decides whether the impedance change is based on a power swing or on a fault. In case of a power swing a »PSB . Start« signal is issued, which can be used to block other protection functions.

Operating Conditions

Power swings are not the only cause for the impedance trajectory entering the MHO circle. In case of a short-circuit fault, for instance, the trajectory can enter the MHO circle spontaneously, whereas during a power swing the impedance travels in the impedance plane with a comparably slow pace. There are two timers that are used to distinguish between power swings and impedance changes that are due to faults or other system transients.

- The first timer measures the time that it takes the impedance trajectory to cross the distance between the border of the MHO circle and the first blinder. The PSB algorithm works according to a double blinder scheme, where the MHO circle is the outer blinder. If this time is longer than the set value of »*Min. dwell time*« a power swing is declared and the »Start« signal is issued. This signal stays active until the impedance has left the MHO circle again. If the required time to cross the distance is lower than »*Min. dwell time*« (which would be the case for a system fault) the »Start« is not issued.
This principle requires that the blinders are within the MHO circle and that the »*Min. dwell time*« is coordinated with the impedance difference between the MHO circle and the blinder in conjunction with the maximum slip frequency.
- »*Max. dwell time*« supervises the maximum dwell time within the MHO circle during a slip cycle. If the timer elapses before the impedance leaves the MHO circle then the PSB module gets internally blocked until the impedance has left the MHO circle. This blocked state is marked by the signal »Int.blocked«.

The power swing detection works only if there is a sufficient positive sequence current. This limit is set via the parameter »*I1 min*«. Moreover, a negative sequence supervision avoids malfunction during unsymmetrical faults: The module is blocked if the measured negative-sequence current is above the setting »*I2 max*«. The default value of 20% for both »*I1 min*« and »*I2 max*« should be sufficient for most applications.

An additional method to distinguish faults from power swings is to block the OST module if the rate of change of impedance $\Delta Z/\Delta t$ is above a particular threshold »*dZ/dt*«. During a fault, the impedance changes very rapidly from the load impedance to the fault impedance, whereas during a power swing, the speed of the impedance trajectory is slower than in case of a fault, because it depends on the slip frequency, the rotor displacement angle and system impedances. There are two settings related to this feature:

- »*Blo by dZ/dt*« has to be set to "active" to activate the $\Delta Z/\Delta t$ blocking.
- »*dZ/dt*« is the setting for the $\Delta Z/\Delta t$ threshold value.

Short-Circuit Fault During Power Swings

As it is important to distinguish between power swing events and short-circuit faults, the change of the impedance is observed continuously. This change is significantly faster for conventional faults than for power swings.

The impedance change during a power swing can be estimated (assuming two sources with equal magnitude, linear behavior between slip angle and slip frequency, etc.) with the following equation:

$$\frac{\Delta Z}{\Delta t} = \frac{\omega_s \cdot Z}{4 \cdot \left(\sin\left(\frac{\delta}{2}\right)\right)^2}$$

With:

- $\omega_s = 2\pi \cdot f_s$
- f_s : slip frequency
- Z : system impedance
- δ : slip angle

This shows that the impedance change depends on the slip frequency, the system impedance and the slip angle. Furthermore, it shows that the impedance change over time has a minimum at a pole slip angle of 180°. The impedance change is usually smaller than 100 Ω/s for a slip angle between 90° and 270° ($f_s = 1$ Hz, $Z = 10$ Ω).

The difference between the minimum expected load impedance and the maximum fault impedance based on $\Delta t = 20$ ms (data window length to get an impedance calculated at 50 Hz resp. $\Delta t = 16.7$ ms at 60 Hz) leads to a typical $\Delta Z/\Delta t$ for a fault:

$$\frac{\Delta Z}{\Delta t} = \frac{Z_L - Z_F}{\Delta t}$$

The OST function uses the $\Delta Z/\Delta t$ threshold (setting parameter: »dZ/dt«) to distinguish between a fault and a power swing. It can be observed that typical impedance changes are about five times higher for conventional faults than for power swings.

This means that the following settings should be sufficient for most applications:

- For $I_n = 1$ A: »dZ/dt« = $\Delta Z/\Delta t = 300$ Ω/s,
- For $I_n = 5$ A: »dZ/dt« = $\Delta Z/\Delta t = 60$ Ω/s.

This should be adapted if a transient stability study shows that the system has a different rate of change of impedance. It is also to note that the “dZ/dt” should in fact be replaced by “dR/dt” because only the resistive part of the impedance is evaluated. This is acceptable if bearing in mind that significant impedance changes by both power swings and faults are clearly represented in their resistive parts but not in their reactive parts.

This, on the other hand, shows that for the rare case of a 3-pole fault with an inception point at the same resistance on the impedance trajectory as the resistance component of the fault, it is on principle not possible to recognize this fault.

Interaction with Distance Protection

Since the PSB module is aimed to be used to block the distance protection module for avoiding potential false tripping during a power swing, its applications should be carefully coordinated with the related distance protection elements. In general, the following considerations should be taken into account:

- It is recommended to do transient stability studies before applying Power Swing Blocking to some distance protection element. This yields the power swing information required for optimized settings. As it is important to detect a power swing and block the distance function **before** the power swing trajectory crosses the distance tripping zone, the PSB MHO circle and the blinder must be placed outside the largest distance zone for which the blocking is required.
- Distance protection needs to be blocked only if it is possible that during a power swing the impedance trajectory can move into the distance tripping zone with dwell time longer than the tripping time of the distance protection zone. This means that Power Swing Blocking is not needed (and therefore not recommended) for distance protection zones which are never invaded by the impedance trajectory, or if false tripping is not possible because of a long trip delay.
- The Power Swing Blocking is established by assigning the »Start« signal to the input »Z[1/2] . *Blo by Power Swing*« of the respective **Phase Distance** element. Further information can be found in the chapter about the Phase Distance Protection (Z) module.

When a generator loses synchronism with the system the impedance locus is expected to travel from right to left through the Out of Step Tripping characteristic. If loss of synchronism happens while the generator is running in motoring mode, the impedance is expected to travel from left to right. Both cases can be detected with this PSB function if both blinders are configured properly.

Functionality

PSB

PSB_Y01

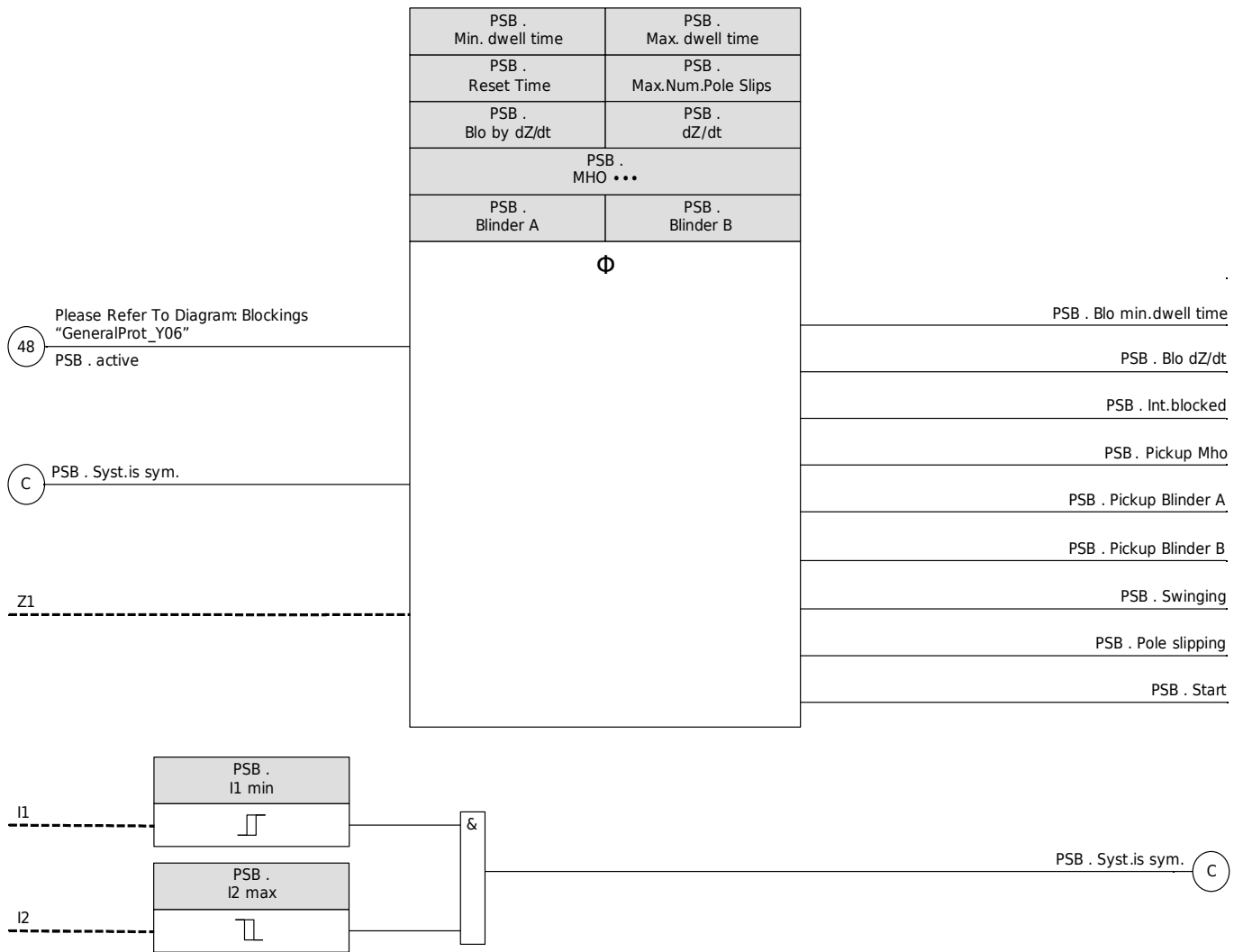

Functionality of the Power Swing Blocking module.

For the temporary or permanent blocking of the phase distance protection module, see the chapter “Blocking”.

PSB – Settings

The configuration of the power swing blocking requires a coordination with the related protection function. It is an important requirement that the power swing blocking function is able to identify a power swing before the impedance trajectory reaches the distance protection tripping zone. That means the the distance protection tripping zone has to be contained completely within the blinders and the MHO circle of the power swing blocking function. As the power swing blocking function uses the same functional principle as the Out of Step Tripping function, the same basic configuration calculations can be used.

The diagram below shows the relationship between a sample power system, a distance protection tripping zone and a PSB characteristic.

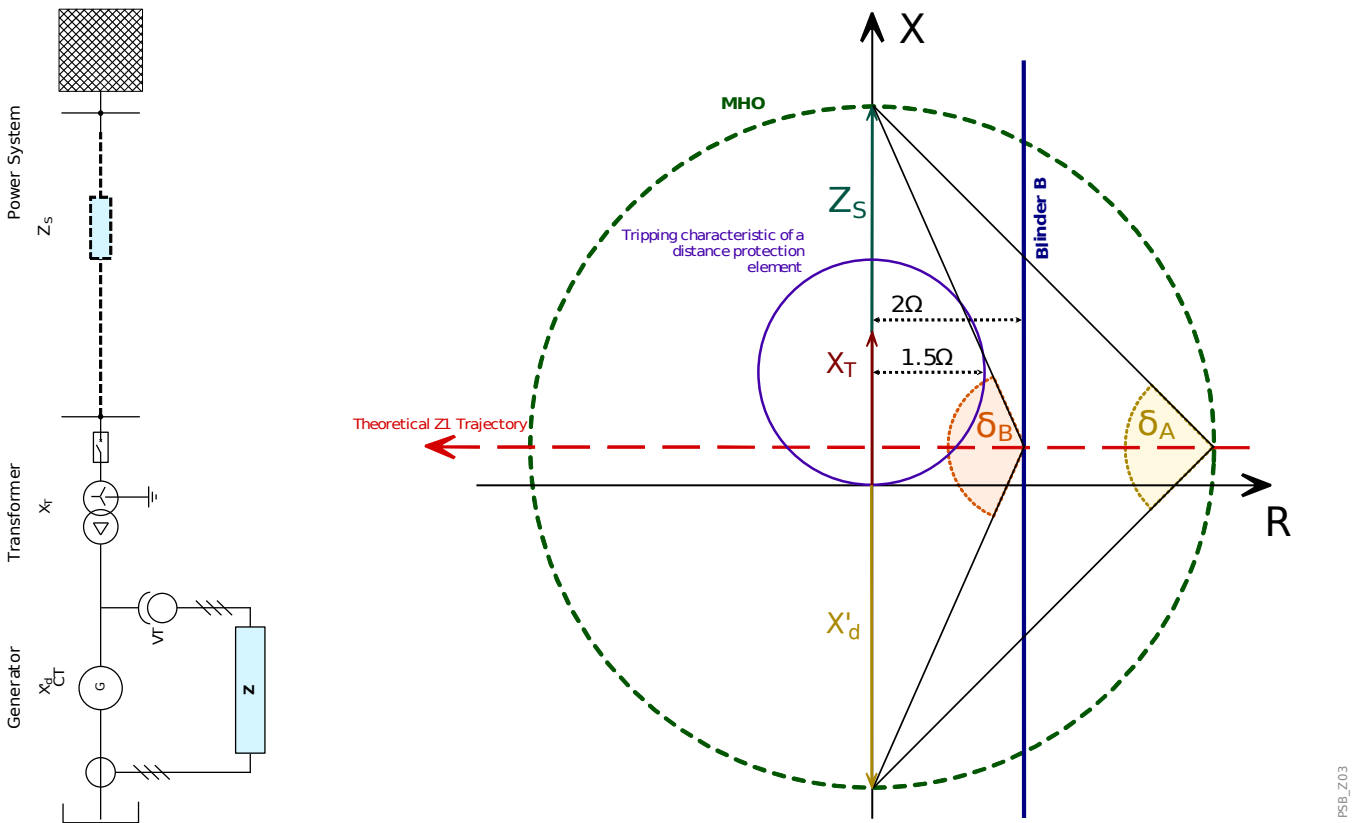

System Single-Line (left) and PSB characteristics (right).

In this context, the generator is described via the transient reactance X'_d , the transformer reactance via X_T and the impedance of the connected power system via Z_S . The system impedance line is the connection of all these three impedances, see diagram.

To simplify the setting calculations, the resistive components of the impedances are neglected and only reactive components are considered.

As an example, we assume the following data (in polar coordinates, i.e. as norm [vector length] and angle):

- • $X_T = 2 \Omega \angle 90^\circ$
- • $Z_S = 3 \Omega \angle 90^\circ$
- • $X'_d = 4 \Omega \angle 90^\circ$

With an assumed resistive reach of the distance protection tripping zone of $R_{21} = 1.5 \Omega$, the Blinder B position at $R_B = 2 \Omega$ would be outside the distance tripping zone as required.

The according pole slip angle at Blinder B can be calculated as follows:

$$\delta_B = 2 \cdot (90^\circ - \tan^{-1}(\frac{2 \cdot R_B}{X_S + X_T + X'_d})) = 132^\circ$$

The angle δ_A is the pole slip angle when the impedance reaches the MHO circle, which is around the electrical center with a diameter equal to the sum of reactances ($X'_d + X_T + X_S$). Since it is an angle within a Thales circle, it equals 90° .

Based on this, and assuming $f_{S,max} = 2.5 \text{ Hz}$ for the maximum slip frequency, the »Min. dwell time« can be calculated:

$$\text{» Min. dwell time «} = \frac{\delta_B - \delta_A}{360^\circ} \cdot \frac{1}{f_{S,max}} = \frac{132^\circ - 90^\circ}{360^\circ} \cdot \frac{1}{2.5 \text{ Hz}} = 47 \text{ ms}$$

The »Max. dwell time« can be used to limit the time the PSB function issues a blocking signal.

Device Planning Parameters of the Power Swing Blocking Module

Parameter	Description	Options	Default	Menu path
Mode	Mode	do not use, use	do not use	[Device planning]

Global Protection Parameters of the Power Swing Blocking Module

Parameter	Description	Setting range	Default	Menu path
ExBlo1	External blocking of the module, if blocking is activated (allowed) within a parameter set and if the state of the assigned signal is true.	1..n, Assignment List	.-	[Protection Para /Global Prot Para /PSB]
ExBlo2	External blocking of the module, if blocking is activated (allowed) within a parameter set and if the state of the assigned signal is true.	1..n, Assignment List	.-	[Protection Para /Global Prot Para /PSB]







Setting Group Parameters of the Power Swing Blocking Module







NOTICE The actually available value range for all impedance settings is dependent on the Field Parameter setting »CT sec«. This dependency is not properly reflected in the parameter table below.

- For »CT sec« = 1 A the min. value from the “Setting Range” table row has to be multiplied by 5.
- For »CT sec« = 5 A the max. value from the “Setting Range” table row has to be divided by 5.

Parameter	Description	Setting range	Default	Menu path
Function	Permanent activation or deactivation of module/stage.	inactive, active	inactive	[Protection Para /<1..4> /PSB /General Settings]
ExBlo Fc	Activate (allow) or inactivate (disallow) blocking of the module/stage. This parameter is only effective if a signal is assigned to the corresponding global protection parameter. If the signal becomes true, those modules/stages are blocked that are parameterized "ExBlo Fc=active".	inactive, active	inactive	[Protection Para /<1..4> /PSB /General Settings]

Protective Elements

Parameter	Description	Setting range	Default	Menu path
 Meas Circuit Superv Activates the use of the measuring circuit supervision. In this case the module will be blocked if a measuring circuit supervision module (e.g. LOP, VTS) signals a disturbed measuring circuit (e.g. caused by a fuse failure).	inactive, active	inactive	[Protection Para /<1..4> /PSB /General Settings]	
 I1 min Minimum value positive phase sequence current	0.02 - 4.00In	0.20In	[Protection Para /<1..4> /PSB /General Settings]	
 I2 max Maximum value negative sequence current	0.02 - 1.00In	0.20In	[Protection Para /<1..4> /PSB /General Settings]	
 Min. dwell time Minimum dwell time within the impedance zone (characteristic). This timer is essential to enable the device to distinguish between a power swing and a system fault. If the measured impedance crosses the first blinder before this timer has expired, the event will be declared as a system fault and not as power swing. This has the consequence that the function is blocked until the impedance has left the MHO circle again.	0.020 - 0.200s	0.100s	[Protection Para /<1..4> /PSB /General Settings]	
 Max. dwell time Maximum dwell time within the impedance zone (characteristic). (Above this time the slip frequency is assumed to be implausibly low.)	0.20 - 20.00s	10.00s	[Protection Para /<1..4> /PSB /General Settings]	
 Blo by dZ/dt Activate (allow) or inactivate (disallow) blocking of the module if the »dZ/dt« limit is exceeded.	inactive, active	active	[Protection Para /<1..4> /PSB /General Settings]	

Parameter	Description	Setting range	Default	Menu path
dZ/dt 	Rate of impedance change per time (secondary value). This setting is essential to enable the device to distinguish between a power swing and a system fault.	2.0 - 1000.0Ω/s	300Ω/s	[Protection Para /<1..4> /PSB /General Settings]
Mho Pos.Imp.Reach 	MHO characteristic: Positive Impedance Reach (secondary value).	0.2 - 750.0Ω	10.0Ω	[Protection Para /<1..4> /PSB /Characteristic]
Mho Pos.Imp.Angle 	MHO characteristic: Positive Impedance Angle	60 - 90°	90°	[Protection Para /<1..4> /PSB /Characteristic]
Mho Offs.Imp.Reach 	MHO characteristic: Offset Impedance Reach (secondary value).	0.0 - 750.0Ω	10.0Ω	[Protection Para /<1..4> /PSB /Characteristic]
Mho Offs.Imp.Angle 	MHO characteristic: Offset Impedance Angle	240 - 270°	270°	[Protection Para /<1..4> /PSB /Characteristic]
Blinder A 	Blinder (left) of the impedance zone (characteristic), defined as a value on the R-axis (secondary value).	-375.0 - 0.0Ω	-2.5Ω	[Protection Para /<1..4> /PSB /Characteristic]
Blinder B 	Blinder (right) of the impedance zone (characteristic), defined as a value on the R-axis (secondary value).	0.0 - 375.0Ω	2.5Ω	[Protection Para /<1..4> /PSB /Characteristic]

Input States of the Power Swing Blocking Module

Name	Description	Assignment via
ExBlo1-I	Module input state: External blocking1	[Protection Para /Global Prot Para /PSB]
ExBlo2-I	Module input state: External blocking2	[Protection Para /Global Prot Para /PSB]

Signals (Output States) of the Power Swing Blocking Module

Signal	Description
active	Signal: active
ExBlo	Signal: External Blocking
Blo by MeasCircSupv	Blocked by Measuring Circuit Supervision
Int.blocked	Signal: The module is internally blocked because the »Max. dwell time« has expired.
Pickup Blinder A	Signal: The impedance is within the MHO circle on the right side of Blinder A.
Pickup Blinder B	Signal: The impedance is within the MHO circle on the left side of Blinder B.
Pickup Mho	Signal: The impedance is within the characteristic.
Swinging	Signal: The impedance is within the instable swing zone (i. e. within the characteristic and inside the borders defined by Blinders A and B).
Start	Signal, that a power swing (or an Out-of-step event) has been detected. The state of this signal becomes true as soon as the impedance traverses the first blinder, and it gets reset when the characteristic area is left.
Pole slipping	Signal, that pole slipping has been detected. The state of this signal becomes true as soon as the impedance reaches 180°, and it gets reset when the characteristic area is left.
Syst.is sym.	Signal that the system state is symmetrical, i. e. the negative-sequence current is below »I2 max«, and the positive-sequence current is above »I1 min«.
Blo dZ/dt	Signal: The module has detected a system fault based on the »rate of impedance change per time«, and therefore it has blocked itself.
Blo min.dwell time	Signal: The module has detected a system fault based on the »minimum dwell time«, and therefore it has blocked itself.

SOTF - Switch Onto Fault

SOTF

In case a faulty line is energized (e.g.: when an earthing switch is in the ON-Position), an instantaneous trip is required. The SOTF module is provided to generate a permissive signal for other protection functions such as overcurrents to accelerate their trips (via adaptive parameters). The SOTF condition is recognized according to the User's operation mode that can be based on:

- The breaker state (CB Pos);
- No current flowing ($I <$);
- Breaker state and no current flowing (CB Pos and $I <$);
- Breaker switched on manually (CB manually On); and/or
- An external trigger (Ex SOTF).

This protection module can initiate a high speed trip of the overcurrent protection modules.

 **This module issues a signal only (the module is not armed and does not issue a trip command).**

In order to influence the trip settings of the overcurrent protection in case of switching onto a fault, the User has to assign the signal "SOTF.ENABLED" onto an Adaptive Parameter Set. Please refer to Parameter / Adaptive Parameter Sets sections. Within the Adaptive Parameter Set, the User has to modify the trip characteristic of the overcurrent protection according to the User's needs.

 **This Notice applies to protective devices that offer control functionality only! This protective element requires, that a switchgear (circuit breaker) is assigned to it. It is allowed only to assign switchgears (circuit breaker) to this protective element, whose measuring transformers provide measuring data to the protective device.**

SOTF

name = SOTF

2 Please Refer To Diagram: Blockings
(stage is not deactived and no active blocking signals)

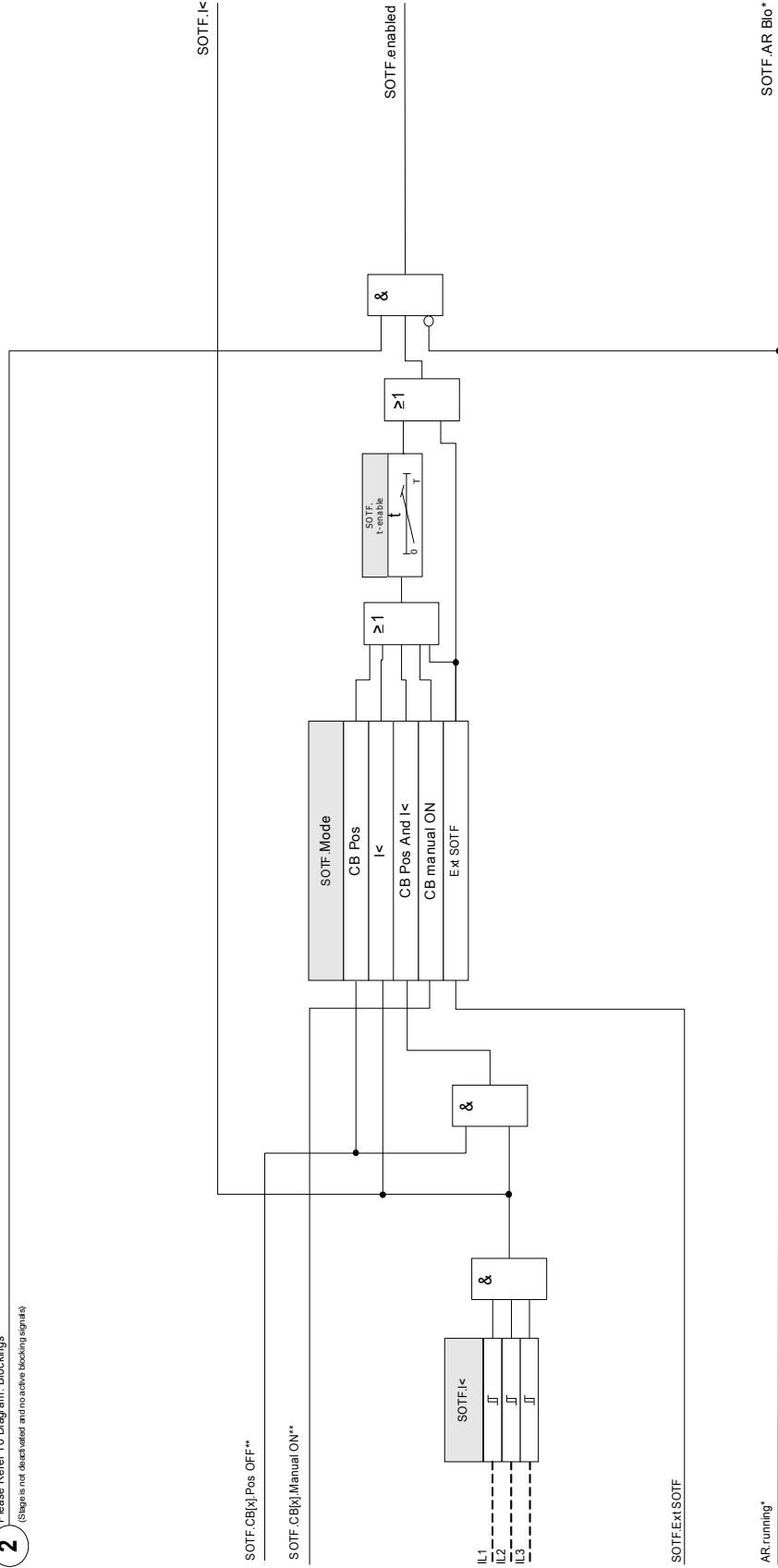



*Applies only for devices with Auto Reclosure

**This signal is the output of the switchgear that is assigned to this protective element. This applies to protective devices that offer control functionality.





Device Planning Parameters of the Switch Onto Fault Module

<i>Parameter</i>	<i>Description</i>	<i>Options</i>	<i>Default</i>	<i>Menu path</i>
Mode 	Mode	do not use, use	do not use	[Device planning]

Global Protection Parameters of the Switch Onto Fault Module

Parameter	Description	Setting range	Default	Menu path
 Mode	Mode	CB Pos, I<, CB Pos And I<, CB manual ON, Ext SOTF	CB Pos	[Protection Para /Global Prot Para /SOTF]
 ExBlo1	External blocking of the module, if blocking is activated (allowed) within a parameter set and if the state of the assigned signal is true.	1..n, Assignment List	-.-	[Protection Para /Global Prot Para /SOTF]
 ExBlo2	External blocking of the module, if blocking is activated (allowed) within a parameter set and if the state of the assigned signal is true.	1..n, Assignment List	-.-	[Protection Para /Global Prot Para /SOTF]
 Ex rev Interl	External blocking of the module by external reverse interlocking, if blocking is activated (allowed) within a parameter set and if the state of the assigned signal is true.	1..n, Assignment List	-.-	[Protection Para /Global Prot Para /SOTF]
 Assigned SG	Assigned Switchgear Only available if: Mode = CB Pos Or CB Pos And I<	-, SG[1], SG[2], SG[3], SG[4], SG[5], SG[6]	SG[1]	[Protection Para /Global Prot Para /SOTF]
 Ext SOTF	External Switch Onto Fault Only available if: Mode = Ext SOTF	1..n, DI-LogicList	-.-	[Protection Para /Global Prot Para /SOTF]

Setting Group Parameters of the Switch Onto Fault Module

Parameter	Description	Setting range	Default	Menu path
Function 	Permanent activation or deactivation of module/stage.	inactive, active	inactive	[Protection Para /<1..4> /SOTF]
ExBlo Fc 	Activate (allow) or inactivate (disallow) blocking of the module/stage. This parameter is only effective if a signal is assigned to the corresponding global protection parameter. If the signal becomes true, those modules/stages are blocked that are parameterized "ExBlo Fc=active".	inactive, active	inactive	[Protection Para /<1..4> /SOTF]
Ex rev Interl Fc 	Activate (allow) or inactivate (disallow) blocking of the module/stage. This parameter is only effective if a signal is assigned to the corresponding global protection parameter. If the signal becomes true, those modules/stages are blocked that are parameterized "Ex rev Interl Fc = active".	inactive, active	inactive	[Protection Para /<1..4> /SOTF]
I< 	The CB is in the OFF Position, if the measured current is less than this parameter.	0.01 - 1.00In	0.01In	[Protection Para /<1..4> /SOTF]
t-enable 	While this timer is running, and while the module is not blocked, the Switch Onto Fault Module is effective (SOTF is armed).	0.10 - 10.00s	2s	[Protection Para /<1..4> /SOTF]

Switch Onto Fault Module Input States

<i>Name</i>	<i>Description</i>	<i>Assignment via</i>
ExBlo1-I	Module input state: External blocking	[Protection Para /Global Prot Para /SOTF]
ExBlo2-I	Module input state: External blocking	[Protection Para /Global Prot Para /SOTF]
Ex rev Interl-I	Module input state: External reverse interlocking	[Protection Para /Global Prot Para /SOTF]
Ext SOTF-I	Module input state: External Switch Onto Fault Alarm	[Protection Para /Global Prot Para /SOTF]

Signals of the Switch Onto Fault Module (Output States)

<i>Signal</i>	<i>Description</i>
active	Signal: active
ExBlo	Signal: External Blocking
Ex rev Interl	Signal: External reverse Interlocking
enabled	Signal: Switch Onto Fault enabled. This Signal can be used to modify Overcurrent Protection Settings.
I<	Signal: No Load Current.

Commissioning: Switch Onto Fault

Object to be tested

Testing the module *Switch Onto Fault* according to the parameterized operating mode:

- The breaker state (CB Pos);
- No current flowing ($I <$);
- Breaker state and no current flowing (CB Pos and $I <$);
- Breaker switched on manually (CB manually On); and/or
- An external trigger (Ex SOTF).

Necessary means:

- Three-phase current source (If the Enable-Mode depends on current);
- Ampere meters (May be needed if the Enable-Mode depends on current); and
- Timer.

Test Example for Mode CB manual ON

NOTICE

Mode $I <$: In order to test the effectiveness: Initially do not feed any current. Start the timer and feed with an abrupt change current that is distinctly greater than the $I <$ -threshold to the measuring inputs of the relay.

Mode $I <$ and Bkr state: Simultaneous switch on the breaker manually and feed with an abrupt change current that is distinctly greater than the $I <$ -threshold.

Mode Bkr state: The breaker has to be in the OFF Position. The signal „SOTF.ENABLED“=0 is untrue. If the breaker is switched on, the signal „SOTF.ENABLED“=1 becomes true as long as the timer t-enabled is running.

- The Circuit Breaker has to be in the OFF Position. There must be no load current.
- The Status Display of the device shows the signal „SOTF.ENABLED“=1.

Testing

- Switch the Circuit Breaker manually ON and start the timer at the same time.
- After the hold time t-enable is expired the state of the signal has to change to „SOTF.ENABLED“=0.
- Write down the measured time.

Successful test result

The measured total tripping delays or individual tripping delays, threshold values and fallback ratios correspond with those values, specified in the adjustment list. Permissible deviations/tolerances can be found under Technical Data.

CLPU - Cold Load Pickup

Available Elements:

CLPU

When the electric load is freshly started or restarted after a prolonged outage, the load current tends to have a temporary surge that could be several times the normal load current in magnitude due to motor starting. This phenomena is called cold load inrush. If the overcurrent pickup threshold is set according to the maximum possible load inrush, the overcurrent protection may be insensitive to some faults, thus making whole protection systems coordination difficult or even impossible. On the other hand, the overcurrent protection could trip on load inrush if it is set based on the fault current studies. The CLPU module is provided to generate a temporary blocking/desensitizing signal to prevent overcurrent protections from unwanted tripping. The cold load pickup function detects a warm-to-cold load transition according to the four selectable cold load detection modes:

- CB POS (Breaker state);
- I< (Undercurrent);
- CB POS AND I< (Breaker state and undercurrent); and
- CB POS OR I< (Breaker state OR undercurrent).

After a warm-to-cold load transition has been detected, a specified load-off timer will be started. This User-settable load-off timer is used in some cases to make sure that the load is really “cold” enough. After the load-off timer times out, the CLPU function issues an “enable” signal »CLPU.ENABLED« that can be used to block some sensitive protection elements like instantaneous overcurrent elements, current unbalance, or power protection elements at User’s choice. Using this enable signal, some time inverse overcurrent elements may also be desensitized at the User’s choice by means of activating adaptive settings of the corresponding overcurrent elements.

When a cold load condition is finished (a cold-to-warm load condition is detected) due to, for example, breaker closing or load current injection, a load inrush detector will be initiated that supervises the coming and going of the load inrush current process. A load inrush is detected if the coming load current exceeds a User-specified inrush current threshold. This load inrush is considered as finished if the load current is decreased to 90% of the inrush current threshold. After the inrush current is diminished, a settle timer starts. The cold load pickup enable signal can only be reset after the settle timer times out. Another max-Block timer, which is started parallel with the load inrush detector after a cold load condition is finished, may also terminate the CLPU enable signal if a load inrush condition is prolonged abnormally.

The cold load pickup function can be blocked manually by external or internal signal at the User’s choice. For the devices with Auto-Reclosing function, the CLPU function will be blocked automatically if auto-reclosure is initiated (AR is running).



This module issues a signal only (it is not armed).

In order to influence the tripping settings of the overcurrent protection, the User has to assign the signal “CLPU.ENABLED“ to an adaptive parameter set. Please refer to the Parameter / Adaptive Parameter Sets section. Within the adaptive parameter set, the User has to modify the tripping characteristic of the overcurrent protection according to the needs.

NOTICE

Please be aware of the meaning of the two delay timers.

t load Off (Pickup Delay): After this time expires, the load is no longer diversified.

t Max Block (Release Delay): After the starting condition is fulfilled (e.g.: breaker switched on manually), the "CLPU.enabled" signal will be issued for this time. That means for the duration of this time, the tripping thresholds of the overcurrent protection can be desensitized by means of adaptive parameters (please refer to the Parameters section). This timer will be stopped if the current falls below 0.9 times of the threshold of the load inrush detector and remains below 0.9 times of the threshold for the duration of the settle time.

NOTICE

This Notice applies to protective devices that offer control functionality only! This protective element requires, that a switchgear (circuit breaker) is assigned to it. It is allowed only to assign switchgears (circuit breaker) to this protective element, whose measuring transformers provide measuring data to the protective device.

CLPU
name = CLPU

2 Please Refer To Diagram: Blockings
(Stage is not deactivated and no active blocking signals)

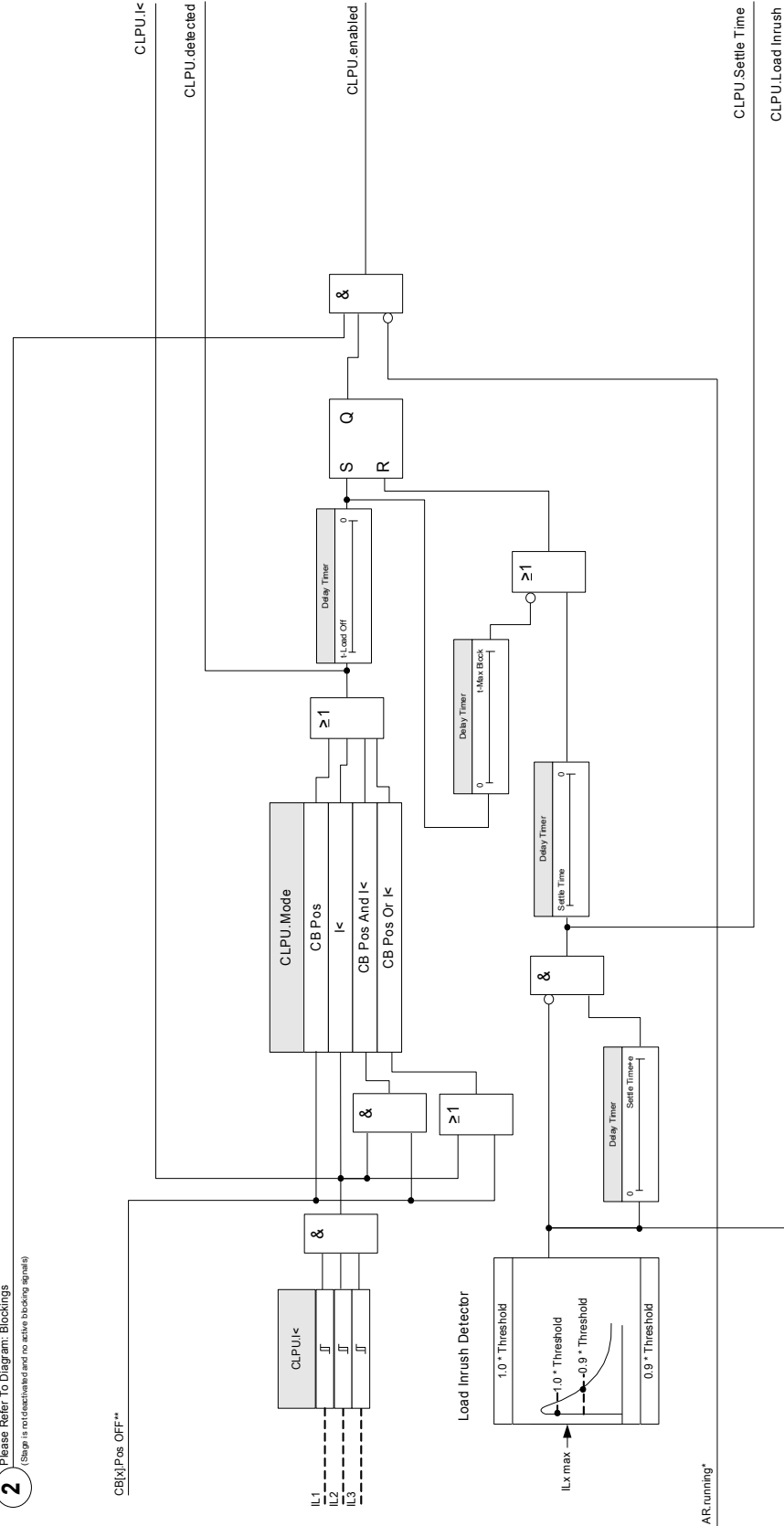

*Applies only for devices with Auto Reclosure

**This signal is the output of the switchgear that is assigned to this protective element. This applies to protective devices that offer control functionality.



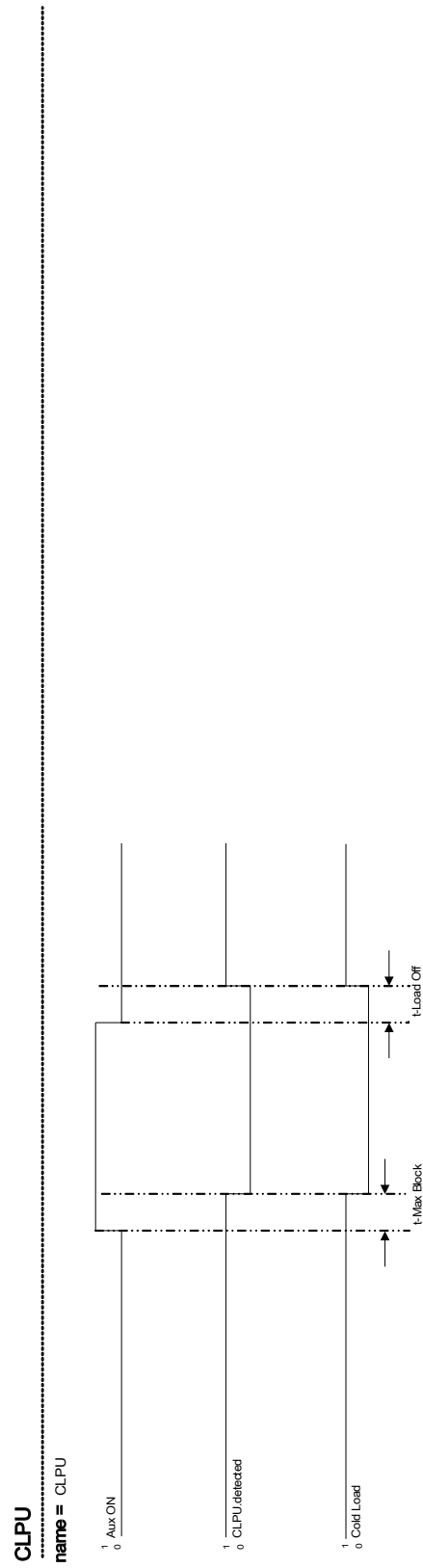

Example Mode: Breaker Position







Device Planning Parameters of the Cold Load Pickup Module

Parameter	Description	Options	Default	Menu path
Mode 	Mode	do not use, use	do not use	[Device planning]

Global Protection Parameter of the Cold Load Pickup Module

Parameter	Description	Setting range	Default	Menu path
Mode 	Mode	CB Pos, I<, CB Pos Or I<, CB Pos And I<	CB Pos	[Protection Para /Global Prot Para /CLPU]
ExBlo1 	External blocking of the module, if blocking is activated (allowed) within a parameter set and if the state of the assigned signal is true.	1..n, Assignment List	-.-	[Protection Para /Global Prot Para /CLPU]
ExBlo2 	External blocking of the module, if blocking is activated (allowed) within a parameter set and if the state of the assigned signal is true.	1..n, Assignment List	-.-	[Protection Para /Global Prot Para /CLPU]
Ex rev Interl 	External blocking of the module by external reverse interlocking, if blocking is activated (allowed) within a parameter set and if the state of the assigned signal is true.	1..n, Assignment List	-.-	[Protection Para /Global Prot Para /CLPU]
CB Pos Detect 	Criterion by which the Circuit Breaker Switch Position is to be detected. Only available if: CLPU.Mode = I<	-., SG[1].Pos, SG[2].Pos, SG[3].Pos, SG[4].Pos, SG[5].Pos, SG[6].Pos	SG[1].Pos	[Protection Para /Global Prot Para /CLPU]

Set Parameters of the Cold Load Pickup Module

Parameter	Description	Setting range	Default	Menu path
Function 	Permanent activation or deactivation of module/stage.	inactive, active	inactive	[Protection Para /<1..4> /CLPU]
ExBlo Fc 	Activate (allow) or inactivate (disallow) blocking of the module/stage. This parameter is only effective if a signal is assigned to the corresponding global protection parameter. If the signal becomes true, those modules/stages are blocked that are parameterized "ExBlo Fc=active".	inactive, active	inactive	[Protection Para /<1..4> /CLPU]
Ex rev Interl Fc 	Activate (allow) or inactivate (disallow) blocking of the module/stage. This parameter is only effective if a signal is assigned to the corresponding global protection parameter. If the signal becomes true, those modules/stages are blocked that are parameterized "Ex rev Interl Fc = active".	inactive, active	inactive	[Protection Para /<1..4> /CLPU]
t-Load Off 	Select the outage time required for a load to be considered cold. If the Pickup Timer (Delay) has run out, a Cold Load Signal will be issued.	0.00 - 7200.00s	1.00s	[Protection Para /<1..4> /CLPU]
t-Max Block 	Select the amount of time for the cold load inrush. If the Release Time (Delay) has run out, a Warm Load Signal will be issued.	0.00 - 300.00s	1.00s	[Protection Para /<1..4> /CLPU]
I< 	The CB is in the OFF Position, if the measured current is less than this parameter.	0.01 - 1.00In	0.01In	[Protection Para /<1..4> /CLPU]
Threshold 	Set the load current inrush threshold.	0.10 - 4.00In	1.2In	[Protection Para /<1..4> /CLPU]
Settle Time 	Select the time for the cold load inrush	0.00 - 300.00s	1.00s	[Protection Para /<1..4> /CLPU]

States of the Inputs of the Cold Load Pickup Module

<i>Name</i>	<i>Description</i>	<i>Assignment via</i>
ExBlo1-I	Module input state: External blocking	[Protection Para /Global Prot Para /CLPU]
ExBlo2-I	Module input state: External blocking	[Protection Para /Global Prot Para /CLPU]
Ex rev Interl-I	Module input state: External reverse interlocking	[Protection Para /Global Prot Para /CLPU]

Signals of the Cold Load Pickup Module (States of the Outputs)

<i>Signal</i>	<i>Description</i>
active	Signal: active
ExBlo	Signal: External Blocking
Ex rev Interl	Signal: External reverse Interlocking
enabled	Signal: Cold Load enabled
detected	Signal: Cold Load detected
I<	Signal: No Load Current.
Load Inrush	Signal: Load Inrush
Settle Time	Signal: Settle Time

Commissioning of the Cold Load Pickup Module

Object to be tested:

Testing the *Cold Load Pickup* module according to the configured operating mode:

- I< (No current);
- Bkr state (Breaker position);
- I< (No Current) and Bkr state (Breaker position); and
- I< (No Current) or Bkr state (Breaker position).

Necessary means:

- Three-phase current source (if the Enable Mode depends on current);
- Ampere meters (may be needed if the Enable Mode depends on current); and
- Timer.

Test Example for Mode Bkr State (Breaker Position)

NOTICE

Mode I<: In order to test the tripping delay, start the timer and feed with an abrupt change current that is distinctly less than the I<-threshold. Measure the tripping delay. In order to measure the drop-out ratio, feed a current with an abrupt change that is distinctly above the I<-threshold.

Mode I< and Bkr state: Combine the abrupt change (switching the current ON and OFF) with the manual switching ON and OFF of the breaker.

Mode I< or Bkr state: Initially carry out the test with an abrupt changing current that is switched ON and OFF (above and below the I<-threshold). Measure the tripping times. Finally, carry out the test by manually switching the breaker ON and OFF.

- The breaker has to be in the OFF position. There must not be any load current.
- The Status Display of the device shows the signal "CLPU.ENABLED"=1.
- The Status Display of the device shows the signal "CLPU.I<"=1.
- Testing the tripping delay and the resetting ratio:*
- Switch the breaker manually ON and simultaneously start the timer.
- After the the »t Max Block (Release Delay)« timer has expired, the signal "CPLU.Enabled"=0 has to become untrue.
- Write down the measured time.
- Manually switch the breaker OFF and simultaneously start the timer.
- After the »t load Off« timer has expired, the signal "CPLU.ENABLED"=1 has to become true.
- Write down the measured time.

Successful test result:

The measured total tripping delays or individual tripping delays, threshold values, and drop-out ratios correspond with those values specified in the adjustment list. Permissible deviations/tolerances can be found in the Technical Data section.

V - Voltage Protection [27,59]

Available stages:

V[1] .V[2] .V[3] .V[4] .V[5] .V[6]

CAUTION

If the VT measurement location is not at the bus bar side but at the output side, the following has to be taken into account:

When disconnecting the line it has to be ensured that by an »*External Blocking*« undervoltage tripping of the U<-elements cannot happen. This is realized through detecting of the CB position (via digital inputs).

When the aux. voltage is switched on and the measuring voltage has not yet been applied, undervoltage tripping has to be prevented by an »*External Blocking*«

CAUTION

In case of an fuse failure, it is important to block the »*U<-stages*« so that an undesired operation can be prevented.

To do this, set »*Meas Circuit Superv*« to "active" and activate the required VT supervision module (e. g. LOP, VTS).

Moreover, set the tripping delay of the undervoltage protection »*t*« to some value that is longer than the detection time of the VT supervision module. Take into account the following times:

- VTS, fuse failure determination via digital input: 20 ms
- VTS, determination via measurements / internal calculation: 20 ms
- LOP, fuse failure determination via digital input: 20 ms
- LOP, determination via measurements / internal calculation: 30 ms

(The "digital input times" do not cover the time-span from the fuse failure occurrence until the signal is available at the digital input.)

! WARNING

(For devices featuring the LOP module:)

The LOP (*Loss of Potential*) module has a fixed built-in undervoltage threshold of $0.03 \cdot V_n$.

Therefore, while commissioning undervoltage protection, do not use a pickup value »*V*« below $0.03 \cdot V_n$ because then the undervoltage module will always be blocked before it can trip.

NOTICE

All voltage elements are identically structured and can optionally be projected as over- or undervoltage element.

NOTICE

If phase voltages are applied to the measuring inputs of the device and field parameter »VT con« is set to »Phase-to-neutral«, the messages issued by the voltage protection module in case of actuation or trip should be interpreted as follows:

»V[1].ALARM L1« or »V[1].TRIP L1« => alarm or trip caused by phase voltage »VL1«.

»V[1].ALARM L2« or »V[1].TRIP L2« => alarm or trip caused by phase voltage »VL2«.

»V[1].ALARM L3« or »V[1].TRIP L3« => alarm or trip caused by phase voltage »VL3«.

If, however, line-to-line voltages are applied to the measuring inputs and field parameter »VT con« is set to »Phase to Phase«, then the messages should be interpreted as follows:

»V[1].ALARM L1« or »V[1].TRIP L1« => alarm or trip caused by line-to-line voltage »V12«.

»V[1].ALARM L2« or »V[1].TRIP L2« => alarm or trip caused by line-to-line voltage »V23«.

»V[1].ALARM L3« or »V[1].TRIP L3« => alarm or trip caused by line-to-line voltage »V31«.

The following table shows the application options of the voltage protection element

Applications of the V-Protection Module	Setting in	Option
ANSI 27 Undervoltage protection	Device Planning menu Setting: V<	<i>Measuring Method:</i> Fundamental/TrueRMS <i>Measuring Mode:</i> Phase to ground, Phase-to-Phase
10 minutes sliding average supervision V<	Device Planning menu Setting: V<	<i>Measuring Method:</i> Umit <i>Measuring Mode:</i> Phase to ground, Phase-to-Phase
ANSI 59 Overvoltage protection	Device Planning menu Setting: V>	<i>Measuring Method:</i> Fundamental/TrueRMS <i>Measuring Mode:</i> Phase to ground, Phase-to-Phase
Sliding average supervision V>	Device Planning menu Setting: V>	<i>Measuring Method:</i> Vavg <i>Measuring Mode:</i> Phase to ground, Phase-to-Phase

Measuring Method

For all protection elements it can be determined, whether the measurement is done on basis of the »Fundamental« or if »TrueRMS« measurement is used. In addition to that a sliding average supervision »Vavg« can be parametrized.

NOTICE The required settings for the calculation of the “average value” of the “sliding average value supervision” have to be taken within menu [Device Para\Statistics\Vavg].

Measuring Mode

If the measuring inputs of the voltage measuring card is fed with “Phase to Ground” voltages, the Field Parameter »VT con« has to be set to “Phase to Ground”. In this case, the user has the option to set the »Measuring Mode« of each phase voltage protection element to “Phase to Ground” or “Phase to Phase”. That means, he can determine for each phase voltage protection element how Vn shall be defined:

- »Measuring Mode« = “Phase to Ground” – $Vn = \frac{VT \text{ sec}}{\sqrt{3}}$
- »Measuring Mode« = “Phase to Phase” – $Vn = VT \text{ sec}$

If, however, the measuring inputs of the voltage measuring card are fed with “Phase to Phase” voltages (»VT con« = “Phase to Phase”), then the setting of »Measuring Mode« is ignored and internally set to “Phase to Phase” instead, so that $Vn = VT \text{ sec}$.

Minimum Current Threshold for Undervoltage Protection

For the voltage protection running in “undervoltage” mode –»Mode« = “V<” – there is the option to activate an undercurrent criterion. This is a “minimum current check”, which blocks the undervoltage protection as soon as **all** phase currents drop below a certain threshold value. And vice versa, if the phase currents get available again after such a dropout, the undervoltage protection is re-enabled only after a settable delay time.

The motivation for using this feature is that a situation where all phase currents are “dead” probably indicates an open circuit breaker, and it is probably not desirable that the undervoltage protection reacts to this event. The purpose of the delay time is to avoid an immediate trip during re-closing of the circuit breaker: Without this delay, there would be the risk that the undervoltage protection trips instantly because the voltages have not yet risen above the tripping threshold »V<« (although the phase currents might already be above the minimum current threshold).

The minimum current check is optional, in the sense that it has to be enabled via setting »Imin release check« = active).

After the minimum current check has been enabled, the threshold value is settable via »Threshold Imin«, i. e. the undervoltage protection is blocked as soon as **all** phase currents drop below this value.

The delay time for re-enabling the undervoltage protection (after any of the phase currents has become “live” again) can be set via »t-delay Imin«.

CAUTION

If this minimum current check is active then you should be aware that without current flow, the undervoltage protection does not trip. So, depending on your application, there might be good reasons to not use this feature.

For the HighPROTEC MCDGV4: As the **MCDGV4** is fitted with two CT measuring inputs, the minimum current check is fixed to always use the current values of the CT Ntrl input (Current transformers on the neutral side, slot X3).

For the HighPROTEC MCDTV4: As the **MCDTV4** is fitted with two CT measuring inputs, the minimum current check always uses the current values according to the Field Parameter setting »VX Winding Side«.

Functionality and Tripping Logic

For each of the voltage protection elements it can be defined if it picks up when over- or undervoltage is detected in one of three, two of three or in all three phases. The dropout ratio is settable.

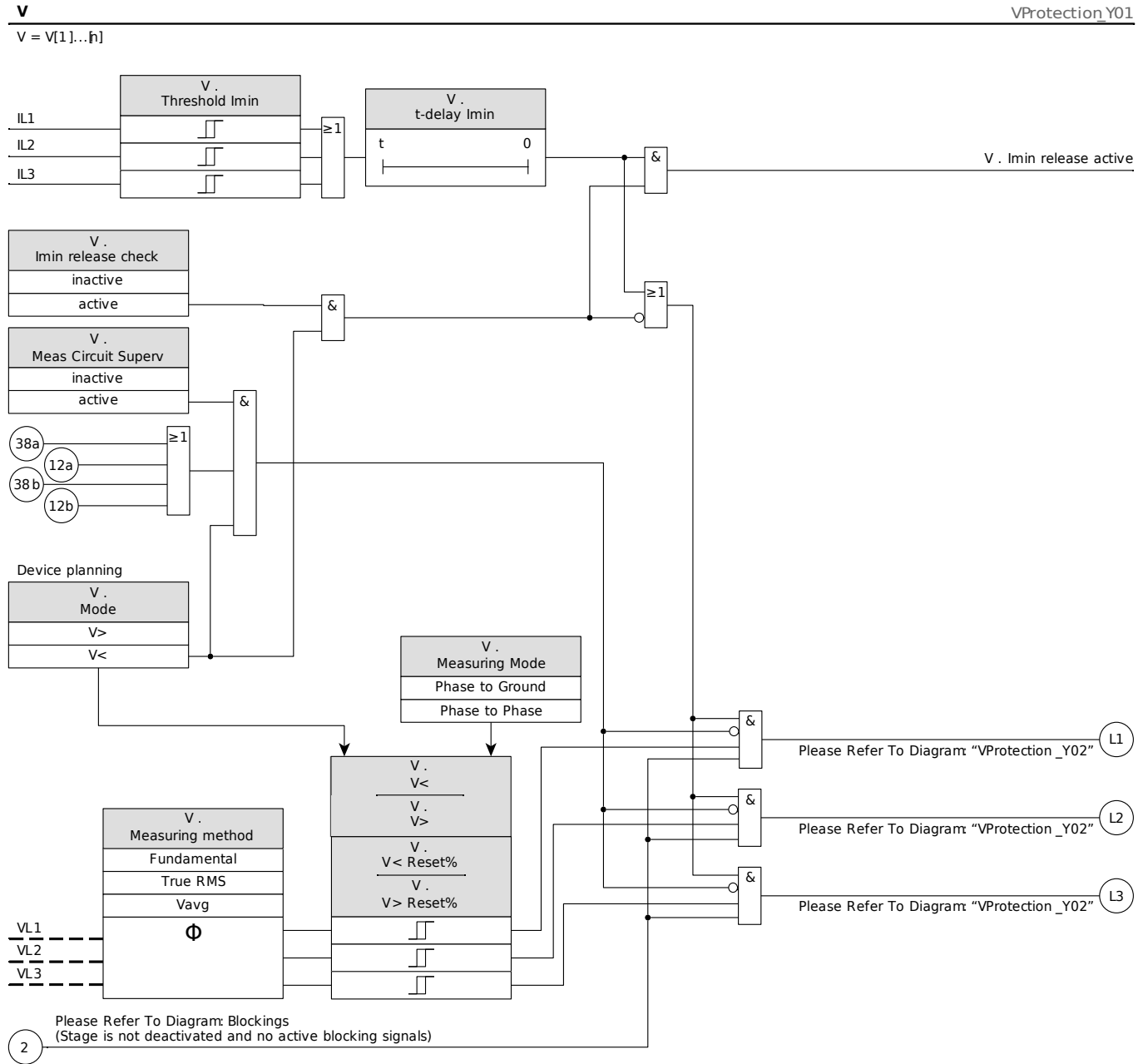

Functionality and tripping logic, part 1.

V = V[1]...[n]

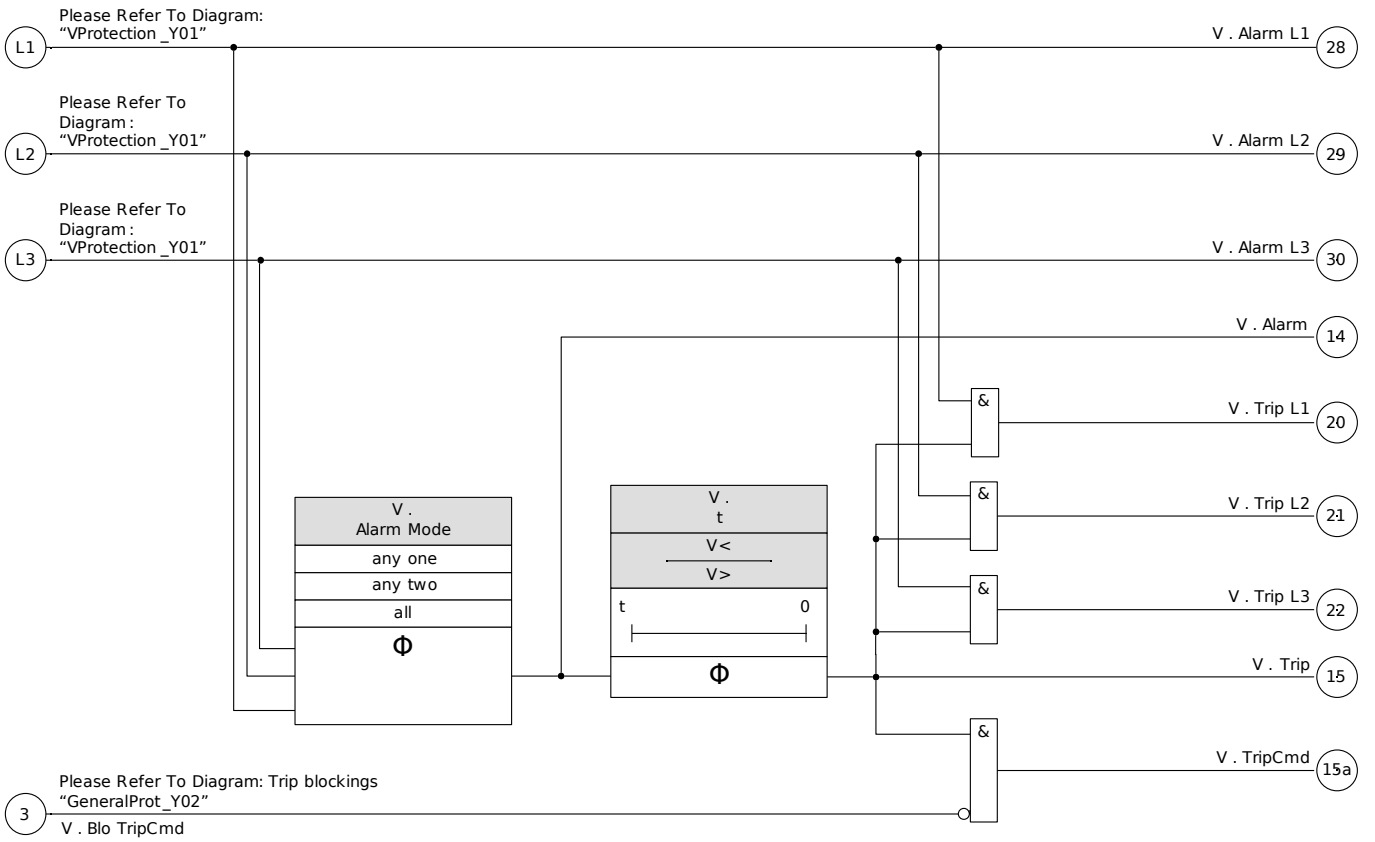



Functionality and tripping logic, part 2.







Device Planning Parameters of the Voltage Protection Module





Parameter	Description	Options	Default	Menu path
Mode 	Mode	do not use, V>, V<	V[1]: V> V[2]: V< V[3]: do not use V[4]: do not use V[5]: do not use V[6]: do not use	[Device planning]







Global Protection Parameters of the Voltage Protection Module

Parameter	Description	Setting range	Default	Menu path
ExBlo1 	External blocking of the module, if blocking is activated (allowed) within a parameter set and if the state of the assigned signal is true.	1..n, Assignment List	-.-	[Protection Para /Global Prot Para /V-Prot /V[1]]
ExBlo2 	External blocking of the module, if blocking is activated (allowed) within a parameter set and if the state of the assigned signal is true.	1..n, Assignment List	-.-	[Protection Para /Global Prot Para /V-Prot /V[1]]
ExBlo TripCmd 	External blocking of the Trip Command of the module/the stage, if blocking is activated (allowed) within a parameter set and if the state of the assigned signal is true.	1..n, Assignment List	-.-	[Protection Para /Global Prot Para /V-Prot /V[1]]

Setting Group Parameters of the Voltage Protection Module

Parameter	Description	Setting range	Default	Menu path
 Function	Permanent activation or deactivation of module/stage.	inactive, active	V[1]: active V[2]: inactive V[3]: inactive V[4]: inactive V[5]: inactive V[6]: inactive	[Protection Para /<1..4> /V-Prot /V[1]]
 ExBlo Fc	Activate (allow) or inactivate (disallow) blocking of the module/stage. This parameter is only effective if a signal is assigned to the corresponding global protection parameter. If the signal becomes true, those modules/stages are blocked that are parameterized "ExBlo Fc=active".	inactive, active	inactive	[Protection Para /<1..4> /V-Prot /V[1]]
 Blo TripCmd	Permanent blocking of the Trip Command of the module/stage.	inactive, active	inactive	[Protection Para /<1..4> /V-Prot /V[1]]
 ExBlo TripCmd Fc	Activate (allow) or inactivate (disallow) blocking of the module/stage. This parameter is only effective if a signal is assigned to the corresponding global protection parameter. If the signal becomes true, those modules/stages are blocked that are parameterized "ExBlo TripCmd Fc=active".	inactive, active	inactive	[Protection Para /<1..4> /V-Prot /V[1]]
 Measuring Mode	Measuring/Supervision Mode: Determines if the phase-to-phase or phase-to-earth voltages are to be supervised	Phase to Ground, Phase to Phase	Phase to Ground	[Protection Para /<1..4> /V-Prot /V[1]]
 Measuring method	Measuring method: fundamental or rms or "sliding average supervision"	Fundamental, True RMS, Vavg	Fundamental	[Protection Para /<1..4> /V-Prot /V[1]]

Parameter	Description	Setting range	Default	Menu path
 Alarm Mode	Alarm criterion for the voltage protection stage.	any one, any two, all	any one	[Protection Para /<1..4> /V-Prot /V[1]]
 V>	If the pickup value is exceeded, the module/element will be started. The definition of Vn is dependent on both the Field Parameter »VT con« and the Setting Group Parameter »Measuring Mode«: If the measuring inputs of the voltage measuring card are fed with phase-to-ground voltages (»VT con« = "Phase-to-Ground") then the setting »Measuring Mode« = "Phase-to-Ground" means that $V_n = V_{Tsec} / \sqrt{3}$, and »Measuring Mode« = "Phase-to-Phase" means that $V_n = V_{Tsec}$. However, if the measuring inputs of the voltage measuring card are fed with phase-to-phase voltages (»VT con« = "Phase-to-Phase") then the setting of "Measuring Mode" is ignored and internally set to "Phase-to-Phase" instead, so that $V_n = V_{Tsec}$.	0.01 - 2.000Vn	V[1]: 1.1Vn V[2]: 1.20Vn V[3]: 1.20Vn V[4]: 1.20Vn V[5]: 1.20Vn V[6]: 1.20Vn	[Protection Para /<1..4> /V-Prot /V[1]]
 V> Reset%	Drop Out (is in percent of setting)	80 - 99%	97%	[Protection Para /<1..4> /V-Prot /V[1]]
 V<	If the pickup value is exceeded, the module/element will be started. The definition of Vn is dependent on both the Field Parameter »VT con« and the Setting Group Parameter »Measuring Mode«: If the measuring inputs of the voltage measuring card are fed with phase-to-ground voltages (»VT con« = "Phase-to-Ground") then the setting »Measuring Mode« = "Phase-to-Ground" means that $V_n = V_{Tsec} / \sqrt{3}$, and »Measuring Mode« = "Phase-to-Phase" means that $V_n = V_{Tsec}$. However, if the measuring inputs of the voltage measuring card are fed with phase-to-phase voltages (»VT con« = "Phase-to-Phase") then the setting of "Measuring Mode" is ignored and internally set to "Phase-to-Phase" instead, so that $V_n = V_{Tsec}$.	0.01 - 2.000Vn	V[1]: 0.80Vn V[2]: 0.9Vn V[3]: 0.80Vn V[4]: 0.80Vn V[5]: 0.80Vn V[6]: 0.80Vn	[Protection Para /<1..4> /V-Prot /V[1]]

Parameter	Description	Setting range	Default	Menu path
V< Reset% 	Drop Out (is in percent of setting)	101 - 110%	103%	[Protection Para /<1..4> /V-Prot /V[1]]
t 	Tripping delay	0.00 - 3000.00s	V[1]: 1s V[2]: 1s V[3]: 0.00s V[4]: 0.00s V[5]: 0.00s V[6]: 0.00s	[Protection Para /<1..4> /V-Prot /V[1]]
Meas Circuit Superv 	Activates the use of the measuring circuit supervision. In this case the module will be blocked if a measuring circuit supervision module (e.g. LOP, VTS) signals a disturbed measuring circuit (e.g. caused by a fuse failure).	inactive, active	inactive	[Protection Para /<1..4> /V-Prot /V[1]]
Imin release check 	Enable a minimum current check. This monitors the current flow (in the CT on the VT side), to detect whether the circuit breaker is permanently in open state; in this case the undervoltage detection is blocked.	inactive, active	inactive	[Protection Para /<1..4> /V-Prot /V[1]]
Threshold Imin 	Threshold value that is used for the Imin release (minimum current) check. If the current flow is below this value, it is assumed that the circuit breaker is permanently in open state. Only available if: Imin release check = active	0.02 - 10.00In	0.05In	[Protection Para /<1..4> /V-Prot /V[1]]
t-delay Imin 	Release delay for the undervoltage detection. This delay is effective only after the minimum current check had blocked the undervoltage detection. When the circuit breaker has been closed and the current flow is re-establishing, this delay continues to block the undervoltage detection; during this time the voltage can rise above the pickup value »V<<. Only available if: Imin release check = active	0.00 - 3000.00s	0.03s	[Protection Para /<1..4> /V-Prot /V[1]]

Voltage Protection Module Input States

<i>Name</i>	<i>Description</i>	<i>Assignment via</i>
ExBlo1-I	Module input state: External blocking1	[Protection Para /Global Prot Para /V-Prot /V[1]]
ExBlo2-I	Module input state: External blocking2	[Protection Para /Global Prot Para /V-Prot /V[1]]
ExBlo TripCmd-I	Module input state: External Blocking of the Trip Command	[Protection Para /Global Prot Para /V-Prot /V[1]]

Voltage Protection Module Signals (Output States)

<i>Signal</i>	<i>Description</i>
active	Signal: active
ExBlo	Signal: External Blocking
Blo TripCmd	Signal: Trip Command blocked
ExBlo TripCmd	Signal: External Blocking of the Trip Command
Alarm L1	Signal: Alarm L1
Alarm L2	Signal: Alarm L2
Alarm L3	Signal: Alarm L3
Alarm	Signal: Alarm voltage stage
Trip L1	Signal: General Trip Phase L1
Trip L2	Signal: General Trip Phase L2
Trip L3	Signal: General Trip Phase L3
Trip	Signal: Trip
TripCmd	Signal: Trip Command
Imin release active	Signal that the Imin release (minimum current) check is enabled and does not block the undervoltage detection at the moment.

Commissioning: Overvoltage Protection [59]

Object to be tested

Test of the overvoltage protection elements, 3 x single-phase and 1 x three-phase (for each element)

CAUTION

Through testing the overvoltage protection stages, it can also be ensured that the wiring from the switchboard input terminals is correct. Wiring errors at the voltage measuring inputs might result in:

- False tripping of the directional current protection
Example: Device suddenly trips in reverse direction but it does not trip in forward direction.
- Wrong or no power factor indication
- Errors with regard to power directions etc.

Necessary means

- 3-phase AC voltage source
- Timer for measuring of the tripping time
- Voltmeter

Procedure (3 x single-phase, 1 x three-phase, for each element)

Testing the threshold values

For testing the threshold values and fallback values, the test voltage has to be increased until the relay is activated. When comparing the displayed values with those of the voltmeter, the deviation must be within the permissible tolerances.

Testing the trip delay

For testing the trip delay, a timer is to be connected to the contact of the associated trip relay.

The timer is started when the limiting value of the tripping voltage is exceeded and it is stopped when the relay trips.

Testing the fallback ratio

Reduce the measuring quantity to less than (e.g.) 97% of the trip value. The relay must only fall back at 97% of the trip value at the earliest.

Successful test result

The measured threshold values, trip delays and fallback ratios comply with those specified in the adjustment list. Permissible deviations/tolerances can be taken from the Technical Data.

Commissioning: Undervoltage Protection [27]

This test can be carried out similar to the test for overvoltage protection (by using the related undervoltage values).

Please consider the following deviations:

- For testing the threshold values the test voltage has to be decreased until the relay is activated.
- For detection of the fallback value, the measuring quantity has to be increased so to achieve more than (e.g.) 103% of the trip value. At 103% of the trip value the relay is to fall back at the earliest.

VG, VX - Voltage Supervision [27A, 27TN/59N, 59A]

Available elements:
 VG[1] ,VG[2]

NOTICE All elements of the voltage supervision of the fourth measuring input are identically structured.

This protective element can be used to (depending on device planning and setting)

- Supervision of the calculated or measured residual voltage. The residual voltage can be calculated only if the phase voltages (star connection) are connected to the measuring inputs of the device.
- Supervision of another (auxiliary) voltage against overvoltage or undervoltage.

The following table shows the application options of the voltage protection element

Applications of the VG/VX-Protection Module	Setting in	Option
ANSI 59N/G Residual voltage protection (measured or calculated)	Device Planning menu Setting: V>	Criterion: Fundamental/TrueRMS VG Source: measured/calculated
ANSI 59A Supervision of an Auxiliary (additional) Voltage in relation to Overvoltage.	Device Planning menu Setting: V> Within the corresponding Parameter-Set: VG Source:measured	Criterion: Fundamental/TrueRMS
ANSI 27A Supervision of an Auxiliary (additional) Voltage in relation to Undervoltage.	Device Planning menu Setting: V< Within the corresponding Parameter-Set: VG Source:measured	Criterion: Fundamental/TrueRMS
ANSI 27TN/59N "Vx meas H3" Stator Ground Fault Protection Note: This option is available in some Generator Protection Relays only. In order to detect 100% Stator Ground faults, a 27TN element has to be or-connected with a 59N element within the programmable logic.	Device Planning menu Setting: V< Within the corresponding Parameter-Set: VX Source:measured	Criterion: VX meas H3 VX Source: measured

Measuring Mode

For all protection elements it can be determined, whether the measurement is done on basis of the »Fundamental« or if »TrueRMS« measurement is used.

27TN/59N - 100% Stator Ground Fault Protection »*VX meas H3*«*

*=only available in Generator Protection Relays

With this setting the relay can detect stator ground faults at high impedance grounded generators near the machines stator neutral.

In order to detect 100% Stator Ground faults, a 27TN element has to be or-connected with a 59N element within the programmable logic.

With the 27TN element the 3rd harmonic of the connected voltage is monitored at the generator neutral side. It is able to detect ground faults, which occur between the stator neutral and up to approx. 20% of the winding towards the stator terminals. In combination with the 59N element, that detects ground faults from the stator terminals down to approximately 10% of the stator winding towards the neutral, a 100% stator ground fault protection can be realized.

The following figure shows the combination of a 27TN with measuring criterion »*VX meas H3*« (third harmonic) and a 59N element.

Both elements have to be or connected via Programmable logic.

In addition to that it is recommended to provide the 27TN element with a voltage release via a AND-Logic with an 59 element in order to prevent faulty tripping e.g. during generator standstill (see logic diagram next page).

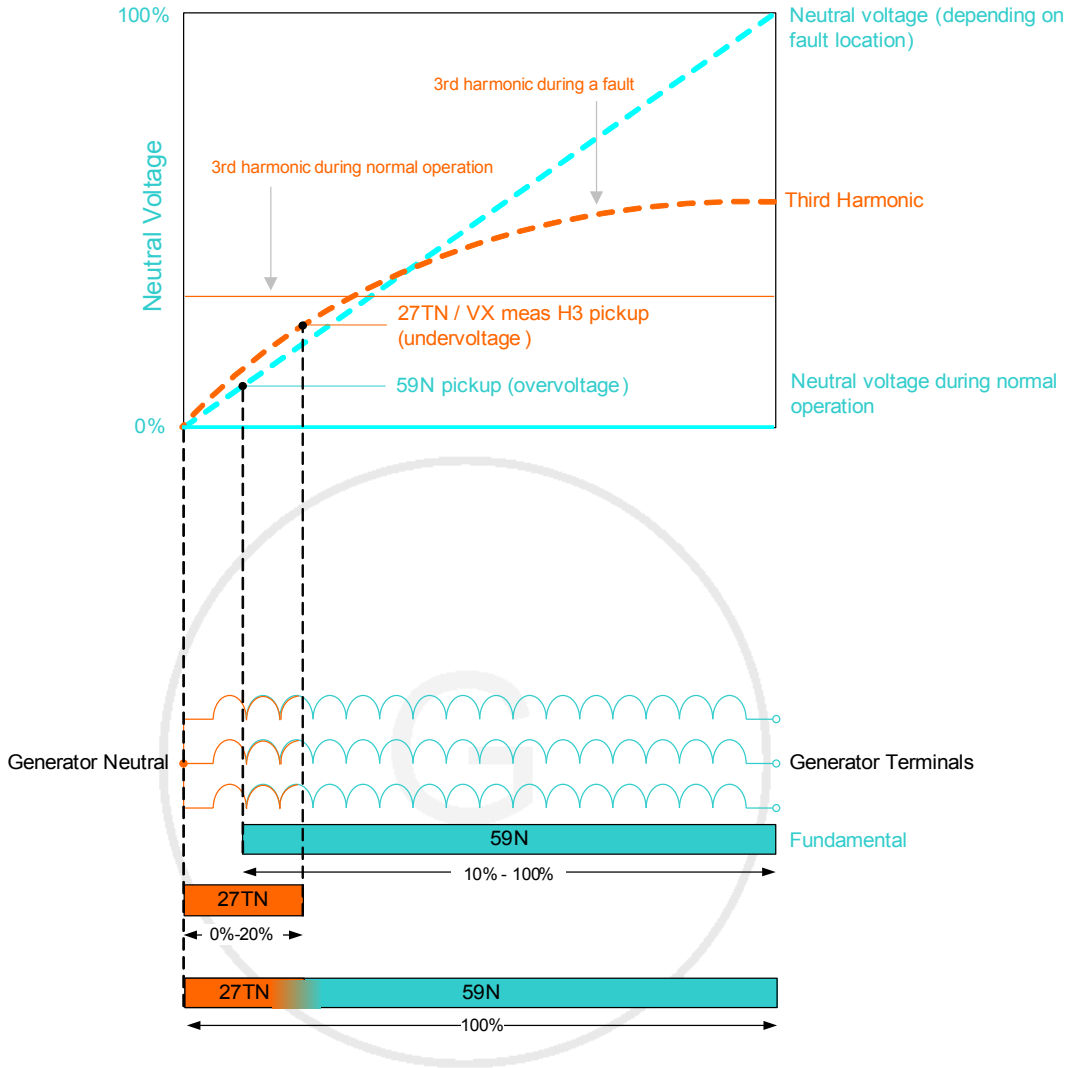

prevents faulty tripping during dead system / generator standstill

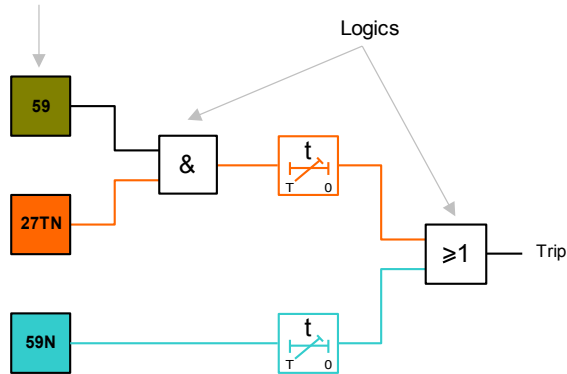

VGf1]..[n]

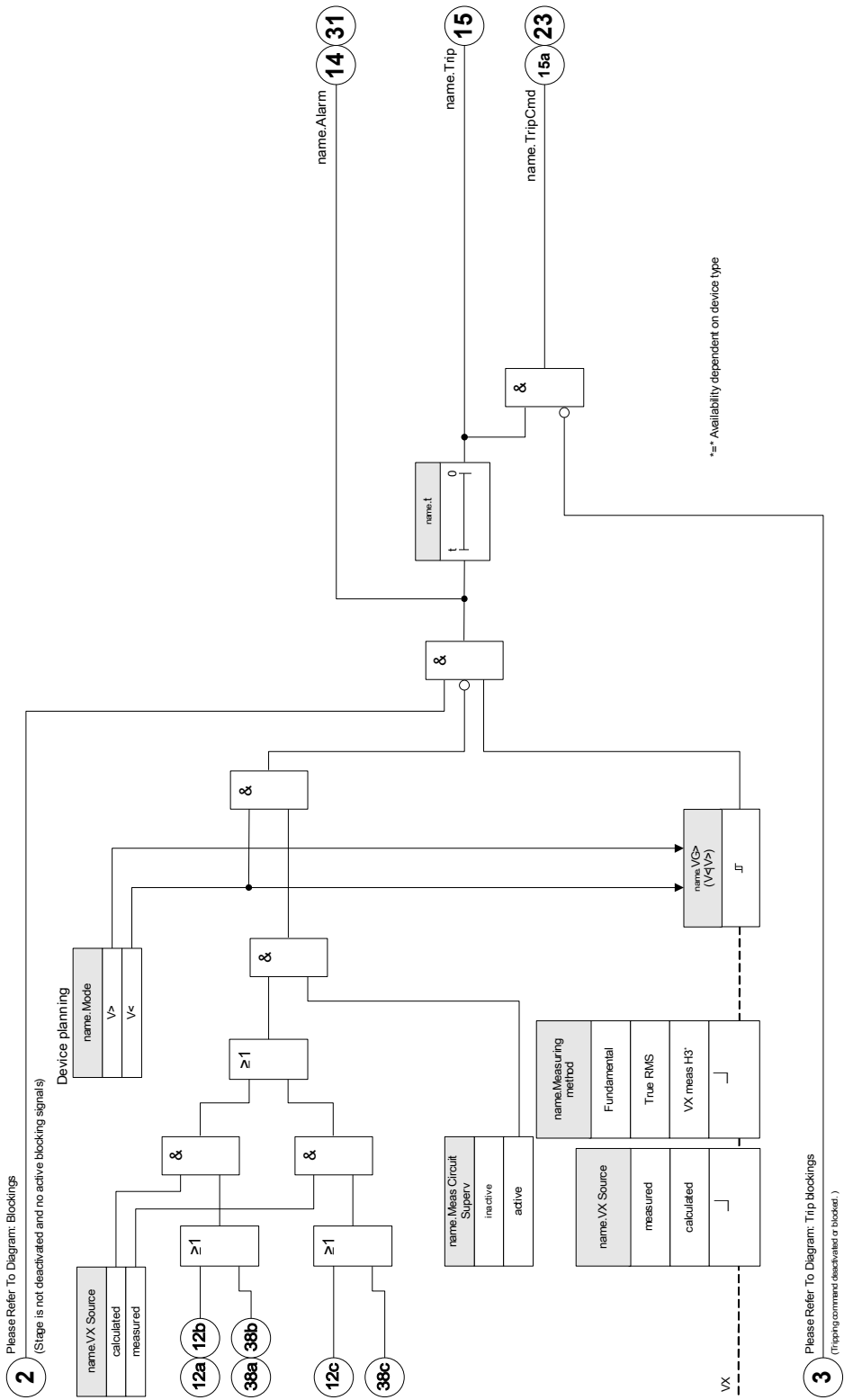

name = VGf1]..[n]



Device Planning Parameters of the Residual Voltage Supervision Module



Parameter	Description	Options	Default	Menu path
Mode 	Mode	do not use, V>, V<	do not use	[Device planning]

Global Protection Parameters of the Residual Voltage Supervision Module

Parameter	Description	Setting range	Default	Menu path
ExBlo1 	External blocking of the module, if blocking is activated (allowed) within a parameter set and if the state of the assigned signal is true.	1..n, Assignment List	-.-	[Protection Para /Global Prot Para /V-Prot /VG[1]]
ExBlo2 	External blocking of the module, if blocking is activated (allowed) within a parameter set and if the state of the assigned signal is true.	1..n, Assignment List	-.-	[Protection Para /Global Prot Para /V-Prot /VG[1]]
ExBlo TripCmd 	External blocking of the Trip Command of the module/the stage, if blocking is activated (allowed) within a parameter set and if the state of the assigned signal is true.	1..n, Assignment List	-.-	[Protection Para /Global Prot Para /V-Prot /VG[1]]

Setting Group Parameters of the Residual Voltage Supervision Module.

Parameter	Description	Setting range	Default	Menu path
Function 	Permanent activation or deactivation of module/stage.	inactive, active	inactive	[Protection Para /<1..4> /V-Prot /VG[1]]
ExBlo Fc 	Activate (allow) or inactivate (disallow) blocking of the module/stage. This parameter is only effective if a signal is assigned to the corresponding global protection parameter. If the signal becomes true, those modules/stages are blocked that are parameterized "ExBlo Fc=active".	inactive, active	inactive	[Protection Para /<1..4> /V-Prot /VG[1]]
Blo TripCmd 	Permanent blocking of the Trip Command of the module/stage.	inactive, active	inactive	[Protection Para /<1..4> /V-Prot /VG[1]]
ExBlo TripCmd Fc 	Activate (allow) or inactivate (disallow) blocking of the module/stage. This parameter is only effective if a signal is assigned to the corresponding global protection parameter. If the signal becomes true, those modules/stages are blocked that are parameterized "ExBlo TripCmd Fc=active".	inactive, active	inactive	[Protection Para /<1..4> /V-Prot /VG[1]]
VX Source 	Selection if VG is measured or calculated (neutral voltage or residual voltage)	measured, calculated	measured	[Protection Para /<1..4> /V-Prot /VG[1]]
Measuring method 	Measuring method: fundamental or rms or 3rd harmonic (only generator protection relays)	Fundamental, True RMS, VX meas H3	Fundamental	[Protection Para /<1..4> /V-Prot /VG[1]]
VG> 	If the pickup value is exceeded, the module/stage will be started. Only available if: Device planning: VG.Mode = V>	0.01 - 2.00Vn	1Vn	[Protection Para /<1..4> /V-Prot /VG[1]]

<i>Parameter</i>	<i>Description</i>	<i>Setting range</i>	<i>Default</i>	<i>Menu path</i>
VG< 	Undervoltage Threshold Only available if: Device planning: VG.Mode = V<	0.01 - 2.00Vn	0.8Vn	[Protection Para /<1..4> /V-Prot /VG[1]]
t 	Tripping delay	0.00 - 300.00s	0.00s	[Protection Para /<1..4> /V-Prot /VG[1]]
Meas Circuit Superv 	Activates the use of the measuring circuit supervision. In this case the module will be blocked if a measuring circuit supervision module (e.g. LOP, VTS) signals a disturbed measuring circuit (e.g. caused by a fuse failure).	inactive, active	inactive	[Protection Para /<1..4> /V-Prot /VG[1]]

Residual Voltage Supervision Module Input States

<i>Name</i>	<i>Description</i>	<i>Assignment via</i>
ExBlo1-I	Module input state: External blocking1	[Protection Para /Global Prot Para /V-Prot /VG[1]]
ExBlo2-I	Module input state: External blocking2	[Protection Para /Global Prot Para /V-Prot /VG[1]]
ExBlo TripCmd-I	Module input state: External Blocking of the Trip Command	[Protection Para /Global Prot Para /V-Prot /VG[1]]

Residual Voltage Supervision Module Signals (Output States)

<i>Signal</i>	<i>Description</i>
active	Signal: active
ExBlo	Signal: External Blocking
Blo TripCmd	Signal: Trip Command blocked
ExBlo TripCmd	Signal: External Blocking of the Trip Command
Alarm	Signal: Alarm Residual Voltage Supervision-stage
Trip	Signal: Trip
TripCmd	Signal: Trip Command

Commissioning: Residual Voltage Protection - Measured [59N]

Object to be tested

Residual voltage protection stages.

Necessary components

- 1-phase AC voltage source
- Timer for measuring of the tripping time
- Voltmeter

Procedure (for each element)

Testing the threshold values

For testing the threshold and fallback values, the test voltage at the measuring input for the residual voltage has to be increased until the relay is activated. When comparing the displayed values with those of the voltmeter, the deviation must be within the permissible tolerances.

Testing the trip delay

For testing the trip delay a timer is to be connected to the contact of the associated trip relay.

The timer is started when the limiting value of the tripping voltage is exceeded and it is stopped when the relay trips.

Testing the fallback ratio

Reduce the measuring quantity to less than 97% of the trip value. The relay must only fall back at 97% of the trip value at the latest.

Successful test result

The measured threshold values, trip delays and fallback ratios comply with those specified in the adjustment list. Permissible deviations/tolerances can be taken from the Technical Data.

Commissioning: Residual Voltage Protection - Calculated [59N]

Object to be tested

Test of the residual voltage protection elements

Necessary means

- 3-phase voltage source

NOTICE

Calculation of the residual voltage is only possible if phase voltages (star) were applied to the voltage measuring inputs and if »VX Source=calculated« is set within the corresponding parameter set.

Procedure

- Feed a three-phase, symmetrical voltage system (V_n) into the voltage measuring inputs of the relay.
- Set the limiting value of VX[x] to 90% V_n .
- Disconnect the phase voltage at two measuring inputs (symmetrical feeding at the secondary side has to be maintained).
- Now the »VX calc« measuring value has to be about 100% of the value V_n .
- Ascertain that the signal »VX.ALARM« or »VX.TRIP« is generated now.

Successful test result

The signal »VX.ALARM« or »VX.TRIP« is generated.

f - Frequency [81O/U, 78, 81R]

Available elements:

f[1] .f[2] .f[3] .f[4] .f[5] .f[6]

NOTICE

All frequency protective elements are identically structured.

Frequency - Measuring Principle

NOTICE

The frequency is calculated as the average of the measured values of the three phase frequencies. Only valid measured frequency values are taken into account. If a phase voltage is no longer measurable, this phase will be excluded from the calculation of the average value.

The measuring principle of the frequency supervision is based in general on the time measurement of complete cycles, whereby a new measurement is started at each zero passage. The influence of harmonics on the measuring result is thus minimized.

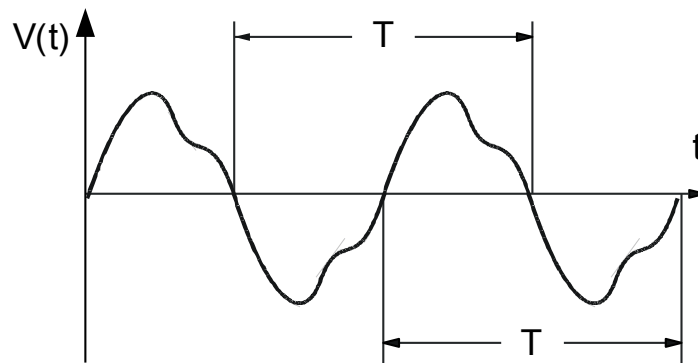

Frequency tripping is sometimes not desired by low measured voltages which for instance occur during alternator acceleration. All frequency supervision functions are blocked if the voltage is lower 0.15 times V_n .

Frequency Functions

Due to its various frequency functions, the device is very flexible. That makes it suitable for a wide range of applications, where frequency supervision is an important criterion.

In the *Device Planning* menu, the User can decide how to use each of the six frequency elements.

f[1] to f[6] can be assigned as:

- f< – Underfrequency;
- f> – Overfrequency;
- df/dt - Rate of Change of Frequency;
- f< + df/dt – Underfrequency and Rate of Change of Frequency;
- f> + df/dt - Overfrequency and Rate of Change of Frequency;

Protective Elements

- $f < + DF/DT$ – Underfrequency and absolute frequency change per definite time interval;
- $f > + DF/DT$ - Overfrequency and absolute frequency change per definite time interval and
- $\Delta\phi$ - Vector Surge

f< – Underfrequency

This protection element provides a pickup threshold and a tripping delay. If the frequency falls below the set pickup threshold, an alarm will be issued instantaneously. If the frequency remains under the set pickup threshold until the tripping delay has elapsed, a tripping command will be issued.

With this setting, the frequency element protects electrical generators, consumers, or electrical operating equipment in general against underfrequency.

f> – Overfrequency

This protection element provides a pickup threshold and a tripping delay. If the frequency exceeds the set pickup threshold, an alarm will be issued instantaneously. If the frequency remains above the set tripping pickup until the tripping delay has elapsed, a tripping command will be issued.

With this setting the frequency element protects electrical generators, consumers, or electrical operating equipment in general against overfrequency.

Working Principle $f<$ and $f>$

(Please refer to the block diagram on next page.)

The frequency element supervises the three voltages (depending on if the voltage transformers are wired in Star or Delta connection »VL12«, »VL23« und »VL31« oder »VL1«, »VL2« und »VL3«). If all of the three phase voltages are e.g. below 15% V_n , the frequency calculation is blocked (settable via parameter »V Block f«). According to the frequency supervision mode set in the Device Planning ($f<$ or $f>$), the evaluated phase voltages are compared to the set pickup threshold for over- or under-frequency. If in any of the phases, the frequency exceeds or falls below the set pickup threshold and if there are no blocking commands for the frequency element, an alarm is issued instantaneously and the tripping delay timer is started. When the frequency still exceeds or is below the set pickup threshold after the tripping delay timer has elapsed, a tripping command will be issued.

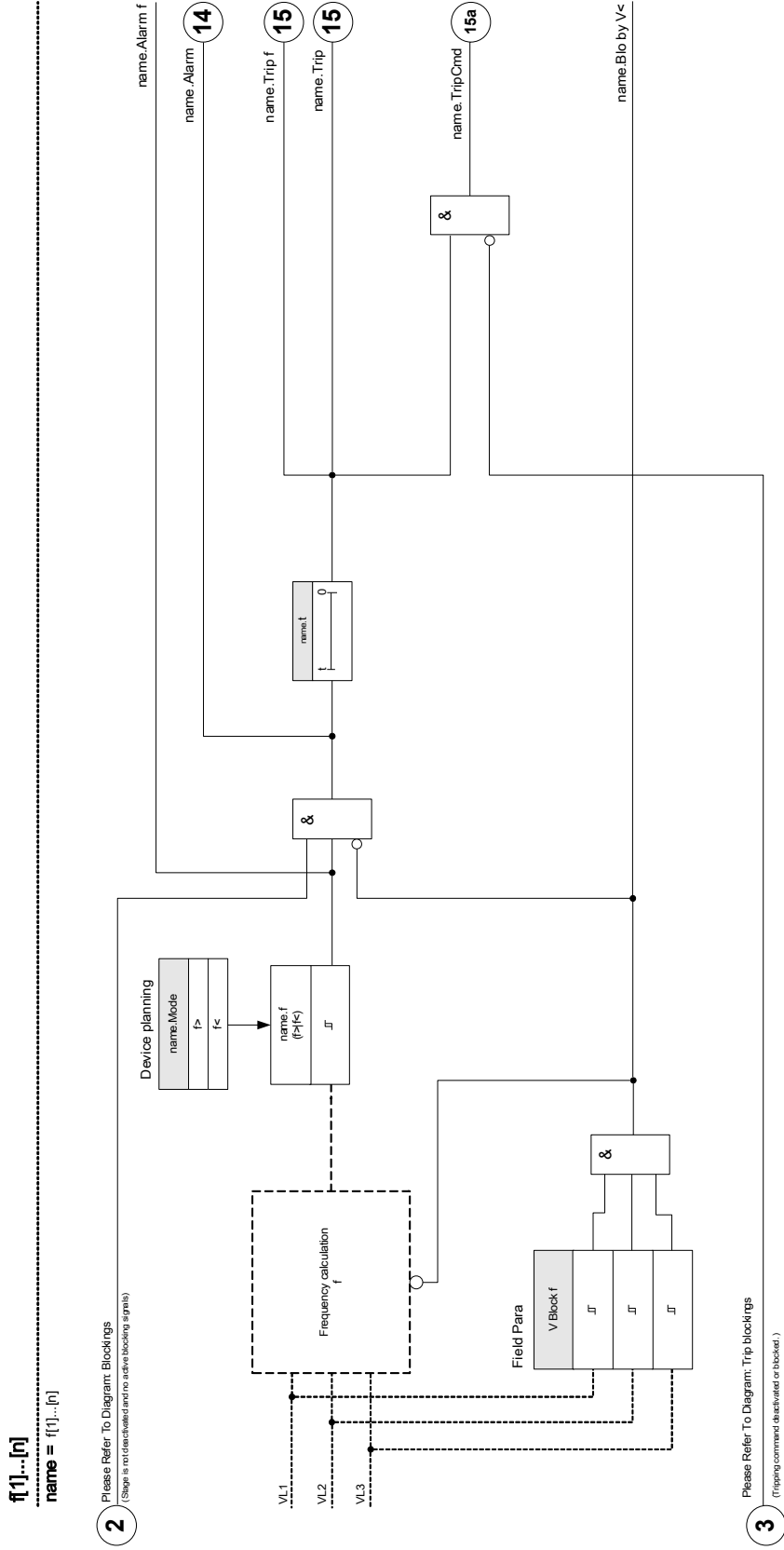

df/dt - Rate of Change of Frequency

Electrical generators running in parallel with the mains, (e. g. industrial internal power supply plants), should be separated from the mains when failure in the intra-system occurs for the following reasons:

- Damage to electrical generators must be prevented when mains voltage is recovering asynchronously, (e. g. after a short interruption).
- The industrial internal power supply must be maintained.

A reliable criterion of detecting mains failure is the measurement of the rate of change of frequency (df/dt). The precondition for this is a load flow via the mains coupling point. At mains failure the load flow change spontaneously leads to an increasing or decreasing frequency. At active power deficit of the internal power station, a linear drop of the frequency occurs and a linear increase occurs at power excess. Typical frequency gradients during application of "mains decoupling" are in the range of 0.5 Hz/s up to over 2 Hz/s.

The protective device detects the instantaneous frequency gradient (df/dt) of each mains voltage period. Through multiple evaluations of the frequency gradient in sequence the continuity of the directional change (sign of the frequency gradient) is determined. Because of this special measuring procedure a high safety in tripping and thus a high stability against transient processes, (e. g. switching procedure) are achieved.

The frequency gradient (rate of change of frequency [df/dt]) may have a negative or positive sign, depending on frequency increase (positive sign) or decrease (negative sign).

In the frequency parameter sets, the User can define the kind of df/dt mode:

- Positive df/dt = the frequency element detects an increase in frequency
- Negative df/dt = the frequency element detects a decrease in frequency and
- Absolute df/dt (positive and negative) = the frequency element detects both, increase and decrease in frequency

This protection element provides a tripping threshold and a tripping delay. If the frequency gradient df/dt exceeds or falls below the set tripping threshold, an alarm will be issued instantaneously. If the frequency gradient remains still above/below the set tripping threshold until the tripping delay has elapsed, a tripping command will be issued.

Working Principle df/dt

(Please refer to the block diagram on next page)

The frequency element supervises the three voltages (depending on if the voltage transformers are wired in Star or Delta connection »VL12«, »VL23« und »VL31« oder »VL1«, »VL2« und »VL3«). If any of the three phase voltages is e.g. below 15% V_n , the frequency calculation is blocked (settable via parameter »V Block f«). According to the frequency supervision mode set in the Device Planning (df/dt), the evaluated phase voltages are compared to the set frequency gradient (df/dt) threshold. If in any of the phases, the frequency gradient exceeds or falls below the set pickup threshold (acc. to the set df/dt mode) and if there are no blocking commands for the frequency element, an alarm is issued instantaneously and the tripping delay timer is started. When the frequency gradient still exceeds or is below the set pickup threshold after the tripping delay timer has elapsed, a tripping command will be issued.

f[1]...[n]: df/dt
 name = f[1]...[n]

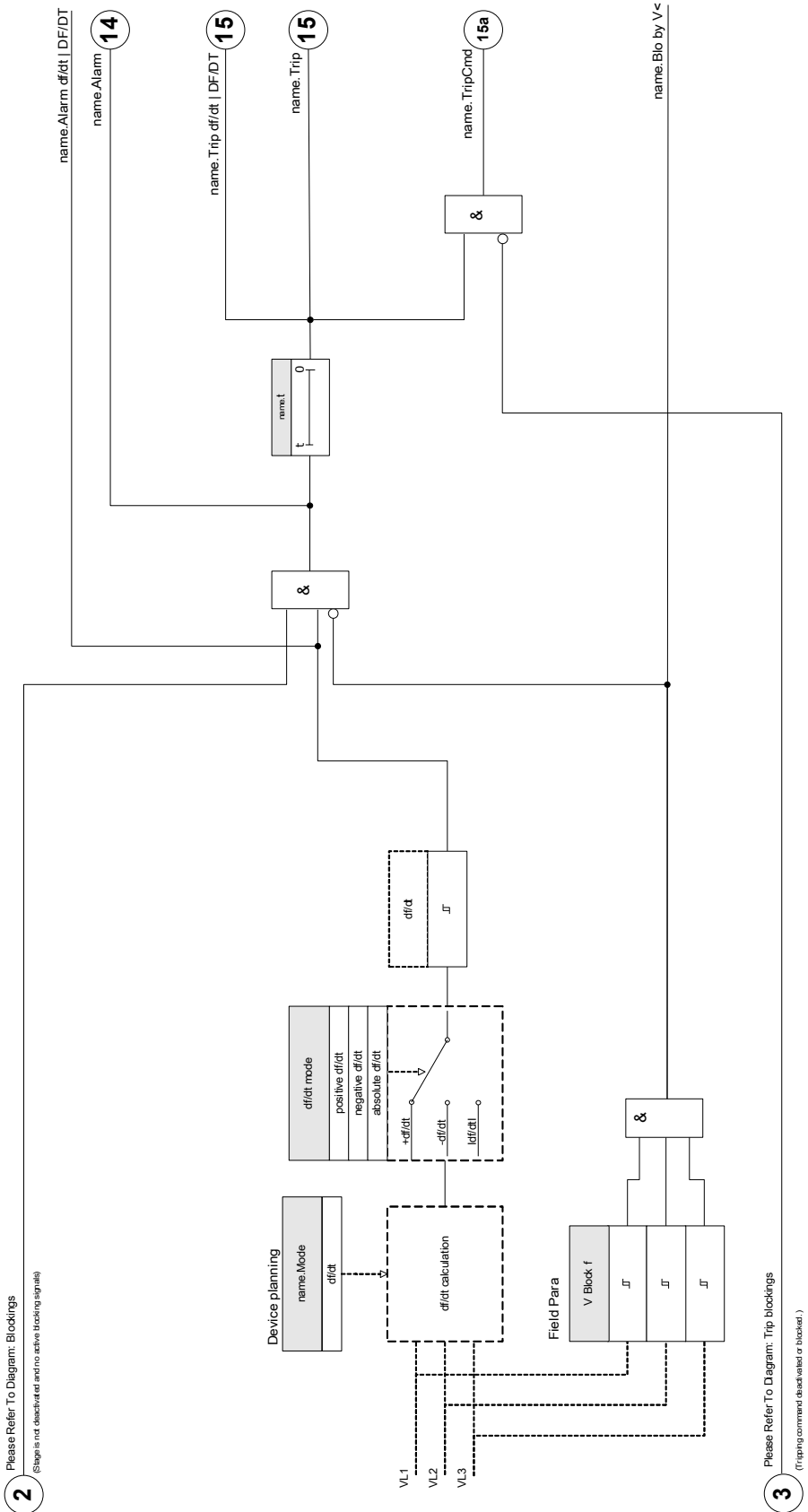

f< and df/dt – Underfrequency and Rate of Change of Frequency

With this setting the frequency element supervises if the frequency falls below a set pickup threshold and if the frequency gradient exceeds a set threshold at the same time.

In the selected frequency parameter set f[X], an underfrequency pickup threshold f<, a frequency gradient df/dt and a tripping delay can be set.

Whereby:

- Positive df/dt = the frequency element detects an increase in frequency
- Negative df/dt = the frequency element detects a decrease in frequency and
- Absolute df/dt (positive and negative) = the frequency element detects both, increase and decrease in frequency

f> and df/dt – Overfrequency and Rate of Change of Frequency

With this setting the frequency element supervises if the frequency exceeds a set pickup threshold and if the frequency gradient exceeds a set threshold at the same time.

In the selected frequency parameter set f[X], an overfrequency pickup threshold f>, a frequency gradient df/dt and a tripping delay can be set.

Whereby:

- Positive df/dt = the frequency element detects an increase in frequency
- Negative df/dt = the frequency element detects a decrease in frequency and
- Absolute df/dt (positive and negative) = the frequency element detects both, increase and decrease in frequency

Working Principle f< and df/dt | f> and df/dt

(Please refer to the block diagram on next page)

The frequency element supervises the three voltages (depending on if the voltage transformers are wired in Star or Delta connection »VL12«, »VL23« und »VL31« oder »VL1«, »VL2« und »VL3«).

If any of the three phase voltages is e.g. below 15% Vn, the frequency calculation is blocked (settable via parameter »V Block f«). According to the frequency supervision mode set in the Device Planning (f< and df/dt or f> and dt/dt), the evaluated phase voltages are compared to the set frequency pickup threshold and the set frequency gradient (df/dt) threshold. If in any of the phases, both - the frequency and the frequency gradient exceed or fall below the set thresholds and if there are no blocking commands for the frequency element, an alarm is issued instantaneously and the tripping delay timer is started. When the frequency and the frequency gradient still exceed or are below the set threshold after the tripping delay timer has elapsed, a tripping command will be issued.

f[1]...[n]: f< and df/dt Or f> and df/dt
name = f[1]...[n]

2

Please Refer To Diagram: Blockings
 (Step is not deactivated and no active blockings present)

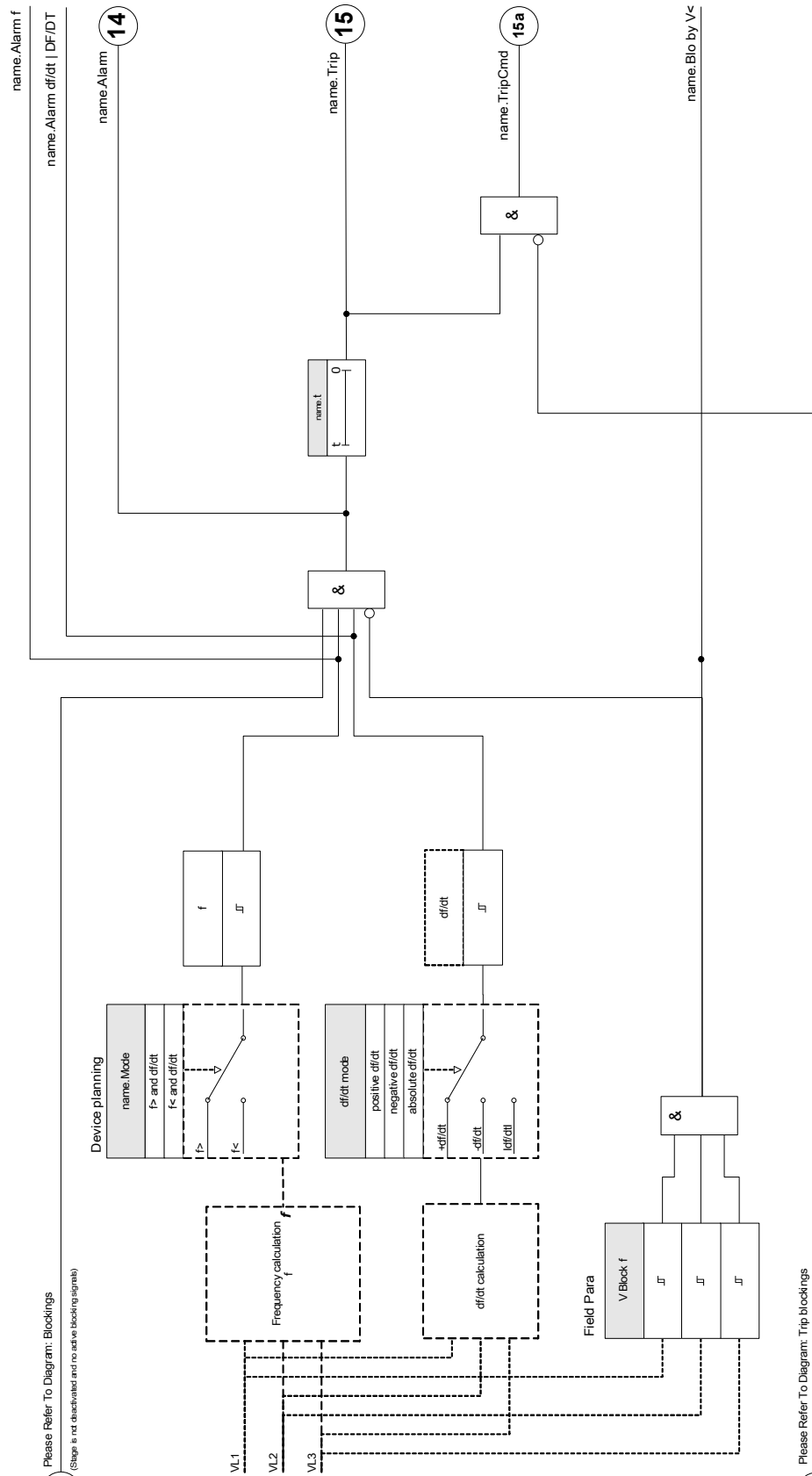

3

Please Refer To Diagram: Trip blockings
 (Tripping command deactivated or blocked.)

f< and DF/DT – Underfrequency and DF/DT

With this setting the frequency element supervises the frequency and the absolute frequency difference during a definite time interval.

In the selected frequency parameter set f[X], an underfrequency pickup threshold f<, a threshold for the absolute frequency difference (frequency decrease) DF and supervision interval DT can be set.

f> and DF/DT – Overfrequency and DF/DT

With this setting the frequency element supervises the frequency and the absolute frequency difference during a definite time interval.

In the selected frequency parameter set f[X], an overfrequency pickup threshold f>, a threshold for the absolute frequency difference (frequency increase) DF and supervision interval DT can be set.

Working principle f< and DF/DT | f> and DF/DT

(please refer to block diagram on next page)

The frequency element supervises the three voltages (depending on if the voltage transformers are wired in Star or Delta connection »VL12«, »VL23« und »VL31« oder »VL1«, »VL2« und »VL3«).

If any of the three phase voltages is e.g. below 15% Vn, the frequency calculation is blocked (settable via parameter »V Block f«). According to the frequency supervision mode set in the Device Planning (f< and DF/DT or f> and DF/DT), the evaluated phase voltages are compared to the set frequency pickup threshold and the set frequency decrease or increase threshold DF.

If in any of the phases, the frequency exceeds or falls below the set pickup threshold and if there are no blocking commands for the frequency element, an alarm is issued instantaneously. At the same time the timer for the supervision interval DT is started. When, during the supervision interval DT, the frequency still exceeds or is below the set pickup threshold and the frequency decrease/increase reaches the set threshold DF, a tripping command will be issued.

Working Principle of DF/DT Function

(Please refer to f(t) diagram after the block diagram)

Case 1:

When the frequency falls below a set f< threshold at t1, the DF/DT element energizes. If the frequency difference (decrease) does not reach the set value DF before the time interval DT has expired, no trip will occur. The frequency element remains blocked until the frequency falls below the underfrequency threshold f< again.

Case 2:

When the frequency falls below a set f< threshold at t4, the DF/DT element energizes. If the frequency difference (decrease) reaches the set value DF before the time interval DT has expired (t5), a trip command is issued.

f(1)...[n]: f< and DF/DT Or f> and DF/DT
name = f(1)...[n]

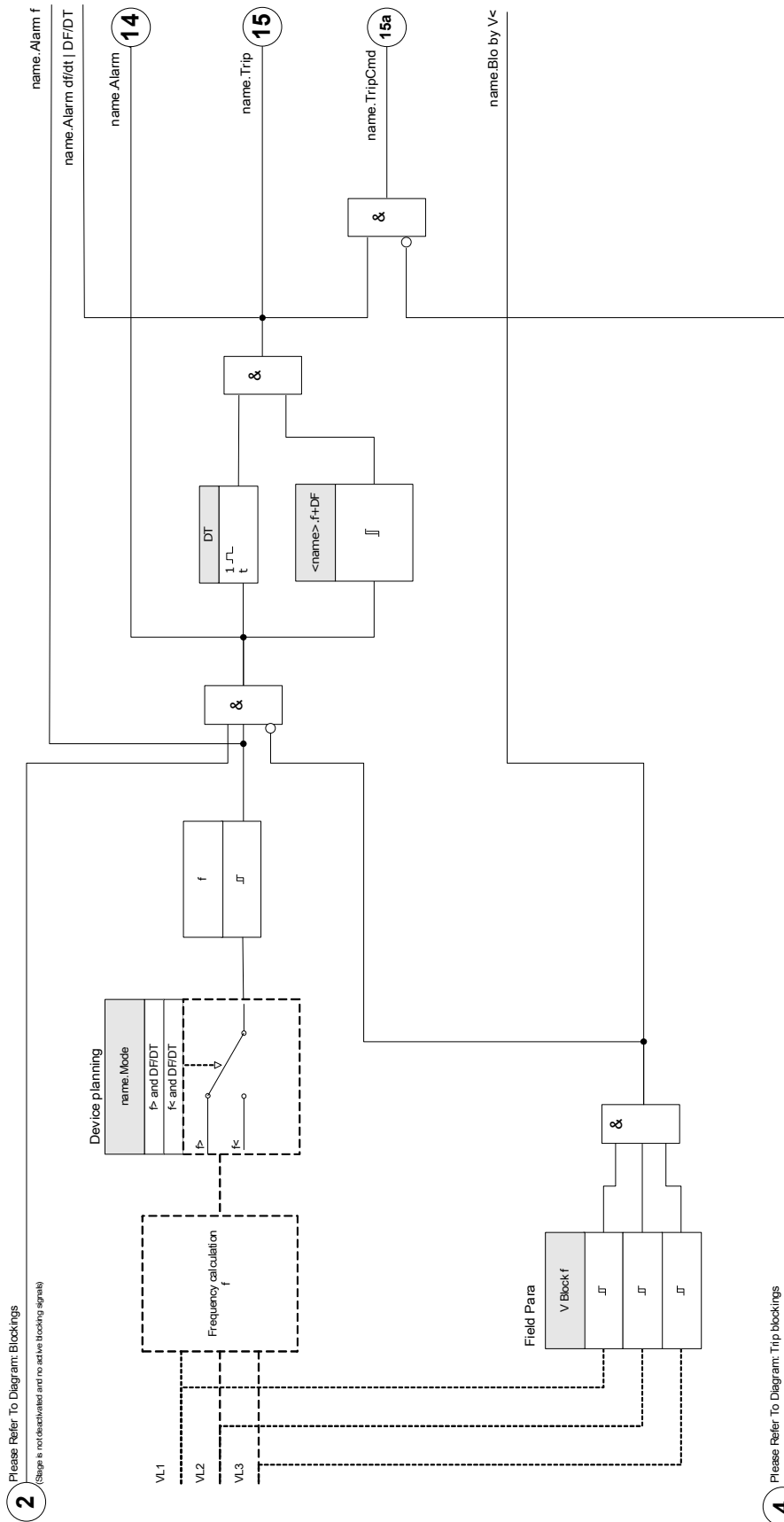

f(1)..
name = f(1)..
k and DF/DT

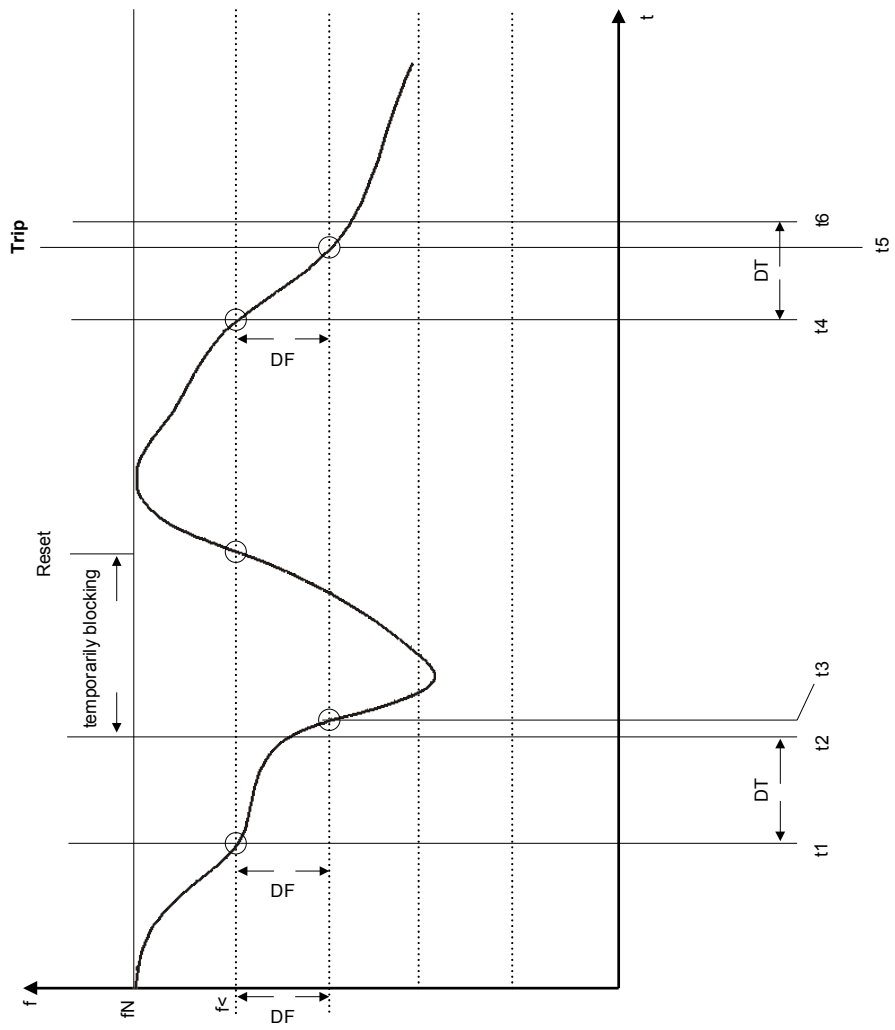

Delta phi - Vector Surge

The vector surge supervision protects synchronous generators in mains parallel operation due to very fast decoupling in case of mains failure. Very dangerous are mains auto reclosings for synchronous generators. The mains voltage returning typically after 300 ms can hit the generator in asynchronous position. A very fast decoupling is also necessary in case of long time mains failures.

Generally there are two different applications:

Only mains parallel operation - no single operation:

In this application the vector surge supervision protects the generator by tripping the generator circuit breaker in case of mains failure.

Mains parallel operation and single operation:

For this application the vector surge supervision trips the mains circuit breaker. Here it is insured that the gen.-set is not blocked when it is required as an emergency set.

A very fast decoupling in case of mains failures for synchronous generators is very difficult. Voltage supervision units cannot be used because the synchronous alternator as well as the consumer impedance support the decreasing voltage.

In this situation the mains voltage drops only after some 100 ms below the pickup threshold of the voltage supervision and therefore a safe detection of mains auto reclosings is not possible with voltage supervision only.

Frequency supervision is partially unsuitable because only a highly loaded generator decreases its speed within 100 ms. Current relays detect a fault only when short-circuit type currents exist, but cannot avoid their development. Power relays are able to pickup within 200 ms, but they also cannot prevent the power rising to short-circuit values. Since power changes are also caused by sudden loaded alternators, the use of power relays can be problematic.

Whereas the vector surge supervision of the device detects mains failures within 60 ms without the restrictions described above because it is specially designed for applications where very fast decoupling from the mains is required. Adding the typical operating time of a circuit breaker or contactor, the total disconnection time remains below 150 ms.

Basic requirement for tripping of the generator/mains monitor is a change in load of more than 15 - 20% of the rated load. Slow changes of the system frequency, for instance at regulating processes (adjustment of speed regulator) do not cause the relay to trip.

Trippings can also be caused by short-circuits within the grid, because a voltage vector surge higher than the preset value can occur. The magnitude of the voltage vector surge depends on the distance between the short-circuit and the generator. This function is also of advantage to the Power Utility Company because the mains short-circuit capacity and, consequently, the energy feeding the short-circuit is limited.

To prevent a possible false tripping, the vector surge measuring is blocked at a low input voltage e.g. <15% V_n (settable via parameter » *V Block f*«). The undervoltage lockout acts faster than the vector surge measurement.

Vector surge tripping is blocked by a phase loss so that a VT fault (e. g.: faulty VTs fuse) does not cause false tripping.

Measuring Principle of Vector Surge Supervision

Equivalent circuit at synchronous generator in parallel with the mains.

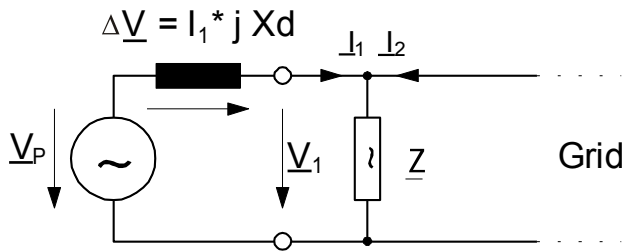

Voltage vectors at mains parallel operation.

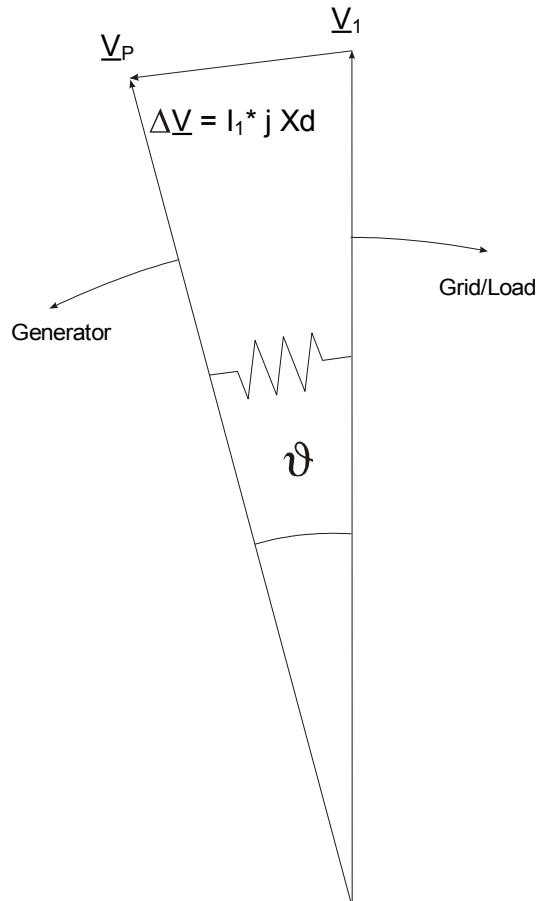

The rotor displacement angle between stator and rotor is dependent on the mechanical moving torque of the generator. The mechanical shaft power is balanced with the electrical fed mains power and, therefore the synchronous speed keeps constant.

Equivalent circuit at mains failure.

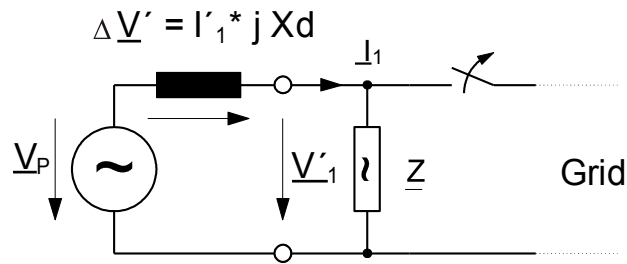

In case of mains failure or auto reclosing the generator suddenly feeds a very high consumer load. The rotor displacement angle is decreased repeatedly and the voltage vector V_1 changes its direction (V'_1).

Voltage vectors at mains failure.

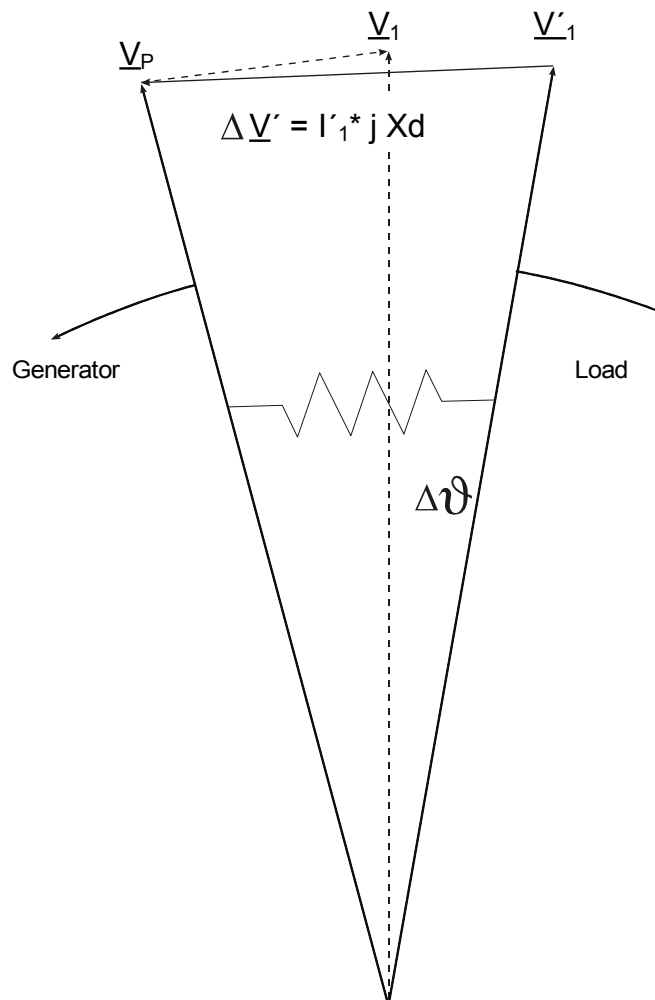

Voltage vector surge.

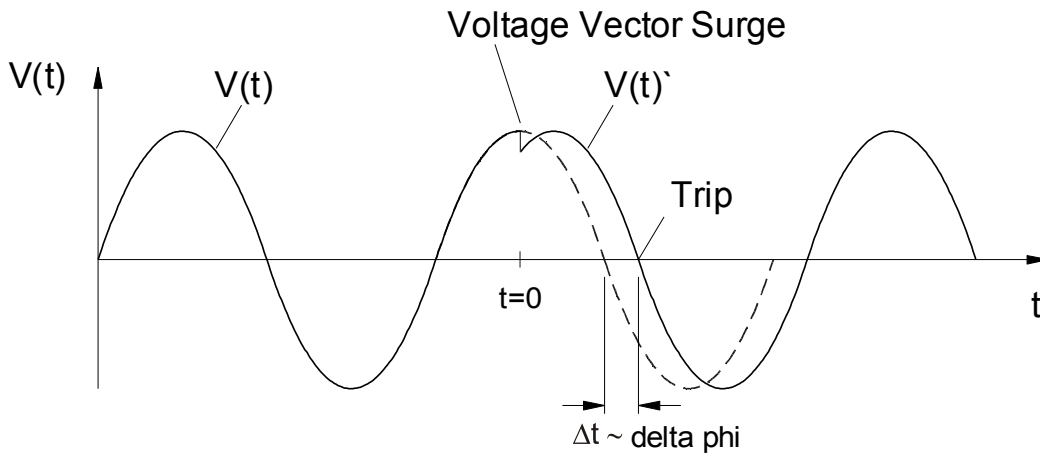

As shown in the voltage/time diagram the instantaneous value of the voltage jumps to another value and the phase position changes. This is called phase or vector surge.

The relay measures the cycle duration. A new measuring is started at each zero passage. The measured cycle duration is internally compared with a reference time and from this the deviation of the cycle duration of the voltage signal is ascertained. In case of a vector surge as shown in the above graphic, the zero passage occurs either earlier or later. The established deviation of the cycle duration is in compliance with the vector surge angle. If the vector surge angle exceeds the set value, the relay trips immediately.

Tripping of the vector surge is blocked in case of loss of one or more phases of the measuring voltage.

Working Principle delta phi

(Please refer to the block diagram on next page)

The frequency element supervises the three voltages (depending on if the voltage transformers are wired in Star or Delta connection »VL12«, »VL23« und »VL31« oder »VL1«, »VL2« und »VL3«).

If any of the three phase voltages is e.g. below 15% V_n , the vector surge calculation is blocked (settable via parameter »V Block f«). According to the frequency supervision mode set in the Device Planning (delta phi), the phase voltages are compared to the set vector surge threshold. If, depending on the parameter setting, in all three, in two or in one of the phases, the vector surge exceeds the set threshold and if there are no blocking commands for the frequency element, an alarm and a trip command is issued instantaneously.

f[1]...[n]: delta phi

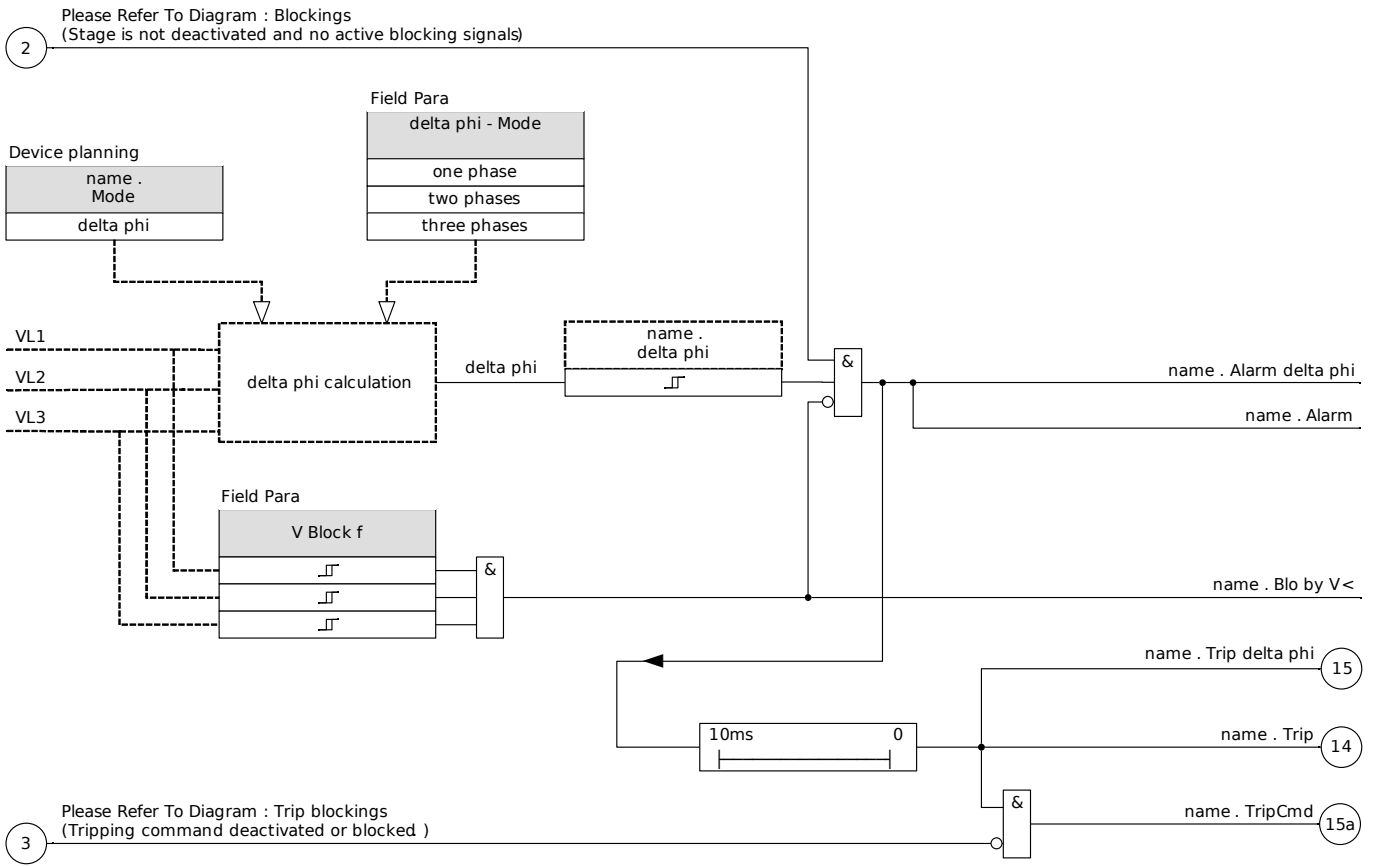

name = f[1]...[n]





Device Planning Parameters of the Frequency Protection Module

Parameter	Description	Options	Default	Menu path
Mode 	Mode	do not use, f<, f>, f< and df/dt, f> and df/dt, f< and DF/DT, f> and DF/DT, df/dt, delta phi	f[1]: f< f[2]: f> f[3]: do not use f[4]: do not use f[5]: do not use f[6]: do not use	[Device planning]







Global Protection Parameters of the Frequency Protection Module

Parameter	Description	Setting range	Default	Menu path
ExBlo1 	External blocking of the module, if blocking is activated (allowed) within a parameter set and if the state of the assigned signal is true.	1..n, Assignment List	.-	[Protection Para /Global Prot Para /f-Prot /f[1]]
ExBlo2 	External blocking of the module, if blocking is activated (allowed) within a parameter set and if the state of the assigned signal is true.	1..n, Assignment List	.-	[Protection Para /Global Prot Para /f-Prot /f[1]]
ExBlo TripCmd 	External blocking of the Trip Command of the module/the stage, if blocking is activated (allowed) within a parameter set and if the state of the assigned signal is true.	1..n, Assignment List	.-	[Protection Para /Global Prot Para /f-Prot /f[1]]

Setting Group Parameters of the Frequency Protection Module

Parameter	Description	Setting range	Default	Menu path
 Function	Permanent activation or deactivation of module/stage.	inactive, active	f[1]: active f[2]: active f[3]: inactive f[4]: inactive f[5]: inactive f[6]: inactive	[Protection Para /<1..4> /f-Prot /f[1]]
 ExBlo Fc	Activate (allow) or inactivate (disallow) blocking of the module/stage. This parameter is only effective if a signal is assigned to the corresponding global protection parameter. If the signal becomes true, those modules/stages are blocked that are parameterized "ExBlo Fc=active".	inactive, active	inactive	[Protection Para /<1..4> /f-Prot /f[1]]
 Blo TripCmd	Permanent blocking of the Trip Command of the module/stage.	inactive, active	inactive	[Protection Para /<1..4> /f-Prot /f[1]]
 ExBlo TripCmd Fc	Activate (allow) or inactivate (disallow) blocking of the module/stage. This parameter is only effective if a signal is assigned to the corresponding global protection parameter. If the signal becomes true, those modules/stages are blocked that are parameterized "ExBlo TripCmd Fc=active".	inactive, active	inactive	[Protection Para /<1..4> /f-Prot /f[1]]
 f>	Pickup value for overfrequency. Only available if: Device planning: f.Mode = f> Or f> and df/dt Or f> and DF/DT	40.00 - 69.95Hz	51.00Hz	[Protection Para /<1..4> /f-Prot /f[1]]
 f<	Pickup value for underfrequency. Only available if: Device planning: f.Mode = f< Or f< and df/dt Or f< and DF/DT	40.00 - 69.95Hz	49.00Hz	[Protection Para /<1..4> /f-Prot /f[1]]

Protective Elements

Parameter	Description	Setting range	Default	Menu path
t 	Tripping delay Only available if: Device planning: f.Mode = f< Or f>Or f> and df/dt Or f< and df/dt	0.00 - 3600.00s	1.00s	[Protection Para /<1..4> /f-Prot /f[1]]
df/dt 	Measured value (calculated): Rate-of-frequency-change. Only available if: Device planning: f.Mode = df/dt Or f< and df/dt Or f> and df/dt	0.100 - 10.000Hz/s	1.000Hz/s	[Protection Para /<1..4> /f-Prot /f[1]]
t-df/dt 	Trip delay df/dt	0.00 - 300.00s	1.00s	[Protection Para /<1..4> /f-Prot /f[1]]
DF 	Frequency difference for the maximum admissible variation of the mean of the rate of frequency-change. This function is inactive if DF=0. Only available if: Device planning: f.Mode = f< and DF/DT Or f> and DF/DT	0.0 - 10.0Hz	1.00Hz	[Protection Para /<1..4> /f-Prot /f[1]]
DT 	Time interval of the maximum admissible rate-of-frequency-change. Only available if: Device planning: f.Mode = f< and DF/DT Or f> and DF/DT	0.1 - 10.0s	1.00s	[Protection Para /<1..4> /f-Prot /f[1]]
df/dt mode 	df/dt mode Only available if: Device planning: f.Mode = df/dt Or f< and df/dt Or f> and df/dt Only available if: Device planning: f.Mode = df/dt Or f< and df/dt Or f> and df/dt Only available if: Device planning: f.Mode = df/dt	absolute df/dt, positive df/dt, negative df/dt	absolute df/dt	[Protection Para /<1..4> /f-Prot /f[1]]
delta phi 	Measured value (calculated): Vector surge Only available if: Device planning: f.Mode = delta phi	1 - 30°	10°	[Protection Para /<1..4> /f-Prot /f[1]]

Frequency Protection Module Input States

<i>Name</i>	<i>Description</i>	<i>Assignment via</i>
ExBlo1-I	Module input state: External blocking1	[Protection Para /Global Prot Para /f-Prot /f[1]]
ExBlo2-I	Module input state: External blocking2	[Protection Para /Global Prot Para /f-Prot /f[1]]
ExBlo TripCmd-I	Module input state: External Blocking of the Trip Command	[Protection Para /Global Prot Para /f-Prot /f[1]]

Frequency Protection Module Signals (Output States)

<i>Signal</i>	<i>Description</i>
active	Signal: active
ExBlo	Signal: External Blocking
Blo by V<	Signal: Module is blocked by undervoltage.
Blo TripCmd	Signal: Trip Command blocked
ExBlo TripCmd	Signal: External Blocking of the Trip Command
Alarm f	Signal: Alarm Frequency Protection
Alarm df/dt DF/DT	Alarm instantaneous or average value of the rate-of-frequency-change
Alarm delta phi	Signal: Alarm Vector Surge
Alarm	Signal: Alarm Frequency Protection (collective signal)
Trip f	Signal: Frequency has exceeded the limit.
Trip df/dt DF/DT	Signal: Trip df/dt or DF/DT
Trip delta phi	Signal: Trip Vector Surge
Trip	Signal: Trip Frequency Protection (collective signal)
TripCmd	Signal: Trip Command

Commissioning: Overfrequency [$f >$]

Object to be tested

All configured overfrequency protection stages.

Necessary means

- Three-phase voltage source with variable frequency and
- Timer

Procedure

Testing the threshold values

- Keep on increasing the frequency until the respective frequency element is activated;
- Note the frequency value and
- Disconnect the test voltage.

Testing the trip delay

- Set the test voltage to nominal frequency and
- Now connect a frequency jump (activation value) and then start a timer. Measure the tripping time at the relay output.

Testing the fallback ratio

Reduce the measuring quantity to less than 99.95% of the trip value (or 0.05% f_n). The relay must only fall back at 99.95% of the trip value at the earliest (or 0.05% f_n).

Successful test result

Permissible deviations/tolerances can be taken from the Technical Data.

Commissioning: Underfrequency [$f <$]

For all configured underfrequency elements, this test can be carried out similar to the test for overfrequency protection (by using the related underfrequency values).

Please consider the following deviations:

- For testing the threshold values, the frequency has to be decreased until the protection element is activated.
- For detection of the fallback ratio, the measuring quantity has to be increased to more than 100.05% of the trip value (or 0.05% f_n). At 100.05% of the trip value the relay is to fall back at the earliest (or 0.05% f_n).

Commissioning: df/dt - ROCOF

Object to be tested

All frequency protection stages that are projected as df/dt .

Necessary means

- Three-phase voltage source and
- Frequency generator that can generate and measure a linear, defined rate of change of frequency.

Procedure

Testing the threshold values

- Keep on increasing the rate of change of frequency until the respective element is activated.
- Note the value.

Testing the trip delay

- Set the test voltage to nominal frequency.
- Now apply a step change (sudden change) that is 1.5 times the setting value (example: apply 3 Hz per second if the setting value is 2 Hz per second) and
- Measure the tripping time at the relay output. Compare the measured tripping time to the configured tripping time.

Successful test result:

Permissible deviations/tolerances and dropout ratios can be taken from the Technical Data.

Commissioning: $f <$ and $-df/dt$ – Underfrequency and ROCOF

Object to be tested:

All frequency protection stages that are projected as $f <$ and $-df/dt$.

Necessary means:

- Three-phase voltage source and
- Frequency generator that can generate and measure a linear, defined rate of change of frequency.

Procedure:

Testing the threshold values

- Feed nominal voltage and nominal frequency to the device
- Decrease the frequency below the $f <$ threshold and
- Apply a rate of change of frequency (step change) that is below the setting value (example apply -1 Hz per second if the setting value is -0.8 Hz per second). After the tripping delay is expired the relay has to trip.

Successful test result

Permissible deviations/tolerances and dropout ratios can be taken from the Technical Data.

Commissioning: $f >$ and df/dt – Overfrequency and ROCOF

Object to be tested

All frequency protection stages that are projected as $f >$ and df/dt .

Necessary means

- Three-phase voltage source and.
- Frequency generator that can generate and measure a linear, defined rate of change of frequency.

Procedure

Testing the threshold values

- Feed nominal voltage and nominal frequency to the device.
- Increase the frequency above the $f >$ threshold and.
- Apply a rate of change of frequency (step change) that is above the setting value (example apply 1 Hz per second if the setting value is 0.8 Hz per second). After the tripping delay is expired the relay has to trip.

Successful test result:

Permissible deviations/tolerances and dropout ratios can be taken from the Technical Data.

Commissioning: $f <$ and DF/DT – Underfrequency and DF/DT

Object to be tested:

All frequency protection stages that are projected as $f <$ and Df/Dt.

Necessary means:

- Three-phase voltage source and
- Frequency generator that can generate and measure a defined frequency change.

Procedure:

Testing the threshold values

- Feed nominal voltage and nominal frequency to the device:
- Decrease the frequency below the $f <$ threshold and
- Apply a defined frequency change (step change) that is above the setting value (example: apply a frequency change of 1 Hz during the set time interval DT if the setting value DF is 0.8 Hz). The relay has to trip immediately.

Successful test result

Permissible deviations/tolerances and dropout ratios can be taken from the Technical Data.

Commissioning: $f >$ and DF/DT – Overfrequency and DF/DT

Object to be tested:

All frequency protection stages that are projected as $f >$ and Df/Dt.

Necessary means:

- Three-phase voltage source and
- Frequency generator that can generate and measure a defined frequency change.

Procedure:

Testing the threshold values

- Feed nominal voltage and nominal frequency to the device:
- Increase the frequency above the $f >$ threshold and
- Apply a defined frequency change (step change) that is above the setting value (example: apply a frequency change of 1 Hz during the set time interval DT if the setting value DF is 0.8 Hz). The relay has to trip immediately.

Successful test result:

Permissible deviations/tolerances and dropout ratios can be taken from the Technical Data.

Commissioning: delta phi - Vector Surge

Object to be tested:

All frequency protection stages that are projected as delta phi (vector surge).

Necessary means:

- Three-phase voltage source that can generate a definite step (sudden change) of the voltage pointers (phase shift).

Procedure:

Testing the threshold values

- Apply a vector surge (sudden change) that is 1.5 times the setting value (example: if the setting value is 10° apply 15°).

Successful test result:

Permissible deviations/tolerances and dropout ratio can be taken from the Technical Data.

V 012 – Voltage Asymmetry [47]

Available elements:

V012[1] .V012[2] .V012[3] .V012[4] .V012[5] .V012[6]

Within the Device planning menu this module can be projected in order to supervise the positive phase sequence voltage for over- or undervoltage or the negative phase sequence system for overvoltage. This module is based on the 3-phase voltages.

The module is alarmed, if the threshold is exceeded. The module will trip, if the measured values remain for the duration of the delay timer above the threshold continuously.

In case that the negative phase sequence voltage is monitored, the threshold » $V2>$ « can be combined with an additional percentage criterion » $\%V2/V1$ « (AND-connected) in order to prevent faulty tripping in case of a lack of voltage within the positive phase sequence system.

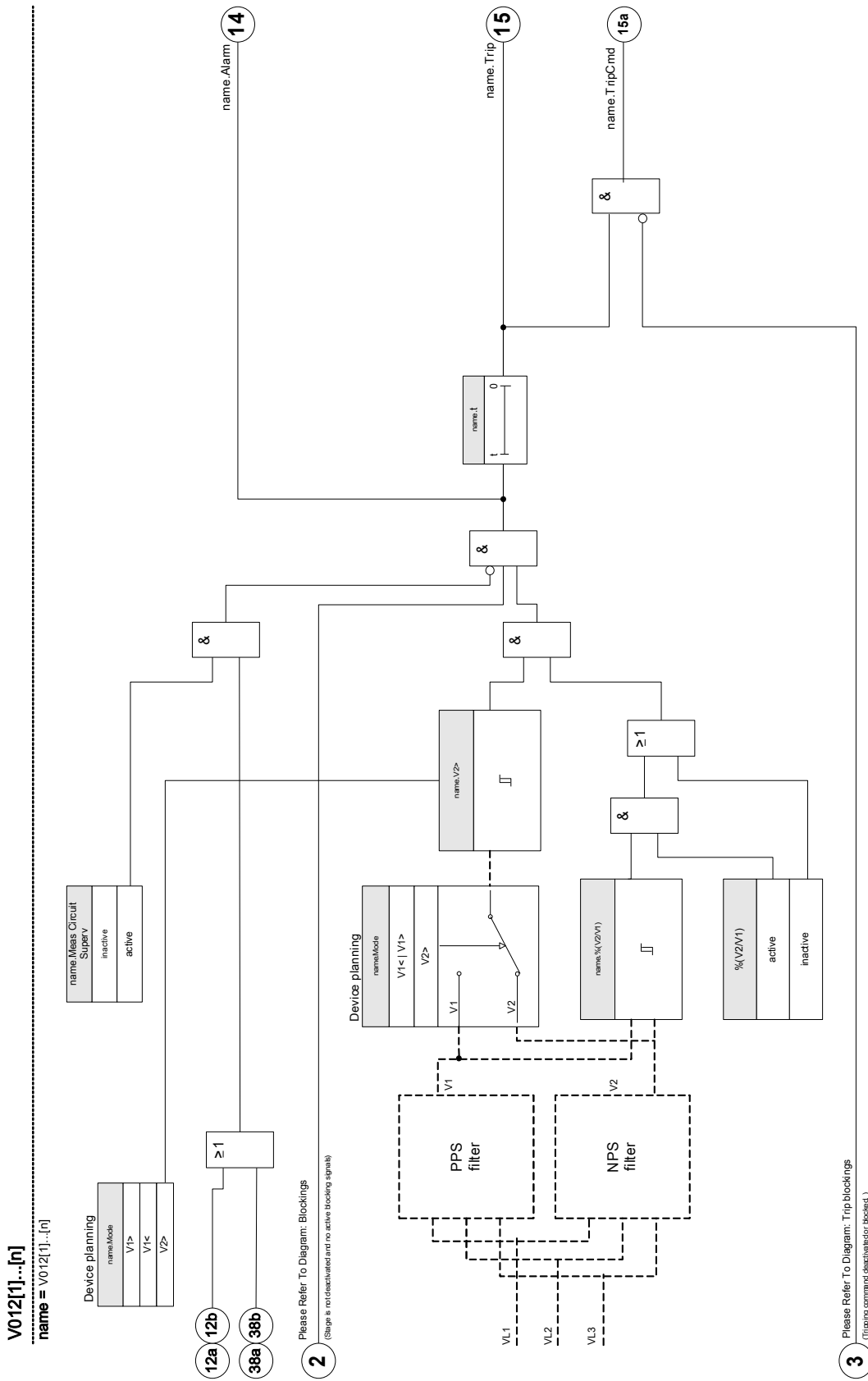

Application Options of the V 012 Module	Setting in	Option
ANSI 47 – Negative Sequence Overvoltage (Supervision of the Negative Phase Sequence System) Setting within the Device Planning ($V2>$)	Device Planning Menu	$\%V2/V1$: The Module trips, if the threshold $U2>$ and the ratio of negative to positive phase sequence voltage is exceeded (after the delay timer has expired). This criterion is to be activated and parametrized within the parameter set.
ANSI 59U1 Overvoltage within the Positive Phase Sequence System Setting within the Device Planning ($V1>$)	Device Planning Menu	-
ANSI 27U1 Undervoltage within the Positive Phase Sequence System Setting within the Device Planning ($V1<$)	Device Planning Menu	-









Device planning parameters of the asymmetry module





Parameter	Description	Options	Default	Menu path
 Mode	Unbalance Protection: Supervision of the Voltage System	do not use, V1>, V1<, V2>	do not use	[Device planning]

Global protection parameter of the asymmetry-module

Parameter	Description	Setting range	Default	Menu path
 ExBlo1	External blocking of the module, if blocking is activated (allowed) within a parameter set and if the state of the assigned signal is true.1	1..n, Assignment List	-.-	[Protection Para /Global Prot Para /V-Prot /V012[1]]
 ExBlo2	External blocking of the module, if blocking is activated (allowed) within a parameter set and if the state of the assigned signal is true.2	1..n, Assignment List	-.-	[Protection Para /Global Prot Para /V-Prot /V012[1]]
 ExBlo TripCmd	External blocking of the Trip Command of the module/the stage, if blocking is activated (allowed) within a parameter set and if the state of the assigned signal is true.	1..n, Assignment List	-.-	[Protection Para /Global Prot Para /V-Prot /V012[1]]

Parameter set parameters of the asymmetry module

Parameter	Description	Setting range	Default	Menu path
Function 	Permanent activation or deactivation of module/stage.	inactive, active	inactive	[Protection Para /<1..4> /V-Prot /V012[1]]
ExBlo Fc 	Activate (allow) or inactivate (disallow) blocking of the module/stage. This parameter is only effective if a signal is assigned to the corresponding global protection parameter. If the signal becomes true, those modules/stages are blocked that are parameterized "ExBlo Fc=active".	inactive, active	inactive	[Protection Para /<1..4> /V-Prot /V012[1]]
Blo TripCmd 	Permanent blocking of the Trip Command of the module/stage.	inactive, active	inactive	[Protection Para /<1..4> /V-Prot /V012[1]]
ExBlo TripCmd Fc 	Activate (allow) or inactivate (disallow) blocking of the module/stage. This parameter is only effective if a signal is assigned to the corresponding global protection parameter. If the signal becomes true, those modules/stages are blocked that are parameterized "ExBlo TripCmd Fc=active".	inactive, active	inactive	[Protection Para /<1..4> /V-Prot /V012[1]]
V1> 	Positive Phase Sequence Overvoltage Only available if: Device planning: V012.Mode = V1>	0.01 - 2.00Vn	1.00Vn	[Protection Para /<1..4> /V-Prot /V012[1]]
V1< 	Positive Phase Sequence Undervoltage Only available if: Device planning: V012.Mode = V1<	0.01 - 2.00Vn	1.00Vn	[Protection Para /<1..4> /V-Prot /V012[1]]
V2> 	Negative Phase Sequence Overvoltage Only available if: Device planning: V012.Mode = V2>	0.01 - 2.00Vn	1.00Vn	[Protection Para /<1..4> /V-Prot /V012[1]]

Parameter	Description	Setting range	Default	Menu path
 % (V2/V1)	The % (V2/V1) setting is the unbalance trip pickup setting. It is defined by the ratio of negative sequence voltage to positive sequence voltage (% Unbalance=V2/V1). Phase sequence will be taken into account automatically.	inactive, active	inactive	[Protection Para /<1..4> /V-Prot /V012[1]]
 % (V2/V1)	The % (V2/V1) setting is the unbalance trip pickup setting. It is defined by the ratio of negative sequence voltage to positive sequence voltage (% Unbalance=V2/V1). Phase sequence will be taken into account automatically. Only available if: % (V2/V1) = use	2 - 40%	20%	[Protection Para /<1..4> /V-Prot /V012[1]]
 t	Tripping delay	0.00 - 300.00s	0.00s	[Protection Para /<1..4> /V-Prot /V012[1]]
 Meas Circuit Superv	Activates the use of the measuring circuit supervision. In this case the module will be blocked if a measuring circuit supervision module (e.g. LOP, VTS) signals a disturbed measuring circuit (e.g. caused by a fuse failure).	inactive, active	inactive	[Protection Para /<1..4> /V-Prot /V012[1]]

States of the inputs of the asymmetry module

Name	Description	Assignment via
ExBlo1-I	Module input state: External blocking1	[Protection Para /Global Prot Para /V-Prot /V012[1]]
ExBlo2-I	Module input state: External blocking2	[Protection Para /Global Prot Para /V-Prot /V012[1]]
ExBlo TripCmd-I	Module input state: External Blocking of the Trip Command	[Protection Para /Global Prot Para /V-Prot /V012[1]]

Signals of the asymmetry module (states of the outputs)

<i>Signal</i>	<i>Description</i>
active	Signal: active
ExBlo	Signal: External Blocking
Blo TripCmd	Signal: Trip Command blocked
ExBlo TripCmd	Signal: External Blocking of the Trip Command
Alarm	Signal: Alarm voltage asymmetry
Trip	Signal: Trip
TripCmd	Signal: Trip Command

Commissioning: Asymmetry Protection

Object to be tested

Test of the asymmetry protection elements.

Necessary means

- 3-phase AC voltage source
- Timer for measuring of the tripping time
- Voltmeter

Testing the tripping values (Example)

Set the pickup value for the voltage in the negative phase sequence to $0.5 V_n$. Set the tripping delay to 1 s.

In order to generate a negative phase sequence voltage interchange the wiring of two phases (VL2 and VL3).

Testing the trip delay

Start the timer and abrupt change (switch) to 1.5 times of the set tripping value. Measure the trip delay.

Successful test result

The measured threshold values and trip delays comply with those specified in the adjustment list. Permissible deviations/tolerances can be taken from the Technical Data.

Sync - Synchrocheck [25]

Available Elements:
Sync



WARNING

The synchrocheck function can be bypassed by external sources. In this case, synchronization has to be secured by other synchronizing systems before breaker closing!

NOTICE

The first three measuring inputs of the voltage measuring card (VL1/VL1-L2, VL2/VL2-L3, VL3/VL3-L1) are named /label as bus voltages within the synchrocheck element (this applies also to generator protection devices). The fourth measuring input of the voltage measuring card (VX) is named /label as line-voltage (this applies also to generator protection devices). In the menu [Field Para/Voltage transf/V Sync] the User has to define to which phase the fourth measuring input is compared.

Synchrocheck

The synchrocheck function is provided for the applications where a line has two-ended power sources. The synchrocheck function has the abilities to check voltage magnitude, angle differences, and frequency difference (slip frequency) between the bus and the line. If enabled, the synchrocheck may supervise the closing operation manually, automatically, or both. This function can be overridden by certain bus-line operation conditions and can be bypassed with an external source.

Voltage Difference ΔV

The first condition for paralleling two electrical systems is that their voltage phasors have the same magnitude. This can be controlled by the generator's AVR.

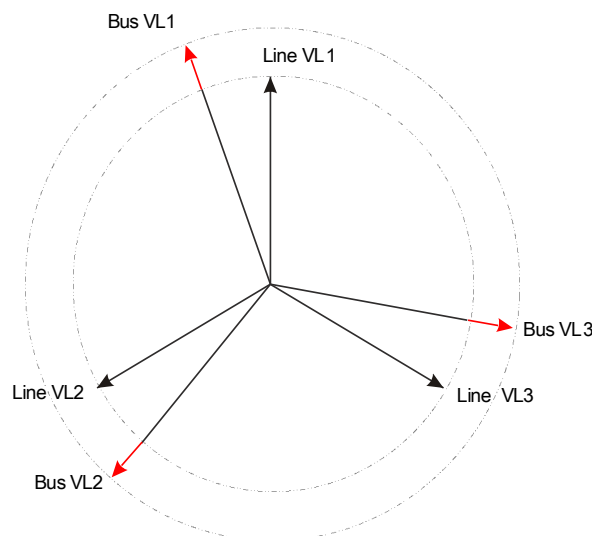

Frequency Difference (Slip Frequency) ΔF

The second condition for paralleling two electrical systems is that their frequencies are nearly equal. This can be controlled by the generator's speed governor.

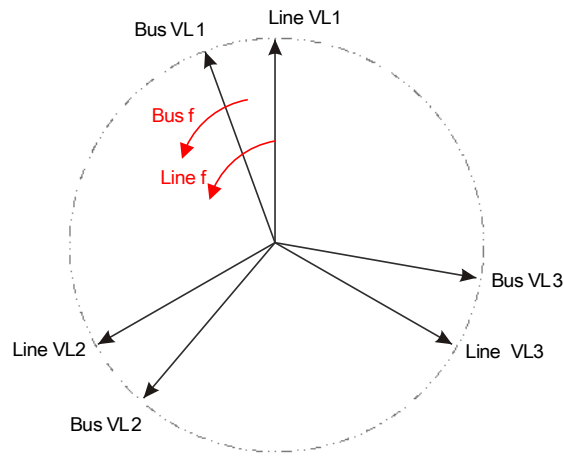

If the generator frequency f_{Bus} is not equal to the mains frequency f_{Line} , it results in a slip frequency $\Delta F = |f_{\text{Bus}} - f_{\text{Line}}|$ between the two system frequencies.

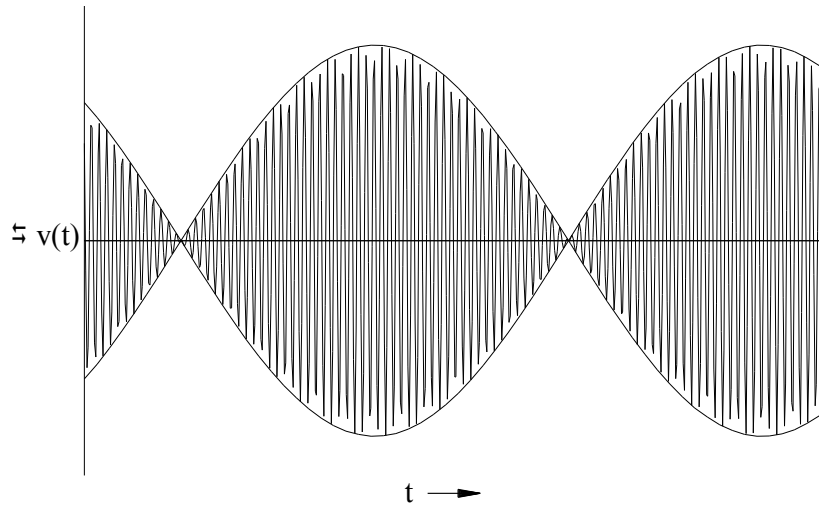

Voltage Curve with Enlarged Resolution.

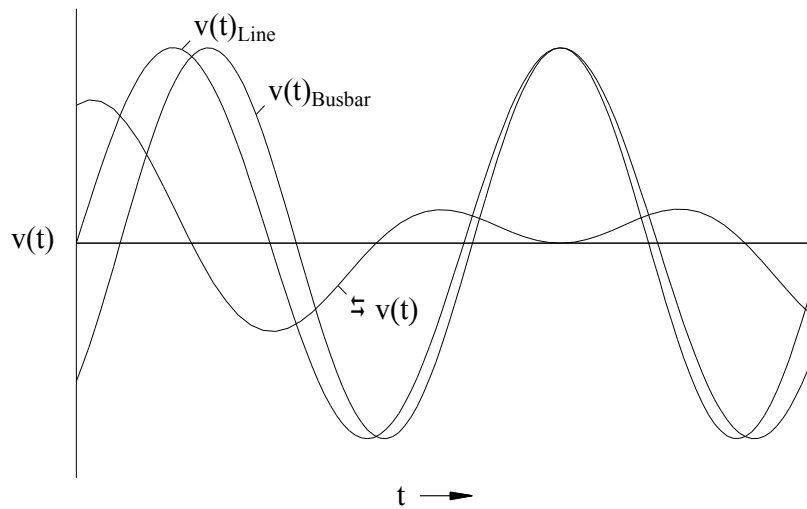

Angular or Phase Difference.

Even if the frequency of both systems is exactly identical, usually an angular difference of the voltage phasors is the case.

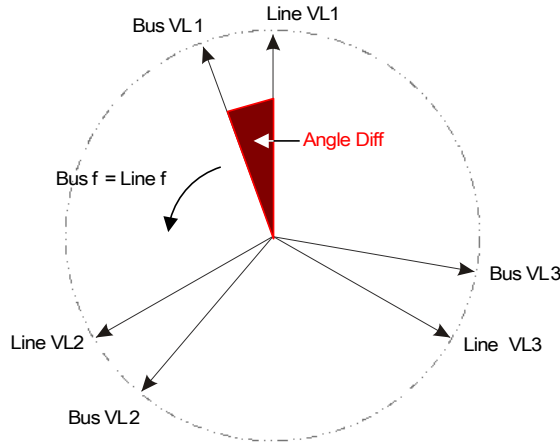

At the instant of synchronization, the angular difference of the two systems should be nearly zero because, otherwise, unwanted load inrushes occur. Theoretically, the angular difference can be regulated to zero by giving short pulses to the speed governors. When paralleling generators with the grid, in practice, synchronization is requested as quick as possible and so usually a slight frequency difference is accepted. In such cases, the angular difference is not constant but changes with the slip frequency ΔF .

By taking the breaker closing time into consideration, a lead of the closing release impulse can be calculated in a way that breaker closing takes place at exactly the time when both systems are in angular conformity.

Basically the following applies:

Where large rotating masses are concerned, the frequency difference (slip frequency) of the two systems should possibly be nearly zero, because of the very high load inrushes at the instant of breaker closing. For smaller rotating masses, the frequency difference of the systems can be higher.

NOTICE This sync-check cannot be used for two voltages that are shifted by a fixed angle (e.g because they are measured on the two sides of a block transformer of a generator).

Synchronization Modes

The synchrocheck module is able to check the synchronization of two electrical systems (system-to-system) or between a generator and an electrical system (generator-to-system). For paralleling two electrical systems, the station frequency, voltage and phase angle should be exactly the same as the utility grid. Whereas the synchronization of a generator to a system can be done with a certain slip-frequency, depending on the size of the generator used. Therefore the maximum breaker closing time has to be taken into consideration. With the set breaker closing time, the synchrocheck module is able to calculate the moment of synchronization and gives the paralleling release.



WARNING When paralleling two systems, it has to be verified that the system-to-system mode is selected. Paralleling two systems in generator-to-system mode can cause severe damage!

Working Principle Synchrocheck (Generator-to-System)

(Please refer to the block diagram on next page.)

The synchrocheck element measures the three phase-to-neutral voltages »VL1«, »VL2«, and »VL3« or the three phase-to-phase voltages »VL1-L2«, »VL2-L3«, and »VL3-L1« of the generator busbar. The line voltage V_x is measured by the fourth voltage input. If all synchronous conditions are fulfilled (i. e.: ΔV [VoltageDiff], ΔF [SlipFrequency], and $\Delta\phi$ [AngleDiff]) are within the limits, a signal will be issued that both systems are synchronous. An advanced Close Angle Evaluator function takes the breaker closing time into consideration.

2 Sync=: SyncMode= Generator2System

Please Refer To Diagram: Blockings
 (Stage is not deactivated and no active blocking signals)

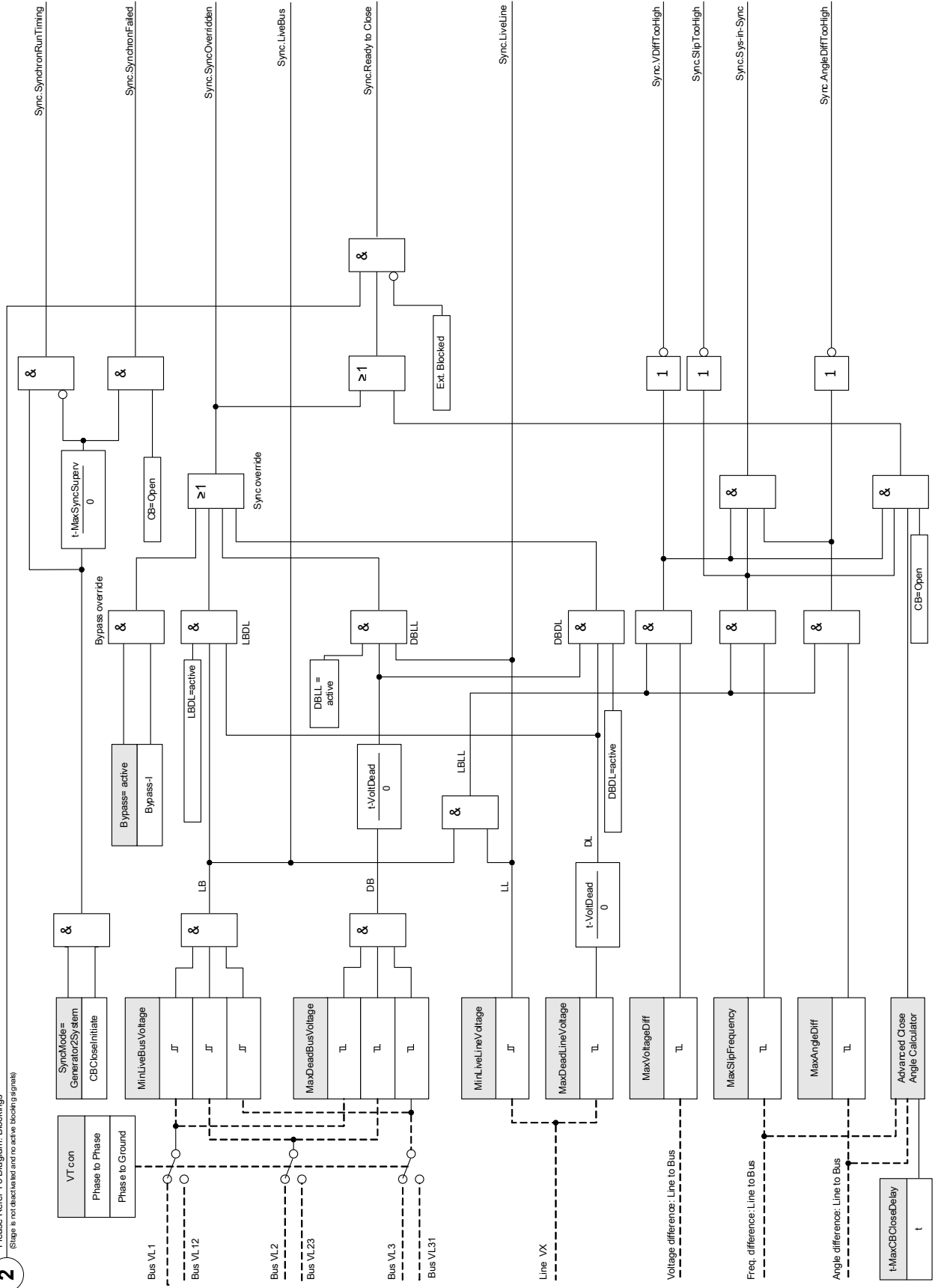

Working Principle Synchrocheck (System-to-System)

(Please refer to the block diagram on next page.)

The synchrocheck function for two systems is very similar to the synchrocheck function for generator-to-system except there is no need to take the breaker closing time into account. The synchrocheck element measures the three phase-to-neutral voltages »VL1«, »VL2«, and »VL3« or the three phase-to-phase voltages »VL1-L2«, »VL2-L3«, and »VL3-L1« of the station voltage bus bar. The line voltage V_x is measured by the fourth voltage input. If all synchronous conditions are fulfilled (i. e.: ΔV [VoltageDiff], ΔF [SlipFrequency], and $\Delta\phi$ [AngleDiff]) are within the limits, a signal will be issued that both systems are synchronous.

Sync: SyncMode= System2System

2

Please Refer To Diagram: Blockings
(Shape is not deactivated and no active blocking signals)

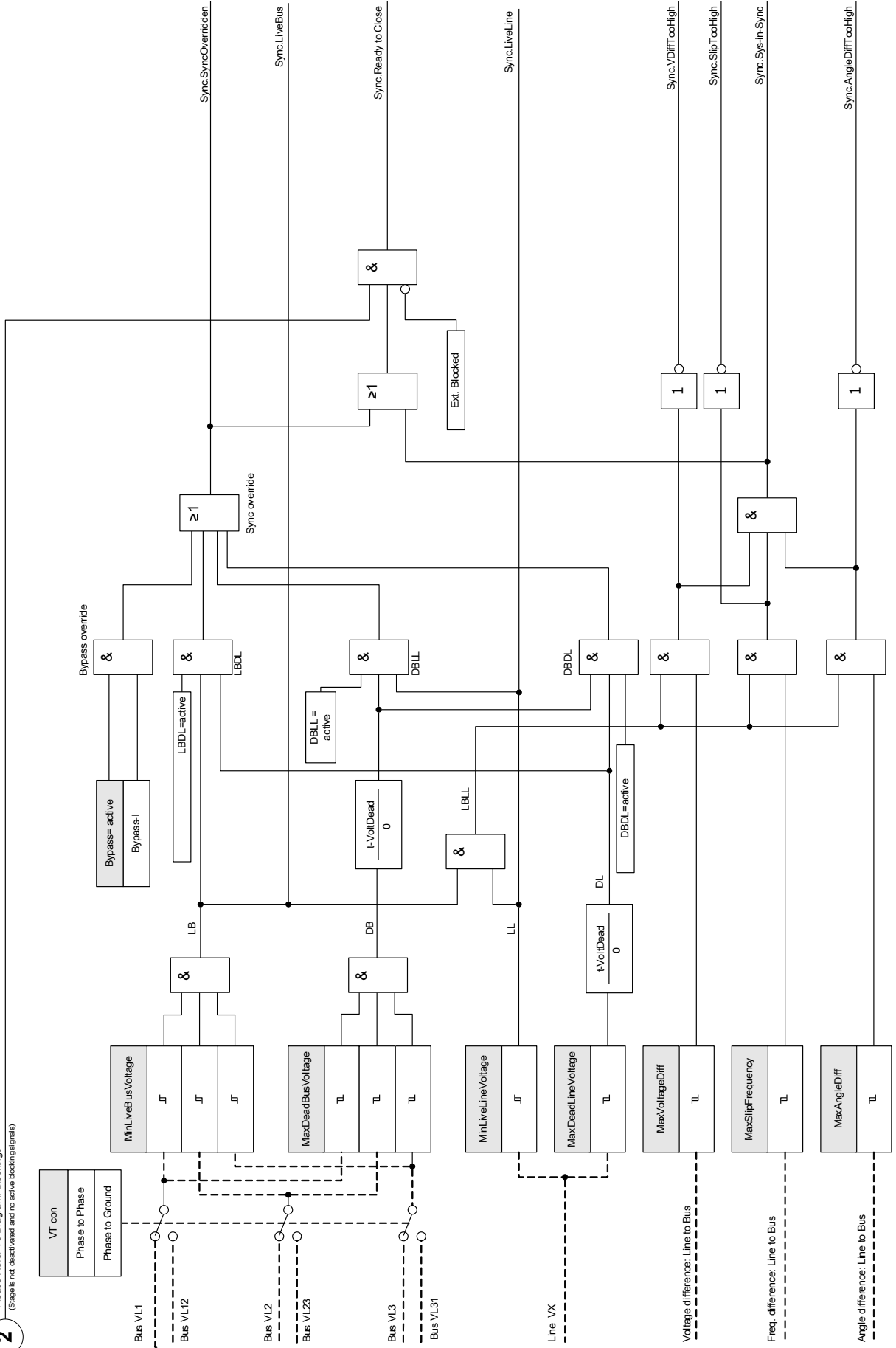

Synchrocheck Override Conditions

If enabled the following conditions can override the synchrocheck function:

- LBDL = Live Bus – Dead Line
- DBLL = Dead Bus – Live Line
- DBDL = Dead Bus – Dead Line

Also the synchrocheck function can be bypassed by an external source.







When the synchrocheck function is overridden or bypassed, synchronization has to be secured by other synchronizing systems before breaker closing!

Device Planning Parameters of the Synchrocheck Module

Parameter	Description	Options	Default	Menu path
Mode 	Mode	do not use, use	do not use	[Device planning]



Global Protection Parameters of the Synchrocheck Module

Parameter	Description	Setting range	Default	Menu path
ExBlo1 	External blocking of the module, if blocking is activated (allowed) within a parameter set and if the state of the assigned signal is true.	1..n, Assignment List	-.-	[Protection Para /Global Prot Para /Intercon-Prot /Sync]
ExBlo2 	External blocking of the module, if blocking is activated (allowed) within a parameter set and if the state of the assigned signal is true.	1..n, Assignment List	-.-	[Protection Para /Global Prot Para /Intercon-Prot /Sync]
Bypass 	The Synchrocheck will be bypassed if the state of the assigned signal (logic input) becomes true.	1..n, DI- LogicList	-.-	[Protection Para /Global Prot Para /Intercon-Prot /Sync]
CB Pos Detect 	Criterion by which the Circuit Breaker Switch Position is to be detected.	-.-, SG[1].Pos, SG[2].Pos, SG[3].Pos, SG[4].Pos, SG[5].Pos, SG[6].Pos	SG[1].Pos	[Protection Para /Global Prot Para /Intercon-Prot /Sync]
CBCloseInitiate 	Breaker Close Initiate with synchronism check from any control sources (e.g. HMI / SCADA). If the state of the assigned signal becomes true, a Breaker Close will be initiated (Trigger Source).	1..n, SyncRequestList	-.-	[Protection Para /Global Prot Para /Intercon-Prot /Sync]

Setting Group Parameters of the Synchrocheck Fault Module

Parameter	Description	Setting range	Default	Menu path
 Function	Permanent activation or deactivation of module/stage.	inactive, active	inactive	[Protection Para /<1..4> /Intercon-Prot /Sync /General Settings]
 ExBlo Fc	Activate (allow) or inactivate (disallow) blocking of the module/stage. This parameter is only effective if a signal is assigned to the corresponding global protection parameter. If the signal becomes true, those modules/stages are blocked that are parameterized "ExBlo Fc=active".	inactive, active	inactive	[Protection Para /<1..4> /Intercon-Prot /Sync /General Settings]
 Bypass Fc	Allowing to bypass the Synchrocheck, if the state signal that is assigned to the parameter with the same name within the Global Parameters (logic input) becomes true.	inactive, active	inactive	[Protection Para /<1..4> /Intercon-Prot /Sync /General Settings]
 SyncMode	Synchrocheck mode: GENERATOR2SYSTEM = Synchronizing generator to system (breaker close initiate needed). SYSTEM2SYSTEM = SynchronCheck between two systems (Stand-Alone, no breaker info needed)	System2System , Generator2System	System2System	[Protection Para /<1..4> /Intercon-Prot /Sync /Mode / Times]
 t- MaxCBCloseDelay	Maximum circuit breaker close time delay (Only used for GENERATOR-SYSTEM working mode and is critical for a correct synchronized switching) Only available if: SyncMode = System2System	0.00 - 300.00s	0.05s	[Protection Para /<1..4> /Intercon-Prot /Sync /Mode / Times]
 t- MaxSyncSuperv	Synchron-Run timer: Max. time allowed for synchronizing process after a close initiate. Only used for GENERATOR2SYSTEM working mode. Only available if: SyncMode = System2System	0.00 - 3000.00s	30.00s	[Protection Para /<1..4> /Intercon-Prot /Sync /Mode / Times]

Protective Elements

Parameter	Description	Setting range	Default	Menu path
 MinLiveBusVoltage	Minimum Live Bus voltage (Live bus detected, when all three phase bus voltages are above this limit).	0.10 - 2.00Vn	0.65Vn	[Protection Para /<1..4> /Intercon-Prot /Sync / DeadLiveVLevels]
 MaxDeadBusVoltage	Maximum Dead Bus voltage (Dead bus detected, when all three phase bus voltages are below this limit).	0.01 - 1.00Vn	0.03Vn	[Protection Para /<1..4> /Intercon-Prot /Sync / DeadLiveVLevels]
 MinLiveLineVoltage	Minimum Live Line voltage (Live line detected, when line voltage above this limit).	0.10 - 2.00Vn	0.65Vn	[Protection Para /<1..4> /Intercon-Prot /Sync / DeadLiveVLevels]
 MaxDeadLineVoltage	Maximum Dead Line voltage (Dead Line detected, when line voltage below this limit).	0.01 - 1.00Vn	0.03Vn	[Protection Para /<1..4> /Intercon-Prot /Sync / DeadLiveVLevels]
 t-VoltDead	Voltage dead time (A Dead Bus/Line condition will be accepted only if the voltage falls below the set dead voltage levels longer than this time setting).	0.000 - 300.000s	0.167s	[Protection Para /<1..4> /Intercon-Prot /Sync / DeadLiveVLevels]

Protective Elements

Parameter	Description	Setting range	Default	Menu path
 MaxVoltageDiff	Maximum voltage difference between bus and line voltage phasors (Delta V)for synchronism (Related to bus voltage secondary rating)	0.01 - 1.00Vn	0.24Vn	[Protection Para /<1..4> /Intercon-Prot /Sync /Conditions]
 MaxSlipFrequency	Maximum frequency difference (Slip: Delta f) between bus and line voltage allowed for synchronism	0.01 - 2.00Hz	0.20Hz	[Protection Para /<1..4> /Intercon-Prot /Sync /Conditions]
 MaxAngleDiff	Maximum phase angle difference (Delta-Phi in degree) between bus and line voltages allowed for synchronism	1 - 60°	20°	[Protection Para /<1..4> /Intercon-Prot /Sync /Conditions]
 DBDL	Enable/disable Dead-Bus AND Dead-Line synchronism overriding	inactive, active	inactive	[Protection Para /<1..4> /Intercon-Prot /Sync /Override]
 DBLL	Enable/disable Dead-Bus AND Live-Line synchronism overriding	inactive, active	inactive	[Protection Para /<1..4> /Intercon-Prot /Sync /Override]
 LBDL	Enable/disable Live-Bus AND Dead-Line synchronism overriding	inactive, active	inactive	[Protection Para /<1..4> /Intercon-Prot /Sync /Override]

Synchrocheck Module Input States

<i>Name</i>	<i>Description</i>	<i>Assignment via</i>
ExBlo1-I	Module input state: External blocking1	[Protection Para /Global Prot Para /Intercon-Prot /Sync]
ExBlo2-I	Module input state: External blocking2	[Protection Para /Global Prot Para /Intercon-Prot /Sync]
Bypass-I	State of the module input: Bypass	[Protection Para /Global Prot Para /Intercon-Prot /Sync]
CBCloseInitiate-I	State of the module input: Breaker Close Initiate with synchronism check from any control sources (e.g. HMI / SCADA). If the state of the assigned signal becomes true, a Breaker Close will be initiated (Trigger Source).	[Protection Para /Global Prot Para /Intercon-Prot /Sync]

Signals of the Synchrocheck Module (Output States)

<i>Signal</i>	<i>Description</i>
active	Signal: active
ExBlo	Signal: External Blocking
LiveBus	Signal: Live-Bus flag: 1=Live-Bus, 0=Voltage is below the LiveBus threshold
LiveLine	Signal: Live Line flag: 1=Live-Line, 0=Voltage is below the LiveLine threshold
SynchronRunTiming	Signal: SynchronRunTiming
SynchronFailed	Signal: This signal indicates a failed synchronization. It is set for 5s when the circuit breaker is still open after the Synchron-Run-timer has timed out.
SyncOverridden	Signal:Synchronism Check is overridden because one of the Synchronism overriding conditions (DB/DL or ExtBypass) is met.
VDiffTooHigh	Signal: Voltage difference between bus and line too high.
SlipTooHigh	Signal: Frequency difference (slip frequency) between bus and line voltages too high.
AngleDiffTooHigh	Signal: Phase Angle difference between bus and line voltages too high.
Sys-in-Sync	Signal: Bus and line voltages are in synchronism according to the system synchronism criteria.
Ready to Close	Signal: Ready to Close

Values of the Syncrocheck

<i>Value</i>	<i>Description</i>	<i>Default</i>	<i>Size</i>	<i>Menu path</i>
Slip Freq	Slip frequency	0Hz	0 - 70.000Hz	[Operation /Measured Values /Synchronism]
Volt Diff	Voltage difference between bus and line.	0V	0 - 500000.0V	[Operation /Measured Values /Synchronism]
Angle Diff	Angle difference between bus and line voltages.	0°	-360.0 - 360.0°	[Operation /Measured Values /Synchronism]
f Bus	Bus frequency	0Hz	0 - 70.000Hz	[Operation /Measured Values /Synchronism]
f Line	Line frequency	0Hz	0 - 70.000Hz	[Operation /Measured Values /Synchronism]
V Bus	Bus Voltage	0V	0 - 500000.0V	[Operation /Measured Values /Synchronism]
V Line	Line Voltage	0V	0 - 500000.0V	[Operation /Measured Values /Synchronism]
Angle Bus	Bus Angle (Reference)	0°	0 - 360°	[Operation /Measured Values /Synchronism]
Angle Line	Line Angle	0°	0 - 360°	[Operation /Measured Values /Synchronism]

Signals that Trigger a Syncrocheck

<i>Name</i>	<i>Description</i>
.-.	No assignment
SG[1].Sync ON request	Signal: Synchronous ON request
SG[2].Sync ON request	Signal: Synchronous ON request
SG[3].Sync ON request	Signal: Synchronous ON request
SG[4].Sync ON request	Signal: Synchronous ON request
SG[5].Sync ON request	Signal: Synchronous ON request

<i>Name</i>	<i>Description</i>
SG[6].Sync ON request	Signal: Synchronous ON request
DI Slot X1.DI 1	Signal: Digital Input
DI Slot X1.DI 2	Signal: Digital Input
DI Slot X1.DI 3	Signal: Digital Input
DI Slot X1.DI 4	Signal: Digital Input
DI Slot X1.DI 5	Signal: Digital Input
DI Slot X1.DI 6	Signal: Digital Input
DI Slot X1.DI 7	Signal: Digital Input
DI Slot X1.DI 8	Signal: Digital Input
DI Slot X5.DI 1	Signal: Digital Input
DI Slot X5.DI 2	Signal: Digital Input
DI Slot X5.DI 3	Signal: Digital Input
DI Slot X5.DI 4	Signal: Digital Input
DI Slot X5.DI 5	Signal: Digital Input
DI Slot X5.DI 6	Signal: Digital Input
DI Slot X5.DI 7	Signal: Digital Input
DI Slot X5.DI 8	Signal: Digital Input
DI Slot X6.DI 1	Signal: Digital Input
DI Slot X6.DI 2	Signal: Digital Input
DI Slot X6.DI 3	Signal: Digital Input
DI Slot X6.DI 4	Signal: Digital Input
DI Slot X6.DI 5	Signal: Digital Input
DI Slot X6.DI 6	Signal: Digital Input
DI Slot X6.DI 7	Signal: Digital Input
DI Slot X6.DI 8	Signal: Digital Input
Logics.LE1.Gate Out	Signal: Output of the logic gate
Logics.LE1.Timer Out	Signal: Timer Output
Logics.LE1.Out	Signal: Latched Output (Q)
Logics.LE1.Out inverted	Signal: Negated Latched Output (Q NOT)
Logics.LE2.Gate Out	Signal: Output of the logic gate
Logics.LE2.Timer Out	Signal: Timer Output
Logics.LE2.Out	Signal: Latched Output (Q)
Logics.LE2.Out inverted	Signal: Negated Latched Output (Q NOT)
Logics.LE3.Gate Out	Signal: Output of the logic gate
Logics.LE3.Timer Out	Signal: Timer Output
Logics.LE3.Out	Signal: Latched Output (Q)
Logics.LE3.Out inverted	Signal: Negated Latched Output (Q NOT)
Logics.LE4.Gate Out	Signal: Output of the logic gate
Logics.LE4.Timer Out	Signal: Timer Output
Logics.LE4.Out	Signal: Latched Output (Q)

<i>Name</i>	<i>Description</i>
Logics.LE4.Out inverted	Signal: Negated Latched Output (Q NOT)
Logics.LE5.Gate Out	Signal: Output of the logic gate
Logics.LE5.Timer Out	Signal: Timer Output
Logics.LE5.Out	Signal: Latched Output (Q)
Logics.LE5.Out inverted	Signal: Negated Latched Output (Q NOT)
Logics.LE6.Gate Out	Signal: Output of the logic gate
Logics.LE6.Timer Out	Signal: Timer Output
Logics.LE6.Out	Signal: Latched Output (Q)
Logics.LE6.Out inverted	Signal: Negated Latched Output (Q NOT)
Logics.LE7.Gate Out	Signal: Output of the logic gate
Logics.LE7.Timer Out	Signal: Timer Output
Logics.LE7.Out	Signal: Latched Output (Q)
Logics.LE7.Out inverted	Signal: Negated Latched Output (Q NOT)
Logics.LE8.Gate Out	Signal: Output of the logic gate
Logics.LE8.Timer Out	Signal: Timer Output
Logics.LE8.Out	Signal: Latched Output (Q)
Logics.LE8.Out inverted	Signal: Negated Latched Output (Q NOT)
Logics.LE9.Gate Out	Signal: Output of the logic gate
Logics.LE9.Timer Out	Signal: Timer Output
Logics.LE9.Out	Signal: Latched Output (Q)
Logics.LE9.Out inverted	Signal: Negated Latched Output (Q NOT)
Logics.LE10.Gate Out	Signal: Output of the logic gate
Logics.LE10.Timer Out	Signal: Timer Output
Logics.LE10.Out	Signal: Latched Output (Q)
Logics.LE10.Out inverted	Signal: Negated Latched Output (Q NOT)
Logics.LE11.Gate Out	Signal: Output of the logic gate
Logics.LE11.Timer Out	Signal: Timer Output
Logics.LE11.Out	Signal: Latched Output (Q)
Logics.LE11.Out inverted	Signal: Negated Latched Output (Q NOT)
Logics.LE12.Gate Out	Signal: Output of the logic gate
Logics.LE12.Timer Out	Signal: Timer Output
Logics.LE12.Out	Signal: Latched Output (Q)
Logics.LE12.Out inverted	Signal: Negated Latched Output (Q NOT)
Logics.LE13.Gate Out	Signal: Output of the logic gate
Logics.LE13.Timer Out	Signal: Timer Output
Logics.LE13.Out	Signal: Latched Output (Q)
Logics.LE13.Out inverted	Signal: Negated Latched Output (Q NOT)
Logics.LE14.Gate Out	Signal: Output of the logic gate
Logics.LE14.Timer Out	Signal: Timer Output
Logics.LE14.Out	Signal: Latched Output (Q)

<i>Name</i>	<i>Description</i>
Logics.LE14.Out inverted	Signal: Negated Latched Output (Q NOT)
Logics.LE15.Gate Out	Signal: Output of the logic gate
Logics.LE15.Timer Out	Signal: Timer Output
Logics.LE15.Out	Signal: Latched Output (Q)
Logics.LE15.Out inverted	Signal: Negated Latched Output (Q NOT)
Logics.LE16.Gate Out	Signal: Output of the logic gate
Logics.LE16.Timer Out	Signal: Timer Output
Logics.LE16.Out	Signal: Latched Output (Q)
Logics.LE16.Out inverted	Signal: Negated Latched Output (Q NOT)
Logics.LE17.Gate Out	Signal: Output of the logic gate
Logics.LE17.Timer Out	Signal: Timer Output
Logics.LE17.Out	Signal: Latched Output (Q)
Logics.LE17.Out inverted	Signal: Negated Latched Output (Q NOT)
Logics.LE18.Gate Out	Signal: Output of the logic gate
Logics.LE18.Timer Out	Signal: Timer Output
Logics.LE18.Out	Signal: Latched Output (Q)
Logics.LE18.Out inverted	Signal: Negated Latched Output (Q NOT)
Logics.LE19.Gate Out	Signal: Output of the logic gate
Logics.LE19.Timer Out	Signal: Timer Output
Logics.LE19.Out	Signal: Latched Output (Q)
Logics.LE19.Out inverted	Signal: Negated Latched Output (Q NOT)
Logics.LE20.Gate Out	Signal: Output of the logic gate
Logics.LE20.Timer Out	Signal: Timer Output
Logics.LE20.Out	Signal: Latched Output (Q)
Logics.LE20.Out inverted	Signal: Negated Latched Output (Q NOT)
Logics.LE21.Gate Out	Signal: Output of the logic gate
Logics.LE21.Timer Out	Signal: Timer Output
Logics.LE21.Out	Signal: Latched Output (Q)
Logics.LE21.Out inverted	Signal: Negated Latched Output (Q NOT)
Logics.LE22.Gate Out	Signal: Output of the logic gate
Logics.LE22.Timer Out	Signal: Timer Output
Logics.LE22.Out	Signal: Latched Output (Q)
Logics.LE22.Out inverted	Signal: Negated Latched Output (Q NOT)
Logics.LE23.Gate Out	Signal: Output of the logic gate
Logics.LE23.Timer Out	Signal: Timer Output
Logics.LE23.Out	Signal: Latched Output (Q)
Logics.LE23.Out inverted	Signal: Negated Latched Output (Q NOT)
Logics.LE24.Gate Out	Signal: Output of the logic gate
Logics.LE24.Timer Out	Signal: Timer Output
Logics.LE24.Out	Signal: Latched Output (Q)

<i>Name</i>	<i>Description</i>
Logics.LE24.Out inverted	Signal: Negated Latched Output (Q NOT)
Logics.LE25.Gate Out	Signal: Output of the logic gate
Logics.LE25.Timer Out	Signal: Timer Output
Logics.LE25.Out	Signal: Latched Output (Q)
Logics.LE25.Out inverted	Signal: Negated Latched Output (Q NOT)
Logics.LE26.Gate Out	Signal: Output of the logic gate
Logics.LE26.Timer Out	Signal: Timer Output
Logics.LE26.Out	Signal: Latched Output (Q)
Logics.LE26.Out inverted	Signal: Negated Latched Output (Q NOT)
Logics.LE27.Gate Out	Signal: Output of the logic gate
Logics.LE27.Timer Out	Signal: Timer Output
Logics.LE27.Out	Signal: Latched Output (Q)
Logics.LE27.Out inverted	Signal: Negated Latched Output (Q NOT)
Logics.LE28.Gate Out	Signal: Output of the logic gate
Logics.LE28.Timer Out	Signal: Timer Output
Logics.LE28.Out	Signal: Latched Output (Q)
Logics.LE28.Out inverted	Signal: Negated Latched Output (Q NOT)
Logics.LE29.Gate Out	Signal: Output of the logic gate
Logics.LE29.Timer Out	Signal: Timer Output
Logics.LE29.Out	Signal: Latched Output (Q)
Logics.LE29.Out inverted	Signal: Negated Latched Output (Q NOT)
Logics.LE30.Gate Out	Signal: Output of the logic gate
Logics.LE30.Timer Out	Signal: Timer Output
Logics.LE30.Out	Signal: Latched Output (Q)
Logics.LE30.Out inverted	Signal: Negated Latched Output (Q NOT)
Logics.LE31.Gate Out	Signal: Output of the logic gate
Logics.LE31.Timer Out	Signal: Timer Output
Logics.LE31.Out	Signal: Latched Output (Q)
Logics.LE31.Out inverted	Signal: Negated Latched Output (Q NOT)
Logics.LE32.Gate Out	Signal: Output of the logic gate
Logics.LE32.Timer Out	Signal: Timer Output
Logics.LE32.Out	Signal: Latched Output (Q)
Logics.LE32.Out inverted	Signal: Negated Latched Output (Q NOT)
Logics.LE33.Gate Out	Signal: Output of the logic gate
Logics.LE33.Timer Out	Signal: Timer Output
Logics.LE33.Out	Signal: Latched Output (Q)
Logics.LE33.Out inverted	Signal: Negated Latched Output (Q NOT)
Logics.LE34.Gate Out	Signal: Output of the logic gate
Logics.LE34.Timer Out	Signal: Timer Output
Logics.LE34.Out	Signal: Latched Output (Q)

<i>Name</i>	<i>Description</i>
Logics.LE34.Out inverted	Signal: Negated Latched Output (Q NOT)
Logics.LE35.Gate Out	Signal: Output of the logic gate
Logics.LE35.Timer Out	Signal: Timer Output
Logics.LE35.Out	Signal: Latched Output (Q)
Logics.LE35.Out inverted	Signal: Negated Latched Output (Q NOT)
Logics.LE36.Gate Out	Signal: Output of the logic gate
Logics.LE36.Timer Out	Signal: Timer Output
Logics.LE36.Out	Signal: Latched Output (Q)
Logics.LE36.Out inverted	Signal: Negated Latched Output (Q NOT)
Logics.LE37.Gate Out	Signal: Output of the logic gate
Logics.LE37.Timer Out	Signal: Timer Output
Logics.LE37.Out	Signal: Latched Output (Q)
Logics.LE37.Out inverted	Signal: Negated Latched Output (Q NOT)
Logics.LE38.Gate Out	Signal: Output of the logic gate
Logics.LE38.Timer Out	Signal: Timer Output
Logics.LE38.Out	Signal: Latched Output (Q)
Logics.LE38.Out inverted	Signal: Negated Latched Output (Q NOT)
Logics.LE39.Gate Out	Signal: Output of the logic gate
Logics.LE39.Timer Out	Signal: Timer Output
Logics.LE39.Out	Signal: Latched Output (Q)
Logics.LE39.Out inverted	Signal: Negated Latched Output (Q NOT)
Logics.LE40.Gate Out	Signal: Output of the logic gate
Logics.LE40.Timer Out	Signal: Timer Output
Logics.LE40.Out	Signal: Latched Output (Q)
Logics.LE40.Out inverted	Signal: Negated Latched Output (Q NOT)
Logics.LE41.Gate Out	Signal: Output of the logic gate
Logics.LE41.Timer Out	Signal: Timer Output
Logics.LE41.Out	Signal: Latched Output (Q)
Logics.LE41.Out inverted	Signal: Negated Latched Output (Q NOT)
Logics.LE42.Gate Out	Signal: Output of the logic gate
Logics.LE42.Timer Out	Signal: Timer Output
Logics.LE42.Out	Signal: Latched Output (Q)
Logics.LE42.Out inverted	Signal: Negated Latched Output (Q NOT)
Logics.LE43.Gate Out	Signal: Output of the logic gate
Logics.LE43.Timer Out	Signal: Timer Output
Logics.LE43.Out	Signal: Latched Output (Q)
Logics.LE43.Out inverted	Signal: Negated Latched Output (Q NOT)
Logics.LE44.Gate Out	Signal: Output of the logic gate
Logics.LE44.Timer Out	Signal: Timer Output
Logics.LE44.Out	Signal: Latched Output (Q)

<i>Name</i>	<i>Description</i>
Logics.LE44.Out inverted	Signal: Negated Latched Output (Q NOT)
Logics.LE45.Gate Out	Signal: Output of the logic gate
Logics.LE45.Timer Out	Signal: Timer Output
Logics.LE45.Out	Signal: Latched Output (Q)
Logics.LE45.Out inverted	Signal: Negated Latched Output (Q NOT)
Logics.LE46.Gate Out	Signal: Output of the logic gate
Logics.LE46.Timer Out	Signal: Timer Output
Logics.LE46.Out	Signal: Latched Output (Q)
Logics.LE46.Out inverted	Signal: Negated Latched Output (Q NOT)
Logics.LE47.Gate Out	Signal: Output of the logic gate
Logics.LE47.Timer Out	Signal: Timer Output
Logics.LE47.Out	Signal: Latched Output (Q)
Logics.LE47.Out inverted	Signal: Negated Latched Output (Q NOT)
Logics.LE48.Gate Out	Signal: Output of the logic gate
Logics.LE48.Timer Out	Signal: Timer Output
Logics.LE48.Out	Signal: Latched Output (Q)
Logics.LE48.Out inverted	Signal: Negated Latched Output (Q NOT)
Logics.LE49.Gate Out	Signal: Output of the logic gate
Logics.LE49.Timer Out	Signal: Timer Output
Logics.LE49.Out	Signal: Latched Output (Q)
Logics.LE49.Out inverted	Signal: Negated Latched Output (Q NOT)
Logics.LE50.Gate Out	Signal: Output of the logic gate
Logics.LE50.Timer Out	Signal: Timer Output
Logics.LE50.Out	Signal: Latched Output (Q)
Logics.LE50.Out inverted	Signal: Negated Latched Output (Q NOT)
Logics.LE51.Gate Out	Signal: Output of the logic gate
Logics.LE51.Timer Out	Signal: Timer Output
Logics.LE51.Out	Signal: Latched Output (Q)
Logics.LE51.Out inverted	Signal: Negated Latched Output (Q NOT)
Logics.LE52.Gate Out	Signal: Output of the logic gate
Logics.LE52.Timer Out	Signal: Timer Output
Logics.LE52.Out	Signal: Latched Output (Q)
Logics.LE52.Out inverted	Signal: Negated Latched Output (Q NOT)
Logics.LE53.Gate Out	Signal: Output of the logic gate
Logics.LE53.Timer Out	Signal: Timer Output
Logics.LE53.Out	Signal: Latched Output (Q)
Logics.LE53.Out inverted	Signal: Negated Latched Output (Q NOT)
Logics.LE54.Gate Out	Signal: Output of the logic gate
Logics.LE54.Timer Out	Signal: Timer Output
Logics.LE54.Out	Signal: Latched Output (Q)

<i>Name</i>	<i>Description</i>
Logics.LE54.Out inverted	Signal: Negated Latched Output (Q NOT)
Logics.LE55.Gate Out	Signal: Output of the logic gate
Logics.LE55.Timer Out	Signal: Timer Output
Logics.LE55.Out	Signal: Latched Output (Q)
Logics.LE55.Out inverted	Signal: Negated Latched Output (Q NOT)
Logics.LE56.Gate Out	Signal: Output of the logic gate
Logics.LE56.Timer Out	Signal: Timer Output
Logics.LE56.Out	Signal: Latched Output (Q)
Logics.LE56.Out inverted	Signal: Negated Latched Output (Q NOT)
Logics.LE57.Gate Out	Signal: Output of the logic gate
Logics.LE57.Timer Out	Signal: Timer Output
Logics.LE57.Out	Signal: Latched Output (Q)
Logics.LE57.Out inverted	Signal: Negated Latched Output (Q NOT)
Logics.LE58.Gate Out	Signal: Output of the logic gate
Logics.LE58.Timer Out	Signal: Timer Output
Logics.LE58.Out	Signal: Latched Output (Q)
Logics.LE58.Out inverted	Signal: Negated Latched Output (Q NOT)
Logics.LE59.Gate Out	Signal: Output of the logic gate
Logics.LE59.Timer Out	Signal: Timer Output
Logics.LE59.Out	Signal: Latched Output (Q)
Logics.LE59.Out inverted	Signal: Negated Latched Output (Q NOT)
Logics.LE60.Gate Out	Signal: Output of the logic gate
Logics.LE60.Timer Out	Signal: Timer Output
Logics.LE60.Out	Signal: Latched Output (Q)
Logics.LE60.Out inverted	Signal: Negated Latched Output (Q NOT)
Logics.LE61.Gate Out	Signal: Output of the logic gate
Logics.LE61.Timer Out	Signal: Timer Output
Logics.LE61.Out	Signal: Latched Output (Q)
Logics.LE61.Out inverted	Signal: Negated Latched Output (Q NOT)
Logics.LE62.Gate Out	Signal: Output of the logic gate
Logics.LE62.Timer Out	Signal: Timer Output
Logics.LE62.Out	Signal: Latched Output (Q)
Logics.LE62.Out inverted	Signal: Negated Latched Output (Q NOT)
Logics.LE63.Gate Out	Signal: Output of the logic gate
Logics.LE63.Timer Out	Signal: Timer Output
Logics.LE63.Out	Signal: Latched Output (Q)
Logics.LE63.Out inverted	Signal: Negated Latched Output (Q NOT)
Logics.LE64.Gate Out	Signal: Output of the logic gate
Logics.LE64.Timer Out	Signal: Timer Output
Logics.LE64.Out	Signal: Latched Output (Q)

<i>Name</i>	<i>Description</i>
Logics.LE64.Out inverted	Signal: Negated Latched Output (Q NOT)
Logics.LE65.Gate Out	Signal: Output of the logic gate
Logics.LE65.Timer Out	Signal: Timer Output
Logics.LE65.Out	Signal: Latched Output (Q)
Logics.LE65.Out inverted	Signal: Negated Latched Output (Q NOT)
Logics.LE66.Gate Out	Signal: Output of the logic gate
Logics.LE66.Timer Out	Signal: Timer Output
Logics.LE66.Out	Signal: Latched Output (Q)
Logics.LE66.Out inverted	Signal: Negated Latched Output (Q NOT)
Logics.LE67.Gate Out	Signal: Output of the logic gate
Logics.LE67.Timer Out	Signal: Timer Output
Logics.LE67.Out	Signal: Latched Output (Q)
Logics.LE67.Out inverted	Signal: Negated Latched Output (Q NOT)
Logics.LE68.Gate Out	Signal: Output of the logic gate
Logics.LE68.Timer Out	Signal: Timer Output
Logics.LE68.Out	Signal: Latched Output (Q)
Logics.LE68.Out inverted	Signal: Negated Latched Output (Q NOT)
Logics.LE69.Gate Out	Signal: Output of the logic gate
Logics.LE69.Timer Out	Signal: Timer Output
Logics.LE69.Out	Signal: Latched Output (Q)
Logics.LE69.Out inverted	Signal: Negated Latched Output (Q NOT)
Logics.LE70.Gate Out	Signal: Output of the logic gate
Logics.LE70.Timer Out	Signal: Timer Output
Logics.LE70.Out	Signal: Latched Output (Q)
Logics.LE70.Out inverted	Signal: Negated Latched Output (Q NOT)
Logics.LE71.Gate Out	Signal: Output of the logic gate
Logics.LE71.Timer Out	Signal: Timer Output
Logics.LE71.Out	Signal: Latched Output (Q)
Logics.LE71.Out inverted	Signal: Negated Latched Output (Q NOT)
Logics.LE72.Gate Out	Signal: Output of the logic gate
Logics.LE72.Timer Out	Signal: Timer Output
Logics.LE72.Out	Signal: Latched Output (Q)
Logics.LE72.Out inverted	Signal: Negated Latched Output (Q NOT)
Logics.LE73.Gate Out	Signal: Output of the logic gate
Logics.LE73.Timer Out	Signal: Timer Output
Logics.LE73.Out	Signal: Latched Output (Q)
Logics.LE73.Out inverted	Signal: Negated Latched Output (Q NOT)
Logics.LE74.Gate Out	Signal: Output of the logic gate
Logics.LE74.Timer Out	Signal: Timer Output
Logics.LE74.Out	Signal: Latched Output (Q)

<i>Name</i>	<i>Description</i>
Logics.LE74.Out inverted	Signal: Negated Latched Output (Q NOT)
Logics.LE75.Gate Out	Signal: Output of the logic gate
Logics.LE75.Timer Out	Signal: Timer Output
Logics.LE75.Out	Signal: Latched Output (Q)
Logics.LE75.Out inverted	Signal: Negated Latched Output (Q NOT)
Logics.LE76.Gate Out	Signal: Output of the logic gate
Logics.LE76.Timer Out	Signal: Timer Output
Logics.LE76.Out	Signal: Latched Output (Q)
Logics.LE76.Out inverted	Signal: Negated Latched Output (Q NOT)
Logics.LE77.Gate Out	Signal: Output of the logic gate
Logics.LE77.Timer Out	Signal: Timer Output
Logics.LE77.Out	Signal: Latched Output (Q)
Logics.LE77.Out inverted	Signal: Negated Latched Output (Q NOT)
Logics.LE78.Gate Out	Signal: Output of the logic gate
Logics.LE78.Timer Out	Signal: Timer Output
Logics.LE78.Out	Signal: Latched Output (Q)
Logics.LE78.Out inverted	Signal: Negated Latched Output (Q NOT)
Logics.LE79.Gate Out	Signal: Output of the logic gate
Logics.LE79.Timer Out	Signal: Timer Output
Logics.LE79.Out	Signal: Latched Output (Q)
Logics.LE79.Out inverted	Signal: Negated Latched Output (Q NOT)
Logics.LE80.Gate Out	Signal: Output of the logic gate
Logics.LE80.Timer Out	Signal: Timer Output
Logics.LE80.Out	Signal: Latched Output (Q)
Logics.LE80.Out inverted	Signal: Negated Latched Output (Q NOT)

Q->&V< Reactive-Power/Undervoltage Protection

Available Elements:

Q->&V<

The number of distributed energy resources (DER) raises continuously. At the same time the controllable power reserve through large-scale power plants decreases.

Therefore various grid codes requirements and regulations stipulate that mains parallel distributed power plants, consisting of one or more power generation units feeding power into the MV grid, have to support the mains voltage in case of failures.

In case of failure the voltage close to the short circuit location drops nearly to zero. Around the fault location a potential gradient area is built whose expansion can be restricted by feeding reactive-power into the grid. At mains failures (voltage drop) the Q->V< protection prevents the expansion of the potential gradient area for the case that any further reactive-power is taken from the mains.

The function of this protection module is not the protection of the power generation system itself, but more the decoupling of the power generation system when it takes reactive current from the mains in case the voltage drops below a certain value. This protection is an upstream system protection.

The Q->V< protection module is implemented as an autonomous protection element according to the German regulations ¹ and ² mentioned below (for reconnection see separate element).

The comprehensive setting and configuration possibilities of this protection element allow the adaptation of connected energy resources to various grid conditions.

For the correct function of this protection module you have to

- Configure the »General Settings«,
- Select and set the decoupling method.
- Configure the reconnection of the power generation units (see chapter Reconnection).

General Settings

For each parameter set [Protection Para\Set [x]\Q->&U<] the general settings »General Settings« can be configured.

Here the entire function of this protection element can be activated or deactivated.

By activating the voltage transformer supervision a malfunction of this protection module can be prevented.

¹ Technische Anschlussregeln für die Hochspannung (VDE-AR-N 4120)

² Technische Richtlinie „Erzeugungsanlagen am Mittelspannungsnetz“, Richtlinie für Anschluss und Parallelbetrieb von Erzeugungsanlagen am Mittelspannungsnetz, Ausgabe Juni 2008, BDEW Bundesverband der Energie- und Wasserwirtschaft e.V., siehe Kap. 3.2.3.2 – Blindleistungs-Unterspannungsschutz Q->&U<

QV Protection Trip Direction

Definitons

- Load Flow Arrow System = Consumed active and reactive are counted positive (greater than zero)
- Generator Flow Arrow System = produced power is to be counted positive (greater than zero)

By means of the parameter power trip dir positive/negative a sign reversal can be applied to the reactive power within the QV-Protection module. Protective devices that use the load flow arrow (like the MCA4 or the MRA4) are to be set to »*Power Trip dir= positive*«. Protective devices that are working on the base of the generator flow arrow system (like the MCDGV4) are to be set to »*Power Trip dir= negative*«. By means of that generator protection relays like the MCDGV4 can be set to the load flow arrow system internal within the QV-Protection (only). That means that outside of the QV-Protection no other power measurement or power protection is effected.

Trip Direction of the QV-Protection

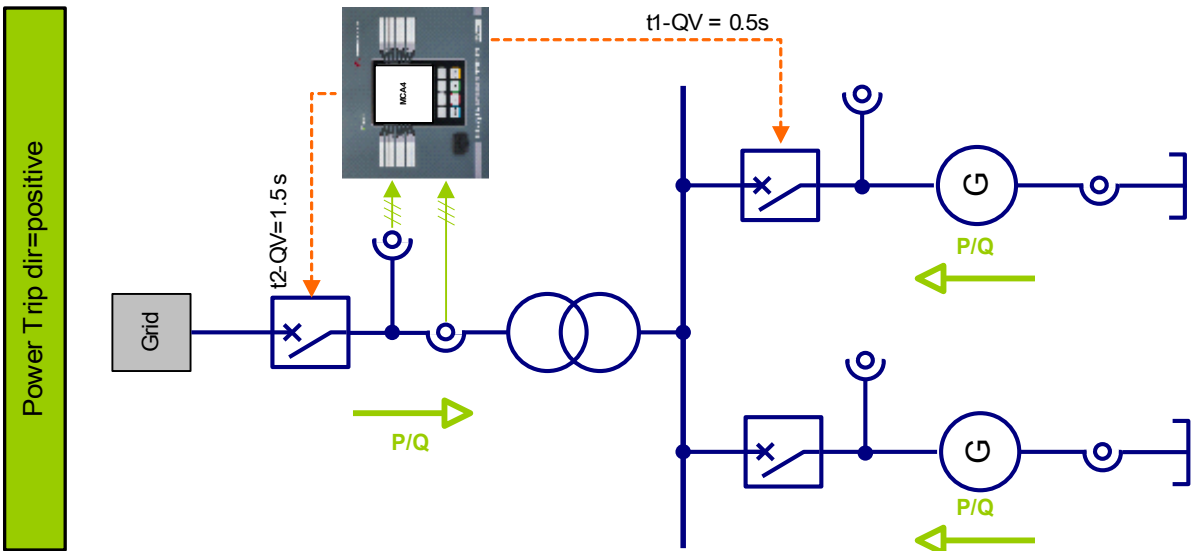
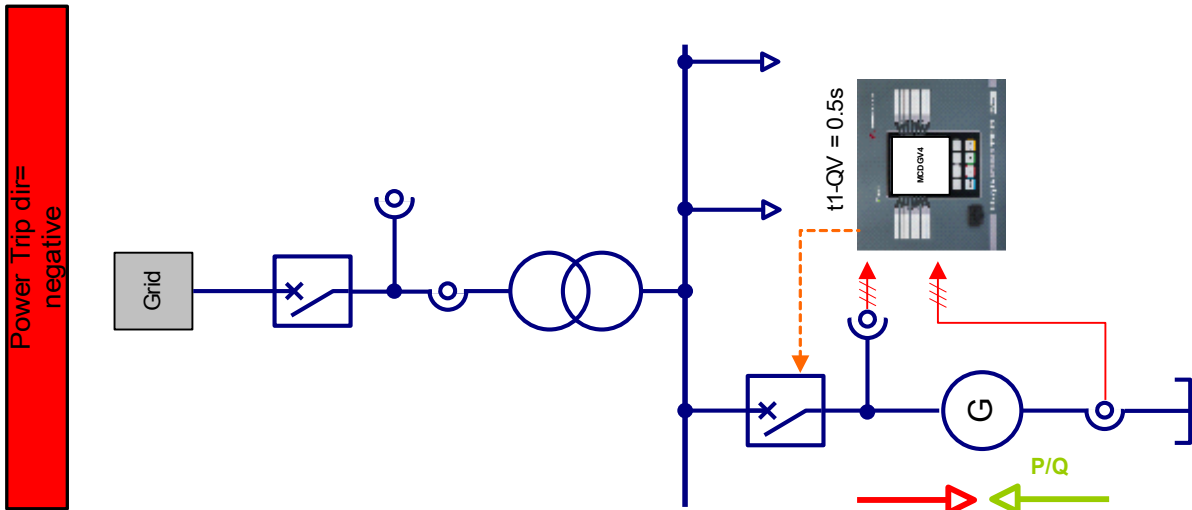

Parameter Setting of Decoupling

To support dynamical the decreasing voltage (voltage drop) during faults the grid codes of the transmission system owners (e.g. VDE AR 4120 page 57) require the following behavior during grid problems (voltage sags) by the connected energy resources:

The QV-Protection supervises the grid compliant behavior after a grid fault. Energy sources that have a negative impact on the restoration by consuming inductive reactive power have to be disconnected from the grid before timers of grid protection devices expire.

Therefore the energy source will be disconnected from the grid after 0.5 seconds by the QV-protection if all three line-to-line voltages at the point of common coupling are less than 0.85 times V_n (logical AND connected) and if the energy resource consumes at the same time inductive reactive power from the grid (VDE AR 4120 page 57).

NOTICE

The reactive-power of the positive phase sequence system (Q1) is evaluated.

The voltage supervision only monitors the phase to phase voltages.
This prevents any influence on the measurement through neutral point displacement in resonant earthed systems.

In the menu [Protection Para\Set[x]\Q->&U<] the »Decoupling« parameters can be set.

The reactive-power demand from the grid can be detected by two different methods. Therefor the decoupling method »*QV-Method*« has to be selected first.

- Power Angle Supervision (method 1)
- Pure Reactive Power Supervision (method 2)

Method 1: Power Angle Supervision

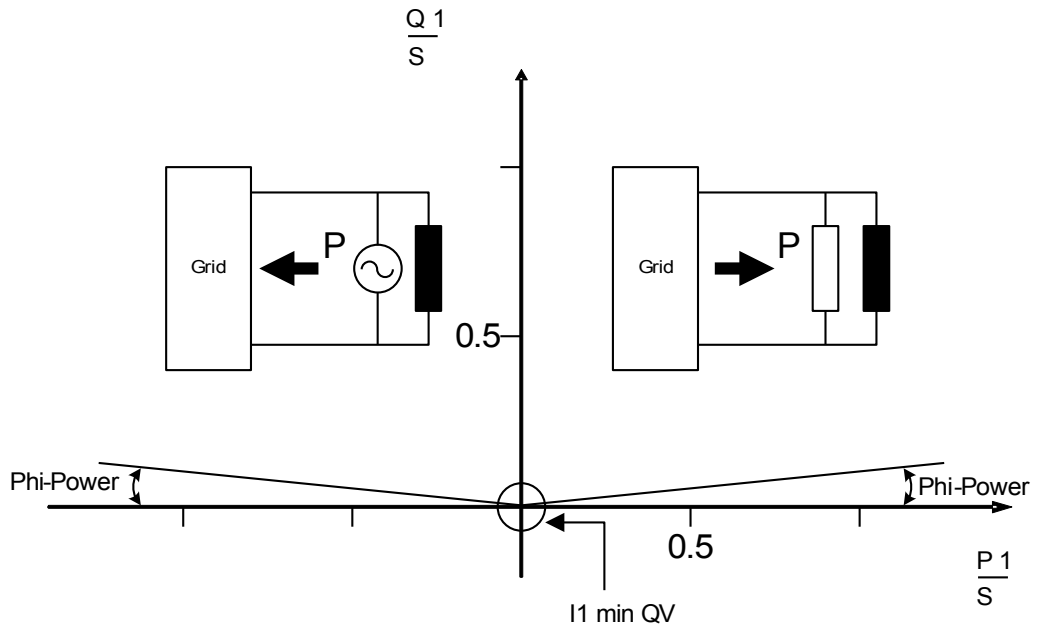

Method 2: Pure Reactive Power Supervision

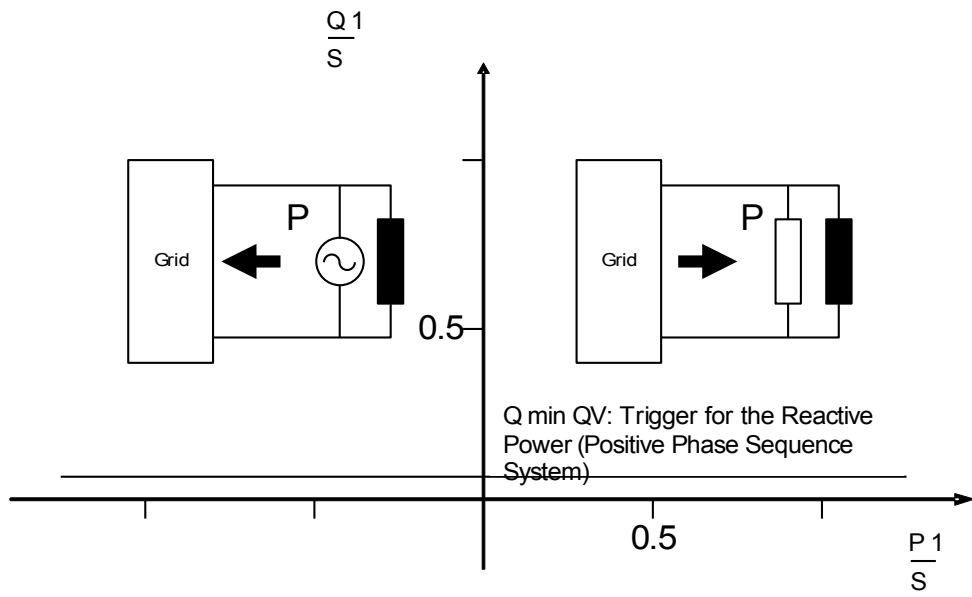

A minimum current supervision (I1) in the positive phase sequence system prevents a hyperfunction of the reactive-power supervision at lower power levels.

For the power angle supervision, the minimum current supervision is always active. For the pure reactive-power supervision the minimum current supervision is optional.

When using the power angle supervision (method 1):

- Set the power angle »Phi-Power« (Default setting 3°).
- Select a suitable minimum current »I min QV« (Default setting 0.1 In) which prevents false tripping.

When using the pure reactive power supervision (method 2):

- Set the reactive-power threshold »Q min QV«(Default setting 0.05 Sn).
- Optionally select a suitable minimum current »I min QV« (Default setting 0.1 In) to prevent false tripping.

Two timer elements are available »t1-QV« and »t2-QV«. Both timer elements will be started at pick-up of the Q->U< module.

First timer element (Decoupling of the power generation unit)

When several mains parallel power generation units feed one PCC, the first timer element can give a trip command to the generator circuit breaker of the power generation unit (Default setting 0.5 s)

Second timer element (Decoupling at the PCC)

For the case, that tripping of the first timer element (decoupling of a certain power generation unit) does not have the expected effect the second timer element can give a trip command to the circuit breaker at the PCC (Default setting 1.5 s). This decouples the entire DER from the grid.

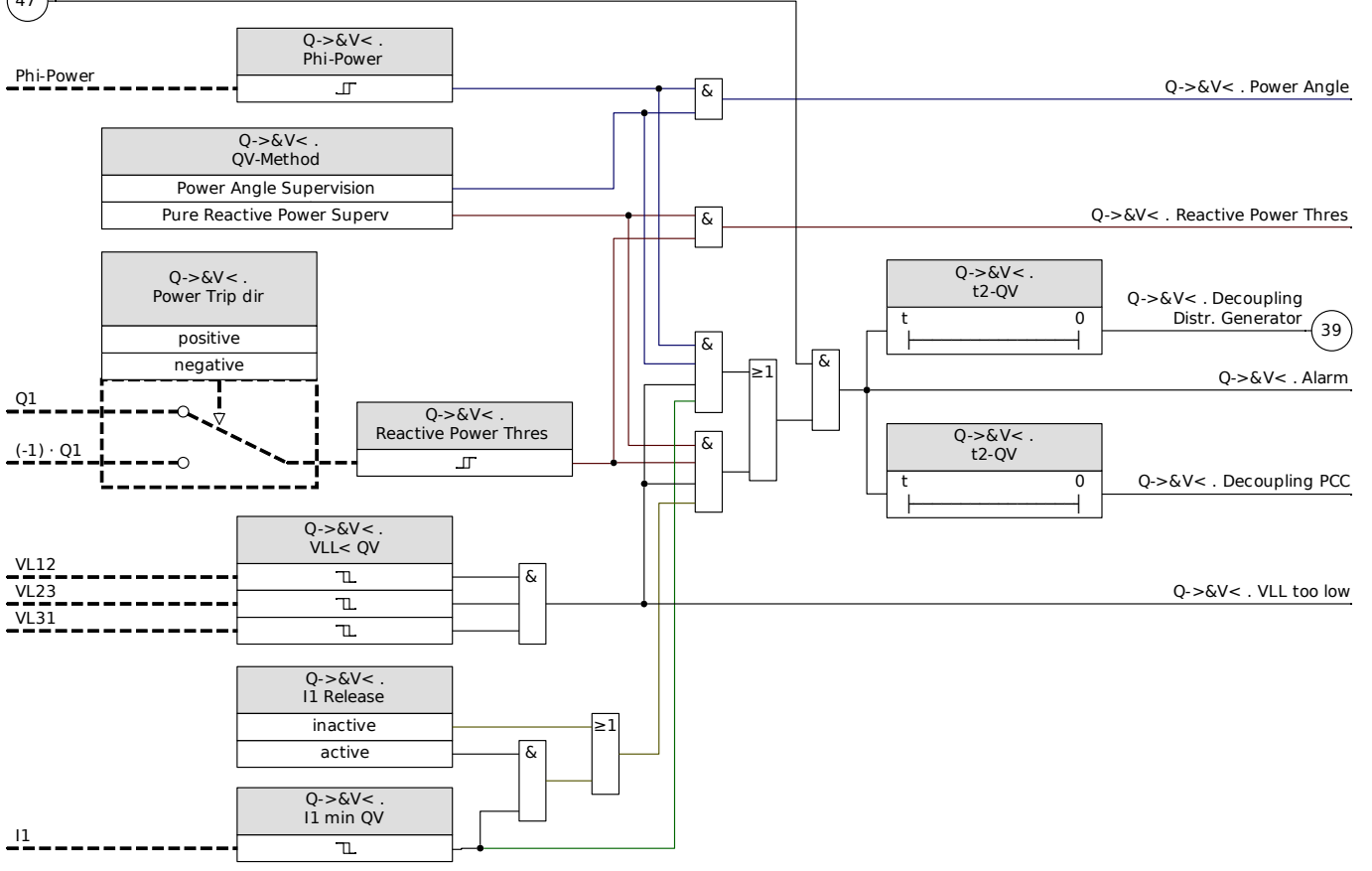

47 (Please Refer To Diagram : QU_Y01, "Blockings Q->&V<")



Device Planning Parameters of the Q->&V< Module





Parameter	Description	Options	Default	Menu path
Mode 	Mode	do not use, use	do not use	[Device planning]





Global Protection Parameters of the Q->&V< Module

Parameter	Description	Setting range	Default	Menu path
ExBlo1 	External blocking of the module, if blocking is activated (allowed) within a parameter set and if the state of the assigned signal is true.	1..n, Assignment List	-.-	[Protection Para /Global Prot Para /Intercon-Prot /Q->&V<]
ExBlo2 	External blocking of the module, if blocking is activated (allowed) within a parameter set and if the state of the assigned signal is true.	1..n, Assignment List	-.-	[Protection Para /Global Prot Para /Intercon-Prot /Q->&V<]
Power Trip dir 	By means of this parameter the trip direction of active and reactive power can be inverted within the QV-Module (sign reversal).	positive, negative	negative	[Protection Para /Global Prot Para /Intercon-Prot /Q->&V<]

Setting Group Parameters of the Q->&V< Module

Parameter	Description	Setting range	Default	Menu path
Function 	Permanent activation or deactivation of module/stage.	inactive, active	inactive	[Protection Para /<1..4> /Intercon-Prot /Q->&V< /General Settings]

Parameter	Description	Setting range	Default	Menu path
 ExBlo Fc	Activate (allow) or inactivate (disallow) blocking of the module/stage. This parameter is only effective if a signal is assigned to the corresponding global protection parameter. If the signal becomes true, those modules/stages are blocked that are parameterized "ExBlo Fc=active".	inactive, active	inactive	[Protection Para /<1..4> /Intercon-Prot /Q->&V< /General Settings]
 Meas Circuit Superv	Activates the use of the measuring circuit supervision. In this case the module will be blocked if a measuring circuit supervision module (e.g. LOP, VTS) signals a disturbed measuring circuit (e.g. caused by a fuse failure).	inactive, active	inactive	[Protection Para /<1..4> /Intercon-Prot /Q->&V< /General Settings]
 QV-Method	Selection of the Q(V)-Method: Power Angle or Reactive Power Threshold	Power Angle Supervision, Pure Reactive Power Superv	Power Angle Supervision	[Protection Para /<1..4> /Intercon-Prot /Q->&V< /Decoupling]
 I1 Release	Activation of the "I1 Minimum Current"-Criterion. Only available if: QV-Method = Power Angle Supervision	inactive, active	active	[Protection Para /<1..4> /Intercon-Prot /Q->&V< /Decoupling]
 I1 min QV	Activation of an "I1 Minimum Current" of the rated current of the (distributed) energy resource can prevent faulty tripping. Only available if:Activation of the "I1 Minimum Current"-Criterion. = active	0.01 - 0.20In	0.10In	[Protection Para /<1..4> /Intercon-Prot /Q->&V< /Decoupling]
 VLL< QV	Undervoltage threshold (line-to-line voltage!)	0.70 - 1.00Vn	0.85Vn	[Protection Para /<1..4> /Intercon-Prot /Q->&V< /Decoupling]

Parameter	Description	Setting range	Default	Menu path
 Phi-Power Trigger Phi-Power (Positive Phase Sequence System) Only available if: QV-Method = Power Angle Supervision	0 - 10°	3°	[Protection Para /<1..4> /Intercon-Prot /Q->&V< /Decoupling]	
 Q min QV Trigger for the Reactive Power (Positive Phase Sequence System) Only available if: QV-Method = Pure Reactive Power Superv	0.01 - 0.20Sn	0.05Sn	[Protection Para /<1..4> /Intercon-Prot /Q->&V< /Decoupling]	
 t1-QV First timer. If this timer has elapsed, a trip signal will be issued to the (local) energy resource.	0.00 - 2.00s	0.5s	[Protection Para /<1..4> /Intercon-Prot /Q->&V< /Decoupling]	
 t2-QV Second timer. If this timer is elapsed, the an trip signal will be issued to the PCC (Point of Common Coupling)	0.00 - 4.00s	1.5s	[Protection Para /<1..4> /Intercon-Prot /Q->&V< /Decoupling]	

Input States of the Q->&V< Module

Name	Description	Assignment via
ExBlo1-I	Module input state: External blocking1	[Protection Para /Global Prot Para /Intercon-Prot /Q->&V<]
ExBlo2-I	Module input state: External blocking2	[Protection Para /Global Prot Para /Intercon-Prot /Q->&V<]

Q->&V< Module Signals (Output States)

Signal	Description
active	Signal: active

Protective Elements

<i>Signal</i>	<i>Description</i>
ExBlo	Signal: External Blocking
Fuse Fail VT Blo	Signal: Blocked by Fuse Failure (VT)
Alarm	Signal: Alarm Reactive Power Undervoltage Protection
Decoupling Distr. Generator	Signal: Decoupling of the (local) Energy Generator/Resource
Decoupling PCC	Signal: Decoupling at the Point of Common Coupling
Power Angle	Signal: Admissible power angle exceeded
Reactive Power Thres	Signal: Admissible Reactive Power Threshold exceeded
VLL too low	Signal: Line-to-Line voltage too low

Reconnection Module

Available Elements:
[ReCon\[1\]](#), [ReCon\[2\]](#)

The reconnection function after a mains decoupling is based on the requirements of the VDE AR-N 4120¹ and the German directive „Erzeugungsanlagen am MS-Netz“².

To monitor the reconnection conditions after a mains decoupling, a reconnection function has been implemented in parallel to the decoupling functions.

Mains voltage (phase to phase) and frequency are the main criteria for reconnection. Always the mains side voltage (line to line) at the generator circuit breaker (mains side) has to be evaluated.

The reconnection function is only one of the system functions for mains decoupling and return synchronizing. The reconnection element is tied to decoupling functions like the $Q \rightarrow V$ element and other integrated decoupling functions like under-/overvoltage, under-/overfrequency. The reconnection can be triggered by up to 6 decoupling elements or via digital input signals, logic functions or via SCADA (communication system).

After a trip of the circuit breaker at the PCC by the decoupling function, reconnection has to be done manually.

⚠ WARNING **Danger of an asynchronous reconnection:**
The reconnection function does not substitute a synchronizing device.
Before connecting different electrical networks, synchronism has to be secured.

After decoupling by the $Q \rightarrow V$ module or other decoupling functions, like $V \rightarrow V$, $V \rightarrow f$, the reconnection release signal for reconnection the circuit breaker of the power generating unit will be blocked for a preset time interval (default setting 10 minutes). This is to wait until all switching operations are completed. The automatic reconnection must not be executed before mains voltage and frequency are inside the acceptable bands (quasi permanent) that means within the admissible limit values for a preset, settable time.

The purpose of the reconnection function is to reconnect a decoupled energy resource safe to the mains/grid.

Release logic for the Generator Circuit Breaker

If the PCC circuit breaker has tripped the reconnection has to be done manually. A special blocking logic is not necessary.

NOTICE **If a power generating unit should be reconnected by the generator circuit breaker the voltage transformers have to be installed at the mains side of the circuit breaker.**

1 „Technische Anschlussregeln für die Hochspannung“ (VDE-AR-N 4120)

2 Technische Richtlinie „Erzeugungsanlagen am Mittelspannungsnetz“, Richtlinie für Anschluss und Parallelbetrieb von Erzeugungsanlagen am Mittelspannungsnetz, Ausgabe Juni 2008, BDEW Bundesverband der Energie- und Wasserwirtschaft e.V., → see „3.2.3.2 – Blindleistungs-Unterspannungsschutz $Q \rightarrow U$ “ therein.

After the decoupling functions have tripped so that the generator circuit breaker has been opened, some conditions must be fulfilled by the network operator before the reconnection of the power generating unit may be performed. These release conditions involve making sure that the mains voltages are within their valid value and frequency ranges. Such a test can (or must) be performed via direct measurement of the mains side voltages or/and an remote control release signal "External Release from PCC".

Since the various network operators may require their individual release conditions for a (re-)connection to their medium or high voltage networks there is a choice between three different release conditions:

1. » *V Internal Release* (Release after a test based on direct measurement of the mains voltages)
2. » *V Ext Release PCC*« (Release based on an external release signal from the PCC)
3. » *Both*« (Release if 1. and 2. are both fulfilled)

Voltage release by (self-) measured voltage values

NOTICE

This method can be used if the PCC is on the MV side.

If the PCC is on the MV side, the device can measure the phase to phase voltages on the mains side and decide if the mains voltage has stabilized sufficiently for reconnection.

For this method the parameter » *V Ext Release PCC Fk*« in the menu [Protection Para\Set[x]\Intercon-Prot\ReCon\General settings] has to be set to » *inactive*«.

Additionally the parameter » *Reclosure. Release Cond*« in the menu [Protection Para\Set[x]\Intercon-Prot\ReCon\Reclosure Release] has to be set to » *V internal release* «

Voltage release via remote control connection from the PCC

NOTICE

The voltage has to be recovered at the PCC before the reconnection is done.

If the PCC is located in the HV level the distance to the PCC is in general large. The information that the voltage is restored is to be transmitted via a remote control signal to the distributed energy resource.

This method has to be used if the PCC is on the HV side.

This method can be used if the PCC is on the MV side.

If reconnection release based on the remote control signal from the PCC is required:

In the menu [Protection Para\Set[x]\Intercon-Prot\ReCon\General settings] the parameter » *V Ext Release PCC Fc*« has to be set to » *active*«. With this setting the voltage release signal from the PCC is used (e. g. signal via digital input).

Additionally the parameter » *Reclosure Release Cond*« in the menu [Protection Para\Set[x]\Intercon-Prot\ReCon\Release Para\Reconnect. Release Cond] has to be set to » *V Ext Release PCC*«.

Moreover, the remote control release signal has to be assigned to the parameter » *V Ext Release PCC*« in the menu [Protection Para\Global Prot Para\Intercon-Prot\ReCon\General settings].

Voltage release by (self-) measured voltage values AND via remote control connection from the PCC

NOTICE

This method can be used if the PCC is on the HV side.

If the PCC is on the HV side the VDE AR-N 4120 (01/2015) permits connecting the power generation unit only if **both** the remote control release signal is present **and** the mains voltage connected to the generation unit is healthy. Therefore the logical AND operation of the internal and external signals has been made available and can be selected in case of HV network applications.

In the menu [Protection Para\Set[x]\Intercon-Prot\ReCon\General settings] the parameter »*V Ext Release PCC Fc*« has to be set to »*active*«. With this setting the voltage release signal from the PCC is used (e. g. signal via digital input).

Additionally the parameter »*Reclosure Release Cond*« in the menu [Protection Para\Set[x]\Intercon-Prot\ReCon\Release Para\Reconnect. Release Cond] has to be set to »*Both*«.

Moreover the remote control release signal has to be assigned to the parameter »*V Ext Release PCC*« in the menu [Protection Para\Global Prot Para\Intercon-Prot\ReCon\General settings].

PCC in HV systems

According to VDE-AR-N 4120 a reconnection of a Distributed Energy Resource to the grid is not allowed before the following conditions are fulfilled: The frequency of the mains/grid has to be between 47.5 and 51.5 Hz and the voltage between 93.5 and 127 kV (100 kV level). Voltage and frequency have to be within their limits for minimum 5 minutes.

Reconnection Conditions:

Before reconnecting a power generation unit it has to be secured that mains voltage has been stabilized sufficiently. According to VDE AR-N 4120 a corresponding remote signal has to be available and also the voltage at the Distributed Energy Resource too.

Set the parameter *»Reclosure Release Cond«* in the menu [Protection Para\Set[x]\Intercon-Prot\ReCon\Release Para] to *»Both«*. The required parameter settings are described in the chapter *»General Settings«*.

Set the blocking signals in the menu [Protection Para\Set[x]\Intercon-Prot\ReCon] the trigger (decoupling) signals which start the mains recovery time (OR logic).

Select a sufficiently long recovery time *»t-Release Blo«* in the menu [Protection Para\Set[x]\Intercon-Prot\Reconnection\Release Para]. Reconnection is only possible after this timer has been elapsed. This timer will be started by the triggers that have to be set in: [Global Para\Intercon-Prot\Reconnection\Decoupling]. (If it happens that the voltage or frequency values are outside the permissible ranges before the timer elapses then the timer is automatically restarted.)

In the menu [Protection Para\Set[x]\Intercon-Prot\Reconnection\Release Para] the frequency and voltage range to be met for reconnection can be set.

Set the parameters for the release of the voltage for the reconnection as described in section "Voltage release by (self-) measured voltage values AND via remote control connection from the PCC".

If one-minute average voltages are required for release condition, the (self-) measured voltage can use the average voltages from the Statistics module:

Set the parameter *»Measuring method«* in the menu [Protection Para\Set[x]\Intercon-Prot\ReCon\Release Para] to *»Vavg«*. Set the parameters for the release of the voltage for the reconnection as described in section "Configuration of the Voltage Based Average Value Calculation".

PCC in MV systems

The German regulation „Erzeugungsanlagen am MS-Netz“ (BDEW, Issue June 2008 ^[2]) recommends to have a time delay (some minutes) between mains voltage recovery and reclosure after a trip of a decoupling system as a result of a mains failure. This is to wait until all switching operations are completed. Usually this is the case after 10 minutes. A reconnection of the DER is only permitted, when the mains voltage is >95% of V_n and the frequency is in the range of 47.5 Hz to 50.05 Hz.

Set the trigger (decoupling) signals in the menu
[Global Prot Para\Intercon-Prot\ReCon\Decoupling] which start the mains recovery time
(OR logic).

Select a sufficiently long recovery time »t1-Release Blo« in the menu
[Protection Para\Set[x]\Intercon-Prot\ReCon\Release Para]. Reconnection is only possible after this timer has elapsed. (This timer stage will be triggered by the signals that are assigned in menu [Global Para\Intercon-Prot\Reconnection\Decoupling]).

In the menu [Protection Para\Set[x]\Intercon-Prot\ReCon\Release Para] the frequency and voltage range to be met for reconnection can be set.

Set the parameters for the release of the voltage as described in the corresponding sections for the voltage release.



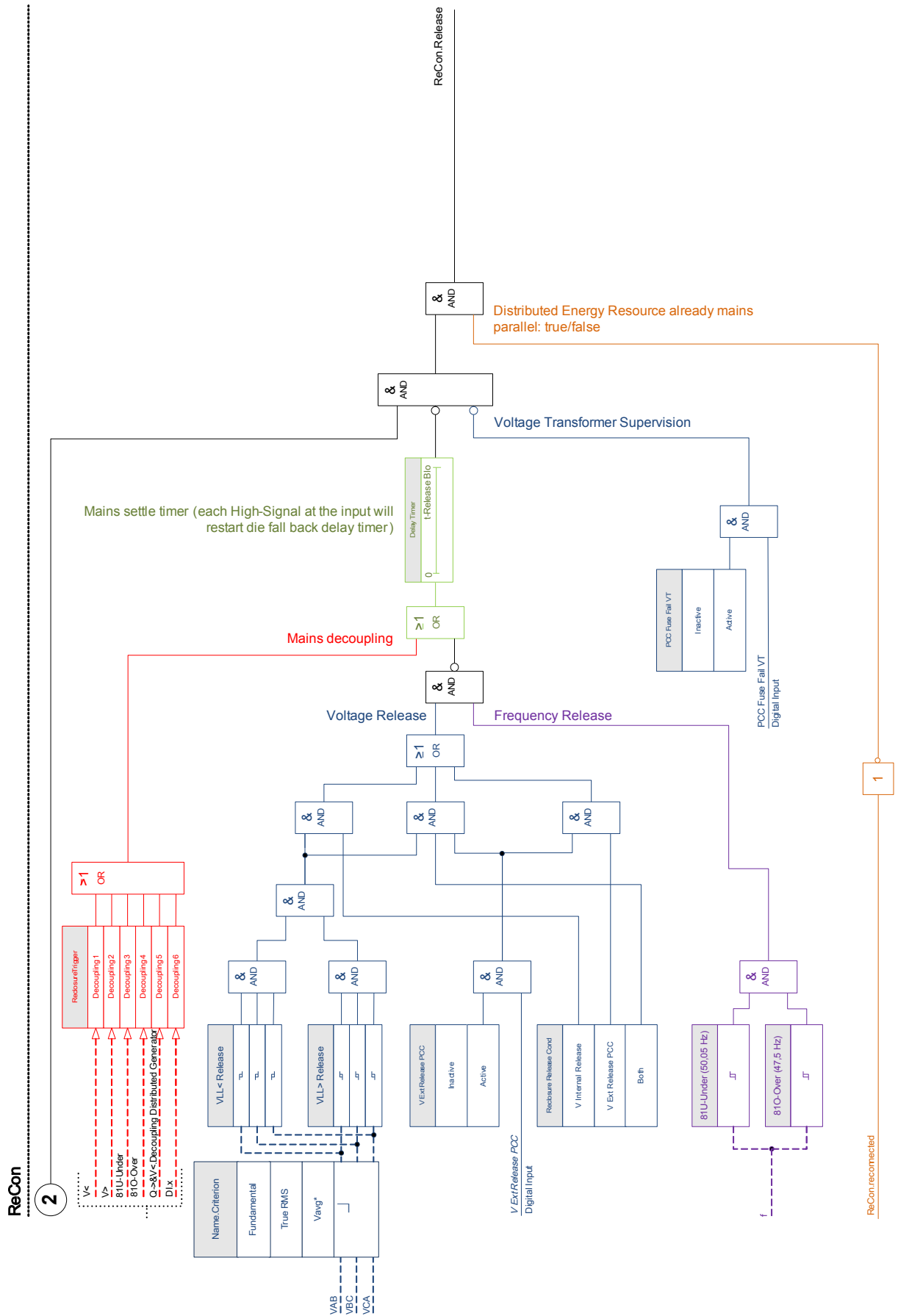

Release logic for the Generator Circuit Breaker



Device Planning Parameters of the Reconnection Module

Parameter	Description	Options	Default	Menu path
Mode 	Mode	do not use, use	do not use	[Device planning]

Global Protection Parameters of the Reconnection Module

Parameter	Description	Setting range	Default	Menu path
ExBlo1 	External blocking of the module, if blocking is activated (allowed) within a parameter set and if the state of the assigned signal is true.	1..n, Assignment List	-.-	[Protection Para /Global Prot Para /Intercon-Prot /ReCon[1] /General Settings]
ExBlo2 	External blocking of the module, if blocking is activated (allowed) within a parameter set and if the state of the assigned signal is true.	1..n, Assignment List	-.-	[Protection Para /Global Prot Para /Intercon-Prot /ReCon[1] /General Settings]
V Ext Release PCC 	Release Signal by the Point of Common Coupling. The line-to-line voltage is greater than 95% of VN.	1..n, Assignment List	-.-	[Protection Para /Global Prot Para /Intercon-Prot /ReCon[1] /General Settings]
PCC Fuse Fail VT 	Blocking if the fuse of a voltage transformer has tripped at the PCC.	1..n, Dig Inputs	-.-	[Protection Para /Global Prot Para /Intercon-Prot /ReCon[1] /General Settings]

<i>Parameter</i>	<i>Description</i>	<i>Setting range</i>	<i>Default</i>	<i>Menu path</i>
reconnected 	This signal indicates the state "reconnected" (mains parallel).	1..n, Assignment List	.-	[Protection Para /Global Prot Para /Intercon-Prot /ReCon[1] /General Settings]
Decoupling1 	Decoupling function, that blocks the reconnection.	Decoupling Functions	.-	[Protection Para /Global Prot Para /Intercon-Prot /ReCon[1] /Decoupling]
Decoupling2 	Decoupling function, that blocks the reconnection.	Decoupling Functions	.-	[Protection Para /Global Prot Para /Intercon-Prot /ReCon[1] /Decoupling]
Decoupling3 	Decoupling function, that blocks the reconnection.	Decoupling Functions	.-	[Protection Para /Global Prot Para /Intercon-Prot /ReCon[1] /Decoupling]
Decoupling4 	Decoupling function, that blocks the reconnection.	Decoupling Functions	.-	[Protection Para /Global Prot Para /Intercon-Prot /ReCon[1] /Decoupling]
Decoupling5 	Decoupling function, that blocks the reconnection.	Decoupling Functions	.-	[Protection Para /Global Prot Para /Intercon-Prot /ReCon[1] /Decoupling]

<i>Parameter</i>	<i>Description</i>	<i>Setting range</i>	<i>Default</i>	<i>Menu path</i>
Decoupling6 	Decoupling function, that blocks the reconnection.	Decoupling Functions	.-.	[Protection Para /Global Prot Para /Intercon-Prot /ReCon[1] /Decoupling]

Decoupling Functions of the Reconnection Module

<i>Name</i>	<i>Description</i>
.-.	No assignment
Id.TripCmd	Signal: Trip Command
IdH.TripCmd	Signal: Trip Command
IdG[1].TripCmd	Signal: Trip Command
IdGH[1].TripCmd	Signal: Trip Command
IdG[2].TripCmd	Signal: Trip Command
IdGH[2].TripCmd	Signal: Trip Command
I[1].TripCmd	Signal: Trip Command
I[2].TripCmd	Signal: Trip Command
I[3].TripCmd	Signal: Trip Command
I[4].TripCmd	Signal: Trip Command
I[5].TripCmd	Signal: Trip Command
I[6].TripCmd	Signal: Trip Command
IG[1].TripCmd	Signal: Trip Command
IG[2].TripCmd	Signal: Trip Command
IG[3].TripCmd	Signal: Trip Command
IG[4].TripCmd	Signal: Trip Command
ThR.TripCmd	Signal: Trip Command
I2>[1].TripCmd	Signal: Trip Command
I2>[2].TripCmd	Signal: Trip Command
I2>G[1].TripCmd	Signal: Trip Command
I2>G[2].TripCmd	Signal: Trip Command
V[1].TripCmd	Signal: Trip Command
V[2].TripCmd	Signal: Trip Command
V[3].TripCmd	Signal: Trip Command
V[4].TripCmd	Signal: Trip Command
V[5].TripCmd	Signal: Trip Command
V[6].TripCmd	Signal: Trip Command
df/dt.TripCmd	Signal: Trip Command

<i>Name</i>	<i>Description</i>
delta phi.TripCmd	Signal: Trip Command
Intertripping.TripCmd	Signal: Trip Command
P.TripCmd	Signal: Trip Command
Q.TripCmd	Signal: Trip Command
LVRT[1].TripCmd	Signal: Trip Command
LVRT[2].TripCmd	Signal: Trip Command
VG[1].TripCmd	Signal: Trip Command
VG[2].TripCmd	Signal: Trip Command
V012[1].TripCmd	Signal: Trip Command
V012[2].TripCmd	Signal: Trip Command
V012[3].TripCmd	Signal: Trip Command
V012[4].TripCmd	Signal: Trip Command
V012[5].TripCmd	Signal: Trip Command
V012[6].TripCmd	Signal: Trip Command
f[1].TripCmd	Signal: Trip Command
f[2].TripCmd	Signal: Trip Command
f[3].TripCmd	Signal: Trip Command
f[4].TripCmd	Signal: Trip Command
f[5].TripCmd	Signal: Trip Command
f[6].TripCmd	Signal: Trip Command
PQS[1].TripCmd	Signal: Trip Command
PQS[2].TripCmd	Signal: Trip Command
PQS[3].TripCmd	Signal: Trip Command
PQS[4].TripCmd	Signal: Trip Command
PQS[5].TripCmd	Signal: Trip Command
PQS[6].TripCmd	Signal: Trip Command
PF[1].TripCmd	Signal: Trip Command
PF[2].TripCmd	Signal: Trip Command
Q->&V<.Decoupling Distr. Generator	Signal: Decoupling of the (local) Energy Generator/Resource
Q->&V<.Decoupling PCC	Signal: Decoupling at the Point of Common Coupling
LoE-Z1[1].TripCmd	Signal: Trip Command
LoE-Z2[1].TripCmd	Signal: Trip Command
LoE-Z1[2].TripCmd	Signal: Trip Command
LoE-Z2[2].TripCmd	Signal: Trip Command
OST.TripCmd	Signal: Trip Command
V/f>[1].TripCmd	Signal: Trip Command
V/f>[2].TripCmd	Signal: Trip Command
InEn.TripCmd	Signal: Trip Command
Z[1].TripCmd	Signal: Trip Command

Protective Elements

<i>Name</i>	<i>Description</i>
Z[2].TripCmd	Signal: Trip Command
ExP[1].TripCmd	Signal: Trip Command
ExP[2].TripCmd	Signal: Trip Command
ExP[3].TripCmd	Signal: Trip Command
ExP[4].TripCmd	Signal: Trip Command
Ext Sudd Press.TripCmd	Signal: Trip Command
Ext Oil Temp.TripCmd	Signal: Trip Command
Ext Temp Superv[1].TripCmd	Signal: Trip Command
Ext Temp Superv[2].TripCmd	Signal: Trip Command
Ext Temp Superv[3].TripCmd	Signal: Trip Command
RTD.TripCmd	Signal: Trip Command
DI Slot X1.DI 1	Signal: Digital Input
DI Slot X1.DI 2	Signal: Digital Input
DI Slot X1.DI 3	Signal: Digital Input
DI Slot X1.DI 4	Signal: Digital Input
DI Slot X1.DI 5	Signal: Digital Input
DI Slot X1.DI 6	Signal: Digital Input
DI Slot X1.DI 7	Signal: Digital Input
DI Slot X1.DI 8	Signal: Digital Input
DI Slot X5.DI 1	Signal: Digital Input
DI Slot X5.DI 2	Signal: Digital Input
DI Slot X5.DI 3	Signal: Digital Input
DI Slot X5.DI 4	Signal: Digital Input
DI Slot X5.DI 5	Signal: Digital Input
DI Slot X5.DI 6	Signal: Digital Input
DI Slot X5.DI 7	Signal: Digital Input
DI Slot X5.DI 8	Signal: Digital Input
DI Slot X6.DI 1	Signal: Digital Input
DI Slot X6.DI 2	Signal: Digital Input
DI Slot X6.DI 3	Signal: Digital Input
DI Slot X6.DI 4	Signal: Digital Input
DI Slot X6.DI 5	Signal: Digital Input
DI Slot X6.DI 6	Signal: Digital Input
DI Slot X6.DI 7	Signal: Digital Input
DI Slot X6.DI 8	Signal: Digital Input
AnaP[1].TripCmd	Signal: Trip Command
AnaP[2].TripCmd	Signal: Trip Command
AnaP[3].TripCmd	Signal: Trip Command

<i>Name</i>	<i>Description</i>
AnaP[4].TripCmd	Signal: Trip Command
DNP3.BinaryOutput0	Virtual Digital Output (DNP). This corresponds to a virtual binary input of the protective device.
DNP3.BinaryOutput1	Virtual Digital Output (DNP). This corresponds to a virtual binary input of the protective device.
DNP3.BinaryOutput2	Virtual Digital Output (DNP). This corresponds to a virtual binary input of the protective device.
DNP3.BinaryOutput3	Virtual Digital Output (DNP). This corresponds to a virtual binary input of the protective device.
DNP3.BinaryOutput4	Virtual Digital Output (DNP). This corresponds to a virtual binary input of the protective device.
DNP3.BinaryOutput5	Virtual Digital Output (DNP). This corresponds to a virtual binary input of the protective device.
DNP3.BinaryOutput6	Virtual Digital Output (DNP). This corresponds to a virtual binary input of the protective device.
DNP3.BinaryOutput7	Virtual Digital Output (DNP). This corresponds to a virtual binary input of the protective device.
DNP3.BinaryOutput8	Virtual Digital Output (DNP). This corresponds to a virtual binary input of the protective device.
DNP3.BinaryOutput9	Virtual Digital Output (DNP). This corresponds to a virtual binary input of the protective device.
DNP3.BinaryOutput10	Virtual Digital Output (DNP). This corresponds to a virtual binary input of the protective device.
DNP3.BinaryOutput11	Virtual Digital Output (DNP). This corresponds to a virtual binary input of the protective device.
DNP3.BinaryOutput12	Virtual Digital Output (DNP). This corresponds to a virtual binary input of the protective device.
DNP3.BinaryOutput13	Virtual Digital Output (DNP). This corresponds to a virtual binary input of the protective device.
DNP3.BinaryOutput14	Virtual Digital Output (DNP). This corresponds to a virtual binary input of the protective device.
DNP3.BinaryOutput15	Virtual Digital Output (DNP). This corresponds to a virtual binary input of the protective device.
DNP3.BinaryOutput16	Virtual Digital Output (DNP). This corresponds to a virtual binary input of the protective device.
DNP3.BinaryOutput17	Virtual Digital Output (DNP). This corresponds to a virtual binary input of the protective device.
DNP3.BinaryOutput18	Virtual Digital Output (DNP). This corresponds to a virtual binary input of the protective device.
DNP3.BinaryOutput19	Virtual Digital Output (DNP). This corresponds to a virtual binary input of the protective device.
DNP3.BinaryOutput20	Virtual Digital Output (DNP). This corresponds to a virtual binary input of the protective device.
DNP3.BinaryOutput21	Virtual Digital Output (DNP). This corresponds to a virtual binary input of the protective device.
DNP3.BinaryOutput22	Virtual Digital Output (DNP). This corresponds to a virtual binary input of the protective device.

<i>Name</i>	<i>Description</i>
DNP3.BinaryOutput23	Virtual Digital Output (DNP). This corresponds to a virtual binary input of the protective device.
DNP3.BinaryOutput24	Virtual Digital Output (DNP). This corresponds to a virtual binary input of the protective device.
DNP3.BinaryOutput25	Virtual Digital Output (DNP). This corresponds to a virtual binary input of the protective device.
DNP3.BinaryOutput26	Virtual Digital Output (DNP). This corresponds to a virtual binary input of the protective device.
DNP3.BinaryOutput27	Virtual Digital Output (DNP). This corresponds to a virtual binary input of the protective device.
DNP3.BinaryOutput28	Virtual Digital Output (DNP). This corresponds to a virtual binary input of the protective device.
DNP3.BinaryOutput29	Virtual Digital Output (DNP). This corresponds to a virtual binary input of the protective device.
DNP3.BinaryOutput30	Virtual Digital Output (DNP). This corresponds to a virtual binary input of the protective device.
DNP3.BinaryOutput31	Virtual Digital Output (DNP). This corresponds to a virtual binary input of the protective device.
Modbus.Scada Cmd 1	Scada Command
Modbus.Scada Cmd 2	Scada Command
Modbus.Scada Cmd 3	Scada Command
Modbus.Scada Cmd 4	Scada Command
Modbus.Scada Cmd 5	Scada Command
Modbus.Scada Cmd 6	Scada Command
Modbus.Scada Cmd 7	Scada Command
Modbus.Scada Cmd 8	Scada Command
Modbus.Scada Cmd 9	Scada Command
Modbus.Scada Cmd 10	Scada Command
Modbus.Scada Cmd 11	Scada Command
Modbus.Scada Cmd 12	Scada Command
Modbus.Scada Cmd 13	Scada Command
Modbus.Scada Cmd 14	Scada Command
Modbus.Scada Cmd 15	Scada Command
Modbus.Scada Cmd 16	Scada Command
IEC61850.VirtInp1	Signal: Virtual Input (IEC61850 GGIO Ind)
IEC61850.VirtInp2	Signal: Virtual Input (IEC61850 GGIO Ind)
IEC61850.VirtInp3	Signal: Virtual Input (IEC61850 GGIO Ind)
IEC61850.VirtInp4	Signal: Virtual Input (IEC61850 GGIO Ind)
IEC61850.VirtInp5	Signal: Virtual Input (IEC61850 GGIO Ind)
IEC61850.VirtInp6	Signal: Virtual Input (IEC61850 GGIO Ind)
IEC61850.VirtInp7	Signal: Virtual Input (IEC61850 GGIO Ind)
IEC61850.VirtInp8	Signal: Virtual Input (IEC61850 GGIO Ind)
IEC61850.VirtInp9	Signal: Virtual Input (IEC61850 GGIO Ind)

<i>Name</i>	<i>Description</i>
IEC61850.VirtInp10	Signal: Virtual Input (IEC61850 GGIO Ind)
IEC61850.VirtInp11	Signal: Virtual Input (IEC61850 GGIO Ind)
IEC61850.VirtInp12	Signal: Virtual Input (IEC61850 GGIO Ind)
IEC61850.VirtInp13	Signal: Virtual Input (IEC61850 GGIO Ind)
IEC61850.VirtInp14	Signal: Virtual Input (IEC61850 GGIO Ind)
IEC61850.VirtInp15	Signal: Virtual Input (IEC61850 GGIO Ind)
IEC61850.VirtInp16	Signal: Virtual Input (IEC61850 GGIO Ind)
IEC61850.VirtInp17	Signal: Virtual Input (IEC61850 GGIO Ind)
IEC61850.VirtInp18	Signal: Virtual Input (IEC61850 GGIO Ind)
IEC61850.VirtInp19	Signal: Virtual Input (IEC61850 GGIO Ind)
IEC61850.VirtInp20	Signal: Virtual Input (IEC61850 GGIO Ind)
IEC61850.VirtInp21	Signal: Virtual Input (IEC61850 GGIO Ind)
IEC61850.VirtInp22	Signal: Virtual Input (IEC61850 GGIO Ind)
IEC61850.VirtInp23	Signal: Virtual Input (IEC61850 GGIO Ind)
IEC61850.VirtInp24	Signal: Virtual Input (IEC61850 GGIO Ind)
IEC61850.VirtInp25	Signal: Virtual Input (IEC61850 GGIO Ind)
IEC61850.VirtInp26	Signal: Virtual Input (IEC61850 GGIO Ind)
IEC61850.VirtInp27	Signal: Virtual Input (IEC61850 GGIO Ind)
IEC61850.VirtInp28	Signal: Virtual Input (IEC61850 GGIO Ind)
IEC61850.VirtInp29	Signal: Virtual Input (IEC61850 GGIO Ind)
IEC61850.VirtInp30	Signal: Virtual Input (IEC61850 GGIO Ind)
IEC61850.VirtInp31	Signal: Virtual Input (IEC61850 GGIO Ind)
IEC61850.VirtInp32	Signal: Virtual Input (IEC61850 GGIO Ind)
IEC61850.SPCSO1	Status bit that can be set by clients like e.g. SCADA (Single Point Controllable Status Output).
IEC61850.SPCSO2	Status bit that can be set by clients like e.g. SCADA (Single Point Controllable Status Output).
IEC61850.SPCSO3	Status bit that can be set by clients like e.g. SCADA (Single Point Controllable Status Output).
IEC61850.SPCSO4	Status bit that can be set by clients like e.g. SCADA (Single Point Controllable Status Output).
IEC61850.SPCSO5	Status bit that can be set by clients like e.g. SCADA (Single Point Controllable Status Output).
IEC61850.SPCSO6	Status bit that can be set by clients like e.g. SCADA (Single Point Controllable Status Output).
IEC61850.SPCSO7	Status bit that can be set by clients like e.g. SCADA (Single Point Controllable Status Output).
IEC61850.SPCSO8	Status bit that can be set by clients like e.g. SCADA (Single Point Controllable Status Output).
IEC61850.SPCSO9	Status bit that can be set by clients like e.g. SCADA (Single Point Controllable Status Output).
IEC61850.SPCSO10	Status bit that can be set by clients like e.g. SCADA (Single Point Controllable Status Output).

<i>Name</i>	<i>Description</i>
IEC61850.SPCSO11	Status bit that can be set by clients like e.g. SCADA (Single Point Controllable Status Output).
IEC61850.SPCSO12	Status bit that can be set by clients like e.g. SCADA (Single Point Controllable Status Output).
IEC61850.SPCSO13	Status bit that can be set by clients like e.g. SCADA (Single Point Controllable Status Output).
IEC61850.SPCSO14	Status bit that can be set by clients like e.g. SCADA (Single Point Controllable Status Output).
IEC61850.SPCSO15	Status bit that can be set by clients like e.g. SCADA (Single Point Controllable Status Output).
IEC61850.SPCSO16	Status bit that can be set by clients like e.g. SCADA (Single Point Controllable Status Output).
IEC 103.Scada Cmd 1	Scada Command
IEC 103.Scada Cmd 2	Scada Command
IEC 103.Scada Cmd 3	Scada Command
IEC 103.Scada Cmd 4	Scada Command
IEC 103.Scada Cmd 5	Scada Command
IEC 103.Scada Cmd 6	Scada Command
IEC 103.Scada Cmd 7	Scada Command
IEC 103.Scada Cmd 8	Scada Command
IEC 103.Scada Cmd 9	Scada Command
IEC 103.Scada Cmd 10	Scada Command
Profibus.Scada Cmd 1	Scada Command
Profibus.Scada Cmd 2	Scada Command
Profibus.Scada Cmd 3	Scada Command
Profibus.Scada Cmd 4	Scada Command
Profibus.Scada Cmd 5	Scada Command
Profibus.Scada Cmd 6	Scada Command
Profibus.Scada Cmd 7	Scada Command
Profibus.Scada Cmd 8	Scada Command
Profibus.Scada Cmd 9	Scada Command
Profibus.Scada Cmd 10	Scada Command
Profibus.Scada Cmd 11	Scada Command
Profibus.Scada Cmd 12	Scada Command
Profibus.Scada Cmd 13	Scada Command
Profibus.Scada Cmd 14	Scada Command
Profibus.Scada Cmd 15	Scada Command
Profibus.Scada Cmd 16	Scada Command
Logics.LE1.Gate Out	Signal: Output of the logic gate
Logics.LE1.Timer Out	Signal: Timer Output
Logics.LE1.Out	Signal: Latched Output (Q)
Logics.LE1.Out inverted	Signal: Negated Latched Output (Q NOT)

<i>Name</i>	<i>Description</i>
Logics.LE2.Gate Out	Signal: Output of the logic gate
Logics.LE2.Timer Out	Signal: Timer Output
Logics.LE2.Out	Signal: Latched Output (Q)
Logics.LE2.Out inverted	Signal: Negated Latched Output (Q NOT)
Logics.LE3.Gate Out	Signal: Output of the logic gate
Logics.LE3.Timer Out	Signal: Timer Output
Logics.LE3.Out	Signal: Latched Output (Q)
Logics.LE3.Out inverted	Signal: Negated Latched Output (Q NOT)
Logics.LE4.Gate Out	Signal: Output of the logic gate
Logics.LE4.Timer Out	Signal: Timer Output
Logics.LE4.Out	Signal: Latched Output (Q)
Logics.LE4.Out inverted	Signal: Negated Latched Output (Q NOT)
Logics.LE5.Gate Out	Signal: Output of the logic gate
Logics.LE5.Timer Out	Signal: Timer Output
Logics.LE5.Out	Signal: Latched Output (Q)
Logics.LE5.Out inverted	Signal: Negated Latched Output (Q NOT)
Logics.LE6.Gate Out	Signal: Output of the logic gate
Logics.LE6.Timer Out	Signal: Timer Output
Logics.LE6.Out	Signal: Latched Output (Q)
Logics.LE6.Out inverted	Signal: Negated Latched Output (Q NOT)
Logics.LE7.Gate Out	Signal: Output of the logic gate
Logics.LE7.Timer Out	Signal: Timer Output
Logics.LE7.Out	Signal: Latched Output (Q)
Logics.LE7.Out inverted	Signal: Negated Latched Output (Q NOT)
Logics.LE8.Gate Out	Signal: Output of the logic gate
Logics.LE8.Timer Out	Signal: Timer Output
Logics.LE8.Out	Signal: Latched Output (Q)
Logics.LE8.Out inverted	Signal: Negated Latched Output (Q NOT)
Logics.LE9.Gate Out	Signal: Output of the logic gate
Logics.LE9.Timer Out	Signal: Timer Output
Logics.LE9.Out	Signal: Latched Output (Q)
Logics.LE9.Out inverted	Signal: Negated Latched Output (Q NOT)
Logics.LE10.Gate Out	Signal: Output of the logic gate
Logics.LE10.Timer Out	Signal: Timer Output
Logics.LE10.Out	Signal: Latched Output (Q)
Logics.LE10.Out inverted	Signal: Negated Latched Output (Q NOT)
Logics.LE11.Gate Out	Signal: Output of the logic gate
Logics.LE11.Timer Out	Signal: Timer Output
Logics.LE11.Out	Signal: Latched Output (Q)
Logics.LE11.Out inverted	Signal: Negated Latched Output (Q NOT)

<i>Name</i>	<i>Description</i>
Logics.LE12.Gate Out	Signal: Output of the logic gate
Logics.LE12.Timer Out	Signal: Timer Output
Logics.LE12.Out	Signal: Latched Output (Q)
Logics.LE12.Out inverted	Signal: Negated Latched Output (Q NOT)
Logics.LE13.Gate Out	Signal: Output of the logic gate
Logics.LE13.Timer Out	Signal: Timer Output
Logics.LE13.Out	Signal: Latched Output (Q)
Logics.LE13.Out inverted	Signal: Negated Latched Output (Q NOT)
Logics.LE14.Gate Out	Signal: Output of the logic gate
Logics.LE14.Timer Out	Signal: Timer Output
Logics.LE14.Out	Signal: Latched Output (Q)
Logics.LE14.Out inverted	Signal: Negated Latched Output (Q NOT)
Logics.LE15.Gate Out	Signal: Output of the logic gate
Logics.LE15.Timer Out	Signal: Timer Output
Logics.LE15.Out	Signal: Latched Output (Q)
Logics.LE15.Out inverted	Signal: Negated Latched Output (Q NOT)
Logics.LE16.Gate Out	Signal: Output of the logic gate
Logics.LE16.Timer Out	Signal: Timer Output
Logics.LE16.Out	Signal: Latched Output (Q)
Logics.LE16.Out inverted	Signal: Negated Latched Output (Q NOT)
Logics.LE17.Gate Out	Signal: Output of the logic gate
Logics.LE17.Timer Out	Signal: Timer Output
Logics.LE17.Out	Signal: Latched Output (Q)
Logics.LE17.Out inverted	Signal: Negated Latched Output (Q NOT)
Logics.LE18.Gate Out	Signal: Output of the logic gate
Logics.LE18.Timer Out	Signal: Timer Output
Logics.LE18.Out	Signal: Latched Output (Q)
Logics.LE18.Out inverted	Signal: Negated Latched Output (Q NOT)
Logics.LE19.Gate Out	Signal: Output of the logic gate
Logics.LE19.Timer Out	Signal: Timer Output
Logics.LE19.Out	Signal: Latched Output (Q)
Logics.LE19.Out inverted	Signal: Negated Latched Output (Q NOT)
Logics.LE20.Gate Out	Signal: Output of the logic gate
Logics.LE20.Timer Out	Signal: Timer Output
Logics.LE20.Out	Signal: Latched Output (Q)
Logics.LE20.Out inverted	Signal: Negated Latched Output (Q NOT)
Logics.LE21.Gate Out	Signal: Output of the logic gate
Logics.LE21.Timer Out	Signal: Timer Output
Logics.LE21.Out	Signal: Latched Output (Q)
Logics.LE21.Out inverted	Signal: Negated Latched Output (Q NOT)

<i>Name</i>	<i>Description</i>
Logics.LE22.Gate Out	Signal: Output of the logic gate
Logics.LE22.Timer Out	Signal: Timer Output
Logics.LE22.Out	Signal: Latched Output (Q)
Logics.LE22.Out inverted	Signal: Negated Latched Output (Q NOT)
Logics.LE23.Gate Out	Signal: Output of the logic gate
Logics.LE23.Timer Out	Signal: Timer Output
Logics.LE23.Out	Signal: Latched Output (Q)
Logics.LE23.Out inverted	Signal: Negated Latched Output (Q NOT)
Logics.LE24.Gate Out	Signal: Output of the logic gate
Logics.LE24.Timer Out	Signal: Timer Output
Logics.LE24.Out	Signal: Latched Output (Q)
Logics.LE24.Out inverted	Signal: Negated Latched Output (Q NOT)
Logics.LE25.Gate Out	Signal: Output of the logic gate
Logics.LE25.Timer Out	Signal: Timer Output
Logics.LE25.Out	Signal: Latched Output (Q)
Logics.LE25.Out inverted	Signal: Negated Latched Output (Q NOT)
Logics.LE26.Gate Out	Signal: Output of the logic gate
Logics.LE26.Timer Out	Signal: Timer Output
Logics.LE26.Out	Signal: Latched Output (Q)
Logics.LE26.Out inverted	Signal: Negated Latched Output (Q NOT)
Logics.LE27.Gate Out	Signal: Output of the logic gate
Logics.LE27.Timer Out	Signal: Timer Output
Logics.LE27.Out	Signal: Latched Output (Q)
Logics.LE27.Out inverted	Signal: Negated Latched Output (Q NOT)
Logics.LE28.Gate Out	Signal: Output of the logic gate
Logics.LE28.Timer Out	Signal: Timer Output
Logics.LE28.Out	Signal: Latched Output (Q)
Logics.LE28.Out inverted	Signal: Negated Latched Output (Q NOT)
Logics.LE29.Gate Out	Signal: Output of the logic gate
Logics.LE29.Timer Out	Signal: Timer Output
Logics.LE29.Out	Signal: Latched Output (Q)
Logics.LE29.Out inverted	Signal: Negated Latched Output (Q NOT)
Logics.LE30.Gate Out	Signal: Output of the logic gate
Logics.LE30.Timer Out	Signal: Timer Output
Logics.LE30.Out	Signal: Latched Output (Q)
Logics.LE30.Out inverted	Signal: Negated Latched Output (Q NOT)
Logics.LE31.Gate Out	Signal: Output of the logic gate
Logics.LE31.Timer Out	Signal: Timer Output
Logics.LE31.Out	Signal: Latched Output (Q)
Logics.LE31.Out inverted	Signal: Negated Latched Output (Q NOT)

Protective Elements

<i>Name</i>	<i>Description</i>
Logics.LE32.Gate Out	Signal: Output of the logic gate
Logics.LE32.Timer Out	Signal: Timer Output
Logics.LE32.Out	Signal: Latched Output (Q)
Logics.LE32.Out inverted	Signal: Negated Latched Output (Q NOT)
Logics.LE33.Gate Out	Signal: Output of the logic gate
Logics.LE33.Timer Out	Signal: Timer Output
Logics.LE33.Out	Signal: Latched Output (Q)
Logics.LE33.Out inverted	Signal: Negated Latched Output (Q NOT)
Logics.LE34.Gate Out	Signal: Output of the logic gate
Logics.LE34.Timer Out	Signal: Timer Output
Logics.LE34.Out	Signal: Latched Output (Q)
Logics.LE34.Out inverted	Signal: Negated Latched Output (Q NOT)
Logics.LE35.Gate Out	Signal: Output of the logic gate
Logics.LE35.Timer Out	Signal: Timer Output
Logics.LE35.Out	Signal: Latched Output (Q)
Logics.LE35.Out inverted	Signal: Negated Latched Output (Q NOT)
Logics.LE36.Gate Out	Signal: Output of the logic gate
Logics.LE36.Timer Out	Signal: Timer Output
Logics.LE36.Out	Signal: Latched Output (Q)
Logics.LE36.Out inverted	Signal: Negated Latched Output (Q NOT)
Logics.LE37.Gate Out	Signal: Output of the logic gate
Logics.LE37.Timer Out	Signal: Timer Output
Logics.LE37.Out	Signal: Latched Output (Q)
Logics.LE37.Out inverted	Signal: Negated Latched Output (Q NOT)
Logics.LE38.Gate Out	Signal: Output of the logic gate
Logics.LE38.Timer Out	Signal: Timer Output
Logics.LE38.Out	Signal: Latched Output (Q)
Logics.LE38.Out inverted	Signal: Negated Latched Output (Q NOT)
Logics.LE39.Gate Out	Signal: Output of the logic gate
Logics.LE39.Timer Out	Signal: Timer Output
Logics.LE39.Out	Signal: Latched Output (Q)
Logics.LE39.Out inverted	Signal: Negated Latched Output (Q NOT)
Logics.LE40.Gate Out	Signal: Output of the logic gate
Logics.LE40.Timer Out	Signal: Timer Output
Logics.LE40.Out	Signal: Latched Output (Q)
Logics.LE40.Out inverted	Signal: Negated Latched Output (Q NOT)
Logics.LE41.Gate Out	Signal: Output of the logic gate
Logics.LE41.Timer Out	Signal: Timer Output
Logics.LE41.Out	Signal: Latched Output (Q)
Logics.LE41.Out inverted	Signal: Negated Latched Output (Q NOT)

<i>Name</i>	<i>Description</i>
Logics.LE42.Gate Out	Signal: Output of the logic gate
Logics.LE42.Timer Out	Signal: Timer Output
Logics.LE42.Out	Signal: Latched Output (Q)
Logics.LE42.Out inverted	Signal: Negated Latched Output (Q NOT)
Logics.LE43.Gate Out	Signal: Output of the logic gate
Logics.LE43.Timer Out	Signal: Timer Output
Logics.LE43.Out	Signal: Latched Output (Q)
Logics.LE43.Out inverted	Signal: Negated Latched Output (Q NOT)
Logics.LE44.Gate Out	Signal: Output of the logic gate
Logics.LE44.Timer Out	Signal: Timer Output
Logics.LE44.Out	Signal: Latched Output (Q)
Logics.LE44.Out inverted	Signal: Negated Latched Output (Q NOT)
Logics.LE45.Gate Out	Signal: Output of the logic gate
Logics.LE45.Timer Out	Signal: Timer Output
Logics.LE45.Out	Signal: Latched Output (Q)
Logics.LE45.Out inverted	Signal: Negated Latched Output (Q NOT)
Logics.LE46.Gate Out	Signal: Output of the logic gate
Logics.LE46.Timer Out	Signal: Timer Output
Logics.LE46.Out	Signal: Latched Output (Q)
Logics.LE46.Out inverted	Signal: Negated Latched Output (Q NOT)
Logics.LE47.Gate Out	Signal: Output of the logic gate
Logics.LE47.Timer Out	Signal: Timer Output
Logics.LE47.Out	Signal: Latched Output (Q)
Logics.LE47.Out inverted	Signal: Negated Latched Output (Q NOT)
Logics.LE48.Gate Out	Signal: Output of the logic gate
Logics.LE48.Timer Out	Signal: Timer Output
Logics.LE48.Out	Signal: Latched Output (Q)
Logics.LE48.Out inverted	Signal: Negated Latched Output (Q NOT)
Logics.LE49.Gate Out	Signal: Output of the logic gate
Logics.LE49.Timer Out	Signal: Timer Output
Logics.LE49.Out	Signal: Latched Output (Q)
Logics.LE49.Out inverted	Signal: Negated Latched Output (Q NOT)
Logics.LE50.Gate Out	Signal: Output of the logic gate
Logics.LE50.Timer Out	Signal: Timer Output
Logics.LE50.Out	Signal: Latched Output (Q)
Logics.LE50.Out inverted	Signal: Negated Latched Output (Q NOT)
Logics.LE51.Gate Out	Signal: Output of the logic gate
Logics.LE51.Timer Out	Signal: Timer Output
Logics.LE51.Out	Signal: Latched Output (Q)
Logics.LE51.Out inverted	Signal: Negated Latched Output (Q NOT)

<i>Name</i>	<i>Description</i>
Logics.LE52.Gate Out	Signal: Output of the logic gate
Logics.LE52.Timer Out	Signal: Timer Output
Logics.LE52.Out	Signal: Latched Output (Q)
Logics.LE52.Out inverted	Signal: Negated Latched Output (Q NOT)
Logics.LE53.Gate Out	Signal: Output of the logic gate
Logics.LE53.Timer Out	Signal: Timer Output
Logics.LE53.Out	Signal: Latched Output (Q)
Logics.LE53.Out inverted	Signal: Negated Latched Output (Q NOT)
Logics.LE54.Gate Out	Signal: Output of the logic gate
Logics.LE54.Timer Out	Signal: Timer Output
Logics.LE54.Out	Signal: Latched Output (Q)
Logics.LE54.Out inverted	Signal: Negated Latched Output (Q NOT)
Logics.LE55.Gate Out	Signal: Output of the logic gate
Logics.LE55.Timer Out	Signal: Timer Output
Logics.LE55.Out	Signal: Latched Output (Q)
Logics.LE55.Out inverted	Signal: Negated Latched Output (Q NOT)
Logics.LE56.Gate Out	Signal: Output of the logic gate
Logics.LE56.Timer Out	Signal: Timer Output
Logics.LE56.Out	Signal: Latched Output (Q)
Logics.LE56.Out inverted	Signal: Negated Latched Output (Q NOT)
Logics.LE57.Gate Out	Signal: Output of the logic gate
Logics.LE57.Timer Out	Signal: Timer Output
Logics.LE57.Out	Signal: Latched Output (Q)
Logics.LE57.Out inverted	Signal: Negated Latched Output (Q NOT)
Logics.LE58.Gate Out	Signal: Output of the logic gate
Logics.LE58.Timer Out	Signal: Timer Output
Logics.LE58.Out	Signal: Latched Output (Q)
Logics.LE58.Out inverted	Signal: Negated Latched Output (Q NOT)
Logics.LE59.Gate Out	Signal: Output of the logic gate
Logics.LE59.Timer Out	Signal: Timer Output
Logics.LE59.Out	Signal: Latched Output (Q)
Logics.LE59.Out inverted	Signal: Negated Latched Output (Q NOT)
Logics.LE60.Gate Out	Signal: Output of the logic gate
Logics.LE60.Timer Out	Signal: Timer Output
Logics.LE60.Out	Signal: Latched Output (Q)
Logics.LE60.Out inverted	Signal: Negated Latched Output (Q NOT)
Logics.LE61.Gate Out	Signal: Output of the logic gate
Logics.LE61.Timer Out	Signal: Timer Output
Logics.LE61.Out	Signal: Latched Output (Q)
Logics.LE61.Out inverted	Signal: Negated Latched Output (Q NOT)







<i>Name</i>	<i>Description</i>
Logics.LE62.Gate Out	Signal: Output of the logic gate
Logics.LE62.Timer Out	Signal: Timer Output
Logics.LE62.Out	Signal: Latched Output (Q)
Logics.LE62.Out inverted	Signal: Negated Latched Output (Q NOT)
Logics.LE63.Gate Out	Signal: Output of the logic gate
Logics.LE63.Timer Out	Signal: Timer Output
Logics.LE63.Out	Signal: Latched Output (Q)
Logics.LE63.Out inverted	Signal: Negated Latched Output (Q NOT)
Logics.LE64.Gate Out	Signal: Output of the logic gate
Logics.LE64.Timer Out	Signal: Timer Output
Logics.LE64.Out	Signal: Latched Output (Q)
Logics.LE64.Out inverted	Signal: Negated Latched Output (Q NOT)
Logics.LE65.Gate Out	Signal: Output of the logic gate
Logics.LE65.Timer Out	Signal: Timer Output
Logics.LE65.Out	Signal: Latched Output (Q)
Logics.LE65.Out inverted	Signal: Negated Latched Output (Q NOT)
Logics.LE66.Gate Out	Signal: Output of the logic gate
Logics.LE66.Timer Out	Signal: Timer Output
Logics.LE66.Out	Signal: Latched Output (Q)
Logics.LE66.Out inverted	Signal: Negated Latched Output (Q NOT)
Logics.LE67.Gate Out	Signal: Output of the logic gate
Logics.LE67.Timer Out	Signal: Timer Output
Logics.LE67.Out	Signal: Latched Output (Q)
Logics.LE67.Out inverted	Signal: Negated Latched Output (Q NOT)
Logics.LE68.Gate Out	Signal: Output of the logic gate
Logics.LE68.Timer Out	Signal: Timer Output
Logics.LE68.Out	Signal: Latched Output (Q)
Logics.LE68.Out inverted	Signal: Negated Latched Output (Q NOT)
Logics.LE69.Gate Out	Signal: Output of the logic gate
Logics.LE69.Timer Out	Signal: Timer Output
Logics.LE69.Out	Signal: Latched Output (Q)
Logics.LE69.Out inverted	Signal: Negated Latched Output (Q NOT)
Logics.LE70.Gate Out	Signal: Output of the logic gate
Logics.LE70.Timer Out	Signal: Timer Output
Logics.LE70.Out	Signal: Latched Output (Q)
Logics.LE70.Out inverted	Signal: Negated Latched Output (Q NOT)
Logics.LE71.Gate Out	Signal: Output of the logic gate
Logics.LE71.Timer Out	Signal: Timer Output
Logics.LE71.Out	Signal: Latched Output (Q)
Logics.LE71.Out inverted	Signal: Negated Latched Output (Q NOT)

<i>Name</i>	<i>Description</i>
Logics.LE72.Gate Out	Signal: Output of the logic gate
Logics.LE72.Timer Out	Signal: Timer Output
Logics.LE72.Out	Signal: Latched Output (Q)
Logics.LE72.Out inverted	Signal: Negated Latched Output (Q NOT)
Logics.LE73.Gate Out	Signal: Output of the logic gate
Logics.LE73.Timer Out	Signal: Timer Output
Logics.LE73.Out	Signal: Latched Output (Q)
Logics.LE73.Out inverted	Signal: Negated Latched Output (Q NOT)
Logics.LE74.Gate Out	Signal: Output of the logic gate
Logics.LE74.Timer Out	Signal: Timer Output
Logics.LE74.Out	Signal: Latched Output (Q)
Logics.LE74.Out inverted	Signal: Negated Latched Output (Q NOT)
Logics.LE75.Gate Out	Signal: Output of the logic gate
Logics.LE75.Timer Out	Signal: Timer Output
Logics.LE75.Out	Signal: Latched Output (Q)
Logics.LE75.Out inverted	Signal: Negated Latched Output (Q NOT)
Logics.LE76.Gate Out	Signal: Output of the logic gate
Logics.LE76.Timer Out	Signal: Timer Output
Logics.LE76.Out	Signal: Latched Output (Q)
Logics.LE76.Out inverted	Signal: Negated Latched Output (Q NOT)
Logics.LE77.Gate Out	Signal: Output of the logic gate
Logics.LE77.Timer Out	Signal: Timer Output
Logics.LE77.Out	Signal: Latched Output (Q)
Logics.LE77.Out inverted	Signal: Negated Latched Output (Q NOT)
Logics.LE78.Gate Out	Signal: Output of the logic gate
Logics.LE78.Timer Out	Signal: Timer Output
Logics.LE78.Out	Signal: Latched Output (Q)
Logics.LE78.Out inverted	Signal: Negated Latched Output (Q NOT)
Logics.LE79.Gate Out	Signal: Output of the logic gate
Logics.LE79.Timer Out	Signal: Timer Output
Logics.LE79.Out	Signal: Latched Output (Q)
Logics.LE79.Out inverted	Signal: Negated Latched Output (Q NOT)
Logics.LE80.Gate Out	Signal: Output of the logic gate
Logics.LE80.Timer Out	Signal: Timer Output
Logics.LE80.Out	Signal: Latched Output (Q)
Logics.LE80.Out inverted	Signal: Negated Latched Output (Q NOT)

Setting Group Parameters of the Reconnection Module

Parameter	Description	Setting range	Default	Menu path
Function 	Permanent activation or deactivation of module/stage.	inactive, active	inactive	[Protection Para <1..4> /Intercon-Prot /ReCon[1] /General Settings]
ExBlo Fc 	Activate (allow) or inactivate (disallow) blocking of the module/stage. This parameter is only effective if a signal is assigned to the corresponding global protection parameter. If the signal becomes true, those modules/stages are blocked that are parameterized "ExBlo Fc=active".	inactive, active	inactive	[Protection Para <1..4> /Intercon-Prot /ReCon[1] /General Settings]
Meas Circuit Superv 	Activates the use of the measuring circuit supervision. In this case the module will be blocked if a measuring circuit supervision module (e.g. LOP, VTS) signals a disturbed measuring circuit (e.g. caused by a fuse failure).	inactive, active	inactive	[Protection Para <1..4> /Intercon-Prot /ReCon[1] /General Settings]
V Ext Release PCC Fc 	Activate the release signal of the Point of Common Coupling. The line-to-line voltage is greater than 95% of VN.	inactive, active	inactive	[Protection Para <1..4> /Intercon-Prot /ReCon[1] /General Settings]
Reconnect. Release Cond 	This parameter ensures that the mains voltage is recovered.	V Internal Release, V Ext Release PCC, Both	Both	[Protection Para <1..4> /Intercon-Prot /ReCon[1] /Release Para]
PCC Fuse Fail VT Fk 	Blocking if the fuse of a voltage transformer has tripped at the PCC. Only available if: Reconnect. Release Cond = V Ext Release PCC Only available if: Reconnect. Release Cond = V Ext Release PCC or Both	inactive, active	inactive	[Protection Para <1..4> /Intercon-Prot /ReCon[1] /Release Para]

Protective Elements

Parameter	Description	Setting range	Default	Menu path
 Measuring method	Measuring method: fundamental or rms or "sliding average supervision"	Fundamental, True RMS, Vavg	Fundamental	[Protection Para /<1..4> /Intercon-Prot /ReCon[1] /Release Para]
 VLL> Release	Minimum voltage (line-to-line) for reclosure (Restoration Voltage) Only available if: Reconnect. Release Cond = V Internal Release Only available if: Reconnect. Release Cond = V Internal Release or Both	0.70 - 1.00Vn	0.95Vn	[Protection Para /<1..4> /Intercon-Prot /ReCon[1] /Release Para]
 VLL< Release	Maximum voltage (line-to-line) for reclosure (Restoration Voltage) Only available if: Reconnect. Release Cond = V Internal Release Only available if: Reconnect. Release Cond = V Internal Release or Both	1.00 - 1.50Vn	1.10Vn	[Protection Para /<1..4> /Intercon-Prot /ReCon[1] /Release Para]
 f<	Lower frequency limit for the reclosure (Restoration Voltage)	40.00 - 69.90Hz	47.5Hz	[Protection Para /<1..4> /Intercon-Prot /ReCon[1] /Release Para]
 f>	Upper frequency limit for the reclosure	40.00 - 69.90Hz	50.05Hz	[Protection Para /<1..4> /Intercon-Prot /ReCon[1] /Release Para]
 t-Release Blo	Time stage (delay) for the reclosure of the energy resources. The Mains saddle time takes based on exirience approx. 10 - 15 minutes.	0.00 - 3600.00s	600s	[Protection Para /<1..4> /Intercon-Prot /ReCon[1] /Release Para]

Input States of the Reconnection Module

<i>Name</i>	<i>Description</i>	<i>Assignment via</i>
ExBlo1-I	Module input state: External blocking1	[Protection Para /Global Prot Para /Intercon-Prot /ReCon[1] /General Settings]
ExBlo2-I	Module input state: External blocking2	[Protection Para /Global Prot Para /Intercon-Prot /ReCon[1] /General Settings]
V Ext Release PCC-I	Module input state: Release signal is being generated by the PCC (External Release)	[Protection Para /Global Prot Para /Intercon-Prot /ReCon[1] /General Settings]
PCC Fuse Fail VT-I	State of the module input: Blocking if the fuse of a voltage transformer has tripped at the PCC.	[Protection Para /Global Prot Para /Intercon-Prot /ReCon[1] /General Settings]
reconnected-I	This signal indicates the state "reconnected" (mains parallel).	[Protection Para /Global Prot Para /Intercon-Prot /ReCon[1] /General Settings]
Decoupling1-I	Decoupling function, that blocks the reconnection.	[Protection Para /Global Prot Para /Intercon-Prot /ReCon[1] /Decoupling]
Decoupling2-I	Decoupling function, that blocks the reconnection.	[Protection Para /Global Prot Para /Intercon-Prot /ReCon[1] /Decoupling]

Protective Elements

<i>Name</i>	<i>Description</i>	<i>Assignment via</i>
Decoupling3-l	Decoupling function, that blocks the reconnection.	[Protection Para /Global Prot Para /Intercon-Prot /ReCon[1] /Decoupling]
Decoupling4-l	Decoupling function, that blocks the reconnection.	[Protection Para /Global Prot Para /Intercon-Prot /ReCon[1] /Decoupling]
Decoupling5-l	Decoupling function, that blocks the reconnection.	[Protection Para /Global Prot Para /Intercon-Prot /ReCon[1] /Decoupling]
Decoupling6-l	Decoupling function, that blocks the reconnection.	[Protection Para /Global Prot Para /Intercon-Prot /ReCon[1] /Decoupling]

Reconnection Module Signals (Output States)

<i>Signal</i>	<i>Description</i>
active	Signal: active
ExBlo	Signal: External Blocking
Blo by Meas Circuit Superv	Signal: Module blocked by measuring circuit supervision
Release Energy Resource	Signal: Release Energy Resource.

LVRT – Low Voltage Ride Through [27(t)]

Available Elements:

LVRT[1], LVRT[2]

Why LVRT? - Motivation for LVRT

The rapid development of distributed resources (DR) based on the renewable energy such as wind, solar and others has been changing the electric power system and concepts for its control, protection, metering and communication rapidly, too.

One of the important challenges for the interconnection between the DR and local electric power system (EPS) is the behaviour of the DR during disturbances within the electrical power system. Most of the disturbances within the EPS are characterized mainly by non-permanent system voltage collapses (voltage dip/sag) with different time durations.

According to traditional protection concepts a distributed energy resource should be tripped as fast as possible from the grid in case of a significant low voltage condition. This is no longer acceptable because of the continuous rising share of distributed energy resources within the energy market. Uncontrolled disconnecting significant parts of the power generation during disturbances within the grid endangers the system stability of the electrical power system.

It was reported³ that during system fault with low voltage drops, a complete 5000 MW wind park (without LVRT capability) was decoupled from the electrical power system. The consequence was a dangerous system voltage and frequency instability.

Based on experiences like that, lots of electric utilities and state public utilities have issued interconnection standards which require Low-Voltage-Ride-Through (LVRT) capability during EPS disturbances.

What does LVRT mean in detail?

It is no longer allowed to decouple/disconnect a DR from the grid just because of a non-permanent voltage dip. Protective relays and control units have to take this into account.

Instead of that, the distributed resource has to be able to ride through such disturbances according to a LVRT profile. The shape of this LVRT profile is very similar according to the different guidelines within different countries or local utilities. But they could differ in details.

By means of LVRT the system stability is improved in situations, when the contribution of DRs is needed mostly. The importance of LVRT will rise with the growing share of DRs within the electrical power system.

Based on the technical requirements mentioned above, a LVRT protection function was developed for the *HighPROTEC* product line which covers the LVRT profiles (capabilities) defined by all relevant national and local grid interconnection standards.

The following drawing shows details on the different LVRT standards in different countries. Please note, that the standards and hence the grid codes are in some countries still under development.

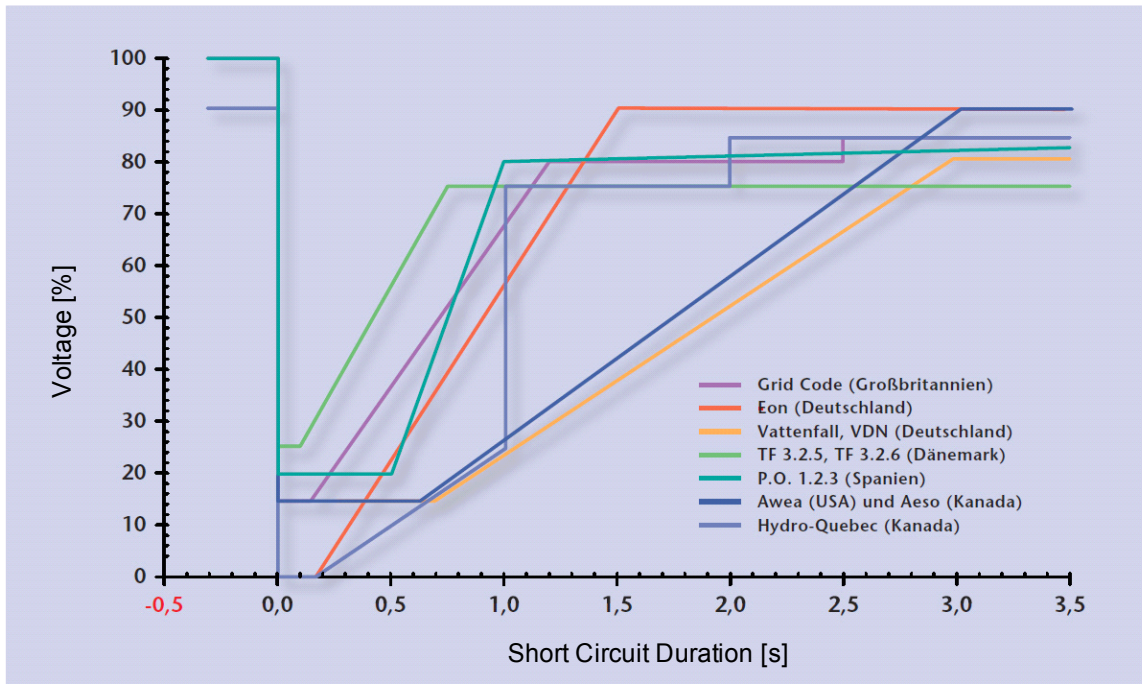

Source: eBWK Bd. 60 (2008) Nr. 4

Authors: Dipl.-Ing. Thomas Smolka, Dr.-Ing. Karl-Heinz Weck, Zertifizierungstelle der FGH e.V., Mannheim, sowie Dipl.-Ing. (FH) Matthias Bartsch, Enercon GmbH, Aurich.

Functional Principle of the LVRT

From the grid operators point of view, a LVRT profile defines a voltage profile which a distributed energy resource, that is connected to the grid, should be able to ride through in case of a low voltage event (voltage dip). The distributed energy resource is only allowed to disconnect from the grid if the voltage at the point of common coupling drops below the LVRT borderline. In other words, a LVRT protection function is a time-dependent voltage supervision according to a predefined voltage profile. The time-dependent voltage supervision will be started, as soon as the voltage at the point of common coupling falls below the start voltage level. The LVRT will be stopped, as soon as the voltage rises above the recover voltage level.

Auto Reclosure controlled LVRT

As already mentioned, the purpose of LVRT is to keep the DR connected to the grid in case of a non-permanent voltage dip/sag. For faults within the electrical power system by which auto-reclosing function is used to coordinate with the short circuit protections like overcurrent or distance protections, it is to expect that more than one voltage dips are coming one after another in a time period which is determined by the preset auto-reclosing dead times and protection relay operating times. Voltage dips/sags caused by the dead times of auto reclosings are non-permanent. Hence the protective device has to be able to detect voltage sags/dips in accordance with an auto reclosure and issues a trip command in that case that the voltage drops below the profile or that all parameterized auto reclosure shots were unsuccessful.

The following figure¹ depicts the voltage excursion by an unsuccessful two-shot Auto-Reclosing. According to some grid codes¹ it is obligated for a distributed generation to ride through a series of temporary voltage dips, but can be disconnected from the electrical power system immediately for a permanent fault. This kind of applications can be realized easily using the feature of »AR-controlled LVRT« in LVRT protection function.

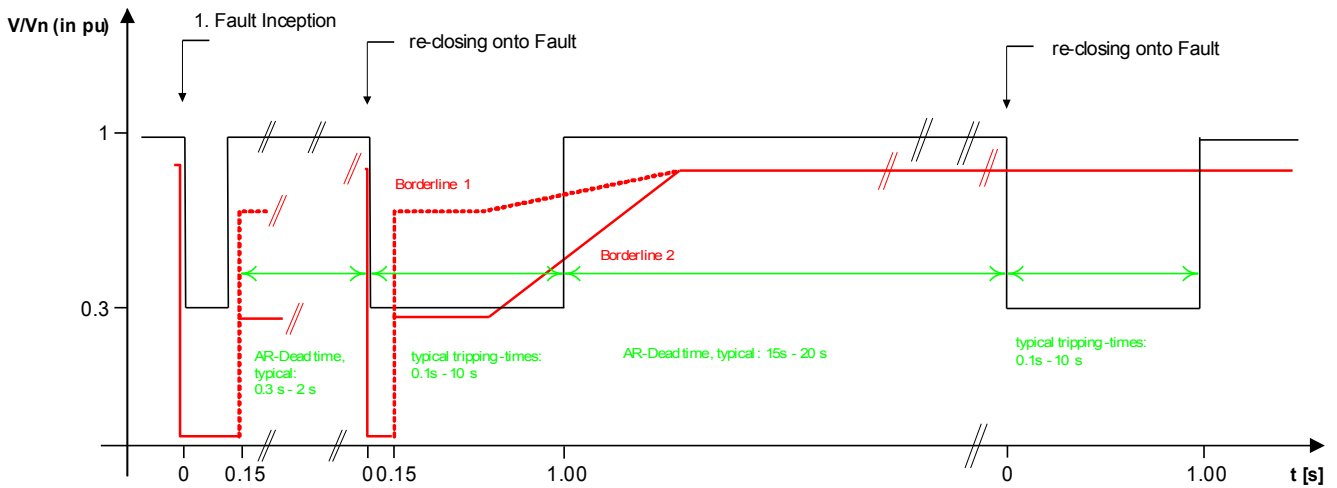

Source: Technische Richtlinie, Erzeugungsanlagen am Mittelspannungsnetz, Ausgabe Juni 2008, BDEW Bundesverband der Energie- und Wasserwirtschaft e.V. (Page 89).

Figure: Run of voltage curve during an unsuccessful two-shot auto reclosure

Functional Description of the LVRT

The LVRT element is designed for distributed generation resources that operate in parallel with the grid. It supervises system voltage disturbances by comparing them with a configurable voltage profile that is triggered once the system voltage falls below a configurable start value »Vstart«.

Once triggered, the LVRT element supervises the system voltage consecutively and determines if the voltage excursion is above or below of the preset voltage profile. A trip signal is only issued if the voltage excursion exits the "Ride-Through" region and goes into the "Tripping" region.

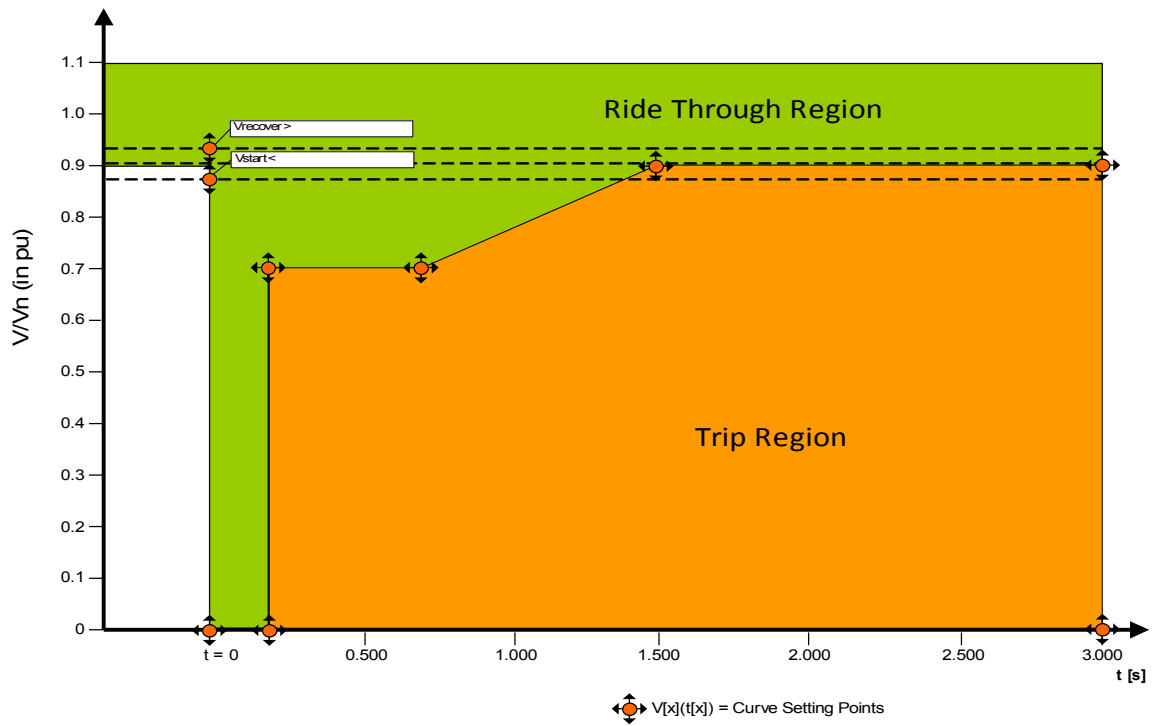

The VRT element will change into standby again as soon as the system voltage recovers: That means, the voltage has risen above the preset recover voltage » *Vrecover*«.

Auto Reclosure controlled LVRT

In case that the LVRT should be able to ride through auto reclosures, the parameter »*ARControlledLVRT*« has to be set to »*active*«.

In order to supervise the Low Voltage Ride Through events during reclosure, the user has to set the supervision timer »*tLVRT*« *at least equal or greater than* the complete Multi-Shot AR-runtime. In addition to that the number of permitted LVRTs has to be set which is usually the number of auto reclosure attempts. The actual LVRT supervision will be controlled to ride through the preset LVRT voltage pattern. By reaching the preset number of LVRT events »*NumberOfLVRT*«, the actual LVRT supervision assumes that the detected system fault is permanent, ignores the voltage profile and issues a tripping command instantaneously in order to disconnect the distributed resource from the electrical power system.

LVVRT



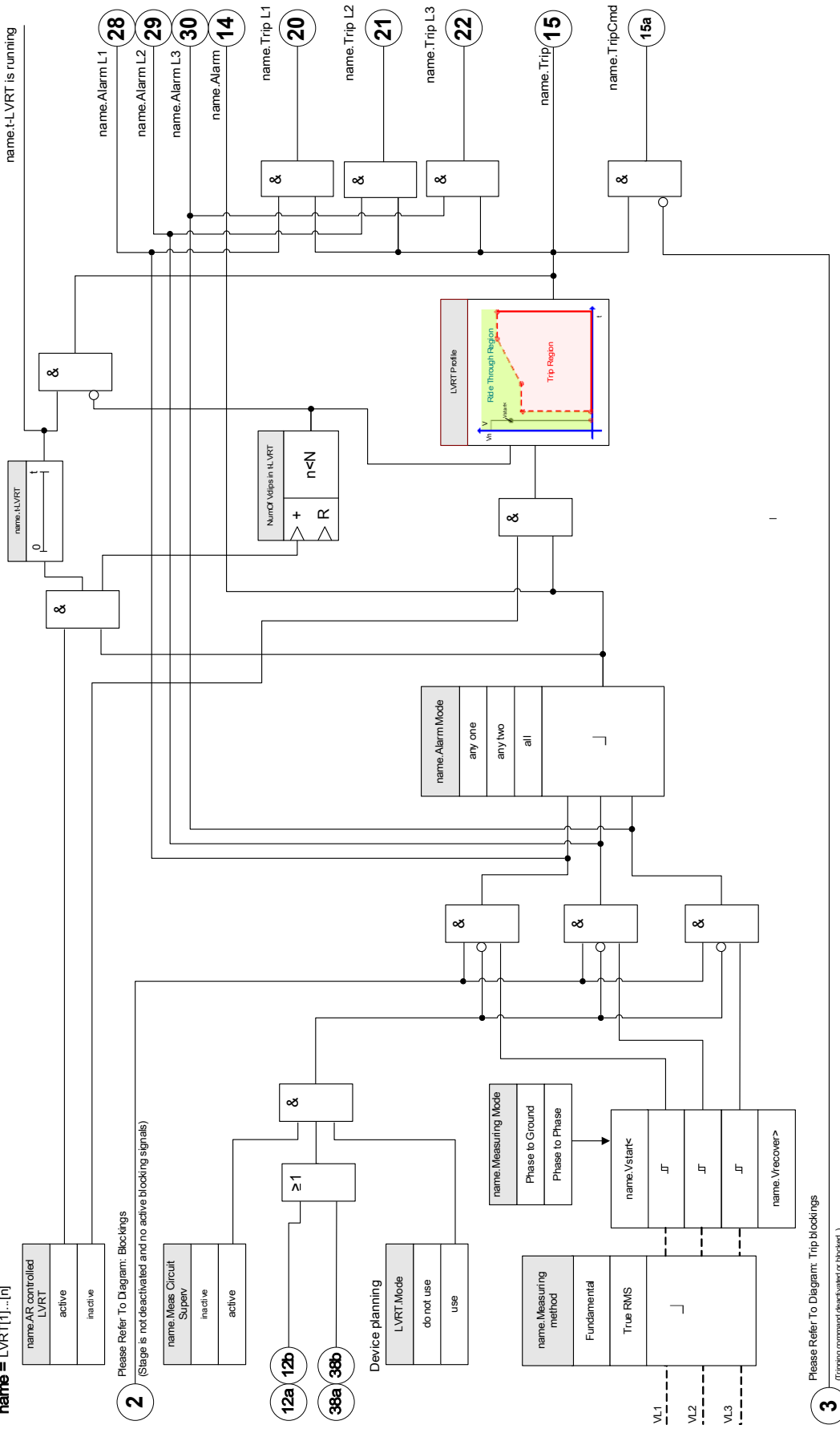

name = LVVRT[1]...[n]









Device Planning Parameters of the Low-Voltage-Ride-Through







Parameter	Description	Options	Default	Menu path
Mode 	Mode	do not use, use	do not use	[Device planning]







Setting Group Parameters of the Low-Voltage-Ride-Through

Parameter	Description	Setting range	Default	Menu path
Function 	Permanent activation or deactivation of module/stage.	inactive, active	inactive	[Protection Para /<1..4> /Intercon-Prot /LVRT[1] /General Settings]
ExBlo Fc 	Activate (allow) or inactivate (disallow) blocking of the module/stage. This parameter is only effective if a signal is assigned to the corresponding global protection parameter. If the signal becomes true, those modules/stages are blocked that are parameterized "ExBlo Fc=active".	inactive, active	inactive	[Protection Para /<1..4> /Intercon-Prot /LVRT[1] /General Settings]
Blo TripCmd 	Permanent blocking of the Trip Command of the module/stage.	inactive, active	inactive	[Protection Para /<1..4> /Intercon-Prot /LVRT[1] /General Settings]
ExBlo TripCmd Fc 	Activate (allow) or inactivate (disallow) blocking of the module/stage. This parameter is only effective if a signal is assigned to the corresponding global protection parameter. If the signal becomes true, those modules/stages are blocked that are parameterized "ExBlo TripCmd Fc=active".	inactive, active	inactive	[Protection Para /<1..4> /Intercon-Prot /LVRT[1] /General Settings]

Parameter	Description	Setting range	Default	Menu path
 Measuring Mode	Measuring/Supervision Mode: Determines if the phase-to-phase or phase-to-earth voltages are to be supervised	Phase to Ground, Phase to Phase	Phase to Ground	[Protection Para /<1..4> /Intercon-Prot /LVRT[1] /General Settings]
 Measuring method	Measuring method: fundamental or rms or 3rd harmonic (only generator protection relays)	Fundamental, True RMS	Fundamental	[Protection Para /<1..4> /Intercon-Prot /LVRT[1] /General Settings]
 Alarm Mode	Alarm criterion for the voltage protection stage.	any one, any two, all	any one	[Protection Para /<1..4> /Intercon-Prot /LVRT[1] /General Settings]
 Meas Circuit Superv	Activates the use of the measuring circuit supervision. In this case the module will be blocked if a measuring circuit supervision module (e.g. LOP, VTS) signals a disturbed measuring circuit (e.g. caused by a fuse failure).	inactive, active	inactive	[Protection Para /<1..4> /Intercon-Prot /LVRT[1] /General Settings]
 AR controlled LVRT	Activates the supervision of the number of voltage dips during a defined time (t-LVRT).	inactive, active	inactive	[Protection Para /<1..4> /Intercon-Prot /LVRT[1] /General Settings]
 Number of V dips to trip	Number of voltage dips until the disconnection signal (trip) will be issued. Only available if:AR controlled LVRT = active	1 - 6	1	[Protection Para /<1..4> /Intercon-Prot /LVRT[1] /General Settings]

Parameter	Description	Setting range	Default	Menu path
t-LVRT 	This timer defines the supervision interval (window/period) for counting the number of voltage dips to trip (“No of V dips to trip”). The first voltage dip will start the timer. The counted number of voltage dips will be reset if the timer is expired. The timer will also be reset if the maximum “No of V dips to trip” is reached. Only available if:AR controlled LVRT = active	0.00 - 3000.00s	30.00s	[Protection Para /<1..4> /Intercon-Prot /LVRT[1] /General Settings]
Vstart< 	A voltage dip is detected if the measured voltage falls below this threshold.	0.00 - 2.00Vn	0.90Vn	[Protection Para /<1..4> /Intercon-Prot /LVRT[1] /LVRT Profile]
Vrecover> 	The voltage is recovered if the measured voltage raises above this threshold.	0.10 - 2.00Vn	0.93Vn	[Protection Para /<1..4> /Intercon-Prot /LVRT[1] /LVRT Profile]
V(t1) 	Voltage value of a point V(t(n)). These points define the LVRT profile.	0.00 - 2.00Vn	0.00Vn	[Protection Para /<1..4> /Intercon-Prot /LVRT[1] /LVRT Profile]
t1 	Point in time for the corresponding voltage value V(t(n)). These points define the LVRT profile.	0.00 - 20.00s	0.00s	[Protection Para /<1..4> /Intercon-Prot /LVRT[1] /LVRT Profile]
V(t2) 	Voltage value of a point V(t(n)). These points define the LVRT profile.	0.00 - 2.00Vn	0.00Vn	[Protection Para /<1..4> /Intercon-Prot /LVRT[1] /LVRT Profile]

Parameter	Description	Setting range	Default	Menu path
t2 	Point in time for the corresponding voltage value $V(t(n))$. These points define the LVRT profile.	0.00 - 20.00s	0.15s	[Protection Para /<1..4> /Intercon-Prot /LVRT[1] /LVRT Profile]
V(t3) 	Voltage value of a point $V(t(n))$. These points define the LVRT profile.	0.00 - 2.00Vn	0.70Vn	[Protection Para /<1..4> /Intercon-Prot /LVRT[1] /LVRT Profile]
t3 	Point in time for the corresponding voltage value $V(t(n))$. These points define the LVRT profile.	0.00 - 20.00s	0.15s	[Protection Para /<1..4> /Intercon-Prot /LVRT[1] /LVRT Profile]
V(t4) 	Voltage value of a point $V(t(n))$. These points define the LVRT profile.	0.00 - 2.00Vn	0.70Vn	[Protection Para /<1..4> /Intercon-Prot /LVRT[1] /LVRT Profile]
t4 	Point in time for the corresponding voltage value $V(t(n))$. These points define the LVRT profile.	0.00 - 20.00s	0.70s	[Protection Para /<1..4> /Intercon-Prot /LVRT[1] /LVRT Profile]
V(t5) 	Voltage value of a point $V(t(n))$. These points define the LVRT profile.	0.00 - 2.00Vn	0.90Vn	[Protection Para /<1..4> /Intercon-Prot /LVRT[1] /LVRT Profile]

Parameter	Description	Setting range	Default	Menu path
t5 	Point in time for the corresponding voltage value $V(t(n))$. These points define the LVRT profile.	0.00 - 20.00s	1.50s	[Protection Para /<1..4> /Intercon-Prot /LVRT[1] /LVRT Profile]
V(t6) 	Voltage value of a point $V(t(n))$. These points define the LVRT profile.	0.00 - 2.00Vn	0.90Vn	[Protection Para /<1..4> /Intercon-Prot /LVRT[1] /LVRT Profile]
t6 	Point in time for the corresponding voltage value $V(t(n))$. These points define the LVRT profile.	0.00 - 20.00s	3.00s	[Protection Para /<1..4> /Intercon-Prot /LVRT[1] /LVRT Profile]
V(t7) 	Voltage value of a point $V(t(n))$. These points define the LVRT profile.	0.00 - 2.00Vn	0.90Vn	[Protection Para /<1..4> /Intercon-Prot /LVRT[1] /LVRT Profile]
t7 	Point in time for the corresponding voltage value $V(t(n))$. These points define the LVRT profile.	0.00 - 20.00s	3.00s	[Protection Para /<1..4> /Intercon-Prot /LVRT[1] /LVRT Profile]
V(t8) 	Voltage value of a point $V(t(n))$. These points define the LVRT profile.	0.00 - 2.00Vn	0.90Vn	[Protection Para /<1..4> /Intercon-Prot /LVRT[1] /LVRT Profile]

<i>Parameter</i>	<i>Description</i>	<i>Setting range</i>	<i>Default</i>	<i>Menu path</i>
t8 	Point in time for the corresponding voltage value $V(t(n))$. These points define the LVRT profile.	0.00 - 20.00s	3.00s	[Protection Para /<1..4> /Intercon-Prot /LVRT[1] /LVRT Profile]
V(t9) 	Voltage value of a point $V(t(n))$. These points define the LVRT profile.	0.00 - 2.00Vn	0.90Vn	[Protection Para /<1..4> /Intercon-Prot /LVRT[1] /LVRT Profile]
t9 	Point in time for the corresponding voltage value $V(t(n))$. These points define the LVRT profile.	0.00 - 20.00s	3.00s	[Protection Para /<1..4> /Intercon-Prot /LVRT[1] /LVRT Profile]
V(t10) 	Voltage value of a point $V(t(n))$. These points define the LVRT profile.	0.00 - 2.00Vn	0.90Vn	[Protection Para /<1..4> /Intercon-Prot /LVRT[1] /LVRT Profile]
t10 	Point in time for the corresponding voltage value $V(t(n))$. These points define the LVRT profile.	0.00 - 20.00s	3.00s	[Protection Para /<1..4> /Intercon-Prot /LVRT[1] /LVRT Profile]

General application notes on setting the LVRT

The LVRT menu comprises among other things the following parameters:

- By means of »Vstart«, the LVRT will be started (triggered).
- By means of »Vrecover« the LVRT will detect the end of the disturbance.
- Please note, that the »Vrecover« should be greater than »Vstart«. If this is not the case, the internal plausibility supervision will set »Vrecover« to 103% of »Vstart«.
- »Vk«, »tk« are the set points for setting the LVRT-profile.

Special application notes on setting the LVRT-profile

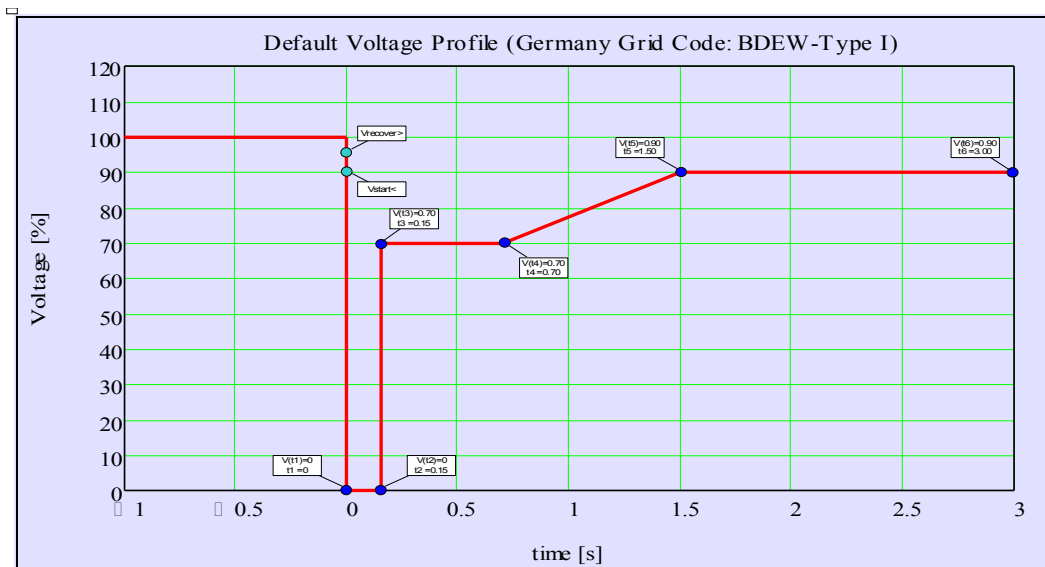

- In many cases not all available setpoints are needed in order to build up the LVRT-profile.
- In case that not all available setpoints are used, the unused setpoints can be set to the same values as the last set point.
- Set points should be selected in a manner of left-to-right with time begin at t=0 (tk+1>tk).
- The voltage setpoints must be selected in a ascending manner (Vk+1>Vk).
- The voltage value for last used set point should be set greater than the starting voltage. If this is not the case, the starting voltage will be modified internally to the value of maximum voltage set value.

In general the factory default LVRT-profile is preset based on the Type-I curve from Germany Grid Code¹⁾ (BDEW 2008) as shown in the following drawing:



LVRT-Default Profile (BDEW-TypI)

Global Protection Parameters of the Low-Voltage-Ride-Through

Parameter	Description	Setting range	Default	Menu path
 ExBlo1	External blocking of the module, if blocking is activated (allowed) within a parameter set and if the state of the assigned signal is true.	1..n, Assignment List	.-	[Protection Para /Global Prot Para /Intercon-Prot /LVRT[1]]
 ExBlo2	External blocking of the module, if blocking is activated (allowed) within a parameter set and if the state of the assigned signal is true.	1..n, Assignment List	.-	[Protection Para /Global Prot Para /Intercon-Prot /LVRT[1]]
 ExBlo TripCmd	External blocking of the Trip Command of the module/the stage, if blocking is activated (allowed) within a parameter set and if the state of the assigned signal is true.	1..n, Assignment List	.-	[Protection Para /Global Prot Para /Intercon-Prot /LVRT[1]]

Inputs of the Low-Voltage-Ride-Through

Name	Description	Assignment via
ExBlo1-I	Module input state: External blocking1	[Protection Para /Global Prot Para /Intercon-Prot /LVRT[1]]
ExBlo2-I	Module input state: External blocking2	[Protection Para /Global Prot Para /Intercon-Prot /LVRT[1]]
ExBlo TripCmd-I	Module input state: External Blocking of the Trip Command	[Protection Para /Global Prot Para /Intercon-Prot /LVRT[1]]

Signals (Output States) of the Low-Voltage-Ride-Through

<i>Signal</i>	<i>Description</i>
active	Signal: active
ExBlo	Signal: External Blocking
Blo TripCmd	Signal: Trip Command blocked
ExBlo TripCmd	Signal: External Blocking of the Trip Command
Alarm L1	Signal: Alarm L1
Alarm L2	Signal: Alarm L2
Alarm L3	Signal: Alarm L3
Alarm	Signal: Alarm voltage stage
Trip L1	Signal: General Trip Phase L1
Trip L2	Signal: General Trip Phase L2
Trip L3	Signal: General Trip Phase L3
Trip	Signal: Trip
TripCmd	Signal: Trip Command
t-LVRT is running	Signal: t-LVRT is running

Counter Values of the Low-Voltage-Ride-Through

<i>Value</i>	<i>Description</i>	<i>Menu path</i>
NumOf Vdips in t-LVRT	Number of Voltage dips during t-LVRT	[Operation /Count and RevData /LVRT[1]]
Cr Tot Numb of Vdips	Counter Total number of voltage dips.	[Operation /Count and RevData /LVRT[1]]
Cr Tot Numb of Vdips to Trip	Counter Total number of voltage dips that caused a Trip.	[Operation /Count and RevData /LVRT[1]]

Direct Commands of the Low-Voltage-Ride-Through

<i>Parameter</i>	<i>Description</i>	<i>Setting range</i>	<i>Default</i>	<i>Menu path</i>
Res LVRT Cr 	Reset of the counter for the total number of voltage dips and reset of the counter of the total number of voltage dips that caused a trip.	inactive, active	inactive	[Operation /Reset]

References:

¹ Technische Richtlinie „Erzeugungsanlagen am Mittelspannungsnetz – Richtlinie für Anschluss und Parallelbetrieb von Erzeugungsanlagen am Mittelspannungsnetz“, Juni 2008, BDEW, Berlin

² IEEE Std 1547™-2003, IEEE Standard for Interconnecting Distributed Resources with Electric Power Systems.

³ Title: Can China Wind Power meet the challenge of “Low-Voltage-Ride-Through” Date: 18.05.2011 Author: Shi Feng-Lei.
<http://energy.people.com.cn/GB/14667118.html>.

Intertripping (Remote)

Elements:
Intertripping

This module enables intertripping (executing external trip commands)

Application Example

Several Distributed Energy Resources are feeding mains parallel into the grid via one point of common coupling (PCC).

A mains protection relay is mounted at the point of common coupling. This might be a distance protection relay that protects the outgoing transmission line.

Let us assume that the outgoing transmission line becomes faulty ❶.

The feeding Distributed Energy Resources will be disconnected from the outgoing transmission line.

Now the produced electrical energy cannot be fed into the grid.

The element „Intertripping“ provides the option to pass the trip command from the mains protection device to the feeding distributed energy resource.

The trip decision of the mains protection relay (at the point of common coupling) will be transmitted via Digital Inputs to the „Intertripping“ elements of the protective devices of the distributed energy resources within the downstream ❷.

The feeding distributed energy resources will overtake the trip command and the corresponding infeeds will be disconnected from the mains ❸. The trip decision of the mains protection device within the upstream will be overtaken.

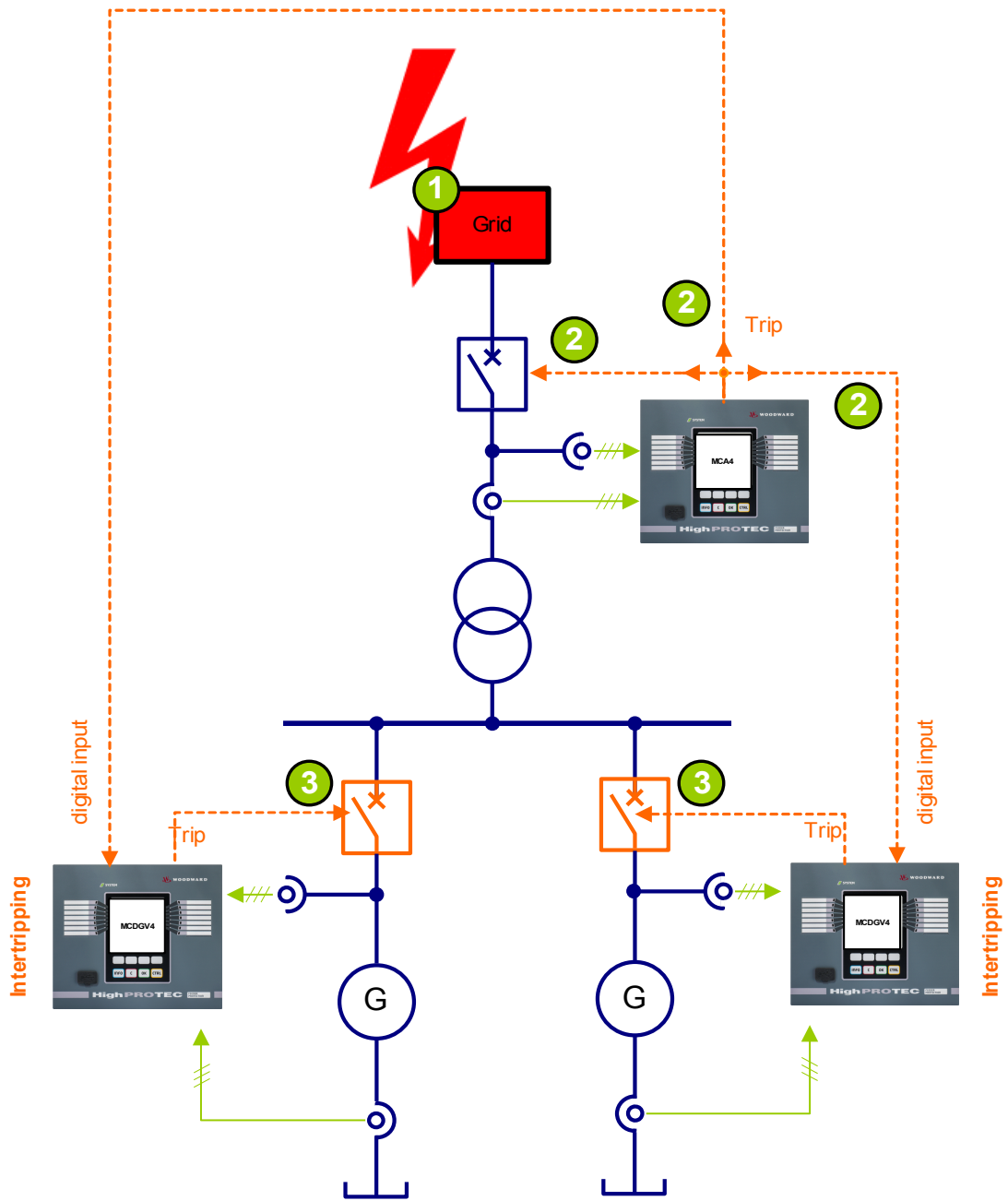

name = Remote Trip

Remote Trip



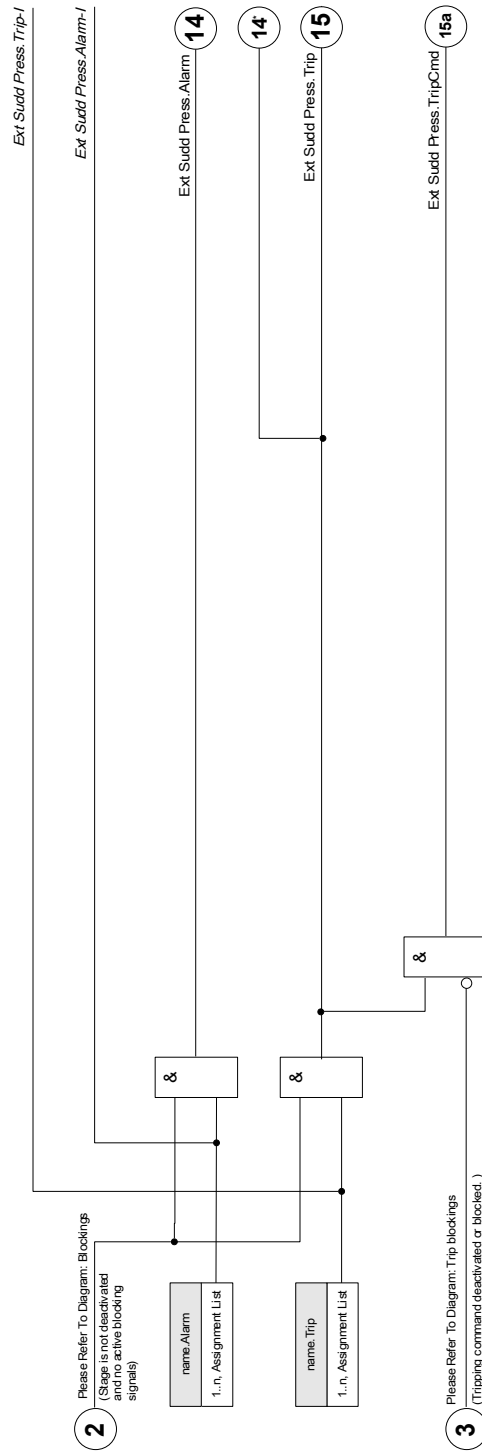

*=If no signal is assigned to the alarm input



Device Planning Parameters of the Intertripping Module

Parameter	Description	Options	Default	Menu path
Mode 	Mode	do not use, use	do not use	[Device planning]





Global Protection Parameters of the Intertripping Module

Parameter	Description	Setting range	Default	Menu path
ExBlo1 	External blocking of the module, if blocking is activated (allowed) within a parameter set and if the state of the assigned signal is true.	1..n, Assignment List	-.-	[Protection Para /Global Prot Para /Intercon-Prot /Mains Decouplg /Intertripping]
ExBlo2 	External blocking of the module, if blocking is activated (allowed) within a parameter set and if the state of the assigned signal is true.	1..n, Assignment List	-.-	[Protection Para /Global Prot Para /Intercon-Prot /Mains Decouplg /Intertripping]
ExBlo TripCmd 	External blocking of the Trip Command of the module/the stage, if blocking is activated (allowed) within a parameter set and if the state of the assigned signal is true.	1..n, Assignment List	-.-	[Protection Para /Global Prot Para /Intercon-Prot /Mains Decouplg /Intertripping]
Alarm 	Assignment for External Alarm	1..n, Assignment List	-.-	[Protection Para /Global Prot Para /Intercon-Prot /Mains Decouplg /Intertripping]

Protective Elements

<i>Parameter</i>	<i>Description</i>	<i>Setting range</i>	<i>Default</i>	<i>Menu path</i>
Trip 	External trip of the CB if the state of the assigned signal is true.	1..n, Assignment List	.-	[Protection Para /Global Prot Para /Intercon-Prot /Mains Decouplg /Intertripping]

Setting Group Parameters of the Intertripping Module

<i>Parameter</i>	<i>Description</i>	<i>Setting range</i>	<i>Default</i>	<i>Menu path</i>
Function 	Permanent activation or deactivation of module/stage.	inactive, active	inactive	[Protection Para /<1..4> /Intercon-Prot /Mains Decouplg /Intertripping]
ExBlo Fc 	Activate (allow) or inactivate (disallow) blocking of the module/stage. This parameter is only effective if a signal is assigned to the corresponding global protection parameter. If the signal becomes true, those modules/stages are blocked that are parameterized "ExBlo Fc=active".	inactive, active	inactive	[Protection Para /<1..4> /Intercon-Prot /Mains Decouplg /Intertripping]
Blo TripCmd 	Permanent blocking of the Trip Command of the module/stage.	inactive, active	inactive	[Protection Para /<1..4> /Intercon-Prot /Mains Decouplg /Intertripping]
ExBlo TripCmd Fc 	Activate (allow) or inactivate (disallow) blocking of the module/stage. This parameter is only effective if a signal is assigned to the corresponding global protection parameter. If the signal becomes true, those modules/stages are blocked that are parameterized "ExBlo TripCmd Fc=active".	inactive, active	inactive	[Protection Para /<1..4> /Intercon-Prot /Mains Decouplg /Intertripping]

Intertripping Module Input States

<i>Name</i>	<i>Description</i>	<i>Assignment via</i>
ExBlo1-I	Module input state: External blocking1	[Protection Para /Global Prot Para /Intercon-Prot /Mains Decouplg /Intertripping]
ExBlo2-I	Module input state: External blocking2	[Protection Para /Global Prot Para /Intercon-Prot /Mains Decouplg /Intertripping]
ExBlo TripCmd-I	Module input state: External Blocking of the Trip Command	[Protection Para /Global Prot Para /Intercon-Prot /Mains Decouplg /Intertripping]
Alarm-I	Module input state: Alarm	[Protection Para /Global Prot Para /Intercon-Prot /Mains Decouplg /Intertripping]
Trip-I	Module input state: Trip	[Protection Para /Global Prot Para /Intercon-Prot /Mains Decouplg /Intertripping]

Intertripping Module Signals (Output States)

<i>Signal</i>	<i>Description</i>
active	Signal: active
ExBlo	Signal: External Blocking
Blo TripCmd	Signal: Trip Command blocked
ExBlo TripCmd	Signal: External Blocking of the Trip Command
Alarm	Signal: Alarm
Trip	Signal: Trip
TripCmd	Signal: Trip Command

Commissioning: Intertripping

Object to be tested:

Test of the Intertripping (Remote) module.

Necessary means:

Dependent on the application.

Procedure:

Simulate the functionality of the Intertripping Trip (pickup, trip, blockings) by (de-)energizing of the digital inputs.

Successful test result:

All external pickups, external trips, and external blockings are correctly recognized and processed by the device.

PQS - Power [32, 37]

Available stages:

PQS[1] .PQS[2] .PQS[3] .PQS[4] .PQS[5] .PQS[6]

Each of the elements can be used as P<, P>, Pr>, Q<, Q>, Qr>, S< or S> within the device planning.

P< and P> are settable and effective in positive active power range, Q< and Q> in positive reactive power range. These modes are used for protecting against underload or overload in positive power direction.

The apparent power makes S< or S> effective like a circle in all power quadrants. Protection is against underload and overload.

In reverse mode, Pr> is effective in negative active power range and Qr> in negative reactive power range. Both modes protect against power direction reversing from positive into negative direction.

The following graphics show the areas that are protected by the corresponding modes.

Setting the Thresholds

All settings/thresholds within the power module are to be set as per unit thresholds. Per definition S_n is to be used as scale basis.

$$S_n = \sqrt{3} * \text{VoltageTransformer}_{\text{Line-to-Line_Rated_Voltage}} * \text{CurrentTransformer}_{\text{Rated_Current}}$$

If thresholds should base on primary side values:

$$S_n = \sqrt{3} * \text{VoltageTransformer}_{\text{Pri_Line-to-Line_Rated_Voltage}} * \text{CurrentTransformer}_{\text{Pri_Rated_Current}}$$

If thresholds should base on secondary side values

$$S_n = \sqrt{3} * \text{VoltageTransformer}_{\text{Sec_Line-to-Line_Rated_Voltage}} * \text{CurrentTransformer}_{\text{Sec_Rated_Current}}$$

Example – Field Data

- CurrentTransformer CT pri =200 A; CT sec = 5 A
- VoltageTransformer VT pri = 10 kV; VT sec =100 V
- Generator rated power 2 MVA
- Reverse power should trip at 3%.

Setting Example 1 for Pr> based on primary side values

Reverse power should trip at 3%. That means 60 kW (on primary side).

First S_n is to be calculated:

$$S_n = \sqrt{3} * \text{VoltageTransformer}_{\text{Pri_Line-to-Line_Rated_Voltage}} * \text{CurrentTransformer}_{\text{Pri_Rated_Current}}$$

$$S_n = 1.73 * 10000 \text{ V} * 200 \text{ A} = 3.464 \text{ MVA}$$

The following threshold is to be set for Pr> within the device = 60 kW / S_n

$$\text{Pr>} = 60 \text{ kW} / 3464 \text{ kVA} = \underline{0,0173} \cdot S_n$$

Setting Example 1 for Pr> based on secondary side values

Reverse power should trip at 3%. That means 60 kW (on primary side).

First S_n is to be calculated:

$$S_n = \sqrt{3} * \text{VoltageTransformer}_{\text{Sec_Line-to-Line_Rated_Voltage}} * \text{CurrentTransformer}_{\text{Sec_Rated_Current}}$$

$$S_n = 1,73 * 100 \text{ V} * 5 \text{ A} = 866,05 \text{ VA}$$

Convert the reverse power onto the secondary side:

$$Pr_{\text{sec}>} = Pr_{\text{Pri}>} / (VT_{\text{Pri_VLL Rated}} / VT_{\text{Sec_VLL Rated}} * CT_{\text{Pri Rated Current}} / CT_{\text{Sec Rated Current}}) = 60 \text{ kW} / 4000 = 15 \text{ W}$$

The following threshold is to be set for Pr> within the device = 15W / S_n

$$Pr> = 15 \text{ W} / 866 \text{ VA} = \underline{0,0173 S_n}$$

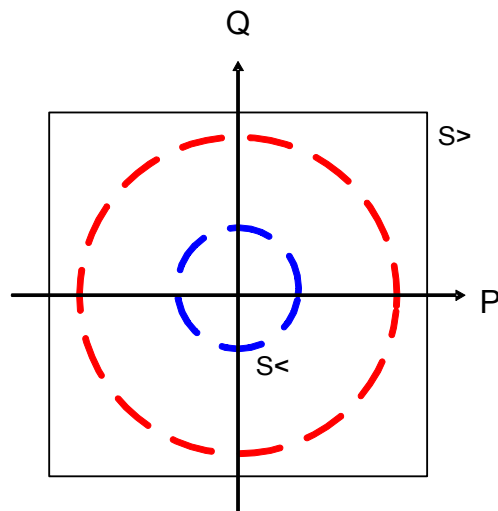
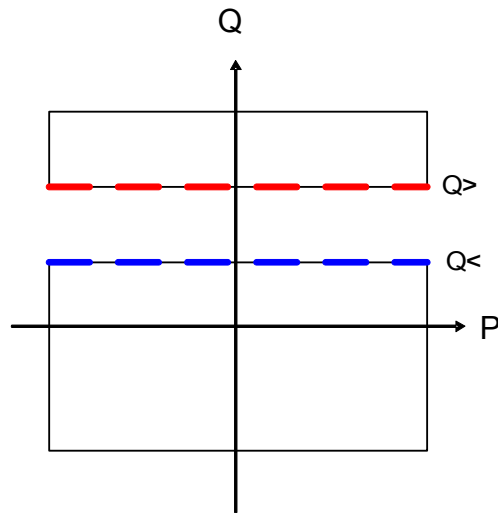
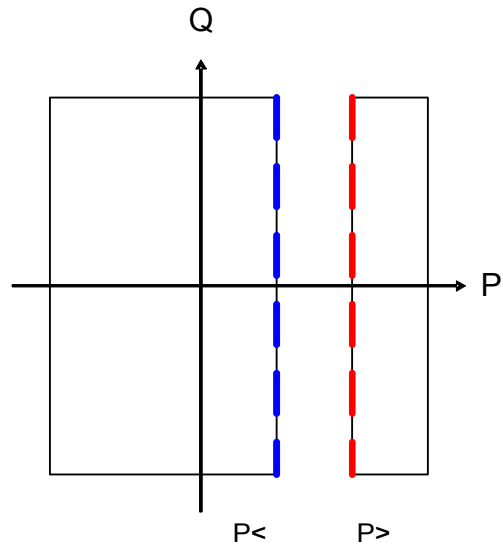

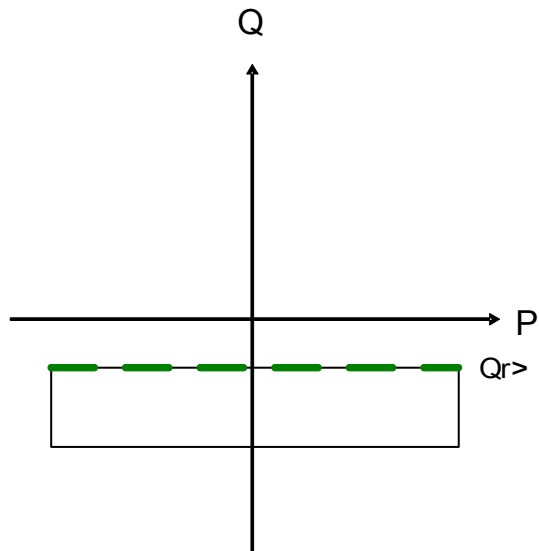
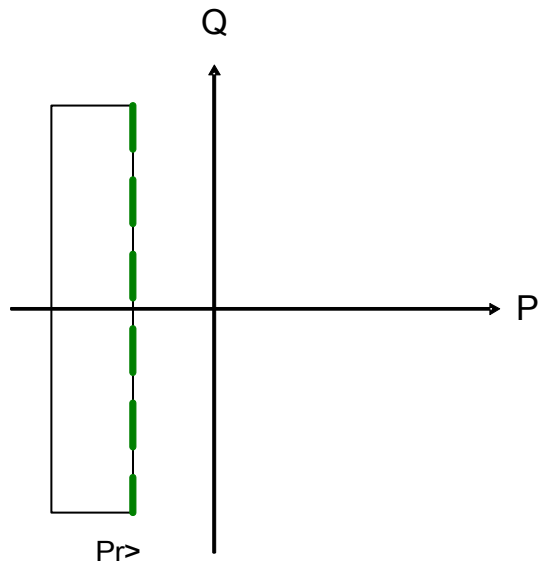

PQS[1]...[n]

name = PQS[1]...[n]

2 Please Refer To Diagram: Blockings
(Stage is not deactivatd and no active blockings)

38a 38b

name.Alarm 14

40

name.Trip 15

name.TripCmd 15a

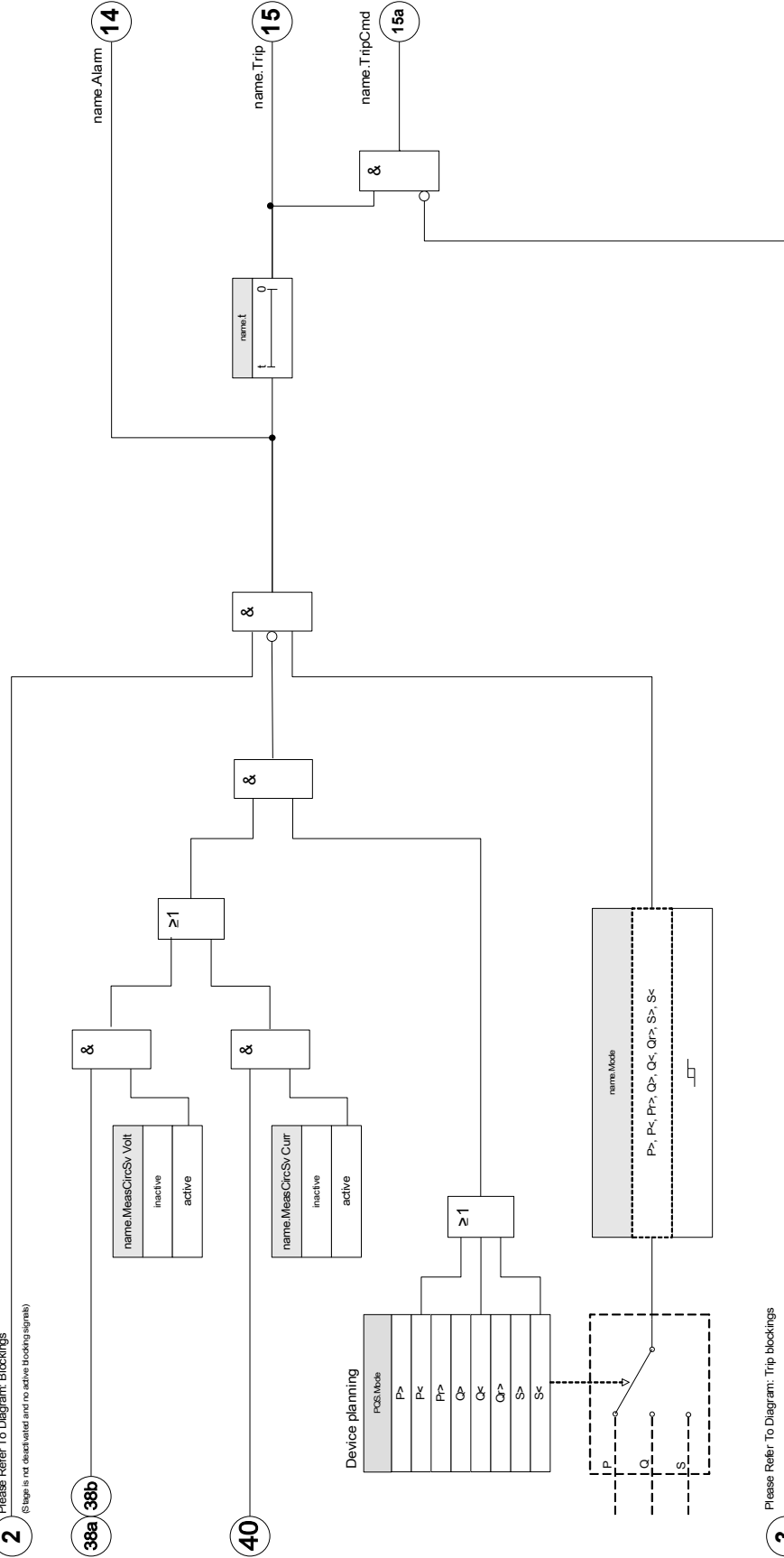



3 Please Refer To Diagram: Trip blockings
(Tripping command deactivatd or blocked)

Device planning parameters of the Power Protection module





Parameter	Description	Options	Default	Menu path
Mode 	Mode	do not use, P>, P<, Pr<, Pr>, Q>, Q<, Qr<, Qr>, S>, S<	PQS[1]: P> PQS[2]: do not use PQS[3]: do not use PQS[4]: do not use PQS[5]: do not use PQS[6]: do not use	[Device planning]







Global protection parameter of the Power Protection-module

Parameter	Description	Setting range	Default	Menu path
ExBlo1 	External blocking of the module, if blocking is activated (allowed) within a parameter set and if the state of the assigned signal is true.	1..n, Assignment List	.-	[Protection Para /Global Prot Para /P-Prot /PQS[1]]
ExBlo2 	External blocking of the module, if blocking is activated (allowed) within a parameter set and if the state of the assigned signal is true.	1..n, Assignment List	.-	[Protection Para /Global Prot Para /P-Prot /PQS[1]]
ExBlo TripCmd 	External blocking of the Trip Command of the module/the stage, if blocking is activated (allowed) within a parameter set and if the state of the assigned signal is true.	1..n, Assignment List	.-	[Protection Para /Global Prot Para /P-Prot /PQS[1]]

Parameter set parameters of the Power Protection module

Parameter	Description	Setting range	Default	Menu path
 Function	Permanent activation or deactivation of module/stage.	inactive, active	PQS[1]: active PQS[2]: inactive PQS[3]: inactive PQS[4]: inactive PQS[5]: inactive PQS[6]: inactive	[Protection Para /<1..4> /P-Prot /PQS[1]]
 ExBlo Fc	Activate (allow) or inactivate (disallow) blocking of the module/stage. This parameter is only effective if a signal is assigned to the corresponding global protection parameter. If the signal becomes true, those modules/stages are blocked that are parameterized "ExBlo Fc=active".	inactive, active	inactive	[Protection Para /<1..4> /P-Prot /PQS[1]]
 Blo TripCmd	Permanent blocking of the Trip Command of the module/stage.	inactive, active	inactive	[Protection Para /<1..4> /P-Prot /PQS[1]]
 ExBlo TripCmd Fc	Activate (allow) or inactivate (disallow) blocking of the module/stage. This parameter is only effective if a signal is assigned to the corresponding global protection parameter. If the signal becomes true, those modules/stages are blocked that are parameterized "ExBlo TripCmd Fc=active".	inactive, active	inactive	[Protection Para /<1..4> /P-Prot /PQS[1]]
 MeasCircSv Volt	Measuring Circuit Supervision Voltage Only available if: Device planning: PQS.Mode = P< Only available if: Device planning: PQS.Mode = Q< Only available if: Device planning: PQS.Mode = S<	inactive, active	inactive	[Protection Para /<1..4> /P-Prot /PQS[1]]
 MeasCircSv Curr	Measuring Circuit Supervision Curent Only available if: Device planning: PQS.Mode = P< Only available if: Device planning: PQS.Mode = Q< Only available if: Device planning: PQS.Mode = S<	inactive, active	inactive	[Protection Para /<1..4> /P-Prot /PQS[1]]

Parameter	Description	Setting range	Default	Menu path
P> 	Over(load) Active Power Pickup Value. Can be used for monitoring the maximum allowed forward power limits of transformers or overhead lines. Definition for Sn is as follows: $S_n = 1.7321 * VT \text{ rating} * CT \text{ rating}$. The voltage is the line-to-line voltage. Only available if: Device planning: PQS.Mode = P>	0.003 - 10.000Sn	PQS[1]: 1.0Sn PQS[2]: 1.20Sn PQS[3]: 1.20Sn PQS[4]: 1.20Sn PQS[5]: 1.20Sn PQS[6]: 1.20Sn	[Protection Para /<1..4> /P-Prot /PQS[1]]
P< 	Under(load) Active Power Pickup Value (e.g. caused by idling motors). Definition for Sn is as follows: $S_n = 1.7321 * VT \text{ rating} * CT \text{ rating}$. The voltage is the line-to-line voltage. Only available if: Device planning: PQS.Mode = P<	0.003 - 10.000Sn	0.80Sn	[Protection Para /<1..4> /P-Prot /PQS[1]]
Pr> 	Overload Reverse Active Power Pickup Value. Protection against reverse feeding into the power supply network. Definition for Sn is as follows: $S_n = 1.7321 * VT \text{ rating} * CT \text{ rating}$. The voltage is the line-to-line voltage. Only available if: Device planning: PQS.Mode = Pr>	0.003 - 10.000Sn	0.020Sn	[Protection Para /<1..4> /P-Prot /PQS[1]]
Pr< 	Under Reverse Definition for Sn is as follows: $S_n = 1.7321 * VT \text{ rating} * CT \text{ rating}$. The voltage is the line-to-line voltage. Only available if: Device planning: PQS.Mode = P	0.003 - 10.000Sn	0.80Sn	[Protection Para /<1..4> /P-Prot /PQS[1]]
Q> 	Over(load) Reactive Power Pickup Value. Monitoring the maximum allowed reactive power of the electrical equipment like transformers or overhead lines). If the maximum value is exceeded a condenser bank could be switched off. Definition for Sn is as follows: $S_n = 1.7321 * VT \text{ rating} * CT \text{ rating}$. The voltage is the line-to-line voltage. Only available if: Device planning: PQS.Mode = Q>	0.003 - 10.000Sn	1.20Sn	[Protection Para /<1..4> /P-Prot /PQS[1]]

Parameter	Description	Setting range	Default	Menu path
Q< 	Under(load) Reactive Power Pickup Value. Monitoring the minimum value of the reactive power. If it falls below the set value a condensator bank could be switched on. Definition for Sn is as follows: $S_n = 1.7321 * VT \text{ rating} * CT \text{ rating}$. The voltage is the line-to-line voltage. Only available if: Device planning: PQS.Mode = Q<	0.003 - 10.000Sn	0.80Sn	[Protection Para /<1..4> /P-Prot /PQS[1]]
Qr> 	Overload Reverse Reactive Power Pickup Value Definition for Sn is as follows: $S_n = 1.7321 * VT \text{ rating} * CT \text{ rating}$. The voltage is the line-to-line voltage. Only available if: Device planning: PQS.Mode = Qr>	0.003 - 10.000Sn	0.020Sn	[Protection Para /<1..4> /P-Prot /PQS[1]]
Qr< 	Under Reverse Definition for Sn is as follows: $S_n = 1.7321 * VT \text{ rating} * CT \text{ rating}$. The voltage is the line-to-line voltage. Only available if: Device planning: PQS.Mode = Q	0.003 - 10.000Sn	0.80Sn	[Protection Para /<1..4> /P-Prot /PQS[1]]
S> 	Over(load) Apparent Power Pickup Value Definition for Sn is as follows: $S_n = 1.7321 * VT \text{ rating} * CT \text{ rating}$. The voltage is the line-to-line voltage. Only available if: Device planning: PQS.Mode = S>	0.02 - 10.00Sn	1.20Sn	[Protection Para /<1..4> /P-Prot /PQS[1]]
S< 	Under(load) Apparent Power Pickup Value Definition for Sn is as follows: $S_n = 1.7321 * VT \text{ rating} * CT \text{ rating}$. The voltage is the line-to-line voltage. Only available if: Device planning: PQS.Mode = S<	0.02 - 10.00Sn	0.80Sn	[Protection Para /<1..4> /P-Prot /PQS[1]]
t 	Tripping delay	0.00 - 1100.00s	PQS[1]: 1.00s PQS[2]: 0.01s PQS[3]: 0.01s PQS[4]: 0.01s PQS[5]: 0.01s PQS[6]: 0.01s	[Protection Para /<1..4> /P-Prot /PQS[1]]
PowMeasMethod 	Determines if the active power, reactive power and apparent power are calculated on the basis of RMS or DFT.	Fundamental, True RMS	Fundamental	[Protection Para /<1..4> /P-Prot /PQS[1]]

States of the inputs of the Power Protection module

<i>Name</i>	<i>Description</i>	<i>Assignment via</i>
ExBlo1-I	Module input state: External blocking	[Protection Para /Global Prot Para /P-Prot /PQS[1]]
ExBlo2-I	Module input state: External blocking	[Protection Para /Global Prot Para /P-Prot /PQS[1]]
ExBlo TripCmd-I	Module input state: External Blocking of the Trip Command	[Protection Para /Global Prot Para /P-Prot /PQS[1]]

Signals of the Power Protection module (states of the outputs)

<i>Signal</i>	<i>Description</i>
active	Signal: active
ExBlo	Signal: External Blocking
Blo TripCmd	Signal: Trip Command blocked
ExBlo TripCmd	Signal: External Blocking of the Trip Command
Alarm	Signal: Alarm Power Protection
Trip	Signal: Trip Power Protection
TripCmd	Signal: Trip Command

Commissioning Examples for the Power Protection Module

Object to be tested

- Testing the projected Power Protection Modules.
- P>
- P<
- Pr
- Q>
- Q<
- Qr
- S>
- S<

Necessary means

- 3-phase AC voltage source
- 3-phase AC current source
- Timer

Procedure – Testing the wiring

- Feed rated voltage and rated current to the measuring inputs of the relay.
- Adjust the current pointers 30° lagging to the voltage pointers.
- The following measuring values have to be shown:
P=0.86 P_n
Q=0.5 Q_n
S=1 S_n

NOTICE

If the measured values are shown with a negative (algebraic) sign check the wiring.

NOTICE

The examples shown within this chapter have to be carried out with the tripping values and tripping delays that apply to your switchboard.

If you are testing „greater than thresholds“ (e.g. P>) start by 80% of the tripping value and increase the object to be tested until the relay picks up.

In case that you are testing „less than thresholds“ (e.g. P<) start by 120% of the tripping value and reduce the object to be tested until the relay picks up.

If you are testing tripping delays of „greater than“ modules (e.g. P>) start a timer simultaneously with an abrupt change of the object to be tested from 80% of the tripping value to 120% of the tripping value.

If you are testing tripping delays of „less than“ modules (e.g. P<) start a timer simultaneously with an abrupt change of the object to be tested from 120% of the tripping value to 80% of the tripping value.

NOTICE

P>

Testing the threshold values (Example, Threshold 1.1 Pn)

- Feed rated voltage and 0.9 times rated current in phase to the measuring inputs of the relay (PF=1).
- The measured values for the active power „P“ must show a positive algebraic sign.
- Set the tripping threshold (e.g. 1.1 Pn).
- In order to test the tripping thresholds feed 0.9 times rated current to the measuring inputs of the relay. Increase the current slowly until the relay picks up. Ensure that the angle between current and voltage remains constant. Compare the tripping value to the parameterized.

Testing the tripping delay (Example, Threshold 1.1 Pn)

- Feed rated voltage and rated current in phase to the measuring inputs of the relay (PF=1).
- The measured values for the active power „P“ must show a positive algebraic sign.
- Set the tripping threshold (e.g. 1.1 Pn).
- In order to test the tripping delay feed 0.9 times rated current to the measuring inputs of the relay. Increase the current with an abrupt change to 1.2 In. Ensure that the angle between current and voltage remains constant. Measure the tripping delay at the output of the relay.

Successful test result

The measured total tripping delays or individual tripping delays, threshold values and fallback ratios correspond with those values, specified in the adjustment list. Permissible deviations/tolerances can be found under Technical Data.

NOTICE

Q>

Testing the threshold values (Example, Threshold 1,1 Qn)

- Feed rated voltage and 0.9 times rated current (90° phase shift) to the measuring inputs of the relay (PF=0).
- The measured values for the active power „Q“ must show a positive algebraic sign.
- Set the tripping threshold (e.g. 1.1 Qn).
- In order to test the tripping thresholds feed 0.9 times rated current to the measuring inputs of the relay. Increase the current slowly until the relay picks up. Ensure that the angle between current and voltage remains constant. Compare the tripping value to the parameterized.

Testing the tripping delay (Example, Threshold 1.1 Qn)

- Feed rated voltage and rated current (90° phase shift) to the measuring inputs of the relay (PF=0).
- The measured values for the active power „Q“ must show a positive algebraic sign.
- Set the tripping threshold (e.g. 1.1 Qn).
- In order to test the tripping delay feed 0.9 times rated current to the measuring inputs of the relay. Increase the current with an abrupt change to 1.2 In. Ensure that the angle between current and voltage remains constant. Measure the tripping delay at the output of the relay.

Successful test result

The measured total tripping delays or individual tripping delays, threshold values and fallback ratios correspond with those values, specified in the adjustment list. Permissible deviations/tolerances can be found under Technical Data.

NOTICE

P<

Testing the threshold values (Example, Threshold 0.3 P_n)

- Feed rated voltage and rated current in phase to the measuring inputs of the relay (PF=1).
- The measured values for the active power „P“ must show a positive algebraic sign.
- Set the tripping threshold (e.g. 0.3 P_n).
- In order to test the tripping thresholds feed 0.5 times rated current to the measuring inputs of the relay. Reduce the current slowly until the relay picks up. Ensure that the angle between current and voltage remains constant. Compare the tripping value to the parameterized.

Testing the tripping delay (Example, Threshold 0.3 P_n)

- Feed rated voltage and rated current in phase to the measuring inputs of the relay (PF=1).
- The measured values for the active power „P“ must show a positive algebraic sign.
- Set the tripping threshold (e.g. 0.3 P_n).
- In order to test the tripping delay feed 0.5 times rated current to the measuring inputs of the relay. Increase the current with an abrupt change to 0.2 I_n. Ensure that the angle between current and voltage remains constant. Measure the tripping delay at the output of the relay.

Successful test result

The measured total tripping delays or individual tripping delays, threshold values and fallback ratios correspond with those values, specified in the adjustment list. Permissible deviations/tolerances can be found under Technical Data.

NOTICE

Q<

Testing the threshold values (Example, Threshold 0.3 Qn)

- Feed rated voltage and 0.9 times rated current (90° phase shift) to the measuring inputs of the relay (PF=0).
- The measured values for the active power „Q“ must show a positive algebraic sign.
- Set the tripping threshold (e.g. 0.3 Qn).
- In order to test the tripping thresholds feed 0.5 times rated current to the measuring inputs of the relay. Reduce the current slowly until the relay picks up. Ensure that the angle between current and voltage remains constant. Compare the tripping value to the parameterized.

Testing the tripping delay (Example, Threshold 0.3 Qn)

- Feed rated voltage and 0.9 times rated current (90° phase shift) to the measuring inputs of the relay (PF=0).
- The measured values for the active power „Q“ must show a positive algebraic sign.
- Set the tripping threshold (e.g. 0.3 Qn).
- In order to test the tripping delay feed 0.5 times rated current to the measuring inputs of the relay. Increase the current with an abrupt change to 0.2 In. Ensure that the angle between current and voltage remains constant. Measure the tripping delay at the output of the relay.

Successful test result

The measured total tripping delays or individual tripping delays, threshold values and fallback ratios correspond with those values, specified in the adjustment list. Permissible deviations/tolerances can be found under Technical Data.

NOTICE

Pr

Testing the threshold values (Example, Threshold 0.2 P_n)

- Feed rated voltage and rated current with 180 degree phase shift between voltage and current pointers to the measuring inputs of the relay.
- The measured values for the active power „P“ must show a negative algebraic sign.
- Set the tripping threshold (e. g. 0.2 P_n).
- In order to test the tripping thresholds feed 0.1 times rated current to the measuring inputs of the relay. Increase the current slowly until the relay picks up. Ensure that the angle between current and voltage remains constant. Compare the tripping value to the parameterized.

Testing the tripping delay (Example, Threshold 0.2 P_n)

- Feed rated voltage and rated current with 180 degree phase shift between voltage and current pointers to the measuring inputs of the relay.
- The measured values for the active power „P“ must show a negative algebraic sign.
- Set the tripping threshold (e.g. 0.2 P_n).
- In order to test the tripping delay feed 0.1 times rated current to the measuring inputs of the relay. Increase the current with an abrupt change to 0.3 I_n. Ensure that the angle between current and voltage remains constant. Measure the tripping delay at the output of the relay.

Successful test result

The measured total tripping delays or individual tripping delays, threshold values and fallback ratios correspond with those values, specified in the adjustment list. Permissible deviations/tolerances can be found under Technical Data.

NOTICE

Qr

Testing the threshold values (Example, Threshold 0.2 Qn)

- Feed rated voltage and rated current with -90 degree phase shift between voltage and current pointers to the measuring inputs of the relay.
- The measured values for the active power „Q“ must show a negative algebraic sign.
- Set the tripping threshold (e. g. 0.2 Qn).
- In order to test the tripping delay feed 0.1 times rated current to the measuring inputs of the relay. Increase the current slowly until the relay picks up. Ensure that the angle between current and voltage remains constant. Measure the tripping delay at the output of the relay.

Testing the tripping delay (Example, Threshold 0.2 Qn)

- Feed rated voltage and rated current with -90 degree phase shift between voltage and current pointers to the measuring inputs of the relay.
- The measured values for the active power „Q“ must show a negative algebraic sign.
- Set the tripping threshold (e. g. 0.2 Qn).
- In order to test the tripping thresholds feed 0.1 times rated current to the measuring inputs of the relay. Increase the current with an abrupt change to 0.3 In. Ensure that the angle between current and voltage remains constant. Compare the tripping value to the parameterized.

Successful test result

The measured total tripping delays or individual tripping delays, threshold values and fallback ratios correspond with those values, specified in the adjustment list. Permissible deviations/tolerances can be found under Technical Data.

NOTICE

S>

Testing the threshold values

- Feed 80% of the S> threshold to the measuring inputs of the relay.
- Increase the fed power slowly until the relay picks up. Compare the measured value at the time of tripping to the parameterized setting.

Testing the tripping delay

- Feed 80% of the S> threshold to the measuring inputs of the relay.
- Increase the fed power with an abrupt change to 120% of the S> threshold. Measure the tripping delay at the output of the relay.

Successful test result

The measured total tripping delays or individual tripping delays, threshold values and fallback ratios correspond with those values, specified in the adjustment list. Permissible deviations/tolerances can be found under Technical Data.

NOTICE

S<

Testing the threshold values

- Feed 120% of the S< threshold to the measuring inputs of the relay.
- Reduce the fed power slowly until the relay picks up. Compare the measured value at the time of tripping to the parameterized setting.

Testing the tripping delay

- Feed 120% of the S< threshold to the measuring inputs of the relay.
- Reduce the fed power with an abrupt change to 80% of the S< threshold. Measure the tripping delay at the output of the relay.

Successful test result

The measured total tripping delays or individual tripping delays, threshold values and fallback ratios correspond with those values, specified in the adjustment list. Permissible deviations/tolerances can be found under Technical Data.

PF - Power Factor [55]

Available stages:

PF[1].PF[2]

These Element supervises the Power Factor within a defined area (limits).

The area is defined by four parameters.

- The Trigger quadrant (lead or lag).
- The Threshold (Power Factor value)
- The Reset quadrant (lead or lag).
- The Reset Value (Power Factor value)

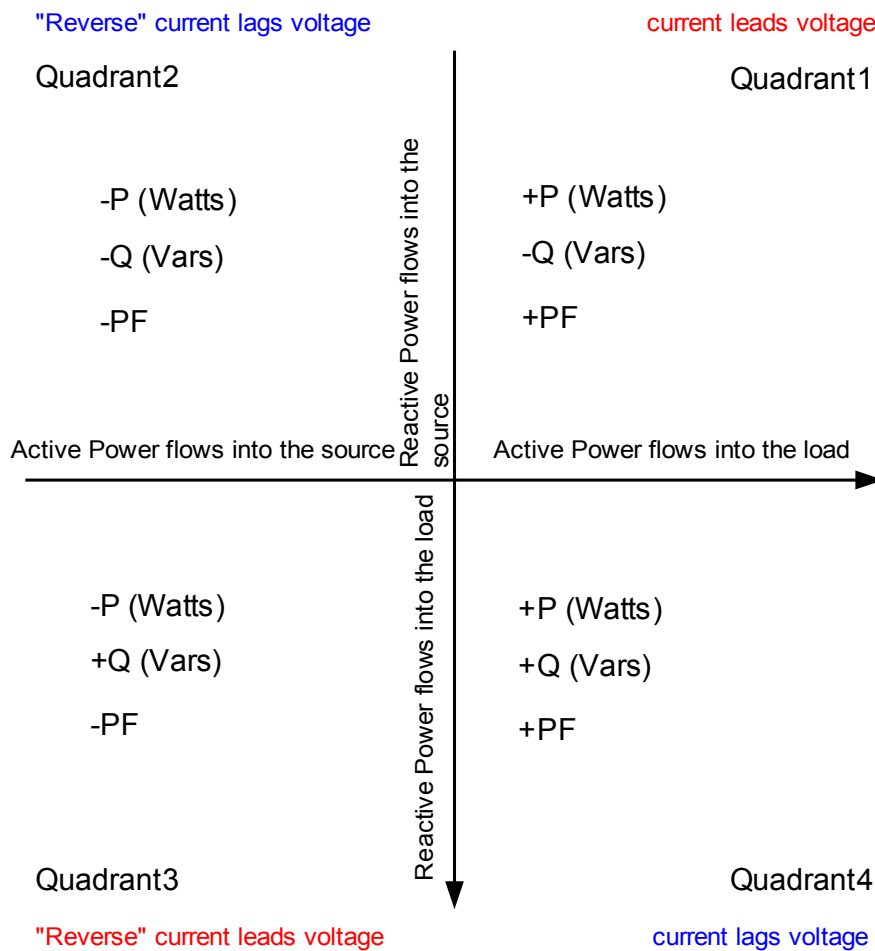

PF1]...[n]

name = PF1]...[n]

2 Please Refer To Diagram: Blockings
(Stage is not deactivated and no active blocking signals)

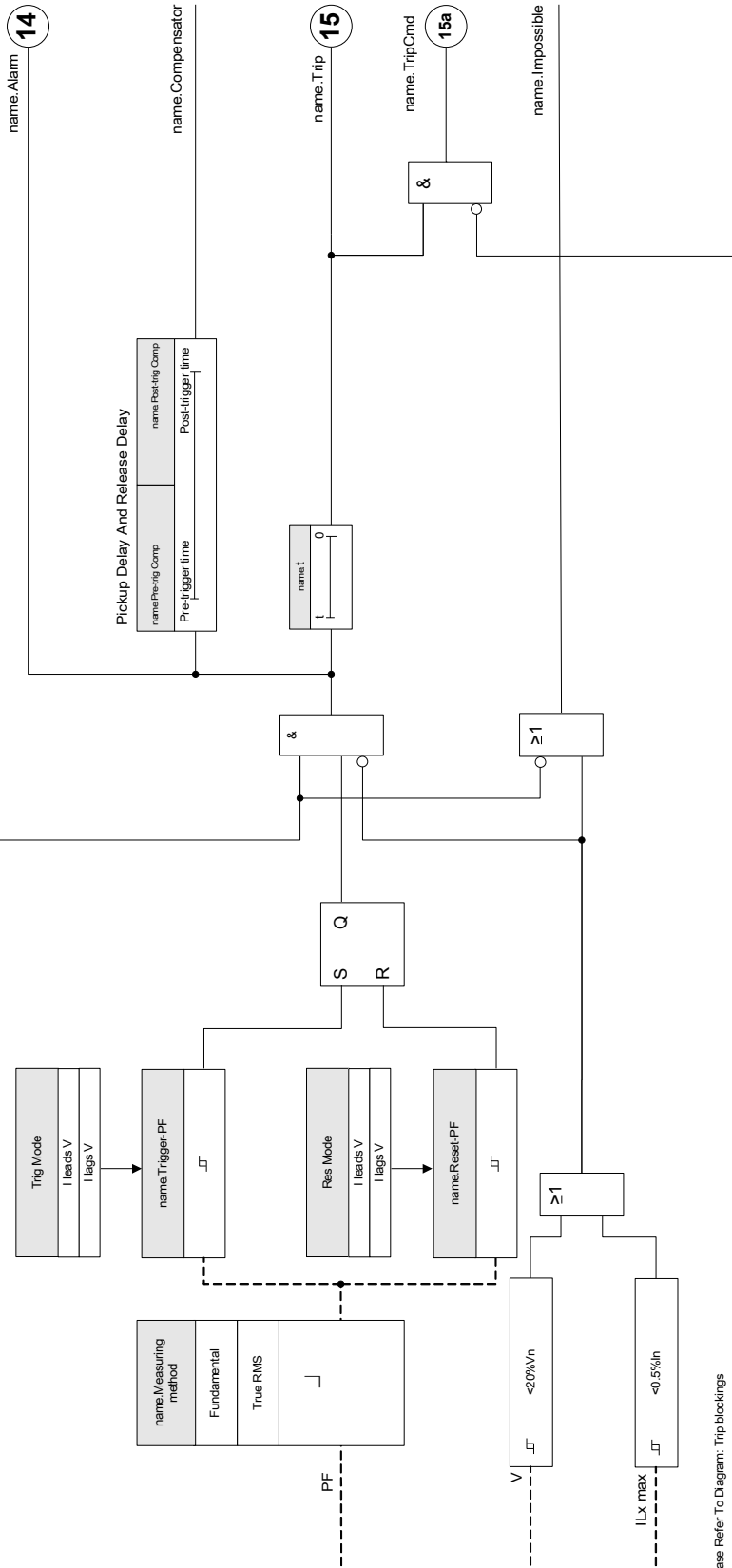



3 Please Refer To Diagram: Trip blockings
(Tripping command deactivated or blocked.)

Device planning parameters of the Power Factor module





Parameter	Description	Options	Default	Menu path
Mode 	Mode	do not use, use	do not use	[Device planning]

Global protection parameter of the Power Factor-module

Parameter	Description	Setting range	Default	Menu path
ExBlo1 	External blocking of the module, if blocking is activated (allowed) within a parameter set and if the state of the assigned signal is true.	1..n, Assignment List	-.-	[Protection Para /Global Prot Para /PF-Prot /PF[1]]
ExBlo2 	External blocking of the module, if blocking is activated (allowed) within a parameter set and if the state of the assigned signal is true.	1..n, Assignment List	-.-	[Protection Para /Global Prot Para /PF-Prot /PF[1]]
ExBlo TripCmd 	External blocking of the Trip Command of the module/the stage, if blocking is activated (allowed) within a parameter set and if the state of the assigned signal is true.	1..n, Assignment List	-.-	[Protection Para /Global Prot Para /PF-Prot /PF[1]]

Parameter set parameters of the Power Factor module

Parameter	Description	Setting range	Default	Menu path
Function 	Permanent activation or deactivation of module/stage.	inactive, active	inactive	[Protection Para /<1..4> /PF-Prot /PF[1]]
ExBlo Fc 	Activate (allow) or inactivate (disallow) blocking of the module/stage. This parameter is only effective if a signal is assigned to the corresponding global protection parameter. If the signal becomes true, those modules/stages are blocked that are parameterized "ExBlo Fc=active".	inactive, active	inactive	[Protection Para /<1..4> /PF-Prot /PF[1]]
Blo TripCmd 	Permanent blocking of the Trip Command of the module/stage.	inactive, active	inactive	[Protection Para /<1..4> /PF-Prot /PF[1]]
ExBlo TripCmd Fc 	Activate (allow) or inactivate (disallow) blocking of the module/stage. This parameter is only effective if a signal is assigned to the corresponding global protection parameter. If the signal becomes true, those modules/stages are blocked that are parameterized "ExBlo TripCmd Fc=active".	inactive, active	inactive	[Protection Para /<1..4> /PF-Prot /PF[1]]
Measuring method 	Measuring method: fundamental or rms or 3rd harmonic (only generator protection relays)	Fundamental, True RMS	Fundamental	[Protection Para /<1..4> /PF-Prot /PF[1]]
Trig Mode 	Trigger Mode. Should the Module be triggered if the Current Phasor is leading to the Voltage Phasor = Lead? Or should the Module be triggered if the Current Phasor is lagging to the Voltage Phasor = Lag?	I leads V, I lags V	I lags V	[Protection Para /<1..4> /PF-Prot /PF[1]]
Trigger-PF 	This is the power factor where the relay will pick-up.	0.5 - 0.99	0.8	[Protection Para /<1..4> /PF-Prot /PF[1]]

Parameter	Description	Setting range	Default	Menu path
 Res Mode	Trigger Mode. Should the Module be triggered if the Current Phasor is leading to the Voltage Phasor = Lead? Or should the Module be triggered if the Current Phasor is lagging to the Voltage Phasor = Lag?	I leads V, I lags V	I leads V	[Protection Para /<1..4> /PF-Prot /PF[1]]
 Reset-PF	This setting is the power factor, at which the relay will reset the power factor trip. It is like setting a hysteresis for the Trigger setting.	0.5 - 0.99	0.99	[Protection Para /<1..4> /PF-Prot /PF[1]]
 t	Tripping delay	0.00 - 300.00s	0.00s	[Protection Para /<1..4> /PF-Prot /PF[1]]
 Pre-trig Comp	Pickup (Pre-trigger) time for the Compensation Signal. When this timer is elapsed the compensation signal will be activated.	0.00 - 300.00s	5.00s	[Protection Para /<1..4> /PF-Prot /PF[1]]
 Post-trig Comp	Post-trigger time of the Compensation Signal. When this timer is elapsed the compensation signal will be deactivated.	0.00 - 300.00s	5.00s	[Protection Para /<1..4> /PF-Prot /PF[1]]

States of the inputs of the Power Factor module

Name	Description	Assignment via
ExBlo1-I	Module input state: External blocking	[Protection Para /Global Prot Para /PF-Prot /PF[1]]
ExBlo2-I	Module input state: External blocking	[Protection Para /Global Prot Para /PF-Prot /PF[1]]

Protective Elements

<i>Name</i>	<i>Description</i>	<i>Assignment via</i>
ExBlo TripCmd-I	Module input state: External Blocking of the Trip Command	[Protection Para /Global Prot Para /PF-Prot /PF[1]]

Signals of the Power Factor module (states of the outputs)

<i>Signal</i>	<i>Description</i>
active	Signal: active
ExBlo	Signal: External Blocking
Blo TripCmd	Signal: Trip Command blocked
ExBlo TripCmd	Signal: External Blocking of the Trip Command
Alarm	Signal: Alarm Power Factor
Trip	Signal: Trip Power Factor
TripCmd	Signal: Trip Command
Compensator	Signal: Compensation Signal
Impossible	Signal: Alarm Power Factor Impossible

Commissioning: Power Factor [55]

Object to be tested

- Testing the projected Power Factor Modules

Necessary means

- 3-phase AC voltage source
- 3-phase AC current source
- Timer

Procedure – Testing the wiring

- Feed rated voltage and rated current to the measuring inputs of the relay.
- Adjust the current pointers 30° lagging to the voltage pointers.
- The following measuring values have to be shown:
P=0.86 Pn
Q=0.5 Qn
S=1 Sn

NOTICE

If the measured values are shown with a negative (algebraic) sign check the wiring.

NOTICE

In this example PF-Trigger is set to 0.86 = 30° (lagging) and PF-Reset is set to 0.86 = 30° leading.

Carry out the test with the settings (trigger and reset) that fit to your switchboard.

Testing the threshold values (Trigger) (PF Trigger: Example = 0.86 lagging)

- Feed rated voltage and rated current in phase to the measuring inputs of the relay (PF=1).
- Adjust the angle between voltage and current (current pointer lagging) until the relay picks up.
- Write down the pickup value.

Testing the Reset (PF Reset: Example = 0.86 leading)

- Reduce the angle between voltage and current beyond PF = 1 (current pointer leading) until the alarm drops off.
- Write down the reset value.

Testing the trip delay (PF Trigger: Example = 0.86 lagging)

- Feed rated voltage and rated current in phase to the measuring inputs of the relay (PF=1).
- Adjust the angle between voltage and current (current pointer lagging) with an abrupt change to PF = 0.707 (45°) lagging.
- Measure the tripping delay at the output of the relay. Compare the measured tripping time to the parameterized.

Successful test result

The measured total tripping delays, threshold and reset values correspond with those values, specified in the adjustment list. Permissible deviations/tolerances can be found under Technical Data.

ExP - External Protection

Available stages:

ExP[1] , ExP[2] , ExP[3] , ExP[4]

NOTICE

All 4 stages of the external protection ExP[1]...[4] are identically structured.

By using the module External Protection the following can be incorporated into the device function: trip commands, alarms and blockades of external protection facilities. Devices which are not provided with a communication interface can be connected to the control system as well.

Exp[1]...[n]

name = Exp[1]...[n]



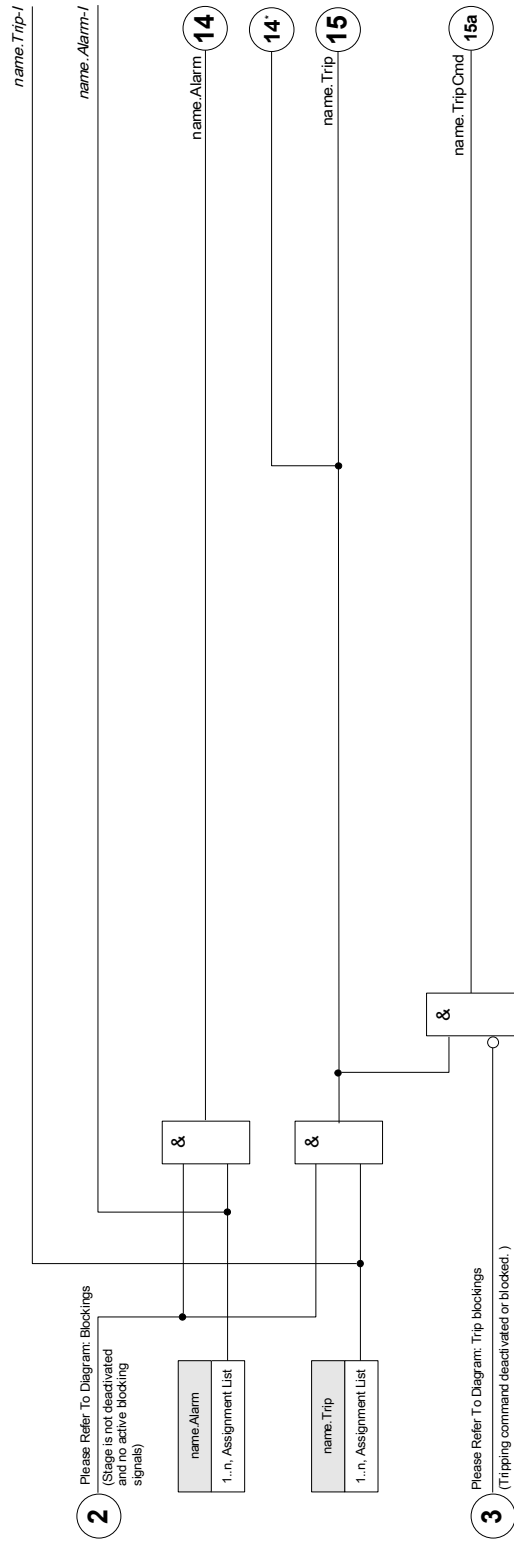

*=if no signal is assigned to the alarm input







Device Planning Parameters of the Module External Protection

Parameter	Description	Options	Default	Menu path
Mode 	Mode	do not use, use	do not use	[Device planning]

Global Protection Parameters of the Module External Protection

Parameter	Description	Setting range	Default	Menu path
ExBlo1 	External blocking of the module, if blocking is activated (allowed) within a parameter set and if the state of the assigned signal is true.	1..n, Assignment List	-.-	[Protection Para /Global Prot Para /ExP /ExP[1]]
ExBlo2 	External blocking of the module, if blocking is activated (allowed) within a parameter set and if the state of the assigned signal is true.	1..n, Assignment List	-.-	[Protection Para /Global Prot Para /ExP /ExP[1]]
ExBlo TripCmd 	External blocking of the Trip Command of the module/the stage, if blocking is activated (allowed) within a parameter set and if the state of the assigned signal is true.	1..n, Assignment List	-.-	[Protection Para /Global Prot Para /ExP /ExP[1]]
Alarm 	Assignment for External Alarm	1..n, Assignment List	-.-	[Protection Para /Global Prot Para /ExP /ExP[1]]
Trip 	External trip of the CB if the state of the assigned signal is true.	1..n, Assignment List	-.-	[Protection Para /Global Prot Para /ExP /ExP[1]]

Setting Group Parameters of the Module External Protection

<i>Parameter</i>	<i>Description</i>	<i>Setting range</i>	<i>Default</i>	<i>Menu path</i>
Function 	Permanent activation or deactivation of module/stage.	inactive, active	inactive	[Protection Para /<1..4> /Exp /Exp[1]]
ExBlo Fc 	Activate (allow) or inactivate (disallow) blocking of the module/stage. This parameter is only effective if a signal is assigned to the corresponding global protection parameter. If the signal becomes true, those modules/stages are blocked that are parameterized "ExBlo Fc=active".	inactive, active	inactive	[Protection Para /<1..4> /Exp /Exp[1]]
Blo TripCmd 	Permanent blocking of the Trip Command of the module/stage.	inactive, active	inactive	[Protection Para /<1..4> /Exp /Exp[1]]
ExBlo TripCmd Fc 	Activate (allow) or inactivate (disallow) blocking of the module/stage. This parameter is only effective if a signal is assigned to the corresponding global protection parameter. If the signal becomes true, those modules/stages are blocked that are parameterized "ExBlo TripCmd Fc=active".	inactive, active	inactive	[Protection Para /<1..4> /Exp /Exp[1]]

Module External Protection Input States

<i>Name</i>	<i>Description</i>	<i>Assignment via</i>
ExBlo1-I	Module input state: External blocking1	[Protection Para /Global Prot Para /ExP /ExP[1]]
ExBlo2-I	Module input state: External blocking2	[Protection Para /Global Prot Para /ExP /ExP[1]]
ExBlo TripCmd-I	Module input state: External Blocking of the Trip Command	[Protection Para /Global Prot Para /ExP /ExP[1]]
Alarm-I	Module input state: Alarm	[Protection Para /Global Prot Para /ExP /ExP[1]]
Trip-I	Module input state: Trip	[Protection Para /Global Prot Para /ExP /ExP[1]]

Module External Protection Signals (Output States)

<i>Signal</i>	<i>Description</i>
active	Signal: active
ExBlo	Signal: External Blocking
Blo TripCmd	Signal: Trip Command blocked
ExBlo TripCmd	Signal: External Blocking of the Trip Command
Alarm	Signal: Alarm
Trip	Signal: Trip
TripCmd	Signal: Trip Command

Commissioning: External Protection

Object to be tested

Test of the module External Protection

Necessary means

- Depending on the application

Procedure

Simulate the functionality of the External Protection (Alarm, Trip, Blockings...) by (de-)energizing of the digital inputs.

Successful test result

All external alarms, external trips and external blockings are correctly recognized and processed by the device.

Ext Temp Superv Protection Module – External Temperature Supervision

Elements:

Ext Temp Superv[1] .Ext Temp Superv[2] .Ext Temp Superv[3]

NOTICE

All elements of the external protection Ext Temp Superv are identically structured.

By using the Ext Temp Superv module, the following can be incorporated into the device function: trip commands, alarms (pickups), and blockages of digital external temperature protection.

Since the Ext Temp Superv module is functionally identical to the Ext. Protection module, it is the User's responsibility to select the proper assignments for the settings Alarm (Pickup) and Trip for reflecting the purpose of this module.

Ext Temp Supervv[1]..[n]
name = Ext Temp Supervv{1}..[n]



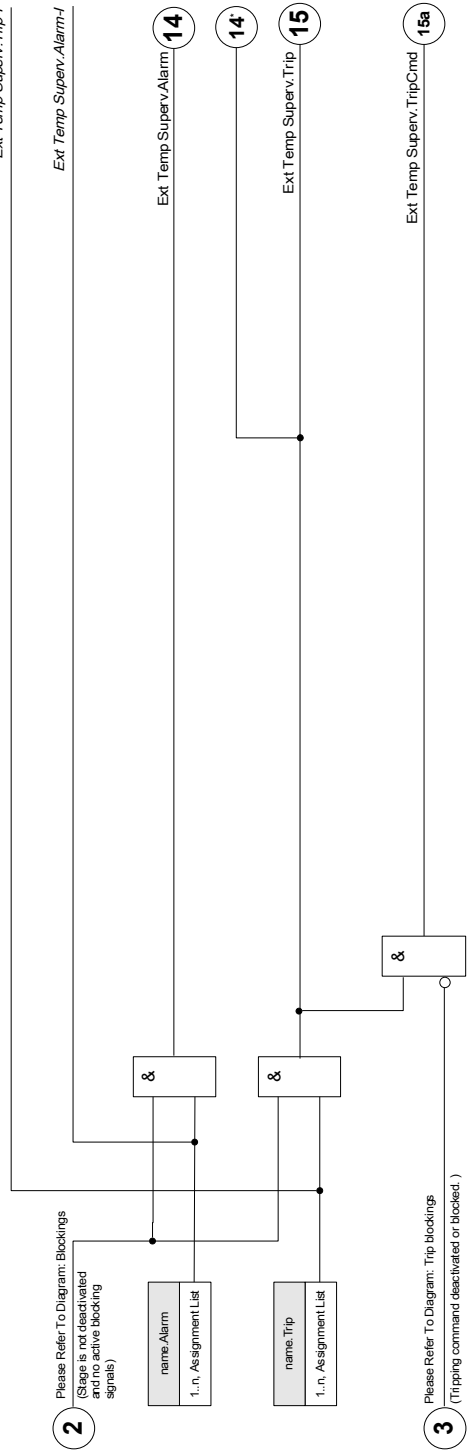

*=If no signal is assigned to the alarm input







Device Planning Parameters of the External Temperature Supervision Module

Parameter	Description	Options	Default	Menu path
Mode 	Mode	do not use, use	do not use	[Device planning]

Global Protection Parameters of the External Temperature Supervision Module

Parameter	Description	Setting range	Default	Menu path
ExBlo1 	External blocking of the module, if blocking is activated (allowed) within a parameter set and if the state of the assigned signal is true.	1..n, Assignment List	.-.	[Protection Para /Global Prot Para /Temp-Prot /Ext Temp Superv[1]]
ExBlo2 	External blocking of the module, if blocking is activated (allowed) within a parameter set and if the state of the assigned signal is true.	1..n, Assignment List	.-.	[Protection Para /Global Prot Para /Temp-Prot /Ext Temp Superv[1]]
ExBlo TripCmd 	External blocking of the Trip Command of the module/the stage, if blocking is activated (allowed) within a parameter set and if the state of the assigned signal is true.	1..n, Assignment List	.-.	[Protection Para /Global Prot Para /Temp-Prot /Ext Temp Superv[1]]
Alarm 	Assignment for External Alarm	1..n, Assignment List	.-.	[Protection Para /Global Prot Para /Temp-Prot /Ext Temp Superv[1]]
Trip 	External trip of the CB if the state of the assigned signal is true.	1..n, Assignment List	.-.	[Protection Para /Global Prot Para /Temp-Prot /Ext Temp Superv[1]]

Setting Group Parameters of the External Temperature Supervision Module

Parameter	Description	Setting range	Default	Menu path
 Function	Permanent activation or deactivation of module/stage.	inactive, active	inactive	[Protection Para /<1..4> /Temp-Prot /Ext Temp Superv[1]]
 ExBlo Fc	Activate (allow) or inactivate (disallow) blocking of the module/stage. This parameter is only effective if a signal is assigned to the corresponding global protection parameter. If the signal becomes true, those modules/stages are blocked that are parameterized "ExBlo Fc=active".	inactive, active	inactive	[Protection Para /<1..4> /Temp-Prot /Ext Temp Superv[1]]
 Blo TripCmd	Permanent blocking of the Trip Command of the module/stage.	inactive, active	inactive	[Protection Para /<1..4> /Temp-Prot /Ext Temp Superv[1]]
 ExBlo TripCmd Fc	Activate (allow) or inactivate (disallow) blocking of the module/stage. This parameter is only effective if a signal is assigned to the corresponding global protection parameter. If the signal becomes true, those modules/stages are blocked that are parameterized "ExBlo TripCmd Fc=active".	inactive, active	inactive	[Protection Para /<1..4> /Temp-Prot /Ext Temp Superv[1]]

External Temperature Supervision Module Input States

<i>Name</i>	<i>Description</i>	<i>Assignment via</i>
ExBlo1-I	Module input state: External blocking1	[Protection Para /Global Prot Para /Temp-Prot /Ext Temp Superv[1]]
ExBlo2-I	Module input state: External blocking2	[Protection Para /Global Prot Para /Temp-Prot /Ext Temp Superv[1]]
ExBlo TripCmd-I	Module input state: External Blocking of the Trip Command	[Protection Para /Global Prot Para /Temp-Prot /Ext Temp Superv[1]]
Alarm-I	Module input state: Alarm	[Protection Para /Global Prot Para /Temp-Prot /Ext Temp Superv[1]]
Trip-I	Module input state: Trip	[Protection Para /Global Prot Para /Temp-Prot /Ext Temp Superv[1]]

External Temperature Supervision Module Signals (Output States)

<i>Signal</i>	<i>Description</i>
active	Signal: active
ExBlo	Signal: External Blocking
Blo TripCmd	Signal: Trip Command blocked
ExBlo TripCmd	Signal: External Blocking of the Trip Command
Alarm	Signal: Alarm
Trip	Signal: Trip
TripCmd	Signal: Trip Command

Commissioning: External Temperature Supervision

Object to be tested:

Test of the External Temperature Supervision module.

Necessary means:

Dependent on the application.

Procedure:

Simulate the functionality of the External Temperature Supervision (pickup, trip, blockings) by (de-)energizing of the digital inputs.

Successful test result:

All external pickups, external trips, and external blockings are correctly recognized and processed by the device.

Ext Oil Temp Protection Module – External Oil Temperature Protection

Available elements:

Ext Oil Temp

By using the Ext Oil Temp module, the following can be incorporated into the device function: trip commands, alarms (pickups), and blockages of digital external temperature facilities.

Since the Ext Oil Temp module is functionally identical to the Ext. Protection module, it is the User's responsibility to select the proper assignments for the settings Alarm (Pickup) and Trip for reflecting the purpose of this module.

Ex Oil Temp[1]...[n]

name = Ex Oil Temp[1]...[n]



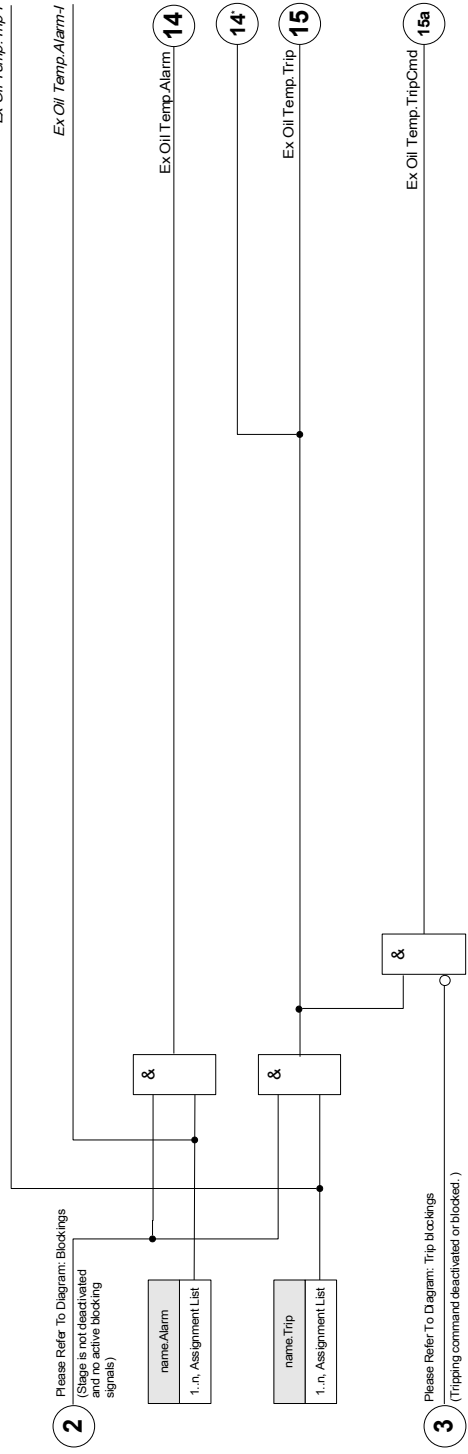

*=if no signal is assigned to the alarm input







Device Planning Parameters of the External Oil Temperature Protection Module

Parameter	Description	Options	Default	Menu path
Mode 	Mode	do not use, use	do not use	[Device planning]

Global Protection Parameters of the External Oil Temperature Protection Module

Parameter	Description	Setting range	Default	Menu path
ExBlo1 	External blocking of the module, if blocking is activated (allowed) within a parameter set and if the state of the assigned signal is true.	1..n, Assignment List	-.-	[Protection Para /Global Prot Para /Temp-Prot /Ext Oil Temp]
ExBlo2 	External blocking of the module, if blocking is activated (allowed) within a parameter set and if the state of the assigned signal is true.	1..n, Assignment List	-.-	[Protection Para /Global Prot Para /Temp-Prot /Ext Oil Temp]
ExBlo TripCmd 	External blocking of the Trip Command of the module/the stage, if blocking is activated (allowed) within a parameter set and if the state of the assigned signal is true.	1..n, Assignment List	-.-	[Protection Para /Global Prot Para /Temp-Prot /Ext Oil Temp]
Alarm 	Assignment for External Alarm	1..n, Assignment List	-.-	[Protection Para /Global Prot Para /Temp-Prot /Ext Oil Temp]
Trip 	External trip of the CB if the state of the assigned signal is true.	1..n, Assignment List	-.-	[Protection Para /Global Prot Para /Temp-Prot /Ext Oil Temp]

Setting Group Parameters of the External Oil Temperature Protection Module

Parameter	Description	Setting range	Default	Menu path
 Function	Permanent activation or deactivation of module/stage.	inactive, active	inactive	[Protection Para /<1..4> /Temp-Prot /Ext Oil Temp]
 ExBlo Fc	Activate (allow) or inactivate (disallow) blocking of the module/stage. This parameter is only effective if a signal is assigned to the corresponding global protection parameter. If the signal becomes true, those modules/stages are blocked that are parameterized "ExBlo Fc=active".	inactive, active	inactive	[Protection Para /<1..4> /Temp-Prot /Ext Oil Temp]
 Blo TripCmd	Permanent blocking of the Trip Command of the module/stage.	inactive, active	inactive	[Protection Para /<1..4> /Temp-Prot /Ext Oil Temp]
 ExBlo TripCmd Fc	Activate (allow) or inactivate (disallow) blocking of the module/stage. This parameter is only effective if a signal is assigned to the corresponding global protection parameter. If the signal becomes true, those modules/stages are blocked that are parameterized "ExBlo TripCmd Fc=active".	inactive, active	inactive	[Protection Para /<1..4> /Temp-Prot /Ext Oil Temp]

External Oil Temperature Protection Module Input States

<i>Name</i>	<i>Description</i>	<i>Assignment via</i>
ExBlo1-I	Module input state: External blocking1	[Protection Para /Global Prot Para /Temp-Prot /Ext Oil Temp]
ExBlo2-I	Module input state: External blocking2	[Protection Para /Global Prot Para /Temp-Prot /Ext Oil Temp]
ExBlo TripCmd-I	Module input state: External Blocking of the Trip Command	[Protection Para /Global Prot Para /Temp-Prot /Ext Oil Temp]
Alarm-I	Module input state: Alarm	[Protection Para /Global Prot Para /Temp-Prot /Ext Oil Temp]
Trip-I	Module input state: Trip	[Protection Para /Global Prot Para /Temp-Prot /Ext Oil Temp]

External Oil Temperature Protection Module Signals (Output States)

<i>Signal</i>	<i>Description</i>
active	Signal: active
ExBlo	Signal: External Blocking
Blo TripCmd	Signal: Trip Command blocked
ExBlo TripCmd	Signal: External Blocking of the Trip Command
Alarm	Signal: Alarm
Trip	Signal: Trip
TripCmd	Signal: Trip Command

Commissioning: External Protection

Object to be tested:

Test of the External Oil Temperature Protection module.

Necessary means:

Dependent on the application.

Procedure:

Simulate the functionality of the External Oil Temperature Protection (pickup, trip, blockings) by (de-)energizing of the digital inputs.

Successful test result:

All external pickups, external trips, and external blockings are correctly recognized and processed by the device.

Sudden Pressure Protection Module – Sudden Pressure Protection

Available elements:

Ext Sudd Press

Principle – General Use

Most large size transformers (5000 KVA or above) are recommended to be equipped with a sudden pressure relay (Buchholz) that detects rapid change in oil or gas pressure within the tank as result of internal arcing. The sudden pressure relay can detect internal faults such as turn to turn faults that other protection functions such as differential and overcurrents may not be sensitive enough to sense. The sudden pressure relay is usually equipped with output contacts that can be directly used for tripping and alarming, but it does not have recording and communication capabilities built in.

A sudden pressure protection module is provided in the protective device to take the output signals from the conventional sudden pressure relay and to form more secure and intelligent transformer protections. Through this module, the events of sudden pressure relay operations can be recorded and communicated to the control center (SCADA).

Ext Sudd Press

name = Ext Sudd Press



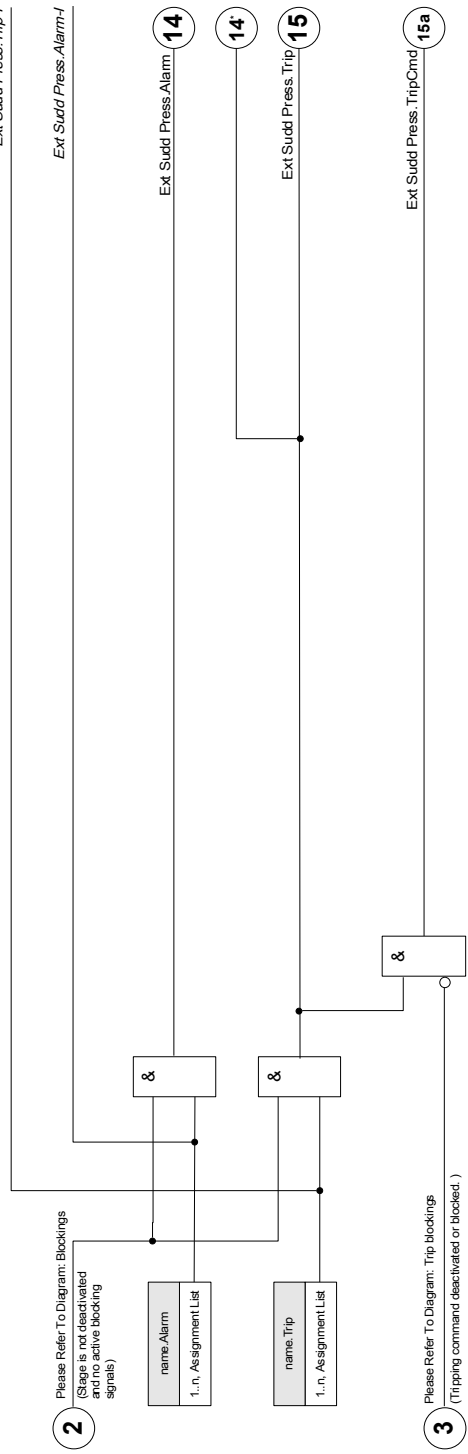

*=If no signal is assigned to the alarm input







Device Planning Parameters of the Sudden Pressure Protection Module

Parameter	Description	Options	Default	Menu path
Mode 	Mode	do not use, use	do not use	[Device planning]

Global Protection Parameters of the Sudden Pressure Protection Module

Parameter	Description	Setting range	Default	Menu path
ExBlo1 	External blocking of the module, if blocking is activated (allowed) within a parameter set and if the state of the assigned signal is true.	1..n, Assignment List	-.-	[Protection Para /Global Prot Para /Ext Sudd Press]
ExBlo2 	External blocking of the module, if blocking is activated (allowed) within a parameter set and if the state of the assigned signal is true.	1..n, Assignment List	-.-	[Protection Para /Global Prot Para /Ext Sudd Press]
ExBlo TripCmd 	External blocking of the Trip Command of the module/the stage, if blocking is activated (allowed) within a parameter set and if the state of the assigned signal is true.	1..n, Assignment List	-.-	[Protection Para /Global Prot Para /Ext Sudd Press]
Alarm 	Assignment for External Alarm	1..n, Assignment List	-.-	[Protection Para /Global Prot Para /Ext Sudd Press]
Trip 	External trip of the CB if the state of the assigned signal is true.	1..n, Assignment List	-.-	[Protection Para /Global Prot Para /Ext Sudd Press]

Setting Group Parameters of the Sudden Pressure Protection Module

Parameter	Description	Setting range	Default	Menu path
 Function	Permanent activation or deactivation of module/stage.	inactive, active	inactive	[Protection Para /<1..4> /Ext Sudd Press]
 ExBlo Fc	Activate (allow) or inactivate (disallow) blocking of the module/stage. This parameter is only effective if a signal is assigned to the corresponding global protection parameter. If the signal becomes true, those modules/stages are blocked that are parameterized "ExBlo Fc=active".	inactive, active	inactive	[Protection Para /<1..4> /Ext Sudd Press]
 Blo TripCmd	Permanent blocking of the Trip Command of the module/stage.	inactive, active	inactive	[Protection Para /<1..4> /Ext Sudd Press]
 ExBlo TripCmd Fc	Activate (allow) or inactivate (disallow) blocking of the module/stage. This parameter is only effective if a signal is assigned to the corresponding global protection parameter. If the signal becomes true, those modules/stages are blocked that are parameterized "ExBlo TripCmd Fc=active".	inactive, active	inactive	[Protection Para /<1..4> /Ext Sudd Press]

Sudden Pressure Protection Module Input States

<i>Name</i>	<i>Description</i>	<i>Assignment via</i>
ExBlo1-I	Module input state: External blocking1	[Protection Para /Global Prot Para /Ext Sudd Press]
ExBlo2-I	Module input state: External blocking2	[Protection Para /Global Prot Para /Ext Sudd Press]
ExBlo TripCmd-I	Module input state: External Blocking of the Trip Command	[Protection Para /Global Prot Para /Ext Sudd Press]
Alarm-I	Module input state: Alarm	[Protection Para /Global Prot Para /Ext Sudd Press]
Trip-I	Module input state: Trip	[Protection Para /Global Prot Para /Ext Sudd Press]

Sudden Pressure Protection Module Signals (Output States)

<i>Signal</i>	<i>Description</i>
active	Signal: active
ExBlo	Signal: External Blocking
Blo TripCmd	Signal: Trip Command blocked
ExBlo TripCmd	Signal: External Blocking of the Trip Command
Alarm	Signal: Alarm
Trip	Signal: Trip
TripCmd	Signal: Trip Command

Commissioning: Sudden Pressure Protection

Object to be tested:

Test of the Sudden Pressure Protection module.

Necessary means:

Dependent on the application.

Procedure:

Simulate the functionality of the Sudden Protection Relay.

Successful test result:

All external pickups, external trips, and external blockings are correctly recognized and processed by the device.

RTD Protection Module [26]

Elements:

RTD

General – Principle Use

NOTICE

The Resistance-based Temperature Detector (RTD) Protection Module uses temperature data that are provided by a Universal Resistance-based Temperature Detector (URTD) module (please refer to the URTD Module section).

NOTICE

If voting trip is required, please map the output used for tripping purposes: “RTD. Voting Trip Grp 1” or “RTD. Voting Trip Grp 2”.

The protective device provides tripping and alarming functions based on the direct temperature measurements read from the URTD device that has 11 temperature sensor channels. Each channel will have one trip function without an intended delay and one alarm function with a delay.

- The “trip” function has only a threshold setting.
- Each individual »Alarm Function« will have a threshold setting range, and can be individually enabled or disabled. Since the temperature cannot change instantaneously (which is a way that temperature differs from current), the “delay” is essentially built in to the function due to the fact that the temperature will take some time to increase from room temperature to the “trip threshold” level.
- The dropout ratio for both trip and alarm is 0.99.
- The temperature rise is limited by the RTD driver.

The entire function can be turned off or on, or individual channels can be turned off or on.

Voting

Additionally, RTD voting schemes are available and User programmable. The Voting feature must be activated and configured within the following menu, [Protection Para\Set[x]\Temp-Prot/ RTD\Vote[x]]. Here, the setting »*Function*« has to be set to »*Active*«.

Once activated, the number of channels that will be used by the voting feature is selected. This is set by way of the parameter »*Voting[x]*«. This parameter defines how many of the selected channels must be over its threshold level in order to get a voting trip. Each individual channel must be selected or deselected by setting to either »*Yes*« or »*No*«. When selecting »*Yes*«, the channel will be used in the voting process. Note that in order to be selected, each channel must also be active and the RTD module itself has to be active.

If for example, Vote[x] is set to »3«, and all channels are set to »*Yes*«, and if any three of the selected channels exceed their individual threshold settings, a Vote trip will occur.

Please note that the voting trip will be issued as a RTD trip only, if the parameter »*TripCmd Selection*« is set to »*Voting trip*« within the Global Protection Parameters of the RTD module. The Trip has to be assigned then within the trip manager to the Breaker.

Alarm, Timeout Alarm and Trip Principle for each RTD Sensor

The following diagram shows the general working principle (delayed alarm, undelayed trip) of each of the RTD sensors.

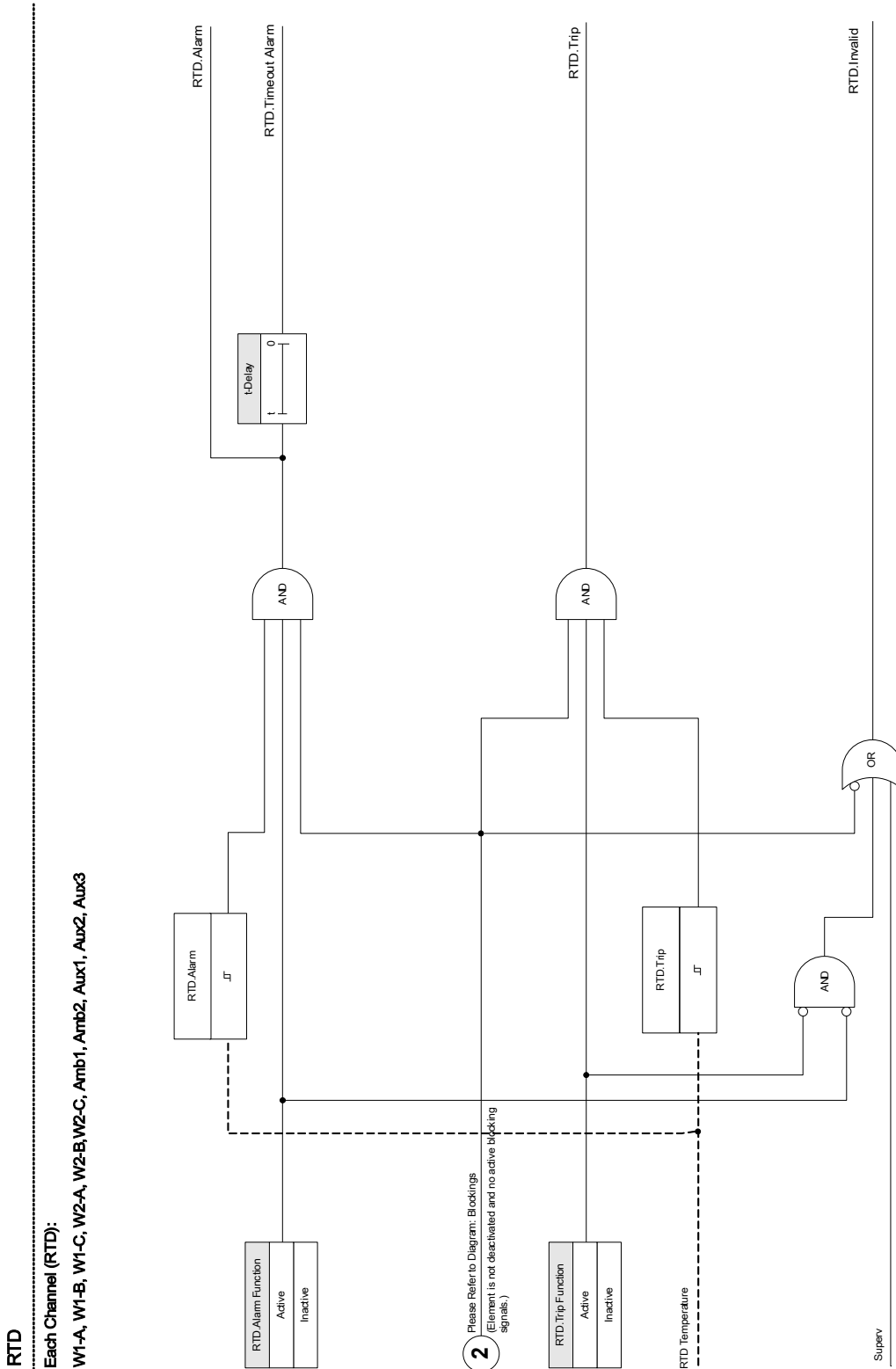

Collective Alarm, Timeout Alarm and Trip Signals

The RTD sensors are assigned to four groups (depending on the ordered device). These four groups are OR-connected to the "AnyGroup". The AnyGroup generates an alarm, an timeout alarm and a trip signal if any of the sensors mounted into this issues the corresponding signal.

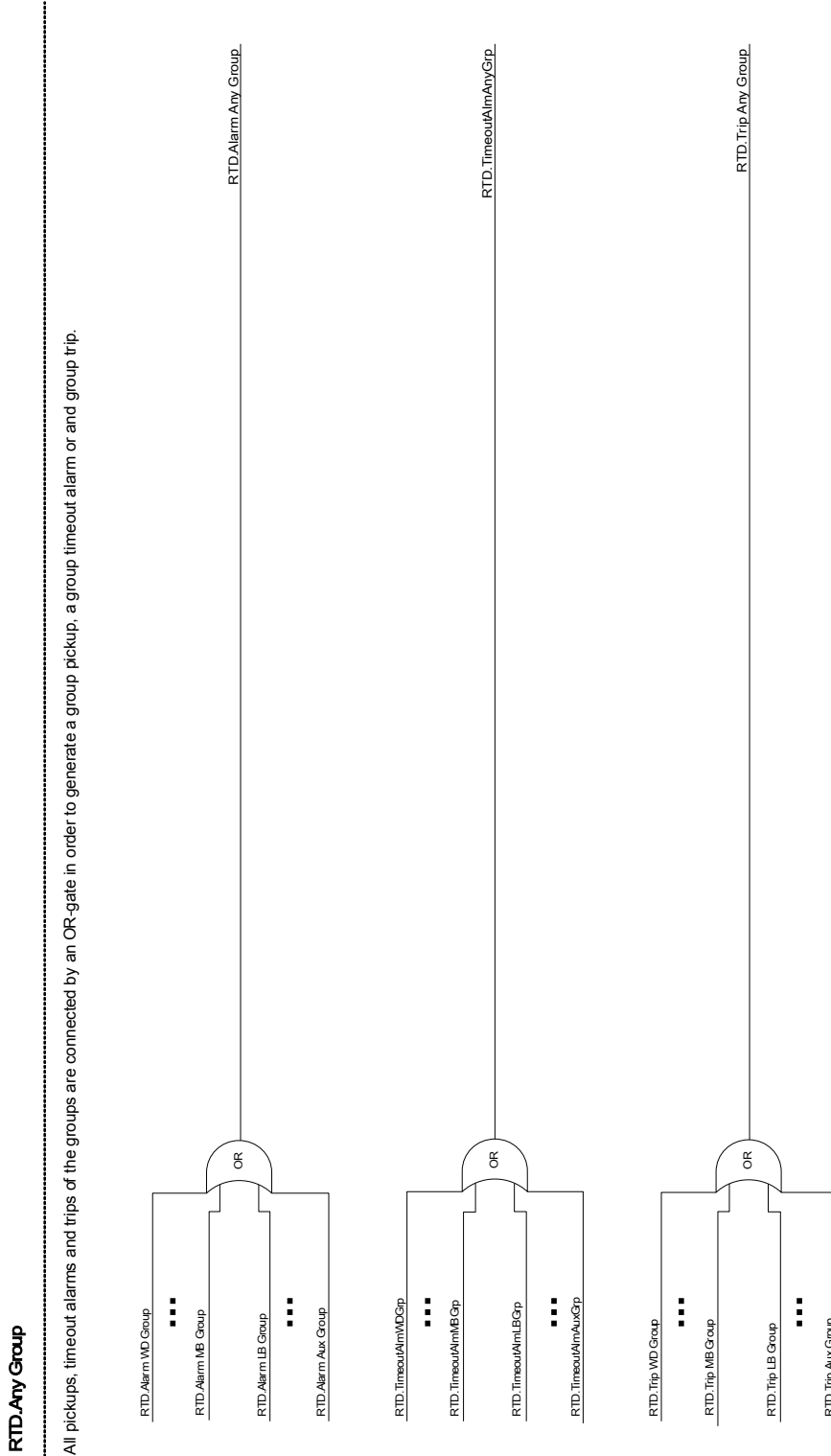

Trips of the Voting Groups

In order to use voting groups the user has to determine the sensors that should belong to a voting group and how many of them have to trip in order to generate a voting trip of the corresponding group.

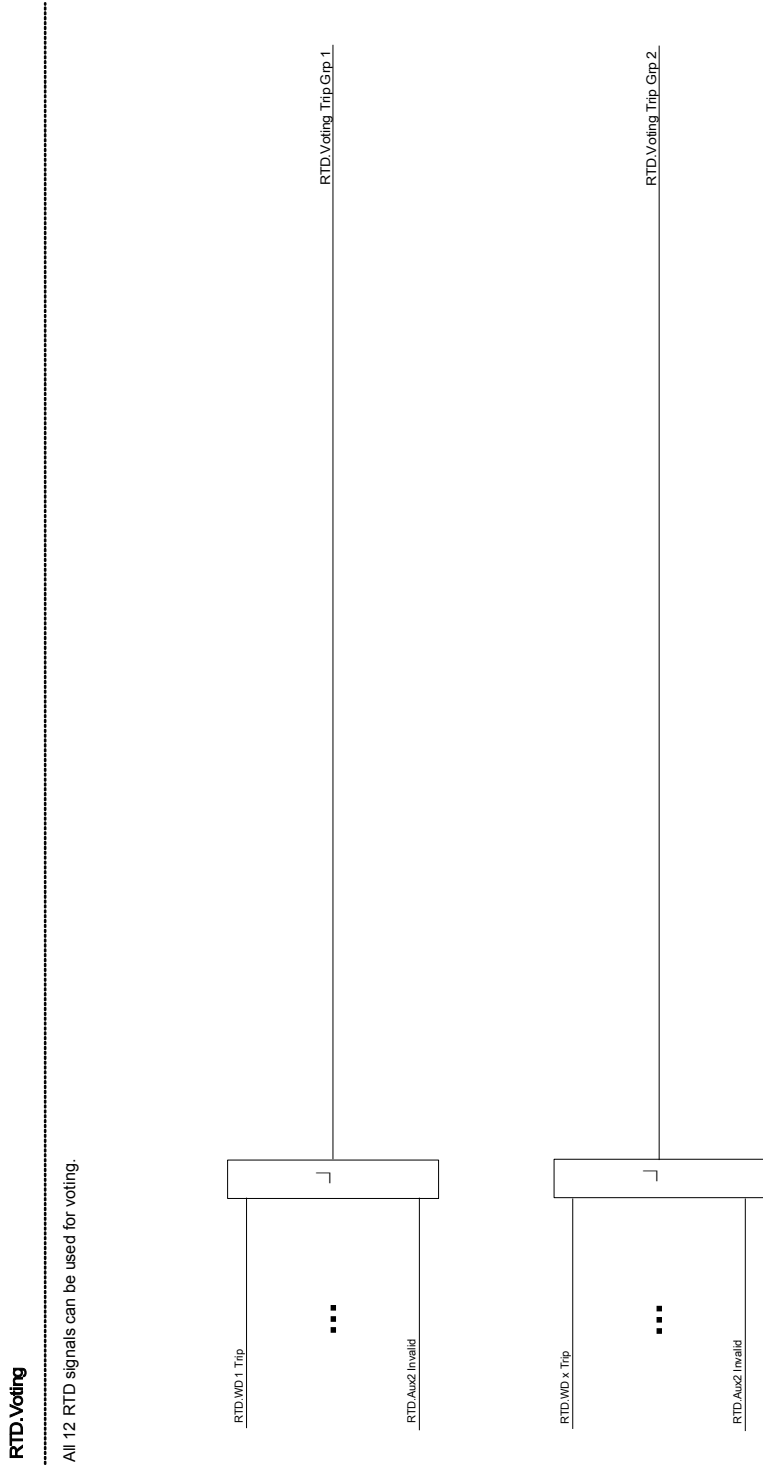

Collective Timeout Alarm Signal

All RTD sensor timeout alarms and all group timeouts are OR-connected.

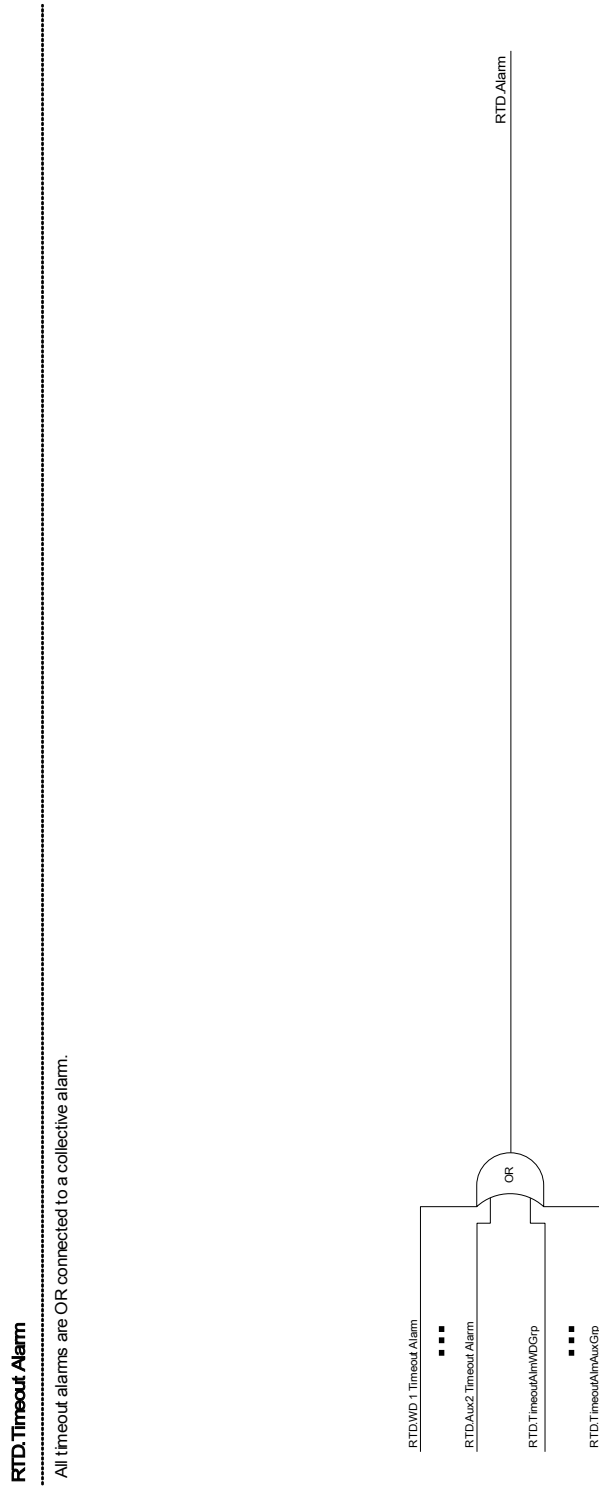

Collective Trip Signal



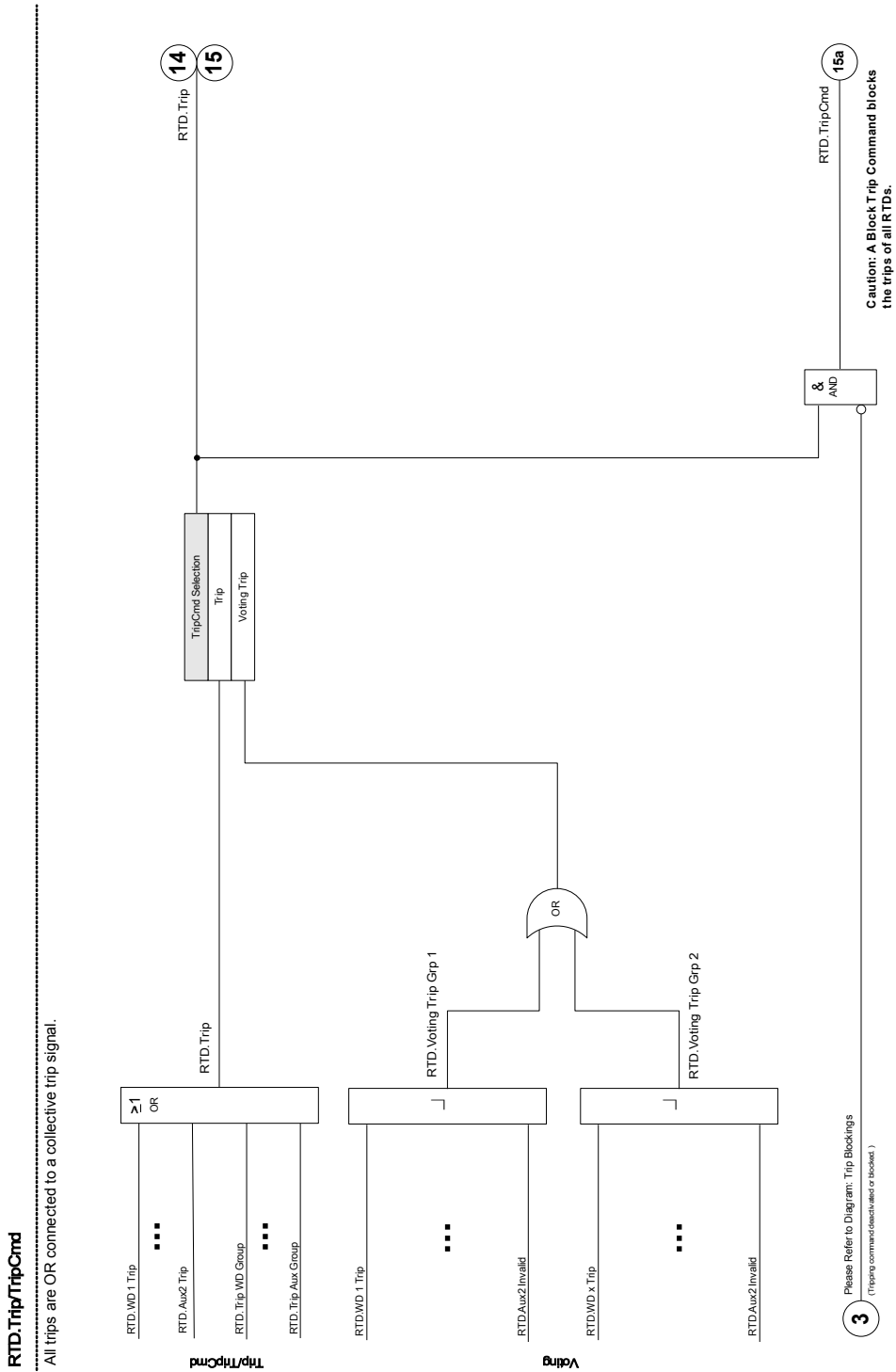

By means of the trip command selection » *TripCmdSelection* « the user determines if the RTD element should use for the final trip signal the OR-connected default RTD trips or if the RTD element should use the OR-connected voting trips.





Device Planning Parameters of the RTD Temperature Protection Module







<i>Parameter</i>	<i>Description</i>	<i>Options</i>	<i>Default</i>	<i>Menu path</i>
Mode 	Mode	do not use, use	do not use	[Device planning]

Global Protection Parameters of the RTD Temperature Protection Module

Parameter	Description	Setting range	Default	Menu path
ExBlo1 	External blocking of the module, if blocking is activated (allowed) within a parameter set and if the state of the assigned signal is true.	1..n, Assignment List	.-	[Protection Para /Global Prot Para /Temp-Prot /RTD]
ExBlo2 	External blocking of the module, if blocking is activated (allowed) within a parameter set and if the state of the assigned signal is true.	1..n, Assignment List	.-	[Protection Para /Global Prot Para /Temp-Prot /RTD]
ExBlo TripCmd 	External blocking of the Trip Command of the module/the stage, if blocking is activated (allowed) within a parameter set and if the state of the assigned signal is true.	1..n, Assignment List	.-	[Protection Para /Global Prot Para /Temp-Prot /RTD]
TripCmd Selection 	This parameter determines if the final trip of the RTD module is issued by the default way or by the voting groups.	Trip, Voting Trip	Trip	[Protection Para /Global Prot Para /Temp-Prot /RTD]





Setting Group Parameters of the RTD Temperature Protection Module

Parameter	Description	Setting range	Default	Menu path
Function 	Permanent activation or deactivation of module/stage.	inactive, active	inactive	[Protection Para /<1..4> /Temp-Prot /RTD /General Settings]
ExBlo Fc 	Activate (allow) or inactivate (disallow) blocking of the module/stage. This parameter is only effective if a signal is assigned to the corresponding global protection parameter. If the signal becomes true, those modules/stages are blocked that are parameterized "ExBlo Fc=active".	inactive, active	inactive	[Protection Para /<1..4> /Temp-Prot /RTD /General Settings]







Parameter	Description	Setting range	Default	Menu path
 Blo TripCmd	Permanent blocking of the Trip Command of the module/stage.	inactive, active	inactive	[Protection Para /<1..4> /Temp-Prot /RTD /General Settings]
 ExBlo TripCmd Fc	Activate (allow) or inactivate (disallow) blocking of the module/stage. This parameter is only effective if a signal is assigned to the corresponding global protection parameter. If the signal becomes true, those modules/stages are blocked that are parameterized "ExBlo TripCmd Fc=active".	inactive, active	inactive	[Protection Para /<1..4> /Temp-Prot /RTD /General Settings]
 Windg 1 Alarm Function	Winding 1 Alarm Function	inactive, active	active	[Protection Para /<1..4> /Temp-Prot /RTD /Windg 1]
 Windg 1 Trip Function	Winding 1 Trip Function	inactive, active	active	[Protection Para /<1..4> /Temp-Prot /RTD /Windg 1]
 Windg 1 Alarm	Winding 1 Threshold for Temperature Alarm Only available if: Device planning: Alarm Function = use	0 - 200°C	80°C	[Protection Para /<1..4> /Temp-Prot /RTD /Windg 1]
 Windg 1 t-Delay	Winding 1 If this time is expired a Temperature Alarm will be generated. Only available if: Device planning: Alarm Function = use	0 - 360min	1min	[Protection Para /<1..4> /Temp-Prot /RTD /Windg 1]

<i>Parameter</i>	<i>Description</i>	<i>Setting range</i>	<i>Default</i>	<i>Menu path</i>
Windg 1 Trip 	Winding 1 Threshold for Temperature Trip Only available if: Device planning: Trip Function = use	0 - 200°C	100°C	[Protection Para <1..4> /Temp-Prot /RTD /Windg 1]
Windg 2 Alarm Function 	Winding 2 Alarm Function	inactive, active	active	[Protection Para <1..4> /Temp-Prot /RTD /Windg 2]
Windg 2 Trip Function 	Winding 2 Trip Function	inactive, active	active	[Protection Para <1..4> /Temp-Prot /RTD /Windg 2]
Windg 2 Alarm 	Winding 2 Threshold for Temperature Alarm Only available if: Device planning: Alarm Function = use	0 - 200°C	80°C	[Protection Para <1..4> /Temp-Prot /RTD /Windg 2]
Windg 2 t-Delay 	Winding 2 If this time is expired a Temperature Alarm will be generated. Only available if: Device planning: Alarm Function = use	0 - 360min	1min	[Protection Para <1..4> /Temp-Prot /RTD /Windg 2]
Windg 2 Trip 	Winding 2 Threshold for Temperature Trip Only available if: Device planning: Trip Function = use	0 - 200°C	100°C	[Protection Para <1..4> /Temp-Prot /RTD /Windg 2]

Protective Elements

<i>Parameter</i>	<i>Description</i>	<i>Setting range</i>	<i>Default</i>	<i>Menu path</i>
Windg 3 Alarm Function 	Winding 3 Alarm Function	inactive, active	active	[Protection Para /<1..4> /Temp-Prot /RTD /Windg 3]
Windg 3 Trip Function 	Winding 3 Trip Function	inactive, active	active	[Protection Para /<1..4> /Temp-Prot /RTD /Windg 3]
Windg 3 Alarm 	Winding 3 Threshold for Temperature Alarm Only available if: Device planning: Alarm Function = use	0 - 200°C	80°C	[Protection Para /<1..4> /Temp-Prot /RTD /Windg 3]
Windg 3 t-Delay 	Winding 3 If this time is expired a Temperature Alarm will be generated. Only available if: Device planning: Alarm Function = use	0 - 360min	1min	[Protection Para /<1..4> /Temp-Prot /RTD /Windg 3]
Windg 3 Trip 	Winding 3 Threshold for Temperature Trip Only available if: Device planning: Trip Function = use	0 - 200°C	100°C	[Protection Para /<1..4> /Temp-Prot /RTD /Windg 3]
Windg 4 Alarm Function 	Winding 4 Alarm Function	inactive, active	active	[Protection Para /<1..4> /Temp-Prot /RTD /Windg 4]





Protective Elements

<i>Parameter</i>	<i>Description</i>	<i>Setting range</i>	<i>Default</i>	<i>Menu path</i>
Windg 4 Trip Function 	Winding 4 Trip Function	inactive, active	active	[Protection Para /<1..4> /Temp-Prot /RTD /Windg 4]
Windg 4 Alarm 	Winding 4 Threshold for Temperature Alarm Only available if: Device planning: Alarm Function = use	0 - 200°C	80°C	[Protection Para /<1..4> /Temp-Prot /RTD /Windg 4]
Windg 4 t-Delay 	Winding 4 If this time is expired a Temperature Alarm will be generated. Only available if: Device planning: Alarm Function = use	0 - 360min	1min	[Protection Para /<1..4> /Temp-Prot /RTD /Windg 4]
Windg 4 Trip 	Winding 4 Threshold for Temperature Trip Only available if: Device planning: Trip Function = use	0 - 200°C	100°C	[Protection Para /<1..4> /Temp-Prot /RTD /Windg 4]
Windg 5 Alarm Function 	Winding 5 Alarm Function	inactive, active	active	[Protection Para /<1..4> /Temp-Prot /RTD /Windg 5]
Windg 5 Trip Function 	Winding 5 Trip Function	inactive, active	active	[Protection Para /<1..4> /Temp-Prot /RTD /Windg 5]

<i>Parameter</i>	<i>Description</i>	<i>Setting range</i>	<i>Default</i>	<i>Menu path</i>
Windg 5 Alarm 	Winding 5 Threshold for Temperature Alarm Only available if: Device planning: Alarm Function = use	0 - 200°C	80°C	[Protection Para /<1..4> /Temp-Prot /RTD /Windg 5]
Windg 5 t-Delay 	Winding 5 If this time is expired a Temperature Alarm will be generated. Only available if: Device planning: Alarm Function = use	0 - 360min	1min	[Protection Para /<1..4> /Temp-Prot /RTD /Windg 5]
Windg 5 Trip 	Winding 5 Threshold for Temperature Trip Only available if: Device planning: Trip Function = use	0 - 200°C	100°C	[Protection Para /<1..4> /Temp-Prot /RTD /Windg 5]
Windg 6 Alarm Function 	Winding 6 Alarm Function	inactive, active	active	[Protection Para /<1..4> /Temp-Prot /RTD /Windg 6]
Windg 6 Trip Function 	Winding 6 Trip Function	inactive, active	active	[Protection Para /<1..4> /Temp-Prot /RTD /Windg 6]
Windg 6 Alarm 	Winding 6 Threshold for Temperature Alarm Only available if: Device planning: Alarm Function = use	0 - 200°C	80°C	[Protection Para /<1..4> /Temp-Prot /RTD /Windg 6]

Protective Elements

Parameter	Description	Setting range	Default	Menu path
 Windg 6 t-Delay	Winding 6 If this time is expired a Temperature Alarm will be generated. Only available if: Device planning: Alarm Function = use	0 - 360min	1min	[Protection Para /<1..4> /Temp-Prot /RTD /Windg 6]
 Windg 6 Trip	Winding 6 Threshold for Temperature Trip Only available if: Device planning: Trip Function = use	0 - 200°C	100°C	[Protection Para /<1..4> /Temp-Prot /RTD /Windg 6]
 MotBear 1 Alarm Function	Motor Bearing 1 Alarm Function	inactive, active	active	[Protection Para /<1..4> /Temp-Prot /RTD /MotBear 1]
 MotBear 1 Trip Function	Motor Bearing 1 Trip Function	inactive, active	active	[Protection Para /<1..4> /Temp-Prot /RTD /MotBear 1]
 MotBear 1 Alarm	Motor Bearing 1 Threshold for Temperature Alarm Only available if: Device planning: Alarm Function = use	0 - 200°C	80°C	[Protection Para /<1..4> /Temp-Prot /RTD /MotBear 1]
 MotBear 1 t-Delay	Motor Bearing 1 If this time is expired a Temperature Alarm will be generated. Only available if: Device planning: Alarm Function = use	0 - 360min	1min	[Protection Para /<1..4> /Temp-Prot /RTD /MotBear 1]

Parameter	Description	Setting range	Default	Menu path
 MotBear 1 Trip	Motor Bearing 1 Threshold for Temperature Trip Only available if: Device planning: Trip Function = use	0 - 200°C	100°C	[Protection Para /<1..4> /Temp-Prot /RTD /MotBear 1]
 MotBear 2 Alarm Function	Motor Bearing 2 Alarm Function	inactive, active	active	[Protection Para /<1..4> /Temp-Prot /RTD /MotBear 2]
 MotBear 2 Trip Function	Motor Bearing 2 Trip Function	inactive, active	active	[Protection Para /<1..4> /Temp-Prot /RTD /MotBear 2]
 MotBear 2 Alarm	Motor Bearing 2 Threshold for Temperature Alarm Only available if: Device planning: Alarm Function = use	0 - 200°C	80°C	[Protection Para /<1..4> /Temp-Prot /RTD /MotBear 2]
 MotBear 2 t-Delay	Motor Bearing 2 If this time is expired a Temperature Alarm will be generated. Only available if: Device planning: Alarm Function = use	0 - 360min	1min	[Protection Para /<1..4> /Temp-Prot /RTD /MotBear 2]
 MotBear 2 Trip	Motor Bearing 2 Threshold for Temperature Trip Only available if: Device planning: Trip Function = use	0 - 200°C	100°C	[Protection Para /<1..4> /Temp-Prot /RTD /MotBear 2]

Protective Elements

Parameter	Description	Setting range	Default	Menu path
 LoadBear 1 Alarm Function	Load Bearing 1 Alarm Function	inactive, active	active	[Protection Para /<1..4> /Temp-Prot /RTD /LoadBear 1]
 LoadBear 1 Trip Function	Load Bearing 1 Trip Function	inactive, active	active	[Protection Para /<1..4> /Temp-Prot /RTD /LoadBear 1]
 LoadBear 1 Alarm	Load Bearing 1 Threshold for Temperature Alarm Only available if: Device planning: Alarm Function = use	0 - 200°C	80°C	[Protection Para /<1..4> /Temp-Prot /RTD /LoadBear 1]
 LoadBear 1 t-Delay	Load Bearing 1 If this time is expired a Temperature Alarm will be generated. Only available if: Device planning: Alarm Function = use	0 - 360min	1min	[Protection Para /<1..4> /Temp-Prot /RTD /LoadBear 1]
 LoadBear 1 Trip	Load Bearing 1 Threshold for Temperature Trip Only available if: Device planning: Trip Function = use	0 - 200°C	80°C	[Protection Para /<1..4> /Temp-Prot /RTD /LoadBear 1]
 LoadBear 2 Alarm Function	Load Bearing 2 Alarm Function	inactive, active	active	[Protection Para /<1..4> /Temp-Prot /RTD /LoadBear 2]

Protective Elements

<i>Parameter</i>	<i>Description</i>	<i>Setting range</i>	<i>Default</i>	<i>Menu path</i>
 LoadBear 2 Trip Function	Load Bearing 2 Trip Function	inactive, active	active	[Protection Para /<1..4> /Temp-Prot /RTD /LoadBear 2]
 LoadBear 2 Alarm	Load Bearing 2 Threshold for Temperature Alarm Only available if: Device planning: Alarm Function = use	0 - 200°C	80°C	[Protection Para /<1..4> /Temp-Prot /RTD /LoadBear 2]
 LoadBear 2 t-Delay	Load Bearing 2 If this time is expired a Temperature Alarm will be generated. Only available if: Device planning: Alarm Function = use	0 - 360min	1min	[Protection Para /<1..4> /Temp-Prot /RTD /LoadBear 2]
 LoadBear 2 Trip	Load Bearing 2 Threshold for Temperature Trip Only available if: Device planning: Trip Function = use	0 - 200°C	80°C	[Protection Para /<1..4> /Temp-Prot /RTD /LoadBear 2]
 Aux1 Alarm Function	Auxiliary 1 Alarm Function	inactive, active	active	[Protection Para /<1..4> /Temp-Prot /RTD /Aux1]
 Aux1 Trip Function	Auxiliary 1 Trip Function	inactive, active	active	[Protection Para /<1..4> /Temp-Prot /RTD /Aux1]

Protective Elements

Parameter	Description	Setting range	Default	Menu path
 Aux1 Alarm	Auxiliary 1 Threshold for Temperature Alarm Only available if: Device planning: Alarm Function1 = use	0 - 200°C	80°C	[Protection Para /<1..4> /Temp-Prot /RTD /Aux1]
 Aux1 t-Delay	Auxiliary 1 If this time is expired a Temperature Alarm will be generated. Only available if: Device planning: Alarm Function1 = use	0 - 360min	1min	[Protection Para /<1..4> /Temp-Prot /RTD /Aux1]
 Aux1 Trip	Auxiliary 1 Threshold for Temperature Trip Only available if: Device planning: Trip Function2 = use	0 - 200°C	100°C	[Protection Para /<1..4> /Temp-Prot /RTD /Aux1]
 Aux2 Alarm Function	Auxiliary 2 Alarm Function	inactive, active	active	[Protection Para /<1..4> /Temp-Prot /RTD /Aux2]
 Aux2 Trip Function	Auxiliary 2 Trip Function	inactive, active	active	[Protection Para /<1..4> /Temp-Prot /RTD /Aux2]
 Aux2 Alarm	Auxiliary 2 Threshold for Temperature Alarm Only available if: Device planning: Alarm Function2 = use	0 - 200°C	80°C	[Protection Para /<1..4> /Temp-Prot /RTD /Aux2]







Protective Elements

Parameter	Description	Setting range	Default	Menu path
 Aux2 t-Delay	Auxiliary 2 If this time is expired a Temperature Alarm will be generated. Only available if: Device planning: Alarm Function2 = use	0 - 360min	1min	[Protection Para /<1..4> /Temp-Prot /RTD /Aux2]
 Aux2 Trip	Auxiliary 2 Threshold for Temperature Trip Only available if: Device planning: Trip Function2 = use	0 - 200°C	100°C	[Protection Para /<1..4> /Temp-Prot /RTD /Aux2]
 Windg Alarm Function	Winding Alarm Function	inactive, active	inactive	[Protection Para /<1..4> /Temp-Prot /RTD /Windg Group]
 Windg Trip Function	Winding Trip Function	inactive, active	inactive	[Protection Para /<1..4> /Temp-Prot /RTD /Windg Group]
 Windg Alarm	Winding Threshold for Temperature Alarm Only available if: Device planning: Alarm Function = use	0 - 200°C	80°C	[Protection Para /<1..4> /Temp-Prot /RTD /Windg Group]
 Windg t-Delay	Winding If this time is expired a Temperature Alarm will be generated. Only available if: Device planning: Alarm Function = use	0 - 360min	1min	[Protection Para /<1..4> /Temp-Prot /RTD /Windg Group]







Parameter	Description	Setting range	Default	Menu path
 Windg Trip	Winding Threshold for Temperature Trip Only available if: Device planning: Trip Function = use	0 - 200°C	100°C	[Protection Para /<1..4> /Temp-Prot /RTD /Windg Group]
 MotBear Alarm Function	Motor Bearing Alarm Function	inactive, active	inactive	[Protection Para /<1..4> /Temp-Prot /RTD /MotBear Group]
 MotBear Trip Function	Motor Bearing Trip Function	inactive, active	inactive	[Protection Para /<1..4> /Temp-Prot /RTD /MotBear Group]
 MotBear Alarm	Motor Bearing Threshold for Temperature Alarm Only available if: Device planning: Alarm Function = use	0 - 200°C	80°C	[Protection Para /<1..4> /Temp-Prot /RTD /MotBear Group]
 MotBear t-Delay	Motor Bearing If this time is expired a Temperature Alarm will be generated. Only available if: Device planning: Alarm Function = use	0 - 360min	1min	[Protection Para /<1..4> /Temp-Prot /RTD /MotBear Group]
 MotBear Trip	Motor Bearing Threshold for Temperature Trip Only available if: Device planning: Trip Function = use	0 - 200°C	100°C	[Protection Para /<1..4> /Temp-Prot /RTD /MotBear Group]

Parameter	Description	Setting range	Default	Menu path
 LoadBear Alarm Function	Load Bearing Alarm Function	inactive, active	inactive	[Protection Para /<1..4> /Temp-Prot /RTD /LoadBear Group]
 LoadBear Trip Function	Load Bearing Trip Function	inactive, active	inactive	[Protection Para /<1..4> /Temp-Prot /RTD /LoadBear Group]
 LoadBear Alarm	Load Bearing Threshold for Temperature Alarm Only available if: Device planning: Alarm Function = use	0 - 200°C	80°C	[Protection Para /<1..4> /Temp-Prot /RTD /LoadBear Group]
 LoadBear t-Delay	Load Bearing If this time is expired a Temperature Alarm will be generated. Only available if: Device planning: Alarm Function = use	0 - 360min	1min	[Protection Para /<1..4> /Temp-Prot /RTD /LoadBear Group]
 LoadBear Trip	Load Bearing Threshold for Temperature Trip Only available if: Device planning: Trip Function = use	0 - 200°C	80°C	[Protection Para /<1..4> /Temp-Prot /RTD /LoadBear Group]
 Aux Alarm Function	Auxiliary Alarm Function	inactive, active	inactive	[Protection Para /<1..4> /Temp-Prot /RTD /Aux Group]

Protective Elements

<i>Parameter</i>	<i>Description</i>	<i>Setting range</i>	<i>Default</i>	<i>Menu path</i>
Aux Trip Function 	Auxiliary Trip Function	inactive, active	inactive	[Protection Para /<1..4> /Temp-Prot /RTD /Aux Group]
Aux Alarm 	Auxiliary Threshold for Temperature Alarm Only available if: Device planning: Alarm Function = use	0 - 200°C	80°C	[Protection Para /<1..4> /Temp-Prot /RTD /Aux Group]
Aux t-Delay 	Auxiliary If this time is expired a Temperature Alarm will be generated. Only available if: Device planning: Alarm Function = use	0 - 360min	1min	[Protection Para /<1..4> /Temp-Prot /RTD /Aux Group]
Aux Trip 	Auxiliary Threshold for Temperature Trip Only available if: Device planning: Aux = use	0 - 200°C	100°C	[Protection Para /<1..4> /Temp-Prot /RTD /Aux Group]
Function 	Permanent activation or deactivation of module/stage.	inactive, active	inactive	[Protection Para /<1..4> /Temp-Prot /RTD /Voting1]
Voting 1 	Voting: This parameter defines how many of the selected channels must be over its threshold level for getting a voting trip	1 - 12	1	[Protection Para /<1..4> /Temp-Prot /RTD /Voting1]







Protective Elements

<i>Parameter</i>	<i>Description</i>	<i>Setting range</i>	<i>Default</i>	<i>Menu path</i>
Windg 1 	Winding 1	no, yes	no	[Protection Para /<1..4> /Temp-Prot /RTD /Voting1]
Windg 2 	Winding 2	no, yes	no	[Protection Para /<1..4> /Temp-Prot /RTD /Voting1]
Windg 3 	Winding 3	no, yes	no	[Protection Para /<1..4> /Temp-Prot /RTD /Voting1]
Windg 4 	Winding 4	no, yes	no	[Protection Para /<1..4> /Temp-Prot /RTD /Voting1]
Windg 5 	Winding 5	no, yes	no	[Protection Para /<1..4> /Temp-Prot /RTD /Voting1]
Windg 6 	Winding 6	no, yes	no	[Protection Para /<1..4> /Temp-Prot /RTD /Voting1]

Protective Elements



<i>Parameter</i>	<i>Description</i>	<i>Setting range</i>	<i>Default</i>	<i>Menu path</i>
MotBear 1 	Motor Bearing 1	no, yes	no	[Protection Para /<1..4> /Temp-Prot /RTD /Voting1]
MotBear 2 	Motor Bearing 2	no, yes	no	[Protection Para /<1..4> /Temp-Prot /RTD /Voting1]
LoadBear 1 	Load Bearing 1	no, yes	no	[Protection Para /<1..4> /Temp-Prot /RTD /Voting1]
LoadBear 2 	Load Bearing 2	no, yes	no	[Protection Para /<1..4> /Temp-Prot /RTD /Voting1]
Aux1 	Auxiliary1	no, yes	no	[Protection Para /<1..4> /Temp-Prot /RTD /Voting1]
Aux2 	Auxiliary2	no, yes	no	[Protection Para /<1..4> /Temp-Prot /RTD /Voting1]

Protective Elements

<i>Parameter</i>	<i>Description</i>	<i>Setting range</i>	<i>Default</i>	<i>Menu path</i>
Function 	Permanent activation or deactivation of module/stage.	inactive, active	inactive	[Protection Para /<1..4> /Temp-Prot /RTD /Voting2]
Voting 2 	Voting: This parameter defines how many of the selected channels must be over its threshold level for getting a voting trip	1 - 12	1	[Protection Para /<1..4> /Temp-Prot /RTD /Voting2]
Windg 1 	Winding 1	no, yes	no	[Protection Para /<1..4> /Temp-Prot /RTD /Voting2]
Windg 2 	Winding 2	no, yes	no	[Protection Para /<1..4> /Temp-Prot /RTD /Voting2]
Windg 3 	Winding 3	no, yes	no	[Protection Para /<1..4> /Temp-Prot /RTD /Voting2]
Windg 4 	Winding 4	no, yes	no	[Protection Para /<1..4> /Temp-Prot /RTD /Voting2]

Protective Elements

<i>Parameter</i>	<i>Description</i>	<i>Setting range</i>	<i>Default</i>	<i>Menu path</i>
Windg 5 	Winding 5	no, yes	no	[Protection Para /<1..4> /Temp-Prot /RTD /Voting2]
Windg 6 	Winding 6	no, yes	no	[Protection Para /<1..4> /Temp-Prot /RTD /Voting2]
MotBear 1 	Motor Bearing 1	no, yes	no	[Protection Para /<1..4> /Temp-Prot /RTD /Voting2]
MotBear 2 	Motor Bearing 2	no, yes	no	[Protection Para /<1..4> /Temp-Prot /RTD /Voting2]
LoadBear 1 	Load Bearing 1	no, yes	no	[Protection Para /<1..4> /Temp-Prot /RTD /Voting2]
LoadBear 2 	Load Bearing 2	no, yes	no	[Protection Para /<1..4> /Temp-Prot /RTD /Voting2]

Parameter	Description	Setting range	Default	Menu path
Aux1 	Auxiliary1	no, yes	no	[Protection Para /<1..4> /Temp-Prot /RTD /Voting2]
Aux2 	Auxiliary2	no, yes	no	[Protection Para /<1..4> /Temp-Prot /RTD /Voting2]

RTD Temperature Protection Module Input States

Name	Description	Assignment via
ExBlo1-I	Module input state: External blocking1	[Protection Para /Global Prot Para /Temp-Prot /RTD]
ExBlo2-I	Module input state: External blocking2	[Protection Para /Global Prot Para /Temp-Prot /RTD]
ExBlo TripCmd-I	Module input state: External Blocking of the Trip Command	[Protection Para /Global Prot Para /Temp-Prot /RTD]

RTD Temperature Protection Module Signals (Output States)

Signal	Description
active	Signal: active
ExBlo	Signal: External Blocking
Blo TripCmd	Signal: Trip Command blocked
ExBlo TripCmd	Signal: External Blocking of the Trip Command
Alarm	Alarm RTD Temperature Protection
Trip	Signal: Trip
TripCmd	Signal: Trip Command
Windg 1 Trip	Winding 1 Signal: Trip

Protective Elements

<i>Signal</i>	<i>Description</i>
Windg 1 Alarm	Winding 1 Alarm RTD Temperature Protection
Windg 1 Timeout Alarm	Winding 1 Timeout Alarm
Windg 1 Invalid	Winding 1 Signal: Invalid Temperature Measurement Value (e.g caused by an defective or interrupted RTD Measurement)
Windg 2 Trip	Winding 2 Signal: Trip
Windg 2 Alarm	Winding 2 Alarm RTD Temperature Protection
Windg 2 Timeout Alarm	Winding 2 Timeout Alarm
Windg 2 Invalid	Winding 2 Signal: Invalid Temperature Measurement Value (e.g caused by an defective or interrupted RTD Measurement)
Windg 3 Trip	Winding 3 Signal: Trip
Windg 3 Alarm	Winding 3 Alarm RTD Temperature Protection
Windg 3 Timeout Alarm	Winding 3 Timeout Alarm
Windg 3 Invalid	Winding 3 Signal: Invalid Temperature Measurement Value (e.g caused by an defective or interrupted RTD Measurement)
Windg 4 Trip	Winding 4 Signal: Trip
Windg 4 Alarm	Winding 4 Alarm RTD Temperature Protection
Windg 4 Timeout Alarm	Winding 4 Timeout Alarm
Windg 4 Invalid	Winding 4 Signal: Invalid Temperature Measurement Value (e.g caused by an defective or interrupted RTD Measurement)
Windg 5 Trip	Winding 5 Signal: Trip
Windg 5 Alarm	Winding 5 Alarm RTD Temperature Protection
Windg 5 Timeout Alarm	Winding 5 Timeout Alarm
Windg 5 Invalid	Winding 5 Signal: Invalid Temperature Measurement Value (e.g caused by an defective or interrupted RTD Measurement)
Windg 6 Trip	Winding 6 Signal: Trip
Windg 6 Alarm	Winding 6 Alarm RTD Temperature Protection
Windg 6 Timeout Alarm	Winding 6 Timeout Alarm
Windg 6 Invalid	Winding 6 Signal: Invalid Temperature Measurement Value (e.g caused by an defective or interrupted RTD Measurement)
MotBear 1 Trip	Motor Bearing 1 Signal: Trip
MotBear 1 Alarm	Motor Bearing 1 Alarm RTD Temperature Protection
MotBear 1 Timeout Alarm	Motor Bearing 1 Timeout Alarm
MotBear 1 Invalid	Motor Bearing 1 Signal: Invalid Temperature Measurement Value (e.g caused by an defective or interrupted RTD Measurement)
MotBear 2 Trip	Motor Bearing 2 Signal: Trip
MotBear 2 Alarm	Motor Bearing 2 Alarm RTD Temperature Protection
MotBear 2 Timeout Alarm	Motor Bearing 2 Timeout Alarm
MotBear 2 Invalid	Motor Bearing 2 Signal: Invalid Temperature Measurement Value (e.g caused by an defective or interrupted RTD Measurement)
LoadBear 1 Trip	Load Bearing 1 Signal: Trip
LoadBear 1 Alarm	Load Bearing 1 Alarm RTD Temperature Protection
LoadBear 1 Timeout Alarm	Load Bearing 1 Timeout Alarm

Protective Elements

<i>Signal</i>	<i>Description</i>
LoadBear 1 Invalid	Load Bearing 1 Signal: Invalid Temperature Measurement Value (e.g caused by an defective or interrupted RTD Measurement)
LoadBear 2 Trip	Load Bearing 2 Signal: Trip
LoadBear 2 Alarm	Load Bearing 2 Alarm RTD Temperature Protection
LoadBear 2 Timeout Alarm	Load Bearing 2 Timeout Alarm
LoadBear 2 Invalid	Load Bearing 2 Signal: Invalid Temperature Measurement Value (e.g caused by an defective or interrupted RTD Measurement)
Aux1 Trip	Auxiliary 1 Signal: Trip
Aux1 Alarm	Auxiliary 1 Alarm RTD Temperature Protection
Aux1 Timeout Alarm	Auxiliary 1 Timeout Alarm
Aux1 Invalid	Auxiliary 1 Signal: Invalid Temperature Measurement Value (e.g caused by an defective or interrupted RTD Measurement)
Aux2 Trip	Auxiliary 2 Signal: Trip
Aux2 Alarm	Auxiliary 2 Alarm RTD Temperature Protection
Aux2 Timeout Alarm	Auxiliary 2 Timeout Alarm
Aux2 Invalid	Auxiliary 2 Signal: Invalid Temperature Measurement Value (e.g caused by an defective or interrupted RTD Measurement)
Trip WD Group	Trip all Windings
Alarm WD Group	Alarm all Windings
TimeoutAlmWDGrp	Timeout Alarm all Windings
Windg Group Invalid	Winding Group Signal: Invalid Temperature Measurement Value (e.g caused by an defective or interrupted RTD Measurement)
Trip MB Group	Trip all Motor Bearings
Alarm MB Group	Alarm all Motor Bearings
TimeoutAlmMBGrp	Timeout Alarm all Motor Bearings
MotBear Group Invalid	Motor Bearing Group Signal: Invalid Temperature Measurement Value (e.g caused by an defective or interrupted RTD Measurement)
Trip LB Group	Trip all Load Bearings
Alarm LB Group	Alarm all Load Bearings
TimeoutAlmLBGrp	Timeout Alarm all Load Bearings
LoadBear Group Invalid	Load Bearing Group Signal: Invalid Temperature Measurement Value (e.g caused by an defective or interrupted RTD Measurement)
Trip Any Group	Trip Any Group
Alarm Any Group	Alarm Any Group
TimeoutAlmAnyGrp	Timeout Alarm Any Group
Trip Group 1	Trip Group 1
Trip Group 2	Trip Group 2
Timeout Alarm	Alarm timeout expired
Trip Aux Group	Trip Auxiliary Group
Alarm Aux Group	Alarm Auxiliary Group
TimeoutAlmAuxGrp	Timeout Alarm Auxiliary Group
AuxGrpInvalid	Invalid Auxiliary Group

RTD Temperature Protection Module Counter Values

<i>Value</i>	<i>Description</i>	<i>Default</i>	<i>Size</i>	<i>Menu path</i>
HottestWindingTemp	Hottest motor winding temperature in degrees C.	0°C	0 - 200°C	[Operation /Measured Values /URTD]
Hottest MotBearTemp	Hottest motor bearing temperature in degrees C.	0°C	0 - 200°C	[Operation /Measured Values /URTD]
Hottest LoadBearTemp	Hottest load bearing temperature in degrees C.	0°C	0 - 200°C	[Operation /Measured Values /URTD]
Hottest Aux Temp	Hottest Auxiliary temperature in degrees C.	0°C	0 - 200°C	[Operation /Measured Values /URTD]

URTDII Module Interface

URTD

Principle – General Use

The optional Universal Resistance-based Temperature Detector II (URTDII) Module provides temperature data to the protective device from up to 12 RTDs embedded in the motor, generator, transformer, or cable connector and driven equipment. The temperature data will be shown as measured values and statistics in the Operating Data menu. In addition, each channel will be monitored. The measured data provided by the URTDII Module can also be used for temperature protection (please refer to the Temperature Protection section).

The URTDII conveys multiplexed temperature data back to the relay via a single optical fiber. The URTDII may be mounted remotely from the protective device. The fiber optic connector is located on the **X102** terminal of the protective device.

Consider the benefit of mounting the URTDII module away from the protective device and as close to the protected equipment as possible. The big bundle of RTD wires to the protected equipment becomes much shorter. The URTDII may be placed up to 400 ft (121.9 m) from the protective device with the optical fiber connection. Note that the URTDII will require a power supply connection at its remote location.

Connect a suitable source to the power terminals J10A-1 and J10A-2 on the URTDII module.

<u>Style</u>	<u>Power Supply</u>
URTDII-01	48-240 V AC 48-250 V DC
URTDII-02	24-48 V DC

URTDII Module Fiber Optic Connection to the Protective Device

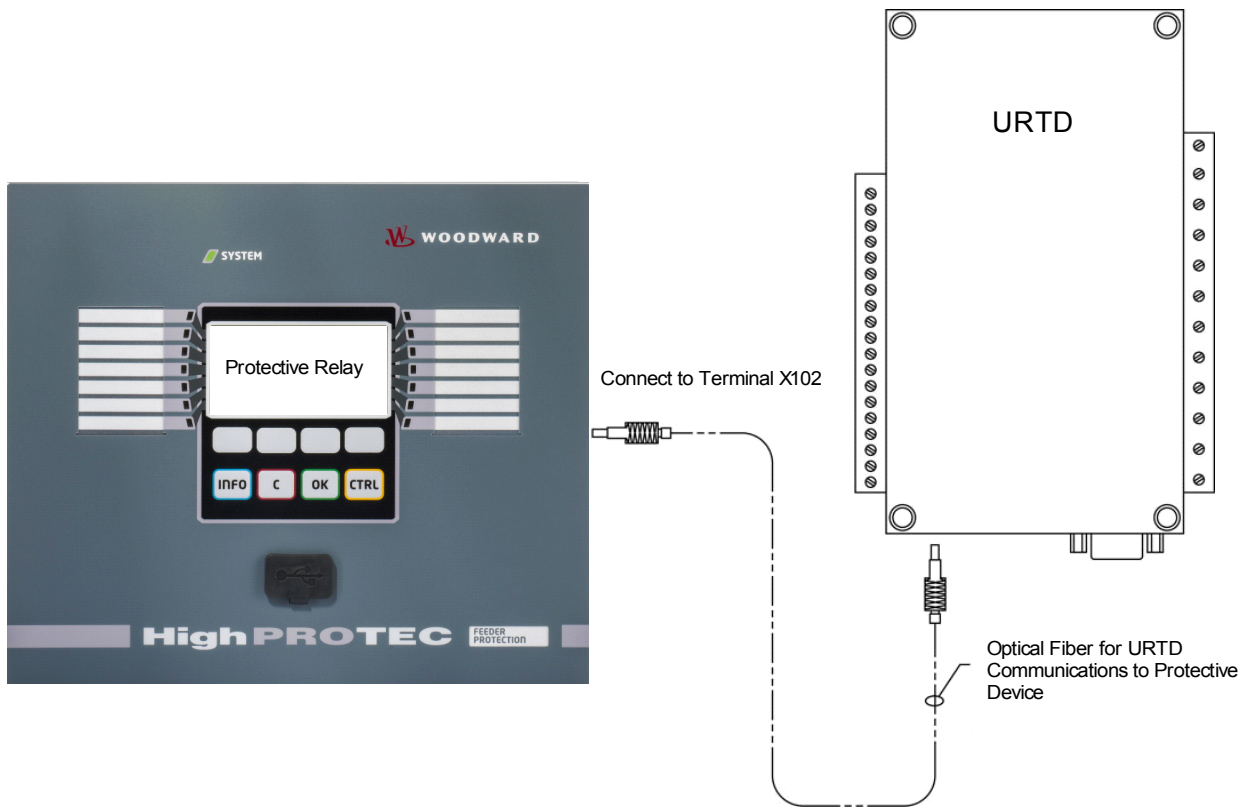

The figure above shows the fiber optic connections between the URTDII Module and the protective device. The protective device supports the optical fiber connection.

Preassembled plastic optical fibers with connectors can be ordered from any distributor of optical fiber products. In addition, these same distributors offer long rolls of cable with connectors that can be installed in the field. Some distributors will make custom lengths to order.

NOTICE Surplus length of a pre-cut fiber does not cause a problems. Simply coil and tie the excess fiber at a convenient point. Avoid high tie pressure. Bending radius of the fiber should be greater than 2 in. (50.8 mm).

The fiber termination at the URTDII simply snaps into or out of the connector. To connect the fiber termination at the protective device, push the plug of the fiber optic onto the device interface then turn it until it “snaps”.

CAUTION The protective device as well as the URTDII have various power supply options. Make certain that the power supply is acceptable for both units before connecting the same power supply to both devices.

NOTICE

Consult the URTDII Module Instruction Leaflet for complete instructions.

Three URTD terminals are provided for each RTD input.

The three terminals for any unused RTD input channel should be wired together. For example, if MW5 and MW6 are unused, MW5 terminals J2-15, J2-16, and J2-17 should be wired together and MW6 terminals J2-19, J2-20, J2-21 should be separately wired together.

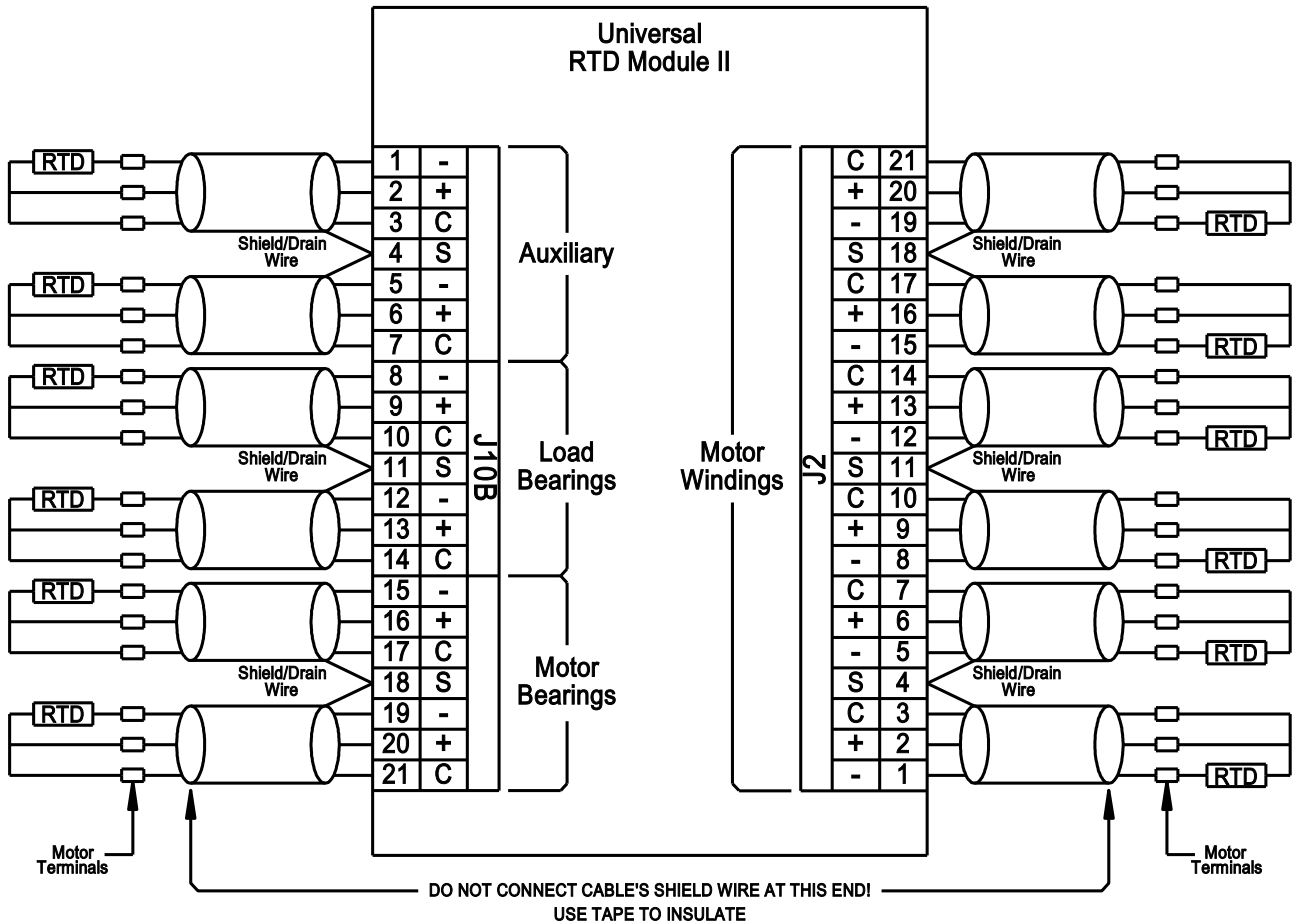





See the figure above for wiring of RTDs to the URTD inputs. Use three-conductor shielded cable. Note the connection rules in the figure. When making connections to a two-lead RTD, connect two of the cable conductors to one of the RTD leads as shown. Make this connection as close to the protected object as possible. Connect the third cable conductor to the remaining RTD lead.

Connect the shield / drain wire to the Shield terminal as shown in the figure. The RTD cable shield should be connected only at the URTD end, and insulated at the RTD end. The RTD's themselves must not be grounded at the object to be protected.



Remember to set the URTDII module DIP switches according to the types of RTDs in each of the channels.

Direct Commands of the URTD Module

<i>Parameter</i>	<i>Description</i>	<i>Setting range</i>	<i>Default</i>	<i>Menu path</i>
Function 	Permanent activation or deactivation of module/stage.	inactive, active	inactive	[Service /Test (Prot inhibit) /URTD]
Force Windg1 	Force Winding 1	0 - 392	0	[Service /Test (Prot inhibit) /URTD]
Force Windg2 	Force Winding 2	0 - 392	0	[Service /Test (Prot inhibit) /URTD]
Force Windg3 	Force Winding 3	0 - 392	0	[Service /Test (Prot inhibit) /URTD]
Force Windg4 	Force Winding 4	0 - 392	0	[Service /Test (Prot inhibit) /URTD]
Force Windg5 	Force Winding 5	0 - 392	0	[Service /Test (Prot inhibit) /URTD]
Force Windg6 	Force Winding 6	0 - 392	0	[Service /Test (Prot inhibit) /URTD]
Force MotBear1 	Force Motor Bearing 1	0 - 392	0	[Service /Test (Prot inhibit) /URTD]
Force MotBear2 	Force Motor Bearing 2	0 - 392	0	[Service /Test (Prot inhibit) /URTD]

<i>Parameter</i>	<i>Description</i>	<i>Setting range</i>	<i>Default</i>	<i>Menu path</i>
Force LoadBear1 	Force Load Bearing 1	0 - 392	0	[Service /Test (Prot inhibit) /URTD]
Force LoadBear2 	Force Load Bearing 2	0 - 392	0	[Service /Test (Prot inhibit) /URTD]
Force Aux1 	Force Auxiliary1	0 - 392	0	[Service /Test (Prot inhibit) /URTD]
Force Aux2 	Force Auxiliary2	0 - 392	0	[Service /Test (Prot inhibit) /URTD]

Global Protection Parameters of the URTD Module

<i>Parameter</i>	<i>Description</i>	<i>Setting range</i>	<i>Default</i>	<i>Menu path</i>
Force Mode 	By means of this function the normal Output Relay States can be overwritten (forced) in case that the Relay is not in a disarmed state. The relays can be set from normal operation (relay works according to the assigned signals) to "force energized" or "force de-energized" state.	permanent, timeout	permanent	[Service /Test (Prot inhibit) /URTD]
t-Timeout Force 	The Output State will be set by force for the duration of this time. That means for the duration of this time the Output Relay does not show the state of the signals that are assigned on it. Only available if: Mode = Timeout DISARM	0.00 - 300.00s	0.03s	[Service /Test (Prot inhibit) /URTD]
Temperature Unit 	Temperature Unit	Celsius, Fahrenheit	Celsius	[Device Para /Measurem Display /General Settings]

URTD Signals (Output States)

<i>Signal</i>	<i>Description</i>
Windg1 Superv	Signal: Supervision Channel Windg1
Windg2 Superv	Signal: Supervision Channel Windg2
Windg3 Superv	Signal: Supervision Channel Windg3
Windg4 Superv	Signal: Supervision Channel Windg4
Windg5 Superv	Signal: Supervision Channel Windg5
Windg6 Superv	Signal: Supervision Channel Windg6
MotBear1 Superv	Signal: Supervision Channel MotBear1
MotBear2 Superv	Signal: Supervision Channel MotBear2
LoadBear1 Superv	Signal: Supervision Channel LoadBear1
LoadBear2 Superv	Signal: Supervision Channel LoadBear2
Aux1 Superv	Signal: Supervision Channel Aux1
Aux2 Superv	Signal: Supervision Channel Aux2
Superv	Signal: URTD Supervision Channel
active	Signal: URTD active
Outs forced	Signal: The State of at least one Relay Output has been set by force. That means that the state of at least one Relay is forced and hence does not show the state of the assigned signals.

URTD Module Statistics

<i>Value</i>	<i>Description</i>	<i>Menu path</i>
Windg1 max	Winding1 Maximum Value	[Operation /Statistics /Max /URTD]
Windg2 max	Winding2 Maximum Value	[Operation /Statistics /Max /URTD]
Windg3 max	Winding3 Maximum Value	[Operation /Statistics /Max /URTD]
Windg4 max	Winding4 Maximum Value	[Operation /Statistics /Max /URTD]
Windg5 max	Winding5 Maximum Value	[Operation /Statistics /Max /URTD]
Windg6 max	Winding6 Maximum Value	[Operation /Statistics /Max /URTD]
MotBear1 max	Motor Bearing1 Maximum Value	[Operation /Statistics /Max /URTD]
MotBear2 max	Motor Bearing2 Maximum Value	[Operation /Statistics /Max /URTD]
LoadBear1 max	Load Bearing1 Maximum Value	[Operation /Statistics /Max /URTD]

Protective Elements

<i>Value</i>	<i>Description</i>	<i>Menu path</i>
LoadBear2 max	Load Bearing2 Maximum Value	[Operation /Statistics /Max /URTD]
Aux1 max	Auxiliary1 Maximum Value	[Operation /Statistics /Max /URTD]
Aux2 max	Auxiliary2 Maximum Value	[Operation /Statistics /Max /URTD]

URTD Measured Values

<i>Value</i>	<i>Description</i>	<i>Menu path</i>
Windg1	Winding 1	[Operation /Measured Values /URTD]
Windg2	Winding 2	[Operation /Measured Values /URTD]
Windg3	Winding 3	[Operation /Measured Values /URTD]
Windg4	Winding 4	[Operation /Measured Values /URTD]
Windg5	Winding 5	[Operation /Measured Values /URTD]
Windg6	Winding 6	[Operation /Measured Values /URTD]
MotBear1	Motor Bearing 1	[Operation /Measured Values /URTD]
MotBear2	Motor Bearing 2	[Operation /Measured Values /URTD]
LoadBear1	Load Bearing 1	[Operation /Measured Values /URTD]
LoadBear2	Load Bearing 2	[Operation /Measured Values /URTD]
Aux1	Auxiliary1	[Operation /Measured Values /URTD]
Aux2	Auxiliary2	[Operation /Measured Values /URTD]

Protective Elements

<i>Value</i>	<i>Description</i>	<i>Menu path</i>
RTD Max	Maximum temperature of all channels.	[Operation /Measured Values /URTD]

Supervision

CBF- Circuit Breaker Failure [50BF*/62BF]

*=only available in protective relays that offer current measurement.

Available elements:

CBF

Principle – General Use

The breaker failure (BF) protection is used to provide backup protection in the event that a breaker fails to operate properly during fault clearing. This signal is to be used to trip the upstream breaker (e.g. infeed of a busbar) either via an output relay or via Communication (SCADA). Depending on the ordered device and type there are different/multiple schemes available to detect a breaker failure.

Start/Trigger of the CBF Timer

A supervision timer »*t-CBF*« will be started, once the CBF module is triggered. Even if the Trigger signal drops again, this timer will continue to run. If the timer runs down/elapses (is not stopped), the module will issue a trip afterwards. This trip signal is to be used to trip the upstream breaker (backup).

Stopping the CBF

The timer will be stopped if the opening of the breaker is detected. Depending on the supervision scheme the timer will be stopped if the current falls below the current threshold or if the position signals indicate the open position of the breaker or a combination of both. The CBF module will remain within the state rejected until the trigger signal drops (falls back).

Detecting a Breaker Failure

Depending on the supervision scheme, the Circuit Breaker Failure signal (Trip) will be set if either:

- the current doesn't fall below the threshold or
- the position signals indicate that the breaker is in the closed position or
- both.

Reject state of the CBF module

The CBF module will switch into the rejected state if the circuit breaker failure triggers are still active while the open position of the breaker has been detected successfully.

Readiness for Operation

The CBF module will switch back into the Stand-by if the trigger signals drop (fall back).

Locking

A locking signal will be issued simultaneously with the CBF-Signal (Trip). The locking signal is permanent. This signal has to be acknowledged at the HMI.

NOTICE

Note on devices that offer Wide Frequency Range measurement:

The supervision scheme 50BF will be blocked as soon as the frequency differs more than 5% from the nominal frequency. As long as the frequency differs more than 5% from the nominal frequency the supervision scheme “50BF and CB Pos” will work according to the “CB Pos” scheme.

Supervision Schemes

Up to three supervision schemes are available depending on the ordered device type and variant in order to detect a circuit breaker failure.

*50BF**

A supervision timer will be started as soon as the CBF module is triggered by a trip signal. A breaker failure will be detected and a signal will be issued if the measured current does not fall below a set threshold while this timer runs down.

This supervision scheme is available within protective relays that offer current measurement.

CB Pos

A supervision timer will be started as soon as the CBF module is triggered by a trip signal. A breaker failure will be detected and a signal will be issued if the evaluation of the position indicators of the circuit breaker does not indicate that the breaker has been switched off successfully while this timer runs down.

This supervision scheme is available within all protective relays. This scheme is recommended if breaker failures have to be detected while there is no or not much load flow (small currents). This might e.g. be the case if overvoltage or overfrequency is supervised for a Gen-Set that is running in Stand-by.

*50 BF and CB Pos**

A supervision timer will be started as soon as the CBF module is triggered by a trip signal. A breaker failure will be detected and a signal will be issued if the measured current does not fall below a set threshold and if simultaneously the evaluation of the position indicators of the circuit breaker does not indicate that the breaker has been switched off successfully while this timer runs down.

This scheme is recommended if breaker failures have to be double checked. This scheme will issue a trip command to the upstream breaker even if position indicators indicate misleadingly (faulty) that the breaker has been opened or if the current measurement indicates misleadingly (faulty) that the breaker is now in the open position.

*=only available in protective relays that offer current measurement.

Trigger Modes

There are three trigger modes for the CBF module available. In addition to that, there are three assignable trigger inputs available that might trigger the CBF module even if they are not assigned within the breaker manager onto the breaker that is to be monitored.

- *All Trips*: All trip signals that are assigned to this breaker (within the trip manager) will start the CBF module (please refer also to section „Trigger signals of the Circuit Breaker Failure“).
- *Current Trips*: All current trips that are assigned to this breaker (within the trip manager) will start the CBF module (please refer also to section „Trigger signals of the Circuit Breaker Failure“).
- *External Trips*: All external trips that are assigned to this breaker (within the trip manager) will start the CBF module (please refer also to section „Trigger signals of the Circuit Breaker Failure“).

•In addition, the User can also select *none* (e.g.: if the User intends to use one of the three additional assignable trigger inputs).

NOTICE

Those trips can exclusively start the breaker failures that are assigned within the trip manager to the breaker that is to be supervised. In contrast to that the additional three triggers 1-3 will trigger the CBFmodule even if they are not assigned onto the breaker within the corresponding breaker manager.

NOTICE

Select the winding side (Breaker, Winding) from which the measured currents should be taken in case this protective device provides more than one current measurement card.

NOTICE

This Notice applies to protective devices that offer control functionality only! This protective element requires, that a switchgear (circuit breaker) is assigned to it. It is allowed only to assign switchgears (circuit breaker) to this protective element, whose measuring transformers provide measuring data to the protective device.

Breaker Failure Lockout

The signal of the Circuit Breaker Failure is latched. This signal can be used to block the breaker against a switching on attempt.

Tabular Summary

	<i>Supervision Schemes</i>		
	Where? Within [Protection Para\Global Prot Para\Supervision\CBF]		
	CB Pos ²⁾	50BF ³⁾	CBPos und 50BF ⁴⁾
<p><i>Which breaker is to be monitored?</i></p> <p>Where to select? Within [Protection Para\Global Prot Para\Supervision\CBF]</p>	<p>Selection of the breaker that is to be monitored.</p> <p>(In case that more than one breaker is available)</p>	<p>Selection of the breaker that is to be monitored.</p> <p>(In case that more than one breaker is available)</p>	<p>Selection of the breaker that is to be monitored.</p> <p>(In case that more than one breaker is available)</p>
<p><i>Trigger Modi</i></p> <p>(Who starts the CBF-timer ?)</p> <p>Where to set? Within [Protection Para\Global Prot Para\Supervision\CBF]</p>	<p>All Trips⁵⁾</p> <p>or</p> <p>All Current Trips⁵⁾</p> <p>or</p> <p>External Trips⁵⁾</p> <p>...and the breaker is in the closed position and the CBF module is within the stand-by state.</p>	<p>All Trips⁵⁾</p> <p>or</p> <p>All Current Trips⁵⁾</p> <p>or</p> <p>External Trips⁵⁾</p> <p>...and the CBF module is within the stand-by state.</p>	<p>All Trips⁵⁾</p> <p>or</p> <p>All Current Trips⁵⁾</p> <p>or</p> <p>External Trips⁵⁾</p> <p>...and the breaker is in the closed position and the CBF module is within the stand-by state.</p>
<p><i>Who stops the CBF-Timer?</i></p> <p>Once the timer has been stopped the CBF module will switch into the state „Rejected“. The module will switch back into the state „Stand-by“ if the trigger signals are dropped.</p>	<p>Position indicators indicate that the switchgear (breaker) is in the open position.</p>	<p>Current is fallen below the I<-threshold¹⁾.</p>	<p>Position indicators indicate that the switchgear (breaker) is in the open position and current is fallen below the I<-threshold¹⁾.</p>
<p><i>A Breaker Failure will be detected</i></p> <p>...and a trip signal to the upstream breaker will be issued?</p>	<p>When the CBF-Timer has run down (elapsed).</p>	<p>When the CBF-Timer has run down (elapsed).</p>	<p>When the CBF-Timer has run down (elapsed).</p>
<p><i>When does the trip signal to the upstream breaker drops (falls back)?</i></p>	<p>If the position indicators indicate that the switchgear (breaker) is in the open position and if the trigger signals are dropped (fallen back)</p>	<p>If the current is fallen below the I< and if the trigger signals are dropped (fallen back)</p>	<p>If the position indicators indicate that the switchgear (breaker) is in the open position and if the current is fallen below the I< and if the trigger signals are dropped (fallen back)</p>

¹⁾ It is recommended to set the I< threshold to a value that is slightly below the fault current that is expectable. By means of that it is possible to shorten the CBF supervision timer and hence reduce thermal and mechanical damage of the electrical equipment in case of a breaker failure. The lower the threshold, the longer the time that is needed to detect, that the breaker is in the open position, especially if there are transients/harmonics.

Note: Tripping delay of the CBF module = Minimum delay time (tripping time) of the backup protection!

Supervision

2), 3), 4)

Available in all devices with the corresponding software

Available in all devices that offer current measurement

Available in all devices that offer current measurement

5)

Only if the signals are assigned onto the breaker within the breaker manager.

Circuit Breaker Failure Protection for devices that offer current measurement

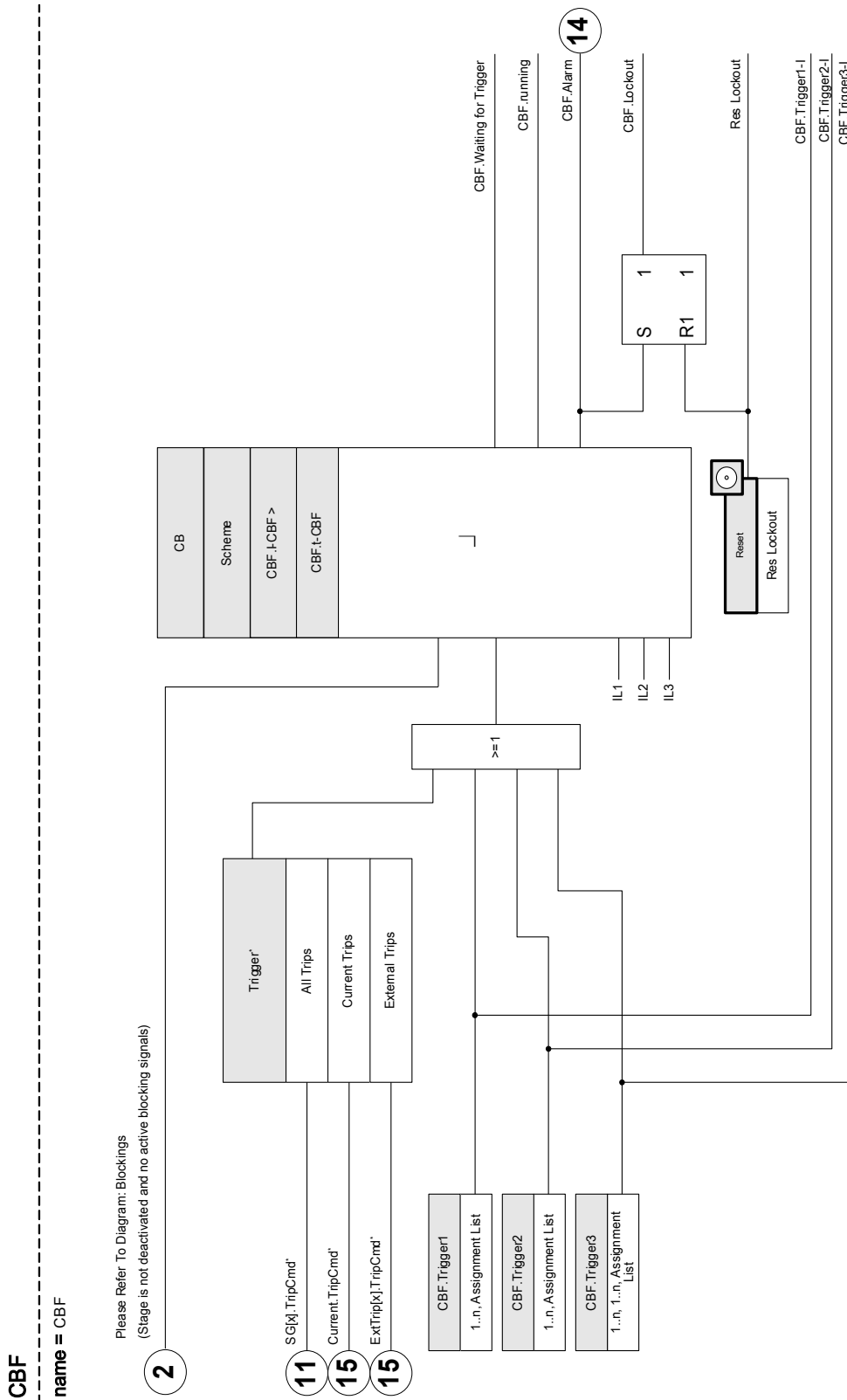

*The Breaker Failure will be triggered only by those trip signals that are assigned onto the breaker within the Trip Manager.

Circuit Breaker Failure Protection for devices that offer voltage measurement only

CBF

name = CBF

Please Refer To Diagram: Blockings

(Stage is not deactivated and no active blocking signals)

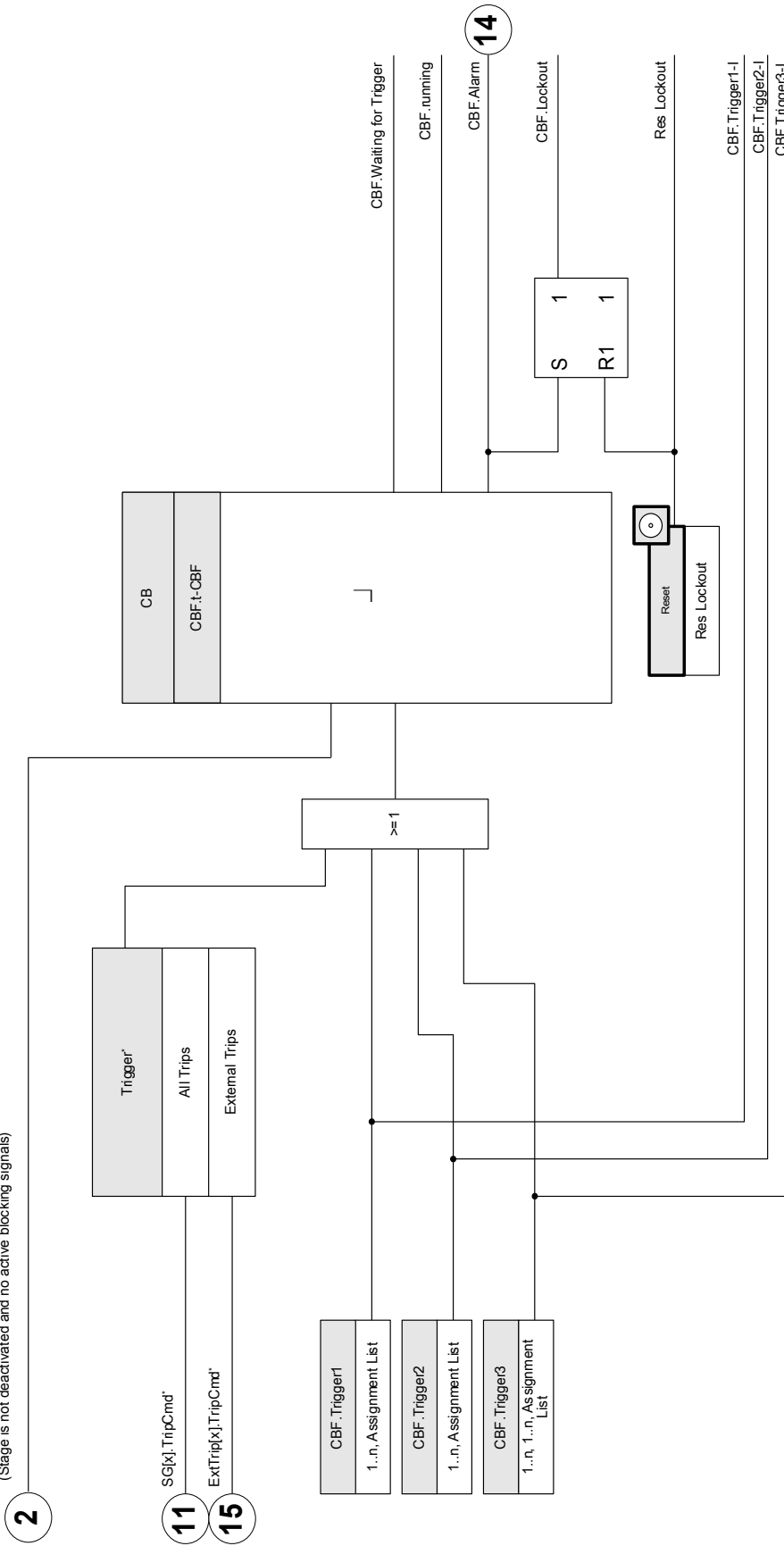









*The Breaker Failure will be triggered only by those trip signals that are assigned onto the breaker within the Trip Manager.

Device Planning Parameters of the CBF

Parameter	Description	Options	Default	Menu path
Mode 	Mode	do not use, use	do not use	[Device planning]

Global Protection Parameters of the CBF

Parameter	Description	Setting range	Default	Menu path
Scheme 	Scheme	50BF, CB Pos, 50BF and CB Pos	50BF	[Protection Para /Global Prot Para /Supervision /CBF]
CT Winding Side 	Measuring values will be used from this winding side Only available if: Scheme50BF = Or Scheme = 50BF and CB Pos	CT Ntrl, CT Mains	CT Ntrl	[Protection Para /Global Prot Para /Supervision /CBF]
CB 	Selection of the Circuit Breaker to be monitored.	-., SG[1]., SG[2]., SG[3]., SG[4]., SG[5]., SG[6].	SG[1].	[Protection Para /Global Prot Para /Supervision /CBF]
ExBlo1 	External blocking of the module, if blocking is activated (allowed) within a parameter set and if the state of the assigned signal is true.	1..n, Assignment List	-.-	[Protection Para /Global Prot Para /Supervision /CBF]
ExBlo2 	External blocking of the module, if blocking is activated (allowed) within a parameter set and if the state of the assigned signal is true.	1..n, Assignment List	-.-	[Protection Para /Global Prot Para /Supervision /CBF]

<i>Parameter</i>	<i>Description</i>	<i>Setting range</i>	<i>Default</i>	<i>Menu path</i>
Trigger 	Determining the trigger mode for the Breaker Failure.	- . -, All Trips, External Trips, Current Trips	All Trips	[Protection Para /Global Prot Para /Supervision /CBF]
Trigger1 	Trigger that will start the CBF	Trigger	.-	[Protection Para /Global Prot Para /Supervision /CBF]
Trigger2 	Trigger that will start the CBF	Trigger	.-	[Protection Para /Global Prot Para /Supervision /CBF]
Trigger3 	Trigger that will start the CBF	Trigger	.-	[Protection Para /Global Prot Para /Supervision /CBF]

Direct Commands of the CBF





<i>Parameter</i>	<i>Description</i>	<i>Setting range</i>	<i>Default</i>	<i>Menu path</i>
Res Lockout 	Reset Lockout	inactive, active	inactive	[Operation /Reset]

Setting Group Parameters of the CBF

NOTICE

In order to prevent a faulty activation of the BF Module, the pickup (alarm) time must be greater than the sum of:

- Operating time of the protective relay
- +The close-open time of the breaker (please refer to the technical data of the manufacturer of the breaker);
- +Drop off time (current- or position indicators)
- +Security margin.

Parameter	Description	Setting range	Default	Menu path
Function 	Permanent activation or deactivation of module/stage.	inactive, active	inactive	[Protection Para /<1..4> /Supervision /CBF]
ExBlo Fc 	Activate (allow) or inactivate (disallow) blocking of the module/stage. This parameter is only effective if a signal is assigned to the corresponding global protection parameter. If the signal becomes true, those modules/stages are blocked that are parameterized "ExBlo Fc=active".	inactive, active	inactive	[Protection Para /<1..4> /Supervision /CBF]
I-CBF > 	Breaker Failure Alarm will be initiated if this threshold is still exceeded after the timer has expired (50 BF). Only available if: Scheme50BF = Or Scheme = 50BF and CB Pos	0.02 - 4.00In	0.02In	[Protection Para /<1..4> /Supervision /CBF]
t-CBF 	If the delay time is expired, an CBF alarm is given out.	0.00 - 10.00s	0.20s	[Protection Para /<1..4> /Supervision /CBF]

CBF Input States

<i>Name</i>	<i>Description</i>	<i>Assignment via</i>
ExBlo1-I	Module input state: External blocking1	[Protection Para /Global Prot Para /Supervision /CBF]
ExBlo2-I	Module input state: External blocking2	[Protection Para /Global Prot Para /Supervision /CBF]
Trigger1-I	Module Input: Trigger that will start the CBF	[Protection Para /Global Prot Para /Supervision /CBF]
Trigger2-I	Module Input: Trigger that will start the CBF	[Protection Para /Global Prot Para /Supervision /CBF]
Trigger3-I	Module Input: Trigger that will start the CBF	[Protection Para /Global Prot Para /Supervision /CBF]

CBF Signals (Output States)

<i>Signal</i>	<i>Description</i>
active	Signal: active
ExBlo	Signal: External Blocking
Waiting for Trigger	Waiting for Trigger
running	Signal: CBF-Module started
Alarm	Signal: Circuit Breaker Failure
Lockout	Signal: Lockout
Res Lockout	Signal: Reset Lockout

Trigger signals of the Circuit Breaker Failure

These trips will start the CBF module if »All trips« have been selected as the trigger event.

Name	Description
.-	No assignment
Id.TripCmd	Signal: Trip Command
IdH.TripCmd	Signal: Trip Command
IdG[1].TripCmd	Signal: Trip Command
IdGH[1].TripCmd	Signal: Trip Command
IdG[2].TripCmd	Signal: Trip Command
IdGH[2].TripCmd	Signal: Trip Command
I[1].TripCmd	Signal: Trip Command
I[2].TripCmd	Signal: Trip Command
I[3].TripCmd	Signal: Trip Command
I[4].TripCmd	Signal: Trip Command
I[5].TripCmd	Signal: Trip Command
I[6].TripCmd	Signal: Trip Command
IG[1].TripCmd	Signal: Trip Command
IG[2].TripCmd	Signal: Trip Command
IG[3].TripCmd	Signal: Trip Command
IG[4].TripCmd	Signal: Trip Command
ThR.TripCmd	Signal: Trip Command
I2>[1].TripCmd	Signal: Trip Command
I2>[2].TripCmd	Signal: Trip Command
I2>G[1].TripCmd	Signal: Trip Command
I2>G[2].TripCmd	Signal: Trip Command
V[1].TripCmd	Signal: Trip Command
V[2].TripCmd	Signal: Trip Command
V[3].TripCmd	Signal: Trip Command
V[4].TripCmd	Signal: Trip Command
V[5].TripCmd	Signal: Trip Command
V[6].TripCmd	Signal: Trip Command
df/dt.TripCmd	Signal: Trip Command
delta phi.TripCmd	Signal: Trip Command
Intertripping.TripCmd	Signal: Trip Command
P.TripCmd	Signal: Trip Command
Q.TripCmd	Signal: Trip Command
LVRT[1].TripCmd	Signal: Trip Command
LVRT[2].TripCmd	Signal: Trip Command
VG[1].TripCmd	Signal: Trip Command

<i>Name</i>	<i>Description</i>
VG[2].TripCmd	Signal: Trip Command
V012[1].TripCmd	Signal: Trip Command
V012[2].TripCmd	Signal: Trip Command
V012[3].TripCmd	Signal: Trip Command
V012[4].TripCmd	Signal: Trip Command
V012[5].TripCmd	Signal: Trip Command
V012[6].TripCmd	Signal: Trip Command
f[1].TripCmd	Signal: Trip Command
f[2].TripCmd	Signal: Trip Command
f[3].TripCmd	Signal: Trip Command
f[4].TripCmd	Signal: Trip Command
f[5].TripCmd	Signal: Trip Command
f[6].TripCmd	Signal: Trip Command
PQS[1].TripCmd	Signal: Trip Command
PQS[2].TripCmd	Signal: Trip Command
PQS[3].TripCmd	Signal: Trip Command
PQS[4].TripCmd	Signal: Trip Command
PQS[5].TripCmd	Signal: Trip Command
PQS[6].TripCmd	Signal: Trip Command
PF[1].TripCmd	Signal: Trip Command
PF[2].TripCmd	Signal: Trip Command
Q->&V<.Decoupling PCC	Signal: Decoupling at the Point of Common Coupling
Q->&V<.Decoupling Distr. Generator	Signal: Decoupling of the (local) Energy Generator/Resource
LoE-Z1[1].TripCmd	Signal: Trip Command
LoE-Z2[1].TripCmd	Signal: Trip Command
LoE-Z1[2].TripCmd	Signal: Trip Command
LoE-Z2[2].TripCmd	Signal: Trip Command
OST.TripCmd	Signal: Trip Command
V/f>[1].TripCmd	Signal: Trip Command
V/f>[2].TripCmd	Signal: Trip Command
InEn.TripCmd	Signal: Trip Command
Z[1].TripCmd	Signal: Trip Command
Z[2].TripCmd	Signal: Trip Command
ExP[1].TripCmd	Signal: Trip Command
ExP[2].TripCmd	Signal: Trip Command
ExP[3].TripCmd	Signal: Trip Command
ExP[4].TripCmd	Signal: Trip Command
Ext Sudd Press.TripCmd	Signal: Trip Command
Ext Oil Temp.TripCmd	Signal: Trip Command

<i>Name</i>	<i>Description</i>
Ext Temp Superv[1].TripCmd	Signal: Trip Command
Ext Temp Superv[2].TripCmd	Signal: Trip Command
Ext Temp Superv[3].TripCmd	Signal: Trip Command
RTD.TripCmd	Signal: Trip Command
DI Slot X1.DI 1	Signal: Digital Input
DI Slot X1.DI 2	Signal: Digital Input
DI Slot X1.DI 3	Signal: Digital Input
DI Slot X1.DI 4	Signal: Digital Input
DI Slot X1.DI 5	Signal: Digital Input
DI Slot X1.DI 6	Signal: Digital Input
DI Slot X1.DI 7	Signal: Digital Input
DI Slot X1.DI 8	Signal: Digital Input
DI Slot X5.DI 1	Signal: Digital Input
DI Slot X5.DI 2	Signal: Digital Input
DI Slot X5.DI 3	Signal: Digital Input
DI Slot X5.DI 4	Signal: Digital Input
DI Slot X5.DI 5	Signal: Digital Input
DI Slot X5.DI 6	Signal: Digital Input
DI Slot X5.DI 7	Signal: Digital Input
DI Slot X5.DI 8	Signal: Digital Input
DI Slot X6.DI 1	Signal: Digital Input
DI Slot X6.DI 2	Signal: Digital Input
DI Slot X6.DI 3	Signal: Digital Input
DI Slot X6.DI 4	Signal: Digital Input
DI Slot X6.DI 5	Signal: Digital Input
DI Slot X6.DI 6	Signal: Digital Input
DI Slot X6.DI 7	Signal: Digital Input
DI Slot X6.DI 8	Signal: Digital Input
AnaP[1].TripCmd	Signal: Trip Command
AnaP[2].TripCmd	Signal: Trip Command
AnaP[3].TripCmd	Signal: Trip Command
AnaP[4].TripCmd	Signal: Trip Command
Logics.LE1.Gate Out	Signal: Output of the logic gate
Logics.LE1.Timer Out	Signal: Timer Output
Logics.LE1.Out	Signal: Latched Output (Q)
Logics.LE1.Out inverted	Signal: Negated Latched Output (Q NOT)
Logics.LE2.Gate Out	Signal: Output of the logic gate
Logics.LE2.Timer Out	Signal: Timer Output

<i>Name</i>	<i>Description</i>
Logics.LE2.Out	Signal: Latched Output (Q)
Logics.LE2.Out inverted	Signal: Negated Latched Output (Q NOT)
Logics.LE3.Gate Out	Signal: Output of the logic gate
Logics.LE3.Timer Out	Signal: Timer Output
Logics.LE3.Out	Signal: Latched Output (Q)
Logics.LE3.Out inverted	Signal: Negated Latched Output (Q NOT)
Logics.LE4.Gate Out	Signal: Output of the logic gate
Logics.LE4.Timer Out	Signal: Timer Output
Logics.LE4.Out	Signal: Latched Output (Q)
Logics.LE4.Out inverted	Signal: Negated Latched Output (Q NOT)
Logics.LE5.Gate Out	Signal: Output of the logic gate
Logics.LE5.Timer Out	Signal: Timer Output
Logics.LE5.Out	Signal: Latched Output (Q)
Logics.LE5.Out inverted	Signal: Negated Latched Output (Q NOT)
Logics.LE6.Gate Out	Signal: Output of the logic gate
Logics.LE6.Timer Out	Signal: Timer Output
Logics.LE6.Out	Signal: Latched Output (Q)
Logics.LE6.Out inverted	Signal: Negated Latched Output (Q NOT)
Logics.LE7.Gate Out	Signal: Output of the logic gate
Logics.LE7.Timer Out	Signal: Timer Output
Logics.LE7.Out	Signal: Latched Output (Q)
Logics.LE7.Out inverted	Signal: Negated Latched Output (Q NOT)
Logics.LE8.Gate Out	Signal: Output of the logic gate
Logics.LE8.Timer Out	Signal: Timer Output
Logics.LE8.Out	Signal: Latched Output (Q)
Logics.LE8.Out inverted	Signal: Negated Latched Output (Q NOT)
Logics.LE9.Gate Out	Signal: Output of the logic gate
Logics.LE9.Timer Out	Signal: Timer Output
Logics.LE9.Out	Signal: Latched Output (Q)
Logics.LE9.Out inverted	Signal: Negated Latched Output (Q NOT)
Logics.LE10.Gate Out	Signal: Output of the logic gate
Logics.LE10.Timer Out	Signal: Timer Output
Logics.LE10.Out	Signal: Latched Output (Q)
Logics.LE10.Out inverted	Signal: Negated Latched Output (Q NOT)
Logics.LE11.Gate Out	Signal: Output of the logic gate
Logics.LE11.Timer Out	Signal: Timer Output
Logics.LE11.Out	Signal: Latched Output (Q)
Logics.LE11.Out inverted	Signal: Negated Latched Output (Q NOT)
Logics.LE12.Gate Out	Signal: Output of the logic gate
Logics.LE12.Timer Out	Signal: Timer Output

<i>Name</i>	<i>Description</i>
Logics.LE12.Out	Signal: Latched Output (Q)
Logics.LE12.Out inverted	Signal: Negated Latched Output (Q NOT)
Logics.LE13.Gate Out	Signal: Output of the logic gate
Logics.LE13.Timer Out	Signal: Timer Output
Logics.LE13.Out	Signal: Latched Output (Q)
Logics.LE13.Out inverted	Signal: Negated Latched Output (Q NOT)
Logics.LE14.Gate Out	Signal: Output of the logic gate
Logics.LE14.Timer Out	Signal: Timer Output
Logics.LE14.Out	Signal: Latched Output (Q)
Logics.LE14.Out inverted	Signal: Negated Latched Output (Q NOT)
Logics.LE15.Gate Out	Signal: Output of the logic gate
Logics.LE15.Timer Out	Signal: Timer Output
Logics.LE15.Out	Signal: Latched Output (Q)
Logics.LE15.Out inverted	Signal: Negated Latched Output (Q NOT)
Logics.LE16.Gate Out	Signal: Output of the logic gate
Logics.LE16.Timer Out	Signal: Timer Output
Logics.LE16.Out	Signal: Latched Output (Q)
Logics.LE16.Out inverted	Signal: Negated Latched Output (Q NOT)
Logics.LE17.Gate Out	Signal: Output of the logic gate
Logics.LE17.Timer Out	Signal: Timer Output
Logics.LE17.Out	Signal: Latched Output (Q)
Logics.LE17.Out inverted	Signal: Negated Latched Output (Q NOT)
Logics.LE18.Gate Out	Signal: Output of the logic gate
Logics.LE18.Timer Out	Signal: Timer Output
Logics.LE18.Out	Signal: Latched Output (Q)
Logics.LE18.Out inverted	Signal: Negated Latched Output (Q NOT)
Logics.LE19.Gate Out	Signal: Output of the logic gate
Logics.LE19.Timer Out	Signal: Timer Output
Logics.LE19.Out	Signal: Latched Output (Q)
Logics.LE19.Out inverted	Signal: Negated Latched Output (Q NOT)
Logics.LE20.Gate Out	Signal: Output of the logic gate
Logics.LE20.Timer Out	Signal: Timer Output
Logics.LE20.Out	Signal: Latched Output (Q)
Logics.LE20.Out inverted	Signal: Negated Latched Output (Q NOT)
Logics.LE21.Gate Out	Signal: Output of the logic gate
Logics.LE21.Timer Out	Signal: Timer Output
Logics.LE21.Out	Signal: Latched Output (Q)
Logics.LE21.Out inverted	Signal: Negated Latched Output (Q NOT)
Logics.LE22.Gate Out	Signal: Output of the logic gate
Logics.LE22.Timer Out	Signal: Timer Output

<i>Name</i>	<i>Description</i>
Logics.LE22.Out	Signal: Latched Output (Q)
Logics.LE22.Out inverted	Signal: Negated Latched Output (Q NOT)
Logics.LE23.Gate Out	Signal: Output of the logic gate
Logics.LE23.Timer Out	Signal: Timer Output
Logics.LE23.Out	Signal: Latched Output (Q)
Logics.LE23.Out inverted	Signal: Negated Latched Output (Q NOT)
Logics.LE24.Gate Out	Signal: Output of the logic gate
Logics.LE24.Timer Out	Signal: Timer Output
Logics.LE24.Out	Signal: Latched Output (Q)
Logics.LE24.Out inverted	Signal: Negated Latched Output (Q NOT)
Logics.LE25.Gate Out	Signal: Output of the logic gate
Logics.LE25.Timer Out	Signal: Timer Output
Logics.LE25.Out	Signal: Latched Output (Q)
Logics.LE25.Out inverted	Signal: Negated Latched Output (Q NOT)
Logics.LE26.Gate Out	Signal: Output of the logic gate
Logics.LE26.Timer Out	Signal: Timer Output
Logics.LE26.Out	Signal: Latched Output (Q)
Logics.LE26.Out inverted	Signal: Negated Latched Output (Q NOT)
Logics.LE27.Gate Out	Signal: Output of the logic gate
Logics.LE27.Timer Out	Signal: Timer Output
Logics.LE27.Out	Signal: Latched Output (Q)
Logics.LE27.Out inverted	Signal: Negated Latched Output (Q NOT)
Logics.LE28.Gate Out	Signal: Output of the logic gate
Logics.LE28.Timer Out	Signal: Timer Output
Logics.LE28.Out	Signal: Latched Output (Q)
Logics.LE28.Out inverted	Signal: Negated Latched Output (Q NOT)
Logics.LE29.Gate Out	Signal: Output of the logic gate
Logics.LE29.Timer Out	Signal: Timer Output
Logics.LE29.Out	Signal: Latched Output (Q)
Logics.LE29.Out inverted	Signal: Negated Latched Output (Q NOT)
Logics.LE30.Gate Out	Signal: Output of the logic gate
Logics.LE30.Timer Out	Signal: Timer Output
Logics.LE30.Out	Signal: Latched Output (Q)
Logics.LE30.Out inverted	Signal: Negated Latched Output (Q NOT)
Logics.LE31.Gate Out	Signal: Output of the logic gate
Logics.LE31.Timer Out	Signal: Timer Output
Logics.LE31.Out	Signal: Latched Output (Q)
Logics.LE31.Out inverted	Signal: Negated Latched Output (Q NOT)
Logics.LE32.Gate Out	Signal: Output of the logic gate
Logics.LE32.Timer Out	Signal: Timer Output

<i>Name</i>	<i>Description</i>
Logics.LE32.Out	Signal: Latched Output (Q)
Logics.LE32.Out inverted	Signal: Negated Latched Output (Q NOT)
Logics.LE33.Gate Out	Signal: Output of the logic gate
Logics.LE33.Timer Out	Signal: Timer Output
Logics.LE33.Out	Signal: Latched Output (Q)
Logics.LE33.Out inverted	Signal: Negated Latched Output (Q NOT)
Logics.LE34.Gate Out	Signal: Output of the logic gate
Logics.LE34.Timer Out	Signal: Timer Output
Logics.LE34.Out	Signal: Latched Output (Q)
Logics.LE34.Out inverted	Signal: Negated Latched Output (Q NOT)
Logics.LE35.Gate Out	Signal: Output of the logic gate
Logics.LE35.Timer Out	Signal: Timer Output
Logics.LE35.Out	Signal: Latched Output (Q)
Logics.LE35.Out inverted	Signal: Negated Latched Output (Q NOT)
Logics.LE36.Gate Out	Signal: Output of the logic gate
Logics.LE36.Timer Out	Signal: Timer Output
Logics.LE36.Out	Signal: Latched Output (Q)
Logics.LE36.Out inverted	Signal: Negated Latched Output (Q NOT)
Logics.LE37.Gate Out	Signal: Output of the logic gate
Logics.LE37.Timer Out	Signal: Timer Output
Logics.LE37.Out	Signal: Latched Output (Q)
Logics.LE37.Out inverted	Signal: Negated Latched Output (Q NOT)
Logics.LE38.Gate Out	Signal: Output of the logic gate
Logics.LE38.Timer Out	Signal: Timer Output
Logics.LE38.Out	Signal: Latched Output (Q)
Logics.LE38.Out inverted	Signal: Negated Latched Output (Q NOT)
Logics.LE39.Gate Out	Signal: Output of the logic gate
Logics.LE39.Timer Out	Signal: Timer Output
Logics.LE39.Out	Signal: Latched Output (Q)
Logics.LE39.Out inverted	Signal: Negated Latched Output (Q NOT)
Logics.LE40.Gate Out	Signal: Output of the logic gate
Logics.LE40.Timer Out	Signal: Timer Output
Logics.LE40.Out	Signal: Latched Output (Q)
Logics.LE40.Out inverted	Signal: Negated Latched Output (Q NOT)
Logics.LE41.Gate Out	Signal: Output of the logic gate
Logics.LE41.Timer Out	Signal: Timer Output
Logics.LE41.Out	Signal: Latched Output (Q)
Logics.LE41.Out inverted	Signal: Negated Latched Output (Q NOT)
Logics.LE42.Gate Out	Signal: Output of the logic gate
Logics.LE42.Timer Out	Signal: Timer Output

<i>Name</i>	<i>Description</i>
Logics.LE42.Out	Signal: Latched Output (Q)
Logics.LE42.Out inverted	Signal: Negated Latched Output (Q NOT)
Logics.LE43.Gate Out	Signal: Output of the logic gate
Logics.LE43.Timer Out	Signal: Timer Output
Logics.LE43.Out	Signal: Latched Output (Q)
Logics.LE43.Out inverted	Signal: Negated Latched Output (Q NOT)
Logics.LE44.Gate Out	Signal: Output of the logic gate
Logics.LE44.Timer Out	Signal: Timer Output
Logics.LE44.Out	Signal: Latched Output (Q)
Logics.LE44.Out inverted	Signal: Negated Latched Output (Q NOT)
Logics.LE45.Gate Out	Signal: Output of the logic gate
Logics.LE45.Timer Out	Signal: Timer Output
Logics.LE45.Out	Signal: Latched Output (Q)
Logics.LE45.Out inverted	Signal: Negated Latched Output (Q NOT)
Logics.LE46.Gate Out	Signal: Output of the logic gate
Logics.LE46.Timer Out	Signal: Timer Output
Logics.LE46.Out	Signal: Latched Output (Q)
Logics.LE46.Out inverted	Signal: Negated Latched Output (Q NOT)
Logics.LE47.Gate Out	Signal: Output of the logic gate
Logics.LE47.Timer Out	Signal: Timer Output
Logics.LE47.Out	Signal: Latched Output (Q)
Logics.LE47.Out inverted	Signal: Negated Latched Output (Q NOT)
Logics.LE48.Gate Out	Signal: Output of the logic gate
Logics.LE48.Timer Out	Signal: Timer Output
Logics.LE48.Out	Signal: Latched Output (Q)
Logics.LE48.Out inverted	Signal: Negated Latched Output (Q NOT)
Logics.LE49.Gate Out	Signal: Output of the logic gate
Logics.LE49.Timer Out	Signal: Timer Output
Logics.LE49.Out	Signal: Latched Output (Q)
Logics.LE49.Out inverted	Signal: Negated Latched Output (Q NOT)
Logics.LE50.Gate Out	Signal: Output of the logic gate
Logics.LE50.Timer Out	Signal: Timer Output
Logics.LE50.Out	Signal: Latched Output (Q)
Logics.LE50.Out inverted	Signal: Negated Latched Output (Q NOT)
Logics.LE51.Gate Out	Signal: Output of the logic gate
Logics.LE51.Timer Out	Signal: Timer Output
Logics.LE51.Out	Signal: Latched Output (Q)
Logics.LE51.Out inverted	Signal: Negated Latched Output (Q NOT)
Logics.LE52.Gate Out	Signal: Output of the logic gate
Logics.LE52.Timer Out	Signal: Timer Output

<i>Name</i>	<i>Description</i>
Logics.LE52.Out	Signal: Latched Output (Q)
Logics.LE52.Out inverted	Signal: Negated Latched Output (Q NOT)
Logics.LE53.Gate Out	Signal: Output of the logic gate
Logics.LE53.Timer Out	Signal: Timer Output
Logics.LE53.Out	Signal: Latched Output (Q)
Logics.LE53.Out inverted	Signal: Negated Latched Output (Q NOT)
Logics.LE54.Gate Out	Signal: Output of the logic gate
Logics.LE54.Timer Out	Signal: Timer Output
Logics.LE54.Out	Signal: Latched Output (Q)
Logics.LE54.Out inverted	Signal: Negated Latched Output (Q NOT)
Logics.LE55.Gate Out	Signal: Output of the logic gate
Logics.LE55.Timer Out	Signal: Timer Output
Logics.LE55.Out	Signal: Latched Output (Q)
Logics.LE55.Out inverted	Signal: Negated Latched Output (Q NOT)
Logics.LE56.Gate Out	Signal: Output of the logic gate
Logics.LE56.Timer Out	Signal: Timer Output
Logics.LE56.Out	Signal: Latched Output (Q)
Logics.LE56.Out inverted	Signal: Negated Latched Output (Q NOT)
Logics.LE57.Gate Out	Signal: Output of the logic gate
Logics.LE57.Timer Out	Signal: Timer Output
Logics.LE57.Out	Signal: Latched Output (Q)
Logics.LE57.Out inverted	Signal: Negated Latched Output (Q NOT)
Logics.LE58.Gate Out	Signal: Output of the logic gate
Logics.LE58.Timer Out	Signal: Timer Output
Logics.LE58.Out	Signal: Latched Output (Q)
Logics.LE58.Out inverted	Signal: Negated Latched Output (Q NOT)
Logics.LE59.Gate Out	Signal: Output of the logic gate
Logics.LE59.Timer Out	Signal: Timer Output
Logics.LE59.Out	Signal: Latched Output (Q)
Logics.LE59.Out inverted	Signal: Negated Latched Output (Q NOT)
Logics.LE60.Gate Out	Signal: Output of the logic gate
Logics.LE60.Timer Out	Signal: Timer Output
Logics.LE60.Out	Signal: Latched Output (Q)
Logics.LE60.Out inverted	Signal: Negated Latched Output (Q NOT)
Logics.LE61.Gate Out	Signal: Output of the logic gate
Logics.LE61.Timer Out	Signal: Timer Output
Logics.LE61.Out	Signal: Latched Output (Q)
Logics.LE61.Out inverted	Signal: Negated Latched Output (Q NOT)
Logics.LE62.Gate Out	Signal: Output of the logic gate
Logics.LE62.Timer Out	Signal: Timer Output

<i>Name</i>	<i>Description</i>
Logics.LE62.Out	Signal: Latched Output (Q)
Logics.LE62.Out inverted	Signal: Negated Latched Output (Q NOT)
Logics.LE63.Gate Out	Signal: Output of the logic gate
Logics.LE63.Timer Out	Signal: Timer Output
Logics.LE63.Out	Signal: Latched Output (Q)
Logics.LE63.Out inverted	Signal: Negated Latched Output (Q NOT)
Logics.LE64.Gate Out	Signal: Output of the logic gate
Logics.LE64.Timer Out	Signal: Timer Output
Logics.LE64.Out	Signal: Latched Output (Q)
Logics.LE64.Out inverted	Signal: Negated Latched Output (Q NOT)
Logics.LE65.Gate Out	Signal: Output of the logic gate
Logics.LE65.Timer Out	Signal: Timer Output
Logics.LE65.Out	Signal: Latched Output (Q)
Logics.LE65.Out inverted	Signal: Negated Latched Output (Q NOT)
Logics.LE66.Gate Out	Signal: Output of the logic gate
Logics.LE66.Timer Out	Signal: Timer Output
Logics.LE66.Out	Signal: Latched Output (Q)
Logics.LE66.Out inverted	Signal: Negated Latched Output (Q NOT)
Logics.LE67.Gate Out	Signal: Output of the logic gate
Logics.LE67.Timer Out	Signal: Timer Output
Logics.LE67.Out	Signal: Latched Output (Q)
Logics.LE67.Out inverted	Signal: Negated Latched Output (Q NOT)
Logics.LE68.Gate Out	Signal: Output of the logic gate
Logics.LE68.Timer Out	Signal: Timer Output
Logics.LE68.Out	Signal: Latched Output (Q)
Logics.LE68.Out inverted	Signal: Negated Latched Output (Q NOT)
Logics.LE69.Gate Out	Signal: Output of the logic gate
Logics.LE69.Timer Out	Signal: Timer Output
Logics.LE69.Out	Signal: Latched Output (Q)
Logics.LE69.Out inverted	Signal: Negated Latched Output (Q NOT)
Logics.LE70.Gate Out	Signal: Output of the logic gate
Logics.LE70.Timer Out	Signal: Timer Output
Logics.LE70.Out	Signal: Latched Output (Q)
Logics.LE70.Out inverted	Signal: Negated Latched Output (Q NOT)
Logics.LE71.Gate Out	Signal: Output of the logic gate
Logics.LE71.Timer Out	Signal: Timer Output
Logics.LE71.Out	Signal: Latched Output (Q)
Logics.LE71.Out inverted	Signal: Negated Latched Output (Q NOT)
Logics.LE72.Gate Out	Signal: Output of the logic gate
Logics.LE72.Timer Out	Signal: Timer Output

<i>Name</i>	<i>Description</i>
Logics.LE72.Out	Signal: Latched Output (Q)
Logics.LE72.Out inverted	Signal: Negated Latched Output (Q NOT)
Logics.LE73.Gate Out	Signal: Output of the logic gate
Logics.LE73.Timer Out	Signal: Timer Output
Logics.LE73.Out	Signal: Latched Output (Q)
Logics.LE73.Out inverted	Signal: Negated Latched Output (Q NOT)
Logics.LE74.Gate Out	Signal: Output of the logic gate
Logics.LE74.Timer Out	Signal: Timer Output
Logics.LE74.Out	Signal: Latched Output (Q)
Logics.LE74.Out inverted	Signal: Negated Latched Output (Q NOT)
Logics.LE75.Gate Out	Signal: Output of the logic gate
Logics.LE75.Timer Out	Signal: Timer Output
Logics.LE75.Out	Signal: Latched Output (Q)
Logics.LE75.Out inverted	Signal: Negated Latched Output (Q NOT)
Logics.LE76.Gate Out	Signal: Output of the logic gate
Logics.LE76.Timer Out	Signal: Timer Output
Logics.LE76.Out	Signal: Latched Output (Q)
Logics.LE76.Out inverted	Signal: Negated Latched Output (Q NOT)
Logics.LE77.Gate Out	Signal: Output of the logic gate
Logics.LE77.Timer Out	Signal: Timer Output
Logics.LE77.Out	Signal: Latched Output (Q)
Logics.LE77.Out inverted	Signal: Negated Latched Output (Q NOT)
Logics.LE78.Gate Out	Signal: Output of the logic gate
Logics.LE78.Timer Out	Signal: Timer Output
Logics.LE78.Out	Signal: Latched Output (Q)
Logics.LE78.Out inverted	Signal: Negated Latched Output (Q NOT)
Logics.LE79.Gate Out	Signal: Output of the logic gate
Logics.LE79.Timer Out	Signal: Timer Output
Logics.LE79.Out	Signal: Latched Output (Q)
Logics.LE79.Out inverted	Signal: Negated Latched Output (Q NOT)
Logics.LE80.Gate Out	Signal: Output of the logic gate
Logics.LE80.Timer Out	Signal: Timer Output
Logics.LE80.Out	Signal: Latched Output (Q)
Logics.LE80.Out inverted	Signal: Negated Latched Output (Q NOT)

These trips will start the BF module if »All current« functions have been selected as the trigger event.

Supervision

<i>Name</i>	<i>Description</i>
.-.	No assignment
Id.TripCmd	Signal: Trip Command
IdH.TripCmd	Signal: Trip Command
IdG[1].TripCmd	Signal: Trip Command
IdGH[1].TripCmd	Signal: Trip Command
IdG[2].TripCmd	Signal: Trip Command
IdGH[2].TripCmd	Signal: Trip Command
I[1].TripCmd	Signal: Trip Command
I[2].TripCmd	Signal: Trip Command
I[3].TripCmd	Signal: Trip Command
I[4].TripCmd	Signal: Trip Command
I[5].TripCmd	Signal: Trip Command
I[6].TripCmd	Signal: Trip Command
IG[1].TripCmd	Signal: Trip Command
IG[2].TripCmd	Signal: Trip Command
IG[3].TripCmd	Signal: Trip Command
IG[4].TripCmd	Signal: Trip Command
ThR.TripCmd	Signal: Trip Command
I2>[1].TripCmd	Signal: Trip Command
I2>[2].TripCmd	Signal: Trip Command
I2>G[1].TripCmd	Signal: Trip Command
I2>G[2].TripCmd	Signal: Trip Command
InEn.TripCmd	Signal: Trip Command

These trips will start the BF module if »External trips« have been selected as the trigger event.

Name	Description
-.-	No assignment
Intertripping.TripCmd	Signal: Trip Command
ExP[1].TripCmd	Signal: Trip Command
ExP[2].TripCmd	Signal: Trip Command
ExP[3].TripCmd	Signal: Trip Command
ExP[4].TripCmd	Signal: Trip Command
Ext Sudd Press.TripCmd	Signal: Trip Command
Ext Oil Temp.TripCmd	Signal: Trip Command
Ext Temp Superv[1].TripCmd	Signal: Trip Command
Ext Temp Superv[2].TripCmd	Signal: Trip Command
Ext Temp Superv[3].TripCmd	Signal: Trip Command
AnaP[1].TripCmd	Signal: Trip Command
AnaP[2].TripCmd	Signal: Trip Command
AnaP[3].TripCmd	Signal: Trip Command
AnaP[4].TripCmd	Signal: Trip Command

Commissioning Example: Supervision Scheme 50BF

Object to Be Tested:

Test of the breaker failure protection (Supervision Scheme 50BF).

Necessary Means:

- Current source;
- Ammeter; and
- Timer.

NOTICE

When testing, the applied test current must always be higher than the tripping threshold »I-CBF«. If the test current falls below the threshold while the breaker is in the "Off" position, no pickup will be generated.

Procedure (Single-Phase):

For testing the tripping time of the CBF protection, a test current has to be higher than the threshold value of one of the current protection modules that are assigned to trigger the CBF protection. The CBF trip delay can be measured from the time when one of the triggering inputs becomes active to the time when the CBF protection trip is asserted.

To avoid wiring errors, checked to make sure the breaker in the upstream system switches off.

The time, measured by the timer, should be in line with the specified tolerances.

Successful Test Result:

The actual times measured comply with the setpoint times. The breaker in the higher-level section switches off.

⚠ WARNING

Re-connect the control cable to the breaker!

TCS - Trip Circuit Supervision [74TC]

Available elements:

TCS

The trip circuit monitoring is used for monitoring if the trip circuit is ready for operations. The monitoring can be fulfilled in two ways. The first assumes only »Aux On (52a)« is used in the trip circuit. The second assumes that, in addition to »Aux On (52a)«, »Aux Off(52b)« is also used for the circuit monitoring.

With »Aux On (52a)«, only in the trip circuit, the monitoring is only effective when the breaker is closed while if both »Aux On (52a)«, and »Aux Off(52b)« are used, the trip circuit will be monitored all time as long as the control power is on.

Note that the digital inputs used for this purpose must be configured properly based on the trip circuit control voltage. If the trip circuit is detected broken, an alarm will be issued with a specified delay, which must be longer than the time when a trip contact is closed to the time when the breaker status is clearly recognized by the relay.

NOTICE

In Slot 1 has 2 digital inputs, each of which has a separate root (contact separation) for the trip circuit supervision.

NOTICE

This Notice applies to protective devices that offer control functionality only!
This protective element requires, that a switchgear (circuit breaker) is assigned to it.

In this case, the trip circuit supply voltage serves also as supply voltage for the digital inputs and so the supply voltage failure of a trip circuit can be detected directly.

In order to identify a conductor failure in the trip circuit on the supply line or in the trip coil, the off-coil has to be looped-in to the supervision circuit.

The time delay is to be set in a way that switching actions cannot cause false trips in this module.

Connection example: Trip circuit supervision with two CB auxiliary contacts.

TCS

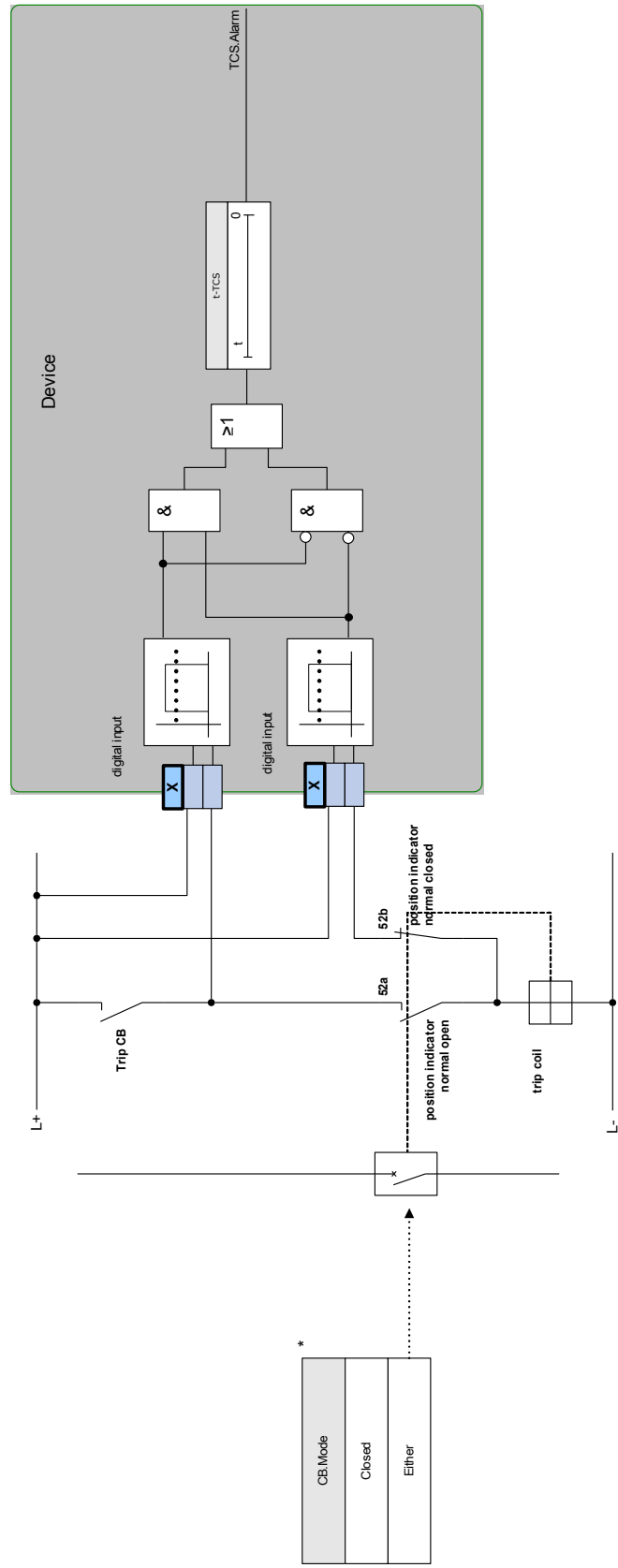

*This signal is the output of the switchgear that is assigned to this protective element. This applies to protective devices that offer control functionality.

Connection example: Trip circuit supervision with one CB auxiliary contact (Aux On (52a)) only.



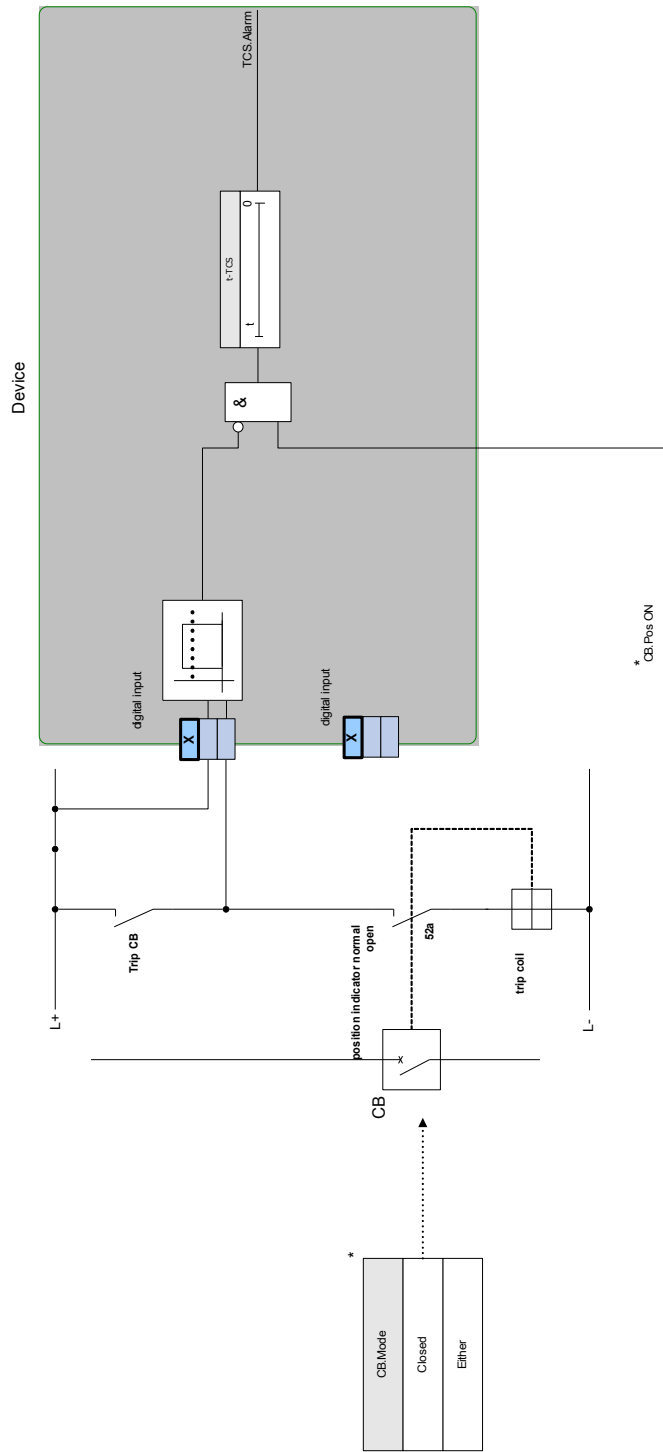



TCS





Device Planning Parameters of the Trip Circuit Supervision

<i>Parameter</i>	<i>Description</i>	<i>Options</i>	<i>Default</i>	<i>Menu path</i>
Mode 	Mode	do not use, use	do not use	[Device planning]

Global Protection Parameters of the Trip Circuit Supervision

Parameter	Description	Setting range	Default	Menu path
 CB Pos Detect	Criterion by which the Circuit Breaker Switch Position is to be detected.	-.-, SG[1].Pos, SG[2].Pos, SG[3].Pos, SG[4].Pos, SG[5].Pos, SG[6].Pos	SG[1].Pos	[Protection Para /Global Prot Para /Supervision /TCS]
 Mode	Select if trip circuit is going to be monitored when the breaker is closed or when the breaker is either open or close.	Closed, Either	Closed	[Protection Para /Global Prot Para /Supervision /TCS]
 Input 1	Select the input configured to monitor the trip coil when the breaker is closed.	1..n, Dig Inputs	-.-	[Protection Para /Global Prot Para /Supervision /TCS]
 Input 2	Select the input configured to monitor the trip coil when the breaker is open. Only available if Mode set to "Either". Only available if: Mode = Either	1..n, Dig Inputs	-.-	[Protection Para /Global Prot Para /Supervision /TCS]
 ExBlo1	External blocking of the module, if blocking is activated (allowed) within a parameter set and if the state of the assigned signal is true.	1..n, Assignment List	-.-	[Protection Para /Global Prot Para /Supervision /TCS]
 ExBlo2	External blocking of the module, if blocking is activated (allowed) within a parameter set and if the state of the assigned signal is true.	1..n, Assignment List	-.-	[Protection Para /Global Prot Para /Supervision /TCS]

Setting Group Parameters of the Trip Circuit Supervision

<i>Parameter</i>	<i>Description</i>	<i>Setting range</i>	<i>Default</i>	<i>Menu path</i>
Function 	Permanent activation or deactivation of module/stage.	inactive, active	inactive	[Protection Para /<1..4> /Supervision /TCS]
ExBlo Fc 	Activate (allow) or inactivate (disallow) blocking of the module/stage. This parameter is only effective if a signal is assigned to the corresponding global protection parameter. If the signal becomes true, those modules/stages are blocked that are parameterized "ExBlo Fc=active".	inactive, active	inactive	[Protection Para /<1..4> /Supervision /TCS]
t-TCS 	Tripping delay time of the Trip Circuit Supervision	0.10 - 10.00s	0.2s	[Protection Para /<1..4> /Supervision /TCS]

Trip Circuit Supervision Input States

<i>Name</i>	<i>Description</i>	<i>Assignment via</i>
Aux ON-I	Module Input State: Position indicator/check-back signal of the CB (52a)	[Protection Para /Global Prot Para /Supervision /TCS]
Aux OFF-I	Module input state: Position indicator/check-back signal of the CB (52b)	[Protection Para /Global Prot Para /Supervision /TCS]
ExBlo1-I	Module input state: External blocking1	[Protection Para /Global Prot Para /Supervision /TCS]
ExBlo2-I	Module input state: External blocking2	[Protection Para /Global Prot Para /Supervision /TCS]

Trip Circuit Supervision Signals (Output States)

<i>Signal</i>	<i>Description</i>
active	Signal: active
ExBlo	Signal: External Blocking
Alarm	Signal: Alarm Trip Circuit Supervision
Not Possible	Not possible because no state indicator assigned to the breaker.

Commissioning: Trip Circuit Supervision [74TC]

NOTICE

For CBs that trip by means of little energy (e.g. via an optocoupler), it has to be ensured that the current applied by the digital inputs will not cause false tripping of the CB.

Object to be tested

Test of the trip circuit supervision.

Procedure, part 1

Simulate failure of the control voltage in the power circuits.

Successful test result, part 1

After expiry of »*t-TCS*« the trip circuit supervision TCS of the device should signal an alarm.

Procedure, part 2

Simulate a broken cable in the CB control circuit.

Successful test result, part 2

After expiry of »*t-TCS*« the trip circuit supervision TCS of the device should signal an alarm.

CTS - Current Transformer Supervision [60L]

Available elements:

CTS

Wire breaks and failures within measuring circuits cause current transformer failures.

The module »CTS« can detect a failure of the CT if the calculated earth current does not match the measured one. If an adjustable threshold value (Difference of measured and calculated earth current) is exceeded, a CT failure can be assumed. This is signaled through a message/alarm.

The precondition is that the conductor currents are measured by the device and the earth current, for instance, by a ring core type current transformer.

The measuring principles of the circuit supervision are based on comparing the measured and the calculated residual currents:

In an ideal case these are:

$$(\vec{I}L1 + \vec{I}L2 + \vec{I}L3) + KI * \vec{I}G = 3 * I_0 + KI * \vec{I}G = 0$$

KI represents a correction factor which takes the different transformation ratio of the phase- and earth current transformers into account. The device automatically calculates this factor from the rated field parameters, i.e. the relation between the rated primary and secondary current values of the phase- and earth current transformers.

For compensating the current proportional ratio error of the measuring circuits, the dynamic correction factor Kd can be used. As a function of the measured max. current this factor is considering the linear rising measuring error.

The limiting value of the CT supervision is calculated as follows:

ΔI = deviation I (rated value)

Kd = correction factor

I_{max} = current maximum

Limiting value = $\Delta I + Kd \times I_{max}$

Precondition for identifying an error

$$3 * \vec{I}_0 + KI * \vec{I}G \geq \Delta I + Kd * I_{max}$$

The evaluation method of the circuit supervision by using factor Kd can be graphically represented as follows:

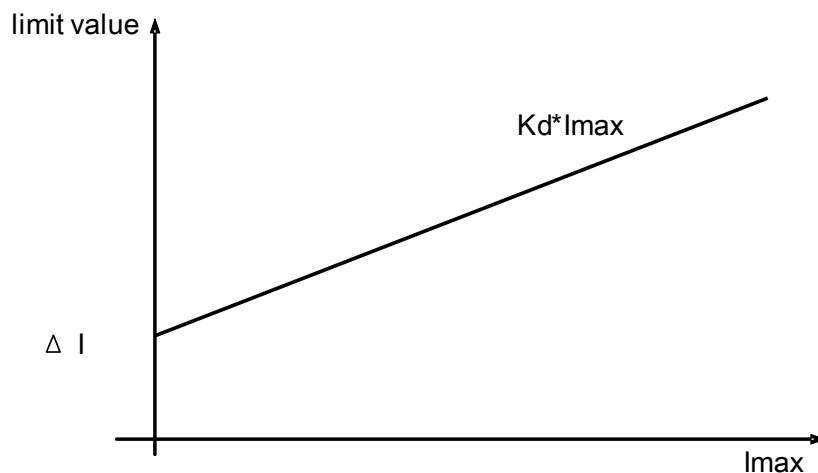

CAUTION

If the current is measured in two phases only (for instant only IL1/IL3) or if there is no separate earth current measuring (e.g. normally via a cable-type CT), the supervision function should be deactivated.

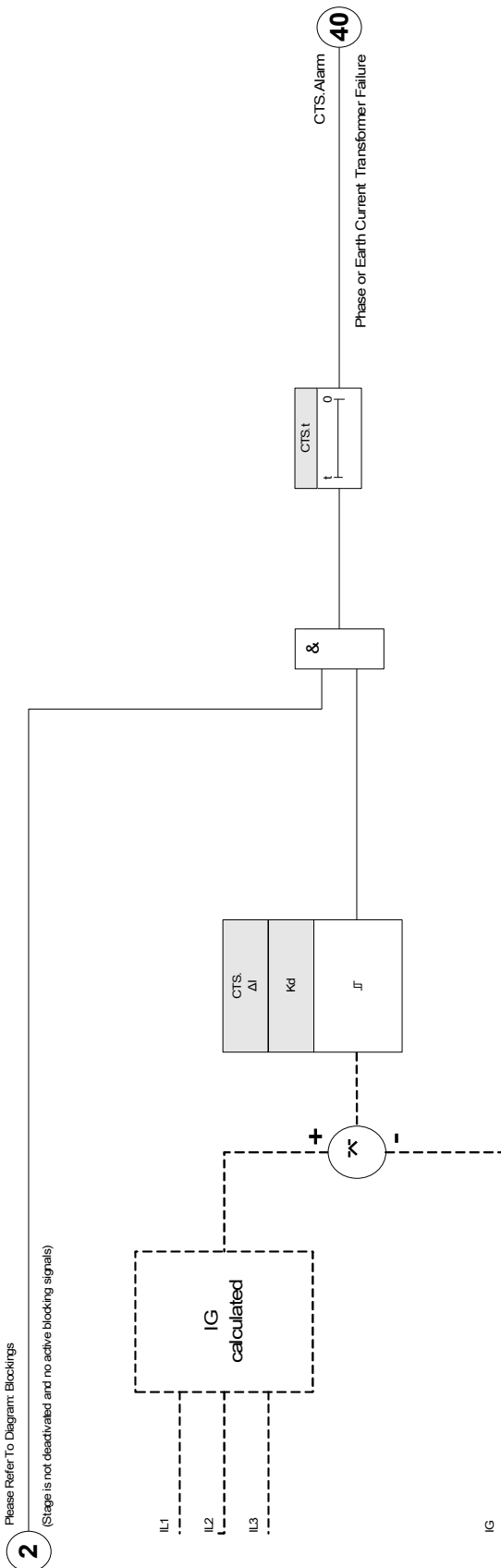

CTS







Device Planning Parameters of the Current Transformer Supervision

Parameter	Description	Options	Default	Menu path
Mode 	Mode	do not use, use	do not use	[Device planning]

Global Protection Parameter of the Current Transformer Supervision

Parameter	Description	Setting range	Default	Menu path
ExBlo1 	External blocking of the module, if blocking is activated (allowed) within a parameter set and if the state of the assigned signal is true.	1..n, Assignment List	.-	[Protection Para /Global Prot Para /Supervision /CTS]
ExBlo2 	External blocking of the module, if blocking is activated (allowed) within a parameter set and if the state of the assigned signal is true.	1..n, Assignment List	.-	[Protection Para /Global Prot Para /Supervision /CTS]

Setting Group Parameters of the Current Transformer Supervision

Parameter	Description	Setting range	Default	Menu path
Function 	Permanent activation or deactivation of module/stage.	inactive, active	inactive	[Protection Para /<1..4> /Supervision /CTS]
ExBlo Fc 	Activate (allow) or inactivate (disallow) blocking of the module/stage. This parameter is only effective if a signal is assigned to the corresponding global protection parameter. If the signal becomes true, those modules/stages are blocked that are parameterized "ExBlo Fc=active".	inactive, active	inactive	[Protection Para /<1..4> /Supervision /CTS]
ΔI 	In order to prevent faulty tripping of phase selective protection functions that use the current as tripping criterion. If the difference of the measured earth current and the calculated value I_0 is higher than the pick up value ΔI , an alarm event is generated after expiring of the excitation time. In such a case, a fuse failure, a broken wire or a faulty measuring circuit can be assumed.	0.10 - 1.00In	0.50In	[Protection Para /<1..4> /Supervision /CTS]
Alarm delay 	Alarm delay	0.0 - 9999.0s	1.0s	[Protection Para /<1..4> /Supervision /CTS]
Kd 	Dynamic correction factor for the evaluation of the difference between calculated and measured earth current. This correction factor allows transformer faults, caused by higher currents, to be compensated.	0.00 - 0.99	0.00	[Protection Para /<1..4> /Supervision /CTS]

Current Transformer Supervision Input States

<i>Name</i>	<i>Description</i>	<i>Assignment via</i>
ExBlo1-I	Module input state: External blocking1	[Protection Para /Global Prot Para /Supervision /CTS]
ExBlo2-I	Module input state: External blocking2	[Protection Para /Global Prot Para /Supervision /CTS]

Current Transformer Supervision Signals (Outputs States)

<i>Signal</i>	<i>Description</i>
active	Signal: active
ExBlo	Signal: External Blocking
Alarm	Signal: Alarm Current Transformer Measuring Circuit Supervision

Commissioning: Current Transformer Failure Supervision

NOTICE

Precondition:

1. Measurement of all three phase currents (are applied to the measuring inputs of the device).
2. The earth current is detected via a cable-type transformer (not in Holmgreen connection).

Object to be tested

Check of the CT supervision (by comparing the calculated with the measured earth current).

Necessary means

- Three-phase current source

Procedure, part 1

- Set the limiting value of the CTS to » $\Delta I = 0.1 \cdot I_n$ «.
- Feed a three-phase, symmetrical current system (approx. nominal current) to the secondary side.
- Disconnect the current of one phase from one of the measuring inputs (the symmetrical feeding at secondary side has to be maintained).
- Make sure that the signal »CTS.ALARM« is generated now.

Successful test result, part 1

- The signal »CTS.ALARM« is generated.

Procedure, part 2

- Feed a three-phase, symmetrical current system (approx. nominal current) to the secondary side.
- Feed a current that is higher than the threshold value for the measuring circuit supervision to the earth current measuring input.
- Ascertain that the signal »CTS.ALARM« is generated now.

Successful test result, part 2

The signal »CTS.ALARM« is generated.

LOP - Loss of Potential

Available elements:

LOP

Loss of Potential - Evaluating Measured Quantities

NOTICE

Ensure that the LOP has enough time to block faulty tripping of modules that use LOP. That means, the delay time of the LOP should to be shorter than the tripping delay of modules that use LOP.

NOTICE

In case of transformer protection relays the LOP element uses current and voltage measured at the winding side determined by paramter: [Field Para / VT / VT Winding Side].

The LOP function detects the loss of voltage in any of the voltage input measuring circuits. Faulty tripping of protective elements that take voltage into account can be prevented by means of this supervision element. The following measured values and information to detect an Phase VT Failure condition:

- Three-phase voltages;
- Ratio of negative-to-positive sequence voltages;
- Zero sequence voltage;
- Three-phase currents;
- Residual current (I0);
- Pickup flags from all overcurrent elements; and
- Breaker status (option)

After a set time delay time an Alarm »LOP.LOP BLo« will be issued.

How to set up the Loss of Potential (Evaluating Measured Quantities)

- Set the Alarm Time Delay »t-Alarm«.
- To prevent a malfunction of the VT supervision for a system fault assign Alarms of overcurrent elements that should block the Loss of Potential element.
- It is necessary to set the parameter »*LOP.LOP Blo Enable*« to »*active*«. Otherwise the Measuring circuit supervision cannot block elements in case of a loss of potential.

How to make the Loss of Potential (Evaluating Measured Quantities) effective

The Loss of Potential respectively measuring circuit supervision can be used to block protective elements like undervoltage protection in order to prevent faulty tripping.

- Set the parameter »*Measuring Circuit Supervision=active*« within those protective elements that should be blocked by the Loss of Potential supervision.

Loss of Potential - Fuse Failure

VT Supervision via digital inputs (Fuse Failure)

The module »LOP« is capable of detecting a fuse failure at the secondary side of the VTs as long as the automatic circuit breakers of the VTs are connected with the device via a digital input and if this input is assigned to the module »LOP«.

Setting the Parameters for detecting a fuse failure (FF) of a phase voltage transformer

In order to detect a fuse failure of a phase voltage transformer via digital input, please proceed as follows:

- Assign a digital input onto the parameter »*LOP.Ex FF VT*« that represents the state of the automatic circuit breaker of the phase voltage transformer.
- Set the parameter »*Measuring Crcuit Supervison=active*« within all those protective elements, that should be blocked by a fuse failure.

Setting the Parameters for detecting a fuse failure (FF) of a earth phase voltage transformer

In order to detect a fuse failure of a phase voltage transformer via digital input, please proceed as follows:

- Assign a digital input onto the parameter »*LOP.Ex FF EVT*« that represents the state of the automatic circuit breaker of the phase voltage transformer.
- Set the parameter »*Measuring Crcuit Supervison=active*« within all those protective elements, that should be blocked by a fuse failure.

LOP

LOP_Y01

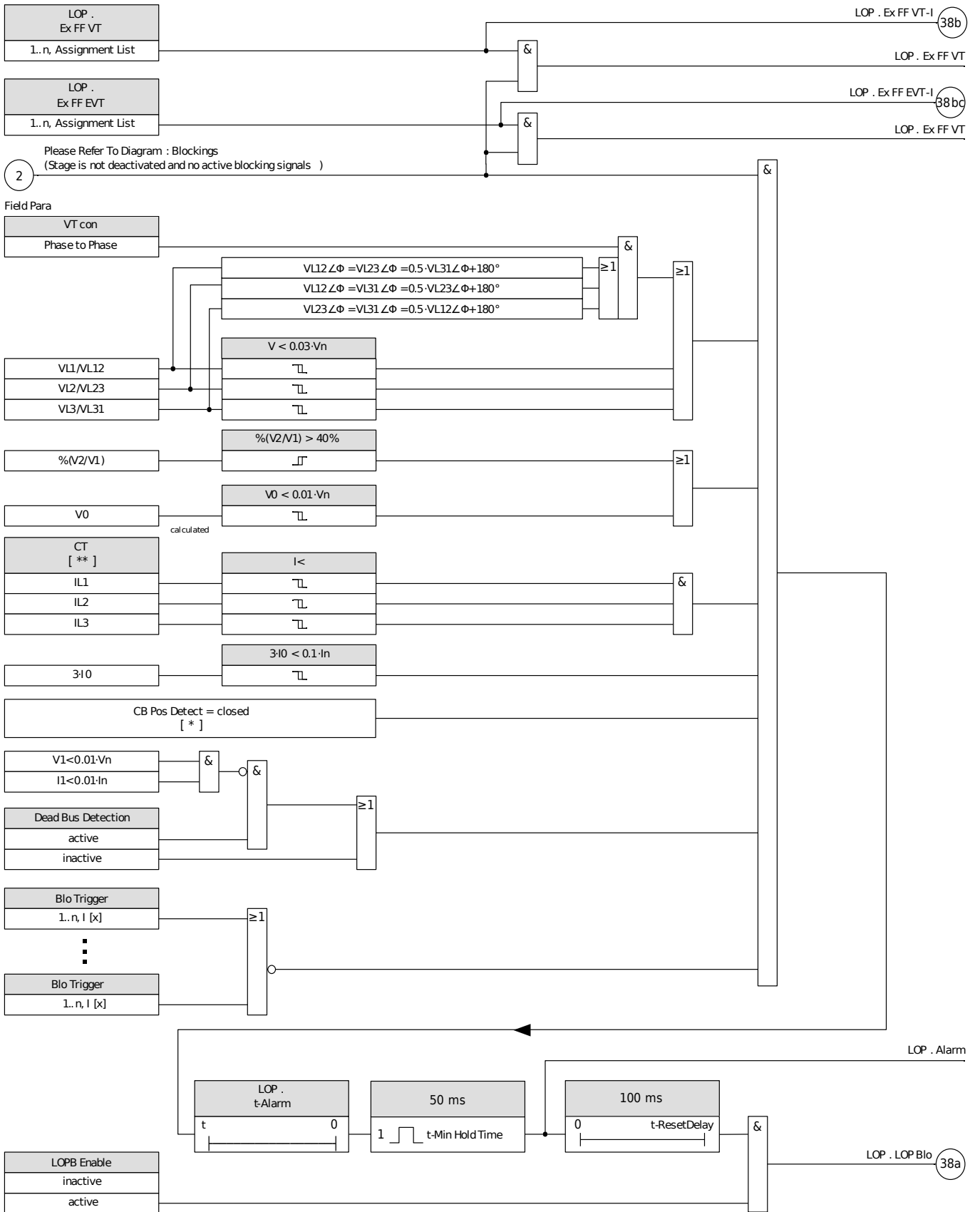





[*] The breaker position is not taken into account if no breaker is selected/assigned.





[**] For devices with more than one CT, "CT" denotes the one at the side to which the VT is connected.

Device Planning Parameters of the LOP Module

Parameter	Description	Options	Default	Menu path
Mode 	Mode	do not use, use	do not use	[Device planning]

Global Protection Parameters of the LOP Module

Parameter	Description	Setting range	Default	Menu path
CB Pos Detect 	If there is a circuit breaker assigned, LOP will be inhibited if the circuit breaker is open. The position of the breaker will not be taken into account by LOP if no breaker is assigned.	-.-, SG[1].Pos, SG[2].Pos, SG[3].Pos, SG[4].Pos, SG[5].Pos, SG[6].Pos	-.-	[Protection Para /Global Prot Para /Supervision /LOP]
ExBlo1 	External blocking of the module, if blocking is activated (allowed) within a parameter set and if the state of the assigned signal is true.	1..n, Assignment List	-.-	[Protection Para /Global Prot Para /Supervision /LOP]
ExBlo2 	External blocking of the module, if blocking is activated (allowed) within a parameter set and if the state of the assigned signal is true.	1..n, Assignment List	-.-	[Protection Para /Global Prot Para /Supervision /LOP]
Blo Trigger1 	An Alarm of this protective element will block the Loss of Potential Detection.	Blo Trigger	-.-	[Protection Para /Global Prot Para /Supervision /LOP]
Blo Trigger2 	An Alarm of this protective element will block the Loss of Potential Detection.	Blo Trigger	-.-	[Protection Para /Global Prot Para /Supervision /LOP]

<i>Parameter</i>	<i>Description</i>	<i>Setting range</i>	<i>Default</i>	<i>Menu path</i>
Blo Trigger3 	An Alarm of this protective element will block the Loss of Potential Detection.	Blo Trigger	-.-	[Protection Para /Global Prot Para /Supervision /LOP]
Blo Trigger4 	An Alarm of this protective element will block the Loss of Potential Detection.	Blo Trigger	-.-	[Protection Para /Global Prot Para /Supervision /LOP]
Blo Trigger5 	An Alarm of this protective element will block the Loss of Potential Detection.	Blo Trigger	-.-	[Protection Para /Global Prot Para /Supervision /LOP]
Ex FF VT 	Alarm Fuse Failure Voltage Transformers	1..n, Assignment List	-.-	[Protection Para /Global Prot Para /Supervision /LOP]
Ex FF EVT 	Alarm Fuse Failure Earth Voltage Transformers	1..n, Assignment List	-.-	[Protection Para /Global Prot Para /Supervision /LOP]

Setting Group Parameters of the LOP Module

<i>Parameter</i>	<i>Description</i>	<i>Setting range</i>	<i>Default</i>	<i>Menu path</i>
Function 	Permanent activation or deactivation of module/stage.	inactive, active	inactive	[Protection Para /<1..4> /Supervision /LOP]

Parameter	Description	Setting range	Default	Menu path
 ExBlo Fc	Activate (allow) or inactivate (disallow) blocking of the module/stage. This parameter is only effective if a signal is assigned to the corresponding global protection parameter. If the signal becomes true, those modules/stages are blocked that are parameterized "ExBlo Fc=active".	inactive, active	inactive	[Protection Para /<1..4> /Supervision /LOP]
 LOPB Enable	Activate (allow) or inactivate (disallow) blocking by the module LOP.	inactive, active	inactive	[Protection Para /<1..4> /Supervision /LOP]
 I<	To prevent unintended operation during faults, this threshold should be used to distinguish between load current and overcurrent. A current above this threshold will be seen as overcurrent and LOP will be inhibited. If the current detector identifies load current as overcurrent (threshold too low), a LOP situation will not be detected and if the threshold is too high, a fault situation will be identified as LOP which results in blocking of protection functions.	0.5 - 4.0In	2.0In	[Protection Para /<1..4> /Supervision /LOP]
 t-Alarm	Pickup Delay	0 - 9999.0s	0.1s	[Protection Para /<1..4> /Supervision /LOP]
 Dead Bus Detection	If this detection is active, LOP will be inhibited if there is no current and voltage applied.	inactive, active	inactive	[Protection Para /<1..4> /Supervision /LOP]

LOP Module Input States

Name	Description	Assignment via
ExBlo1-I	Module input state: External blocking1	[Protection Para /Global Prot Para /Supervision /LOP]

<i>Name</i>	<i>Description</i>	<i>Assignment via</i>
ExBlo2-I	Module input state: External blocking2	[Protection Para /Global Prot Para /Supervision /LOP]
Ex FF VT-I	State of the module input: Alarm Fuse Failure Voltage Transformers	[Protection Para /Global Prot Para /Supervision /LOP]
Ex FF EVT-I	State of the module input: Alarm Fuse Failure Earth Voltage Transformers	[Protection Para /Global Prot Para /Supervision /LOP]
Blo Trigger1-I	State of the module input: An Alarm of this protective element will block the Loss of Potential Detection.	[Protection Para /Global Prot Para /Supervision /LOP]
Blo Trigger2-I	State of the module input: An Alarm of this protective element will block the Loss of Potential Detection.	[Protection Para /Global Prot Para /Supervision /LOP]
Blo Trigger3-I	State of the module input: An Alarm of this protective element will block the Loss of Potential Detection.	[Protection Para /Global Prot Para /Supervision /LOP]
Blo Trigger4-I	State of the module input: An Alarm of this protective element will block the Loss of Potential Detection.	[Protection Para /Global Prot Para /Supervision /LOP]
Blo Trigger5-I	State of the module input: An Alarm of this protective element will block the Loss of Potential Detection.	[Protection Para /Global Prot Para /Supervision /LOP]

LOP Module Signals (Output States)

<i>Signal</i>	<i>Description</i>
active	Signal: active
ExBlo	Signal: External Blocking
Alarm	Signal: Alarm Loss of Potential

<i>Signal</i>	<i>Description</i>
LOP Blo	Signal: Loss of Potential blocks other elements.
Ex FF VT	Signal: Ex FF VT
Ex FF EVT	Signal: Alarm Fuse Failure Earth Voltage Transformers

Blocking Trigger

<i>Name</i>	<i>Description</i>
.-	No assignment
I[1].Alarm	Signal: Alarm
I[2].Alarm	Signal: Alarm
I[3].Alarm	Signal: Alarm
I[4].Alarm	Signal: Alarm
I[5].Alarm	Signal: Alarm
I[6].Alarm	Signal: Alarm
IG[1].Alarm	Signal: Alarm IG
IG[2].Alarm	Signal: Alarm IG
IG[3].Alarm	Signal: Alarm IG
IG[4].Alarm	Signal: Alarm IG

Commissioning: Loss of Potential

Object to be tested:

Test of the module LOP.

Necessary means:

- Three-phase current source
- Three-phase voltage source.

Procedure

Test part 1:

Examine if the output signal »LOP BLO « becomes true if:

- Any of the three-phase voltages becomes less $0.01 \cdot V_n$ Volt
- The residual voltage is less than $0.01 \cdot V_n$ Volt or the $\%V_2/V_1$ ratio is greater 40%
- All three-phase currents are less than the load current / overcurrent detection (I_{\leq}) threshold.
- The residual current is less than 0.1 Ipu (rated current)
- No pickup of an OC element which should blocks VT Supervision
- The breaker is closed (option, if a breaker is assigned).
- The offline detection has not detected a dead busbar (No current, no voltage measured).

Successful test result part 1:

The output signals only become true if all the above mentioned conditions are fulfilled.

Test part 2:

Set the parameter »*Measuring Circuit Supervision=active*« within those protective elements that should be blocked by the Loss of Potential supervision (like undervoltage protection., voltage controlled overcurrent protection...).

Check those protective elements if they are blocked if the Loss of Potential supervision has generated a block command.

Successful test result part 2:

All protective elements that should be blocked in case of Loss of Potential supervision are blocked if the conditions (Procedure part 1) are fulfilled.

Commissioning: Loss of Potential (FF via DI)

Object to be tested:

Check if the auto fuse failure is correctly identified by the device.

Procedure

- Turn off the automatic circuit breaker of the VTs (all poles to be dead)

Successful test result

- The state of the respective digital input changes.
- All protective elements are blocked which should not have an unwanted operation caused by a fuse failure
»*Measuring Circuit Supervision=active*«.

Phase Sequence Supervision

The device calculates the phase sequence at each CT and VT (based on positive-sequence and negative-sequence components). The calculated phase sequence (i. e. „ACB“ or „ABC“) is permanently compared with the setting that has been made at [Field Para/General Settings] »Phase Sequence«.

The menu [Operation/Status Display/Supervision/Phase Sequence] contains a specific (warning) signal for each CT and VT. If the check of a CT / VT finds that the actual phase sequence is different from the setting under [Field Para] then the respective signal becomes true (active).

The phase sequence supervision is especially useful during commissioning of the device because it helps making sure that the »Phase Sequence« setting under [Field Para] is correct



The supervision requires minimum values for the current (in case of a CT), or for the voltage (in case of a VT, respectively), otherwise the phase sequence cannot be reliably determined.

- For a VT: The minimum voltage is $0.1 \cdot V_n$.
- For a CT: The minimum current is $0.1 \cdot I_n$.

Self Supervision

SSV

The protection devices are supervised by various check routines during normal operation and during the start-up phase on faulty operation.

The protection devices are carrying out various self supervision tests.

<i>Self Supervision within the devices</i>		
Supervision of...	Supervised by...	Action on detected issue...
Start phase	The duration (permitted time) of the boot phase is monitored.	The device will be rebooted. => The device will be taken out of service after three unsuccessful start attempts.
Supervision of the duration of a protection cycle (Software cycle)	The maximum permitted time for a protection cycle is monitored by a timing analysis.	The self-supervision contact will be deenergized if the permitted time for a protection cycle is exceeded (first threshold). The protection device will be rebooted, if the protection cycle exceeds the second threshold.
Monitoring of the communication between Main and Digital Signal Processor (DSP)	The cyclic measured value processing of the DSP is monitored by the main processor.	The device will be rebooted, if a failure is detected. The self-supervision contact will be deenergized.
Analog-Digital-Converter	The DSP does a plausibility check on the digitalized data.	Protection will be blocked, if a failure is detected, in order to prevent faulty tripping.
Supervision of data consistency after an outage of the power supply. (e.g. outage of the power supply while changing the parameter settings).	An internal logic detects fragmentary saved data after an outage of the power supply.	If the new data is incomplete or corrupt, it will be deleted during the reboot phase of the device. The device will continue to work with the last valid data set.
Data consistency in general	Generation of check-sums.	The device will be taken out of service in case that inconsistent data is detected that is not caused by an outage of the power supply. (fatal internal error).

<i>Self Supervision within the devices</i>		
Parameter Setting (Device)	Protecting the parameter setting by plausibility checks.	<p>Implausibilities within the parameter configuration can be detected by means of plausibility checks.</p> <p>Detected implausibilities are highlighted by a question mark symbol. Please refer to chapter parameter setting for detailed information.</p>
Quality of the power supply	A hardware circuit ensures that the device can only be used, if the power supply is in the range specified by the technical data.	If the supply voltage is too low, the device will not start up or it will be set out of service respectively.
Sags of the supply voltage	<p>Short-term sags of the supply voltage are detected and can be bridged in most of the cases by means of the integrated buffer within the power supply hardware.</p> <p>This buffer also allows the termination of ongoing data writing procedures.</p>	The module for the supervision of the system utilization will detect repetitive short-term sags of the supply voltage.
Internal data of the device (memory load, internal resources, ...)	An internal module monitors the system utilization.	The module for the supervision of the system utilization initiates in case of a fatal error a reboot of the device. In case of minor faults the System LED will flash alternating red and green (please refer to the <i>Troubleshooting Guide</i>). The issue will be recorded as a system message.
Battery	<p>The battery is monitored continuously.</p> <p>Notice: The battery serves as buffering of the clock (real time clock). There's no impact on the functionality of the device if the battery breaks down, except for the buffering of the clock while the unit is in de-energized condition.</p>	If the battery is low the System LED will flash alternating red and green (please refer to the <i>Troubleshooting Guide</i>).
Status of the device communication (SCADA)	The projected and activated SCADA module supervises its connection to the master communication system.	<p>You can check if there is active communication with the master system within menu <Operation/ Status display/ Communication>.</p> <p>In order to monitor this state you can assign this status onto an LED and/or an output relay.</p> <p>For details on the status of the GOOSE communication please refer to chapter IEC61850.</p>

Device Start (Reboot)

The device starts up if:

- it is connected to the supply voltage,
- the User initiates (intentionally) a restart of the device,
- the device is set back to factory defaults,
- the internal self-supervision of the device detects a fatal error.

The reason for a device start/reboot is shown numerically within menu <Operation/ Status display/ Sys/ Restart> (please refer to the table below). The reason will also be logged within the event recorder (Event: Sys.Restart).

The table below explains the numbers indicating the reason of the restart.

<i>Device Start-up Codes</i>	
1.	Normal Start-up Start-up after clean disconnection of the supply voltage.
2.	Reboot by the Operator Device reboot triggered by the operator via HMI or Smart view.
3.	Reboot by means of Super Reset Automatic reboot when setting the device back to factory defaults.
4.	-- (outdated)
5.	-- (outdated)
6.	Unknown Error Source Reboot due to unknown error source.
7.	Forced Reboot (initiated by the main processor) The main processor identified invalid conditions or data.
8.	Exceeded Time Limit of the Protection Cycle Unexpected interruption of the Protection Cycle.
9.	Forced Reboot (initiated by the digital signal processor) The digital signal processor identified invalid conditions or data.
10.	Exceeded Time Limit of the Measured Value Processing Unexpected interruption of the cyclic measured value processing.
11.	Sags of the Supply Voltage Reboot after short-term sag or outage of the supply voltage.
12.	Illegal Memory Access Reboot after illegal memory access.

Internal Messages

The menu [Operation / Self Supervision / Messages] gives access to the list of internal messages. In particular, it is recommended to check these in case of some problem directly related to the device.

All messages that can potentially appear here are described in detail in a separate document, the “HighPROTEC Troubleshooting Guide” (DOK-HB-TS).

Device taken out of Service “Device Stopped”

The protection device will be taken out of service, if there is an undefined state that cannot be escaped after three reboots.

In this state the system LED will be illuminated red or red flashing. The display will show the message „Device Stopped“ followed by a 6-digit error code, e.g. E01487.

In addition to the recorders, messages and display information that can be accessed by the user, there may exist additional error information accessible by the Service Staff. These offer further failure analysis and diagnosis opportunities to the Service Staff.

NOTICE

In such a case please contact the Woodward Service Staff and provide them the error code.

For further information on trouble shooting please refer to the separately provided “HighPROTEC Trouble Shooting Guide”.

Direct Commands of the Self Supervision

<i>Parameter</i>	<i>Description</i>	<i>Setting range</i>	<i>Default</i>	<i>Menu path</i>
Ack System LED 	Acknowledge System LED (red/green flashing LED)	False, True	False	[Operation /Acknowledge]

Signals (Output States) of the Self Supervision

<i>Signal</i>	<i>Description</i>
System Error	Signal: Device Failure
SelfSuperVision Contact	Signal: SelfSuperVision Contact

Counter Values of the Self Supervision

<i>Value</i>	<i>Description</i>	<i>Menu path</i>
Cr No of free sockets	Counter for network diagnosis. Number of free sockets.	[Operation /Self Supervision /System State]

Programmable Logic

Available Elements (Equations):
Logics

General Description

The Protective Relay includes programmable Logic Equations for programming output relays, blocking of protective functions and custom logic functions in the relay.

The logic provides control of the output relays based on the state of the inputs that can be chosen from the assignment list (protective function pickups, protective function states, breaker states, system alarms, and module inputs). The user can use the outputs signals of a Logic Equation as inputs in higher equations (e.g. the output signal of Logic Equation 10 might be used as an input of Logic Equation 11).

Principle Overview

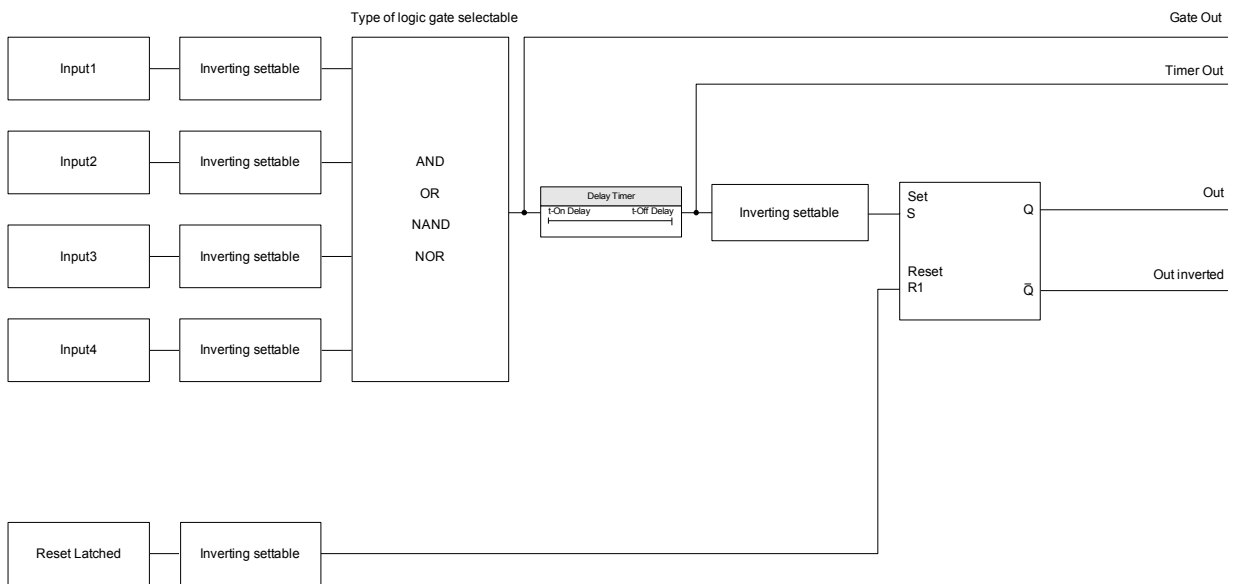

Detailed Overview – Overall Logic diagram

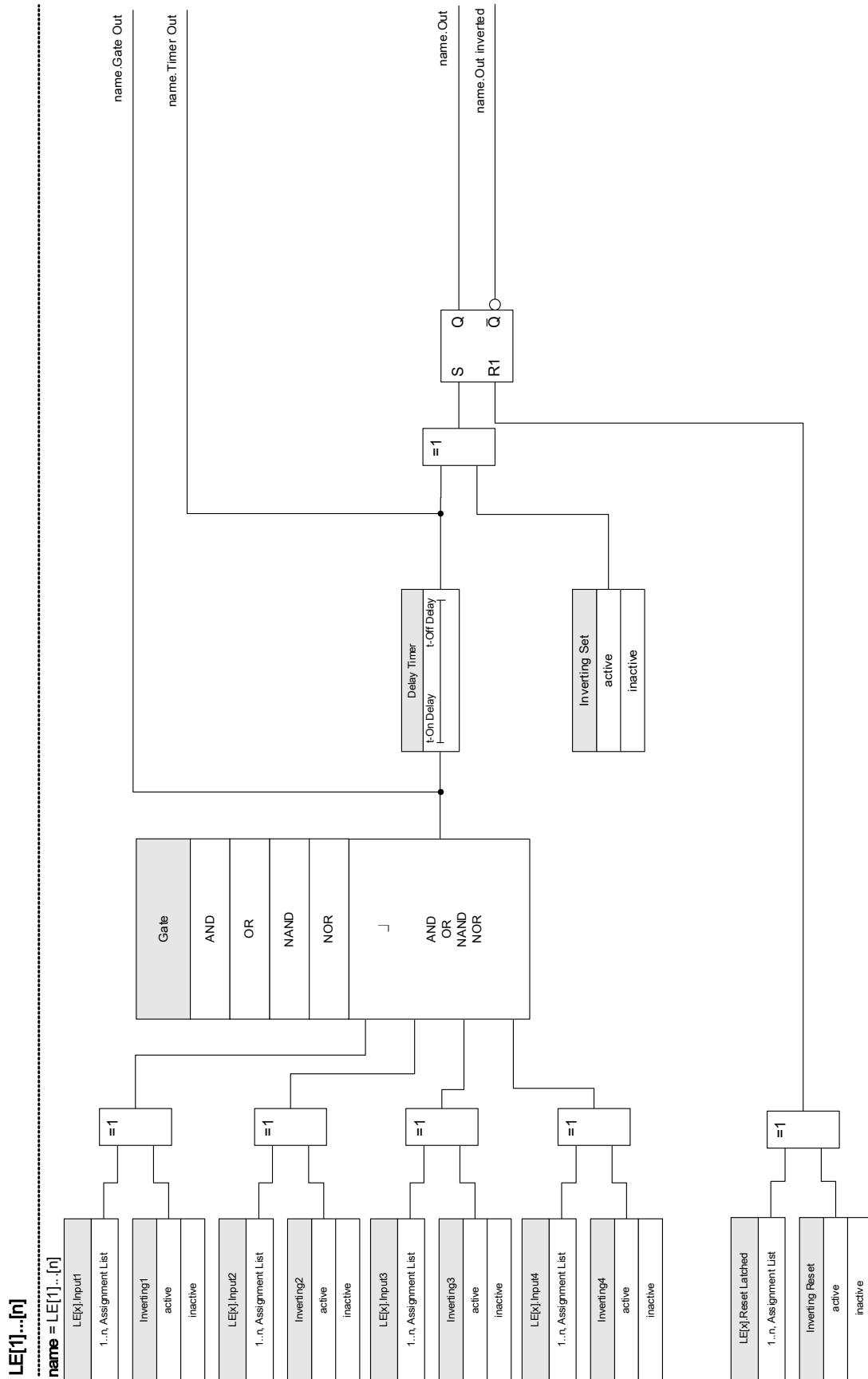

Available Gates (Operators)

Within the Logic Equation, the following Gates can be used:

Gate

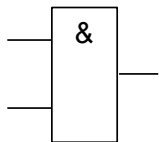

AND

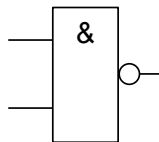

NAND

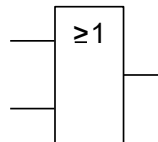

OR

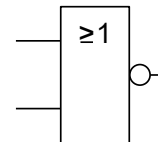

NOR

Input Signals

The user can assign up to 4 Input signals (from the assignment list) to the inputs of the gate.

As an option, each of the 4 input signals can be inverted (negated)

Timer Gate (On Delay and Off Delay)

The output of the gate can be delayed. The user has the option to set an On and an Off delay.

Latching

The logic equations issues two signals. An unlatched and a latched signal. The latched output is also available as an inverted output.

In order to reset the latched signal the user has to assign a reset signal from the assignment list. The reset signal can also optionally be inverted. The latching works based on reset priority. That means, the reset input is dominant.

Cascading Logical Outputs

The device will evaluate output states of the Logic Equations starting from Logic Equation 1 up to the Logic Equation with the highest number. This evaluation (device) cycle will be continuously repeated.

Cascading Logic Equations in an ascending sequence

Cascading in an ascending sequence means that the user uses the output signal of “Logic Equation n ” as input of “Logic Equation $n+1$ ”. If the state of “Logic Equation n ” changes, the state of the output of “Logic Equation $n+1$ ” will be updated within the same cycle.

Cascading Logic Equations in a descending sequence

Cascading in a descending sequence means that the user uses the output signal of “Logic Equation $n+1$ ” as input of “Logic Equation n ”. If the output of “Logic Equation $n+1$ ” changes, this change of the feed back signal at the input of “Logic Equation n ” will be delayed for one cycle.

Cascading in Ascending Order

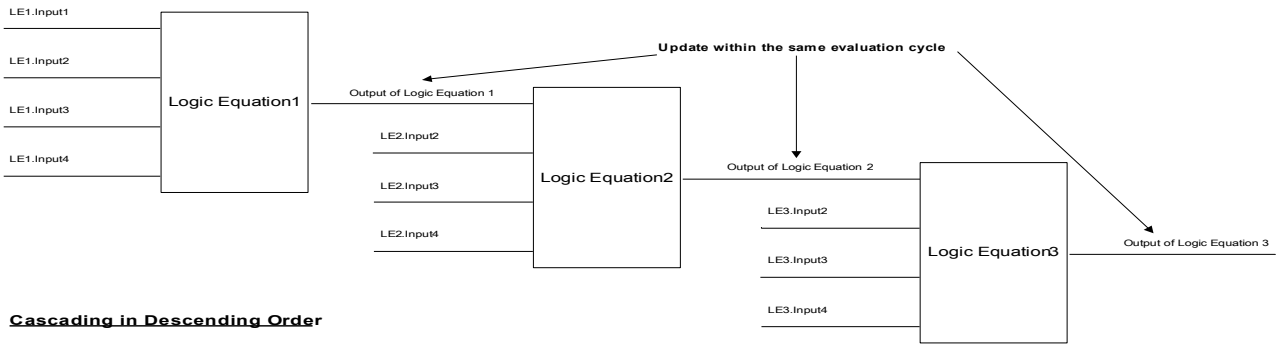
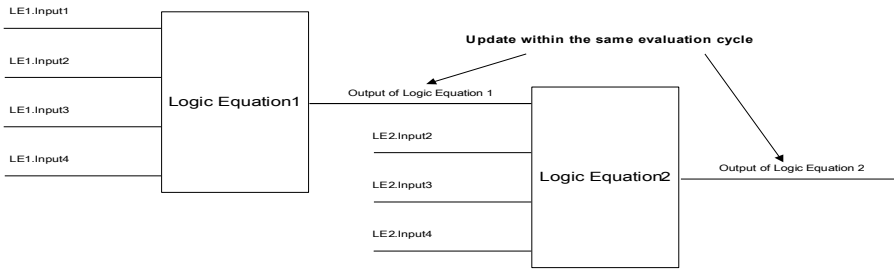

Cascading in Descending Order

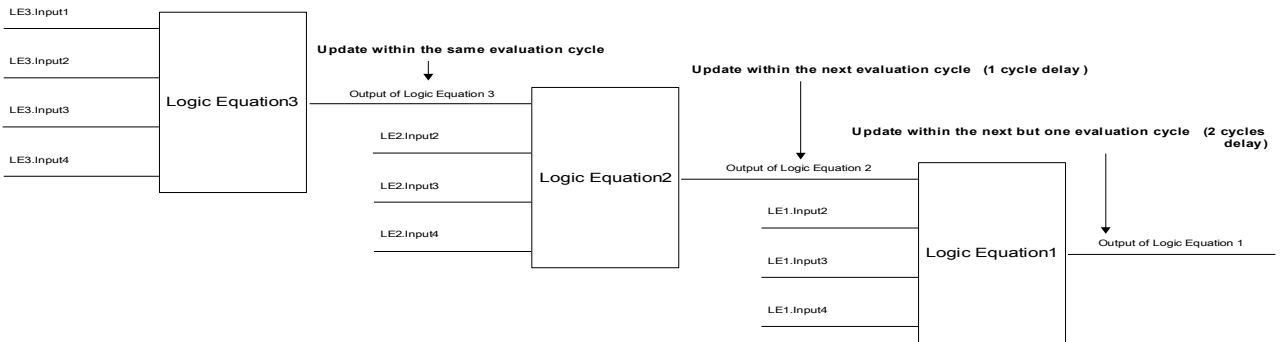
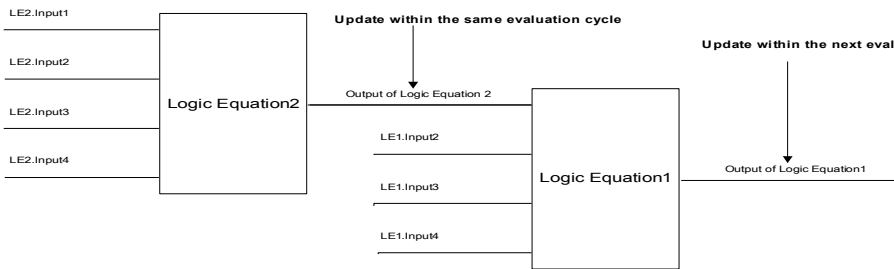

Programmable Logic at the Panel



WARNING improper use of Logic Equations might result in personal injury or damage the electrical equipment.

Don't use Logic Equations unless that you can ensure the safe functionality.

How to configure a Logic Equation?

- Call up menu [Logics/LE [x]]:

- Set the Input Signals (where necessary, invert them).

- If required, configure the timer («*On delay*» and «*Off delay*»).

- If the latched output signal is used assign a reset signal to the reset input.

- Within the «status display», the user can check the status of the logical inputs and outputs of the Logic Equation.











In case that Logic Equations should be cascaded the user has to be aware of timing delays (cycles) in case of descending sequences (Please refer to section: Cascading Logical Outputs).





By means the Status Display [Operation/Status Display] the logical states can be verified.]

Device Planning Parameters of the Programmable Logic

<i>Parameter</i>	<i>Description</i>	<i>Options</i>	<i>Default</i>	<i>Menu path</i>
No of Equations: 	Number of required Logic Equations:	0, 5, 10, 20, 40, 80	20	[Device planning]

Global Protection Parameter of the Programmable Logic

Parameter	Description	Setting range	Default	Menu path
LE1.Gate 	Logic gate	AND, OR, NAND, NOR	AND	[Logics /LE 1]
LE1.Input1 	Assignment of the Input Signal	1..n, Assignment List	.-	[Logics /LE 1]
LE1.Inverting1 	Inverting the input signals. Only available if an input signal has been assigned.	inactive, active	inactive	[Logics /LE 1]
LE1.Input2 	Assignment of the Input Signal	1..n, Assignment List	.-	[Logics /LE 1]
LE1.Inverting2 	Inverting the input signals. Only available if an input signal has been assigned.	inactive, active	inactive	[Logics /LE 1]
LE1.Input3 	Assignment of the Input Signal	1..n, Assignment List	.-	[Logics /LE 1]
LE1.Inverting3 	Inverting the input signals. Only available if an input signal has been assigned.	inactive, active	inactive	[Logics /LE 1]
LE1.Input4 	Assignment of the Input Signal	1..n, Assignment List	.-	[Logics /LE 1]
LE1.Inverting4 	Inverting the input signals. Only available if an input signal has been assigned.	inactive, active	inactive	[Logics /LE 1]
LE1.t-On Delay 	Switch On Delay	0.00 - 36000.00s	0.00s	[Logics /LE 1]

<i>Parameter</i>	<i>Description</i>	<i>Setting range</i>	<i>Default</i>	<i>Menu path</i>
LE1.t-Off Delay 	Switch Off Delay	0.00 - 36000.00s	0.00s	[Logics /LE 1]
LE1.Reset Latched 	Reset Signal for the Latching	1..n, Assignment List	-.-	[Logics /LE 1]
LE1.Inverting Reset 	Inverting Reset Signal for the Latching	inactive, active	inactive	[Logics /LE 1]
LE1.Inverting Set 	Inverting the Setting Signal for the Latching	inactive, active	inactive	[Logics /LE 1]

Programmable Logic Inputs

<i>Name</i>	<i>Description</i>	<i>Assignment via</i>
LE1.Gate In1-I	State of the module input: Assignment of the Input Signal	[Logics /LE 1]
LE1.Gate In2-I	State of the module input: Assignment of the Input Signal	[Logics /LE 1]
LE1.Gate In3-I	State of the module input: Assignment of the Input Signal	[Logics /LE 1]
LE1.Gate In4-I	State of the module input: Assignment of the Input Signal	[Logics /LE 1]
LE1.Reset Latch-I	State of the module input: Reset Signal for the Latching	[Logics /LE 1]

Programmable Logic Outputs

<i>Signal</i>	<i>Description</i>
LE1.Gate Out	Signal: Output of the logic gate
LE1.Timer Out	Signal: Timer Output
LE1.Out	Signal: Latched Output (Q)
LE1.Out inverted	Signal: Negated Latched Output (Q NOT)

Commissioning

Before starting work on an opened switchboard it is imperative that the complete switchboard is dead and the following 5 safety regulations are always met: ,

DANGER

Safety precautions:

- Disconnect from the power supply
- Secure against reconnection
- Verify if the equipment is dead
- Connect to ground and short-circuit all phases
- Cover or safeguard all live adjacent parts

DANGER

The secondary circuit of a current transformer must never be opened during operation. The prevailing high voltages are dangerous to life.

WARNING

Even when the auxiliary voltage is switched off, it is likely that there are still hazardous voltages at the component connections.

All locally applicable national and international installation and safety regulations for working at electrical power installations must always be followed (e.g. VDE, EN, DIN, IEC).

WARNING

Prior to the initial voltage connection, the following must be guaranteed:

- Correct grounding of the device
- That all signal circuits are tested
- That all control circuits are tested
- Transformer wiring is checked
- Correct rating of the CTs
- Correct burden of the CTs
- That the operational conditions are in line with the Technical Data
- Correct rating of the transformer protection
- Function of the transformer fuses
- Correct wiring of all digital inputs
- Polarity and capacity of the supply voltage
- Correct wiring of the analogue inputs and outputs
- *For line differential protection:* Correct fiber optics connection for a reliable Protection Communication

NOTICE

The permissible deviations of measuring values and device adjustment are dependent on the technical data/tolerances.

Commissioning/Protection Test

WARNING

Putting into operation/Protection test must be carried out by authorized and qualified personnel. Before the device is put into operation the related documentation has to be read and understood.

WARNING

With any test of the protection functions the following has to be checked:

- Is activation/tripping saved in the event recorder?
- Is tripping saved in the fault recorder?
- Is tripping saved in the disturbance recorder?
- Are all signals/messages correctly generated?
- Do all general parameterized blocking functions work properly?
- Do all temporary parameterized (via DI) blocking functions work properly?
- To enable checks on all LEDs and relay functions, these have to be provided with the relevant alarm and tripping functions of the respective protection functions/elements. This has to be tested in practical operation.

WARNING

Check of all temporary blockings (via digital inputs):

- In order to avoid malfunctions, all blockings related to tripping/non-tripping of protection function have to be tested. The test can be very complex and should therefore be performed by the same people who set up the protection concept.

CAUTION

Check of all general trip blockings:

- All general trip blockings have to be tested.

NOTICE

Prior to the initial operation of the protection device all tripping times and values shown in the adjustment list have to be confirmed by a secondary test

NOTICE

Any description of functions, parameters, inputs or outputs that does not match the device in hand, can be ignored.

Putting out of Operation – Plug out the Relay



Warning! Dismounting the relay will lead to a loss of the protection functionality. Ensure that there is a back-up protection. If you are not aware of the consequences of dismantling the device – stop! Don't start.



Inform SCADA before you start.

Switch-off the power supply.

Ensure, that the cabinet is dead and that there are no voltages that could lead to personal injury.

Plug-out the terminals at the rear-side of the device. Do not pull any cable – pull on the plugs! If it is stuck use for example a screw driver.

Fasten the cables and terminals in the cabinet by means of cable clips to ensure that no accidental electrical connections are caused.

Hold the device at the front-side while opening the mounting nuts.

Remove the device carefully out of the cabinet.

In case no other device is to be mounted or replaced cover/close the cut-out in the front-door.

Close the cabinet.

Service and Commissioning Support

Within the service menu various functions support maintenance and commissioning of the device.

General

Within the menu [Service/General], the user can initiate a reboot of the device.

Phase Sequence

Within the menu [Operation/Status Display/Supervision/Phase Sequence], there are signals showing whether the phase sequence calculated by the device is different from the setting under [Field Para/General Settings] »*Phase Sequence*«. See Chapter “Phase Sequence Supervision” for details.

Forcing the Relay Output Contacts

NOTICE

The parameters, their defaults and setting ranges have to be taken from Relay Output Contacts section.

Principle – General Use

⚠ DANGER

The User **MUST ENSURE** that the relay output contacts operate normally after the maintenance is completed. If the relay output contacts do not operate normally, the protective device **WILL NOT** provide protection.

For commissioning purposes or for maintenance, relay output contacts can be set by force.

Within this mode [Service/Test Mode/Force OR/BO Slot X(2/5)], relay output contacts can be set by force:

- Permanent; or
- Via timeout.

If they are set with a timeout, they will only keep their “Force Position” as long as this timer runs. If the timer expires, the relay will operate normally. If they are set as Permanent, they will keep the “Force Position” continuously.

There are two options available:

- Forcing a single relay »*Force ORx*«; and
- Forcing an entire group of relay output contacts »*Force all Outs*«.

Forcing an entire group takes precedence over forcing a single relay output contact!

NOTICE

A relay output contact will NOT follow a force command as long as it is disarmed at the same time.

NOTICE

A relay output contact will follow a force command:

- If it is not disarmed; and
- If the Direct Command is applied to the relay(s).

Keep in mind, that the forcing of all relay output contacts (of the same assembly group) takes precedence over the force command of a single relay output contact.

Disarming the Relay Output Contacts

NOTICE

The parameters, their defaults, and setting ranges have to be taken from the Relay Output Contacts section.

Principle – General Use

Within this mode [Service/Test Mode/DISARMED], entire groups of relay output contacts can be disabled. By means of this test mode, contact outputs switching actions of the relay output contacts are prevented. If the relay output contacts are disarmed, maintenance actions can be carried out without the risk of taking entire processes off-line.

⚠ DANGER

The User **MUST ENSURE** that the relay output contacts are **ARMED AGAIN** after the maintenance is complete. If they are not armed, the protective device **WILL NOT** provide protection.

NOTICE

Zone Interlocking Output and the Supervision Contact cannot be disarmed.

Within this mode [Service/Test Mode/DISARMED] entire groups of relay output contacts can be disarmed:

- Permanent; or
- Via timeout.

If they are set with a timeout, they will only keep their “Disarm Position” as long as this timer runs. If the timer expires, the relay output contacts will operate normally. If they are set Permanent, they will keep the “Disarm State” continuously.

NOTICE

A relay output contact will NOT be disarmed as long as:

- It's latched (and not yet reset).
- As long as a running t-OFF-delay timer is not yet expired (hold time of a relay output contact).
- The Disarm Control is not set to active.
- The Direct Command is not applied.

NOTICE

A relay output contact will be disarmed if it's not latched and

- There is no running t-OFF-delay timer (hold time of a relay output contact) and

- The DISARM Control is set to active and

- The Direct Command Disarm is applied.

Forcing RTDs*

* = Availability depends on ordered device.

NOTICE

The parameters, their defaults, and setting ranges have to be taken from RTD/UTRD section.

Principle – General Use

⚠ DANGER

The User **MUST ENSURE** that the RTDs operate normally after the maintenance is completed. If the RTDs do not operate normally, the protective device **WILL NOT** provide protection.

For commissioning purposes or for maintenance, RTD temperatures can be set by force.

Within this mode [Service/Test Mode/URTD], RTD temperatures can be set by force:

- Permanent; or
- Via timeout.

If they are set with a timeout, they will keep their “Forced Temperature” only as long as this timer runs. If the timer expires, the RTD will operate normally. If they are set as »*Permanent*«, they will keep the “Forced Temperature” continuously. This menu will show the measured values of the RTDs until the User activates the force mode by calling up the »*Function*«. As soon as the force mode is activated, the shown values will be frozen as long as this mode is active. Now the User can force RTD values. As soon as the force mode is deactivated, measured values will be shown again.

Forcing Analog Outputs*

* = Availability depends on ordered device.

NOTICE

The parameters, their defaults, and setting ranges have to be taken from Analog Output section.

Principle – General Use

⚠ DANGER

The User **MUST ENSURE** that the Analog Outputs operate normally after maintenance is completed. Do not use this mode if forced Analog Outputs cause issues in external processes.

For commissioning purposes or for maintenance, Analog Outputs can be set by force.

Within this mode [Service/Test Mode/Analog Output(x)], Analog Outputs can be set by force:

- Permanent; or
- Via timeout.

If they are set with a timeout, they will only keep their “Forced Value” as long as this timer runs. If the timer expires, the Analog Output will operate normally. If they are set as »*Permanent*«, they will keep the “Forced Value” continuously. This menu will show the current value that is assigned onto the Analog Output until the User activates the force mode by calling up the »*Function*«. As soon as the force mode is activated, the shown values will be frozen as long as this mode is active. Now the User can force Analog Output values. As soon as the force mode is deactivated, measured values will be shown again.

Forcing Analog Inputs*

* = Availability depends on ordered device.

NOTICE

The parameters, their defaults, and setting ranges have to be taken from Analog Inputs section.

Principle – General Use

⚠ DANGER

The User **MUST ENSURE** that the Analog Inputs operate normally after maintenance is completed.

For commissioning purposes or for maintenance, Analog Inputs can be set by force.

Within this mode [Service/Test Mode (Prot inhibit)/WARNING! Cont?/Analog Inputs], Analog Inputs can be set by force:

- Permanent; or
- Via timeout.

If they are set with a timeout, they will only keep their “Forced Value” as long as this timer runs. If the timer expires, the Analog Input will operate normally. If they are set as »*Permanent*«, they will keep the “Forced Value” continuously. This menu will show the current value that is fed to the Analog Input until the User activates the force mode by calling up the »*Function*«. As soon as the force mode is activated, the shown value will be frozen as long as this mode is active. Now the User can force the Analog Input value. As soon as the force mode is deactivated, measured value will be shown again.

Fault Simulator (Sequencer)*

Available Elements:

Sgen

* = Availability depends on ordered device.

For commissioning support and in order to analyze failures, the protective device offers the option to simulate measuring quantities. The simulation menu can be found within the [Service/Test Mode/Sgen] menu.

The simulation cycle consists of three states:

1. Pre-fault;
2. Failure;
3. Post-fault State (Phase).

In addition to these three states, there is a short “reset stage” of about 100 ms immediately before the Pre-failure state, and another one after the Post-failure state, where all protection functions are deactivated. This is necessary to re-initialize all protection modules and related filters and set them to a healthy new state.

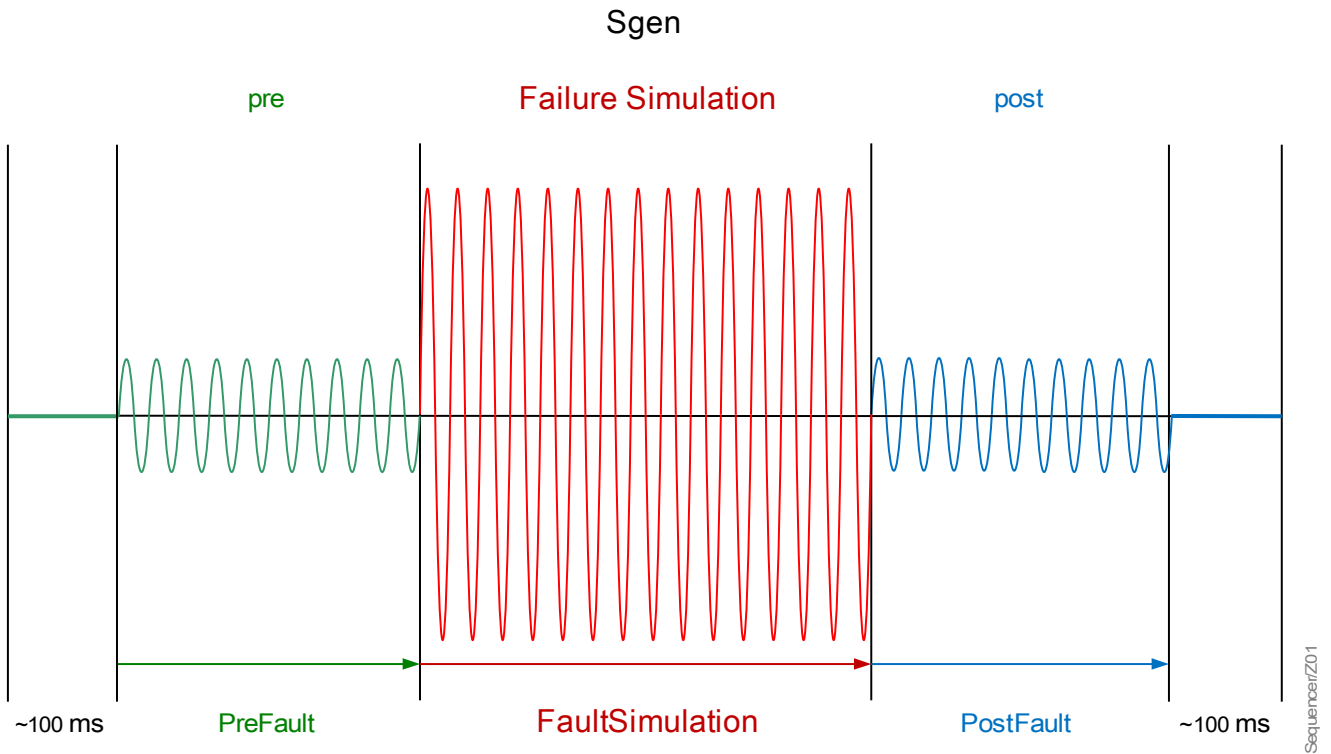

The states are recorded by the Event and Disturbance Recorders as follows:

- **0** Normal operation (i. e. without fault simulation)
- **1** Pre-fault
- **2** Fault
- **3** Post-fault
- **4** Reset / initialization phase

Within the [Service/Test Mode (Prot inhibit) / Sgen / Configuration / Times] sub-menu, the duration of each phase can be set. In addition; the measuring quantities to be simulated can be determined (e. g.: voltages, currents, and the corresponding angles) for each phase (and ground). The simulation will be terminated, if a phase current

exceeds $0.1 \cdot I_n$. A simulation can be restarted, five seconds after the current has fallen below $0.1 \cdot I_n$.

Moreover, within the [Service / Test Mode (Prot inhibit) / Sgen / Process] sub-menu there are two blocking parameters *ExBlo1*, *ExBlo2*. Signals that are assigned to any of these block the Fault Simulator. For example, it can be recommended for security considerations to have the Fault Simulator blocked if the circuit breaker is in closed position.

Furthermore, there is the possibility to assign a signal to the parameter *Ex ForcePost*. Then this signal interrupts the actual state of the Fault Simulator (Pre-fault or Failure) and leads to an immediate transition into the Post-fault state. The typical application for this is a test whether the protective device correctly generates a trip decision, so that it is not necessary to always wait until the regular end of the Failure state. It is possible to assign the trip signal to *Ex ForcePost*, so that the Failure state is ended immediately after the trip signal has been correctly generated.

⚠ DANGER

Setting the device into the simulation mode means taking the protective device out of operation for the duration of the simulation. Do not use this feature during operation of the device if the User cannot guarantee that there is a running and properly working backup protection.

NOTICE

The energy counters are stopped while the failure simulator is running.

NOTICE

The simulation voltages are always phase to neutral voltages, irrespectively of the mains voltage transformers' connection method (Phase-to-phase / Wye / Open Delta).

NOTICE

Due to internal dependencies, the frequency of the simulation module is 0.16% greater than the rated one.

Application Options of the Fault Simulator



<i>Stop Options</i>	Cold Simulation (Option 1)	Hot Simulation (Option 2)
<p>Manual start, no stop</p> <p>Run complete: Pre Failure, Failure, Post Failure.</p> <ol style="list-style-type: none"> 1. Call up [Service / Test Mode / Sgen / Process] 2. <i>Ex Force Post</i> = no assignment 3. Press/Call up <i>Start Simulation</i>. 	<p>Simulation without tripping the circuit breaker:</p> <p>The TripCmd of all protection functions will be blocked. The protection function will possibly trip but not generate a TripCmd.</p> <ol style="list-style-type: none"> 1. Call up [Service / Test Mode / Sgen / Process] 2. <i>TripCmd Mode</i> = No TripCmd 	<p>Simulation is authorized to trip the breaker:</p> <ol style="list-style-type: none"> 1. Call up [Service / Test Mode / Sgen / Process] 2. <i>TripCmd Mode</i> = With TripCmd
<p>Manual start, stop by external signal</p> <p>Force Post: As soon as this signal becomes true, the Fault Simulation will be forced to switch into the Post Failure mode.</p> <ol style="list-style-type: none"> 1. Call up [Service / Test Mode / Sgen / Process] 2. <i>Ex Force Post</i> = Assigned Signal 		
<p>Manual start, manual stop</p> <p>As soon as this signal becomes true, the Fault Simulation will be terminated and the device changes back to normal operation.</p> <ol style="list-style-type: none"> 1. Call up [Service / Test Mode / Sgen / Process] 2. Press/Call up <i>Stop Simulation</i>. 		
<p>Start by external signal</p> <p>The start of the Fault Simulator is triggered by the assigned external signal (unless a phase current exceeds $0.1 \cdot I_n$ or the Fault Simulator is blocked, see also description above).</p> <ol style="list-style-type: none"> 1. Call up [Service / Test Mode / Sgen / Process] 2. <i>Ex Start Simulation</i> = Assigned Signal 		

Device Planning Parameters of the Failure Simulator



Parameter	Description	Options	Default	Menu path
Mode 	Mode	do not use, use	use	[Device planning]





Global Protection Parameter of the Failure Simulator





Parameter	Description	Setting range	Default	Menu path
PreFault 	Pre Fault Duration	0.00 - 300.00s	0.0s	[Service /Test (Prot inhibit) /Sgen /Configuration /Times]
FaultSimulation 	Duration of Fault Simulation	0.00 - 10800.00s	0.0s	[Service /Test (Prot inhibit) /Sgen /Configuration /Times]
PostFault 	PostFault	0.00 - 300.00s	0.0s	[Service /Test (Prot inhibit) /Sgen /Configuration /Times]
TripCmd Mode 	Trip Command Mode	No TripCmd, With TripCmd	No TripCmd	[Service /Test (Prot inhibit) /Sgen /Process]
Ex Start Simulation 	External Start of Fault Simulation (Using the test parameters)	1..n, Assignment List	.-	[Service /Test (Prot inhibit) /Sgen /Process]



Parameter	Description	Setting range	Default	Menu path
ExBlo1 	External blocking of the module, if blocking is activated (allowed) within a parameter set and if the state of the assigned signal is true.1	1..n, Assignment List	SG[1].Pos ON	[Service /Test (Prot inhibit) /Sgen /Process]
ExBlo2 	External blocking of the module, if blocking is activated (allowed) within a parameter set and if the state of the assigned signal is true.2	1..n, Assignment List	-.-	[Service /Test (Prot inhibit) /Sgen /Process]
Ex ForcePost 	Force Post state. Abort simulation.	1..n, Assignment List	-.-	[Service /Test (Prot inhibit) /Sgen /Process]

Voltage Parameter of the Failure Simulator

Parameter	Description	Setting range	Default	Menu path
VL1 	Voltage Fundamental Magnitude in Pre State: phase L1	0.00 - 2.00Vn	0.57Vn	[Service /Test (Prot inhibit) /Sgen /Configuration /PreFault /VT]
VL2 	Voltage Fundamental Magnitude in Pre State: phase L2	0.00 - 2.00Vn	0.57Vn	[Service /Test (Prot inhibit) /Sgen /Configuration /PreFault /VT]
VL3 	Voltage Fundamental Magnitude in Pre State: phase L3	0.00 - 2.00Vn	0.57Vn	[Service /Test (Prot inhibit) /Sgen /Configuration /PreFault /VT]

Parameter	Description	Setting range	Default	Menu path
VX 	Voltage Fundamental Magnitude in Pre State: VX	0.00 - 2.00Vn	0.0Vn	[Service /Test (Prot inhibit) /Sgen /Configuration /PreFault /VT]
phi VL1 	Start Position respectively Start Angle of the Voltage Phasor during Pre-Phase:phase L1	-360 - 360°	0°	[Service /Test (Prot inhibit) /Sgen /Configuration /PreFault /VT]
phi VL2 	Start Position respectively Start Angle of the Voltage Phasor during Pre-Phase:phase L2	-360 - 360°	240°	[Service /Test (Prot inhibit) /Sgen /Configuration /PreFault /VT]
phi VL3 	Start Position respectively Start Angle of the Voltage Phasor during Pre-Phase:phase L3	-360 - 360°	120°	[Service /Test (Prot inhibit) /Sgen /Configuration /PreFault /VT]
phi VX meas 	Start Position respectively Start Angle of the Voltage Phasor during Pre-Phase: VX	-360 - 360°	0°	[Service /Test (Prot inhibit) /Sgen /Configuration /PreFault /VT]

<i>Parameter</i>	<i>Description</i>	<i>Setting range</i>	<i>Default</i>	<i>Menu path</i>
VL1 	Voltage Fundamental Magnitude in Fault State: phase L1	0.00 - 2.00Vn	0.29Vn	[Service /Test (Prot inhibit) /Sgen /Configuration / FaultSimulation /VT]
VL2 	Voltage Fundamental Magnitude in Fault State: phase L2	0.00 - 2.00Vn	0.29Vn	[Service /Test (Prot inhibit) /Sgen /Configuration / FaultSimulation /VT]
VL3 	Voltage Fundamental Magnitude in Fault State: phase L3	0.00 - 2.00Vn	0.29Vn	[Service /Test (Prot inhibit) /Sgen /Configuration / FaultSimulation /VT]
VX 	Voltage Fundamental Magnitude in Fault State: phase VX	0.00 - 2.00Vn	0.29Vn	[Service /Test (Prot inhibit) /Sgen /Configuration / FaultSimulation /VT]
phi VL1 	Start Position respectively Start Angle of the Voltage Phasor during Fault-Phase:phase L1	-360 - 360°	0°	[Service /Test (Prot inhibit) /Sgen /Configuration / FaultSimulation /VT]





Parameter	Description	Setting range	Default	Menu path
phi VL2 	Start Position respectively Start Angle of the Voltage Phasor during Fault-Phase:phase L2	-360 - 360°	240°	[Service /Test (Prot inhibit) /Sgen /Configuration / FaultSimulation /VT]
phi VL3 	Start Position respectively Start Angle of the Voltage Phasor during Fault-Phase:phase L3	-360 - 360°	120°	[Service /Test (Prot inhibit) /Sgen /Configuration / FaultSimulation /VT]
phi VX meas 	Start Position respectively Start Angle of the Voltage Phasor during Fault-Phase: VX	-360 - 360°	0°	[Service /Test (Prot inhibit) /Sgen /Configuration / FaultSimulation /VT]
VL1 	Voltage Fundamental Magnitude during Post phase: phase L1	0.00 - 2.00Vn	0.57Vn	[Service /Test (Prot inhibit) /Sgen /Configuration /PostFault /VT]
VL2 	Voltage Fundamental Magnitude during Post phase: phase L2	0.00 - 2.00Vn	0.57Vn	[Service /Test (Prot inhibit) /Sgen /Configuration /PostFault /VT]





<i>Parameter</i>	<i>Description</i>	<i>Setting range</i>	<i>Default</i>	<i>Menu path</i>
VL3 	Voltage Fundamental Magnitude during Post phase: phase L3	0.00 - 2.00Vn	0.57Vn	[Service /Test (Prot inhibit) /Sgen /Configuration /PostFault /VT]
VX 	Voltage Fundamental Magnitude during Post phase: phase VX	0.00 - 2.00Vn	0.0Vn	[Service /Test (Prot inhibit) /Sgen /Configuration /PostFault /VT]
phi VL1 	Start Position respectively Start Angle of the Voltage Phasor during Post phase: phase L1	-360 - 360°	0°	[Service /Test (Prot inhibit) /Sgen /Configuration /PostFault /VT]
phi VL2 	Start Position respectively Start Angle of the Voltage Phasor during Post phase: phase L2	-360 - 360°	240°	[Service /Test (Prot inhibit) /Sgen /Configuration /PostFault /VT]
phi VL3 	Start Position respectively Start Angle of the Voltage Phasor during Post phase: phase L3	-360 - 360°	120°	[Service /Test (Prot inhibit) /Sgen /Configuration /PostFault /VT]





Parameter	Description	Setting range	Default	Menu path
 phi VX meas	Start Position respectively Start Angle of the Voltage Phasor during Post phase: phase VX	-360 - 360°	0°	[Service /Test (Prot inhibit) /Sgen /Configuration /PostFault /VT]





Parameter	Description	Setting range	Default	Menu path
 CT Ntrl.IL1	Current Fundamental Magnitude in Pre State: phase L1	0.00 - 40.00In	0.0In	[Service /Test (Prot inhibit) /Sgen /Configuration /PreFault /CT Ntrl]
 CT Ntrl.IL2	Current Fundamental Magnitude in Pre State: phase L2	0.00 - 40.00In	0.0In	[Service /Test (Prot inhibit) /Sgen /Configuration /PreFault /CT Ntrl]
 CT Ntrl.IL3	Current Fundamental Magnitude in Pre State: phase L3	0.00 - 40.00In	0.0In	[Service /Test (Prot inhibit) /Sgen /Configuration /PreFault /CT Ntrl]
 CT Ntrl.IG meas	Current Fundamental Magnitude in Pre State: IG	0.00 - 25.00In	0.0In	[Service /Test (Prot inhibit) /Sgen /Configuration /PreFault /CT Ntrl]





Parameter	Description	Setting range	Default	Menu path
 CT Ntrl.phi IL1	Start Position respectively Start Angle of the Current Phasor during Pre-Phase:phase L1	-360 - 360°	0°	[Service /Test (Prot inhibit) /Sgen /Configuration /PreFault /CT Ntrl]
 CT Ntrl.phi IL2	Start Position respectively Start Angle of the Current Phasor during Pre-Phase:phase L2	-360 - 360°	240°	[Service /Test (Prot inhibit) /Sgen /Configuration /PreFault /CT Ntrl]
 CT Ntrl.phi IL3	Start Position respectively Start Angle of the Current Phasor during Pre-Phase:phase L3	-360 - 360°	120°	[Service /Test (Prot inhibit) /Sgen /Configuration /PreFault /CT Ntrl]
 CT Ntrl.phi IG meas	Start Position respectively Start Angle of the Current Phasor during Pre-Phase: IG	-360 - 360°	0°	[Service /Test (Prot inhibit) /Sgen /Configuration /PreFault /CT Ntrl]
 CT Ntrl.IL1	Current Fundamental Magnitude in Fault State: phase L1	0.00 - 40.00In	0.0In	[Service /Test (Prot inhibit) /Sgen /Configuration / FaultSimulation /CT Ntrl]

Parameter	Description	Setting range	Default	Menu path
CT Ntrl.IL2 	Current Fundamental Magnitude in Fault State: phase L2	0.00 - 40.00In	0.0In	[Service /Test (Prot inhibit) /Sgen /Configuration / FaultSimulation /CT Ntrl]
CT Ntrl.IL3 	Current Fundamental Magnitude in Fault State: phase L3	0.00 - 40.00In	0.0In	[Service /Test (Prot inhibit) /Sgen /Configuration / FaultSimulation /CT Ntrl]
CT Ntrl.IG meas 	Current Fundamental Magnitude in Fault State: IG	0.00 - 25.00In	0.0In	[Service /Test (Prot inhibit) /Sgen /Configuration / FaultSimulation /CT Ntrl]
CT Ntrl.phi IL1 	Start Position respectively Start Angle of the Current Phasor during Fault-Phase:phase L1	-360 - 360°	0°	[Service /Test (Prot inhibit) /Sgen /Configuration / FaultSimulation /CT Ntrl]
CT Ntrl.phi IL2 	Start Position respectively Start Angle of the Current Phasor during Fault-Phase:phase L2	-360 - 360°	240°	[Service /Test (Prot inhibit) /Sgen /Configuration / FaultSimulation /CT Ntrl]





Parameter	Description	Setting range	Default	Menu path
 CT Ntrl.phi IL3	Start Position respectively Start Angle of the Current Phasor during Fault-Phase:phase L3	-360 - 360°	120°	[Service /Test (Prot inhibit) /Sgen /Configuration / FaultSimulation /CT Ntrl]
 CT Ntrl.phi IG meas	Start Position respectively Start Angle of the Current Phasor during Fault-Phase: IG	-360 - 360°	0°	[Service /Test (Prot inhibit) /Sgen /Configuration / FaultSimulation /CT Ntrl]
 CT Ntrl.IL1	Current Fundamental Magnitude during Post phase: phase L1	0.00 - 40.00In	0.0In	[Service /Test (Prot inhibit) /Sgen /Configuration /PostFault /CT Ntrl]
 CT Ntrl.IL2	Current Fundamental Magnitude during Post phase: phase L2	0.00 - 40.00In	0.0In	[Service /Test (Prot inhibit) /Sgen /Configuration /PostFault /CT Ntrl]
 CT Ntrl.IL3	Current Fundamental Magnitude during Post phase: phase L3	0.00 - 40.00In	0.0In	[Service /Test (Prot inhibit) /Sgen /Configuration /PostFault /CT Ntrl]





<i>Parameter</i>	<i>Description</i>	<i>Setting range</i>	<i>Default</i>	<i>Menu path</i>
 CT Ntrl.IG meas	Current Fundamental Magnitude during Post phase: IG	0.00 - 25.00In	0.0In	[Service /Test (Prot inhibit) /Sgen /Configuration /PostFault /CT Ntrl]
 CT Ntrl.phi IL1	Start Position respectively Start Angle of the Current Phasor during Post phase: phase L1	-360 - 360°	0°	[Service /Test (Prot inhibit) /Sgen /Configuration /PostFault /CT Ntrl]
 CT Ntrl.phi IL2	Start Position respectively Start Angle of the Current Phasor during Post phase: phase L2	-360 - 360°	240°	[Service /Test (Prot inhibit) /Sgen /Configuration /PostFault /CT Ntrl]
 CT Ntrl.phi IL3	Start Position respectively Start Angle of the Current Phasor during Post phase: phase L3	-360 - 360°	120°	[Service /Test (Prot inhibit) /Sgen /Configuration /PostFault /CT Ntrl]
 CT Ntrl.phi IG meas	Start Position respectively Start Angle of the Current Phasor during Post phase: IG	-360 - 360°	0°	[Service /Test (Prot inhibit) /Sgen /Configuration /PostFault /CT Ntrl]

<i>Parameter</i>	<i>Description</i>	<i>Setting range</i>	<i>Default</i>	<i>Menu path</i>
CT Mains.IL1 	Current Fundamental Magnitude in Pre State: phase L1	0.00 - 40.00In	0.0In	[Service /Test (Prot inhibit) /Sgen /Configuration /PreFault /CT Mains]
CT Mains.IL2 	Current Fundamental Magnitude in Pre State: phase L2	0.00 - 40.00In	0.0In	[Service /Test (Prot inhibit) /Sgen /Configuration /PreFault /CT Mains]
CT Mains.IL3 	Current Fundamental Magnitude in Pre State: phase L3	0.00 - 40.00In	0.0In	[Service /Test (Prot inhibit) /Sgen /Configuration /PreFault /CT Mains]
CT Mains.IG meas 	Current Fundamental Magnitude in Pre State: IG	0.00 - 25.00In	0.0In	[Service /Test (Prot inhibit) /Sgen /Configuration /PreFault /CT Mains]
CT Mains.phi IL1 	Start Position respectively Start Angle of the Current Phasor during Pre-Phase:phase L1	-360 - 360°	0°	[Service /Test (Prot inhibit) /Sgen /Configuration /PreFault /CT Mains]

Parameter	Description	Setting range	Default	Menu path
CT Mains.phi IL2 	Start Position respectively Start Angle of the Current Phasor during Pre-Phase:phase L2	-360 - 360°	240°	[Service /Test (Prot inhibit) /Sgen /Configuration /PreFault /CT Mains]
CT Mains.phi IL3 	Start Position respectively Start Angle of the Current Phasor during Pre-Phase:phase L3	-360 - 360°	120°	[Service /Test (Prot inhibit) /Sgen /Configuration /PreFault /CT Mains]
CT Mains.phi IG meas 	Start Position respectively Start Angle of the Current Phasor during Pre-Phase: IG	-360 - 360°	0°	[Service /Test (Prot inhibit) /Sgen /Configuration /PreFault /CT Mains]
CT Mains.IL1 	Current Fundamental Magnitude in Fault State: phase L1	0.00 - 40.00In	0.0In	[Service /Test (Prot inhibit) /Sgen /Configuration / FaultSimulation /CT Mains]
CT Mains.IL2 	Current Fundamental Magnitude in Fault State: phase L2	0.00 - 40.00In	0.0In	[Service /Test (Prot inhibit) /Sgen /Configuration / FaultSimulation /CT Mains]

Parameter	Description	Setting range	Default	Menu path
 CT Mains.IL3	Current Fundamental Magnitude in Fault State: phase L3	0.00 - 40.00In	0.0In	[Service /Test (Prot inhibit) /Sgen /Configuration / FaultSimulation /CT Mains]
 CT Mains.IG meas	Current Fundamental Magnitude in Fault State: IG	0.00 - 25.00In	0.0In	[Service /Test (Prot inhibit) /Sgen /Configuration / FaultSimulation /CT Mains]
 CT Mains.phi IL1	Start Position respectively Start Angle of the Current Phasor during Fault-Phase:phase L1	-360 - 360°	0°	[Service /Test (Prot inhibit) /Sgen /Configuration / FaultSimulation /CT Mains]
 CT Mains.phi IL2	Start Position respectively Start Angle of the Current Phasor during Fault-Phase:phase L2	-360 - 360°	240°	[Service /Test (Prot inhibit) /Sgen /Configuration / FaultSimulation /CT Mains]
 CT Mains.phi IL3	Start Position respectively Start Angle of the Current Phasor during Fault-Phase:phase L3	-360 - 360°	120°	[Service /Test (Prot inhibit) /Sgen /Configuration / FaultSimulation /CT Mains]

Parameter	Description	Setting range	Default	Menu path
CT Mains.phi IG meas 	Start Position respectively Start Angle of the Current Phasor during Fault-Phase: IG	-360 - 360°	0°	[Service /Test (Prot inhibit) /Sgen /Configuration / FaultSimulation /CT Mains]
CT Mains.IL1 	Current Fundamental Magnitude during Post phase: phase L1	0.00 - 40.00In	0.0In	[Service /Test (Prot inhibit) /Sgen /Configuration /PostFault /CT Mains]
CT Mains.IL2 	Current Fundamental Magnitude during Post phase: phase L2	0.00 - 40.00In	0.0In	[Service /Test (Prot inhibit) /Sgen /Configuration /PostFault /CT Mains]
CT Mains.IL3 	Current Fundamental Magnitude during Post phase: phase L3	0.00 - 40.00In	0.0In	[Service /Test (Prot inhibit) /Sgen /Configuration /PostFault /CT Mains]
CT Mains.IG meas 	Current Fundamental Magnitude during Post phase: IG	0.00 - 25.00In	0.0In	[Service /Test (Prot inhibit) /Sgen /Configuration /PostFault /CT Mains]

<i>Parameter</i>	<i>Description</i>	<i>Setting range</i>	<i>Default</i>	<i>Menu path</i>
CT Mains.phi IL1 	Start Position respectively Start Angle of the Current Phasor during Post phase: phase L1	-360 - 360°	0°	[Service /Test (Prot inhibit) /Sgen /Configuration /PostFault /CT Mains]
CT Mains.phi IL2 	Start Position respectively Start Angle of the Current Phasor during Post phase: phase L2	-360 - 360°	240°	[Service /Test (Prot inhibit) /Sgen /Configuration /PostFault /CT Mains]
CT Mains.phi IL3 	Start Position respectively Start Angle of the Current Phasor during Post phase: phase L3	-360 - 360°	120°	[Service /Test (Prot inhibit) /Sgen /Configuration /PostFault /CT Mains]
CT Mains.phi IG meas 	Start Position respectively Start Angle of the Current Phasor during Post phase: IG	-360 - 360°	0°	[Service /Test (Prot inhibit) /Sgen /Configuration /PostFault /CT Mains]

States of the Inputs of the Failure Simulator



<i>Name</i>	<i>Description</i>	<i>Assignment via</i>
Ex Start Simulation-I	State of the module input: External Start of Fault Simulation (Using the test parameters)	[Service /Test (Prot inhibit) /Sgen /Process]
ExBlo1-I	Module input state: External blocking1	[Service /Test (Prot inhibit) /Sgen /Process]

Name	Description	Assignment via
ExBlo2-I	Module input state: External blocking2	[Service /Test (Prot inhibit) /Sgen /Process]
Ex ForcePost-I	State of the module input:Force Post state. Abort simulation.	[Service /Test (Prot inhibit) /Sgen /Process]

Signals of the Failure Simulator (States of the Outputs)

Signal	Description
Manual Start	Fault Simulation has been started manually.
Manual Stop	Fault Simulation has been stopped manually.
Running	Signal; Measuring value simulation is running
Started	Fault Simulation has been started
Stopped	Fault Simulation has been stopped
State	Signal: Wave generation states: 0=Off, 1=PreFault, 2=Fault, 3=PostFault, 4=InitReset

Direct Commands of the Failure Simulator

Parameter	Description	Setting range	Default	Menu path
 Start Simulation	Start Fault Simulation (Using the test parameters)	inactive, active	inactive	[Service /Test (Prot inhibit) /Sgen /Process]
 Stop Simulation	Stopp Fault Simulation (Using the test parameters)	inactive, active	inactive	[Service /Test (Prot inhibit) /Sgen /Process]

Failure Simulator Values

<i>Value</i>	<i>Description</i>	<i>Default</i>	<i>Size</i>	<i>Menu path</i>
State	Wave generation states: 0=Off, 1=PreFault, 2=Fault, 3=PostFault, 4=InitReset	Off	Off, PreFault, FaultSimulation, PostFault, Init Res	[Service /Test (Prot inhibit) /Sgen /State]

Technical Data

NOTICE

Use Copper conductors only, 75°C.
Conductor size AWG 14 [2.5 mm²].

Climatic Environmental Conditions

Storage Temperature:	Operating Temperature:
-30°C up to +70°C (-22°F to 158°F)	-20°C up to +60°C (-4°F to 140°F)

Permissible Humidity at Ann. Average: <75% rel. (on 56d up to 95% rel.)
 Permissible Installation Altitude: <2000 m (6561.67 ft) above sea level
 If 4000 m (13123.35 ft) altitude apply a changed classification of the operating and test voltages may be necessary.

Degree of Protection EN 60529

HMI front panel with seal	IP54
HMI front panel without seal	IP50
Rear side terminals	IP20

Routine Test

Insulation test acc. to IEC60255-5: All tests to be carried out against earth and other input- and output circuits
 Aux. voltage supply, digital inputs, 2.5 kV (eff) / 50 Hz
 current measuring inputs, signal relay outputs:
 Voltage measuring inputs: 3.0 kV (eff) / 50 Hz
 All wire-bound communication interfaces: 1.5 kV DC

Housing

Housing B2: height/-width (7 Pushbottoms/Door Mounting)	173 mm (6.811")/ 212.7 mm (8.374")
Housing B2: height/-width (8 Pushbottoms/Door Mounting)	183 mm (7.205")/ 212.7 mm (8.374")
Housing B2: height/-width (7 and 8 Pushbottoms/19")	173 mm (6.811" / 4U)/ 212.7 mm (8.374" / 42 HP)
Housing depth (incl. terminals):	208 mm (8.189")
Material, housing:	Aluminum extruded section
Material, front panel:	Aluminum/Foil front
Mounting position:	Horizontal ($\pm 45^\circ$ around the X-axis are allowed)
Weight:	approx. 4.7 kg (10.36 lb)

Current and Earth Current Measurement

Plug-in Connectors with Integrated Short-Circuiter

(Conventional Current Inputs)

Nominal currents:	1 A / 5 A	
Max. measuring range:	up to 40 x I _n (phase currents) up to 25 x I _n (earth current standard)	up to 2.5 x I _n (earth current sensitive) ¹⁾
Continuous loading capacity:	Phase current/Earth current 4 x I _n /continuously	Earth current sensitive ¹⁾ 2 x I _n /continuously
Overcurrent proof:	Phase current/Earth current 30 x I _n /10 s 100 x I _n /1 s 250 x I _n /10 ms (1 half-wave)	Earth current sensitive ¹⁾ 10 x I _n /10 s 25 x I _n /1 s 100 x I _n /10 ms (1 half-wave)
Power consumption:	Phase current inputs: at I _n = 1 A S = 25 mVA at I _n = 5 A S = 90 mVA Earth current input: at I _n = 1 A S = 25 mVA at I _n = 5 A S = 90 mVA	Sensitive earth ¹⁾ current input: at 0,1 A (1A) S = 7 mVA (550 mVA) at 0,5 A (5A) S = 10 mVA (870 mVA)
Frequency range:	50 Hz / 60 Hz ±10%	
Terminals:	Screw-type terminals with integrated short-circuiters (contacts)	
Screws:	M4, captive type acc. to VDEW	
Connection Cross Sections:	1 x or 2 x 2.5 mm ² (2 x AWG 14) with wire end ferrule 1 x or 2 x 4.0 mm ² (2 x AWG 12) with ring cable sleeve or cable sleeve 1 x or 2 x 6 mm ² (2 x AWG 10) with ring cable sleeve or cable sleeve Only The current measuring board's terminal blocks may be used as with 2 (double) conductors AWG 10,12,14 otherwise with single conductors only.	

¹⁾ only in completion with sensitive earth measuring (see ordering information)

Voltage and Residual Voltage Measurement

The following Technical Data are valid for 8-pole (large) voltage measurement terminals.

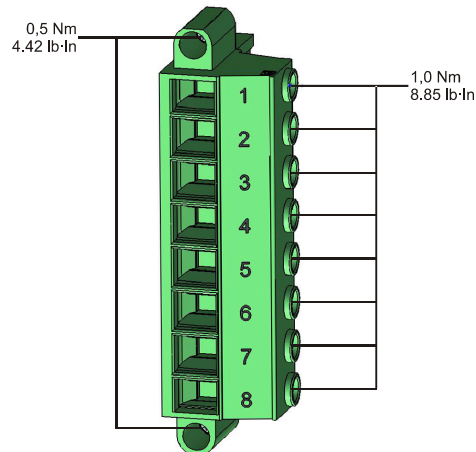

Nominal voltages: 60 - 520 V (can be configured)

Max. measuring range: 800 V AC

Continuous loading capacity: 800 V AC

Power consumption:
at $V_n = 100\text{ V}$ $S = 22\text{ mVA}$
at $V_n = 110\text{ V}$ $S = 25\text{ mVA}$
at $V_n = 230\text{ V}$ $S = 110\text{ mVA}$
at $V_n = 400\text{ V}$ $S = 330\text{ mVA}$

Frequency range: 50 Hz or 60 Hz $\pm 10\%$

Terminals: Screw-type terminals

Frequency Measurement

Nominal frequencies: 50 Hz / 60 Hz

Voltage and Residual Voltage Measurement

The following Technical Data apply to 18-pole (combined) terminals. These terminals offer in addition to the voltage measurement inputs also output relays or digital inputs.

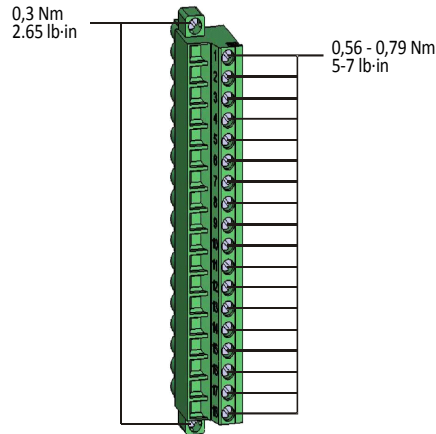

Nominal voltages:	60 - 200 V (can be configured)
Max. measuring range:	300 V AC
Continuous loading capacity:	300 V AC
Power consumption:	at $V_n = 100\text{ V}$ $S = 22\text{ mVA}$ at $V_n = 110\text{ V}$ $S = 25\text{ mVA}$
Frequency range:	50 Hz or 60 Hz $\pm 10\%$
Terminals:	Screw-type terminals

Frequency Measurement

Nominal frequencies:	50 Hz / 60 Hz
----------------------	---------------

Voltage Supply

Aux. Voltage: 24V - 270 V DC/48 - 230 V AC (-20/+10%) \approx

Buffer time in case of supply failure: \geq 50 ms at minimal aux. voltage. The device will shut down if the buffer time is expired.

Note: communication could be interrupted

Max. permissible making current: 18 A peak value for 10.25 ms
12 A peak value for 1 ms

The voltage supply must be protected by a fuse of:

- 2,5 A time-lag miniature fuse 5x20 mm (approx. 1/5" x 0.8") according to IEC 60127
- 3,5 A time-lag miniature fuse 6,3x32 mm (approx. 1/4" x 1 1/4") according to UL 248-14

Power Consumption

Power supply range:	Power consumption in idle mode	Max. power consumption
24-270 V DC:	8 W	13 W
48-230 V AC (for frequencies of 50-60 Hz):	8W / 16 VA	13 W / 21 VA

Display

Display type: LCD with LED background illumination
Resolution graphics display: 128 x 128 pixel

LED-Type: Two colored: red/green
Number of LEDs, Housing B2: 15

Front Interface USB

Type: Mini B

Analog Inputs

The following technical data only apply to devices, which are equipped with analog inputs. Please refer to the order code of your device.

The mode of each input can be individually selected between current or voltage input. Shielded cable for the analog inputs is recommended. The terminals of the HF shield should be used, when connecting the shield to earth on both sides of the cable is not possible. On one side of the cable the shield has to be directly connected to earth. In case of the use of unshielded twisted pair cables, the length must not exceed 10 m. All analog inputs have a common potential. Each input has an own common terminal.

Current mode

Range: 0-20 mA
Input resistance: 500 Ω

Voltage mode

Range: 0-10 V
Input resistance: 100 k Ω

Accuracy 0.5% of the nominal value 20 mA resp. 10 V

Influence of temperature to accuracy <1%

Test voltage of inputs (one group)
against other electrical groups 2.5 kV

Test voltage of inputs (one group)
against earth 1.0 kV

Analog Outputs

The following technical data only apply to devices, which are equipped with analog outputs. Please refer to the order code of your device.

The mode of each output can be individually selected between current or voltage output. Shielded cable for the analog outputs is recommended. The terminals of the HF shield should be used, when connecting the shield to earth on both sides of the cable is not possible. On one side of the cable the shield has to be directly connected to earth. In case of the use of unshielded twisted pair cables, the length must not exceed 10 m. All analog outputs have a common potential. Each output has an own common terminal.

Current mode

Range: 0-20 mA
Max. load resistance: 1 k Ω

Voltage mode

Range: 0-10 V maximum output current 1 mA

Accuracy: 0.5% of the nominal value 20 mA resp. 10 V

Influence of temperature to accuracy: <1%

Test voltage of outputs (one group)
against other electrical groups: 2.5 kV

Test voltage of outputs (one group)
against earth: 1.0 kV

Real Time Clock

Running reserve of the real time clock: 1 year min.

Digital Inputs

Max. input voltage: 300 V DC/259 V AC
 Input current: DC <4 mA
 AC <16 mA

Reaction time: <20 ms

Fallback Time:
 Shorted inputs <30 ms
 Open inputs <90 ms

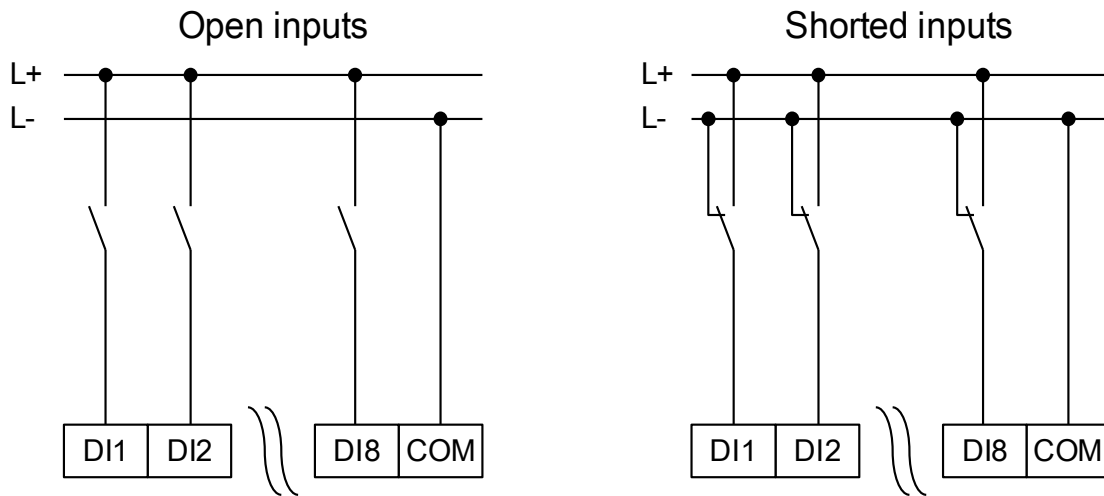

(Safe state of the digital inputs)

4 Switching thresholds: $U_n = 24 \text{ V DC}, 48 \text{ V DC}, 60 \text{ V DC}, 110 \text{ V AC/DC}, 230 \text{ V AC/DC}$

$U_n = 24 \text{ V DC}$:
 Switching threshold 1 ON: min. 19.2 V DC
 Switching threshold 1 OFF: max. 9.6 V DC

$U_n = 48 \text{ V}/60 \text{ V DC}$:
 Switching threshold 2 ON: Min. 42.6 V DC
 Switching threshold 2 OFF: max. 21.3 V DC

$U_n = 110 \text{ V AC/DC}$:
 Switching threshold 3 ON: min. 88.0 V DC/88.0 V AC
 Switching threshold 3 OFF: max. 44.0 V DC/44.0 V AC

$U_n = 230 \text{ V AC/DC}$:
 Switching threshold 4 ON: min. 184 V DC/184 V AC
 Switching threshold 4 OFF: max. 92 V DC/92 V AC

Terminals: Screw-type terminals

Binary Output Relays

Continuous current:	5 A AC/DC
Max. Switch-on current:	25 A AC/DC for 4 s 48W (VA) at L/R = 40ms 30 A / 230 Vac according to ANSI IEEE Std C37.90-2005 30 A / 250 Vdc according to ANSI IEEE Std C37.90-2005
Max. breaking current:	5 A AC up to 240 V AC 4 A AC at 230V and $\cos \phi = 0,4$ 5 A DC up to 30 V (resistive) 0.3 A DC at 250 V (resistive) 0,1 A DC at 220 V and L/R = 40ms
Max. switching voltage:	250 V AC/250 V DC
Switching capacity:	3000 VA
Operating time: (*)	typ. 7 ms
Reset time: (*)	typ. 3 ms
Contact type:	1 changeover contact or normally open or normally closed
Terminals:	Screw-type terminals

(*) The operating and reset times are the pure hardware-related switching times (coil – making/breaking contact), i. e. without the time that it takes the software to calculate the decisions.

Supervision Contact (SC)

Continuous current::	5 A AC/DC
Max. Switch-on current:	15 A AC/DC for 4 s
Max. breaking current:	5 A AC up to 250 V AC 5 A DC up to 30 V (resistive) 0.25 A DC at 250 V (resistive)
Max. switching voltage:	250 V AC/250 V DC
Switching capacity:	1250 VA
Contact type:	1 changeover contact
Terminals:	Screw-type terminals

Time Synchronization IRIG

Nominal input voltage: 5 V
Connection: Screw-type terminals (twisted pair)

RS485*

Connection: 9-pole D-Sub socket
(external terminating resistors/in D-Sub)
or 6 screw-clamping terminals RM 3.5 mm (138 MIL)
(terminating resistors internal)

*availability depends on device

CAUTION

In case that the RS485 interface is realised via terminals, the communication cable has to be shielded.

Fiber Optic Module with ST connector*

Connector: ST Port
Compatible Fiber: 50/125 µm, 62,5/125 µm, 100/140 µm and 200 µm HCS
Wavelength: 820 nm
Minimum Optical Input Power: -24,0 dBm
Minimum Optical Output Power: -19,8 dBm with 50/125 µm fiber
-16,0 dBm with 62,5/125 µm fiber
-12,5 dBm with 100/145 µm fiber
-8,5 dBm with 200 µm HCS fiber
Maximum Link Length: approx. 2.7 km (depending on link attenuation)

*availability depends on device

Please note: The transmission speed of the optical interfaces is limited to 3 MBaud for Profibus.

Fiber Optic Module with LC Connector for Long-distance Protection Communication**

Connector: LC Port
Compatible Fiber: 9 µm single mode
Wavelength: 1310 nm
Minimum Optical Input Power: -31.0 dBm
Minimum Optical Output Power: -15.0 dBm
Maximum Link Length: approx. 20 km (depending on link attenuation)

** only for Line Differential Protection (MCDLV4)

Optical Ethernet Module with LC connector*

Connector:	LC-Port
Compatible Fiber:	50/125 µm and 62,5/125 µm
Wavelength:	1300 nm
Minimum Optical Input Power:	-30,0 dBm
Minimum Optical Output Power:	-22.5 dBm with 50/125 µm fiber -19,0 dBm with 62,5/125 µm fiber
Maximum Link Length:	approx. 2 km (depending on link attenuation)
*availability depends on device	

URTD-Interface*

Connector:	Versatile Link
Compatible Fiber:	1 mm
Wavelength:	660 nm
Minimum Optical Input Power:	-39,0 dBm
*availability depends on device	

Boot phase

After switching on the power supply the protection will be available in approximately 10 seconds.

After approximately 79 seconds (depending on the configuration) the boot phase is completed (HMI and Communication initialized).

Servicing and Maintenance

Within the scope of servicing and maintenance following checks of the unit hardware have to be conducted:

<i>Component</i>	<i>Step</i>	<i>Interval/How often?</i>
Output Relays	Please check the Output Relays via Test menu Force/Disarm (please see chapter Service)	Every 1–4 years, depending on ambient conditions.
Digital Inputs	Please supply a voltage to the Digital Inputs and control if the appropriate status signal appears.	Every 1–4 years, depending on ambient conditions.
Current plugs and Current measurements	Please supply testing current to the Current measurement inputs and control the displayed measure values from the unit.	Every 1–4 years, depending on ambient conditions.
Voltage plugs and Voltage measurements	Please supply testing current to the Voltage measurement inputs and control the displayed measure values from the unit.	Every 1–4 years, depending on ambient conditions.
Analog Inputs	Please feed analog signals into the measurement inputs and check if the displayed measure values match.	Every 1–4 years, depending on ambient conditions.
Analog Outputs	Please check the Analog Outputs via Test menu Force/Disarm (please see chapter Service)	Every 1–4 years, depending on ambient conditions.
Battery	The device checks the battery as part of its Self-Supervision, therefore no dedicated testing activities are required. If the battery is low, the System LED flashes red/green, and an error code is generated (see <i>Troubleshooting Guide</i>).	In general the battery lasts more than 10 years. Exchange by manufacturer. Notice: The battery serves as buffering of the clock (real time clock). There's no impact on the functionality of the device if the battery breaks down, except for the buffering of the clock while the unit is in de-energized condition.
Self-monitoring contact	Switch of the auxiliary supply of the unit. The Self-monitoring contact has to dropout now. Please switch on the auxiliary supply again.	Every 1–4 years, depending on ambient conditions.
Mechanical mounting of the unit of the cabinet door	Check the torque related to the specification of the Installation chapter.	With each maintenance or yearly.
Torque of all cable connections	Check the torque related to the specification of the Installation chapter which describes the hardware modules.	With each maintenance or yearly.

We recommend to execute an protection test after each 4 years period. This period can be extended to 6 years if a function test is executed at least every 3 years.

Standards

Approvals

- UL- File No.: E217753
- CSA File No.: 251990**
- CEI 0-16* (Tested by EuroTest Laboratori S.r.l, Italy)*
- BDEW Certified (FGW TR3/ FGW TR8/ Q-U-Schutz)**
- KEMA***
- EAC

* = applies to MRU4

** = applies to MCA4

*** = applies to (MRDT4, MCA4, MRA4, MRI4, MRU4)

Design Standards

Generic standard

EN 61000-6-2 , 2005
EN 61000-6-3 , 2006

Product standard

IEC 60255-1; 2009
IEC 60255-27, 2013
EN 50178, 1998
UL 508 (Industrial Control Equipment), 2005
CSA C22.2 No. 14-95 (Industrial Control Equipment), 1995
ANSI C37.90, 2005

High Voltage Tests

High frequency interference test

IEC 60255-22-1	Within one circuit	1 kV , 2 s
IEEE C37.90.1		
IEC 61000-4-18	Circuit to earth	2.5 kV , 2 s
class 3	Circuit to circuit	2.5 kV , 2 s

Insulation voltage test

IEC 60255-27 (10.5.3.2)	All circuits to other circuits and exposed conductive parts	2.5 kV (eff.)/50Hz , 1 min.
IEC 60255-5	Except interfaces	1,5 kV DC , 1 min.
EN 50178	and Voltage measuring input	3 kV (eff.)/50 Hz , 1 min.

Impulse voltage test

IEC 60255-27 (10.5.3.1)		5 kV/0.5J, 1.2/50 μ s
IEC 60255-5		

Insulation resistance test

IEC 60255-27 (10.5.3.3)	Within one circuit	500V DC , 5s
EN 50178	Circuit to circuit	500V DC , 5s

EMC Immunity Tests

Fast transient disturbance immunity test (Burst)

IEC 60255-22-4	Power supply, mains inputs	±4 kV, 2.5 kHz
IEC 61000-4-4 class 4	Other in- and outputs	±2 kV, 5 kHz

Surge immunity test (Surge)

IEC 60255-22-5	Within one circuit	2 kV
IEC 61000-4-5 class 4	Circuit to earth	4 kV
class 3	Communication cables to earth	2 kV

Electrical discharge immunity test (ESD)

IEC 60255-22-2	Air discharge	8 kV
IEC 61000-4-2 class 3	Contact discharge	6 kV

Radiated radio-frequency electromagnetic field immunity test

IEC 60255-22-3	26 MHz – 80 MHz	10 V/m
IEC 61000-4-3	80 MHz – 1 GHz	35 V/m
	1 GHz – 3 GHz	10 V/m

Immunity to conducted disturbances induced by radio frequency fields

IEC 61000-4-6 class 3	150kHz - 80MHz	10 V
--------------------------	----------------	------

Power frequency magnetic field immunity test

IEC 61000-4-8 class 4	continues 3 sec	30 A/m 300 A/m
--------------------------	--------------------	-------------------

EMC Emission Tests

Radio interference suppression test

IEC/CISPR22 150kHz - 30MHz
IEC60255-26
DIN EN 55022

Limit value class B

Radio interference radiation test

IEC/CISPR22 30MHz - 1GHz
IEC60255-25
DIN EN 55022

Limit value class B

Environmental Tests

<i>Classification:</i> IEC 60068-1	Climatic classification	20/060/56
IEC 60721-3-1	Classification of ambient conditions (Storage)	1K5/1B1/1C1L/1S1/1M2 but min. -30°C
IEC 60721-3-2	Classification of ambient conditions (Transportation)	2K2/2B1/2C1/2S1/2M2 but min. -30°C
IEC 60721-3-3	Classification of ambient conditions (Stationary use at weather protected locations)	3K6/3B1/3C1/3S1/3M2 but min. -20°C/max +60°C
<i>Test Ad: Cold</i> IEC 60068-2-1	Temperature test duration	-20°C 16 h
<i>Test Bd: Dry Heat</i> IEC 60068-2-2	Temperature Relative humidity test duration	60°C <50% 72 h
<i>Test Db: Damp Heat (cyclic)</i> IEC 60068-2-30	Temperature Relative humidity Cycles (12 + 12-hour)	60°C 95% 2

Environmental Tests

Test Cab: Damp Heat (permanent)

IEC 60255 (6.12.3.6)	Temperature	60°C
IEC 60068-2-78	Relative humidity	95%
	test duration	56 days

Test Nb: Temperature Change

IEC 60255 (6.12.3.5)	Temperature	60°C/-20°C
IEC 60068-2-14	cycle	5
	test duration	1°C/5min

Test BD: Dry Heat Transport and storage test

IEC 60255 (6.12.3.3)	Temperature	70°C
IEC 60068-2-2	test duration	16 h

Test AB: Cold Transport and storage test

IEC 60255-1 (6.12.3.4)	Temperature	-30°C
IEC 60068-2-1	test duration	16 h

Mechanical Tests

Test Fc: Vibration response test

IEC 60068-2-6	(10 Hz – 59 Hz)	0.035 mm
IEC 60255-21-1	Displacement	
class 1	(59Hz – 150Hz)	0,5 gn
	Acceleration	
	Number of cycles in each axis	1

Test Fc: Vibration endurance test

IEC 60068-2-6	(10 Hz – 150 Hz)	1.0 gn
IEC 60255-21-1	Acceleration	
class 1	Number of cycles in each axis	20

Test Ea: Shock tests

IEC 60068-2-27	Shock response test	5 gn, 11 ms, 3 impulses in each direction
IEC 60255-21-2		
class 1	Shock resistance test	15 gn, 11 ms, 3 impulses in each direction

Test Eb: Shockendurance test

IEC 60068-2-29	Shock endurance test	10 gn, 16 ms, 1000 impulses in each direction
IEC 60255-21-2		
class 1		

Test Fe: Earthquake test

IEC 60068-3-3	Single axis earthquake vibration test	1 – 9 Hz horizontal: 7.5 mm,
IEC 60255-21-3		1 – 9 Hz vertical :3.5 mm,
		1 sweep per axis
class 2		9 – 35 Hz horizontal: 2 gn,
		9 – 35 Hz vertical : 1 gn,
		1 sweep per axis

General Lists

Assignment List

The »ASSIGNMENT LIST« [below](#) summarizes all module outputs (signals) and inputs (e.g. states of the assignments).

<i>Name</i>	<i>Description</i>
.-.	No assignment
Prot.available	Signal: Protection is available
Prot.active	Signal: active
Prot.ExBlo	Signal: External Blocking
Prot.Blo TripCmd	Signal: Trip Command blocked
Prot.ExBlo TripCmd	Signal: External Blocking of the Trip Command
Prot.Alarm L1	Signal: General-Alarm L1
Prot.Alarm L2	Signal: General-Alarm L2
Prot.Alarm L3	Signal: General-Alarm L3
Prot.Alarm G	Signal: General-Alarm - Earth fault
Prot.Alarm	Signal: General Alarm
Prot.Trip L1	Signal: General Trip L1
Prot.Trip L2	Signal: General Trip L2
Prot.Trip L3	Signal: General Trip L3
Prot.Trip G	Signal: General Trip Ground fault
Prot.Trip	Signal: General Trip
Prot.Res FaultNo a GridFaultNo	Signal: Resetting of fault number and grid fault number.
Prot.I dir fwd	Signal: Phase current failure forward direction
Prot.I dir rev	Signal: Phase current failure reverse direction
Prot.I dir n poss	Signal: Phase fault - missing reference voltage
Prot.IG calc dir fwd	Signal: Ground fault (calculated) forward
Prot.IG calc dir rev	Signal: Ground fault (calculated) reverse direction
Prot.IG calc dir n poss	Signal: Ground fault (calculated) direction detection not possible
Prot.IG meas dir fwd	Signal: Ground fault (measured) forward
Prot.IG meas dir rev	Signal: Ground fault (measured) reverse direction
Prot.IG meas dir n poss	Signal: Ground fault (measured) direction detection not possible
Prot.f(VL123)<10Hz	Frequency of the measuring channels 1-3 (VL1,VL2,VL3) is lower than 10Hz.
Prot.f(VL123)>10Hz	Frequency of the measuring channels 1-3 (VL1,VL2,VL3) is greater than 10Hz.
Prot.f(VL123)<70Hz	Frequency of the measuring channels 1-3 (VL1,VL2,VL3) is lower than 70Hz.
Prot.f(VL123)>70Hz	Frequency of the measuring channels 1-3 (VL1,VL2,VL3) is greater than 70Hz.
Prot.DFT Invalid	DFT values of fundamental and harmonics (except VX) are not valid. They depend on period time of frequency and measured channels 1-3 (VL1,VL2,VL3).
Prot.DFT Valid	DFT values of fundamental and harmonics (except VX) are valid. They depend on period time of frequency and measured channels 1-3 (VL1,VL2,VL3).

Name	Description
Prot.f(VX)<10Hz	Frequency of the measuring channel 4 (VX) is lower than 10Hz.
Prot.f(VX)>10Hz	Frequency of the measuring channel 4 (VX) is greater than 10Hz.
Prot.f(VX)<70Hz	Frequency of the measuring channel 4 (VX) is lower than 70Hz.
Prot.f(VX)>70Hz	Frequency of the measuring channel 4 (VX) is greater than 70Hz.
Prot.DFT Invalid (VX)	DFT values of fundamental and harmonics of VX (only) are not valid.
Prot.DFT Valid (VX)	DFT values of fundamental and harmonics of VX (only) are valid.
Prot.ExBlo1-I	Module input state: External blocking1
Prot.ExBlo2-I	Module input state: External blocking2
Prot.ExBlo TripCmd-I	Module input state: External Blocking of the Trip Command
VT.Phase seq. wrong	Signal that the device has detected a phase sequence (L1-L2-L3 / L1-L3-L2) that is different from the one that had been set at [Field settings / General Settings] »Phase Sequence«.
CT Ntrl.Phase seq. wrong	Signal that the device has detected a phase sequence (L1-L2-L3 / L1-L3-L2) that is different from the one that had been set at [Field settings / General Settings] »Phase Sequence«.
CT Mains.Phase seq. wrong	Signal that the device has detected a phase sequence (L1-L2-L3 / L1-L3-L2) that is different from the one that had been set at [Field settings / General Settings] »Phase Sequence«.
Generator.Running hours Alarm	Running hours Alarm
Generator.Res Running hours	Reset Running hours
Ctrl.Local	Switching Authority: Local
Ctrl.Remote	Switching Authority: Remote
Ctrl.NonInterl	Non-Interlocking is active
Ctrl.SG Indeterm	Minimum one Switchgear is moving (Position cannot be determined).
Ctrl.SG Disturb	Minimum one Switchgear is disturbed.
Ctrl.NonInterl-I	Non-Interlocking
SG[1].SI SingleContactInd	Signal: The Position of the Switchgear is detected by one auxiliary contact (pole) only. Thus indeterminate and disturbed Positions cannot be detected.
SG[1].Pos not ON	Signal: Pos not ON
SG[1].Pos ON	Signal: Circuit Breaker is in ON-Position
SG[1].Pos OFF	Signal: Circuit Breaker is in OFF-Position
SG[1].Pos Indeterm	Signal: Circuit Breaker is in Indeterminate Position
SG[1].Pos Disturb	Signal: Circuit Breaker Disturbed - Undefined Breaker Position. The Position Indicators contradict themselves. After expiring of a supervision timer this signal becomes true.
SG[1].Ready	Signal: Circuit breaker is ready for operation.
SG[1].t-Dwell	Signal: Dwell time
SG[1].Removed	Signal: The withdrawable circuit breaker is Removed
SG[1].Interl ON	Signal: One or more IL_On inputs are active.
SG[1].Interl OFF	Signal: One or more IL_Off inputs are active.
SG[1].CES succesf	Signal: Command Execution Supervision: Switching command executed successfully.

General Lists

<i>Name</i>	<i>Description</i>
SG[1].CES Disturbed	Signal: Command Execution Supervision: Switching Command unsuccessful. Switchgear in disturbed position.
SG[1].CES Fail TripCmd	Signal: Command Execution Supervision: Command execution failed because trip command is pending.
SG[1].CES SwitchDir	Signal: Command Execution Supervision respectively Switching Direction Control: This signal becomes true, if a switch command is issued even though the switchgear is already in the requested position. Example: A switchgear that is already OFF should be switched OFF again (doubly). The same applies to CLOSE commands.
SG[1].CES ON d OFF	Signal: Command Execution Supervision: On Command during a pending OFF Command.
SG[1].CES SG not ready	Signal: Command Execution Supervision: Switchgear not ready
SG[1].CES Fiel Interl	Signal: Command Execution Supervision: Switching Command not executed because of field interlocking.
SG[1].CES SyncTimeout	Signal: Command Execution Supervision: Switching Command not executed. No Synchronization signal while t-sync was running.
SG[1].CES SG removed	Signal: Command Execution Supervision: Switching Command unsuccessful, Switchgear removed.
SG[1].Prot ON	Signal: ON Command issued by the Prot module
SG[1].TripCmd	Signal: Trip Command
SG[1].Ack TripCmd	Signal: Acknowledge Trip Command
SG[1].ON incl Prot ON	Signal: The ON Command includes the ON Command issued by the Protection module.
SG[1].OFF incl TripCmd	Signal: The OFF Command includes the OFF Command issued by the Protection module.
SG[1].Position Ind manipul	Signal: Position Indicators faked
SG[1].SGwear Slow SG	Signal: Alarm, the circuit breaker (load-break switch) becomes slower
SG[1].Res SGwear Sl SG	Signal: Resetting the slow Switchgear Alarm
SG[1].ON Cmd	Signal: ON Command issued to the switchgear. Depending on the setting the signal may include the ON command of the Prot module.
SG[1].OFF Cmd	Signal: OFF Command issued to the switchgear. Depending on the setting the signal may include the OFF command of the Prot module.
SG[1].ON Cmd manual	Signal: ON Cmd manual
SG[1].OFF Cmd manual	Signal: OFF Cmd manual
SG[1].Sync ON request	Signal: Synchronous ON request
SG[1].Aux ON-I	Module Input State: Position indicator/check-back signal of the CB (52a)
SG[1].Aux OFF-I	Module input state: Position indicator/check-back signal of the CB (52b)
SG[1].Ready-I	Module input state: CB ready
SG[1].Sys-in-Sync-I	State of the module input: This signals has to become true within the synchronization time. If not, switching is unsuccessful.
SG[1].Removed-I	State of the module input: The withdrawable circuit breaker is Removed
SG[1].Ack TripCmd-I	State of the module input: Acknowledgement Signal (only for automatic acknowledgement) Module input signal
SG[1].Interl ON1-I	State of the module input: Interlocking of the ON command
SG[1].Interl ON2-I	State of the module input: Interlocking of the ON command

General Lists

<i>Name</i>	<i>Description</i>
SG[1].Interl ON3-I	State of the module input: Interlocking of the ON command
SG[1].Interl OFF1-I	State of the module input: Interlocking of the OFF command
SG[1].Interl OFF2-I	State of the module input: Interlocking of the OFF command
SG[1].Interl OFF3-I	State of the module input: Interlocking of the OFF command
SG[1].SCmd ON-I	State of the module input: Switching ON Command, e.g. the state of the Logics or the state of the digital input
SG[1].SCmd OFF-I	State of the module input: Switching OFF Command, e.g. the state of the Logics or the state of the digital input
SG[1].Operations Alarm	Signal: Service Alarm, too many Operations
SG[1].Isum Intr trip: IL1	Signal: Maximum permissible Summation of the interrupting (tripping) currents exceeded: IL1
SG[1].Isum Intr trip: IL2	Signal: Maximum permissible Summation of the interrupting (tripping) currents exceeded: IL2
SG[1].Isum Intr trip: IL3	Signal: Maximum permissible Summation of the interrupting (tripping) currents exceeded: IL3
SG[1].Isum Intr trip	Signal: Maximum permissible Summation of the interrupting (tripping) currents exceeded in at least one phase.
SG[1].Res TripCmd Cr	Signal: Resetting of the Counter: total number of trip commands
SG[1].Res Sum trip	Signal: Reset summation of the tripping currents
SG[1].WearLevel Alarm	Signal: Threshold for the Alarm
SG[1].WearLevel Lockout	Signal: Threshold for the Lockout Level
SG[1].Res CB OPEN capacity	Signal: Reset of the wear maintenance curve (i. e. of the counter for the Circuit Breaker OPEN capacity).
SG[1].Isum Intr ph Alm	Signal: Alarm, the per hour Sum (Limit) of interrupting currents has been exceeded.
SG[1].Res Isum Intr ph Alm	Signal: Reset of the Alarm, "the per hour Sum (Limit) of interrupting currents has been exceeded".
SG[2].SI SingleContactInd	Signal: The Position of the Switchgear is detected by one auxiliary contact (pole) only. Thus indeterminate and disturbed Positions cannot be detected.
SG[2].Pos not ON	Signal: Pos not ON
SG[2].Pos ON	Signal: Circuit Breaker is in ON-Position
SG[2].Pos OFF	Signal: Circuit Breaker is in OFF-Position
SG[2].Pos Indeterm	Signal: Circuit Breaker is in Indeterminate Position
SG[2].Pos Disturb	Signal: Circuit Breaker Disturbed - Undefined Breaker Position. The Position Indicators contradict themselves. After expiring of a supervision timer this signal becomes true.
SG[2].Ready	Signal: Circuit breaker is ready for operation.
SG[2].t-Dwell	Signal: Dwell time
SG[2].Removed	Signal: The withdrawable circuit breaker is Removed
SG[2].Interl ON	Signal: One or more IL_On inputs are active.
SG[2].Interl OFF	Signal: One or more IL_Off inputs are active.
SG[2].CES succesf	Signal: Command Execution Supervision: Switching command executed successfully.
SG[2].CES Disturbed	Signal: Command Execution Supervision: Switching Command unsuccessful. Switchgear in disturbed position.

Name	Description
SG[2].CES Fail TripCmd	Signal: Command Execution Supervision: Command execution failed because trip command is pending.
SG[2].CES SwitchDir	Signal: Command Execution Supervision respectively Switching Direction Control: This signal becomes true, if a switch command is issued even though the switchgear is already in the requested position. Example: A switchgear that is already OFF should be switched OFF again (doubly). The same applies to CLOSE commands.
SG[2].CES ON d OFF	Signal: Command Execution Supervision: On Command during a pending OFF Command.
SG[2].CES SG not ready	Signal: Command Execution Supervision: Switchgear not ready
SG[2].CES Fiel Interl	Signal: Command Execution Supervision: Switching Command not executed because of field interlocking.
SG[2].CES SyncTimeout	Signal: Command Execution Supervision: Switching Command not executed. No Synchronization signal while t-sync was running.
SG[2].CES SG removed	Signal: Command Execution Supervision: Switching Command unsuccessful, Switchgear removed.
SG[2].Prot ON	Signal: ON Command issued by the Prot module
SG[2].TripCmd	Signal: Trip Command
SG[2].Ack TripCmd	Signal: Acknowledge Trip Command
SG[2].ON incl Prot ON	Signal: The ON Command includes the ON Command issued by the Protection module.
SG[2].OFF incl TripCmd	Signal: The OFF Command includes the OFF Command issued by the Protection module.
SG[2].Position Ind manipul	Signal: Position Indicators faked
SG[2].SGwear Slow SG	Signal: Alarm, the circuit breaker (load-break switch) becomes slower
SG[2].Res SGwear SI SG	Signal: Resetting the slow Switchgear Alarm
SG[2].ON Cmd	Signal: ON Command issued to the switchgear. Depending on the setting the signal may include the ON command of the Prot module.
SG[2].OFF Cmd	Signal: OFF Command issued to the switchgear. Depending on the setting the signal may include the OFF command of the Prot module.
SG[2].ON Cmd manual	Signal: ON Cmd manual
SG[2].OFF Cmd manual	Signal: OFF Cmd manual
SG[2].Sync ON request	Signal: Synchronous ON request
SG[2].Aux ON-I	Module Input State: Position indicator/check-back signal of the CB (52a)
SG[2].Aux OFF-I	Module input state: Position indicator/check-back signal of the CB (52b)
SG[2].Ready-I	Module input state: CB ready
SG[2].Sys-in-Sync-I	State of the module input: This signals has to become true within the synchronization time. If not, switching is unsuccessful.
SG[2].Removed-I	State of the module input: The withdrawable circuit breaker is Removed
SG[2].Ack TripCmd-I	State of the module input: Acknowledgement Signal (only for automatic acknowledgement) Module input signal
SG[2].Interl ON1-I	State of the module input: Interlocking of the ON command
SG[2].Interl ON2-I	State of the module input: Interlocking of the ON command
SG[2].Interl ON3-I	State of the module input: Interlocking of the ON command
SG[2].Interl OFF1-I	State of the module input: Interlocking of the OFF command

General Lists

<i>Name</i>	<i>Description</i>
SG[2].Interl OFF2-I	State of the module input: Interlocking of the OFF command
SG[2].Interl OFF3-I	State of the module input: Interlocking of the OFF command
SG[2].SCmd ON-I	State of the module input: Switching ON Command, e.g. the state of the Logics or the state of the digital input
SG[2].SCmd OFF-I	State of the module input: Switching OFF Command, e.g. the state of the Logics or the state of the digital input
SG[2].Operations Alarm	Signal: Service Alarm, too many Operations
SG[2].Isum Intr trip: IL1	Signal: Maximum permissible Summation of the interrupting (tripping) currents exceeded: IL1
SG[2].Isum Intr trip: IL2	Signal: Maximum permissible Summation of the interrupting (tripping) currents exceeded: IL2
SG[2].Isum Intr trip: IL3	Signal: Maximum permissible Summation of the interrupting (tripping) currents exceeded: IL3
SG[2].Isum Intr trip	Signal: Maximum permissible Summation of the interrupting (tripping) currents exceeded in at least one phase.
SG[2].Res TripCmd Cr	Signal: Resetting of the Counter: total number of trip commands
SG[2].Res Sum trip	Signal: Reset summation of the tripping currents
SG[2].WearLevel Alarm	Signal: Threshold for the Alarm
SG[2].WearLevel Lockout	Signal: Threshold for the Lockout Level
SG[2].Res CB OPEN capacity	Signal: Reset of the wear maintenance curve (i. e. of the counter for the Circuit Breaker OPEN capacity).
SG[2].Isum Intr ph Alm	Signal: Alarm, the per hour Sum (Limit) of interrupting currents has been exceeded.
SG[2].Res Isum Intr ph Alm	Signal: Reset of the Alarm, "the per hour Sum (Limit) of interrupting currents has been exceeded".
SG[3].SI SingleContactInd	Signal: The Position of the Switchgear is detected by one auxiliary contact (pole) only. Thus indeterminate and disturbed Positions cannot be detected.
SG[3].Pos not ON	Signal: Pos not ON
SG[3].Pos ON	Signal: Circuit Breaker is in ON-Position
SG[3].Pos OFF	Signal: Circuit Breaker is in OFF-Position
SG[3].Pos Indeterm	Signal: Circuit Breaker is in Indeterminate Position
SG[3].Pos Disturb	Signal: Circuit Breaker Disturbed - Undefined Breaker Position. The Position Indicators contradict themselves. After expiring of a supervision timer this signal becomes true.
SG[3].Ready	Signal: Circuit breaker is ready for operation.
SG[3].t-Dwell	Signal: Dwell time
SG[3].Removed	Signal: The withdrawable circuit breaker is Removed
SG[3].Interl ON	Signal: One or more IL_On inputs are active.
SG[3].Interl OFF	Signal: One or more IL_Off inputs are active.
SG[3].CES succesf	Signal: Command Execution Supervision: Switching command executed successfully.
SG[3].CES Disturbed	Signal: Command Execution Supervision: Switching Command unsuccessful. Switchgear in disturbed position.
SG[3].CES Fail TripCmd	Signal: Command Execution Supervision: Command execution failed because trip command is pending.

Name	Description
SG[3].CES SwitchDir	Signal: Command Execution Supervision respectively Switching Direction Control: This signal becomes true, if a switch command is issued even though the switchgear is already in the requested position. Example: A switchgear that is already OFF should be switched OFF again (doubly). The same applies to CLOSE commands.
SG[3].CES ON d OFF	Signal: Command Execution Supervision: On Command during a pending OFF Command.
SG[3].CES SG not ready	Signal: Command Execution Supervision: Switchgear not ready
SG[3].CES Fiel Interl	Signal: Command Execution Supervision: Switching Command not executed because of field interlocking.
SG[3].CES SyncTimeout	Signal: Command Execution Supervision: Switching Command not executed. No Synchronization signal while t-sync was running.
SG[3].CES SG removed	Signal: Command Execution Supervision: Switching Command unsuccessful, Switchgear removed.
SG[3].Prot ON	Signal: ON Command issued by the Prot module
SG[3].TripCmd	Signal: Trip Command
SG[3].Ack TripCmd	Signal: Acknowledge Trip Command
SG[3].ON incl Prot ON	Signal: The ON Command includes the ON Command issued by the Protection module.
SG[3].OFF incl TripCmd	Signal: The OFF Command includes the OFF Command issued by the Protection module.
SG[3].Position Ind manipul	Signal: Position Indicators faked
SG[3].SGwear Slow SG	Signal: Alarm, the circuit breaker (load-break switch) becomes slower
SG[3].Res SGwear SI SG	Signal: Resetting the slow Switchgear Alarm
SG[3].ON Cmd	Signal: ON Command issued to the switchgear. Depending on the setting the signal may include the ON command of the Prot module.
SG[3].OFF Cmd	Signal: OFF Command issued to the switchgear. Depending on the setting the signal may include the OFF command of the Prot module.
SG[3].ON Cmd manual	Signal: ON Cmd manual
SG[3].OFF Cmd manual	Signal: OFF Cmd manual
SG[3].Sync ON request	Signal: Synchronous ON request
SG[3].Aux ON-I	Module Input State: Position indicator/check-back signal of the CB (52a)
SG[3].Aux OFF-I	Module input state: Position indicator/check-back signal of the CB (52b)
SG[3].Ready-I	Module input state: CB ready
SG[3].Sys-in-Sync-I	State of the module input: This signals has to become true within the synchronization time. If not, switching is unsuccessful.
SG[3].Removed-I	State of the module input: The withdrawable circuit breaker is Removed
SG[3].Ack TripCmd-I	State of the module input: Acknowledgement Signal (only for automatic acknowledgement) Module input signal
SG[3].Interl ON1-I	State of the module input: Interlocking of the ON command
SG[3].Interl ON2-I	State of the module input: Interlocking of the ON command
SG[3].Interl ON3-I	State of the module input: Interlocking of the ON command
SG[3].Interl OFF1-I	State of the module input: Interlocking of the OFF command
SG[3].Interl OFF2-I	State of the module input: Interlocking of the OFF command

General Lists

<i>Name</i>	<i>Description</i>
SG[3].Interl OFF3-I	State of the module input: Interlocking of the OFF command
SG[3].SCmd ON-I	State of the module input: Switching ON Command, e.g. the state of the Logics or the state of the digital input
SG[3].SCmd OFF-I	State of the module input: Switching OFF Command, e.g. the state of the Logics or the state of the digital input
SG[3].Operations Alarm	Signal: Service Alarm, too many Operations
SG[3].Isum Intr trip: IL1	Signal: Maximum permissible Summation of the interrupting (tripping) currents exceeded: IL1
SG[3].Isum Intr trip: IL2	Signal: Maximum permissible Summation of the interrupting (tripping) currents exceeded: IL2
SG[3].Isum Intr trip: IL3	Signal: Maximum permissible Summation of the interrupting (tripping) currents exceeded: IL3
SG[3].Isum Intr trip	Signal: Maximum permissible Summation of the interrupting (tripping) currents exceeded in at least one phase.
SG[3].Res TripCmd Cr	Signal: Resetting of the Counter: total number of trip commands
SG[3].Res Sum trip	Signal: Reset summation of the tripping currents
SG[3].WearLevel Alarm	Signal: Threshold for the Alarm
SG[3].WearLevel Lockout	Signal: Threshold for the Lockout Level
SG[3].Res CB OPEN capacity	Signal: Reset of the wear maintenance curve (i. e. of the counter for the Circuit Breaker OPEN capacity.
SG[3].Isum Intr ph Alm	Signal: Alarm, the per hour Sum (Limit) of interrupting currents has been exceeded.
SG[3].Res Isum Intr ph Alm	Signal: Reset of the Alarm, "the per hour Sum (Limit) of interrupting currents has been exceeded".
SG[4].SI SingleContactInd	Signal: The Position of the Switchgear is detected by one auxiliary contact (pole) only. Thus indeterminate and disturbed Positions cannot be detected.
SG[4].Pos not ON	Signal: Pos not ON
SG[4].Pos ON	Signal: Circuit Breaker is in ON-Position
SG[4].Pos OFF	Signal: Circuit Breaker is in OFF-Position
SG[4].Pos Indeterm	Signal: Circuit Breaker is in Indeterminate Position
SG[4].Pos Disturb	Signal: Circuit Breaker Disturbed - Undefined Breaker Position. The Position Indicators contradict themselves. After expiring of a supervision timer this signal becomes true.
SG[4].Ready	Signal: Circuit breaker is ready for operation.
SG[4].t-Dwell	Signal: Dwell time
SG[4].Removed	Signal: The withdrawable circuit breaker is Removed
SG[4].Interl ON	Signal: One or more IL_On inputs are active.
SG[4].Interl OFF	Signal: One or more IL_Off inputs are active.
SG[4].CES succesf	Signal: Command Execution Supervision: Switching command executed successfully.
SG[4].CES Disturbed	Signal: Command Execution Supervision: Switching Command unsuccessful. Switchgear in disturbed position.
SG[4].CES Fail TripCmd	Signal: Command Execution Supervision: Command execution failed because trip command is pending.

Name	Description
SG[4].CES SwitchDir	Signal: Command Execution Supervision respectively Switching Direction Control: This signal becomes true, if a switch command is issued even though the switchgear is already in the requested position. Example: A switchgear that is already OFF should be switched OFF again (doubly). The same applies to CLOSE commands.
SG[4].CES ON d OFF	Signal: Command Execution Supervision: On Command during a pending OFF Command.
SG[4].CES SG not ready	Signal: Command Execution Supervision: Switchgear not ready
SG[4].CES Fiel Interl	Signal: Command Execution Supervision: Switching Command not executed because of field interlocking.
SG[4].CES SyncTimeout	Signal: Command Execution Supervision: Switching Command not executed. No Synchronization signal while t-sync was running.
SG[4].CES SG removed	Signal: Command Execution Supervision: Switching Command unsuccessful, Switchgear removed.
SG[4].Prot ON	Signal: ON Command issued by the Prot module
SG[4].TripCmd	Signal: Trip Command
SG[4].Ack TripCmd	Signal: Acknowledge Trip Command
SG[4].ON incl Prot ON	Signal: The ON Command includes the ON Command issued by the Protection module.
SG[4].OFF incl TripCmd	Signal: The OFF Command includes the OFF Command issued by the Protection module.
SG[4].Position Ind manipul	Signal: Position Indicators faked
SG[4].SGwear Slow SG	Signal: Alarm, the circuit breaker (load-break switch) becomes slower
SG[4].Res SGwear Sl SG	Signal: Resetting the slow Switchgear Alarm
SG[4].ON Cmd	Signal: ON Command issued to the switchgear. Depending on the setting the signal may include the ON command of the Prot module.
SG[4].OFF Cmd	Signal: OFF Command issued to the switchgear. Depending on the setting the signal may include the OFF command of the Prot module.
SG[4].ON Cmd manual	Signal: ON Cmd manual
SG[4].OFF Cmd manual	Signal: OFF Cmd manual
SG[4].Sync ON request	Signal: Synchronous ON request
SG[4].Aux ON-I	Module Input State: Position indicator/check-back signal of the CB (52a)
SG[4].Aux OFF-I	Module input state: Position indicator/check-back signal of the CB (52b)
SG[4].Ready-I	Module input state: CB ready
SG[4].Sys-in-Sync-I	State of the module input: This signals has to become true within the synchronization time. If not, switching is unsuccessful.
SG[4].Removed-I	State of the module input: The withdrawable circuit breaker is Removed
SG[4].Ack TripCmd-I	State of the module input: Acknowledgement Signal (only for automatic acknowledgement) Module input signal
SG[4].Interl ON1-I	State of the module input: Interlocking of the ON command
SG[4].Interl ON2-I	State of the module input: Interlocking of the ON command
SG[4].Interl ON3-I	State of the module input: Interlocking of the ON command
SG[4].Interl OFF1-I	State of the module input: Interlocking of the OFF command
SG[4].Interl OFF2-I	State of the module input: Interlocking of the OFF command

General Lists

<i>Name</i>	<i>Description</i>
SG[4].Interl OFF3-I	State of the module input: Interlocking of the OFF command
SG[4].SCmd ON-I	State of the module input: Switching ON Command, e.g. the state of the Logics or the state of the digital input
SG[4].SCmd OFF-I	State of the module input: Switching OFF Command, e.g. the state of the Logics or the state of the digital input
SG[4].Operations Alarm	Signal: Service Alarm, too many Operations
SG[4].Isum Intr trip: IL1	Signal: Maximum permissible Summation of the interrupting (tripping) currents exceeded: IL1
SG[4].Isum Intr trip: IL2	Signal: Maximum permissible Summation of the interrupting (tripping) currents exceeded: IL2
SG[4].Isum Intr trip: IL3	Signal: Maximum permissible Summation of the interrupting (tripping) currents exceeded: IL3
SG[4].Isum Intr trip	Signal: Maximum permissible Summation of the interrupting (tripping) currents exceeded in at least one phase.
SG[4].Res TripCmd Cr	Signal: Resetting of the Counter: total number of trip commands
SG[4].Res Sum trip	Signal: Reset summation of the tripping currents
SG[4].WearLevel Alarm	Signal: Threshold for the Alarm
SG[4].WearLevel Lockout	Signal: Threshold for the Lockout Level
SG[4].Res CB OPEN capacity	Signal: Reset of the wear maintenance curve (i. e. of the counter for the Circuit Breaker OPEN capacity.
SG[4].Isum Intr ph Alm	Signal: Alarm, the per hour Sum (Limit) of interrupting currents has been exceeded.
SG[4].Res Isum Intr ph Alm	Signal: Reset of the Alarm, "the per hour Sum (Limit) of interrupting currents has been exceeded".
SG[5].SI SingleContactInd	Signal: The Position of the Switchgear is detected by one auxiliary contact (pole) only. Thus indeterminate and disturbed Positions cannot be detected.
SG[5].Pos not ON	Signal: Pos not ON
SG[5].Pos ON	Signal: Circuit Breaker is in ON-Position
SG[5].Pos OFF	Signal: Circuit Breaker is in OFF-Position
SG[5].Pos Indeterm	Signal: Circuit Breaker is in Indeterminate Position
SG[5].Pos Disturb	Signal: Circuit Breaker Disturbed - Undefined Breaker Position. The Position Indicators contradict themselves. After expiring of a supervision timer this signal becomes true.
SG[5].Ready	Signal: Circuit breaker is ready for operation.
SG[5].t-Dwell	Signal: Dwell time
SG[5].Removed	Signal: The withdrawable circuit breaker is Removed
SG[5].Interl ON	Signal: One or more IL_On inputs are active.
SG[5].Interl OFF	Signal: One or more IL_Off inputs are active.
SG[5].CES succesf	Signal: Command Execution Supervision: Switching command executed successfully.
SG[5].CES Disturbed	Signal: Command Execution Supervision: Switching Command unsuccessful. Switchgear in disturbed position.
SG[5].CES Fail TripCmd	Signal: Command Execution Supervision: Command execution failed because trip command is pending.

Name	Description
SG[5].CES SwitchDir	Signal: Command Execution Supervision respectively Switching Direction Control: This signal becomes true, if a switch command is issued even though the switchgear is already in the requested position. Example: A switchgear that is already OFF should be switched OFF again (doubly). The same applies to CLOSE commands.
SG[5].CES ON d OFF	Signal: Command Execution Supervision: On Command during a pending OFF Command.
SG[5].CES SG not ready	Signal: Command Execution Supervision: Switchgear not ready
SG[5].CES Fiel Interl	Signal: Command Execution Supervision: Switching Command not executed because of field interlocking.
SG[5].CES SyncTimeout	Signal: Command Execution Supervision: Switching Command not executed. No Synchronization signal while t-sync was running.
SG[5].CES SG removed	Signal: Command Execution Supervision: Switching Command unsuccessful, Switchgear removed.
SG[5].Prot ON	Signal: ON Command issued by the Prot module
SG[5].TripCmd	Signal: Trip Command
SG[5].Ack TripCmd	Signal: Acknowledge Trip Command
SG[5].ON incl Prot ON	Signal: The ON Command includes the ON Command issued by the Protection module.
SG[5].OFF incl TripCmd	Signal: The OFF Command includes the OFF Command issued by the Protection module.
SG[5].Position Ind manipul	Signal: Position Indicators faked
SG[5].SGwear Slow SG	Signal: Alarm, the circuit breaker (load-break switch) becomes slower
SG[5].Res SGwear Sl SG	Signal: Resetting the slow Switchgear Alarm
SG[5].ON Cmd	Signal: ON Command issued to the switchgear. Depending on the setting the signal may include the ON command of the Prot module.
SG[5].OFF Cmd	Signal: OFF Command issued to the switchgear. Depending on the setting the signal may include the OFF command of the Prot module.
SG[5].ON Cmd manual	Signal: ON Cmd manual
SG[5].OFF Cmd manual	Signal: OFF Cmd manual
SG[5].Sync ON request	Signal: Synchronous ON request
SG[5].Aux ON-I	Module Input State: Position indicator/check-back signal of the CB (52a)
SG[5].Aux OFF-I	Module input state: Position indicator/check-back signal of the CB (52b)
SG[5].Ready-I	Module input state: CB ready
SG[5].Sys-in-Sync-I	State of the module input: This signals has to become true within the synchronization time. If not, switching is unsuccessful.
SG[5].Removed-I	State of the module input: The withdrawable circuit breaker is Removed
SG[5].Ack TripCmd-I	State of the module input: Acknowledgement Signal (only for automatic acknowledgement) Module input signal
SG[5].Interl ON1-I	State of the module input: Interlocking of the ON command
SG[5].Interl ON2-I	State of the module input: Interlocking of the ON command
SG[5].Interl ON3-I	State of the module input: Interlocking of the ON command
SG[5].Interl OFF1-I	State of the module input: Interlocking of the OFF command
SG[5].Interl OFF2-I	State of the module input: Interlocking of the OFF command

General Lists

<i>Name</i>	<i>Description</i>
SG[5].Interl OFF3-I	State of the module input: Interlocking of the OFF command
SG[5].SCmd ON-I	State of the module input: Switching ON Command, e.g. the state of the Logics or the state of the digital input
SG[5].SCmd OFF-I	State of the module input: Switching OFF Command, e.g. the state of the Logics or the state of the digital input
SG[5].Operations Alarm	Signal: Service Alarm, too many Operations
SG[5].Isum Intr trip: IL1	Signal: Maximum permissible Summation of the interrupting (tripping) currents exceeded: IL1
SG[5].Isum Intr trip: IL2	Signal: Maximum permissible Summation of the interrupting (tripping) currents exceeded: IL2
SG[5].Isum Intr trip: IL3	Signal: Maximum permissible Summation of the interrupting (tripping) currents exceeded: IL3
SG[5].Isum Intr trip	Signal: Maximum permissible Summation of the interrupting (tripping) currents exceeded in at least one phase.
SG[5].Res TripCmd Cr	Signal: Resetting of the Counter: total number of trip commands
SG[5].Res Sum trip	Signal: Reset summation of the tripping currents
SG[5].WearLevel Alarm	Signal: Threshold for the Alarm
SG[5].WearLevel Lockout	Signal: Threshold for the Lockout Level
SG[5].Res CB OPEN capacity	Signal: Reset of the wear maintenance curve (i. e. of the counter for the Circuit Breaker OPEN capacity.
SG[5].Isum Intr ph Alm	Signal: Alarm, the per hour Sum (Limit) of interrupting currents has been exceeded.
SG[5].Res Isum Intr ph Alm	Signal: Reset of the Alarm, "the per hour Sum (Limit) of interrupting currents has been exceeded".
SG[6].SI SingleContactInd	Signal: The Position of the Switchgear is detected by one auxiliary contact (pole) only. Thus indeterminate and disturbed Positions cannot be detected.
SG[6].Pos not ON	Signal: Pos not ON
SG[6].Pos ON	Signal: Circuit Breaker is in ON-Position
SG[6].Pos OFF	Signal: Circuit Breaker is in OFF-Position
SG[6].Pos Indeterm	Signal: Circuit Breaker is in Indeterminate Position
SG[6].Pos Disturb	Signal: Circuit Breaker Disturbed - Undefined Breaker Position. The Position Indicators contradict themselves. After expiring of a supervision timer this signal becomes true.
SG[6].Ready	Signal: Circuit breaker is ready for operation.
SG[6].t-Dwell	Signal: Dwell time
SG[6].Removed	Signal: The withdrawable circuit breaker is Removed
SG[6].Interl ON	Signal: One or more IL_On inputs are active.
SG[6].Interl OFF	Signal: One or more IL_Off inputs are active.
SG[6].CES succesf	Signal: Command Execution Supervision: Switching command executed successfully.
SG[6].CES Disturbed	Signal: Command Execution Supervision: Switching Command unsuccessful. Switchgear in disturbed position.
SG[6].CES Fail TripCmd	Signal: Command Execution Supervision: Command execution failed because trip command is pending.

Name	Description
SG[6].CES SwitchDir	Signal: Command Execution Supervision respectively Switching Direction Control: This signal becomes true, if a switch command is issued even though the switchgear is already in the requested position. Example: A switchgear that is already OFF should be switched OFF again (doubly). The same applies to CLOSE commands.
SG[6].CES ON d OFF	Signal: Command Execution Supervision: On Command during a pending OFF Command.
SG[6].CES SG not ready	Signal: Command Execution Supervision: Switchgear not ready
SG[6].CES Fiel Interl	Signal: Command Execution Supervision: Switching Command not executed because of field interlocking.
SG[6].CES SyncTimeout	Signal: Command Execution Supervision: Switching Command not executed. No Synchronization signal while t-sync was running.
SG[6].CES SG removed	Signal: Command Execution Supervision: Switching Command unsuccessful, Switchgear removed.
SG[6].Prot ON	Signal: ON Command issued by the Prot module
SG[6].TripCmd	Signal: Trip Command
SG[6].Ack TripCmd	Signal: Acknowledge Trip Command
SG[6].ON incl Prot ON	Signal: The ON Command includes the ON Command issued by the Protection module.
SG[6].OFF incl TripCmd	Signal: The OFF Command includes the OFF Command issued by the Protection module.
SG[6].Position Ind manipul	Signal: Position Indicators faked
SG[6].SGwear Slow SG	Signal: Alarm, the circuit breaker (load-break switch) becomes slower
SG[6].Res SGwear SI SG	Signal: Resetting the slow Switchgear Alarm
SG[6].ON Cmd	Signal: ON Command issued to the switchgear. Depending on the setting the signal may include the ON command of the Prot module.
SG[6].OFF Cmd	Signal: OFF Command issued to the switchgear. Depending on the setting the signal may include the OFF command of the Prot module.
SG[6].ON Cmd manual	Signal: ON Cmd manual
SG[6].OFF Cmd manual	Signal: OFF Cmd manual
SG[6].Sync ON request	Signal: Synchronous ON request
SG[6].Aux ON-I	Module Input State: Position indicator/check-back signal of the CB (52a)
SG[6].Aux OFF-I	Module input state: Position indicator/check-back signal of the CB (52b)
SG[6].Ready-I	Module input state: CB ready
SG[6].Sys-in-Sync-I	State of the module input: This signals has to become true within the synchronization time. If not, switching is unsuccessful.
SG[6].Removed-I	State of the module input: The withdrawable circuit breaker is Removed
SG[6].Ack TripCmd-I	State of the module input: Acknowledgement Signal (only for automatic acknowledgement) Module input signal
SG[6].Interl ON1-I	State of the module input: Interlocking of the ON command
SG[6].Interl ON2-I	State of the module input: Interlocking of the ON command
SG[6].Interl ON3-I	State of the module input: Interlocking of the ON command
SG[6].Interl OFF1-I	State of the module input: Interlocking of the OFF command
SG[6].Interl OFF2-I	State of the module input: Interlocking of the OFF command

General Lists

<i>Name</i>	<i>Description</i>
SG[6].Interl OFF3-I	State of the module input: Interlocking of the OFF command
SG[6].SCmd ON-I	State of the module input: Switching ON Command, e.g. the state of the Logics or the state of the digital input
SG[6].SCmd OFF-I	State of the module input: Switching OFF Command, e.g. the state of the Logics or the state of the digital input
SG[6].Operations Alarm	Signal: Service Alarm, too many Operations
SG[6].Isum Intr trip: IL1	Signal: Maximum permissible Summation of the interrupting (tripping) currents exceeded: IL1
SG[6].Isum Intr trip: IL2	Signal: Maximum permissible Summation of the interrupting (tripping) currents exceeded: IL2
SG[6].Isum Intr trip: IL3	Signal: Maximum permissible Summation of the interrupting (tripping) currents exceeded: IL3
SG[6].Isum Intr trip	Signal: Maximum permissible Summation of the interrupting (tripping) currents exceeded in at least one phase.
SG[6].Res TripCmd Cr	Signal: Resetting of the Counter: total number of trip commands
SG[6].Res Sum trip	Signal: Reset summation of the tripping currents
SG[6].WearLevel Alarm	Signal: Threshold for the Alarm
SG[6].WearLevel Lockout	Signal: Threshold for the Lockout Level
SG[6].Res CB OPEN capacity	Signal: Reset of the wear maintenance curve (i. e. of the counter for the Circuit Breaker OPEN capacity.
SG[6].Isum Intr ph Alm	Signal: Alarm, the per hour Sum (Limit) of interrupting currents has been exceeded.
SG[6].Res Isum Intr ph Alm	Signal: Reset of the Alarm, "the per hour Sum (Limit) of interrupting currents has been exceeded".
Id.active	Signal: active
Id.ExBlo	Signal: External Blocking
Id.Blo TripCmd	Signal: Trip Command blocked
Id.ExBlo TripCmd	Signal: External Blocking of the Trip Command
Id.Alarm L1	Signal: Alarm System Phase L1
Id.Alarm L2	Signal: Alarm System Phase L2
Id.Alarm L3	Signal: Alarm System L3
Id.Alarm	Signal: Alarm
Id.Trip L1	Signal: Trip System Phase L1
Id.Trip L2	Signal: Trip System Phase L2
Id.Trip L3	Signal: Trip System Phase L3
Id.Trip	Signal: Trip
Id.TripCmd	Signal: Trip Command
Id.Blo H2	Signal: Blocked by Harmonic:2
Id.Blo H4	Signal: Blocked by Harmonic:4
Id.Blo H5	Signal: Blocked by Harmonic:5
Id.H2,H4,H5 Blo	Signal: Blocked by Harmonics (Inhibit)
Id.Slope Blo	Signal: Differential protection was blocked by current transformer saturation. The tripping characteristic was lifted because of current transformer saturation.

General Lists

<i>Name</i>	<i>Description</i>
Id.Transient	Signal: Temporary stabilization of the differential protection afterwards the transformer is being energized.
Id.Restricting	Signal: Restraining of the differential protection by means of rising the tripping curve.
Id.Slope Blo: L1	Slope Blo: L1
Id.Slope Blo: L2	Slope Blo: L2
Id.Slope Blo: L3	Slope Blo: L3
Id.Restricting: L1	Restraining: L1
Id.Restricting: L2	Restraining: L2
Id.Restricting: L3	Restraining: L3
Id.IH2 Blo L1	Signal:Phase L1: Blocking of the Phase Differential Protection because of second Harmonic.
Id.IH2 Blo L2	Signal:Phase L2: Blocking of the Phase Differential Protection because of second Harmonic.
Id.IH2 Blo L3	Signal:Phase L3: Blocking of the Phase Differential Protection because of second Harmonic.
Id.IH4 Blo L1	Signal:Phase L1: Blocking of the Phase Differential Protection because of fourth Harmonic.
Id.IH4 Blo L2	Signal:Phase L2: Blocking of the Phase Differential Protection because of fourth Harmonic.
Id.IH4 Blo L3	Signal:Phase L3: Blocking of the Phase Differential Protection because of fourth Harmonic.
Id.IH5 Blo L1	Signal:Phase L1: Blocking of the Phase Differential Protection because of fifth Harmonic.
Id.IH5 Blo L2	Signal:Phase L2: Blocking of the Phase Differential Protection because of fifth Harmonic.
Id.IH5 Blo L3	Signal:Phase L3: Blocking of the Phase Differential Protection because of fifth Harmonic.
Id.ExBlo1-I	Module input state: External blocking1
Id.ExBlo2-I	Module input state: External blocking2
Id.ExBlo TripCmd-I	Module input state: External Blocking of the Trip Command
IdH.active	Signal: active
IdH.ExBlo	Signal: External Blocking
IdH.Blo TripCmd	Signal: Trip Command blocked
IdH.ExBlo TripCmd	Signal: External Blocking of the Trip Command
IdH.Alarm L1	Signal: Alarm System Phase L1
IdH.Alarm L2	Signal: Alarm System Phase L2
IdH.Alarm L3	Signal: Alarm System L3
IdH.Alarm	Signal: Alarm
IdH.Trip L1	Signal: Trip System Phase L1
IdH.Trip L2	Signal: Trip System Phase L2
IdH.Trip L3	Signal: Trip System Phase L3
IdH.Trip	Signal: Trip
IdH.TripCmd	Signal: Trip Command

General Lists

<i>Name</i>	<i>Description</i>
IdH.ExBlo1-I	Module input state: External blocking1
IdH.ExBlo2-I	Module input state: External blocking2
IdH.ExBlo TripCmd-I	Module input state: External Blocking of the Trip Command
IdG[1].active	Signal: active
IdG[1].ExBlo	Signal: External Blocking
IdG[1].Blo TripCmd	Signal: Trip Command blocked
IdG[1].ExBlo TripCmd	Signal: External Blocking of the Trip Command
IdG[1].Alarm	Signal: Alarm
IdG[1].Trip	Signal: Trip
IdG[1].TripCmd	Signal: Trip Command
IdG[1].ExBlo1-I	Module input state: External blocking1
IdG[1].ExBlo2-I	Module input state: External blocking2
IdG[1].ExBlo TripCmd-I	Module input state: External Blocking of the Trip Command
IdGH[1].active	Signal: active
IdGH[1].ExBlo	Signal: External Blocking
IdGH[1].Blo TripCmd	Signal: Trip Command blocked
IdGH[1].ExBlo TripCmd	Signal: External Blocking of the Trip Command
IdGH[1].Alarm	Signal: Alarm
IdGH[1].Trip	Signal: Trip
IdGH[1].TripCmd	Signal: Trip Command
IdGH[1].ExBlo1-I	Module input state: External blocking1
IdGH[1].ExBlo2-I	Module input state: External blocking2
IdGH[1].ExBlo TripCmd-I	Module input state: External Blocking of the Trip Command
IdG[2].active	Signal: active
IdG[2].ExBlo	Signal: External Blocking
IdG[2].Blo TripCmd	Signal: Trip Command blocked
IdG[2].ExBlo TripCmd	Signal: External Blocking of the Trip Command
IdG[2].Alarm	Signal: Alarm
IdG[2].Trip	Signal: Trip
IdG[2].TripCmd	Signal: Trip Command
IdG[2].ExBlo1-I	Module input state: External blocking1
IdG[2].ExBlo2-I	Module input state: External blocking2
IdG[2].ExBlo TripCmd-I	Module input state: External Blocking of the Trip Command
IdGH[2].active	Signal: active
IdGH[2].ExBlo	Signal: External Blocking
IdGH[2].Blo TripCmd	Signal: Trip Command blocked
IdGH[2].ExBlo TripCmd	Signal: External Blocking of the Trip Command
IdGH[2].Alarm	Signal: Alarm
IdGH[2].Trip	Signal: Trip
IdGH[2].TripCmd	Signal: Trip Command

General Lists

<i>Name</i>	<i>Description</i>
IdGH[2].ExBlo1-I	Module input state: External blocking1
IdGH[2].ExBlo2-I	Module input state: External blocking2
IdGH[2].ExBlo TripCmd-I	Module input state: External Blocking of the Trip Command
IH2.active	Signal: active
IH2.ExBlo	Signal: External Blocking
IH2.Blo L1	Signal: Blocked L1
IH2.Blo L2	Signal: Blocked L2
IH2.Blo L3	Signal: Blocked L3
IH2.Blo IG meas	Signal: Blocking of the ground (earth) protection module (measured ground current)
IH2.Blo IG calc	Signal: Blocking of the ground (earth) protection module (calculated ground current)
IH2.3-ph Blo	Signal: Inrush was detected in at least one phase - trip command blocked.
IH2.ExBlo1-I	Module input state: External blocking1
IH2.ExBlo2-I	Module input state: External blocking2
I[1].active	Signal: active
I[1].ExBlo	Signal: External Blocking
I[1].Ex rev Interl	Signal: External reverse Interlocking
I[1].Blo TripCmd	Signal: Trip Command blocked
I[1].ExBlo TripCmd	Signal: External Blocking of the Trip Command
I[1].IH2 Blo	Signal: Blocking the trip command by an inrush
I[1].Alarm L1	Signal: Alarm L1
I[1].Alarm L2	Signal: Alarm L2
I[1].Alarm L3	Signal: Alarm L3
I[1].Alarm	Signal: Alarm
I[1].Trip L1	Signal: General Trip Phase L1
I[1].Trip L2	Signal: General Trip Phase L2
I[1].Trip L3	Signal: General Trip Phase L3
I[1].Trip	Signal: Trip
I[1].TripCmd	Signal: Trip Command
I[1].DefaultSet	Signal: Default Parameter Set
I[1].AdaptSet 1	Signal: Adaptive Parameter 1
I[1].AdaptSet 2	Signal: Adaptive Parameter 2
I[1].AdaptSet 3	Signal: Adaptive Parameter 3
I[1].AdaptSet 4	Signal: Adaptive Parameter 4
I[1].ExBlo1-I	Module input state: External blocking1
I[1].ExBlo2-I	Module input state: External blocking2
I[1].ExBlo TripCmd-I	Module input state: External Blocking of the Trip Command
I[1].Ex rev Interl-I	Module input state: External reverse interlocking
I[1].AdaptSet1-I	Module input state: Adaptive Parameter1
I[1].AdaptSet2-I	Module input state: Adaptive Parameter2
I[1].AdaptSet3-I	Module input state: Adaptive Parameter3

General Lists

<i>Name</i>	<i>Description</i>
I[1].AdaptSet4-I	Module input state: Adaptive Parameter4
I[2].active	Signal: active
I[2].ExBlo	Signal: External Blocking
I[2].Ex rev Interl	Signal: External reverse Interlocking
I[2].Blo TripCmd	Signal: Trip Command blocked
I[2].ExBlo TripCmd	Signal: External Blocking of the Trip Command
I[2].IH2 Blo	Signal: Blocking the trip command by an inrush
I[2].Alarm L1	Signal: Alarm L1
I[2].Alarm L2	Signal: Alarm L2
I[2].Alarm L3	Signal: Alarm L3
I[2].Alarm	Signal: Alarm
I[2].Trip L1	Signal: General Trip Phase L1
I[2].Trip L2	Signal: General Trip Phase L2
I[2].Trip L3	Signal: General Trip Phase L3
I[2].Trip	Signal: Trip
I[2].TripCmd	Signal: Trip Command
I[2].DefaultSet	Signal: Default Parameter Set
I[2].AdaptSet 1	Signal: Adaptive Parameter 1
I[2].AdaptSet 2	Signal: Adaptive Parameter 2
I[2].AdaptSet 3	Signal: Adaptive Parameter 3
I[2].AdaptSet 4	Signal: Adaptive Parameter 4
I[2].ExBlo1-I	Module input state: External blocking1
I[2].ExBlo2-I	Module input state: External blocking2
I[2].ExBlo TripCmd-I	Module input state: External Blocking of the Trip Command
I[2].Ex rev Interl-I	Module input state: External reverse interlocking
I[2].AdaptSet1-I	Module input state: Adaptive Parameter1
I[2].AdaptSet2-I	Module input state: Adaptive Parameter2
I[2].AdaptSet3-I	Module input state: Adaptive Parameter3
I[2].AdaptSet4-I	Module input state: Adaptive Parameter4
I[3].active	Signal: active
I[3].ExBlo	Signal: External Blocking
I[3].Ex rev Interl	Signal: External reverse Interlocking
I[3].Blo TripCmd	Signal: Trip Command blocked
I[3].ExBlo TripCmd	Signal: External Blocking of the Trip Command
I[3].IH2 Blo	Signal: Blocking the trip command by an inrush
I[3].Alarm L1	Signal: Alarm L1
I[3].Alarm L2	Signal: Alarm L2
I[3].Alarm L3	Signal: Alarm L3
I[3].Alarm	Signal: Alarm
I[3].Trip L1	Signal: General Trip Phase L1

General Lists

<i>Name</i>	<i>Description</i>
I[3].Trip L2	Signal: General Trip Phase L2
I[3].Trip L3	Signal: General Trip Phase L3
I[3].Trip	Signal: Trip
I[3].TripCmd	Signal: Trip Command
I[3].DefaultSet	Signal: Default Parameter Set
I[3].AdaptSet 1	Signal: Adaptive Parameter 1
I[3].AdaptSet 2	Signal: Adaptive Parameter 2
I[3].AdaptSet 3	Signal: Adaptive Parameter 3
I[3].AdaptSet 4	Signal: Adaptive Parameter 4
I[3].ExBlo1-I	Module input state: External blocking1
I[3].ExBlo2-I	Module input state: External blocking2
I[3].ExBlo TripCmd-I	Module input state: External Blocking of the Trip Command
I[3].Ex rev Interl-I	Module input state: External reverse interlocking
I[3].AdaptSet1-I	Module input state: Adaptive Parameter1
I[3].AdaptSet2-I	Module input state: Adaptive Parameter2
I[3].AdaptSet3-I	Module input state: Adaptive Parameter3
I[3].AdaptSet4-I	Module input state: Adaptive Parameter4
I[4].active	Signal: active
I[4].ExBlo	Signal: External Blocking
I[4].Ex rev Interl	Signal: External reverse Interlocking
I[4].Blo TripCmd	Signal: Trip Command blocked
I[4].ExBlo TripCmd	Signal: External Blocking of the Trip Command
I[4].IH2 Blo	Signal: Blocking the trip command by an inrush
I[4].Alarm L1	Signal: Alarm L1
I[4].Alarm L2	Signal: Alarm L2
I[4].Alarm L3	Signal: Alarm L3
I[4].Alarm	Signal: Alarm
I[4].Trip L1	Signal: General Trip Phase L1
I[4].Trip L2	Signal: General Trip Phase L2
I[4].Trip L3	Signal: General Trip Phase L3
I[4].Trip	Signal: Trip
I[4].TripCmd	Signal: Trip Command
I[4].DefaultSet	Signal: Default Parameter Set
I[4].AdaptSet 1	Signal: Adaptive Parameter 1
I[4].AdaptSet 2	Signal: Adaptive Parameter 2
I[4].AdaptSet 3	Signal: Adaptive Parameter 3
I[4].AdaptSet 4	Signal: Adaptive Parameter 4
I[4].ExBlo1-I	Module input state: External blocking1
I[4].ExBlo2-I	Module input state: External blocking2
I[4].ExBlo TripCmd-I	Module input state: External Blocking of the Trip Command

General Lists

<i>Name</i>	<i>Description</i>
I[4].Ex rev Interl-I	Module input state: External reverse interlocking
I[4].AdaptSet1-I	Module input state: Adaptive Parameter1
I[4].AdaptSet2-I	Module input state: Adaptive Parameter2
I[4].AdaptSet3-I	Module input state: Adaptive Parameter3
I[4].AdaptSet4-I	Module input state: Adaptive Parameter4
I[5].active	Signal: active
I[5].ExBlo	Signal: External Blocking
I[5].Ex rev Interl	Signal: External reverse Interlocking
I[5].Blo TripCmd	Signal: Trip Command blocked
I[5].ExBlo TripCmd	Signal: External Blocking of the Trip Command
I[5].IH2 Blo	Signal: Blocking the trip command by an inrush
I[5].Alarm L1	Signal: Alarm L1
I[5].Alarm L2	Signal: Alarm L2
I[5].Alarm L3	Signal: Alarm L3
I[5].Alarm	Signal: Alarm
I[5].Trip L1	Signal: General Trip Phase L1
I[5].Trip L2	Signal: General Trip Phase L2
I[5].Trip L3	Signal: General Trip Phase L3
I[5].Trip	Signal: Trip
I[5].TripCmd	Signal: Trip Command
I[5].DefaultSet	Signal: Default Parameter Set
I[5].AdaptSet 1	Signal: Adaptive Parameter 1
I[5].AdaptSet 2	Signal: Adaptive Parameter 2
I[5].AdaptSet 3	Signal: Adaptive Parameter 3
I[5].AdaptSet 4	Signal: Adaptive Parameter 4
I[5].ExBlo1-I	Module input state: External blocking1
I[5].ExBlo2-I	Module input state: External blocking2
I[5].ExBlo TripCmd-I	Module input state: External Blocking of the Trip Command
I[5].Ex rev Interl-I	Module input state: External reverse interlocking
I[5].AdaptSet1-I	Module input state: Adaptive Parameter1
I[5].AdaptSet2-I	Module input state: Adaptive Parameter2
I[5].AdaptSet3-I	Module input state: Adaptive Parameter3
I[5].AdaptSet4-I	Module input state: Adaptive Parameter4
I[6].active	Signal: active
I[6].ExBlo	Signal: External Blocking
I[6].Ex rev Interl	Signal: External reverse Interlocking
I[6].Blo TripCmd	Signal: Trip Command blocked
I[6].ExBlo TripCmd	Signal: External Blocking of the Trip Command
I[6].IH2 Blo	Signal: Blocking the trip command by an inrush
I[6].Alarm L1	Signal: Alarm L1

General Lists

<i>Name</i>	<i>Description</i>
I[6].Alarm L2	Signal: Alarm L2
I[6].Alarm L3	Signal: Alarm L3
I[6].Alarm	Signal: Alarm
I[6].Trip L1	Signal: General Trip Phase L1
I[6].Trip L2	Signal: General Trip Phase L2
I[6].Trip L3	Signal: General Trip Phase L3
I[6].Trip	Signal: Trip
I[6].TripCmd	Signal: Trip Command
I[6].DefaultSet	Signal: Default Parameter Set
I[6].AdaptSet 1	Signal: Adaptive Parameter 1
I[6].AdaptSet 2	Signal: Adaptive Parameter 2
I[6].AdaptSet 3	Signal: Adaptive Parameter 3
I[6].AdaptSet 4	Signal: Adaptive Parameter 4
I[6].ExBlo1-I	Module input state: External blocking1
I[6].ExBlo2-I	Module input state: External blocking2
I[6].ExBlo TripCmd-I	Module input state: External Blocking of the Trip Command
I[6].Ex rev Interl-I	Module input state: External reverse interlocking
I[6].AdaptSet1-I	Module input state: Adaptive Parameter1
I[6].AdaptSet2-I	Module input state: Adaptive Parameter2
I[6].AdaptSet3-I	Module input state: Adaptive Parameter3
I[6].AdaptSet4-I	Module input state: Adaptive Parameter4
IG[1].active	Signal: active
IG[1].ExBlo	Signal: External Blocking
IG[1].Ex rev Interl	Signal: External reverse Interlocking
IG[1].Blo TripCmd	Signal: Trip Command blocked
IG[1].ExBlo TripCmd	Signal: External Blocking of the Trip Command
IG[1].Alarm	Signal: Alarm IG
IG[1].Trip	Signal: Trip
IG[1].TripCmd	Signal: Trip Command
IG[1].IGH2 Blo	Signal: blocked by an inrush
IG[1].DefaultSet	Signal: Default Parameter Set
IG[1].AdaptSet 1	Signal: Adaptive Parameter 1
IG[1].AdaptSet 2	Signal: Adaptive Parameter 2
IG[1].AdaptSet 3	Signal: Adaptive Parameter 3
IG[1].AdaptSet 4	Signal: Adaptive Parameter 4
IG[1].ExBlo1-I	Module input state: External blocking1
IG[1].ExBlo2-I	Module input state: External blocking2
IG[1].ExBlo TripCmd-I	Module input state: External Blocking of the Trip Command
IG[1].Ex rev Interl-I	Module input state: External reverse interlocking
IG[1].AdaptSet1-I	Module input state: Adaptive Parameter1

General Lists

<i>Name</i>	<i>Description</i>
IG[1].AdaptSet2-I	Module input state: Adaptive Parameter2
IG[1].AdaptSet3-I	Module input state: Adaptive Parameter3
IG[1].AdaptSet4-I	Module input state: Adaptive Parameter4
IG[2].active	Signal: active
IG[2].ExBlo	Signal: External Blocking
IG[2].Ex rev Interl	Signal: External reverse Interlocking
IG[2].Blo TripCmd	Signal: Trip Command blocked
IG[2].ExBlo TripCmd	Signal: External Blocking of the Trip Command
IG[2].Alarm	Signal: Alarm IG
IG[2].Trip	Signal: Trip
IG[2].TripCmd	Signal: Trip Command
IG[2].IGH2 Blo	Signal: blocked by an inrush
IG[2].DefaultSet	Signal: Default Parameter Set
IG[2].AdaptSet 1	Signal: Adaptive Parameter 1
IG[2].AdaptSet 2	Signal: Adaptive Parameter 2
IG[2].AdaptSet 3	Signal: Adaptive Parameter 3
IG[2].AdaptSet 4	Signal: Adaptive Parameter 4
IG[2].ExBlo1-I	Module input state: External blocking1
IG[2].ExBlo2-I	Module input state: External blocking2
IG[2].ExBlo TripCmd-I	Module input state: External Blocking of the Trip Command
IG[2].Ex rev Interl-I	Module input state: External reverse interlocking
IG[2].AdaptSet1-I	Module input state: Adaptive Parameter1
IG[2].AdaptSet2-I	Module input state: Adaptive Parameter2
IG[2].AdaptSet3-I	Module input state: Adaptive Parameter3
IG[2].AdaptSet4-I	Module input state: Adaptive Parameter4
IG[3].active	Signal: active
IG[3].ExBlo	Signal: External Blocking
IG[3].Ex rev Interl	Signal: External reverse Interlocking
IG[3].Blo TripCmd	Signal: Trip Command blocked
IG[3].ExBlo TripCmd	Signal: External Blocking of the Trip Command
IG[3].Alarm	Signal: Alarm IG
IG[3].Trip	Signal: Trip
IG[3].TripCmd	Signal: Trip Command
IG[3].IGH2 Blo	Signal: blocked by an inrush
IG[3].DefaultSet	Signal: Default Parameter Set
IG[3].AdaptSet 1	Signal: Adaptive Parameter 1
IG[3].AdaptSet 2	Signal: Adaptive Parameter 2
IG[3].AdaptSet 3	Signal: Adaptive Parameter 3
IG[3].AdaptSet 4	Signal: Adaptive Parameter 4
IG[3].ExBlo1-I	Module input state: External blocking1

General Lists

<i>Name</i>	<i>Description</i>
IG[3].ExBlo2-I	Module input state: External blocking2
IG[3].ExBlo TripCmd-I	Module input state: External Blocking of the Trip Command
IG[3].Ex rev Interl-I	Module input state: External reverse interlocking
IG[3].AdaptSet1-I	Module input state: Adaptive Parameter1
IG[3].AdaptSet2-I	Module input state: Adaptive Parameter2
IG[3].AdaptSet3-I	Module input state: Adaptive Parameter3
IG[3].AdaptSet4-I	Module input state: Adaptive Parameter4
IG[4].active	Signal: active
IG[4].ExBlo	Signal: External Blocking
IG[4].Ex rev Interl	Signal: External reverse Interlocking
IG[4].Blo TripCmd	Signal: Trip Command blocked
IG[4].ExBlo TripCmd	Signal: External Blocking of the Trip Command
IG[4].Alarm	Signal: Alarm IG
IG[4].Trip	Signal: Trip
IG[4].TripCmd	Signal: Trip Command
IG[4].IGH2 Blo	Signal: blocked by an inrush
IG[4].DefaultSet	Signal: Default Parameter Set
IG[4].AdaptSet 1	Signal: Adaptive Parameter 1
IG[4].AdaptSet 2	Signal: Adaptive Parameter 2
IG[4].AdaptSet 3	Signal: Adaptive Parameter 3
IG[4].AdaptSet 4	Signal: Adaptive Parameter 4
IG[4].ExBlo1-I	Module input state: External blocking1
IG[4].ExBlo2-I	Module input state: External blocking2
IG[4].ExBlo TripCmd-I	Module input state: External Blocking of the Trip Command
IG[4].Ex rev Interl-I	Module input state: External reverse interlocking
IG[4].AdaptSet1-I	Module input state: Adaptive Parameter1
IG[4].AdaptSet2-I	Module input state: Adaptive Parameter2
IG[4].AdaptSet3-I	Module input state: Adaptive Parameter3
IG[4].AdaptSet4-I	Module input state: Adaptive Parameter4
ThR.active	Signal: active
ThR.ExBlo	Signal: External Blocking
ThR.Blo TripCmd	Signal: Trip Command blocked
ThR.ExBlo TripCmd	Signal: External Blocking of the Trip Command
ThR.Alarm	Signal: Alarm Thermal Overload
ThR.Trip	Signal: Trip
ThR.TripCmd	Signal: Trip Command
ThR.Res Thermal Cap	Signal: Resetting Thermal Replica
ThR.ExBlo1-I	Module input state: External blocking1
ThR.ExBlo2-I	Module input state: External blocking2
ThR.ExBlo TripCmd-I	Module input state: External Blocking of the Trip Command

General Lists

<i>Name</i>	<i>Description</i>
I2>[1].active	Signal: active
I2>[1].ExBlo	Signal: External Blocking
I2>[1].Blo TripCmd	Signal: Trip Command blocked
I2>[1].ExBlo TripCmd	Signal: External Blocking of the Trip Command
I2>[1].Alarm	Signal: Alarm Negative Sequence
I2>[1].Trip	Signal: Trip
I2>[1].TripCmd	Signal: Trip Command
I2>[1].ExBlo1-I	Module input state: External blocking1
I2>[1].ExBlo2-I	Module input state: External blocking2
I2>[1].ExBlo TripCmd-I	Module input state: External Blocking of the Trip Command
I2>[2].active	Signal: active
I2>[2].ExBlo	Signal: External Blocking
I2>[2].Blo TripCmd	Signal: Trip Command blocked
I2>[2].ExBlo TripCmd	Signal: External Blocking of the Trip Command
I2>[2].Alarm	Signal: Alarm Negative Sequence
I2>[2].Trip	Signal: Trip
I2>[2].TripCmd	Signal: Trip Command
I2>[2].ExBlo1-I	Module input state: External blocking1
I2>[2].ExBlo2-I	Module input state: External blocking2
I2>[2].ExBlo TripCmd-I	Module input state: External Blocking of the Trip Command
I2>G[1].active	Signal: active
I2>G[1].ExBlo	Signal: External Blocking
I2>G[1].Blo TripCmd	Signal: Trip Command blocked
I2>G[1].ExBlo TripCmd	Signal: External Blocking of the Trip Command
I2>G[1].Alarm	Signal: Alarm Negative Sequence
I2>G[1].Trip	Signal: Trip
I2>G[1].TripCmd	Signal: Trip Command
I2>G[1].ExBlo1-I	Module input state: External blocking1
I2>G[1].ExBlo2-I	Module input state: External blocking2
I2>G[1].ExBlo TripCmd-I	Module input state: External Blocking of the Trip Command
I2>G[2].active	Signal: active
I2>G[2].ExBlo	Signal: External Blocking
I2>G[2].Blo TripCmd	Signal: Trip Command blocked
I2>G[2].ExBlo TripCmd	Signal: External Blocking of the Trip Command
I2>G[2].Alarm	Signal: Alarm Negative Sequence
I2>G[2].Trip	Signal: Trip
I2>G[2].TripCmd	Signal: Trip Command
I2>G[2].ExBlo1-I	Module input state: External blocking1
I2>G[2].ExBlo2-I	Module input state: External blocking2
I2>G[2].ExBlo TripCmd-I	Module input state: External Blocking of the Trip Command

General Lists

<i>Name</i>	<i>Description</i>
V[1].active	Signal: active
V[1].ExBlo	Signal: External Blocking
V[1].Blo TripCmd	Signal: Trip Command blocked
V[1].ExBlo TripCmd	Signal: External Blocking of the Trip Command
V[1].Alarm L1	Signal: Alarm L1
V[1].Alarm L2	Signal: Alarm L2
V[1].Alarm L3	Signal: Alarm L3
V[1].Alarm	Signal: Alarm voltage stage
V[1].Trip L1	Signal: General Trip Phase L1
V[1].Trip L2	Signal: General Trip Phase L2
V[1].Trip L3	Signal: General Trip Phase L3
V[1].Trip	Signal: Trip
V[1].TripCmd	Signal: Trip Command
V[1].Imin release active	Signal that the Imin release (minimum current) check is enabled and does not block the undervoltage detection at the moment.
V[1].ExBlo1-I	Module input state: External blocking1
V[1].ExBlo2-I	Module input state: External blocking2
V[1].ExBlo TripCmd-I	Module input state: External Blocking of the Trip Command
V[2].active	Signal: active
V[2].ExBlo	Signal: External Blocking
V[2].Blo TripCmd	Signal: Trip Command blocked
V[2].ExBlo TripCmd	Signal: External Blocking of the Trip Command
V[2].Alarm L1	Signal: Alarm L1
V[2].Alarm L2	Signal: Alarm L2
V[2].Alarm L3	Signal: Alarm L3
V[2].Alarm	Signal: Alarm voltage stage
V[2].Trip L1	Signal: General Trip Phase L1
V[2].Trip L2	Signal: General Trip Phase L2
V[2].Trip L3	Signal: General Trip Phase L3
V[2].Trip	Signal: Trip
V[2].TripCmd	Signal: Trip Command
V[2].Imin release active	Signal that the Imin release (minimum current) check is enabled and does not block the undervoltage detection at the moment.
V[2].ExBlo1-I	Module input state: External blocking1
V[2].ExBlo2-I	Module input state: External blocking2
V[2].ExBlo TripCmd-I	Module input state: External Blocking of the Trip Command
V[3].active	Signal: active
V[3].ExBlo	Signal: External Blocking
V[3].Blo TripCmd	Signal: Trip Command blocked
V[3].ExBlo TripCmd	Signal: External Blocking of the Trip Command

General Lists

<i>Name</i>	<i>Description</i>
V[3].Alarm L1	Signal: Alarm L1
V[3].Alarm L2	Signal: Alarm L2
V[3].Alarm L3	Signal: Alarm L3
V[3].Alarm	Signal: Alarm voltage stage
V[3].Trip L1	Signal: General Trip Phase L1
V[3].Trip L2	Signal: General Trip Phase L2
V[3].Trip L3	Signal: General Trip Phase L3
V[3].Trip	Signal: Trip
V[3].TripCmd	Signal: Trip Command
V[3].Imin release active	Signal that the Imin release (minimum current) check is enabled and does not block the undervoltage detection at the moment.
V[3].ExBlo1-I	Module input state: External blocking1
V[3].ExBlo2-I	Module input state: External blocking2
V[3].ExBlo TripCmd-I	Module input state: External Blocking of the Trip Command
V[4].active	Signal: active
V[4].ExBlo	Signal: External Blocking
V[4].Blo TripCmd	Signal: Trip Command blocked
V[4].ExBlo TripCmd	Signal: External Blocking of the Trip Command
V[4].Alarm L1	Signal: Alarm L1
V[4].Alarm L2	Signal: Alarm L2
V[4].Alarm L3	Signal: Alarm L3
V[4].Alarm	Signal: Alarm voltage stage
V[4].Trip L1	Signal: General Trip Phase L1
V[4].Trip L2	Signal: General Trip Phase L2
V[4].Trip L3	Signal: General Trip Phase L3
V[4].Trip	Signal: Trip
V[4].TripCmd	Signal: Trip Command
V[4].Imin release active	Signal that the Imin release (minimum current) check is enabled and does not block the undervoltage detection at the moment.
V[4].ExBlo1-I	Module input state: External blocking1
V[4].ExBlo2-I	Module input state: External blocking2
V[4].ExBlo TripCmd-I	Module input state: External Blocking of the Trip Command
V[5].active	Signal: active
V[5].ExBlo	Signal: External Blocking
V[5].Blo TripCmd	Signal: Trip Command blocked
V[5].ExBlo TripCmd	Signal: External Blocking of the Trip Command
V[5].Alarm L1	Signal: Alarm L1
V[5].Alarm L2	Signal: Alarm L2
V[5].Alarm L3	Signal: Alarm L3
V[5].Alarm	Signal: Alarm voltage stage

General Lists

<i>Name</i>	<i>Description</i>
V[5].Trip L1	Signal: General Trip Phase L1
V[5].Trip L2	Signal: General Trip Phase L2
V[5].Trip L3	Signal: General Trip Phase L3
V[5].Trip	Signal: Trip
V[5].TripCmd	Signal: Trip Command
V[5].Imin release active	Signal that the Imin release (minimum current) check is enabled and does not block the undervoltage detection at the moment.
V[5].ExBlo1-I	Module input state: External blocking1
V[5].ExBlo2-I	Module input state: External blocking2
V[5].ExBlo TripCmd-I	Module input state: External Blocking of the Trip Command
V[6].active	Signal: active
V[6].ExBlo	Signal: External Blocking
V[6].Blo TripCmd	Signal: Trip Command blocked
V[6].ExBlo TripCmd	Signal: External Blocking of the Trip Command
V[6].Alarm L1	Signal: Alarm L1
V[6].Alarm L2	Signal: Alarm L2
V[6].Alarm L3	Signal: Alarm L3
V[6].Alarm	Signal: Alarm voltage stage
V[6].Trip L1	Signal: General Trip Phase L1
V[6].Trip L2	Signal: General Trip Phase L2
V[6].Trip L3	Signal: General Trip Phase L3
V[6].Trip	Signal: Trip
V[6].TripCmd	Signal: Trip Command
V[6].Imin release active	Signal that the Imin release (minimum current) check is enabled and does not block the undervoltage detection at the moment.
V[6].ExBlo1-I	Module input state: External blocking1
V[6].ExBlo2-I	Module input state: External blocking2
V[6].ExBlo TripCmd-I	Module input state: External Blocking of the Trip Command
df/dt.active	Signal: active
df/dt.ExBlo	Signal: External Blocking
df/dt.Blo by V<	Signal: Module is blocked by undervoltage.
df/dt.Blo TripCmd	Signal: Trip Command blocked
df/dt.ExBlo TripCmd	Signal: External Blocking of the Trip Command
df/dt.Alarm	Signal: Alarm Frequency Protection (collective signal)
df/dt.Trip	Signal: Trip Frequency Protection (collective signal)
df/dt.TripCmd	Signal: Trip Command
df/dt.ExBlo1-I	Module input state: External blocking1
df/dt.ExBlo2-I	Module input state: External blocking2
df/dt.ExBlo TripCmd-I	Module input state: External Blocking of the Trip Command
delta phi.active	Signal: active

General Lists

<i>Name</i>	<i>Description</i>
delta phi.ExBlo	Signal: External Blocking
delta phi.Blo by V<	Signal: Module is blocked by undervoltage.
delta phi.Blo TripCmd	Signal: Trip Command blocked
delta phi.ExBlo TripCmd	Signal: External Blocking of the Trip Command
delta phi.Alarm	Signal: Alarm Frequency Protection (collective signal)
delta phi.Trip	Signal: Trip Frequency Protection (collective signal)
delta phi.TripCmd	Signal: Trip Command
delta phi.ExBlo1-I	Module input state: External blocking1
delta phi.ExBlo2-I	Module input state: External blocking2
delta phi.ExBlo TripCmd-I	Module input state: External Blocking of the Trip Command
Intertripping.active	Signal: active
Intertripping.ExBlo	Signal: External Blocking
Intertripping.Blo TripCmd	Signal: Trip Command blocked
Intertripping.ExBlo TripCmd	Signal: External Blocking of the Trip Command
Intertripping.Alarm	Signal: Alarm
Intertripping.Trip	Signal: Trip
Intertripping.TripCmd	Signal: Trip Command
Intertripping.ExBlo1-I	Module input state: External blocking1
Intertripping.ExBlo2-I	Module input state: External blocking2
Intertripping.ExBlo TripCmd-I	Module input state: External Blocking of the Trip Command
Intertripping.Alarm-I	Module input state: Alarm
Intertripping.Trip-I	Module input state: Trip
P.active	Signal: active
P.ExBlo	Signal: External Blocking
P.Blo TripCmd	Signal: Trip Command blocked
P.ExBlo TripCmd	Signal: External Blocking of the Trip Command
P.Alarm	Signal: Alarm Power Protection
P.Trip	Signal: Trip Power Protection
P.TripCmd	Signal: Trip Command
P.ExBlo1-I	Module input state: External blocking
P.ExBlo2-I	Module input state: External blocking
P.ExBlo TripCmd-I	Module input state: External Blocking of the Trip Command
Q.active	Signal: active
Q.ExBlo	Signal: External Blocking
Q.Blo TripCmd	Signal: Trip Command blocked
Q.ExBlo TripCmd	Signal: External Blocking of the Trip Command
Q.Alarm	Signal: Alarm Power Protection

General Lists

<i>Name</i>	<i>Description</i>
Q.Trip	Signal: Trip Power Protection
Q.TripCmd	Signal: Trip Command
Q.ExBlo1-I	Module input state: External blocking
Q.ExBlo2-I	Module input state: External blocking
Q.ExBlo TripCmd-I	Module input state: External Blocking of the Trip Command
LVRT[1].active	Signal: active
LVRT[1].ExBlo	Signal: External Blocking
LVRT[1].Blo TripCmd	Signal: Trip Command blocked
LVRT[1].ExBlo TripCmd	Signal: External Blocking of the Trip Command
LVRT[1].Alarm L1	Signal: Alarm L1
LVRT[1].Alarm L2	Signal: Alarm L2
LVRT[1].Alarm L3	Signal: Alarm L3
LVRT[1].Alarm	Signal: Alarm voltage stage
LVRT[1].Trip L1	Signal: General Trip Phase L1
LVRT[1].Trip L2	Signal: General Trip Phase L2
LVRT[1].Trip L3	Signal: General Trip Phase L3
LVRT[1].Trip	Signal: Trip
LVRT[1].TripCmd	Signal: Trip Command
LVRT[1].t-LVRT is running	Signal: t-LVRT is running
LVRT[1].ExBlo1-I	Module input state: External blocking1
LVRT[1].ExBlo2-I	Module input state: External blocking2
LVRT[1].ExBlo TripCmd-I	Module input state: External Blocking of the Trip Command
LVRT[2].active	Signal: active
LVRT[2].ExBlo	Signal: External Blocking
LVRT[2].Blo TripCmd	Signal: Trip Command blocked
LVRT[2].ExBlo TripCmd	Signal: External Blocking of the Trip Command
LVRT[2].Alarm L1	Signal: Alarm L1
LVRT[2].Alarm L2	Signal: Alarm L2
LVRT[2].Alarm L3	Signal: Alarm L3
LVRT[2].Alarm	Signal: Alarm voltage stage
LVRT[2].Trip L1	Signal: General Trip Phase L1
LVRT[2].Trip L2	Signal: General Trip Phase L2
LVRT[2].Trip L3	Signal: General Trip Phase L3
LVRT[2].Trip	Signal: Trip
LVRT[2].TripCmd	Signal: Trip Command
LVRT[2].t-LVRT is running	Signal: t-LVRT is running
LVRT[2].ExBlo1-I	Module input state: External blocking1
LVRT[2].ExBlo2-I	Module input state: External blocking2

General Lists

<i>Name</i>	<i>Description</i>
LVRT[2].ExBlo TripCmd-I	Module input state: External Blocking of the Trip Command
VG[1].active	Signal: active
VG[1].ExBlo	Signal: External Blocking
VG[1].Blo TripCmd	Signal: Trip Command blocked
VG[1].ExBlo TripCmd	Signal: External Blocking of the Trip Command
VG[1].Alarm	Signal: Alarm Residual Voltage Supervision-stage
VG[1].Trip	Signal: Trip
VG[1].TripCmd	Signal: Trip Command
VG[1].ExBlo1-I	Module input state: External blocking1
VG[1].ExBlo2-I	Module input state: External blocking2
VG[1].ExBlo TripCmd-I	Module input state: External Blocking of the Trip Command
VG[2].active	Signal: active
VG[2].ExBlo	Signal: External Blocking
VG[2].Blo TripCmd	Signal: Trip Command blocked
VG[2].ExBlo TripCmd	Signal: External Blocking of the Trip Command
VG[2].Alarm	Signal: Alarm Residual Voltage Supervision-stage
VG[2].Trip	Signal: Trip
VG[2].TripCmd	Signal: Trip Command
VG[2].ExBlo1-I	Module input state: External blocking1
VG[2].ExBlo2-I	Module input state: External blocking2
VG[2].ExBlo TripCmd-I	Module input state: External Blocking of the Trip Command
V012[1].active	Signal: active
V012[1].ExBlo	Signal: External Blocking
V012[1].Blo TripCmd	Signal: Trip Command blocked
V012[1].ExBlo TripCmd	Signal: External Blocking of the Trip Command
V012[1].Alarm	Signal: Alarm voltage asymmetry
V012[1].Trip	Signal: Trip
V012[1].TripCmd	Signal: Trip Command
V012[1].ExBlo1-I	Module input state: External blocking1
V012[1].ExBlo2-I	Module input state: External blocking2
V012[1].ExBlo TripCmd-I	Module input state: External Blocking of the Trip Command
V012[2].active	Signal: active
V012[2].ExBlo	Signal: External Blocking
V012[2].Blo TripCmd	Signal: Trip Command blocked
V012[2].ExBlo TripCmd	Signal: External Blocking of the Trip Command
V012[2].Alarm	Signal: Alarm voltage asymmetry
V012[2].Trip	Signal: Trip
V012[2].TripCmd	Signal: Trip Command
V012[2].ExBlo1-I	Module input state: External blocking1
V012[2].ExBlo2-I	Module input state: External blocking2

General Lists

<i>Name</i>	<i>Description</i>
V012[2].ExBlo TripCmd-I	Module input state: External Blocking of the Trip Command
V012[3].active	Signal: active
V012[3].ExBlo	Signal: External Blocking
V012[3].Blo TripCmd	Signal: Trip Command blocked
V012[3].ExBlo TripCmd	Signal: External Blocking of the Trip Command
V012[3].Alarm	Signal: Alarm voltage asymmetry
V012[3].Trip	Signal: Trip
V012[3].TripCmd	Signal: Trip Command
V012[3].ExBlo1-I	Module input state: External blocking1
V012[3].ExBlo2-I	Module input state: External blocking2
V012[3].ExBlo TripCmd-I	Module input state: External Blocking of the Trip Command
V012[4].active	Signal: active
V012[4].ExBlo	Signal: External Blocking
V012[4].Blo TripCmd	Signal: Trip Command blocked
V012[4].ExBlo TripCmd	Signal: External Blocking of the Trip Command
V012[4].Alarm	Signal: Alarm voltage asymmetry
V012[4].Trip	Signal: Trip
V012[4].TripCmd	Signal: Trip Command
V012[4].ExBlo1-I	Module input state: External blocking1
V012[4].ExBlo2-I	Module input state: External blocking2
V012[4].ExBlo TripCmd-I	Module input state: External Blocking of the Trip Command
V012[5].active	Signal: active
V012[5].ExBlo	Signal: External Blocking
V012[5].Blo TripCmd	Signal: Trip Command blocked
V012[5].ExBlo TripCmd	Signal: External Blocking of the Trip Command
V012[5].Alarm	Signal: Alarm voltage asymmetry
V012[5].Trip	Signal: Trip
V012[5].TripCmd	Signal: Trip Command
V012[5].ExBlo1-I	Module input state: External blocking1
V012[5].ExBlo2-I	Module input state: External blocking2
V012[5].ExBlo TripCmd-I	Module input state: External Blocking of the Trip Command
V012[6].active	Signal: active
V012[6].ExBlo	Signal: External Blocking
V012[6].Blo TripCmd	Signal: Trip Command blocked
V012[6].ExBlo TripCmd	Signal: External Blocking of the Trip Command
V012[6].Alarm	Signal: Alarm voltage asymmetry
V012[6].Trip	Signal: Trip
V012[6].TripCmd	Signal: Trip Command
V012[6].ExBlo1-I	Module input state: External blocking1
V012[6].ExBlo2-I	Module input state: External blocking2

General Lists

<i>Name</i>	<i>Description</i>
V012[6].ExBlo TripCmd-I	Module input state: External Blocking of the Trip Command
f[1].active	Signal: active
f[1].ExBlo	Signal: External Blocking
f[1].Blo by V<	Signal: Module is blocked by undervoltage.
f[1].Blo TripCmd	Signal: Trip Command blocked
f[1].ExBlo TripCmd	Signal: External Blocking of the Trip Command
f[1].Alarm f	Signal: Alarm Frequency Protection
f[1].Alarm df/dt DF/DT	Alarm instantaneous or average value of the rate-of-frequency-change
f[1].Alarm delta phi	Signal: Alarm Vector Surge
f[1].Alarm	Signal: Alarm Frequency Protection (collective signal)
f[1].Trip f	Signal: Frequency has exceeded the limit.
f[1].Trip df/dt DF/DT	Signal: Trip df/dt or DF/DT
f[1].Trip delta phi	Signal: Trip Vector Surge
f[1].Trip	Signal: Trip Frequency Protection (collective signal)
f[1].TripCmd	Signal: Trip Command
f[1].ExBlo1-I	Module input state: External blocking1
f[1].ExBlo2-I	Module input state: External blocking2
f[1].ExBlo TripCmd-I	Module input state: External Blocking of the Trip Command
f[2].active	Signal: active
f[2].ExBlo	Signal: External Blocking
f[2].Blo by V<	Signal: Module is blocked by undervoltage.
f[2].Blo TripCmd	Signal: Trip Command blocked
f[2].ExBlo TripCmd	Signal: External Blocking of the Trip Command
f[2].Alarm f	Signal: Alarm Frequency Protection
f[2].Alarm df/dt DF/DT	Alarm instantaneous or average value of the rate-of-frequency-change
f[2].Alarm delta phi	Signal: Alarm Vector Surge
f[2].Alarm	Signal: Alarm Frequency Protection (collective signal)
f[2].Trip f	Signal: Frequency has exceeded the limit.
f[2].Trip df/dt DF/DT	Signal: Trip df/dt or DF/DT
f[2].Trip delta phi	Signal: Trip Vector Surge
f[2].Trip	Signal: Trip Frequency Protection (collective signal)
f[2].TripCmd	Signal: Trip Command
f[2].ExBlo1-I	Module input state: External blocking1
f[2].ExBlo2-I	Module input state: External blocking2
f[2].ExBlo TripCmd-I	Module input state: External Blocking of the Trip Command
f[3].active	Signal: active
f[3].ExBlo	Signal: External Blocking
f[3].Blo by V<	Signal: Module is blocked by undervoltage.
f[3].Blo TripCmd	Signal: Trip Command blocked
f[3].ExBlo TripCmd	Signal: External Blocking of the Trip Command

General Lists

<i>Name</i>	<i>Description</i>
f[3].Alarm f	Signal: Alarm Frequency Protection
f[3].Alarm df/dt DF/DT	Alarm instantaneous or average value of the rate-of-frequency-change
f[3].Alarm delta phi	Signal: Alarm Vector Surge
f[3].Alarm	Signal: Alarm Frequency Protection (collective signal)
f[3].Trip f	Signal: Frequency has exceeded the limit.
f[3].Trip df/dt DF/DT	Signal: Trip df/dt or DF/DT
f[3].Trip delta phi	Signal: Trip Vector Surge
f[3].Trip	Signal: Trip Frequency Protection (collective signal)
f[3].TripCmd	Signal: Trip Command
f[3].ExBlo1-I	Module input state: External blocking1
f[3].ExBlo2-I	Module input state: External blocking2
f[3].ExBlo TripCmd-I	Module input state: External Blocking of the Trip Command
f[4].active	Signal: active
f[4].ExBlo	Signal: External Blocking
f[4].Blo by V<	Signal: Module is blocked by undervoltage.
f[4].Blo TripCmd	Signal: Trip Command blocked
f[4].ExBlo TripCmd	Signal: External Blocking of the Trip Command
f[4].Alarm f	Signal: Alarm Frequency Protection
f[4].Alarm df/dt DF/DT	Alarm instantaneous or average value of the rate-of-frequency-change
f[4].Alarm delta phi	Signal: Alarm Vector Surge
f[4].Alarm	Signal: Alarm Frequency Protection (collective signal)
f[4].Trip f	Signal: Frequency has exceeded the limit.
f[4].Trip df/dt DF/DT	Signal: Trip df/dt or DF/DT
f[4].Trip delta phi	Signal: Trip Vector Surge
f[4].Trip	Signal: Trip Frequency Protection (collective signal)
f[4].TripCmd	Signal: Trip Command
f[4].ExBlo1-I	Module input state: External blocking1
f[4].ExBlo2-I	Module input state: External blocking2
f[4].ExBlo TripCmd-I	Module input state: External Blocking of the Trip Command
f[5].active	Signal: active
f[5].ExBlo	Signal: External Blocking
f[5].Blo by V<	Signal: Module is blocked by undervoltage.
f[5].Blo TripCmd	Signal: Trip Command blocked
f[5].ExBlo TripCmd	Signal: External Blocking of the Trip Command
f[5].Alarm f	Signal: Alarm Frequency Protection
f[5].Alarm df/dt DF/DT	Alarm instantaneous or average value of the rate-of-frequency-change
f[5].Alarm delta phi	Signal: Alarm Vector Surge
f[5].Alarm	Signal: Alarm Frequency Protection (collective signal)
f[5].Trip f	Signal: Frequency has exceeded the limit.
f[5].Trip df/dt DF/DT	Signal: Trip df/dt or DF/DT

General Lists

<i>Name</i>	<i>Description</i>
f[5].Trip delta phi	Signal: Trip Vector Surge
f[5].Trip	Signal: Trip Frequency Protection (collective signal)
f[5].TripCmd	Signal: Trip Command
f[5].ExBlo1-I	Module input state: External blocking1
f[5].ExBlo2-I	Module input state: External blocking2
f[5].ExBlo TripCmd-I	Module input state: External Blocking of the Trip Command
f[6].active	Signal: active
f[6].ExBlo	Signal: External Blocking
f[6].Blo by V<	Signal: Module is blocked by undervoltage.
f[6].Blo TripCmd	Signal: Trip Command blocked
f[6].ExBlo TripCmd	Signal: External Blocking of the Trip Command
f[6].Alarm f	Signal: Alarm Frequency Protection
f[6].Alarm df/dt DF/DT	Alarm instantaneous or average value of the rate-of-frequency-change
f[6].Alarm delta phi	Signal: Alarm Vector Surge
f[6].Alarm	Signal: Alarm Frequency Protection (collective signal)
f[6].Trip f	Signal: Frequency has exceeded the limit.
f[6].Trip df/dt DF/DT	Signal: Trip df/dt or DF/DT
f[6].Trip delta phi	Signal: Trip Vector Surge
f[6].Trip	Signal: Trip Frequency Protection (collective signal)
f[6].TripCmd	Signal: Trip Command
f[6].ExBlo1-I	Module input state: External blocking1
f[6].ExBlo2-I	Module input state: External blocking2
f[6].ExBlo TripCmd-I	Module input state: External Blocking of the Trip Command
PQS[1].active	Signal: active
PQS[1].ExBlo	Signal: External Blocking
PQS[1].Blo TripCmd	Signal: Trip Command blocked
PQS[1].ExBlo TripCmd	Signal: External Blocking of the Trip Command
PQS[1].Alarm	Signal: Alarm Power Protection
PQS[1].Trip	Signal: Trip Power Protection
PQS[1].TripCmd	Signal: Trip Command
PQS[1].ExBlo1-I	Module input state: External blocking
PQS[1].ExBlo2-I	Module input state: External blocking
PQS[1].ExBlo TripCmd-I	Module input state: External Blocking of the Trip Command
PQS[2].active	Signal: active
PQS[2].ExBlo	Signal: External Blocking
PQS[2].Blo TripCmd	Signal: Trip Command blocked
PQS[2].ExBlo TripCmd	Signal: External Blocking of the Trip Command
PQS[2].Alarm	Signal: Alarm Power Protection
PQS[2].Trip	Signal: Trip Power Protection
PQS[2].TripCmd	Signal: Trip Command

General Lists

<i>Name</i>	<i>Description</i>
PQS[2].ExBlo1-I	Module input state: External blocking
PQS[2].ExBlo2-I	Module input state: External blocking
PQS[2].ExBlo TripCmd-I	Module input state: External Blocking of the Trip Command
PQS[3].active	Signal: active
PQS[3].ExBlo	Signal: External Blocking
PQS[3].Blo TripCmd	Signal: Trip Command blocked
PQS[3].ExBlo TripCmd	Signal: External Blocking of the Trip Command
PQS[3].Alarm	Signal: Alarm Power Protection
PQS[3].Trip	Signal: Trip Power Protection
PQS[3].TripCmd	Signal: Trip Command
PQS[3].ExBlo1-I	Module input state: External blocking
PQS[3].ExBlo2-I	Module input state: External blocking
PQS[3].ExBlo TripCmd-I	Module input state: External Blocking of the Trip Command
PQS[4].active	Signal: active
PQS[4].ExBlo	Signal: External Blocking
PQS[4].Blo TripCmd	Signal: Trip Command blocked
PQS[4].ExBlo TripCmd	Signal: External Blocking of the Trip Command
PQS[4].Alarm	Signal: Alarm Power Protection
PQS[4].Trip	Signal: Trip Power Protection
PQS[4].TripCmd	Signal: Trip Command
PQS[4].ExBlo1-I	Module input state: External blocking
PQS[4].ExBlo2-I	Module input state: External blocking
PQS[4].ExBlo TripCmd-I	Module input state: External Blocking of the Trip Command
PQS[5].active	Signal: active
PQS[5].ExBlo	Signal: External Blocking
PQS[5].Blo TripCmd	Signal: Trip Command blocked
PQS[5].ExBlo TripCmd	Signal: External Blocking of the Trip Command
PQS[5].Alarm	Signal: Alarm Power Protection
PQS[5].Trip	Signal: Trip Power Protection
PQS[5].TripCmd	Signal: Trip Command
PQS[5].ExBlo1-I	Module input state: External blocking
PQS[5].ExBlo2-I	Module input state: External blocking
PQS[5].ExBlo TripCmd-I	Module input state: External Blocking of the Trip Command
PQS[6].active	Signal: active
PQS[6].ExBlo	Signal: External Blocking
PQS[6].Blo TripCmd	Signal: Trip Command blocked
PQS[6].ExBlo TripCmd	Signal: External Blocking of the Trip Command
PQS[6].Alarm	Signal: Alarm Power Protection
PQS[6].Trip	Signal: Trip Power Protection
PQS[6].TripCmd	Signal: Trip Command

General Lists

<i>Name</i>	<i>Description</i>
PQS[6].ExBlo1-I	Module input state: External blocking
PQS[6].ExBlo2-I	Module input state: External blocking
PQS[6].ExBlo TripCmd-I	Module input state: External Blocking of the Trip Command
PF[1].active	Signal: active
PF[1].ExBlo	Signal: External Blocking
PF[1].Blo TripCmd	Signal: Trip Command blocked
PF[1].ExBlo TripCmd	Signal: External Blocking of the Trip Command
PF[1].Alarm	Signal: Alarm Power Factor
PF[1].Trip	Signal: Trip Power Factor
PF[1].TripCmd	Signal: Trip Command
PF[1].Compensator	Signal: Compensation Signal
PF[1].Impossible	Signal: Alarm Power Factor Impossible
PF[1].ExBlo1-I	Module input state: External blocking
PF[1].ExBlo2-I	Module input state: External blocking
PF[1].ExBlo TripCmd-I	Module input state: External Blocking of the Trip Command
PF[2].active	Signal: active
PF[2].ExBlo	Signal: External Blocking
PF[2].Blo TripCmd	Signal: Trip Command blocked
PF[2].ExBlo TripCmd	Signal: External Blocking of the Trip Command
PF[2].Alarm	Signal: Alarm Power Factor
PF[2].Trip	Signal: Trip Power Factor
PF[2].TripCmd	Signal: Trip Command
PF[2].Compensator	Signal: Compensation Signal
PF[2].Impossible	Signal: Alarm Power Factor Impossible
PF[2].ExBlo1-I	Module input state: External blocking
PF[2].ExBlo2-I	Module input state: External blocking
PF[2].ExBlo TripCmd-I	Module input state: External Blocking of the Trip Command
Q->&V<.active	Signal: active
Q->&V<.ExBlo	Signal: External Blocking
Q->&V<.Fuse Fail VT Blo	Signal: Blocked by Fuse Failure (VT)
Q->&V<.Alarm	Signal: Alarm Reactive Power Undervoltage Protection
Q->&V<.Decoupling Distr. Generator	Signal: Decoupling of the (local) Energy Generator/Resource
Q->&V<.Decoupling PCC	Signal: Decoupling at the Point of Common Coupling
Q->&V<.Power Angle	Signal: Admissible power angle exceeded
Q->&V<.Reactive Power Thres	Signal: Admissible Reactive Power Threshold exceeded
Q->&V<.VLL too low	Signal: Line-to-Line voltage too low
Q->&V<.ExBlo1-I	Module input state: External blocking1
Q->&V<.ExBlo2-I	Module input state: External blocking2

General Lists

<i>Name</i>	<i>Description</i>
ReCon[1].active	Signal: active
ReCon[1].ExBlo	Signal: External Blocking
ReCon[1].Blo by Meas Circuit Superv	Signal: Module blocked by measuring circuit supervision
ReCon[1].Release Energy Resource	Signal: Release Energy Resource.
ReCon[1].ExBlo1-I	Module input state: External blocking1
ReCon[1].ExBlo2-I	Module input state: External blocking2
ReCon[1].V Ext Release PCC-I	Module input state: Release signal is being generated by the PCC (External Release)
ReCon[1].PCC Fuse Fail VT-I	State of the module input: Blocking if the fuse of a voltage transformer has tripped at the PCC.
ReCon[1].reconnected-I	This signal indicates the state "reconnected" (mains parallel).
ReCon[1].Decoupling1-I	Decoupling function, that blocks the reconnection.
ReCon[1].Decoupling2-I	Decoupling function, that blocks the reconnection.
ReCon[1].Decoupling3-I	Decoupling function, that blocks the reconnection.
ReCon[1].Decoupling4-I	Decoupling function, that blocks the reconnection.
ReCon[1].Decoupling5-I	Decoupling function, that blocks the reconnection.
ReCon[1].Decoupling6-I	Decoupling function, that blocks the reconnection.
ReCon[2].active	Signal: active
ReCon[2].ExBlo	Signal: External Blocking
ReCon[2].Blo by Meas Circuit Superv	Signal: Module blocked by measuring circuit supervision
ReCon[2].Release Energy Resource	Signal: Release Energy Resource.
ReCon[2].ExBlo1-I	Module input state: External blocking1
ReCon[2].ExBlo2-I	Module input state: External blocking2
ReCon[2].V Ext Release PCC-I	Module input state: Release signal is being generated by the PCC (External Release)
ReCon[2].PCC Fuse Fail VT-I	State of the module input: Blocking if the fuse of a voltage transformer has tripped at the PCC.
ReCon[2].reconnected-I	This signal indicates the state "reconnected" (mains parallel).
ReCon[2].Decoupling1-I	Decoupling function, that blocks the reconnection.
ReCon[2].Decoupling2-I	Decoupling function, that blocks the reconnection.
ReCon[2].Decoupling3-I	Decoupling function, that blocks the reconnection.
ReCon[2].Decoupling4-I	Decoupling function, that blocks the reconnection.
ReCon[2].Decoupling5-I	Decoupling function, that blocks the reconnection.
ReCon[2].Decoupling6-I	Decoupling function, that blocks the reconnection.
Sync.active	Signal: active
Sync.ExBlo	Signal: External Blocking
Sync.LiveBus	Signal: Live-Bus flag: 1=Live-Bus, 0=Voltage is below the LiveBus threshold
Sync.LiveLine	Signal: Live Line flag: 1=Live-Line, 0=Voltage is below the LiveLine threshold

General Lists

Name	Description
Sync.SynchronRunTiming	Signal: SynchronRunTiming
Sync.SynchronFailed	Signal: This signal indicates a failed synchronization. It is set for 5s when the circuit breaker is still open after the Synchron-Run-timer has timed out.
Sync.SyncOverridden	Signal:Synchronism Check is overridden because one of the Synchronism overriding conditions (DB/DL or ExtBypass) is met.
Sync.VDiffTooHigh	Signal: Voltage difference between bus and line too high.
Sync.SlipTooHigh	Signal: Frequency difference (slip frequency) between bus and line voltages too high.
Sync.AngleDiffTooHigh	Signal: Phase Angle difference between bus and line voltages too high.
Sync.Sys-in-Sync	Signal: Bus and line voltages are in synchronism according to the system synchronism criteria.
Sync.Ready to Close	Signal: Ready to Close
Sync.ExBlo1-I	Module input state: External blocking1
Sync.ExBlo2-I	Module input state: External blocking2
Sync.Bypass-I	State of the module input: Bypass
Sync.CBCloseInitiate-I	State of the module input: Breaker Close Initiate with synchronism check from any control sources (e.g. HMI / SCADA). If the state of the assigned signal becomes true, a Breaker Close will be initiated (Trigger Source).
LoE-Z1[1].active	Signal: active
LoE-Z1[1].ExBlo	Signal: External Blocking
LoE-Z1[1].Blo TripCmd	Signal: Trip Command blocked
LoE-Z1[1].ExBlo TripCmd	Signal: External Blocking of the Trip Command
LoE-Z1[1].Alarm	Signal: Alarm Loss of Excitation
LoE-Z1[1].Trip	Signal: Trip
LoE-Z1[1].TripCmd	Signal: Trip Command
LoE-Z1[1].FastTrip V<	Signal: FastTrip V<
LoE-Z1[1].Blo by MeasCircSupv	Blocked by Measuring Circuit Supervision
LoE-Z1[1].ExBlo1-I	Module input state: External blocking1
LoE-Z1[1].ExBlo2-I	Module input state: External blocking2
LoE-Z1[1].ExBlo TripCmd-I	Module input state: External Blocking of the Trip Command
LoE-Z2[1].active	Signal: active
LoE-Z2[1].ExBlo	Signal: External Blocking
LoE-Z2[1].Blo TripCmd	Signal: Trip Command blocked
LoE-Z2[1].ExBlo TripCmd	Signal: External Blocking of the Trip Command
LoE-Z2[1].Alarm	Signal: Alarm Loss of Excitation
LoE-Z2[1].Trip	Signal: Trip
LoE-Z2[1].TripCmd	Signal: Trip Command
LoE-Z2[1].FastTrip V<	Signal: FastTrip V<
LoE-Z2[1].Blo by MeasCircSupv	Blocked by Measuring Circuit Supervision
LoE-Z2[1].ExBlo1-I	Module input state: External blocking1

<i>Name</i>	<i>Description</i>
LoE-Z2[1].ExBlo2-I	Module input state: External blocking2
LoE-Z2[1].ExBlo TripCmd-I	Module input state: External Blocking of the Trip Command
LoE-Z1[2].active	Signal: active
LoE-Z1[2].ExBlo	Signal: External Blocking
LoE-Z1[2].Blo TripCmd	Signal: Trip Command blocked
LoE-Z1[2].ExBlo TripCmd	Signal: External Blocking of the Trip Command
LoE-Z1[2].Alarm	Signal: Alarm Loss of Excitation
LoE-Z1[2].Trip	Signal: Trip
LoE-Z1[2].TripCmd	Signal: Trip Command
LoE-Z1[2].FastTrip V<	Signal: FastTrip V<
LoE-Z1[2].Blo by MeasCircSupv	Blocked by Measuring Circuit Supervision
LoE-Z1[2].ExBlo1-I	Module input state: External blocking1
LoE-Z1[2].ExBlo2-I	Module input state: External blocking2
LoE-Z1[2].ExBlo TripCmd-I	Module input state: External Blocking of the Trip Command
LoE-Z2[2].active	Signal: active
LoE-Z2[2].ExBlo	Signal: External Blocking
LoE-Z2[2].Blo TripCmd	Signal: Trip Command blocked
LoE-Z2[2].ExBlo TripCmd	Signal: External Blocking of the Trip Command
LoE-Z2[2].Alarm	Signal: Alarm Loss of Excitation
LoE-Z2[2].Trip	Signal: Trip
LoE-Z2[2].TripCmd	Signal: Trip Command
LoE-Z2[2].FastTrip V<	Signal: FastTrip V<
LoE-Z2[2].Blo by MeasCircSupv	Blocked by Measuring Circuit Supervision
LoE-Z2[2].ExBlo1-I	Module input state: External blocking1
LoE-Z2[2].ExBlo2-I	Module input state: External blocking2
LoE-Z2[2].ExBlo TripCmd-I	Module input state: External Blocking of the Trip Command
OST.active	Signal: active
OST.ExBlo	Signal: External Blocking
OST.Blo TripCmd	Signal: Trip Command blocked
OST.ExBlo TripCmd	Signal: External Blocking of the Trip Command
OST.Blo by MeasCircSupv	Blocked by Measuring Circuit Supervision
OST.Int.blocked	Signal: The module is internally blocked because the »Max. dwell time« has expired.
OST.Pickup Blinder A	Signal: The impedance is within the MHO circle on the right side of Blinder A.
OST.Pickup Blinder B	Signal: The impedance is within the MHO circle on the left side of Blinder B.
OST.Pickup Mho	Signal: The impedance is within the characteristic.

Name	Description
OST.Swinging	Signal: The impedance is within the instable swing zone (i. e. within the characteristic and inside the borders defined by Blinders A and B).
OST.Start	Signal, that a power swing (or an Out-of-step event) has been detected. The state of this signal becomes true as soon as the impedance traverses the first blinder, and it gets reset when the characteristic area is left.
OST.Pole slipping	Signal, that pole slipping has been detected. The state of this signal becomes true as soon as the impedance reaches 180°, and it gets reset when the characteristic area is left.
OST.Operate	Signal: The module is ready to send a trip command. The state of this signal becomes true as soon as the impedance traverses the second blinder, and it gets reset after the impedance has left the MHO circle.
OST.Alarm	Signal that the module has started, i. e. the impedance has entered the MHO circle and crossed the first blinder. »Alarm« is reset when the measured impedance has left the MHO circle without an »Operate«, or when the »Trip« signal is reset. If »Max.Num.Pole Slips« is greater than 1, the »Alarm« signal stays active until the »Trip« signal is reset or the »Reset Time« has expired.
OST.Trip	Signal: Trip
OST.TripCmd	Signal: Trip Command
OST.Syst.is sym.	Signal that the system state is symmetrical, i. e. the negative-sequence current is below »I2 max«, and the positive-sequence current is above »I1 min«.
OST.Blo dZ/dt	Signal: The module has detected a system fault based on the »rate of impedance change per time«, and therefore it has blocked itself.
OST.Blo min.dwell time	Signal: The module has detected a system fault based on the »minimum dwell time«, and therefore it has blocked itself.
OST.ExBlo1-I	Module input state: External blocking1
OST.ExBlo2-I	Module input state: External blocking2
OST.ExBlo TripCmd-I	Module input state: External Blocking of the Trip Command
V/f>[1].active	Signal: active
V/f>[1].ExBlo	Signal: External Blocking
V/f>[1].Blo TripCmd	Signal: Trip Command blocked
V/f>[1].ExBlo TripCmd	Signal: External Blocking of the Trip Command
V/f>[1].Alarm	Signal: Alarm Overexcitation
V/f>[1].Trip	Signal: Trip
V/f>[1].TripCmd	Signal: Trip Command
V/f>[1].ExBlo1-I	Module input state: External blocking1
V/f>[1].ExBlo2-I	Module input state: External blocking2
V/f>[1].ExBlo TripCmd-I	Module input state: External Blocking of the Trip Command
V/f>[2].active	Signal: active
V/f>[2].ExBlo	Signal: External Blocking
V/f>[2].Blo TripCmd	Signal: Trip Command blocked
V/f>[2].ExBlo TripCmd	Signal: External Blocking of the Trip Command
V/f>[2].Alarm	Signal: Alarm Overexcitation
V/f>[2].Trip	Signal: Trip
V/f>[2].TripCmd	Signal: Trip Command

General Lists

<i>Name</i>	<i>Description</i>
V/f>[2].ExBlo1-I	Module input state: External blocking1
V/f>[2].ExBlo2-I	Module input state: External blocking2
V/f>[2].ExBlo TripCmd-I	Module input state: External Blocking of the Trip Command
InEn.active	Signal: active
InEn.ExBlo	Signal: External Blocking
InEn.Blo TripCmd	Signal: Trip Command blocked
InEn.ExBlo TripCmd	Signal: External Blocking of the Trip Command
InEn.Alarm	Signal: Inadvertent Energization
InEn.Trip	Signal: Trip
InEn.TripCmd	Signal: Trip Command
InEn.Blo by MeasCircSupv	Blocked by Measuring Circuit Supervision
InEn.ExBlo1-I	Module input state: External blocking1
InEn.ExBlo2-I	Module input state: External blocking2
InEn.ExBlo TripCmd-I	Module input state: External Blocking of the Trip Command
Z[1].active	Signal: active
Z[1].ExBlo	Signal: External Blocking
Z[1].Blo TripCmd	Signal: Trip Command blocked
Z[1].ExBlo TripCmd	Signal: External Blocking of the Trip Command
Z[1].Blo by Power Swing	Signal: Distance Protection blocked by Power Swing detection
Z[1].Blo by LB	Signal: Distance Protection blocked by Load Blinder module
Z[1].Blo by MeasCircSupv	Blocked by Measuring Circuit Supervision
Z[1].Started	Signal: Distance Protection has been started.
Z[1].Alarm	Alarm
Z[1].Trip	Trip
Z[1].TripCmd	Signal: Trip Command
Z[1].Fault type L1-L2	Fault type: L1-L2
Z[1].Fault type L2-L3	Fault type: L2-L3
Z[1].Fault type L3-L1	Fault type: L3-L1
Z[1].Fault type L1-L2-L3	Fault type: L1-L2-L3
Z[1].DefaultSet	Signal: Default Parameter Set
Z[1].AdaptSet 1	Signal: Adaptive Parameter 1
Z[1].AdaptSet 2	Signal: Adaptive Parameter 2
Z[1].ExBlo1-I	Module input state: External blocking1
Z[1].ExBlo2-I	Module input state: External blocking2
Z[1].ExBlo TripCmd-I	Module input state: External Blocking of the Trip Command
Z[1].Blo by Power Swing-I	Module input state: Blocking (of the distance protection) by Power Swing detection
Z[1].Blo by LB-I	Module input state: Blocking (of the distance protection) by Load Blinder module
Z[1].AdaptSet1-I	Module input state: Adaptive Parameter1

<i>Name</i>	<i>Description</i>
Z[1].AdaptSet2-I	Module input state: Adaptive Parameter2
Z[2].active	Signal: active
Z[2].ExBlo	Signal: External Blocking
Z[2].Blo TripCmd	Signal: Trip Command blocked
Z[2].ExBlo TripCmd	Signal: External Blocking of the Trip Command
Z[2].Blo by Power Swing	Signal: Distance Protection blocked by Power Swing detection
Z[2].Blo by LB	Signal: Distance Protection blocked by Load Blinder module
Z[2].Blo by MeasCircSupv	Blocked by Measuring Circuit Supervision
Z[2].Started	Signal: Distance Protection has been started.
Z[2].Alarm	Alarm
Z[2].Trip	Trip
Z[2].TripCmd	Signal: Trip Command
Z[2].Fault type L1-L2	Fault type: L1-L2
Z[2].Fault type L2-L3	Fault type: L2-L3
Z[2].Fault type L3-L1	Fault type: L3-L1
Z[2].Fault type L1-L2-L3	Fault type: L1-L2-L3
Z[2].DefaultSet	Signal: Default Parameter Set
Z[2].AdaptSet 1	Signal: Adaptive Parameter 1
Z[2].AdaptSet 2	Signal: Adaptive Parameter 2
Z[2].ExBlo1-I	Module input state: External blocking1
Z[2].ExBlo2-I	Module input state: External blocking2
Z[2].ExBlo TripCmd-I	Module input state: External Blocking of the Trip Command
Z[2].Blo by Power Swing-I	Module input state: Blocking (of the distance protection) by Power Swing detection
Z[2].Blo by LB-I	Module input state: Blocking (of the distance protection) by Load Blinder module
Z[2].AdaptSet1-I	Module input state: Adaptive Parameter1
Z[2].AdaptSet2-I	Module input state: Adaptive Parameter2
LB.active	Signal: active
LB.ExBlo	Signal: External Blocking
LB.Blo by MeasCircSupv	Blocked by Measuring Circuit Supervision
LB.Pickup	Signal that the measured system impedance is within the Load Blinder area.
LB.Operate	Signal that the measured system impedance is within the Load Blinder area for at least the duration t-Delay.
LB.ExBlo1-I	Module input state: External blocking1
LB.ExBlo2-I	Module input state: External blocking2
PSB.active	Signal: active
PSB.ExBlo	Signal: External Blocking
PSB.Blo by MeasCircSupv	Blocked by Measuring Circuit Supervision
PSB.Int.blocked	Signal: The module is internally blocked because the »Max. dwell time« has expired.

<i>Name</i>	<i>Description</i>
PSB.Pickup Blinder A	Signal: The impedance is within the MHO circle on the right side of Blinder A.
PSB.Pickup Blinder B	Signal: The impedance is within the MHO circle on the left side of Blinder B.
PSB.Pickup Mho	Signal: The impedance is within the characteristic.
PSB.Swinging	Signal: The impedance is within the instable swing zone (i. e. within the characteristic and inside the borders defined by Blinders A and B).
PSB.Start	Signal, that a power swing (or an Out-of-step event) has been detected. The state of this signal becomes true as soon as the impedance traverses the first blinder, and it gets reset when the characteristic area is left.
PSB.Pole slipping	Signal, that pole slipping has been detected. The state of this signal becomes true as soon as the impedance reaches 180°, and it gets reset when the characteristic area is left.
PSB.Syst.is sym.	Signal that the system state is symmetrical, i. e. the negative-sequence current is below »I2 max«, and the positive-sequence current is above »I1 min«.
PSB.Blo dZ/dt	Signal: The module has detected a system fault based on the »rate of impedance change per time«, and therefore it has blocked itself.
PSB.Blo min.dwell time	Signal: The module has detected a system fault based on the »minimum dwell time«, and therefore it has blocked itself.
PSB.ExBlo1-I	Module input state: External blocking1
PSB.ExBlo2-I	Module input state: External blocking2
SOTF.active	Signal: active
SOTF.ExBlo	Signal: External Blocking
SOTF.Ex rev Interl	Signal: External reverse Interlocking
SOTF.enabled	Signal: Switch Onto Fault enabled. This Signal can be used to modify Overcurrent Protection Settings.
SOTF.I<	Signal: No Load Current.
SOTF.ExBlo1-I	Module input state: External blocking
SOTF.ExBlo2-I	Module input state: External blocking
SOTF.Ex rev Interl-I	Module input state: External reverse interlocking
SOTF.Ext SOTF-I	Module input state: External Switch Onto Fault Alarm
CLPU.active	Signal: active
CLPU.ExBlo	Signal: External Blocking
CLPU.Ex rev Interl	Signal: External reverse Interlocking
CLPU.enabled	Signal: Cold Load enabled
CLPU.detected	Signal: Cold Load detected
CLPU.I<	Signal: No Load Current.
CLPU.Load Inrush	Signal: Load Inrush
CLPU.Settle Time	Signal: Settle Time
CLPU.ExBlo1-I	Module input state: External blocking
CLPU.ExBlo2-I	Module input state: External blocking
CLPU.Ex rev Interl-I	Module input state: External reverse interlocking
Exp[1].active	Signal: active
Exp[1].ExBlo	Signal: External Blocking
Exp[1].Blo TripCmd	Signal: Trip Command blocked

General Lists

<i>Name</i>	<i>Description</i>
Exp[1].ExBlo TripCmd	Signal: External Blocking of the Trip Command
Exp[1].Alarm	Signal: Alarm
Exp[1].Trip	Signal: Trip
Exp[1].TripCmd	Signal: Trip Command
Exp[1].ExBlo1-I	Module input state: External blocking1
Exp[1].ExBlo2-I	Module input state: External blocking2
Exp[1].ExBlo TripCmd-I	Module input state: External Blocking of the Trip Command
Exp[1].Alarm-I	Module input state: Alarm
Exp[1].Trip-I	Module input state: Trip
Exp[2].active	Signal: active
Exp[2].ExBlo	Signal: External Blocking
Exp[2].Blo TripCmd	Signal: Trip Command blocked
Exp[2].ExBlo TripCmd	Signal: External Blocking of the Trip Command
Exp[2].Alarm	Signal: Alarm
Exp[2].Trip	Signal: Trip
Exp[2].TripCmd	Signal: Trip Command
Exp[2].ExBlo1-I	Module input state: External blocking1
Exp[2].ExBlo2-I	Module input state: External blocking2
Exp[2].ExBlo TripCmd-I	Module input state: External Blocking of the Trip Command
Exp[2].Alarm-I	Module input state: Alarm
Exp[2].Trip-I	Module input state: Trip
Exp[3].active	Signal: active
Exp[3].ExBlo	Signal: External Blocking
Exp[3].Blo TripCmd	Signal: Trip Command blocked
Exp[3].ExBlo TripCmd	Signal: External Blocking of the Trip Command
Exp[3].Alarm	Signal: Alarm
Exp[3].Trip	Signal: Trip
Exp[3].TripCmd	Signal: Trip Command
Exp[3].ExBlo1-I	Module input state: External blocking1
Exp[3].ExBlo2-I	Module input state: External blocking2
Exp[3].ExBlo TripCmd-I	Module input state: External Blocking of the Trip Command
Exp[3].Alarm-I	Module input state: Alarm
Exp[3].Trip-I	Module input state: Trip
Exp[4].active	Signal: active
Exp[4].ExBlo	Signal: External Blocking
Exp[4].Blo TripCmd	Signal: Trip Command blocked
Exp[4].ExBlo TripCmd	Signal: External Blocking of the Trip Command
Exp[4].Alarm	Signal: Alarm
Exp[4].Trip	Signal: Trip
Exp[4].TripCmd	Signal: Trip Command

General Lists

<i>Name</i>	<i>Description</i>
Exp[4].ExBlo1-I	Module input state: External blocking1
Exp[4].ExBlo2-I	Module input state: External blocking2
Exp[4].ExBlo TripCmd-I	Module input state: External Blocking of the Trip Command
Exp[4].Alarm-I	Module input state: Alarm
Exp[4].Trip-I	Module input state: Trip
Ext Sudd Press.active	Signal: active
Ext Sudd Press.ExBlo	Signal: External Blocking
Ext Sudd Press.Blo TripCmd	Signal: Trip Command blocked
Ext Sudd Press.ExBlo TripCmd	Signal: External Blocking of the Trip Command
Ext Sudd Press.Alarm	Signal: Alarm
Ext Sudd Press.Trip	Signal: Trip
Ext Sudd Press.TripCmd	Signal: Trip Command
Ext Sudd Press.ExBlo1-I	Module input state: External blocking1
Ext Sudd Press.ExBlo2-I	Module input state: External blocking2
Ext Sudd Press.ExBlo TripCmd-I	Module input state: External Blocking of the Trip Command
Ext Sudd Press.Alarm-I	Module input state: Alarm
Ext Sudd Press.Trip-I	Module input state: Trip
Ext Oil Temp.active	Signal: active
Ext Oil Temp.ExBlo	Signal: External Blocking
Ext Oil Temp.Blo TripCmd	Signal: Trip Command blocked
Ext Oil Temp.ExBlo TripCmd	Signal: External Blocking of the Trip Command
Ext Oil Temp.Alarm	Signal: Alarm
Ext Oil Temp.Trip	Signal: Trip
Ext Oil Temp.TripCmd	Signal: Trip Command
Ext Oil Temp.ExBlo1-I	Module input state: External blocking1
Ext Oil Temp.ExBlo2-I	Module input state: External blocking2
Ext Oil Temp.ExBlo TripCmd-I	Module input state: External Blocking of the Trip Command
Ext Oil Temp.Alarm-I	Module input state: Alarm
Ext Oil Temp.Trip-I	Module input state: Trip
Ext Temp Superv[1].active	Signal: active
Ext Temp Superv[1].ExBlo	Signal: External Blocking
Ext Temp Superv[1].Blo TripCmd	Signal: Trip Command blocked

General Lists

Name	Description
Ext Temp Superv[1].ExBlo TripCmd	Signal: External Blocking of the Trip Command
Ext Temp Superv[1].Alarm	Signal: Alarm
Ext Temp Superv[1].Trip	Signal: Trip
Ext Temp Superv[1].TripCmd	Signal: Trip Command
Ext Temp Superv[1].ExBlo1-I	Module input state: External blocking1
Ext Temp Superv[1].ExBlo2-I	Module input state: External blocking2
Ext Temp Superv[1].ExBlo TripCmd-I	Module input state: External Blocking of the Trip Command
Ext Temp Superv[1].Alarm-I	Module input state: Alarm
Ext Temp Superv[1].Trip-I	Module input state: Trip
Ext Temp Superv[2].active	Signal: active
Ext Temp Superv[2].ExBlo	Signal: External Blocking
Ext Temp Superv[2].Blo TripCmd	Signal: Trip Command blocked
Ext Temp Superv[2].ExBlo TripCmd	Signal: External Blocking of the Trip Command
Ext Temp Superv[2].Alarm	Signal: Alarm
Ext Temp Superv[2].Trip	Signal: Trip
Ext Temp Superv[2].TripCmd	Signal: Trip Command
Ext Temp Superv[2].ExBlo1-I	Module input state: External blocking1
Ext Temp Superv[2].ExBlo2-I	Module input state: External blocking2
Ext Temp Superv[2].ExBlo TripCmd-I	Module input state: External Blocking of the Trip Command
Ext Temp Superv[2].Alarm-I	Module input state: Alarm
Ext Temp Superv[2].Trip-I	Module input state: Trip
Ext Temp Superv[3].active	Signal: active
Ext Temp Superv[3].ExBlo	Signal: External Blocking

General Lists

<i>Name</i>	<i>Description</i>
Ext Temp Superv[3].Blo TripCmd	Signal: Trip Command blocked
Ext Temp Superv[3].ExBlo TripCmd	Signal: External Blocking of the Trip Command
Ext Temp Superv[3].Alarm	Signal: Alarm
Ext Temp Superv[3].Trip	Signal: Trip
Ext Temp Superv[3].TripCmd	Signal: Trip Command
Ext Temp Superv[3].ExBlo1-I	Module input state: External blocking1
Ext Temp Superv[3].ExBlo2-I	Module input state: External blocking2
Ext Temp Superv[3].ExBlo TripCmd-I	Module input state: External Blocking of the Trip Command
Ext Temp Superv[3].Alarm-I	Module input state: Alarm
Ext Temp Superv[3].Trip-I	Module input state: Trip
URTD.Windg1 Superv	Signal: Supervision Channel Windg1
URTD.Windg2 Superv	Signal: Supervision Channel Windg2
URTD.Windg3 Superv	Signal: Supervision Channel Windg3
URTD.Windg4 Superv	Signal: Supervision Channel Windg4
URTD.Windg5 Superv	Signal: Supervision Channel Windg5
URTD.Windg6 Superv	Signal: Supervision Channel Windg6
URTD.MotBear1 Superv	Signal: Supervision Channel MotBear1
URTD.MotBear2 Superv	Signal: Supervision Channel MotBear2
URTD.LoadBear1 Superv	Signal: Supervision Channel LoadBear1
URTD.LoadBear2 Superv	Signal: Supervision Channel LoadBear2
URTD.Aux1 Superv	Signal: Supervision Channel Aux1
URTD.Aux2 Superv	Signal: Supervision Channel Aux2
URTD.Superv	Signal: URTD Supervision Channel
URTD.active	Signal: URTD active
URTD.Outs forced	Signal: The State of at least one Relay Output has been set by force. That means that the state of at least one Relay is forced and hence does not show the state of the assigned signals.
RTD.active	Signal: active
RTD.ExBlo	Signal: External Blocking
RTD.Blo TripCmd	Signal: Trip Command blocked
RTD.ExBlo TripCmd	Signal: External Blocking of the Trip Command
RTD.Alarm	Alarm RTD Temperature Protection
RTD.Trip	Signal: Trip

General Lists

<i>Name</i>	<i>Description</i>
RTD.TripCmd	Signal: Trip Command
RTD.Windg 1 Trip	Winding 1 Signal: Trip
RTD.Windg 1 Alarm	Winding 1 Alarm RTD Temperature Protection
RTD.Windg 1 Timeout Alarm	Winding 1 Timeout Alarm
RTD.Windg 1 Invalid	Winding 1 Signal: Invalid Temperature Measurement Value (e.g caused by an defective or interrupted RTD Measurement)
RTD.Windg 2 Trip	Winding 2 Signal: Trip
RTD.Windg 2 Alarm	Winding 2 Alarm RTD Temperature Protection
RTD.Windg 2 Timeout Alarm	Winding 2 Timeout Alarm
RTD.Windg 2 Invalid	Winding 2 Signal: Invalid Temperature Measurement Value (e.g caused by an defective or interrupted RTD Measurement)
RTD.Windg 3 Trip	Winding 3 Signal: Trip
RTD.Windg 3 Alarm	Winding 3 Alarm RTD Temperature Protection
RTD.Windg 3 Timeout Alarm	Winding 3 Timeout Alarm
RTD.Windg 3 Invalid	Winding 3 Signal: Invalid Temperature Measurement Value (e.g caused by an defective or interrupted RTD Measurement)
RTD.Windg 4 Trip	Winding 4 Signal: Trip
RTD.Windg 4 Alarm	Winding 4 Alarm RTD Temperature Protection
RTD.Windg 4 Timeout Alarm	Winding 4 Timeout Alarm
RTD.Windg 4 Invalid	Winding 4 Signal: Invalid Temperature Measurement Value (e.g caused by an defective or interrupted RTD Measurement)
RTD.Windg 5 Trip	Winding 5 Signal: Trip
RTD.Windg 5 Alarm	Winding 5 Alarm RTD Temperature Protection
RTD.Windg 5 Timeout Alarm	Winding 5 Timeout Alarm
RTD.Windg 5 Invalid	Winding 5 Signal: Invalid Temperature Measurement Value (e.g caused by an defective or interrupted RTD Measurement)
RTD.Windg 6 Trip	Winding 6 Signal: Trip
RTD.Windg 6 Alarm	Winding 6 Alarm RTD Temperature Protection
RTD.Windg 6 Timeout Alarm	Winding 6 Timeout Alarm
RTD.Windg 6 Invalid	Winding 6 Signal: Invalid Temperature Measurement Value (e.g caused by an defective or interrupted RTD Measurement)
RTD.MotBear 1 Trip	Motor Bearing 1 Signal: Trip
RTD.MotBear 1 Alarm	Motor Bearing 1 Alarm RTD Temperature Protection
RTD.MotBear 1 Timeout Alarm	Motor Bearing 1 Timeout Alarm
RTD.MotBear 1 Invalid	Motor Bearing 1 Signal: Invalid Temperature Measurement Value (e.g caused by an defective or interrupted RTD Measurement)
RTD.MotBear 2 Trip	Motor Bearing 2 Signal: Trip

General Lists

<i>Name</i>	<i>Description</i>
RTD.MotBear 2 Alarm	Motor Bearing 2 Alarm RTD Temperature Protection
RTD.MotBear 2 Timeout Alarm	Motor Bearing 2 Timeout Alarm
RTD.MotBear 2 Invalid	Motor Bearing 2 Signal: Invalid Temperature Measurement Value (e.g caused by an defective or interrupted RTD Measurement)
RTD.LoadBear 1 Trip	Load Bearing 1 Signal: Trip
RTD.LoadBear 1 Alarm	Load Bearing 1 Alarm RTD Temperature Protection
RTD.LoadBear 1 Timeout Alarm	Load Bearing 1 Timeout Alarm
RTD.LoadBear 1 Invalid	Load Bearing 1 Signal: Invalid Temperature Measurement Value (e.g caused by an defective or interrupted RTD Measurement)
RTD.LoadBear 2 Trip	Load Bearing 2 Signal: Trip
RTD.LoadBear 2 Alarm	Load Bearing 2 Alarm RTD Temperature Protection
RTD.LoadBear 2 Timeout Alarm	Load Bearing 2 Timeout Alarm
RTD.LoadBear 2 Invalid	Load Bearing 2 Signal: Invalid Temperature Measurement Value (e.g caused by an defective or interrupted RTD Measurement)
RTD.Aux1 Trip	Auxiliary 1 Signal: Trip
RTD.Aux1 Alarm	Auxiliary 1 Alarm RTD Temperature Protection
RTD.Aux1 Timeout Alarm	Auxiliary 1 Timeout Alarm
RTD.Aux1 Invalid	Auxiliary 1 Signal: Invalid Temperature Measurement Value (e.g caused by an defective or interrupted RTD Measurement)
RTD.Aux2 Trip	Auxiliary 2 Signal: Trip
RTD.Aux2 Alarm	Auxiliary 2 Alarm RTD Temperature Protection
RTD.Aux2 Timeout Alarm	Auxiliary 2 Timeout Alarm
RTD.Aux2 Invalid	Auxiliary 2 Signal: Invalid Temperature Measurement Value (e.g caused by an defective or interrupted RTD Measurement)
RTD.Trip WD Group	Trip all Windings
RTD.Alarm WD Group	Alarm all Windings
RTD.TimeoutAlmWDGrp	Timeout Alarm all Windings
RTD.Windg Group Invalid	Winding Group Signal: Invalid Temperature Measurement Value (e.g caused by an defective or interrupted RTD Measurement)
RTD.Trip MB Group	Trip all Motor Bearings
RTD.Alarm MB Group	Alarm all Motor Bearings
RTD.TimeoutAlmMBGrp	Timeout Alarm all Motor Bearings
RTD.MotBear Group Invalid	Motor Bearing Group Signal: Invalid Temperature Measurement Value (e.g caused by an defective or interrupted RTD Measurement)
RTD.Trip LB Group	Trip all Load Bearings
RTD.Alarm LB Group	Alarm all Load Bearings
RTD.TimeoutAlmLBGrp	Timeout Alarm all Load Bearings
RTD.LoadBear Group Invalid	Load Bearing Group Signal: Invalid Temperature Measurement Value (e.g caused by an defective or interrupted RTD Measurement)

General Lists

<i>Name</i>	<i>Description</i>
RTD.Trip Any Group	Trip Any Group
RTD.Alarm Any Group	Alarm Any Group
RTD.TimeoutAlmAnyGrp	Timeout Alarm Any Group
RTD.Trip Group 1	Trip Group 1
RTD.Trip Group 2	Trip Group 2
RTD.Timeout Alarm	Alarm timeout expired
RTD.Trip Aux Group	Trip Auxiliary Group
RTD.Alarm Aux Group	Alarm Auxiliary Group
RTD.TimeoutAlmAuxGrp	Timeout Alarm Auxiliary Group
RTD.AuxGrpInvalid	Invalid Auxiliary Group
RTD.ExBlo1-I	Module input state: External blocking1
RTD.ExBlo2-I	Module input state: External blocking2
RTD.ExBlo TripCmd-I	Module input state: External Blocking of the Trip Command
CBF.active	Signal: active
CBF.ExBlo	Signal: External Blocking
CBF.Waiting for Trigger	Waiting for Trigger
CBF.running	Signal: CBF-Module started
CBF.Alarm	Signal: Circuit Breaker Failure
CBF.Lockout	Signal: Lockout
CBF.Res Lockout	Signal: Reset Lockout
CBF.ExBlo1-I	Module input state: External blocking1
CBF.ExBlo2-I	Module input state: External blocking2
CBF.Trigger1-I	Module Input: Trigger that will start the CBF
CBF.Trigger2-I	Module Input: Trigger that will start the CBF
CBF.Trigger3-I	Module Input: Trigger that will start the CBF
TCS.active	Signal: active
TCS.ExBlo	Signal: External Blocking
TCS.Alarm	Signal: Alarm Trip Circuit Supervision
TCS.Not Possible	Not possible because no state indicator assigned to the breaker.
TCS.Aux ON-I	Module Input State: Position indicator/check-back signal of the CB (52a)
TCS.Aux OFF-I	Module input state: Position indicator/check-back signal of the CB (52b)
TCS.ExBlo1-I	Module input state: External blocking1
TCS.ExBlo2-I	Module input state: External blocking2
CTS.active	Signal: active
CTS.ExBlo	Signal: External Blocking
CTS.Alarm	Signal: Alarm Current Transformer Measuring Circuit Supervision
CTS.ExBlo1-I	Module input state: External blocking1
CTS.ExBlo2-I	Module input state: External blocking2
LOP.active	Signal: active
LOP.ExBlo	Signal: External Blocking

<i>Name</i>	<i>Description</i>
LOP.Alarm	Signal: Alarm Loss of Potential
LOP.LOP Blo	Signal: Loss of Potential blocks other elements.
LOP.Ex FF VT	Signal: Ex FF VT
LOP.Ex FF EVT	Signal: Alarm Fuse Failure Earth Voltage Transformers
LOP.ExBlo1-I	Module input state: External blocking1
LOP.ExBlo2-I	Module input state: External blocking2
LOP.Ex FF VT-I	State of the module input: Alarm Fuse Failure Voltage Transformers
LOP.Ex FF EVT-I	State of the module input: Alarm Fuse Failure Earth Voltage Transformers
LOP.Blo Trigger1-I	State of the module input: An Alarm of this protective element will block the Loss of Potential Detection.
LOP.Blo Trigger2-I	State of the module input: An Alarm of this protective element will block the Loss of Potential Detection.
LOP.Blo Trigger3-I	State of the module input: An Alarm of this protective element will block the Loss of Potential Detection.
LOP.Blo Trigger4-I	State of the module input: An Alarm of this protective element will block the Loss of Potential Detection.
LOP.Blo Trigger5-I	State of the module input: An Alarm of this protective element will block the Loss of Potential Detection.
PQScr.Cr Oflw Ws Net	Signal: Counter Overflow Ws Net
PQScr.Cr Oflw Wp Net	Signal: Counter Overflow Wp Net
PQScr.Cr Oflw Wp+	Signal: Counter Overflow Wp+
PQScr.Cr Oflw Wp-	Signal: Counter Overflow Wp-
PQScr.Cr Oflw Wq Net	Signal: Counter Overflow Wq Net
PQScr.Cr Oflw Wq+	Signal: Counter Overflow Wq+
PQScr.Cr Oflw Wq-	Signal: Counter Overflow Wq-
PQScr.Ws Net Res Cr	Signal: Ws Net Reset Counter
PQScr.Wp Net Res Cr	Signal: Wp Net Reset Counter
PQScr.Wp+ Res Cr	Signal: Wp+ Reset Counter
PQScr.Wp- Res Cr	Signal: Wp- Reset Counter
PQScr.Wq Net Res Cr	Signal: Wq Net Reset Counter
PQScr.Wq+ Res Cr	Signal: Wq+ Reset Counter
PQScr.Wq- Res Cr	Signal: Wq- Reset Counter
PQScr.Res all Energy Cr	Signal: Reset of all Energy Counters
PQScr.Cr OflwW Ws Net	Signal: Counter Ws Net will overflow soon
PQScr.Cr OflwW Wp Net	Signal: Counter Wp Net will overflow soon
PQScr.Cr OflwW Wp+	Signal: Counter Wp+ will overflow soon
PQScr.Cr OflwW Wp-	Signal: Counter Wp- will overflow soon
PQScr.Cr OflwW Wq Net	Signal: Counter Wq Net will overflow soon
PQScr.Cr OflwW Wq+	Signal: Counter Wq+ will overflow soon
PQScr.Cr OflwW Wq-	Signal: Counter Wq- will overflow soon
SysA.active	Signal: active

General Lists

<i>Name</i>	<i>Description</i>
SysA.ExBlo	Signal: External Blocking
SysA.Alarm Watt Power	Signal: Alarm permitted Active Power exceeded
SysA.Alarm VAr Power	Signal: Alarm permitted Reactive Power exceeded
SysA.Alarm VA Power	Signal: Alarm permitted Apparent Power exceeded
SysA.Alarm Watt Demand	Signal: Alarm averaged Active Power exceeded
SysA.Alarm VAr Demand	Signal: Alarm averaged Reactive Power exceeded
SysA.Alarm VA Demand	Signal: Alarm averaged Apparent Power exceeded
SysA.Alm Current Demd	Signal: Alarm averaged demand current
SysA.Alarm I THD	Signal: Alarm Total Harmonic Distortion Current
SysA.Alarm V THD	Signal: Alarm Total Harmonic Distortion Voltage
SysA.Trip Watt Power	Signal: Trip permitted Active Power exceeded
SysA.Trip VAr Power	Signal: Trip permitted Reactive Power exceeded
SysA.Trip VA Power	Signal: Trip permitted Apparent Power exceeded
SysA.Trip Watt Demand	Signal: Trip averaged Active Power exceeded
SysA.Trip VAr Demand	Signal: Trip averaged Reactive Power exceeded
SysA.Trip VA Demand	Signal: Trip averaged Apparent Power exceeded
SysA.Trip Current Demand	Signal: Trip averaged demand current
SysA.Trip I THD	Signal: Trip Total Harmonic Distortion Current
SysA.Trip V THD	Signal: Trip Total Harmonic Distortion Voltage
SysA.ExBlo-I	Module input state: External blocking
DI Slot X1.DI 1	Signal: Digital Input
DI Slot X1.DI 2	Signal: Digital Input
DI Slot X1.DI 3	Signal: Digital Input
DI Slot X1.DI 4	Signal: Digital Input
DI Slot X1.DI 5	Signal: Digital Input
DI Slot X1.DI 6	Signal: Digital Input
DI Slot X1.DI 7	Signal: Digital Input
DI Slot X1.DI 8	Signal: Digital Input
DI Slot X5.DI 1	Signal: Digital Input
DI Slot X5.DI 2	Signal: Digital Input
DI Slot X5.DI 3	Signal: Digital Input
DI Slot X5.DI 4	Signal: Digital Input
DI Slot X5.DI 5	Signal: Digital Input
DI Slot X5.DI 6	Signal: Digital Input
DI Slot X5.DI 7	Signal: Digital Input
DI Slot X5.DI 8	Signal: Digital Input
DI Slot X6.DI 1	Signal: Digital Input
DI Slot X6.DI 2	Signal: Digital Input

Name	Description
DI Slot X6.DI 3	Signal: Digital Input
DI Slot X6.DI 4	Signal: Digital Input
DI Slot X6.DI 5	Signal: Digital Input
DI Slot X6.DI 6	Signal: Digital Input
DI Slot X6.DI 7	Signal: Digital Input
DI Slot X6.DI 8	Signal: Digital Input
BO Slot X2.BO 1	Signal: Binary Output Relay
BO Slot X2.BO 2	Signal: Binary Output Relay
BO Slot X2.BO 3	Signal: Binary Output Relay
BO Slot X2.BO 4	Signal: Binary Output Relay
BO Slot X2.BO 5	Signal: Binary Output Relay
BO Slot X2.BO 6	Signal: Binary Output Relay
BO Slot X2.DISARMED!	Signal: CAUTION! RELAYS DISARMED in order to safely perform maintenance while eliminating the risk of taking an entire process off-line. (Note: The Self Supervision Contact cannot be disarmed). YOU MUST ENSURE that the relays are ARMED AGAIN after maintenance
BO Slot X2.Outs forced	Signal: The State of at least one Relay Output has been set by force. That means that the state of at least one Relay is forced and hence does not show the state of the assigned signals.
BO Slot X5.BO 1	Signal: Binary Output Relay
BO Slot X5.BO 2	Signal: Binary Output Relay
BO Slot X5.BO 3	Signal: Binary Output Relay
BO Slot X5.BO 4	Signal: Binary Output Relay
BO Slot X5.DISARMED!	Signal: CAUTION! RELAYS DISARMED in order to safely perform maintenance while eliminating the risk of taking an entire process off-line. (Note: The Self Supervision Contact cannot be disarmed). YOU MUST ENSURE that the relays are ARMED AGAIN after maintenance
BO Slot X5.Outs forced	Signal: The State of at least one Relay Output has been set by force. That means that the state of at least one Relay is forced and hence does not show the state of the assigned signals.
BO Slot X6.BO 1	Signal: Binary Output Relay
BO Slot X6.BO 2	Signal: Binary Output Relay
BO Slot X6.BO 3	Signal: Binary Output Relay
BO Slot X6.BO 4	Signal: Binary Output Relay
BO Slot X6.BO 5	Signal: Binary Output Relay
BO Slot X6.DISARMED!	Signal: CAUTION! RELAYS DISARMED in order to safely perform maintenance while eliminating the risk of taking an entire process off-line. (Note: The Self Supervision Contact cannot be disarmed). YOU MUST ENSURE that the relays are ARMED AGAIN after maintenance
BO Slot X6.Outs forced	Signal: The State of at least one Relay Output has been set by force. That means that the state of at least one Relay is forced and hence does not show the state of the assigned signals.
AnIn[1].Broken wire	Signal: Broken wire. This signal is only valid, if the analog input is used in the 4...20 mA mode.

<i>Name</i>	<i>Description</i>
AnIn[1].Input forced	The value of analog Input has been set by force. That means that the value of the analog Input is forced and does not represent the real measured value.
AnIn[2].Broken wire	Signal: Broken wire. This signal is only valid, if the analog input is used in the 4...20 mA mode.
AnIn[2].Input forced	The value of analog Input has been set by force. That means that the value of the analog Input is forced and does not represent the real measured value.
AnaP[1].active	Signal: active
AnaP[1].ExBlo	Signal: External Blocking
AnaP[1].Blo TripCmd	Signal: Trip Command blocked
AnaP[1].ExBlo TripCmd	Signal: External Blocking of the Trip Command
AnaP[1].Pickup	Signal: Alarm Analog Input
AnaP[1].Trip	Signal: Trip
AnaP[1].TripCmd	Signal: Trip Command
AnaP[1].ExBlo1-l	Module input state: External blocking1
AnaP[1].ExBlo2-l	Module input state: External blocking2
AnaP[1].ExBlo TripCmd-l	Module input state: External Blocking of the Trip Command
AnaP[2].active	Signal: active
AnaP[2].ExBlo	Signal: External Blocking
AnaP[2].Blo TripCmd	Signal: Trip Command blocked
AnaP[2].ExBlo TripCmd	Signal: External Blocking of the Trip Command
AnaP[2].Pickup	Signal: Alarm Analog Input
AnaP[2].Trip	Signal: Trip
AnaP[2].TripCmd	Signal: Trip Command
AnaP[2].ExBlo1-l	Module input state: External blocking1
AnaP[2].ExBlo2-l	Module input state: External blocking2
AnaP[2].ExBlo TripCmd-l	Module input state: External Blocking of the Trip Command
AnaP[3].active	Signal: active
AnaP[3].ExBlo	Signal: External Blocking
AnaP[3].Blo TripCmd	Signal: Trip Command blocked
AnaP[3].ExBlo TripCmd	Signal: External Blocking of the Trip Command
AnaP[3].Pickup	Signal: Alarm Analog Input
AnaP[3].Trip	Signal: Trip
AnaP[3].TripCmd	Signal: Trip Command
AnaP[3].ExBlo1-l	Module input state: External blocking1
AnaP[3].ExBlo2-l	Module input state: External blocking2
AnaP[3].ExBlo TripCmd-l	Module input state: External Blocking of the Trip Command
AnaP[4].active	Signal: active
AnaP[4].ExBlo	Signal: External Blocking
AnaP[4].Blo TripCmd	Signal: Trip Command blocked
AnaP[4].ExBlo TripCmd	Signal: External Blocking of the Trip Command
AnaP[4].Pickup	Signal: Alarm Analog Input

<i>Name</i>	<i>Description</i>
AnaP[4].Trip	Signal: Trip
AnaP[4].TripCmd	Signal: Trip Command
AnaP[4].ExBlo1-I	Module input state: External blocking1
AnaP[4].ExBlo2-I	Module input state: External blocking2
AnaP[4].ExBlo TripCmd-I	Module input state: External Blocking of the Trip Command
AnOut[1].Force Mode	For commissioning purposes or for maintenance, Analog Outputs can be set by force. By means of this function the normal Analog Outputs can be overwritten (forced).
AnOut[2].Force Mode	For commissioning purposes or for maintenance, Analog Outputs can be set by force. By means of this function the normal Analog Outputs can be overwritten (forced).
Event rec.Res all records	Signal: All records deleted
Disturb rec.recording	Signal: Recording
Disturb rec.memory full	Signal: Memory full
Disturb rec.Clear fail	Signal: Clear failure in memory
Disturb rec.Res all records	Signal: All records deleted
Disturb rec.Res rec	Signal: Delete record
Disturb rec.Man Trigger	Signal: Manual Trigger
Disturb rec.Start1-I	State of the module input:: Trigger event / start recording if:
Disturb rec.Start2-I	State of the module input:: Trigger event / start recording if:
Disturb rec.Start3-I	State of the module input:: Trigger event / start recording if:
Disturb rec.Start4-I	State of the module input:: Trigger event / start recording if:
Disturb rec.Start5-I	State of the module input:: Trigger event / start recording if:
Disturb rec.Start6-I	State of the module input:: Trigger event / start recording if:
Disturb rec.Start7-I	State of the module input:: Trigger event / start recording if:
Disturb rec.Start8-I	State of the module input:: Trigger event / start recording if:
Fault rec.Res rec	Signal: Delete record
Trend rec.Hand Reset	Hand Reset
SSV.System Error	Signal: Device Failure
SSV.SelfSuperVision Contact	Signal: SelfSuperVision Contact
Scada.SCADA connected	At least one SCADA System is connected to the device.
Scada.SCADA not connected	No SCADA System is connected to the device
DNP3.busy	This message is set if the protocol is started. It will be reset if the protocol is shut down.
DNP3.ready	The message will be set if the protocol is successfully started and ready for data exchange.
DNP3.active	The communication with the Master (SCADA) is active. Note that for TCP/UDP, this state is permanently "Low" unless »DataLink confirm« is set to "Always".
DNP3.BinaryOutput0	Virtual Digital Output (DNP). This corresponds to a virtual binary input of the protective device.

<i>Name</i>	<i>Description</i>
DNP3.BinaryOutput1	Virtual Digital Output (DNP). This corresponds to a virtual binary input of the protective device.
DNP3.BinaryOutput2	Virtual Digital Output (DNP). This corresponds to a virtual binary input of the protective device.
DNP3.BinaryOutput3	Virtual Digital Output (DNP). This corresponds to a virtual binary input of the protective device.
DNP3.BinaryOutput4	Virtual Digital Output (DNP). This corresponds to a virtual binary input of the protective device.
DNP3.BinaryOutput5	Virtual Digital Output (DNP). This corresponds to a virtual binary input of the protective device.
DNP3.BinaryOutput6	Virtual Digital Output (DNP). This corresponds to a virtual binary input of the protective device.
DNP3.BinaryOutput7	Virtual Digital Output (DNP). This corresponds to a virtual binary input of the protective device.
DNP3.BinaryOutput8	Virtual Digital Output (DNP). This corresponds to a virtual binary input of the protective device.
DNP3.BinaryOutput9	Virtual Digital Output (DNP). This corresponds to a virtual binary input of the protective device.
DNP3.BinaryOutput10	Virtual Digital Output (DNP). This corresponds to a virtual binary input of the protective device.
DNP3.BinaryOutput11	Virtual Digital Output (DNP). This corresponds to a virtual binary input of the protective device.
DNP3.BinaryOutput12	Virtual Digital Output (DNP). This corresponds to a virtual binary input of the protective device.
DNP3.BinaryOutput13	Virtual Digital Output (DNP). This corresponds to a virtual binary input of the protective device.
DNP3.BinaryOutput14	Virtual Digital Output (DNP). This corresponds to a virtual binary input of the protective device.
DNP3.BinaryOutput15	Virtual Digital Output (DNP). This corresponds to a virtual binary input of the protective device.
DNP3.BinaryOutput16	Virtual Digital Output (DNP). This corresponds to a virtual binary input of the protective device.
DNP3.BinaryOutput17	Virtual Digital Output (DNP). This corresponds to a virtual binary input of the protective device.
DNP3.BinaryOutput18	Virtual Digital Output (DNP). This corresponds to a virtual binary input of the protective device.
DNP3.BinaryOutput19	Virtual Digital Output (DNP). This corresponds to a virtual binary input of the protective device.
DNP3.BinaryOutput20	Virtual Digital Output (DNP). This corresponds to a virtual binary input of the protective device.
DNP3.BinaryOutput21	Virtual Digital Output (DNP). This corresponds to a virtual binary input of the protective device.
DNP3.BinaryOutput22	Virtual Digital Output (DNP). This corresponds to a virtual binary input of the protective device.
DNP3.BinaryOutput23	Virtual Digital Output (DNP). This corresponds to a virtual binary input of the protective device.

<i>Name</i>	<i>Description</i>
DNP3.BinaryOutput24	Virtual Digital Output (DNP). This corresponds to a virtual binary input of the protective device.
DNP3.BinaryOutput25	Virtual Digital Output (DNP). This corresponds to a virtual binary input of the protective device.
DNP3.BinaryOutput26	Virtual Digital Output (DNP). This corresponds to a virtual binary input of the protective device.
DNP3.BinaryOutput27	Virtual Digital Output (DNP). This corresponds to a virtual binary input of the protective device.
DNP3.BinaryOutput28	Virtual Digital Output (DNP). This corresponds to a virtual binary input of the protective device.
DNP3.BinaryOutput29	Virtual Digital Output (DNP). This corresponds to a virtual binary input of the protective device.
DNP3.BinaryOutput30	Virtual Digital Output (DNP). This corresponds to a virtual binary input of the protective device.
DNP3.BinaryOutput31	Virtual Digital Output (DNP). This corresponds to a virtual binary input of the protective device.
DNP3.BinaryInput0-I	Virtual Digital Input (DNP). This corresponds to a virtual binary output of the protective device.
DNP3.BinaryInput1-I	Virtual Digital Input (DNP). This corresponds to a virtual binary output of the protective device.
DNP3.BinaryInput2-I	Virtual Digital Input (DNP). This corresponds to a virtual binary output of the protective device.
DNP3.BinaryInput3-I	Virtual Digital Input (DNP). This corresponds to a virtual binary output of the protective device.
DNP3.BinaryInput4-I	Virtual Digital Input (DNP). This corresponds to a virtual binary output of the protective device.
DNP3.BinaryInput5-I	Virtual Digital Input (DNP). This corresponds to a virtual binary output of the protective device.
DNP3.BinaryInput6-I	Virtual Digital Input (DNP). This corresponds to a virtual binary output of the protective device.
DNP3.BinaryInput7-I	Virtual Digital Input (DNP). This corresponds to a virtual binary output of the protective device.
DNP3.BinaryInput8-I	Virtual Digital Input (DNP). This corresponds to a virtual binary output of the protective device.
DNP3.BinaryInput9-I	Virtual Digital Input (DNP). This corresponds to a virtual binary output of the protective device.
DNP3.BinaryInput10-I	Virtual Digital Input (DNP). This corresponds to a virtual binary output of the protective device.
DNP3.BinaryInput11-I	Virtual Digital Input (DNP). This corresponds to a virtual binary output of the protective device.
DNP3.BinaryInput12-I	Virtual Digital Input (DNP). This corresponds to a virtual binary output of the protective device.
DNP3.BinaryInput13-I	Virtual Digital Input (DNP). This corresponds to a virtual binary output of the protective device.
DNP3.BinaryInput14-I	Virtual Digital Input (DNP). This corresponds to a virtual binary output of the protective device.

General Lists

Name	Description
DNP3.BinaryInput61-I	Virtual Digital Input (DNP). This corresponds to a virtual binary output of the protective device.
DNP3.BinaryInput62-I	Virtual Digital Input (DNP). This corresponds to a virtual binary output of the protective device.
DNP3.BinaryInput63-I	Virtual Digital Input (DNP). This corresponds to a virtual binary output of the protective device.
Modbus.Transmission RTU	Signal: SCADA active
Modbus.Transmission TCP	Signal: SCADA active
Modbus.Scada Cmd 1	Scada Command
Modbus.Scada Cmd 2	Scada Command
Modbus.Scada Cmd 3	Scada Command
Modbus.Scada Cmd 4	Scada Command
Modbus.Scada Cmd 5	Scada Command
Modbus.Scada Cmd 6	Scada Command
Modbus.Scada Cmd 7	Scada Command
Modbus.Scada Cmd 8	Scada Command
Modbus.Scada Cmd 9	Scada Command
Modbus.Scada Cmd 10	Scada Command
Modbus.Scada Cmd 11	Scada Command
Modbus.Scada Cmd 12	Scada Command
Modbus.Scada Cmd 13	Scada Command
Modbus.Scada Cmd 14	Scada Command
Modbus.Scada Cmd 15	Scada Command
Modbus.Scada Cmd 16	Scada Command
Modbus.Config Bin Inp1-I	State of the module input: Config Bin Inp
Modbus.Config Bin Inp2-I	State of the module input: Config Bin Inp
Modbus.Config Bin Inp3-I	State of the module input: Config Bin Inp
Modbus.Config Bin Inp4-I	State of the module input: Config Bin Inp
Modbus.Config Bin Inp5-I	State of the module input: Config Bin Inp
Modbus.Config Bin Inp6-I	State of the module input: Config Bin Inp
Modbus.Config Bin Inp7-I	State of the module input: Config Bin Inp
Modbus.Config Bin Inp8-I	State of the module input: Config Bin Inp
Modbus.Config Bin Inp9-I	State of the module input: Config Bin Inp
Modbus.Config Bin Inp10-I	State of the module input: Config Bin Inp
Modbus.Config Bin Inp11-I	State of the module input: Config Bin Inp
Modbus.Config Bin Inp12-I	State of the module input: Config Bin Inp
Modbus.Config Bin Inp13-I	State of the module input: Config Bin Inp

General Lists

<i>Name</i>	<i>Description</i>
Modbus.Config Bin Inp14-I	State of the module input: Config Bin Inp
Modbus.Config Bin Inp15-I	State of the module input: Config Bin Inp
Modbus.Config Bin Inp16-I	State of the module input: Config Bin Inp
Modbus.Config Bin Inp17-I	State of the module input: Config Bin Inp
Modbus.Config Bin Inp18-I	State of the module input: Config Bin Inp
Modbus.Config Bin Inp19-I	State of the module input: Config Bin Inp
Modbus.Config Bin Inp20-I	State of the module input: Config Bin Inp
Modbus.Config Bin Inp21-I	State of the module input: Config Bin Inp
Modbus.Config Bin Inp22-I	State of the module input: Config Bin Inp
Modbus.Config Bin Inp23-I	State of the module input: Config Bin Inp
Modbus.Config Bin Inp24-I	State of the module input: Config Bin Inp
Modbus.Config Bin Inp25-I	State of the module input: Config Bin Inp
Modbus.Config Bin Inp26-I	State of the module input: Config Bin Inp
Modbus.Config Bin Inp27-I	State of the module input: Config Bin Inp
Modbus.Config Bin Inp28-I	State of the module input: Config Bin Inp
Modbus.Config Bin Inp29-I	State of the module input: Config Bin Inp
Modbus.Config Bin Inp30-I	State of the module input: Config Bin Inp
Modbus.Config Bin Inp31-I	State of the module input: Config Bin Inp
Modbus.Config Bin Inp32-I	State of the module input: Config Bin Inp
IEC61850.MMS Client connected	At least one MMS client is connected to the device
IEC61850.All Goose Subscriber active	All Goose subscriber in the device are working
IEC61850.VirtInp1	Signal: Virtual Input (IEC61850 GGIO Ind)
IEC61850.VirtInp2	Signal: Virtual Input (IEC61850 GGIO Ind)
IEC61850.VirtInp3	Signal: Virtual Input (IEC61850 GGIO Ind)
IEC61850.VirtInp4	Signal: Virtual Input (IEC61850 GGIO Ind)

General Lists

<i>Name</i>	<i>Description</i>
IEC61850.VirtInp5	Signal: Virtual Input (IEC61850 GGIO Ind)
IEC61850.VirtInp6	Signal: Virtual Input (IEC61850 GGIO Ind)
IEC61850.VirtInp7	Signal: Virtual Input (IEC61850 GGIO Ind)
IEC61850.VirtInp8	Signal: Virtual Input (IEC61850 GGIO Ind)
IEC61850.VirtInp9	Signal: Virtual Input (IEC61850 GGIO Ind)
IEC61850.VirtInp10	Signal: Virtual Input (IEC61850 GGIO Ind)
IEC61850.VirtInp11	Signal: Virtual Input (IEC61850 GGIO Ind)
IEC61850.VirtInp12	Signal: Virtual Input (IEC61850 GGIO Ind)
IEC61850.VirtInp13	Signal: Virtual Input (IEC61850 GGIO Ind)
IEC61850.VirtInp14	Signal: Virtual Input (IEC61850 GGIO Ind)
IEC61850.VirtInp15	Signal: Virtual Input (IEC61850 GGIO Ind)
IEC61850.VirtInp16	Signal: Virtual Input (IEC61850 GGIO Ind)
IEC61850.VirtInp17	Signal: Virtual Input (IEC61850 GGIO Ind)
IEC61850.VirtInp18	Signal: Virtual Input (IEC61850 GGIO Ind)
IEC61850.VirtInp19	Signal: Virtual Input (IEC61850 GGIO Ind)
IEC61850.VirtInp20	Signal: Virtual Input (IEC61850 GGIO Ind)
IEC61850.VirtInp21	Signal: Virtual Input (IEC61850 GGIO Ind)
IEC61850.VirtInp22	Signal: Virtual Input (IEC61850 GGIO Ind)
IEC61850.VirtInp23	Signal: Virtual Input (IEC61850 GGIO Ind)
IEC61850.VirtInp24	Signal: Virtual Input (IEC61850 GGIO Ind)
IEC61850.VirtInp25	Signal: Virtual Input (IEC61850 GGIO Ind)
IEC61850.VirtInp26	Signal: Virtual Input (IEC61850 GGIO Ind)
IEC61850.VirtInp27	Signal: Virtual Input (IEC61850 GGIO Ind)
IEC61850.VirtInp28	Signal: Virtual Input (IEC61850 GGIO Ind)
IEC61850.VirtInp29	Signal: Virtual Input (IEC61850 GGIO Ind)
IEC61850.VirtInp30	Signal: Virtual Input (IEC61850 GGIO Ind)
IEC61850.VirtInp31	Signal: Virtual Input (IEC61850 GGIO Ind)
IEC61850.VirtInp32	Signal: Virtual Input (IEC61850 GGIO Ind)
IEC61850.Quality of GGIO In1	Self-Supervision of the GGIO Input
IEC61850.Quality of GGIO In2	Self-Supervision of the GGIO Input
IEC61850.Quality of GGIO In3	Self-Supervision of the GGIO Input
IEC61850.Quality of GGIO In4	Self-Supervision of the GGIO Input
IEC61850.Quality of GGIO In5	Self-Supervision of the GGIO Input
IEC61850.Quality of GGIO In6	Self-Supervision of the GGIO Input
IEC61850.Quality of GGIO In7	Self-Supervision of the GGIO Input

General Lists

Name	Description
IEC61850.Quality of GGIO In8	Self-Supervision of the GGIO Input
IEC61850.Quality of GGIO In9	Self-Supervision of the GGIO Input
IEC61850.Quality of GGIO In10	Self-Supervision of the GGIO Input
IEC61850.Quality of GGIO In11	Self-Supervision of the GGIO Input
IEC61850.Quality of GGIO In12	Self-Supervision of the GGIO Input
IEC61850.Quality of GGIO In13	Self-Supervision of the GGIO Input
IEC61850.Quality of GGIO In14	Self-Supervision of the GGIO Input
IEC61850.Quality of GGIO In15	Self-Supervision of the GGIO Input
IEC61850.Quality of GGIO In16	Self-Supervision of the GGIO Input
IEC61850.Quality of GGIO In17	Self-Supervision of the GGIO Input
IEC61850.Quality of GGIO In18	Self-Supervision of the GGIO Input
IEC61850.Quality of GGIO In19	Self-Supervision of the GGIO Input
IEC61850.Quality of GGIO In20	Self-Supervision of the GGIO Input
IEC61850.Quality of GGIO In21	Self-Supervision of the GGIO Input
IEC61850.Quality of GGIO In22	Self-Supervision of the GGIO Input
IEC61850.Quality of GGIO In23	Self-Supervision of the GGIO Input
IEC61850.Quality of GGIO In24	Self-Supervision of the GGIO Input
IEC61850.Quality of GGIO In25	Self-Supervision of the GGIO Input
IEC61850.Quality of GGIO In26	Self-Supervision of the GGIO Input
IEC61850.Quality of GGIO In27	Self-Supervision of the GGIO Input
IEC61850.Quality of GGIO In28	Self-Supervision of the GGIO Input
IEC61850.Quality of GGIO In29	Self-Supervision of the GGIO Input
IEC61850.Quality of GGIO In30	Self-Supervision of the GGIO Input

<i>Name</i>	<i>Description</i>
IEC61850.Quality of GGIO In31	Self-Supervision of the GGIO Input
IEC61850.Quality of GGIO In32	Self-Supervision of the GGIO Input
IEC61850.SPCSO1	Status bit that can be set by clients like e.g. SCADA (Single Point Controllable Status Output).
IEC61850.SPCSO2	Status bit that can be set by clients like e.g. SCADA (Single Point Controllable Status Output).
IEC61850.SPCSO3	Status bit that can be set by clients like e.g. SCADA (Single Point Controllable Status Output).
IEC61850.SPCSO4	Status bit that can be set by clients like e.g. SCADA (Single Point Controllable Status Output).
IEC61850.SPCSO5	Status bit that can be set by clients like e.g. SCADA (Single Point Controllable Status Output).
IEC61850.SPCSO6	Status bit that can be set by clients like e.g. SCADA (Single Point Controllable Status Output).
IEC61850.SPCSO7	Status bit that can be set by clients like e.g. SCADA (Single Point Controllable Status Output).
IEC61850.SPCSO8	Status bit that can be set by clients like e.g. SCADA (Single Point Controllable Status Output).
IEC61850.SPCSO9	Status bit that can be set by clients like e.g. SCADA (Single Point Controllable Status Output).
IEC61850.SPCSO10	Status bit that can be set by clients like e.g. SCADA (Single Point Controllable Status Output).
IEC61850.SPCSO11	Status bit that can be set by clients like e.g. SCADA (Single Point Controllable Status Output).
IEC61850.SPCSO12	Status bit that can be set by clients like e.g. SCADA (Single Point Controllable Status Output).
IEC61850.SPCSO13	Status bit that can be set by clients like e.g. SCADA (Single Point Controllable Status Output).
IEC61850.SPCSO14	Status bit that can be set by clients like e.g. SCADA (Single Point Controllable Status Output).
IEC61850.SPCSO15	Status bit that can be set by clients like e.g. SCADA (Single Point Controllable Status Output).
IEC61850.SPCSO16	Status bit that can be set by clients like e.g. SCADA (Single Point Controllable Status Output).
IEC61850.SPCSO17	Status bit that can be set by clients like e.g. SCADA (Single Point Controllable Status Output).
IEC61850.SPCSO18	Status bit that can be set by clients like e.g. SCADA (Single Point Controllable Status Output).
IEC61850.SPCSO19	Status bit that can be set by clients like e.g. SCADA (Single Point Controllable Status Output).
IEC61850.SPCSO20	Status bit that can be set by clients like e.g. SCADA (Single Point Controllable Status Output).
IEC61850.SPCSO21	Status bit that can be set by clients like e.g. SCADA (Single Point Controllable Status Output).

<i>Name</i>	<i>Description</i>
IEC61850.SPCSO22	Status bit that can be set by clients like e.g. SCADA (Single Point Controllable Status Output).
IEC61850.SPCSO23	Status bit that can be set by clients like e.g. SCADA (Single Point Controllable Status Output).
IEC61850.SPCSO24	Status bit that can be set by clients like e.g. SCADA (Single Point Controllable Status Output).
IEC61850.SPCSO25	Status bit that can be set by clients like e.g. SCADA (Single Point Controllable Status Output).
IEC61850.SPCSO26	Status bit that can be set by clients like e.g. SCADA (Single Point Controllable Status Output).
IEC61850.SPCSO27	Status bit that can be set by clients like e.g. SCADA (Single Point Controllable Status Output).
IEC61850.SPCSO28	Status bit that can be set by clients like e.g. SCADA (Single Point Controllable Status Output).
IEC61850.SPCSO29	Status bit that can be set by clients like e.g. SCADA (Single Point Controllable Status Output).
IEC61850.SPCSO30	Status bit that can be set by clients like e.g. SCADA (Single Point Controllable Status Output).
IEC61850.SPCSO31	Status bit that can be set by clients like e.g. SCADA (Single Point Controllable Status Output).
IEC61850.SPCSO32	Status bit that can be set by clients like e.g. SCADA (Single Point Controllable Status Output).
IEC61850.VirtOut1-I	Module input state: Binary state of the Virtual Output (GGIO)
IEC61850.VirtOut2-I	Module input state: Binary state of the Virtual Output (GGIO)
IEC61850.VirtOut3-I	Module input state: Binary state of the Virtual Output (GGIO)
IEC61850.VirtOut4-I	Module input state: Binary state of the Virtual Output (GGIO)
IEC61850.VirtOut5-I	Module input state: Binary state of the Virtual Output (GGIO)
IEC61850.VirtOut6-I	Module input state: Binary state of the Virtual Output (GGIO)
IEC61850.VirtOut7-I	Module input state: Binary state of the Virtual Output (GGIO)
IEC61850.VirtOut8-I	Module input state: Binary state of the Virtual Output (GGIO)
IEC61850.VirtOut9-I	Module input state: Binary state of the Virtual Output (GGIO)
IEC61850.VirtOut10-I	Module input state: Binary state of the Virtual Output (GGIO)
IEC61850.VirtOut11-I	Module input state: Binary state of the Virtual Output (GGIO)
IEC61850.VirtOut12-I	Module input state: Binary state of the Virtual Output (GGIO)
IEC61850.VirtOut13-I	Module input state: Binary state of the Virtual Output (GGIO)
IEC61850.VirtOut14-I	Module input state: Binary state of the Virtual Output (GGIO)
IEC61850.VirtOut15-I	Module input state: Binary state of the Virtual Output (GGIO)
IEC61850.VirtOut16-I	Module input state: Binary state of the Virtual Output (GGIO)
IEC61850.VirtOut17-I	Module input state: Binary state of the Virtual Output (GGIO)
IEC61850.VirtOut18-I	Module input state: Binary state of the Virtual Output (GGIO)
IEC61850.VirtOut19-I	Module input state: Binary state of the Virtual Output (GGIO)
IEC61850.VirtOut20-I	Module input state: Binary state of the Virtual Output (GGIO)
IEC61850.VirtOut21-I	Module input state: Binary state of the Virtual Output (GGIO)

General Lists

<i>Name</i>	<i>Description</i>
IEC61850.VirtOut22-I	Module input state: Binary state of the Virtual Output (GGIO)
IEC61850.VirtOut23-I	Module input state: Binary state of the Virtual Output (GGIO)
IEC61850.VirtOut24-I	Module input state: Binary state of the Virtual Output (GGIO)
IEC61850.VirtOut25-I	Module input state: Binary state of the Virtual Output (GGIO)
IEC61850.VirtOut26-I	Module input state: Binary state of the Virtual Output (GGIO)
IEC61850.VirtOut27-I	Module input state: Binary state of the Virtual Output (GGIO)
IEC61850.VirtOut28-I	Module input state: Binary state of the Virtual Output (GGIO)
IEC61850.VirtOut29-I	Module input state: Binary state of the Virtual Output (GGIO)
IEC61850.VirtOut30-I	Module input state: Binary state of the Virtual Output (GGIO)
IEC61850.VirtOut31-I	Module input state: Binary state of the Virtual Output (GGIO)
IEC61850.VirtOut32-I	Module input state: Binary state of the Virtual Output (GGIO)
IEC 103.Scada Cmd 1	Scada Command
IEC 103.Scada Cmd 2	Scada Command
IEC 103.Scada Cmd 3	Scada Command
IEC 103.Scada Cmd 4	Scada Command
IEC 103.Scada Cmd 5	Scada Command
IEC 103.Scada Cmd 6	Scada Command
IEC 103.Scada Cmd 7	Scada Command
IEC 103.Scada Cmd 8	Scada Command
IEC 103.Scada Cmd 9	Scada Command
IEC 103.Scada Cmd 10	Scada Command
IEC 103.Transmission	Signal: SCADA active
IEC 103.Failure Event lost	Failure event lost
IEC 103.Test mode active	Signal: IEC103 communication has been switched over into Test Mode.
IEC 103.Block MD active	Signal: The blocking of IEC103 transmission in monitor direction has been activated.
IEC 103.Ex activate test mode-I	Module input state: Test Mode of the IEC103 communication.
IEC 103.Ex activate Block MD-I	Module input state: Activation of the blocking of IEC103 transmission in monitor direction.
Profibus.Data OK	Data within the Input field are OK (Yes=1)
Profibus.SubModul Err	Assignable Signal, Failure in Sub-Module, Communication Failure.
Profibus.Connection active	Connection active
Profibus.Scada Cmd 1	Scada Command
Profibus.Scada Cmd 2	Scada Command
Profibus.Scada Cmd 3	Scada Command
Profibus.Scada Cmd 4	Scada Command
Profibus.Scada Cmd 5	Scada Command
Profibus.Scada Cmd 6	Scada Command

Name	Description
Profibus.Scada Cmd 7	Scada Command
Profibus.Scada Cmd 8	Scada Command
Profibus.Scada Cmd 9	Scada Command
Profibus.Scada Cmd 10	Scada Command
Profibus.Scada Cmd 11	Scada Command
Profibus.Scada Cmd 12	Scada Command
Profibus.Scada Cmd 13	Scada Command
Profibus.Scada Cmd 14	Scada Command
Profibus.Scada Cmd 15	Scada Command
Profibus.Scada Cmd 16	Scada Command
IRIG-B.IRIG-B active	Signal: If there is no valid IRIG-B signal for 60 sec, IRIG-B is regarded as inactive.
IRIG-B.High-Low Invert	Signal: The High and Low signals of the IRIG-B are inverted. This does NOT mean that the wiring is faulty. If the wiring is faulty no IRIG-B signal will be detected.
IRIG-B.Control Signal1	Signal: IRIG-B Control Signal. The external IRIG-B generator can set these signals. They can be used for further control procedures inside the device (e.g. logic funtions).
IRIG-B.Control Signal2	Signal: IRIG-B Control Signal. The external IRIG-B generator can set these signals. They can be used for further control procedures inside the device (e.g. logic funtions).
IRIG-B.Control Signal3	Signal: IRIG-B Control Signal. The external IRIG-B generator can set these signals. They can be used for further control procedures inside the device (e.g. logic funtions).
IRIG-B.Control Signal4	Signal: IRIG-B Control Signal. The external IRIG-B generator can set these signals. They can be used for further control procedures inside the device (e.g. logic funtions).
IRIG-B.Control Signal5	Signal: IRIG-B Control Signal. The external IRIG-B generator can set these signals. They can be used for further control procedures inside the device (e.g. logic funtions).
IRIG-B.Control Signal6	Signal: IRIG-B Control Signal. The external IRIG-B generator can set these signals. They can be used for further control procedures inside the device (e.g. logic funtions).
IRIG-B.Control Signal7	Signal: IRIG-B Control Signal. The external IRIG-B generator can set these signals. They can be used for further control procedures inside the device (e.g. logic funtions).
IRIG-B.Control Signal8	Signal: IRIG-B Control Signal. The external IRIG-B generator can set these signals. They can be used for further control procedures inside the device (e.g. logic funtions).
IRIG-B.Control Signal9	Signal: IRIG-B Control Signal. The external IRIG-B generator can set these signals. They can be used for further control procedures inside the device (e.g. logic funtions).
IRIG-B.Control Signal10	Signal: IRIG-B Control Signal. The external IRIG-B generator can set these signals. They can be used for further control procedures inside the device (e.g. logic funtions).
IRIG-B.Control Signal11	Signal: IRIG-B Control Signal. The external IRIG-B generator can set these signals. They can be used for further control procedures inside the device (e.g. logic funtions).

<i>Name</i>	<i>Description</i>
IRIG-B.Control Signal12	Signal: IRIG-B Control Signal. The external IRIG-B generator can set these signals. They can be used for further control procedures inside the device (e.g. logic funtions).
IRIG-B.Control Signal13	Signal: IRIG-B Control Signal. The external IRIG-B generator can set these signals. They can be used for further control procedures inside the device (e.g. logic funtions).
IRIG-B.Control Signal14	Signal: IRIG-B Control Signal. The external IRIG-B generator can set these signals. They can be used for further control procedures inside the device (e.g. logic funtions).
IRIG-B.Control Signal15	Signal: IRIG-B Control Signal. The external IRIG-B generator can set these signals. They can be used for further control procedures inside the device (e.g. logic funtions).
IRIG-B.Control Signal16	Signal: IRIG-B Control Signal. The external IRIG-B generator can set these signals. They can be used for further control procedures inside the device (e.g. logic funtions).
IRIG-B.Control Signal17	Signal: IRIG-B Control Signal. The external IRIG-B generator can set these signals. They can be used for further control procedures inside the device (e.g. logic funtions).
IRIG-B.Control Signal18	Signal: IRIG-B Control Signal. The external IRIG-B generator can set these signals. They can be used for further control procedures inside the device (e.g. logic funtions).
SNTP.SNTP active	Signal: If there is no valid SNTP signal for 120 sec, SNTP is regarded as inactive.
TimeSync.synchronized	Clock is synchronized.
Statistics.ResFc all	Signal: Resetting of all Statistic values (Current Demand, Power Demand, Min, Max)
Statistics.ResFc Vavg	Signal: Resetting of the sliding average calculation.
Statistics.ResFc I Demand	Signal: Resetting of Statistics - Current Demand (avg, peak avg)
Statistics.ResFc P Demand	Signal: Resetting of Statistics - Power Demand (avg, peak avg)
Statistics.ResFc Max	Signal: Resetting of all Maximum values
Statistics.ResFc Min	Signal: Resetting of all Minimum values
Statistics.StartFc Vavg-I	State of the module input: Start of Statistics Average Voltage
Statistics.StartFc I Demand-I	State of the module input: Start of the Statistics of the Current Demand
Statistics.StartFc P Demand-I	State of the module input: Start of the Statistics of the Active Power Demand
Logics.LE1.Gate Out	Signal: Output of the logic gate
Logics.LE1.Timer Out	Signal: Timer Output
Logics.LE1.Out	Signal: Latched Output (Q)
Logics.LE1.Out inverted	Signal: Negated Latched Output (Q NOT)
Logics.LE1.Gate In1-I	State of the module input: Assignment of the Input Signal
Logics.LE1.Gate In2-I	State of the module input: Assignment of the Input Signal
Logics.LE1.Gate In3-I	State of the module input: Assignment of the Input Signal
Logics.LE1.Gate In4-I	State of the module input: Assignment of the Input Signal
Logics.LE1.Reset Latch-I	State of the module input: Reset Signal for the Latching

General Lists

<i>Name</i>	<i>Description</i>
Logics.LE2.Gate Out	Signal: Output of the logic gate
Logics.LE2.Timer Out	Signal: Timer Output
Logics.LE2.Out	Signal: Latched Output (Q)
Logics.LE2.Out inverted	Signal: Negated Latched Output (Q NOT)
Logics.LE2.Gate In1-I	State of the module input: Assignment of the Input Signal
Logics.LE2.Gate In2-I	State of the module input: Assignment of the Input Signal
Logics.LE2.Gate In3-I	State of the module input: Assignment of the Input Signal
Logics.LE2.Gate In4-I	State of the module input: Assignment of the Input Signal
Logics.LE2.Reset Latch-I	State of the module input: Reset Signal for the Latching
Logics.LE3.Gate Out	Signal: Output of the logic gate
Logics.LE3.Timer Out	Signal: Timer Output
Logics.LE3.Out	Signal: Latched Output (Q)
Logics.LE3.Out inverted	Signal: Negated Latched Output (Q NOT)
Logics.LE3.Gate In1-I	State of the module input: Assignment of the Input Signal
Logics.LE3.Gate In2-I	State of the module input: Assignment of the Input Signal
Logics.LE3.Gate In3-I	State of the module input: Assignment of the Input Signal
Logics.LE3.Gate In4-I	State of the module input: Assignment of the Input Signal
Logics.LE3.Reset Latch-I	State of the module input: Reset Signal for the Latching
Logics.LE4.Gate Out	Signal: Output of the logic gate
Logics.LE4.Timer Out	Signal: Timer Output
Logics.LE4.Out	Signal: Latched Output (Q)
Logics.LE4.Out inverted	Signal: Negated Latched Output (Q NOT)
Logics.LE4.Gate In1-I	State of the module input: Assignment of the Input Signal
Logics.LE4.Gate In2-I	State of the module input: Assignment of the Input Signal
Logics.LE4.Gate In3-I	State of the module input: Assignment of the Input Signal
Logics.LE4.Gate In4-I	State of the module input: Assignment of the Input Signal
Logics.LE4.Reset Latch-I	State of the module input: Reset Signal for the Latching
Logics.LE5.Gate Out	Signal: Output of the logic gate
Logics.LE5.Timer Out	Signal: Timer Output
Logics.LE5.Out	Signal: Latched Output (Q)
Logics.LE5.Out inverted	Signal: Negated Latched Output (Q NOT)
Logics.LE5.Gate In1-I	State of the module input: Assignment of the Input Signal
Logics.LE5.Gate In2-I	State of the module input: Assignment of the Input Signal
Logics.LE5.Gate In3-I	State of the module input: Assignment of the Input Signal
Logics.LE5.Gate In4-I	State of the module input: Assignment of the Input Signal
Logics.LE5.Reset Latch-I	State of the module input: Reset Signal for the Latching
Logics.LE6.Gate Out	Signal: Output of the logic gate
Logics.LE6.Timer Out	Signal: Timer Output
Logics.LE6.Out	Signal: Latched Output (Q)
Logics.LE6.Out inverted	Signal: Negated Latched Output (Q NOT)

General Lists

<i>Name</i>	<i>Description</i>
Logics.LE6.Gate In1-I	State of the module input: Assignment of the Input Signal
Logics.LE6.Gate In2-I	State of the module input: Assignment of the Input Signal
Logics.LE6.Gate In3-I	State of the module input: Assignment of the Input Signal
Logics.LE6.Gate In4-I	State of the module input: Assignment of the Input Signal
Logics.LE6.Reset Latch-I	State of the module input: Reset Signal for the Latching
Logics.LE7.Gate Out	Signal: Output of the logic gate
Logics.LE7.Timer Out	Signal: Timer Output
Logics.LE7.Out	Signal: Latched Output (Q)
Logics.LE7.Out inverted	Signal: Negated Latched Output (Q NOT)
Logics.LE7.Gate In1-I	State of the module input: Assignment of the Input Signal
Logics.LE7.Gate In2-I	State of the module input: Assignment of the Input Signal
Logics.LE7.Gate In3-I	State of the module input: Assignment of the Input Signal
Logics.LE7.Gate In4-I	State of the module input: Assignment of the Input Signal
Logics.LE7.Reset Latch-I	State of the module input: Reset Signal for the Latching
Logics.LE8.Gate Out	Signal: Output of the logic gate
Logics.LE8.Timer Out	Signal: Timer Output
Logics.LE8.Out	Signal: Latched Output (Q)
Logics.LE8.Out inverted	Signal: Negated Latched Output (Q NOT)
Logics.LE8.Gate In1-I	State of the module input: Assignment of the Input Signal
Logics.LE8.Gate In2-I	State of the module input: Assignment of the Input Signal
Logics.LE8.Gate In3-I	State of the module input: Assignment of the Input Signal
Logics.LE8.Gate In4-I	State of the module input: Assignment of the Input Signal
Logics.LE8.Reset Latch-I	State of the module input: Reset Signal for the Latching
Logics.LE9.Gate Out	Signal: Output of the logic gate
Logics.LE9.Timer Out	Signal: Timer Output
Logics.LE9.Out	Signal: Latched Output (Q)
Logics.LE9.Out inverted	Signal: Negated Latched Output (Q NOT)
Logics.LE9.Gate In1-I	State of the module input: Assignment of the Input Signal
Logics.LE9.Gate In2-I	State of the module input: Assignment of the Input Signal
Logics.LE9.Gate In3-I	State of the module input: Assignment of the Input Signal
Logics.LE9.Gate In4-I	State of the module input: Assignment of the Input Signal
Logics.LE9.Reset Latch-I	State of the module input: Reset Signal for the Latching
Logics.LE10.Gate Out	Signal: Output of the logic gate
Logics.LE10.Timer Out	Signal: Timer Output
Logics.LE10.Out	Signal: Latched Output (Q)
Logics.LE10.Out inverted	Signal: Negated Latched Output (Q NOT)
Logics.LE10.Gate In1-I	State of the module input: Assignment of the Input Signal
Logics.LE10.Gate In2-I	State of the module input: Assignment of the Input Signal
Logics.LE10.Gate In3-I	State of the module input: Assignment of the Input Signal
Logics.LE10.Gate In4-I	State of the module input: Assignment of the Input Signal

<i>Name</i>	<i>Description</i>
Logics.LE10.Reset Latch-I	State of the module input: Reset Signal for the Latching
Logics.LE11.Gate Out	Signal: Output of the logic gate
Logics.LE11.Timer Out	Signal: Timer Output
Logics.LE11.Out	Signal: Latched Output (Q)
Logics.LE11.Out inverted	Signal: Negated Latched Output (Q NOT)
Logics.LE11.Gate In1-I	State of the module input: Assignment of the Input Signal
Logics.LE11.Gate In2-I	State of the module input: Assignment of the Input Signal
Logics.LE11.Gate In3-I	State of the module input: Assignment of the Input Signal
Logics.LE11.Gate In4-I	State of the module input: Assignment of the Input Signal
Logics.LE11.Reset Latch-I	State of the module input: Reset Signal for the Latching
Logics.LE12.Gate Out	Signal: Output of the logic gate
Logics.LE12.Timer Out	Signal: Timer Output
Logics.LE12.Out	Signal: Latched Output (Q)
Logics.LE12.Out inverted	Signal: Negated Latched Output (Q NOT)
Logics.LE12.Gate In1-I	State of the module input: Assignment of the Input Signal
Logics.LE12.Gate In2-I	State of the module input: Assignment of the Input Signal
Logics.LE12.Gate In3-I	State of the module input: Assignment of the Input Signal
Logics.LE12.Gate In4-I	State of the module input: Assignment of the Input Signal
Logics.LE12.Reset Latch-I	State of the module input: Reset Signal for the Latching
Logics.LE13.Gate Out	Signal: Output of the logic gate
Logics.LE13.Timer Out	Signal: Timer Output
Logics.LE13.Out	Signal: Latched Output (Q)
Logics.LE13.Out inverted	Signal: Negated Latched Output (Q NOT)
Logics.LE13.Gate In1-I	State of the module input: Assignment of the Input Signal
Logics.LE13.Gate In2-I	State of the module input: Assignment of the Input Signal
Logics.LE13.Gate In3-I	State of the module input: Assignment of the Input Signal
Logics.LE13.Gate In4-I	State of the module input: Assignment of the Input Signal
Logics.LE13.Reset Latch-I	State of the module input: Reset Signal for the Latching
Logics.LE14.Gate Out	Signal: Output of the logic gate
Logics.LE14.Timer Out	Signal: Timer Output
Logics.LE14.Out	Signal: Latched Output (Q)
Logics.LE14.Out inverted	Signal: Negated Latched Output (Q NOT)
Logics.LE14.Gate In1-I	State of the module input: Assignment of the Input Signal
Logics.LE14.Gate In2-I	State of the module input: Assignment of the Input Signal
Logics.LE14.Gate In3-I	State of the module input: Assignment of the Input Signal
Logics.LE14.Gate In4-I	State of the module input: Assignment of the Input Signal

<i>Name</i>	<i>Description</i>
Logics.LE14.Reset Latch-I	State of the module input: Reset Signal for the Latching
Logics.LE15.Gate Out	Signal: Output of the logic gate
Logics.LE15.Timer Out	Signal: Timer Output
Logics.LE15.Out	Signal: Latched Output (Q)
Logics.LE15.Out inverted	Signal: Negated Latched Output (Q NOT)
Logics.LE15.Gate In1-I	State of the module input: Assignment of the Input Signal
Logics.LE15.Gate In2-I	State of the module input: Assignment of the Input Signal
Logics.LE15.Gate In3-I	State of the module input: Assignment of the Input Signal
Logics.LE15.Gate In4-I	State of the module input: Assignment of the Input Signal
Logics.LE15.Reset Latch-I	State of the module input: Reset Signal for the Latching
Logics.LE16.Gate Out	Signal: Output of the logic gate
Logics.LE16.Timer Out	Signal: Timer Output
Logics.LE16.Out	Signal: Latched Output (Q)
Logics.LE16.Out inverted	Signal: Negated Latched Output (Q NOT)
Logics.LE16.Gate In1-I	State of the module input: Assignment of the Input Signal
Logics.LE16.Gate In2-I	State of the module input: Assignment of the Input Signal
Logics.LE16.Gate In3-I	State of the module input: Assignment of the Input Signal
Logics.LE16.Gate In4-I	State of the module input: Assignment of the Input Signal
Logics.LE16.Reset Latch-I	State of the module input: Reset Signal for the Latching
Logics.LE17.Gate Out	Signal: Output of the logic gate
Logics.LE17.Timer Out	Signal: Timer Output
Logics.LE17.Out	Signal: Latched Output (Q)
Logics.LE17.Out inverted	Signal: Negated Latched Output (Q NOT)
Logics.LE17.Gate In1-I	State of the module input: Assignment of the Input Signal
Logics.LE17.Gate In2-I	State of the module input: Assignment of the Input Signal
Logics.LE17.Gate In3-I	State of the module input: Assignment of the Input Signal
Logics.LE17.Gate In4-I	State of the module input: Assignment of the Input Signal
Logics.LE17.Reset Latch-I	State of the module input: Reset Signal for the Latching
Logics.LE18.Gate Out	Signal: Output of the logic gate
Logics.LE18.Timer Out	Signal: Timer Output
Logics.LE18.Out	Signal: Latched Output (Q)
Logics.LE18.Out inverted	Signal: Negated Latched Output (Q NOT)
Logics.LE18.Gate In1-I	State of the module input: Assignment of the Input Signal
Logics.LE18.Gate In2-I	State of the module input: Assignment of the Input Signal
Logics.LE18.Gate In3-I	State of the module input: Assignment of the Input Signal
Logics.LE18.Gate In4-I	State of the module input: Assignment of the Input Signal

<i>Name</i>	<i>Description</i>
Logics.LE18.Reset Latch-I	State of the module input: Reset Signal for the Latching
Logics.LE19.Gate Out	Signal: Output of the logic gate
Logics.LE19.Timer Out	Signal: Timer Output
Logics.LE19.Out	Signal: Latched Output (Q)
Logics.LE19.Out inverted	Signal: Negated Latched Output (Q NOT)
Logics.LE19.Gate In1-I	State of the module input: Assignment of the Input Signal
Logics.LE19.Gate In2-I	State of the module input: Assignment of the Input Signal
Logics.LE19.Gate In3-I	State of the module input: Assignment of the Input Signal
Logics.LE19.Gate In4-I	State of the module input: Assignment of the Input Signal
Logics.LE19.Reset Latch-I	State of the module input: Reset Signal for the Latching
Logics.LE20.Gate Out	Signal: Output of the logic gate
Logics.LE20.Timer Out	Signal: Timer Output
Logics.LE20.Out	Signal: Latched Output (Q)
Logics.LE20.Out inverted	Signal: Negated Latched Output (Q NOT)
Logics.LE20.Gate In1-I	State of the module input: Assignment of the Input Signal
Logics.LE20.Gate In2-I	State of the module input: Assignment of the Input Signal
Logics.LE20.Gate In3-I	State of the module input: Assignment of the Input Signal
Logics.LE20.Gate In4-I	State of the module input: Assignment of the Input Signal
Logics.LE20.Reset Latch-I	State of the module input: Reset Signal for the Latching
Logics.LE21.Gate Out	Signal: Output of the logic gate
Logics.LE21.Timer Out	Signal: Timer Output
Logics.LE21.Out	Signal: Latched Output (Q)
Logics.LE21.Out inverted	Signal: Negated Latched Output (Q NOT)
Logics.LE21.Gate In1-I	State of the module input: Assignment of the Input Signal
Logics.LE21.Gate In2-I	State of the module input: Assignment of the Input Signal
Logics.LE21.Gate In3-I	State of the module input: Assignment of the Input Signal
Logics.LE21.Gate In4-I	State of the module input: Assignment of the Input Signal
Logics.LE21.Reset Latch-I	State of the module input: Reset Signal for the Latching
Logics.LE22.Gate Out	Signal: Output of the logic gate
Logics.LE22.Timer Out	Signal: Timer Output
Logics.LE22.Out	Signal: Latched Output (Q)
Logics.LE22.Out inverted	Signal: Negated Latched Output (Q NOT)
Logics.LE22.Gate In1-I	State of the module input: Assignment of the Input Signal
Logics.LE22.Gate In2-I	State of the module input: Assignment of the Input Signal
Logics.LE22.Gate In3-I	State of the module input: Assignment of the Input Signal
Logics.LE22.Gate In4-I	State of the module input: Assignment of the Input Signal

<i>Name</i>	<i>Description</i>
Logics.LE22.Reset Latch-I	State of the module input: Reset Signal for the Latching
Logics.LE23.Gate Out	Signal: Output of the logic gate
Logics.LE23.Timer Out	Signal: Timer Output
Logics.LE23.Out	Signal: Latched Output (Q)
Logics.LE23.Out inverted	Signal: Negated Latched Output (Q NOT)
Logics.LE23.Gate In1-I	State of the module input: Assignment of the Input Signal
Logics.LE23.Gate In2-I	State of the module input: Assignment of the Input Signal
Logics.LE23.Gate In3-I	State of the module input: Assignment of the Input Signal
Logics.LE23.Gate In4-I	State of the module input: Assignment of the Input Signal
Logics.LE23.Reset Latch-I	State of the module input: Reset Signal for the Latching
Logics.LE24.Gate Out	Signal: Output of the logic gate
Logics.LE24.Timer Out	Signal: Timer Output
Logics.LE24.Out	Signal: Latched Output (Q)
Logics.LE24.Out inverted	Signal: Negated Latched Output (Q NOT)
Logics.LE24.Gate In1-I	State of the module input: Assignment of the Input Signal
Logics.LE24.Gate In2-I	State of the module input: Assignment of the Input Signal
Logics.LE24.Gate In3-I	State of the module input: Assignment of the Input Signal
Logics.LE24.Gate In4-I	State of the module input: Assignment of the Input Signal
Logics.LE24.Reset Latch-I	State of the module input: Reset Signal for the Latching
Logics.LE25.Gate Out	Signal: Output of the logic gate
Logics.LE25.Timer Out	Signal: Timer Output
Logics.LE25.Out	Signal: Latched Output (Q)
Logics.LE25.Out inverted	Signal: Negated Latched Output (Q NOT)
Logics.LE25.Gate In1-I	State of the module input: Assignment of the Input Signal
Logics.LE25.Gate In2-I	State of the module input: Assignment of the Input Signal
Logics.LE25.Gate In3-I	State of the module input: Assignment of the Input Signal
Logics.LE25.Gate In4-I	State of the module input: Assignment of the Input Signal
Logics.LE25.Reset Latch-I	State of the module input: Reset Signal for the Latching
Logics.LE26.Gate Out	Signal: Output of the logic gate
Logics.LE26.Timer Out	Signal: Timer Output
Logics.LE26.Out	Signal: Latched Output (Q)
Logics.LE26.Out inverted	Signal: Negated Latched Output (Q NOT)
Logics.LE26.Gate In1-I	State of the module input: Assignment of the Input Signal
Logics.LE26.Gate In2-I	State of the module input: Assignment of the Input Signal
Logics.LE26.Gate In3-I	State of the module input: Assignment of the Input Signal
Logics.LE26.Gate In4-I	State of the module input: Assignment of the Input Signal

General Lists

<i>Name</i>	<i>Description</i>
Logics.LE26.Reset Latch-I	State of the module input: Reset Signal for the Latching
Logics.LE27.Gate Out	Signal: Output of the logic gate
Logics.LE27.Timer Out	Signal: Timer Output
Logics.LE27.Out	Signal: Latched Output (Q)
Logics.LE27.Out inverted	Signal: Negated Latched Output (Q NOT)
Logics.LE27.Gate In1-I	State of the module input: Assignment of the Input Signal
Logics.LE27.Gate In2-I	State of the module input: Assignment of the Input Signal
Logics.LE27.Gate In3-I	State of the module input: Assignment of the Input Signal
Logics.LE27.Gate In4-I	State of the module input: Assignment of the Input Signal
Logics.LE27.Reset Latch-I	State of the module input: Reset Signal for the Latching
Logics.LE28.Gate Out	Signal: Output of the logic gate
Logics.LE28.Timer Out	Signal: Timer Output
Logics.LE28.Out	Signal: Latched Output (Q)
Logics.LE28.Out inverted	Signal: Negated Latched Output (Q NOT)
Logics.LE28.Gate In1-I	State of the module input: Assignment of the Input Signal
Logics.LE28.Gate In2-I	State of the module input: Assignment of the Input Signal
Logics.LE28.Gate In3-I	State of the module input: Assignment of the Input Signal
Logics.LE28.Gate In4-I	State of the module input: Assignment of the Input Signal
Logics.LE28.Reset Latch-I	State of the module input: Reset Signal for the Latching
Logics.LE29.Gate Out	Signal: Output of the logic gate
Logics.LE29.Timer Out	Signal: Timer Output
Logics.LE29.Out	Signal: Latched Output (Q)
Logics.LE29.Out inverted	Signal: Negated Latched Output (Q NOT)
Logics.LE29.Gate In1-I	State of the module input: Assignment of the Input Signal
Logics.LE29.Gate In2-I	State of the module input: Assignment of the Input Signal
Logics.LE29.Gate In3-I	State of the module input: Assignment of the Input Signal
Logics.LE29.Gate In4-I	State of the module input: Assignment of the Input Signal
Logics.LE29.Reset Latch-I	State of the module input: Reset Signal for the Latching
Logics.LE30.Gate Out	Signal: Output of the logic gate
Logics.LE30.Timer Out	Signal: Timer Output
Logics.LE30.Out	Signal: Latched Output (Q)
Logics.LE30.Out inverted	Signal: Negated Latched Output (Q NOT)
Logics.LE30.Gate In1-I	State of the module input: Assignment of the Input Signal
Logics.LE30.Gate In2-I	State of the module input: Assignment of the Input Signal
Logics.LE30.Gate In3-I	State of the module input: Assignment of the Input Signal
Logics.LE30.Gate In4-I	State of the module input: Assignment of the Input Signal

<i>Name</i>	<i>Description</i>
Logics.LE30.Reset Latch-I	State of the module input: Reset Signal for the Latching
Logics.LE31.Gate Out	Signal: Output of the logic gate
Logics.LE31.Timer Out	Signal: Timer Output
Logics.LE31.Out	Signal: Latched Output (Q)
Logics.LE31.Out inverted	Signal: Negated Latched Output (Q NOT)
Logics.LE31.Gate In1-I	State of the module input: Assignment of the Input Signal
Logics.LE31.Gate In2-I	State of the module input: Assignment of the Input Signal
Logics.LE31.Gate In3-I	State of the module input: Assignment of the Input Signal
Logics.LE31.Gate In4-I	State of the module input: Assignment of the Input Signal
Logics.LE31.Reset Latch-I	State of the module input: Reset Signal for the Latching
Logics.LE32.Gate Out	Signal: Output of the logic gate
Logics.LE32.Timer Out	Signal: Timer Output
Logics.LE32.Out	Signal: Latched Output (Q)
Logics.LE32.Out inverted	Signal: Negated Latched Output (Q NOT)
Logics.LE32.Gate In1-I	State of the module input: Assignment of the Input Signal
Logics.LE32.Gate In2-I	State of the module input: Assignment of the Input Signal
Logics.LE32.Gate In3-I	State of the module input: Assignment of the Input Signal
Logics.LE32.Gate In4-I	State of the module input: Assignment of the Input Signal
Logics.LE32.Reset Latch-I	State of the module input: Reset Signal for the Latching
Logics.LE33.Gate Out	Signal: Output of the logic gate
Logics.LE33.Timer Out	Signal: Timer Output
Logics.LE33.Out	Signal: Latched Output (Q)
Logics.LE33.Out inverted	Signal: Negated Latched Output (Q NOT)
Logics.LE33.Gate In1-I	State of the module input: Assignment of the Input Signal
Logics.LE33.Gate In2-I	State of the module input: Assignment of the Input Signal
Logics.LE33.Gate In3-I	State of the module input: Assignment of the Input Signal
Logics.LE33.Gate In4-I	State of the module input: Assignment of the Input Signal
Logics.LE33.Reset Latch-I	State of the module input: Reset Signal for the Latching
Logics.LE34.Gate Out	Signal: Output of the logic gate
Logics.LE34.Timer Out	Signal: Timer Output
Logics.LE34.Out	Signal: Latched Output (Q)
Logics.LE34.Out inverted	Signal: Negated Latched Output (Q NOT)
Logics.LE34.Gate In1-I	State of the module input: Assignment of the Input Signal
Logics.LE34.Gate In2-I	State of the module input: Assignment of the Input Signal
Logics.LE34.Gate In3-I	State of the module input: Assignment of the Input Signal
Logics.LE34.Gate In4-I	State of the module input: Assignment of the Input Signal

<i>Name</i>	<i>Description</i>
Logics.LE34.Reset Latch-I	State of the module input: Reset Signal for the Latching
Logics.LE35.Gate Out	Signal: Output of the logic gate
Logics.LE35.Timer Out	Signal: Timer Output
Logics.LE35.Out	Signal: Latched Output (Q)
Logics.LE35.Out inverted	Signal: Negated Latched Output (Q NOT)
Logics.LE35.Gate In1-I	State of the module input: Assignment of the Input Signal
Logics.LE35.Gate In2-I	State of the module input: Assignment of the Input Signal
Logics.LE35.Gate In3-I	State of the module input: Assignment of the Input Signal
Logics.LE35.Gate In4-I	State of the module input: Assignment of the Input Signal
Logics.LE35.Reset Latch-I	State of the module input: Reset Signal for the Latching
Logics.LE36.Gate Out	Signal: Output of the logic gate
Logics.LE36.Timer Out	Signal: Timer Output
Logics.LE36.Out	Signal: Latched Output (Q)
Logics.LE36.Out inverted	Signal: Negated Latched Output (Q NOT)
Logics.LE36.Gate In1-I	State of the module input: Assignment of the Input Signal
Logics.LE36.Gate In2-I	State of the module input: Assignment of the Input Signal
Logics.LE36.Gate In3-I	State of the module input: Assignment of the Input Signal
Logics.LE36.Gate In4-I	State of the module input: Assignment of the Input Signal
Logics.LE36.Reset Latch-I	State of the module input: Reset Signal for the Latching
Logics.LE37.Gate Out	Signal: Output of the logic gate
Logics.LE37.Timer Out	Signal: Timer Output
Logics.LE37.Out	Signal: Latched Output (Q)
Logics.LE37.Out inverted	Signal: Negated Latched Output (Q NOT)
Logics.LE37.Gate In1-I	State of the module input: Assignment of the Input Signal
Logics.LE37.Gate In2-I	State of the module input: Assignment of the Input Signal
Logics.LE37.Gate In3-I	State of the module input: Assignment of the Input Signal
Logics.LE37.Gate In4-I	State of the module input: Assignment of the Input Signal
Logics.LE37.Reset Latch-I	State of the module input: Reset Signal for the Latching
Logics.LE38.Gate Out	Signal: Output of the logic gate
Logics.LE38.Timer Out	Signal: Timer Output
Logics.LE38.Out	Signal: Latched Output (Q)
Logics.LE38.Out inverted	Signal: Negated Latched Output (Q NOT)
Logics.LE38.Gate In1-I	State of the module input: Assignment of the Input Signal
Logics.LE38.Gate In2-I	State of the module input: Assignment of the Input Signal
Logics.LE38.Gate In3-I	State of the module input: Assignment of the Input Signal
Logics.LE38.Gate In4-I	State of the module input: Assignment of the Input Signal

General Lists

<i>Name</i>	<i>Description</i>
Logics.LE38.Reset Latch-I	State of the module input: Reset Signal for the Latching
Logics.LE39.Gate Out	Signal: Output of the logic gate
Logics.LE39.Timer Out	Signal: Timer Output
Logics.LE39.Out	Signal: Latched Output (Q)
Logics.LE39.Out inverted	Signal: Negated Latched Output (Q NOT)
Logics.LE39.Gate In1-I	State of the module input: Assignment of the Input Signal
Logics.LE39.Gate In2-I	State of the module input: Assignment of the Input Signal
Logics.LE39.Gate In3-I	State of the module input: Assignment of the Input Signal
Logics.LE39.Gate In4-I	State of the module input: Assignment of the Input Signal
Logics.LE39.Reset Latch-I	State of the module input: Reset Signal for the Latching
Logics.LE40.Gate Out	Signal: Output of the logic gate
Logics.LE40.Timer Out	Signal: Timer Output
Logics.LE40.Out	Signal: Latched Output (Q)
Logics.LE40.Out inverted	Signal: Negated Latched Output (Q NOT)
Logics.LE40.Gate In1-I	State of the module input: Assignment of the Input Signal
Logics.LE40.Gate In2-I	State of the module input: Assignment of the Input Signal
Logics.LE40.Gate In3-I	State of the module input: Assignment of the Input Signal
Logics.LE40.Gate In4-I	State of the module input: Assignment of the Input Signal
Logics.LE40.Reset Latch-I	State of the module input: Reset Signal for the Latching
Logics.LE41.Gate Out	Signal: Output of the logic gate
Logics.LE41.Timer Out	Signal: Timer Output
Logics.LE41.Out	Signal: Latched Output (Q)
Logics.LE41.Out inverted	Signal: Negated Latched Output (Q NOT)
Logics.LE41.Gate In1-I	State of the module input: Assignment of the Input Signal
Logics.LE41.Gate In2-I	State of the module input: Assignment of the Input Signal
Logics.LE41.Gate In3-I	State of the module input: Assignment of the Input Signal
Logics.LE41.Gate In4-I	State of the module input: Assignment of the Input Signal
Logics.LE41.Reset Latch-I	State of the module input: Reset Signal for the Latching
Logics.LE42.Gate Out	Signal: Output of the logic gate
Logics.LE42.Timer Out	Signal: Timer Output
Logics.LE42.Out	Signal: Latched Output (Q)
Logics.LE42.Out inverted	Signal: Negated Latched Output (Q NOT)
Logics.LE42.Gate In1-I	State of the module input: Assignment of the Input Signal
Logics.LE42.Gate In2-I	State of the module input: Assignment of the Input Signal
Logics.LE42.Gate In3-I	State of the module input: Assignment of the Input Signal
Logics.LE42.Gate In4-I	State of the module input: Assignment of the Input Signal

<i>Name</i>	<i>Description</i>
Logics.LE42.Reset Latch-I	State of the module input: Reset Signal for the Latching
Logics.LE43.Gate Out	Signal: Output of the logic gate
Logics.LE43.Timer Out	Signal: Timer Output
Logics.LE43.Out	Signal: Latched Output (Q)
Logics.LE43.Out inverted	Signal: Negated Latched Output (Q NOT)
Logics.LE43.Gate In1-I	State of the module input: Assignment of the Input Signal
Logics.LE43.Gate In2-I	State of the module input: Assignment of the Input Signal
Logics.LE43.Gate In3-I	State of the module input: Assignment of the Input Signal
Logics.LE43.Gate In4-I	State of the module input: Assignment of the Input Signal
Logics.LE43.Reset Latch-I	State of the module input: Reset Signal for the Latching
Logics.LE44.Gate Out	Signal: Output of the logic gate
Logics.LE44.Timer Out	Signal: Timer Output
Logics.LE44.Out	Signal: Latched Output (Q)
Logics.LE44.Out inverted	Signal: Negated Latched Output (Q NOT)
Logics.LE44.Gate In1-I	State of the module input: Assignment of the Input Signal
Logics.LE44.Gate In2-I	State of the module input: Assignment of the Input Signal
Logics.LE44.Gate In3-I	State of the module input: Assignment of the Input Signal
Logics.LE44.Gate In4-I	State of the module input: Assignment of the Input Signal
Logics.LE44.Reset Latch-I	State of the module input: Reset Signal for the Latching
Logics.LE45.Gate Out	Signal: Output of the logic gate
Logics.LE45.Timer Out	Signal: Timer Output
Logics.LE45.Out	Signal: Latched Output (Q)
Logics.LE45.Out inverted	Signal: Negated Latched Output (Q NOT)
Logics.LE45.Gate In1-I	State of the module input: Assignment of the Input Signal
Logics.LE45.Gate In2-I	State of the module input: Assignment of the Input Signal
Logics.LE45.Gate In3-I	State of the module input: Assignment of the Input Signal
Logics.LE45.Gate In4-I	State of the module input: Assignment of the Input Signal
Logics.LE45.Reset Latch-I	State of the module input: Reset Signal for the Latching
Logics.LE46.Gate Out	Signal: Output of the logic gate
Logics.LE46.Timer Out	Signal: Timer Output
Logics.LE46.Out	Signal: Latched Output (Q)
Logics.LE46.Out inverted	Signal: Negated Latched Output (Q NOT)
Logics.LE46.Gate In1-I	State of the module input: Assignment of the Input Signal
Logics.LE46.Gate In2-I	State of the module input: Assignment of the Input Signal
Logics.LE46.Gate In3-I	State of the module input: Assignment of the Input Signal
Logics.LE46.Gate In4-I	State of the module input: Assignment of the Input Signal

<i>Name</i>	<i>Description</i>
Logics.LE46.Reset Latch-I	State of the module input: Reset Signal for the Latching
Logics.LE47.Gate Out	Signal: Output of the logic gate
Logics.LE47.Timer Out	Signal: Timer Output
Logics.LE47.Out	Signal: Latched Output (Q)
Logics.LE47.Out inverted	Signal: Negated Latched Output (Q NOT)
Logics.LE47.Gate In1-I	State of the module input: Assignment of the Input Signal
Logics.LE47.Gate In2-I	State of the module input: Assignment of the Input Signal
Logics.LE47.Gate In3-I	State of the module input: Assignment of the Input Signal
Logics.LE47.Gate In4-I	State of the module input: Assignment of the Input Signal
Logics.LE47.Reset Latch-I	State of the module input: Reset Signal for the Latching
Logics.LE48.Gate Out	Signal: Output of the logic gate
Logics.LE48.Timer Out	Signal: Timer Output
Logics.LE48.Out	Signal: Latched Output (Q)
Logics.LE48.Out inverted	Signal: Negated Latched Output (Q NOT)
Logics.LE48.Gate In1-I	State of the module input: Assignment of the Input Signal
Logics.LE48.Gate In2-I	State of the module input: Assignment of the Input Signal
Logics.LE48.Gate In3-I	State of the module input: Assignment of the Input Signal
Logics.LE48.Gate In4-I	State of the module input: Assignment of the Input Signal
Logics.LE48.Reset Latch-I	State of the module input: Reset Signal for the Latching
Logics.LE49.Gate Out	Signal: Output of the logic gate
Logics.LE49.Timer Out	Signal: Timer Output
Logics.LE49.Out	Signal: Latched Output (Q)
Logics.LE49.Out inverted	Signal: Negated Latched Output (Q NOT)
Logics.LE49.Gate In1-I	State of the module input: Assignment of the Input Signal
Logics.LE49.Gate In2-I	State of the module input: Assignment of the Input Signal
Logics.LE49.Gate In3-I	State of the module input: Assignment of the Input Signal
Logics.LE49.Gate In4-I	State of the module input: Assignment of the Input Signal
Logics.LE49.Reset Latch-I	State of the module input: Reset Signal for the Latching
Logics.LE50.Gate Out	Signal: Output of the logic gate
Logics.LE50.Timer Out	Signal: Timer Output
Logics.LE50.Out	Signal: Latched Output (Q)
Logics.LE50.Out inverted	Signal: Negated Latched Output (Q NOT)
Logics.LE50.Gate In1-I	State of the module input: Assignment of the Input Signal
Logics.LE50.Gate In2-I	State of the module input: Assignment of the Input Signal
Logics.LE50.Gate In3-I	State of the module input: Assignment of the Input Signal
Logics.LE50.Gate In4-I	State of the module input: Assignment of the Input Signal

<i>Name</i>	<i>Description</i>
Logics.LE50.Reset Latch-I	State of the module input: Reset Signal for the Latching
Logics.LE51.Gate Out	Signal: Output of the logic gate
Logics.LE51.Timer Out	Signal: Timer Output
Logics.LE51.Out	Signal: Latched Output (Q)
Logics.LE51.Out inverted	Signal: Negated Latched Output (Q NOT)
Logics.LE51.Gate In1-I	State of the module input: Assignment of the Input Signal
Logics.LE51.Gate In2-I	State of the module input: Assignment of the Input Signal
Logics.LE51.Gate In3-I	State of the module input: Assignment of the Input Signal
Logics.LE51.Gate In4-I	State of the module input: Assignment of the Input Signal
Logics.LE51.Reset Latch-I	State of the module input: Reset Signal for the Latching
Logics.LE52.Gate Out	Signal: Output of the logic gate
Logics.LE52.Timer Out	Signal: Timer Output
Logics.LE52.Out	Signal: Latched Output (Q)
Logics.LE52.Out inverted	Signal: Negated Latched Output (Q NOT)
Logics.LE52.Gate In1-I	State of the module input: Assignment of the Input Signal
Logics.LE52.Gate In2-I	State of the module input: Assignment of the Input Signal
Logics.LE52.Gate In3-I	State of the module input: Assignment of the Input Signal
Logics.LE52.Gate In4-I	State of the module input: Assignment of the Input Signal
Logics.LE52.Reset Latch-I	State of the module input: Reset Signal for the Latching
Logics.LE53.Gate Out	Signal: Output of the logic gate
Logics.LE53.Timer Out	Signal: Timer Output
Logics.LE53.Out	Signal: Latched Output (Q)
Logics.LE53.Out inverted	Signal: Negated Latched Output (Q NOT)
Logics.LE53.Gate In1-I	State of the module input: Assignment of the Input Signal
Logics.LE53.Gate In2-I	State of the module input: Assignment of the Input Signal
Logics.LE53.Gate In3-I	State of the module input: Assignment of the Input Signal
Logics.LE53.Gate In4-I	State of the module input: Assignment of the Input Signal
Logics.LE53.Reset Latch-I	State of the module input: Reset Signal for the Latching
Logics.LE54.Gate Out	Signal: Output of the logic gate
Logics.LE54.Timer Out	Signal: Timer Output
Logics.LE54.Out	Signal: Latched Output (Q)
Logics.LE54.Out inverted	Signal: Negated Latched Output (Q NOT)
Logics.LE54.Gate In1-I	State of the module input: Assignment of the Input Signal
Logics.LE54.Gate In2-I	State of the module input: Assignment of the Input Signal
Logics.LE54.Gate In3-I	State of the module input: Assignment of the Input Signal
Logics.LE54.Gate In4-I	State of the module input: Assignment of the Input Signal

<i>Name</i>	<i>Description</i>
Logics.LE54.Reset Latch-I	State of the module input: Reset Signal for the Latching
Logics.LE55.Gate Out	Signal: Output of the logic gate
Logics.LE55.Timer Out	Signal: Timer Output
Logics.LE55.Out	Signal: Latched Output (Q)
Logics.LE55.Out inverted	Signal: Negated Latched Output (Q NOT)
Logics.LE55.Gate In1-I	State of the module input: Assignment of the Input Signal
Logics.LE55.Gate In2-I	State of the module input: Assignment of the Input Signal
Logics.LE55.Gate In3-I	State of the module input: Assignment of the Input Signal
Logics.LE55.Gate In4-I	State of the module input: Assignment of the Input Signal
Logics.LE55.Reset Latch-I	State of the module input: Reset Signal for the Latching
Logics.LE56.Gate Out	Signal: Output of the logic gate
Logics.LE56.Timer Out	Signal: Timer Output
Logics.LE56.Out	Signal: Latched Output (Q)
Logics.LE56.Out inverted	Signal: Negated Latched Output (Q NOT)
Logics.LE56.Gate In1-I	State of the module input: Assignment of the Input Signal
Logics.LE56.Gate In2-I	State of the module input: Assignment of the Input Signal
Logics.LE56.Gate In3-I	State of the module input: Assignment of the Input Signal
Logics.LE56.Gate In4-I	State of the module input: Assignment of the Input Signal
Logics.LE56.Reset Latch-I	State of the module input: Reset Signal for the Latching
Logics.LE57.Gate Out	Signal: Output of the logic gate
Logics.LE57.Timer Out	Signal: Timer Output
Logics.LE57.Out	Signal: Latched Output (Q)
Logics.LE57.Out inverted	Signal: Negated Latched Output (Q NOT)
Logics.LE57.Gate In1-I	State of the module input: Assignment of the Input Signal
Logics.LE57.Gate In2-I	State of the module input: Assignment of the Input Signal
Logics.LE57.Gate In3-I	State of the module input: Assignment of the Input Signal
Logics.LE57.Gate In4-I	State of the module input: Assignment of the Input Signal
Logics.LE57.Reset Latch-I	State of the module input: Reset Signal for the Latching
Logics.LE58.Gate Out	Signal: Output of the logic gate
Logics.LE58.Timer Out	Signal: Timer Output
Logics.LE58.Out	Signal: Latched Output (Q)
Logics.LE58.Out inverted	Signal: Negated Latched Output (Q NOT)
Logics.LE58.Gate In1-I	State of the module input: Assignment of the Input Signal
Logics.LE58.Gate In2-I	State of the module input: Assignment of the Input Signal
Logics.LE58.Gate In3-I	State of the module input: Assignment of the Input Signal
Logics.LE58.Gate In4-I	State of the module input: Assignment of the Input Signal

<i>Name</i>	<i>Description</i>
Logics.LE58.Reset Latch-I	State of the module input: Reset Signal for the Latching
Logics.LE59.Gate Out	Signal: Output of the logic gate
Logics.LE59.Timer Out	Signal: Timer Output
Logics.LE59.Out	Signal: Latched Output (Q)
Logics.LE59.Out inverted	Signal: Negated Latched Output (Q NOT)
Logics.LE59.Gate In1-I	State of the module input: Assignment of the Input Signal
Logics.LE59.Gate In2-I	State of the module input: Assignment of the Input Signal
Logics.LE59.Gate In3-I	State of the module input: Assignment of the Input Signal
Logics.LE59.Gate In4-I	State of the module input: Assignment of the Input Signal
Logics.LE59.Reset Latch-I	State of the module input: Reset Signal for the Latching
Logics.LE60.Gate Out	Signal: Output of the logic gate
Logics.LE60.Timer Out	Signal: Timer Output
Logics.LE60.Out	Signal: Latched Output (Q)
Logics.LE60.Out inverted	Signal: Negated Latched Output (Q NOT)
Logics.LE60.Gate In1-I	State of the module input: Assignment of the Input Signal
Logics.LE60.Gate In2-I	State of the module input: Assignment of the Input Signal
Logics.LE60.Gate In3-I	State of the module input: Assignment of the Input Signal
Logics.LE60.Gate In4-I	State of the module input: Assignment of the Input Signal
Logics.LE60.Reset Latch-I	State of the module input: Reset Signal for the Latching
Logics.LE61.Gate Out	Signal: Output of the logic gate
Logics.LE61.Timer Out	Signal: Timer Output
Logics.LE61.Out	Signal: Latched Output (Q)
Logics.LE61.Out inverted	Signal: Negated Latched Output (Q NOT)
Logics.LE61.Gate In1-I	State of the module input: Assignment of the Input Signal
Logics.LE61.Gate In2-I	State of the module input: Assignment of the Input Signal
Logics.LE61.Gate In3-I	State of the module input: Assignment of the Input Signal
Logics.LE61.Gate In4-I	State of the module input: Assignment of the Input Signal
Logics.LE61.Reset Latch-I	State of the module input: Reset Signal for the Latching
Logics.LE62.Gate Out	Signal: Output of the logic gate
Logics.LE62.Timer Out	Signal: Timer Output
Logics.LE62.Out	Signal: Latched Output (Q)
Logics.LE62.Out inverted	Signal: Negated Latched Output (Q NOT)
Logics.LE62.Gate In1-I	State of the module input: Assignment of the Input Signal
Logics.LE62.Gate In2-I	State of the module input: Assignment of the Input Signal
Logics.LE62.Gate In3-I	State of the module input: Assignment of the Input Signal
Logics.LE62.Gate In4-I	State of the module input: Assignment of the Input Signal

<i>Name</i>	<i>Description</i>
Logics.LE62.Reset Latch-I	State of the module input: Reset Signal for the Latching
Logics.LE63.Gate Out	Signal: Output of the logic gate
Logics.LE63.Timer Out	Signal: Timer Output
Logics.LE63.Out	Signal: Latched Output (Q)
Logics.LE63.Out inverted	Signal: Negated Latched Output (Q NOT)
Logics.LE63.Gate In1-I	State of the module input: Assignment of the Input Signal
Logics.LE63.Gate In2-I	State of the module input: Assignment of the Input Signal
Logics.LE63.Gate In3-I	State of the module input: Assignment of the Input Signal
Logics.LE63.Gate In4-I	State of the module input: Assignment of the Input Signal
Logics.LE63.Reset Latch-I	State of the module input: Reset Signal for the Latching
Logics.LE64.Gate Out	Signal: Output of the logic gate
Logics.LE64.Timer Out	Signal: Timer Output
Logics.LE64.Out	Signal: Latched Output (Q)
Logics.LE64.Out inverted	Signal: Negated Latched Output (Q NOT)
Logics.LE64.Gate In1-I	State of the module input: Assignment of the Input Signal
Logics.LE64.Gate In2-I	State of the module input: Assignment of the Input Signal
Logics.LE64.Gate In3-I	State of the module input: Assignment of the Input Signal
Logics.LE64.Gate In4-I	State of the module input: Assignment of the Input Signal
Logics.LE64.Reset Latch-I	State of the module input: Reset Signal for the Latching
Logics.LE65.Gate Out	Signal: Output of the logic gate
Logics.LE65.Timer Out	Signal: Timer Output
Logics.LE65.Out	Signal: Latched Output (Q)
Logics.LE65.Out inverted	Signal: Negated Latched Output (Q NOT)
Logics.LE65.Gate In1-I	State of the module input: Assignment of the Input Signal
Logics.LE65.Gate In2-I	State of the module input: Assignment of the Input Signal
Logics.LE65.Gate In3-I	State of the module input: Assignment of the Input Signal
Logics.LE65.Gate In4-I	State of the module input: Assignment of the Input Signal
Logics.LE65.Reset Latch-I	State of the module input: Reset Signal for the Latching
Logics.LE66.Gate Out	Signal: Output of the logic gate
Logics.LE66.Timer Out	Signal: Timer Output
Logics.LE66.Out	Signal: Latched Output (Q)
Logics.LE66.Out inverted	Signal: Negated Latched Output (Q NOT)
Logics.LE66.Gate In1-I	State of the module input: Assignment of the Input Signal
Logics.LE66.Gate In2-I	State of the module input: Assignment of the Input Signal
Logics.LE66.Gate In3-I	State of the module input: Assignment of the Input Signal
Logics.LE66.Gate In4-I	State of the module input: Assignment of the Input Signal

<i>Name</i>	<i>Description</i>
Logics.LE66.Reset Latch-I	State of the module input: Reset Signal for the Latching
Logics.LE67.Gate Out	Signal: Output of the logic gate
Logics.LE67.Timer Out	Signal: Timer Output
Logics.LE67.Out	Signal: Latched Output (Q)
Logics.LE67.Out inverted	Signal: Negated Latched Output (Q NOT)
Logics.LE67.Gate In1-I	State of the module input: Assignment of the Input Signal
Logics.LE67.Gate In2-I	State of the module input: Assignment of the Input Signal
Logics.LE67.Gate In3-I	State of the module input: Assignment of the Input Signal
Logics.LE67.Gate In4-I	State of the module input: Assignment of the Input Signal
Logics.LE67.Reset Latch-I	State of the module input: Reset Signal for the Latching
Logics.LE68.Gate Out	Signal: Output of the logic gate
Logics.LE68.Timer Out	Signal: Timer Output
Logics.LE68.Out	Signal: Latched Output (Q)
Logics.LE68.Out inverted	Signal: Negated Latched Output (Q NOT)
Logics.LE68.Gate In1-I	State of the module input: Assignment of the Input Signal
Logics.LE68.Gate In2-I	State of the module input: Assignment of the Input Signal
Logics.LE68.Gate In3-I	State of the module input: Assignment of the Input Signal
Logics.LE68.Gate In4-I	State of the module input: Assignment of the Input Signal
Logics.LE68.Reset Latch-I	State of the module input: Reset Signal for the Latching
Logics.LE69.Gate Out	Signal: Output of the logic gate
Logics.LE69.Timer Out	Signal: Timer Output
Logics.LE69.Out	Signal: Latched Output (Q)
Logics.LE69.Out inverted	Signal: Negated Latched Output (Q NOT)
Logics.LE69.Gate In1-I	State of the module input: Assignment of the Input Signal
Logics.LE69.Gate In2-I	State of the module input: Assignment of the Input Signal
Logics.LE69.Gate In3-I	State of the module input: Assignment of the Input Signal
Logics.LE69.Gate In4-I	State of the module input: Assignment of the Input Signal
Logics.LE69.Reset Latch-I	State of the module input: Reset Signal for the Latching
Logics.LE70.Gate Out	Signal: Output of the logic gate
Logics.LE70.Timer Out	Signal: Timer Output
Logics.LE70.Out	Signal: Latched Output (Q)
Logics.LE70.Out inverted	Signal: Negated Latched Output (Q NOT)
Logics.LE70.Gate In1-I	State of the module input: Assignment of the Input Signal
Logics.LE70.Gate In2-I	State of the module input: Assignment of the Input Signal
Logics.LE70.Gate In3-I	State of the module input: Assignment of the Input Signal
Logics.LE70.Gate In4-I	State of the module input: Assignment of the Input Signal

General Lists

<i>Name</i>	<i>Description</i>
Logics.LE70.Reset Latch-I	State of the module input: Reset Signal for the Latching
Logics.LE71.Gate Out	Signal: Output of the logic gate
Logics.LE71.Timer Out	Signal: Timer Output
Logics.LE71.Out	Signal: Latched Output (Q)
Logics.LE71.Out inverted	Signal: Negated Latched Output (Q NOT)
Logics.LE71.Gate In1-I	State of the module input: Assignment of the Input Signal
Logics.LE71.Gate In2-I	State of the module input: Assignment of the Input Signal
Logics.LE71.Gate In3-I	State of the module input: Assignment of the Input Signal
Logics.LE71.Gate In4-I	State of the module input: Assignment of the Input Signal
Logics.LE71.Reset Latch-I	State of the module input: Reset Signal for the Latching
Logics.LE72.Gate Out	Signal: Output of the logic gate
Logics.LE72.Timer Out	Signal: Timer Output
Logics.LE72.Out	Signal: Latched Output (Q)
Logics.LE72.Out inverted	Signal: Negated Latched Output (Q NOT)
Logics.LE72.Gate In1-I	State of the module input: Assignment of the Input Signal
Logics.LE72.Gate In2-I	State of the module input: Assignment of the Input Signal
Logics.LE72.Gate In3-I	State of the module input: Assignment of the Input Signal
Logics.LE72.Gate In4-I	State of the module input: Assignment of the Input Signal
Logics.LE72.Reset Latch-I	State of the module input: Reset Signal for the Latching
Logics.LE73.Gate Out	Signal: Output of the logic gate
Logics.LE73.Timer Out	Signal: Timer Output
Logics.LE73.Out	Signal: Latched Output (Q)
Logics.LE73.Out inverted	Signal: Negated Latched Output (Q NOT)
Logics.LE73.Gate In1-I	State of the module input: Assignment of the Input Signal
Logics.LE73.Gate In2-I	State of the module input: Assignment of the Input Signal
Logics.LE73.Gate In3-I	State of the module input: Assignment of the Input Signal
Logics.LE73.Gate In4-I	State of the module input: Assignment of the Input Signal
Logics.LE73.Reset Latch-I	State of the module input: Reset Signal for the Latching
Logics.LE74.Gate Out	Signal: Output of the logic gate
Logics.LE74.Timer Out	Signal: Timer Output
Logics.LE74.Out	Signal: Latched Output (Q)
Logics.LE74.Out inverted	Signal: Negated Latched Output (Q NOT)
Logics.LE74.Gate In1-I	State of the module input: Assignment of the Input Signal
Logics.LE74.Gate In2-I	State of the module input: Assignment of the Input Signal
Logics.LE74.Gate In3-I	State of the module input: Assignment of the Input Signal
Logics.LE74.Gate In4-I	State of the module input: Assignment of the Input Signal

<i>Name</i>	<i>Description</i>
Logics.LE74.Reset Latch-I	State of the module input: Reset Signal for the Latching
Logics.LE75.Gate Out	Signal: Output of the logic gate
Logics.LE75.Timer Out	Signal: Timer Output
Logics.LE75.Out	Signal: Latched Output (Q)
Logics.LE75.Out inverted	Signal: Negated Latched Output (Q NOT)
Logics.LE75.Gate In1-I	State of the module input: Assignment of the Input Signal
Logics.LE75.Gate In2-I	State of the module input: Assignment of the Input Signal
Logics.LE75.Gate In3-I	State of the module input: Assignment of the Input Signal
Logics.LE75.Gate In4-I	State of the module input: Assignment of the Input Signal
Logics.LE75.Reset Latch-I	State of the module input: Reset Signal for the Latching
Logics.LE76.Gate Out	Signal: Output of the logic gate
Logics.LE76.Timer Out	Signal: Timer Output
Logics.LE76.Out	Signal: Latched Output (Q)
Logics.LE76.Out inverted	Signal: Negated Latched Output (Q NOT)
Logics.LE76.Gate In1-I	State of the module input: Assignment of the Input Signal
Logics.LE76.Gate In2-I	State of the module input: Assignment of the Input Signal
Logics.LE76.Gate In3-I	State of the module input: Assignment of the Input Signal
Logics.LE76.Gate In4-I	State of the module input: Assignment of the Input Signal
Logics.LE76.Reset Latch-I	State of the module input: Reset Signal for the Latching
Logics.LE77.Gate Out	Signal: Output of the logic gate
Logics.LE77.Timer Out	Signal: Timer Output
Logics.LE77.Out	Signal: Latched Output (Q)
Logics.LE77.Out inverted	Signal: Negated Latched Output (Q NOT)
Logics.LE77.Gate In1-I	State of the module input: Assignment of the Input Signal
Logics.LE77.Gate In2-I	State of the module input: Assignment of the Input Signal
Logics.LE77.Gate In3-I	State of the module input: Assignment of the Input Signal
Logics.LE77.Gate In4-I	State of the module input: Assignment of the Input Signal
Logics.LE77.Reset Latch-I	State of the module input: Reset Signal for the Latching
Logics.LE78.Gate Out	Signal: Output of the logic gate
Logics.LE78.Timer Out	Signal: Timer Output
Logics.LE78.Out	Signal: Latched Output (Q)
Logics.LE78.Out inverted	Signal: Negated Latched Output (Q NOT)
Logics.LE78.Gate In1-I	State of the module input: Assignment of the Input Signal
Logics.LE78.Gate In2-I	State of the module input: Assignment of the Input Signal
Logics.LE78.Gate In3-I	State of the module input: Assignment of the Input Signal
Logics.LE78.Gate In4-I	State of the module input: Assignment of the Input Signal

General Lists

<i>Name</i>	<i>Description</i>
Logics.LE78.Reset Latch-I	State of the module input: Reset Signal for the Latching
Logics.LE79.Gate Out	Signal: Output of the logic gate
Logics.LE79.Timer Out	Signal: Timer Output
Logics.LE79.Out	Signal: Latched Output (Q)
Logics.LE79.Out inverted	Signal: Negated Latched Output (Q NOT)
Logics.LE79.Gate In1-I	State of the module input: Assignment of the Input Signal
Logics.LE79.Gate In2-I	State of the module input: Assignment of the Input Signal
Logics.LE79.Gate In3-I	State of the module input: Assignment of the Input Signal
Logics.LE79.Gate In4-I	State of the module input: Assignment of the Input Signal
Logics.LE79.Reset Latch-I	State of the module input: Reset Signal for the Latching
Logics.LE80.Gate Out	Signal: Output of the logic gate
Logics.LE80.Timer Out	Signal: Timer Output
Logics.LE80.Out	Signal: Latched Output (Q)
Logics.LE80.Out inverted	Signal: Negated Latched Output (Q NOT)
Logics.LE80.Gate In1-I	State of the module input: Assignment of the Input Signal
Logics.LE80.Gate In2-I	State of the module input: Assignment of the Input Signal
Logics.LE80.Gate In3-I	State of the module input: Assignment of the Input Signal
Logics.LE80.Gate In4-I	State of the module input: Assignment of the Input Signal
Logics.LE80.Reset Latch-I	State of the module input: Reset Signal for the Latching
Sgen.Manual Start	Fault Simulation has been started manually.
Sgen.Manual Stop	Fault Simulation has been stopped manually.
Sgen.Running	Signal; Measuring value simulation is running
Sgen.Started	Fault Simulation has been started
Sgen.Stopped	Fault Simulation has been stopped
Sgen.Ex Start Simulation-I	State of the module input:External Start of Fault Simulation (Using the test parameters)
Sgen.ExBlo1-I	Module input state: External blocking1
Sgen.ExBlo2-I	Module input state: External blocking2
Sgen.Ex ForcePost-I	State of the module input:Force Post state. Abort simulation.
Sys.PS 1	Signal: Parameter Set 1
Sys.PS 2	Signal: Parameter Set 2
Sys.PS 3	Signal: Parameter Set 3
Sys.PS 4	Signal: Parameter Set 4
Sys.PSS manual	Signal: Manual Switch over of a Parameter Set
Sys.PSS via Scada	Signal: Parameter Set Switch via Scada. Write into this output byte the integer of the parameter set that should become active (e.g. 4 => Switch onto parameter set 4).
Sys.PSS via Inp fct	Signal: Parameter Set Switch via input function
Sys.min 1 param changed	Signal: At least one parameter has been changed

General Lists

<i>Name</i>	<i>Description</i>
Sys.Setting Lock Bypass	Signal: Short-period unlock of the Setting Lock
Sys.Ack LED	Signal: LEDs acknowledgement
Sys.Ack BO	Signal: Acknowledgement of the Binary Outputs
Sys.Ack Scada	Signal: Acknowledge Scada
Sys.Ack TripCmd	Signal: Reset Trip Command
Sys.Ack LED-HMI	Signal: LEDs acknowledgement :HMI
Sys.Ack BO-HMI	Signal: Acknowledgement of the Binary Outputs :HMI
Sys.Ack Scada-HMI	Signal: Acknowledge Scada :HMI
Sys.Ack TripCmd-HMI	Signal: Reset Trip Command :HMI
Sys.Ack LED-Sca	Signal: LEDs acknowledgement :SCADA
Sys.Ack BO-Sca	Signal: Acknowledgement of the Binary Outputs :SCADA
Sys.Ack Counter-Sca	Signal: Reset of all Counters :SCADA
Sys.Ack Scada-Sca	Signal: Acknowledge Scada :SCADA
Sys.Ack TripCmd-Sca	Signal: Reset Trip Command :SCADA
Sys.Res OperationsCr	Signal:: Res OperationsCr
Sys.Res AlarmCr	Signal:: Res AlarmCr
Sys.Res TripCmdCr	Signal:: Res TripCmdCr
Sys.Res TotalCr	Signal:: Res TotalCr
Sys.Ack LED-I	Module input state: LEDs acknowledgement by digital input
Sys.Ack BO-I	Module input state: Acknowledgement of the binary Output Relays
Sys.Ack Scada-I	Module input state: Acknowledge Scada via digital input. The replica that SCADA has got from the device is to be reset.
Sys.PS1-I	State of the module input respectively of the signal, that should activate this Parameter Setting Group.
Sys.PS2-I	State of the module input respectively of the signal, that should activate this Parameter Setting Group.
Sys.PS3-I	State of the module input respectively of the signal, that should activate this Parameter Setting Group.
Sys.PS4-I	State of the module input respectively of the signal, that should activate this Parameter Setting Group.
Sys.Lock Settings-I	State of the module input: No parameters can be changed as long as this input is true. The parameter settings are locked.
Sys.Internal test state	Auxiliary state for testing purposes.

List of the Digital Inputs

The following list comprises all Digital Inputs. This list is used in various Protective Elements (e.g. TCS, Q->&V<...). The availability and the number of entries depends on the type of device.

<i>Name</i>	<i>Description</i>
-.-	No assignment
DI Slot X1.DI 1	Signal: Digital Input
DI Slot X1.DI 2	Signal: Digital Input
DI Slot X1.DI 3	Signal: Digital Input
DI Slot X1.DI 4	Signal: Digital Input
DI Slot X1.DI 5	Signal: Digital Input
DI Slot X1.DI 6	Signal: Digital Input
DI Slot X1.DI 7	Signal: Digital Input
DI Slot X1.DI 8	Signal: Digital Input
DI Slot X5.DI 1	Signal: Digital Input
DI Slot X5.DI 2	Signal: Digital Input
DI Slot X5.DI 3	Signal: Digital Input
DI Slot X5.DI 4	Signal: Digital Input
DI Slot X5.DI 5	Signal: Digital Input
DI Slot X5.DI 6	Signal: Digital Input
DI Slot X5.DI 7	Signal: Digital Input
DI Slot X5.DI 8	Signal: Digital Input
DI Slot X6.DI 1	Signal: Digital Input
DI Slot X6.DI 2	Signal: Digital Input
DI Slot X6.DI 3	Signal: Digital Input
DI Slot X6.DI 4	Signal: Digital Input
DI Slot X6.DI 5	Signal: Digital Input
DI Slot X6.DI 6	Signal: Digital Input
DI Slot X6.DI 7	Signal: Digital Input
DI Slot X6.DI 8	Signal: Digital Input

Signals of the Digital Inputs and Logic

The following list comprises the signals of the Digital Inputs and the Logic. This list is used in various protective elements.

<i>Name</i>	<i>Description</i>
.-	No assignment
DI Slot X1.DI 1	Signal: Digital Input
DI Slot X1.DI 2	Signal: Digital Input
DI Slot X1.DI 3	Signal: Digital Input
DI Slot X1.DI 4	Signal: Digital Input
DI Slot X1.DI 5	Signal: Digital Input
DI Slot X1.DI 6	Signal: Digital Input
DI Slot X1.DI 7	Signal: Digital Input
DI Slot X1.DI 8	Signal: Digital Input
DI Slot X5.DI 1	Signal: Digital Input
DI Slot X5.DI 2	Signal: Digital Input
DI Slot X5.DI 3	Signal: Digital Input
DI Slot X5.DI 4	Signal: Digital Input
DI Slot X5.DI 5	Signal: Digital Input
DI Slot X5.DI 6	Signal: Digital Input
DI Slot X5.DI 7	Signal: Digital Input
DI Slot X5.DI 8	Signal: Digital Input
DI Slot X6.DI 1	Signal: Digital Input
DI Slot X6.DI 2	Signal: Digital Input
DI Slot X6.DI 3	Signal: Digital Input
DI Slot X6.DI 4	Signal: Digital Input
DI Slot X6.DI 5	Signal: Digital Input
DI Slot X6.DI 6	Signal: Digital Input
DI Slot X6.DI 7	Signal: Digital Input
DI Slot X6.DI 8	Signal: Digital Input
DNP3.BinaryOutput0	Virtual Digital Output (DNP). This corresponds to a virtual binary input of the protective device.
DNP3.BinaryOutput1	Virtual Digital Output (DNP). This corresponds to a virtual binary input of the protective device.
DNP3.BinaryOutput2	Virtual Digital Output (DNP). This corresponds to a virtual binary input of the protective device.
DNP3.BinaryOutput3	Virtual Digital Output (DNP). This corresponds to a virtual binary input of the protective device.
DNP3.BinaryOutput4	Virtual Digital Output (DNP). This corresponds to a virtual binary input of the protective device.
DNP3.BinaryOutput5	Virtual Digital Output (DNP). This corresponds to a virtual binary input of the protective device.

<i>Name</i>	<i>Description</i>
DNP3.BinaryOutput6	Virtual Digital Output (DNP). This corresponds to a virtual binary input of the protective device.
DNP3.BinaryOutput7	Virtual Digital Output (DNP). This corresponds to a virtual binary input of the protective device.
DNP3.BinaryOutput8	Virtual Digital Output (DNP). This corresponds to a virtual binary input of the protective device.
DNP3.BinaryOutput9	Virtual Digital Output (DNP). This corresponds to a virtual binary input of the protective device.
DNP3.BinaryOutput10	Virtual Digital Output (DNP). This corresponds to a virtual binary input of the protective device.
DNP3.BinaryOutput11	Virtual Digital Output (DNP). This corresponds to a virtual binary input of the protective device.
DNP3.BinaryOutput12	Virtual Digital Output (DNP). This corresponds to a virtual binary input of the protective device.
DNP3.BinaryOutput13	Virtual Digital Output (DNP). This corresponds to a virtual binary input of the protective device.
DNP3.BinaryOutput14	Virtual Digital Output (DNP). This corresponds to a virtual binary input of the protective device.
DNP3.BinaryOutput15	Virtual Digital Output (DNP). This corresponds to a virtual binary input of the protective device.
DNP3.BinaryOutput16	Virtual Digital Output (DNP). This corresponds to a virtual binary input of the protective device.
DNP3.BinaryOutput17	Virtual Digital Output (DNP). This corresponds to a virtual binary input of the protective device.
DNP3.BinaryOutput18	Virtual Digital Output (DNP). This corresponds to a virtual binary input of the protective device.
DNP3.BinaryOutput19	Virtual Digital Output (DNP). This corresponds to a virtual binary input of the protective device.
DNP3.BinaryOutput20	Virtual Digital Output (DNP). This corresponds to a virtual binary input of the protective device.
DNP3.BinaryOutput21	Virtual Digital Output (DNP). This corresponds to a virtual binary input of the protective device.
DNP3.BinaryOutput22	Virtual Digital Output (DNP). This corresponds to a virtual binary input of the protective device.
DNP3.BinaryOutput23	Virtual Digital Output (DNP). This corresponds to a virtual binary input of the protective device.
DNP3.BinaryOutput24	Virtual Digital Output (DNP). This corresponds to a virtual binary input of the protective device.
DNP3.BinaryOutput25	Virtual Digital Output (DNP). This corresponds to a virtual binary input of the protective device.
DNP3.BinaryOutput26	Virtual Digital Output (DNP). This corresponds to a virtual binary input of the protective device.
DNP3.BinaryOutput27	Virtual Digital Output (DNP). This corresponds to a virtual binary input of the protective device.
DNP3.BinaryOutput28	Virtual Digital Output (DNP). This corresponds to a virtual binary input of the protective device.

General Lists

<i>Name</i>	<i>Description</i>
DNP3.BinaryOutput29	Virtual Digital Output (DNP). This corresponds to a virtual binary input of the protective device.
DNP3.BinaryOutput30	Virtual Digital Output (DNP). This corresponds to a virtual binary input of the protective device.
DNP3.BinaryOutput31	Virtual Digital Output (DNP). This corresponds to a virtual binary input of the protective device.
Logics.LE1.Gate Out	Signal: Output of the logic gate
Logics.LE1.Timer Out	Signal: Timer Output
Logics.LE1.Out	Signal: Latched Output (Q)
Logics.LE1.Out inverted	Signal: Negated Latched Output (Q NOT)
Logics.LE2.Gate Out	Signal: Output of the logic gate
Logics.LE2.Timer Out	Signal: Timer Output
Logics.LE2.Out	Signal: Latched Output (Q)
Logics.LE2.Out inverted	Signal: Negated Latched Output (Q NOT)
Logics.LE3.Gate Out	Signal: Output of the logic gate
Logics.LE3.Timer Out	Signal: Timer Output
Logics.LE3.Out	Signal: Latched Output (Q)
Logics.LE3.Out inverted	Signal: Negated Latched Output (Q NOT)
Logics.LE4.Gate Out	Signal: Output of the logic gate
Logics.LE4.Timer Out	Signal: Timer Output
Logics.LE4.Out	Signal: Latched Output (Q)
Logics.LE4.Out inverted	Signal: Negated Latched Output (Q NOT)
Logics.LE5.Gate Out	Signal: Output of the logic gate
Logics.LE5.Timer Out	Signal: Timer Output
Logics.LE5.Out	Signal: Latched Output (Q)
Logics.LE5.Out inverted	Signal: Negated Latched Output (Q NOT)
Logics.LE6.Gate Out	Signal: Output of the logic gate
Logics.LE6.Timer Out	Signal: Timer Output
Logics.LE6.Out	Signal: Latched Output (Q)
Logics.LE6.Out inverted	Signal: Negated Latched Output (Q NOT)
Logics.LE7.Gate Out	Signal: Output of the logic gate
Logics.LE7.Timer Out	Signal: Timer Output
Logics.LE7.Out	Signal: Latched Output (Q)
Logics.LE7.Out inverted	Signal: Negated Latched Output (Q NOT)
Logics.LE8.Gate Out	Signal: Output of the logic gate
Logics.LE8.Timer Out	Signal: Timer Output
Logics.LE8.Out	Signal: Latched Output (Q)
Logics.LE8.Out inverted	Signal: Negated Latched Output (Q NOT)
Logics.LE9.Gate Out	Signal: Output of the logic gate
Logics.LE9.Timer Out	Signal: Timer Output
Logics.LE9.Out	Signal: Latched Output (Q)

General Lists

<i>Name</i>	<i>Description</i>
Logics.LE9.Out inverted	Signal: Negated Latched Output (Q NOT)
Logics.LE10.Gate Out	Signal: Output of the logic gate
Logics.LE10.Timer Out	Signal: Timer Output
Logics.LE10.Out	Signal: Latched Output (Q)
Logics.LE10.Out inverted	Signal: Negated Latched Output (Q NOT)
Logics.LE11.Gate Out	Signal: Output of the logic gate
Logics.LE11.Timer Out	Signal: Timer Output
Logics.LE11.Out	Signal: Latched Output (Q)
Logics.LE11.Out inverted	Signal: Negated Latched Output (Q NOT)
Logics.LE12.Gate Out	Signal: Output of the logic gate
Logics.LE12.Timer Out	Signal: Timer Output
Logics.LE12.Out	Signal: Latched Output (Q)
Logics.LE12.Out inverted	Signal: Negated Latched Output (Q NOT)
Logics.LE13.Gate Out	Signal: Output of the logic gate
Logics.LE13.Timer Out	Signal: Timer Output
Logics.LE13.Out	Signal: Latched Output (Q)
Logics.LE13.Out inverted	Signal: Negated Latched Output (Q NOT)
Logics.LE14.Gate Out	Signal: Output of the logic gate
Logics.LE14.Timer Out	Signal: Timer Output
Logics.LE14.Out	Signal: Latched Output (Q)
Logics.LE14.Out inverted	Signal: Negated Latched Output (Q NOT)
Logics.LE15.Gate Out	Signal: Output of the logic gate
Logics.LE15.Timer Out	Signal: Timer Output
Logics.LE15.Out	Signal: Latched Output (Q)
Logics.LE15.Out inverted	Signal: Negated Latched Output (Q NOT)
Logics.LE16.Gate Out	Signal: Output of the logic gate
Logics.LE16.Timer Out	Signal: Timer Output
Logics.LE16.Out	Signal: Latched Output (Q)
Logics.LE16.Out inverted	Signal: Negated Latched Output (Q NOT)
Logics.LE17.Gate Out	Signal: Output of the logic gate
Logics.LE17.Timer Out	Signal: Timer Output
Logics.LE17.Out	Signal: Latched Output (Q)
Logics.LE17.Out inverted	Signal: Negated Latched Output (Q NOT)
Logics.LE18.Gate Out	Signal: Output of the logic gate
Logics.LE18.Timer Out	Signal: Timer Output
Logics.LE18.Out	Signal: Latched Output (Q)
Logics.LE18.Out inverted	Signal: Negated Latched Output (Q NOT)
Logics.LE19.Gate Out	Signal: Output of the logic gate
Logics.LE19.Timer Out	Signal: Timer Output
Logics.LE19.Out	Signal: Latched Output (Q)

General Lists

<i>Name</i>	<i>Description</i>
Logics.LE19.Out inverted	Signal: Negated Latched Output (Q NOT)
Logics.LE20.Gate Out	Signal: Output of the logic gate
Logics.LE20.Timer Out	Signal: Timer Output
Logics.LE20.Out	Signal: Latched Output (Q)
Logics.LE20.Out inverted	Signal: Negated Latched Output (Q NOT)
Logics.LE21.Gate Out	Signal: Output of the logic gate
Logics.LE21.Timer Out	Signal: Timer Output
Logics.LE21.Out	Signal: Latched Output (Q)
Logics.LE21.Out inverted	Signal: Negated Latched Output (Q NOT)
Logics.LE22.Gate Out	Signal: Output of the logic gate
Logics.LE22.Timer Out	Signal: Timer Output
Logics.LE22.Out	Signal: Latched Output (Q)
Logics.LE22.Out inverted	Signal: Negated Latched Output (Q NOT)
Logics.LE23.Gate Out	Signal: Output of the logic gate
Logics.LE23.Timer Out	Signal: Timer Output
Logics.LE23.Out	Signal: Latched Output (Q)
Logics.LE23.Out inverted	Signal: Negated Latched Output (Q NOT)
Logics.LE24.Gate Out	Signal: Output of the logic gate
Logics.LE24.Timer Out	Signal: Timer Output
Logics.LE24.Out	Signal: Latched Output (Q)
Logics.LE24.Out inverted	Signal: Negated Latched Output (Q NOT)
Logics.LE25.Gate Out	Signal: Output of the logic gate
Logics.LE25.Timer Out	Signal: Timer Output
Logics.LE25.Out	Signal: Latched Output (Q)
Logics.LE25.Out inverted	Signal: Negated Latched Output (Q NOT)
Logics.LE26.Gate Out	Signal: Output of the logic gate
Logics.LE26.Timer Out	Signal: Timer Output
Logics.LE26.Out	Signal: Latched Output (Q)
Logics.LE26.Out inverted	Signal: Negated Latched Output (Q NOT)
Logics.LE27.Gate Out	Signal: Output of the logic gate
Logics.LE27.Timer Out	Signal: Timer Output
Logics.LE27.Out	Signal: Latched Output (Q)
Logics.LE27.Out inverted	Signal: Negated Latched Output (Q NOT)
Logics.LE28.Gate Out	Signal: Output of the logic gate
Logics.LE28.Timer Out	Signal: Timer Output
Logics.LE28.Out	Signal: Latched Output (Q)
Logics.LE28.Out inverted	Signal: Negated Latched Output (Q NOT)
Logics.LE29.Gate Out	Signal: Output of the logic gate
Logics.LE29.Timer Out	Signal: Timer Output
Logics.LE29.Out	Signal: Latched Output (Q)

General Lists

<i>Name</i>	<i>Description</i>
Logics.LE29.Out inverted	Signal: Negated Latched Output (Q NOT)
Logics.LE30.Gate Out	Signal: Output of the logic gate
Logics.LE30.Timer Out	Signal: Timer Output
Logics.LE30.Out	Signal: Latched Output (Q)
Logics.LE30.Out inverted	Signal: Negated Latched Output (Q NOT)
Logics.LE31.Gate Out	Signal: Output of the logic gate
Logics.LE31.Timer Out	Signal: Timer Output
Logics.LE31.Out	Signal: Latched Output (Q)
Logics.LE31.Out inverted	Signal: Negated Latched Output (Q NOT)
Logics.LE32.Gate Out	Signal: Output of the logic gate
Logics.LE32.Timer Out	Signal: Timer Output
Logics.LE32.Out	Signal: Latched Output (Q)
Logics.LE32.Out inverted	Signal: Negated Latched Output (Q NOT)
Logics.LE33.Gate Out	Signal: Output of the logic gate
Logics.LE33.Timer Out	Signal: Timer Output
Logics.LE33.Out	Signal: Latched Output (Q)
Logics.LE33.Out inverted	Signal: Negated Latched Output (Q NOT)
Logics.LE34.Gate Out	Signal: Output of the logic gate
Logics.LE34.Timer Out	Signal: Timer Output
Logics.LE34.Out	Signal: Latched Output (Q)
Logics.LE34.Out inverted	Signal: Negated Latched Output (Q NOT)
Logics.LE35.Gate Out	Signal: Output of the logic gate
Logics.LE35.Timer Out	Signal: Timer Output
Logics.LE35.Out	Signal: Latched Output (Q)
Logics.LE35.Out inverted	Signal: Negated Latched Output (Q NOT)
Logics.LE36.Gate Out	Signal: Output of the logic gate
Logics.LE36.Timer Out	Signal: Timer Output
Logics.LE36.Out	Signal: Latched Output (Q)
Logics.LE36.Out inverted	Signal: Negated Latched Output (Q NOT)
Logics.LE37.Gate Out	Signal: Output of the logic gate
Logics.LE37.Timer Out	Signal: Timer Output
Logics.LE37.Out	Signal: Latched Output (Q)
Logics.LE37.Out inverted	Signal: Negated Latched Output (Q NOT)
Logics.LE38.Gate Out	Signal: Output of the logic gate
Logics.LE38.Timer Out	Signal: Timer Output
Logics.LE38.Out	Signal: Latched Output (Q)
Logics.LE38.Out inverted	Signal: Negated Latched Output (Q NOT)
Logics.LE39.Gate Out	Signal: Output of the logic gate
Logics.LE39.Timer Out	Signal: Timer Output
Logics.LE39.Out	Signal: Latched Output (Q)

General Lists

<i>Name</i>	<i>Description</i>
Logics.LE39.Out inverted	Signal: Negated Latched Output (Q NOT)
Logics.LE40.Gate Out	Signal: Output of the logic gate
Logics.LE40.Timer Out	Signal: Timer Output
Logics.LE40.Out	Signal: Latched Output (Q)
Logics.LE40.Out inverted	Signal: Negated Latched Output (Q NOT)
Logics.LE41.Gate Out	Signal: Output of the logic gate
Logics.LE41.Timer Out	Signal: Timer Output
Logics.LE41.Out	Signal: Latched Output (Q)
Logics.LE41.Out inverted	Signal: Negated Latched Output (Q NOT)
Logics.LE42.Gate Out	Signal: Output of the logic gate
Logics.LE42.Timer Out	Signal: Timer Output
Logics.LE42.Out	Signal: Latched Output (Q)
Logics.LE42.Out inverted	Signal: Negated Latched Output (Q NOT)
Logics.LE43.Gate Out	Signal: Output of the logic gate
Logics.LE43.Timer Out	Signal: Timer Output
Logics.LE43.Out	Signal: Latched Output (Q)
Logics.LE43.Out inverted	Signal: Negated Latched Output (Q NOT)
Logics.LE44.Gate Out	Signal: Output of the logic gate
Logics.LE44.Timer Out	Signal: Timer Output
Logics.LE44.Out	Signal: Latched Output (Q)
Logics.LE44.Out inverted	Signal: Negated Latched Output (Q NOT)
Logics.LE45.Gate Out	Signal: Output of the logic gate
Logics.LE45.Timer Out	Signal: Timer Output
Logics.LE45.Out	Signal: Latched Output (Q)
Logics.LE45.Out inverted	Signal: Negated Latched Output (Q NOT)
Logics.LE46.Gate Out	Signal: Output of the logic gate
Logics.LE46.Timer Out	Signal: Timer Output
Logics.LE46.Out	Signal: Latched Output (Q)
Logics.LE46.Out inverted	Signal: Negated Latched Output (Q NOT)
Logics.LE47.Gate Out	Signal: Output of the logic gate
Logics.LE47.Timer Out	Signal: Timer Output
Logics.LE47.Out	Signal: Latched Output (Q)
Logics.LE47.Out inverted	Signal: Negated Latched Output (Q NOT)
Logics.LE48.Gate Out	Signal: Output of the logic gate
Logics.LE48.Timer Out	Signal: Timer Output
Logics.LE48.Out	Signal: Latched Output (Q)
Logics.LE48.Out inverted	Signal: Negated Latched Output (Q NOT)
Logics.LE49.Gate Out	Signal: Output of the logic gate
Logics.LE49.Timer Out	Signal: Timer Output
Logics.LE49.Out	Signal: Latched Output (Q)

General Lists

<i>Name</i>	<i>Description</i>
Logics.LE49.Out inverted	Signal: Negated Latched Output (Q NOT)
Logics.LE50.Gate Out	Signal: Output of the logic gate
Logics.LE50.Timer Out	Signal: Timer Output
Logics.LE50.Out	Signal: Latched Output (Q)
Logics.LE50.Out inverted	Signal: Negated Latched Output (Q NOT)
Logics.LE51.Gate Out	Signal: Output of the logic gate
Logics.LE51.Timer Out	Signal: Timer Output
Logics.LE51.Out	Signal: Latched Output (Q)
Logics.LE51.Out inverted	Signal: Negated Latched Output (Q NOT)
Logics.LE52.Gate Out	Signal: Output of the logic gate
Logics.LE52.Timer Out	Signal: Timer Output
Logics.LE52.Out	Signal: Latched Output (Q)
Logics.LE52.Out inverted	Signal: Negated Latched Output (Q NOT)
Logics.LE53.Gate Out	Signal: Output of the logic gate
Logics.LE53.Timer Out	Signal: Timer Output
Logics.LE53.Out	Signal: Latched Output (Q)
Logics.LE53.Out inverted	Signal: Negated Latched Output (Q NOT)
Logics.LE54.Gate Out	Signal: Output of the logic gate
Logics.LE54.Timer Out	Signal: Timer Output
Logics.LE54.Out	Signal: Latched Output (Q)
Logics.LE54.Out inverted	Signal: Negated Latched Output (Q NOT)
Logics.LE55.Gate Out	Signal: Output of the logic gate
Logics.LE55.Timer Out	Signal: Timer Output
Logics.LE55.Out	Signal: Latched Output (Q)
Logics.LE55.Out inverted	Signal: Negated Latched Output (Q NOT)
Logics.LE56.Gate Out	Signal: Output of the logic gate
Logics.LE56.Timer Out	Signal: Timer Output
Logics.LE56.Out	Signal: Latched Output (Q)
Logics.LE56.Out inverted	Signal: Negated Latched Output (Q NOT)
Logics.LE57.Gate Out	Signal: Output of the logic gate
Logics.LE57.Timer Out	Signal: Timer Output
Logics.LE57.Out	Signal: Latched Output (Q)
Logics.LE57.Out inverted	Signal: Negated Latched Output (Q NOT)
Logics.LE58.Gate Out	Signal: Output of the logic gate
Logics.LE58.Timer Out	Signal: Timer Output
Logics.LE58.Out	Signal: Latched Output (Q)
Logics.LE58.Out inverted	Signal: Negated Latched Output (Q NOT)
Logics.LE59.Gate Out	Signal: Output of the logic gate
Logics.LE59.Timer Out	Signal: Timer Output
Logics.LE59.Out	Signal: Latched Output (Q)

General Lists

<i>Name</i>	<i>Description</i>
Logics.LE59.Out inverted	Signal: Negated Latched Output (Q NOT)
Logics.LE60.Gate Out	Signal: Output of the logic gate
Logics.LE60.Timer Out	Signal: Timer Output
Logics.LE60.Out	Signal: Latched Output (Q)
Logics.LE60.Out inverted	Signal: Negated Latched Output (Q NOT)
Logics.LE61.Gate Out	Signal: Output of the logic gate
Logics.LE61.Timer Out	Signal: Timer Output
Logics.LE61.Out	Signal: Latched Output (Q)
Logics.LE61.Out inverted	Signal: Negated Latched Output (Q NOT)
Logics.LE62.Gate Out	Signal: Output of the logic gate
Logics.LE62.Timer Out	Signal: Timer Output
Logics.LE62.Out	Signal: Latched Output (Q)
Logics.LE62.Out inverted	Signal: Negated Latched Output (Q NOT)
Logics.LE63.Gate Out	Signal: Output of the logic gate
Logics.LE63.Timer Out	Signal: Timer Output
Logics.LE63.Out	Signal: Latched Output (Q)
Logics.LE63.Out inverted	Signal: Negated Latched Output (Q NOT)
Logics.LE64.Gate Out	Signal: Output of the logic gate
Logics.LE64.Timer Out	Signal: Timer Output
Logics.LE64.Out	Signal: Latched Output (Q)
Logics.LE64.Out inverted	Signal: Negated Latched Output (Q NOT)
Logics.LE65.Gate Out	Signal: Output of the logic gate
Logics.LE65.Timer Out	Signal: Timer Output
Logics.LE65.Out	Signal: Latched Output (Q)
Logics.LE65.Out inverted	Signal: Negated Latched Output (Q NOT)
Logics.LE66.Gate Out	Signal: Output of the logic gate
Logics.LE66.Timer Out	Signal: Timer Output
Logics.LE66.Out	Signal: Latched Output (Q)
Logics.LE66.Out inverted	Signal: Negated Latched Output (Q NOT)
Logics.LE67.Gate Out	Signal: Output of the logic gate
Logics.LE67.Timer Out	Signal: Timer Output
Logics.LE67.Out	Signal: Latched Output (Q)
Logics.LE67.Out inverted	Signal: Negated Latched Output (Q NOT)
Logics.LE68.Gate Out	Signal: Output of the logic gate
Logics.LE68.Timer Out	Signal: Timer Output
Logics.LE68.Out	Signal: Latched Output (Q)
Logics.LE68.Out inverted	Signal: Negated Latched Output (Q NOT)
Logics.LE69.Gate Out	Signal: Output of the logic gate
Logics.LE69.Timer Out	Signal: Timer Output
Logics.LE69.Out	Signal: Latched Output (Q)

General Lists

<i>Name</i>	<i>Description</i>
Logics.LE69.Out inverted	Signal: Negated Latched Output (Q NOT)
Logics.LE70.Gate Out	Signal: Output of the logic gate
Logics.LE70.Timer Out	Signal: Timer Output
Logics.LE70.Out	Signal: Latched Output (Q)
Logics.LE70.Out inverted	Signal: Negated Latched Output (Q NOT)
Logics.LE71.Gate Out	Signal: Output of the logic gate
Logics.LE71.Timer Out	Signal: Timer Output
Logics.LE71.Out	Signal: Latched Output (Q)
Logics.LE71.Out inverted	Signal: Negated Latched Output (Q NOT)
Logics.LE72.Gate Out	Signal: Output of the logic gate
Logics.LE72.Timer Out	Signal: Timer Output
Logics.LE72.Out	Signal: Latched Output (Q)
Logics.LE72.Out inverted	Signal: Negated Latched Output (Q NOT)
Logics.LE73.Gate Out	Signal: Output of the logic gate
Logics.LE73.Timer Out	Signal: Timer Output
Logics.LE73.Out	Signal: Latched Output (Q)
Logics.LE73.Out inverted	Signal: Negated Latched Output (Q NOT)
Logics.LE74.Gate Out	Signal: Output of the logic gate
Logics.LE74.Timer Out	Signal: Timer Output
Logics.LE74.Out	Signal: Latched Output (Q)
Logics.LE74.Out inverted	Signal: Negated Latched Output (Q NOT)
Logics.LE75.Gate Out	Signal: Output of the logic gate
Logics.LE75.Timer Out	Signal: Timer Output
Logics.LE75.Out	Signal: Latched Output (Q)
Logics.LE75.Out inverted	Signal: Negated Latched Output (Q NOT)
Logics.LE76.Gate Out	Signal: Output of the logic gate
Logics.LE76.Timer Out	Signal: Timer Output
Logics.LE76.Out	Signal: Latched Output (Q)
Logics.LE76.Out inverted	Signal: Negated Latched Output (Q NOT)
Logics.LE77.Gate Out	Signal: Output of the logic gate
Logics.LE77.Timer Out	Signal: Timer Output
Logics.LE77.Out	Signal: Latched Output (Q)
Logics.LE77.Out inverted	Signal: Negated Latched Output (Q NOT)
Logics.LE78.Gate Out	Signal: Output of the logic gate
Logics.LE78.Timer Out	Signal: Timer Output
Logics.LE78.Out	Signal: Latched Output (Q)
Logics.LE78.Out inverted	Signal: Negated Latched Output (Q NOT)
Logics.LE79.Gate Out	Signal: Output of the logic gate
Logics.LE79.Timer Out	Signal: Timer Output
Logics.LE79.Out	Signal: Latched Output (Q)

General Lists

<i>Name</i>	<i>Description</i>
Logics.LE79.Out inverted	Signal: Negated Latched Output (Q NOT)
Logics.LE80.Gate Out	Signal: Output of the logic gate
Logics.LE80.Timer Out	Signal: Timer Output
Logics.LE80.Out	Signal: Latched Output (Q)
Logics.LE80.Out inverted	Signal: Negated Latched Output (Q NOT)

Specifications

Specifications of the Real Time Clock

Resolution: 1 ms
 Tolerance: <1 minute / month (+20°C [68°F])
 <±1ms if synchronized via IRIG-B

Time Synchronisation Tolerances

The different protocols for time synchronisation vary in their accuracy:

Used Protocol	Time drift over one month	Deviation to time generator
Without time synchronization	<1 min (+20°C)	Time drifts
IRIG-B	Dependent on the time drift of the time generator	<±1 ms
SNTP	Dependent on the time drift of the time generator	<±1 ms, if network connection is GOOD (see operation status of SNTP)
IEC60870-5-103	Dependent on the time drift of the time generator	<±1 ms
Modbus TCP	Dependent on the time drift of the time generator	Dependent on the network load
Modbus RTU	Dependent on the time drift of the time generator	<±1 ms
DNP3 TCP	Dependent on the time drift of the time generator	Dependent on the network load
DNP3 UDP	Dependent on the time drift of the time generator	Dependent on the network load
DNP3 RTU	Dependent on the time drift of the time generator	<±1 ms

Specifications of the Measured Value Acquisition Phase and Ground Current Measuring

Frequency Range:	50 Hz / 60 Hz \pm 10% ^{*1)}
Accuracy:	Class 0.5
Amplitude Error if $I < I_n$:	\pm 0.5% of the rated current ^{*2) *3)}
Amplitude Error if $I > I_n$:	\pm 0.5% of the measured current ^{*2) *3)}
Amplitude Error if $I > 2 I_n$:	\pm 1.0% of the measured current ^{*2) *3)}
Harmonics:	Up to 20% 3rd harmonic \pm 2% Up to 20% 5th harmonic \pm 2%
Frequency Influence:	$<\pm$ 2% / Hz in the range of \pm 10% of the configured nominal frequency
Temperature Influence:	$<\pm$ 1% within the range of 0°C to +60°C (+32°F to +140°F)

*1) Wide frequency range (10..70Hz) is active outside 50Hz/60Hz \pm 10%. DFT values get more inaccurate, protective elements which have DFT values as input may be blocked automatically.

*2) Accuracy for True RMS values in wide frequency range: 30...70Hz same accuracy like specified above. $<$ 30Hz accuracy is $<$ 3%. True RMS values are updated only every full cycle (period time).

*3) For earth current sensitive the precision does not depend on the nominal value but is referenced to 100 mA (with $I_n = 1$ A) respectively. 500 mA (with $I_n = 5$ A)

Phase-to-ground and Residual Voltage Measurement

Frequency Range:	50 Hz / 60 Hz \pm 10% ^{*1)}
Accuracy for <u>measured</u> values:	Class 0.5
Amplitude error for $V < V_n$:	\pm 0.5% of rated voltage or \pm 0.5 V ^{*2)}
Amplitude error for $V > V_n$:	\pm 0.5% of measured voltage or \pm 0.5 V ^{*2)}
Accuracy for <u>calculated</u> values:	Class 1.0
Amplitude error for $V < V_n$:	\pm 1.0% of rated voltage or \pm 1.0 V ^{*2)}
Amplitude error for $V > V_n$:	\pm 1.0% of calculated voltage or \pm 1.0 V ^{*2)}
Harmonics:	Up to 20% 3rd harmonic \pm 1% Up to 20% 5th harmonic \pm 1%
Frequency influence:	$<\pm$ 2% / Hz in the range of \pm 10% of the configured nominal frequency
Temperature influence:	$<\pm$ 1% within the range of 0°C up to +60°C

*1) Wide frequency range (10..70Hz) is active outside 50Hz/60Hz \pm 10%. DFT values get more inaccurate, protective elements which have DFT values as input may be blocked automatically.

*2) Accuracy for True RMS values in wide frequency range: 30...70Hz same accuracy like specified above. $<$ 30Hz accuracy is $<$ 3%. True RMS values are updated only every full cycle (period time).

Frequency measurement

Nominal frequency:	50 Hz / 60 Hz
Precision:	$\pm 0.05\%$ of f_n within the range of 40-70 Hz at voltages >50 V
Voltage dependency:	frequency acquisition of 5 V – 800 V

Energy measurement*

Energy counter error	1.5% of measured energy or 1.5% $S_n \cdot 1h$
----------------------	--

Power Measurement*

S, P, Q:	$\pm 1\%$ of the measured value or 0.1% S_n (for fundamental) $\pm 2\%$ of the measured value or 0.2% S_n (for RMS)
P1, Q1:	$\pm 2\%$ of the measured value or 0.2% S_n

Power Factor Measurement*

PF:	± 0.01 of measured power factor or 1° $I > 30\% I_n$ and $S > 2\% S_n$
-----	--

*)Tolerance at 0.8 ... 1.2 x V_n (with $V_n=100V$), $|PF|>0.5$, at f_n , symmetrically fed
 $S_n=1.73 \cdot V_T \text{ rating} \cdot CT \text{ rating}$

Protection Elements Accuracy

NOTICE

The tripping delay relates to the time between alarm and trip.
 The accuracy of the operating time relates to the time between fault entry and the time when the protection element is picked-up.

Reference conditions for all Protection Elements: sine wave, at rated frequency, THD < 1%
 Measuring method: Fundamental

Overcurrent Protection Elements: I[x]	Accuracy ^{*1) *2)}
I>	±1.5% of the setting value or ±1% I _n
Dropout Ratio	97% or 0.5% I _n
t	DEFT ±1% or ±10 ms
Operating Time At testing current ≥ 2 times pickup value	<36ms (directional elements: <40ms)
Disengaging Time	<55ms
t-char	±5% (according to selected curve)
t-reset (Reset Mode = t-delay)	±1% or ±10 ms

Overcurrent Protection Elements: I[x] with selected Measuring method = I2 (Negative phase sequence current)	Accuracy ^{*3)}
I>	±2% of the setting value or ±1% I _n
Dropout Ratio	97% or 0.5% I _n
t	DEFT ±1% or ±10 ms
Operating Time At testing current ≥ 2 times pickup value	<60ms
Disengaging Time	<45ms

- *1) When RMS is selected and |f - fn| > 10% fn: operating and disengaging time < 4 cycles.
 If f < 30Hz, pickup accuracy ±6% of the setting value or 5% I_n.
- *2) For directional elements, accuracy of MTA: ±3° at I > 20% I_n.
- *3) works only in frequency range |f - fn| < 10% fn.

Ground Current Elements: IG[x]	Accuracy ^{*1) *2) *3)}
IG>	±1.5% of the setting value or ±1% I _n
Dropout Ratio	97% or 0.5% x I _n
t	DEFT ±1% or ±10 ms
Operating time Starting from IG higher than 1.2 x IG>	<45ms
Disengaging Time	<55ms
t-char	±5% (according to selected curve)
t-reset (Reset Mode = t-delay)	±1% or ±10 ms
VE>	±1.5% of the setting value or ±1% V _n
Dropout Ratio	97% or 0.5% V _n

- *1) When RMS is selected and |f - fn| > 10% fn: operating and disengaging time < 4 cycles.
 If f < 30Hz, pickup accuracy < ±6% of the setting value or 5% I_n.
- *2) For directional elements, accuracy of MTA: ±3° at IG > 20% I_n.
- *3) For earth current sensitive the precision does not depend on the nominal value but is referenced to 100 mA (with I_n = 1 A) respectively 500 mA (with I_n = 5 A)

NOTICE Because detection of direction is based on DFT values, direction elements works only in nominal range ($f_N \pm 5\text{Hz}$).

Phase Directional Sensitivity: I[x]	Value	Release Level In: 1A (5A)	Blocking Level In: 1A (5A)
I - V (3-phases)	I V	10 mA (50 mA) 0.35 V	5 mA (25mA) 0.25 V

Ground Directional Sensitivity: IG[x]	Value	Release Level In: 1A (5A)	Blocking Level In: 1A (5A)
IG meas - 3V0	IG meas IG (sensitive) 3V0	10 mA (50 mA) 1 mA (5 mA) 0.35 V	5 mA (25 mA) 0.5 mA (2.5 mA) 0.25 V
IG calc - 3V0	IG calc 3V0	18 mA (90 mA) 1 V	11 mA (55 mA) 0.8 V
IG calc - Ipol (IG meas)	IG calc IG meas IG (sensitive)	18 mA (90 mA) 10 mA (50 mA) 1 mA (5 mA)	11 mA (55 mA) 5 mA (25 mA) 0.5 mA (2.5 mA)
IG meas - Neg, IG calc - Neg	I2 V2	10 mA (50 mA) 0.35 V	5 mA (25 mA) 0.25 V

Phase Differential Protection: Id	Accuracy
Id >	$\pm 3\%$ of the setting value or 2% In.
Operating time	
Id > 2 x pickup (step from zero to 200% pickup of 87-Char)	<40 ms
Typically trip time	30 ms
Shortest trip time	18 ms

Unrestrained Phase Differential Protection: IdH	Accuracy
Id >>	$\pm 3\%$ of the setting value or 2% In.
Operating time	
Id > 1.1 x pickup:	<30 ms
Typically trip time	19 ms
Shortest trip time	13 ms

Ground Differential Protection: IdG[x]	Accuracy
Idg >	$\pm 3\%$ of the setting value or 2% In.
Operating time	
Idg > 2 x pickup (step from zero to 200% pickup of 87G-Char)	<40 ms
Typically trip time	30 ms
Shortest trip time	18 ms

Unrestrained Ground Differential Protection: IdGH[x]	Accuracy
IdG >>	$\pm 3\%$ of the setting value or 2% In.
Operating time	
Idg > 1.1 x pickup:	<30 ms
Typically trip time	19 ms
Shortest trip time	13 ms

Specifications

RTD Protection: RTD/URTD	Accuracy
Trip Threshold	±1°C (1.8°F)
Alarm Threshold	±1°C (1.8°F)
t-delay Alarm	DEFT ±1% or ±10 ms
Reset Hysteresis	-2°C (-3.6°F) of threshold ±1°C (1.8°F)

Thermal Replica: ThR	Accuracy
lb	±2% of the setting value or 1% In
Alarm ThR	±1.5 % of the setting value

Inrush Supervision: IH2	Accuracy
IH2/IH1	±1% In
Dropout Ratio	5% IH2 or 1% In
Operating Time	<30 ms ^{*1)}

*1) Inrush supervision is possible, if the fundamental Harmonic (IH1) > 0.1 In and 2nd Harmonic (IH2) > 0.01 In.

Current unbalance: I2>[x]	Accuracy ^{*1)}
I2>	±2% of the setting value or 1% In
Dropout Ratio	97% or 0.5% x In
%(I2/I1)	±1%
t	DEFT ±1% or ±10 ms
Operating Time	<70 ms
Disengaging Time	<50 ms
K	±5% INV
T-cool	±5% INV

*1) Negative-sequence current I2 must be ≥ 0.01 x In, I1 must be ≥ 0.1 x In.

Voltage Protection: V[x]	Accuracy ^{*1)}
Pickup	±1.5% of the setting value or 1% Vn
Dropout Ratio	Adjustable, at least 0.5% Vn
t	DEFT ±1% or ±10 ms
Operating Time	<40 ms
Starting from V higher than 1.2 x pickup value for V> or V lower than 0.8 x pickup value for V<	35 ms typically
Disengaging Time	<45 ms

Specifications

Residual Voltage Protection: VG[x]	Accuracy ^{*1)}
Pickup	±1.5% of the setting value or 1% Vn
Dropout Ratio	97% or 0.5% Vn for VG> 103% or 0.5% Vn for VG<
t	DEFT ±1% or ±10 ms
Operating Time Starting from V higher than 1.2 x pickup value for VG> or V lower than 0.8 x pickup value for VG<	<40 ms 35 ms typically
Disengaging Time	<45 ms

*1) When RMS is selected and $|f - f_n| > 10\% f_n$: operating and disengaging time < 4 cycles or ±1%.
If $f < 30\text{Hz}$, pickup accuracy < ±6% of the setting value or 5% Vn.

Low Voltage Ride Through Protection: LVRT	Accuracy ^{*1)}
Voltage Pickup (Start)	±1.5% of the setting value or 1% Vn
Voltage Dropout Ratio (Recover)	Adjustable, at least 0.5% Vn
Tripping time delay	±1% from settings or ±10 ms
Operating Time Starting from V lower than 0.9 x pickup value	<35 ms
Disengaging Time	<45 ms

*1) When RMS is selected and $|f - f_n| > 10\% f_n$: operating and disengaging time < 4 cycles or ±1%.
If $f < 30\text{Hz}$, pickup accuracy < ±6% of the setting value or 5% Vn.

Volts per Hertz: V/f > [x]	Accuracy
Pickup	±1% ^{*1)} (20-70Hz / 0.1-1.5 Vn (with Vn=100V) / 100-150%)
t	DEFT ±1% or ±10 ms
t-Multiplier	±5% ±10 ms (Volts/Hertz (%) higher than 1.1 x Pickup) INV A INV B INV C
t-reset	±1% or ±10 ms INV A INV B INV C
Operating Time Starting from Volts/Hertz (%) higher than 1.1 x Pickup	<60 ms (at fn) or < 4 cycles
Disengaging Time	<85 ms (at fn) or < 5 cycles

*1) The V/Hz function provides reliable measurements of V/Hz up to 200% for a frequency range of 5–70 Hz,
if voltage (rms) is greater than 15% Vn and < 800V. $U/f < 48\text{ V/Hz}$.

Voltage unbalance: V012[x]	Accuracy ^{*1)}
Threshold	±2% of the setting value or 1% Vn
Dropout Ratio	97% or 0.5% x Vn for V1> or V2> 103% or 0.5% x Vn for V1<
%(V2/V1)	±1%
t	DEFT ±1% or ±10 ms
Operating Time	<60 ms
Disengaging Time	<45 ms

*1) Negative-sequence voltage V2 must be ≥ 0.01 x Vn, V1 must be ≥ 0.1 x Vn.

Over Frequency Protection: f>[x]	Accuracy ^{*1)}
f>	±10 mHz at fn
Dropout	< 0.05% fn
t	±1% or ±10 ms
Operating time Starting from f higher than f> + 0.02 Hz + 0.1 Hz + 2.0 Hz	<100 ms typically 70 ms typically 50 ms
Disengaging time	<120 ms

Under Frequency Protection: f<[x]	Accuracy ^{*1)}
f<	±10 mHz at fn
Dropout	< 0.05% fn
t	±1% or ±10 ms
Operating time Starting from f lower than f< - 0.02 Hz - 0.1 Hz - 2.0 Hz	<100 ms typically 70 ms typically 50 ms
Disengaging time	<120 ms
V Block f	±1.5% of the setting value or 1% Vn
Dropout ratio	103% or 0.5% Vn

*1) Accuracy is given for rated frequency fn±10%.

Rate of Change of Frequency: df/dt	Accuracy ^{*1)}
df/dt	±0.1 Hz/s ²⁾
t	±1% or ±10 ms
Operating time Starting from fn and df/dt > pickup + 0.1 Hz/s At df/dt > 2 times pickup At df/dt > 5 times pickup	<200 ms typically <100 ms typically < 70 ms
Disengaging time	<120 ms

*1) Accuracy is given for rated frequency fn±10%.

*2) 10% additional tolerance per Hz deviation from nominal frequency fn (e.g. at 45Hz, tolerance is 0.15Hz/s).

Rate of Change of Frequency: DF/DT	Accuracy
DF	±20 mHz at fn
DT	±1% or ±10 ms

Vector surge: delta phi	Accuracy
delta phi	$\pm 0.5^\circ$ [1-30°] at Vn and fn
Operating time	<40 ms

Power Factor: PF[x]	Accuracy
Trigger-PF	± 0.01 (absolute) or $\pm 1^\circ$
Reset-PF	± 0.01 (absolute) or $\pm 1^\circ$
t-trip	$\pm 1\%$ or ± 10 ms
Operating time	*1)
Measuring Method = Fundamental	<130 ms
Measuring Method = True RMS	<200 ms

*1) The calculation of the Power Factor will be available 300 ms after the required measuring values ($I > 2.5\% I_n$ and $V > 20\% V_n$) have energized the measuring inputs.

Directional Power Protection: PQS[x] with Mode = S> or S<	Accuracy *1) *2)
Threshold	$\pm 3\%$ or $\pm 0.1\% S_n$
Dropout Ratio	97% or 1 VA for S> 103% or 1 VA for S<
t	$\pm 1\%$ or ± 10 ms
Operating time	75 ms
Disengaging time	100 ms

Directional Power Protection: PQS[x] with Mode = P> P< or Pr>/Pr<	Accuracy *1) *2)
Threshold	$\pm 3\%$ or $\pm 0.1\% S_n$
Dropout Ratio	97% or 1 VA for P> and Pr> 103% or 1 VA for P< and Pr< for setting values $\leq 0.1 S_n$: 58% or 0.5 VA for P> and Pr> 142% or 0.5 VA for P< and Pr< for setting values $\leq 0.01 S_n$: 58% or 0.2 VA for P> and Pr> 142% or 0.2 VA for P< and Pr<
t	$\pm 1\%$ or ± 10 ms
Operating time	75 ms
Disengaging time	100 ms

Directional Power Protection: PQS[x] with Mode = Q>/Q< or Qr>/Qr<	Accuracy^{*1) *2)}
Threshold	±3% or ±0.1% Sn
Dropout Ratio	97% or 1 VA for Q> and Qr> 103% or 1 VA for Q< and Qr< for setting values ≤ 0.1 Sn: 58% or 0.5 VA for Q> and Qr> 142% or 0.5 VA for Q< and Qr< for setting values ≤ 0.01 Sn 58% or 0.2 VA for Q> and Qr> 142% or 0.2 VA for Q< and Qr<
t	±1% or ±10 ms
Operating time	75 ms
Disengaging time	100 ms

*1) Common reference conditions: at |PF|>0.5, symmetrically fed, at fn and 0.8 - 1.3 x Vn (Vn=100V)

*2) If RMS is selected and |f - fn| > 10% fn: operating and disengaging time < 6 cycles or ±1%.

If f < 30Hz, pickup accuracy < ±6% of the setting value or 5% Sn. Q[x] protection elements may be blocked if |f - fn| > 10% fn.

If DFT is selected protection elements are blocked if |f - fn| > 10% fn

Loss of Excitation:	Accuracy^{*1)}
Mho	±1.5% or ±0.01 Ohm (5 A)/ ±0.05 Ohm (1 A) (related to the maximum impedance reach)
Dropout Ratio	105% or +0.02 Ohm (5 A)/ +0.1 Ohm (1 A) (related to Mho pickup radius)
t-Z	±1% or ±20 ms
V(Positive Sequence) < Pickup	±2% of the setting value or ±1% Vn
t-V<	±1% or ±30 ms
Directional Angle Pickup	±1°
Operating Time	<50 ms

Out of Step Tripping OST	Accuracy^{*1)}
Mho	±2% or ±0.01 Ohm (5 A)/ ±0.05 Ohm (1 A) (related to the maximum impedance reach)
Dropout Ratio	105% or +0.02 Ohm (5 A)/ +0.1 Ohm (1 A) (related to Mho pickup radius)
t (Trip delay time)	±1% or ±20 ms
I1 min, I2 max	±1.5% of the setting value or ±1% In
Blinder	±1.5% or ±0.01 Ohm (5 A)/ ±0.05 Ohm (1 A)
Operating Time	<55 ms

Power Swing Blocking: PSB	Accuracy^{*1)}
Mho	±2% or ±0.01 Ohm (5 A)/ ±0.05 Ohm (1 A) (related to the maximum impedance reach)
Dropout Ratio	105% or +0.02 Ohm (5 A)/ +0.1 Ohm (1 A) (related to Mho pickup radius)
I1 min, I2 max	±1.5% of the setting value or ±1% In
Blinder	±1.5% or ±0.01 Ohm (5 A)/ ±0.05 Ohm (1 A)
Operating Time	<55 ms

Phase Distance Protection: Z[x]	Accuracy *1)
Mho/Polygon	±2% or ±0.01 Ohm (5 A)/ ±0.05 Ohm (1 A) (related to the maximum impedance reach)
Dropout Ratio	103% or +0.02 Ohm (5 A)/ +0.1 Ohm (1 A) Mho: related to Mho radius Polygon: related to polygon reach settings
t	±1% or ±20 ms
V< Start	±2% of the setting value or ±1% Vn
I> Start	±1.5% of the setting value or ±1% In
Z< Start	±2% or ±0.01 Ohm (5 A)/ ±0.05 Ohm (1 A)
Directional Angle Pickup	±1°
Operating Time	<55 ms

Load Blinder: LB	Accuracy *1)
Impedance Circle	±2% or ±0.01 Ohm (5 A)/ ±0.05 Ohm (1 A)
Dropout Ratio	105% or +0.02 Ohm (5 A)/ +0.1 Ohm (1 A) (related to Mho pickup radius)
I1 min, I2 max	±1.5% of the setting value or ±1% In
Impedance Angle	±1°
Operating Time	<55 ms

*1) Accuracy is given for I > 20% In.

Inadvertent Energy:	Accuracy
O/C Pickup	±1.5% of the setting value or 1% In
U/V Pickup	±1.5% of the setting value or 1% In
Pickup Delay	±1% or ±10 ms
Dropout Delay	±1% or ±10 ms
O/C Pickup operating time	<35 ms
O/C Pickup disengaging time	<45 ms
U/V Pickup operating time	<30 ms
U/V Pickup disengaging time	<30 ms

Sync-Check: Sync	Accuracy
Voltage measurement	±1.5% of the setting value or 1% Vn
Slip Frequency measurement	±20 mHz at fn
Angle measurement	±2°
Angle Compensation measurement	±4°
t (all timers)	±1% or ±10 ms

Q->&V< / Decoupling	Tolerance
I min QV	±1.5% of the setting value or ±1% In
Dropout Ratio	95% or 0.5% In
VLL< QV	±1,5% of the setting value or ±1% Vn
Dropout Ratio	102% or 0.5% Vn
Phi-Power	±1°
Q min QV	±3% of the setting value or ±0.1% Sn
Dropout Ratio	95%
t1-QV	±1% or ±10 ms
t2-QV	±1% or ±10 ms
Operating Time	<40 ms
Disengaging Time	<40 ms

ReCon / Reconnection	Tolerance
VLL-Release	±1.5% of the setting value or ±1% Vn
Dropout Ratio	98% or 0.5% Vn for VLL> 102% or 0.5% Vn for VLL<
f	±20 mHz at fn
Dropout	< 0.05% fn
t-Release	±1% or ±10 ms
Operating Time	<100 ms

Switch onto Fault: SOTF	Accuracy
Operating time	<35 ms
I<	±1.5% of the setting value or 1% In
t-enable	±1% or ±10 ms

Cold Load Pickup: CLPU	Accuracy
Threshold	±1.5% of the setting value or 1% In
Operating time	<35 ms
I<	±1.5% of the setting value or 1% In
t-Load OFF	±1% or ±15 ms
t-Max Block	±1% or ±15 ms
Settle Time	±1% or ±15 ms

Circuit Breaker Failure Protection: CBF	Accuracy
I-CBF>	±1.5% of the setting value or 1% In
t-CBF	±1% or ±10 ms
Operating Time Starting from I Higher than 1.3 x I-CBF>	<40 ms
Disengaging Time	<40 ms

Trip Circuit Supervision: TCS	Accuracy
t-TCS	±1% or ±10 ms

Specifications

Current Transformer Supervision: CTS	Accuracy
ΔI	$\pm 2\%$ of the setting value or 1.5% In
Dropout Ratio	94%
Alarm delay	$\pm 1\%$ or ± 10 ms

Loss of Potential: LOP	Accuracy
t-Pickup	$\pm 1\%$ or ± 10 ms

Revision History

This chapter lists all changes since version 3.0. If you need a change history for the versions 2.x please contact Woodward Kempen GmbH.

NOTICE

All 3.x hardware and software versions are downwards compatible with each other. For special questions and more detailed information, please contact Woodward Kempen GmbH Support.

NOTICE

Up to date documentation?

Please check the web site of Woodward Kempen GmbH for the latest revision of this Technical Manual and if there is an Errata Sheet with updated information.

Version: 3.4.x

- Date: 2017-October-01
- Revision: D

Hardware

- A metal protecting cap has been added to the LC connectors for the Ethernet / TCP/IP via fiber optics. Since the cap improves the EMC immunity it is recommended to always fasten it carefully after plugging in the LC connectors.
- There is a new communication type “T” available:
RS485 (IEC 60870-5-103, MODBUS RTU, DNP3.0 RTU)
+ RJ45 Ethernet 100 Mbit/s (IEC 61850, Modbus TCP, DNP3.0 TCP/UDP)

Software

- The device firmware is also available in Romanian language now.
- If the MCDGV4 is connected to *Smart view as of* version 4.50 the synchronization of date and considers automatically that the timezone settings might be different on PC and MCDGV4.

Communication

The menu [Device Para / HMI / Security] now makes the following setting parameters available:

- »*Smart view via Eth*« activates or deactivates the access of Smart view via Ethernet.
- »*Smart view via USB*« activates or deactivates the access of Smart view via the USB interface.

IEC60870-5-103

This communication protocol now supports the blocking of the transmission in Monitor Direction and the test mode.

Modbus

The transmission of fault values via Modbus protocol has been added. For the last fault event, all fault values are accessible with addresses above 50000. For each fault value, the Modbus address corresponds to the address of the respective instantaneous value shifted by the offset 30000. (Example: The current value IE1 has the address 20100, therefore the corresponding fault value has the address 50100.) For a detailed list, please consult the SCADA documentation.

For devices with RS485 *and* Ethernet interfaces (communication types “I” or “T”), the project setting „Modbus RTU/TCP“ is available now (via parameter [Device Planning] »*Scada . Protocol*«).

This makes the device communicate via serial line (RTU) and Ethernet (TCP) in parallel. In particular, note that:

- All masters see the same set of states.
- All masters can reset latched states.
- All masters can control the same breaker, make resets and acknowledgments.

Device Para

The Reset dialog, that starts when the »C« key is pressed during a cold start, has been adapted to new security-related requests: Now there is a new setting parameter »*Reset Options*« that allows to remove options from the Reset dialog.

Z

New protection module “Phase Distance Protection” (ANSI 21). This module is intended to provide backup protection for phase-to-phase faults on the electrical power system to which the generator set is connected.

PSB

New (auxiliary) protection module “Power Swing Blocking” (ANSI 68).

This module is intended to avoid false tripping decisions from the distance protection module. It detects power

swing events and issues a blocking signal to the distance protection module.

OST

New protection module “Out of Step Tripping” (ANSI 78).

This module is intended to detect out of step conditions, so that generators and turbines are protected against potential damages due to high peak currents, pulsating torques and mechanical resonances.

LB

New protection module “Load Blinder” (Load Encroachment). The Load Blinder module is used in combination with the distance protection module to reduce the operating characteristic of the distance protection. This can be required to lower the possibility of tripping under maximum load conditions.

Overcurrent – I[n], IG[n]

All ANSI and IEC inverse time characteristics have a time limit now according to IEC 60255-151.

A new inverse time characteristic “RINV” has been added.

Overcurrent – I[n]

It is now possible (via the setting »I[n] . CT Winding Side«) to decide which CT the module monitors (“CT Ntrl” = Current transformers on the neutral side or “CT Mains” = Current Transformer Main Side).

It must be noted, however, that the direction determination is available only with the setting »CT Winding Side« = “CT Mains”.

Prot, Overcurrent

The MCDGV4 now displays the determined direction of the phase currents and of the measured and calculated ground current) under the menu path [Operation / Measured Values / Direction detection]. It is recommended to verify the current direction by these values during commissioning.

Undervoltage – V[n]

For the voltage protection running in “undervoltage” mode –»Mode« = “V<” – an undercurrent criterion is available as a new feature.

The basic principle of this “minimum current check”, is that it blocks the undervoltage protection as soon as all phase currents drop below a certain threshold value. The motivation for using this feature is that a situation where all phase currents are “dead” probably indicates an open circuit breaker, and it is probably not desirable that the undervoltage protection reacts to this event.

Thermal replica module – ThR

The setting range of the overload factor »K« has been extended (from 0.80–1.20) to 0.80–1.50 (IEC 60255-149).

Generator Unbalance Protection – I2>G[n]

A second element “I2>G[2]” has been added. (Its functionality is identical with “I2>G[1]”.)

Loss of Potential – LOP

The (internally fixed) undervoltage threshold has been increased from 0.01 Vn to 0.03 Vn (“FNN 2015” – Specification published by the *Forum Netztechnik / Netzbetrieb im VDE*).

SelfSupervision

Device-internal messages (in particular error messages) are now accessible under the menu [Operation / Self Supervision / Messages].

All messages that can potentially appear here are described in a separate document, the “HighPROTEC Troubleshooting Guide” (DOK-HB-TS).

Supervision

The MCDGV4 supervises the phase sequence and compares it with the setting that has been made at [Field Para / General Settings] »Phase Sequence« (i. e. „ACB“ or „ABC“).

Under the menu [Operation / Status Display / Supervision / Phase Sequence], there is a specific signal for each CT and VT, which is set active if the check of the respective CT / VT finds that the actual phase sequence is different from the setting under [Field Para].

LEDs

There is a new automatic acknowledgment mode for all LEDs: The latching of all LEDs is acknowledged (reset) in case of an alarm (from any protection module).

The automatic acknowledgment must be activated by setting: [Device Para / LEDs / LEDs group A / LED 1...n] »Latched« = “active, ack. by alarm”

Manual Acknowledgment

It is possible to acknowledge LEDs, SCADA, binary output relays and / or a pending trip command by pressing the »C« key at the panel. After it has been configured which items shall be assigned to the »Ack via »C« key«, these are acknowledged by simply pressing the »C« key (for ca. 1 second).

Notice: If there is the need to be able to acknowledge without entering any password set an empty password for the level »Prot-Lv1«.

Version: 3.1

- Date: 2017-March-06
- Revision: C

Hardware

No changes.

Software

Reconnection – ReCon[n]

The Reconnection module has been enhanced according to VDE-AR-N 4120.

- The release condition has been made selectable via ReCon . Reconnect. Release Cond (options: V Internal Release, V Ext Release PCC, Both).
- The measuring method has been made selectable via ReCon . Measuring method (options: Fundamental, True RMS, Vavg).

SCADA

Datapoints have been added for the second instance of the Reconnection module.

TCP

Bugfix:

- Some problem with the PPP/TCP communication has been fixed.

Version: 3.0.b

- Date: 2016-February-20
- Revision: B

Hardware

No changes.

Software

The self-monitoring has been improved.

Overcurrent – I[n]

Bugfix:

- An initialization issue has been fixed in the Overcurrent module. In case of MeasureMode I2 and DEFT characteristic, this issue could have caused a false pickup or trip after start-up.

Sys

Bugfix:

- Under special circumstances, an unintended warm restart had been possible.

SCADA / Modbus

Bugfix:

- The Modbus protocol did not read the system time correctly.

Self Supervision

Bugfix:

- Warnings related to the internal temperature monitoring did not work correctly.

Version: 3.0

- Date: 2015-October-01
- Revision: B

Hardware

- A new front plate in dark gray color replaces the blue housing that had been used for all 2.x versions.
- The new front plate features a USB interface for the connection with the *Smart view* operating software. (This replaces the serial interface of the 2.x versions.)
- There is a new communication type “I” available:
RS485 (IEC 60870-5-103, MODBUS RTU, DNP3.0 RTU) + RJ45 Ethernet 100 Mbit/s (Modbus TCP, DNP3.0 TCP/UDP)
- “Conformal coating” is available now as an order option.
- The characters -2 in the typecode signify the major version upgrade from 2.x to 3.x.

Software

The device firmware is also available in Spanish language now.

Various small changes and restructuring have been made to the menu and the display.

Protection

Cause of trips are shown directly on the display.

Voltage-stage – V

The setting precision has been increased to 3 decimal places (0.1% Vn).

Low Voltage Ride Through – LVRT

A second LVRT element has been added.

Loss of Potential – LOP

The Dead Bus Detection has been made configurable.

The breaker assignment is optional. (If no breaker has been assigned then the position is ignored.)

The general IOC blocking has been removed.

The load current threshold LOP . I< can be set with a range 0.5 to 4 In.

Q->&V< / ReCon

The reconnection part has been split off and has become an independent module.

The decoupling functions of the Reconnection module has been extended to all trip commands.

Loss of Excitation – LoE

The setting range has been increased.

Temperature Protection Module – RTD

The trip command has been made selectable.

Differential Protection Module – Id

The setting precision has been increased.

Restricted Ground Fault Differential Protection Module – IdG, IdGH

The alarm signals have been enhanced.

Inadvertent Energization – InEn

The trip command has been added to the CBF trigger list.

SCADA

The DNP3 has been made available (with RTU/TCP/UDP).

New fiber-optic interfaces for SCADA.

Setting procedure (menu structure, default settings) has been modified.

New “SCADA connection status” signal.

Ethernet “TCP Keep Alive” according to RFC 793.

Bugfix:

- After a hardware exception, the IP address might have been lost.

SCADA / IEC 61850

New support of Direct-Control.

Support for LN descriptions via DAI entry in the SCD file.

Handling of InGGIO Ind improved.

Speed of GOOSE messages improved. Potential problem with time-correlated GOOSE messages fixed.

New Logical Nodes for energy counters, LVRT, ExP, TCM, 47.

New LNClass for sensors and monitoring.

Updated reports if angles become zero, and if angles of phasors exceed deadband.

Deadband algorithm improved.

It is now possible to assign IEC 61850 alarm signals to the LEDs of the device.

Counter for the number of active client-server connections added.

Missing modes of directional power fixed.

SCADA / Modbus

“Fast Status Register” added.

Configurable registers added.

Read Fault Recorder and some device-specific information via Modbus.

Stability of Modbus TCP improved.

IEC 60870-5-103

Bugfix:

- Problem with reading disturbances fixed.

SNTP

Start the network after protection is active.

Bugfix:

- SNTP might not have worked correctly in case of an empty battery.
- Default daylight-saving changed to “Sunday”.

PC interface / Smart view connection

As of *Smart view* R4.30, it is possible to exchange the single-line for devices that support this.

The user interface supports the improved validation of IEC 61850 SCD files.

Characteristic curves can now be shown graphically.

There is now a Page Editor for creating single lines and device-pages.

Bugfix:

- After an interruption of communication, waveforms could no longer be received from the PC.
- After an interrupted download of the Device Model, file handling could be erroneous.

PC simulation

The LED status has been added to the simulation software.

Trend recorder

Bugfix:

- A memory leak has been fixed.

Analog Output – AnOut

Bugfix:

- After a restart of the device the output could peak to 100% for a short time.

When upgrading from a version 2.x device, the following must be noted with respect to the settings:

HINWEIS

- *All communication settings have to be re-defined. An automatic conversion is only partly possible.*
- *The VirtualOutput assignment of IEC 61850 communication has been restructured.*
- *All assignment settings need to be re-defined.*
- *The reconnection part of Q->&V< has been split off as a new module ReCon. An automatic conversion is not possible.*
- *The V-Prot mode V<(f) has been abandoned and replaced by the LVRT module.*

Abbreviations, and Acronyms

The following abbreviations and acronyms are used in this manual.

°C	Degrees Celsius
°F	Degrees Fahrenheit
A	Ampere(s), Amp(s)
AC	Alternating current
Ack.	Acknowledge
AND	Logical gate (The output becomes true if all Input signals are true.)
ANSI	American National Standards Institute
avg.	Average
AWG	American wire gauge
BF	Circuit breaker failure
Bkr	Breaker
Blo	Blocking(s)
BO	Binary output relay
BO1	1st binary output relay
BO2	2nd binary output relay
BO3	3rd binary output relay
calc	Calculated
CB	Circuit breaker
CBF	Module Circuit Breaker Failure protection
CD	Compact disk
Char	Curve shape
CLPU	Cold Load Pickup Module
Cmd.	Command
CMN	Common input
COM	Common input
Comm	Communication
Cr.	Counter(s)
CSA	Canadian Standards Association
CT	Control transformer
Ctrl.	Control
CTS	Current Transformer Supervision
CTS	Current transformer supervision
d	Day
D-Sub-Plug	Communication interface
DC	Direct current
DEFT	Definite time characteristic (Tripping time does not depend on the height of the current.)
delta phi	Vector surge
df/dt	Rate-of-frequency-change
DI	Digital Input
Diagn Cr	Diagnosis counter(s)
Diagn.	Diagnosis

Abbreviations, and Acronyms

DIN	Deutsche Industrie Norm
dir	Directional
EINV	Extremely inverse tripping characteristic
EMC	Electromagnetic compatibility
EN	Europäische Norm
err. / Err.	Error
EVTcon	Parameter determines if the residual voltage is measured or calculated.
Ex	External
Ex Oil Temp	External Oil Temperature
ExBlo	External blocking(s)
ExP	External Protection - Module
ExP	External protection
Ext Sudd Press	Sudden Pressure
Ext Temp Superv	External Temperature Supervision
f	Frequency Protection Module
Fc	Function (Enable or disable functionality = allow or disallow.)
FIFO	First in first out
FIFO Principal	First in first out
fund	Fundamental (ground wave)
gn	Acceleration of the earth in vertical direction (9.81 m/s ²)
GND	Ground
h	Hour
HMI	Human machine interface (Front of the protective relay)
HTL	Manufacturer internal product designation
Hz	Hertz
I	Phase Overcurrent Stage
I	Fault current
I	Current
I-BF	Tripping threshold
I0	Zero current (symmetrical components)
I1	Positive sequence current (symmetrical components)
I2	Negative sequence current (symmetrical components)
I2>	Unbalanced Load-Stage
I2T	Thermal Characteristic
I4T	Thermal Characteristic
IA	Phase A current
IB	Phase B current
IC	Phase C current
IC's	Manufacturer internal product designation
Id	Differential Protection Module
IdG	Restricted Ground Fault Differential Protection Module
IdGH	Restricted Ground Fault Highset Protection Module
IdH	High-Set Differential Protection Module
IEC	International Electrotechnical Commission
IEC61850	IEC61850

Abbreviations, and Acronyms

IEEE	Institute of Electrical and Electronics Engineers
IG	Earth current protection - Stage
IG	Ground current
IG	Fault current
IGNom	Nominal ground current
IH1	1st harmonic
IH2	Module Inrush
IH2	2nd harmonic
in.	Inch
incl.	Include, including
InEn	Inadvertent Energization
Info.	Information
Interl.	Interlocking
Intertripping	Intertripping
INV	Inverse characteristic (The tripping time will be calculated depending on the height of the current)
IR	Calculated ground current
IRIG	Input for time synchronization (Clock)
IRIG-B	IRIG-B-Module
IT	Thermal Characteristic
IX	4th measuring input of the current measuring assembly group (either ground or neutral current)
J	Joule
kg	Kilogram
kHz	Kilohertz
kV	Kilovolt(s)
kVdc or kVDC	Kilovolt(s) direct current
I/In	Ratio of current to nominal current.
L1	Phase A
L2	Phase B
L3	Phase C
lb-in	Pound-inch
LED	Light emitting diode
LINV	Long time inverse tripping characteristic
LoE-Z1	Loss of Excitation
LoE-Z2	Loss of Excitation
Logics	Logic
LOP	Loss of Potential
LV	Low voltage
LVRT	Low Voltage Ride Through
m	Meter
mA	Milliampere(s), Milliamp(s)
man.	Manual
max.	Maximum
meas	Measured
min.	Minimum

Abbreviations, and Acronyms

min.	Minute
MINV	Moderately Inverse Tripping Characteristic
MK	Manufacturer Internal Product Designation Code
mm	Millimeter
MMU	Memory mapping unit
ms	Milli-second(s)
MV	Medium voltage
mVA	Milli volt amperes (Power)
N.C.	Not connected
N.O.	Normal open (Contact)
NINV	Normal inverse tripping characteristic
Nm	Newton-meter
No	Number
Nom.	Nominal
NT	Manufacturer internal product designation code
P	Reverse Active Power
Para.	Parameter
PC	Personal computer
PCB	Printed circuit board
PE	Protected Earth
p.u.	per unit
PF	Power Factor - Module
Ph	Phase
PQS	Power Protection - Module
pri	Primary
PROT or Prot	Protection Module (Master Module)
PS1	Parameter set 1
PS2	Parameter set 2
PS3	Parameter set 3
PS4	Parameter set 4
PSet	Parameter set
PSS	Parameter set switch (Switching from one parameter set to another)
Q	Reverse Reactive Power
Q->&V<	Undervoltage and Reactive Power Direction Protection
R	Reset
rec.	Record
rel	Relative
res	Reset
ResetFct	Reset function
RevData	Review data
RMS	Root mean square
Rst	Reset
RTD	Temperature Protection Module
s	Second
SC	Supervision Contact (Synonyms: Life-Contact, Watchdog, State of Health Contact)

Abbreviations, and Acronyms

Sca	SCADA
SCADA	Communication module
sec	Second(s)
sec	Secondary
Sgen	Sine wave generator
Sig.	Signal
SNTP	SNTP-Module
SOTF	Switch Onto Fault - Module
StartFct	Start function
Sum	Summation
SW	Software
Sync	Synchrocheck
Sys.	System
t	Tripping delay
t or t.	Time
Tcmd	Trip command
TCP/IP	Communication protocol
TCS	Trip circuit supervision
ThR	Thermal replica module
TI	Manufacturer internal product designation code
TripCmd	Trip command
txt	Text
UL	Underwriters Laboratories
UMZ	DEFT (definite time tripping characteristic)
USB	Universal serial bus
V	Voltage-stage
V	Volts
V/f>	Overexcitation
V012	Symmetrical Components: Supervision of the Positive Phase Sequence or Negative Phase Sequence
Vac / V ac	Volts alternating current
Vdc / V dc	Volts direct current
VDE	Verband Deutscher Elektrotechnik
VDEW	Verband der Elektrizitätswirtschaft
VE	Residual voltage
VG	Residual voltage-Stage
VINV	Very inverse tripping characteristic
VTS	Voltage transformer supervision
W	Watt(s)
WDC	Watch dog contact (supervision contact)
www	World wide web
XCT	4th current measuring input (ground or neutral current)
XInv	Inverse characteristic

List of ANSI Codes

ANSI	Functions
14	Underspeed
21	Distance Protection
21P	Phase Distance Protection
24	Overexcitation Protection (Volts per Hertz)
25	Synchronizing or Synchronism-check via 4 th measuring channel of voltage measurement card
26	Temperature Protection
27	Undervoltage Protection
27(t)	Undervoltage (time dependent) Protection
27A	Undervoltage Protection (Auxiliar) via 4 th measuring channel of voltage measurement card
27N	Neutral Undervoltage via 4 th measuring channel of voltage measurement card
27TN	Third Harmonic Neutral Undervoltage via 4 th measuring channel of voltage measurement card
32	Directional Power Protection
32F	Forward Power Protection
32R	Reverse Power Protection
37	Undercurrent / Under Power
38	Temperature Protection (optional via Interface/external Box)
40	Loss of Excitation / Loss of Field
46	Unbalanced Current Protection
46G	Unbalanced Generator Current Protection
47	Unbalanced Voltage Protection
48	Incomplete Sequence (Start-up time Supervisor)
49	Thermal Protection
49M	Thermal Motor Protection
49R	Thermal Rotor Protection
49S	Thermal Stator Protection
50BF	Breaker Failure
50	Overcurrent (instantaneous)
50P	Phase Overcurrent (instantaneous)
50N	Neutral Overcurrent (instantaneous)
50Ns	Sensitive Neutral Overcurrent (instantaneous)
51	Overcurrent
51P	Phase Overcurrent
51N	Neutral Overcurrent
51Ns	Sensitive Neutral Overcurrent
51LR	Locked Rotor
51LRS	Locked Rotor Start (during start sequence)
51C	Voltage Controlled Overcurrent (via adaptive Parameters)
51Q	Negative Phase Sequence Overcurrent (multiple trip characteristics)
51V	Voltage Restrained Overcurrent
55	Power Factor Protection
56	Field Application Relay
59	Overvoltage Protection
59TN	Third Harmonic Neutral Overvoltage via 4 th measuring channel of voltage measurement card
59A	Overvoltage Protection via 4 th (Auxiliar) measuring channel of voltage measurement card
59N	Neutral Overvoltage Protection
60FL	Voltage Transformer Supervision
60L	Current Transformer Supervision
64R	Rotor Earth Fault Protection
64REF	Restricted Ground Fault Protection

List of ANSI Codes

ANSI	Functions
66	Starts per h (Start Inhibit)
67	Directional Overcurrent
67N	Directional Neutral Overcurrent
67Ns	Sensitive Directional Neutral Overcurrent
68	Power Swing Blocking
74TC	Trip Circuit Supervision
78	Out of Step Tripping
78V	Vector Surge Protection
79	Auto Reclosure
81	Frequency Protection
81U	Underfrequency Protection
81O	Overfrequency Protection
81R	ROCOF (df/dt)
86	Lock Out
87B	Busbar Differential Protection
87G	Generator Differential Protection
87GP	Generator Phase Differential Protection
87GN	Generator Ground Differential Protection
87L	Cable and Line Differential Protection
87M	Motor Differential Protection
87T	Transformer Differential Protection
87TP	Transformer Phase Differential Protection
87TN	Transformer Ground Differential Protection
87U	Unit Differential Protection (protected zone includes generator and step-up transformer)
87UP	Unit Phase Differential Protection (protected zone includes generator and step-up transformer)

We appreciate your comments about the content of our publications.

Please send comments to: kemp.doc@woodward.com

Please include the manual number from the front cover of this publication.

Woodward Kempen GmbH reserves the right to update any portion of this publication at any time. Information provided by Woodward Kempen GmbH is believed to be correct and reliable. However, Woodward Kempen GmbH assumes no responsibility unless otherwise expressly undertaken.

This is the original manual (source).

© Woodward Kempen GmbH , all rights reserved



Woodward Kempen GmbH

Krefelder Weg 47 • D – 47906 Kempen (Germany)
Postfach 10 07 55 (P.O.Box) • D – 47884 Kempen (Germany)
Phone: +49 (0) 21 52 145 1

Internet

www.woodward.com

Sales

Phone: +49 (0) 21 52 145 331 or +49 (0) 711 789 54 510
Fax: +49 (0) 21 52 145 354 or +49 (0) 711 789 54 101
e-mail: SalesPGD_EUROPE@woodward.com

Service

Phone: +49 (0) 21 52 145 600 • Telefax: +49 (0) 21 52 145 455
e-mail: SupportPGD_Europe@woodward.com