

High**PROTEC**

Manual | Directional Feeder Protection



MCA4

Software-Version: 3.1.a

DOK-HB-MCA4-2E

Revision: D

English

MCA4 Functional Overview

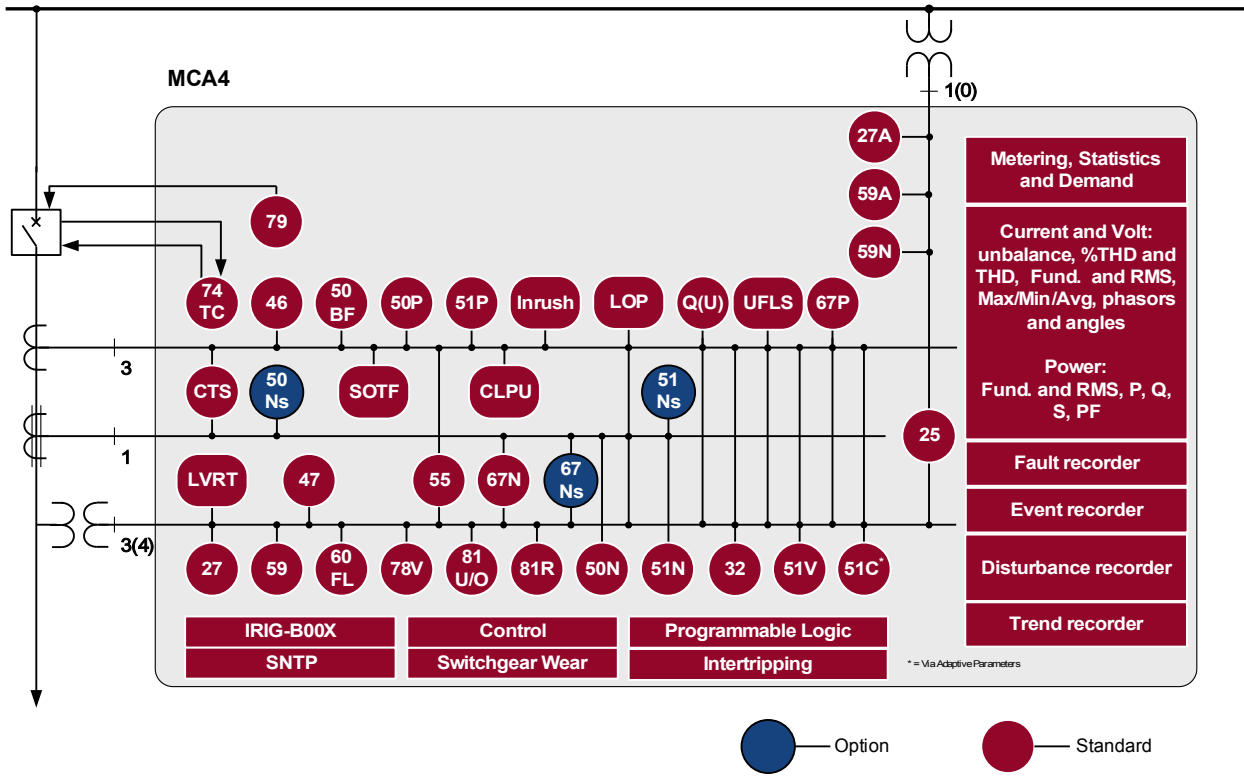

Order Code

| | | | | | | | | | |
|--|-----------------------------|----------------|----------------------|-------------|-----------|--|--|----------|-----------|
| Directional Feeder Protection (Version 2 with USB, enhanced communication options and new front plate) | | | | MCA4 | -2 | | | | |
| Digital Inputs | Binary output relays | Housing | Large display | | | | | | |
| 8 | 7 | B2 | X | | | | | A | |
| 16 | 13 | B2 | X | | | | | D | |
| Hardware variant 2 | | | | | | | | | |
| Phase Current 5 A/1 A, Ground Current 5 A/1 A | | | | | | | | 0 | |
| Phase Current 5 A/1 A, Sensitive Ground Current 5 A/1 A | | | | | | | | 1 | |
| Housing and mounting | | | | | | | | | |
| Door mounting | | | | | | | | | A |
| Door mounting 19" (flush mounting) | | | | | | | | | B |
| Communication protocol | | | | | | | | | |
| Without protocol | | | | | | | | | A |
| Modbus RTU, IEC60870-5-103, DNP3.0 RTU <i>RS485/terminals</i> | | | | | | | | | B* |
| Modbus TCP, DNP3.0 TCP/UDP <i>Ethernet 100 MB/RJ45</i> | | | | | | | | | C* |
| Profibus-DP <i>optic fiber/ST-connector</i> | | | | | | | | | D* |
| Profibus-DP <i>RS485/D-SUB</i> | | | | | | | | | E* |
| Modbus RTU, IEC60870-5-103, DNP3.0 RTU <i>optic fiber/ST-connector</i> | | | | | | | | | F* |
| Modbus RTU, IEC60870-5-103, DNP3.0 RTU <i>RS485/D-SUB</i> | | | | | | | | | G* |
| IEC61850, Modbus TCP, DNP3.0 TCP/UDP <i>Ethernet 100MB/RJ45</i> | | | | | | | | | H* |
| IEC60870-5-103, Modbus RTU, DNP3.0 RTU <i>RS485/terminals</i> | | | | | | | | | I* |
| Modbus TCP, DNP3.0 TCP/UDP <i>Ethernet 100 MB/RJ45</i> | | | | | | | | | |
| IEC61850, Modbus TCP, DNP3.0 TCP/UDP <i>Optical Ethernet 100MB/LC duplex connector</i> | | | | | | | | | K* |
| Modbus TCP, DNP3.0 TCP/UDP <i>Optical Ethernet 100MB/LC duplex connector</i> | | | | | | | | | L* |
| Harsh Environment Option | | | | | | | | | |
| None | | | | | | | | | A |
| Conformal Coating | | | | | | | | | B |
| Available menu languages | | | | | | | | | |
| Standard English/German/Spanish/Russian/Polish/Portuguese/French | | | | | | | | | |

* Within every communication option only one communication protocol is usable.
Smart view can be used in parallel via the Ethernet interface (RJ45).

The parameterizing- and disturbance analyzing software Smart view is included in the delivery of HighPROTEC devices.

All devices are equipped with an IRIG-B interface for Time Synchronization.

ANSI: 50, 51, 67, 51C, 51V, 25, 50N, 51N, 67N, 50Ns, 51Ns, 67Ns, 46, 49, 27, 59, 59N, 51Q, 81U/O, 60FL, 79, 86, 50BF, 74TC, 81R, 78, 47, 60FL, 60L, 32F, 37F, 32Q, 37Q, 37QR, 32S, 37S, 37R, 55, 51C, LVRT

With control functions for up to 6 switchgears and logic up to 80 equations.

Table of Contents

| | |
|---|------------|
| MCA4 Functional Overview | 2 |
| Order Code | 3 |
| Table of Contents | 5 |
| Comments on the Manual | 6 |
| Information Concerning Liability and Warranty | 6 |
| IMPORTANT DEFINITIONS | 7 |
| Important Information | 9 |
| Scope of Delivery | 11 |
| Storage..... | 12 |
| Waste Disposal..... | 13 |
| Symbols..... | 14 |
| General Conventions..... | 16 |
| Load Reference Arrow System..... | 21 |
| Device | 22 |
| Device Planning..... | 22 |
| Device Configuration Parameters of the Device..... | 23 |
| Installation and Connection | 25 |
| Three-Side-View - 19"..... | 25 |
| Three-Side-View - 8-Pushbutton Version..... | 27 |
| Installation Diagram 8-Pushbutton Version..... | 28 |
| Assembly Groups..... | 29 |
| Grounding..... | 30 |
| Legend for Wiring Diagrams..... | 31 |
| Slot X1: Power Supply Card with Digital Inputs..... | 33 |
| Slot X2: Relay Output Card..... | 37 |
| Slot X3: Current Transformer Measuring Inputs..... | 40 |
| Slot X4: Voltage Transformer Measuring Inputs..... | 51 |
| Slot X5: Relay Output Card..... | 61 |
| Slot X6: Digital Inputs..... | 62 |
| Digital Inputs..... | 63 |
| Slot X100: Ethernet Interface..... | 65 |
| Slot X103: Data Communication..... | 67 |
| Slot X104: IRIG-B00X and Supervision Contact..... | 78 |
| Navigation - Operation | 81 |
| Basic Menu Control | 86 |
| Input, Output and LED Settings | 87 |
| Configuration of the Digital Inputs..... | 87 |
| Output Relays Settings..... | 98 |
| OR-6 X..... | 102 |
| LED configuration..... | 141 |
| Smart View | 145 |
| Data visualizer | 146 |
| Wide Frequency Range | 147 |
| Measuring Values | 148 |
| Read out Measured Values..... | 148 |
| Power - Measured Values..... | 157 |
| Energy Counter | 159 |
| Global Parameters of the Energy Counter Module..... | 159 |
| Direct Commands of the Energy Counter Module | 159 |
| Signals of the Energy Counter Module (States of the Outputs)..... | 159 |

| | |
|---|------------|
| Statistics | 161 |
| Configuration of the Minimum and Maximum Values..... | 161 |
| Configuration of the Average Value Calculation..... | 162 |
| Direct Commands..... | 164 |
| Global Protection Parameters of the Statistics Module..... | 164 |
| States of the Inputs of the Statistics Module..... | 168 |
| Signals of the Statistics Module..... | 169 |
| Counters of the Module Statistics..... | 169 |
| System Alarms | 180 |
| Demand Management..... | 180 |
| Peak Values..... | 183 |
| Min. and Max. Values..... | 183 |
| THD Protection..... | 184 |
| Device Planning Parameters of the Demand Management..... | 184 |
| Signals of the Demand Management (States of the Outputs)..... | 184 |
| Global Protection Parameter of the Demand Management..... | 185 |
| States of the Inputs of the Demand Management..... | 188 |
| Acknowledgments | 189 |
| Manual Acknowledgment..... | 191 |
| External Acknowledgments..... | 192 |
| Manual Resets | 193 |
| Reset to Factory Defaults..... | 193 |
| Status Display | 194 |
| Operating Panel (HMI) | 195 |
| Special Parameters of the Panel..... | 195 |
| Direct Commands of the Panel..... | 195 |
| Global Protection Parameters of the Panel..... | 195 |
| Recorders | 196 |
| Disturbance Recorder | 196 |
| Fault Recorder | 205 |
| Event Recorder | 213 |
| Trend Recorder..... | 215 |
| Communication Protocols | 222 |
| SCADA Interface..... | 222 |
| TCP/IP Parameter..... | 222 |
| Modbus®..... | 224 |
| Profibus..... | 246 |
| IEC60870-5-103..... | 260 |
| IEC61850..... | 265 |
| DNP3..... | 280 |
| Time Synchronisation | 323 |
| SNTP..... | 330 |
| IRIG-B00X..... | 338 |
| Parameters | 343 |
| Parameter Definitions..... | 343 |
| Access Authorizations (access areas)..... | 362 |
| Passwords – Areas..... | 362 |
| How to find out what access areas/levels are unlocked?..... | 365 |
| Unlocking Access Areas..... | 366 |
| Changing Passwords..... | 366 |
| Password Entry at the Panel..... | 367 |
| Password Forgotten | 367 |
| Parameter Setting at the HMI..... | 368 |

| | |
|---|------------|
| Setting Groups..... | 372 |
| Setting Lock..... | 382 |
| Device Parameters..... | 383 |
| Date and Time..... | 383 |
| Version..... | 383 |
| Display of ANSI-Codes..... | 383 |
| TCP/IP Settings..... | 384 |
| Direct Commands of the System Module..... | 385 |
| Global Protection Parameters of the System..... | 385 |
| System Module Input States..... | 388 |
| System Module Signals..... | 389 |
| Special Values of the System Module..... | 390 |
| Field Parameters | 391 |
| General Field Parameters..... | 391 |
| Field Parameters – Current Related..... | 392 |
| Field Parameters – Voltage Related..... | 394 |
| Blockings..... | 397 |
| Permanent Blocking..... | 397 |
| Temporary Blocking..... | 397 |
| To Activate or Deactivate the Tripping Command of a Protection Module..... | 399 |
| Activate, Deactivate Respectively Block Temporarily Protection Functions..... | 400 |
| Module: Protection (Prot)..... | 404 |
| Blocking all Protective Elements enduringly..... | 404 |
| Blocking all Protective Elements temporarily..... | 404 |
| Blocking all Trip Commands enduringly..... | 405 |
| Blocking all Trip Commands temporarily..... | 405 |
| General Alarms and General Trips..... | 407 |
| Direct Commands of the Protection Module..... | 412 |
| Global Protection Parameters of the Protection Module | 412 |
| Protection Module Input States..... | 413 |
| Protection Module Signals (Output States)..... | 413 |
| Protection Module Values..... | 415 |
| Switchgear/Breaker – Manager..... | 416 |
| Single Line Diagram..... | 417 |
| Notes on Special Switchgears..... | 419 |
| Switchgear Configuration..... | 421 |
| Switchgear Wear..... | 432 |
| Control - Example: Switching of a Circuit Breaker..... | 439 |
| Control Parameters..... | 443 |
| Controlled Circuit Breaker..... | 454 |
| Monitored Circuit Breaker..... | 467 |
| Controlled Disconnecter..... | 480 |
| Monitored Disconnecter..... | 493 |
| Protective Elements..... | 505 |
| Interconnection..... | 505 |
| I - Overcurrent Protection [50, 51,51Q, 51V, 67]..... | 506 |
| IH2 - Inrush..... | 540 |
| Directional Features for Measured Ground Fault Elements 50N/51N..... | 545 |
| Directional Features for Calculated (IG calc) Ground Fault 50N/51N..... | 547 |
| IG - Ground Fault [50N/G, 51N/G, 67N/G]..... | 550 |
| I2> and %I2/I1> - Unbalanced Load [46]..... | 576 |
| ThR-Protection Module: Thermal Replica [49]..... | 585 |
| SOTF - Switch Onto Fault..... | 594 |

| | |
|--|------------|
| CLPU - Cold Load Pickup..... | 601 |
| AR - Automatic Reclosure [79]..... | 609 |
| V - Voltage Protection [27,59]..... | 644 |
| VG, VX - Voltage Supervision [27A, 27TN/59N, 59A]..... | 655 |
| f - Frequency [81O/U, 78, 81R]..... | 666 |
| V 012 – Voltage Asymmetry [47]..... | 691 |
| Sync - Synchrocheck [25]..... | 698 |
| Q->&V< Reactive-Power/Undervoltage Protection..... | 723 |
| Reconnection Module..... | 735 |
| UFLS Under Frequency Load Shedding..... | 761 |
| LVRT – Low Voltage Ride Through [27(t)]..... | 780 |
| Intertripping (Remote)..... | 795 |
| PQS - Power [32, 37]..... | 802 |
| PF - Power Factor [55]..... | 822 |
| ExP - External Protection..... | 830 |
| Supervision..... | 836 |
| CBF- Circuit Breaker Failure [50BF*/62BF]..... | 836 |
| TCS - Trip Circuit Supervision [74TC]..... | 860 |
| CTS - Current Transformer Supervision [60L]..... | 869 |
| LOP - Loss of Potential..... | 875 |
| Self Supervision..... | 887 |
| Programmable Logic..... | 892 |
| General Description..... | 892 |
| Programmable Logic at the Panel..... | 897 |
| Commissioning | 903 |
| Commissioning/Protection Test | 904 |
| Putting out of Operation – Plug out the Relay..... | 905 |
| Service and Commissioning Support..... | 906 |
| General..... | 906 |
| Forcing the Relay Output Contacts..... | 907 |
| Forcing RTDs*..... | 910 |
| Forcing Analog Outputs*..... | 911 |
| Forcing Analog Inputs*..... | 912 |
| Failure Simulator (Sequencer)*..... | 913 |
| Technical Data | 928 |
| Climatic Environmental Conditions..... | 928 |
| Degree of Protection EN 60529..... | 928 |
| Routine Test..... | 928 |
| Housing..... | 929 |
| Current and Earth Current Measurement..... | 930 |
| Voltage and Residual Voltage Measurement..... | 931 |
| Frequency Measurement | 931 |
| Voltage Supply..... | 932 |
| Power Consumption..... | 932 |
| Display..... | 933 |
| Front Interface USB..... | 933 |
| Real Time Clock..... | 933 |
| Digital Inputs..... | 934 |
| Binary Output Relays..... | 935 |
| Supervision Contact (SC)..... | 935 |
| Time Synchronization IRIG..... | 936 |
| RS485*..... | 936 |
| Fibre Optic Module with ST connector*..... | 936 |

Fibre Optic Module with LC Connector for Long-distance Protection Communication** 936

Optical Ethernet Module with LC connector* **936**

URTD-Interface* **937**

Boot phase..... 938

Servicing and Maintenance..... **939**

Standards..... **941**

Approvals..... 941

Design Standards..... 941

High Voltage Tests 942

EMC Immunity Tests..... 943

EMC Emission Tests..... 944

Environmental Tests..... 945

Environmental Tests..... 946

Mechanical Tests..... 947

General Lists..... **948**

Assignment List 948

List of the Digital Inputs..... 1016

Signals of the Digital Inputs and Logic..... 1017

Specifications..... **1027**

Specifications of the Real Time Clock..... 1027

Time Synchronisation Tolerances..... 1027

Specifications of the Measured Value Acquisition..... 1028

Protection Elements Accuracy..... 1030

Abbreviations, and Acronyms..... **1038**

List of ANSI Codes..... **1043**

This manual applies to devices (version):

Version 3.1.a

Build: 32435

Comments on the Manual

This manual explains in general the tasks of device planning, parameter setting, installation, commissioning, operation and maintenance of the HighPROTEC devices.

The manual serves as working basis for:

- Engineers in the protection field,
- commissioning engineers,
- people dealing with setting, testing and maintenance of protection and control devices,
- as well as trained personnel for electrical installations and power stations.

All functions concerning the type code will be defined. Should there be a description of any functions, parameters or inputs/outputs which do not apply to the device in use, please ignore that information.

All details and references are explained to the best of our knowledge and are based on our experience and observations.

This manual describes the (optionally) full featured versions of the devices.

All technical information and data included in this manual reflect their state at the time this document was issued. We reserve the right to carry out technical modifications in line with further development without changing this manual and without previous notice. Hence no claim can be brought based on the information and descriptions this manual includes.

Text, graphic and formulae do not always apply to the actual delivery scope. The drawings and graphics are not true to scale. We do not accept any liability for damage and operational failures caused by operating errors or disregarding the directions of this manual.

No part of this manual is allowed to be reproduced or passed on to others in any form, unless *Woodward Kempen GmbH* have approved in writing.

This user manual is part of the delivery scope when purchasing the device. In case the device is passed on (sold) to a third party, the manual has to be handed over as well.

Any repair work carried out on the device requires skilled and competent personnel who need to be well aware especially of the local safety regulations and have the necessary experience for working on electronic protection devices and power installations (provided by evidence).

Information Concerning Liability and Warranty

Woodward does not accept any liability for damage resulting from conversions or changes carried out on the device or planning (projecting) work, parameter setting or adjustment changes done by the customer.

The warranty expires after a device has been opened by others than *Woodward* specialists.

Warranty and liability conditions stated in *Woodward* General Terms and Conditions are not supplemented by the above mentioned explanations.

IMPORTANT DEFINITIONS

The signal definitions shown below serve the safety of life and limb as well as for the appropriate operating life of the device.

 **DANGER** indicates a hazardous situation which, if not avoided, will result in death or serious injury.

 **WARNING** indicates a hazardous situation which, if not avoided, could result in death or serious injury.

 **CAUTION**, used with the safety alert symbol, indicates a hazardous situation which, if not avoided, could result in minor or moderate injury.

 **NOTICE** is used to address practices not related to personal injury.

 **CAUTION**, without the safety alert symbol, is used to address practices not related to personal injury.



FOLLOW INSTRUCTIONS

Read this entire manual and all other publications pertaining to the work to be performed before installing, operating, or servicing this equipment. Practice all plant and safety instructions and precautions. Failure to follow instructions can cause personal injury and/or property damage.



PROPER USE

Any unauthorized modifications to or use of this equipment outside its specified mechanical, electrical, or other operating limits may cause personal injury and/or property damage, including damage to the equipment. Any such unauthorized modifications: (1) constitute "misuse" and/or "negligence" within the meaning of the product warranty thereby excluding warranty coverage for any resulting damage, and (2) invalidate product certifications or listings.

The programmable devices subject to this manual are designed for protection and also control of power installations and operational devices that are fed by voltage sources with a fixed frequency, i.e. fixed at 50 or 60 Hertz. They are not intended for use with Variable Frequency Drives. The devices are further designed for installation in low-voltage (LV) compartments of medium voltage (MV) switchgear panels or in decentralized protection panels. The programming and parameterization has to meet all requirements of the protection concept (of the equipment that is to be protected). You must ensure that the device will properly recognize and manage (e.g. switch off the circuit breaker) on the basis of your programming and parameterization all operational conditions (failures). The proper use requires a backup protection by an additional protective device. Before starting any operation and after any modification of the programming (parameterization) test make a documentary proof that your programming and parameterization meets the requirements of your protection concept.

The Self-Supervision Contact (Life-Contact) has to be wired with the substation automation system in order to supervise and monitor the state of health of the programmable protective device. It is very important that an alarm annunciation is driven from the programmable protective device self-supervision contact (Life-Contact) that requires immediate attention when tripped. The alarm indicates that the protective device is no longer protecting the circuit and the system should be serviced.

Typical applications for this product family/device line are for instance:

- Feeder protection
- Mains protection
- Machine protection
- Transformer Differential Protection

Any usage beyond these applications the devices are not designed for. This applies also to the use as a partly completed machinery. The manufacturer cannot be held liable for any resulting damage, the user alone bears the risk for this. As to the appropriate use of the device: The technical data and tolerances specified by *Woodward* have to be met.

⚠ WARNING OUT-OF-DATE PUBLICATION

This publication may have been revised or updated since this copy was produced. To verify that you have the latest revision, please visit the download section of our website:

www.woodward.com

If your publication is not there, please contact your customer service representative to get the latest copy.

Important Information

⚠ WARNING In line with the customer's requirement the devices are combined in a modular way (in compliance with the order code). The terminal assignment of the device can be found on the top of the device (wiring diagram).

CAUTION

Electrostatic Discharge Awareness

All electronic equipment is electro static-sensitive, some components more than others. To protect these components from electro static damage, you must take special precautions to minimize or eliminate electrostatic discharges.

Follow these precautions when working with or near the control.

1. Before doing maintenance on the electronic control, discharge the static electricity on your body to ground by touching and holding a grounded metal object (pipes, cabinets, equipment, etc.).
2. Avoid the build-up of static electricity on your body by not wearing clothing made of synthetic materials. Wear cotton or cotton-blend materials as much as possible because these do not store static electric charges as much as synthetics.
3. Keep plastic, vinyl, and Styrofoam materials (such as plastic or Styrofoam cups, cup holders, cigarette packages, cellophane wrappers, vinyl books or folders, plastic bottles, and plastic ash trays) away from the control, the modules, and the work area as much as possible.
4. Do not remove any printed circuit board (PCB) from the control cabinet unless absolutely necessary. If you must remove the PCB from the control cabinet, follow these precautions:
 - Verify the safe isolation from supply. All connectors have to be unplugged.
 - Do not touch any part of the PCB except the edges.
 - Do not touch the electrical conductors, the connectors, or the components with conductive devices or with your hands.
 - When replacing a PCB, keep the new PCB in the plastic antistatic protective bag it comes in until you are ready to install it. Immediately after removing the old PCB from the control cabinet, place it in the antistatic protective bag.

To prevent damage to electronic components caused by improper handling, read and observe the precautions in Woodward manual 82715, Guide for Handling and Protection of Electronic Controls, Printed Circuit Boards, and Modules.

Woodward reserves the right to update any portion of this publication at any time. Information provided by Woodward is believed to be correct and reliable. However, no responsibility is assumed by Woodward unless otherwise expressly undertaken.

© Woodward 2016. All Rights Reserved.

Scope of Delivery

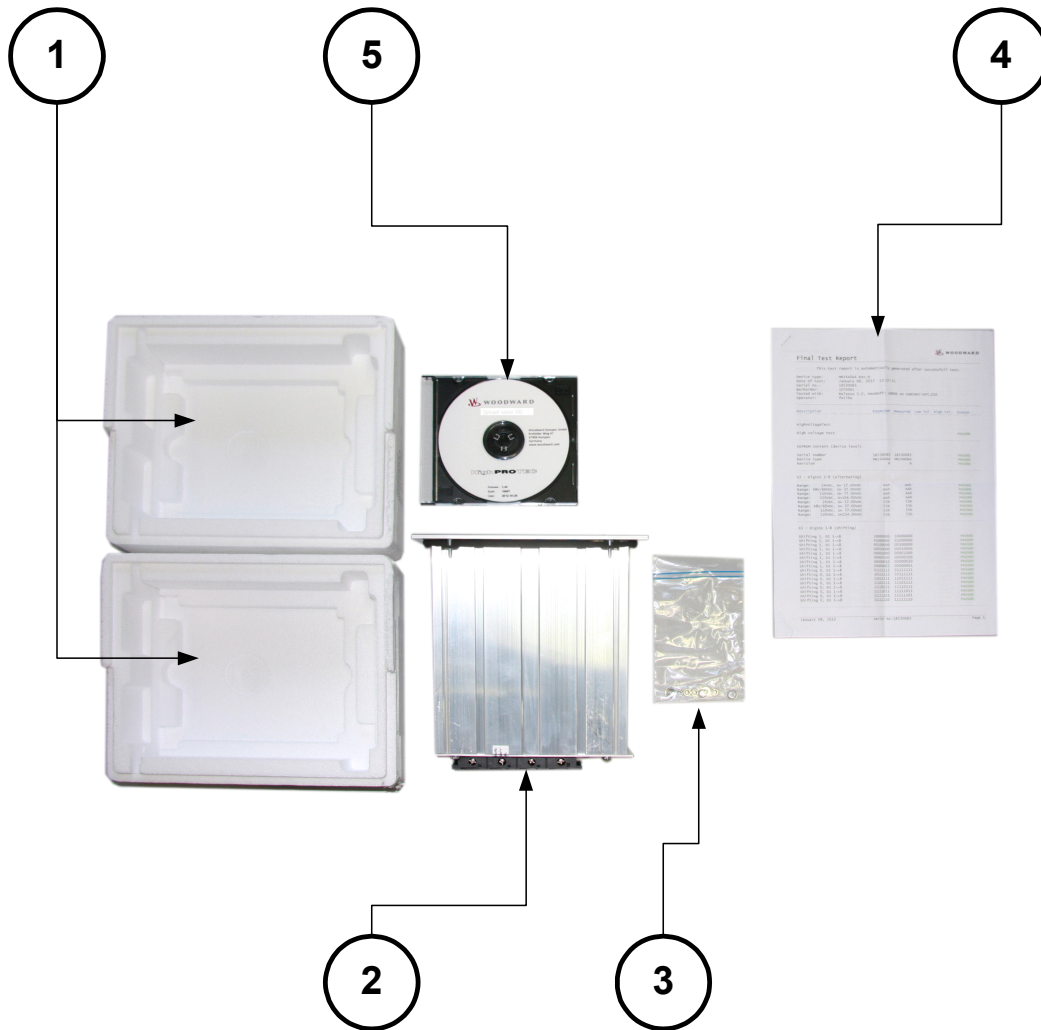

The delivery scope includes:

| | |
|----------|--|
| <p>1</p> | <p>The transportation box</p> |
| <p>2</p> | <p>The protective device</p> |
| <p>3</p> | <p>The mounting nuts</p> |
| <p>4</p> | <p>The test report</p> |
| <p>5</p> | <p>The product DVD that includes the manuals and related documentation as well as the parameter setting and evaluation software.</p> |

Please check the consignment for completeness on arrival (delivery note).

Please ascertain whether the type plate, connection diagram, type code and description of the device tally. If you have any doubts please contact our Service Department (contact address to be found on the reverse of the manual).

Storage

The devices must not be stored outdoors. The storing facilities have to be sufficiently ventilated and must be dry (see Technical Data).

Waste Disposal

Devices that contain batteries are to be labeled according to EU Directive 2006/66/EG "Directive on batteries and accumulators and waste batteries and accumulators and..." with the following symbol

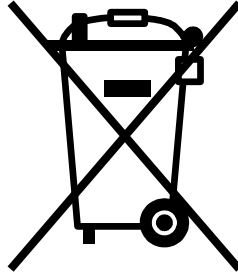

The battery has to be disposed appropriately after the end of life of the protective device.

Purpose of the Battery

The purpose of the battery is to buffer the real time clock in case of an outage of the power supply of the protective device.

Removal of the Battery

The battery has to be soldered out or alternatively the contacts have to be pinched off. Please see the product safety data sheet of the battery manufacturer for further information.

Manufacturer and type of the Battery

Panasonic Typ BR2032 (<http://panasonic.net/ec/>) or equal.

Symbols

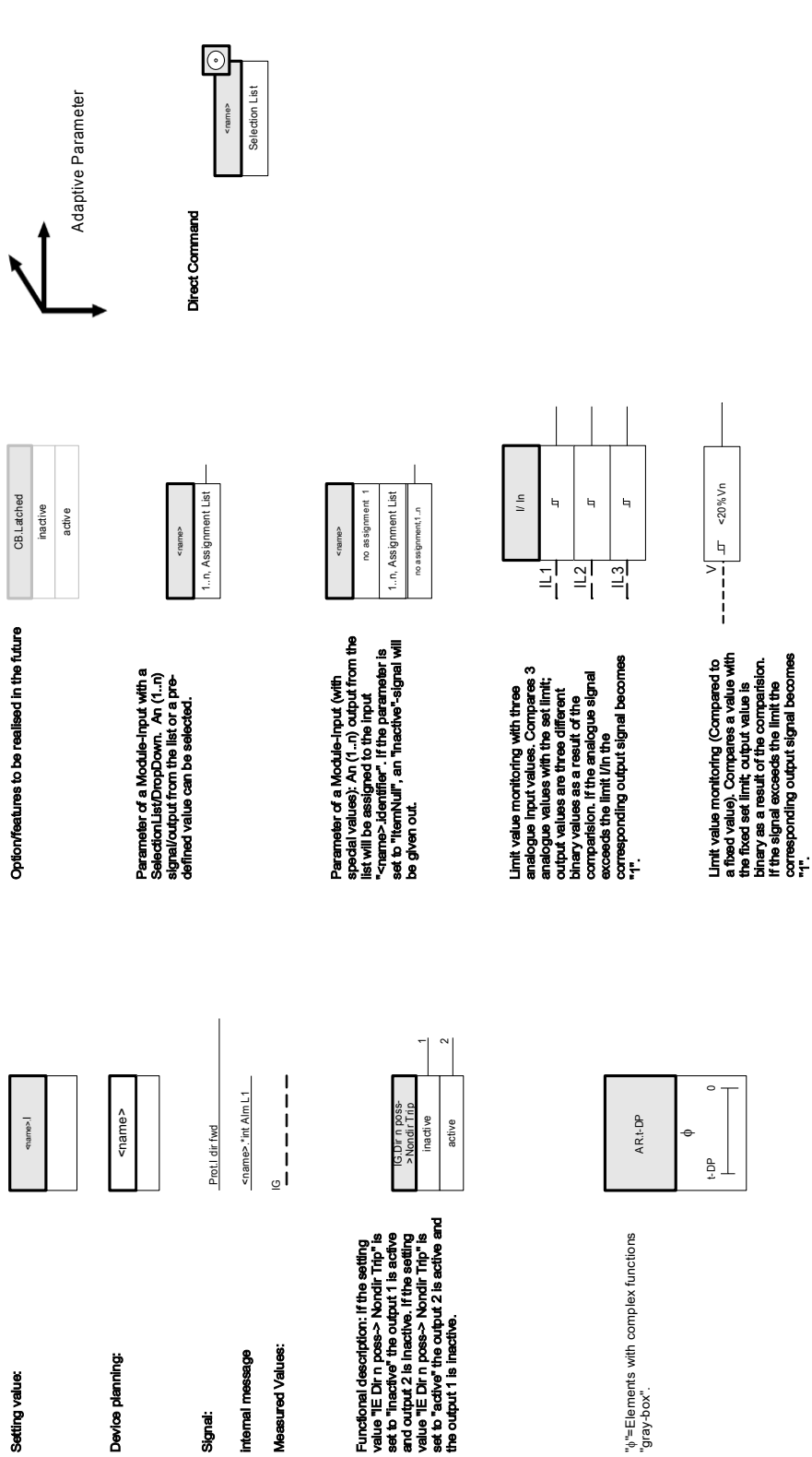

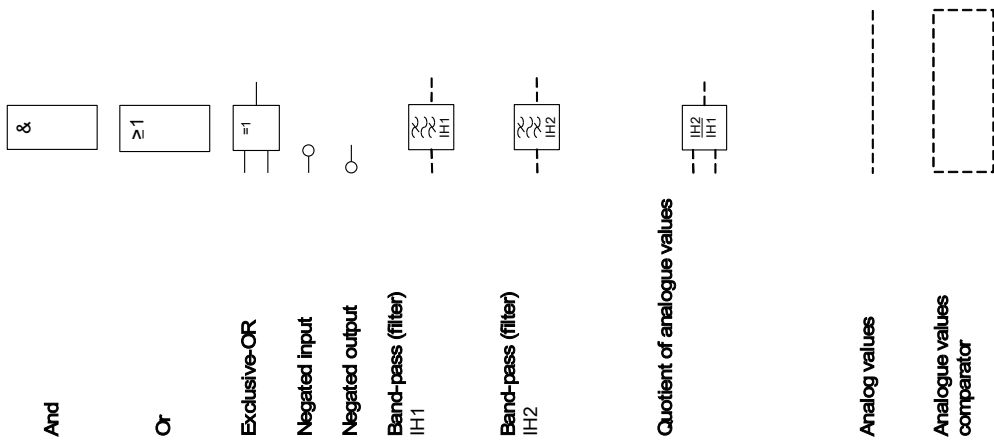

RS flip-flop



a b c d
 0 0 Unchanged
 0 1 0 1
 1 0 1 0
 1 1 0 1

Time stage: A "1" at the input starts the stage. If the time <name>.t is expired the output becomes "1" too. The time stage will be reset by "0" at the input. Thus the output will be set to "0" at the same time.

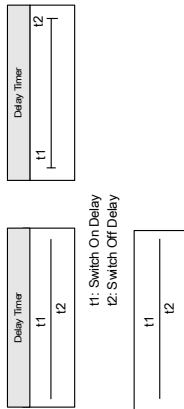

Edge triggered counter
 + increment
 R Reset

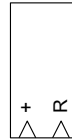

Counter increments with every rising edge. Output will be set as long as $n < N$.

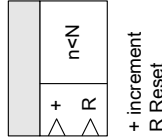

Quotient of analogue values

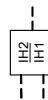

Time stage minimum pulse width: The pulse width <name>.t will be started if a "1" is feed to the input. By starting <name>.t the output becomes "1". If the time is expired, the output becomes "0" independent from the input signal.

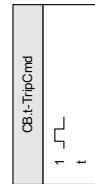

Analog values

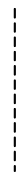

Analogue values comparator



General Conventions

»Parameters are indicated by right and left double arrow heads and written in *italic* .«

»SIGNALS are indicated by right and left double arrow heads and small caps .«

[Paths are indicated by brackets.]

Software and Device names are written in italic.

Module and Instance (Element) names are displayed italic and underlined.

»Pushbuttons, Modes and Menu entries are indicated by right and left double arrow heads .«



Image References (Squares)

Output Signal

Input Signal

- 1 Prot. available Please Refer To Diagram: Pdt
- 2 name.active Please Refer To Diagram: Blockings
- 3 name.Blo_TripCmd Please Refer To Diagram: Trip blockings
- 4 name.active Please Refer To Diagram: Blockings**
- 5 IH2.Bb L1 Please Refer To Diagram: IH2
- 6 IH2.Bb L2 Please Refer To Diagram: IH2
- 7 IH2.Bb L3 Please Refer To Diagram: IH2
- 8 IH2.Blo IG Please Refer To Diagram: IH2
- 9 name.Fault in projected direction Please Refer To Diagram: direction decision phase overcurent
- 10 name.Fault in projected direction Please Refer To Diagram: direction decision Earth fault
- 11 CB.Trip CB Please Refer To Diagram: CB
- 12a VTS.Alarm Please Refer To Diagram: VTS
- 12b VTS.VTS.Ex FF VT Please Refer To Diagram: VTS
- 12c VTS.VTS.Ex FF EVT Please Refer To Diagram: VTS
Each alarm of a module (except from supervision modules but including CBE) will lead to a general alarm. (collective alarm).
- 14 name.Alarm
- 15 name.Trip Each trip of an active, trip authorized protection module will lead to a general trip.

- 15a name.TripCmd Each trip of an active, trip authorized protection module will lead to a general trip.
- 16 name.Trip L1 Each trip of an active, trip authorized protection module will lead to a general trip.
- 16a name.Trip L1 Each trip of an active, trip authorized protection module will lead to a general trip.
- 16b name.Trip L1 Each trip of an active, trip authorized protection module will lead to a general trip.
- 17 name.Trip L2 Each trip of an active, trip authorized protection module will lead to a general trip.
- 17a name.Trip L2 Each trip of an active, trip authorized protection module will lead to a general trip.
- 17b name.Trip L2 Each trip of an active, trip authorized protection module will lead to a general trip.
- 18 name.Trip L3 Each trip of an active, trip authorized protection module will lead to a general trip.
- 18a name.Trip L3 Each trip of an active, trip authorized protection module will lead to a general trip.
- 18b name.Trip L3 Each trip of an active, trip authorized protection module will lead to a general trip.
- 19 name.TripCmd Each trip of an active, trip authorized protection module will lead to a general trip.
- 19a name.TripCmd Each trip of an active, trip authorized protection module will lead to a general trip.
- 19b name.TripCmd Each trip of an active, trip authorized protection module will lead to a general trip.
- 19c name.TripCmd Each trip of an active, trip authorized protection module will lead to a general trip.
- 19d name.TripCmd Each trip of an active, trip authorized protection module will lead to a general trip.

- 20 Each trip of an active, trip authorized protection module will lead to a general trip.
name.Trip L1
- 21 Each trip of an active, trip authorized protection module will lead to a general trip.
name.Trip L2
- 22 Each trip of an active, trip authorized protection module will lead to a general trip.
name.Trip L3
- 23 Each trip of an active, trip authorized protection module will lead to a general trip.
name.Trip
- 24 Each phase selective alarm of a module (I, IG, V, VX depending on the device type) will lead to a phase selective general alarm (collective alarm).
name.Alarm L1
- 24a Each phase selective alarm of a module (I, IG, V, VX depending on the device type) will lead to a phase selective general alarm (collective alarm).
name.Alarm L1
- 24b Each phase selective alarm of a module (I, IG, V, VX depending on the device type) will lead to a phase selective general alarm (collective alarm).
name.Alarm L1
- 25 Each phase selective alarm of a module (I, IG, V, VX depending on the device type) will lead to a phase selective general alarm (collective alarm).
name.Alarm L2
- 25a Each phase selective alarm of a module (I, IG, V, VX depending on the device type) will lead to a phase selective general alarm (collective alarm).
name.Alarm L2
- 25b Each phase selective alarm of a module (I, IG, V, VX depending on the device type) will lead to a phase selective general alarm (collective alarm).
name.Alarm L2
- 26 Each phase selective alarm of a module (I, IG, V, VX depending on the device type) will lead to a phase selective general alarm (collective alarm).
name.Alarm L3
- 26a Each phase selective alarm of a module (I, IG, V, VX depending on the device type) will lead to a phase selective general alarm (collective alarm).
name.Alarm L3
- 26b Each phase selective alarm of a module (I, IG, V, VX depending on the device type) will lead to a phase selective general alarm (collective alarm).
name.Alarm L3
- 27 Each phase selective alarm of a module (I, IG, V, VX depending on the device type) will lead to a phase selective general alarm (collective alarm).
name.Alarm
- 27a Each phase selective alarm of a module (I, IG, V, VX depending on the device type) will lead to a phase selective general alarm (collective alarm).
name.Alarm
- 27b Each phase selective alarm of a module (I, IG, V, VX depending on the device type) will lead to a phase selective general alarm (collective alarm).
name.Alarm
- 27c Each phase selective alarm of a module (I, IG, V, VX depending on the device type) will lead to a phase selective general alarm (collective alarm).
name.Alarm
- 27d Each phase selective alarm of a module (I, IG, V, VX depending on the device type) will lead to a phase selective general alarm (collective alarm).
name.Alarm
- 28 Each phase selective alarm of a module (I, IG, V, VX depending on the device type) will lead to a phase selective general alarm (collective alarm).
name.Alarm L1
- 29 Each phase selective alarm of a module (I, IG, V, VX depending on the device type) will lead to a phase selective general alarm (collective alarm).
name.Alarm L2
- 30 Each phase selective alarm of a module (I, IG, V, VX depending on the device type) will lead to a phase selective general alarm (collective alarm).
name.Alarm L3
- 31 Each phase selective alarm of a module (I, IG, V, VX depending on the device type) will lead to a phase selective general alarm (collective alarm).
name.Alarm
- 32 Prot.Blo TripCmd
CB.Pos
Please Refer To Diagram: CB.CB Manager
- 33 CB.Pos ON
Please Refer To Diagram: CB.CB Manager
- 34 CB.Pos OFF
Please Refer To Diagram: CB.CB Manager
- 35 CB.Pos Indeterm
Please Refer To Diagram: CB.CB Manager
- 36 CB.Pos Disturb
Please Refer To Diagram: CB.CB Manager
- 37 LOP.LOP Blo
Please Refer To Diagram: LOP.LOP Blo
- 38a LOP.Ex FF VT
Please Refer To Diagram: LOP.Ex FF VT
- 38b LOP.Ex FF EVT
Please Refer To Diagram: LOP.Ex FF EVT

- 39 Q->&V<-Decoupling Distributed Generator
Please Refer To Diagram: Q->&V<-Decoupling Distributed Generator
- 40 CTS.Alarm
Please Refer To Diagram: CTS.Alarm
- 41
Please Refer To Diagram: SG.Prot ON
- 42 SG.ON Cmd
Please Refer To Diagram: SG.ON Cmd
- 43 AnIn[1].Value
Please Refer To Diagram: Analog values
- 44 AnIn[2].Value
Please Refer To Diagram: Analog values
- 45 AnIn[n].Value
Please Refer To Diagram: Analog values
- 46 Trip Incomplete (Motor) Start Sequence

Access Level

(Please refer to chapter [Parameter\Access Level])

Read Only-Lv0

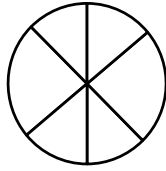

Parameters can only be read within this level.

Prot-Lv1



This level enables execution of Resets and Acknowledgements

Prot-Lv2



This level enables modification of protection settings

Control-Lv1

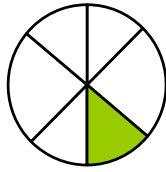

This level enables control functions

Control-Lv2

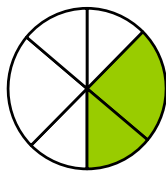

This level enables modification of switchgear settings

Supervisor-Lv3

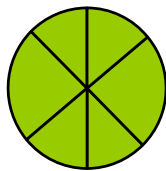

This level provides full access (not limited) to all settings

Load Reference Arrow System

Within the HighPROTEC the “Load Reference Arrow System” is used in principal. Generator protection relays are working based on the “Generator Reference System”.

Device

MCA4

Device Planning

Planning of a device means to reduce the functional range to a degree that suits the protection task to be fulfilled, i.e. the device shows only those functions you really need. If you, for example, deactivate the voltage protection function, all parameter branches related to this function do not appear in the parameter tree any more. All corresponding events, signals etc. will be deactivated too. By this the parameter trees become very transparent. Planning also involves adjustment of all basic system data (frequency etc.).



WARNING

But it has to be taken into account that by deactivating, for instance, protective functions, you also change the functionality of the device. If you cancel the directional feature of the overcurrent protections then the device no longer trips in a directional way but merely in a non-directional way.

The manufacturer does not accept liability for any personal or material damage as a result of wrong planning.

A planning service is also offered by *Woodward Kempen GmbH*.





WARNING



Beware of inadvertent deactivating protective functions/modules

If you are deactivating modules within the device planning all parameters of those modules will be set on default.

If you are activating one of these modules again all parameters of those reactivated modules will be set on default.

Device Configuration Parameters of the Device

| <i>Parameter</i> | <i>Description</i> | <i>Options</i> | <i>Default</i> | <i>Menu path</i> |
|---|-----------------------------|--|---|------------------|
| Hardware Variant 1  | Optional Hardware Extension | »A« 8 digital inputs 7 binary output relays, »D« 16 digital inputs 13 binary output relays | 16 digital inputs 13 binary output relays | [MCA4] |
| Hardware Variant 2  | Optional Hardware Extension | »0« Phase Current 5A/1A, Ground Current 5A/1A, »1« Phase Current 5A/1A, Sensitive Ground Current 5A/1A | Phase Current 5A/1A, Ground Current 5A/1A | [MCA4] |
| Housing  | Mounting form | »A« Flush mounting, »B« 19 inch mounting (semi-flush), »H« Customized Version 1, »K« Customized Version 2 | Flush mounting | [MCA4] |

| Parameter | Description | Options | Default | Menu path |
|--|-----------------------|--|--------------|-----------|
| Communication  | Communication | »A« Without, »B« RS 485: Modbus RTU IEC 60870-5-103 DNP RTU, »C« Ethernet: Modbus TCP DNP UDP, TCP, »D« Fiber Optics: Profibus-DP, »E« D-SUB: Profibus-DP, »F« Fiber Optics: Modbus RTU IEC 60870-5-103 DNP RTU, »G« RS 485/D-SUB: Modbus RTU IEC 60870-5-103 DNP RTU, »H« Ethernet: IEC61850 Modbus TCP DNP UDP, TCP, »I« RS 485 and Ethernet: Modbus TCP, RTU DNP UDP, TCP, RTU, »K« Ethernet/Fiber Optics: IEC61850 Modbus TCP DNP UDP, TCP, »L« Ethernet/Fiber Optics: Modbus TCP DNP UDP, TCP, »T« RS 485 and Ethernet: Communication Test | »A« Without | [MCA4] |
| Printed Circuit Board  | Printed Circuit Board | »A« Standard, »B« conformal coating | »A« Standard | [MCA4] |

Installation and Connection

Three-Side-View - 19"

NOTICE Dependent on the connection method of the SCADA system used the needed space (depth) differs. If, for instance, a D-Sub-Plug is used, it has to be added to the depth dimension.

NOTICE The three-side-view shown in this section is exclusively valid for 19" devices.

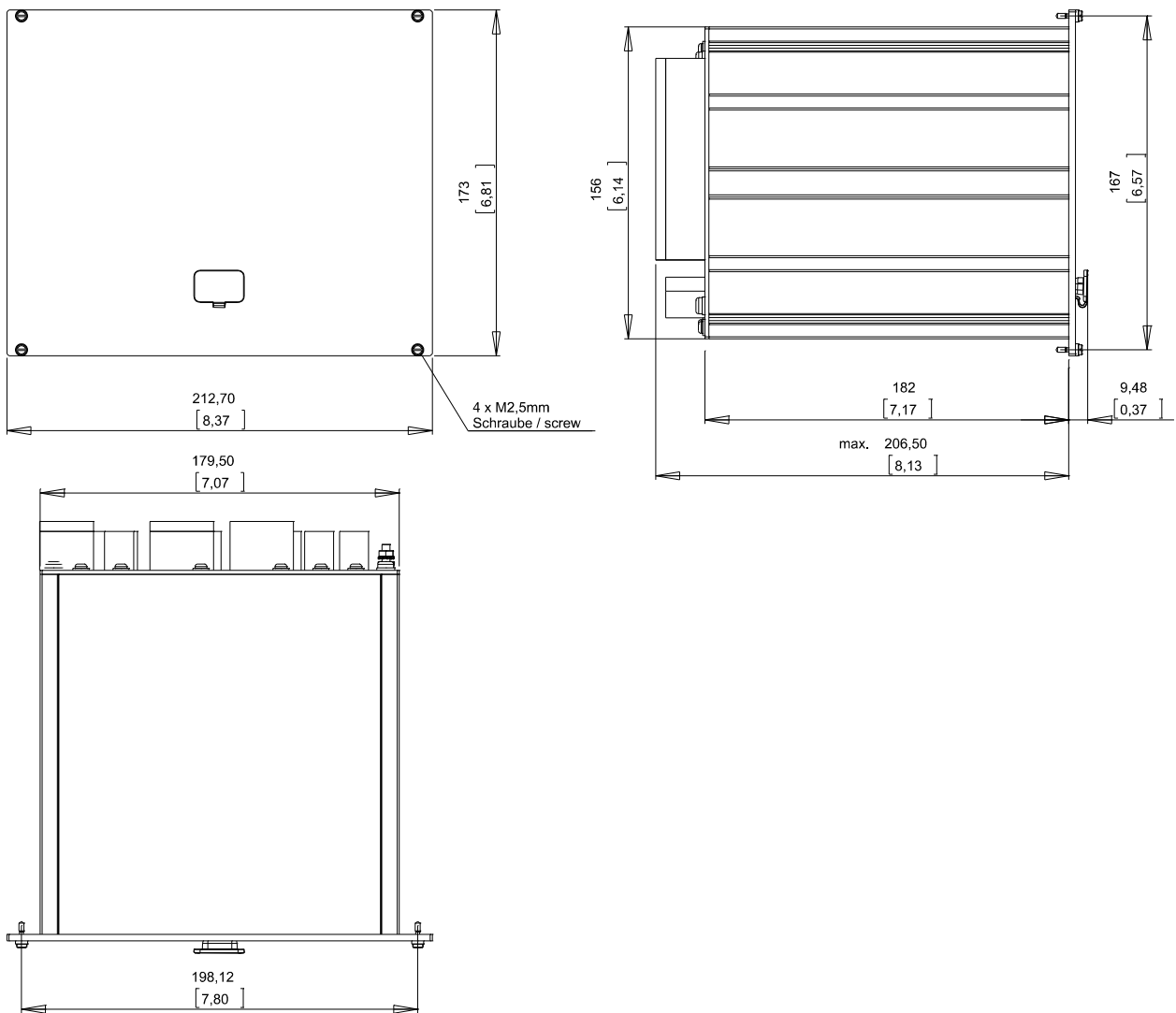

3-Side-View B2 Housing (19" Devices). (All dimensions in mm, except dimensions in brackets [inch].)

⚠ WARNING

The housing must be carefully grounded. Connect a ground cable (4 to 6 mm² [AWG 12-10], tightening torque 1.7 Nm [15 In-lb]) to the housing, using the screw that is marked with the ground symbol (at the rear side of the device).

Moreover, the power supply card needs a separate ground connection (2.5 mm² [AWG 14], tightening torque 0,56 – 0,79 Nm [5–7 lb•in]). See the “Terminal Marking” diagram in Section “DI-4 X – Power Supply and Digital Inputs” to check for the correct terminal.

Three-Side-View - 8-Pushbutton Version

NOTICE Dependent on the connection method of the SCADA system used the needed space (depth) differs. If, for instance, a D-Sub-Plug is used, it has to be added to the depth dimension.

NOTICE The installation diagram shown in this section is exclusively valid for devices with 8 pushbuttons at the front side of the HMI.
(INFO-, C-, OK-, CTRL-Pushbutton and 4 Softkeys (Pushbuttons)).

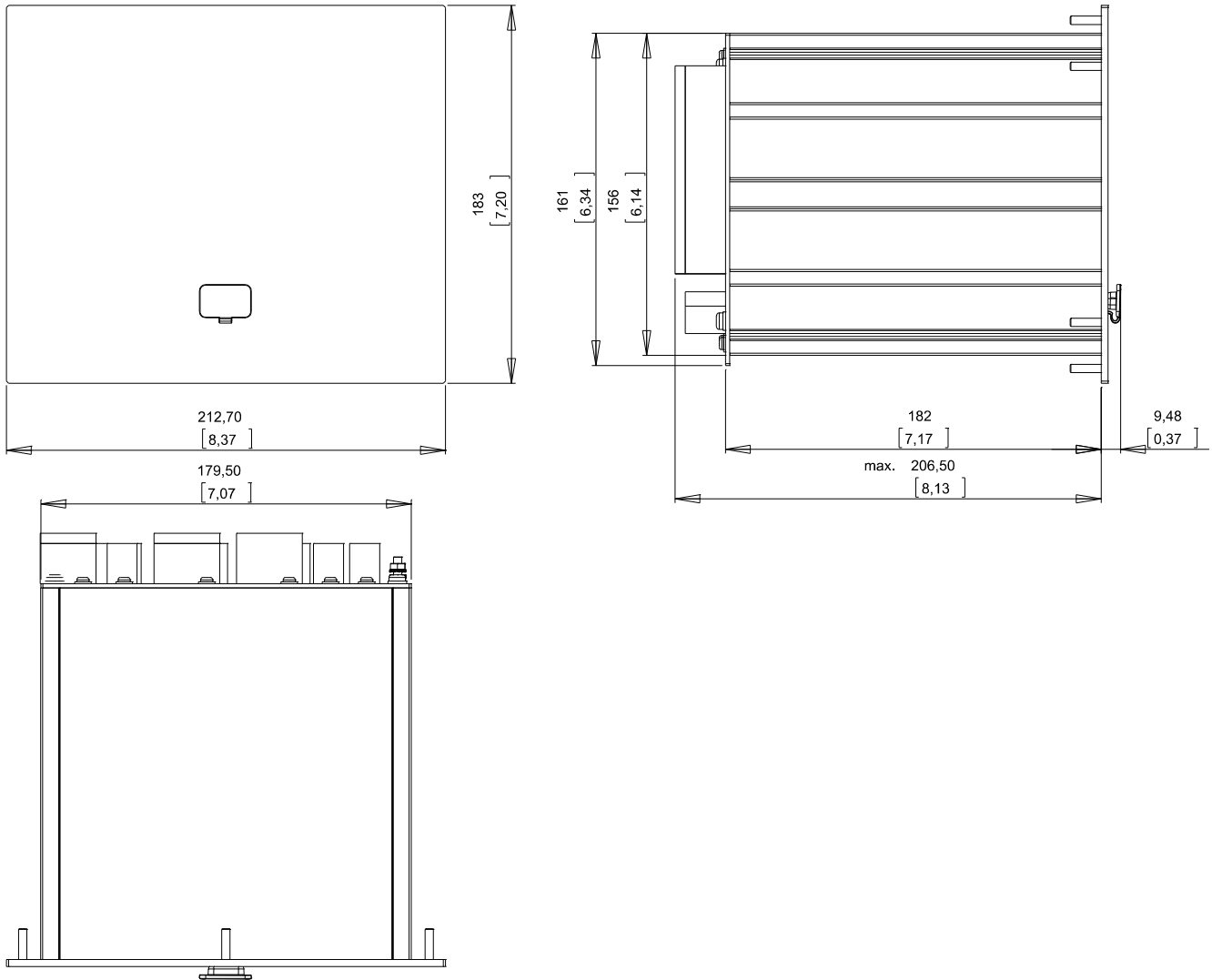

3-Side-View B2 Housing (Devices with 8 Softkeys). (All dimensions in mm, except dimensions in brackets [inch].)

WARNING The housing must be carefully grounded. Connect a ground cable (4 to 6 mm² [AWG 12-10], tightening torque 1.7 Nm [15 In-lb]) to the housing, using the screw that is marked with the ground symbol (at the rear side of the device).

Moreover, the power supply card needs a separate ground connection (2.5 mm² [AWG 14], tightening torque 0,56 – 0,79 Nm [5–7 lb•in]). See the “Terminal Marking” diagram in Section “DI-4 X – Power Supply and Digital Inputs” to check for the correct terminal.

Installation Diagram 8-Pushbutton Version

WARNING Even when the auxiliary voltage is switched-off, unsafe voltages might remain at the device connections.

NOTICE The installation diagram shown in this section is exclusively valid for devices with 8 pushbuttons at the front side of the HMI.
(INFO-, C-, OK-, CTRL-Pushbutton and 4 Softkeys (Pushbuttons)).

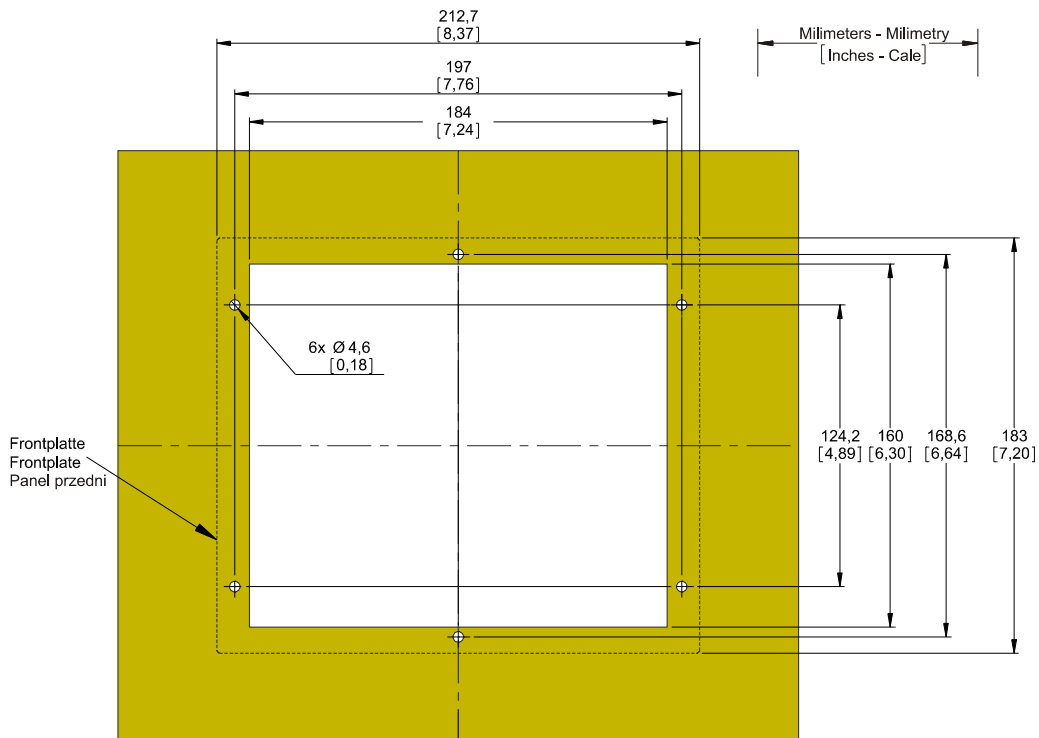

B2 Housing Door Cut-out (8-Pushbutton Version). (All dimensions in mm, except dimensions in brackets [inch].)

WARNING The housing must be carefully grounded. Connect a ground cable (4 to 6 mm² [AWG 12-10], tightening torque 1.7 Nm [15 In-lb]) to the housing, using the screw that is marked with the ground symbol (at the rear side of the device).

Moreover, the power supply card needs a separate ground connection (2.5 mm² [AWG 14], tightening torque 0,56 – 0,79 Nm [5–7 lb•in]). See the “Terminal Marking” diagram in Section “DI-4 X – Power Supply and Digital Inputs” to check for the correct terminal.

CAUTION Be careful. Do not overtighten the mountings nuts of the relay (M4 metric 4 mm). Check the torque by means of a torque wrench (1.7 Nm [15 In-lb]). Over-tightening the mounting nuts could cause personal injury or damage the relay.

Assembly Groups



WARNING

In line with the customer's requirement the devices are combined in a modular way (in compliance with the order code). In each of the slots an assembly-group may be integrated. In the following the terminal assignment of the individual assembly-groups are shown. The exact installation place of the individual modules can be learned from the connection diagram fixed at the top of your device.

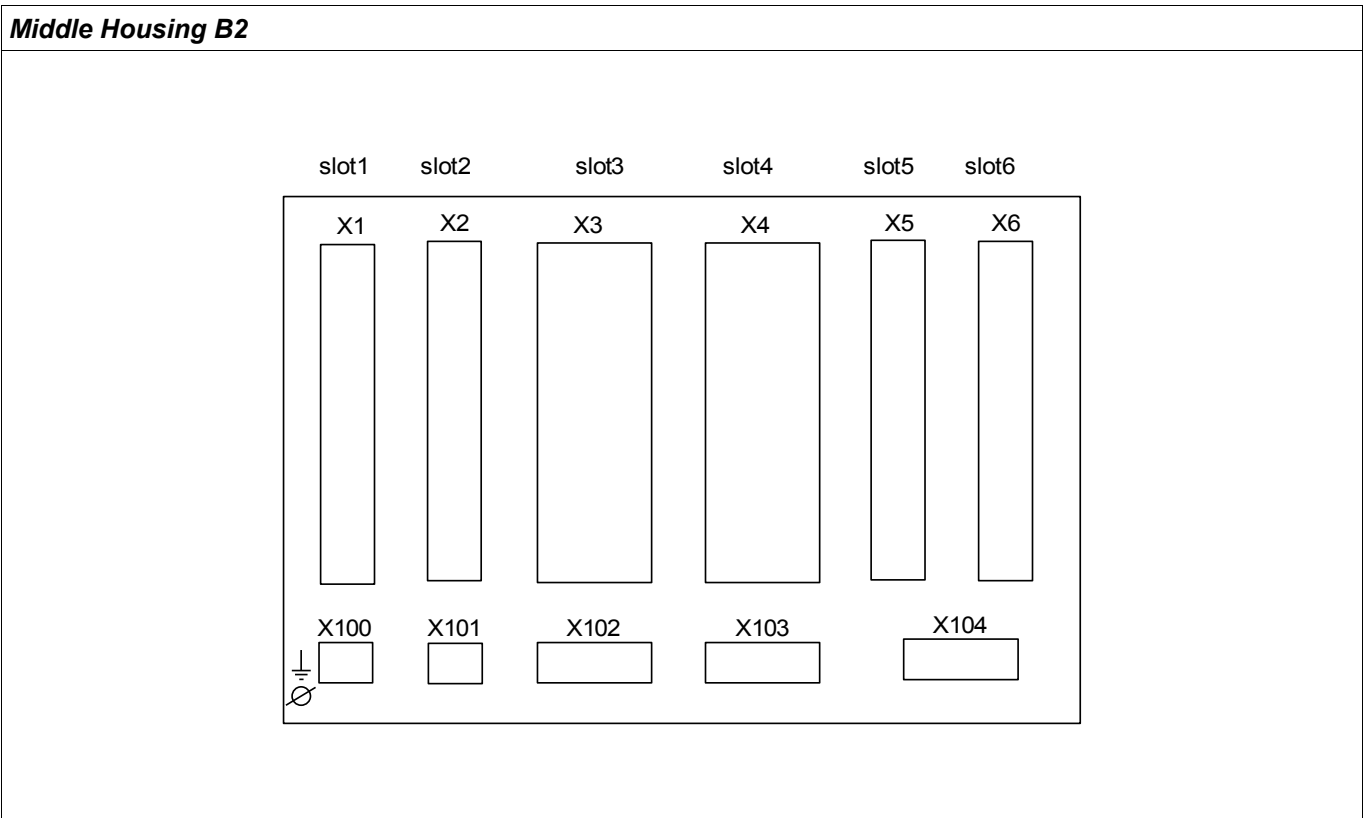

Rear view of B2 housing

Grounding

⚠ WARNING

The housing must be carefully grounded. Connect a ground cable (4 to 6 mm² [AWG 12-10], tightening torque 1.7 Nm [15 In-lb]) to the housing, using the screw that is marked with the ground symbol (at the rear side of the device).

Moreover, the power supply card needs a separate ground connection (2.5 mm² [AWG 14], tightening torque 0,56 – 0,79 Nm [5–7 lb•in]). See the “Terminal Marking” diagram in Section “DI-4 X – Power Supply and Digital Inputs” to check for the correct terminal.

CAUTION

The devices are very sensitive to electro-static discharges.

Legend for Wiring Diagrams

In this legend designations of various device types are listed, e. g. transformer protection, motor protection, generator protection, etc. Therefore it can occur that you will not find each designation on the wiring diagram of your device.

| Designation | Meaning |
|--------------|---|
| FE | Connection of functional earth |
| Power Supply | Connection for auxiliary power supply |
| I L1 | Phase current input L1 |
| I L2 | Phase current input L2 |
| I L3 | Phase current input L3 |
| IG | Earth current input IG |
| I L1 W1 | Phase current input L1, winding side 1 |
| I L2 W1 | Phase current input L2, winding side 1 |
| I L3 W1 | Phase current input L3, winding side 1 |
| I G W1 | Earth current input IG, winding side 1 |
| I L1 W2 | Phase current input L1, winding side 2 |
| I L2 W2 | Phase current input L2, winding side 2 |
| I L3 W2 | Phase current input L3, winding side 2 |
| I G W2 | Earth current input IG, winding side 2 |
| V L1 | Phase voltage L1 |
| V L2 | Phase voltage L2 |
| V L3 | Phase voltage L3 |
| V 12 | Phase to phase voltage V 12 |
| V 23 | Phase to phase voltage V 23 |
| V 31 | Phase to phase voltage V 31 |
| V X | Forth voltage measuring input for measuring residual voltage or for Synchro-check |
| BO | Contact output, change over contact |
| NO | Contact output, normally open |
| DI | Digital input |
| COM | Common connection of digital inputs |
| Out+ | Analog output + (0/4...20 mA or 0...10 V) |
| IN- | Analog input + (0/4...20 mA or 0...10 V) |
| N.C. | Not connected |
| DO NOT USE | Do not use |
| SC | Self supervision contact |
| GND | Ground |

| Designation | Meaning |
|--|--|
| HF SHIELD | Connection cable shield |
| Fibre Connection | Fibre optic connection |
| Only for use with external galvanic decoupled CTs. See chapter Current Transformers of the manual. | Only for use with external galvanic decoupled CTs. See chapter Current Transformers of the manual. |
| Caution Sensitive Current Inputs | Caution Sensitive Current Inputs |
| Connection Diagram see specification | Connection Diagram see specification |

Slot X1: Power Supply Card with Digital Inputs

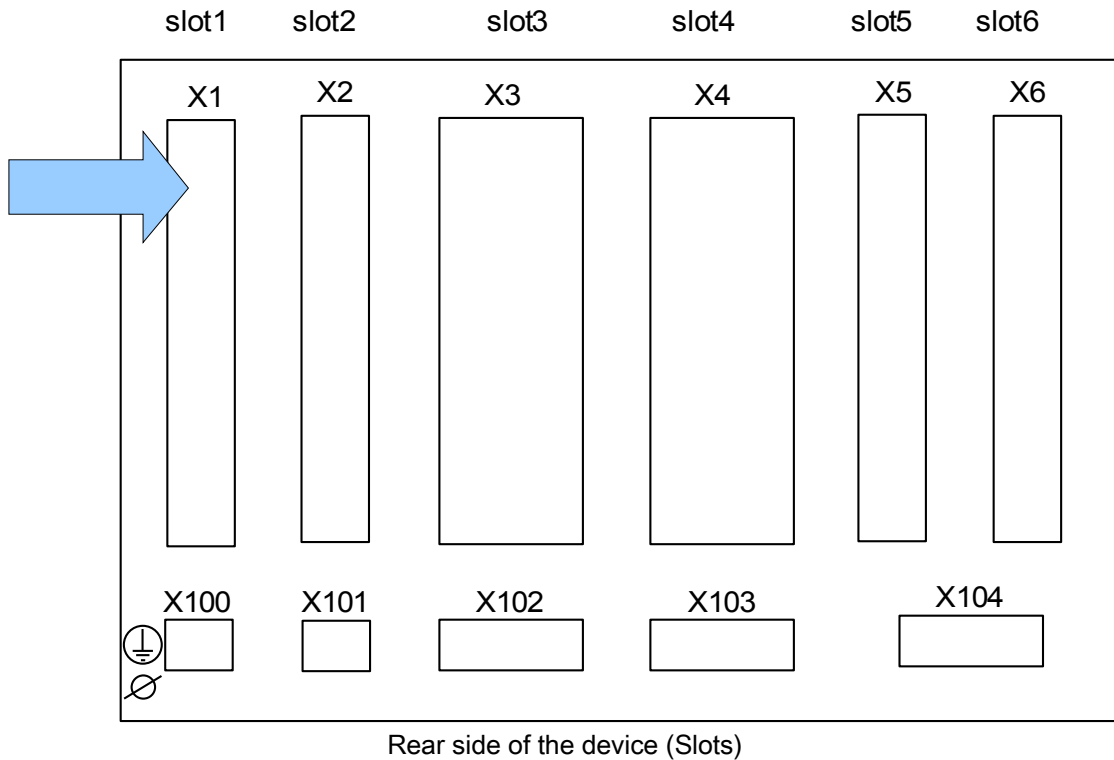

The type of power supply card and the number of digital inputs on it used in this slot is dependent on the ordered device type. The different variants have a different scope of functions.

Available assembly groups in this slot:

- **(DI8-X1):** This assembly group comprises a wide-range power supply unit; and two non-grouped digital inputs and six (6) digital inputs (grouped).

NOTICE The available combinations can be gathered from the ordering code.

DI8-X Power Supply and Digital Inputs

⚠ WARNING Ensure the correct tightening torques.

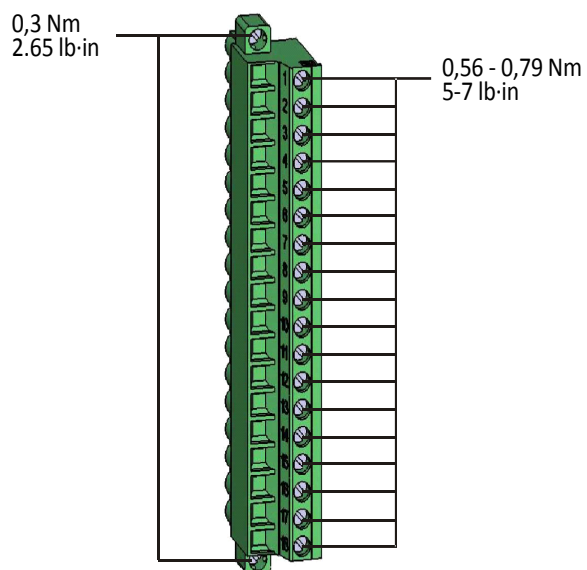

This assembly group comprises:

- a wide-range power supply unit
- 6 digital inputs, grouped
- 2 digital inputs, non-grouped
- Connector for the functional earth

Functional Earth



WARNING In addition to the grounding of the housing (see Chapter “Installation and Wiring”) there must be an additional ground cable connected to the power supply card (2.5 mm² [AWG 14], tightening torque 0,56 – 0,79 Nm [5–7 lb·in]).
Connect this ground cable to terminal No. 1, see the “Terminals” diagram below.

Auxiliary voltage supply

- The aux. voltage inputs (wide-range power supply unit) are non-polarized. The device could be provided with AC or DC voltage.

Digital inputs



CAUTION For each digital input group the related voltage input range has to be parameterized. Wrong switching thresholds can result in malfunctions/wrong signal transfer times.

The digital inputs are provided with different switching thresholds (can be parameterized) (two AC and five DC input ranges). For the six grouped (connected to common potential) inputs and the two non-grouped inputs the following switching levels can be defined:

- 24V DC
- 48V DC / 60V DC
- 110 V AC/DC
- 230 V AC/DC

If a voltage >80% of the set switching threshold is applied at the digital input, the state change is recognized (physically “1”). If the voltage is below 40% of the set switching threshold, the device detects physically “0”.



CAUTION When using DC supply, the negative potential has to be connected to the common terminal (COM1, COM2, COM3 - please see the terminal marking).

Terminals

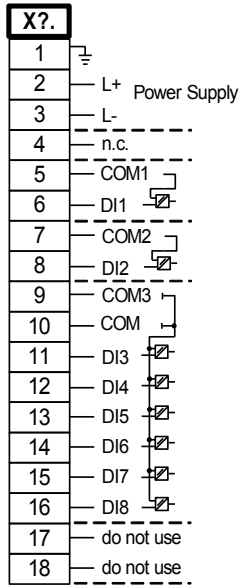

Electro-mechanical assignment

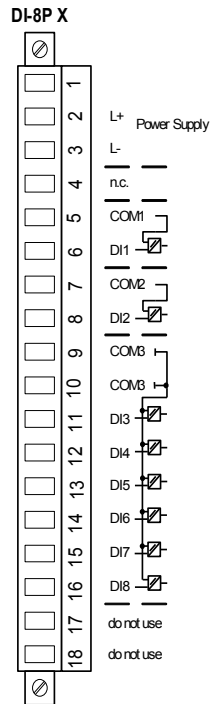

Slot X2: Relay Output Card

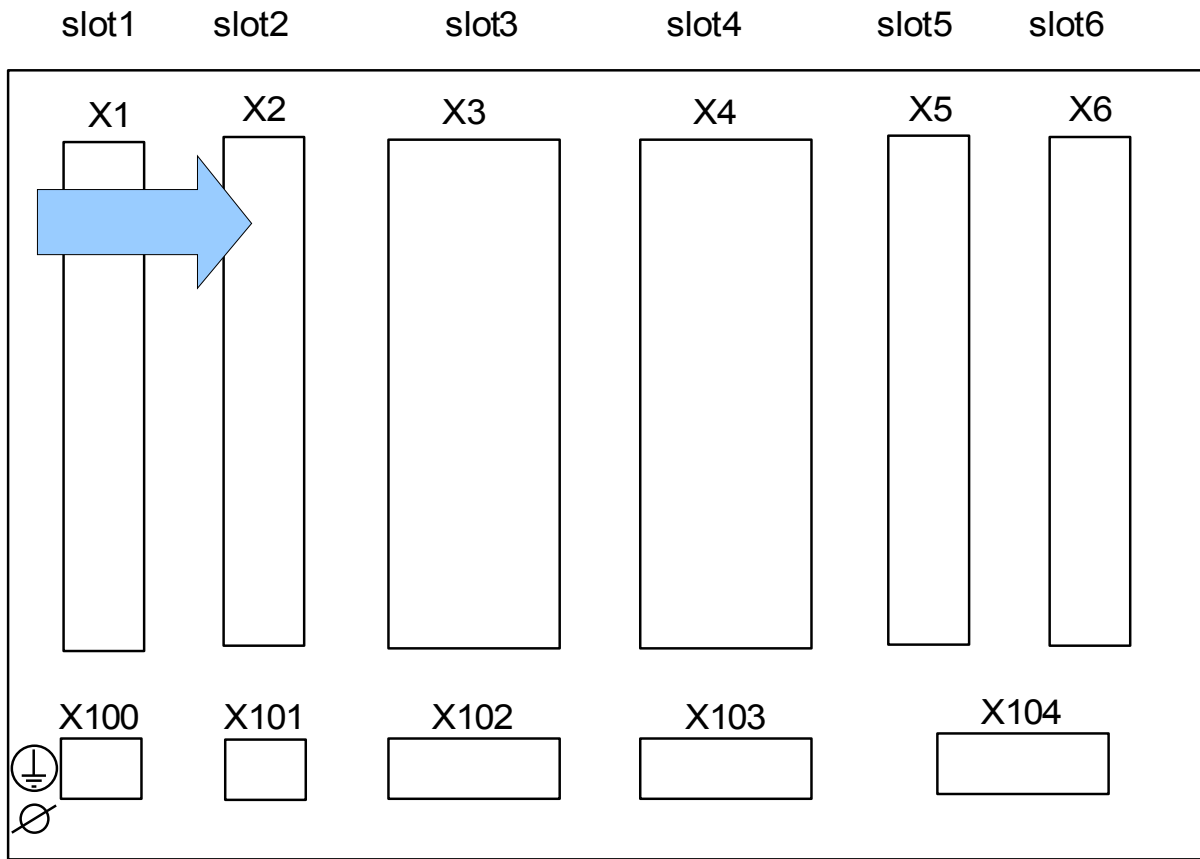

Rear side of the device (Slots)

The type of card in this slot is dependent on the ordered device type. The different variants have a different scope of functions.

Available assembly groups in this slot:

- **(RO-6 X2):** Assembly Group with 6 Relay Outputs.

NOTICE

The available combinations can be gathered from the ordering code.

Binary Output Relays

The number of the binary output relay contacts is related to the type of the device or type code. The binary output relays are potential-free change-over contacts. In chapter [Assignment/binary outputs] the assignment of the binary output relays is specified. The changeable signals are listed in the »assignment list« which can be found in the appendix.



WARNING Ensure the correct tightening torques.

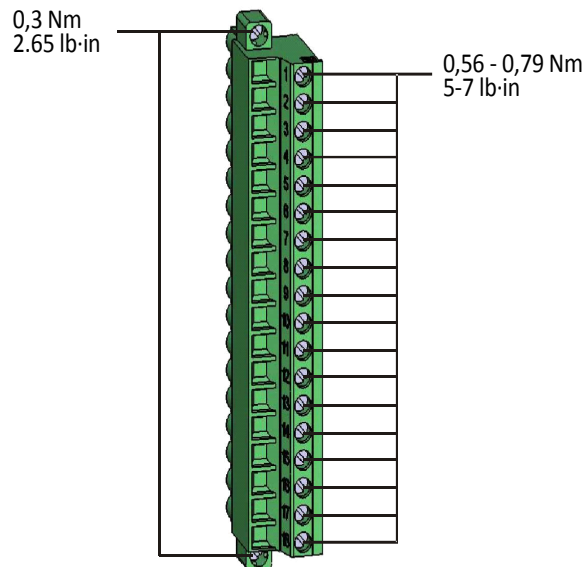

CAUTION

Please duly consider the current carrying capacity of the binary output relays.
Please refer to the Technical Data.

Terminals

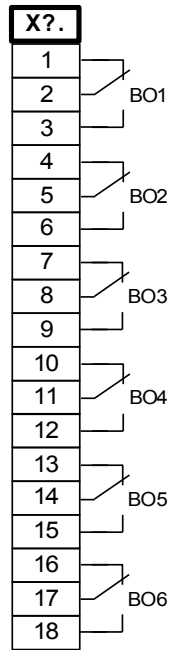

Electro-mechanical assignment

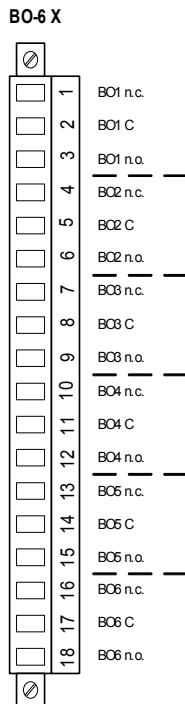

Slot X3: Current Transformer Measuring Inputs

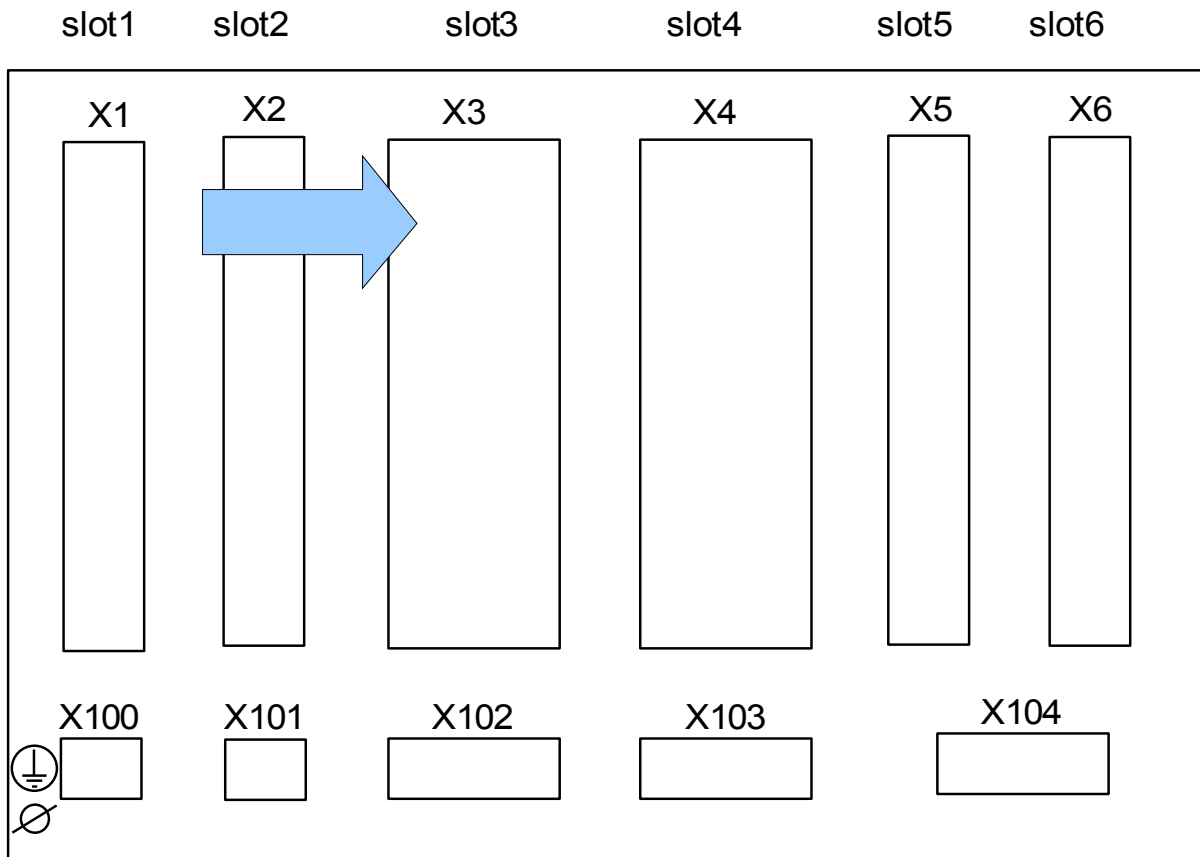

Rear side of the device (Slots)

This slot contains the current transformer measuring inputs. Depending on the order code, this might be a standard current measuring card or a sensitive ground current measuring card.

Available assembly groups in this slot:

- **(TI-4 X3):** Standard ground current measuring card.
- **(TIS-4 X3):** Sensitive Ground current measuring card. The Technical data of the sensitive ground measuring input deviate are different to the Technical Data of the phase current measuring inputs. Please refer to the Technical Data.

TI X- Standard Phase and Ground Current Measuring Input Card

This measuring card is provided with 4 current measuring inputs: three for measuring the phase currents and one for measuring of the earth current. Each of the current measuring inputs has a measuring input for 1 A and 5 A.

The input for earth current measuring either can be connected to a cable-type current transformer or alternatively it is possible to connect the summation current path of the phase current transformer to this input (Holmgreen connection).



Current transformers have to be earthed on their secondary side.



Interrupting the secondary circuits of current transformers causes hazardous voltages.

The secondary side of the current transformers have to be short circuited before the current circuit to the device is opened.



The current measuring inputs may exclusively be connected to current measuring transformers (with galvanic separation).



- Do not interchange the inputs (1 A/5 A)
- Make sure the transformation ratios and the power of the CTs are correctly rated. If the rating of the CTs is not right (overrated), then the normal operational conditions may not be recognized. The pickup value of the measuring unit amounts approx. 3% of the rated current of the device. Also the CTs need a current greater than approx 3% of the rated current to ensure sufficient accuracy. Example: For a 600 A CT (primary current) any currents below 18 A cannot be detected any more.
- Overloading can result in destruction of the measuring inputs or faulty signals. Overloading means that in case of a short-circuit the current-carrying capacity of the measuring inputs could be exceeded.



Ensure the correct tightening torques.

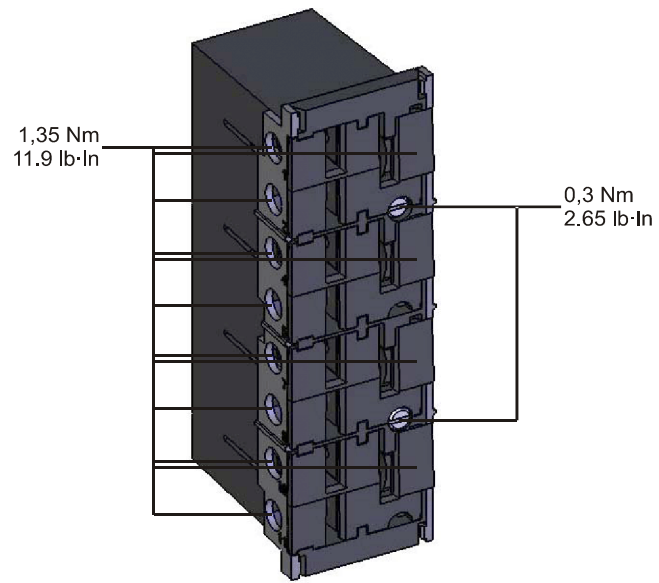

Terminals

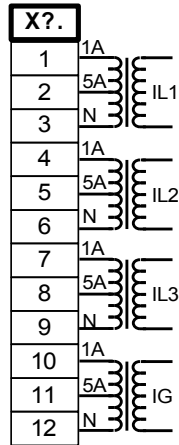

Electro-mechanical assignment

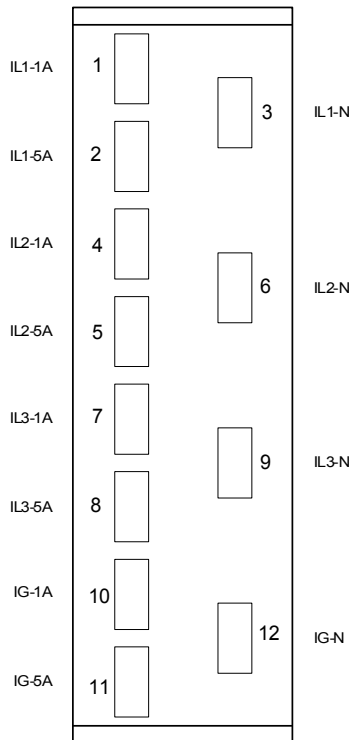

Current Transformers (CT)

Check the installation direction.



DANGER It is imperative that the secondary sides of measuring transformers be grounded.



DANGER The current measuring inputs may exclusively be connected to current measuring transformers (with galvanic separation).



WARNING CT secondary circuits must always to be low burdened or short-circuited during operation.

NOTICE

For current and voltage sensing function external wired and appropriate current and voltage transformer shall be used, based on the required input measurement ratings. Those devices provide the necessary insulation functionality.

All current measuring inputs can be provided with 1 A or 5 A nominal. Make sure that the wiring is correct.

Sensitive Ground Current Measurement

The proper use of sensitive current measuring inputs is the measurement of small currents like they could occur in isolated and high resistance grounded networks.

Due to the sensitiveness of these measuring inputs don't use them for the measurement of ground short circuit currents like they occur in solidly earthed networks.

If a sensitive measuring input should be used for the measurement of ground short circuit currents, it has to be ensured, that the measuring currents are transformed by a matching transformer according to the technical data of the protective device.

Current Transformer Connection Examples

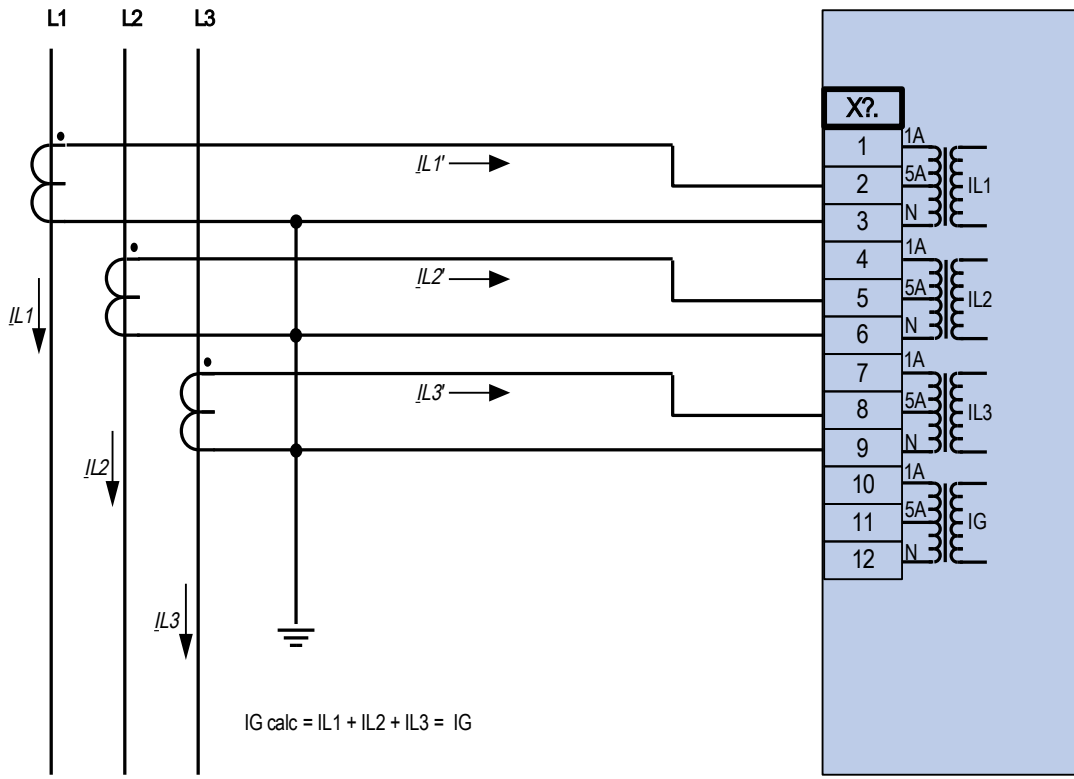

Three phase current measurement; In secondary = 5 A.

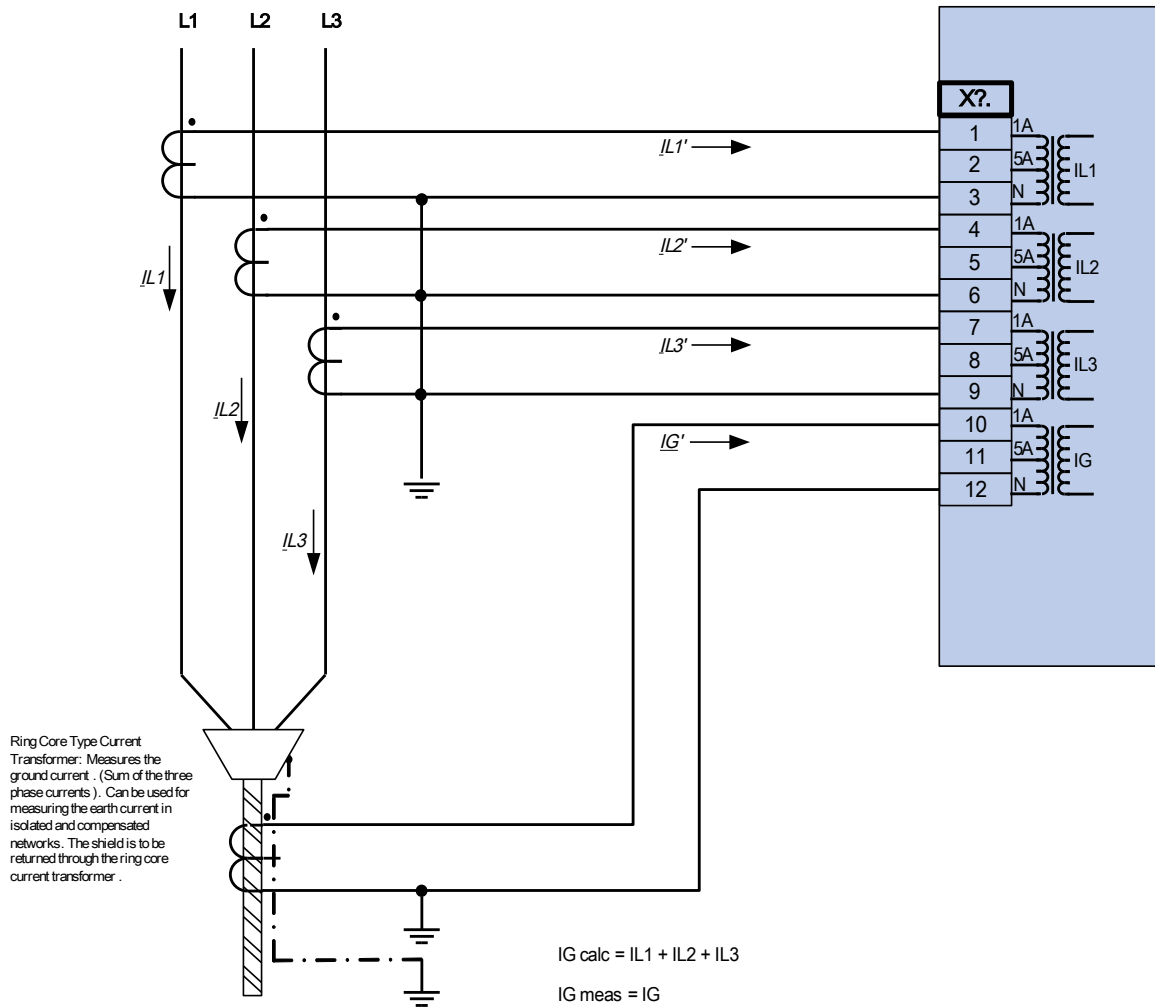

Three phase current measurement ; In secondary = 1 A.
 Earth-current measuring via cable-type current transformer ; IGnom secondary = 1 A.



Warning!
 The shielding at the dismantled end of the line has to be put through the cable -type current transformer and has to be grounded at the cable side .

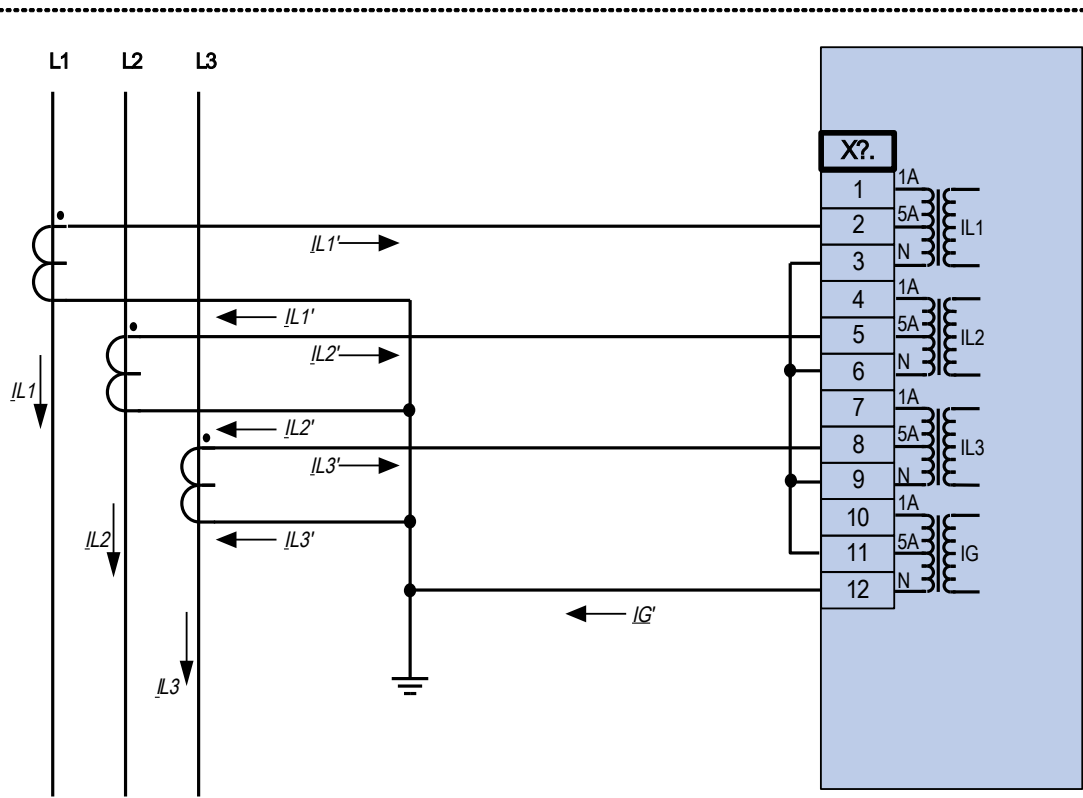

Three phase current measurement; I_n secondary = 5 A.
 Earth-current measuring via Holmgreen-connection; I_{Gnom} secondary = 5 A.

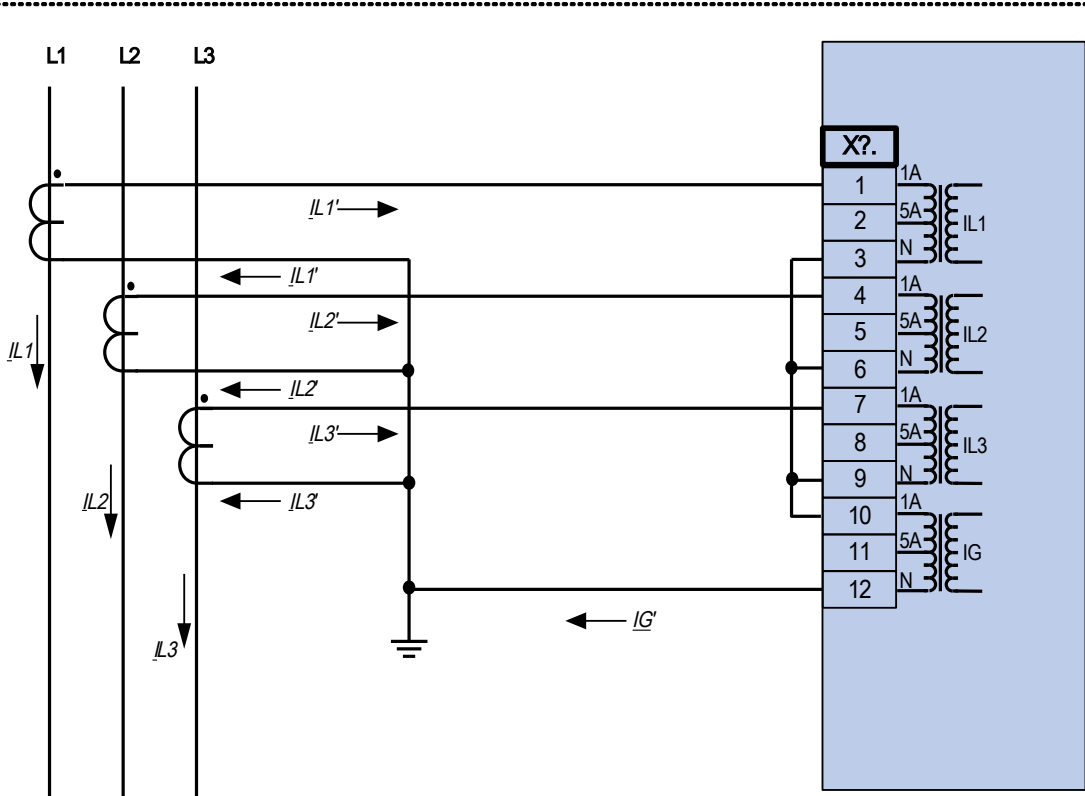

Three phase current measurement; I_n secondary = 1 A.
 Earth-current measuring via Holmgren-connection; I_{Gnom} secondary = 1 A.

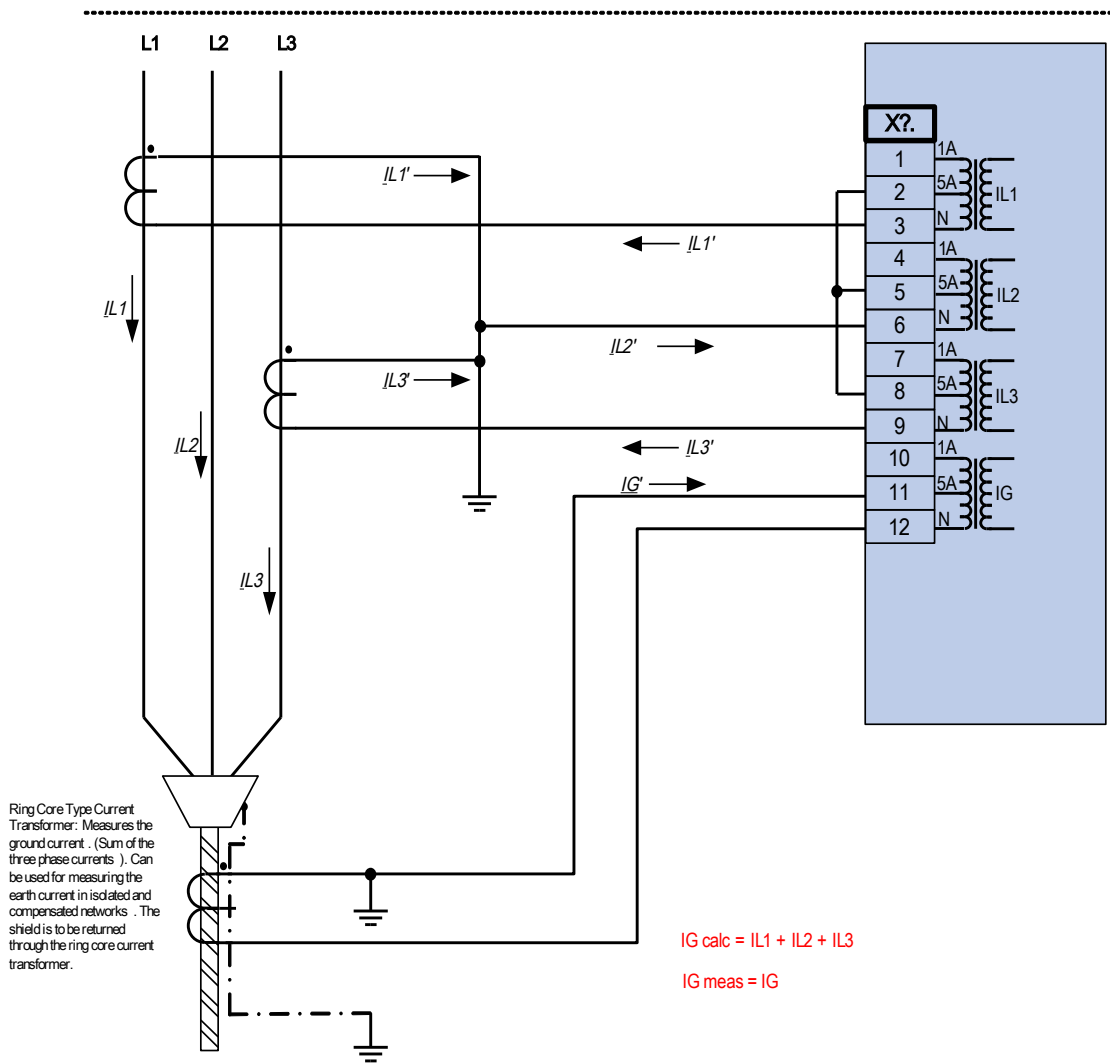

Two phase current measurement (Open Delta); In secondary = 5 A.
 Earth-current measuring via cable-type current transformer ; IGnom secondary = 5 A.



Warning! The shielding at the dismantled end of the line has to be put through the cable -type current transformer and has to be grounded at the cable side .

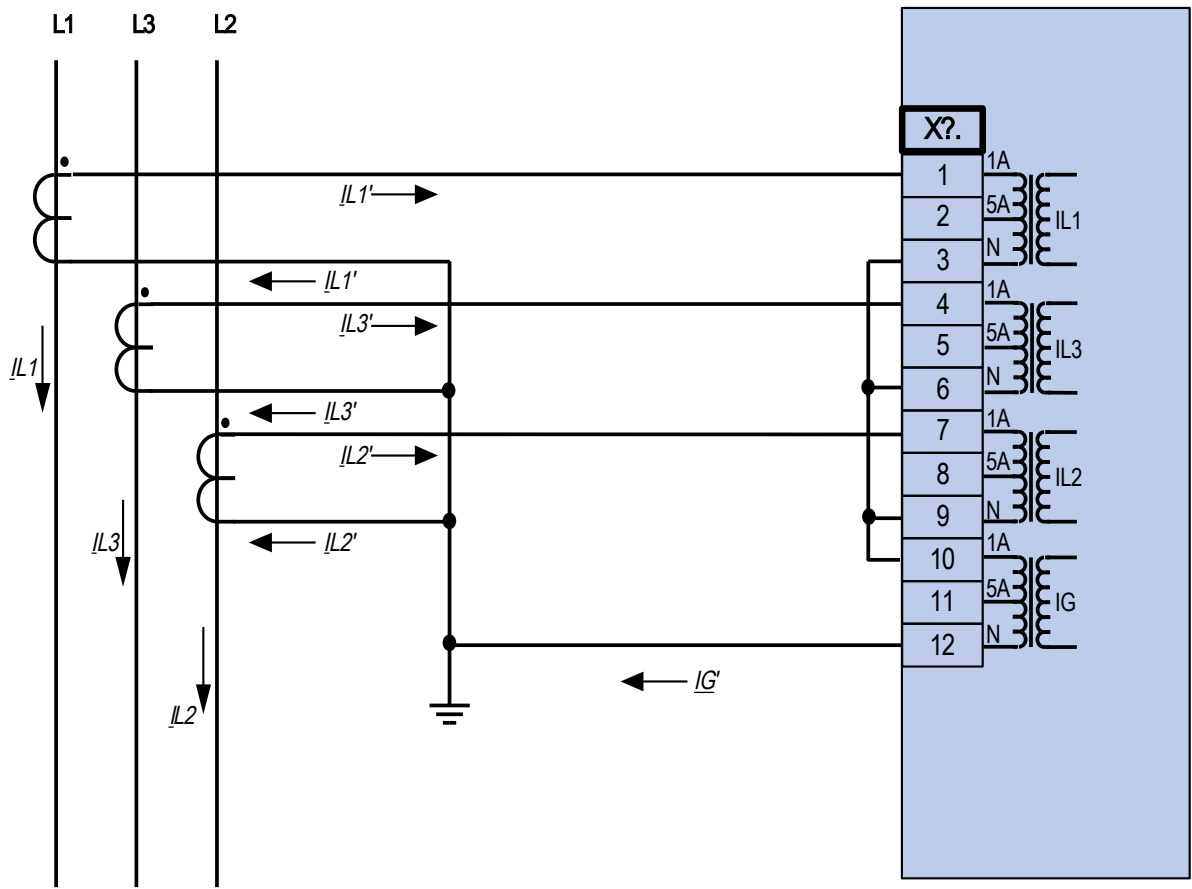

Three phase current measurement; I_n secondary = 1 A.

Earth-current measuring via Holmgreen-connection; I_{Gnom} secondary = 1 A.

Slot X4: Voltage Transformer Measuring Inputs

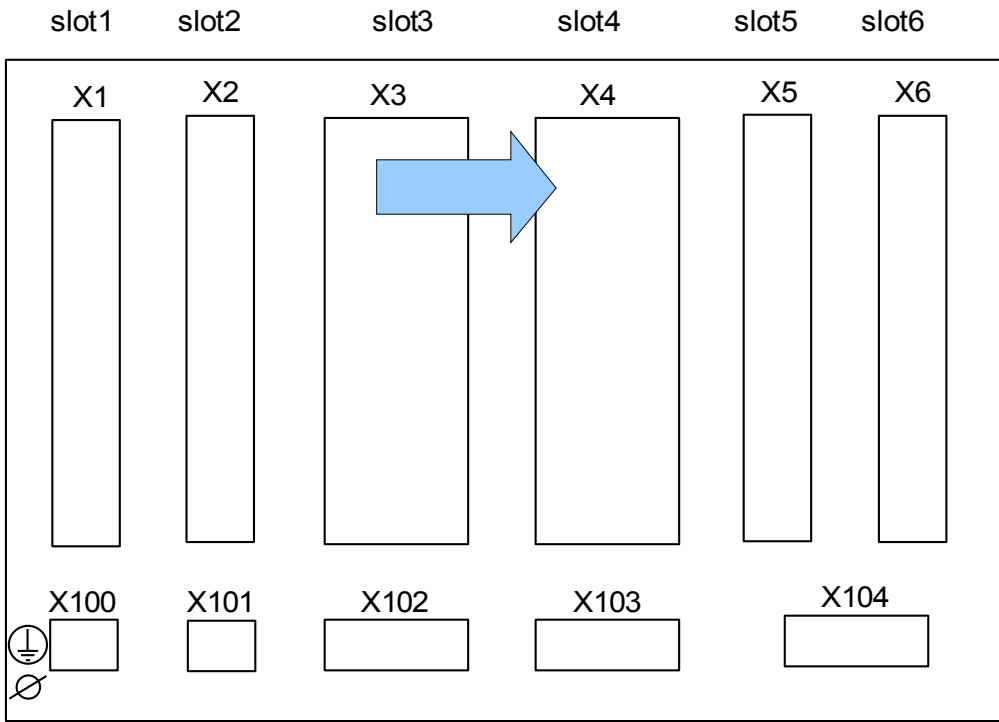

Rear side of the device (Slots)

This slot contains the voltage transformer measuring inputs.

Voltage Measuring Inputs

The device is provided with 4 voltage measuring inputs: three for measuring the phase-to-phase voltages (»V12«, »V23«, »V31«) or phase-to-neutral voltages (»VL1«, »VL2«, »VL3«) and one for the measuring of the residual voltage »VE«. With the field parameters the correct connection of the voltage measuring inputs has to be set:

- phase-to-neutral (star)
- phase-to-phase (Open Delta respectively V-Connection)

⚠ WARNING Ensure the correct tightening torques.

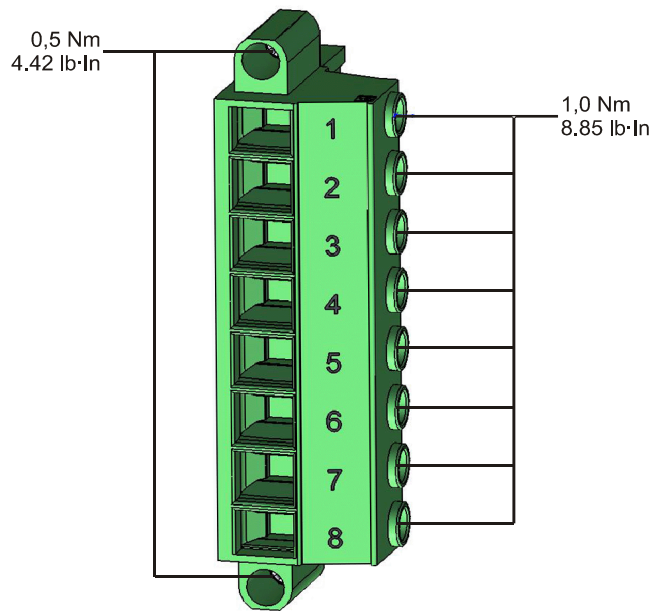

CAUTION The rotating field of your power supply system has to be taken in to account. Make sure that the transformer is wired correctly.

For the V-connection the parameter »VT con« has to be set to »phase-to-phase«.

Please refer to the Technical Data.

Terminals

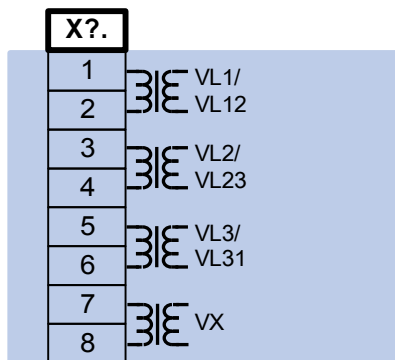

Electro-mechanical assignment

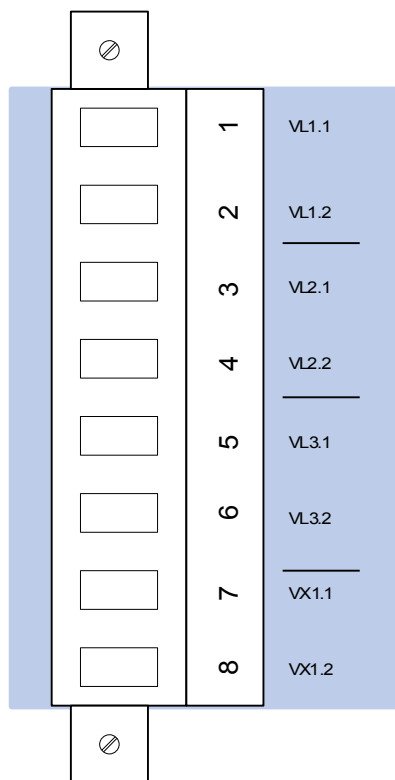

Voltage Transformers

Check the installation direction of the VTs.

⚠ DANGER

It is imperative that the secondary sides of measuring transformers be grounded.

NOTICE

For current and voltage sensing function external wired and appropriate current and voltage transformer shall be used, based on the required input measurement ratings. Those devices provide the necessary insulation functionality.

Check of the Voltage Measuring Values

Connect a three-phase measuring voltage equal to the rated voltage to the relay.

NOTICE

Take connection of the measuring transformers (star connection/open delta connection) duly into account.

Now adjust voltage values in the nominal voltage range with the corresponding nominal frequency which are not likely to cause overvoltage- or undervoltage trips.

Compare the values shown in the device display with the readings of the measuring instruments. The deviation must be according to the technical data.

NOTICE

When r.m.s. value measuring instruments are used, higher deviations can arise if the fed voltage has a very high harmonic content. Since the device is provided with a filter for the harmonics, only the fundamental oscillation is evaluated (exception: thermal protection functions). If, however, a r.m.s. value forming measuring instrument is used, the harmonics are also measured.

Wiring Examples of the Voltage Transformers

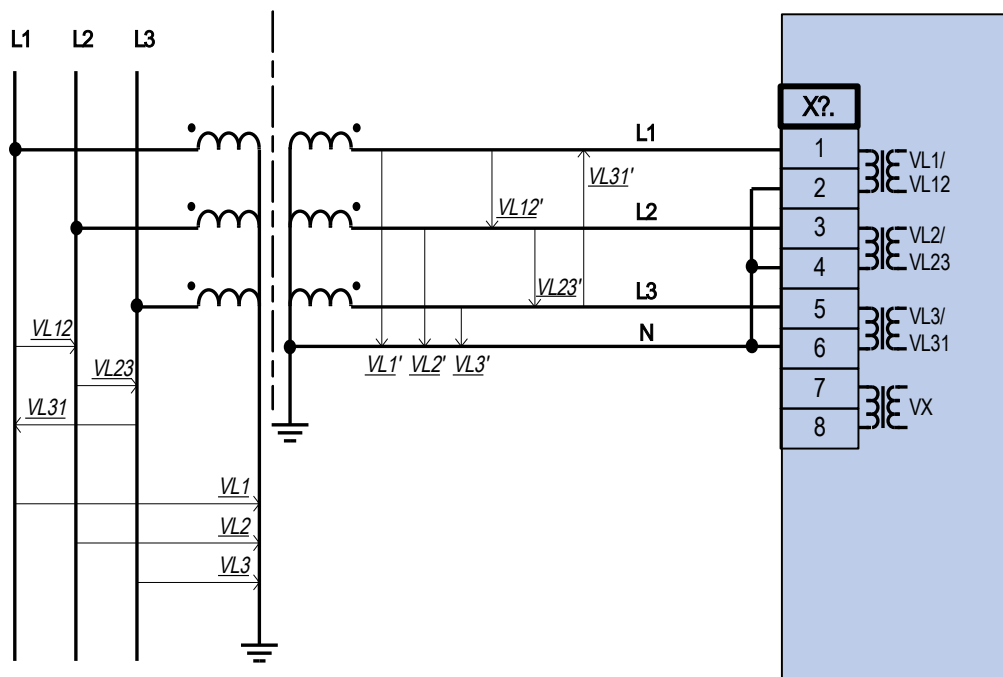

Three-phase voltage measurement - wiring of the measurement inputs : "star-connection"

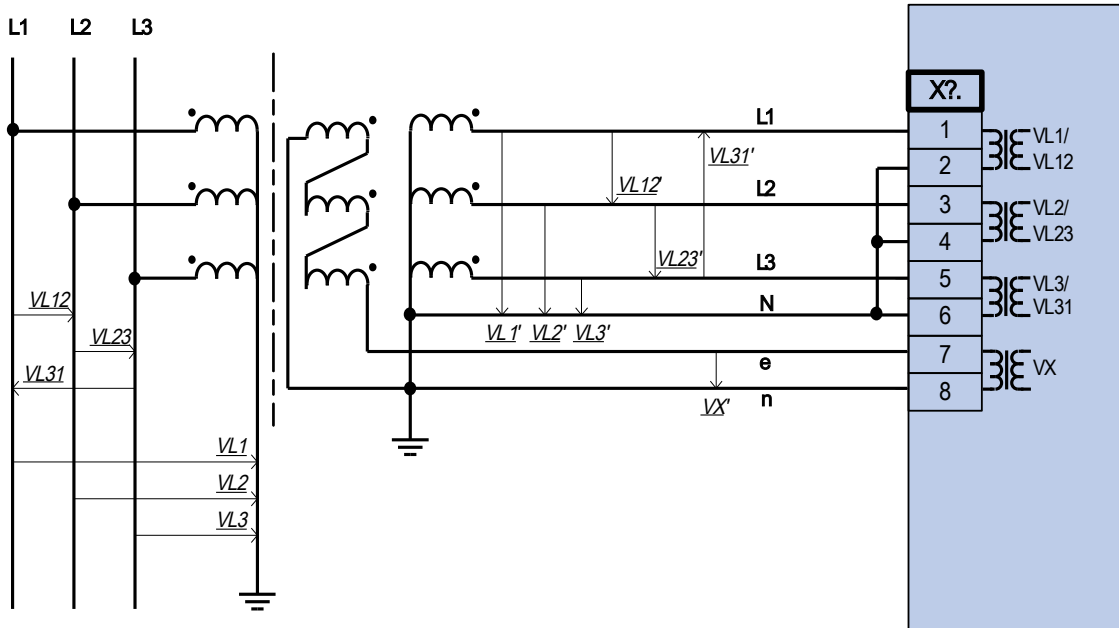

Three-phase voltage measurement - wiring of the measurement inputs: "star-connection"
 Measurement of the residual voltage VG via auxilliary windings (e-n) "broken delta"

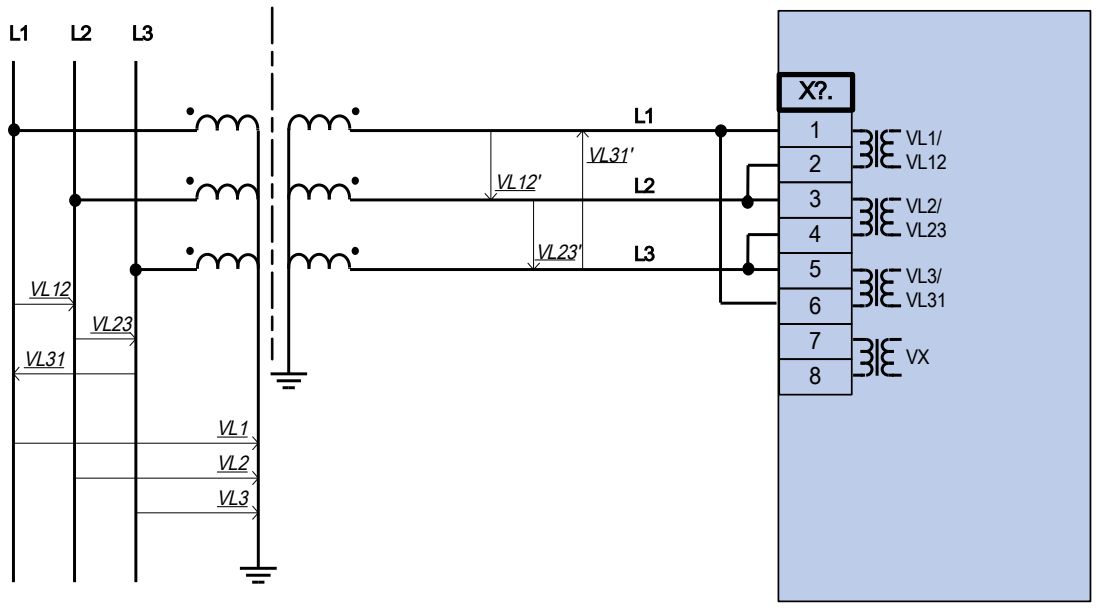

Three-phase voltage measurement - wiring of the measurement inputs : "delta-connection"



Notice!
Calculation of the residual voltage VG is not possible

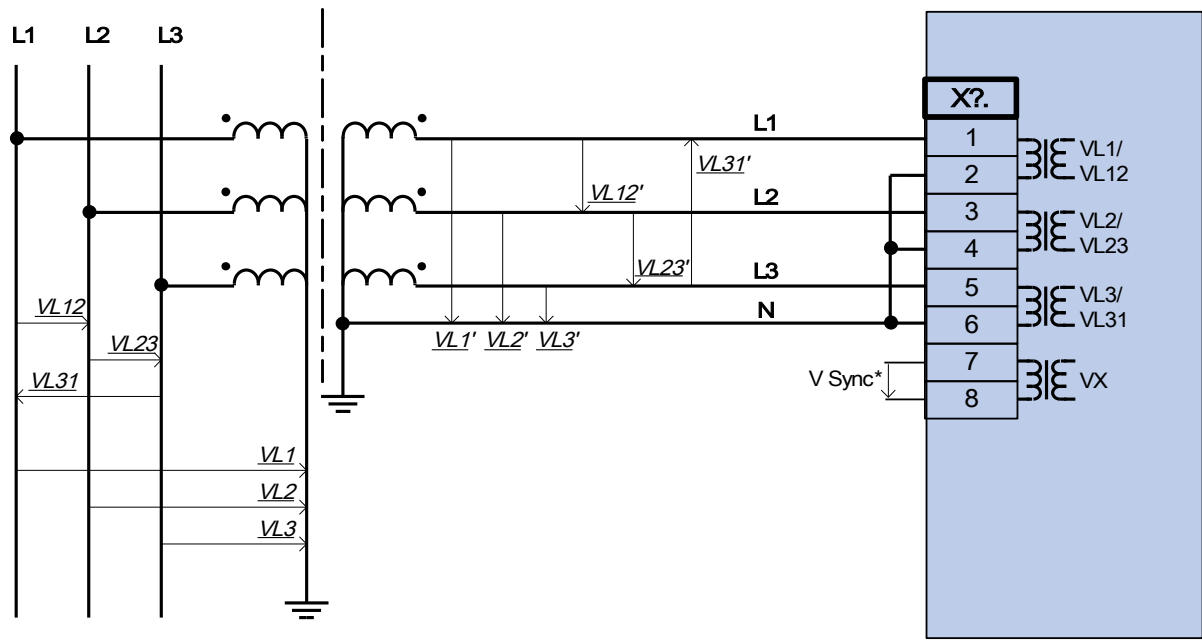

= Availability dependent on device type

Three-phase voltage measurement - wiring of the measurement inputs : "star-connection".
 Fourth measuring input for measuring a synchronisation voltage .

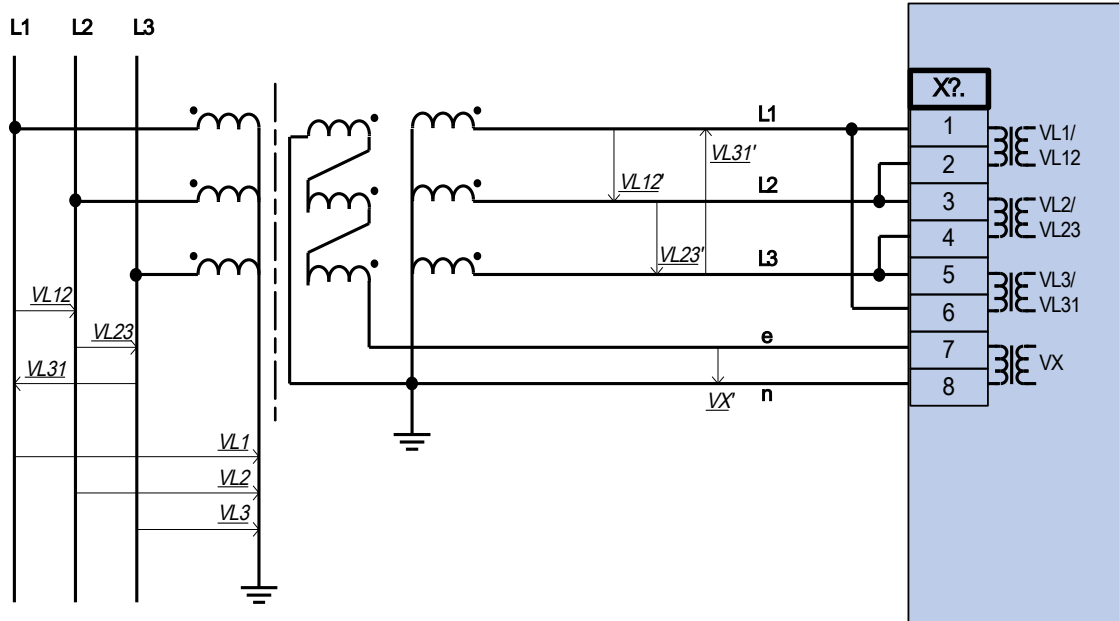

Three-phase voltage measurement - wiring of the measurement inputs : "delta-connection"
 Measurement of the residual voltage VG via auxilliary windings (e-n) "broken delta"

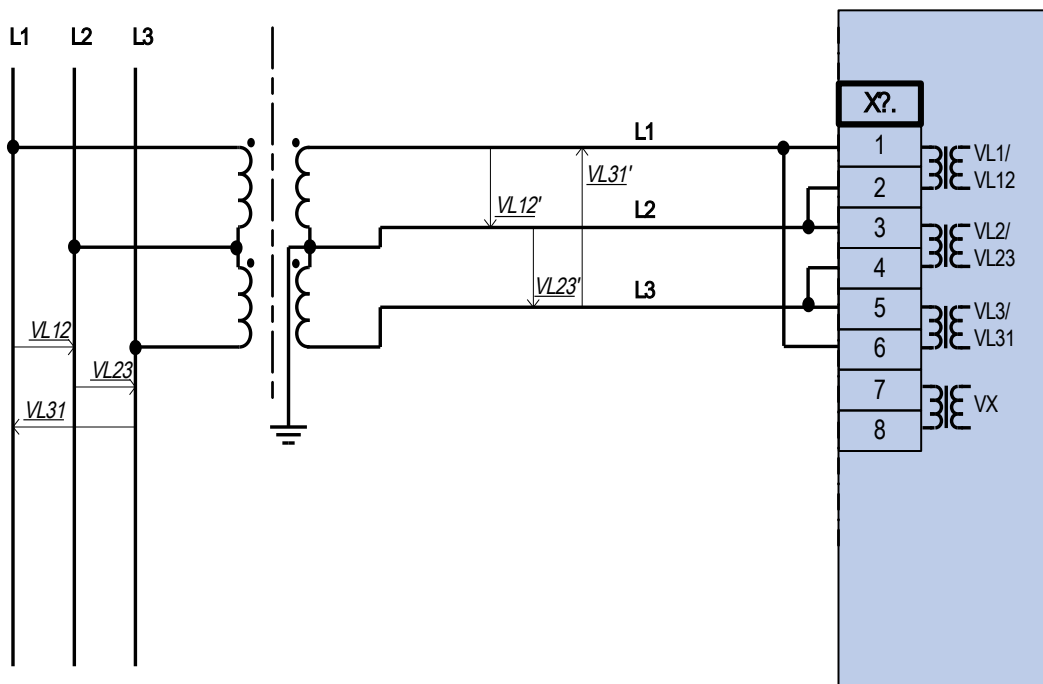

Two-phase voltage measurement - wiring of the measuring inputs: "Open Delta"

Slot X5: Relay Output Card

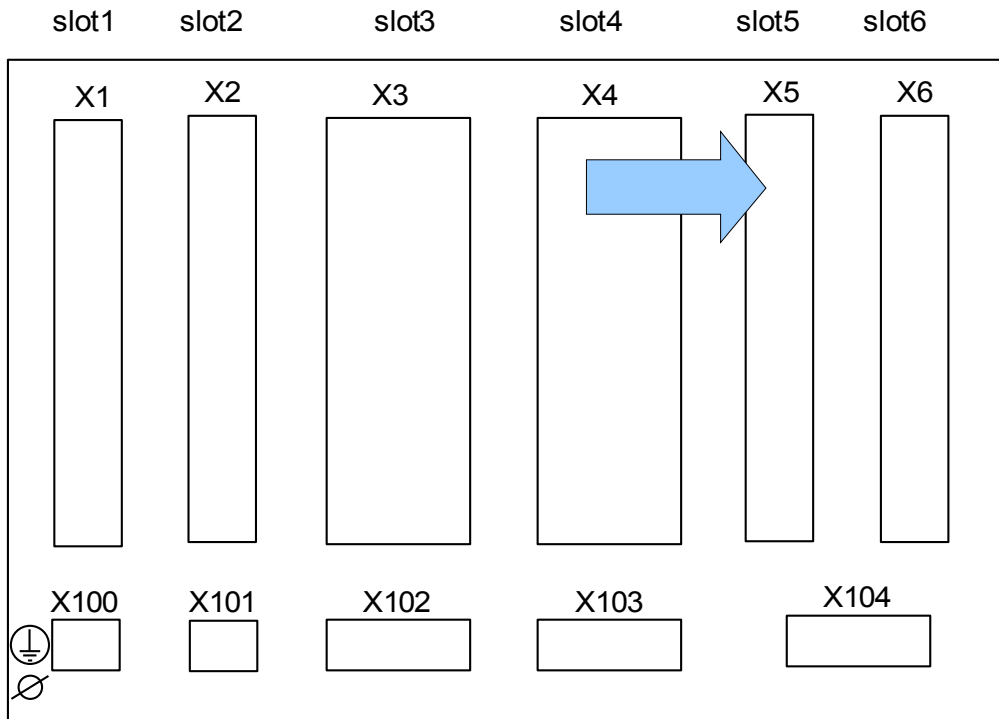

Rear side of the device (Slots)

The type of card in this slot is dependent on the ordered device type. The different variants have a different scope of functions.

Available assembly groups in this slot:

- **(RO-6 X5):** Assembly Group with 6 Relay Outputs. The Relay Output Card is identical with the one on Slot X2.

NOTICE The available combinations can be gathered from the ordering code.

Slot X6: Digital Inputs

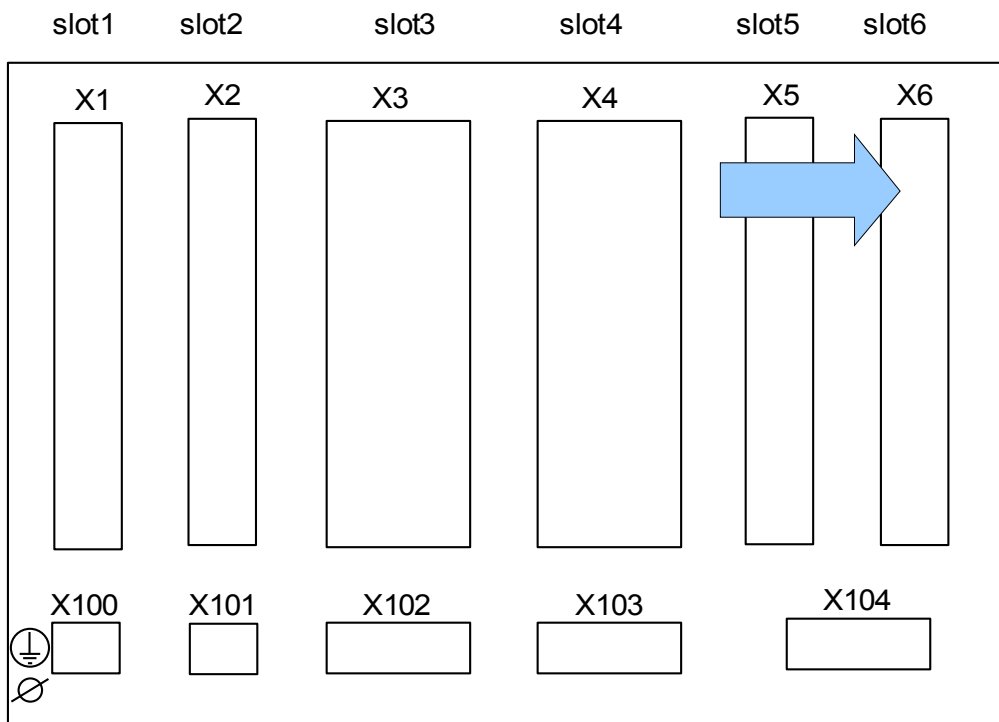

Rear side of the device (Slots)

The type of card in this slot is dependent on the ordered device type. The different variants have a different scope of functions.

Available assembly groups in this slot:

- **(DI-8 X6):** Assembly Group with 8 Digital Inputs.

NOTICE The available combinations can be gathered from the ordering code.

Digital Inputs

This module is provided with 8 grouped digital inputs.
In chapter [Device parameter/Digital Inputs] the assignment of the digital inputs is specified.

WARNING Ensure the correct tightening torques.

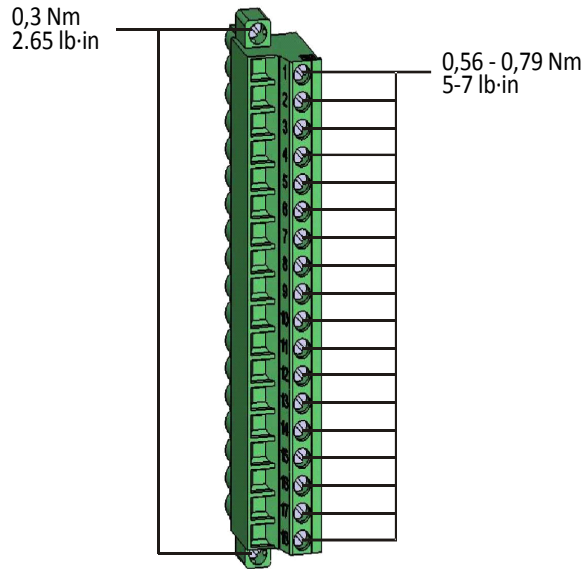

CAUTION When using DC supply, the negative potential has to be connected to the common terminal (COM1, COM2, COM3 - please see the terminal marking).

CAUTION For each digital input group the related voltage input range has to be parameterized. Wrong switching thresholds can result in malfunctions/wrong signal transfer times.

NOTICE Via the »assignment list« the states of the digital inputs are assigned to the module inputs (e.g. I[1]).

The digital inputs are provided with different switching thresholds (can be parameterized) (two AC and five DC input ranges). For each group the following switching thresholds can be defined:

- 24V DC
- 48V DC / 60V DC
- 110 V AC/DC
- 230 V AC/DC

If a voltage >80% of the set switching threshold is applied at the digital input, the state change is recognized (physically "1"). If the voltage is below 40% of the set switching threshold, the device detects physically "0".

Terminal Marking

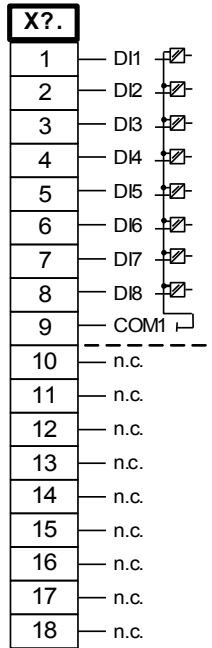

Electro-mechanical assignment

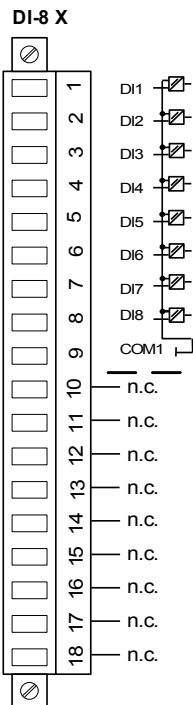

Slot X100: Ethernet Interface

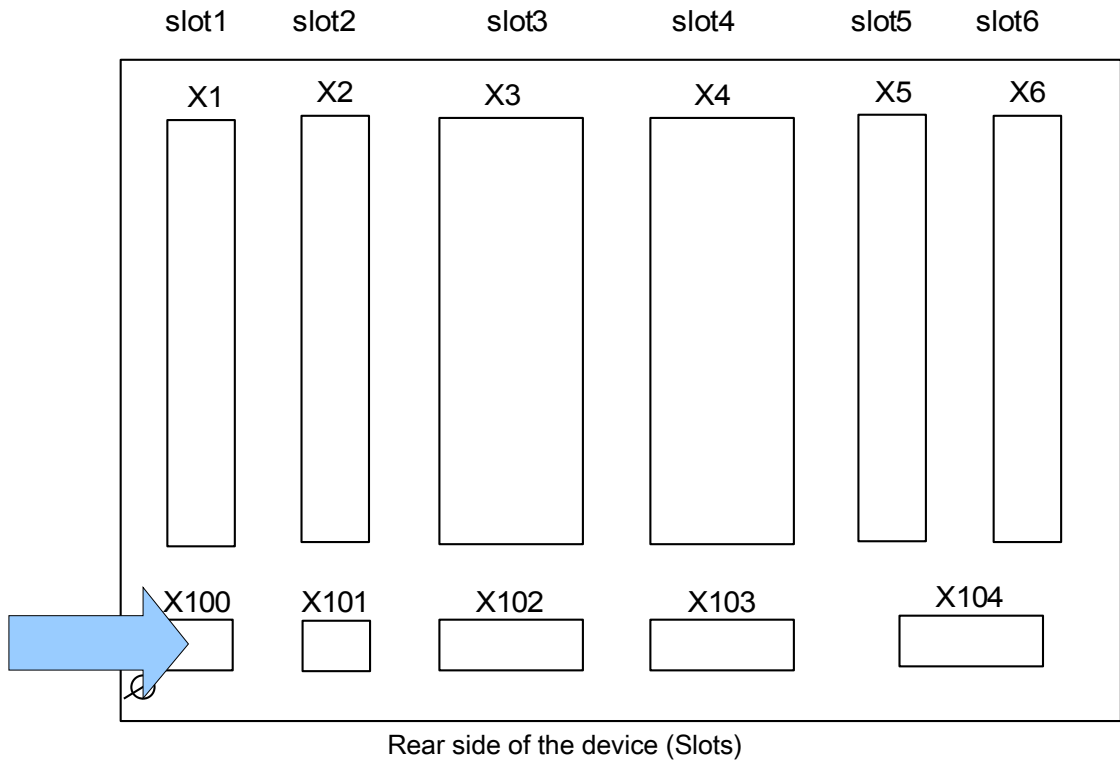

An Ethernet interface may be available depending on the device type ordered.

NOTICE The available combinations can be gathered from the ordering code.

Ethernet - RJ45

Terminals

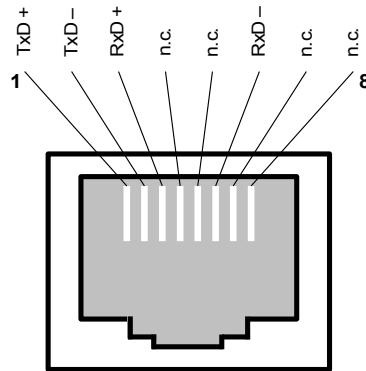

Slot X103: Data Communication

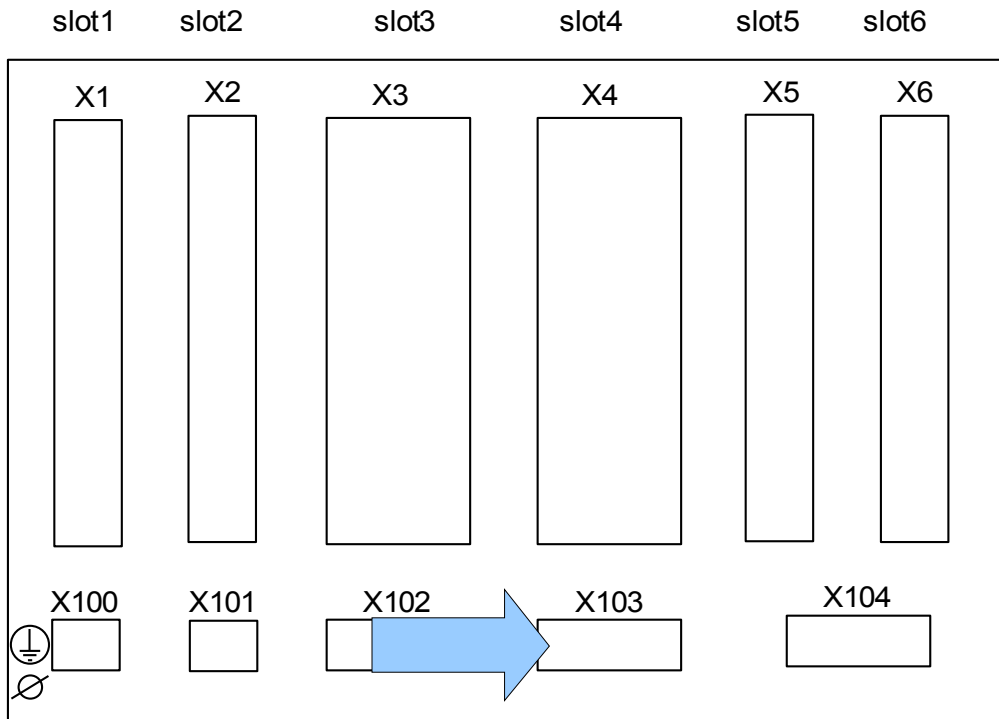

Rear side of the device (Slots)

The data communication interface in the **X103** slot is dependent on the ordered device type. The scope of functions is dependent on the type of data communication interface.

Available assembly groups in this slot:

- RS485 Terminals for Modbus, DNP and IEC
- Fiber Optics Interface for Modbus, DNP and IEC
- Fiber Optics Interface for Profibus
- D-SUB Interface for Modbus, DNP and IEC
- D-SUB Interface for Profibus
- Fiber Optics Interface for Ethernet

NOTICE The available combinations can be gathered from the ordering code.

Modbus® RTU / IEC 60870-5-103 via RS485



WARNING There are two different versions of the RS485 interface. By means of the wiring diagram on the top of your device, you have to find out which version is built in your device (Type1 or Type2).



WARNING Ensure the correct tightening torques.

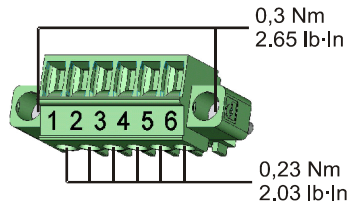

RS485 – Type 1 (see wiring diagram)

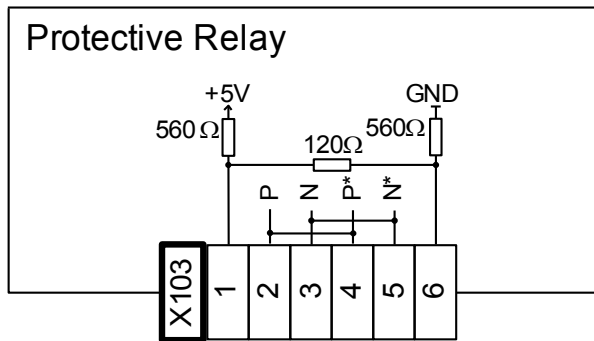

Electro-mechanical assignment Type 1 (see wiring diagram)

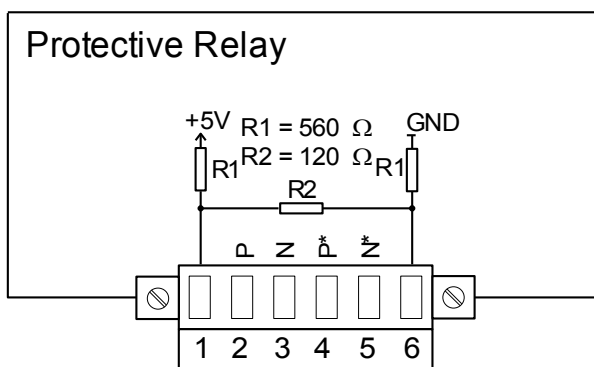

NOTICE The Modbus® / IEC 60870-5-103 connection cable must be shielded. The shielding has to be fixed at the screw which is marked with the ground symbol at the rear side of the device.

The communication is Halfduplex.

Type 1 Wiring example, Device in the Middle of the BUS

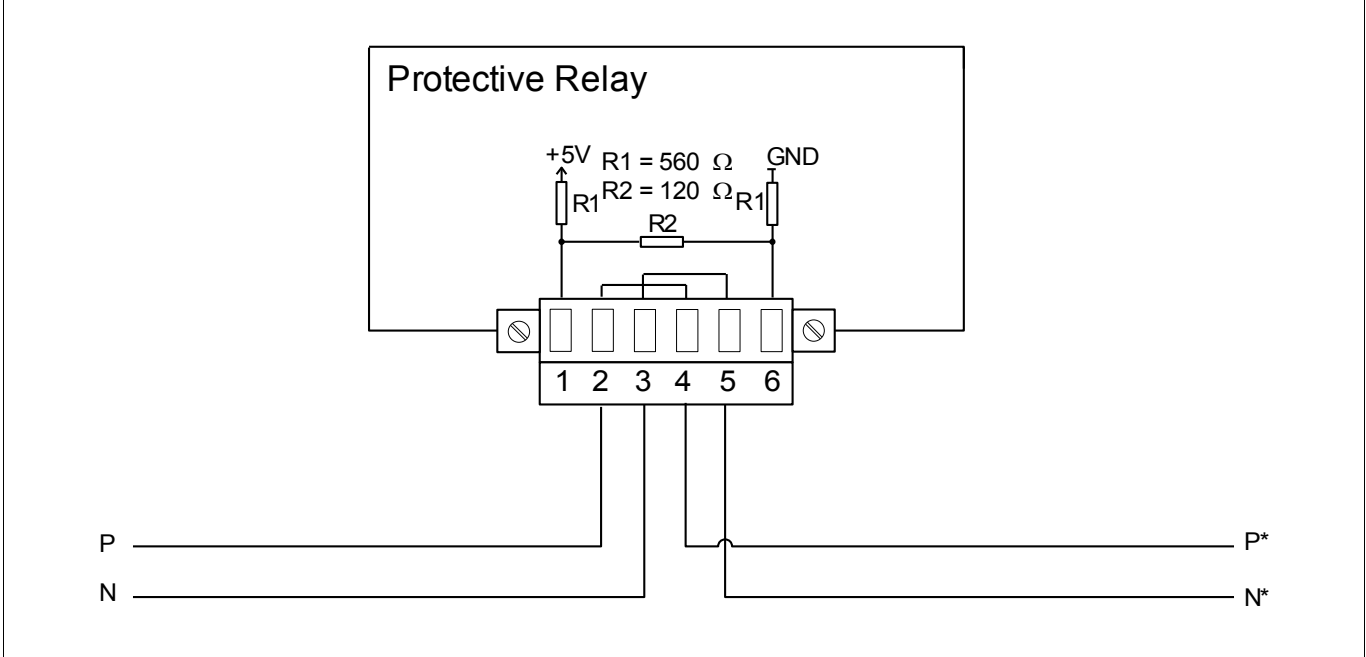

Type 1 Wiring example, Device at the End of the BUS (using the integrated Terminal Resistor)

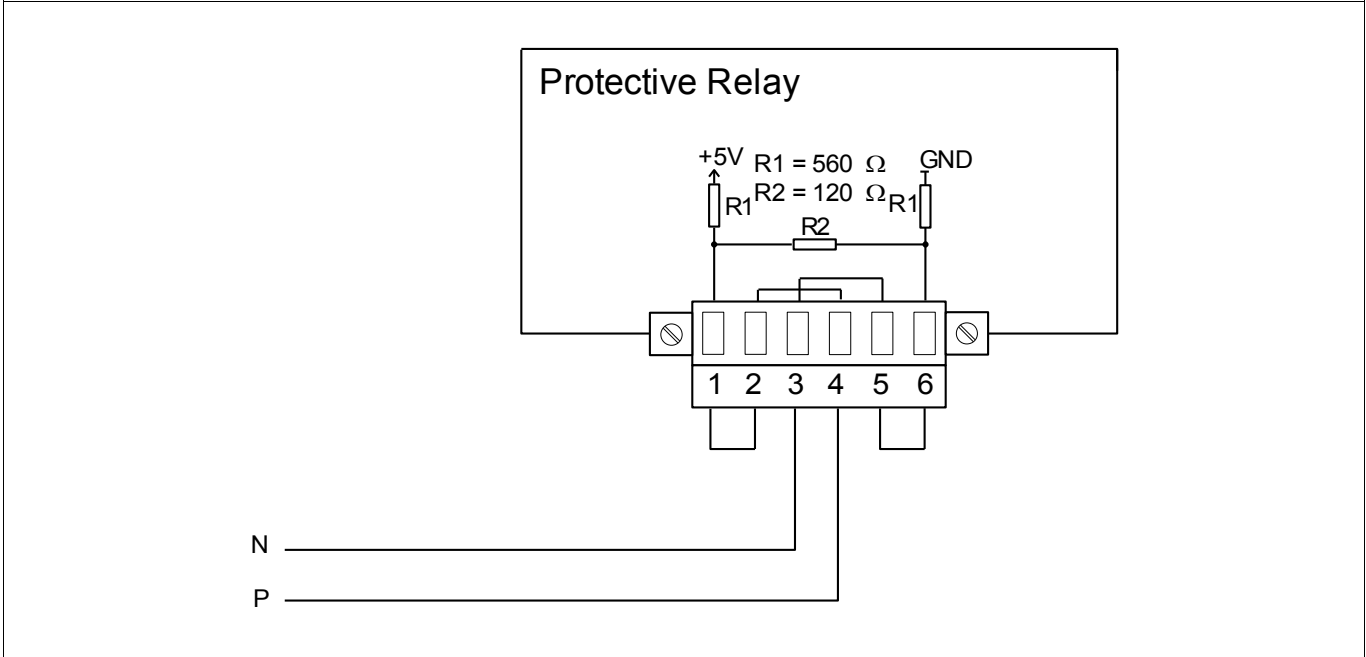



WARNING

There are two different versions of the RS485 interface. By means of the wiring diagram on the top of your device, you have to find out which version is built in your device (Type1 or Type2).



WARNING

Ensure the correct tightening torques.

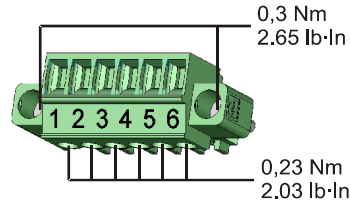

RS485 – Type 2 (see wiring diagram)

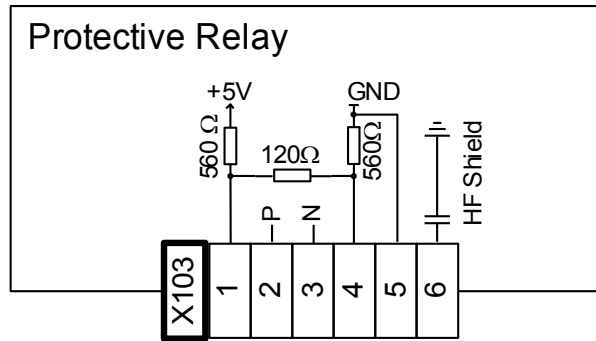

Electro-mechanical assignment Type 2 (see wiring diagram)

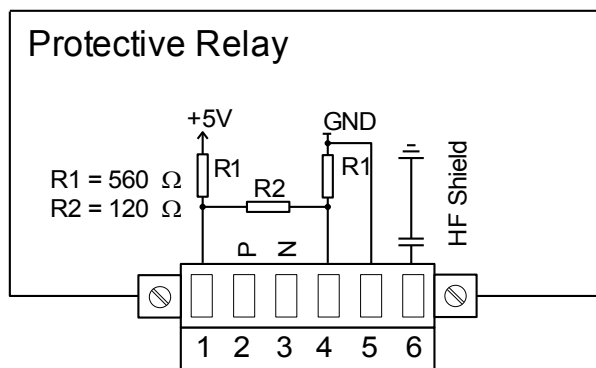

NOTICE

The Modbus® / IEC 60870-5-103 connection cable must be shielded. The shielding has to be fixed at the screw beneath the interface at the rear side of the device.

The communication is Halfduplex.

Type 2 Wiring example, Device in the Middle of the BUS

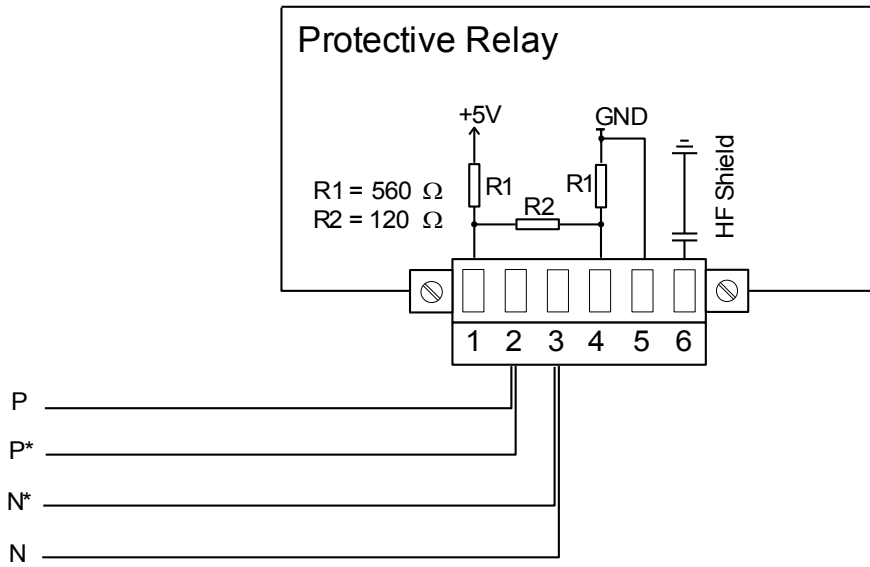

Type 2 Wiring example, Device at the End of the BUS (using the integrated Terminal Resistor)

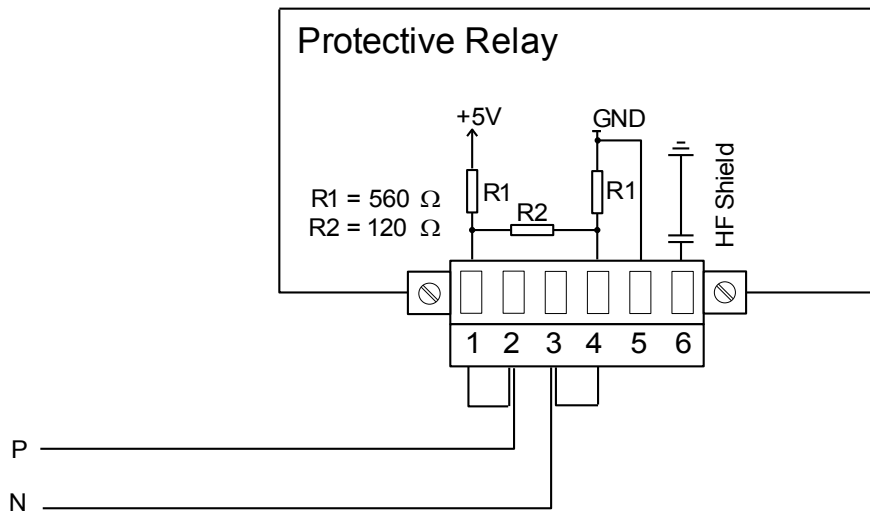

Type 2 Shielding Options (2-wire + Shield)

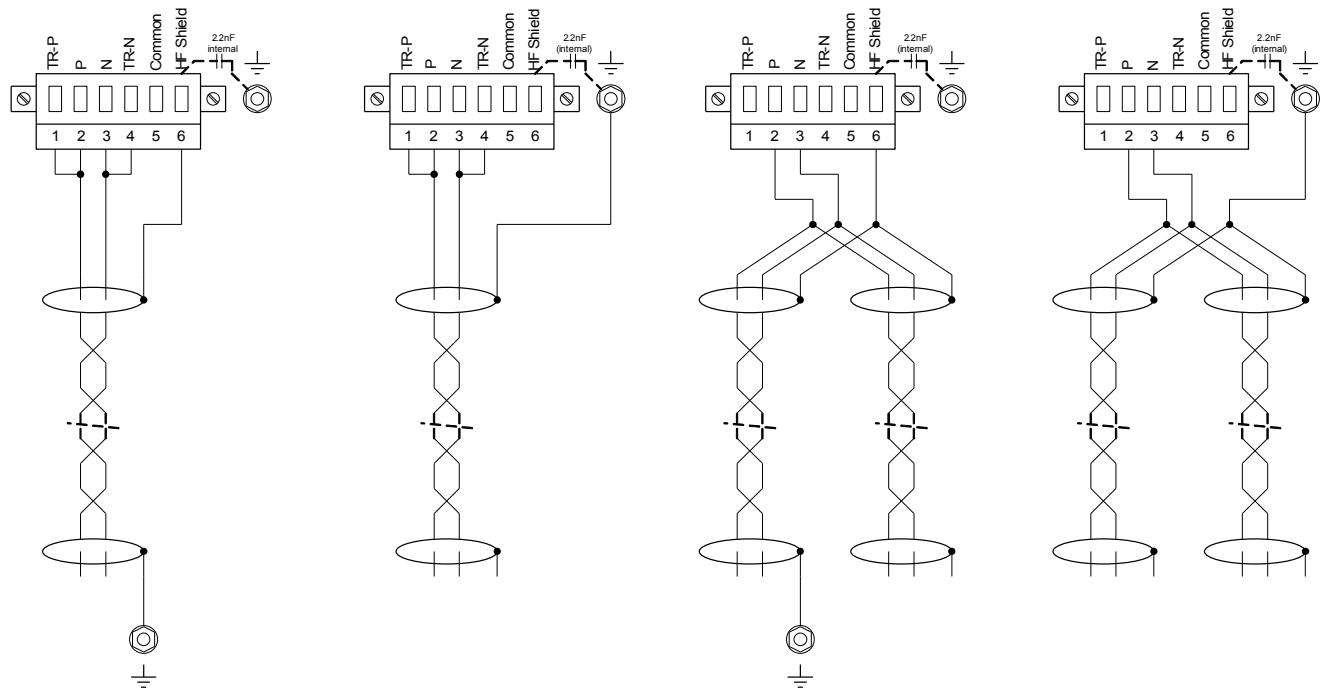

Shield at bus master side connected to earth termination resistors used

Shield at bus device side connected to earth termination resistors used

Shield at bus master side connected to earth termination resistors not used

Shield at bus device side connected to earth termination resistors not used

Type 2 Shielding Options (3-wire + Shield)

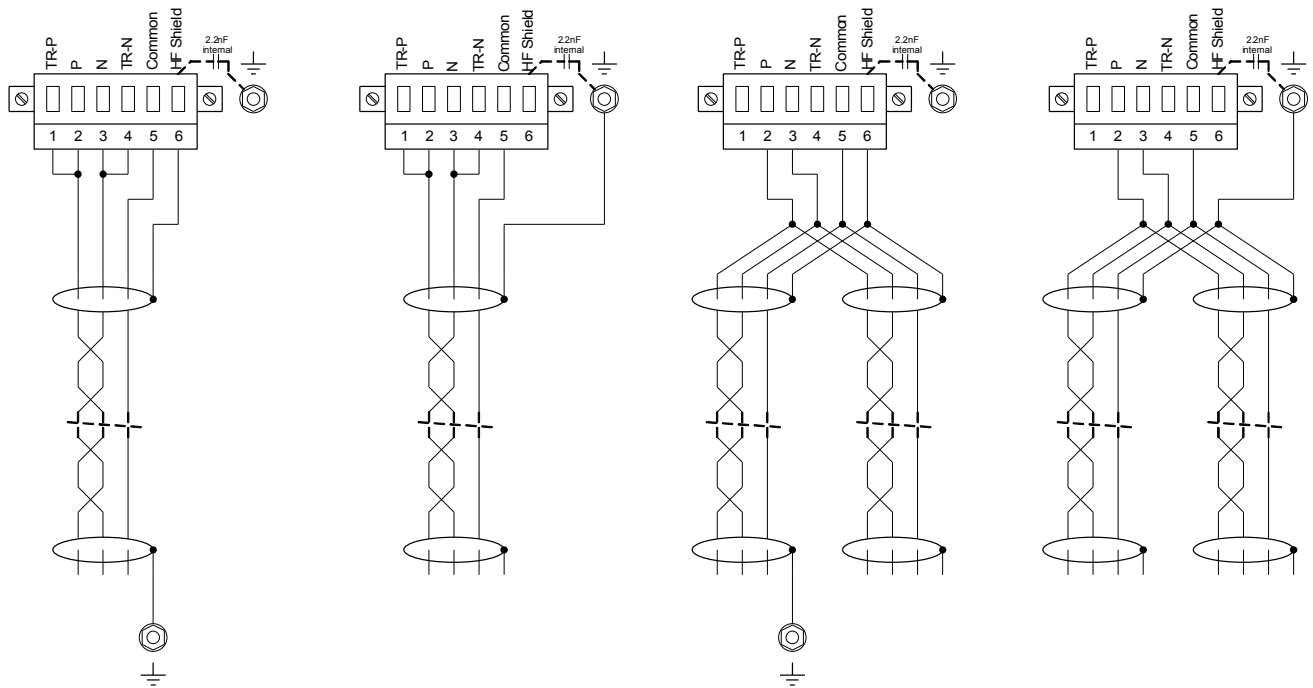

Shield at bus master side connected to earth termination resistors used

Shield at bus device side connected to earth termination resistors used

Shield at bus master side connected to earth termination resistors not used

Shield at bus device side connected to earth termination resistors not used

Profibus DP/ Modbus® RTU / IEC 60870-5-103 via fibre optic

Fibre Optic

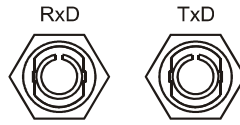

Modbus® RTU / IEC 60870-5-103 via D-SUB

D-SUB

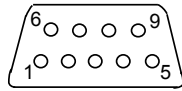

Electro-mechanical assignment

D-SUB assignment - bushing
1 Earthing/shielding
3 RxD TxD - P: High-Level
4 RTS-signal
5 DGND: Ground, neg. Potential of aux voltage supply
6 VP: pos. Potential of the aux voltage supply
8 RxD TxD - N: Low-Level

NOTICE

The connection cable must be shielded.

Profibus DP via D-SUB

D-SUB

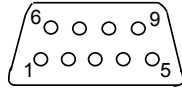

Electro-mechanical assignment

D-SUB assignment - bushing
1 Earthing/shielding
3 RxD TxD - P: High-Level
4 RTS-signal
5 DGND: Ground, neg. Potential of aux voltage supply
6 VP: pos. Potential of the aux voltage supply
8 RxD TxD - N: Low-Level

NOTICE

The connection cable must be shielded. The shielding has to be fixed at the screw which is marked with the ground symbol at the back side of the device.

Profibus DP/ Modbus® RTU / IEC 60870-5-103 via fibre optic

Fibre Optic

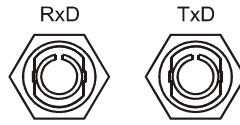

Ethernet / TCP/IP via Fiber Optics

Fiber Optics - FO

Fibre connection / LWL

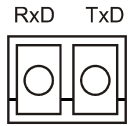

Slot X104: IRIG-B00X and Supervision Contact

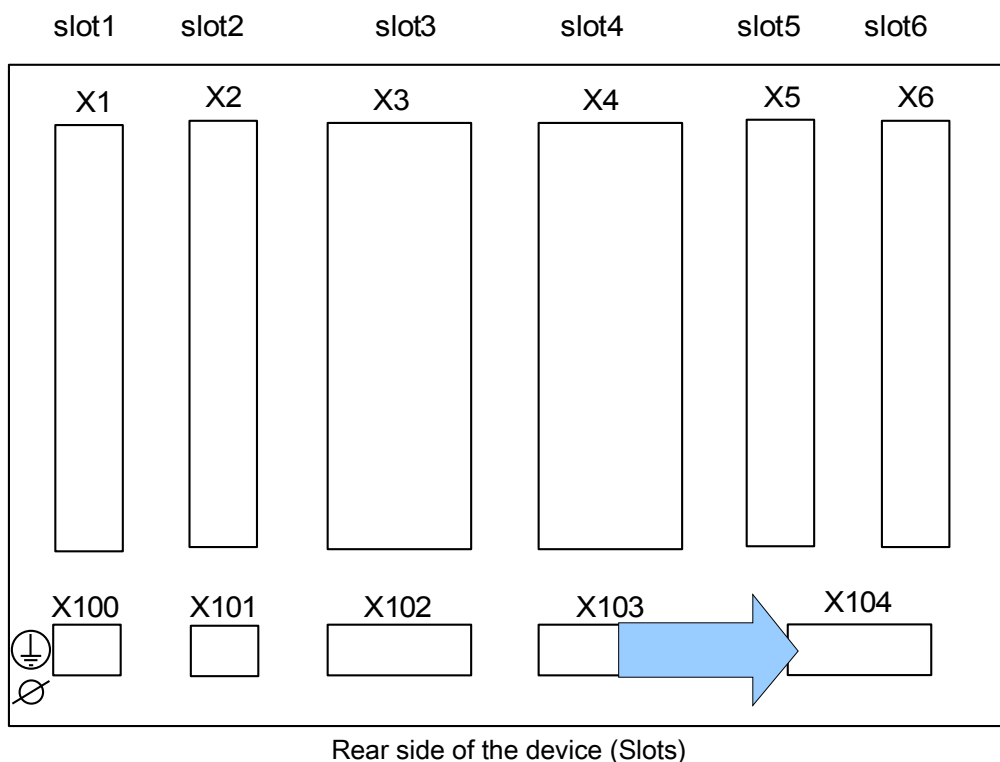

This comprises the IRIG-B00X and the System contact (Supervision Contact).

Self-Supervision Contact (SC)/Life-Contact and IRIG-B00X



WARNING Ensure the correct tightening torques.

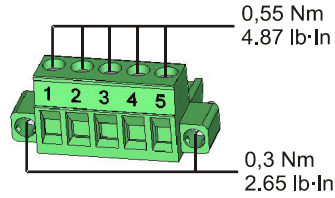

Terminal

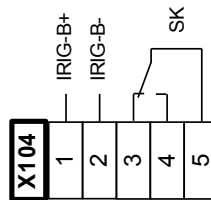

Electro-mechanical assignment

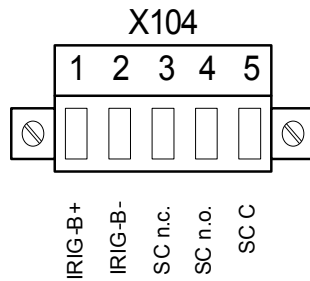

The *Self-Supervision Contact (SC relay)/Life-Contact* cannot be configured. The system contact is a changeover contact that picks up when the device is free from internal faults. While the device is booting up, the *Self-Supervision Contact (SC relay)/Life-Contact* remains dropped-off (unenergized). As soon as the system is properly started (and protection is active), the *Self-Supervision Contact (SC relay)/Life-Contact* picks up and the assigned LED (System OK) is activated accordingly (please refer to the Self Supervision chapter).

PC Interface - X120

- USB (Mini-B)

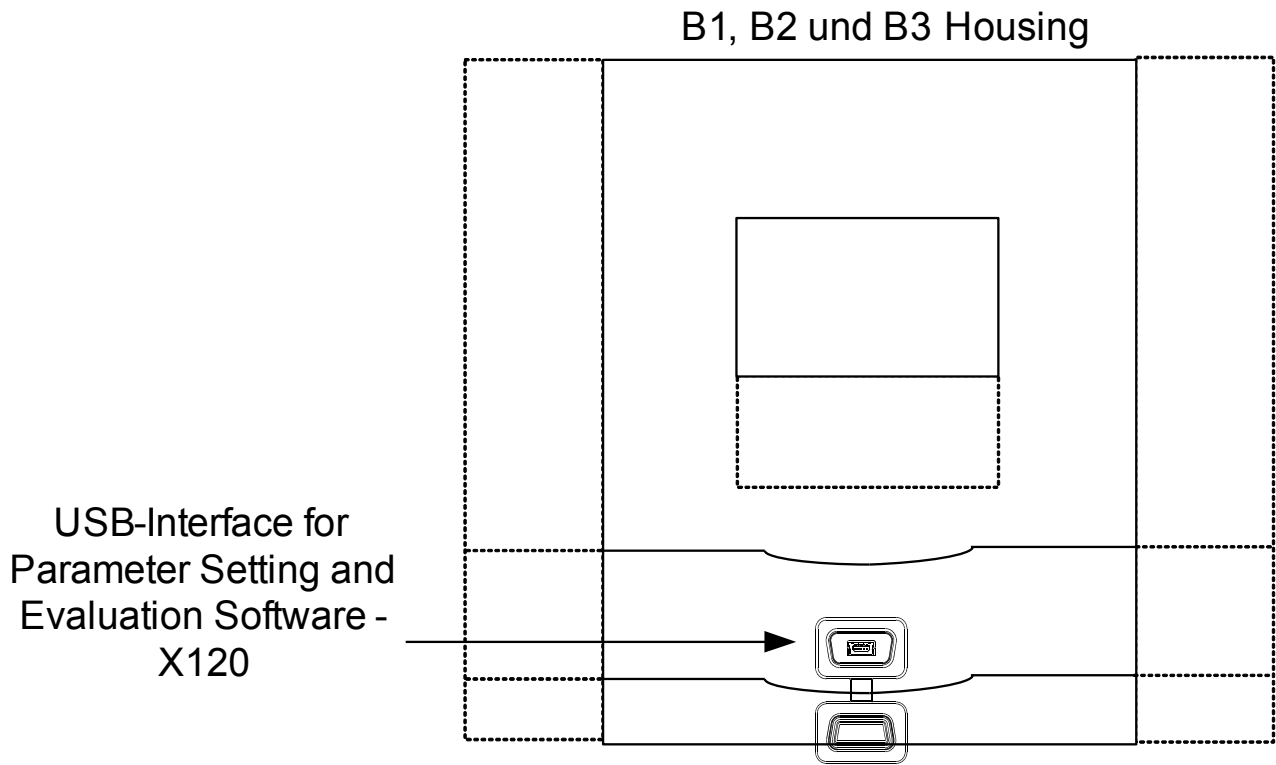





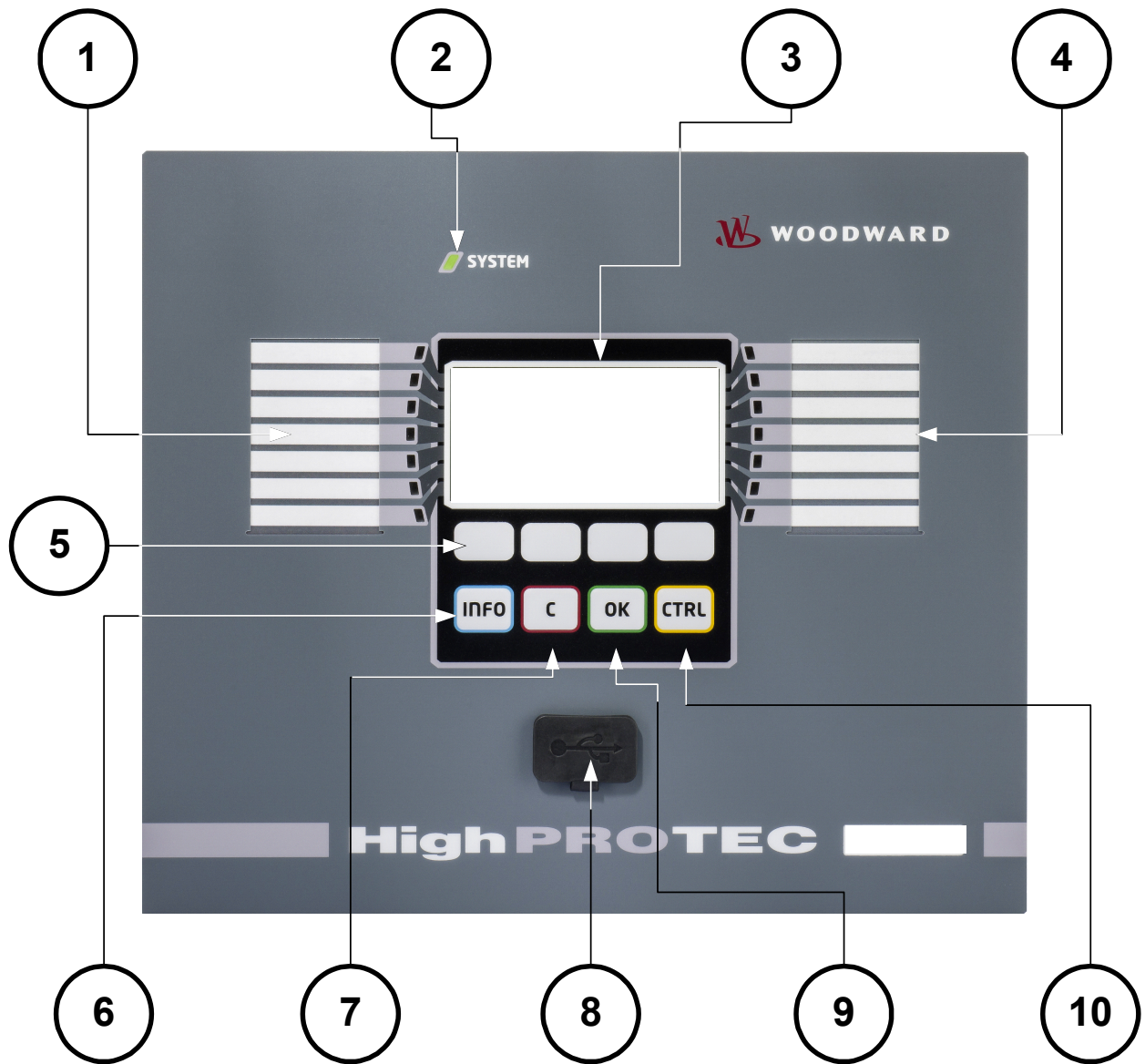

Navigation - Operation

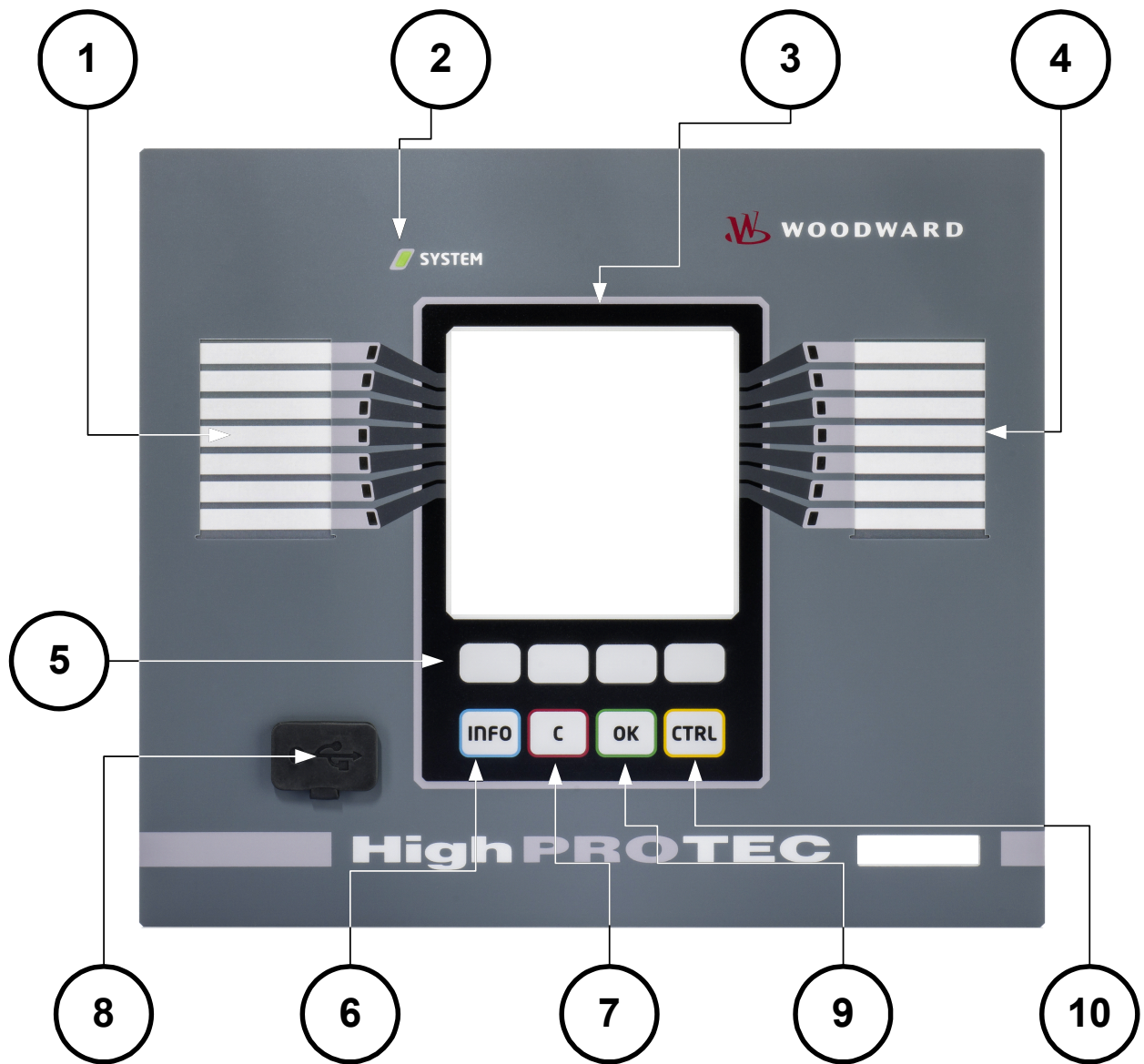
The following illustration applies to protective devices with a small display:



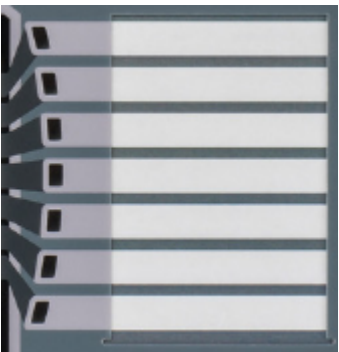

The following illustration applies to protective devices with a large display:

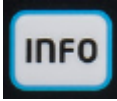

| | | | |
|---|---|----------------------|--|
| 1 |  | LEDs group A (left) | <p>Messages inform you about operational conditions, system data or other device particulars. They additionally provide you with information regarding failures and functioning of the device as well as other states of the device and the equipment.</p> <p>Alarm signals can be freely allocated to LEDs out of the »assignment list«.</p> <p>An overview about all alarm signals available in the device can be obtained from the »ASSIGNMENT LIST« which can be found in the appendix.</p> |
| | <p>SYSTEM </p> | LED »System OK« | Should LED »System OK« flash red during operation, contact the Service Dept. immediately. |
| 3 |  | Display | Via the display you can read-out operational data and edit parameters. |
| 4 |  | LEDs group B (right) | <p>Messages inform you about operational conditions, system data or other device particulars. They additionally provide you with information regarding failures and functioning of the device as well as other states of the device and the equipment.</p> <p>Alarm signals can be freely allocated to LEDs out of the »assignment list« .</p> <p>An overview about all alarm signals available in the device can be obtained from the »assignment list« which can be found in the appendix.</p> |
| 5 |  | Softkeys | <p>The function of the »SOFTKEYS« are contextual. On the bottom line of the display the present function is displayed/symbolized.</p> <p>Possible functions are:</p> |

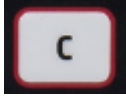

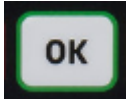
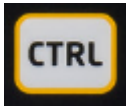











| | | | |
|---|---|------------------------------------|---|
| | | | <ul style="list-style-type: none"> ■ Navigation ■ Parameter decrement/increment. ■ Scrolling up/down a menu page ■ Moving to a digit ■ Change into the parameter setting mode »wrench symbol«. |
| 6 |  | <p>INFO Key (Signals/Messages)</p> | <p>Looking through the present LED assignment. The direct select key can be actuated at any time.</p> <p>If the INFO key is actuated once, the »LEFT LED SIGNALS« are inserted, if the INFO key is actuated again, the »RIGHT LED SIGNALS« are inserted. If the INFO key is actuated again you will leave the LED menu.</p> <p>Here only the first assignments of the LEDs will be shown. Every three seconds the »SOFTKEYS« will be shown (flashing).</p> <p><i>Displaying the multiple Assignments</i></p> <p>If the INFO-Button is pressed only the first assignments of any LED is shown. Every three seconds the »SOFTKEYS« will be shown (flashing).</p> <p>If there is more than one signal assigned to a LED (indicated by three dots) you can check the state of the multiple assignments if you proceed as follows.</p> <p>In order to show all (multiple) assignments select a LED by means of the »SOFTKEYS« »up« and »down«</p> <p>Via the »Softkey« »right« call up a Submenu of this LED that gives you detailed information on the state of all signals</p> |

| | | | |
|----|---|--|---|
| | | | <p>assigned to this LED. An arrow symbol points to the LED whose assignments are currently displayed.</p> <p>Via the »SOFTKEYS« »up« and »down« you can call up the next / previous LED.</p> <p>In order to leave the LED menu press the »SOFTKEY« »left« multiple times.</p> |
| 7 |  | »C Key« | <p>To abort changes and to acknowledge messages.</p> <p>In order to reset please press the Softkey »wrench« and enter the password.</p> <p>The reset menu can be left by pressing the Softkey »Arrow-left«</p> |
| 8 |  | USB Interface (<i>Smart view</i> Connection) | <p>Connection to software <i>Smart view</i> is done via the USB interface.</p> |
| 9 |  | »OK Key« | <p>When using the »OK« key parameter changes are temporarily stored. If the »OK« key is pressed again, those changes are stored definitely.</p> |
| 10 |  | »CTRL Key«* | <p>Direct Access to the Control Menu.</p> |

*=Not for all devices available.

Basic Menu Control

The graphic user interface is equivalent to a hierarchical structured menu tree. For access to the individual submenus the »SOFTKEYS«/Navigation Keys are used. The function of the »SOFTKEYS« can be found as symbol in the footer of the display.

| <i>Softkey</i> | <i>Description</i> |
|---|---|
|  | ■ Via »SOFTKEY« »up« you will come to the prior menu point/one parameter up by scrolling upwards. |
|  | ■ Via »SOFTKEY« »left« you will go one step back. |
|  | ■ Via »SOFTKEY« »down« you will change to the next menu point/one parameter down by scrolling downwards. |
|  | ■ Via »SOFTKEY« »right« you will come to a submenu. |
|  | ■ Via »SOFTKEY« »Top of list« you will jump directly to the top of a list. |
|  | ■ Via »SOFTKEY« »Bottom of list« you will jump directly to the end of a list. |
|  | ■ Via »SOFTKEY« »+«the related digit will be incremented. (Continuous pressure -> fast). |
|  | ■ Via »SOFTKEY« »-«the related digit will be decremented. (Continuous pressure -> fast) |
|  | ■ Via »SOFTKEY« »left« you will go one digit to the left. |
|  | ■ Via »SOFTKEY« »right« you will go one digit to the right. |
|  | ■ Via »SOFTKEY« »Parameter setting« you will call up the parameter setting mode. |
|  | ■ Via »SOFTKEY« »Parameter setting« you will call up the parameter setting mode. Password authorization required. |
|  | ■ Via »SOFTKEY« »delete« data will be deleted. |
|  | ■ Fast forward scrolling is possible via »SOFTKEY« »Fast forward« |
|  | ■ Fast backward scrolling is possible via »SOFTKEY« »Fast backward« |

In order to return to the main menu, just keep pressing the Softkey »Arrow-Left« until you arrive at the »main menu«.

Input, Output and LED Settings

Configuration of the Digital Inputs

Set the following parameters for each of the digital inputs:

- »Nominal voltage«
- »Debouncing time«: A state change will only be adopted by the digital input after the debouncing time has expired.
- »Inverting« (where necessary)

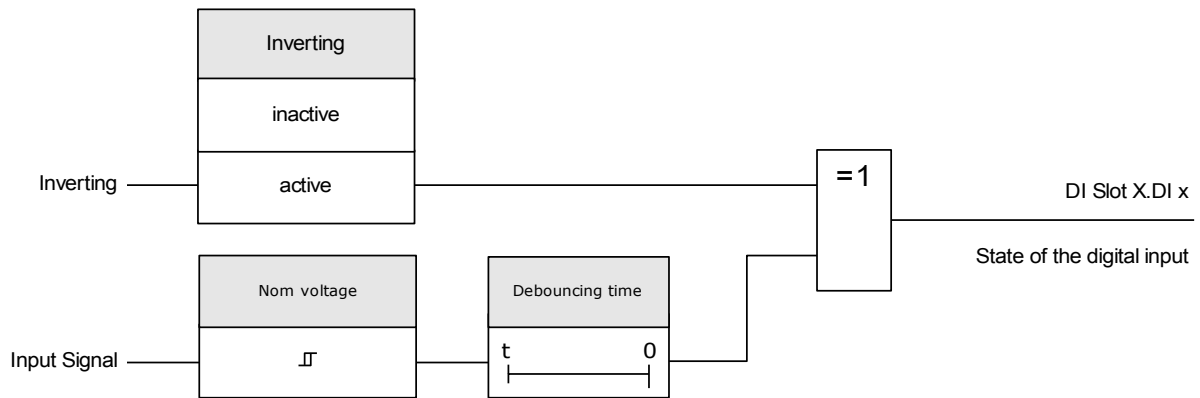

CAUTION The debouncing time will be started each time the state of the input signal alternates.

CAUTION In addition to the debouncing time that can be set via software, there is always a hardware debouncing time (approx 12 ms) that cannot be turned of.

Assignment of Digital Inputs

There are two options available in order to determine where a Digital Input should be assigned to.

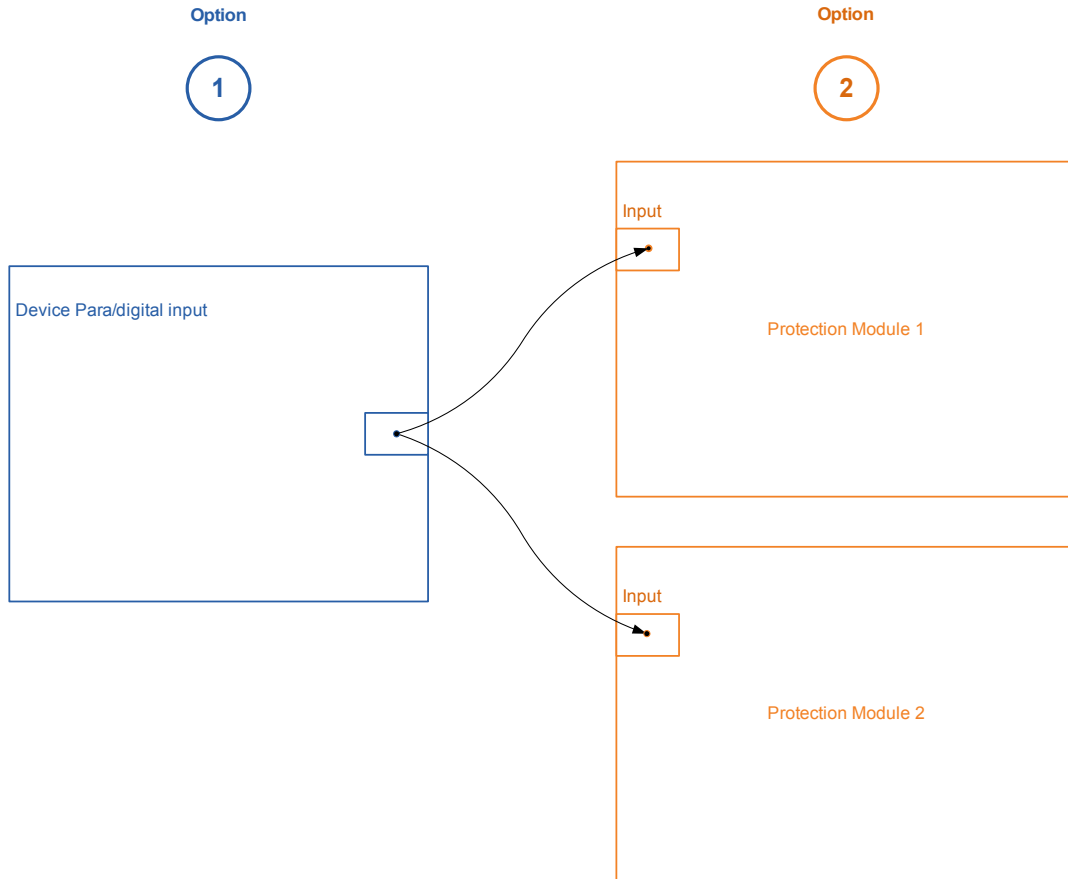

Option 1 - Assigning a Digital Input onto one or multiple modules.

Adding an assignment:

Within menu [Device Parameter\Digital Inputs] Digital Inputs can be assigned onto one or multiple targets. Call up the Digital Input (Arrow right on the DI). Click on the Softkey »Parameter Setting/Wrench«. Click on »Add« and assign a target. Assign where required additional targets.

Deleting an assignment:

Select as described above a Digital Input that should be edited at the HMI. Call up the assignments of the Digital Input (Arrow-right on the DI) and select the assignment that should be removed/deleted (Please note, this has to be marked with the cursor). The assignment can now be deleted at the HMI by means of the Softkey »Parameter setting« and selection of »remove«. Confirm the parameter setting update.

Option 2 – Connecting a Module Input with a Digital Input

Call a module. Within this module assign a Digital Input onto a module input. Example: A protection module should be blocked depending on the state of a Digital Input.. For this assign onto the blocking input within the Global Parameters the Digital Input (e.g. Ex Blo 1).

Checking the Assignments of a Digital Input

In order to check the targets that a Digital Input is assigned to please proceed as follows:

Call up menu [Device Parameter\Digital Inputs].

Navigate to the Digital Input that should be checked.







At the HMI:

A multiple assignment, that means if a Digital Input is used more than once (if it is assigned to multiple targets), this will be indicated by an "...” behind a Digital Input. Call up this Digital Input by Softkey »Arrow right« in order to see the list of targets of this Digital Input.





DI-8P X

DI Slot X1

Device Parameters of the Digital Inputs on DI-8P X

| Parameter | Description | Setting range | Default | Menu path |
|---|--|---|--------------------|---|
|  Nom voltage | Nominal voltage of the digital inputs | 24 V DC, 48 V DC, 60 V DC, 110 V DC, 230 V DC, 110 V AC, 230 V AC | 24 V DC | [Device Para /Digital Inputs /DI Slot X1 /Group 1] |
|  Inverting 1 | Inverting the input signals. | inactive, active | inactive | [Device Para /Digital Inputs /DI Slot X1 /Group 1] |
|  Debouncing time 1 | A change of the state of a digital input will only be recognized after the debouncing time has expired (become effective). Thus, transient signals will not be misinterpreted. | no debouncing time, 20 ms, 50 ms, 100 ms | no debouncing time | [Device Para /Digital Inputs /DI Slot X1 /Group 1] |
|  Nom voltage | Nominal voltage of the digital inputs | 24 V DC, 48 V DC, 60 V DC, 110 V DC, 230 V DC, 110 V AC, 230 V AC | 24 V DC | [Device Para /Digital Inputs /DI Slot X1 /Group 2] |
|  Inverting 2 | Inverting the input signals. | inactive, active | inactive | [Device Para /Digital Inputs /DI Slot X1 /Group 2] |
|  Debouncing time 2 | A change of the state of a digital input will only be recognized after the debouncing time has expired (become effective). Thus, transient signals will not be misinterpreted. | no debouncing time, 20 ms, 50 ms, 100 ms | no debouncing time | [Device Para /Digital Inputs /DI Slot X1 /Group 2] |

| Parameter | Description | Setting range | Default | Menu path |
|--|--|---|--------------------|---|
| Nom voltage  | Nominal voltage of the digital inputs | 24 V DC, 48 V DC, 60 V DC, 110 V DC, 230 V DC, 110 V AC, 230 V AC | 24 V DC | [Device Para /Digital Inputs /DI Slot X1 /Group 3] |
| Inverting 3  | Inverting the input signals. | inactive, active | inactive | [Device Para /Digital Inputs /DI Slot X1 /Group 3] |
| Debouncing time 3  | A change of the state of a digital input will only be recognized after the debouncing time has expired (become effective). Thus, transient signals will not be misinterpreted. | no debouncing time, 20 ms, 50 ms, 100 ms | no debouncing time | [Device Para /Digital Inputs /DI Slot X1 /Group 3] |
| Inverting 4  | Inverting the input signals. | inactive, active | inactive | [Device Para /Digital Inputs /DI Slot X1 /Group 3] |
| Debouncing time 4  | A change of the state of a digital input will only be recognized after the debouncing time has expired (become effective). Thus, transient signals will not be misinterpreted. | no debouncing time, 20 ms, 50 ms, 100 ms | no debouncing time | [Device Para /Digital Inputs /DI Slot X1 /Group 3] |
| Inverting 5  | Inverting the input signals. | inactive, active | inactive | [Device Para /Digital Inputs /DI Slot X1 /Group 3] |
| Debouncing time 5  | A change of the state of a digital input will only be recognized after the debouncing time has expired (become effective). Thus, transient signals will not be misinterpreted. | no debouncing time, 20 ms, 50 ms, 100 ms | no debouncing time | [Device Para /Digital Inputs /DI Slot X1 /Group 3] |
| Inverting 6  | Inverting the input signals. | inactive, active | inactive | [Device Para /Digital Inputs /DI Slot X1 /Group 3] |

| <i>Parameter</i> | <i>Description</i> | <i>Setting range</i> | <i>Default</i> | <i>Menu path</i> |
|---|--|---|--------------------|---|
|  Debouncing time 6 | A change of the state of a digital input will only be recognized after the debouncing time has expired (become effective). Thus, transient signals will not be misinterpreted. | no debouncing time, 20 ms, 50 ms, 100 ms | no debouncing time | [Device Para /Digital Inputs /DI Slot X1 /Group 3] |
|  Inverting 7 | Inverting the input signals. | inactive, active | inactive | [Device Para /Digital Inputs /DI Slot X1 /Group 3] |
|  Debouncing time 7 | A change of the state of a digital input will only be recognized after the debouncing time has expired (become effective). Thus, transient signals will not be misinterpreted. | no debouncing time, 20 ms, 50 ms, 100 ms | no debouncing time | [Device Para /Digital Inputs /DI Slot X1 /Group 3] |
|  Inverting 8 | Inverting the input signals. | inactive, active | inactive | [Device Para /Digital Inputs /DI Slot X1 /Group 3] |
|  Debouncing time 8 | A change of the state of a digital input will only be recognized after the debouncing time has expired (become effective). Thus, transient signals will not be misinterpreted. 8 | no debouncing time, 20 ms, 50 ms, 100 ms | no debouncing time | [Device Para /Digital Inputs /DI Slot X1 /Group 3] |







Signals of the Digital Inputs on DI-8P X

| <i>Signal</i> | <i>Description</i> |
|---------------|-----------------------|
| DI 1 | Signal: Digital Input |
| DI 2 | Signal: Digital Input |
| DI 3 | Signal: Digital Input |
| DI 4 | Signal: Digital Input |
| DI 5 | Signal: Digital Input |
| DI 6 | Signal: Digital Input |
| DI 7 | Signal: Digital Input |
| DI 8 | Signal: Digital Input |

DI-8 X

DI Slot X6

Device Parameters of the Digital Inputs on DI-8 X

| Parameter | Description | Setting range | Default | Menu path |
|---|--|---|--------------------|---|
|  Nom voltage | Nominal voltage of the digital inputs | 24 V DC, 48 V DC, 60 V DC, 110 V DC, 230 V DC, 110 V AC, 230 V AC | 24 V DC | [Device Para /Digital Inputs /DI Slot X6 /Group 1] |
|  Inverting 1 | Inverting the input signals. | inactive, active | inactive | [Device Para /Digital Inputs /DI Slot X6 /Group 1] |
|  Debouncing time 1 | A change of the state of a digital input will only be recognized after the debouncing time has expired (become effective). Thus, transient signals will not be misinterpreted. | no debouncing time, 20 ms, 50 ms, 100 ms | no debouncing time | [Device Para /Digital Inputs /DI Slot X6 /Group 1] |
|  Inverting 2 | Inverting the input signals. | inactive, active | inactive | [Device Para /Digital Inputs /DI Slot X6 /Group 1] |
|  Debouncing time 2 | A change of the state of a digital input will only be recognized after the debouncing time has expired (become effective). Thus, transient signals will not be misinterpreted. | no debouncing time, 20 ms, 50 ms, 100 ms | no debouncing time | [Device Para /Digital Inputs /DI Slot X6 /Group 1] |
|  Inverting 3 | Inverting the input signals. | inactive, active | inactive | [Device Para /Digital Inputs /DI Slot X6 /Group 1] |
|  Debouncing time 3 | A change of the state of a digital input will only be recognized after the debouncing time has expired (become effective). Thus, transient signals will not be misinterpreted. | no debouncing time, 20 ms, 50 ms, 100 ms | no debouncing time | [Device Para /Digital Inputs /DI Slot X6 /Group 1] |

| Parameter | Description | Setting range | Default | Menu path |
|--|--|---|--------------------|---|
| Inverting 4  | Inverting the input signals. | inactive, active | inactive | [Device Para /Digital Inputs /DI Slot X6 /Group 1] |
| Debouncing time 4  | A change of the state of a digital input will only be recognized after the debouncing time has expired (become effective). Thus, transient signals will not be misinterpreted. | no debouncing time, 20 ms, 50 ms, 100 ms | no debouncing time | [Device Para /Digital Inputs /DI Slot X6 /Group 1] |
| Inverting 5  | Inverting the input signals. | inactive, active | inactive | [Device Para /Digital Inputs /DI Slot X6 /Group 1] |
| Debouncing time 5  | A change of the state of a digital input will only be recognized after the debouncing time has expired (become effective). Thus, transient signals will not be misinterpreted. | no debouncing time, 20 ms, 50 ms, 100 ms | no debouncing time | [Device Para /Digital Inputs /DI Slot X6 /Group 1] |
| Inverting 6  | Inverting the input signals. | inactive, active | inactive | [Device Para /Digital Inputs /DI Slot X6 /Group 1] |
| Debouncing time 6  | A change of the state of a digital input will only be recognized after the debouncing time has expired (become effective). Thus, transient signals will not be misinterpreted. | no debouncing time, 20 ms, 50 ms, 100 ms | no debouncing time | [Device Para /Digital Inputs /DI Slot X6 /Group 1] |
| Inverting 7  | Inverting the input signals. | inactive, active | inactive | [Device Para /Digital Inputs /DI Slot X6 /Group 1] |
| Debouncing time 7  | A change of the state of a digital input will only be recognized after the debouncing time has expired (become effective). Thus, transient signals will not be misinterpreted. | no debouncing time, 20 ms, 50 ms, 100 ms | no debouncing time | [Device Para /Digital Inputs /DI Slot X6 /Group 1] |
| Inverting 8  | Inverting the input signals. | inactive, active | inactive | [Device Para /Digital Inputs /DI Slot X6 /Group 1] |

| <i>Parameter</i> | <i>Description</i> | <i>Setting range</i> | <i>Default</i> | <i>Menu path</i> |
|--|--|---|--------------------|---|
| Debouncing time 8  | A change of the state of a digital input will only be recognized after the debouncing time has expired (become effective). Thus, transient signals will not be misinterpreted. 8 | no debouncing time, 20 ms, 50 ms, 100 ms | no debouncing time | [Device Para /Digital Inputs /DI Slot X6 /Group 1] |

Signals of the Digital Inputs on DI-8 X

| <i>Signal</i> | <i>Description</i> |
|---------------|-----------------------|
| DI 1 | Signal: Digital Input |
| DI 2 | Signal: Digital Input |
| DI 3 | Signal: Digital Input |
| DI 4 | Signal: Digital Input |
| DI 5 | Signal: Digital Input |
| DI 6 | Signal: Digital Input |
| DI 7 | Signal: Digital Input |
| DI 8 | Signal: Digital Input |

Output Relays Settings

The conditions of module outputs and signals/protective functions (such as reverse interlocking) can be passed by means of alarm relays. The alarm relays are potential-free contacts (which can be used as opening or closing contact). Each alarm relay can be assigned up to 7 functions out of the »assignment list«.

Set the following parameters for each of the binary output relays:

- Up to 7 signals from the »assignment list« (OR-connected)
- Each of the assigned signals can be inverted.
- The (collective) state of the binary output relay can be inverted (open or closed circuit current principle)
- By the Operating Mode it can be determined whether the relay output works in working current or closed-circuit principle.
- »Latched« active or inactive
 - »Latched = inactive«:
If the latching function is »inactive«, the alarm relay respectively the alarm contact will adopt the state of those alarms that were assigned.
 - »Latched = active«
If the »latching function« is »active«, the state of the alarm relay respectively alarm contact that was set by the alarms will be stored.

The alarm relay can only be acknowledged after reset of those signals that had initiated setting of the relay and after expiry of the minimum retention time.

- »Hold time«: At signal changes, the minimal latching time ensures that the relay will be maintained picked-up or released for at least this period.

CAUTION

If binary outputs are parameterized »Latched=*active*«, they will keep (return into) their position even if there is a break within the power supply.

If binary output relays are parameterized »Latched=*active*«, The binary output will also retain, if the binary output is reprogrammed in another way. This applies also if »Latched is set to *inactive*«. Resetting a binary output that has latched a signal will always require an acknowledgement.

NOTICE

The »*System OK Relay*« (watchdog) cannot be configured.

Acknowledgment options

Binary output relays can be acknowledged:

- Via the push-button »C« at the operating panel.
- Each binary output relay can be acknowledged by a signal of the »assignment list« (If »*Latched is active*«).
- Via the module »Ex Acknowledge« all binary output relays can be acknowledged at once, if the signal for external acknowledgement that was selected from the »assignment list« becomes true. (e.g the state of a digital input).
- Via SCADA, all output relays can be acknowledged at once.

⚠ WARNING

Relay output contacts can be set by force or disarmed (for commissioning support, please refer to the „Service/Disarming the Output Relay Contacts“ and „Service/Forcing the Output Relay Contacts“ sections).

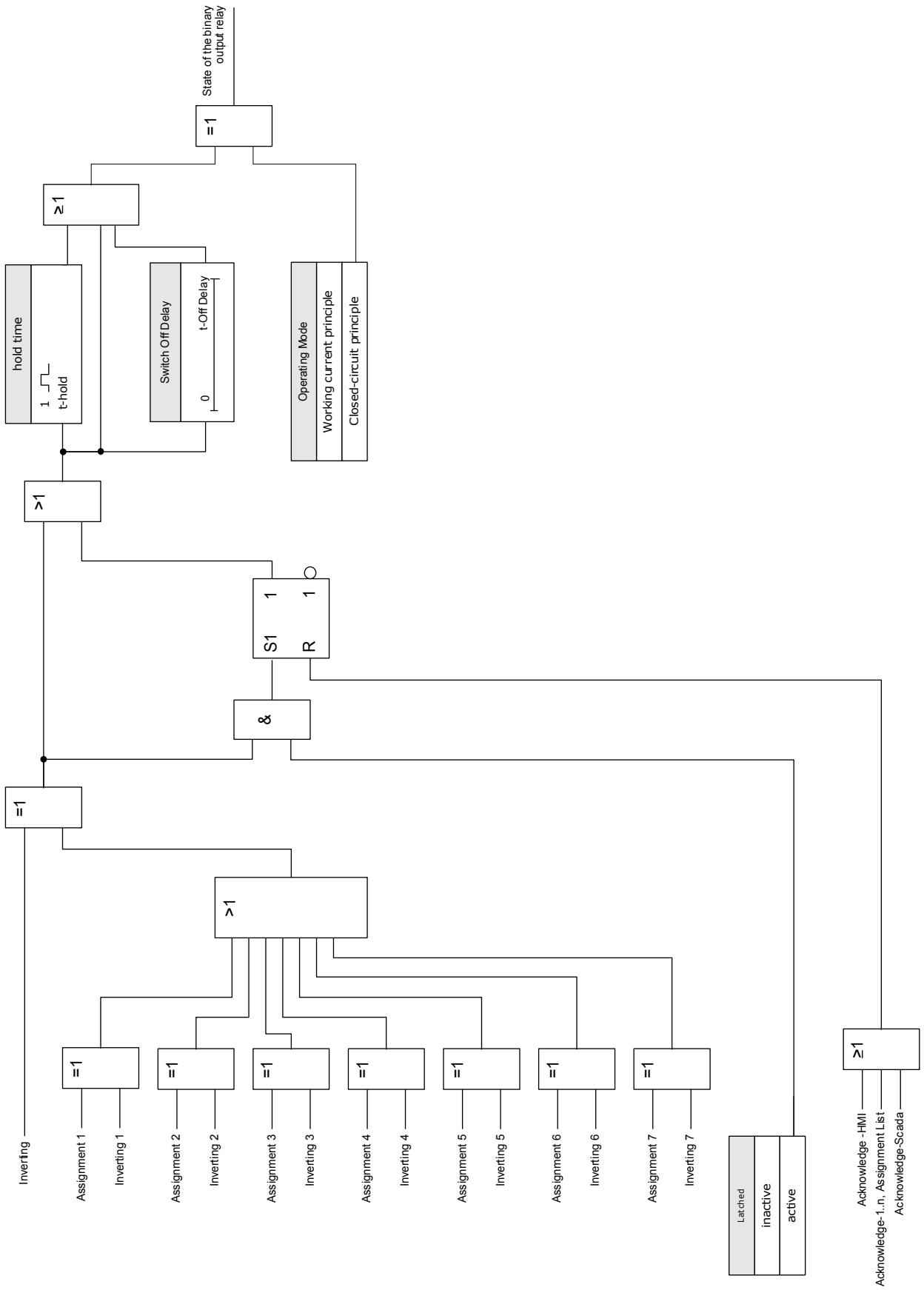

System Contact

The *System OK alarm relay (SC)* is the devices »LIFE CONTACT«. Its installation location depends on the housing type. Please refer to the wiring diagram of the device (WDC-contact).



The *System-OK relay (SC)* cannot be parameterized. The system contact is an operating current contact that picks-up, when the device is free from internal faults. While the device is booting up, the *System OK relay (SC)* remains dropped-off. As soon as the system was duly started up, the relay picks up and the assigned LED is activated accordingly (please refer to chapter Self Supervision).

OR-6 X





BO Slot X2 ,BO Slot X5





Direct Commands of OR-6 X







| Parameter | Description | Setting range | Default | Menu path |
|---|---|---------------------------------------|----------|---|
|  DISARMED | <p>This is the second step, after the "DISARMED Ctrl" has been activated, that is required to DISARM the relay outputs. This will DISARM those output relays that are currently not latched and that are not on "hold" by a pending minimum hold time. CAUTION! RELAYS DISARMED in order to safely perform maintenance while eliminating the risk of taking an entire process off-line. (Note: Zone Interlocking and Supervision Contact cannot be disarmed). YOU MUST ENSURE that the relays are ARMED AGAIN after maintenance.</p> <p>Only available if: DISARMED Ctrl = active</p> | inactive, active | inactive | [Service /Test (Prot inhibit) /DISARMED /BO Slot X2] |
|  Force all Outs | By means of this function the normal Output Relay State can be overwritten (forced). The relay can be set from normal operation (relay works according to the assigned signals) to "force energized" or "force de-energized" state. Forcing all outputs relays of an entire assembly group is superior to forcing a single output relay. | Normal, De-Energized, Energized | Normal | [Service /Test (Prot inhibit) /Force OR /BO Slot X2] |
|  Force OR1 | By means of this function the normal Output Relay State can be overwritten (forced). The relay can be set from normal operation (relay works according to the assigned signals) to "force energized" or "force de-energized" state. | Normal, De-Energized, Energized | Normal | [Service /Test (Prot inhibit) /Force OR /BO Slot X2] |
|  Force OR2 | By means of this function the normal Output Relay State can be overwritten (forced). The relay can be set from normal operation (relay works according to the assigned signals) to "force energized" or "force de-energized" state. | Normal, De-Energized, Energized | Normal | [Service /Test (Prot inhibit) /Force OR /BO Slot X2] |
|  Force OR3 | By means of this function the normal Output Relay State can be overwritten (forced). The relay can be set from normal operation (relay works according to the assigned signals) to "force energized" or "force de-energized" state. | Normal, De-Energized, Energized | Normal | [Service /Test (Prot inhibit) /Force OR /BO Slot X2] |



| <i>Parameter</i> | <i>Description</i> | <i>Setting range</i> | <i>Default</i> | <i>Menu path</i> |
|--|---|---------------------------------------|----------------|---|
| Force OR4  | By means of this function the normal Output Relay State can be overwritten (forced). The relay can be set from normal operation (relay works according to the assigned signals) to "force energized" or "force de-energized" state. | Normal, De-Energized, Energized | Normal | [Service /Test (Prot inhibit) /Force OR /BO Slot X2] |
| Force OR5  | By means of this function the normal Output Relay State can be overwritten (forced). The relay can be set from normal operation (relay works according to the assigned signals) to "force energized" or "force de-energized" state. | Normal, De-Energized, Energized | Normal | [Service /Test (Prot inhibit) /Force OR /BO Slot X2] |
| Force OR6  | By means of this function the normal Output Relay State can be overwritten (forced). The relay can be set from normal operation (relay works according to the assigned signals) to "force energized" or "force de-energized" state. | Normal, De-Energized, Energized | Normal | [Service /Test (Prot inhibit) /Force OR /BO Slot X2] |

Device Parameters of the Binary Output Relays on OR-6 X

| <i>Parameter</i> | <i>Description</i> | <i>Setting range</i> | <i>Default</i> | <i>Menu path</i> |
|---|---|--|---------------------------|--|
| Operating Mode  | Operating Mode | Working current principle, Closed-circuit principle | Working current principle | [Device Para /Binary Outputs /BO Slot X2 /BO 1] |
| t-hold  | To clearly identify the state transition of a binary output relay, the "new state" is being hold, at least for the duration of the hold time. | 0.00 - 300.00s | 0.00s | [Device Para /Binary Outputs /BO Slot X2 /BO 1] |
| t-Off Delay  | Switch Off Delay | 0.00 - 300.00s | 0.00s | [Device Para /Binary Outputs /BO Slot X2 /BO 1] |
| Latched  | Defines whether the Relay Output will be latched when it picks up. | inactive, active | inactive | [Device Para /Binary Outputs /BO Slot X2 /BO 1] |

| Parameter | Description | Setting range | Default | Menu path |
|--|---|-----------------------|---|---|
|  Acknowledgement | Acknowledgement Signal - An acknowledgement signal (that acknowledges the corresponding binary output relay) can be assigned to each output relay. The acknowledgement-signal is only effective if the parameter "Latched" is set to active. Only available if: Latched = active | 1..n, Assignment List | -- | [Device Para /Binary Outputs /BO Slot X2 /BO 1] |
|  Inverting | Inverting of the collective signal (OR-gate/disjunction). In combination with inverted input signals an AND-gate can be programmed (Conjunction). | inactive, active | inactive | [Device Para /Binary Outputs /BO Slot X2 /BO 1] |
|  Assignment 1 | Assignment | 1..n, Assignment List | BO Slot X2: SG[1].TripCmd BO Slot X5: -- | [Device Para /Binary Outputs /BO Slot X2 /BO 1] |
|  Inverting 1 | Inverting of the state of the assigned signal. | inactive, active | inactive | [Device Para /Binary Outputs /BO Slot X2 /BO 1] |
|  Assignment 2 | Assignment | 1..n, Assignment List | -- | [Device Para /Binary Outputs /BO Slot X2 /BO 1] |
|  Inverting 2 | Inverting of the state of the assigned signal. | inactive, active | inactive | [Device Para /Binary Outputs /BO Slot X2 /BO 1] |
|  Assignment 3 | Assignment | 1..n, Assignment List | -- | [Device Para /Binary Outputs /BO Slot X2 /BO 1] |
|  Inverting 3 | Inverting of the state of the assigned signal. | inactive, active | inactive | [Device Para /Binary Outputs /BO Slot X2 /BO 1] |
|  Assignment 4 | Assignment | 1..n, Assignment List | -- | [Device Para /Binary Outputs /BO Slot X2 /BO 1] |

| <i>Parameter</i> | <i>Description</i> | <i>Setting range</i> | <i>Default</i> | <i>Menu path</i> |
|---|---|--|------------------------------|--|
| Inverting 4  | Inverting of the state of the assigned signal. | inactive, active | inactive | [Device Para /Binary Outputs /BO Slot X2 /BO 1] |
| Assignment 5  | Assignment | 1..n, Assignment List | -- | [Device Para /Binary Outputs /BO Slot X2 /BO 1] |
| Inverting 5  | Inverting of the state of the assigned signal. | inactive, active | inactive | [Device Para /Binary Outputs /BO Slot X2 /BO 1] |
| Assignment 6  | Assignment | 1..n, Assignment List | -- | [Device Para /Binary Outputs /BO Slot X2 /BO 1] |
| Inverting 6  | Inverting of the state of the assigned signal. | inactive, active | inactive | [Device Para /Binary Outputs /BO Slot X2 /BO 1] |
| Assignment 7  | Assignment | 1..n, Assignment List | -- | [Device Para /Binary Outputs /BO Slot X2 /BO 1] |
| Inverting 7  | Inverting of the state of the assigned signal. | inactive, active | inactive | [Device Para /Binary Outputs /BO Slot X2 /BO 1] |
| Operating Mode  | Operating Mode | Working current principle, Closed-circuit principle | Working current principle | [Device Para /Binary Outputs /BO Slot X2 /BO 2] |
| t-hold  | To clearly identify the state transition of a binary output relay, the "new state" is being hold, at least for the duration of the hold time. | 0.00 - 300.00s | 0.00s | [Device Para /Binary Outputs /BO Slot X2 /BO 2] |

| Parameter | Description | Setting range | Default | Menu path |
|--|---|-----------------------|--|--|
| t-Off Delay  | Switch Off Delay | 0.00 - 300.00s | 0.00s | [Device Para /Binary Outputs /BO Slot X2 /BO 2] |
| Latched  | Defines whether the Relay Output will be latched when it picks up. | inactive, active | inactive | [Device Para /Binary Outputs /BO Slot X2 /BO 2] |
| Acknowledgement  | Acknowledgement Signal - An acknowledgement signal (that acknowledges the corresponding binary output relay) can be assigned to each output relay. The acknowledgement-signal is only effective if the parameter "Latched" is set to active. Only available if: Latched = active | 1..n, Assignment List | -- | [Device Para /Binary Outputs /BO Slot X2 /BO 2] |
| Inverting  | Inverting of the collective signal (OR-gate/disjunction). In combination with inverted input signals an AND-gate can be programmed (Conjunction). | inactive, active | inactive | [Device Para /Binary Outputs /BO Slot X2 /BO 2] |
| Assignment 1  | Assignment | 1..n, Assignment List | BO Slot X2: Prot.Alarm BO Slot X5: -- | [Device Para /Binary Outputs /BO Slot X2 /BO 2] |
| Inverting 1  | Inverting of the state of the assigned signal. | inactive, active | inactive | [Device Para /Binary Outputs /BO Slot X2 /BO 2] |
| Assignment 2  | Assignment | 1..n, Assignment List | -- | [Device Para /Binary Outputs /BO Slot X2 /BO 2] |
| Inverting 2  | Inverting of the state of the assigned signal. | inactive, active | inactive | [Device Para /Binary Outputs /BO Slot X2 /BO 2] |
| Assignment 3  | Assignment | 1..n, Assignment List | -- | [Device Para /Binary Outputs /BO Slot X2 /BO 2] |

| <i>Parameter</i> | <i>Description</i> | <i>Setting range</i> | <i>Default</i> | <i>Menu path</i> |
|---|--|--------------------------|----------------|--|
| Inverting 3  | Inverting of the state of the assigned signal. | inactive, active | inactive | [Device Para /Binary Outputs /BO Slot X2 /BO 2] |
| Assignment 4  | Assignment | 1..n, Assignment List | -- | [Device Para /Binary Outputs /BO Slot X2 /BO 2] |
| Inverting 4  | Inverting of the state of the assigned signal. | inactive, active | inactive | [Device Para /Binary Outputs /BO Slot X2 /BO 2] |
| Assignment 5  | Assignment | 1..n, Assignment List | -- | [Device Para /Binary Outputs /BO Slot X2 /BO 2] |
| Inverting 5  | Inverting of the state of the assigned signal. | inactive, active | inactive | [Device Para /Binary Outputs /BO Slot X2 /BO 2] |
| Assignment 6  | Assignment | 1..n, Assignment List | -- | [Device Para /Binary Outputs /BO Slot X2 /BO 2] |
| Inverting 6  | Inverting of the state of the assigned signal. | inactive, active | inactive | [Device Para /Binary Outputs /BO Slot X2 /BO 2] |
| Assignment 7  | Assignment | 1..n, Assignment List | -- | [Device Para /Binary Outputs /BO Slot X2 /BO 2] |
| Inverting 7  | Inverting of the state of the assigned signal. | inactive, active | inactive | [Device Para /Binary Outputs /BO Slot X2 /BO 2] |









| Parameter | Description | Setting range | Default | Menu path |
|--|---|--|--|--|
| Operating Mode  | Operating Mode | Working current principle, Closed-circuit principle | Working current principle | [Device Para /Binary Outputs /BO Slot X2 /BO 3] |
| t-hold  | To clearly identify the state transition of a binary output relay, the "new state" is being hold, at least for the duration of the hold time. | 0.00 - 300.00s | 0.00s | [Device Para /Binary Outputs /BO Slot X2 /BO 3] |
| t-Off Delay  | Switch Off Delay | 0.00 - 300.00s | 0.00s | [Device Para /Binary Outputs /BO Slot X2 /BO 3] |
| Latched  | Defines whether the Relay Output will be latched when it picks up. | inactive, active | inactive | [Device Para /Binary Outputs /BO Slot X2 /BO 3] |
| Acknowledgement  | Acknowledgement Signal - An acknowledgement signal (that acknowledges the corresponding binary output relay) can be assigned to each output relay. The acknowledgement-signal is only effective if the parameter "Latched" is set to active. Only available if: Latched = active | 1..n, Assignment List | -- | [Device Para /Binary Outputs /BO Slot X2 /BO 3] |
| Inverting  | Inverting of the collective signal (OR-gate/disjunction). In combination with inverted input signals an AND-gate can be programmed (Conjunction). | inactive, active | inactive | [Device Para /Binary Outputs /BO Slot X2 /BO 3] |
| Assignment 1  | Assignment | 1..n, Assignment List | BO Slot X2: SG[1].ON Cmd BO Slot X5: -- | [Device Para /Binary Outputs /BO Slot X2 /BO 3] |
| Inverting 1  | Inverting of the state of the assigned signal. | inactive, active | inactive | [Device Para /Binary Outputs /BO Slot X2 /BO 3] |
| Assignment 2  | Assignment | 1..n, Assignment List | -- | [Device Para /Binary Outputs /BO Slot X2 /BO 3] |

| <i>Parameter</i> | <i>Description</i> | <i>Setting range</i> | <i>Default</i> | <i>Menu path</i> |
|---|--|--------------------------|----------------|--|
| Inverting 2  | Inverting of the state of the assigned signal. | inactive, active | inactive | [Device Para /Binary Outputs /BO Slot X2 /BO 3] |
| Assignment 3  | Assignment | 1..n, Assignment List | -.- | [Device Para /Binary Outputs /BO Slot X2 /BO 3] |
| Inverting 3  | Inverting of the state of the assigned signal. | inactive, active | inactive | [Device Para /Binary Outputs /BO Slot X2 /BO 3] |
| Assignment 4  | Assignment | 1..n, Assignment List | -.- | [Device Para /Binary Outputs /BO Slot X2 /BO 3] |
| Inverting 4  | Inverting of the state of the assigned signal. | inactive, active | inactive | [Device Para /Binary Outputs /BO Slot X2 /BO 3] |
| Assignment 5  | Assignment | 1..n, Assignment List | -.- | [Device Para /Binary Outputs /BO Slot X2 /BO 3] |
| Inverting 5  | Inverting of the state of the assigned signal. | inactive, active | inactive | [Device Para /Binary Outputs /BO Slot X2 /BO 3] |
| Assignment 6  | Assignment | 1..n, Assignment List | -.- | [Device Para /Binary Outputs /BO Slot X2 /BO 3] |
| Inverting 6  | Inverting of the state of the assigned signal. | inactive, active | inactive | [Device Para /Binary Outputs /BO Slot X2 /BO 3] |

| Parameter | Description | Setting range | Default | Menu path |
|--|---|--|--|--|
| Assignment 7  | Assignment | 1..n, Assignment List | -- | [Device Para /Binary Outputs /BO Slot X2 /BO 3] |
| Inverting 7  | Inverting of the state of the assigned signal. | inactive, active | inactive | [Device Para /Binary Outputs /BO Slot X2 /BO 3] |
| Operating Mode  | Operating Mode | Working current principle, Closed-circuit principle | Working current principle | [Device Para /Binary Outputs /BO Slot X2 /BO 4] |
| t-hold  | To clearly identify the state transition of a binary output relay, the "new state" is being hold, at least for the duration of the hold time. | 0.00 - 300.00s | 0.00s | [Device Para /Binary Outputs /BO Slot X2 /BO 4] |
| t-Off Delay  | Switch Off Delay | 0.00 - 300.00s | 0.00s | [Device Para /Binary Outputs /BO Slot X2 /BO 4] |
| Latched  | Defines whether the Relay Output will be latched when it picks up. | inactive, active | inactive | [Device Para /Binary Outputs /BO Slot X2 /BO 4] |
| Acknowledgement  | Acknowledgement Signal - An acknowledgement signal (that acknowledges the corresponding binary output relay) can be assigned to each output relay. The acknowledgement-signal is only effective if the parameter "Latched" is set to active. Only available if: Latched = active | 1..n, Assignment List | -- | [Device Para /Binary Outputs /BO Slot X2 /BO 4] |
| Inverting  | Inverting of the collective signal (OR-gate/disjunction). In combination with inverted input signals an AND-gate can be programmed (Conjunction). | inactive, active | inactive | [Device Para /Binary Outputs /BO Slot X2 /BO 4] |
| Assignment 1  | Assignment | 1..n, Assignment List | BO Slot X2: SG[1].OFF Cmd BO Slot X5: -- | [Device Para /Binary Outputs /BO Slot X2 /BO 4] |









| <i>Parameter</i> | <i>Description</i> | <i>Setting range</i> | <i>Default</i> | <i>Menu path</i> |
|---|--|--------------------------|----------------|--|
| Inverting 1  | Inverting of the state of the assigned signal. | inactive, active | inactive | [Device Para /Binary Outputs /BO Slot X2 /BO 4] |
| Assignment 2  | Assignment | 1..n, Assignment List | -- | [Device Para /Binary Outputs /BO Slot X2 /BO 4] |
| Inverting 2  | Inverting of the state of the assigned signal. | inactive, active | inactive | [Device Para /Binary Outputs /BO Slot X2 /BO 4] |
| Assignment 3  | Assignment | 1..n, Assignment List | -- | [Device Para /Binary Outputs /BO Slot X2 /BO 4] |
| Inverting 3  | Inverting of the state of the assigned signal. | inactive, active | inactive | [Device Para /Binary Outputs /BO Slot X2 /BO 4] |
| Assignment 4  | Assignment | 1..n, Assignment List | -- | [Device Para /Binary Outputs /BO Slot X2 /BO 4] |
| Inverting 4  | Inverting of the state of the assigned signal. | inactive, active | inactive | [Device Para /Binary Outputs /BO Slot X2 /BO 4] |
| Assignment 5  | Assignment | 1..n, Assignment List | -- | [Device Para /Binary Outputs /BO Slot X2 /BO 4] |
| Inverting 5  | Inverting of the state of the assigned signal. | inactive, active | inactive | [Device Para /Binary Outputs /BO Slot X2 /BO 4] |





| Parameter | Description | Setting range | Default | Menu path |
|--|---|---|---------------------------|---|
| Assignment 6  | Assignment | 1..n, Assignment List | .- | [Device Para /Binary Outputs /BO Slot X2 /BO 4] |
| Inverting 6  | Inverting of the state of the assigned signal. | inactive, active | inactive | [Device Para /Binary Outputs /BO Slot X2 /BO 4] |
| Assignment 7  | Assignment | 1..n, Assignment List | .- | [Device Para /Binary Outputs /BO Slot X2 /BO 4] |
| Inverting 7  | Inverting of the state of the assigned signal. | inactive, active | inactive | [Device Para /Binary Outputs /BO Slot X2 /BO 4] |
| Operating Mode  | Operating Mode | Working current principle, Closed-circuit principle | Working current principle | [Device Para /Binary Outputs /BO Slot X2 /BO 5] |
| t-hold  | To clearly identify the state transition of a binary output relay, the "new state" is being hold, at least for the duration of the hold time. | 0.00 - 300.00s | 0.00s | [Device Para /Binary Outputs /BO Slot X2 /BO 5] |
| t-Off Delay  | Switch Off Delay | 0.00 - 300.00s | 0.00s | [Device Para /Binary Outputs /BO Slot X2 /BO 5] |
| Latched  | Defines whether the Relay Output will be latched when it picks up. | inactive, active | inactive | [Device Para /Binary Outputs /BO Slot X2 /BO 5] |
| Acknowledgement  | Acknowledgement Signal - An acknowledgement signal (that acknowledges the corresponding binary output relay) can be assigned to each output relay. The acknowledgement-signal is only effective if the parameter "Latched" is set to active. Only available if: Latched = active | 1..n, Assignment List | .- | [Device Para /Binary Outputs /BO Slot X2 /BO 5] |

| <i>Parameter</i> | <i>Description</i> | <i>Setting range</i> | <i>Default</i> | <i>Menu path</i> |
|---|---|-----------------------|--|--|
| Inverting  | Inverting of the collective signal (OR-gate/disjunction). In combination with inverted input signals an AND-gate can be programmed (Conjunction). | inactive, active | inactive | [Device Para /Binary Outputs /BO Slot X2 /BO 5] |
| Assignment 1  | Assignment | 1..n, Assignment List | BO Slot X2: SG[4].ON Cmd BO Slot X5: -.- | [Device Para /Binary Outputs /BO Slot X2 /BO 5] |
| Inverting 1  | Inverting of the state of the assigned signal. | inactive, active | inactive | [Device Para /Binary Outputs /BO Slot X2 /BO 5] |
| Assignment 2  | Assignment | 1..n, Assignment List | -.- | [Device Para /Binary Outputs /BO Slot X2 /BO 5] |
| Inverting 2  | Inverting of the state of the assigned signal. | inactive, active | inactive | [Device Para /Binary Outputs /BO Slot X2 /BO 5] |
| Assignment 3  | Assignment | 1..n, Assignment List | -.- | [Device Para /Binary Outputs /BO Slot X2 /BO 5] |
| Inverting 3  | Inverting of the state of the assigned signal. | inactive, active | inactive | [Device Para /Binary Outputs /BO Slot X2 /BO 5] |
| Assignment 4  | Assignment | 1..n, Assignment List | -.- | [Device Para /Binary Outputs /BO Slot X2 /BO 5] |
| Inverting 4  | Inverting of the state of the assigned signal. | inactive, active | inactive | [Device Para /Binary Outputs /BO Slot X2 /BO 5] |

| Parameter | Description | Setting range | Default | Menu path |
|---|---|---|---------------------------|---|
| Assignment 5  | Assignment | 1..n, Assignment List | -- | [Device Para /Binary Outputs /BO Slot X2 /BO 5] |
| Inverting 5  | Inverting of the state of the assigned signal. | inactive, active | inactive | [Device Para /Binary Outputs /BO Slot X2 /BO 5] |
| Assignment 6  | Assignment | 1..n, Assignment List | -- | [Device Para /Binary Outputs /BO Slot X2 /BO 5] |
| Inverting 6  | Inverting of the state of the assigned signal. | inactive, active | inactive | [Device Para /Binary Outputs /BO Slot X2 /BO 5] |
| Assignment 7  | Assignment | 1..n, Assignment List | -- | [Device Para /Binary Outputs /BO Slot X2 /BO 5] |
| Inverting 7  | Inverting of the state of the assigned signal. | inactive, active | inactive | [Device Para /Binary Outputs /BO Slot X2 /BO 5] |
| Operating Mode  | Operating Mode | Working current principle, Closed-circuit principle | Working current principle | [Device Para /Binary Outputs /BO Slot X2 /BO 6] |
| t-hold  | To clearly identify the state transition of a binary output relay, the "new state" is being hold, at least for the duration of the hold time. | 0.00 - 300.00s | 0.00s | [Device Para /Binary Outputs /BO Slot X2 /BO 6] |
| t-Off Delay  | Switch Off Delay | 0.00 - 300.00s | 0.00s | [Device Para /Binary Outputs /BO Slot X2 /BO 6] |

| Parameter | Description | Setting range | Default | Menu path |
|--|---|-----------------------|--|--|
| Latched  | Defines whether the Relay Output will be latched when it picks up. | inactive, active | inactive | [Device Para /Binary Outputs /BO Slot X2 /BO 6] |
| Acknowledgement  | Acknowledgement Signal - An acknowledgement signal (that acknowledges the corresponding binary output relay) can be assigned to each output relay. The acknowledgement-signal is only effective if the parameter "Latched" is set to active. Only available if: Latched = active | 1..n, Assignment List | -- | [Device Para /Binary Outputs /BO Slot X2 /BO 6] |
| Inverting  | Inverting of the collective signal (OR-gate/disjunction). In combination with inverted input signals an AND-gate can be programmed (Conjunction). | inactive, active | inactive | [Device Para /Binary Outputs /BO Slot X2 /BO 6] |
| Assignment 1  | Assignment | 1..n, Assignment List | BO Slot X2: SG[4].OFF Cmd BO Slot X5: -- | [Device Para /Binary Outputs /BO Slot X2 /BO 6] |
| Inverting 1  | Inverting of the state of the assigned signal. | inactive, active | inactive | [Device Para /Binary Outputs /BO Slot X2 /BO 6] |
| Assignment 2  | Assignment | 1..n, Assignment List | -- | [Device Para /Binary Outputs /BO Slot X2 /BO 6] |
| Inverting 2  | Inverting of the state of the assigned signal. | inactive, active | inactive | [Device Para /Binary Outputs /BO Slot X2 /BO 6] |
| Assignment 3  | Assignment | 1..n, Assignment List | -- | [Device Para /Binary Outputs /BO Slot X2 /BO 6] |
| Inverting 3  | Inverting of the state of the assigned signal. | inactive, active | inactive | [Device Para /Binary Outputs /BO Slot X2 /BO 6] |

| <i>Parameter</i> | <i>Description</i> | <i>Setting range</i> | <i>Default</i> | <i>Menu path</i> |
|--|---|-----------------------|----------------|---|
| Assignment 4  | Assignment | 1..n, Assignment List | -- | [Device Para /Binary Outputs /BO Slot X2 /BO 6] |
| Inverting 4  | Inverting of the state of the assigned signal. | inactive, active | inactive | [Device Para /Binary Outputs /BO Slot X2 /BO 6] |
| Assignment 5  | Assignment | 1..n, Assignment List | -- | [Device Para /Binary Outputs /BO Slot X2 /BO 6] |
| Inverting 5  | Inverting of the state of the assigned signal. | inactive, active | inactive | [Device Para /Binary Outputs /BO Slot X2 /BO 6] |
| Assignment 6  | Assignment | 1..n, Assignment List | -- | [Device Para /Binary Outputs /BO Slot X2 /BO 6] |
| Inverting 6  | Inverting of the state of the assigned signal. | inactive, active | inactive | [Device Para /Binary Outputs /BO Slot X2 /BO 6] |
| Assignment 7  | Assignment | 1..n, Assignment List | -- | [Device Para /Binary Outputs /BO Slot X2 /BO 6] |
| Inverting 7  | Inverting of the state of the assigned signal. | inactive, active | inactive | [Device Para /Binary Outputs /BO Slot X2 /BO 6] |
| DISARMED Ctrl  | Enables and disables the disarming of the relay outputs. This is the first step of a two step process, to inhibit the operation or the relay outputs. Please refer to "DISARMED" for the second step. | inactive, active | inactive | [Service /Test (Prot inhibit) /DISARMED /BO Slot X2] |

| <i>Parameter</i> | <i>Description</i> | <i>Setting range</i> | <i>Default</i> | <i>Menu path</i> |
|--|---|-----------------------|----------------|---|
| Disarm Mode  | CAUTION!RELAYS DISARMED in order to safely perform maintenance while eliminating the risk of taking an entire process off-line. (Note: The Supervision Contact cannot be disarmed). YOU MUST ENSURE that the relays are ARMED AGAIN after maintenance. | permanent, timeout | permanent | [Service /Test (Prot inhibit) /DISARMED /BO Slot X2] |
| t-Timeout DISARM  | The relays will be armed again after expiring of this time. Only available if: Mode = Timeout DISARM | 0.00 - 300.00s | 0.03s | [Service /Test (Prot inhibit) /DISARMED /BO Slot X2] |
| Force Mode  | By means of this function the normal Output Relay States can be overwritten (forced) in case that the Relay is not in a disarmed state. The relays can be set from normal operation (relay works according to the assigned signals) to "force energized" or "force de-energized" state. | permanent, timeout | permanent | [Service /Test (Prot inhibit) /Force OR /BO Slot X2] |
| t-Timeout Force  | The Output State will be set by force for the duration of this time. That means for the duration of this time the Output Relay does not show the state of the signals that are assigned on it. Only available if: Mode = Timeout DISARM | 0.00 - 300.00s | 0.03s | [Service /Test (Prot inhibit) /Force OR /BO Slot X2] |

Input States of the Binary Output Relays on OR-6 X

| <i>Name</i> | <i>Description</i> | <i>Assignment via</i> |
|-----------------|--|--|
| BO1.1 | Module input state: Assignment | [Device Para /Binary Outputs /BO Slot X2 /BO 1] |
| BO1.2 | Module input state: Assignment | [Device Para /Binary Outputs /BO Slot X2 /BO 1] |
| BO1.3 | Module input state: Assignment | [Device Para /Binary Outputs /BO Slot X2 /BO 1] |
| BO1.4 | Module input state: Assignment | [Device Para /Binary Outputs /BO Slot X2 /BO 1] |
| BO1.5 | Module input state: Assignment | [Device Para /Binary Outputs /BO Slot X2 /BO 1] |
| BO1.6 | Module input state: Assignment | [Device Para /Binary Outputs /BO Slot X2 /BO 1] |
| BO1.7 | Module input state: Assignment | [Device Para /Binary Outputs /BO Slot X2 /BO 1] |
| Ack signal BO 1 | Module input state: Acknowledgement signal for the binary output relay. If latching is set to active, the binary output relay can only be acknowledged if those signals that initiated the setting are fallen back and the hold time is expired. | [Device Para /Binary Outputs /BO Slot X2 /BO 1] |
| BO2.1 | Module input state: Assignment | [Device Para /Binary Outputs /BO Slot X2 /BO 2] |

| <i>Name</i> | <i>Description</i> | <i>Assignment via</i> |
|-----------------|--|--|
| BO2.2 | Module input state: Assignment | [Device Para /Binary Outputs /BO Slot X2 /BO 2] |
| BO2.3 | Module input state: Assignment | [Device Para /Binary Outputs /BO Slot X2 /BO 2] |
| BO2.4 | Module input state: Assignment | [Device Para /Binary Outputs /BO Slot X2 /BO 2] |
| BO2.5 | Module input state: Assignment | [Device Para /Binary Outputs /BO Slot X2 /BO 2] |
| BO2.6 | Module input state: Assignment | [Device Para /Binary Outputs /BO Slot X2 /BO 2] |
| BO2.7 | Module input state: Assignment | [Device Para /Binary Outputs /BO Slot X2 /BO 2] |
| Ack signal BO 2 | Module input state: Acknowledgement signal for the binary output relay. If latching is set to active, the binary output relay can only be acknowledged if those signals that initiated the setting are fallen back and the hold time is expired. | [Device Para /Binary Outputs /BO Slot X2 /BO 2] |
| BO3.1 | Module input state: Assignment | [Device Para /Binary Outputs /BO Slot X2 /BO 3] |
| BO3.2 | Module input state: Assignment | [Device Para /Binary Outputs /BO Slot X2 /BO 3] |

| Name | Description | Assignment via |
|-----------------|--|--|
| BO3.3 | Module input state: Assignment | [Device Para /Binary Outputs /BO Slot X2 /BO 3] |
| BO3.4 | Module input state: Assignment | [Device Para /Binary Outputs /BO Slot X2 /BO 3] |
| BO3.5 | Module input state: Assignment | [Device Para /Binary Outputs /BO Slot X2 /BO 3] |
| BO3.6 | Module input state: Assignment | [Device Para /Binary Outputs /BO Slot X2 /BO 3] |
| BO3.7 | Module input state: Assignment | [Device Para /Binary Outputs /BO Slot X2 /BO 3] |
| Ack signal BO 3 | Module input state: Acknowledgement signal for the binary output relay. If latching is set to active, the binary output relay can only be acknowledged if those signals that initiated the setting are fallen back and the hold time is expired. | [Device Para /Binary Outputs /BO Slot X2 /BO 3] |
| BO4.1 | Module input state: Assignment | [Device Para /Binary Outputs /BO Slot X2 /BO 4] |
| BO4.2 | Module input state: Assignment | [Device Para /Binary Outputs /BO Slot X2 /BO 4] |
| BO4.3 | Module input state: Assignment | [Device Para /Binary Outputs /BO Slot X2 /BO 4] |

| <i>Name</i> | <i>Description</i> | <i>Assignment via</i> |
|-----------------|--|--|
| BO4.4 | Module input state: Assignment | [Device Para /Binary Outputs /BO Slot X2 /BO 4] |
| BO4.5 | Module input state: Assignment | [Device Para /Binary Outputs /BO Slot X2 /BO 4] |
| BO4.6 | Module input state: Assignment | [Device Para /Binary Outputs /BO Slot X2 /BO 4] |
| BO4.7 | Module input state: Assignment | [Device Para /Binary Outputs /BO Slot X2 /BO 4] |
| Ack signal BO 4 | Module input state: Acknowledgement signal for the binary output relay. If latching is set to active, the binary output relay can only be acknowledged if those signals that initiated the setting are fallen back and the hold time is expired. | [Device Para /Binary Outputs /BO Slot X2 /BO 4] |
| BO5.1 | Module input state: Assignment | [Device Para /Binary Outputs /BO Slot X2 /BO 5] |
| BO5.2 | Module input state: Assignment | [Device Para /Binary Outputs /BO Slot X2 /BO 5] |
| BO5.3 | Module input state: Assignment | [Device Para /Binary Outputs /BO Slot X2 /BO 5] |
| BO5.4 | Module input state: Assignment | [Device Para /Binary Outputs /BO Slot X2 /BO 5] |

| Name | Description | Assignment via |
|-----------------|--|--|
| BO5.5 | Module input state: Assignment | [Device Para /Binary Outputs /BO Slot X2 /BO 5] |
| BO5.6 | Module input state: Assignment | [Device Para /Binary Outputs /BO Slot X2 /BO 5] |
| BO5.7 | Module input state: Assignment | [Device Para /Binary Outputs /BO Slot X2 /BO 5] |
| Ack signal BO 5 | Module input state: Acknowledgement signal for the binary output relay. If latching is set to active, the binary output relay can only be acknowledged if those signals that initiated the setting are fallen back and the hold time is expired. | [Device Para /Binary Outputs /BO Slot X2 /BO 5] |
| BO6.1 | Module input state: Assignment | [Device Para /Binary Outputs /BO Slot X2 /BO 6] |
| BO6.2 | Module input state: Assignment | [Device Para /Binary Outputs /BO Slot X2 /BO 6] |
| BO6.3 | Module input state: Assignment | [Device Para /Binary Outputs /BO Slot X2 /BO 6] |
| BO6.4 | Module input state: Assignment | [Device Para /Binary Outputs /BO Slot X2 /BO 6] |
| BO6.5 | Module input state: Assignment | [Device Para /Binary Outputs /BO Slot X2 /BO 6] |









| <i>Name</i> | <i>Description</i> | <i>Assignment via</i> |
|-----------------|--|--|
| BO6.6 | Module input state: Assignment | [Device Para /Binary Outputs /BO Slot X2 /BO 6] |
| BO6.7 | Module input state: Assignment | [Device Para /Binary Outputs /BO Slot X2 /BO 6] |
| Ack signal BO 6 | Module input state: Acknowledgement signal for the binary output relay. If latching is set to active, the binary output relay can only be acknowledged if those signals that initiated the setting are fallen back and the hold time is expired. | [Device Para /Binary Outputs /BO Slot X2 /BO 6] |









Signals of the Binary Output Relays on OR-6 X









| <i>Signal</i> | <i>Description</i> |
|---------------|---|
| BO 1 | Signal: Binary Output Relay |
| BO 2 | Signal: Binary Output Relay |
| BO 3 | Signal: Binary Output Relay |
| BO 4 | Signal: Binary Output Relay |
| BO 5 | Signal: Binary Output Relay |
| BO 6 | Signal: Binary Output Relay |
| DISARMED! | Signal: CAUTION! RELAYS DISARMED in order to safely perform maintenance while eliminating the risk of taking an entire process off-line. (Note: The Self Supervision Contact cannot be disarmed). YOU MUST ENSURE that the relays are ARMED AGAIN after maintenance |
| Outs forced | Signal: The State of at least one Relay Output has been set by force. That means that the state of at least one Relay is forced and hence does not show the state of the assigned signals. |









Global Protection Parameters of the LED Module









LEDs group A ,LEDs group B









| Parameter | Description | Setting range | Default | Menu path |
|---|--|---|---|---|
| Latched  | Defines whether the LED will be latched when it picks up. | inactive, active | inactive | [Device Para /LEDs /LEDs group A /LED 1] |
| Ack signal  | Acknowledgement signal for the LED. If latching is set to active the LED can only be acknowledged if those signals that initiated the setting are no longer present. Dependency Only available if: Latched = active | 1..n, Assignment List | -.- | [Device Para /LEDs /LEDs group A /LED 1] |
| LED active color  | The LED lights up in this color if the state of the OR-assignment of the signals is true. | green, red, red flash, green flash, - | LEDs group A: green LEDs group B: red | [Device Para /LEDs /LEDs group A /LED 1] |
| LED inactive color  | The LED lights up in this color if the state of the OR-assignment of the signals is untrue. | green, red, red flash, green flash, - | - | [Device Para /LEDs /LEDs group A /LED 1] |
| Assignment 1  | Assignment | 1..n, Assignment List | LEDs group A: Prot.active LEDs group B: -.- | [Device Para /LEDs /LEDs group A /LED 1] |
| Inverting 1  | Inverting of the state of the assigned signal. | inactive, active | inactive | [Device Para /LEDs /LEDs group A /LED 1] |
| Assignment 2  | Assignment | 1..n, Assignment List | -.- | [Device Para /LEDs /LEDs group A /LED 1] |
| Inverting 2  | Inverting of the state of the assigned signal. | inactive, active | inactive | [Device Para /LEDs /LEDs group A /LED 1] |









| Parameter | Description | Setting range | Default | Menu path |
|---|---|---|--|---|
| Assignment 3  | Assignment | 1..n, Assignment List | -- | [Device Para /LEDs /LEDs group A /LED 1] |
| Inverting 3  | Inverting of the state of the assigned signal. | inactive, active | inactive | [Device Para /LEDs /LEDs group A /LED 1] |
| Assignment 4  | Assignment | 1..n, Assignment List | -- | [Device Para /LEDs /LEDs group A /LED 1] |
| Inverting 4  | Inverting of the state of the assigned signal. | inactive, active | inactive | [Device Para /LEDs /LEDs group A /LED 1] |
| Assignment 5  | Assignment | 1..n, Assignment List | -- | [Device Para /LEDs /LEDs group A /LED 1] |
| Inverting 5  | Inverting of the state of the assigned signal. | inactive, active | inactive | [Device Para /LEDs /LEDs group A /LED 1] |
| Latched  | Defines whether the LED will be latched when it picks up. | inactive, active | LEDs group A: active LEDs group B: inactive | [Device Para /LEDs /LEDs group A /LED 2] |
| Ack signal  | Acknowledgement signal for the LED. If latching is set to active the LED can only be acknowledged if those signals that initiated the setting are no longer present. Only available if: Latched = active | 1..n, Assignment List | -- | [Device Para /LEDs /LEDs group A /LED 2] |
| LED active color  | The LED lights up in this color if the state of the OR-assignment of the signals is true. | green, red, red flash, green flash, - | red | [Device Para /LEDs /LEDs group A /LED 2] |









| Parameter | Description | Setting range | Default | Menu path |
|---|---|---|--|---|
| LED inactive color  | The LED lights up in this color if the state of the OR-assignment of the signals is untrue. | green, red, red flash, green flash, - | - | [Device Para /LEDs /LEDs group A /LED 2] |
| Assignment 1  | Assignment | 1..n, Assignment List | LEDs group A: SG[1].TripCmd LEDs group B: -.- | [Device Para /LEDs /LEDs group A /LED 2] |
| Inverting 1  | Inverting of the state of the assigned signal. | inactive, active | inactive | [Device Para /LEDs /LEDs group A /LED 2] |
| Assignment 2  | Assignment | 1..n, Assignment List | -.- | [Device Para /LEDs /LEDs group A /LED 2] |
| Inverting 2  | Inverting of the state of the assigned signal. | inactive, active | inactive | [Device Para /LEDs /LEDs group A /LED 2] |
| Assignment 3  | Assignment | 1..n, Assignment List | -.- | [Device Para /LEDs /LEDs group A /LED 2] |
| Inverting 3  | Inverting of the state of the assigned signal. | inactive, active | inactive | [Device Para /LEDs /LEDs group A /LED 2] |
| Assignment 4  | Assignment | 1..n, Assignment List | -.- | [Device Para /LEDs /LEDs group A /LED 2] |
| Inverting 4  | Inverting of the state of the assigned signal. | inactive, active | inactive | [Device Para /LEDs /LEDs group A /LED 2] |









| Parameter | Description | Setting range | Default | Menu path |
|---|---|---|--|---|
|  Assignment 5 | Assignment | 1..n, Assignment List | -- | [Device Para /LEDs /LEDs group A /LED 2] |
|  Inverting 5 | Inverting of the state of the assigned signal. | inactive, active | inactive | [Device Para /LEDs /LEDs group A /LED 2] |
|  Latched | Defines whether the LED will be latched when it picks up. | inactive, active | inactive | [Device Para /LEDs /LEDs group A /LED 3] |
|  Ack signal | Acknowledgement signal for the LED. If latching is set to active the LED can only be acknowledged if those signals that initiated the setting are no longer present. Only available if: Latched = active | 1..n, Assignment List | -- | [Device Para /LEDs /LEDs group A /LED 3] |
|  LED active color | The LED lights up in this color if the state of the OR-assignment of the signals is true. | green, red, red flash, green flash, - | LEDs group A: red flash LEDs group B: red | [Device Para /LEDs /LEDs group A /LED 3] |
|  LED inactive color | The LED lights up in this color if the state of the OR-assignment of the signals is untrue. | green, red, red flash, green flash, - | - | [Device Para /LEDs /LEDs group A /LED 3] |
|  Assignment 1 | Assignment | 1..n, Assignment List | LEDs group A: Prot.Alarm LEDs group B: -- | [Device Para /LEDs /LEDs group A /LED 3] |
|  Inverting 1 | Inverting of the state of the assigned signal. | inactive, active | inactive | [Device Para /LEDs /LEDs group A /LED 3] |
|  Assignment 2 | Assignment | 1..n, Assignment List | -- | [Device Para /LEDs /LEDs group A /LED 3] |









| Parameter | Description | Setting range | Default | Menu path |
|---|---|--------------------------|----------|---|
| Inverting 2  | Inverting of the state of the assigned signal. | inactive, active | inactive | [Device Para /LEDs /LEDs group A /LED 3] |
| Assignment 3  | Assignment | 1..n, Assignment List | -- | [Device Para /LEDs /LEDs group A /LED 3] |
| Inverting 3  | Inverting of the state of the assigned signal. | inactive, active | inactive | [Device Para /LEDs /LEDs group A /LED 3] |
| Assignment 4  | Assignment | 1..n, Assignment List | -- | [Device Para /LEDs /LEDs group A /LED 3] |
| Inverting 4  | Inverting of the state of the assigned signal. | inactive, active | inactive | [Device Para /LEDs /LEDs group A /LED 3] |
| Assignment 5  | Assignment | 1..n, Assignment List | -- | [Device Para /LEDs /LEDs group A /LED 3] |
| Inverting 5  | Inverting of the state of the assigned signal. | inactive, active | inactive | [Device Para /LEDs /LEDs group A /LED 3] |
| Latched  | Defines whether the LED will be latched when it picks up. | inactive, active | inactive | [Device Para /LEDs /LEDs group A /LED 4] |
| Ack signal  | Acknowledgement signal for the LED. If latching is set to active the LED can only be acknowledged if those signals that initiated the setting are no longer present. Only available if: Latched = active | 1..n, Assignment List | -- | [Device Para /LEDs /LEDs group A /LED 4] |









| Parameter | Description | Setting range | Default | Menu path |
|---|---|---|----------|---|
| LED active color  | The LED lights up in this color if the state of the OR-assignment of the signals is true. | green, red, red flash, green flash, - | red | [Device Para /LEDs /LEDs group A /LED 4] |
| LED inactive color  | The LED lights up in this color if the state of the OR-assignment of the signals is untrue. | green, red, red flash, green flash, - | - | [Device Para /LEDs /LEDs group A /LED 4] |
| Assignment 1  | Assignment | 1..n, Assignment List | .- | [Device Para /LEDs /LEDs group A /LED 4] |
| Inverting 1  | Inverting of the state of the assigned signal. | inactive, active | inactive | [Device Para /LEDs /LEDs group A /LED 4] |
| Assignment 2  | Assignment | 1..n, Assignment List | .- | [Device Para /LEDs /LEDs group A /LED 4] |
| Inverting 2  | Inverting of the state of the assigned signal. | inactive, active | inactive | [Device Para /LEDs /LEDs group A /LED 4] |
| Assignment 3  | Assignment | 1..n, Assignment List | .- | [Device Para /LEDs /LEDs group A /LED 4] |
| Inverting 3  | Inverting of the state of the assigned signal. | inactive, active | inactive | [Device Para /LEDs /LEDs group A /LED 4] |
| Assignment 4  | Assignment | 1..n, Assignment List | .- | [Device Para /LEDs /LEDs group A /LED 4] |

| Parameter | Description | Setting range | Default | Menu path |
|---|---|---|----------|---|
| Inverting 4  | Inverting of the state of the assigned signal. | inactive, active | inactive | [Device Para /LEDs /LEDs group A /LED 4] |
| Assignment 5  | Assignment | 1..n, Assignment List | -- | [Device Para /LEDs /LEDs group A /LED 4] |
| Inverting 5  | Inverting of the state of the assigned signal. | inactive, active | inactive | [Device Para /LEDs /LEDs group A /LED 4] |
| Latched  | Defines whether the LED will be latched when it picks up. | inactive, active | inactive | [Device Para /LEDs /LEDs group A /LED 5] |
| Ack signal  | Acknowledgement signal for the LED. If latching is set to active the LED can only be acknowledged if those signals that initiated the setting are no longer present. Only available if: Latched = active | 1..n, Assignment List | -- | [Device Para /LEDs /LEDs group A /LED 5] |
| LED active color  | The LED lights up in this color if the state of the OR-assignment of the signals is true. | green, red, red flash, green flash, - | red | [Device Para /LEDs /LEDs group A /LED 5] |
| LED inactive color  | The LED lights up in this color if the state of the OR-assignment of the signals is untrue. | green, red, red flash, green flash, - | - | [Device Para /LEDs /LEDs group A /LED 5] |
| Assignment 1  | Assignment | 1..n, Assignment List | -- | [Device Para /LEDs /LEDs group A /LED 5] |
| Inverting 1  | Inverting of the state of the assigned signal. | inactive, active | inactive | [Device Para /LEDs /LEDs group A /LED 5] |

| <i>Parameter</i> | <i>Description</i> | <i>Setting range</i> | <i>Default</i> | <i>Menu path</i> |
|---|---|-----------------------|----------------|--|
| Assignment 2  | Assignment | 1..n, Assignment List | -- | [Device Para /LEDs /LEDs group A /LED 5] |
| Inverting 2  | Inverting of the state of the assigned signal. | inactive, active | inactive | [Device Para /LEDs /LEDs group A /LED 5] |
| Assignment 3  | Assignment | 1..n, Assignment List | -- | [Device Para /LEDs /LEDs group A /LED 5] |
| Inverting 3  | Inverting of the state of the assigned signal. | inactive, active | inactive | [Device Para /LEDs /LEDs group A /LED 5] |
| Assignment 4  | Assignment | 1..n, Assignment List | -- | [Device Para /LEDs /LEDs group A /LED 5] |
| Inverting 4  | Inverting of the state of the assigned signal. | inactive, active | inactive | [Device Para /LEDs /LEDs group A /LED 5] |
| Assignment 5  | Assignment | 1..n, Assignment List | -- | [Device Para /LEDs /LEDs group A /LED 5] |
| Inverting 5  | Inverting of the state of the assigned signal. | inactive, active | inactive | [Device Para /LEDs /LEDs group A /LED 5] |
| Latched  | Defines whether the LED will be latched when it picks up. | inactive, active | inactive | [Device Para /LEDs /LEDs group A /LED 6] |

| <i>Parameter</i> | <i>Description</i> | <i>Setting range</i> | <i>Default</i> | <i>Menu path</i> |
|---|---|---|----------------|---|
| Ack signal  | Acknowledgement signal for the LED. If latching is set to active the LED can only be acknowledged if those signals that initiated the setting are no longer present. Only available if: Latched = active | 1..n, Assignment List | -- | [Device Para /LEDs /LEDs group A /LED 6] |
| LED active color  | The LED lights up in this color if the state of the OR-assignment of the signals is true. | green, red, red flash, green flash, - | red | [Device Para /LEDs /LEDs group A /LED 6] |
| LED inactive color  | The LED lights up in this color if the state of the OR-assignment of the signals is untrue. | green, red, red flash, green flash, - | - | [Device Para /LEDs /LEDs group A /LED 6] |
| Assignment 1  | Assignment | 1..n, Assignment List | -- | [Device Para /LEDs /LEDs group A /LED 6] |
| Inverting 1  | Inverting of the state of the assigned signal. | inactive, active | inactive | [Device Para /LEDs /LEDs group A /LED 6] |
| Assignment 2  | Assignment | 1..n, Assignment List | -- | [Device Para /LEDs /LEDs group A /LED 6] |
| Inverting 2  | Inverting of the state of the assigned signal. | inactive, active | inactive | [Device Para /LEDs /LEDs group A /LED 6] |
| Assignment 3  | Assignment | 1..n, Assignment List | -- | [Device Para /LEDs /LEDs group A /LED 6] |
| Inverting 3  | Inverting of the state of the assigned signal. | inactive, active | inactive | [Device Para /LEDs /LEDs group A /LED 6] |

| Parameter | Description | Setting range | Default | Menu path |
|---|---|---|----------|---|
| Assignment 4  | Assignment | 1..n, Assignment List | -.- | [Device Para /LEDs /LEDs group A /LED 6] |
| Inverting 4  | Inverting of the state of the assigned signal. | inactive, active | inactive | [Device Para /LEDs /LEDs group A /LED 6] |
| Assignment 5  | Assignment | 1..n, Assignment List | -.- | [Device Para /LEDs /LEDs group A /LED 6] |
| Inverting 5  | Inverting of the state of the assigned signal. | inactive, active | inactive | [Device Para /LEDs /LEDs group A /LED 6] |
| Latched  | Defines whether the LED will be latched when it picks up. | inactive, active | inactive | [Device Para /LEDs /LEDs group A /LED 7] |
| Ack signal  | Acknowledgement signal for the LED. If latching is set to active the LED can only be acknowledged if those signals that initiated the setting are no longer present. Only available if: Latched = active | 1..n, Assignment List | -.- | [Device Para /LEDs /LEDs group A /LED 7] |
| LED active color  | The LED lights up in this color if the state of the OR-assignment of the signals is true. | green, red, red flash, green flash, - | red | [Device Para /LEDs /LEDs group A /LED 7] |
| LED inactive color  | The LED lights up in this color if the state of the OR-assignment of the signals is untrue. | green, red, red flash, green flash, - | - | [Device Para /LEDs /LEDs group A /LED 7] |
| Assignment 1  | Assignment | 1..n, Assignment List | -.- | [Device Para /LEDs /LEDs group A /LED 7] |

| <i>Parameter</i> | <i>Description</i> | <i>Setting range</i> | <i>Default</i> | <i>Menu path</i> |
|---|--|--------------------------|----------------|---|
| Inverting 1  | Inverting of the state of the assigned signal. | inactive, active | inactive | [Device Para /LEDs /LEDs group A /LED 7] |
| Assignment 2  | Assignment | 1..n, Assignment List | -- | [Device Para /LEDs /LEDs group A /LED 7] |
| Inverting 2  | Inverting of the state of the assigned signal. | inactive, active | inactive | [Device Para /LEDs /LEDs group A /LED 7] |
| Assignment 3  | Assignment | 1..n, Assignment List | -- | [Device Para /LEDs /LEDs group A /LED 7] |
| Inverting 3  | Inverting of the state of the assigned signal. | inactive, active | inactive | [Device Para /LEDs /LEDs group A /LED 7] |
| Assignment 4  | Assignment | 1..n, Assignment List | -- | [Device Para /LEDs /LEDs group A /LED 7] |
| Inverting 4  | Inverting of the state of the assigned signal. | inactive, active | inactive | [Device Para /LEDs /LEDs group A /LED 7] |
| Assignment 5  | Assignment | 1..n, Assignment List | -- | [Device Para /LEDs /LEDs group A /LED 7] |
| Inverting 5  | Inverting of the state of the assigned signal. | inactive, active | inactive | [Device Para /LEDs /LEDs group A /LED 7] |

LED Module Input States

| <i>Name</i> | <i>Description</i> | <i>Assignment via</i> |
|--------------|---|---|
| LED1.1 | Module input state: LED | [Device Para /LEDs /LEDs group A /LED 1] |
| LED1.2 | Module input state: LED | [Device Para /LEDs /LEDs group A /LED 1] |
| LED1.3 | Module input state: LED | [Device Para /LEDs /LEDs group A /LED 1] |
| LED1.4 | Module input state: LED | [Device Para /LEDs /LEDs group A /LED 1] |
| LED1.5 | Module input state: LED | [Device Para /LEDs /LEDs group A /LED 1] |
| Acknow Sig 1 | Module input state: Acknowledgement Signal (only for automatic acknowledgement) | [Device Para /LEDs /LEDs group A /LED 1] |
| LED2.1 | Module input state: LED | [Device Para /LEDs /LEDs group A /LED 2] |
| LED2.2 | Module input state: LED | [Device Para /LEDs /LEDs group A /LED 2] |
| LED2.3 | Module input state: LED | [Device Para /LEDs /LEDs group A /LED 2] |

Input, Output and LED Settings

| <i>Name</i> | <i>Description</i> | <i>Assignment via</i> |
|--------------|---|---|
| LED2.4 | Module input state: LED | [Device Para /LEDs /LEDs group A /LED 2] |
| LED2.5 | Module input state: LED | [Device Para /LEDs /LEDs group A /LED 2] |
| Acknow Sig 2 | Module input state: Acknowledgement Signal (only for automatic acknowledgement) | [Device Para /LEDs /LEDs group A /LED 2] |
| LED3.1 | Module input state: LED | [Device Para /LEDs /LEDs group A /LED 3] |
| LED3.2 | Module input state: LED | [Device Para /LEDs /LEDs group A /LED 3] |
| LED3.3 | Module input state: LED | [Device Para /LEDs /LEDs group A /LED 3] |
| LED3.4 | Module input state: LED | [Device Para /LEDs /LEDs group A /LED 3] |
| LED3.5 | Module input state: LED | [Device Para /LEDs /LEDs group A /LED 3] |
| Acknow Sig 3 | Module input state: Acknowledgement Signal (only for automatic acknowledgement) | [Device Para /LEDs /LEDs group A /LED 3] |

Input, Output and LED Settings

| Name | Description | Assignment via |
|--------------|---|---|
| LED4.1 | Module input state: LED | [Device Para /LEDs /LEDs group A /LED 4] |
| LED4.2 | Module input state: LED | [Device Para /LEDs /LEDs group A /LED 4] |
| LED4.3 | Module input state: LED | [Device Para /LEDs /LEDs group A /LED 4] |
| LED4.4 | Module input state: LED | [Device Para /LEDs /LEDs group A /LED 4] |
| LED4.5 | Module input state: LED | [Device Para /LEDs /LEDs group A /LED 4] |
| Acknow Sig 4 | Module input state: Acknowledgement Signal (only for automatic acknowledgement) | [Device Para /LEDs /LEDs group A /LED 4] |
| LED5.1 | Module input state: LED | [Device Para /LEDs /LEDs group A /LED 5] |
| LED5.2 | Module input state: LED | [Device Para /LEDs /LEDs group A /LED 5] |
| LED5.3 | Module input state: LED | [Device Para /LEDs /LEDs group A /LED 5] |

Input, Output and LED Settings

| <i>Name</i> | <i>Description</i> | <i>Assignment via</i> |
|--------------|---|---|
| LED5.4 | Module input state: LED | [Device Para /LEDs /LEDs group A /LED 5] |
| LED5.5 | Module input state: LED | [Device Para /LEDs /LEDs group A /LED 5] |
| Acknow Sig 5 | Module input state: Acknowledgement Signal (only for automatic acknowledgement) | [Device Para /LEDs /LEDs group A /LED 5] |
| LED6.1 | Module input state: LED | [Device Para /LEDs /LEDs group A /LED 6] |
| LED6.2 | Module input state: LED | [Device Para /LEDs /LEDs group A /LED 6] |
| LED6.3 | Module input state: LED | [Device Para /LEDs /LEDs group A /LED 6] |
| LED6.4 | Module input state: LED | [Device Para /LEDs /LEDs group A /LED 6] |
| LED6.5 | Module input state: LED | [Device Para /LEDs /LEDs group A /LED 6] |
| Acknow Sig 6 | Module input state: Acknowledgement Signal (only for automatic acknowledgement) | [Device Para /LEDs /LEDs group A /LED 6] |

| <i>Name</i> | <i>Description</i> | <i>Assignment via</i> |
|--------------|---|---|
| LED7.1 | Module input state: LED | [Device Para /LEDs /LEDs group A /LED 7] |
| LED7.2 | Module input state: LED | [Device Para /LEDs /LEDs group A /LED 7] |
| LED7.3 | Module input state: LED | [Device Para /LEDs /LEDs group A /LED 7] |
| LED7.4 | Module input state: LED | [Device Para /LEDs /LEDs group A /LED 7] |
| LED7.5 | Module input state: LED | [Device Para /LEDs /LEDs group A /LED 7] |
| Acknow Sig 7 | Module input state: Acknowledgement Signal (only for automatic acknowledgement) | [Device Para /LEDs /LEDs group A /LED 7] |

LED configuration

The LEDs can be configured within menu:

[Device Para/LEDs/Group X]

CAUTION

Attention must be paid that there are no overlapping functions due to double or multiple LED assignment of colors and flashing codes.

CAUTION

If LEDs are parameterized »Latched=*active*«, they will keep (return into) their blink code/color even if there is a break within the power supply.

If LEDs are parameterized »Latched=*active*«, The LED blink code will also retain, if the LED is reprogrammed in another way. This applies also if »Latched is set to *inactive*«. Resetting a LED that has latched a signal will always require an acknowledgement.

NOTICE

This chapter contains information on the LEDs that are placed on the left hand of the display (group A).

If your device is also equipped with LEDs on the right hand of the display (group B), the information in this chapter is valid analog. The only difference is "group A" and "group B" within the menu paths.

Via push button »INFO« it is always possible to display the current alarms/alarm texts that are assigned to an LED. Please refer to chapter *Navigation* (description of the »INFO-key«).

Set the following parameters for each LED:

- »Latching/self holding function«. If »Latching« is set to »*active*«, the state that is set by the alarms will be stored. If latching »Latching« is set to »*inactive*«, the LED always adopts the state of those alarms that were assigned.
- »Acknowledgment« (signal from the »assignment list«)
- »LED active color«, LED lights up in this color in case that at least one of the allocated functions is valid (red, red flashing, green, green flashing, off).
- »LED inactive color«, LED lights up in this color in case that none of the allocated functions is valid (red, red flashing, green, green flashing, off).
- Apart from the *LED for System OK*, each LED can be assigned up to five functions/alarms out of the »assignment list«.
- »Inverting« (of the signals), if necessary.

Acknowledgment options

LEDs can be acknowledged by:

- Via the push-button »C« at the operating panel.
- Each LED can be acknowledged by a signal of the »assignment list« (If »*Latched = active*«).
- Via the module »Ex Acknowledge« all LEDs can be acknowledged at once, if the signal for external acknowledgment that was selected from the »assignment list« becomes true (e.g. the state of a digital input).
- Via SCADA, all LEDs can be acknowledged at once.

NOTICE

The Product-CD that is delivered with the device contains a PDF-Template in order to create and print out self adhesive films for LED assignment texts (front foil) by means of a laser printer. Recommendation: (AVERY Zweckform Art.Nr.3482)

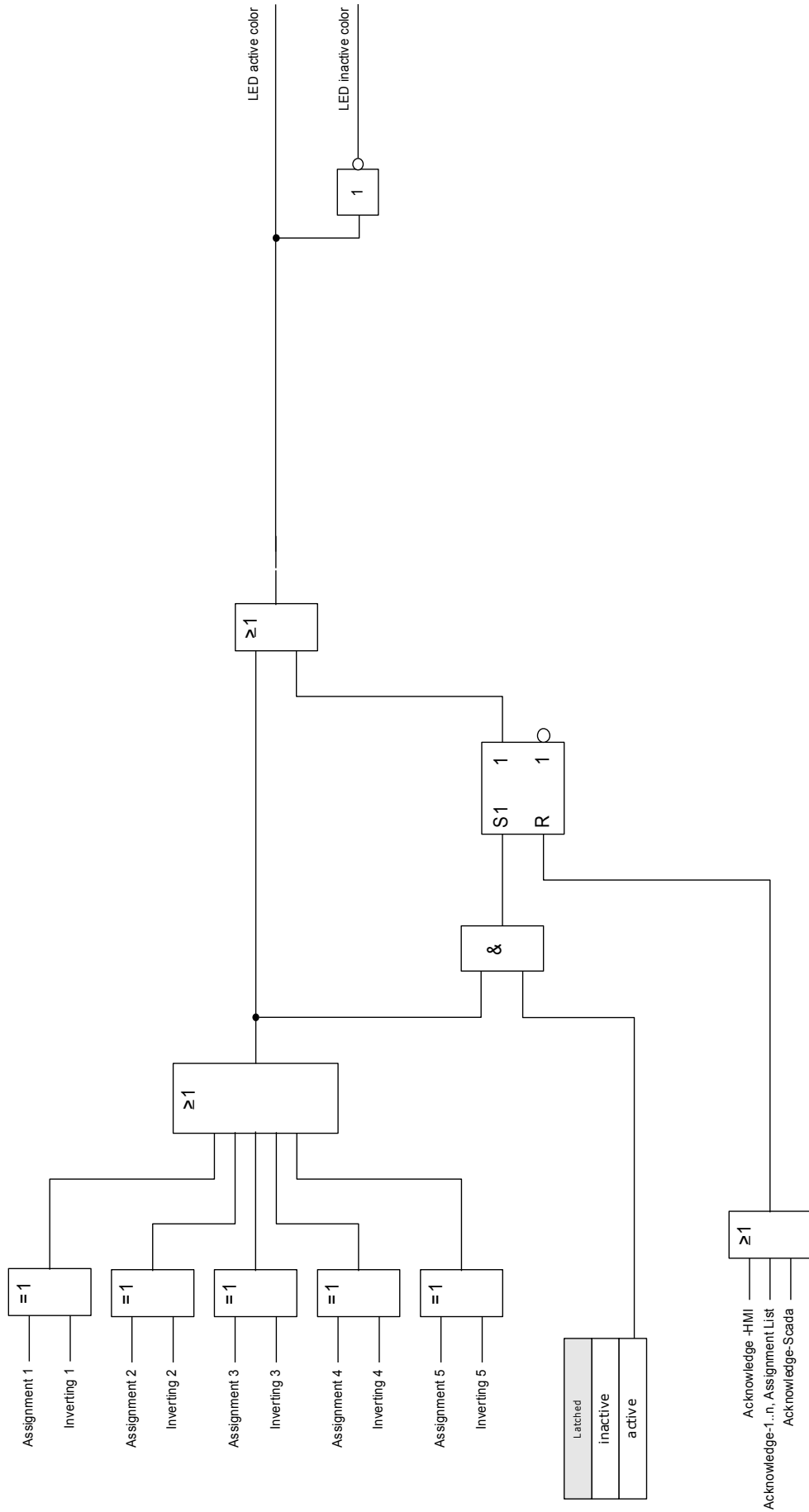

The »System OK« LED

This LED flashes green while the device is booting. After completed booting, the LED for *System OK* lights up in green thus signaling that the *protection* (function) is »*activated*«. Please refer to chapter "Self-Supervision" and to the external document "*Trouble Shooting Guide*" to find out further information on blink codes of the *System OK LED*

LED System OK cannot be parameterized.

Smart View

Smart view is a parameter setting and evaluation software. Please see separate manual (DOK-HB-SMARTVE).

- Menu-controlled parameter setting incl. validity checks
- Offline configuration of all relay types
- Reading and evaluating of statistical data and measuring values
- Setting into operation assistance
- Display of the device status
- Fault analysis via event- and fault recorder

Data visualizer

Data visualizer is an disturbance record and event viewing software. It is installed automatically with *Smart view*. It can also be used as a standard COMTRADE file viewer.

- Open and review downloaded disturbance records.
- Customize disturbance record channel layout and views including channel overlapping and zooming
- Analyze sample by sample data points and line up the displayed analog waveform channels along with the recorded internal relay logic
- Save window setups (snapshots) and print for reporting
- Open industry standard COMTRADE files from other intelligent electronic devices
- Convert downloaded waveform files to COMTRADE file format using "Export" feature

Wide Frequency Range

The frequency will be calculated based on the three phase voltages as well as the fourth voltage measuring input.

Some protective elements are using Discrete Fourier Transformation (DFT) in order to extract the fundamentals and phase angles from the measured values. Other protective elements are using True RMS values. For some protective elements, the User can specify if they should work based on DFT or True RMS values.

The calculation of measuring quantities via DFT is very fast. The values are calculated several times per cycle. For some technical reasons, the calculation of DFT values is only possible if the frequency is close to the nominal frequency (+/- 5 Hz). If the frequency is out of the nominal frequency range, the DFT values are no longer precise. That is why protective elements (and directional features), that work based on DFT values, will be blocked either because they are set fixed to DFT or they are set by the User to DFT, as soon as the frequency leaves the nominal range (+/- 5 Hz).

Protective elements, that are working based on True RMS values are able to work in a wide frequency range (5-70 Hz). For technical reasons, the True RMS based calculation of measured values will be done once per cycle. The lower the frequency, the longer the cycle, the slower the calculation will become. That means that the True RMS based calculations will have longer settling times (<2 cycles). This especially applies the lower the frequency is.

The duration of a cycle will be calculated based on the voltage measuring channels. The duration of a cycle for True RMS is possible if the voltage magnitudes exceeds 10 V. In case the cycle duration cannot be determined, the rated frequency will be assumed for DFT and True RMS calculations. As soon as a sufficient magnitude is fed to the relay, the wide frequency range will be activated a few cycles later (after the settling time) if the frequency is out of the nominal range.

| $ (f - fN) < 5 \text{ Hz}$ | $ (f - fN) > 5 \text{ Hz}$ |
|--|--|
| DFT available: The measured values are calculated several times per cycle. | DFT imprecise: Protective elements will be blocked. |
| True RMS available: The measured values are calculated several times per cycle. | True RMS available 5-70 Hz: Measured values are updated after each cycle. |

The dropout ratio is 1 Hz below 5 Hz.

Measuring Values

Read out Measured Values

In menu »Operation/Measured Values« both measured and calculated values can be viewed. The measured values are ordered by »Standard values« and »special values« (depending on the type of device).

Measurement Display

Menu [Device Para\Measurem Display] offers options to change the display of measured values.

Scaling of Measured values

By means of the parameter »Scaling« the user can determine how measured values are to be displayed within the HMI and *Smart view*.

- Primary quantities
- Secondary quantities
- Per Unit quantities

Power Units (applies only for devices with power measurement)

By means of the parameter »Power Units« the User can determine how measured values are to be displayed within the HMI and *Smart view*.

- Power Auto Scaling
- kW, kVAr or kVA
- MW, MVar or MVA
- GW, GVar or GVA

Energy Units (applies only for devices with energy measurement)

By means of the parameter »Energy Units« the User can determine how measured values are to be displayed within the HMI and *Smart view*:

- Energy Auto Scaling
- kWh, kVAh or kVAh
- MWh, MVAh or MVAh
- GWh, GVAh or GVAh

In case of an overflow of the counter, the counter will start counting again at zero. A corresponding signal will indicate the counter overflow.

Counter overflow at:

- | | |
|-----------------------|--|
| ■ Energy Auto Scaling | Depends on the settings for the current and voltage transformers |
| ■ kWh, kVAh or kVAh | 999,999.99 |
| ■ MWh, MVAh or MVAh | 999,999.99 |
| ■ GWh, GVAh or GVAh | 999,999.99 |

Temperature Unit (applies only for devices with temperature measurement)

By means of the parameter »Temperatur Unit« the User can determine how measured values are to be displayed within the HMI and *Smart view*:

- ° Celsius
- ° Fahrenheit

Cutoff level

In order to suppress noise within measured values that are close to zero the user has the option to set cutoff levels. By means of the cutoff levels, measuring quantities that are close to zero will be displayed as zero. These parameters have no impact on recorded values.

Current - Measured Values

Verfügbare Elemente:
[StW Sternp, StW Netz]

CT

If the device is not equipped with an voltage measuring card the first measuring input on the first current measuring card (slot with the lowest number) will be used as the reference angle (»IL 1«).

| Value | Description | Menu path |
|---------|--|--|
| IL1 | Measured value: Phase current (fundamental) | [Operation /Measured Values /Current] |
| IL2 | Measured value: Phase current (fundamental) | [Operation /Measured Values /Current] |
| IL3 | Measured value: Phase current (fundamental) | [Operation /Measured Values /Current] |
| IG meas | Measured value (measured): IG (fundamental) | [Operation /Measured Values /Current] |
| IG calc | Measured value (calculated): IG (fundamental) | [Operation /Measured Values /Current] |
| I0 | Measured value (calculated): Zero current (fundamental) | [Operation /Measured Values /Current] |
| I1 | Measured value (calculated): Positive phase sequence current (fundamental) | [Operation /Measured Values /Current] |
| I2 | Measured value (calculated): Unbalanced load current (fundamental) | [Operation /Measured Values /Current] |
| IL1 H2 | Measured value: 2nd harmonic/1st harmonic of IL1 | [Operation /Measured Values /Current] |

Measuring Values

| <i>Value</i> | <i>Description</i> | <i>Menu path</i> |
|--------------|---|---|
| IL2 H2 | Measured value: 2nd harmonic/1st harmonic of IL2 | [Operation /Measured Values /Current] |
| IL3 H2 | Measured value: 2nd harmonic/1st harmonic of IL3 | [Operation /Measured Values /Current] |
| IG H2 meas | Measured value: 2nd harmonic/1st harmonic of IG (measured) | [Operation /Measured Values /Current] |
| IG H2 calc | Measured value (calculated): 2nd harmonic/1st harmonic of IG (calculated) | [Operation /Measured Values /Current] |
| phi IL1 | Measured value (calculated): Angle of Phasor IL1 | [Operation /Measured Values /Current] |
| phi IL2 | Measured value (calculated): Angle of Phasor IL2 | [Operation /Measured Values /Current] |
| phi IL3 | Measured value (calculated): Angle of Phasor IL3 | [Operation /Measured Values /Current] |
| phi IG meas | Measured value (calculated): Angle of Phasor IG meas | [Operation /Measured Values /Current] |
| phi IG calc | Measured value (calculated): Angle of Phasor IG calc | [Operation /Measured Values /Current] |
| phi I0 | Measured value (calculated): Angle Zero Sequence System | [Operation /Measured Values /Current] |
| phi I1 | Measured value (calculated): Angle of Positive Sequence System | [Operation /Measured Values /Current] |
| phi I2 | Measured Value (calculated): Angle of Negative Sequence System | [Operation /Measured Values /Current] |
| IL1 RMS | Measured value: Phase current (RMS) | [Operation /Measured Values /Current RMS] |

Measuring Values

| <i>Value</i> | <i>Description</i> | <i>Menu path</i> |
|--------------|--|---|
| IL2 RMS | Measured value: Phase current (RMS) | [Operation /Measured Values /Current RMS] |
| IL3 RMS | Measured value: Phase current (RMS) | [Operation /Measured Values /Current RMS] |
| IG meas RMS | Measured value (measured): IG (RMS) | [Operation /Measured Values /Current RMS] |
| IG calc RMS | Measured value (calculated): IG (RMS) | [Operation /Measured Values /Current RMS] |
| %IL1 THD | Measured value (calculated): IL1 Total Harmonic Distortion | [Operation /Measured Values /Current RMS] |
| %IL2 THD | Measured value (calculated): IL2 Total Harmonic Distortion | [Operation /Measured Values /Current RMS] |
| %IL3 THD | Measured value (calculated): IL3 Total Harmonic Distortion | [Operation /Measured Values /Current RMS] |
| IL1 THD | Measured value (calculated): IL1 Total Harmonic Current | [Operation /Measured Values /Current RMS] |
| IL2 THD | Measured value (calculated): IL2 Total Harmonic Current | [Operation /Measured Values /Current RMS] |
| IL3 THD | Measured value (calculated): IL3 Total Harmonic Current | [Operation /Measured Values /Current RMS] |
| %(I2/I1) | Measured value (calculated): I2/I1, phase sequence will be taken into account automatically. | [Operation /Measured Values /Current] |

Voltage - Measured Values

VT

The first measuring input on the first measuring card (slot with the lowest number) is used as the reference angle.
E.g. » VL 1« respectively » VL 12«.

| <i>Value</i> | <i>Description</i> | <i>Menu path</i> |
|--------------|--|--|
| f | Measured value: Frequency | [Operation /Measured Values /Voltage] |
| VL12 | Measured value: Phase-to-phase voltage (fundamental) | [Operation /Measured Values /Voltage] |
| VL23 | Measured value: Phase-to-phase voltage (fundamental) | [Operation /Measured Values /Voltage] |
| VL31 | Measured value: Phase-to-phase voltage (fundamental) | [Operation /Measured Values /Voltage] |
| VL1 | Measured value: Phase-to-neutral voltage (fundamental) | [Operation /Measured Values /Voltage] |
| VL2 | Measured value: Phase-to-neutral voltage (fundamental) | [Operation /Measured Values /Voltage] |
| VL3 | Measured value: Phase-to-neutral voltage (fundamental) | [Operation /Measured Values /Voltage] |
| VX meas | Measured value (measured): VX measured (fundamental) | [Operation /Measured Values /Voltage] |
| VG calc | Measured value (calculated): VG (fundamental) | [Operation /Measured Values /Voltage] |
| V0 | Measured value (calculated): Symmetrical components Zero voltage(fundamental) | [Operation /Measured Values /Voltage] |
| V1 | Measured value (calculated): Symmetrical components positive phase sequence voltage(fundamental) | [Operation /Measured Values /Voltage] |

Measuring Values

| <i>Value</i> | <i>Description</i> | <i>Menu path</i> |
|--------------|--|---|
| V2 | Measured value (calculated): Symmetrical components negative phase sequence voltage(fundamental) | [Operation /Measured Values /Voltage] |
| VL12 RMS | Measured value: Phase-to-phase voltage (RMS) | [Operation /Measured Values /Voltage RMS] |
| VL23 RMS | Measured value: Phase-to-phase voltage (RMS) | [Operation /Measured Values /Voltage RMS] |
| VL31 RMS | Measured value: Phase-to-phase voltage (RMS) | [Operation /Measured Values /Voltage RMS] |
| VL1 RMS | Measured value: Phase-to-neutral voltage (RMS) | [Operation /Measured Values /Voltage RMS] |
| VL2 RMS | Measured value: Phase-to-neutral voltage (RMS) | [Operation /Measured Values /Voltage RMS] |
| VL3 RMS | Measured value: Phase-to-neutral voltage (RMS) | [Operation /Measured Values /Voltage RMS] |
| VX meas RMS | Measured value (measured): VX measured (RMS) | [Operation /Measured Values /Voltage RMS] |
| VG calc RMS | Measured value (calculated): VG (RMS) | [Operation /Measured Values /Voltage RMS] |
| phi VL12 | Measured value (calculated): Angle of Phasor VL12 | [Operation /Measured Values /Voltage] |
| phi VL23 | Measured value (calculated): Angle of Phasor VL23 | [Operation /Measured Values /Voltage] |
| phi VL31 | Measured value (calculated): Angle of Phasor VL31 | [Operation /Measured Values /Voltage] |
| phi VL1 | Measured value (calculated): Angle of Phasor VL1 | [Operation /Measured Values /Voltage] |

Measuring Values

| Value | Description | Menu path |
|-------------|--|---|
| phi VL2 | Measured value (calculated): Angle of Phasor VL2 | [Operation /Measured Values /Voltage] |
| phi VL3 | Measured value (calculated): Angle of Phasor VL3 | [Operation /Measured Values /Voltage] |
| phi VX meas | Measured value: Angle of Phasor VX meas | [Operation /Measured Values /Voltage] |
| phi VG calc | Measured value (calculated): Angle of Phasor VG calc | [Operation /Measured Values /Voltage] |
| phi V0 | Measured value (calculated): Angle Zero Sequence System | [Operation /Measured Values /Voltage] |
| phi V1 | Measured value (calculated): Angle of Positive Sequence System | [Operation /Measured Values /Voltage] |
| phi V2 | Measured Value (calculated): Angle of Negative Sequence System | [Operation /Measured Values /Voltage] |
| %(V2/V1) | Measured value (calculated): V2/V1, phase sequence will be taken into account automatically. | [Operation /Measured Values /Voltage] |
| %VL12 THD | Measured value (calculated): V12 Total Harmonic Distortion / Ground wave | [Operation /Measured Values /Voltage RMS] |
| %VL23 THD | Measured value (calculated): V23 Total Harmonic Distortion / Ground wave | [Operation /Measured Values /Voltage RMS] |
| %VL31 THD | Measured value (calculated): V31 Total Harmonic Distortion / Ground wave | [Operation /Measured Values /Voltage RMS] |
| %VL1 THD | Measured value (calculated): VL1 Total Harmonic Distortion / Ground wave | [Operation /Measured Values /Voltage RMS] |

Measuring Values

| <i>Value</i> | <i>Description</i> | <i>Menu path</i> |
|--------------|--|---|
| %VL2 THD | Measured value (calculated): VL2 Total Harmonic Distortion / Ground wave | [Operation /Measured Values /Voltage RMS] |
| %VL3 THD | Measured value (calculated): VL3 Total Harmonic Distortion / Ground wave | [Operation /Measured Values /Voltage RMS] |
| VL12 THD | Measured value (calculated): V12 Total Harmonic Distortion | [Operation /Measured Values /Voltage RMS] |
| VL23 THD | Measured value (calculated): V23 Total Harmonic Distortion | [Operation /Measured Values /Voltage RMS] |
| VL31 THD | Measured value (calculated): V31 Total Harmonic Distortion | [Operation /Measured Values /Voltage RMS] |
| VL1 THD | Measured value (calculated): VL1 Total Harmonic Distortion | [Operation /Measured Values /Voltage RMS] |
| VL2 THD | Measured value (calculated): VL2 Total Harmonic Distortion | [Operation /Measured Values /Voltage RMS] |
| VL3 THD | Measured value (calculated): VL3 Total Harmonic Distortion | [Operation /Measured Values /Voltage RMS] |

Power - Measured Values

| <i>Value</i> | <i>Description</i> | <i>Menu path</i> |
|-----------------|--|--|
| S | Measured Value (Calculated): Apparent power (fundamental) | [Operation /Measured Values /Power] |
| P | Measured value (calculated): Active power (P- = Fed Active Power, P+ = Consumted Active Power) (fundamental) | [Operation /Measured Values /Power] |
| Q | Measured value (calculated): Reactive power (Q- = Fed Reactive Power, Q+ = Consumted Reactive Power) (fundamental) | [Operation /Measured Values /Power] |
| cos phi | Measured value (calculated): Power factor: Sign Convention: sign(PF) = sign(P) | [Operation /Measured Values /Power] |
| Wp+ | Positive Active Power is consumed active energy | [Operation /Measured Values /Energy] |
| Wp- | Negative Active Power (Fed Energy) | [Operation /Measured Values /Energy] |
| Wq+ | Positive Reactive Power is consumed Reactive Energy | [Operation /Measured Values /Energy] |
| Wq- | Negative Reactive Power (Fed Energy) | [Operation /Measured Values /Energy] |
| Ws Net | Absolute Apparent Power Hours | [Operation /Measured Values /Energy] |
| Wp Net | Absolute Active Power Hours | [Operation /Measured Values /Energy] |
| Wq Net | Absolute Reactive Power Hours | [Operation /Measured Values /Energy] |
| Start Date/Time | Energy counters run since... (Date and time of last reset) | [Operation /Measured Values /Energy] |



Measuring Values

| <i>Value</i> | <i>Description</i> | <i>Menu path</i> |
|--------------|--|---|
| S RMS | Measured Value (Calculated): Apparent power (RMS) | [Operation /Measured Values /Power RMS] |
| P RMS | Measured value (calculated): Active power (P- = Fed Active Power, P+ = Consumted Active Power) (RMS) | [Operation /Measured Values /Power RMS] |
| cos phi RMS | Measured value (calculated): Power factor: Sign Convention: sign(PF) = sign(P) | [Operation /Measured Values /Power RMS] |
| P 1 | Measured value (calculated): Active power in positive sequence system (P- = Fed Active Power, P+ = Consumted Active Power) | [Operation /Measured Values /Power] |
| Q 1 | Measured value (calculated): Reactive power in positive sequence system (Q- = Fed Reactive Power, Q+ = Consumted Reactive Power) | [Operation /Measured Values /Power] |

Energy Counter

PQSCr

Global Parameters of the Energy Counter Module

| Parameter | Description | Setting range | Default | Menu path |
|--|---|---|--------------------|--|
|  S, P, Q Cutoff Level | The Active/Reactive/Apparent Power shown in the Display or within the PC Software will be displayed as zero, if the absolute value of the corresponding Power falls below this Cutoff Level. This parameter has no impact on recorders. | 0.0 - 0.100Sn | 0.005Sn | [Device Para /Measurement Display /Power] |
|  Power Units | Power Units | Power Auto Scaling, kW/kVAr/kVA, MW/MVAr/MVA, GW/GVAr/GVA | Power Auto Scaling | [Device Para /Measurement Display /General settings] |
|  Energy Units | Energy Units | Energy Auto Scaling, kWh/kVArh/kVAh, MWh/MVArh/MVAh, GWh/GVArh/GVAh | MWh/MVArh/MVAh | [Device Para /Measurement Display /General settings] |

Direct Commands of the Energy Counter Module

| Parameter | Description | Setting range | Default | Menu path |
|---|------------------------------|------------------|----------|--------------------|
|  Res all Energy Cr | Reset of all Energy Counters | inactive, active | inactive | [Operation /Reset] |

Signals of the Energy Counter Module (States of the Outputs)

| Signal | Description |
|----------------|---------------------------------|
| Cr OfIw Ws Net | Signal: Counter Overflow Ws Net |
| Cr OfIw Wp Net | Signal: Counter Overflow Wp Net |
| Cr OfIw Wp+ | Signal: Counter Overflow Wp+ |
| Cr OfIw Wp- | Signal: Counter Overflow Wp- |
| Cr OfIw Wq Net | Signal: Counter Overflow Wq Net |
| Cr OfIw Wq+ | Signal: Counter Overflow Wq+ |

Energy Counter

| <i>Signal</i> | <i>Description</i> |
|-------------------|---|
| Cr Oflw Wq- | Signal: Counter Overflow Wq- |
| Ws Net Res Cr | Signal: Ws Net Reset Counter |
| Wp Net Res Cr | Signal: Wp Net Reset Counter |
| Wp+ Res Cr | Signal: Wp+ Reset Counter |
| Wp- Res Cr | Signal: Wp- Reset Counter |
| Wq Net Res Cr | Signal: Wq Net Reset Counter |
| Wq+ Res Cr | Signal: Wq+ Reset Counter |
| Wq- Res Cr | Signal: Wq- Reset Counter |
| Res all Energy Cr | Signal: Reset of all Energy Counters |
| Cr OflwW Ws Net | Signal: Counter Ws Net will overflow soon |
| Cr OflwW Wp Net | Signal: Counter Wp Net will overflow soon |
| Cr OflwW Wp+ | Signal: Counter Wp+ will overflow soon |
| Cr OflwW Wp- | Signal: Counter Wp- will overflow soon |
| Cr OflwW Wq Net | Signal: Counter Wq Net will overflow soon |
| Cr OflwW Wq+ | Signal: Counter Wq+ will overflow soon |
| Cr OflwW Wq- | Signal: Counter Wq- will overflow soon |

Statistics

Statistics

In menu »*Operation/Statistics*« the min., max. and mean values of the measured and calculated measured quantities can be found.

Configuration of the Minimum and Maximum Values

The calculation of the minimum and maximum values will be started:

- When a Reset signal becomes active (Min/Max)
- When the device is restarted
- After configuration

| <i>Minimum and Maximum Values (Peak Values/Pointers)</i> | | |
|---|--|---|
| | Time interval for the calculation of the minimum and maximum values | Reset |
| <i>Configuration Options</i> Where to configure? Within menu [Device Para\ Statistics\ Min/Max] | The minimum and maximum values will be reset with the rising edge of the corresponding reset signal. | Res Min Res Max (e.g. via digital Inputs). These signals will reset the minimum and maximum pointers. |
| <i>Display of Minimum Values</i> | Where? Within menu [Operation\Statistics\Min] | |
| <i>Display of Maximum Values</i> | Where? Within menu [Operation\Statistics\Max] | |

Configuration of the Average Value Calculation

Configuration of the Current Based Average Value Calculation*

*=Availability depends on the ordered device code.

| Current based Average Values and Peak Values | | | |
|--|--|--|--|
| | Time period for the calculation of the average and peak values | Start options | Reset of the average and peak values |
| Configuration Options Where to configure? In [Device Para\ Statistics\ Demand\ Current Demand] | sliding: (sliding: average calculation based on sliding period) fixed: (fixed: Average calculation is reset by the end of the period, that means with the next starting period) | duration: (fixed or sliding period) Start Fct: (The average values are calculated based on the time period between two rising edges of this signal) | Res Fc (e.g. via Digital Input in order to reset the average values in advance (before the next rising edge of the start signal). This applies to option „Start FC“ only. |
| <i>Trip (command) option to limit the average current demand: Yes</i> | Please refer to chapter „System Alarms“ | | |
| <i>View average values and peak values</i> | Where? Within menu [Operation\Statistics\Demand] | | |

Configuration of the Voltage Based Average Value Calculation*

*=Availability depends on the ordered device code.





| Voltage based Average Values | | | |
|---|--|--|--|
| | Time period for the calculation of the average values | Start options | Reset of the average and peak values |
| Configuration Options Where to configure? In [Device Para\ Statistics\ Umit] | sliding: (sliding: average calculation based on sliding period) fixed: (fixed: Average calculation is reset by the end of the period, that means with the next starting period) | duration: (fixed or sliding period) Start Fct: (The average values are calculated based on the time period between two rising edges of this signal) | Res Fc (e.g. via Digital Input in order to reset the average values in advance (before the next rising edge of the start signal). This applies to option „Start FC“ only. |
| <i>View average values</i> | Where? Within menu [Operation\Statistics\Vavg] | | |

Configuration of the Power Based Average Value Calculation*





*=Availability depends on the ordered device code.







| <i>Power based Average Values (Demand) and Peak Values</i> | | | |
|--|--|--|--|
| | Time period for the calculation of the average and peak values | Start options | Reset of the average and peak values |
| Configuration Options Where to configure? In [Device Para\ Statistics\ Bezugsmanagm\ Power Demand] | sliding: (sliding: average calculation based on sliding period) fixed: (fixed: Average calculation is reset by the end of the period, that means with the next starting period) | duration: (fixed or sliding period) Start Fct: (The average values are calculated based on the time period between two rising edges of this signal) | Res Fc (e.g. via Digital Input in order to reset the average values in advance (before the next rising edge of the start signal). This applies to option „Start FC“ only. |
| <i>Trip (command) option to limit the average power demand: Yes</i> | Please refer to chapter „System Alarms“ | | |
| <i>View average values and peak values</i> | Where? Within menu [Operation\Statistics\Demand] | | |





Direct Commands



| Parameter | Description | Setting range | Default | Menu path |
|---|--|---------------------|----------|-----------------------|
| ResFc all  | Resetting of all Statistic values (Current Demand, Power Demand, Min, Max) | inactive, active | inactive | [Operation /Reset] |
| ResFc Vavg  | Resetting of the sliding average calculation. | inactive, active | inactive | [Operation /Reset] |
| ResFc I Demand  | Resetting of Statistics - Current Demand (avg, peak avg) | inactive, active | inactive | [Operation /Reset] |
| ResFc P Demand  | Resetting of Statistics - Power Demand (avg, peak avg) | inactive, active | inactive | [Operation /Reset] |
| ResFc Min  | Resetting of all Minimum values | inactive, active | inactive | [Operation /Reset] |
| ResFc Max  | Resetting of all Maximum values | inactive, active | inactive | [Operation /Reset] |

Global Protection Parameters of the Statistics Module

| Parameter | Description | Setting range | Default | Menu path |
|--|---|-----------------------|----------|--|
| ResFc Max  | Resetting of all Maximum values | 1..n, Assignment List | .- | [Device Para /Statistics /Min / Max] |
| ResFc Min  | Resetting of all Minimum values | 1..n, Assignment List | .- | [Device Para /Statistics /Min / Max] |
| Start Vavg via:  | Start sliding average supervision by: | Duration, StartFct | Duration | [Device Para /Statistics /Vavg] |
| Start Vavg Fc  | Start of the calculation, if the assigned signal becomes true. Only available if: Start P Demand via: = StartFct | 1..n, Assignment List | .- | [Device Para /Statistics /Vavg] |

| Parameter | Description | Setting range | Default | Menu path |
|--|---|--|----------|---|
| ResFc Vavg  | Resetting of the sliding average calculation. | 1..n, Assignment List | -- | [Device Para /Statistics /Vavg] |
| Duration Vavg  | Recording time | 2 s, 5 s, 10 s, 15 s, 30 s, 1 min, 5 min, 10 min, 15 min, 30 min, 1 h, 2 h, 6 h, 12 h, 1 d, 2 d, 5 d, 7 d, 10 d, 30 d | 10 min | [Device Para /Statistics /Vavg] |
| Window Vavg  | Window configuration | sliding, fixed | sliding | [Device Para /Statistics /Vavg] |
| Start I Demand via:  | Start Current demand by: | Duration, StartFct | Duration | [Device Para /Statistics /Demand /Current Demand] |
| Start I Demand Fc  | Start of the calculation, if the assigned signal becomes true. Only available if: Start I Demand via: = StartFct | 1..n, Assignment List | -- | [Device Para /Statistics /Demand /Current Demand] |
| ResFc I Demand  | Resetting of Statistics - Current Demand (avg, peak avg) | 1..n, Assignment List | -- | [Device Para /Statistics /Demand /Current Demand] |

| Parameter | Description | Setting range | Default | Menu path |
|---|---|--|----------|--|
|  Duration I Demand | Recording time Only available if: Start I Demand via: = Duration | 2 s, 5 s, 10 s, 15 s, 30 s, 1 min, 5 min, 10 min, 15 min, 30 min, 1 h, 2 h, 6 h, 12 h, 1 d, 2 d, 5 d, 7 d, 10 d, 30 d | 15 s | [Device Para /Statistics /Demand /Current Demand] |
|  Window I Demand | Window configuration | sliding, fixed | sliding | [Device Para /Statistics /Demand /Current Demand] |
|  Start P Demand via: | Start Active Power demand by: | Duration, StartFct | Duration | [Device Para /Statistics /Demand /Power Demand] |
|  Start P Demand Fc | Start of the calculation, if the assigned signal becomes true. Only available if: Start P Demand via: = StartFct | 1..n, Assignment List | -- | [Device Para /Statistics /Demand /Power Demand] |
|  ResFc P Demand | Resetting of Statistics - Power Demand (avg, peak avg) | 1..n, Assignment List | -- | [Device Para /Statistics /Demand /Power Demand] |

| <i>Parameter</i> | <i>Description</i> | <i>Setting range</i> | <i>Default</i> | <i>Menu path</i> |
|--|---|--|----------------|--|
| Duration P Demand  | Recording time Only available if: Start P Demand via: = Duration | 2 s, 5 s, 10 s, 15 s, 30 s, 1 min, 5 min, 10 min, 15 min, 30 min, 1 h, 2 h, 6 h, 12 h, 1 d, 2 d, 5 d, 7 d, 10 d, 30 d | 15 s | [Device Para /Statistics /Demand /Power Demand] |
| Window P Demand  | Window configuration | sliding, fixed | sliding | [Device Para /Statistics /Demand /Power Demand] |

States of the Inputs of the Statistics Module

| <i>Name</i> | <i>Description</i> | <i>Assignment via</i> |
|--------------------|---|--|
| StartFc Vavg-I | State of the module input: (StartFunc3_h) | [Device Para /Statistics /Vavg] |
| StartFc I Demand-I | State of the module input: Start of the Statistics of the Current Demand | [Device Para /Statistics /Demand /Current Demand] |
| StartFc P Demand-I | State of the module input: Start of the Statistics of the Active Power Demand | [Device Para /Statistics /Demand /Power Demand] |
| ResFc Vavg-I | State of the module input: Resetting of the sliding average calculation. | [Device Para /Statistics /Vavg] |
| ResFc I Demand-I | State of the module input: Resetting of Statistics - Current Demand (avg, peak avg) | [Device Para /Statistics /Demand /Current Demand] |
| ResFc P Demand-I | State of the module input: Resetting of Statistics - Power Demand (avg, peak avg) | [Device Para /Statistics /Demand /Power Demand] |
| ResFc Max-I | State of the module input: Resetting of all Maximum values | [Device Para /Statistics /Min / Max] |
| ResFc Min-I | State of the module input: Resetting of all Minimum values | [Device Para /Statistics /Min / Max] |

Signals of the Statistics Module

| <i>Signal</i> | <i>Description</i> |
|----------------|--|
| ResFc all | Signal: Resetting of all Statistic values (Current Demand, Power Demand, Min, Max) |
| ResFc Vavg | Signal: Resetting of the sliding average calculation. |
| ResFc I Demand | Signal: Resetting of Statistics - Current Demand (avg, peak avg) |
| ResFc P Demand | Signal: Resetting of Statistics - Power Demand (avg, peak avg) |
| ResFc Max | Signal: Resetting of all Maximum values |
| ResFc Min | Signal: Resetting of all Minimum values |

Counters of the Module Statistics

| <i>Value</i> | <i>Description</i> | <i>Menu path</i> |
|-------------------|---|--|
| Res Cr Vavg | Number of resets since last booting. The timestamp shows date and time of the last reset. | [Operation /Statistics /Vavg] |
| Res Cr I Demand | Number of resets since last booting. The timestamp shows date and time of the last reset. | [Operation /Statistics /Demand /Current Demand] |
| Res Cr P Demand | Number of resets since last booting. The timestamp shows date and time of the last reset. | [Operation /Statistics /Demand /Power Demand] |
| Res Cr Min values | Number of resets since last booting. The timestamp shows date and time of the last reset. | [Operation /Statistics /Min /Power] |
| Res Cr Max values | Number of resets since last booting. The timestamp shows date and time of the last reset. | [Operation /Statistics /Max /Power] |

Current - Statistic Values

| <i>Value</i> | <i>Description</i> | <i>Menu path</i> |
|--------------|---|--|
| I1 max | Maximum value positive phase sequence current (fundamental) | [Operation /Statistics /Max /Current] |
| I1 min | Minimum value positive phase sequence current (fundamental) | [Operation /Statistics /Min /Current] |
| I2 max | Maximum value unbalanced load (fundamental) | [Operation /Statistics /Max /Current] |
| I2 min | Minimum value unbalanced load current (fundamental) | [Operation /Statistics /Min /Current] |
| IL1 H2 max | Maximum ratio of 2nd harmonic over fundamental of IL1 | [Operation /Statistics /Max /Current] |
| IL1 H2 min | Minimum ratio of 2nd harmonic over fundamental of IL1 | [Operation /Statistics /Min /Current] |
| IL2 H2 max | Maximum ratio of 2nd harmonic over fundamental of IL2 | [Operation /Statistics /Max /Current] |
| IL2 H2 min | Minimum ratio of 2nd harmonic over fundamental of IL2 | [Operation /Statistics /Min /Current] |
| IL3 H2 max | Maximum ratio of 2nd harmonic over fundamental of IL3 | [Operation /Statistics /Max /Current] |

| <i>Value</i> | <i>Description</i> | <i>Menu path</i> |
|----------------|--|--|
| IL3 H2 min | Minimum ratio of 2nd harmonic/1st harmonic minimum value of IL3 | [Operation /Statistics /Min /Current] |
| IG H2 meas max | Measured value: Maximum ratio of 2nd harmonic over fundamental of IG (measured) | [Operation /Statistics /Max /Current] |
| IG H2 meas min | Measured value: Minimum ratio of 2nd harmonic over fundamental of IG (measured) | [Operation /Statistics /Min /Current] |
| IG H2 calc max | Measured value (calculated): Maximum ratio of 2nd harmonic over fundamental of IG (calculated) | [Operation /Statistics /Max /Current] |
| IG H2 calc min | IG H2 calc min | [Operation /Statistics /Min /Current] |
| IL1 max RMS | IL1 maximum value (RMS) | [Operation /Statistics /Max /Current] |
| IL1 avg RMS | IL1 average value (RMS) | [Operation /Statistics /Demand /Current Demand] |
| IL1 min RMS | IL1 minimum value (RMS) | [Operation /Statistics /Min /Current] |
| IL2 max RMS | IL2 maximum value (RMS) | [Operation /Statistics /Max /Current] |

| <i>Value</i> | <i>Description</i> | <i>Menu path</i> |
|-----------------|--|--|
| IL2 avg RMS | IL2 average value (RMS) | [Operation /Statistics /Demand /Current Demand] |
| IL2 min RMS | IL2 minimum value (RMS) | [Operation /Statistics /Min /Current] |
| IL3 max RMS | IL3 maximum value (RMS) | [Operation /Statistics /Max /Current] |
| IL3 avg RMS | IL3 average value (RMS) | [Operation /Statistics /Demand /Current Demand] |
| IL3 min RMS | IL3 minimum value (RMS) | [Operation /Statistics /Min /Current] |
| IG meas max RMS | Measured value: IG maximum value (RMS) | [Operation /Statistics /Max /Current] |
| IG meas min RMS | Measured value: IG minimum value (RMS) | [Operation /Statistics /Min /Current] |
| IG calc max RMS | Measured value (calculated):IG maximum value (RMS) | [Operation /Statistics /Max /Current] |
| IG calc min RMS | Measured value (calculated):IG minimum value (RMS) | [Operation /Statistics /Min /Current] |

| <i>Value</i> | <i>Description</i> | <i>Menu path</i> |
|-----------------|---|--|
| %(I2/I1) max | Measured value (calculated): I2/I1 maximum value, phase sequence will be taken into account automatically | [Operation /Statistics /Max /Current] |
| %(I2/I1) min | Measured value (calculated): I2/I1 minimum value, phase sequence will be taken into account automatically | [Operation /Statistics /Min /Current] |
| IL1 Peak demand | IL1 Peak value, RMS value | [Operation /Statistics /Demand /Current Demand] |
| IL2 Peak demand | IL2 Peak value, RMS value | [Operation /Statistics /Demand /Current Demand] |
| IL3 Peak demand | IL3 Peak value, RMS value | [Operation /Statistics /Demand /Current Demand] |

Voltage - Statistic Values

| <i>Value</i> | <i>Description</i> | <i>Menu path</i> |
|--------------|--|--|
| f max | Max. frequency value | [Operation /Statistics /Max /Voltage] |
| f min | Min. frequency value | [Operation /Statistics /Min /Voltage] |
| V1 max | Maximum value: Symmetrical components positive phase sequence voltage(fundamental) | [Operation /Statistics /Max /Voltage] |
| V1 min | Minimum value: Symmetrical components positive phase sequence voltage(fundamental) | [Operation /Statistics /Min /Voltage] |
| V2 max | Maximum value: Symmetrical components negative phase sequence voltage(fundamental) | [Operation /Statistics /Max /Voltage] |
| V2 min | Minimum value: Symmetrical components negative phase sequence voltage(fundamental) | [Operation /Statistics /Min /Voltage] |
| VL12 max RMS | VL12 maximum value (RMS) | [Operation /Statistics /Max /Voltage] |
| VL12 avg RMS | VL12 average value (RMS) | [Operation /Statistics /Avg] |
| VL12 min RMS | VL12 minimum value (RMS) | [Operation /Statistics /Min /Voltage] |

| <i>Value</i> | <i>Description</i> | <i>Menu path</i> |
|--------------|--------------------------|--|
| VL23 max RMS | VL23 maximum value (RMS) | [Operation /Statistics /Max /Voltage] |
| VL23 avg RMS | VL23 average value (RMS) | [Operation /Statistics /Avg] |
| VL23 min RMS | VL23 minimum value (RMS) | [Operation /Statistics /Min /Voltage] |
| VL31 max RMS | VL31 maximum value (RMS) | [Operation /Statistics /Max /Voltage] |
| VL31 avg RMS | VL31 average value (RMS) | [Operation /Statistics /Avg] |
| VL31 min RMS | VL31 minimum value (RMS) | [Operation /Statistics /Min /Voltage] |
| VL1 max RMS | VL1 maximum value (RMS) | [Operation /Statistics /Max /Voltage] |
| VL1 avg RMS | VL1 average value (RMS) | [Operation /Statistics /Avg] |
| VL1 min RMS | VL1 minimum value (RMS) | [Operation /Statistics /Min /Voltage] |
| VL2 max RMS | VL2 maximum value (RMS) | [Operation /Statistics /Max /Voltage] |

| <i>Value</i> | <i>Description</i> | <i>Menu path</i> |
|-----------------|--|--|
| VL2 avg RMS | VL2 average value (RMS) | [Operation /Statistics /Vavg] |
| VL2 min RMS | VL2 minimum value (RMS) | [Operation /Statistics /Min /Voltage] |
| VL3 max RMS | VL3 maximum value (RMS) | [Operation /Statistics /Max /Voltage] |
| VL3 avg RMS | VL3 average value (RMS) | [Operation /Statistics /Vavg] |
| VL3 min RMS | VL3 minimum value (RMS) | [Operation /Statistics /Min /Voltage] |
| VX meas max RMS | Measured value: VX maximum value (RMS) | [Operation /Statistics /Max /Voltage] |
| VX meas min RMS | Measured value: VX minimum value (RMS) | [Operation /Statistics /Min /Voltage] |
| VG calc max RMS | Measured value (calculated):VX maximum value (RMS) | [Operation /Statistics /Max /Voltage] |
| VG calc min RMS | Measured value (calculated):VX minimum value (RMS) | [Operation /Statistics /Min /Voltage] |
| %(V2/V1) max | Measured value (calculated):V2/V1 maximum value, phase sequence will be taken into account automatically | [Operation /Statistics /Max /Voltage] |

Statistics

| <i>Value</i> | <i>Description</i> | <i>Menu path</i> |
|--------------|---|--|
| %(V2/V1) min | Measured value (calculated):V2/V1 minimum value , phase sequence will be taken into account automatically | [Operation /Statistics /Min /Voltage] |

Power - Statistic Values

| <i>Value</i> | <i>Description</i> | <i>Menu path</i> |
|--------------|---|--|
| cos phi max | Maximum value of the power factor: Sign Convention: sign(PF) = sign(P) | [Operation /Statistics /Max /Power] |
| cos phi min | Minimum value of the power factor: Sign Convention: sign(PF) = sign(P) | [Operation /Statistics /Min /Power] |
| S max | Maximum value of the apparent power | [Operation /Statistics /Max /Power] |
| S avg | Average of the apparent power | [Operation /Statistics /Demand /Power Demand] |
| S min | Minimum value of the apparent power | [Operation /Statistics /Min /Power] |
| P max | Maximum value of the active power | [Operation /Statistics /Max /Power] |
| P avg | Average of the active power | [Operation /Statistics /Demand /Power Demand] |
| P min | Minimum value of the active power | [Operation /Statistics /Min /Power] |
| Q max | Maximum value of the reactive power | [Operation /Statistics /Max /Power] |

| <i>Value</i> | <i>Description</i> | <i>Menu path</i> |
|------------------|---|--|
| Q avg | Average of the reactive power | [Operation /Statistics /Demand /Power Demand] |
| Q min | Minimum value of the reactive power | [Operation /Statistics /Min /Power] |
| cos phi max RMS | Maximum value of the power factor: Sign Convention: sign(PF) = sign(P) | [Operation /Statistics /Max /Power] |
| cos phi min RMS | Minimum value of the power factor: Sign Convention: sign(PF) = sign(P) | [Operation /Statistics /Min /Power] |
| VA Peak demand | VA Peak value, RMS value | [Operation /Statistics /Demand /Power Demand] |
| Watt Peak demand | WATTS Peak value, RMS value | [Operation /Statistics /Demand /Power Demand] |
| VAr Peak demand | VARs Peak value, RMS value | [Operation /Statistics /Demand /Power Demand] |

System Alarms

Available Elements:

SysA

NOTICE

Please note that Power Protection and (Active/Reactive/Apparent) Power Demand is only available within Protective Devices that offer current and voltage measurement.

Within the System Alarms menu [SysA] the User can configure:

- General Settings (activate/inactivate the Demand Management, optional assign a signal, that will block the Demand Management);
- Power Protection (Peak values);
- Demand Management (Power and Current); and
- THD Protection.

Please note, that all thresholds are to be set as primary values.

Demand Management

Demand is the average of system current or power over a time interval (window). Demand management supports the User to keep energy demand below target values bound by contract (with the energy supplier). If the contractual target values are exceeded, extra charges are to be paid to the energy supplier.

Therefore, demand management helps the User detect and avoid averaged peak loads that are taken into account for the billing. In order to reduce the demand charge respective to demand rate, peak loads, if possible, should be diversified. That means, if possible, avoiding large loads at the same time. In order to assist the User in analyzing the demand, demand management might inform the User by an alarm. The User might also use demand alarms and assign them on relays in order to perform load shedding (where applicable).

Demand management comprises:

- Power Demand
 - Watt Demand (Active Power);
 - VAr Demand (Reactive Power);
 - VA Demand (Apparent Power); and
- Current Demand.

Configuring the Demand

Configuring the demand is a two step procedure. Proceed as follows.

Step1: Configure the general settings within the [Device Para/Statistics/Demand] menu:

- Set the trigger source to »*Duration*«.
- Select a time base for the »*window*«.
- Determine if the window is »*fixed*« or »*sliding*«.
- If applicable assign a reset signal.

The interval time (window) can be set to fixed or sliding.

Example for a fixed window: If the range is set for 15 minutes, the protective device calculates the average current or power over the past 15 minutes and updates the value every 15 minutes.

Example for a sliding window: If the sliding window is selected and the interval is set to 15 minutes, the protective device calculates and updates the average current or power continuously, for the past 15 minutes (the newest measuring value replaces the oldest measuring value continuously).

Window configuration = sliding

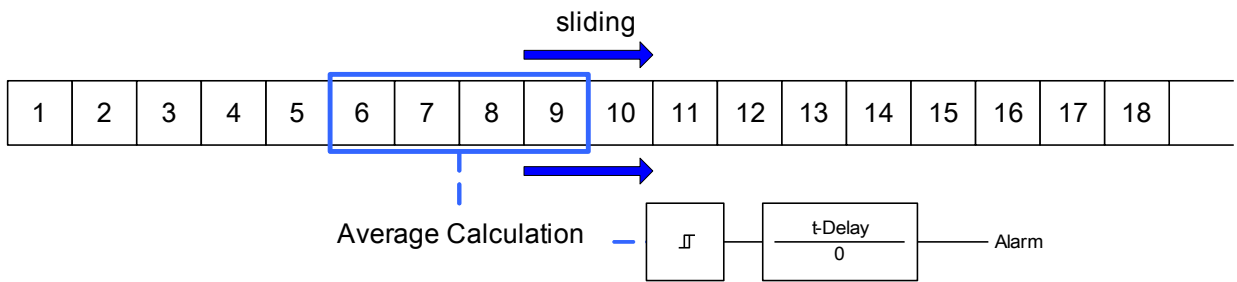
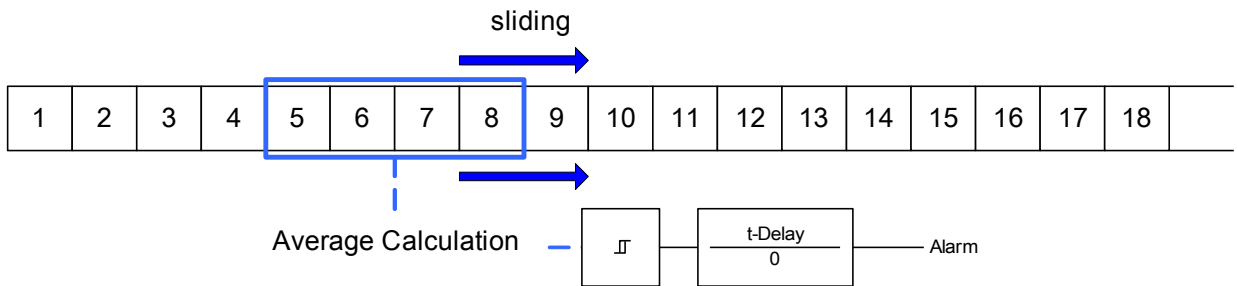
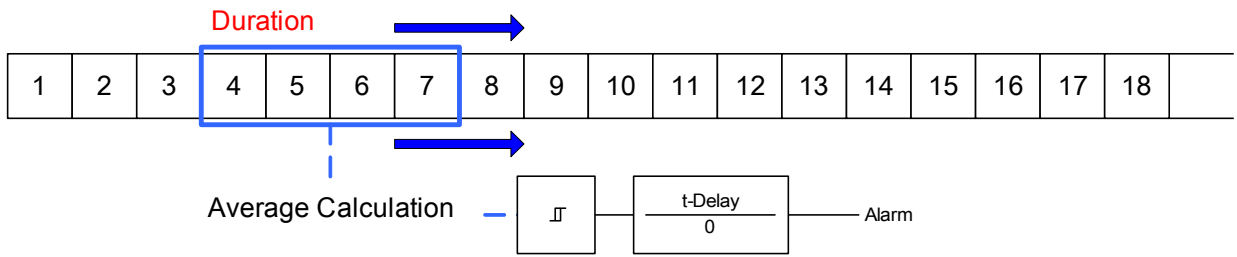

Window configuration = fixed

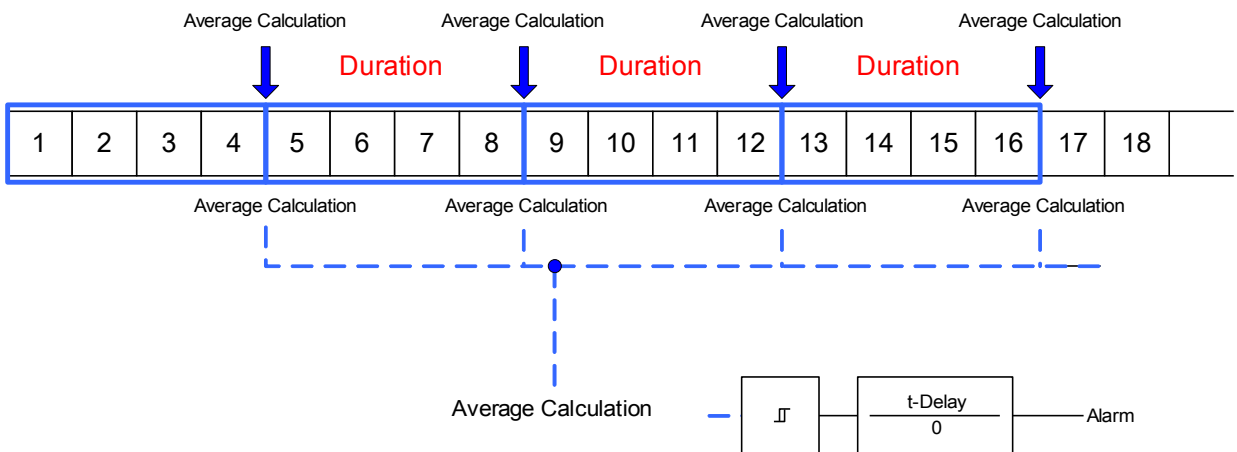

Step 2:

- In addition, the Demand specific settings have to be configured in the [SysA/Demand] menu.
- Determine if the demand should generate an alarm or if it should run in the silent mode. (Alarm active/inactive).
- Set the threshold.
- Where applicable, set a delay time for the alarm.

Peak Values

The protective device also saves the peak demand values for current and power. The quantities represent the largest demand value since the demand values were last reset. Peak demands for current and system power are date and time stamped.

Within the [Operation/Statistics] menu, the current Demand and Peak demand values can be seen.

Configuring the Peak Value Supervision

The supervision for the peak values can be configured within menu [SysA/Power] in order to monitor:

- Active Power (Watt),
- Reactive Power (VAr)
- Apparent Power (VA)

The specific settings are to be set within menu [SysA/Power].

- Determine if the peak value supervision should generate an alarm or if it should run in the silent mode. (Alarm active/inactive).
- Set the threshold.
- Where applicable, set a delay time for the alarm.

Min. and Max. Values.

Within [Operation/Statistics] menu the minimum (min.) and maximum (max.) values can be seen.

Minimum values since last reset: The minimum values are continuously compared to the last minimum value for that measuring value. If the new value is less than the last minimum, the value is updated. Within the [Device Para/Statistics/"Min / Max"] menu, a reset signal can be assigned.

Maximum values since last reset: The maximum values are continuously compared to the last maximum value for that measuring value. If the new value is greater than the last maximum, the value is updated. Within the [Device Para/Statistics/"Min / Max"] menu, a reset signal can be assigned.

THD Protection

In order to supervise power quality, the protective device can monitor the voltage (phase-to-phase) and current THDs.

Within the [SysA/THD] menu:

- Determine if an alarm is to be issued or not (Alarm active/inactive);
- Set the threshold; and
- Where applicable, set a delay time for the alarm.











Device Planning Parameters of the Demand Management

| Parameter | Description | Options | Default | Menu path |
|---|-------------|--------------------|------------|-------------------|
| Mode  | Mode | do not use, use | do not use | [Device planning] |









Signals of the Demand Management (States of the Outputs)

| Signal | Description |
|---------------------|---|
| active | Signal: active |
| ExBlo | Signal: External Blocking |
| Alarm Watt Power | Signal: Alarm permitted Active Power exceeded |
| Alarm VAr Power | Signal: Alarm permitted Reactive Power exceeded |
| Alarm VA Power | Signal: Alarm permitted Apparent Power exceeded |
| Alarm Watt Demand | Signal: Alarm averaged Active Power exceeded |
| Alarm VAr Demand | Signal: Alarm averaged Reactive Power exceeded |
| Alarm VA Demand | Signal: Alarm averaged Apparent Power exceeded |
| Alm Current Demd | Signal: Alarm averaged demand current |
| Alarm I THD | Signal: Alarm Total Harmonic Distortion Current |
| Alarm V THD | Signal: Alarm Total Harmonic Distortion Voltage |
| Trip Watt Power | Signal: Trip permitted Active Power exceeded |
| Trip VAr Power | Signal: Trip permitted Reactive Power exceeded |
| Trip VA Power | Signal: Trip permitted Apparent Power exceeded |
| Trip Watt Demand | Signal: Trip averaged Active Power exceeded |
| Trip VAr Demand | Signal: Trip averaged Reactive Power exceeded |
| Trip VA Demand | Signal: Trip averaged Apparent Power exceeded |
| Trip Current Demand | Signal: Trip averaged demand current |
| Trip I THD | Signal: Trip Total Harmonic Distortion Current |
| Trip V THD | Signal: Trip Total Harmonic Distortion Voltage |

Global Protection Parameter of the Demand Management

| Parameter | Description | Setting range | Default | Menu path |
|--|---|-----------------------|-----------|-----------------------------|
| Function  | Permanent activation or deactivation of module/stage. | inactive, active | inactive | [SysA /General settings] |
| ExBlo Fc  | Activate (allow) or inactivate (disallow) blocking of the module/stage. This parameter is only effective if a signal is assigned to the corresponding global protection parameter. If the signal becomes true, those modules/stages are blocked that are parameterized "ExBlo Fc=active". | 1..n, Assignment List | -- | [SysA /General settings] |
| Alarm  | Alarm | inactive, active | inactive | [SysA /Power /Watt] |
| Threshold  | Threshold (to be entered as primary value) | 1 - 40000000kW | 10000kW | [SysA /Power /Watt] |
| t-Delay  | Tripping Delay | 0 - 60min | 0min | [SysA /Power /Watt] |
| Alarm  | Alarm | inactive, active | inactive | [SysA /Power /VAr] |
| Threshold  | Threshold (to be entered as primary value) | 1 - 40000000kVAr | 10000kVAr | [SysA /Power /VAr] |
| t-Delay  | Tripping Delay | 0 - 60min | 0min | [SysA /Power /VAr] |
| Alarm  | Alarm | inactive, active | inactive | [SysA /Power /VA] |
| Threshold  | Threshold (to be entered as primary value) | 1 - 40000000kVA | 10000kVA | [SysA /Power /VA] |

System Alarms

| Parameter | Description | Setting range | Default | Menu path |
|---|--|---------------------|-----------|--|
|  t-Delay | Tripping Delay | 0 - 60min | 0min | [SysA /Power /VA] |
|  Alarm | Alarm | inactive, active | inactive | [SysA /Demand /Power Demand /Watt Demand] |
|  Threshold | Threshold (to be entered as primary value) | 1 - 40000000kW | 10000kW | [SysA /Demand /Power Demand /Watt Demand] |
|  t-Delay | Tripping Delay | 0 - 60min | 0min | [SysA /Demand /Power Demand /Watt Demand] |
|  Alarm | Alarm | inactive, active | inactive | [SysA /Demand /Power Demand /VAr Demand] |
|  Threshold | Threshold (to be entered as primary value) | 1 - 40000000kVAr | 20000kVAr | [SysA /Demand /Power Demand /VAr Demand] |
|  t-Delay | Tripping Delay | 0 - 60min | 0min | [SysA /Demand /Power Demand /VAr Demand] |
|  Alarm | Alarm | inactive, active | inactive | [SysA /Demand /Power Demand /VA Demand] |
|  Threshold | Threshold (to be entered as primary value) | 1 - 40000000kVA | 20000kVA | [SysA /Demand /Power Demand /VA Demand] |
|  t-Delay | Tripping Delay | 0 - 60min | 0min | [SysA /Demand /Power Demand /VA Demand] |

System Alarms

| Parameter | Description | Setting range | Default | Menu path |
|--|--|---------------------|----------|--------------------------------------|
| Alarm  | Alarm | inactive, active | inactive | [SysA /Demand /Current Demand] |
| Threshold  | Threshold (to be entered as primary value) | 10 - 500000A | 500A | [SysA /Demand /Current Demand] |
| t-Delay  | Tripping Delay | 0 - 60min | 0min | [SysA /Demand /Current Demand] |
| Alarm  | Alarm | inactive, active | inactive | [SysA /THD /I THD] |
| Threshold  | Threshold (to be entered as primary value) | 1 - 500000A | 500A | [SysA /THD /I THD] |
| t-Delay  | Tripping Delay | 0 - 3600s | 0s | [SysA /THD /I THD] |
| Alarm  | Alarm | inactive, active | inactive | [SysA /THD /V THD] |
| Threshold  | Threshold (to be entered as primary value) | 1 - 500000V | 10000V | [SysA /THD /V THD] |
| t-Delay  | Tripping Delay | 0 - 3600s | 0s | [SysA /THD /V THD] |

States of the Inputs of the Demand Management

| <i>Name</i> | <i>Description</i> | <i>Assignment via</i> |
|-------------|---------------------------------------|-----------------------------|
| ExBlo-I | Module input state: External blocking | [SysA /General settings] |

Acknowledgments

Collective Acknowledgments for latched signals:

| Collective Acknowledgments | | | | | |
|--|---|---|--|--|---|
| | <i>LEDs</i> | <i>Binary Output Relays</i> | <i>SCADA</i> | <i>Pending Trip Command</i> | <i>LEDs+ Binary Output Relays+ SCADA+ Pending Trip Command</i> |
| <p>Via Smart view or at the panel all... can be acknowledged.</p> <p>At the panel, the menu [Operation\ Acknowledge] can directly be accessed via the »C« key</p> | <p>All LEDs at once: Where? [Operation\ Acknowledge]</p> | <p>All Binary Output Relays at once: Where? [Operation\ Acknowledge]</p> | <p>All SCADA signals at once: Where? [Operation\ Acknowledge]</p> | <p>All pending trip commands at once: Where? [Operation\ Acknowledge]</p> | <p>All at once: Where? [Operation\ Acknowledge]</p> |
| <p>External Acknowledgment *: Via a signal from the assignment list (e.g. a digital Input) all... can be acknowledged.</p> | <p>All LEDs at once: Where? Within the menu <u>Ex Acknowledge</u></p> | <p>All Binary Output Relays at once: <u>Where? Within the menu Ex Acknowledge</u></p> | <p>All SCADA signals at once: <u>Where? Within the menu Ex Acknowledge</u></p> | <p>All pending trip commands at once: <u>Where? Within the menu Ex Acknowledge</u></p> | |

*The External Acknowledgement might be disabled if parameter **»Ex Ack** «is set to **»inactive«** within menu [Device Para/Ex Acknowledge]. This blocks also the acknowledgement via Communication (e.g. Modbus).

Options for individual acknowledgments for latched signals:

| Individual Acknowledgment | | | |
|---|---|--|--|
| | <i>LEDs</i> | <i>Binary Output Relays</i> | <i>Pending Trip Command</i> |
| Via a signal from the assignment list (e.g.:a digital Input) a single ... can be acknowledged. | <p>Single LED:</p> <p>Where?</p> <p>Within the configuration menu of this single LED.</p> | <p>Binary Output Relay:</p> <p>Where?</p> <p>Within the configuration menu of this single Binary Output Relay.</p> | <p>Pending Trip Command.</p> <p>Where?</p> <p>Within the module <u>TripControl</u></p> |

NOTICE As long as you are within the parameter setting mode, you cannot acknowledge.

NOTICE In case of a fault during parameter setting via the operating panel, you must first leave the parameter mode by pressing either push-button »C« or »OK« before you may access to menu »Acknowledgments« via push-button.

Manual Acknowledgment

- Press the C-Button at the panel.
- Select the item to be acknowledged via the Softkeys:
 - Binary output relays,
 - LEDs,
 - SCADA,
 - a pending trip command or
 - all (above) mentioned items at once.
- Press the Softkey with the »Wrench-Symbol«.
- Enter your password.

External Acknowledgments

Within the menu [Device Parameter\Ex Acknowledge] you can assign a signal (e.g. the state of a digital input) from the assignment list that:

- acknowledges all (acknowledgeable) LEDs at once;
- acknowledges all (acknowledgeable) binary outputs at once:
- acknowledges all (acknowledgeable) SCADA-signals at once.

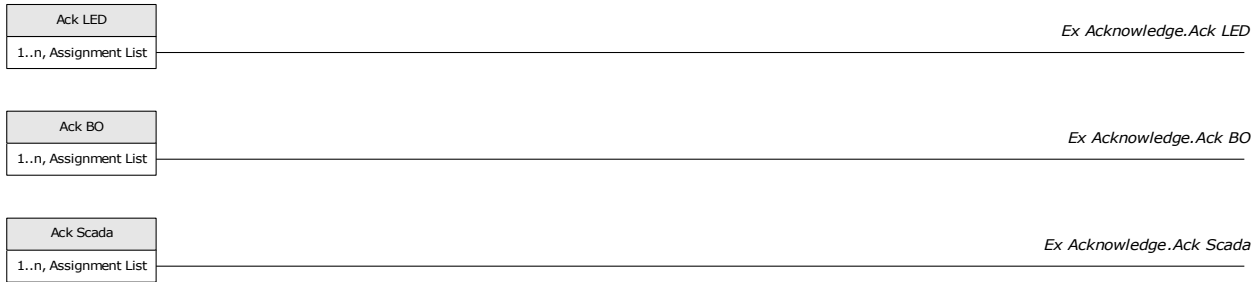

Manual Resets

In menu »*Operation/Reset*« you can:

- reset counters,
- delete records (e.g. disturbance records) and
- reset special things (like statistics, thermal replica...).

NOTICE

The description of the reset commands can be found within the corresponding modules.

Reset to Factory Defaults

⚠ WARNING



This Function will reset the device to the factory defaults. All records will be deleted and the measured values and counters will be reset. The operation hours counter will be kept.

This Function is available at the HMI only.

- Press the »C-key« during a cold start, in order to access the »Reset« menu.
- Select »Reset to factory default«.
- Confirm »Reset device to factory defaults and reboot« with »Yes« in order to execute the reset to factory defaults.«

Status Display

In the status display within the »Operation« menu, the present state of all signals can be viewed. This means the User is able to see if the individual signals are active or inactive at that moment. The User can see all signals sorted by protective elements/modules.

| <i>State of the module input/signal is...</i> | <i>Is shown at the panel as...</i> |
|---|---|
| false / »0« |  |
| true / »1« |  |

Operating Panel (HMI)

HMI





Special Parameters of the Panel

This menu »Device Parameter/HMI« is used to define the contrast of the display, the maximum admissible edit time and the menu language (after expiry of which, all unsaved parameter changes will be rejected).

Direct Commands of the Panel

| Parameter | Description | Setting range | Default | Menu path |
|---|-------------|---------------|---------|-----------------------|
| Contrast  | Contrast | 0 - 100% | 50% | [Device Para /HMI] |

Global Protection Parameters of the Panel

| Parameter | Description | Setting range | Default | Menu path |
|--|---|--|---------|-----------------------|
| t-max Edit/Access  | If no other key(s) is pressed at the panel, after expiration of this time, all cached (changed) parameters are canceled. The device access will be locked by falling back into Read-only level Lv0. | 20 - 3600s | 180s | [Device Para /HMI] |
| Display Off  | The display back light will be turned off when this timer has expired. | 20 - 3600s | 180s | [Device Para /HMI] |
| Menu language  | Selection of the language | English, German, Russian, Polish, French, Portuguese, Spanish, Romanian/English | English | [Device Para /HMI] |
| Display ANSI Device Numbers  | Display ANSI Device Numbers | inactive, active | active | [Device Para /HMI] |

Recorders

Disturbance Recorder

Available elements:

Disturb rec

- Disturbance records can be downloaded (read out) by means of the parameter setting and evaluation software *Smart view*.
- The disturbance records can be viewed and analyzed within *Data visualizer* (will be installed with *Smart view*).
- Disturbance records can be converted into the comtrade file format by means of *Data visualizers*.

The disturbance recorder works with 32 samples per cycle. The disturbance recorder can be started by one of eight start events (selection from the »assignment list«/OR-Logic). The disturbance record contains the measuring values inclusively pre-trigger-time. By means of *Smart view/Datavisualizer* (option) the oscillographic curves of the analogue (current, voltage) and digital channels/traces can be shown and evaluated in a graphical form. The disturbance recorder has a storage capacity of 120s. The disturbance recorder is able to record up to 10 s (adjustable) per record. The amount of records depends on the file size of each record.

The disturbance recorder can be parameterized in the menu »*Device Parameter/Recorder/Disturb rec*«.

Determine the max. recording time to register a disturbance event. The max. total length of a recording is 10s (inclusive pre-trigger and post-trigger time).

To trigger the disturbance recorder, up to 8 signals can be selected from the »assignment list«. The trigger events are OR-linked. If a disturbance record is written, a new disturbance record cannot be triggered until all trigger signals, which have triggered the previous disturbance record, are gone. Recording is only done for the time the assigned event exists (event controlled), plus the time for the pre- and post-trigger, but not longer than 10s. The time for forward run and tracking of the disturbance recorder is shown in percent of the total recording length.

NOTICE

The post-trigger time will be up to "Post-trigger time" depending on the duration of the trigger signal. The post-trigger will be the remaining time of the "Max file size" but at maximum "Post-trigger time"

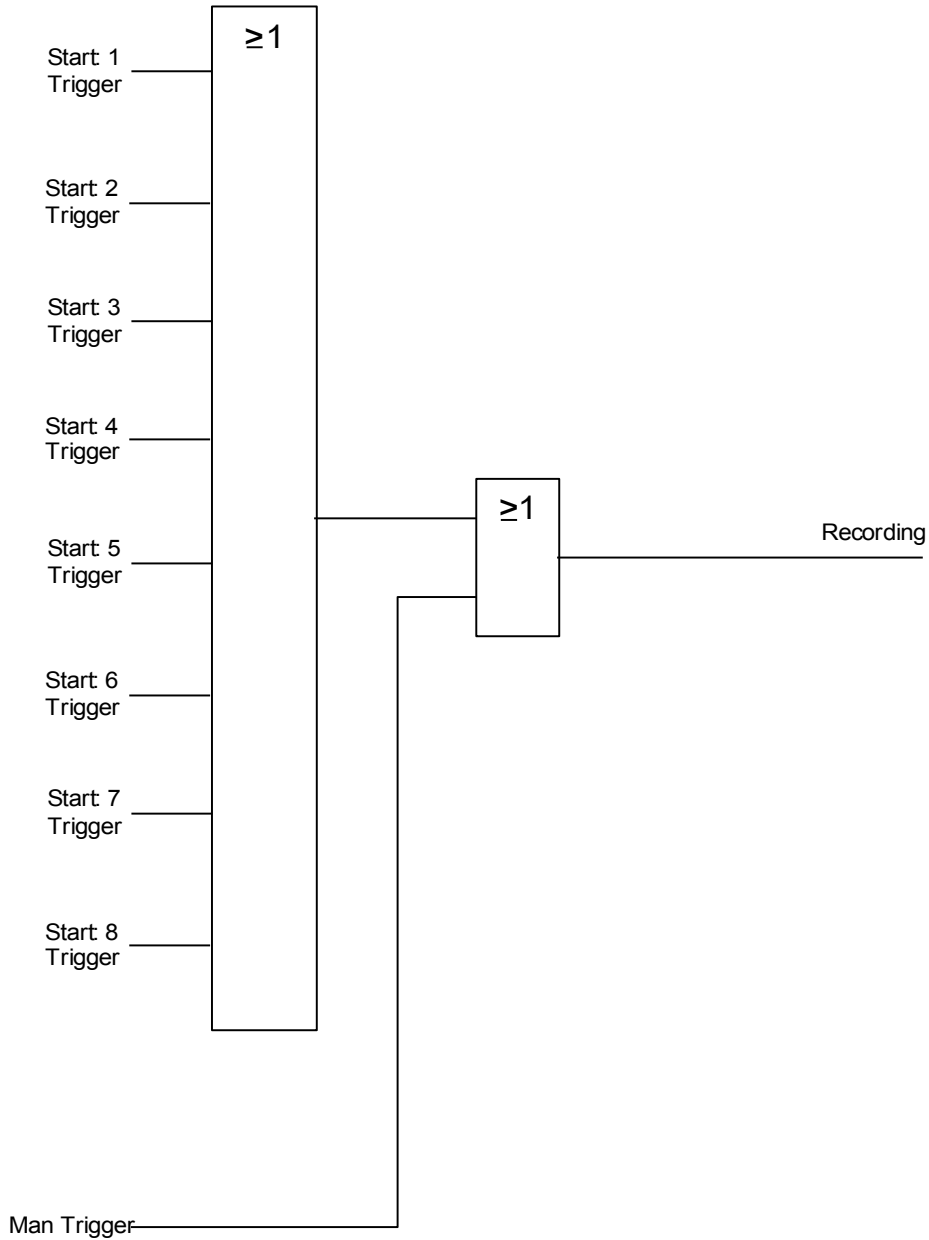

Example

The disturbance recorder is started by the general activation facility. After the fault has been cancelled (+ follow-up time), the recording process is stopped (but after 10s at the latest).

The parameter *»Auto Delete«* defines how the device shall react if there is no saving place available. In case *»Auto Delete«* is *»active«*, the first recorded disturbance will be overwritten according to the FIFO principle. If the parameter is set to *»inactive«*, recording of the disturbance events will be stopped until the storage location is released manually.

Example Disturbance Recorder Timing Chart I

- Start 1 = Prot.Trip
- Start 2 = -.-
- Start 3 = -.-
- Start 4 = -.-
- Start 5 = -.-
- Start 6 = -.-
- Start 7 = -.-
- Start 8 = -.-
- Auto overwriting = active
- Post-trigger time = 25%
- Pre-trigger time = 15%
- Max file size = 2s

t-rec < Max file size

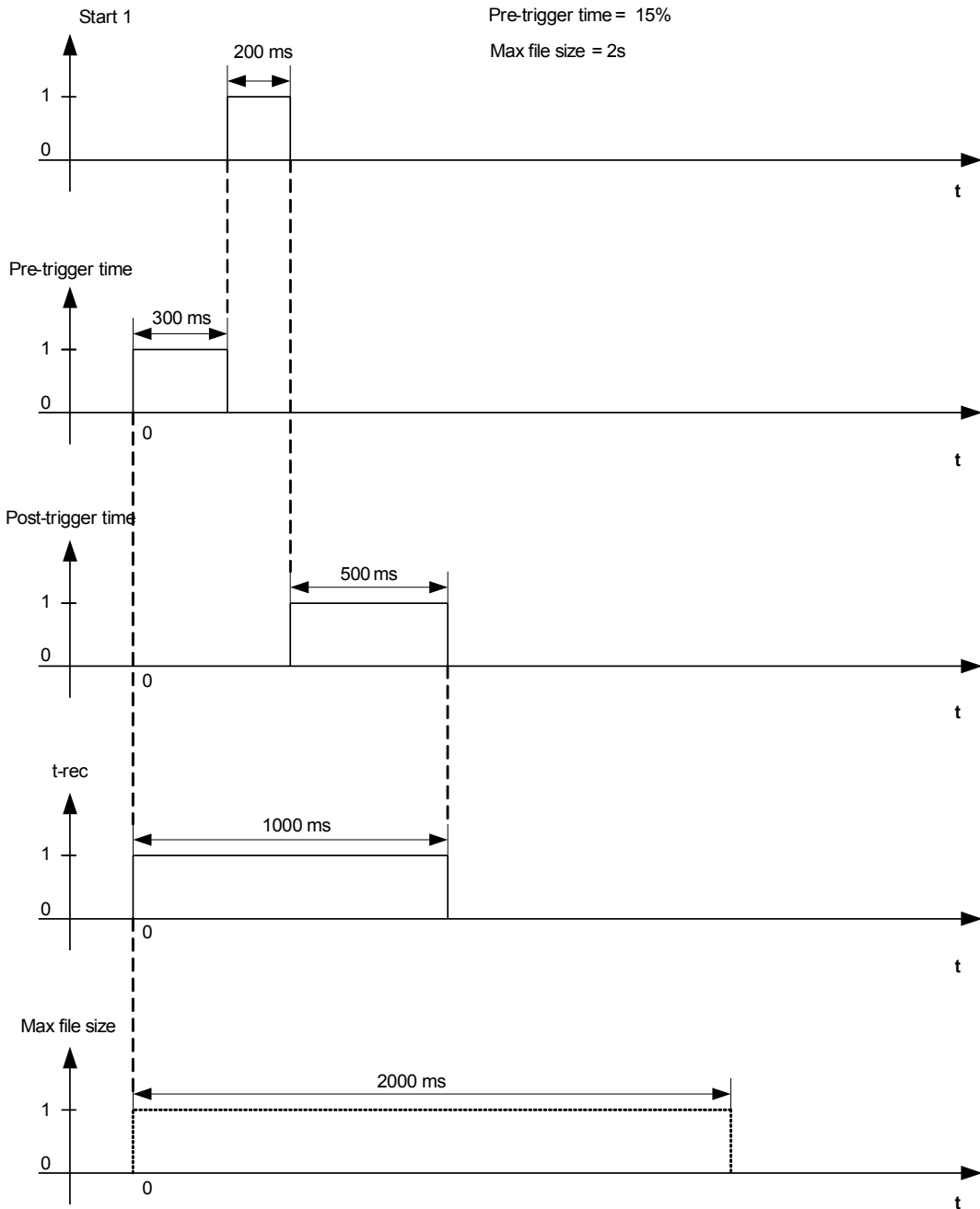

Example Disturbance Recorder Timing Chart II

- Start 1 = Prot.Alarm
- Start 2 = -.-
- Start 3 = -.-
- Start 4 = -.-
- Start 5 = -.-
- Start 6 = -.-
- Start 7 = -.-
- Start 8 = -.-
- Auto overwriting = active
- Post-trigger time = 25%
- Pre-trigger time = 15%
- Max file size = 2s

t-rec = Max file size

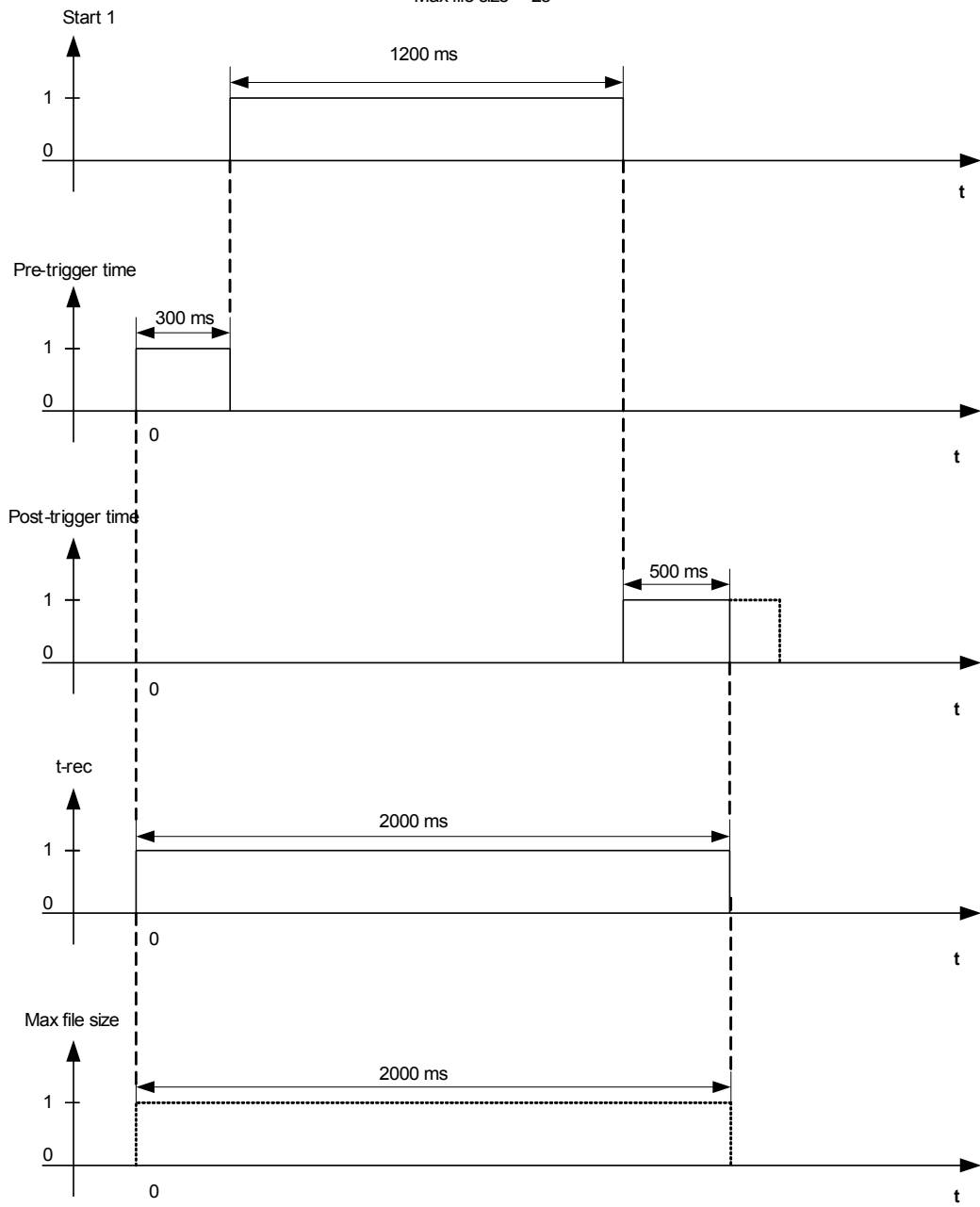

Read Out Disturbance Records

Within the Menu Operation/Disturb rec you can

- Detect accumulated Disturbance Records.

NOTICE



Within the Menu »Operation/Recorders/Man Trigger« you can trigger the disturbance recorder manually.

Deleting Disturbance Records







Within the Menu Operation/Disturb rec you can

- Delete Disturbance Records.
- Choose via »SOFTKEY« »up« and »SOFTKEY« »down« the disturbance record that is to be deleted.
- Call up the detailed view of the disturbance record via »SOFTKEY« »right«.
- Confirm by pressing »SOFTKEY« »delete«
- Enter your password followed by pressing the key »OK«
- Choose whether only the current or whether all disturbance records should be deleted.
- Confirm by pressing »SOFTKEY« »OK«





Direct Commands of the Disturbance Recorder

| Parameter | Description | Setting range | Default | Menu path |
|--|-------------------|---------------------|----------|---|
| Man Trigger  | Manual Trigger | False, True | False | [Operation /Recorders /Man Trigger] |
| Res all rec  | Reset all records | inactive, active | inactive | [Operation /Reset] |

Global Protection Parameters of the Disturbance Recorder

| Parameter | Description | Setting range | Default | Menu path |
|---|---|-----------------------|------------|---|
| Start: 1  | Start recording if the assigned signal is true. | 1..n, Assignment List | Prot.Alarm | [Device Para /Recorders /Disturb rec] |
| Start: 2  | Start recording if the assigned signal is true. | 1..n, Assignment List | -- | [Device Para /Recorders /Disturb rec] |
| Start: 3  | Start recording if the assigned signal is true. | 1..n, Assignment List | -- | [Device Para /Recorders /Disturb rec] |
| Start: 4  | Start recording if the assigned signal is true. | 1..n, Assignment List | -- | [Device Para /Recorders /Disturb rec] |
| Start: 5  | Start recording if the assigned signal is true. | 1..n, Assignment List | -- | [Device Para /Recorders /Disturb rec] |
| Start: 6  | Start recording if the assigned signal is true. | 1..n, Assignment List | -- | [Device Para /Recorders /Disturb rec] |
| Start: 7  | Start recording if the assigned signal is true. | 1..n, Assignment List | -- | [Device Para /Recorders /Disturb rec] |

Recorders

| <i>Parameter</i> | <i>Description</i> | <i>Setting range</i> | <i>Default</i> | <i>Menu path</i> |
|--|--|-----------------------|----------------|---|
| Start: 8  | Start recording if the assigned signal is true. | 1..n, Assignment List | -- | [Device Para /Recorders /Disturb rec] |
| Auto overwriting  | If there is no more free memory capacity left, the oldest file will be overwritten. | inactive, active | active | [Device Para /Recorders /Disturb rec] |
| Post-trigger time  | The post trigger time is settable up to a maximum of 50% of the Maximum file size setting. The post-trigger will be the remaining time of the "Max file size" but at maximum "Post-trigger time" | 0 - 50% | 20% | [Device Para /Recorders /Disturb rec] |
| Pre-trigger time  | The pre trigger time is settable up to a maximum of 50% of the Maximum file size setting. | 0 - 50% | 20% | [Device Para /Recorders /Disturb rec] |
| Max file size  | The maximum storage capacity per record is 10 seconds, including pre-trigger and post-trigger time. The disturbance recorder has a total storage capacity of 120 seconds. | 0.1 - 10.0s | 2s | [Device Para /Recorders /Disturb rec] |

Disturbance Recorder Input States

| <i>Name</i> | <i>Description</i> | <i>Assignment via</i> |
|-------------|---|---|
| Start1-l | State of the module input:: Trigger event / start recording if: | [Device Para /Recorders /Disturb rec] |
| Start2-l | State of the module input:: Trigger event / start recording if: | [Device Para /Recorders /Disturb rec] |
| Start3-l | State of the module input:: Trigger event / start recording if: | [Device Para /Recorders /Disturb rec] |
| Start4-l | State of the module input:: Trigger event / start recording if: | [Device Para /Recorders /Disturb rec] |
| Start5-l | State of the module input:: Trigger event / start recording if: | [Device Para /Recorders /Disturb rec] |
| Start6-l | State of the module input:: Trigger event / start recording if: | [Device Para /Recorders /Disturb rec] |
| Start7-l | State of the module input:: Trigger event / start recording if: | [Device Para /Recorders /Disturb rec] |
| Start8-l | State of the module input:: Trigger event / start recording if: | [Device Para /Recorders /Disturb rec] |

Disturbance Recorder Signals

| <i>Signal</i> | <i>Description</i> |
|-----------------|---------------------------------|
| recording | Signal: Recording |
| memory full | Signal: Memory full |
| Clear fail | Signal: Clear failure in memory |
| Res all records | Signal: All records deleted |
| Res rec | Signal: Delete record |
| Man Trigger | Signal: Manual Trigger |

Special Parameters of the Disturbance Recorder

| <i>Value</i> | <i>Description</i> | <i>Default</i> | <i>Size</i> | <i>Menu path</i> |
|--------------|--------------------|----------------|--|--|
| Rec state | Recording state | Ready | Ready, Recording, Writing file, Trigger Blo | [Operation /Status Display /Recorders /Disturb rec] |
| Error code | Error code | OK | OK, Write err, Clear fail, Calculation err, File not found, Auto overwriting off | [Operation /Status Display /Recorders /Disturb rec] |

Fault Recorder

Fault rec

Purpose of the Fault recorder

The *Fault Recorder* provides compressed information about faults (e.g. Trip Causes). The compressed information can be read out also at the HMI. This might be helpful for fast fault analysis already at the HMI. After a fault, a popup window will be sent onto the display in order to draw the users attention to the fault. The *Fault Recorder* will provide information on the causes of the fault. A detailed fault analysis (in oscillographic form) can be done means of the Disturbance Recorder. The reference between the Fault Records and the corresponding Disturbance Records are the »*Fault Number*« and the »*Grid Fault Number*«.

Definitions

- Time to Trip: Time between *First Alarm* (Prot.Pickup) and *First Trip* (Prot.Trip) decision
- Fault Duration: Time period from the rising edge of the General Pickup («PROT.PICKUP») signal up to the falling edge of the General Pickup Signal. Please note that General Pickup is an or-connection (disjunction) of all Pickup signals. General Trip is an OR-connection of all Trips.

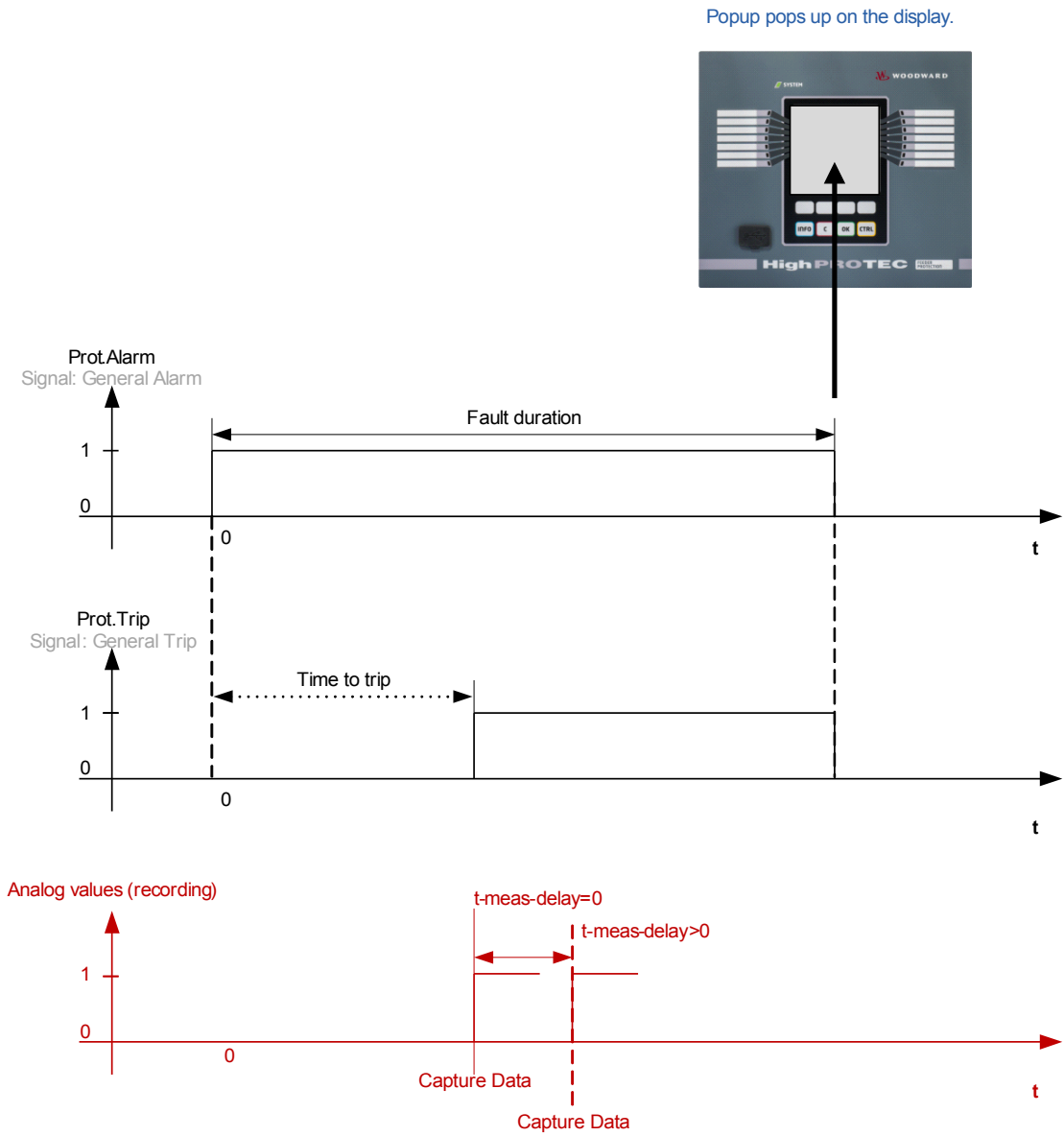

Behaviour of the Fault Recorder

Who triggers the Fault Recorder?

The *Fault Recorder* will be triggered by the rising edge of the »PROT.PICKUP« (General Pickup) signal. Please note that »PROT.PICKUP« (General Pickup) is an or-connection of all Pickup signals. The first Pickup will trigger the Fault recorder.

At which point of time will the fault measurements be captured?

The fault measurements will be captured (written) when the trip decision is taken. The point in time, when the measurements are captured (after a trip) can be delayed optionally by the parameter »*t-meas-delay*«. This might be reasonable in order to achieve more reliable measuring values (e.g. in order to avoid measuring disturbances caused by significant DC-components).

Modes

In case of a fault record should be written even if an general alarm has not lead to a trip, the parameter »*Record-Mode*« is to be set to »*Alarms and Trips*« .

Set parameter »*Record-Mode*« to »*Trips only*«, if an Alarm that is not followed by a trip decision should not lead to a trip.

When does the overlay (popup) appears on the display of the HMI?

A popup will appear on the HMI display, when the General Pickup (Prot.Pickup) disappears.

NOTICE

No time to trip will be shown if the pickup signal that triggers the fault recorder is issued by another protection module than the trip signal. This might happen if more than one protection module is involved into a fault.

NOTICE

Please note: The parameter settings (thresholds etc.) that are shown in a fault record are not part of the fault record itself. They are always read out from the current device setting. If parameters settings that are shown in a fault record could have been updated, they will be indicated with an asterisk symbol within the fault record.

To prevent this please proceed as follows:

Save any fault record that should be archived to your local network/hard disk before doing any parameter change. Delete all the fault records in your fault recorder afterwards.

Memory

The last stored fault record is saved (fail-safe) within the *Fault Recorder* (the others are saved within a memory that depends on the auxiliary power of the protective relay). If there is no more memory free, the oldest record will be overwritten (FIFO). Up to 20 records can be stored.

How to close the overlay/popup?

By using Softkey »OK«.

How to find out fast, if a fault has lead to a trip or not?

Faults that lead to a trip will be indicated by a flash icon  (right side) within the overview menu of the fault recorder.

Which fault record pops up?

The newest fault.

Content of a Fault Record





A fault record comprises information about:

| | | | | |
|-----------------|---|---------------|---------------|------------|
| Date/Time | Date and Time of the Fault | | | |
| FaultNr | The number of the fault will be incremented with each fault (General Alarm or »PROT.PICKUP«) | | | |
| Grid Fault No. | This counter will be incremented by each General Pickup (Exception AR: this applies only to devices that offer auto reclosing). | | | |
| Active Set | The active parameter set | | | |
| Time to trip | The time between pickup and trip. Please note: No time to trip will be shown if the first pickup and the first trip are issued by different protection modules. | | | |
| Alarm | Name of the module that picked up first. | | | |
| Trip | Name of the module that tripped first. The information that will be displayed depends on which protection module has tripped. That means e.g. that the thresholds are shown. In case that the trip was initiated by the MotorStart (applies to motor protection relays) protection module, additional information will be displayed. | | | |
| Adaptive Set | In case that adaptive sets are used, the number of the active set will be displayed. | | | |
| Fault type | In case of overcurrent trips, the fault type will be evaluated based on the energized phases. | | | |
| | | | | |
| | Alarm Phase A | Alarm Phase B | Alarm Phase C | Fault Type |
| | x | | | L1G |
| | | x | | L2G |
| | | | x | L3G |
| | x | x | | L1B |
| | | x | x | L2L3 |
| | x | | x | L1L3 |
| | x | x | x | L1L2L3 |
| Direction | In case that a direction has been detected, the evaluated direction will be displayed (this applies to directional phase and ground overcurrent relays only). | | | |
| Measured Values | Various measuring values at the time of tripping (or delayed depending on parameter setting) will be displayed. | | | |

How to set up the Fault Recorder

The »Record-Mode« will determine if trips only cause a fault record or if also Alarms without a consecutively trip should cause a fault record. This parameter is to be set within menu [Device Para\Recorders\Fault rec]

How to navigate within the Fault Recorder

| <i>Navigation within the Fault recorder</i> | Softkey |
|---|--|
| Back to overview. |  |
| Next (upper) item within this fault record. |  |
| Previous fault record. |  |
| Next (lower) item within this fault record. |  |

How to read Out the Fault Recorder

In order to read out a fault record there are two options available:

- Option 1: A Fault has popped up on the HMI (because an trip or pickup has occurred).
- Option 2: Call up manually the Fault recorder menu.

Option 1 (in case a fault record pops up on the display (overlay):

- Analyze the fault record by using Softkeys Arrow Up and Arrow Down.
- Or close the Popup by using Softkey OK



Option 2 :

- Call up the main menu;
- Call up the sub-menu »Operation/Recorders/Fault rec.«;
- Select a fault record; and
- Analyze the fault record by using Softkeys Arrow Up and Arrow Down.

Direct Commands of the Fault Recorder

| <i>Parameter</i> | <i>Description</i> | <i>Setting range</i> | <i>Default</i> | <i>Menu path</i> |
|--|--------------------|----------------------|----------------|-----------------------|
| Res all rec  | Reset all records | inactive, active | inactive | [Operation /Reset] |

Global Protection Parameters of the Fault Recorder

| <i>Parameter</i> | <i>Description</i> | <i>Setting range</i> | <i>Default</i> | <i>Menu path</i> |
|---|--|---------------------------------|----------------|---|
| Record-Mode  | Recorder Mode (Set the behaviour of the recorder) | Alarms and Trips, Trips only | Trips only | [Device Para /Recorders /Fault rec] |
| t-meas-delay  | After the Trip, the measurement will be delayed for this time. | 0 - 60ms | 0ms | [Device Para /Recorders /Fault rec] |

Fault Recorder Signals

| <i>Signal</i> | <i>Description</i> |
|---------------|-----------------------|
| Res rec | Signal: Delete record |

Event Recorder

Event rec

The event recorder can register up to 300 events and the last (minimum) 50 saved events are recorded fail-safe. The following information is provided for any of the events:

Events are logged as follows:

| <i>Record No.</i> | <i>Fault No.</i> | <i>No of grid faults</i> | <i>Date of Record</i> | <i>Module.Name</i> | <i>State</i> |
|-------------------|--|---|-----------------------|--------------------|---------------|
| Sequential Number | Number of the ongoing fault This counter will be incremented by each General Alarm (Prot.Alarm) | A grid fault No. can have several Fault No. This counter will be incremented by each General Alarm (Exception AR: this applies only to devices that offer auto reclosing) | Time stamp | What has changed? | Changed Value |

There are three different classes of events:

- **Alternation of binary states are shown as:**
 - 0->1 if the signal changes physically from »0« to »1«.
 - 1->0 if the signal changes physically from »1« to »0«.

- **Counters increment is shown as:**
 - Old Counter state -> New Counter state (e.g. 3->4)

- **Alternation of multiple states are shown as:**
 - Old state -> New state (e.g. 0->2)

Read Out the Event Recorder

- Call up the »*main menu*«.
- Call up the submenu »*Operation/Recorders/Event rec*«.
- Select an event.

Direct Commands of the Event Recorder

| <i>Parameter</i> | <i>Description</i> | <i>Setting range</i> | <i>Default</i> | <i>Menu path</i> |
|--|--------------------|----------------------|----------------|-----------------------|
| Res all rec  | Reset all records | inactive, active | inactive | [Operation /Reset] |

Event Recorder Signals

| <i>Signal</i> | <i>Description</i> |
|-----------------|-----------------------------|
| Res all records | Signal: All records deleted |

Trend Recorder

Available Elements:

Trend_rec

Configuring the Trend Recorder







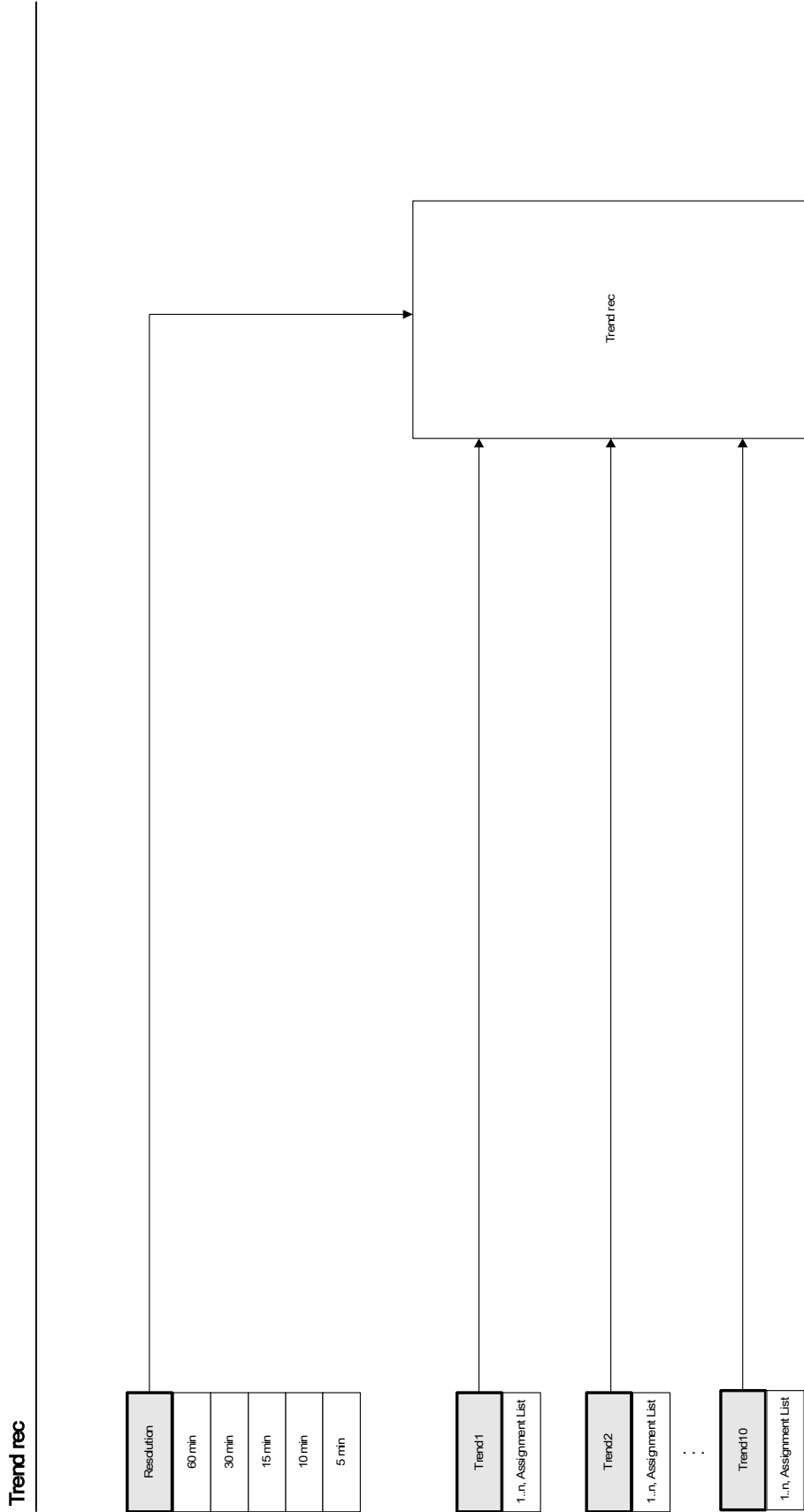



The Trend Recorder is to be configured within [Device Para/Recorders/Trend Recorder] menu.

The User has to set the time interval. This defines the distance between two measuring points.

The User can select up to ten values that will be recorded.



Global Protection Parameters of the Trend Recorder

| <i>Parameter</i> | <i>Description</i> | <i>Setting range</i> | <i>Default</i> | <i>Menu path</i> |
|---|----------------------------------|---|-------------------|---|
| Resolution  | Resolution (recording frequency) | 60 min, 30 min, 15 min, 10 min, 5 min | 15 min | [Device Para /Recorders /Trend rec] |
| Trend1  | Observed Value1 | 1..n, TrendRecList | CT.IL1 RMS | [Device Para /Recorders /Trend rec] |
| Trend2  | Observed Value2 | 1..n, TrendRecList | CT.IL2 RMS | [Device Para /Recorders /Trend rec] |
| Trend3  | Observed Value3 | 1..n, TrendRecList | CT.IL3 RMS | [Device Para /Recorders /Trend rec] |
| Trend4  | Observed Value4 | 1..n, TrendRecList | CT.IG meas RMS | [Device Para /Recorders /Trend rec] |
| Trend5  | Observed Value5 | 1..n, TrendRecList | VT.VL1 RMS | [Device Para /Recorders /Trend rec] |
| Trend6  | Observed Value6 | 1..n, TrendRecList | VT.VL2 RMS | [Device Para /Recorders /Trend rec] |
| Trend7  | Observed Value7 | 1..n, TrendRecList | VT.VL3 RMS | [Device Para /Recorders /Trend rec] |
| Trend8  | Observed Value8 | 1..n, TrendRecList | VT.VX meas RMS | [Device Para /Recorders /Trend rec] |
| Trend9  | Observed Value9 | 1..n, TrendRecList | -- | [Device Para /Recorders /Trend rec] |

Recorders

| <i>Parameter</i> | <i>Description</i> | <i>Setting range</i> | <i>Default</i> | <i>Menu path</i> |
|--|--------------------|----------------------|----------------|---|
| Trend10  | Observed Value10 | 1..n, TrendReclList | .-. | [Device Para /Recorders /Trend rec] |

Trend Recorder Signals (Output States)

| <i>Signal</i> | <i>Description</i> |
|---------------|--------------------|
| Hand Reset | Hand Reset |

Direct Commands of the Trend Recorder

| Parameter | Description | Setting range | Default | Menu path |
|--|--------------------|---------------------|----------|-----------------------|
| Reset  | Delete all entries | inactive, active | inactive | [Operation /Reset] |

General Values of the Trend Recorder

| Value | Description | Default | Size | Menu path |
|-------------------|--|---------|---------------|---|
| Max avail Entries | Maximum available entries in the current configuration | 0 | 0 - 999999999 | [Operation /Count and RevData /Trend rec] |

Global Values of the Trend Recorder

The »TrendRecList« below summarizes all signals that the User can assign.

| Name | Description |
|----------------|--|
| -- | No assignment |
| VT.VL1 | Measured value: Phase-to-neutral voltage (fundamental) |
| VT.VL2 | Measured value: Phase-to-neutral voltage (fundamental) |
| VT.VL3 | Measured value: Phase-to-neutral voltage (fundamental) |
| VT.VX meas | Measured value (measured): VX measured (fundamental) |
| VT.VG calc | Measured value (calculated): VG (fundamental) |
| VT.VL12 | Measured value: Phase-to-phase voltage (fundamental) |
| VT.VL23 | Measured value: Phase-to-phase voltage (fundamental) |
| VT.VL31 | Measured value: Phase-to-phase voltage (fundamental) |
| VT.VL1 RMS | Measured value: Phase-to-neutral voltage (RMS) |
| VT.VL2 RMS | Measured value: Phase-to-neutral voltage (RMS) |
| VT.VL3 RMS | Measured value: Phase-to-neutral voltage (RMS) |
| VT.VX meas RMS | Measured value (measured): VX measured (RMS) |
| VT.VG calc RMS | Measured value (calculated): VG (RMS) |
| VT.VL12 RMS | Measured value: Phase-to-phase voltage (RMS) |
| VT.VL23 RMS | Measured value: Phase-to-phase voltage (RMS) |
| VT.VL31 RMS | Measured value: Phase-to-phase voltage (RMS) |
| VT.V0 | Measured value (calculated): Symmetrical components Zero voltage(fundamental) |
| VT.V1 | Measured value (calculated): Symmetrical components positive phase sequence voltage(fundamental) |
| VT.V2 | Measured value (calculated): Symmetrical components negative phase sequence voltage(fundamental) |

Recorders

| Name | Description |
|----------------------|---|
| VT.%(V2/V1) | Measured value (calculated): V2/V1, phase sequence will be taken into account automatically. |
| VT.VL1 avg RMS | VL1 average value (RMS) |
| VT.VL2 avg RMS | VL2 average value (RMS) |
| VT.VL3 avg RMS | VL3 average value (RMS) |
| VT.VL12 avg RMS | VL12 average value (RMS) |
| VT.VL23 avg RMS | VL23 average value (RMS) |
| VT.VL31 avg RMS | VL31 average value (RMS) |
| VT.f | Measured value: Frequency |
| VT.VL1 THD | Measured value (calculated): VL1 Total Harmonic Distortion |
| VT.VL2 THD | Measured value (calculated): VL2 Total Harmonic Distortion |
| VT.VL3 THD | Measured value (calculated): VL3 Total Harmonic Distortion |
| VT.VL12 THD | Measured value (calculated): V12 Total Harmonic Distortion |
| VT.VL23 THD | Measured value (calculated): V23 Total Harmonic Distortion |
| VT.VL31 THD | Measured value (calculated): V31 Total Harmonic Distortion |
| CT.IL1 | Measured value: Phase current (fundamental) |
| CT.IL2 | Measured value: Phase current (fundamental) |
| CT.IL3 | Measured value: Phase current (fundamental) |
| CT.IG meas | Measured value (measured): IG (fundamental) |
| CT.IG calc | Measured value (calculated): IG (fundamental) |
| CT.IL1 RMS | Measured value: Phase current (RMS) |
| CT.IL2 RMS | Measured value: Phase current (RMS) |
| CT.IL3 RMS | Measured value: Phase current (RMS) |
| CT.IG meas RMS | Measured value (measured): IG (RMS) |
| CT.IG calc RMS | Measured value (calculated): IG (RMS) |
| CT.I0 | Measured value (calculated): Zero current (fundamental) |
| CT.I1 | Measured value (calculated): Positive phase sequence current (fundamental) |
| CT.I2 | Measured value (calculated): Unbalanced load current (fundamental) |
| CT.%(I2/I1) | Measured value (calculated): I2/I1, phase sequence will be taken into account automatically. |
| CT.IL1 avg RMS | IL1 average value (RMS) |
| CT.IL2 avg RMS | IL2 average value (RMS) |
| CT.IL3 avg RMS | IL3 average value (RMS) |
| CT.IL1 THD | Measured value (calculated): IL1 Total Harmonic Current |
| CT.IL2 THD | Measured value (calculated): IL2 Total Harmonic Current |
| CT.IL3 THD | Measured value (calculated): IL3 Total Harmonic Current |
| ThR.Thermal Cap Used | Measured value: Thermal Capacity Used |
| PQSCr.S | Measured Value (Calculated): Apparent power (fundamental) |
| PQSCr.P | Measured value (calculated): Active power (P- = Fed Active Power, P+ = Consumpted Active Power) (fundamental) |
| PQSCr.Q | Measured value (calculated): Reactive power (Q- = Fed Reactive Power, Q+ = Consumpted Reactive Power) (fundamental) |

Recorders

| Name | Description |
|-------------------|---|
| PQSCr.P 1 | Measured value (calculated): Active power in positive sequence system (P- = Fed Active Power, P+ = Consumpted Active Power) |
| PQSCr.Q 1 | Measured value (calculated): Reactive power in positive sequence system (Q- = Fed Reactive Power, Q+ = Consumpted Reactive Power) |
| PQSCr.S RMS | Measured Value (Calculated): Apparent power (RMS) |
| PQSCr.P RMS | Measured value (calculated): Active power (P- = Fed Active Power, P+ = Consumpted Active Power) (RMS) |
| PQSCr.cos phi | Measured value (calculated): Power factor: Sign Convention: sign(PF) = sign(P) |
| PQSCr.cos phi RMS | Measured value (calculated): Power factor: Sign Convention: sign(PF) = sign(P) |
| PQSCr.Ws Net | Absolute Apparent Power Hours |
| PQSCr.Wp Net | Absolute Active Power Hours |
| PQSCr.Wq Net | Absolute Reactive Power Hours |
| PQSCr.Wp+ | Positive Active Power is consumed active energy |
| PQSCr.Wp- | Negative Active Power (Fed Energy) |
| PQSCr.Wq+ | Positive Reactive Power is consumed Reactive Energy |
| PQSCr.Wq- | Negative Reactive Power (Fed Energy) |

Communication Protocols

SCADA Interface

Scada

Device Planning Parameters of the Serial Scada Interface

| Parameter | Description | Options | Default | Menu path |
|---|----------------------------|--|------------|-------------------|
|  Protocol | Select used SCADA protocol | do not use, Modbus RTU, Modbus TCP, DNP3 RTU, DNP3 TCP, DNP3 UDP, IEC60870-5-103, IEC61850, Profibus | do not use | [Device planning] |



Signals (Output States) of the SCADA Interface

| Signal | Description |
|---------------------|---|
| SCADA connected | At least one SCADA System is connected to the device. |
| SCADA not connected | No SCADA System is connected to the device |

TCP/IP Parameter

Tcplp

Global TCP/IP Parameters

| Parameter | Description | Setting range | Default | Menu path |
|--|--|---------------|---------|---|
|  Keep Alive Time | Keep Alive Time is the duration between two keep alive transmissions in idle condition | 1 - 7200s | 720s | [Device Para /TCP/IP /Advanced Settings] |
|  Keep Alive Interval | Keep Alive Interval is the duration between two successive keep alive retransmissions, if the acknowledgement to the previous keepalive transmission was not received. | 1 - 60s | 15s | [Device Para /TCP/IP /Advanced Settings] |

Communication Protocols

| <i>Parameter</i> | <i>Description</i> | <i>Setting range</i> | <i>Default</i> | <i>Menu path</i> |
|---|--|----------------------|----------------|---|
| Keep Alive Retry  | Keep alive retry is the number of retransmissions to be carried out before declaring that the remote end is not available. | 3 - 3 | 3 | [Device Para /TCP/IP /Advanced Settings] |

Modbus®

Modbus

Modbus® Protocol Configuration

The time-controlled Modbus® protocol is based on the Master-Slave working principle. This means that the substation control and protection system sends an enquiry or instruction to a certain device (slave address) which will then be answered or carried out accordingly. If the enquiry/instruction cannot be answered/carried out (e.g. because of an invalid slave address), a failure message is returned to the master.

The Master (substation control and protection system) can query information from the device, such as:

- Type of unit version
- Measuring values/Statistical measured values
- Switch operating position
- State of device
- Time and date
- State of the device's digital inputs
- Protection-/State alarms

The Master (control system) can give commands/instructions to the device, such as:

- Control of switchgear (where applicable, i.e. each acc. to the applied device version)
- Change-over of parameter set
- Reset and acknowledgement of alarms/signals
- Adjustment of date and time
- Control of alarm relays

For detailed information on data point lists and error handling, please refer to the Modbus® documentation.

To allow configuration of the devices for Modbus® connection, some default values of the control system must be available.

Modbus RTU

Part 1: Configuration of the Devices

Call up »*Device parameter/Modbus*« and set the following communication parameters there:

- Slave-address, to allow clear identification of the device.
- Baud-Rate

Also, select below indicated RS485 interface-related parameters from there, such as:

- Number of data bits
- One of the following supported communication variants: Number of data bits, even, odd, parity or no parity, number of stop bits.
- »*t-timeout*«: communication errors are only identified after expiry of a supervision time »*t-timeout*«.
- Response time (defining the period within which an enquiry from the master has to be answered).

Part 2: Hardware Connection

- For hardware connection to the control system, there is an RS485 interface at the rear side of the device (RS485, fiber optic or terminals).
- Connect bus and device (wiring).

Error Handling - Hardware Errors

Information on physical communication errors, such as:

- Baudrate Error
- Parity Error ...

can be obtained from the event recorder.

Error Handling – Errors on protocol level

If, for example, an invalid memory address is enquired, error codes will be returned by the device that need to be interpreted.

Modbus TCP

NOTICE Establishing a connection via TCP/IP to the device is only possible if your device is equipped with an Ethernet Interface (RJ45).

Contact your IT administrator in order to establish the network connection.

Part 1: Setting the TCP/IP Parameters

Call up »Device parameter/TCP/IP« at the HMI (panel) and set the following parameters:

- TCP/IP address
- Subnetmask
- Gateway

Part 2: Configuration of the Devices

Call up »Device parameter/Modbus« and set the following communication parameters:

- Setting a Unit Identifier is only necessary if a TCP network should be coupled to a RTU network.
- If a different port than the default port 502 should be used please proceed as follows:
 - Choose “Private” within the TCP-Port-Configuration.
 - Set the port-number.
- Set the maximum accepted time of “no communication”. If this time has expired – without any communication, the device concludes a failure within the master system.
- Allow or disallow the blocking of SCADA commands.

Part 3: Hardware Connection







- There is a RJ45 interface at the rear side of the device for the hardware connection to the control system.
- Establish the connection to the device by means of a proper Ethernet cable.

Direct Commands of the Modbus®









| Parameter | Description | Setting range | Default | Menu path |
|--------------|--|---------------------|----------|-----------------------|
| Res Diagn Cr | All Modbus Diagnosis Counters will be reset. | inactive, active | inactive | [Operation /Reset] |















Global Protection Parameters of the Modbus®





| Parameter | Description | Setting range | Default | Menu path |
|--|---|---|---------|--|
|  Slave ID | Device address (Slave ID) within the bus system. Each device address has to be unique within a bus system. | 1 - 247 | 1 | [Device Para /Modbus /Communication] |
|  Unit ID | The Unit Identifier is used for routing. This parameter is to be set, if a Modbus RTU and a Modbus TCP network should be coupled. | 1 - 255 | 255 | [Device Para /Modbus /Communication] |
|  TCP Port Config | TCP Port Configuration. This parameter is to be set only if the default Modbus TCP Port should not be used. | Default, Private | Default | [Device Para /Modbus /Communication] |
|  Port | Port number And Only available if: TCP Port Config = Private | 502 - 65535 | 502 | [Device Para /Modbus /Communication] |
|  t-timeout | Within this time the answer has to be received by the SCADA system, otherwise the request will be disregarded. In that case the Scada system detects a communication failure and the Scada System has to send a new request. | 0.01 - 10.00s | 1s | [Device Para /Modbus /Communication] |
|  Baud rate | Baud rate | 1200, 2400, 4800, 9600, 19200, 38400 | 19200 | [Device Para /Modbus /Communication] |
|  Physical Settings | Digit 1: Number of bits. Digit 2: E=even parity, O=odd parity, N=no parity. Digit 3: Number of stop bits. More information on the parity: It is possible that the last data bit is followed by a parity bit which is used for recognition of communication errors. The parity bit ensures that with even parity ("EVEN") always an even number of bits with valence "1" or with odd parity ("ODD") an odd number of "1" valence bits are transmitted. But it is also possible to transmit no parity bits (here the setting is "Parity = None"). More information on the stop-bits: The end of a data byte is terminated by the stop-bits. | 8E1, 8O1, 8N1, 8N2 | 8E1 | [Device Para /Modbus /Communication] |









| Parameter | Description | Setting range | Default | Menu path |
|--|--|------------------------|----------|---|
| t-call  | If there is no request telegram sent from Scada to the device after expiry of this time - the device concludes a communication failure within the Scada system. | 1 - 3600s | 10s | [Device Para /Modbus /Communication] |
| Scada CmdBlo  | Activating (allowing)/ Deactivating (disallowing) the blocking of the Scada Commands | inactive, active | inactive | [Device Para /Modbus /Communication] |
| Disable Latching  | Disable Latching: If this parameter is active (true), none of the Modbus states will be latched. That means that trip signals wont be latched by Modbus. | inactive, active | inactive | [Device Para /Modbus /Communication] |
| AllowGap  | If this parameter is active (True), the user can request a set of modbus register without getting an exception, because of invalid address in the requested array. The invalid addresses have a special value 0xFAFA, but the user is responsible for ignoring invalid addresses. Attention: This special value can be valid, if address is valid. | inactive, active | inactive | [Device Para /Modbus /Communication] |
| Optical rest position  | Optical rest position | Light off, Light on | Light on | [Device Para /Modbus /Communication] |
| Config Bin Inp1  | Virtual Digital Input. This corresponds to a virtual binary output of the protective device. | 1..n, Assignment List | .- | [Device Para /Modbus /Configb Registers /States] |
| Latched Config Bin Inp1  | Latched Configurable Binary Input | inactive, active | inactive | [Device Para /Modbus /Configb Registers /States] |
| Config Bin Inp2  | Virtual Digital Input. This corresponds to a virtual binary output of the protective device. | 1..n, Assignment List | .- | [Device Para /Modbus /Configb Registers /States] |
| Latched Config Bin Inp2  | Latched Configurable Binary Input | inactive, active | inactive | [Device Para /Modbus /Configb Registers /States] |



| <i>Parameter</i> | <i>Description</i> | <i>Setting range</i> | <i>Default</i> | <i>Menu path</i> |
|---|--|-----------------------|----------------|--|
|  Config Bin Inp3 | Virtual Digital Input. This corresponds to a virtual binary output of the protective device. | 1..n, Assignment List | -- | [Device Para /Modbus /Configb Registers /States] |
|  Latched Config Bin Inp3 | Latched Configurable Binary Input | inactive, active | inactive | [Device Para /Modbus /Configb Registers /States] |
|  Config Bin Inp4 | Virtual Digital Input. This corresponds to a virtual binary output of the protective device. | 1..n, Assignment List | -- | [Device Para /Modbus /Configb Registers /States] |
|  Latched Config Bin Inp4 | Latched Configurable Binary Input | inactive, active | inactive | [Device Para /Modbus /Configb Registers /States] |
|  Config Bin Inp5 | Virtual Digital Input. This corresponds to a virtual binary output of the protective device. | 1..n, Assignment List | -- | [Device Para /Modbus /Configb Registers /States] |
|  Latched Config Bin Inp5 | Latched Configurable Binary Input | inactive, active | inactive | [Device Para /Modbus /Configb Registers /States] |
|  Config Bin Inp6 | Virtual Digital Input. This corresponds to a virtual binary output of the protective device. | 1..n, Assignment List | -- | [Device Para /Modbus /Configb Registers /States] |
|  Latched Config Bin Inp6 | Latched Configurable Binary Input | inactive, active | inactive | [Device Para /Modbus /Configb Registers /States] |
|  Config Bin Inp7 | Virtual Digital Input. This corresponds to a virtual binary output of the protective device. | 1..n, Assignment List | -- | [Device Para /Modbus /Configb Registers /States] |









| <i>Parameter</i> | <i>Description</i> | <i>Setting range</i> | <i>Default</i> | <i>Menu path</i> |
|---|--|-----------------------|----------------|---|
| Latched Config Bin Inp7  | Latched Configurable Binary Input | inactive, active | inactive | [Device Para /Modbus /Configb Registers /States] |
| Config Bin Inp8  | Virtual Digital Input. This corresponds to a virtual binary output of the protective device. | 1..n, Assignment List | -- | [Device Para /Modbus /Configb Registers /States] |
| Latched Config Bin Inp8  | Latched Configurable Binary Input | inactive, active | inactive | [Device Para /Modbus /Configb Registers /States] |
| Config Bin Inp9  | Virtual Digital Input. This corresponds to a virtual binary output of the protective device. | 1..n, Assignment List | -- | [Device Para /Modbus /Configb Registers /States] |
| Latched Config Bin Inp9  | Latched Configurable Binary Input | inactive, active | inactive | [Device Para /Modbus /Configb Registers /States] |
| Config Bin Inp10  | Virtual Digital Input. This corresponds to a virtual binary output of the protective device. | 1..n, Assignment List | -- | [Device Para /Modbus /Configb Registers /States] |
| Latched Config Bin Inp10  | Latched Configurable Binary Input | inactive, active | inactive | [Device Para /Modbus /Configb Registers /States] |
| Config Bin Inp11  | Virtual Digital Input. This corresponds to a virtual binary output of the protective device. | 1..n, Assignment List | -- | [Device Para /Modbus /Configb Registers /States] |
| Latched Config Bin Inp11  | Latched Configurable Binary Input | inactive, active | inactive | [Device Para /Modbus /Configb Registers /States] |









| Parameter | Description | Setting range | Default | Menu path |
|--|--|-----------------------|----------|--|
|  Config Bin Inp12 | Virtual Digital Input. This corresponds to a virtual binary output of the protective device. | 1..n, Assignment List | -- | [Device Para /Modbus /Configb Registers /States] |
|  Latched Config Bin Inp12 | Latched Configurable Binary Input | inactive, active | inactive | [Device Para /Modbus /Configb Registers /States] |
|  Config Bin Inp13 | Virtual Digital Input. This corresponds to a virtual binary output of the protective device. | 1..n, Assignment List | -- | [Device Para /Modbus /Configb Registers /States] |
|  Latched Config Bin Inp13 | Latched Configurable Binary Input | inactive, active | inactive | [Device Para /Modbus /Configb Registers /States] |
|  Config Bin Inp14 | Virtual Digital Input. This corresponds to a virtual binary output of the protective device. | 1..n, Assignment List | -- | [Device Para /Modbus /Configb Registers /States] |
|  Latched Config Bin Inp14 | Latched Configurable Binary Input | inactive, active | inactive | [Device Para /Modbus /Configb Registers /States] |
|  Config Bin Inp15 | Virtual Digital Input. This corresponds to a virtual binary output of the protective device. | 1..n, Assignment List | -- | [Device Para /Modbus /Configb Registers /States] |
|  Latched Config Bin Inp15 | Latched Configurable Binary Input | inactive, active | inactive | [Device Para /Modbus /Configb Registers /States] |
|  Config Bin Inp16 | Virtual Digital Input. This corresponds to a virtual binary output of the protective device. | 1..n, Assignment List | -- | [Device Para /Modbus /Configb Registers /States] |





| <i>Parameter</i> | <i>Description</i> | <i>Setting range</i> | <i>Default</i> | <i>Menu path</i> |
|---|--|-----------------------|----------------|---|
| Latched Config Bin Inp16  | Latched Configurable Binary Input | inactive, active | inactive | [Device Para /Modbus /Configb Registers /States] |
| Config Bin Inp17  | Virtual Digital Input. This corresponds to a virtual binary output of the protective device. | 1..n, Assignment List | -- | [Device Para /Modbus /Configb Registers /States] |
| Latched Config Bin Inp17  | Latched Configurable Binary Input | inactive, active | inactive | [Device Para /Modbus /Configb Registers /States] |
| Config Bin Inp18  | Virtual Digital Input. This corresponds to a virtual binary output of the protective device. | 1..n, Assignment List | -- | [Device Para /Modbus /Configb Registers /States] |
| Latched Config Bin Inp18  | Latched Configurable Binary Input | inactive, active | inactive | [Device Para /Modbus /Configb Registers /States] |
| Config Bin Inp19  | Virtual Digital Input. This corresponds to a virtual binary output of the protective device. | 1..n, Assignment List | -- | [Device Para /Modbus /Configb Registers /States] |
| Latched Config Bin Inp19  | Latched Configurable Binary Input | inactive, active | inactive | [Device Para /Modbus /Configb Registers /States] |
| Config Bin Inp20  | Virtual Digital Input. This corresponds to a virtual binary output of the protective device. | 1..n, Assignment List | -- | [Device Para /Modbus /Configb Registers /States] |
| Latched Config Bin Inp20  | Latched Configurable Binary Input | inactive, active | inactive | [Device Para /Modbus /Configb Registers /States] |

| <i>Parameter</i> | <i>Description</i> | <i>Setting range</i> | <i>Default</i> | <i>Menu path</i> |
|--|--|-----------------------|----------------|--|
|  Config Bin Inp21 | Virtual Digital Input. This corresponds to a virtual binary output of the protective device. | 1..n, Assignment List | -- | [Device Para /Modbus /Configb Registers /States] |
|  Latched Config Bin Inp21 | Latched Configurable Binary Input | inactive, active | inactive | [Device Para /Modbus /Configb Registers /States] |
|  Config Bin Inp22 | Virtual Digital Input. This corresponds to a virtual binary output of the protective device. | 1..n, Assignment List | -- | [Device Para /Modbus /Configb Registers /States] |
|  Latched Config Bin Inp22 | Latched Configurable Binary Input | inactive, active | inactive | [Device Para /Modbus /Configb Registers /States] |
|  Config Bin Inp23 | Virtual Digital Input. This corresponds to a virtual binary output of the protective device. | 1..n, Assignment List | -- | [Device Para /Modbus /Configb Registers /States] |
|  Latched Config Bin Inp23 | Latched Configurable Binary Input | inactive, active | inactive | [Device Para /Modbus /Configb Registers /States] |
|  Config Bin Inp24 | Virtual Digital Input. This corresponds to a virtual binary output of the protective device. | 1..n, Assignment List | -- | [Device Para /Modbus /Configb Registers /States] |
|  Latched Config Bin Inp24 | Latched Configurable Binary Input | inactive, active | inactive | [Device Para /Modbus /Configb Registers /States] |
|  Config Bin Inp25 | Virtual Digital Input. This corresponds to a virtual binary output of the protective device. | 1..n, Assignment List | -- | [Device Para /Modbus /Configb Registers /States] |

| <i>Parameter</i> | <i>Description</i> | <i>Setting range</i> | <i>Default</i> | <i>Menu path</i> |
|---|--|-----------------------|----------------|---|
| Latched Config Bin Inp25  | Latched Configurable Binary Input | inactive, active | inactive | [Device Para /Modbus /Configb Registers /States] |
| Config Bin Inp26  | Virtual Digital Input. This corresponds to a virtual binary output of the protective device. | 1..n, Assignment List | -- | [Device Para /Modbus /Configb Registers /States] |
| Latched Config Bin Inp26  | Latched Configurable Binary Input | inactive, active | inactive | [Device Para /Modbus /Configb Registers /States] |
| Config Bin Inp27  | Virtual Digital Input. This corresponds to a virtual binary output of the protective device. | 1..n, Assignment List | -- | [Device Para /Modbus /Configb Registers /States] |
| Latched Config Bin Inp27  | Latched Configurable Binary Input | inactive, active | inactive | [Device Para /Modbus /Configb Registers /States] |
| Config Bin Inp28  | Virtual Digital Input. This corresponds to a virtual binary output of the protective device. | 1..n, Assignment List | -- | [Device Para /Modbus /Configb Registers /States] |
| Latched Config Bin Inp28  | Latched Configurable Binary Input | inactive, active | inactive | [Device Para /Modbus /Configb Registers /States] |
| Config Bin Inp29  | Virtual Digital Input. This corresponds to a virtual binary output of the protective device. | 1..n, Assignment List | -- | [Device Para /Modbus /Configb Registers /States] |
| Latched Config Bin Inp29  | Latched Configurable Binary Input | inactive, active | inactive | [Device Para /Modbus /Configb Registers /States] |

| <i>Parameter</i> | <i>Description</i> | <i>Setting range</i> | <i>Default</i> | <i>Menu path</i> |
|--|--|-----------------------|----------------|--|
|  Config Bin Inp30 | Virtual Digital Input. This corresponds to a virtual binary output of the protective device. | 1..n, Assignment List | -- | [Device Para /Modbus /Configb Registers /States] |
|  Latched Config Bin Inp30 | Latched Configurable Binary Input | inactive, active | inactive | [Device Para /Modbus /Configb Registers /States] |
|  Config Bin Inp31 | Virtual Digital Input. This corresponds to a virtual binary output of the protective device. | 1..n, Assignment List | -- | [Device Para /Modbus /Configb Registers /States] |
|  Latched Config Bin Inp31 | Latched Configurable Binary Input | inactive, active | inactive | [Device Para /Modbus /Configb Registers /States] |
|  Config Bin Inp32 | Virtual Digital Input. This corresponds to a virtual binary output of the protective device. | 1..n, Assignment List | -- | [Device Para /Modbus /Configb Registers /States] |
|  Latched Config Bin Inp32 | Latched Configurable Binary Input | inactive, active | inactive | [Device Para /Modbus /Configb Registers /States] |
|  Mapped Meas 1 | Mapped Measured Values. They can be used to provide measured values to the Modbus Master. | 1..n, TrendReclList | -- | [Device Para /Modbus /Configb Registers /Measured Values] |
|  Mapped Meas 2 | Mapped Measured Values. They can be used to provide measured values to the Modbus Master. | 1..n, TrendReclList | -- | [Device Para /Modbus /Configb Registers /Measured Values] |
|  Mapped Meas 3 | Mapped Measured Values. They can be used to provide measured values to the Modbus Master. | 1..n, TrendReclList | -- | [Device Para /Modbus /Configb Registers /Measured Values] |

| <i>Parameter</i> | <i>Description</i> | <i>Setting range</i> | <i>Default</i> | <i>Menu path</i> |
|---|---|----------------------|----------------|--|
| Mapped Meas 4  | Mapped Measured Values. They can be used to provide measured values to the Modbus Master. | 1..n, TrendReclList | -- | [Device Para /Modbus /Configb Registers /Measured Values] |
| Mapped Meas 5  | Mapped Measured Values. They can be used to provide measured values to the Modbus Master. | 1..n, TrendReclList | -- | [Device Para /Modbus /Configb Registers /Measured Values] |
| Mapped Meas 6  | Mapped Measured Values. They can be used to provide measured values to the Modbus Master. | 1..n, TrendReclList | -- | [Device Para /Modbus /Configb Registers /Measured Values] |
| Mapped Meas 7  | Mapped Measured Values. They can be used to provide measured values to the Modbus Master. | 1..n, TrendReclList | -- | [Device Para /Modbus /Configb Registers /Measured Values] |
| Mapped Meas 8  | Mapped Measured Values. They can be used to provide measured values to the Modbus Master. | 1..n, TrendReclList | -- | [Device Para /Modbus /Configb Registers /Measured Values] |
| Mapped Meas 9  | Mapped Measured Values. They can be used to provide measured values to the Modbus Master. | 1..n, TrendReclList | -- | [Device Para /Modbus /Configb Registers /Measured Values] |
| Mapped Meas 10  | Mapped Measured Values. They can be used to provide measured values to the Modbus Master. | 1..n, TrendReclList | -- | [Device Para /Modbus /Configb Registers /Measured Values] |
| Mapped Meas 11  | Mapped Measured Values. They can be used to provide measured values to the Modbus Master. | 1..n, TrendReclList | -- | [Device Para /Modbus /Configb Registers /Measured Values] |
| Mapped Meas 12  | Mapped Measured Values. They can be used to provide measured values to the Modbus Master. | 1..n, TrendReclList | -- | [Device Para /Modbus /Configb Registers /Measured Values] |

| Parameter | Description | Setting range | Default | Menu path |
|---|---|-------------------|---------|--|
| Mapped Meas 13  | Mapped Measured Values. They can be used to provide measured values to the Modbus Master. | 1..n, TrendReclst | -.- | [Device Para /Modbus /Configb Registers /Measured Values] |
| Mapped Meas 14  | Mapped Measured Values. They can be used to provide measured values to the Modbus Master. | 1..n, TrendReclst | -.- | [Device Para /Modbus /Configb Registers /Measured Values] |
| Mapped Meas 15  | Mapped Measured Values. They can be used to provide measured values to the Modbus Master. | 1..n, TrendReclst | -.- | [Device Para /Modbus /Configb Registers /Measured Values] |
| Mapped Meas 16  | Mapped Measured Values. They can be used to provide measured values to the Modbus Master. | 1..n, TrendReclst | -.- | [Device Para /Modbus /Configb Registers /Measured Values] |

States of the Module Inputs of the MODBUS® Protocol

| Name | Description | Assignment via |
|-------------------|---|---|
| Config Bin Inp1-I | State of the module input: Config Bin Inp | [Device Para /Modbus /Configb Registers /States] |
| Config Bin Inp2-I | State of the module input: Config Bin Inp | [Device Para /Modbus /Configb Registers /States] |
| Config Bin Inp3-I | State of the module input: Config Bin Inp | [Device Para /Modbus /Configb Registers /States] |
| Config Bin Inp4-I | State of the module input: Config Bin Inp | [Device Para /Modbus /Configb Registers /States] |

| Name | Description | Assignment via |
|--------------------|---|---|
| Config Bin Inp5-I | State of the module input: Config Bin Inp | [Device Para /Modbus /Configb Registers /States] |
| Config Bin Inp6-I | State of the module input: Config Bin Inp | [Device Para /Modbus /Configb Registers /States] |
| Config Bin Inp7-I | State of the module input: Config Bin Inp | [Device Para /Modbus /Configb Registers /States] |
| Config Bin Inp8-I | State of the module input: Config Bin Inp | [Device Para /Modbus /Configb Registers /States] |
| Config Bin Inp9-I | State of the module input: Config Bin Inp | [Device Para /Modbus /Configb Registers /States] |
| Config Bin Inp10-I | State of the module input: Config Bin Inp | [Device Para /Modbus /Configb Registers /States] |
| Config Bin Inp11-I | State of the module input: Config Bin Inp | [Device Para /Modbus /Configb Registers /States] |
| Config Bin Inp12-I | State of the module input: Config Bin Inp | [Device Para /Modbus /Configb Registers /States] |
| Config Bin Inp13-I | State of the module input: Config Bin Inp | [Device Para /Modbus /Configb Registers /States] |

| Name | Description | Assignment via |
|--------------------|---|---|
| Config Bin Inp14-I | State of the module input: Config Bin Inp | [Device Para /Modbus /Configb Registers /States] |
| Config Bin Inp15-I | State of the module input: Config Bin Inp | [Device Para /Modbus /Configb Registers /States] |
| Config Bin Inp16-I | State of the module input: Config Bin Inp | [Device Para /Modbus /Configb Registers /States] |
| Config Bin Inp17-I | State of the module input: Config Bin Inp | [Device Para /Modbus /Configb Registers /States] |
| Config Bin Inp18-I | State of the module input: Config Bin Inp | [Device Para /Modbus /Configb Registers /States] |
| Config Bin Inp19-I | State of the module input: Config Bin Inp | [Device Para /Modbus /Configb Registers /States] |
| Config Bin Inp20-I | State of the module input: Config Bin Inp | [Device Para /Modbus /Configb Registers /States] |
| Config Bin Inp21-I | State of the module input: Config Bin Inp | [Device Para /Modbus /Configb Registers /States] |
| Config Bin Inp22-I | State of the module input: Config Bin Inp | [Device Para /Modbus /Configb Registers /States] |

| <i>Name</i> | <i>Description</i> | <i>Assignment via</i> |
|--------------------|---|---|
| Config Bin Inp23-I | State of the module input: Config Bin Inp | [Device Para /Modbus /Configb Registers /States] |
| Config Bin Inp24-I | State of the module input: Config Bin Inp | [Device Para /Modbus /Configb Registers /States] |
| Config Bin Inp25-I | State of the module input: Config Bin Inp | [Device Para /Modbus /Configb Registers /States] |
| Config Bin Inp26-I | State of the module input: Config Bin Inp | [Device Para /Modbus /Configb Registers /States] |
| Config Bin Inp27-I | State of the module input: Config Bin Inp | [Device Para /Modbus /Configb Registers /States] |
| Config Bin Inp28-I | State of the module input: Config Bin Inp | [Device Para /Modbus /Configb Registers /States] |
| Config Bin Inp29-I | State of the module input: Config Bin Inp | [Device Para /Modbus /Configb Registers /States] |
| Config Bin Inp30-I | State of the module input: Config Bin Inp | [Device Para /Modbus /Configb Registers /States] |
| Config Bin Inp31-I | State of the module input: Config Bin Inp | [Device Para /Modbus /Configb Registers /States] |

| <i>Name</i> | <i>Description</i> | <i>Assignment via</i> |
|--------------------|---|---|
| Config Bin Inp32-I | State of the module input: Config Bin Inp | [Device Para /Modbus /Configb Registers /States] |

Values of the MODBUS® Protocol

| <i>Value</i> | <i>Description</i> | <i>Menu path</i> |
|---------------|---|--|
| Mapped Meas 1 | Mapped Measured Values. They can be used to provide measured values to the Modbus Master. | [Operation /Count and RevData /Modbus] |
| Mapped Meas 2 | Mapped Measured Values. They can be used to provide measured values to the Modbus Master. | [Operation /Count and RevData /Modbus] |
| Mapped Meas 3 | Mapped Measured Values. They can be used to provide measured values to the Modbus Master. | [Operation /Count and RevData /Modbus] |
| Mapped Meas 4 | Mapped Measured Values. They can be used to provide measured values to the Modbus Master. | [Operation /Count and RevData /Modbus] |
| Mapped Meas 5 | Mapped Measured Values. They can be used to provide measured values to the Modbus Master. | [Operation /Count and RevData /Modbus] |
| Mapped Meas 6 | Mapped Measured Values. They can be used to provide measured values to the Modbus Master. | [Operation /Count and RevData /Modbus] |
| Mapped Meas 7 | Mapped Measured Values. They can be used to provide measured values to the Modbus Master. | [Operation /Count and RevData /Modbus] |
| Mapped Meas 8 | Mapped Measured Values. They can be used to provide measured values to the Modbus Master. | [Operation /Count and RevData /Modbus] |
| Mapped Meas 9 | Mapped Measured Values. They can be used to provide measured values to the Modbus Master. | [Operation /Count and RevData /Modbus] |

| <i>Value</i> | <i>Description</i> | <i>Menu path</i> |
|----------------|---|--|
| Mapped Meas 10 | Mapped Measured Values. They can be used to provide measured values to the Modbus Master. | [Operation /Count and RevData /Modbus] |
| Mapped Meas 11 | Mapped Measured Values. They can be used to provide measured values to the Modbus Master. | [Operation /Count and RevData /Modbus] |
| Mapped Meas 12 | Mapped Measured Values. They can be used to provide measured values to the Modbus Master. | [Operation /Count and RevData /Modbus] |
| Mapped Meas 13 | Mapped Measured Values. They can be used to provide measured values to the Modbus Master. | [Operation /Count and RevData /Modbus] |
| Mapped Meas 14 | Mapped Measured Values. They can be used to provide measured values to the Modbus Master. | [Operation /Count and RevData /Modbus] |
| Mapped Meas 15 | Mapped Measured Values. They can be used to provide measured values to the Modbus Master. | [Operation /Count and RevData /Modbus] |
| Mapped Meas 16 | Mapped Measured Values. They can be used to provide measured values to the Modbus Master. | [Operation /Count and RevData /Modbus] |

Counters of the MODBUS® Protocol

| <i>Parameter</i> | <i>Description</i> |
|------------------|---|
| Device Type | Device Type: Device type code for relationship between devcie name and its Modbus code: Woodward: MRI4 - 1000 MRU4 - 1001 MRA4 - 1002 MCA4 - 1003 MRDT4 - 1005 MCDTV4 - 1006 MCDGV4 - 1007 MRM4 - 1009 MRMV4 - 1010 |
| Comm Version | Modbus Communication version. This version number changes if something becomes incompatible between different Modbus releases. |

Modbus® Signals (Output States)

NOTICE Some signals (that are for a short time active only) have to be acknowledged separately (e.g. Trip signals) by the Communication System.

| <i>Signal</i> | <i>Description</i> |
|---------------|----------------------|
| Transmission | Signal: SCADA active |
| Scada Cmd 1 | Scada Command |
| Scada Cmd 2 | Scada Command |
| Scada Cmd 3 | Scada Command |
| Scada Cmd 4 | Scada Command |
| Scada Cmd 5 | Scada Command |
| Scada Cmd 6 | Scada Command |
| Scada Cmd 7 | Scada Command |
| Scada Cmd 8 | Scada Command |
| Scada Cmd 9 | Scada Command |
| Scada Cmd 10 | Scada Command |
| Scada Cmd 11 | Scada Command |
| Scada Cmd 12 | Scada Command |
| Scada Cmd 13 | Scada Command |
| Scada Cmd 14 | Scada Command |
| Scada Cmd 15 | Scada Command |
| Scada Cmd 16 | Scada Command |

Modbus® Values

| <i>Value</i> | <i>Description</i> | <i>Default</i> | <i>Size</i> | <i>Menu path</i> |
|----------------------------|---|----------------|----------------|--|
| NoOfRequestsTotal | Total number of requests. Includes requests for other slaves. | 0 | 0 - 9999999999 | [Operation /Count and RevData /Modbus] |
| NoOfRequestsForMe | Total Number of requests for this slave. | 0 | 0 - 9999999999 | [Operation /Count and RevData /Modbus] |
| NoOfResponse | Total number of requests having been responded. | 0 | 0 - 9999999999 | [Operation /Count and RevData /Modbus] |
| NoOfResponTimeO verruns | Total number of requests with exceeded response time. Physically corrupted Frame. | 0 | 0 - 9999999999 | [Operation /Count and RevData /Modbus] |
| NoOfOverrunErros | Total Number of Overrun Failures. Physically corrupted Frame. | 0 | 0 - 9999999999 | [Operation /Count and RevData /Modbus] |
| NoOfParityErrors | Total number of parity errors. Physically corrupted Frame. | 0 | 0 - 9999999999 | [Operation /Count and RevData /Modbus] |
| NoOfFrameErrors | Total Number of Frame Errors. Physically corrupted Frame. | 0 | 0 - 9999999999 | [Operation /Count and RevData /Modbus] |
| NoOfBreaks | Number of detected communication aborts | 0 | 0 - 9999999999 | [Operation /Count and RevData /Modbus] |
| NoOfQueryInvalid | Total number of Request errors. Request could not be interpreted | 0 | 0 - 9999999999 | [Operation /Count and RevData /Modbus] |
| NoOfInternalError | Total Number of Internal errors while interpreting the request. | 0 | 0 - 9999999999 | [Operation /Count and RevData /Modbus] |

Profibus

Profibus

Part 1: Configuration of the Devices

Call up »*Device parameter/Profibus*« and set the following communication parameter:

- Slave-address, to allow clear identification of the device.

In addition to that the Master has to be provided with the GSD-file. The GSD-file can be taken from the Product-CD.

Part 2: Hardware Connection

- For hardware connection to the control system, there is optional an D-SUB interface at the rear side of the device.
- Connect bus and device (wiring).
- Up to 123 slaves can be connected.
- Terminate the Bus by means of an Terminate Resistor.

Error Handling

Information on physical communication errors, such as:

- Baudrate Error

can be obtained from the event recorder or the status display.

Error Handling – Status LED at the rear side

The Profibus D-SUB interface at the rear side of the device is equipped with an status LED.

- Baud Search -> red flashing
- Baud Found -> green flashing
- Data Exchange -> green
- No Profibus/Unplugged, not connected -> red

Direct Commands of the Profibus

| Parameter | Description | Setting range | Default | Menu path |
|---|--------------------------------------|---------------------|----------|-----------------------|
|  Reset Comds | All Profibus Commands will be reset. | inactive, active | inactive | [Operation /Reset] |

Global Protection Parameters of the Profibus

| Parameter | Description | Setting range | Default | Menu path |
|--|--|-----------------------|----------|--|
|  Config Bin Inp 1 | Virtual Digital Input. This corresponds to a virtual binary output of the protective device. | 1..n, Assignment List | -- | [Device Para /Profibus /Config Bin Inp 1-16] |
|  Latched 1 | Defines whether the Input is latched. Only available if: Latched = active | inactive, active | inactive | [Device Para /Profibus /Config Bin Inp 1-16] |
|  Config Bin Inp 2 | Virtual Digital Input. This corresponds to a virtual binary output of the protective device. | 1..n, Assignment List | -- | [Device Para /Profibus /Config Bin Inp 1-16] |
|  Latched 2 | Defines whether the Input is latched. Only available if: Latched = active | inactive, active | inactive | [Device Para /Profibus /Config Bin Inp 1-16] |
|  Config Bin Inp 3 | Virtual Digital Input. This corresponds to a virtual binary output of the protective device. | 1..n, Assignment List | -- | [Device Para /Profibus /Config Bin Inp 1-16] |
|  Latched 3 | Defines whether the Input is latched. Only available if: Latched = active | inactive, active | inactive | [Device Para /Profibus /Config Bin Inp 1-16] |
|  Config Bin Inp 4 | Virtual Digital Input. This corresponds to a virtual binary output of the protective device. | 1..n, Assignment List | -- | [Device Para /Profibus /Config Bin Inp 1-16] |
|  Latched 4 | Defines whether the Input is latched. Only available if: Latched = active | inactive, active | inactive | [Device Para /Profibus /Config Bin Inp 1-16] |







| Parameter | Description | Setting range | Default | Menu path |
|--|--|-----------------------|----------|--|
|  Config Bin Inp 5 | Virtual Digital Input. This corresponds to a virtual binary output of the protective device. | 1..n, Assignment List | -.- | [Device Para /Profibus /Config Bin Inp 1-16] |
|  Latched 5 | Defines whether the Input is latched. Only available if: Latched = active | inactive, active | inactive | [Device Para /Profibus /Config Bin Inp 1-16] |
|  Config Bin Inp 6 | Virtual Digital Input. This corresponds to a virtual binary output of the protective device. | 1..n, Assignment List | -.- | [Device Para /Profibus /Config Bin Inp 1-16] |
|  Latched 6 | Defines whether the Input is latched. Only available if: Latched = active | inactive, active | inactive | [Device Para /Profibus /Config Bin Inp 1-16] |
|  Config Bin Inp 7 | Virtual Digital Input. This corresponds to a virtual binary output of the protective device. | 1..n, Assignment List | -.- | [Device Para /Profibus /Config Bin Inp 1-16] |
|  Latched 7 | Defines whether the Input is latched. Only available if: Latched = active | inactive, active | inactive | [Device Para /Profibus /Config Bin Inp 1-16] |
|  Config Bin Inp 8 | Virtual Digital Input. This corresponds to a virtual binary output of the protective device. | 1..n, Assignment List | -.- | [Device Para /Profibus /Config Bin Inp 1-16] |
|  Latched 8 | Defines whether the Input is latched. Only available if: Latched = active | inactive, active | inactive | [Device Para /Profibus /Config Bin Inp 1-16] |
|  Config Bin Inp 9 | Virtual Digital Input. This corresponds to a virtual binary output of the protective device. | 1..n, Assignment List | -.- | [Device Para /Profibus /Config Bin Inp 1-16] |
|  Latched 9 | Defines whether the Input is latched. Only available if: Latched = active | inactive, active | inactive | [Device Para /Profibus /Config Bin Inp 1-16] |

| Parameter | Description | Setting range | Default | Menu path |
|---|--|-----------------------|----------|--|
|  Config Bin Inp 10 | Virtual Digital Input. This corresponds to a virtual binary output of the protective device. | 1..n, Assignment List | .- | [Device Para /Profibus /Config Bin Inp 1-16] |
|  Latched 10 | Defines whether the Input is latched. Only available if: Latched = active | inactive, active | inactive | [Device Para /Profibus /Config Bin Inp 1-16] |
|  Config Bin Inp 11 | Virtual Digital Input. This corresponds to a virtual binary output of the protective device. | 1..n, Assignment List | .- | [Device Para /Profibus /Config Bin Inp 1-16] |
|  Latched 11 | Defines whether the Input is latched. Only available if: Latched = active | inactive, active | inactive | [Device Para /Profibus /Config Bin Inp 1-16] |
|  Config Bin Inp 12 | Virtual Digital Input. This corresponds to a virtual binary output of the protective device. | 1..n, Assignment List | .- | [Device Para /Profibus /Config Bin Inp 1-16] |
|  Latched 12 | Defines whether the Input is latched. Only available if: Latched = active | inactive, active | inactive | [Device Para /Profibus /Config Bin Inp 1-16] |
|  Config Bin Inp 13 | Virtual Digital Input. This corresponds to a virtual binary output of the protective device. | 1..n, Assignment List | .- | [Device Para /Profibus /Config Bin Inp 1-16] |
|  Latched 13 | Defines whether the Input is latched. Only available if: Latched = active | inactive, active | inactive | [Device Para /Profibus /Config Bin Inp 1-16] |
|  Config Bin Inp 14 | Virtual Digital Input. This corresponds to a virtual binary output of the protective device. | 1..n, Assignment List | .- | [Device Para /Profibus /Config Bin Inp 1-16] |
|  Latched 14 | Defines whether the Input is latched. Only available if: Latched = active | inactive, active | inactive | [Device Para /Profibus /Config Bin Inp 1-16] |

| Parameter | Description | Setting range | Default | Menu path |
|---|--|-----------------------|----------|---|
|  Config Bin Inp 15 | Virtual Digital Input. This corresponds to a virtual binary output of the protective device. | 1..n, Assignment List | -.- | [Device Para /Profibus /Config Bin Inp 1-16] |
|  Latched 15 | Defines whether the Input is latched. Only available if: Latched = active | inactive, active | inactive | [Device Para /Profibus /Config Bin Inp 1-16] |
|  Config Bin Inp 16 | Virtual Digital Input. This corresponds to a virtual binary output of the protective device. | 1..n, Assignment List | -.- | [Device Para /Profibus /Config Bin Inp 1-16] |
|  Latched 16 | Defines whether the Input is latched. Only available if: Latched = active | inactive, active | inactive | [Device Para /Profibus /Config Bin Inp 1-16] |
|  Config Bin Inp 17 | Virtual Digital Input. This corresponds to a virtual binary output of the protective device. | 1..n, Assignment List | -.- | [Device Para /Profibus /Config Bin Inp 17-32] |
|  Latched 17 | Defines whether the Input is latched. Only available if: Latched = active | inactive, active | inactive | [Device Para /Profibus /Config Bin Inp 17-32] |
|  Config Bin Inp 18 | Virtual Digital Input. This corresponds to a virtual binary output of the protective device. | 1..n, Assignment List | -.- | [Device Para /Profibus /Config Bin Inp 17-32] |
|  Latched 18 | Defines whether the Input is latched. Only available if: Latched = active | inactive, active | inactive | [Device Para /Profibus /Config Bin Inp 17-32] |
|  Config Bin Inp 19 | Virtual Digital Input. This corresponds to a virtual binary output of the protective device. | 1..n, Assignment List | -.- | [Device Para /Profibus /Config Bin Inp 17-32] |
|  Latched 19 | Defines whether the Input is latched. Only available if: Latched = active | inactive, active | inactive | [Device Para /Profibus /Config Bin Inp 17-32] |

| Parameter | Description | Setting range | Default | Menu path |
|---|--|-----------------------|----------|---|
|  Config Bin Inp 20 | Virtual Digital Input. This corresponds to a virtual binary output of the protective device. | 1..n, Assignment List | -.- | [Device Para /Profibus /Config Bin Inp 17-32] |
|  Latched 20 | Defines whether the Input is latched. Only available if: Latched = active | inactive, active | inactive | [Device Para /Profibus /Config Bin Inp 17-32] |
|  Config Bin Inp 21 | Virtual Digital Input. This corresponds to a virtual binary output of the protective device. | 1..n, Assignment List | -.- | [Device Para /Profibus /Config Bin Inp 17-32] |
|  Latched 21 | Defines whether the Input is latched. Only available if: Latched = active | inactive, active | inactive | [Device Para /Profibus /Config Bin Inp 17-32] |
|  Config Bin Inp 22 | Virtual Digital Input. This corresponds to a virtual binary output of the protective device. | 1..n, Assignment List | -.- | [Device Para /Profibus /Config Bin Inp 17-32] |
|  Latched 22 | Defines whether the Input is latched. Only available if: Latched = active | inactive, active | inactive | [Device Para /Profibus /Config Bin Inp 17-32] |
|  Config Bin Inp 23 | Virtual Digital Input. This corresponds to a virtual binary output of the protective device. | 1..n, Assignment List | -.- | [Device Para /Profibus /Config Bin Inp 17-32] |
|  Latched 23 | Defines whether the Input is latched. Only available if: Latched = active | inactive, active | inactive | [Device Para /Profibus /Config Bin Inp 17-32] |
|  Config Bin Inp 24 | Virtual Digital Input. This corresponds to a virtual binary output of the protective device. | 1..n, Assignment List | -.- | [Device Para /Profibus /Config Bin Inp 17-32] |
|  Latched 24 | Defines whether the Input is latched. Only available if: Latched = active | inactive, active | inactive | [Device Para /Profibus /Config Bin Inp 17-32] |

| Parameter | Description | Setting range | Default | Menu path |
|---|--|-----------------------|----------|---|
|  Config Bin Inp 25 | Virtual Digital Input. This corresponds to a virtual binary output of the protective device. | 1..n, Assignment List | -.- | [Device Para /Profibus /Config Bin Inp 17-32] |
|  Latched 25 | Defines whether the Input is latched. Only available if: Latched = active | inactive, active | inactive | [Device Para /Profibus /Config Bin Inp 17-32] |
|  Config Bin Inp 26 | Virtual Digital Input. This corresponds to a virtual binary output of the protective device. | 1..n, Assignment List | -.- | [Device Para /Profibus /Config Bin Inp 17-32] |
|  Latched 26 | Defines whether the Input is latched. Only available if: Latched = active | inactive, active | inactive | [Device Para /Profibus /Config Bin Inp 17-32] |
|  Config Bin Inp 27 | Virtual Digital Input. This corresponds to a virtual binary output of the protective device. | 1..n, Assignment List | -.- | [Device Para /Profibus /Config Bin Inp 17-32] |
|  Latched 27 | Defines whether the Input is latched. Only available if: Latched = active | inactive, active | inactive | [Device Para /Profibus /Config Bin Inp 17-32] |
|  Config Bin Inp 28 | Virtual Digital Input. This corresponds to a virtual binary output of the protective device. | 1..n, Assignment List | -.- | [Device Para /Profibus /Config Bin Inp 17-32] |
|  Latched 28 | Defines whether the Input is latched. Only available if: Latched = active | inactive, active | inactive | [Device Para /Profibus /Config Bin Inp 17-32] |
|  Config Bin Inp 29 | Virtual Digital Input. This corresponds to a virtual binary output of the protective device. | 1..n, Assignment List | -.- | [Device Para /Profibus /Config Bin Inp 17-32] |
|  Latched 29 | Defines whether the Input is latched. Only available if: Latched = active | inactive, active | inactive | [Device Para /Profibus /Config Bin Inp 17-32] |

| <i>Parameter</i> | <i>Description</i> | <i>Setting range</i> | <i>Default</i> | <i>Menu path</i> |
|---|--|-----------------------|----------------|---|
|  Config Bin Inp 30 | Virtual Digital Input. This corresponds to a virtual binary output of the protective device. | 1..n, Assignment List | -- | [Device Para /Profibus /Config Bin Inp 17-32] |
|  Latched 30 | Defines whether the Input is latched. Only available if: Latched = active | inactive, active | inactive | [Device Para /Profibus /Config Bin Inp 17-32] |
|  Config Bin Inp 31 | Virtual Digital Input. This corresponds to a virtual binary output of the protective device. | 1..n, Assignment List | -- | [Device Para /Profibus /Config Bin Inp 17-32] |
|  Latched 31 | Defines whether the Input is latched. Only available if: Latched = active | inactive, active | inactive | [Device Para /Profibus /Config Bin Inp 17-32] |
|  Config Bin Inp 32 | Virtual Digital Input. This corresponds to a virtual binary output of the protective device. | 1..n, Assignment List | -- | [Device Para /Profibus /Config Bin Inp 17-32] |
|  Latched 32 | Defines whether the Input is latched. Only available if: Latched = active | inactive, active | inactive | [Device Para /Profibus /Config Bin Inp 17-32] |
|  Slave ID | Device address (Slave ID) within the bus system. Each device address has to be unique within a bus system. | 2 - 125 | 2 | [Device Para /Profibus /Bus parameters] |

Inputs of the Profibus

| <i>Name</i> | <i>Description</i> | <i>Assignment via</i> |
|-----------------|--------------------------------------|--|
| Assignment 1-I | Module input state: Scada Assignment | [Device Para /Profibus /Config Bin Inp 1-16] |
| Assignment 2-I | Module input state: Scada Assignment | [Device Para /Profibus /Config Bin Inp 1-16] |
| Assignment 3-I | Module input state: Scada Assignment | [Device Para /Profibus /Config Bin Inp 1-16] |
| Assignment 4-I | Module input state: Scada Assignment | [Device Para /Profibus /Config Bin Inp 1-16] |
| Assignment 5-I | Module input state: Scada Assignment | [Device Para /Profibus /Config Bin Inp 1-16] |
| Assignment 6-I | Module input state: Scada Assignment | [Device Para /Profibus /Config Bin Inp 1-16] |
| Assignment 7-I | Module input state: Scada Assignment | [Device Para /Profibus /Config Bin Inp 1-16] |
| Assignment 8-I | Module input state: Scada Assignment | [Device Para /Profibus /Config Bin Inp 1-16] |
| Assignment 9-I | Module input state: Scada Assignment | [Device Para /Profibus /Config Bin Inp 1-16] |
| Assignment 10-I | Module input state: Scada Assignment | [Device Para /Profibus /Config Bin Inp 1-16] |
| Assignment 11-I | Module input state: Scada Assignment | [Device Para /Profibus /Config Bin Inp 1-16] |
| Assignment 12-I | Module input state: Scada Assignment | [Device Para /Profibus /Config Bin Inp 1-16] |

| Name | Description | Assignment via |
|-----------------|--------------------------------------|---|
| Assignment 13-I | Module input state: Scada Assignment | [Device Para /Profibus /Config Bin Inp 1-16] |
| Assignment 14-I | Module input state: Scada Assignment | [Device Para /Profibus /Config Bin Inp 1-16] |
| Assignment 15-I | Module input state: Scada Assignment | [Device Para /Profibus /Config Bin Inp 1-16] |
| Assignment 16-I | Module input state: Scada Assignment | [Device Para /Profibus /Config Bin Inp 1-16] |
| Assignment 17-I | Module input state: Scada Assignment | [Device Para /Profibus /Config Bin Inp 17-32] |
| Assignment 18-I | Module input state: Scada Assignment | [Device Para /Profibus /Config Bin Inp 17-32] |
| Assignment 19-I | Module input state: Scada Assignment | [Device Para /Profibus /Config Bin Inp 17-32] |
| Assignment 20-I | Module input state: Scada Assignment | [Device Para /Profibus /Config Bin Inp 17-32] |
| Assignment 21-I | Module input state: Scada Assignment | [Device Para /Profibus /Config Bin Inp 17-32] |
| Assignment 22-I | Module input state: Scada Assignment | [Device Para /Profibus /Config Bin Inp 17-32] |
| Assignment 23-I | Module input state: Scada Assignment | [Device Para /Profibus /Config Bin Inp 17-32] |
| Assignment 24-I | Module input state: Scada Assignment | [Device Para /Profibus /Config Bin Inp 17-32] |
| Assignment 25-I | Module input state: Scada Assignment | [Device Para /Profibus /Config Bin Inp 17-32] |

| <i>Name</i> | <i>Description</i> | <i>Assignment via</i> |
|-----------------|--------------------------------------|---|
| Assignment 26-I | Module input state: Scada Assignment | [Device Para /Profibus /Config Bin Inp 17-32] |
| Assignment 27-I | Module input state: Scada Assignment | [Device Para /Profibus /Config Bin Inp 17-32] |
| Assignment 28-I | Module input state: Scada Assignment | [Device Para /Profibus /Config Bin Inp 17-32] |
| Assignment 29-I | Module input state: Scada Assignment | [Device Para /Profibus /Config Bin Inp 17-32] |
| Assignment 30-I | Module input state: Scada Assignment | [Device Para /Profibus /Config Bin Inp 17-32] |
| Assignment 31-I | Module input state: Scada Assignment | [Device Para /Profibus /Config Bin Inp 17-32] |
| Assignment 32-I | Module input state: Scada Assignment | [Device Para /Profibus /Config Bin Inp 17-32] |

Profibus Signals (Output States)

| <i>Signal</i> | <i>Description</i> |
|-------------------|--|
| Data OK | Data within the Input field are OK (Yes=1) |
| SubModul Err | Assignable Signal, Failure in Sub-Module, Communication Failure. |
| Connection active | Connection active |
| Scada Cmd 1 | Scada Command |
| Scada Cmd 2 | Scada Command |
| Scada Cmd 3 | Scada Command |
| Scada Cmd 4 | Scada Command |
| Scada Cmd 5 | Scada Command |
| Scada Cmd 6 | Scada Command |
| Scada Cmd 7 | Scada Command |
| Scada Cmd 8 | Scada Command |
| Scada Cmd 9 | Scada Command |
| Scada Cmd 10 | Scada Command |
| Scada Cmd 11 | Scada Command |
| Scada Cmd 12 | Scada Command |
| Scada Cmd 13 | Scada Command |
| Scada Cmd 14 | Scada Command |
| Scada Cmd 15 | Scada Command |
| Scada Cmd 16 | Scada Command |

Profibus Values

| <i>Value</i> | <i>Description</i> | <i>Default</i> | <i>Size</i> | <i>Menu path</i> |
|--------------|--|----------------|----------------|---|
| Fr Sync Err | Frames, that were sent from the Master to the Slave are faulty. | 1 | 1 - 99999999 | [Operation /Count and RevData /Profibus] |
| crcErrors | Number of CRC errors that the ss manager has recognized in received response frames from ss (each error caused a subsystem reset) | 1 | 1 - 99999999 | [Operation /Count and RevData /Profibus] |
| frLossErrors | Number of frame loss errors that the ss manager recognized in received response frames from ss (each error caused a subsystem reset) | 1 | 1 - 99999999 | [Operation /Count and RevData /Profibus] |
| ssCrcErrors | Number of CRC errors that the subsystem has recognized in received trigger frames from host | 1 | 1 - 99999999 | [Operation /Count and RevData /Profibus] |
| ssResets | Number of subsystem resets/restarts from ss manager | 1 | 1 - 99999999 | [Operation /Count and RevData /Profibus] |
| Master ID | Device address (Master ID) within the bus system. Each device address has to be unique within a bus system. | 1 | 1 - 125 | [Operation /Status Display /Profibus /State] |
| HO Id PSub | Handoff Id of PbSub | 0 | 0 - 9999999999 | [Operation /Status Display /Profibus /State] |
| t-WatchDog | The Profibus Chip detects a communication issue if this timer is expired without any communication (Parameterising telegram). | 0 | 0 - 9999999999 | [Operation /Status Display /Profibus /State] |

Communication Protocols

| <i>Value</i> | <i>Description</i> | <i>Default</i> | <i>Size</i> | <i>Menu path</i> |
|--------------|--|----------------|--|---|
| Slave State | Communication State between Slave and Master. | Baud Search | Baud Search, Baud Found, PRM OK, PRM REQ, PRM Fault, CFG Fault, Clear Data, Data exchange | [Operation /Status Display /Profibus /State] |
| Baud rate | The baud rate that has been detected lastly, will still be shown after a connection issue. | -.- | 12 Mb/s, 6 Mb/s, 3 Mb/s, 1.5 Mb/s, 0.5 Mb/s, 187500 baud, 93750 baud, 45450 baud, 19200 baud, 9600 baud, -.- | [Operation /Status Display /Profibus /State] |
| PNO Id | PNO Identification Number. GSD Identification Number. | 0C50h | 0C50h | [Operation /Status Display /Profibus /State] |

IEC60870-5-103

IEC 103

IEC60870-5-103 Protocol Configuration

In order to use the IEC60870-5-103 protocol it has to be assigned to the X103 Interface within the Device Planning. The device will reboot after setting this parameter.

NOTICE

The parameter X103 is only available if the device is at the rear side equipped with an interface like RS485 or Fiber Optic.

NOTICE

If the device is equipped with an Fiber Optic Interface, the Optical Rest Position has to be set within the Device Parameters .

The time-controlled IEC60870-5-103 protocol is based on the Master-Slave working principle. This means that the substation control and protection system sends an enquiry or instruction to a certain device (slave address) which will then be answered or carried out accordingly.

The device meets the compatibility mode 2. Compatibility mode 3 is not supported.

The following IEC60870-5-103-functions will be supported:

- Initialization (Reset)
- Time Synchronization
- Reading out of time stamped, instantaneous signals
- General Queries
- Cyclic Signals
- General Commands
- Transmission of Disturbance Data

Initialization

The communication has to be reset by a Reset Command each time that the device is turned on or that communication parameters have been changed. The "Reset CU" Command resets. The relay acts on both Reset Commands (Reset CU or Reset FCB).

The relay acts on the reset command by an identification signal ASDU 5 (Application Service Data Unit), as a reason (Cause Of Transmission, COT) for the transmission of the answer either a "Reset CU" or a "Reset FCB" will be sent depending on the type of the reset command. This information can be part of the data section of the ASDU-signal.

Name of the Manufacturer

The section for the identification of the software contains three digits of the device code for the identification of the device type. Beside the upper mentioned identification number the device generates a communication start event.

Time Synchronization

Time and date of the relay can be set by means of the time synchronization function of the IEC60870-5-103 protocol. If the time synchronization signal is send out with a confirmation request, the device will answer with a confirmation signal.

Spontaneous Events

The events that are generated by the device will be forwarded to the master with numbers for standard function types / standard information. The data point list comprises all events that can be generated by the device.

Cyclic Measurement

The device generates on a cyclic base measured values by means of ASDU 9. They can be read out via a class 2 query. Please take into account that the measured values will be send out as multiples (1.2 or 2.4 times the rated value). How to set 1.2 or 2.4 as multiplier for a value can be taken from the data point list.

The parameter "Transm priv meas val" defines if additional measurement values should be transmitted in the private part. Public and private measured values are transmitted by ASDU9. That means that either a "private" or a "public" ASDU9 will be transmitted. If this parameter is set, the ASDU9 will contain additional measured values that are an enhancement of the standard. The "private" ASDU9 is send with a fixed function type and information number that does not depend the type of device. Please refer to the data point list.

Commands

The data point list comprises a list of the supported commands. Any command will be responded by the device with a positive or negative confirmation. If the command is executable, the execution with the corresponding reason for the transmission (COT) will be lead in at first, and subsequently the execution will be confirmed with COT1 within a ASDU9.

Disturbance Recording

The disturbances recorded by the device can be read out by means described in standard IEC60870-5-103. The device is in compliance with the VDEW-Control System by transmission of an ASDU 23 without disturbance records at the beginning of an GI-Cycle.





A disturbance record contains the following information:

- Analog Measured Values, IL1, IL2, IL3, IN, Voltages VL1, VL2, VL3, VEN;
- Binary States, transmitted as marks, e.g. Alarms and Trips.
- The Transmission ratio will not be supported. The transmission ratio is included in the "Multiplier".

Blocking the Transmission Direction

The relay does not support functions to block the transmission in a certain direction (supervision direction).

Global Protection Parameters of the IEC60870-5-103

| Parameter | Description | Setting range | Default | Menu path |
|--|---|---|----------|------------------------|
| Slave ID  | Device address (Slave ID) within the bus system. Each device address has to be unique within a bus system. | 1 - 247 | 1 | [Device Para /IEC 103] |
| t-call  | If there is no request telegram sent from Scada to the device after expiry of this time - the device concludes a communication failure within the Scada system. | 1 - 3600s | 60s | [Device Para /IEC 103] |
| Transm priv meas val  | Transmit additional (private) measuring values | inactive, active | inactive | [Device Para /IEC 103] |
| Transfer Disturb Rec  | Activates the transmission of disturbance records | inactive, active | inactive | [Device Para /IEC 103] |
| Baud rate  | Baud rate | 1200, 2400, 4800, 9600, 19200, 38400, 57600 | 19200 | [Device Para /IEC 103] |
| Physical Settings  | Digit 1: Number of bits. Digit 2: E=even parity, O=odd parity, N=no parity. Digit 3: Number of stop bits. More information on the parity: It is possible that the last data bit is followed by a parity bit which is used for recognition of communication errors. The parity bit ensures that with even parity ("EVEN") always an even number of bits with valence "1" or with odd parity ("ODD") an odd number of "1" valence bits are transmitted. But it is also possible to transmit no parity bits (here the setting is "Parity = None"). More information on the stop-bits: The end of a data byte is terminated by the stop-bits. | 8E1, 8O1, 8N1, 8N2 | 8E1 | [Device Para /IEC 103] |
| Optical rest position  | Optical rest position | Light off, Light on | Light on | [Device Para /IEC 103] |

IEC60870-5-103 Signals (Output States)

| <i>Signal</i> | <i>Description</i> |
|--------------------|----------------------|
| Scada Cmd 1 | Scada Command |
| Scada Cmd 2 | Scada Command |
| Scada Cmd 3 | Scada Command |
| Scada Cmd 4 | Scada Command |
| Scada Cmd 5 | Scada Command |
| Scada Cmd 6 | Scada Command |
| Scada Cmd 7 | Scada Command |
| Scada Cmd 8 | Scada Command |
| Scada Cmd 9 | Scada Command |
| Scada Cmd 10 | Scada Command |
| Transmission | Signal: SCADA active |
| Failure Event lost | Failure event lost |

IEC60870-5-103 Values

| <i>Value</i> | <i>Description</i> | <i>Default</i> | <i>Size</i> | <i>Menu path</i> |
|------------------|------------------------------------|----------------|----------------|---|
| NReceived | Total Number of received Messages | 0 | 0 - 9999999999 | [Operation /Count and RevData /IEC 103] |
| NSent | Total Number of sent Messages | 0 | 0 - 9999999999 | [Operation /Count and RevData /IEC 103] |
| NBadFramings | Number of bad Messages | 0 | 0 - 9999999999 | [Operation /Count and RevData /IEC 103] |
| NBadParities | Number of Parity Errors | 0 | 0 - 9999999999 | [Operation /Count and RevData /IEC 103] |
| NBreakSignals | Number of Communication Interrupts | 0 | 0 - 9999999999 | [Operation /Count and RevData /IEC 103] |
| NInternalError | Number of Internal Errors | 0 | 0 - 9999999999 | [Operation /Count and RevData /IEC 103] |
| NBadCharChecksum | Number of Checksum Errors | 0 | 0 - 9999999999 | [Operation /Count and RevData /IEC 103] |

IEC61850

IEC61850

Introduction

To understand the functioning and mode of operation of a substation in an IEC61850 automation environment, it is useful to compare the commissioning steps with those of a conventional substation in a Modbus TCP environment.

In a conventional substation the individual IEDs (Intelligent Electronic Devices) communicate in vertically direction with the higher level control center via SCADA. The horizontal communication is exclusively realized by wiring output relays (OR) and digital inputs (DI) among each other.

In an IEC61850 environment communication between the IEDs takes place digitally (via Ethernet) by a service called GOOSE (Generic Object Oriented Substation Event). By means of this service information about events is submitted between each IED. Therefore each IED has to know about the functional capability of all other connected IEDs.

Each IEC61850 capable device includes a description of it's own functionality and communications skills (IED Capability Description, *.ICD).

By means of a Substation Configuration Tool to describe the structure of the substation, assignment of the devices to the primary technique, etc. a virtual wiring of the IEDs among each other and with other switch gear of the substation can be done. A description of the substation configuration will be generated in form of a *.SCD file. At last this file has to be submitted to each device. Now the IEDs are able to communicate closed among each other, react to interlockings and operate switch gear.

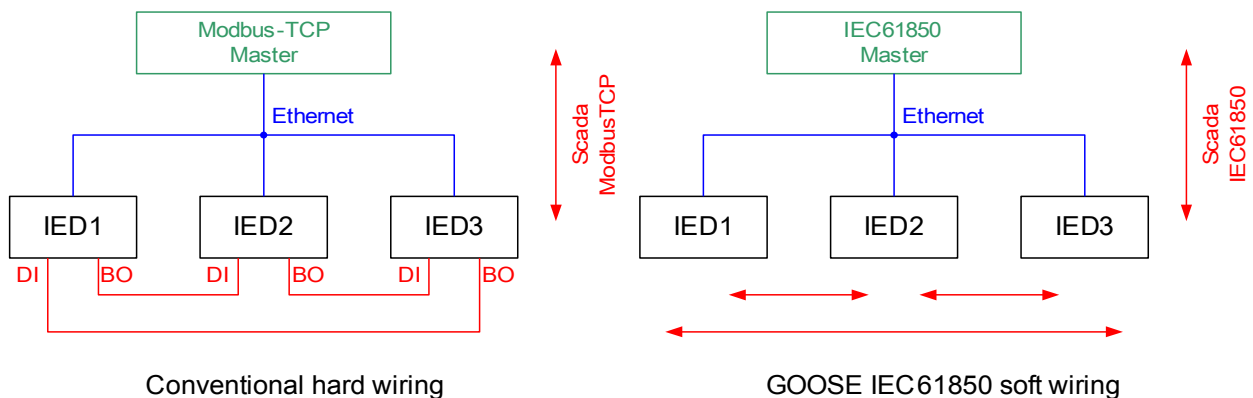

Commissioning steps for a conventional substation with modbus TCP environment:

- Parameter setting of the IEDs
- Ethernet installation
- TCP/IP settings for the IEDs
- Wiring according to wiring scheme

Commissioning steps for a substation with IEC61850 environment:

1. Parameter setting of the IEDs
Ethernet installation
TCP/IP settings for the IEDs
2. IEC61850 configuration (software wiring)
 - a) Exporting an ICD file from each device
 - b) Configuration of the substation (generating a SCD file)
 - c) Transmit SCD file to each device

Generation/Export of a device specific ICD file

Please refer to chapter "IEC61850" of the Smart view Manual.

Generation/Export of a SCD file

Please refer to chapter "IEC61850" of the Smart view Manual.

Substation configuration, Generation of .SCD file (Station Configuration Description)

The substation configuration, i. e. connection of all logical nodes of protection and control devices, as well as switch gear usually is done with a „Substation Configuration Tool“. Therefore the ICD files of all connected IEDs in the IEC61850 environment have to be available. The result of the station wide "software wiring" can be exported in the form of a SCD file (Station Configuration Description).

Suitable Substation Configuration Tools (SCT) are available by the following Companies:

H&S, Hard- & Software Technologie GmbH & Co. KG, Dortmund (Germany) (www.hstech.de).

Applied Systems Engineering Inc. (www.ase-systems.com)

Kalki Communication Technologies Limited (www.kalkitech.com)

Import of the .SCD file into the device

Please refer to chapter "IEC61850" of the Smart view Manual.



IEC 61850 Virtual Outputs

Additionally to the standardized logical node status information up to 32 free configurable status information can be assigned to 32 Virtual Outputs. This can be done in the menu [Device Para/IEC61850].





Direct Commands of the IEC 61850

| Parameter | Description | Setting range | Default | Menu path |
|---|---|---------------------|----------|-----------------------|
| ResetStatistic  | Reset of all IEC61850 diagnostic counters | inactive, active | inactive | [Operation /Reset] |

Global Parameters of the IEC 61850







| Parameter | Description | Setting range | Default | Menu path |
|--|---|---------------------|----------|----------------------------|
| Function  | Permanent activation or deactivation of module/stage. | inactive, active | inactive | [Device Para /IEC61850] |
| Deadb integr time  | Deadband integration time. | 0 - 300 | 0 | [Device Para /IEC61850] |

Global Parameters of the IEC 61850

| Parameter | Description | Setting range | Default | Menu path |
|---|---|-----------------------|---------|----------------------------|
| VirtualOutput1  | Virtual Output. This signal can be assigned or visualized via the SCD file to other devices within the IEC61850 substation. | 1..n, Assignment List | -- | [Device Para /IEC61850] |
| VirtualOutput2  | Virtual Output. This signal can be assigned or visualized via the SCD file to other devices within the IEC61850 substation. | 1..n, Assignment List | -- | [Device Para /IEC61850] |
| VirtualOutput3  | Virtual Output. This signal can be assigned or visualized via the SCD file to other devices within the IEC61850 substation. | 1..n, Assignment List | -- | [Device Para /IEC61850] |
| VirtualOutput4  | Virtual Output. This signal can be assigned or visualized via the SCD file to other devices within the IEC61850 substation. | 1..n, Assignment List | -- | [Device Para /IEC61850] |
| VirtualOutput5  | Virtual Output. This signal can be assigned or visualized via the SCD file to other devices within the IEC61850 substation. | 1..n, Assignment List | -- | [Device Para /IEC61850] |

| Parameter | Description | Setting range | Default | Menu path |
|--|---|-----------------------|---------|-------------------------|
| VirtualOutput6  | Virtual Output. This signal can be assigned or visualized via the SCD file to other devices within the IEC61850 substation. | 1..n, Assignment List | -- | [Device Para /IEC61850] |
| VirtualOutput7  | Virtual Output. This signal can be assigned or visualized via the SCD file to other devices within the IEC61850 substation. | 1..n, Assignment List | -- | [Device Para /IEC61850] |
| VirtualOutput8  | Virtual Output. This signal can be assigned or visualized via the SCD file to other devices within the IEC61850 substation. | 1..n, Assignment List | -- | [Device Para /IEC61850] |
| VirtualOutput9  | Virtual Output. This signal can be assigned or visualized via the SCD file to other devices within the IEC61850 substation. | 1..n, Assignment List | -- | [Device Para /IEC61850] |
| VirtualOutput10  | Virtual Output. This signal can be assigned or visualized via the SCD file to other devices within the IEC61850 substation. | 1..n, Assignment List | -- | [Device Para /IEC61850] |
| VirtualOutput11  | Virtual Output. This signal can be assigned or visualized via the SCD file to other devices within the IEC61850 substation. | 1..n, Assignment List | -- | [Device Para /IEC61850] |
| VirtualOutput12  | Virtual Output. This signal can be assigned or visualized via the SCD file to other devices within the IEC61850 substation. | 1..n, Assignment List | -- | [Device Para /IEC61850] |
| VirtualOutput13  | Virtual Output. This signal can be assigned or visualized via the SCD file to other devices within the IEC61850 substation. | 1..n, Assignment List | -- | [Device Para /IEC61850] |
| VirtualOutput14  | Virtual Output. This signal can be assigned or visualized via the SCD file to other devices within the IEC61850 substation. | 1..n, Assignment List | -- | [Device Para /IEC61850] |
| VirtualOutput15  | Virtual Output. This signal can be assigned or visualized via the SCD file to other devices within the IEC61850 substation. | 1..n, Assignment List | -- | [Device Para /IEC61850] |

| Parameter | Description | Setting range | Default | Menu path |
|--|---|-----------------------|---------|-------------------------|
| VirtualOutput16  | Virtual Output. This signal can be assigned or visualized via the SCD file to other devices within the IEC61850 substation. | 1..n, Assignment List | -- | [Device Para /IEC61850] |
| VirtualOutput17  | Virtual Output. This signal can be assigned or visualized via the SCD file to other devices within the IEC61850 substation. | 1..n, Assignment List | -- | [Device Para /IEC61850] |
| VirtualOutput18  | Virtual Output. This signal can be assigned or visualized via the SCD file to other devices within the IEC61850 substation. | 1..n, Assignment List | -- | [Device Para /IEC61850] |
| VirtualOutput19  | Virtual Output. This signal can be assigned or visualized via the SCD file to other devices within the IEC61850 substation. | 1..n, Assignment List | -- | [Device Para /IEC61850] |
| VirtualOutput20  | Virtual Output. This signal can be assigned or visualized via the SCD file to other devices within the IEC61850 substation. | 1..n, Assignment List | -- | [Device Para /IEC61850] |
| VirtualOutput21  | Virtual Output. This signal can be assigned or visualized via the SCD file to other devices within the IEC61850 substation. | 1..n, Assignment List | -- | [Device Para /IEC61850] |
| VirtualOutput22  | Virtual Output. This signal can be assigned or visualized via the SCD file to other devices within the IEC61850 substation. | 1..n, Assignment List | -- | [Device Para /IEC61850] |
| VirtualOutput23  | Virtual Output. This signal can be assigned or visualized via the SCD file to other devices within the IEC61850 substation. | 1..n, Assignment List | -- | [Device Para /IEC61850] |
| VirtualOutput24  | Virtual Output. This signal can be assigned or visualized via the SCD file to other devices within the IEC61850 substation. | 1..n, Assignment List | -- | [Device Para /IEC61850] |
| VirtualOutput25  | Virtual Output. This signal can be assigned or visualized via the SCD file to other devices within the IEC61850 substation. | 1..n, Assignment List | -- | [Device Para /IEC61850] |

| Parameter | Description | Setting range | Default | Menu path |
|--|---|-----------------------|---------|-------------------------|
| VirtualOutput26  | Virtual Output. This signal can be assigned or visualized via the SCD file to other devices within the IEC61850 substation. | 1..n, Assignment List | -- | [Device Para /IEC61850] |
| VirtualOutput27  | Virtual Output. This signal can be assigned or visualized via the SCD file to other devices within the IEC61850 substation. | 1..n, Assignment List | -- | [Device Para /IEC61850] |
| VirtualOutput28  | Virtual Output. This signal can be assigned or visualized via the SCD file to other devices within the IEC61850 substation. | 1..n, Assignment List | -- | [Device Para /IEC61850] |
| VirtualOutput29  | Virtual Output. This signal can be assigned or visualized via the SCD file to other devices within the IEC61850 substation. | 1..n, Assignment List | -- | [Device Para /IEC61850] |
| VirtualOutput30  | Virtual Output. This signal can be assigned or visualized via the SCD file to other devices within the IEC61850 substation. | 1..n, Assignment List | -- | [Device Para /IEC61850] |
| VirtualOutput31  | Virtual Output. This signal can be assigned or visualized via the SCD file to other devices within the IEC61850 substation. | 1..n, Assignment List | -- | [Device Para /IEC61850] |
| VirtualOutput32  | Virtual Output. This signal can be assigned or visualized via the SCD file to other devices within the IEC61850 substation. | 1..n, Assignment List | -- | [Device Para /IEC61850] |

States of the Inputs of the IEC 61850

| <i>Name</i> | <i>Description</i> | <i>Assignment via</i> |
|-------------|---|-------------------------|
| VirtOut1-I | Module input state: Binary state of the Virtual Output (GGIO) | [Device Para /IEC61850] |
| VirtOut2-I | Module input state: Binary state of the Virtual Output (GGIO) | [Device Para /IEC61850] |
| VirtOut3-I | Module input state: Binary state of the Virtual Output (GGIO) | [Device Para /IEC61850] |
| VirtOut4-I | Module input state: Binary state of the Virtual Output (GGIO) | [Device Para /IEC61850] |
| VirtOut5-I | Module input state: Binary state of the Virtual Output (GGIO) | [Device Para /IEC61850] |
| VirtOut6-I | Module input state: Binary state of the Virtual Output (GGIO) | [Device Para /IEC61850] |
| VirtOut7-I | Module input state: Binary state of the Virtual Output (GGIO) | [Device Para /IEC61850] |
| VirtOut8-I | Module input state: Binary state of the Virtual Output (GGIO) | [Device Para /IEC61850] |
| VirtOut9-I | Module input state: Binary state of the Virtual Output (GGIO) | [Device Para /IEC61850] |
| VirtOut10-I | Module input state: Binary state of the Virtual Output (GGIO) | [Device Para /IEC61850] |
| VirtOut11-I | Module input state: Binary state of the Virtual Output (GGIO) | [Device Para /IEC61850] |
| VirtOut12-I | Module input state: Binary state of the Virtual Output (GGIO) | [Device Para /IEC61850] |
| VirtOut13-I | Module input state: Binary state of the Virtual Output (GGIO) | [Device Para /IEC61850] |
| VirtOut14-I | Module input state: Binary state of the Virtual Output (GGIO) | [Device Para /IEC61850] |
| VirtOut15-I | Module input state: Binary state of the Virtual Output (GGIO) | [Device Para /IEC61850] |
| VirtOut16-I | Module input state: Binary state of the Virtual Output (GGIO) | [Device Para /IEC61850] |
| VirtOut17-I | Module input state: Binary state of the Virtual Output (GGIO) | [Device Para /IEC61850] |
| VirtOut18-I | Module input state: Binary state of the Virtual Output (GGIO) | [Device Para /IEC61850] |

| <i>Name</i> | <i>Description</i> | <i>Assignment via</i> |
|-------------|---|-------------------------|
| VirtOut19-I | Module input state: Binary state of the Virtual Output (GGIO) | [Device Para /IEC61850] |
| VirtOut20-I | Module input state: Binary state of the Virtual Output (GGIO) | [Device Para /IEC61850] |
| VirtOut21-I | Module input state: Binary state of the Virtual Output (GGIO) | [Device Para /IEC61850] |
| VirtOut22-I | Module input state: Binary state of the Virtual Output (GGIO) | [Device Para /IEC61850] |
| VirtOut23-I | Module input state: Binary state of the Virtual Output (GGIO) | [Device Para /IEC61850] |
| VirtOut24-I | Module input state: Binary state of the Virtual Output (GGIO) | [Device Para /IEC61850] |
| VirtOut25-I | Module input state: Binary state of the Virtual Output (GGIO) | [Device Para /IEC61850] |
| VirtOut26-I | Module input state: Binary state of the Virtual Output (GGIO) | [Device Para /IEC61850] |
| VirtOut27-I | Module input state: Binary state of the Virtual Output (GGIO) | [Device Para /IEC61850] |
| VirtOut28-I | Module input state: Binary state of the Virtual Output (GGIO) | [Device Para /IEC61850] |
| VirtOut29-I | Module input state: Binary state of the Virtual Output (GGIO) | [Device Para /IEC61850] |
| VirtOut30-I | Module input state: Binary state of the Virtual Output (GGIO) | [Device Para /IEC61850] |
| VirtOut31-I | Module input state: Binary state of the Virtual Output (GGIO) | [Device Para /IEC61850] |
| VirtOut32-I | Module input state: Binary state of the Virtual Output (GGIO) | [Device Para /IEC61850] |

IEC 61850 Module Signals (Output States)

| <i>Signal</i> | <i>Description</i> |
|-----------------------------|--|
| MMS Client connected | At least one MMS client is connected to the device |
| All Goose Subscriber active | All Goose subscriber in the device are working |
| VirtInp1 | Signal: Virtual Input (IEC61850 GGIO Ind) |
| VirtInp2 | Signal: Virtual Input (IEC61850 GGIO Ind) |
| VirtInp3 | Signal: Virtual Input (IEC61850 GGIO Ind) |
| VirtInp4 | Signal: Virtual Input (IEC61850 GGIO Ind) |
| VirtInp5 | Signal: Virtual Input (IEC61850 GGIO Ind) |
| VirtInp6 | Signal: Virtual Input (IEC61850 GGIO Ind) |
| VirtInp7 | Signal: Virtual Input (IEC61850 GGIO Ind) |
| VirtInp8 | Signal: Virtual Input (IEC61850 GGIO Ind) |
| VirtInp9 | Signal: Virtual Input (IEC61850 GGIO Ind) |
| VirtInp10 | Signal: Virtual Input (IEC61850 GGIO Ind) |
| VirtInp11 | Signal: Virtual Input (IEC61850 GGIO Ind) |
| VirtInp12 | Signal: Virtual Input (IEC61850 GGIO Ind) |
| VirtInp13 | Signal: Virtual Input (IEC61850 GGIO Ind) |
| VirtInp14 | Signal: Virtual Input (IEC61850 GGIO Ind) |
| VirtInp15 | Signal: Virtual Input (IEC61850 GGIO Ind) |
| VirtInp16 | Signal: Virtual Input (IEC61850 GGIO Ind) |
| VirtInp17 | Signal: Virtual Input (IEC61850 GGIO Ind) |
| VirtInp18 | Signal: Virtual Input (IEC61850 GGIO Ind) |
| VirtInp19 | Signal: Virtual Input (IEC61850 GGIO Ind) |
| VirtInp20 | Signal: Virtual Input (IEC61850 GGIO Ind) |
| VirtInp21 | Signal: Virtual Input (IEC61850 GGIO Ind) |
| VirtInp22 | Signal: Virtual Input (IEC61850 GGIO Ind) |
| VirtInp23 | Signal: Virtual Input (IEC61850 GGIO Ind) |
| VirtInp24 | Signal: Virtual Input (IEC61850 GGIO Ind) |
| VirtInp25 | Signal: Virtual Input (IEC61850 GGIO Ind) |
| VirtInp26 | Signal: Virtual Input (IEC61850 GGIO Ind) |
| VirtInp27 | Signal: Virtual Input (IEC61850 GGIO Ind) |
| VirtInp28 | Signal: Virtual Input (IEC61850 GGIO Ind) |
| VirtInp29 | Signal: Virtual Input (IEC61850 GGIO Ind) |
| VirtInp30 | Signal: Virtual Input (IEC61850 GGIO Ind) |
| VirtInp31 | Signal: Virtual Input (IEC61850 GGIO Ind) |
| VirtInp32 | Signal: Virtual Input (IEC61850 GGIO Ind) |
| Quality of GGIO In1 | Self-Supervision of the GGIO Input |
| Quality of GGIO In2 | Self-Supervision of the GGIO Input |
| Quality of GGIO In3 | Self-Supervision of the GGIO Input |
| Quality of GGIO In4 | Self-Supervision of the GGIO Input |

| <i>Signal</i> | <i>Description</i> |
|----------------------|--|
| Quality of GGIO In5 | Self-Supervision of the GGIO Input |
| Quality of GGIO In6 | Self-Supervision of the GGIO Input |
| Quality of GGIO In7 | Self-Supervision of the GGIO Input |
| Quality of GGIO In8 | Self-Supervision of the GGIO Input |
| Quality of GGIO In9 | Self-Supervision of the GGIO Input |
| Quality of GGIO In10 | Self-Supervision of the GGIO Input |
| Quality of GGIO In11 | Self-Supervision of the GGIO Input |
| Quality of GGIO In12 | Self-Supervision of the GGIO Input |
| Quality of GGIO In13 | Self-Supervision of the GGIO Input |
| Quality of GGIO In14 | Self-Supervision of the GGIO Input |
| Quality of GGIO In15 | Self-Supervision of the GGIO Input |
| Quality of GGIO In16 | Self-Supervision of the GGIO Input |
| Quality of GGIO In17 | Self-Supervision of the GGIO Input |
| Quality of GGIO In18 | Self-Supervision of the GGIO Input |
| Quality of GGIO In19 | Self-Supervision of the GGIO Input |
| Quality of GGIO In20 | Self-Supervision of the GGIO Input |
| Quality of GGIO In21 | Self-Supervision of the GGIO Input |
| Quality of GGIO In22 | Self-Supervision of the GGIO Input |
| Quality of GGIO In23 | Self-Supervision of the GGIO Input |
| Quality of GGIO In24 | Self-Supervision of the GGIO Input |
| Quality of GGIO In25 | Self-Supervision of the GGIO Input |
| Quality of GGIO In26 | Self-Supervision of the GGIO Input |
| Quality of GGIO In27 | Self-Supervision of the GGIO Input |
| Quality of GGIO In28 | Self-Supervision of the GGIO Input |
| Quality of GGIO In29 | Self-Supervision of the GGIO Input |
| Quality of GGIO In30 | Self-Supervision of the GGIO Input |
| Quality of GGIO In31 | Self-Supervision of the GGIO Input |
| Quality of GGIO In32 | Self-Supervision of the GGIO Input |
| SPCSO1 | Status bit that can be set by clients like e.g. SCADA (Single Point Controllable Status Output). |
| SPCSO2 | Status bit that can be set by clients like e.g. SCADA (Single Point Controllable Status Output). |
| SPCSO3 | Status bit that can be set by clients like e.g. SCADA (Single Point Controllable Status Output). |
| SPCSO4 | Status bit that can be set by clients like e.g. SCADA (Single Point Controllable Status Output). |
| SPCSO5 | Status bit that can be set by clients like e.g. SCADA (Single Point Controllable Status Output). |
| SPCSO6 | Status bit that can be set by clients like e.g. SCADA (Single Point Controllable Status Output). |
| SPCSO7 | Status bit that can be set by clients like e.g. SCADA (Single Point Controllable Status Output). |
| SPCSO8 | Status bit that can be set by clients like e.g. SCADA (Single Point Controllable Status Output). |
| SPCSO9 | Status bit that can be set by clients like e.g. SCADA (Single Point Controllable Status Output). |
| SPCSO10 | Status bit that can be set by clients like e.g. SCADA (Single Point Controllable Status Output). |
| SPCSO11 | Status bit that can be set by clients like e.g. SCADA (Single Point Controllable Status Output). |
| SPCSO12 | Status bit that can be set by clients like e.g. SCADA (Single Point Controllable Status Output). |

| <i>Signal</i> | <i>Description</i> |
|---------------|--|
| SPCSO13 | Status bit that can be set by clients like e.g. SCADA (Single Point Controllable Status Output). |
| SPCSO14 | Status bit that can be set by clients like e.g. SCADA (Single Point Controllable Status Output). |
| SPCSO15 | Status bit that can be set by clients like e.g. SCADA (Single Point Controllable Status Output). |
| SPCSO16 | Status bit that can be set by clients like e.g. SCADA (Single Point Controllable Status Output). |
| SPCSO17 | Status bit that can be set by clients like e.g. SCADA (Single Point Controllable Status Output). |
| SPCSO18 | Status bit that can be set by clients like e.g. SCADA (Single Point Controllable Status Output). |
| SPCSO19 | Status bit that can be set by clients like e.g. SCADA (Single Point Controllable Status Output). |
| SPCSO20 | Status bit that can be set by clients like e.g. SCADA (Single Point Controllable Status Output). |
| SPCSO21 | Status bit that can be set by clients like e.g. SCADA (Single Point Controllable Status Output). |
| SPCSO22 | Status bit that can be set by clients like e.g. SCADA (Single Point Controllable Status Output). |
| SPCSO23 | Status bit that can be set by clients like e.g. SCADA (Single Point Controllable Status Output). |
| SPCSO24 | Status bit that can be set by clients like e.g. SCADA (Single Point Controllable Status Output). |
| SPCSO25 | Status bit that can be set by clients like e.g. SCADA (Single Point Controllable Status Output). |
| SPCSO26 | Status bit that can be set by clients like e.g. SCADA (Single Point Controllable Status Output). |
| SPCSO27 | Status bit that can be set by clients like e.g. SCADA (Single Point Controllable Status Output). |
| SPCSO28 | Status bit that can be set by clients like e.g. SCADA (Single Point Controllable Status Output). |
| SPCSO29 | Status bit that can be set by clients like e.g. SCADA (Single Point Controllable Status Output). |
| SPCSO30 | Status bit that can be set by clients like e.g. SCADA (Single Point Controllable Status Output). |
| SPCSO31 | Status bit that can be set by clients like e.g. SCADA (Single Point Controllable Status Output). |
| SPCSO32 | Status bit that can be set by clients like e.g. SCADA (Single Point Controllable Status Output). |

IEC 61850 Module Values

| <i>Value</i> | <i>Description</i> | <i>Default</i> | <i>Size</i> | <i>Menu path</i> |
|-----------------------|--|----------------|----------------|--|
| NoOfGooseRxAll | Total number of received GOOSE messages including messages for other devices (subscribed and not subscribed messages). | 0 | 0 - 9999999999 | [Operation /Count and RevData /IEC61850] |
| NoOfGooseRxSubscribed | Total Number of subscribed GOOSE messages including messages with incorrect content. | 0 | 0 - 9999999999 | [Operation /Count and RevData /IEC61850] |
| NoOfGooseRxCorrect | Total Number of subscribed and correctly received GOOSE messages. | 0 | 0 - 9999999999 | [Operation /Count and RevData /IEC61850] |
| NoOfGooseRxNew | Number of subscribed and correctly received GOOSE messages with new content. | 0 | 0 - 9999999999 | [Operation /Count and RevData /IEC61850] |
| NoOfGooseTxAll | Total Number of GOOSE messages that have been published by this device. | 0 | 0 - 9999999999 | [Operation /Count and RevData /IEC61850] |
| NoOfGooseTxNew | Total Number of new GOOSE messages (modified content) that have been published by this device. | 0 | 0 - 9999999999 | [Operation /Count and RevData /IEC61850] |
| NoOfServerRequestsAll | Total number of MMS Server requests including incorrect requests. | 0 | 0 - 9999999999 | [Operation /Count and RevData /IEC61850] |
| NoOfDataReadAll | Total Number of values read from this device including incorrect requests. | 0 | 0 - 9999999999 | [Operation /Count and RevData /IEC61850] |
| NoOfDataReadCorrect | Total Number of correctly read values from this device. | 0 | 0 - 9999999999 | [Operation /Count and RevData /IEC61850] |
| NoOfDataWrittenAll | Total Number of values written by this device including incorrect ones. | 0 | 0 - 9999999999 | [Operation /Count and RevData /IEC61850] |

Communication Protocols

| <i>Value</i> | <i>Description</i> | <i>Default</i> | <i>Size</i> | <i>Menu path</i> |
|----------------------------|--|----------------|----------------|--|
| NoOfDataWrittenCorrect | Total Number of correctly written values by this device. | 0 | 0 - 9999999999 | [Operation /Count and RevData /IEC61850] |
| NoOfDataChangeNotification | Number of detected changes within the datasets that are published with GOOSE messages. | 0 | 0 - 9999999999 | [Operation /Count and RevData /IEC61850] |
| No of Client Connections | Number of active MMS client connections | 0 | 0 - 9999999999 | [Operation /Count and RevData /IEC61850] |

Values of the IEC 61850

| <i>Value</i> | <i>Description</i> | <i>Default</i> | <i>Size</i> | <i>Menu path</i> |
|----------------------|---|----------------|----------------------|---|
| GoosePublisherState | State of the GOOSE Publisher (on or off) | Off | Off, On, Error | [Operation /Status Display /IEC61850 /State] |
| GooseSubscriberState | State of the GOOSE Subscriber (on or off) | Off | Off, On, Error | [Operation /Status Display /IEC61850 /State] |
| MmsServerState | State of MMS Server (on or off) | Off | Off, On, Error | [Operation /Status Display /IEC61850 /State] |

DNP3

DNP3

DNP (Distributed Network Protocol) is for data and information exchange between SCADA (Master) and IEDs (Intelligent Electronic Devices). The DNP protocol has been developed in first releases for serial communication. Due to further development of the DNP protocol, it offers now also TCP and UDP communication options via Ethernet.

DNP Device Planning

Depending on the hardware of the protective device up to three DNP communication options are available within the Device Planning.

Call up the device planning menu.

Select (depending on device code) the appropriate SCADA Protocol.

- DNP3 RTU (via serial Port)
- DNP3 TCP (via Ethernet)
- DNP3 UDP (via Ethernet)

DNP Protocol General Settings

NOTICE

Please note that unsolicited reporting is not available for serial communication, if more than one slave is connected to the serial communication (collisions). Do not use in these cases unsolicited reporting for DNP RTU.

Unsolicited reporting is available also for serial communication, if each slave is connected via a separated connection to the Master-System. That means, the master is equipped with a separate serial interface for each slave (multi serial cards).

Call up menu [Device Para/DNP3/Communication].

The Communication (General Settings) Settings have to be set according to the needs of the SCADA (Master) – System.

Self Addressing is available for DNP-TCP. That means that the Master and Slave id are auto-detected.

Point Mapping

NOTICE Please take into account that the designations of inputs and outputs are set from the Masters perspective. This way of choosing the designations is due to a definition in the DNP standard. That means for example that Binary Inputs that can be set within the Device Parameters of the DNP protocol are the “Binary Inputs” of the Master.

Call up menu [Device Para/DNP3/Point Map]. Once the general settings of the DNP protocol are done, the point mapping is to be done as a next step.

- Binary Inputs (States to be send to the master)
- Double Bit Inputs (Breaker states to be send to the master)
- Counters (Counters to be send to the master)
- Analog Inputs (e.g. measured values to be send to the master). Please take into account that floating values have to be transmitted as integers. That means they have to be scaled (multiplied) with a scaling factor in order to bring them into the integer format.

Use Binary outputs in order to control e.g. LEDs or Relays within the protective device (via Logic).

Point Mapping

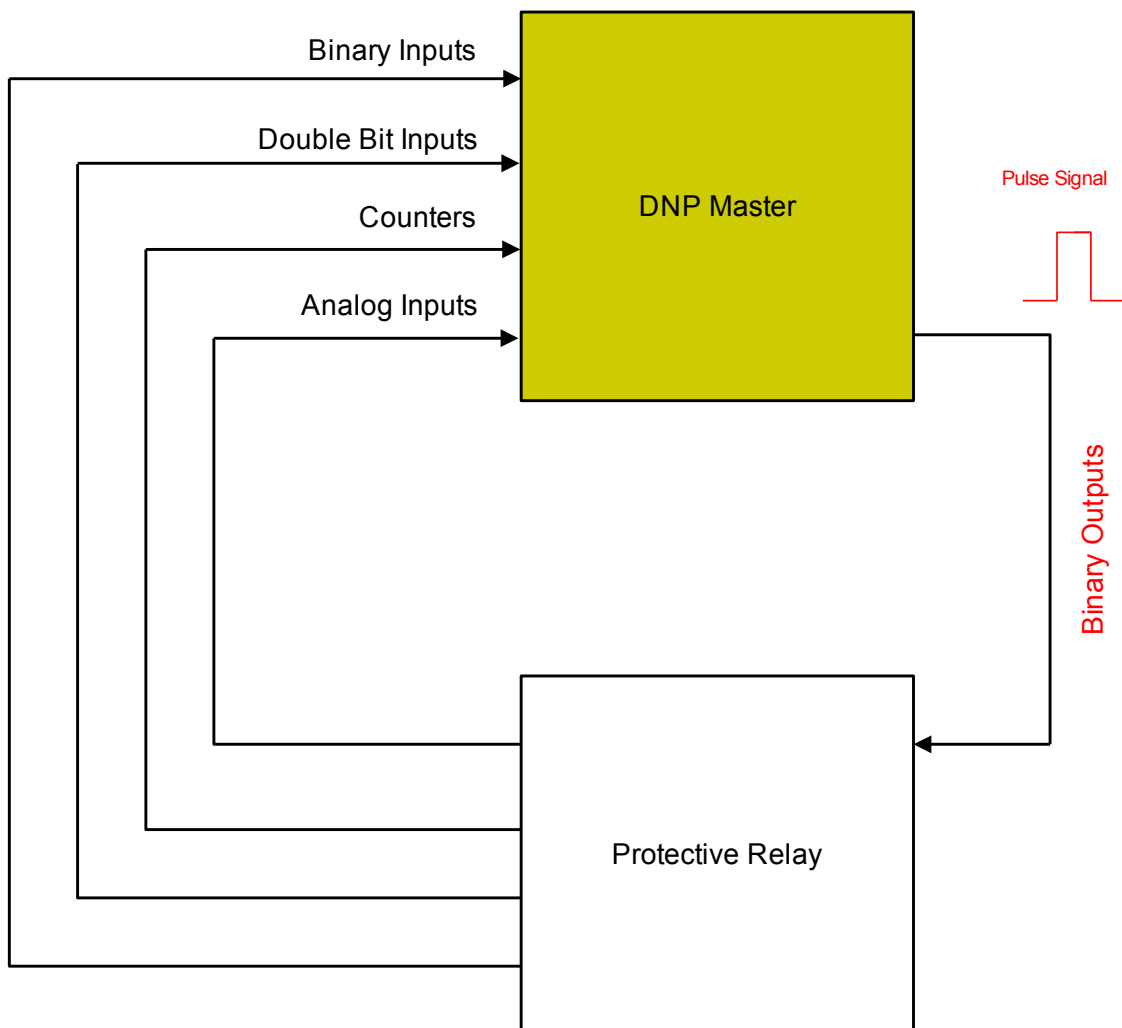

Please try to avoid gaps that will slow down the performance of the DNP communication. That means do not leave unused inputs / outputs in between used inputs / outputs (e.g. Do not use Binary Output 1 and 3 when 2 is unused).

Application Example Setting a Relay:

Binary Output signals of the DNP cannot directly be used in order to switch relays because the DNP Binary Outputs are pulse signals (by DNP definition, not steady state). Steady states can be created by means of Logic functions. The Logic Functions can be assigned onto the Relay Inputs.



Please note: You can use a Set/Reset element (Flip Flop) from Logics.

Logics

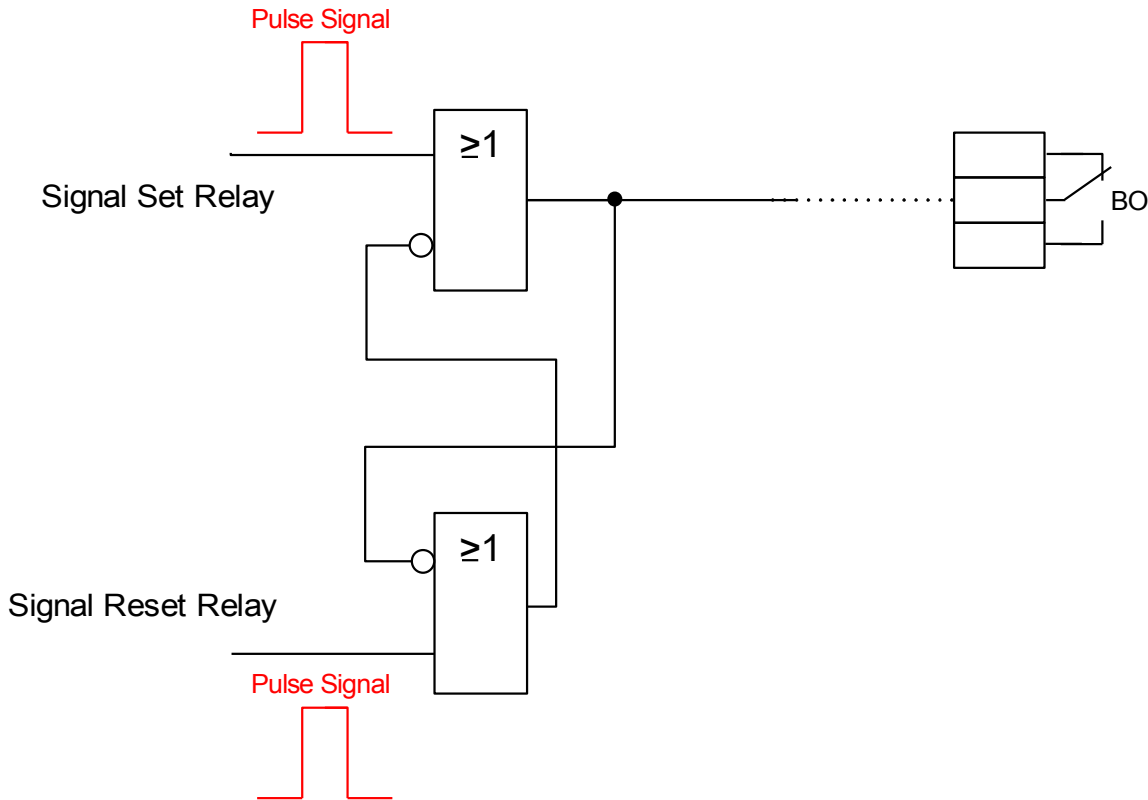
Assign Logic Functions onto Relay Inputs











Direct Commands of the DNP

| Parameter | Description | Setting range | Default | Menu path |
|--|--|---------------------|----------|--|
| Res all Diag Cr  | Reset all diagnosis counters | inactive, active | inactive | [Operation /Reset] |
| Slave Id  | SlaveId defines the DNP3 address of this device (Outstation) | 0 - 65519 | 1 | [Device Para /DNP3 /Communication] |









| Parameter | Description | Setting range | Default | Menu path |
|---|---|---------------|---------|--|
|  Master Id | MasterId defines the DNP3 address of master (SCADA) | 0 - 65519 | 65500 | [Device Para /DNP3 /Communication] |









Global Protection Parameters of the DNP







| Parameter | Description | Setting range | Default | Menu path |
|---|--|--|----------|--|
|  Function | Permanent activation or deactivation of module/stage. | inactive, active | inactive | [Device Para /DNP3 /Communication] |
|  IP Port Number | Port Number of the IP address | 0 - 65535 | 20000 | [Device Para /DNP3 /Communication] |
|  Baud rate | Baud rate for communication | 1200, 2400, 4800, 9600, 19200, 38400, 57600, 115200 | 19200 | [Device Para /DNP3 /Communication] |
|  Frame Layout | Frame Layout | 8E1, 8O1, 8N1, 8N2 | 8E1 | [Device Para /DNP3 /Communication] |
|  Optical rest position | Optical rest position | Light off, Light on | Light on | [Device Para /DNP3 /Communication] |
|  SelfAddress | Support of self (automatic) addresses | inactive, active | inactive | [Device Para /DNP3 /Communication] |
|  DataLink confirm | Enables or disables the data layer confirmation (ack). | Never, Always, On_Large | Never | [Device Para /DNP3 /Communication] |
|  t-DataLink confirm | Data layer confirmation timeout | 0.1 - 10.0s | 1s | [Device Para /DNP3 /Communication] |







| Parameter | Description | Setting range | Default | Menu path |
|--|---|----------------------|----------|------------------------------------|
| DataLink num retries  | Number of repetition of data link packet sending after failing | 0 - 255 | 3 | [Device Para /DNP3 /Communication] |
| Direction Bit  | Enables Direction Bit functionality. The Direction Bit is 0 for SlaveStation and 1 for MasterStation | inactive, active | inactive | [Device Para /DNP3 /Communication] |
| Max Frame Size  | This value is used to limit the net Frame Size | 64 - 255 | 255 | [Device Para /DNP3 /Communication] |
| Test Link Period  | This value specifies the time period when to send a Test Link-Frame | 0.0 - 120.0s | 0s | [Device Para /DNP3 /Communication] |
| AppLink confirm  | Determines if the device will request that the Application Layer response be confirmed or not | Never, Always, Event | Always | [Device Para /DNP3 /Communication] |
| t-AppLink confirm  | Application layer response timeout | 0.1 - 10.0s | 5s | [Device Para /DNP3 /Communication] |
| AppLink num retries  | The number of times the device will retransmit an Application Layer fragment | 0 - 255 | 0 | [Device Para /DNP3 /Communication] |
| Unsol Reporting  | Enables supports unsolicited reporting. This is only for Network connections available. For serial connection this setting is fix set to inactive | inactive, active | inactive | [Device Para /DNP3 /Communication] |
| Unsol Reporting Timeout  | Set the amount of time that the outstation will wait for an Application Layer confirmation back from the master indicating that the master received the unsolicited response message. | 1.0 - 60.0s | 10s | [Device Para /DNP3 /Communication] |
| Unsol Reporting Retry  | Set the number of retries that an outstation transmits in each unsolicited response series if it does not receive confirmation back from the master. | 0 - 255 | 2 | [Device Para /DNP3 /Communication] |









| Parameter | Description | Setting range | Default | Menu path |
|---|---|-----------------------|----------|--|
|  TestSeqNo | Test if sequence number of request is incremented. If it is not correctly incremented the request will be ignored. It is recommended to have it inactive but some older DNP implementations need it activated. | inactive, active | inactive | [Device Para /DNP3 /Communication] |
|  TestSBO | It enables a stricter comparing of SBO and operate command. For older DNP versions it is recommended to deactivated it. | inactive, active | active | [Device Para /DNP3 /Communication] |
|  Timeout SBO | DNP Outputs can be controlled in a two stage procedure (SBO: Select Before Operate). These outputs are to be selected first by a select command. After this the bit is reserved for this operate request. When this timer is expired, the bit will be released. | 1.0 - 60.0s | 30s | [Device Para /DNP3 /Communication] |
|  ColdRestart | Enables support for Cold Restart function. | inactive, active | inactive | [Device Para /DNP3 /Communication] |
|  Deadb integr time | Deadband integration time. | 0 - 300 | 1 | [Device Para /DNP3 /Communication] |
|  BinaryInput 0 | Virtual Digital Input (DNP). This corresponds to a virtual binary output of the protective device. | 1..n, Assignment List | -- | [Device Para /DNP3 /Point map /Binary Inputs] |
|  BinaryInput 1 | Virtual Digital Input (DNP). This corresponds to a virtual binary output of the protective device. | 1..n, Assignment List | -- | [Device Para /DNP3 /Point map /Binary Inputs] |
|  BinaryInput 2 | Virtual Digital Input (DNP). This corresponds to a virtual binary output of the protective device. | 1..n, Assignment List | -- | [Device Para /DNP3 /Point map /Binary Inputs] |
|  BinaryInput 3 | Virtual Digital Input (DNP). This corresponds to a virtual binary output of the protective device. | 1..n, Assignment List | -- | [Device Para /DNP3 /Point map /Binary Inputs] |







| <i>Parameter</i> | <i>Description</i> | <i>Setting range</i> | <i>Default</i> | <i>Menu path</i> |
|---|--|-----------------------|----------------|--|
| BinaryInput 4  | Virtual Digital Input (DNP). This corresponds to a virtual binary output of the protective device. | 1..n, Assignment List | -- | [Device Para /DNP3 /Point map /Binary Inputs] |
| BinaryInput 5  | Virtual Digital Input (DNP). This corresponds to a virtual binary output of the protective device. | 1..n, Assignment List | -- | [Device Para /DNP3 /Point map /Binary Inputs] |
| BinaryInput 6  | Virtual Digital Input (DNP). This corresponds to a virtual binary output of the protective device. | 1..n, Assignment List | -- | [Device Para /DNP3 /Point map /Binary Inputs] |
| BinaryInput 7  | Virtual Digital Input (DNP). This corresponds to a virtual binary output of the protective device. | 1..n, Assignment List | -- | [Device Para /DNP3 /Point map /Binary Inputs] |
| BinaryInput 8  | Virtual Digital Input (DNP). This corresponds to a virtual binary output of the protective device. | 1..n, Assignment List | -- | [Device Para /DNP3 /Point map /Binary Inputs] |
| BinaryInput 9  | Virtual Digital Input (DNP). This corresponds to a virtual binary output of the protective device. | 1..n, Assignment List | -- | [Device Para /DNP3 /Point map /Binary Inputs] |
| BinaryInput 10  | Virtual Digital Input (DNP). This corresponds to a virtual binary output of the protective device. | 1..n, Assignment List | -- | [Device Para /DNP3 /Point map /Binary Inputs] |
| BinaryInput 11  | Virtual Digital Input (DNP). This corresponds to a virtual binary output of the protective device. | 1..n, Assignment List | -- | [Device Para /DNP3 /Point map /Binary Inputs] |
| BinaryInput 12  | Virtual Digital Input (DNP). This corresponds to a virtual binary output of the protective device. | 1..n, Assignment List | -- | [Device Para /DNP3 /Point map /Binary Inputs] |



| <i>Parameter</i> | <i>Description</i> | <i>Setting range</i> | <i>Default</i> | <i>Menu path</i> |
|---|--|-----------------------|----------------|--|
| BinaryInput 13  | Virtual Digital Input (DNP). This corresponds to a virtual binary output of the protective device. | 1..n, Assignment List | -- | [Device Para /DNP3 /Point map /Binary Inputs] |
| BinaryInput 14  | Virtual Digital Input (DNP). This corresponds to a virtual binary output of the protective device. | 1..n, Assignment List | -- | [Device Para /DNP3 /Point map /Binary Inputs] |
| BinaryInput 15  | Virtual Digital Input (DNP). This corresponds to a virtual binary output of the protective device. | 1..n, Assignment List | -- | [Device Para /DNP3 /Point map /Binary Inputs] |
| BinaryInput 16  | Virtual Digital Input (DNP). This corresponds to a virtual binary output of the protective device. | 1..n, Assignment List | -- | [Device Para /DNP3 /Point map /Binary Inputs] |
| BinaryInput 17  | Virtual Digital Input (DNP). This corresponds to a virtual binary output of the protective device. | 1..n, Assignment List | -- | [Device Para /DNP3 /Point map /Binary Inputs] |
| BinaryInput 18  | Virtual Digital Input (DNP). This corresponds to a virtual binary output of the protective device. | 1..n, Assignment List | -- | [Device Para /DNP3 /Point map /Binary Inputs] |
| BinaryInput 19  | Virtual Digital Input (DNP). This corresponds to a virtual binary output of the protective device. | 1..n, Assignment List | -- | [Device Para /DNP3 /Point map /Binary Inputs] |
| BinaryInput 20  | Virtual Digital Input (DNP). This corresponds to a virtual binary output of the protective device. | 1..n, Assignment List | -- | [Device Para /DNP3 /Point map /Binary Inputs] |
| BinaryInput 21  | Virtual Digital Input (DNP). This corresponds to a virtual binary output of the protective device. | 1..n, Assignment List | -- | [Device Para /DNP3 /Point map /Binary Inputs] |



| Parameter | Description | Setting range | Default | Menu path |
|---|--|-----------------------|---------|--|
| BinaryInput 22  | Virtual Digital Input (DNP). This corresponds to a virtual binary output of the protective device. | 1..n, Assignment List | -- | [Device Para /DNP3 /Point map /Binary Inputs] |
| BinaryInput 23  | Virtual Digital Input (DNP). This corresponds to a virtual binary output of the protective device. | 1..n, Assignment List | -- | [Device Para /DNP3 /Point map /Binary Inputs] |
| BinaryInput 24  | Virtual Digital Input (DNP). This corresponds to a virtual binary output of the protective device. | 1..n, Assignment List | -- | [Device Para /DNP3 /Point map /Binary Inputs] |
| BinaryInput 25  | Virtual Digital Input (DNP). This corresponds to a virtual binary output of the protective device. | 1..n, Assignment List | -- | [Device Para /DNP3 /Point map /Binary Inputs] |
| BinaryInput 26  | Virtual Digital Input (DNP). This corresponds to a virtual binary output of the protective device. | 1..n, Assignment List | -- | [Device Para /DNP3 /Point map /Binary Inputs] |
| BinaryInput 27  | Virtual Digital Input (DNP). This corresponds to a virtual binary output of the protective device. | 1..n, Assignment List | -- | [Device Para /DNP3 /Point map /Binary Inputs] |
| BinaryInput 28  | Virtual Digital Input (DNP). This corresponds to a virtual binary output of the protective device. | 1..n, Assignment List | -- | [Device Para /DNP3 /Point map /Binary Inputs] |
| BinaryInput 29  | Virtual Digital Input (DNP). This corresponds to a virtual binary output of the protective device. | 1..n, Assignment List | -- | [Device Para /DNP3 /Point map /Binary Inputs] |
| BinaryInput 30  | Virtual Digital Input (DNP). This corresponds to a virtual binary output of the protective device. | 1..n, Assignment List | -- | [Device Para /DNP3 /Point map /Binary Inputs] |



| Parameter | Description | Setting range | Default | Menu path |
|---|--|-----------------------|---------|--|
| BinaryInput 31  | Virtual Digital Input (DNP). This corresponds to a virtual binary output of the protective device. | 1..n, Assignment List | -- | [Device Para /DNP3 /Point map /Binary Inputs] |
| BinaryInput 32  | Virtual Digital Input (DNP). This corresponds to a virtual binary output of the protective device. | 1..n, Assignment List | -- | [Device Para /DNP3 /Point map /Binary Inputs] |
| BinaryInput 33  | Virtual Digital Input (DNP). This corresponds to a virtual binary output of the protective device. | 1..n, Assignment List | -- | [Device Para /DNP3 /Point map /Binary Inputs] |
| BinaryInput 34  | Virtual Digital Input (DNP). This corresponds to a virtual binary output of the protective device. | 1..n, Assignment List | -- | [Device Para /DNP3 /Point map /Binary Inputs] |
| BinaryInput 35  | Virtual Digital Input (DNP). This corresponds to a virtual binary output of the protective device. | 1..n, Assignment List | -- | [Device Para /DNP3 /Point map /Binary Inputs] |
| BinaryInput 36  | Virtual Digital Input (DNP). This corresponds to a virtual binary output of the protective device. | 1..n, Assignment List | -- | [Device Para /DNP3 /Point map /Binary Inputs] |
| BinaryInput 37  | Virtual Digital Input (DNP). This corresponds to a virtual binary output of the protective device. | 1..n, Assignment List | -- | [Device Para /DNP3 /Point map /Binary Inputs] |
| BinaryInput 38  | Virtual Digital Input (DNP). This corresponds to a virtual binary output of the protective device. | 1..n, Assignment List | -- | [Device Para /DNP3 /Point map /Binary Inputs] |
| BinaryInput 39  | Virtual Digital Input (DNP). This corresponds to a virtual binary output of the protective device. | 1..n, Assignment List | -- | [Device Para /DNP3 /Point map /Binary Inputs] |







| <i>Parameter</i> | <i>Description</i> | <i>Setting range</i> | <i>Default</i> | <i>Menu path</i> |
|---|--|-----------------------|----------------|--|
| BinaryInput 40  | Virtual Digital Input (DNP). This corresponds to a virtual binary output of the protective device. | 1..n, Assignment List | -- | [Device Para /DNP3 /Point map /Binary Inputs] |
| BinaryInput 41  | Virtual Digital Input (DNP). This corresponds to a virtual binary output of the protective device. | 1..n, Assignment List | -- | [Device Para /DNP3 /Point map /Binary Inputs] |
| BinaryInput 42  | Virtual Digital Input (DNP). This corresponds to a virtual binary output of the protective device. | 1..n, Assignment List | -- | [Device Para /DNP3 /Point map /Binary Inputs] |
| BinaryInput 43  | Virtual Digital Input (DNP). This corresponds to a virtual binary output of the protective device. | 1..n, Assignment List | -- | [Device Para /DNP3 /Point map /Binary Inputs] |
| BinaryInput 44  | Virtual Digital Input (DNP). This corresponds to a virtual binary output of the protective device. | 1..n, Assignment List | -- | [Device Para /DNP3 /Point map /Binary Inputs] |
| BinaryInput 45  | Virtual Digital Input (DNP). This corresponds to a virtual binary output of the protective device. | 1..n, Assignment List | -- | [Device Para /DNP3 /Point map /Binary Inputs] |
| BinaryInput 46  | Virtual Digital Input (DNP). This corresponds to a virtual binary output of the protective device. | 1..n, Assignment List | -- | [Device Para /DNP3 /Point map /Binary Inputs] |
| BinaryInput 47  | Virtual Digital Input (DNP). This corresponds to a virtual binary output of the protective device. | 1..n, Assignment List | -- | [Device Para /DNP3 /Point map /Binary Inputs] |
| BinaryInput 48  | Virtual Digital Input (DNP). This corresponds to a virtual binary output of the protective device. | 1..n, Assignment List | -- | [Device Para /DNP3 /Point map /Binary Inputs] |







| Parameter | Description | Setting range | Default | Menu path |
|---|--|-----------------------|---------|--|
| BinaryInput 49  | Virtual Digital Input (DNP). This corresponds to a virtual binary output of the protective device. | 1..n, Assignment List | -- | [Device Para /DNP3 /Point map /Binary Inputs] |
| BinaryInput 50  | Virtual Digital Input (DNP). This corresponds to a virtual binary output of the protective device. | 1..n, Assignment List | -- | [Device Para /DNP3 /Point map /Binary Inputs] |
| BinaryInput 51  | Virtual Digital Input (DNP). This corresponds to a virtual binary output of the protective device. | 1..n, Assignment List | -- | [Device Para /DNP3 /Point map /Binary Inputs] |
| BinaryInput 52  | Virtual Digital Input (DNP). This corresponds to a virtual binary output of the protective device. | 1..n, Assignment List | -- | [Device Para /DNP3 /Point map /Binary Inputs] |
| BinaryInput 53  | Virtual Digital Input (DNP). This corresponds to a virtual binary output of the protective device. | 1..n, Assignment List | -- | [Device Para /DNP3 /Point map /Binary Inputs] |
| BinaryInput 54  | Virtual Digital Input (DNP). This corresponds to a virtual binary output of the protective device. | 1..n, Assignment List | -- | [Device Para /DNP3 /Point map /Binary Inputs] |
| BinaryInput 55  | Virtual Digital Input (DNP). This corresponds to a virtual binary output of the protective device. | 1..n, Assignment List | -- | [Device Para /DNP3 /Point map /Binary Inputs] |
| BinaryInput 56  | Virtual Digital Input (DNP). This corresponds to a virtual binary output of the protective device. | 1..n, Assignment List | -- | [Device Para /DNP3 /Point map /Binary Inputs] |
| BinaryInput 57  | Virtual Digital Input (DNP). This corresponds to a virtual binary output of the protective device. | 1..n, Assignment List | -- | [Device Para /DNP3 /Point map /Binary Inputs] |







| <i>Parameter</i> | <i>Description</i> | <i>Setting range</i> | <i>Default</i> | <i>Menu path</i> |
|---|--|-----------------------|----------------|--|
| BinaryInput 58  | Virtual Digital Input (DNP). This corresponds to a virtual binary output of the protective device. | 1..n, Assignment List | -- | [Device Para /DNP3 /Point map /Binary Inputs] |
| BinaryInput 59  | Virtual Digital Input (DNP). This corresponds to a virtual binary output of the protective device. | 1..n, Assignment List | -- | [Device Para /DNP3 /Point map /Binary Inputs] |
| BinaryInput 60  | Virtual Digital Input (DNP). This corresponds to a virtual binary output of the protective device. | 1..n, Assignment List | -- | [Device Para /DNP3 /Point map /Binary Inputs] |
| BinaryInput 61  | Virtual Digital Input (DNP). This corresponds to a virtual binary output of the protective device. | 1..n, Assignment List | -- | [Device Para /DNP3 /Point map /Binary Inputs] |
| BinaryInput 62  | Virtual Digital Input (DNP). This corresponds to a virtual binary output of the protective device. | 1..n, Assignment List | -- | [Device Para /DNP3 /Point map /Binary Inputs] |
| BinaryInput 63  | Virtual Digital Input (DNP). This corresponds to a virtual binary output of the protective device. | 1..n, Assignment List | -- | [Device Para /DNP3 /Point map /Binary Inputs] |
| DoubleBitInput 0  | Double Bit Digital Input (DNP). This corresponds to a double bit binary output of the protective device. | 1..n, Assignment List | -- | [Device Para /DNP3 /Point map /Double Bit Inputs] |
| DoubleBitInput 1  | Double Bit Digital Input (DNP). This corresponds to a double bit binary output of the protective device. | 1..n, Assignment List | -- | [Device Para /DNP3 /Point map /Double Bit Inputs] |
| DoubleBitInput 2  | Double Bit Digital Input (DNP). This corresponds to a double bit binary output of the protective device. | 1..n, Assignment List | -- | [Device Para /DNP3 /Point map /Double Bit Inputs] |







| <i>Parameter</i> | <i>Description</i> | <i>Setting range</i> | <i>Default</i> | <i>Menu path</i> |
|---|--|-----------------------|----------------|--|
|  DoubleBitInput 3 | Double Bit Digital Input (DNP). This corresponds to a double bit binary output of the protective device. | 1..n, Assignment List | -- | [Device Para /DNP3 /Point map /Double Bit Inputs] |
|  DoubleBitInput 4 | Double Bit Digital Input (DNP). This corresponds to a double bit binary output of the protective device. | 1..n, Assignment List | -- | [Device Para /DNP3 /Point map /Double Bit Inputs] |
|  DoubleBitInput 5 | Double Bit Digital Input (DNP). This corresponds to a double bit binary output of the protective device. | 1..n, Assignment List | -- | [Device Para /DNP3 /Point map /Double Bit Inputs] |
|  BinaryCounter 0 | Counter can be used to report counter values to the DNP master. | 1..n, Assignment List | -- | [Device Para /DNP3 /Point map /BinaryCounter] |
|  BinaryCounter 1 | Counter can be used to report counter values to the DNP master. | 1..n, Assignment List | -- | [Device Para /DNP3 /Point map /BinaryCounter] |
|  BinaryCounter 2 | Counter can be used to report counter values to the DNP master. | 1..n, Assignment List | -- | [Device Para /DNP3 /Point map /BinaryCounter] |
|  BinaryCounter 3 | Counter can be used to report counter values to the DNP master. | 1..n, Assignment List | -- | [Device Para /DNP3 /Point map /BinaryCounter] |
|  BinaryCounter 4 | Counter can be used to report counter values to the DNP master. | 1..n, Assignment List | -- | [Device Para /DNP3 /Point map /BinaryCounter] |
|  BinaryCounter 5 | Counter can be used to report counter values to the DNP master. | 1..n, Assignment List | -- | [Device Para /DNP3 /Point map /BinaryCounter] |







| Parameter | Description | Setting range | Default | Menu path |
|---|---|---|---------|--|
| BinaryCounter 6  | Counter can be used to report counter values to the DNP master. | 1..n, Assignment List | -- | [Device Para /DNP3 /Point map /BinaryCounter] |
| BinaryCounter 7  | Counter can be used to report counter values to the DNP master. | 1..n, Assignment List | -- | [Device Para /DNP3 /Point map /BinaryCounter] |
| Analog value 0  | Analog value can be used to report values to the master (DNP) | 1..n, TrendReclList | -- | [Device Para /DNP3 /Point map /Analog Input] |
| Scale Factor 0  | The scale factor is used to convert the measured value in an integer format | 0.001, 0.01, 0.1, 1, 10, 100, 1000, 10000, 100000, 1000000 | 1 | [Device Para /DNP3 /Point map /Analog Input] |
| Dead Band 0  | If a change of measured value is greater than the deadband value it will be reported to the master. | 0.01 - 100.00% | 1% | [Device Para /DNP3 /Point map /Analog Input] |
| Analog value 1  | Analog value can be used to report values to the master (DNP) | 1..n, TrendReclList | -- | [Device Para /DNP3 /Point map /Analog Input] |







| Parameter | Description | Setting range | Default | Menu path |
|---|---|---|---------|---|
| Scale Factor 1  | The scale factor is used to convert the measured value in an integer format | 0.001, 0.01, 0.1, 1, 10, 100, 1000, 10000, 100000, 1000000 | 1 | [Device Para /DNP3 /Point map /Analog Input] |
| Dead Band 1  | If a change of measured value is greater than the deadband value it will be reported to the master. | 0.01 - 100.00% | 1% | [Device Para /DNP3 /Point map /Analog Input] |
| Analog value 2  | Analog value can be used to report values to the master (DNP) | 1..n, TrendRecList | -- | [Device Para /DNP3 /Point map /Analog Input] |
| Scale Factor 2  | The scale factor is used to convert the measured value in an integer format | 0.001, 0.01, 0.1, 1, 10, 100, 1000, 10000, 100000, 1000000 | 1 | [Device Para /DNP3 /Point map /Analog Input] |
| Dead Band 2  | If a change of measured value is greater than the deadband value it will be reported to the master. | 0.01 - 100.00% | 1% | [Device Para /DNP3 /Point map /Analog Input] |
| Analog value 3  | Analog value can be used to report values to the master (DNP) | 1..n, TrendRecList | -- | [Device Para /DNP3 /Point map /Analog Input] |







| Parameter | Description | Setting range | Default | Menu path |
|---|---|---|---------|---|
| Scale Factor 3  | The scale factor is used to convert the measured value in an integer format | 0.001, 0.01, 0.1, 1, 10, 100, 1000, 10000, 100000, 1000000 | 1 | [Device Para /DNP3 /Point map /Analog Input] |
| Dead Band 3  | If a change of measured value is greater than the deadband value it will be reported to the master. | 0.01 - 100.00% | 1% | [Device Para /DNP3 /Point map /Analog Input] |
| Analog value 4  | Analog value can be used to report values to the master (DNP) | 1..n, TrendRecList | -- | [Device Para /DNP3 /Point map /Analog Input] |
| Scale Factor 4  | The scale factor is used to convert the measured value in an integer format | 0.001, 0.01, 0.1, 1, 10, 100, 1000, 10000, 100000, 1000000 | 1 | [Device Para /DNP3 /Point map /Analog Input] |
| Dead Band 4  | If a change of measured value is greater than the deadband value it will be reported to the master. | 0.01 - 100.00% | 1% | [Device Para /DNP3 /Point map /Analog Input] |
| Analog value 5  | Analog value can be used to report values to the master (DNP) | 1..n, TrendRecList | -- | [Device Para /DNP3 /Point map /Analog Input] |







| Parameter | Description | Setting range | Default | Menu path |
|---|---|---|---------|---|
| Scale Factor 5  | The scale factor is used to convert the measured value in an integer format | 0.001, 0.01, 0.1, 1, 10, 100, 1000, 10000, 100000, 1000000 | 1 | [Device Para /DNP3 /Point map /Analog Input] |
| Dead Band 5  | If a change of measured value is greater than the deadband value it will be reported to the master. | 0.01 - 100.00% | 1% | [Device Para /DNP3 /Point map /Analog Input] |
| Analog value 6  | Analog value can be used to report values to the master (DNP) | 1..n, TrendRecList | -- | [Device Para /DNP3 /Point map /Analog Input] |
| Scale Factor 6  | The scale factor is used to convert the measured value in an integer format | 0.001, 0.01, 0.1, 1, 10, 100, 1000, 10000, 100000, 1000000 | 1 | [Device Para /DNP3 /Point map /Analog Input] |
| Dead Band 6  | If a change of measured value is greater than the deadband value it will be reported to the master. | 0.01 - 100.00% | 1% | [Device Para /DNP3 /Point map /Analog Input] |
| Analog value 7  | Analog value can be used to report values to the master (DNP) | 1..n, TrendRecList | -- | [Device Para /DNP3 /Point map /Analog Input] |







| Parameter | Description | Setting range | Default | Menu path |
|---|---|---|---------|---|
| Scale Factor 7  | The scale factor is used to convert the measured value in an integer format | 0.001, 0.01, 0.1, 1, 10, 100, 1000, 10000, 100000, 1000000 | 1 | [Device Para /DNP3 /Point map /Analog Input] |
| Dead Band 7  | If a change of measured value is greater than the deadband value it will be reported to the master. | 0.01 - 100.00% | 1% | [Device Para /DNP3 /Point map /Analog Input] |
| Analog value 8  | Analog value can be used to report values to the master (DNP) | 1..n, TrendRecList | -- | [Device Para /DNP3 /Point map /Analog Input] |
| Scale Factor 8  | The scale factor is used to convert the measured value in an integer format | 0.001, 0.01, 0.1, 1, 10, 100, 1000, 10000, 100000, 1000000 | 1 | [Device Para /DNP3 /Point map /Analog Input] |
| Dead Band 8  | If a change of measured value is greater than the deadband value it will be reported to the master. | 0.01 - 100.00% | 1% | [Device Para /DNP3 /Point map /Analog Input] |
| Analog value 9  | Analog value can be used to report values to the master (DNP) | 1..n, TrendRecList | -- | [Device Para /DNP3 /Point map /Analog Input] |







| Parameter | Description | Setting range | Default | Menu path |
|--|---|---|---------|---|
| Scale Factor 9  | The scale factor is used to convert the measured value in an integer format | 0.001, 0.01, 0.1, 1, 10, 100, 1000, 10000, 100000, 1000000 | 1 | [Device Para /DNP3 /Point map /Analog Input] |
| Dead Band 9  | If a change of measured value is greater than the deadband value it will be reported to the master. | 0.01 - 100.00% | 1% | [Device Para /DNP3 /Point map /Analog Input] |
| Analog value 10  | Analog value can be used to report values to the master (DNP) | 1..n, TrendRecList | -- | [Device Para /DNP3 /Point map /Analog Input] |
| Scale Factor 10  | The scale factor is used to convert the measured value in an integer format | 0.001, 0.01, 0.1, 1, 10, 100, 1000, 10000, 100000, 1000000 | 1 | [Device Para /DNP3 /Point map /Analog Input] |
| Dead Band 10  | If a change of measured value is greater than the deadband value it will be reported to the master. | 0.01 - 100.00% | 1% | [Device Para /DNP3 /Point map /Analog Input] |
| Analog value 11  | Analog value can be used to report values to the master (DNP) | 1..n, TrendRecList | -- | [Device Para /DNP3 /Point map /Analog Input] |







| Parameter | Description | Setting range | Default | Menu path |
|--|---|---|---------|---|
| Scale Factor 11  | The scale factor is used to convert the measured value in an integer format | 0.001, 0.01, 0.1, 1, 10, 100, 1000, 10000, 100000, 1000000 | 1 | [Device Para /DNP3 /Point map /Analog Input] |
| Dead Band 11  | If a change of measured value is greater than the deadband value it will be reported to the master. | 0.01 - 100.00% | 1% | [Device Para /DNP3 /Point map /Analog Input] |
| Analog value 12  | Analog value can be used to report values to the master (DNP) | 1..n, TrendRecList | -- | [Device Para /DNP3 /Point map /Analog Input] |
| Scale Factor 12  | The scale factor is used to convert the measured value in an integer format | 0.001, 0.01, 0.1, 1, 10, 100, 1000, 10000, 100000, 1000000 | 1 | [Device Para /DNP3 /Point map /Analog Input] |
| Dead Band 12  | If a change of measured value is greater than the deadband value it will be reported to the master. | 0.01 - 100.00% | 1% | [Device Para /DNP3 /Point map /Analog Input] |
| Analog value 13  | Analog value can be used to report values to the master (DNP) | 1..n, TrendRecList | -- | [Device Para /DNP3 /Point map /Analog Input] |







| Parameter | Description | Setting range | Default | Menu path |
|--|---|---|---------|---|
| Scale Factor 13  | The scale factor is used to convert the measured value in an integer format | 0.001, 0.01, 0.1, 1, 10, 100, 1000, 10000, 100000, 1000000 | 1 | [Device Para /DNP3 /Point map /Analog Input] |
| Dead Band 13  | If a change of measured value is greater than the deadband value it will be reported to the master. | 0.01 - 100.00% | 1% | [Device Para /DNP3 /Point map /Analog Input] |
| Analog value 14  | Analog value can be used to report values to the master (DNP) | 1..n, TrendRecList | -- | [Device Para /DNP3 /Point map /Analog Input] |
| Scale Factor 14  | The scale factor is used to convert the measured value in an integer format | 0.001, 0.01, 0.1, 1, 10, 100, 1000, 10000, 100000, 1000000 | 1 | [Device Para /DNP3 /Point map /Analog Input] |
| Dead Band 14  | If a change of measured value is greater than the deadband value it will be reported to the master. | 0.01 - 100.00% | 1% | [Device Para /DNP3 /Point map /Analog Input] |
| Analog value 15  | Analog value can be used to report values to the master (DNP) | 1..n, TrendRecList | -- | [Device Para /DNP3 /Point map /Analog Input] |







| Parameter | Description | Setting range | Default | Menu path |
|--|---|---|---------|---|
| Scale Factor 15  | The scale factor is used to convert the measured value in an integer format | 0.001, 0.01, 0.1, 1, 10, 100, 1000, 10000, 100000, 1000000 | 1 | [Device Para /DNP3 /Point map /Analog Input] |
| Dead Band 15  | If a change of measured value is greater than the deadband value it will be reported to the master. | 0.01 - 100.00% | 1% | [Device Para /DNP3 /Point map /Analog Input] |
| Analog value 16  | Analog value can be used to report values to the master (DNP) | 1..n, TrendRecList | -- | [Device Para /DNP3 /Point map /Analog Input] |
| Scale Factor 16  | The scale factor is used to convert the measured value in an integer format | 0.001, 0.01, 0.1, 1, 10, 100, 1000, 10000, 100000, 1000000 | 1 | [Device Para /DNP3 /Point map /Analog Input] |
| Dead Band 16  | If a change of measured value is greater than the deadband value it will be reported to the master. | 0.01 - 100.00% | 1% | [Device Para /DNP3 /Point map /Analog Input] |
| Analog value 17  | Analog value can be used to report values to the master (DNP) | 1..n, TrendRecList | -- | [Device Para /DNP3 /Point map /Analog Input] |







| Parameter | Description | Setting range | Default | Menu path |
|--|---|---|---------|---|
| Scale Factor 17  | The scale factor is used to convert the measured value in an integer format | 0.001, 0.01, 0.1, 1, 10, 100, 1000, 10000, 100000, 1000000 | 1 | [Device Para /DNP3 /Point map /Analog Input] |
| Dead Band 17  | If a change of measured value is greater than the deadband value it will be reported to the master. | 0.01 - 100.00% | 1% | [Device Para /DNP3 /Point map /Analog Input] |
| Analog value 18  | Analog value can be used to report values to the master (DNP) | 1..n, TrendRecList | -- | [Device Para /DNP3 /Point map /Analog Input] |
| Scale Factor 18  | The scale factor is used to convert the measured value in an integer format | 0.001, 0.01, 0.1, 1, 10, 100, 1000, 10000, 100000, 1000000 | 1 | [Device Para /DNP3 /Point map /Analog Input] |
| Dead Band 18  | If a change of measured value is greater than the deadband value it will be reported to the master. | 0.01 - 100.00% | 1% | [Device Para /DNP3 /Point map /Analog Input] |
| Analog value 19  | Analog value can be used to report values to the master (DNP) | 1..n, TrendRecList | -- | [Device Para /DNP3 /Point map /Analog Input] |







| Parameter | Description | Setting range | Default | Menu path |
|--|---|---|---------|---|
| Scale Factor 19  | The scale factor is used to convert the measured value in an integer format | 0.001, 0.01, 0.1, 1, 10, 100, 1000, 10000, 100000, 1000000 | 1 | [Device Para /DNP3 /Point map /Analog Input] |
| Dead Band 19  | If a change of measured value is greater than the deadband value it will be reported to the master. | 0.01 - 100.00% | 1% | [Device Para /DNP3 /Point map /Analog Input] |
| Analog value 20  | Analog value can be used to report values to the master (DNP) | 1..n, TrendRecList | -- | [Device Para /DNP3 /Point map /Analog Input] |
| Scale Factor 20  | The scale factor is used to convert the measured value in an integer format | 0.001, 0.01, 0.1, 1, 10, 100, 1000, 10000, 100000, 1000000 | 1 | [Device Para /DNP3 /Point map /Analog Input] |
| Dead Band 20  | If a change of measured value is greater than the deadband value it will be reported to the master. | 0.01 - 100.00% | 1% | [Device Para /DNP3 /Point map /Analog Input] |
| Analog value 21  | Analog value can be used to report values to the master (DNP) | 1..n, TrendRecList | -- | [Device Para /DNP3 /Point map /Analog Input] |



| Parameter | Description | Setting range | Default | Menu path |
|--|---|---|---------|---|
| Scale Factor 21  | The scale factor is used to convert the measured value in an integer format | 0.001, 0.01, 0.1, 1, 10, 100, 1000, 10000, 100000, 1000000 | 1 | [Device Para /DNP3 /Point map /Analog Input] |
| Dead Band 21  | If a change of measured value is greater than the deadband value it will be reported to the master. | 0.01 - 100.00% | 1% | [Device Para /DNP3 /Point map /Analog Input] |
| Analog value 22  | Analog value can be used to report values to the master (DNP) | 1..n, TrendRecList | -- | [Device Para /DNP3 /Point map /Analog Input] |
| Scale Factor 22  | The scale factor is used to convert the measured value in an integer format | 0.001, 0.01, 0.1, 1, 10, 100, 1000, 10000, 100000, 1000000 | 1 | [Device Para /DNP3 /Point map /Analog Input] |
| Dead Band 22  | If a change of measured value is greater than the deadband value it will be reported to the master. | 0.01 - 100.00% | 1% | [Device Para /DNP3 /Point map /Analog Input] |
| Analog value 23  | Analog value can be used to report values to the master (DNP) | 1..n, TrendRecList | -- | [Device Para /DNP3 /Point map /Analog Input] |

| Parameter | Description | Setting range | Default | Menu path |
|--|---|---|---------|---|
| Scale Factor 23  | The scale factor is used to convert the measured value in an integer format | 0.001, 0.01, 0.1, 1, 10, 100, 1000, 10000, 100000, 1000000 | 1 | [Device Para /DNP3 /Point map /Analog Input] |
| Dead Band 23  | If a change of measured value is greater than the deadband value it will be reported to the master. | 0.01 - 100.00% | 1% | [Device Para /DNP3 /Point map /Analog Input] |
| Analog value 24  | Analog value can be used to report values to the master (DNP) | 1..n, TrendRecList | -- | [Device Para /DNP3 /Point map /Analog Input] |
| Scale Factor 24  | The scale factor is used to convert the measured value in an integer format | 0.001, 0.01, 0.1, 1, 10, 100, 1000, 10000, 100000, 1000000 | 1 | [Device Para /DNP3 /Point map /Analog Input] |
| Dead Band 24  | If a change of measured value is greater than the deadband value it will be reported to the master. | 0.01 - 100.00% | 1% | [Device Para /DNP3 /Point map /Analog Input] |
| Analog value 25  | Analog value can be used to report values to the master (DNP) | 1..n, TrendRecList | -- | [Device Para /DNP3 /Point map /Analog Input] |

| Parameter | Description | Setting range | Default | Menu path |
|--|---|---|---------|---|
| Scale Factor 25  | The scale factor is used to convert the measured value in an integer format | 0.001, 0.01, 0.1, 1, 10, 100, 1000, 10000, 100000, 1000000 | 1 | [Device Para /DNP3 /Point map /Analog Input] |
| Dead Band 25  | If a change of measured value is greater than the deadband value it will be reported to the master. | 0.01 - 100.00% | 1% | [Device Para /DNP3 /Point map /Analog Input] |
| Analog value 26  | Analog value can be used to report values to the master (DNP) | 1..n, TrendRecList | -- | [Device Para /DNP3 /Point map /Analog Input] |
| Scale Factor 26  | The scale factor is used to convert the measured value in an integer format | 0.001, 0.01, 0.1, 1, 10, 100, 1000, 10000, 100000, 1000000 | 1 | [Device Para /DNP3 /Point map /Analog Input] |
| Dead Band 26  | If a change of measured value is greater than the deadband value it will be reported to the master. | 0.01 - 100.00% | 1% | [Device Para /DNP3 /Point map /Analog Input] |
| Analog value 27  | Analog value can be used to report values to the master (DNP) | 1..n, TrendRecList | -- | [Device Para /DNP3 /Point map /Analog Input] |

| Parameter | Description | Setting range | Default | Menu path |
|--|---|---|---------|---|
| Scale Factor 27  | The scale factor is used to convert the measured value in an integer format | 0.001, 0.01, 0.1, 1, 10, 100, 1000, 10000, 100000, 1000000 | 1 | [Device Para /DNP3 /Point map /Analog Input] |
| Dead Band 27  | If a change of measured value is greater than the deadband value it will be reported to the master. | 0.01 - 100.00% | 1% | [Device Para /DNP3 /Point map /Analog Input] |
| Analog value 28  | Analog value can be used to report values to the master (DNP) | 1..n, TrendRecList | -- | [Device Para /DNP3 /Point map /Analog Input] |
| Scale Factor 28  | The scale factor is used to convert the measured value in an integer format | 0.001, 0.01, 0.1, 1, 10, 100, 1000, 10000, 100000, 1000000 | 1 | [Device Para /DNP3 /Point map /Analog Input] |
| Dead Band 28  | If a change of measured value is greater than the deadband value it will be reported to the master. | 0.01 - 100.00% | 1% | [Device Para /DNP3 /Point map /Analog Input] |
| Analog value 29  | Analog value can be used to report values to the master (DNP) | 1..n, TrendRecList | -- | [Device Para /DNP3 /Point map /Analog Input] |

| Parameter | Description | Setting range | Default | Menu path |
|--|---|---|---------|---|
| Scale Factor 29  | The scale factor is used to convert the measured value in an integer format | 0.001, 0.01, 0.1, 1, 10, 100, 1000, 10000, 100000, 1000000 | 1 | [Device Para /DNP3 /Point map /Analog Input] |
| Dead Band 29  | If a change of measured value is greater than the deadband value it will be reported to the master. | 0.01 - 100.00% | 1% | [Device Para /DNP3 /Point map /Analog Input] |
| Analog value 30  | Analog value can be used to report values to the master (DNP) | 1..n, TrendRecList | -- | [Device Para /DNP3 /Point map /Analog Input] |
| Scale Factor 30  | The scale factor is used to convert the measured value in an integer format | 0.001, 0.01, 0.1, 1, 10, 100, 1000, 10000, 100000, 1000000 | 1 | [Device Para /DNP3 /Point map /Analog Input] |
| Dead Band 30  | If a change of measured value is greater than the deadband value it will be reported to the master. | 0.01 - 100.00% | 1% | [Device Para /DNP3 /Point map /Analog Input] |
| Analog value 31  | Analog value can be used to report values to the master (DNP) | 1..n, TrendRecList | -- | [Device Para /DNP3 /Point map /Analog Input] |

| Parameter | Description | Setting range | Default | Menu path |
|--|---|---|---------|---|
| Scale Factor 31  | The scale factor is used to convert the measured value in an integer format | 0.001, 0.01, 0.1, 1, 10, 100, 1000, 10000, 100000, 1000000 | 1 | [Device Para /DNP3 /Point map /Analog Input] |
| Dead Band 31  | If a change of measured value is greater than the deadband value it will be reported to the master. | 0.01 - 100.00% | 1% | [Device Para /DNP3 /Point map /Analog Input] |

Inputs of the DNP

| Name | Description | Assignment via |
|----------------|--|--|
| BinaryInput0-I | Virtual Digital Input (DNP). This corresponds to a virtual binary output of the protective device. | [Device Para /DNP3 /Point map /Binary Inputs] |
| BinaryInput1-I | Virtual Digital Input (DNP). This corresponds to a virtual binary output of the protective device. | [Device Para /DNP3 /Point map /Binary Inputs] |
| BinaryInput2-I | Virtual Digital Input (DNP). This corresponds to a virtual binary output of the protective device. | [Device Para /DNP3 /Point map /Binary Inputs] |
| BinaryInput3-I | Virtual Digital Input (DNP). This corresponds to a virtual binary output of the protective device. | [Device Para /DNP3 /Point map /Binary Inputs] |
| BinaryInput4-I | Virtual Digital Input (DNP). This corresponds to a virtual binary output of the protective device. | [Device Para /DNP3 /Point map /Binary Inputs] |

| Name | Description | Assignment via |
|-----------------|--|--|
| BinaryInput5-I | Virtual Digital Input (DNP). This corresponds to a virtual binary output of the protective device. | [Device Para /DNP3 /Point map /Binary Inputs] |
| BinaryInput6-I | Virtual Digital Input (DNP). This corresponds to a virtual binary output of the protective device. | [Device Para /DNP3 /Point map /Binary Inputs] |
| BinaryInput7-I | Virtual Digital Input (DNP). This corresponds to a virtual binary output of the protective device. | [Device Para /DNP3 /Point map /Binary Inputs] |
| BinaryInput8-I | Virtual Digital Input (DNP). This corresponds to a virtual binary output of the protective device. | [Device Para /DNP3 /Point map /Binary Inputs] |
| BinaryInput9-I | Virtual Digital Input (DNP). This corresponds to a virtual binary output of the protective device. | [Device Para /DNP3 /Point map /Binary Inputs] |
| BinaryInput10-I | Virtual Digital Input (DNP). This corresponds to a virtual binary output of the protective device. | [Device Para /DNP3 /Point map /Binary Inputs] |
| BinaryInput11-I | Virtual Digital Input (DNP). This corresponds to a virtual binary output of the protective device. | [Device Para /DNP3 /Point map /Binary Inputs] |
| BinaryInput12-I | Virtual Digital Input (DNP). This corresponds to a virtual binary output of the protective device. | [Device Para /DNP3 /Point map /Binary Inputs] |
| BinaryInput13-I | Virtual Digital Input (DNP). This corresponds to a virtual binary output of the protective device. | [Device Para /DNP3 /Point map /Binary Inputs] |

| Name | Description | Assignment via |
|-----------------|--|--|
| BinaryInput14-I | Virtual Digital Input (DNP). This corresponds to a virtual binary output of the protective device. | [Device Para /DNP3 /Point map /Binary Inputs] |
| BinaryInput15-I | Virtual Digital Input (DNP). This corresponds to a virtual binary output of the protective device. | [Device Para /DNP3 /Point map /Binary Inputs] |
| BinaryInput16-I | Virtual Digital Input (DNP). This corresponds to a virtual binary output of the protective device. | [Device Para /DNP3 /Point map /Binary Inputs] |
| BinaryInput17-I | Virtual Digital Input (DNP). This corresponds to a virtual binary output of the protective device. | [Device Para /DNP3 /Point map /Binary Inputs] |
| BinaryInput18-I | Virtual Digital Input (DNP). This corresponds to a virtual binary output of the protective device. | [Device Para /DNP3 /Point map /Binary Inputs] |
| BinaryInput19-I | Virtual Digital Input (DNP). This corresponds to a virtual binary output of the protective device. | [Device Para /DNP3 /Point map /Binary Inputs] |
| BinaryInput20-I | Virtual Digital Input (DNP). This corresponds to a virtual binary output of the protective device. | [Device Para /DNP3 /Point map /Binary Inputs] |
| BinaryInput21-I | Virtual Digital Input (DNP). This corresponds to a virtual binary output of the protective device. | [Device Para /DNP3 /Point map /Binary Inputs] |
| BinaryInput22-I | Virtual Digital Input (DNP). This corresponds to a virtual binary output of the protective device. | [Device Para /DNP3 /Point map /Binary Inputs] |

| Name | Description | Assignment via |
|-----------------|--|--|
| BinaryInput23-I | Virtual Digital Input (DNP). This corresponds to a virtual binary output of the protective device. | [Device Para /DNP3 /Point map /Binary Inputs] |
| BinaryInput24-I | Virtual Digital Input (DNP). This corresponds to a virtual binary output of the protective device. | [Device Para /DNP3 /Point map /Binary Inputs] |
| BinaryInput25-I | Virtual Digital Input (DNP). This corresponds to a virtual binary output of the protective device. | [Device Para /DNP3 /Point map /Binary Inputs] |
| BinaryInput26-I | Virtual Digital Input (DNP). This corresponds to a virtual binary output of the protective device. | [Device Para /DNP3 /Point map /Binary Inputs] |
| BinaryInput27-I | Virtual Digital Input (DNP). This corresponds to a virtual binary output of the protective device. | [Device Para /DNP3 /Point map /Binary Inputs] |
| BinaryInput28-I | Virtual Digital Input (DNP). This corresponds to a virtual binary output of the protective device. | [Device Para /DNP3 /Point map /Binary Inputs] |
| BinaryInput29-I | Virtual Digital Input (DNP). This corresponds to a virtual binary output of the protective device. | [Device Para /DNP3 /Point map /Binary Inputs] |
| BinaryInput30-I | Virtual Digital Input (DNP). This corresponds to a virtual binary output of the protective device. | [Device Para /DNP3 /Point map /Binary Inputs] |
| BinaryInput31-I | Virtual Digital Input (DNP). This corresponds to a virtual binary output of the protective device. | [Device Para /DNP3 /Point map /Binary Inputs] |

| Name | Description | Assignment via |
|-----------------|--|--|
| BinaryInput32-I | Virtual Digital Input (DNP). This corresponds to a virtual binary output of the protective device. | [Device Para /DNP3 /Point map /Binary Inputs] |
| BinaryInput33-I | Virtual Digital Input (DNP). This corresponds to a virtual binary output of the protective device. | [Device Para /DNP3 /Point map /Binary Inputs] |
| BinaryInput34-I | Virtual Digital Input (DNP). This corresponds to a virtual binary output of the protective device. | [Device Para /DNP3 /Point map /Binary Inputs] |
| BinaryInput35-I | Virtual Digital Input (DNP). This corresponds to a virtual binary output of the protective device. | [Device Para /DNP3 /Point map /Binary Inputs] |
| BinaryInput36-I | Virtual Digital Input (DNP). This corresponds to a virtual binary output of the protective device. | [Device Para /DNP3 /Point map /Binary Inputs] |
| BinaryInput37-I | Virtual Digital Input (DNP). This corresponds to a virtual binary output of the protective device. | [Device Para /DNP3 /Point map /Binary Inputs] |
| BinaryInput38-I | Virtual Digital Input (DNP). This corresponds to a virtual binary output of the protective device. | [Device Para /DNP3 /Point map /Binary Inputs] |
| BinaryInput39-I | Virtual Digital Input (DNP). This corresponds to a virtual binary output of the protective device. | [Device Para /DNP3 /Point map /Binary Inputs] |
| BinaryInput40-I | Virtual Digital Input (DNP). This corresponds to a virtual binary output of the protective device. | [Device Para /DNP3 /Point map /Binary Inputs] |

| Name | Description | Assignment via |
|-----------------|--|--|
| BinaryInput41-l | Virtual Digital Input (DNP). This corresponds to a virtual binary output of the protective device. | [Device Para /DNP3 /Point map /Binary Inputs] |
| BinaryInput42-l | Virtual Digital Input (DNP). This corresponds to a virtual binary output of the protective device. | [Device Para /DNP3 /Point map /Binary Inputs] |
| BinaryInput43-l | Virtual Digital Input (DNP). This corresponds to a virtual binary output of the protective device. | [Device Para /DNP3 /Point map /Binary Inputs] |
| BinaryInput44-l | Virtual Digital Input (DNP). This corresponds to a virtual binary output of the protective device. | [Device Para /DNP3 /Point map /Binary Inputs] |
| BinaryInput45-l | Virtual Digital Input (DNP). This corresponds to a virtual binary output of the protective device. | [Device Para /DNP3 /Point map /Binary Inputs] |
| BinaryInput46-l | Virtual Digital Input (DNP). This corresponds to a virtual binary output of the protective device. | [Device Para /DNP3 /Point map /Binary Inputs] |
| BinaryInput47-l | Virtual Digital Input (DNP). This corresponds to a virtual binary output of the protective device. | [Device Para /DNP3 /Point map /Binary Inputs] |
| BinaryInput48-l | Virtual Digital Input (DNP). This corresponds to a virtual binary output of the protective device. | [Device Para /DNP3 /Point map /Binary Inputs] |
| BinaryInput49-l | Virtual Digital Input (DNP). This corresponds to a virtual binary output of the protective device. | [Device Para /DNP3 /Point map /Binary Inputs] |

| <i>Name</i> | <i>Description</i> | <i>Assignment via</i> |
|-----------------|--|--|
| BinaryInput50-I | Virtual Digital Input (DNP). This corresponds to a virtual binary output of the protective device. | [Device Para /DNP3 /Point map /Binary Inputs] |
| BinaryInput51-I | Virtual Digital Input (DNP). This corresponds to a virtual binary output of the protective device. | [Device Para /DNP3 /Point map /Binary Inputs] |
| BinaryInput52-I | Virtual Digital Input (DNP). This corresponds to a virtual binary output of the protective device. | [Device Para /DNP3 /Point map /Binary Inputs] |
| BinaryInput53-I | Virtual Digital Input (DNP). This corresponds to a virtual binary output of the protective device. | [Device Para /DNP3 /Point map /Binary Inputs] |
| BinaryInput54-I | Virtual Digital Input (DNP). This corresponds to a virtual binary output of the protective device. | [Device Para /DNP3 /Point map /Binary Inputs] |
| BinaryInput55-I | Virtual Digital Input (DNP). This corresponds to a virtual binary output of the protective device. | [Device Para /DNP3 /Point map /Binary Inputs] |
| BinaryInput56-I | Virtual Digital Input (DNP). This corresponds to a virtual binary output of the protective device. | [Device Para /DNP3 /Point map /Binary Inputs] |
| BinaryInput57-I | Virtual Digital Input (DNP). This corresponds to a virtual binary output of the protective device. | [Device Para /DNP3 /Point map /Binary Inputs] |
| BinaryInput58-I | Virtual Digital Input (DNP). This corresponds to a virtual binary output of the protective device. | [Device Para /DNP3 /Point map /Binary Inputs] |

| <i>Name</i> | <i>Description</i> | <i>Assignment via</i> |
|-------------------|--|--|
| BinaryInput59-I | Virtual Digital Input (DNP). This corresponds to a virtual binary output of the protective device. | [Device Para /DNP3 /Point map /Binary Inputs] |
| BinaryInput60-I | Virtual Digital Input (DNP). This corresponds to a virtual binary output of the protective device. | [Device Para /DNP3 /Point map /Binary Inputs] |
| BinaryInput61-I | Virtual Digital Input (DNP). This corresponds to a virtual binary output of the protective device. | [Device Para /DNP3 /Point map /Binary Inputs] |
| BinaryInput62-I | Virtual Digital Input (DNP). This corresponds to a virtual binary output of the protective device. | [Device Para /DNP3 /Point map /Binary Inputs] |
| BinaryInput63-I | Virtual Digital Input (DNP). This corresponds to a virtual binary output of the protective device. | [Device Para /DNP3 /Point map /Binary Inputs] |
| DoubleBitInput0-I | Double Bit Digital Input (DNP). This corresponds to a double bit binary output of the protective device. | [Device Para /DNP3 /Point map /Double Bit Inputs] |
| DoubleBitInput1-I | Double Bit Digital Input (DNP). This corresponds to a double bit binary output of the protective device. | [Device Para /DNP3 /Point map /Double Bit Inputs] |
| DoubleBitInput2-I | Double Bit Digital Input (DNP). This corresponds to a double bit binary output of the protective device. | [Device Para /DNP3 /Point map /Double Bit Inputs] |
| DoubleBitInput3-I | Double Bit Digital Input (DNP). This corresponds to a double bit binary output of the protective device. | [Device Para /DNP3 /Point map /Double Bit Inputs] |

| Name | Description | Assignment via |
|-------------------|--|--|
| DoubleBitInput4-I | Double Bit Digital Input (DNP). This corresponds to a double bit binary output of the protective device. | [Device Para /DNP3 /Point map /Double Bit Inputs] |
| DoubleBitInput5-I | Double Bit Digital Input (DNP). This corresponds to a double bit binary output of the protective device. | [Device Para /DNP3 /Point map /Double Bit Inputs] |

Options of the DNP

| Name | Description |
|--------------------------------------|--|
| -.- | No assignment |
| Prot.FaultNo | Disturbance No |
| Prot.No of grid faults | Number of grid faults: A grid fault, e.g. a short circuit, might cause several faults with trip and autoreclosing, each fault being identified by an increased fault number. In this case, the grid fault number remains the same. |
| SG[1].TripCmd Cr | Counter: Total number of trips of the switchgear (circuit breaker, load break switch...). Resettable with Total or All. |
| SG[2].TripCmd Cr | Counter: Total number of trips of the switchgear (circuit breaker, load break switch...). Resettable with Total or All. |
| SG[3].TripCmd Cr | Counter: Total number of trips of the switchgear (circuit breaker, load break switch...). Resettable with Total or All. |
| SG[4].TripCmd Cr | Counter: Total number of trips of the switchgear (circuit breaker, load break switch...). Resettable with Total or All. |
| SG[5].TripCmd Cr | Counter: Total number of trips of the switchgear (circuit breaker, load break switch...). Resettable with Total or All. |
| SG[6].TripCmd Cr | Counter: Total number of trips of the switchgear (circuit breaker, load break switch...). Resettable with Total or All. |
| LVRT[1].NumOf Vdips in t-LVRT | Number of Voltage dips during t-LVRT |
| LVRT[1].Cr Tot Numb of Vdips | Counter Total number of voltage dips. |
| LVRT[1].Cr Tot Numb of Vdips to Trip | Counter Total number of voltage dips that caused a Trip. |
| LVRT[2].NumOf Vdips in t-LVRT | Number of Voltage dips during t-LVRT |
| LVRT[2].Cr Tot Numb of Vdips | Counter Total number of voltage dips. |
| LVRT[2].Cr Tot Numb of Vdips to Trip | Counter Total number of voltage dips that caused a Trip. |
| AR.AR Shot No. | Counter - Auto Reclosure Attempts |
| AR.Total number Cr | Total number of all executed Automatic Reclosures Attempts |
| AR.Cr successfl | Total number of successfully executed Automatic Reclosures |
| AR.Cr failed | Total number of unsuccessfully executed automatic reclosure attempts |

| <i>Name</i> | <i>Description</i> |
|------------------------|---|
| AR.Cr Service Alarm1 | Remaining numbers of ARs until Service Alarm 1 |
| AR.Cr Service Alarm2 | Remaining numbers of ARs until Service Alarm 2 |
| AR.Max Shots / h Cr | Counter for the maximum allowed shots per hour. |
| PQSCr.Wp+ | Positive Active Power is consumed active energy |
| PQSCr.Wp- | Negative Active Power (Fed Energy) |
| PQSCr.Wq+ | Positive Reactive Power is consumed Reactive Energy |
| PQSCr.Wq- | Negative Reactive Power (Fed Energy) |
| Sys.Operating hours Cr | Operating hours counter of the protective device |

Selectable Switchgears of the DNP

| <i>Name</i> | <i>Description</i> |
|-------------|--|
| -- | No assignment |
| SG[1].Pos | Signal: Circuit Breaker Position (0 = Indeterminate, 1 = OFF, 2 = ON, 3 = Disturbed) |
| SG[2].Pos | Signal: Circuit Breaker Position (0 = Indeterminate, 1 = OFF, 2 = ON, 3 = Disturbed) |
| SG[3].Pos | Signal: Circuit Breaker Position (0 = Indeterminate, 1 = OFF, 2 = ON, 3 = Disturbed) |
| SG[4].Pos | Signal: Circuit Breaker Position (0 = Indeterminate, 1 = OFF, 2 = ON, 3 = Disturbed) |
| SG[5].Pos | Signal: Circuit Breaker Position (0 = Indeterminate, 1 = OFF, 2 = ON, 3 = Disturbed) |
| SG[6].Pos | Signal: Circuit Breaker Position (0 = Indeterminate, 1 = OFF, 2 = ON, 3 = Disturbed) |

DNP Signals (Output States)

NOTICE Some signals (that are for a short time active only) have to be acknowledged separately (e.g. Trip signals) by the Communication System.

| <i>Signal</i> | <i>Description</i> |
|----------------|--|
| busy | This message is set if the protocol is started. It will be reset if the protocol is shut down. |
| ready | The message will be set if the protocol is successfully started and ready for data exchange. |
| active | The communication with the Master (Scada) is active. |
| BinaryOutput0 | Virtual Digital Output (DNP). This corresponds to a virtual binary input of the protective device. |
| BinaryOutput1 | Virtual Digital Output (DNP). This corresponds to a virtual binary input of the protective device. |
| BinaryOutput2 | Virtual Digital Output (DNP). This corresponds to a virtual binary input of the protective device. |
| BinaryOutput3 | Virtual Digital Output (DNP). This corresponds to a virtual binary input of the protective device. |
| BinaryOutput4 | Virtual Digital Output (DNP). This corresponds to a virtual binary input of the protective device. |
| BinaryOutput5 | Virtual Digital Output (DNP). This corresponds to a virtual binary input of the protective device. |
| BinaryOutput6 | Virtual Digital Output (DNP). This corresponds to a virtual binary input of the protective device. |
| BinaryOutput7 | Virtual Digital Output (DNP). This corresponds to a virtual binary input of the protective device. |
| BinaryOutput8 | Virtual Digital Output (DNP). This corresponds to a virtual binary input of the protective device. |
| BinaryOutput9 | Virtual Digital Output (DNP). This corresponds to a virtual binary input of the protective device. |
| BinaryOutput10 | Virtual Digital Output (DNP). This corresponds to a virtual binary input of the protective device. |
| BinaryOutput11 | Virtual Digital Output (DNP). This corresponds to a virtual binary input of the protective device. |
| BinaryOutput12 | Virtual Digital Output (DNP). This corresponds to a virtual binary input of the protective device. |
| BinaryOutput13 | Virtual Digital Output (DNP). This corresponds to a virtual binary input of the protective device. |
| BinaryOutput14 | Virtual Digital Output (DNP). This corresponds to a virtual binary input of the protective device. |
| BinaryOutput15 | Virtual Digital Output (DNP). This corresponds to a virtual binary input of the protective device. |
| BinaryOutput16 | Virtual Digital Output (DNP). This corresponds to a virtual binary input of the protective device. |
| BinaryOutput17 | Virtual Digital Output (DNP). This corresponds to a virtual binary input of the protective device. |
| BinaryOutput18 | Virtual Digital Output (DNP). This corresponds to a virtual binary input of the protective device. |
| BinaryOutput19 | Virtual Digital Output (DNP). This corresponds to a virtual binary input of the protective device. |
| BinaryOutput20 | Virtual Digital Output (DNP). This corresponds to a virtual binary input of the protective device. |
| BinaryOutput21 | Virtual Digital Output (DNP). This corresponds to a virtual binary input of the protective device. |
| BinaryOutput22 | Virtual Digital Output (DNP). This corresponds to a virtual binary input of the protective device. |
| BinaryOutput23 | Virtual Digital Output (DNP). This corresponds to a virtual binary input of the protective device. |
| BinaryOutput24 | Virtual Digital Output (DNP). This corresponds to a virtual binary input of the protective device. |
| BinaryOutput25 | Virtual Digital Output (DNP). This corresponds to a virtual binary input of the protective device. |
| BinaryOutput26 | Virtual Digital Output (DNP). This corresponds to a virtual binary input of the protective device. |
| BinaryOutput27 | Virtual Digital Output (DNP). This corresponds to a virtual binary input of the protective device. |
| BinaryOutput28 | Virtual Digital Output (DNP). This corresponds to a virtual binary input of the protective device. |
| BinaryOutput29 | Virtual Digital Output (DNP). This corresponds to a virtual binary input of the protective device. |
| BinaryOutput30 | Virtual Digital Output (DNP). This corresponds to a virtual binary input of the protective device. |
| BinaryOutput31 | Virtual Digital Output (DNP). This corresponds to a virtual binary input of the protective device. |

DNP Values

| <i>Value</i> | <i>Description</i> | <i>Default</i> | <i>Size</i> | <i>Menu path</i> |
|---------------|--|----------------|----------------|--|
| NReceived | Diagnostic counter: Number of received characters | 0 | 0 - 9999999999 | [Operation /Count and RevData /DNP3] |
| NSent | Diagnostic counter: Number of sent characters | 0 | 0 - 9999999999 | [Operation /Count and RevData /DNP3] |
| NBadFramings | Diagnostic counter: Number of bad framings. A large number indicates a disturbed serial connection. | 0 | 0 - 9999999999 | [Operation /Count and RevData /DNP3] |
| NBadParities | Diagnostic counter: Number of parity errors. A large number indicates a disturbed serial connection. | 0 | 0 - 9999999999 | [Operation /Count and RevData /DNP3] |
| NBreakSignals | Diagnostic counter: Number of break signals. A large number indicates a disturbed serial connection. | 0 | 0 - 9999999999 | [Operation /Count and RevData /DNP3] |
| NBadChecksum | Diagnostic counter: Number of frames received with bad checksum. | 0 | 0 - 9999999999 | [Operation /Count and RevData /DNP3] |

Time Synchronisation

TimeZones

The user has the possibility to synchronise the device with a central time generator. This offers the following advantages:

- The time does not drift off from the reference time. A continuously accumulating deviation from the reference time thereby will be balanced. Also refer to the chapter Specifications (Tolerances Real Time Clock).
- All time synchronised devices operate with the same time. Thus logged events of the individual devices can be compared exactly and be evaluated in conjunction (single events of the event recorder, disturbance records).

The device's time can be synchronised via the following protocols:

- IRIG-B
- SNTP
- Communications-Protocol Modbus (RTU or TCP)
- Communications-Protocol IEC60870-5-103

The provided protocols use different hardware interfaces and differ also in their achieved time accuracy. Further information can be found in the chapter Specifications.

| <i>Used Protocol</i> | <i>Hardware-Interface</i> | <i>Recommended Application</i> |
|------------------------------|-----------------------------|--|
| Without time synchronisation | --- | Not recommended |
| IRIG-B | IRIG-B Terminal | Recommended, if interface available |
| SNTP | RJ45 (Ethernet) | Recommended alternative to IRIG-B, especially when using IEC 61850 or Modbus TCP |
| Modbus RTU | RS485, D-SUB or Fibre Optic | Recommended when using Modbus RTU communication protocol and when no IRIG-B code generator is available |
| Modbus TCP | RJ45 (Ethernet) | Limited recommendation when Modbus TCP communication protocol is used and no IRIG-B code generator or SNTP-Server is available |
| IEC 60870-5-103 | RS485, D-SUB or Fibre Optic | Recommended when using IEC 10870-5-103 communication protocol and no IRIG-B code generator is available |

Accuracy of Time Synchronisation

The accuracy of the device's synchronised system time depends on several factors:

- accuracy of the connected time generator
- used synchronisation protocol
- when using Modbus TCP or SNTP: Network load and data package transmission times

NOTICE

Please consider the accuracy of the used time generator. Fluctuations of the time generator's time will cause the same fluctuations of the protection relay's system time.

Selection of Timezone and Synchronisation Protocol

The protection relay masters both UTC and local time. This means that the device can be synchronised with UTC time while using local time for user display.

Time Synchronisation with UTC time (recommended):

Time synchronisation is usually done using UTC time. This means for example that an IRIG-B time generator is sending UTC time information to the protection relay. This is the recommended use case, since here a continuous time synchronisation can be ensured. There are no “leaps in time” through change of summer- and wintertime.

To achieve that the device shows the current local time, the timezone and the change between summer- and wintertime can be configured.

Please carry out the following parameterization steps under [Device Para/ Time]:

1. Select your local timezone in the timezone menu.
2. There also configure the switching of daylight saving time.
3. Select the used time synchronisation protocol in the TimeSync menu (e.g. “IRIG-B”).
4. Set the parameters of the synchronisation protocol (refer to the according chapter).

Time Synchronisation with local time:

Should the time synchronisation however be done using local time, then please leave the timezone to »UTC+0 London« and do not use switching of daylight saving time.

NOTICE

The synchronisation of the relay’s system time is exclusively done by the synchronisation protocol selected in the menu [Device Para/ Time/ TimeSync/ Used Protocol].







Without Time Synchronisation:







To achieve that the device shows the current local time, the timezone and the change between summer- and wintertime can be configured.

Please carry out the following parameterization steps under [Device Para/ Time]:

1. Select your local timezone in the timezone menu.
2. There also configure the switching of daylight saving time.
3. Select »manual« as your used protocol in the TimeSync menu.
4. Set date and time.

Global Protection Parameters of the Time Synchronization

| Parameter | Description | Setting range | Default | Menu path |
|--|--|---|----------|-------------------------------------|
|  DST offset | Difference to wintertime | -180 - 180min | 60min | [Device Para /Time /Timezone] |
|  DST manual | Manual setting of the Daylight Saving Time | inactive, active | active | [Device Para /Time /Timezone] |
|  Summertime | Daylight Saving Time Only available if: DST manual = active | inactive, active | inactive | [Device Para /Time /Timezone] |
|  Summertime m | Month of clock change summertime Only available if: DST manual = inactive | January, February, March, April, May, June, July, August, September, October, November, December | March | [Device Para /Time /Timezone] |
|  Summertime d | Day of clock change summertime Only available if: DST manual = inactive | Sunday, Monday, Tuesday, Wednesday, Thursday, Friday, Saturday, General day | Sunday | [Device Para /Time /Timezone] |
|  Summertime w | Place of selected day in month (for clock change summertime) Only available if: DST manual = inactive | First, Second, Third, Fourth, Last | Last | [Device Para /Time /Timezone] |

| <i>Parameter</i> | <i>Description</i> | <i>Setting range</i> | <i>Default</i> | <i>Menu path</i> |
|---|--|---|----------------|-------------------------------------|
| Summertime h  | Hour of clock change summertime Only available if: DST manual = inactive | 0 - 23h | 2h | [Device Para /Time /Timezone] |
| Summertime min  | Minute of clock change summertime Only available if: DST manual = inactive | 0 - 59min | 0min | [Device Para /Time /Timezone] |
| Wintertime m  | Month of clock change wintertime Only available if: DST manual = inactive | January, February, March, April, May, June, July, August, September, October, November, December | October | [Device Para /Time /Timezone] |
| Wintertime d  | Day of clock change wintertime Only available if: DST manual = inactive | Sunday, Monday, Tuesday, Wednesday, Thursday, Friday, Saturday, General day | Sunday | [Device Para /Time /Timezone] |
| Wintertime w  | Place of selected day in month (for clock change wintertime) Only available if: DST manual = inactive | First, Second, Third, Fourth, Last | Last | [Device Para /Time /Timezone] |
| Wintertime h  | Hour of clock change wintertime Only available if: DST manual = inactive | 0 - 23h | 3h | [Device Para /Time /Timezone] |
| Wintertime min  | Minute of clock change wintertime Only available if: DST manual = inactive | 0 - 59min | 0min | [Device Para /Time /Timezone] |

Time Synchronisation

| Parameter | Description | Setting range | Default | Menu path |
|---|-------------|--|--------------|-------------------------------------|
| Time Zones  | Time Zones | UTC+14 Kiritimati, UTC+13 Rawaki, UTC+12.75 Chatham Island, UTC+12 Wellington, UTC+11.5 Kingston, UTC+11 Port Vila, UTC+10.5 Lord Howe Island, UTC+10 Sydney, UTC+9.5 Adelaide, UTC+9 Tokyo, UTC+8 Hong Kong, UTC+7 Bangkok, UTC+6.5 Rangoon, UTC+6 Colombo, UTC+5.75 Kathmandu, UTC+5.5 New Delhi, UTC+5 Islamabad, UTC+4.5 Kabul, UTC+4 Abu Dhabi, UTC+3.5 Tehran, UTC+3 Moscow, UTC+2 Athens, UTC+1 Berlin, UTC+0 London, UTC-1 Azores, UTC-2 Fern. d. Noronha, UTC-3 Buenos Aires, UTC-3.5 St. John's, UTC-4 Santiago, UTC-5 New York, UTC-6 Chicago, UTC-7 Salt Lake City, UTC-8 Los Angeles, | UTC+0 London | [Device Para /Time /Timezone] |

Time Synchronisation

| <i>Parameter</i> | <i>Description</i> | <i>Setting range</i> | <i>Default</i> | <i>Menu path</i> |
|---|----------------------|--|----------------|--|
| TimeSync  | Time synchronisation | -, IRIG-B, SNTP, Modbus, IEC60870-5-103, DNP3 | - | [Device Para /Time /TimeSync /TimeSync] |

SNTP

SNTP

NOTICE Important pre-condition: The protective relay needs to have access to a SNTP server via the connected network. This server preferably should be installed locally.

Principle – General Use

SNTP is a standard protocol for time synchronisation via a network. For this at least one SNTP server has to be available within the network. The device can be configured for one or two SNTP servers.

The protection relay's system time will be synchronised with the connected SNTP server 1-4 times per minute. In turn the SNTP server synchronises its time via NTP with other NTP servers. This is the normal case. Alternatively it can synchronise its time via GPS, radio controlled clock or the like.

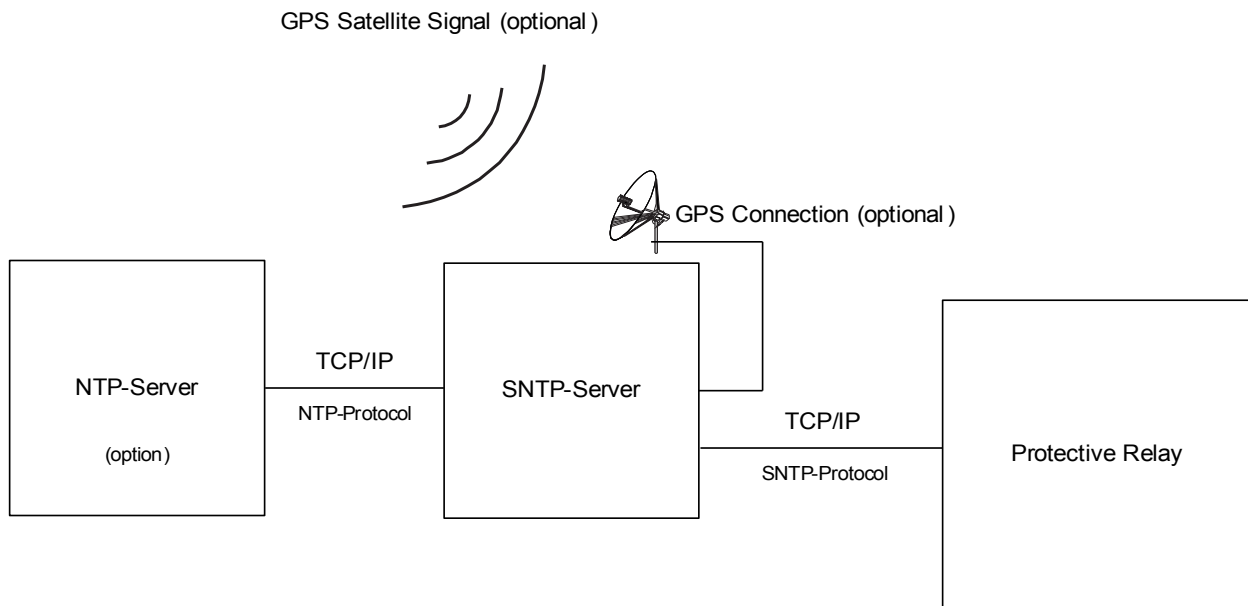

Accuracy

The accuracy of the used SNTP server and the excellence of its reference clock influences the accuracy of the protection relay's clock.

For further information about accuracy refer to chapter Specifications.

With each transmitted time information, the SNTP server also sends information about its accuracy:

- **Stratum:** The stratum indicates over how many interacting NTP-Servers the used SNTP server is connected to an atomic or radio controlled clock.
- **Precision:** This indicates the accuracy of the system time provided by the SNTP server.

Additionally the performance of the connected network (traffic and data package transmission times) has an influence on the accuracy of the time synchronisation.

Recommended is a locally installed SNTP server with an accuracy of ≤ 200 μ sec. If this cannot be realised, the connected server's excellence can be checked in the menu [Operation/Status Display/TimeSync]:

- The server quality gives information about the accuracy of the used server. The quality should be GOOD or SUFFICIENT. A server with BAD quality should not be used, because this could cause fluctuations in time synchronisation.
- The network quality gives information about the network's load and data package transmission time. The quality should be GOOD or SUFFICIENT. A network with BAD quality should not be used, because this could cause fluctuations in time synchronisation.

Using two SNTP Servers

When configuring two SNTP servers, the device selects the server with the lower stratum value, because this generally provides a more precise time synchronisation. If the servers have the same stratum value, the device selects the server with the better precision. It does not matter, which of the servers is configured as server 1 or server 2.

When the last used server fails, the device automatically switches to the other server. Should the first server recover after some time, the device switches back to this (better) server automatically.

SNTP Commissioning

Activate the SNTP time synchronisation by means of the menu [Device Para/ Time/ TimeSync]:

- Select »SNTP« in the time synchronisation menu.
- Set the IP address of the first server in the SNTP menu.
- Set the IP address of the second server, if available.
- Set all configured servers to "active".

Fault Analysis

If there is no SNTP signal for more than 120 sec, the SNTP status changes from “active” to “inactive” and an entry in the Event Recorder will be created.

The SNTP functionality can be checked in the menu [Operation/Status Display/TimeSync/Sntp]:
If the SNTP status is not indicated as being “active”, please proceed as follows:

- Check if the wiring is correct (Ethernet-cable connected).
- Check if a valid IP address is set in the device (Device Para/TCP/IP).
- Check if the Ethernet connection is active (Device Para/TCP/IP/Link = Up?).
- Check if both the SNTP server and the protection device answer to a Ping.
- Check if the SNTP server is up and working.





Device Planning Parameters of the SNTP

| Parameter | Description | Options | Default | Menu path |
|---|-------------|--------------------|------------|-------------------|
| Mode  | Mode | do not use, use | do not use | [Device planning] |





Direct Commands of the SNTP

| Parameter | Description | Setting range | Default | Menu path |
|--|---------------------|---------------------|----------|-----------------------|
| Res Counter  | Reset all Counters. | inactive, active | inactive | [Operation /Reset] |

Global Protection Parameters of the SNTP

| Parameter | Description | Setting range | Default | Menu path |
|---|-----------------|---------------------|----------|--|
| Server1  | Server 1 | inactive, active | inactive | [Device Para /Time /TimeSync /SNTP] |
| IP Byte1  | IP1.IP2.IP3.IP4 | 0 - 255 | 0 | [Device Para /Time /TimeSync /SNTP] |
| IP Byte2  | IP1.IP2.IP3.IP4 | 0 - 255 | 0 | [Device Para /Time /TimeSync /SNTP] |
| IP Byte3  | IP1.IP2.IP3.IP4 | 0 - 255 | 0 | [Device Para /Time /TimeSync /SNTP] |
| IP Byte4  | IP1.IP2.IP3.IP4 | 0 - 255 | 0 | [Device Para /Time /TimeSync /SNTP] |

Time Synchronisation

| <i>Parameter</i> | <i>Description</i> | <i>Setting range</i> | <i>Default</i> | <i>Menu path</i> |
|---|--------------------|----------------------|----------------|--|
| Server2  | Server 2 | inactive, active | inactive | [Device Para /Time /TimeSync /SNTP] |
| IP Byte1  | IP1.IP2.IP3.IP4 | 0 - 255 | 0 | [Device Para /Time /TimeSync /SNTP] |
| IP Byte2  | IP1.IP2.IP3.IP4 | 0 - 255 | 0 | [Device Para /Time /TimeSync /SNTP] |
| IP Byte3  | IP1.IP2.IP3.IP4 | 0 - 255 | 0 | [Device Para /Time /TimeSync /SNTP] |
| IP Byte4  | IP1.IP2.IP3.IP4 | 0 - 255 | 0 | [Device Para /Time /TimeSync /SNTP] |

Signals of the SNTP

| <i>Signal</i> | <i>Description</i> |
|---------------|---|
| SNTP active | Signal: If there is no valid SNTP signal for 120 sec, SNTP is regarded as inactive. |

SNTP Counters

| <i>Value</i> | <i>Description</i> | <i>Default</i> | <i>Size</i> | <i>Menu path</i> |
|-----------------|---|----------------|---------------|---|
| NoOfSyncs | Total Number of Synchronizations. | 0 | 0 - 999999999 | [Operation /Count and RevData /TimeSync /SNTP] |
| NoOfConnectLost | Total Number of lost SNTP Connections (no sync for 120 sec). | 0 | 0 - 999999999 | [Operation /Count and RevData /TimeSync /SNTP] |
| NoOfSmallSyncs | Service counter: Total Number of very small Time Corrections. | 0 | 0 - 999999999 | [Operation /Count and RevData /TimeSync /SNTP] |
| NoOfNormSyncs | Service counter: Total Number of normal Time Corrections | 0 | 0 - 999999999 | [Operation /Count and RevData /TimeSync /SNTP] |
| NoOfBigSyncs | Service counter: Total Number of big Time Corrections | 0 | 0 - 999999999 | [Operation /Count and RevData /TimeSync /SNTP] |
| NoOfFiltSyncs | Service counter: Total Number of filtered Time Corrections | 0 | 0 - 999999999 | [Operation /Count and RevData /TimeSync /SNTP] |
| NoOfSlowTrans | Service counter: Total Number of slow Transfers. | 0 | 0 - 999999999 | [Operation /Count and RevData /TimeSync /SNTP] |

Time Synchronisation

| <i>Value</i> | <i>Description</i> | <i>Default</i> | <i>Size</i> | <i>Menu path</i> |
|-----------------|---|----------------|----------------|---|
| NoOfHighOffs | Service counter: Total Number of high Offsets. | 0 | 0 - 9999999999 | [Operation /Count and RevData /TimeSync /SNTP] |
| NoOfIntTimeouts | Service counter: Total Number of internal timeouts. | 0 | 0 - 9999999999 | [Operation /Count and RevData /TimeSync /SNTP] |
| StratumServer1 | Stratum of Server 1 | 0 | 0 - 9999999999 | [Operation /Status Display /TimeSync /SNTP] |
| StratumServer2 | Stratum of Server 2 | 0 | 0 - 9999999999 | [Operation /Status Display /TimeSync /SNTP] |

SNTP Values

| <i>Value</i> | <i>Description</i> | <i>Default</i> | <i>Size</i> | <i>Menu path</i> |
|--------------|---|----------------|-----------------------------------|--|
| Used Server | Which Server is used for SNTP synchronization. | None | Server1, Server2, None | [Operation /Status Display /TimeSync /SNTP] |
| PrecServer1 | Precision of Server 1 | 0ms | 0 - 1000.00000ms | [Operation /Status Display /TimeSync /SNTP] |
| PrecServer2 | Precision of Server 2 | 0ms | 0 - 1000.00000ms | [Operation /Status Display /TimeSync /SNTP] |
| ServerQty | Quality of Server used for Synchronization (GOOD, SUFFICIENT, BAD) | - | GOOD, SUFFICIENT, BAD, - | [Operation /Status Display /TimeSync /SNTP] |

Time Synchronisation

| <i>Value</i> | <i>Description</i> | <i>Default</i> | <i>Size</i> | <i>Menu path</i> |
|--------------|--|----------------|-----------------------------------|--|
| NetConn | Quality of Network Connection (GOOD, SUFFICIENT, BAD). | - | GOOD, SUFFICIENT, BAD, - | [Operation /Status Display /TimeSync /SNTP] |

IRIG-B00X

IRIG-B

NOTICE Requirement: An IRIG-B00X time code generator is needed. IRIG-B004 and higher will support/transmit the “year information”.

If you are using an IRIG time code that does not support the “year information” (IRIG-B000, IRIG-B001, IRIG-B002, IRIG-B003), you have to set the “year” manually within the device. In these cases the correct year information is a precondition for a properly working IRIG-B.

Principle - General Use

The IRIG-B standard is the most used standard to synchronize the time of protection devices in medium voltage applications.

The protection device supports IRIG-B according to the IRIG STANDARD 200-04. This means that all time synchronization formats IRIG-B00X (IRIG-B000 / B001 / B002 / B003 / B004 / B005 / B006 / B007) are supported. It is recommended to use IRIG-B004 and higher which also transmits the “year information”.

The system time of the protection device is being synchronized with the connected IRIG-B code generator once a second. The accuracy of the used IRIG-B code generator can be increased by connecting a GPS-receiver to it.

GPS Satellite Signal (optional)

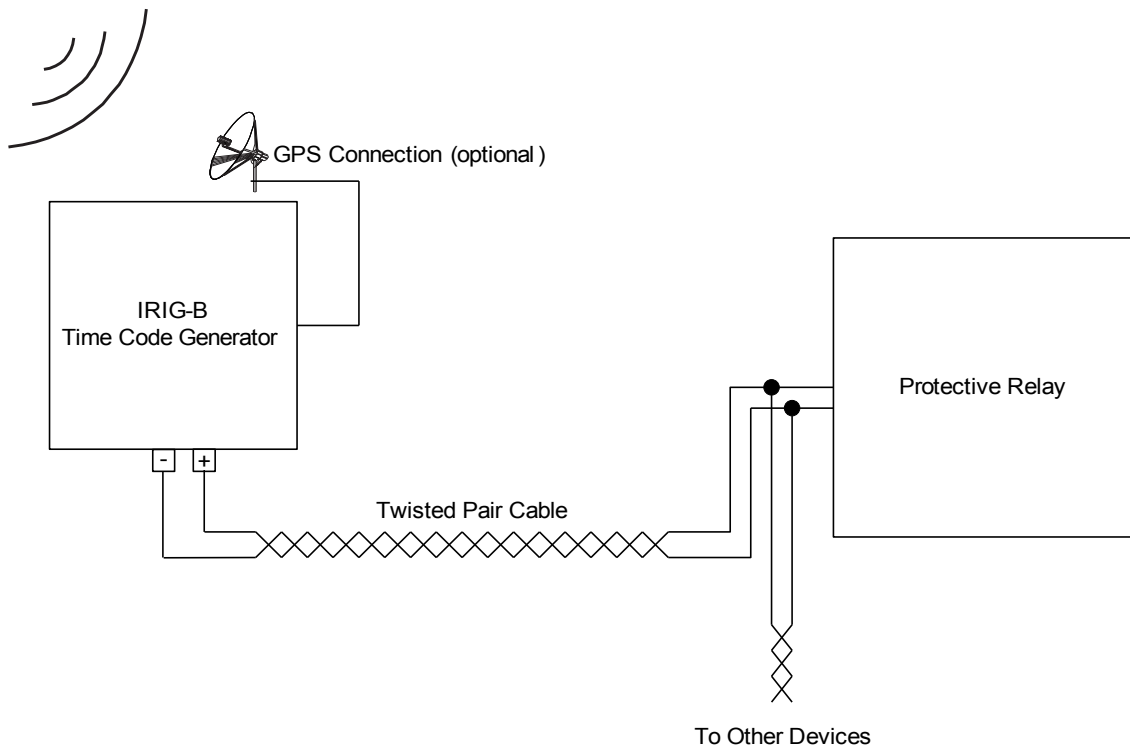

The location of the IRIG-B interface depends to the device type. Please refer to the wiring diagram supplied with the protective device.

IRIG-B Commissioning

Activate the IRIG-B synchronization within menu [Device Para/ Time/ TimeSync]:

- Select »IRIG-B« in the time synchronisation menu.
- Set the time synchronization in the IRIG-B menu to »Active«.
- Select the IRIG-B type (choose B000 through B007).

Fault Analysis

If the device does not receive any IRIG-B time code for more than 60 s, the IRIG-B status switches from »active« to »inactive« and there is created an entry within the Event Recorder.

Check the IRIG-B functionality through the menu [Operation/ Status display/ TimeSync/ IRIG-B]:
Should the IRIG-B status not be reported as being »active«, please proceed as follows:

- To begin with check the IRIG-B wiring.
- Check, if the correct IRIG-B00X type is configured.

IRIG-B Control Commands

In addition to the date and time information, the IRIG-B code offers the option to transmit up to 18 control commands that can be processed by the protective device. They have to be set and issued by the IRIG-B code generator.

The protective device offers up to 18 IRIG-B assignment options for those control commands in order to carry out the assigned action. If there is a control command assigned to an action, this action is being triggered as soon as the control command is transmitted as being true. As an example there can be triggered the start of statistics or the street lighting can be switched on through a relay.



Device Planning Parameters of the IRIG-B00X

| Parameter | Description | Options | Default | Menu path |
|---|-------------|--------------------|------------|-------------------|
| Mode  | Mode | do not use, use | do not use | [Device planning] |

Direct Commands of the IRIG-B00X

| Parameter | Description | Setting range | Default | Menu path |
|--|---|---------------------|----------|-----------------------|
| Res IRIG-B Cr  | Resetting of the Diagnosis Counters: IRIG-B | inactive, active | inactive | [Operation /Reset] |

Global Protection Parameters of the IRIG-B00X

| Parameter | Description | Setting range | Default | Menu path |
|--|--|---|-----------|--|
| Function  | Permanent activation or deactivation of module/stage. | inactive, active | inactive | [Device Para /Time /TimeSync /IRIG-B] |
| IRIG-B00X  | Determination of the Type: IRIG-B00X. IRIG-B types differ in types of included "Coded Expressions" (year, control-functions, straight-binary-seconds). | IRIGB-000, IRIGB-001, IRIGB-002, IRIGB-003, IRIGB-004, IRIGB-005, IRIGB-006, IRIGB-007 | IRIGB-000 | [Device Para /Time /TimeSync /IRIG-B] |

Signals of the IRIG-B00X (Output States)

| <i>Signal</i> | <i>Description</i> |
|------------------|--|
| IRIG-B active | Signal: If there is no valid IRIG-B signal for 60 sec, IRIG-B is regarded as inactive. |
| High-Low Invert | Signal: The High and Low signals of the IRIG-B are inverted. This does NOT mean that the wiring is faulty. If the wiring is faulty no IRIG-B signal will be detected. |
| Control Signal1 | Signal: IRIG-B Control Signal. The external IRIG-B generator can set these signals. They can be used for further control procedures inside the device (e.g. logic funtions). |
| Control Signal2 | Signal: IRIG-B Control Signal. The external IRIG-B generator can set these signals. They can be used for further control procedures inside the device (e.g. logic funtions). |
| Control Signal3 | Signal: IRIG-B Control Signal. The external IRIG-B generator can set these signals. They can be used for further control procedures inside the device (e.g. logic funtions). |
| Control Signal4 | Signal: IRIG-B Control Signal. The external IRIG-B generator can set these signals. They can be used for further control procedures inside the device (e.g. logic funtions). |
| Control Signal5 | Signal: IRIG-B Control Signal. The external IRIG-B generator can set these signals. They can be used for further control procedures inside the device (e.g. logic funtions). |
| Control Signal6 | Signal: IRIG-B Control Signal. The external IRIG-B generator can set these signals. They can be used for further control procedures inside the device (e.g. logic funtions). |
| Control Signal7 | Signal: IRIG-B Control Signal. The external IRIG-B generator can set these signals. They can be used for further control procedures inside the device (e.g. logic funtions). |
| Control Signal8 | Signal: IRIG-B Control Signal. The external IRIG-B generator can set these signals. They can be used for further control procedures inside the device (e.g. logic funtions). |
| Control Signal9 | Signal: IRIG-B Control Signal. The external IRIG-B generator can set these signals. They can be used for further control procedures inside the device (e.g. logic funtions). |
| Control Signal10 | Signal: IRIG-B Control Signal. The external IRIG-B generator can set these signals. They can be used for further control procedures inside the device (e.g. logic funtions). |
| Control Signal11 | Signal: IRIG-B Control Signal. The external IRIG-B generator can set these signals. They can be used for further control procedures inside the device (e.g. logic funtions). |
| Control Signal12 | Signal: IRIG-B Control Signal. The external IRIG-B generator can set these signals. They can be used for further control procedures inside the device (e.g. logic funtions). |
| Control Signal13 | Signal: IRIG-B Control Signal. The external IRIG-B generator can set these signals. They can be used for further control procedures inside the device (e.g. logic funtions). |
| Control Signal14 | Signal: IRIG-B Control Signal. The external IRIG-B generator can set these signals. They can be used for further control procedures inside the device (e.g. logic funtions). |
| Control Signal15 | Signal: IRIG-B Control Signal. The external IRIG-B generator can set these signals. They can be used for further control procedures inside the device (e.g. logic funtions). |
| Control Signal16 | Signal: IRIG-B Control Signal. The external IRIG-B generator can set these signals. They can be used for further control procedures inside the device (e.g. logic funtions). |
| Control Signal17 | Signal: IRIG-B Control Signal. The external IRIG-B generator can set these signals. They can be used for further control procedures inside the device (e.g. logic funtions). |
| Control Signal18 | Signal: IRIG-B Control Signal. The external IRIG-B generator can set these signals. They can be used for further control procedures inside the device (e.g. logic funtions). |

IRIG-B00X Values

Time Synchronisation

| <i>Value</i> | <i>Description</i> | <i>Default</i> | <i>Size</i> | <i>Menu path</i> |
|-----------------|--|----------------|-------------|---|
| NoOfFramesOK | Total Number valid Frames. | 0 | 0 - 65535 | [Operation /Count and RevData /TimeSync /IRIG-B] |
| NoOfFrameErrors | Total Number of Frame Errors. Physically corrupted Frame. | 0 | 0 - 65535 | [Operation /Count and RevData /TimeSync /IRIG-B] |
| Edges | Edges: Total number of rising and falling edges. This signal indicates if a signal is available at the IRIG-B input. | 0 | 0 - 65535 | [Operation /Count and RevData /TimeSync /IRIG-B] |

Parameters

Parameter setting and planning can be done:

- directly at the device or
- by way of the *Smart view* software.

Parameter Definitions

Device Parameters

Device Parameters are part of the Parameter Tree. By means of them you can (depending on the type of device):

- Set cutoff levels,
- Configure Digital Inputs,
- Configure Output Relays,
- Assign LEDs,
- Assign Acknowledgment Signals,
- Configure Statistics,
- Configure Protocol Parameters,
- Adapt HMI Settings,
- Configure Recorders (reports),
- Set Date and Time,
- Change Passwords,
- Check the version (build) of the device.

Field Parameters

Field Parameters are part of the Parameter Tree. Field Parameters comprise the essential, basic settings of your switchboard such as rated frequency, transformer ratios.

Protection Parameters

Protection Parameters are part of the Parameter Tree. This tree comprises:

- ***Global Protection Parameters are part of the Protection Parameters:*** All settings and assignments that are done within the Global Parameter Tree are valid independent of the Setting Groups. They have to be set once only. In addition to that they comprise the CB Management.
- ***The Parameter Setting Switch is part of the Protection Parameters:*** You can either direct switch onto a certain parameter setting group or you can determine the conditions for switching onto another parameter setting group.
- ***Setting Group Parameters are part of the Protection Parameters:*** By means of the Parameter Setting Group Parameters you can individually adapt your protective device to the current conditions or grid conditions. They can be individually set in each Setting group.

Device Planning Parameters

Device Planning Parameters are part of the Parameter Tree.

- **Improving the Usability (clearness):** All protection modules that are currently not needed can be de-protected (switched to invisible) by means of Device Planning. In Menu Device Planning you can adapt the scope of functionality of the protective device exactly to your needs. You can improve the usability by de-projecting all modules that are currently not needed.
- **Adapting the device to your application:** For those modules that you need, determine how they should work (e.g. directional, non-directional, <, >...).

Direct Commands

Direct Commands are part of the Device Parameter Tree but they are **NOT** part of the parameter file. They will be executed directly (e.g. Resetting of a Counter).

State of the Module Inputs

Module Inputs are part of the Parameter Tree. The State of the Module Input is context-dependent.

By means of the Module Inputs influence can be taken on the Modules. You can assign Signals onto **Module Inputs**. The state of the signals that are assigned to an input can be taken from the Status Display. Module Inputs can be identified by an „-I“ at the end of the name.

Signals

Signals are part of the Parameter Tree. The state of the signal is context-dependent.

- **Signals** represent the state of your installation/equipment (e.g. Position Indicators of the Circuit Breaker).
- **Signals** are assessments of the state of the grid and the equipment (System OK, Transformer failure detected...).
- **Signals** represent decisions that are taken by the device (e.g. Trip command) based on your parameter settings.

Adaptive Parameter Sets

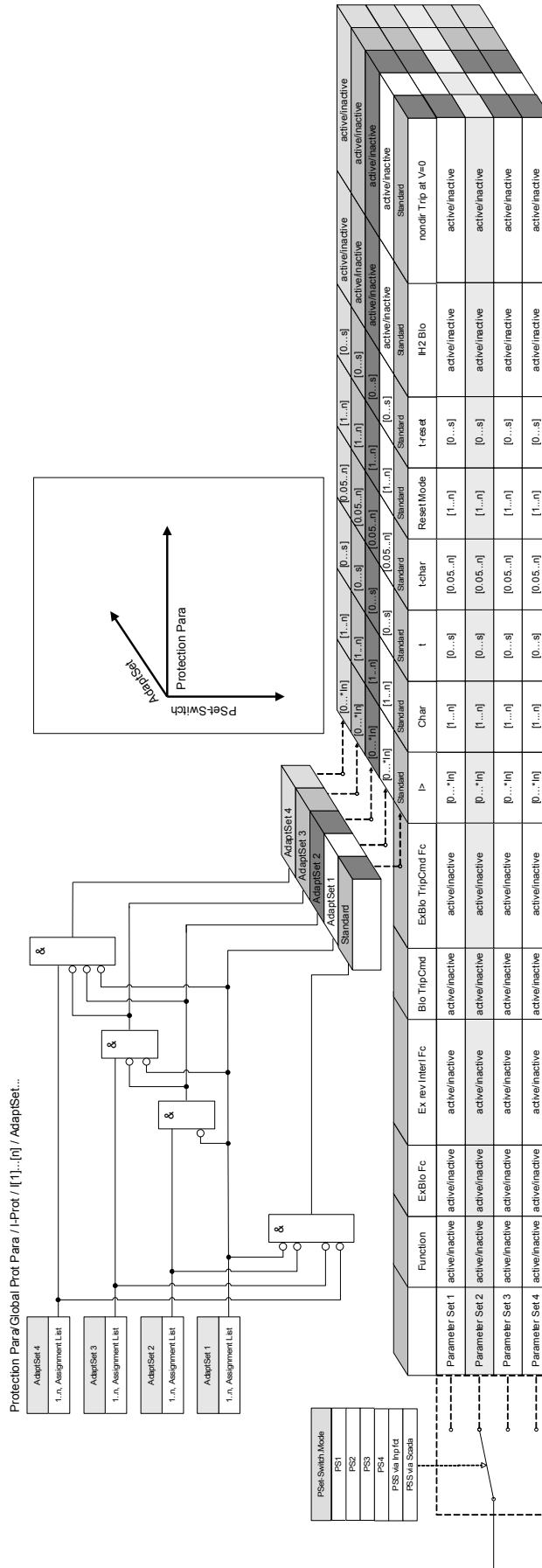

Adaptive Parameter Sets are part of the Parameter Tree.

By means of **Adaptive Parameter Sets** you can modify temporarily single parameters within the parameter setting groups.

NOTICE

Adaptive Parameters fall back automatically, if the acknowledged signal, that has activated them, has fallen back. Please take into account that Adaptive Set 1 is dominant to Adaptive Set 2. Adaptive Set 2 is dominant to Adaptive Set 3. Adaptive Set 3 is dominant to Adaptive Set 4.

NOTICE

In order to increase the usability (clearness) Adaptive Parameter Sets become visible if an corresponding activation signals has been assigned (Smart view 2.0 and higher).

Example: In order to use Adaptive Parameters within Protective Element I[1] please proceed as follows:

- Assign within the Global Parameter tree within Protective Element I[1] an activation signal for AdaptiveParameterSet 1.
- AdaptiveParameterSet 1 becomes now visible within the Protection Parameter Sets for element I[1].

By means of additional activation signals further Adaptive Parameter Sets can be used.

The functionality of the IED (relay) can be enhanced / adapted by means of **Adaptive Parameters** in order to meet the requirements of modified states of the grid or the power supply system respectively to manage unpredictable events.

Moreover, the adaptive parameter can also be used to realize various special protective functions or to expand the existing function modules in a simple way without to redesign the existing hardware or software platform costly.

The **Adaptive Parameter** feature allows, besides a standard parameter set, one of the four parameter sets labeled from 1 to 4, to be used for example in a time overcurrent element under the control of the configurable Set Control Logics. The dynamical switch-over of the adaptive parameter set is only active for a particular element when its adaptive set control logic is configured and only as long as the activation signal is true.

For some protection elements such as time overcurrent and instantaneous overcurrent (50P, 51P, 50G, 51G...), besides the “default” setting there exist another 4 “alternative” settings for pickup value, curve type, time dial, reset mode set values which can be switched-over dynamically by means of the configurable adaptive setting control logics in the single set parameter.

If the **Adaptive Parameter** feature is not used, the adaptive set control logics will not be selected (assigned). The protective elements work in this case just like a normal protection using the “Default” settings. If one of the **Adaptive Set** Control logics” is assigned to a logic function, the protective element will be “switched-over” to the corresponding adaptive settings if the assigned logic function is asserted and will fall back to the “Default” Setting if the assigned signal that has been activated the **Adaptive Set** has fallen back.

Application Example

During a Switch-OnTo-Fault condition, it is usually requested to make the embedded protective function tripping the faulted line faster, instantaneously or sometimes non-directionally.

Such a Switch-OnTo-Fault application can easily be realized using the **Adaptive Parameter** features above mentioned: The standard time overcurrent protection element (e.g. 51P) normally works with an inverse curve type (e.g. ANSI Type A), while in case of **SOTF** condition, it should trip instantaneously. If the **SOTF** logic function »SOTF_ENABLED« is detecting a manual circuit breaker close condition the relay switches to **AdaptiveSet1** if the signal »SOTF_ENABLED« is assigned to **AdaptiveSet1**. The corresponding **AdaptiveSet1** will become active and that means e.g. »curve type = DEFT« and »t = 0« sec.

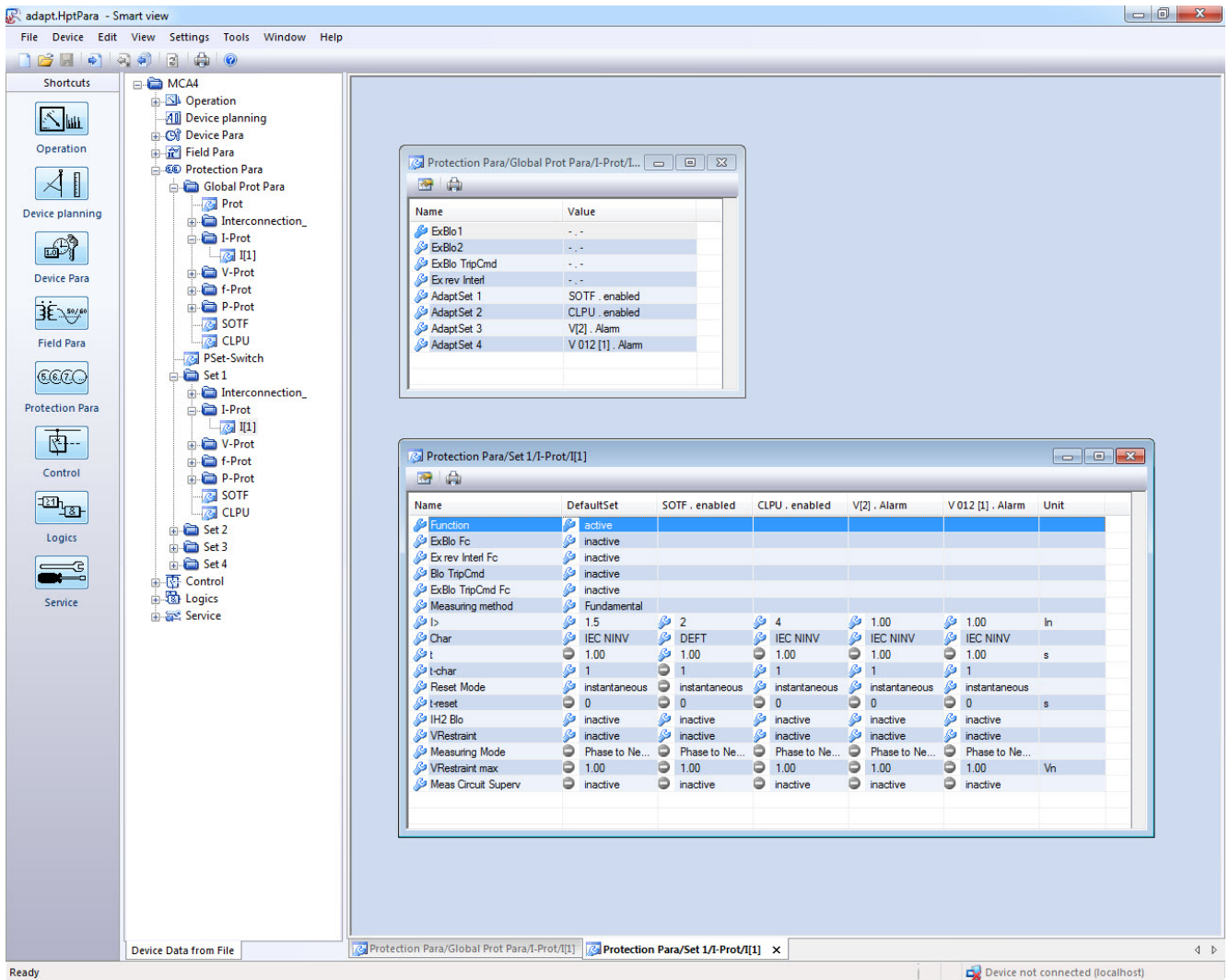

The screenshot above shows the adaptive setting configurations following applications based on only one simple overcurrent protection element:

1. Standard Set: Default settings
2. Adaptive Set 1: *SOTF* application (Switch-Onto-Fault)
3. Adaptive Set 2: *CLPU* application (Cold Load Pickup)
4. Adaptive Set 3: Voltage-Controlled time overcurrent protection (ANSI 51V)
5. Adaptive Set 4: Negative- Phase- Sequence- Voltage-Controlled time overcurrent protection

Application Examples

- The output signal of the Switch Onto Fault module can be used to activate an **Adaptive Parameter Set** that sensibilizes the overcurrent protection.
- The output signal of the Cold Load Pickup module can be used to activate an **Adaptive Parameter Set** that desensitizes the overcurrent protection.
- By means of **Adaptive Parameter Sets** an Adaptive Auto Reclosure can be realized. After a reclosure attempt the tripping thresholds or tripping curves of the overcurrent protection can be adapted.
- Depending on undervoltage the overcurrent protection can be modified (Voltage Controlled).
- The earth overcurrent protection can be modified by the residual voltage.
- Matching the ground current protective settings dynamically and automatically according to the single-phase load diversity (Adaptive relay Setting – Normal Setting/Alternative Setting)

NOTICE

Adaptive Parameter Sets are only available for devices with current protection modules.

Adaptive Parameter Set Activation Signals

| Name | Description |
|---------------------------|---|
| -- | No assignment |
| IH2.Blo L1 | Signal: Blocked L1 |
| IH2.Blo L2 | Signal: Blocked L2 |
| IH2.Blo L3 | Signal: Blocked L3 |
| IH2.Blo IG meas | Signal: Blocking of the ground (earth) protection module (measured ground current) |
| IH2.Blo IG calc | Signal: Blocking of the ground (earth) protection module (calculated ground current) |
| IH2.3-ph Blo | Signal: Inrush was detected in at least one phase - trip command blocked. |
| V[1].Alarm | Signal: Alarm voltage stage |
| V[2].Alarm | Signal: Alarm voltage stage |
| V[3].Alarm | Signal: Alarm voltage stage |
| V[4].Alarm | Signal: Alarm voltage stage |
| V[5].Alarm | Signal: Alarm voltage stage |
| V[6].Alarm | Signal: Alarm voltage stage |
| Intertripping.Alarm | Signal: Alarm |
| LVRT[1].Alarm | Signal: Alarm voltage stage |
| LVRT[1].t-LVRT is running | Signal: t-LVRT is running |
| LVRT[2].Alarm | Signal: Alarm voltage stage |
| LVRT[2].t-LVRT is running | Signal: t-LVRT is running |
| VG[1].Alarm | Signal: Alarm Residual Voltage Supervision-stage |
| VG[2].Alarm | Signal: Alarm Residual Voltage Supervision-stage |
| V012[1].Alarm | Signal: Alarm voltage asymmetry |
| V012[2].Alarm | Signal: Alarm voltage asymmetry |
| V012[3].Alarm | Signal: Alarm voltage asymmetry |
| V012[4].Alarm | Signal: Alarm voltage asymmetry |
| V012[5].Alarm | Signal: Alarm voltage asymmetry |
| V012[6].Alarm | Signal: Alarm voltage asymmetry |
| UFLS.Alarm | Signal: Alarm P->&f< |
| UFLS.Trip | Signal: Signal: Trip |
| AR.running | Signal: Auto Reclosing running |
| AR.Pre Shot | Pre Shot Control |
| AR.Shot 1 | Shot Control |
| AR.Shot 2 | Shot Control |
| AR.Shot 3 | Shot Control |
| AR.Shot 4 | Shot Control |
| AR.Shot 5 | Shot Control |
| AR.Shot 6 | Shot Control |
| SOTF.enabled | Signal: Switch Onto Fault enabled. This Signal can be used to modify Overcurrent Protection Settings. |
| CLPU.enabled | Signal: Cold Load enabled |

Parameters

| <i>Name</i> | <i>Description</i> |
|---------------------|---|
| Exp[1].Alarm | Signal: Alarm |
| Exp[2].Alarm | Signal: Alarm |
| Exp[3].Alarm | Signal: Alarm |
| Exp[4].Alarm | Signal: Alarm |
| CTS.Alarm | Signal: Alarm Current Transformer Measuring Circuit Supervision |
| LOP.Alarm | Signal: Alarm Loss of Potential |
| DI Slot X1.DI 1 | Signal: Digital Input |
| DI Slot X1.DI 2 | Signal: Digital Input |
| DI Slot X1.DI 3 | Signal: Digital Input |
| DI Slot X1.DI 4 | Signal: Digital Input |
| DI Slot X1.DI 5 | Signal: Digital Input |
| DI Slot X1.DI 6 | Signal: Digital Input |
| DI Slot X1.DI 7 | Signal: Digital Input |
| DI Slot X1.DI 8 | Signal: Digital Input |
| DI Slot X6.DI 1 | Signal: Digital Input |
| DI Slot X6.DI 2 | Signal: Digital Input |
| DI Slot X6.DI 3 | Signal: Digital Input |
| DI Slot X6.DI 4 | Signal: Digital Input |
| DI Slot X6.DI 5 | Signal: Digital Input |
| DI Slot X6.DI 6 | Signal: Digital Input |
| DI Slot X6.DI 7 | Signal: Digital Input |
| DI Slot X6.DI 8 | Signal: Digital Input |
| Modbus.Scada Cmd 1 | Scada Command |
| Modbus.Scada Cmd 2 | Scada Command |
| Modbus.Scada Cmd 3 | Scada Command |
| Modbus.Scada Cmd 4 | Scada Command |
| Modbus.Scada Cmd 5 | Scada Command |
| Modbus.Scada Cmd 6 | Scada Command |
| Modbus.Scada Cmd 7 | Scada Command |
| Modbus.Scada Cmd 8 | Scada Command |
| Modbus.Scada Cmd 9 | Scada Command |
| Modbus.Scada Cmd 10 | Scada Command |
| Modbus.Scada Cmd 11 | Scada Command |
| Modbus.Scada Cmd 12 | Scada Command |
| Modbus.Scada Cmd 13 | Scada Command |
| Modbus.Scada Cmd 14 | Scada Command |
| Modbus.Scada Cmd 15 | Scada Command |
| Modbus.Scada Cmd 16 | Scada Command |
| IEC61850.VirtInp1 | Signal: Virtual Input (IEC61850 GGIO Ind) |
| IEC61850.VirtInp2 | Signal: Virtual Input (IEC61850 GGIO Ind) |

Parameters

| <i>Name</i> | <i>Description</i> |
|--------------------|--|
| IEC61850.VirtInp3 | Signal: Virtual Input (IEC61850 GGIO Ind) |
| IEC61850.VirtInp4 | Signal: Virtual Input (IEC61850 GGIO Ind) |
| IEC61850.VirtInp5 | Signal: Virtual Input (IEC61850 GGIO Ind) |
| IEC61850.VirtInp6 | Signal: Virtual Input (IEC61850 GGIO Ind) |
| IEC61850.VirtInp7 | Signal: Virtual Input (IEC61850 GGIO Ind) |
| IEC61850.VirtInp8 | Signal: Virtual Input (IEC61850 GGIO Ind) |
| IEC61850.VirtInp9 | Signal: Virtual Input (IEC61850 GGIO Ind) |
| IEC61850.VirtInp10 | Signal: Virtual Input (IEC61850 GGIO Ind) |
| IEC61850.VirtInp11 | Signal: Virtual Input (IEC61850 GGIO Ind) |
| IEC61850.VirtInp12 | Signal: Virtual Input (IEC61850 GGIO Ind) |
| IEC61850.VirtInp13 | Signal: Virtual Input (IEC61850 GGIO Ind) |
| IEC61850.VirtInp14 | Signal: Virtual Input (IEC61850 GGIO Ind) |
| IEC61850.VirtInp15 | Signal: Virtual Input (IEC61850 GGIO Ind) |
| IEC61850.VirtInp16 | Signal: Virtual Input (IEC61850 GGIO Ind) |
| IEC61850.VirtInp17 | Signal: Virtual Input (IEC61850 GGIO Ind) |
| IEC61850.VirtInp18 | Signal: Virtual Input (IEC61850 GGIO Ind) |
| IEC61850.VirtInp19 | Signal: Virtual Input (IEC61850 GGIO Ind) |
| IEC61850.VirtInp20 | Signal: Virtual Input (IEC61850 GGIO Ind) |
| IEC61850.VirtInp21 | Signal: Virtual Input (IEC61850 GGIO Ind) |
| IEC61850.VirtInp22 | Signal: Virtual Input (IEC61850 GGIO Ind) |
| IEC61850.VirtInp23 | Signal: Virtual Input (IEC61850 GGIO Ind) |
| IEC61850.VirtInp24 | Signal: Virtual Input (IEC61850 GGIO Ind) |
| IEC61850.VirtInp25 | Signal: Virtual Input (IEC61850 GGIO Ind) |
| IEC61850.VirtInp26 | Signal: Virtual Input (IEC61850 GGIO Ind) |
| IEC61850.VirtInp27 | Signal: Virtual Input (IEC61850 GGIO Ind) |
| IEC61850.VirtInp28 | Signal: Virtual Input (IEC61850 GGIO Ind) |
| IEC61850.VirtInp29 | Signal: Virtual Input (IEC61850 GGIO Ind) |
| IEC61850.VirtInp30 | Signal: Virtual Input (IEC61850 GGIO Ind) |
| IEC61850.VirtInp31 | Signal: Virtual Input (IEC61850 GGIO Ind) |
| IEC61850.VirtInp32 | Signal: Virtual Input (IEC61850 GGIO Ind) |
| IEC61850.SPSCO1 | Status bit that can be set by clients like e.g. SCADA (Single Point Controllable Status Output). |
| IEC61850.SPSCO2 | Status bit that can be set by clients like e.g. SCADA (Single Point Controllable Status Output). |
| IEC61850.SPSCO3 | Status bit that can be set by clients like e.g. SCADA (Single Point Controllable Status Output). |
| IEC61850.SPSCO4 | Status bit that can be set by clients like e.g. SCADA (Single Point Controllable Status Output). |
| IEC61850.SPSCO5 | Status bit that can be set by clients like e.g. SCADA (Single Point Controllable Status Output). |
| IEC61850.SPSCO6 | Status bit that can be set by clients like e.g. SCADA (Single Point Controllable Status Output). |
| IEC61850.SPSCO7 | Status bit that can be set by clients like e.g. SCADA (Single Point Controllable Status Output). |
| IEC61850.SPSCO8 | Status bit that can be set by clients like e.g. SCADA (Single Point Controllable Status Output). |
| IEC61850.SPSCO9 | Status bit that can be set by clients like e.g. SCADA (Single Point Controllable Status Output). |
| IEC61850.SPSCO10 | Status bit that can be set by clients like e.g. SCADA (Single Point Controllable Status Output). |

Parameters

| <i>Name</i> | <i>Description</i> |
|-------------------------|--|
| IEC61850.SPCSO11 | Status bit that can be set by clients like e.g. SCADA (Single Point Controllable Status Output). |
| IEC61850.SPCSO12 | Status bit that can be set by clients like e.g. SCADA (Single Point Controllable Status Output). |
| IEC61850.SPCSO13 | Status bit that can be set by clients like e.g. SCADA (Single Point Controllable Status Output). |
| IEC61850.SPCSO14 | Status bit that can be set by clients like e.g. SCADA (Single Point Controllable Status Output). |
| IEC61850.SPCSO15 | Status bit that can be set by clients like e.g. SCADA (Single Point Controllable Status Output). |
| IEC61850.SPCSO16 | Status bit that can be set by clients like e.g. SCADA (Single Point Controllable Status Output). |
| IEC 103.Scada Cmd 1 | Scada Command |
| IEC 103.Scada Cmd 2 | Scada Command |
| IEC 103.Scada Cmd 3 | Scada Command |
| IEC 103.Scada Cmd 4 | Scada Command |
| IEC 103.Scada Cmd 5 | Scada Command |
| IEC 103.Scada Cmd 6 | Scada Command |
| IEC 103.Scada Cmd 7 | Scada Command |
| IEC 103.Scada Cmd 8 | Scada Command |
| IEC 103.Scada Cmd 9 | Scada Command |
| IEC 103.Scada Cmd 10 | Scada Command |
| Profibus.Scada Cmd 1 | Scada Command |
| Profibus.Scada Cmd 2 | Scada Command |
| Profibus.Scada Cmd 3 | Scada Command |
| Profibus.Scada Cmd 4 | Scada Command |
| Profibus.Scada Cmd 5 | Scada Command |
| Profibus.Scada Cmd 6 | Scada Command |
| Profibus.Scada Cmd 7 | Scada Command |
| Profibus.Scada Cmd 8 | Scada Command |
| Profibus.Scada Cmd 9 | Scada Command |
| Profibus.Scada Cmd 10 | Scada Command |
| Profibus.Scada Cmd 11 | Scada Command |
| Profibus.Scada Cmd 12 | Scada Command |
| Profibus.Scada Cmd 13 | Scada Command |
| Profibus.Scada Cmd 14 | Scada Command |
| Profibus.Scada Cmd 15 | Scada Command |
| Profibus.Scada Cmd 16 | Scada Command |
| Logics.LE1.Gate Out | Signal: Output of the logic gate |
| Logics.LE1.Timer Out | Signal: Timer Output |
| Logics.LE1.Out | Signal: Latched Output (Q) |
| Logics.LE1.Out inverted | Signal: Negated Latched Output (Q NOT) |
| Logics.LE2.Gate Out | Signal: Output of the logic gate |
| Logics.LE2.Timer Out | Signal: Timer Output |
| Logics.LE2.Out | Signal: Latched Output (Q) |
| Logics.LE2.Out inverted | Signal: Negated Latched Output (Q NOT) |

Parameters

| <i>Name</i> | <i>Description</i> |
|--------------------------|--|
| Logics.LE3.Gate Out | Signal: Output of the logic gate |
| Logics.LE3.Timer Out | Signal: Timer Output |
| Logics.LE3.Out | Signal: Latched Output (Q) |
| Logics.LE3.Out inverted | Signal: Negated Latched Output (Q NOT) |
| Logics.LE4.Gate Out | Signal: Output of the logic gate |
| Logics.LE4.Timer Out | Signal: Timer Output |
| Logics.LE4.Out | Signal: Latched Output (Q) |
| Logics.LE4.Out inverted | Signal: Negated Latched Output (Q NOT) |
| Logics.LE5.Gate Out | Signal: Output of the logic gate |
| Logics.LE5.Timer Out | Signal: Timer Output |
| Logics.LE5.Out | Signal: Latched Output (Q) |
| Logics.LE5.Out inverted | Signal: Negated Latched Output (Q NOT) |
| Logics.LE6.Gate Out | Signal: Output of the logic gate |
| Logics.LE6.Timer Out | Signal: Timer Output |
| Logics.LE6.Out | Signal: Latched Output (Q) |
| Logics.LE6.Out inverted | Signal: Negated Latched Output (Q NOT) |
| Logics.LE7.Gate Out | Signal: Output of the logic gate |
| Logics.LE7.Timer Out | Signal: Timer Output |
| Logics.LE7.Out | Signal: Latched Output (Q) |
| Logics.LE7.Out inverted | Signal: Negated Latched Output (Q NOT) |
| Logics.LE8.Gate Out | Signal: Output of the logic gate |
| Logics.LE8.Timer Out | Signal: Timer Output |
| Logics.LE8.Out | Signal: Latched Output (Q) |
| Logics.LE8.Out inverted | Signal: Negated Latched Output (Q NOT) |
| Logics.LE9.Gate Out | Signal: Output of the logic gate |
| Logics.LE9.Timer Out | Signal: Timer Output |
| Logics.LE9.Out | Signal: Latched Output (Q) |
| Logics.LE9.Out inverted | Signal: Negated Latched Output (Q NOT) |
| Logics.LE10.Gate Out | Signal: Output of the logic gate |
| Logics.LE10.Timer Out | Signal: Timer Output |
| Logics.LE10.Out | Signal: Latched Output (Q) |
| Logics.LE10.Out inverted | Signal: Negated Latched Output (Q NOT) |
| Logics.LE11.Gate Out | Signal: Output of the logic gate |
| Logics.LE11.Timer Out | Signal: Timer Output |
| Logics.LE11.Out | Signal: Latched Output (Q) |
| Logics.LE11.Out inverted | Signal: Negated Latched Output (Q NOT) |
| Logics.LE12.Gate Out | Signal: Output of the logic gate |
| Logics.LE12.Timer Out | Signal: Timer Output |
| Logics.LE12.Out | Signal: Latched Output (Q) |
| Logics.LE12.Out inverted | Signal: Negated Latched Output (Q NOT) |

Parameters

| <i>Name</i> | <i>Description</i> |
|--------------------------|--|
| Logics.LE13.Gate Out | Signal: Output of the logic gate |
| Logics.LE13.Timer Out | Signal: Timer Output |
| Logics.LE13.Out | Signal: Latched Output (Q) |
| Logics.LE13.Out inverted | Signal: Negated Latched Output (Q NOT) |
| Logics.LE14.Gate Out | Signal: Output of the logic gate |
| Logics.LE14.Timer Out | Signal: Timer Output |
| Logics.LE14.Out | Signal: Latched Output (Q) |
| Logics.LE14.Out inverted | Signal: Negated Latched Output (Q NOT) |
| Logics.LE15.Gate Out | Signal: Output of the logic gate |
| Logics.LE15.Timer Out | Signal: Timer Output |
| Logics.LE15.Out | Signal: Latched Output (Q) |
| Logics.LE15.Out inverted | Signal: Negated Latched Output (Q NOT) |
| Logics.LE16.Gate Out | Signal: Output of the logic gate |
| Logics.LE16.Timer Out | Signal: Timer Output |
| Logics.LE16.Out | Signal: Latched Output (Q) |
| Logics.LE16.Out inverted | Signal: Negated Latched Output (Q NOT) |
| Logics.LE17.Gate Out | Signal: Output of the logic gate |
| Logics.LE17.Timer Out | Signal: Timer Output |
| Logics.LE17.Out | Signal: Latched Output (Q) |
| Logics.LE17.Out inverted | Signal: Negated Latched Output (Q NOT) |
| Logics.LE18.Gate Out | Signal: Output of the logic gate |
| Logics.LE18.Timer Out | Signal: Timer Output |
| Logics.LE18.Out | Signal: Latched Output (Q) |
| Logics.LE18.Out inverted | Signal: Negated Latched Output (Q NOT) |
| Logics.LE19.Gate Out | Signal: Output of the logic gate |
| Logics.LE19.Timer Out | Signal: Timer Output |
| Logics.LE19.Out | Signal: Latched Output (Q) |
| Logics.LE19.Out inverted | Signal: Negated Latched Output (Q NOT) |
| Logics.LE20.Gate Out | Signal: Output of the logic gate |
| Logics.LE20.Timer Out | Signal: Timer Output |
| Logics.LE20.Out | Signal: Latched Output (Q) |
| Logics.LE20.Out inverted | Signal: Negated Latched Output (Q NOT) |
| Logics.LE21.Gate Out | Signal: Output of the logic gate |
| Logics.LE21.Timer Out | Signal: Timer Output |
| Logics.LE21.Out | Signal: Latched Output (Q) |
| Logics.LE21.Out inverted | Signal: Negated Latched Output (Q NOT) |
| Logics.LE22.Gate Out | Signal: Output of the logic gate |
| Logics.LE22.Timer Out | Signal: Timer Output |
| Logics.LE22.Out | Signal: Latched Output (Q) |
| Logics.LE22.Out inverted | Signal: Negated Latched Output (Q NOT) |

Parameters

| <i>Name</i> | <i>Description</i> |
|--------------------------|--|
| Logics.LE23.Gate Out | Signal: Output of the logic gate |
| Logics.LE23.Timer Out | Signal: Timer Output |
| Logics.LE23.Out | Signal: Latched Output (Q) |
| Logics.LE23.Out inverted | Signal: Negated Latched Output (Q NOT) |
| Logics.LE24.Gate Out | Signal: Output of the logic gate |
| Logics.LE24.Timer Out | Signal: Timer Output |
| Logics.LE24.Out | Signal: Latched Output (Q) |
| Logics.LE24.Out inverted | Signal: Negated Latched Output (Q NOT) |
| Logics.LE25.Gate Out | Signal: Output of the logic gate |
| Logics.LE25.Timer Out | Signal: Timer Output |
| Logics.LE25.Out | Signal: Latched Output (Q) |
| Logics.LE25.Out inverted | Signal: Negated Latched Output (Q NOT) |
| Logics.LE26.Gate Out | Signal: Output of the logic gate |
| Logics.LE26.Timer Out | Signal: Timer Output |
| Logics.LE26.Out | Signal: Latched Output (Q) |
| Logics.LE26.Out inverted | Signal: Negated Latched Output (Q NOT) |
| Logics.LE27.Gate Out | Signal: Output of the logic gate |
| Logics.LE27.Timer Out | Signal: Timer Output |
| Logics.LE27.Out | Signal: Latched Output (Q) |
| Logics.LE27.Out inverted | Signal: Negated Latched Output (Q NOT) |
| Logics.LE28.Gate Out | Signal: Output of the logic gate |
| Logics.LE28.Timer Out | Signal: Timer Output |
| Logics.LE28.Out | Signal: Latched Output (Q) |
| Logics.LE28.Out inverted | Signal: Negated Latched Output (Q NOT) |
| Logics.LE29.Gate Out | Signal: Output of the logic gate |
| Logics.LE29.Timer Out | Signal: Timer Output |
| Logics.LE29.Out | Signal: Latched Output (Q) |
| Logics.LE29.Out inverted | Signal: Negated Latched Output (Q NOT) |
| Logics.LE30.Gate Out | Signal: Output of the logic gate |
| Logics.LE30.Timer Out | Signal: Timer Output |
| Logics.LE30.Out | Signal: Latched Output (Q) |
| Logics.LE30.Out inverted | Signal: Negated Latched Output (Q NOT) |
| Logics.LE31.Gate Out | Signal: Output of the logic gate |
| Logics.LE31.Timer Out | Signal: Timer Output |
| Logics.LE31.Out | Signal: Latched Output (Q) |
| Logics.LE31.Out inverted | Signal: Negated Latched Output (Q NOT) |
| Logics.LE32.Gate Out | Signal: Output of the logic gate |
| Logics.LE32.Timer Out | Signal: Timer Output |
| Logics.LE32.Out | Signal: Latched Output (Q) |
| Logics.LE32.Out inverted | Signal: Negated Latched Output (Q NOT) |

Parameters

| <i>Name</i> | <i>Description</i> |
|--------------------------|--|
| Logics.LE33.Gate Out | Signal: Output of the logic gate |
| Logics.LE33.Timer Out | Signal: Timer Output |
| Logics.LE33.Out | Signal: Latched Output (Q) |
| Logics.LE33.Out inverted | Signal: Negated Latched Output (Q NOT) |
| Logics.LE34.Gate Out | Signal: Output of the logic gate |
| Logics.LE34.Timer Out | Signal: Timer Output |
| Logics.LE34.Out | Signal: Latched Output (Q) |
| Logics.LE34.Out inverted | Signal: Negated Latched Output (Q NOT) |
| Logics.LE35.Gate Out | Signal: Output of the logic gate |
| Logics.LE35.Timer Out | Signal: Timer Output |
| Logics.LE35.Out | Signal: Latched Output (Q) |
| Logics.LE35.Out inverted | Signal: Negated Latched Output (Q NOT) |
| Logics.LE36.Gate Out | Signal: Output of the logic gate |
| Logics.LE36.Timer Out | Signal: Timer Output |
| Logics.LE36.Out | Signal: Latched Output (Q) |
| Logics.LE36.Out inverted | Signal: Negated Latched Output (Q NOT) |
| Logics.LE37.Gate Out | Signal: Output of the logic gate |
| Logics.LE37.Timer Out | Signal: Timer Output |
| Logics.LE37.Out | Signal: Latched Output (Q) |
| Logics.LE37.Out inverted | Signal: Negated Latched Output (Q NOT) |
| Logics.LE38.Gate Out | Signal: Output of the logic gate |
| Logics.LE38.Timer Out | Signal: Timer Output |
| Logics.LE38.Out | Signal: Latched Output (Q) |
| Logics.LE38.Out inverted | Signal: Negated Latched Output (Q NOT) |
| Logics.LE39.Gate Out | Signal: Output of the logic gate |
| Logics.LE39.Timer Out | Signal: Timer Output |
| Logics.LE39.Out | Signal: Latched Output (Q) |
| Logics.LE39.Out inverted | Signal: Negated Latched Output (Q NOT) |
| Logics.LE40.Gate Out | Signal: Output of the logic gate |
| Logics.LE40.Timer Out | Signal: Timer Output |
| Logics.LE40.Out | Signal: Latched Output (Q) |
| Logics.LE40.Out inverted | Signal: Negated Latched Output (Q NOT) |
| Logics.LE41.Gate Out | Signal: Output of the logic gate |
| Logics.LE41.Timer Out | Signal: Timer Output |
| Logics.LE41.Out | Signal: Latched Output (Q) |
| Logics.LE41.Out inverted | Signal: Negated Latched Output (Q NOT) |
| Logics.LE42.Gate Out | Signal: Output of the logic gate |
| Logics.LE42.Timer Out | Signal: Timer Output |
| Logics.LE42.Out | Signal: Latched Output (Q) |
| Logics.LE42.Out inverted | Signal: Negated Latched Output (Q NOT) |

Parameters

| <i>Name</i> | <i>Description</i> |
|--------------------------|--|
| Logics.LE43.Gate Out | Signal: Output of the logic gate |
| Logics.LE43.Timer Out | Signal: Timer Output |
| Logics.LE43.Out | Signal: Latched Output (Q) |
| Logics.LE43.Out inverted | Signal: Negated Latched Output (Q NOT) |
| Logics.LE44.Gate Out | Signal: Output of the logic gate |
| Logics.LE44.Timer Out | Signal: Timer Output |
| Logics.LE44.Out | Signal: Latched Output (Q) |
| Logics.LE44.Out inverted | Signal: Negated Latched Output (Q NOT) |
| Logics.LE45.Gate Out | Signal: Output of the logic gate |
| Logics.LE45.Timer Out | Signal: Timer Output |
| Logics.LE45.Out | Signal: Latched Output (Q) |
| Logics.LE45.Out inverted | Signal: Negated Latched Output (Q NOT) |
| Logics.LE46.Gate Out | Signal: Output of the logic gate |
| Logics.LE46.Timer Out | Signal: Timer Output |
| Logics.LE46.Out | Signal: Latched Output (Q) |
| Logics.LE46.Out inverted | Signal: Negated Latched Output (Q NOT) |
| Logics.LE47.Gate Out | Signal: Output of the logic gate |
| Logics.LE47.Timer Out | Signal: Timer Output |
| Logics.LE47.Out | Signal: Latched Output (Q) |
| Logics.LE47.Out inverted | Signal: Negated Latched Output (Q NOT) |
| Logics.LE48.Gate Out | Signal: Output of the logic gate |
| Logics.LE48.Timer Out | Signal: Timer Output |
| Logics.LE48.Out | Signal: Latched Output (Q) |
| Logics.LE48.Out inverted | Signal: Negated Latched Output (Q NOT) |
| Logics.LE49.Gate Out | Signal: Output of the logic gate |
| Logics.LE49.Timer Out | Signal: Timer Output |
| Logics.LE49.Out | Signal: Latched Output (Q) |
| Logics.LE49.Out inverted | Signal: Negated Latched Output (Q NOT) |
| Logics.LE50.Gate Out | Signal: Output of the logic gate |
| Logics.LE50.Timer Out | Signal: Timer Output |
| Logics.LE50.Out | Signal: Latched Output (Q) |
| Logics.LE50.Out inverted | Signal: Negated Latched Output (Q NOT) |
| Logics.LE51.Gate Out | Signal: Output of the logic gate |
| Logics.LE51.Timer Out | Signal: Timer Output |
| Logics.LE51.Out | Signal: Latched Output (Q) |
| Logics.LE51.Out inverted | Signal: Negated Latched Output (Q NOT) |
| Logics.LE52.Gate Out | Signal: Output of the logic gate |
| Logics.LE52.Timer Out | Signal: Timer Output |
| Logics.LE52.Out | Signal: Latched Output (Q) |
| Logics.LE52.Out inverted | Signal: Negated Latched Output (Q NOT) |

Parameters

| <i>Name</i> | <i>Description</i> |
|--------------------------|--|
| Logics.LE53.Gate Out | Signal: Output of the logic gate |
| Logics.LE53.Timer Out | Signal: Timer Output |
| Logics.LE53.Out | Signal: Latched Output (Q) |
| Logics.LE53.Out inverted | Signal: Negated Latched Output (Q NOT) |
| Logics.LE54.Gate Out | Signal: Output of the logic gate |
| Logics.LE54.Timer Out | Signal: Timer Output |
| Logics.LE54.Out | Signal: Latched Output (Q) |
| Logics.LE54.Out inverted | Signal: Negated Latched Output (Q NOT) |
| Logics.LE55.Gate Out | Signal: Output of the logic gate |
| Logics.LE55.Timer Out | Signal: Timer Output |
| Logics.LE55.Out | Signal: Latched Output (Q) |
| Logics.LE55.Out inverted | Signal: Negated Latched Output (Q NOT) |
| Logics.LE56.Gate Out | Signal: Output of the logic gate |
| Logics.LE56.Timer Out | Signal: Timer Output |
| Logics.LE56.Out | Signal: Latched Output (Q) |
| Logics.LE56.Out inverted | Signal: Negated Latched Output (Q NOT) |
| Logics.LE57.Gate Out | Signal: Output of the logic gate |
| Logics.LE57.Timer Out | Signal: Timer Output |
| Logics.LE57.Out | Signal: Latched Output (Q) |
| Logics.LE57.Out inverted | Signal: Negated Latched Output (Q NOT) |
| Logics.LE58.Gate Out | Signal: Output of the logic gate |
| Logics.LE58.Timer Out | Signal: Timer Output |
| Logics.LE58.Out | Signal: Latched Output (Q) |
| Logics.LE58.Out inverted | Signal: Negated Latched Output (Q NOT) |
| Logics.LE59.Gate Out | Signal: Output of the logic gate |
| Logics.LE59.Timer Out | Signal: Timer Output |
| Logics.LE59.Out | Signal: Latched Output (Q) |
| Logics.LE59.Out inverted | Signal: Negated Latched Output (Q NOT) |
| Logics.LE60.Gate Out | Signal: Output of the logic gate |
| Logics.LE60.Timer Out | Signal: Timer Output |
| Logics.LE60.Out | Signal: Latched Output (Q) |
| Logics.LE60.Out inverted | Signal: Negated Latched Output (Q NOT) |
| Logics.LE61.Gate Out | Signal: Output of the logic gate |
| Logics.LE61.Timer Out | Signal: Timer Output |
| Logics.LE61.Out | Signal: Latched Output (Q) |
| Logics.LE61.Out inverted | Signal: Negated Latched Output (Q NOT) |
| Logics.LE62.Gate Out | Signal: Output of the logic gate |
| Logics.LE62.Timer Out | Signal: Timer Output |
| Logics.LE62.Out | Signal: Latched Output (Q) |
| Logics.LE62.Out inverted | Signal: Negated Latched Output (Q NOT) |

Parameters

| <i>Name</i> | <i>Description</i> |
|--------------------------|--|
| Logics.LE63.Gate Out | Signal: Output of the logic gate |
| Logics.LE63.Timer Out | Signal: Timer Output |
| Logics.LE63.Out | Signal: Latched Output (Q) |
| Logics.LE63.Out inverted | Signal: Negated Latched Output (Q NOT) |
| Logics.LE64.Gate Out | Signal: Output of the logic gate |
| Logics.LE64.Timer Out | Signal: Timer Output |
| Logics.LE64.Out | Signal: Latched Output (Q) |
| Logics.LE64.Out inverted | Signal: Negated Latched Output (Q NOT) |
| Logics.LE65.Gate Out | Signal: Output of the logic gate |
| Logics.LE65.Timer Out | Signal: Timer Output |
| Logics.LE65.Out | Signal: Latched Output (Q) |
| Logics.LE65.Out inverted | Signal: Negated Latched Output (Q NOT) |
| Logics.LE66.Gate Out | Signal: Output of the logic gate |
| Logics.LE66.Timer Out | Signal: Timer Output |
| Logics.LE66.Out | Signal: Latched Output (Q) |
| Logics.LE66.Out inverted | Signal: Negated Latched Output (Q NOT) |
| Logics.LE67.Gate Out | Signal: Output of the logic gate |
| Logics.LE67.Timer Out | Signal: Timer Output |
| Logics.LE67.Out | Signal: Latched Output (Q) |
| Logics.LE67.Out inverted | Signal: Negated Latched Output (Q NOT) |
| Logics.LE68.Gate Out | Signal: Output of the logic gate |
| Logics.LE68.Timer Out | Signal: Timer Output |
| Logics.LE68.Out | Signal: Latched Output (Q) |
| Logics.LE68.Out inverted | Signal: Negated Latched Output (Q NOT) |
| Logics.LE69.Gate Out | Signal: Output of the logic gate |
| Logics.LE69.Timer Out | Signal: Timer Output |
| Logics.LE69.Out | Signal: Latched Output (Q) |
| Logics.LE69.Out inverted | Signal: Negated Latched Output (Q NOT) |
| Logics.LE70.Gate Out | Signal: Output of the logic gate |
| Logics.LE70.Timer Out | Signal: Timer Output |
| Logics.LE70.Out | Signal: Latched Output (Q) |
| Logics.LE70.Out inverted | Signal: Negated Latched Output (Q NOT) |
| Logics.LE71.Gate Out | Signal: Output of the logic gate |
| Logics.LE71.Timer Out | Signal: Timer Output |
| Logics.LE71.Out | Signal: Latched Output (Q) |
| Logics.LE71.Out inverted | Signal: Negated Latched Output (Q NOT) |
| Logics.LE72.Gate Out | Signal: Output of the logic gate |
| Logics.LE72.Timer Out | Signal: Timer Output |
| Logics.LE72.Out | Signal: Latched Output (Q) |
| Logics.LE72.Out inverted | Signal: Negated Latched Output (Q NOT) |











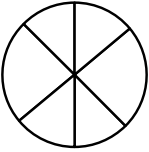

Parameters

| <i>Name</i> | <i>Description</i> |
|--------------------------|--|
| Logics.LE73.Gate Out | Signal: Output of the logic gate |
| Logics.LE73.Timer Out | Signal: Timer Output |
| Logics.LE73.Out | Signal: Latched Output (Q) |
| Logics.LE73.Out inverted | Signal: Negated Latched Output (Q NOT) |
| Logics.LE74.Gate Out | Signal: Output of the logic gate |
| Logics.LE74.Timer Out | Signal: Timer Output |
| Logics.LE74.Out | Signal: Latched Output (Q) |
| Logics.LE74.Out inverted | Signal: Negated Latched Output (Q NOT) |
| Logics.LE75.Gate Out | Signal: Output of the logic gate |
| Logics.LE75.Timer Out | Signal: Timer Output |
| Logics.LE75.Out | Signal: Latched Output (Q) |
| Logics.LE75.Out inverted | Signal: Negated Latched Output (Q NOT) |
| Logics.LE76.Gate Out | Signal: Output of the logic gate |
| Logics.LE76.Timer Out | Signal: Timer Output |
| Logics.LE76.Out | Signal: Latched Output (Q) |
| Logics.LE76.Out inverted | Signal: Negated Latched Output (Q NOT) |
| Logics.LE77.Gate Out | Signal: Output of the logic gate |
| Logics.LE77.Timer Out | Signal: Timer Output |
| Logics.LE77.Out | Signal: Latched Output (Q) |
| Logics.LE77.Out inverted | Signal: Negated Latched Output (Q NOT) |
| Logics.LE78.Gate Out | Signal: Output of the logic gate |
| Logics.LE78.Timer Out | Signal: Timer Output |
| Logics.LE78.Out | Signal: Latched Output (Q) |
| Logics.LE78.Out inverted | Signal: Negated Latched Output (Q NOT) |
| Logics.LE79.Gate Out | Signal: Output of the logic gate |
| Logics.LE79.Timer Out | Signal: Timer Output |
| Logics.LE79.Out | Signal: Latched Output (Q) |
| Logics.LE79.Out inverted | Signal: Negated Latched Output (Q NOT) |
| Logics.LE80.Gate Out | Signal: Output of the logic gate |
| Logics.LE80.Timer Out | Signal: Timer Output |
| Logics.LE80.Out | Signal: Latched Output (Q) |
| Logics.LE80.Out inverted | Signal: Negated Latched Output (Q NOT) |

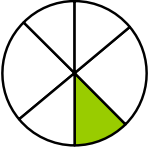
Access Authorizations (access areas)

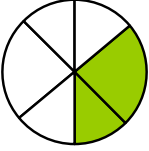
Passwords – Areas

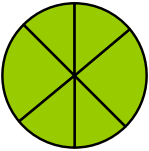
The following table shows the access areas and the authorization passwords that they require in order to access them.

| <i>Area Symbol</i> | <i>Authorization Password</i> | <i>Access to:</i> |
|---|--|---|
|  |  Read Only-Lv0 | Level 0 provides Read Only access to all settings and parameters of the device. The device will fall back into this level automatically after a longer period or inactivity |
|  |  Prot-Lv1 | This password provides access to the reset- and acknowledge options. In addition to that, it permits the execution of manual trigger signals. |
|  |  Prot-Lv2 | This password provides access to the reset and acknowledge options. In addition to that it permits changing of protection settings and the configuration of the trip manager. |
|  |  Control-Lv1 | This password grants permission for switching operations (switching switchgears) |
|  |  Control-Lv2 | This password grants permission for switching operations (switching switchgears). In addition to that it gives access to the switchgear settings (switching authority, interlockings, general settings of switchgears, Breaker wear...). |
|  |  Supervisor-Lv3 | This password grants non-restricted access to all parameters and settings of the device (device configuration). This includes also the devices planning, device parameters (e.g. Date and Time), Field Parameters, Service Parameters and Logic Parameters. |

NOTICE

If the device was not active within the parameter setting mode for a longer time (can be set between 20 – 3600 seconds) it changes into »Read Only-Lv0« mode automatically. This parameter (t-max-Edit) can be modified within menu [Device Para\HMI].

Access Areas (Password Level):

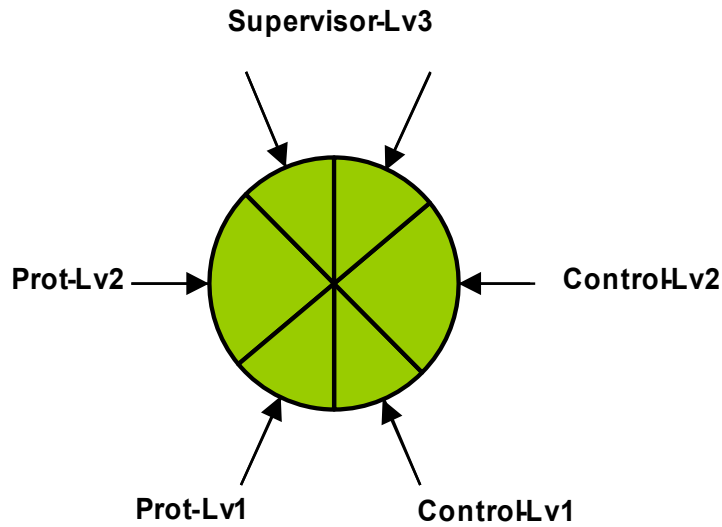

NOTICE

You have to ensure, that the access authorizations are protected by secure passwords. These passwords have to be kept as a secret and to be known only by the authorized persons.

NOTICE

A lock symbol indicates in the upper right corner of the display if there are any access authorizations active at the moment . That means, within the mode "Read Only Lv0" a closed (locked) lock symbol will be shown in the upper right corner of the display. As soon as there are any access authorizations active (above the "Read Only-Lv0" level), the upper right corner of the display will show an unlocked (open) lock symbol.

NOTICE

During setting parameters the C-Button will be used for the cancelling of parameter changes. Because of that it is not possible, to acknowledge (LEDs, Output Relays...) as long as there are non saved (cached only) parameters.

The acknowledgement menu cannot be accessed as long as the parameter modifications are not overtaken by the device (indicated by a star symbol in the upper left corner).

NOTICE



The passwords are part of the device (fixed assignments). That means, passwords will not be overwritten, if a parameter file is transmitted into a device.

Existing passwords are persistent (assigned to a device). If an offline created parameter file is transmitted into a device, or if a parameter file is transmitted from one device to another, this will have no impact on existing passwords within the device.

Available Levels/Access Authorizations

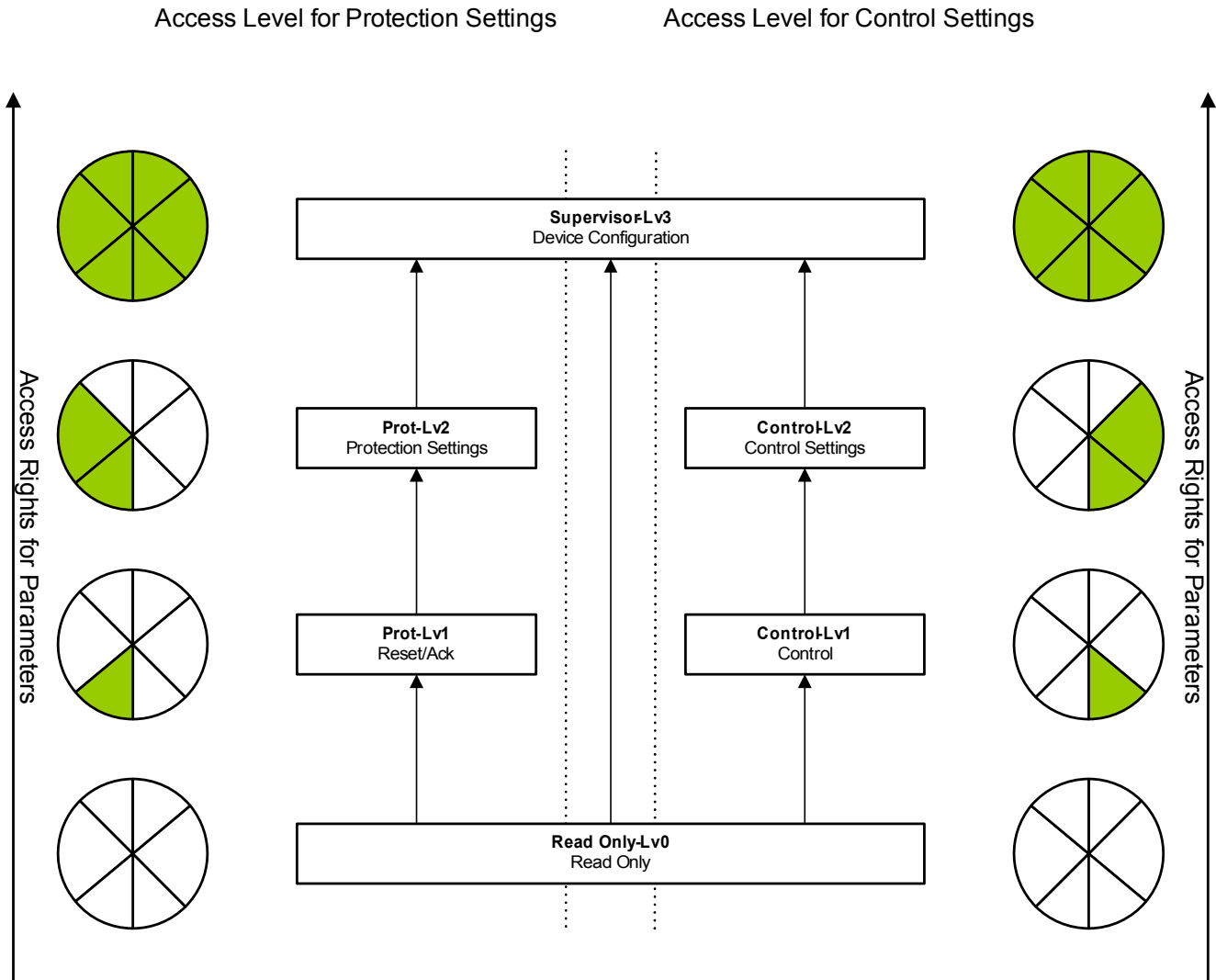
The access authorizations are designed in form of two hierachic strings.
 The supervisor (administrator) password provides access to all parameters and settings.



- Legend : Lv = Level
-  Parameters are read only
 -  Parameters can be modified

How to find out what access areas/levels are unlocked?

The menu [Device para\Access levels] provides the information, which access areas (authorizations) are currently unlocked.

As soon as there is an unlocked access area (authorization) above »Read Only-Lv0«, this will be indicated by an unlocked lock symbol within the upper right corner of the device display.

Unlocking Access Areas

Within the menu [Device Para\Access level] access areas can be unlocked or locked (at the HMI).

Changing Passwords

Passwords can be changed at the device in menu [Device Para/Passwords] or by means of the *Smart view* software.

NOTICE

A password must be a user-defined combination of the numerics 1, 2, 3 and 4.

All other characters and keys won't be accepted.

When you want to change a password, the existing one has to be entered firstly. The new password (up to 8 digits) is then to be confirmed twice. Please proceed as follows:

- In order to change the password please enter your old password by means of the Softkeys followed by pressing the »OK«-key.
- Enter the new password by means of the Softkeys and press the »OK«-key.
- Afterwards enter the new password once again by means of the Softkeys and press the »OK«-key.

Deactivating Passwords during Commissioning

It is possible optionally to deactivate passwords during commissioning. It is not allowed to use this feature for other purposes than commissioning. In order to deactivate the password protection replace the existing password with an empty one for the corresponding access areas. All access authorizations (access areas) that are protected by an empty password are unlocked permanent. That means, that all parameters and settings within those areas can be modified without any further access authorization. It is no longer possible to change into the »*Read Only-Lv0*« level (the protective device will also not fall back into this mode if the maximum edit time is expired (t-max-Edit).

WARNING

You have to ensure that all passwords are activated again after the commissioning. That means, that all access areas have to be protected by a password that consists of 4 digits as minimum.

Woodward will not overtake any liability for any personal injuries or damages that are caused by deactivated password protection.

Password Entry at the Panel

Passwords can be entered by way of the Softkeys.



Example: For password (3244) press successively:

- Softkey 3
- Softkey 2
- Softkey 4
- Softkey 4

Password Forgotten

By pressing the »C« key during cold booting a reset menu will be called up. By selecting »Reset All Passwords?« and confirming with »Yes« all passwords will be reset to the defaults »1234«.

Parameter Setting at the HMI

Every parameter belongs to an access area. Editing and changing of a parameter requires a sufficient access authorization.

The User can obtain the required access authorizations by unlocking access areas in advance of parameter changes or context-dependent. In the following sections both options will be explained.

Option 1: Direct Authorization for an Access Area

Call up menu [Device Para\Access level].

Select the required access level respectively navigate to the required access authorization (level). Enter the required password. If the correct password has been entered, the required access authorization will be obtained. In order to do the parameter changes please proceed as follows:

- Move to the parameter you want to change by using the Softkeys. If the parameter is selected, the lower right corner of the display should show a »Wrench« symbol.



This symbol indicates, that the parameter is unlocked and can be edited, because the required access authorization is available. Confirm the Softkey »Wrench«, in order to edit the parameter. Change the parameter.

Now you can:

- save the change you made and have them adopted by the system or:
- change additional parameters and save finally all the altered parameters and have them adopted by the system.

To save parameter changes immediately,

- press the »OK« key for saving changed parameters directly and to have them adopted by the device. Confirm the parameter changes by pressing the »Yes« Softkey or dismiss by pressing »No«.

To change additional parameters and save afterwards,

- move to other parameters and change them

NOTICE

A star symbol in front of the changed parameters indicates that the modifications have only been saved temporarily, they are not yet finally stored and adopted by the device.

In order to make things easier to follow, especially where complex parameter changes are involved, on every superior/higher-ranking menu level the intended change of the parameter is indicated by the star symbol (star trace). This makes it possible to control or follow up from the main menu level at any time where parameter changes have been made and have not been saved finally.

In addition to the star trace to the temporary saved parameter changes, a

general parameter changing symbol is faded-in at the left corner of the display, and so it is possible from each point of the menu tree to see that there are parameter changes still not adopted by the device.

Press the »OK« key to initiate the final storage of all parameter changes. Confirm the parameter changes by pressing the »Yes« softkey or dismiss by pressing Softkey »No«.

NOTICE

If the display shows a Key Symbol instead of a Wrench-Symbol, this will indicate, that the required access authorization is not available.



In order to edit this parameter, a password is required, that provides the required authorization.

NOTICE

Plausibility check: In order to prevent obvious wrong settings the device monitors constantly all temporary saved parameter changes. If the device detects an implausibility, this is indicated by a question mark in front of the respective parameter.

In order to make things easier to follow up, especially where complex parameter changes are involved, on every superior/higher-ranking menu level, above the temporarily saved parameters an invalidity is indicated by the question mark (plausibility trace). This makes it possible to control or follow from the main menu level at any time where implausibilities are intended to be saved.

In addition to the question mark trace to the temporary saved implausible parameter changes a general implausibility symbol/question mark is faded-in at the left corner of the display, and so it is possible to see from each point of the menu tree that implausibilities have been detected by the device.

A star/parameter change indication is always overwritten by the question mark/implausibility symbol.

If a device detects an implausibility, it rejects saving and adopting of the parameters.

Option 2: Context-dependent Access Authorization

Navigate to the parameter, that is to be changed. If the parameter is selected, the lower right corner of the display shows a »Key«-Symbol.



This symbol indicates, that the device is still within the »Read Only Lv0«-Level, or that the current level does not provide sufficient access rights to allow editing of this parameter.

Press this Softkey and enter the password¹⁾ that provides access to this parameter.
Please change the parameter settings.

¹⁾ This page provides also information, which password/access authorization is required to do changes on this parameter.

Now you can:

- save the change you made and have them adopted by the system or:
- change additional parameters and save finally all the altered parameters and have them adopted by the system.

To save parameter changes immediately,

- press the »OK« key for saving changed parameters directly and to have them adopted by the device.
Confirm the parameter changes by pressing the »Yes« Softkey or dismiss by pressing »No«.

To change additional parameters and save afterwards,

- move to other parameters and change them

NOTICE

A star symbol in front of the changed parameters indicates that the modifications have only been saved temporary, they are not yet finally stored and adopted by the device.

In order to make things easier to follow up, especially where complex parameter changes are involved, on every superior/higher-ranking menu level the intended change of the parameter is indicated by the star symbol (star trace). This makes it possible to control or follow from the main menu level at any time where parameter changes have been made and have not been saved finally.

In addition to the star trace to the temporary saved parameter changes, a general parameter changing symbol is faded-in at the left corner of the display, and so it is possible from each point of the menu tree to see that there are parameter changes still not adopted by the device.

Press the »OK« key to initiate the final storage of all parameter changes. Confirm the parameter changes by pressing the »Yes« Softkey or dismiss by pressing Softkey »No«.

NOTICE

Plausibility check: In order to prevent obvious wrong settings the device monitors constantly all temporary saved parameter changes. If the device detects an implausibility, this is indicated by a question mark in front of the respective parameter.

In order to make things easier to follow up, especially where complex parameter changes are involved, on every superior/higher-ranking menu level, above the temporary saved parameters an invalidity is indicated by the question mark (plausibility trace). This makes it possible to control or follow from the main menu level at any time where implausibilities are intended to be saved.

In addition to the question mark trace to the temporary saved implausible parameter changes a general implausibility symbol/question mark is faded-in at the left corner of the display, and so it is possible to see from each point of the menu tree that implausibilities have been detected by the device.

A star/parameter change indication is always overwritten by the question mark/implausibility symbol.

If a device detects an implausibility, it rejects saving and adopting of the parameters.

Setting Groups

Setting Group Switch

Within the menu »Protection Para/P-Set Switch« you have the following possibilities:

- To set one of the four setting groups active manually.
- To assign a signal to each setting group that sets this group to active.
- Scada switches the setting groups.

| Option | Setting Group Switch |
|--|---|
| <i>Manual Selection</i> | Switch over, if another setting group is chosen manually within the menu »Protection Para/P-Set Switch« |
| <i>Via Input Function (e.g. Digital Input)</i> | <p>Switch over not until the request is clear.</p> <p>That means, if there is more or less than one request signal active, no switch over will be executed.</p> <p>Example::</p> <p>DI3 is assigned onto Parameter set 1. DI3 is active „1“.</p> <p>DI4 is assigned onto Parameter set 2. DI4 is inactive „0“.</p> <p>Now the device should switch from parameter set 1 to parameter set 2. Therefore at first DI3 has to become inactive “0”. Than DI4 has to be active “1”.</p> <p>If DI4 becomes again inactive „0“, parameter set 2 will remain active “1” as long as there is no clear request (e.g. DI3 becomes active “1”, all the other assignments are inactive “0”)</p> |
| <i>Via Scada</i> | <p>Switch over if there is a clear SCADA request.</p> <p>Otherwise no switch over will be executed.</p> |

NOTICE

The description of the parameters can be found within chapter System Parameters.

Signals that can be used for PSS

| <i>Name</i> | <i>Description</i> |
|-------------------------|---|
| -- | No assignment |
| Prot.DFT Invalid | DFT values of fundamental and harmonics (except VX) are not valid. They depend on period time of frequency and measured channels 1-3 (VL1,VL2,VL3). |
| Prot.DFT Valid | DFT values of fundamental and harmonics (except VX) are valid. They depend on period time of frequency and measured channels 1-3 (VL1,VL2,VL3). |
| Prot.DFT Invalid (VX) | DFT values of fundamental and harmonics of VX (only) are not valid. |
| Prot.DFT Valid (VX) | DFT values of fundamental and harmonics of VX (only) are valid. |
| CTS.Alarm | Signal: Alarm Current Transformer Measuring Circuit Supervision |
| LOP.Alarm | Signal: Alarm Loss of Potential |
| DI Slot X1.DI 1 | Signal: Digital Input |
| DI Slot X1.DI 2 | Signal: Digital Input |
| DI Slot X1.DI 3 | Signal: Digital Input |
| DI Slot X1.DI 4 | Signal: Digital Input |
| DI Slot X1.DI 5 | Signal: Digital Input |
| DI Slot X1.DI 6 | Signal: Digital Input |
| DI Slot X1.DI 7 | Signal: Digital Input |
| DI Slot X1.DI 8 | Signal: Digital Input |
| DI Slot X6.DI 1 | Signal: Digital Input |
| DI Slot X6.DI 2 | Signal: Digital Input |
| DI Slot X6.DI 3 | Signal: Digital Input |
| DI Slot X6.DI 4 | Signal: Digital Input |
| DI Slot X6.DI 5 | Signal: Digital Input |
| DI Slot X6.DI 6 | Signal: Digital Input |
| DI Slot X6.DI 7 | Signal: Digital Input |
| DI Slot X6.DI 8 | Signal: Digital Input |
| Logics.LE1.Gate Out | Signal: Output of the logic gate |
| Logics.LE1.Timer Out | Signal: Timer Output |
| Logics.LE1.Out | Signal: Latched Output (Q) |
| Logics.LE1.Out inverted | Signal: Negated Latched Output (Q NOT) |
| Logics.LE2.Gate Out | Signal: Output of the logic gate |
| Logics.LE2.Timer Out | Signal: Timer Output |
| Logics.LE2.Out | Signal: Latched Output (Q) |
| Logics.LE2.Out inverted | Signal: Negated Latched Output (Q NOT) |
| Logics.LE3.Gate Out | Signal: Output of the logic gate |
| Logics.LE3.Timer Out | Signal: Timer Output |
| Logics.LE3.Out | Signal: Latched Output (Q) |
| Logics.LE3.Out inverted | Signal: Negated Latched Output (Q NOT) |
| Logics.LE4.Gate Out | Signal: Output of the logic gate |

Parameters

| <i>Name</i> | <i>Description</i> |
|--------------------------|--|
| Logics.LE4.Timer Out | Signal: Timer Output |
| Logics.LE4.Out | Signal: Latched Output (Q) |
| Logics.LE4.Out inverted | Signal: Negated Latched Output (Q NOT) |
| Logics.LE5.Gate Out | Signal: Output of the logic gate |
| Logics.LE5.Timer Out | Signal: Timer Output |
| Logics.LE5.Out | Signal: Latched Output (Q) |
| Logics.LE5.Out inverted | Signal: Negated Latched Output (Q NOT) |
| Logics.LE6.Gate Out | Signal: Output of the logic gate |
| Logics.LE6.Timer Out | Signal: Timer Output |
| Logics.LE6.Out | Signal: Latched Output (Q) |
| Logics.LE6.Out inverted | Signal: Negated Latched Output (Q NOT) |
| Logics.LE7.Gate Out | Signal: Output of the logic gate |
| Logics.LE7.Timer Out | Signal: Timer Output |
| Logics.LE7.Out | Signal: Latched Output (Q) |
| Logics.LE7.Out inverted | Signal: Negated Latched Output (Q NOT) |
| Logics.LE8.Gate Out | Signal: Output of the logic gate |
| Logics.LE8.Timer Out | Signal: Timer Output |
| Logics.LE8.Out | Signal: Latched Output (Q) |
| Logics.LE8.Out inverted | Signal: Negated Latched Output (Q NOT) |
| Logics.LE9.Gate Out | Signal: Output of the logic gate |
| Logics.LE9.Timer Out | Signal: Timer Output |
| Logics.LE9.Out | Signal: Latched Output (Q) |
| Logics.LE9.Out inverted | Signal: Negated Latched Output (Q NOT) |
| Logics.LE10.Gate Out | Signal: Output of the logic gate |
| Logics.LE10.Timer Out | Signal: Timer Output |
| Logics.LE10.Out | Signal: Latched Output (Q) |
| Logics.LE10.Out inverted | Signal: Negated Latched Output (Q NOT) |
| Logics.LE11.Gate Out | Signal: Output of the logic gate |
| Logics.LE11.Timer Out | Signal: Timer Output |
| Logics.LE11.Out | Signal: Latched Output (Q) |
| Logics.LE11.Out inverted | Signal: Negated Latched Output (Q NOT) |
| Logics.LE12.Gate Out | Signal: Output of the logic gate |
| Logics.LE12.Timer Out | Signal: Timer Output |
| Logics.LE12.Out | Signal: Latched Output (Q) |
| Logics.LE12.Out inverted | Signal: Negated Latched Output (Q NOT) |
| Logics.LE13.Gate Out | Signal: Output of the logic gate |
| Logics.LE13.Timer Out | Signal: Timer Output |
| Logics.LE13.Out | Signal: Latched Output (Q) |
| Logics.LE13.Out inverted | Signal: Negated Latched Output (Q NOT) |
| Logics.LE14.Gate Out | Signal: Output of the logic gate |

Parameters

| <i>Name</i> | <i>Description</i> |
|--------------------------|--|
| Logics.LE14.Timer Out | Signal: Timer Output |
| Logics.LE14.Out | Signal: Latched Output (Q) |
| Logics.LE14.Out inverted | Signal: Negated Latched Output (Q NOT) |
| Logics.LE15.Gate Out | Signal: Output of the logic gate |
| Logics.LE15.Timer Out | Signal: Timer Output |
| Logics.LE15.Out | Signal: Latched Output (Q) |
| Logics.LE15.Out inverted | Signal: Negated Latched Output (Q NOT) |
| Logics.LE16.Gate Out | Signal: Output of the logic gate |
| Logics.LE16.Timer Out | Signal: Timer Output |
| Logics.LE16.Out | Signal: Latched Output (Q) |
| Logics.LE16.Out inverted | Signal: Negated Latched Output (Q NOT) |
| Logics.LE17.Gate Out | Signal: Output of the logic gate |
| Logics.LE17.Timer Out | Signal: Timer Output |
| Logics.LE17.Out | Signal: Latched Output (Q) |
| Logics.LE17.Out inverted | Signal: Negated Latched Output (Q NOT) |
| Logics.LE18.Gate Out | Signal: Output of the logic gate |
| Logics.LE18.Timer Out | Signal: Timer Output |
| Logics.LE18.Out | Signal: Latched Output (Q) |
| Logics.LE18.Out inverted | Signal: Negated Latched Output (Q NOT) |
| Logics.LE19.Gate Out | Signal: Output of the logic gate |
| Logics.LE19.Timer Out | Signal: Timer Output |
| Logics.LE19.Out | Signal: Latched Output (Q) |
| Logics.LE19.Out inverted | Signal: Negated Latched Output (Q NOT) |
| Logics.LE20.Gate Out | Signal: Output of the logic gate |
| Logics.LE20.Timer Out | Signal: Timer Output |
| Logics.LE20.Out | Signal: Latched Output (Q) |
| Logics.LE20.Out inverted | Signal: Negated Latched Output (Q NOT) |
| Logics.LE21.Gate Out | Signal: Output of the logic gate |
| Logics.LE21.Timer Out | Signal: Timer Output |
| Logics.LE21.Out | Signal: Latched Output (Q) |
| Logics.LE21.Out inverted | Signal: Negated Latched Output (Q NOT) |
| Logics.LE22.Gate Out | Signal: Output of the logic gate |
| Logics.LE22.Timer Out | Signal: Timer Output |
| Logics.LE22.Out | Signal: Latched Output (Q) |
| Logics.LE22.Out inverted | Signal: Negated Latched Output (Q NOT) |
| Logics.LE23.Gate Out | Signal: Output of the logic gate |
| Logics.LE23.Timer Out | Signal: Timer Output |
| Logics.LE23.Out | Signal: Latched Output (Q) |
| Logics.LE23.Out inverted | Signal: Negated Latched Output (Q NOT) |
| Logics.LE24.Gate Out | Signal: Output of the logic gate |

Parameters

| <i>Name</i> | <i>Description</i> |
|--------------------------|--|
| Logics.LE24.Timer Out | Signal: Timer Output |
| Logics.LE24.Out | Signal: Latched Output (Q) |
| Logics.LE24.Out inverted | Signal: Negated Latched Output (Q NOT) |
| Logics.LE25.Gate Out | Signal: Output of the logic gate |
| Logics.LE25.Timer Out | Signal: Timer Output |
| Logics.LE25.Out | Signal: Latched Output (Q) |
| Logics.LE25.Out inverted | Signal: Negated Latched Output (Q NOT) |
| Logics.LE26.Gate Out | Signal: Output of the logic gate |
| Logics.LE26.Timer Out | Signal: Timer Output |
| Logics.LE26.Out | Signal: Latched Output (Q) |
| Logics.LE26.Out inverted | Signal: Negated Latched Output (Q NOT) |
| Logics.LE27.Gate Out | Signal: Output of the logic gate |
| Logics.LE27.Timer Out | Signal: Timer Output |
| Logics.LE27.Out | Signal: Latched Output (Q) |
| Logics.LE27.Out inverted | Signal: Negated Latched Output (Q NOT) |
| Logics.LE28.Gate Out | Signal: Output of the logic gate |
| Logics.LE28.Timer Out | Signal: Timer Output |
| Logics.LE28.Out | Signal: Latched Output (Q) |
| Logics.LE28.Out inverted | Signal: Negated Latched Output (Q NOT) |
| Logics.LE29.Gate Out | Signal: Output of the logic gate |
| Logics.LE29.Timer Out | Signal: Timer Output |
| Logics.LE29.Out | Signal: Latched Output (Q) |
| Logics.LE29.Out inverted | Signal: Negated Latched Output (Q NOT) |
| Logics.LE30.Gate Out | Signal: Output of the logic gate |
| Logics.LE30.Timer Out | Signal: Timer Output |
| Logics.LE30.Out | Signal: Latched Output (Q) |
| Logics.LE30.Out inverted | Signal: Negated Latched Output (Q NOT) |
| Logics.LE31.Gate Out | Signal: Output of the logic gate |
| Logics.LE31.Timer Out | Signal: Timer Output |
| Logics.LE31.Out | Signal: Latched Output (Q) |
| Logics.LE31.Out inverted | Signal: Negated Latched Output (Q NOT) |
| Logics.LE32.Gate Out | Signal: Output of the logic gate |
| Logics.LE32.Timer Out | Signal: Timer Output |
| Logics.LE32.Out | Signal: Latched Output (Q) |
| Logics.LE32.Out inverted | Signal: Negated Latched Output (Q NOT) |
| Logics.LE33.Gate Out | Signal: Output of the logic gate |
| Logics.LE33.Timer Out | Signal: Timer Output |
| Logics.LE33.Out | Signal: Latched Output (Q) |
| Logics.LE33.Out inverted | Signal: Negated Latched Output (Q NOT) |
| Logics.LE34.Gate Out | Signal: Output of the logic gate |

Parameters

| <i>Name</i> | <i>Description</i> |
|--------------------------|--|
| Logics.LE34.Timer Out | Signal: Timer Output |
| Logics.LE34.Out | Signal: Latched Output (Q) |
| Logics.LE34.Out inverted | Signal: Negated Latched Output (Q NOT) |
| Logics.LE35.Gate Out | Signal: Output of the logic gate |
| Logics.LE35.Timer Out | Signal: Timer Output |
| Logics.LE35.Out | Signal: Latched Output (Q) |
| Logics.LE35.Out inverted | Signal: Negated Latched Output (Q NOT) |
| Logics.LE36.Gate Out | Signal: Output of the logic gate |
| Logics.LE36.Timer Out | Signal: Timer Output |
| Logics.LE36.Out | Signal: Latched Output (Q) |
| Logics.LE36.Out inverted | Signal: Negated Latched Output (Q NOT) |
| Logics.LE37.Gate Out | Signal: Output of the logic gate |
| Logics.LE37.Timer Out | Signal: Timer Output |
| Logics.LE37.Out | Signal: Latched Output (Q) |
| Logics.LE37.Out inverted | Signal: Negated Latched Output (Q NOT) |
| Logics.LE38.Gate Out | Signal: Output of the logic gate |
| Logics.LE38.Timer Out | Signal: Timer Output |
| Logics.LE38.Out | Signal: Latched Output (Q) |
| Logics.LE38.Out inverted | Signal: Negated Latched Output (Q NOT) |
| Logics.LE39.Gate Out | Signal: Output of the logic gate |
| Logics.LE39.Timer Out | Signal: Timer Output |
| Logics.LE39.Out | Signal: Latched Output (Q) |
| Logics.LE39.Out inverted | Signal: Negated Latched Output (Q NOT) |
| Logics.LE40.Gate Out | Signal: Output of the logic gate |
| Logics.LE40.Timer Out | Signal: Timer Output |
| Logics.LE40.Out | Signal: Latched Output (Q) |
| Logics.LE40.Out inverted | Signal: Negated Latched Output (Q NOT) |
| Logics.LE41.Gate Out | Signal: Output of the logic gate |
| Logics.LE41.Timer Out | Signal: Timer Output |
| Logics.LE41.Out | Signal: Latched Output (Q) |
| Logics.LE41.Out inverted | Signal: Negated Latched Output (Q NOT) |
| Logics.LE42.Gate Out | Signal: Output of the logic gate |
| Logics.LE42.Timer Out | Signal: Timer Output |
| Logics.LE42.Out | Signal: Latched Output (Q) |
| Logics.LE42.Out inverted | Signal: Negated Latched Output (Q NOT) |
| Logics.LE43.Gate Out | Signal: Output of the logic gate |
| Logics.LE43.Timer Out | Signal: Timer Output |
| Logics.LE43.Out | Signal: Latched Output (Q) |
| Logics.LE43.Out inverted | Signal: Negated Latched Output (Q NOT) |
| Logics.LE44.Gate Out | Signal: Output of the logic gate |

Parameters

| <i>Name</i> | <i>Description</i> |
|--------------------------|--|
| Logics.LE44.Timer Out | Signal: Timer Output |
| Logics.LE44.Out | Signal: Latched Output (Q) |
| Logics.LE44.Out inverted | Signal: Negated Latched Output (Q NOT) |
| Logics.LE45.Gate Out | Signal: Output of the logic gate |
| Logics.LE45.Timer Out | Signal: Timer Output |
| Logics.LE45.Out | Signal: Latched Output (Q) |
| Logics.LE45.Out inverted | Signal: Negated Latched Output (Q NOT) |
| Logics.LE46.Gate Out | Signal: Output of the logic gate |
| Logics.LE46.Timer Out | Signal: Timer Output |
| Logics.LE46.Out | Signal: Latched Output (Q) |
| Logics.LE46.Out inverted | Signal: Negated Latched Output (Q NOT) |
| Logics.LE47.Gate Out | Signal: Output of the logic gate |
| Logics.LE47.Timer Out | Signal: Timer Output |
| Logics.LE47.Out | Signal: Latched Output (Q) |
| Logics.LE47.Out inverted | Signal: Negated Latched Output (Q NOT) |
| Logics.LE48.Gate Out | Signal: Output of the logic gate |
| Logics.LE48.Timer Out | Signal: Timer Output |
| Logics.LE48.Out | Signal: Latched Output (Q) |
| Logics.LE48.Out inverted | Signal: Negated Latched Output (Q NOT) |
| Logics.LE49.Gate Out | Signal: Output of the logic gate |
| Logics.LE49.Timer Out | Signal: Timer Output |
| Logics.LE49.Out | Signal: Latched Output (Q) |
| Logics.LE49.Out inverted | Signal: Negated Latched Output (Q NOT) |
| Logics.LE50.Gate Out | Signal: Output of the logic gate |
| Logics.LE50.Timer Out | Signal: Timer Output |
| Logics.LE50.Out | Signal: Latched Output (Q) |
| Logics.LE50.Out inverted | Signal: Negated Latched Output (Q NOT) |
| Logics.LE51.Gate Out | Signal: Output of the logic gate |
| Logics.LE51.Timer Out | Signal: Timer Output |
| Logics.LE51.Out | Signal: Latched Output (Q) |
| Logics.LE51.Out inverted | Signal: Negated Latched Output (Q NOT) |
| Logics.LE52.Gate Out | Signal: Output of the logic gate |
| Logics.LE52.Timer Out | Signal: Timer Output |
| Logics.LE52.Out | Signal: Latched Output (Q) |
| Logics.LE52.Out inverted | Signal: Negated Latched Output (Q NOT) |
| Logics.LE53.Gate Out | Signal: Output of the logic gate |
| Logics.LE53.Timer Out | Signal: Timer Output |
| Logics.LE53.Out | Signal: Latched Output (Q) |
| Logics.LE53.Out inverted | Signal: Negated Latched Output (Q NOT) |
| Logics.LE54.Gate Out | Signal: Output of the logic gate |

Parameters

| <i>Name</i> | <i>Description</i> |
|--------------------------|--|
| Logics.LE54.Timer Out | Signal: Timer Output |
| Logics.LE54.Out | Signal: Latched Output (Q) |
| Logics.LE54.Out inverted | Signal: Negated Latched Output (Q NOT) |
| Logics.LE55.Gate Out | Signal: Output of the logic gate |
| Logics.LE55.Timer Out | Signal: Timer Output |
| Logics.LE55.Out | Signal: Latched Output (Q) |
| Logics.LE55.Out inverted | Signal: Negated Latched Output (Q NOT) |
| Logics.LE56.Gate Out | Signal: Output of the logic gate |
| Logics.LE56.Timer Out | Signal: Timer Output |
| Logics.LE56.Out | Signal: Latched Output (Q) |
| Logics.LE56.Out inverted | Signal: Negated Latched Output (Q NOT) |
| Logics.LE57.Gate Out | Signal: Output of the logic gate |
| Logics.LE57.Timer Out | Signal: Timer Output |
| Logics.LE57.Out | Signal: Latched Output (Q) |
| Logics.LE57.Out inverted | Signal: Negated Latched Output (Q NOT) |
| Logics.LE58.Gate Out | Signal: Output of the logic gate |
| Logics.LE58.Timer Out | Signal: Timer Output |
| Logics.LE58.Out | Signal: Latched Output (Q) |
| Logics.LE58.Out inverted | Signal: Negated Latched Output (Q NOT) |
| Logics.LE59.Gate Out | Signal: Output of the logic gate |
| Logics.LE59.Timer Out | Signal: Timer Output |
| Logics.LE59.Out | Signal: Latched Output (Q) |
| Logics.LE59.Out inverted | Signal: Negated Latched Output (Q NOT) |
| Logics.LE60.Gate Out | Signal: Output of the logic gate |
| Logics.LE60.Timer Out | Signal: Timer Output |
| Logics.LE60.Out | Signal: Latched Output (Q) |
| Logics.LE60.Out inverted | Signal: Negated Latched Output (Q NOT) |
| Logics.LE61.Gate Out | Signal: Output of the logic gate |
| Logics.LE61.Timer Out | Signal: Timer Output |
| Logics.LE61.Out | Signal: Latched Output (Q) |
| Logics.LE61.Out inverted | Signal: Negated Latched Output (Q NOT) |
| Logics.LE62.Gate Out | Signal: Output of the logic gate |
| Logics.LE62.Timer Out | Signal: Timer Output |
| Logics.LE62.Out | Signal: Latched Output (Q) |
| Logics.LE62.Out inverted | Signal: Negated Latched Output (Q NOT) |
| Logics.LE63.Gate Out | Signal: Output of the logic gate |
| Logics.LE63.Timer Out | Signal: Timer Output |
| Logics.LE63.Out | Signal: Latched Output (Q) |
| Logics.LE63.Out inverted | Signal: Negated Latched Output (Q NOT) |
| Logics.LE64.Gate Out | Signal: Output of the logic gate |

Parameters

| <i>Name</i> | <i>Description</i> |
|--------------------------|--|
| Logics.LE64.Timer Out | Signal: Timer Output |
| Logics.LE64.Out | Signal: Latched Output (Q) |
| Logics.LE64.Out inverted | Signal: Negated Latched Output (Q NOT) |
| Logics.LE65.Gate Out | Signal: Output of the logic gate |
| Logics.LE65.Timer Out | Signal: Timer Output |
| Logics.LE65.Out | Signal: Latched Output (Q) |
| Logics.LE65.Out inverted | Signal: Negated Latched Output (Q NOT) |
| Logics.LE66.Gate Out | Signal: Output of the logic gate |
| Logics.LE66.Timer Out | Signal: Timer Output |
| Logics.LE66.Out | Signal: Latched Output (Q) |
| Logics.LE66.Out inverted | Signal: Negated Latched Output (Q NOT) |
| Logics.LE67.Gate Out | Signal: Output of the logic gate |
| Logics.LE67.Timer Out | Signal: Timer Output |
| Logics.LE67.Out | Signal: Latched Output (Q) |
| Logics.LE67.Out inverted | Signal: Negated Latched Output (Q NOT) |
| Logics.LE68.Gate Out | Signal: Output of the logic gate |
| Logics.LE68.Timer Out | Signal: Timer Output |
| Logics.LE68.Out | Signal: Latched Output (Q) |
| Logics.LE68.Out inverted | Signal: Negated Latched Output (Q NOT) |
| Logics.LE69.Gate Out | Signal: Output of the logic gate |
| Logics.LE69.Timer Out | Signal: Timer Output |
| Logics.LE69.Out | Signal: Latched Output (Q) |
| Logics.LE69.Out inverted | Signal: Negated Latched Output (Q NOT) |
| Logics.LE70.Gate Out | Signal: Output of the logic gate |
| Logics.LE70.Timer Out | Signal: Timer Output |
| Logics.LE70.Out | Signal: Latched Output (Q) |
| Logics.LE70.Out inverted | Signal: Negated Latched Output (Q NOT) |
| Logics.LE71.Gate Out | Signal: Output of the logic gate |
| Logics.LE71.Timer Out | Signal: Timer Output |
| Logics.LE71.Out | Signal: Latched Output (Q) |
| Logics.LE71.Out inverted | Signal: Negated Latched Output (Q NOT) |
| Logics.LE72.Gate Out | Signal: Output of the logic gate |
| Logics.LE72.Timer Out | Signal: Timer Output |
| Logics.LE72.Out | Signal: Latched Output (Q) |
| Logics.LE72.Out inverted | Signal: Negated Latched Output (Q NOT) |
| Logics.LE73.Gate Out | Signal: Output of the logic gate |
| Logics.LE73.Timer Out | Signal: Timer Output |
| Logics.LE73.Out | Signal: Latched Output (Q) |
| Logics.LE73.Out inverted | Signal: Negated Latched Output (Q NOT) |
| Logics.LE74.Gate Out | Signal: Output of the logic gate |

Parameters

| <i>Name</i> | <i>Description</i> |
|--------------------------|--|
| Logics.LE74.Timer Out | Signal: Timer Output |
| Logics.LE74.Out | Signal: Latched Output (Q) |
| Logics.LE74.Out inverted | Signal: Negated Latched Output (Q NOT) |
| Logics.LE75.Gate Out | Signal: Output of the logic gate |
| Logics.LE75.Timer Out | Signal: Timer Output |
| Logics.LE75.Out | Signal: Latched Output (Q) |
| Logics.LE75.Out inverted | Signal: Negated Latched Output (Q NOT) |
| Logics.LE76.Gate Out | Signal: Output of the logic gate |
| Logics.LE76.Timer Out | Signal: Timer Output |
| Logics.LE76.Out | Signal: Latched Output (Q) |
| Logics.LE76.Out inverted | Signal: Negated Latched Output (Q NOT) |
| Logics.LE77.Gate Out | Signal: Output of the logic gate |
| Logics.LE77.Timer Out | Signal: Timer Output |
| Logics.LE77.Out | Signal: Latched Output (Q) |
| Logics.LE77.Out inverted | Signal: Negated Latched Output (Q NOT) |
| Logics.LE78.Gate Out | Signal: Output of the logic gate |
| Logics.LE78.Timer Out | Signal: Timer Output |
| Logics.LE78.Out | Signal: Latched Output (Q) |
| Logics.LE78.Out inverted | Signal: Negated Latched Output (Q NOT) |
| Logics.LE79.Gate Out | Signal: Output of the logic gate |
| Logics.LE79.Timer Out | Signal: Timer Output |
| Logics.LE79.Out | Signal: Latched Output (Q) |
| Logics.LE79.Out inverted | Signal: Negated Latched Output (Q NOT) |
| Logics.LE80.Gate Out | Signal: Output of the logic gate |
| Logics.LE80.Timer Out | Signal: Timer Output |
| Logics.LE80.Out | Signal: Latched Output (Q) |
| Logics.LE80.Out inverted | Signal: Negated Latched Output (Q NOT) |

Setting Lock

By means of the Setting Lock, parameter settings can be locked against any changes as long as the assigned signal is true (active). The Setting Lock can be activated within menu [Field Para/General Settings/Lock Settings].

Bypass of the Setting Lock

The setting lock can be overwritten (temporarily) in case that the status of the signal that activates the setting lock cannot be modified or should not be modified (spare key).

The Setting Lock can be bypassed by means of the Direct Control Parameter »*Setting Lock Bypass*« [Field Para/General Settings/Setting Lock Bypass]. The protective device will fall back into the Setting Lock either:

- Directly after a parameter change has been saved, else
- 10 minutes after the bypass has been activated.

Device Parameters

Sys

Date and Time

In menu »*Device parameters/Date/Time*« you can set date and time.

Version

Within this menu »*Device parameters/Version*« you can obtain information on the soft- and hardware version.

Display of ANSI-Codes

The display of ANSI codes can be activated within menu »*Device parameters/HMI//Display ANSI device numbers*«

TCP/IP Settings

Within menu »*Device Para / TCP/IP/TCP/IP Config*« the TCP/IP settings have to be set.

The first-time setting of the TCP/IP Parameters can be done at the panel (HMI) only.

NOTICE

Establishing a connection via TCP/IP to the device is only possible if your device is equipped with an Ethernet Interface (RJ45).







Contact your IT administrator in order to establish the network connection.

Set the TCP/IP Parameters

Call up »*Device parameter/TCP/IP*« at the HMI (panel) and set the following parameters:

- TCP/IP address
- Subnetmask
- Gateway







Direct Commands of the System Module

| Parameter | Description | Setting range | Default | Menu path |
|--|---|------------------|----------|--------------------------------|
| Ack BO LED Scd TCmd  | Reset the binary output relays, LEDs, SCADA and the Trip Command. | inactive, active | inactive | [Operation /Acknowledge] |
| Ack LED  | All acknowledgeable LEDs will be acknowledged. | inactive, active | inactive | [Operation /Acknowledge] |
| Ack BO  | All acknowledgeable binary output relays will be acknowledged. | inactive, active | inactive | [Operation /Acknowledge] |
| Ack Scada  | SCADA will be acknowledged. | inactive, active | inactive | [Operation /Acknowledge] |
| Reboot  | Rebooting the device. | no, yes | no | [Service /General] |
| Setting Lock Bypass  | Short-period unlock of the Setting Lock | inactive, active | inactive | [Field Para /General settings] |



CAUTION CAUTION, rebooting the device manually will release the Supervision Contact.

Global Protection Parameters of the System

| Parameter | Description | Setting range | Default | Menu path |
|--|-------------------------|--|---------|--------------------------------|
| PSet-Switch  | Switching Parameter Set | PS1, PS2, PS3, PS4, PSS via Inp fct, PSS via Scada | PS1 | [Protection Para /PSet-Switch] |

| Parameter | Description | Setting range | Default | Menu path |
|---|---|-----------------------|---------|--------------------------------|
|  PS1: activated by | <p>This Setting Group will be the active one if: The Parameter Setting Group Switch is set to "Switch via Input" and the other three input functions are inactive at the same time. In case that there is more than one input function active, no Parameter Setting Group Switch will be executed. In case all input functions are inactive, the device will keep working with the Setting Group that was activated lastly.</p> <p>Only available if: PSet-Switch = PSS via Inp fct</p> | 1..n, PSS | -- | [Protection Para /PSet-Switch] |
|  PS2: activated by | <p>This Setting Group will be the active one if: The Parameter Setting Group Switch is set to "Switch via Input" and the other three input functions are inactive at the same time. In case that there is more than one input function active, no Parameter Setting Group Switch will be executed. In case all input functions are inactive, the device will keep working with the Setting Group that was activated lastly.</p> <p>Only available if: PSet-Switch = PSS via Inp fct</p> | 1..n, PSS | -- | [Protection Para /PSet-Switch] |
|  PS3: activated by | <p>This Setting Group will be the active one if: The Parameter Setting Group Switch is set to "Switch via Input" and the other three input functions are inactive at the same time. In case that there is more than one input function active, no Parameter Setting Group Switch will be executed. In case all input functions are inactive, the device will keep working with the Setting Group that was activated lastly.</p> <p>Only available if: PSet-Switch = PSS via Inp fct</p> | 1..n, PSS | -- | [Protection Para /PSet-Switch] |
|  PS4: activated by | <p>This Setting Group will be the active one if: The Parameter Setting Group Switch is set to "Switch via Input" and the other three input functions are inactive at the same time. In case that there is more than one input function active, no Parameter Setting Group Switch will be executed. In case all input functions are inactive, the device will keep working with the Setting Group that was activated lastly.</p> <p>Only available if: PSet-Switch = PSS via Inp fct</p> | 1..n, PSS | -- | [Protection Para /PSet-Switch] |
|  Remote Reset | <p>Enables or disables the option to acknowledge from external/remote via signals (assignments) and SCADA.</p> | inactive, active | active | [Device Para /Ex Acknowledge] |
|  Ack LED | <p>All acknowledgeable LEDs will be acknowledged if the state of the assigned signal becomes true.</p> <p>Only available if: Remote Reset = active</p> | 1..n, Assignment List | -- | [Device Para /Ex Acknowledge] |
|  Ack BO | <p>All acknowledgeable binary output relays will be acknowledged if the state of the assigned signal becomes true.</p> <p>Only available if: Remote Reset = active</p> | 1..n, Assignment List | -- | [Device Para /Ex Acknowledge] |

Device Parameters

| <i>Parameter</i> | <i>Description</i> | <i>Setting range</i> | <i>Default</i> | <i>Menu path</i> |
|--|--|---|-----------------|---|
| Ack Scada  | SCADA will be acknowledged if the state of the assigned signal becomes true. Only available if: Remote Reset = active | 1..n, Assignment List | .-. | [Device Para /Ex Acknowledge] |
| Scaling  | Display of the measured values as primary, secondary or per unit values | Per unit values, Primary values, Secondary values | Per unit values | [Device Para /Measurment Display /General settings] |
| Lock Settings  | No parameters can be changed as long as this input is true. The parameter settings are locked. | 1..n, Assignment List | .-. | [Field Para /General settings] |

System Module Input States

| <i>Name</i> | <i>Description</i> | <i>Assignment via</i> |
|-----------------|---|-----------------------------------|
| Ack LED-I | Module input state: LEDs acknowledgement by digital input | [Device Para /Ex Acknowledge] |
| Ack BO-I | Module input state: Acknowledgement of the binary Output Relays | [Device Para /Ex Acknowledge] |
| Ack Scada-I | Module input state: Acknowledge Scada via digital input. The replica that SCADA has got from the device is to be reset. | [Device Para /Ex Acknowledge] |
| PS1-I | State of the module input respectively of the signal, that should activate this Parameter Setting Group. | [Protection Para /PSet-Switch] |
| PS2-I | State of the module input respectively of the signal, that should activate this Parameter Setting Group. | [Protection Para /PSet-Switch] |
| PS3-I | State of the module input respectively of the signal, that should activate this Parameter Setting Group. | [Protection Para /PSet-Switch] |
| PS4-I | State of the module input respectively of the signal, that should activate this Parameter Setting Group. | [Protection Para /PSet-Switch] |
| Lock Settings-I | State of the module input: No parameters can be changed as long as this input is true. The parameter settings are locked. | [Field Para /General settings] |

System Module Signals

| <i>Signal</i> | <i>Description</i> |
|---------------------|--|
| Reboot | Signal: Rebooting the device: 1=Normal Start-up; 2=Reboot by the Operator; 3=Reboot by means of Super Reset; 4=outdated; 5=outdated; 6=Unknown Error Source; 7=Forced Reboot (initiated by the main processor); 8=Exceeded Time Limit of the Protection Cycle; 9= Forced Reboot (initiated by the digital signal processor); 10=Exceeded Time Limit of the Measured Value Processing; 11=Sags of the Supply Voltage; 12=Illegal Memory Access. |
| Act Set | Signal: Active Parameter Set |
| PS 1 | Signal: Parameter Set 1 |
| PS 2 | Signal: Parameter Set 2 |
| PS 3 | Signal: Parameter Set 3 |
| PS 4 | Signal: Parameter Set 4 |
| PSS manual | Signal: Manual Switch over of a Parameter Set |
| PSS via Scada | Signal: Parameter Set Switch via Scada. Write into this output byte the integer of the parameter set that should become active (e.g. 4 => Switch onto parameter set 4). |
| PSS via Inp fct | Signal: Parameter Set Switch via input function |
| min 1 param changed | Signal: At least one parameter has been changed |
| Setting Lock Bypass | Signal: Short-period unlock of the Setting Lock |
| Param to be saved | Number of parameters to be saved. 0 means that all parameter changes are overtaken. |
| Ack LED | Signal: LEDs acknowledgement |
| Ack BO | Signal: Acknowledgement of the Binary Outputs |
| Ack Counter | Signal: Reset of all Counters |
| Ack Scada | Signal: Acknowledge Scada |
| Ack TripCmd | Signal: Reset Trip Command |
| Ack LED-HMI | Signal: LEDs acknowledgement :HMI |
| Ack BO-HMI | Signal: Acknowledgement of the Binary Outputs :HMI |
| Ack Counter-HMI | Signal: Reset of all Counters :HMI |
| Ack Scada-HMI | Signal: Acknowledge Scada :HMI |
| Ack TripCmd-HMI | Signal: Reset Trip Command :HMI |
| Ack LED-Sca | Signal: LEDs acknowledgement :SCADA |
| Ack BO-Sca | Signal: Acknowledgement of the Binary Outputs :SCADA |
| Ack Counter-Sca | Signal: Reset of all Counters :SCADA |
| Ack Scada-Sca | Signal: Acknowledge Scada :SCADA |
| Ack TripCmd-Sca | Signal: Reset Trip Command :SCADA |
| Res OperationsCr | Signal:: Res OperationsCr |
| Res AlarmCr | Signal:: Res AlarmCr |
| Res TripCmdCr | Signal:: Res TripCmdCr |
| Res TotalCr | Signal:: Res TotalCr |

Special Values of the System Module



| <i>Value</i> | <i>Description</i> | <i>Menu path</i> |
|--------------------|--|---|
| Build | Build | [Device Para /Version] |
| Version | Version | [Device Para /Version] |
| Operating hours Cr | Operating hours counter of the protective device | [Operation /Count and RevData /Sys] |

Field Parameters







Field Para

Within the field parameters you can set all parameters, that are relevant for the primary side and the mains operational method like frequency, primary and secondary values...



General Field Parameters

| <i>Parameter</i> | <i>Description</i> | <i>Setting range</i> | <i>Default</i> | <i>Menu path</i> |
|---|--------------------------|----------------------|----------------|-----------------------------------|
| Phase Sequence  | Phase Sequence direction | ABC, ACB | ABC | [Field Para /General settings] |
| f  | Nominal frequency | 50Hz, 60Hz | 50Hz | [Field Para /General settings] |









Field Parameters – Current Related







| Parameter | Description | Setting range | Default | Menu path |
|---|--|---------------|---------|--|
| CT pri  | Nominal current of the primary side of the current transformers. | 1 - 50000A | 1000A | [Field Para /CT] |
| CT sec  | Nominal current of the secondary side of the current transformers. | 1A, 5A | 1A | [Field Para /CT] |
| CT dir  | Protection functions with directional feature can only work properly if the connection of the current transformers is free of wiring errors. If all current transformers are connected to the device with an incorrect polarity, the wiring error can be compensated by this parameter. This parameter turns the current vectors by 180 degrees. | 0°, 180° | 0° | [Field Para /CT] |
| ECT pri  | This parameter defines the primary nominal current of the connected earth current transformer. If the earth current is measured via the Holmgreen connection, the primary value of the phase current transformer must be entered here. | 1 - 50000A | 1000A | [Field Para /CT] |
| ECT sec  | This parameter defines the secondary nominal current of the connected earth current transformer. If the earth current is done via the Holmgreen connection, the primary value of the phase current transformer must be entered here. | 1A, 5A | 1A | [Field Para /CT] |
| ECT dir  | Earth fault protection with directional feature depends also on the correct wiring of the earth current transformer. An incorrect polarity/wiring can be corrected by means of the settings "0°" or "180°". The operator has the possibility of turning the current vector by 180 degrees (change of sign) without modification of the wiring. This means, that – in terms of figures - the determined current indicator was turned by 180° by the device. | 0°, 180° | 0° | [Field Para /CT] |
| IL1, IL2, IL3 Cutoff Level  | The Current shown in the Display or within the PC Software will be displayed as zero, if the Current falls below this Cutoff Level. This parameter has no impact on recorders. | 0.0 - 0.100In | 0.005In | [Device Para /Measurem Display /Current] |

Field Parameters



| <i>Parameter</i> | <i>Description</i> | <i>Setting range</i> | <i>Default</i> | <i>Menu path</i> |
|---|--|----------------------|----------------|--|
| IG meas Cutoff Level  | The measured Earth Current shown in the Display or within the PC Software will be displayed as zero, if the measured Earth Current falls below this Cutoff Level. This parameter has no impact on recorders. | 0.0 - 0.100In | 0.005In | [Device Para /Measurem Display /Current] |
| IG calc Cutoff Level  | The calculated Earth Current shown in the Display or within the PC Software will be displayed as zero, if the calculated Earth Current falls below this Cutoff Level. This parameter has no impact on recorders. | 0.0 - 0.100In | 0.005In | [Device Para /Measurem Display /Current] |
| I012 Cutoff Level  | The Symmetrical Component shown in the Display or within the PC Software will be displayed as zero, if the Symmetrical Component falls below this Cutoff Level. This parameter has no impact on recorders. | 0.0 - 0.100In | 0.005In | [Device Para /Measurem Display /Current] |

Field Parameters – Voltage Related

| Parameter | Description | Setting range | Default | Menu path |
|---|---|---|-----------------|-----------------------------------|
| VT pri  | Nominal voltage of the Voltage Transformers at the primary side. The phase to phase voltage is to be entered even if the load is in delta connection. | 60 - 500000V | 10000V | [Field Para /VT] |
| VT sec  | Nominal voltage of the Voltage Transformers at the secondary side. The phase to phase voltage is to be entered even if the load is in delta connection. | 60.00 - 520.00V | 100V | [Field Para /VT] |
| VT con  | This parameter has to be set in order to ensure the correct assignment of the voltage measurement channels in the device. | Phase to Phase, Phase to Ground | Phase to Ground | [Field Para /VT] |
| EVT pri  | Primary nominal voltage of the e-n winding of the voltage transformers, which is only taken into account in the direct measurement of the residual voltage (GVT con=measured/broken delta). | 60 - 500000V | 10000V | [Field Para /VT] |
| EVT sec  | Secondary nominal voltage of the e-n winding of the voltage transformers, which is only taken into account in the direct measurement of the residual voltage. | 35.00 - 520.00V | 100V | [Field Para /VT] |
| V Block f  | Threshold for the release of the frequency stages | 0.15 - 1.00Vn | 0.5Vn | [Field Para /General settings] |
| V Sync  | The fourth measuring input of the voltage measuring card measures the voltage that is to be synchronized. | L1, L2, L3, L12, L23, L31 | L12 | [Field Para /VT] |
| delta phi - Mode  | The delta phi element (vector surge) trips, if the permissible voltage angle shift (delta phi) of the three measured voltages (phase-ground or phase-phase) in: one phase, two phases or within all phases is exceeded. | one phase, two phases, three phases | two phases | [Field Para /VT] |
| Phase MTA  | Maximum Torque Angle: Angle between phase current and reference voltage in case of a short circuit. This angle is needed to determine the fault direction in case of short circuits. | 0 - 360° | 45° | [Field Para /Direction] |

| Parameter | Description | Setting range | Default | Menu path |
|---|--|---|-------------|--|
| IG calc dir ctrl  | Options for direction detection. IGcalc is used as operating quantity. | IG calc 3V0, IG calc IPol (IG meas), Dual, I2,V2 | IG calc 3V0 | [Field Para /Direction] |
| IG meas dir ctrl  | Options for direction detection. IGmeas is used as operating quantity. | IG meas 3V0, I2,V2, Dual | IG meas 3V0 | [Field Para /Direction] |
| 3V0 Source  | Earth overcurrent protection elements take into account this parameter for direction decisions. You have to ensure, that this parameter is set to "Measured" only if the residual voltage is fed to the fourth measuring input of the voltage measuring card. | measured, calculated | measured | [Field Para /Direction] |
| Ground MTA  | Ground Maximum Torque Angle: Angle between chosen operating quantity and chosen reference quantity in case of a ground fault. This angle is needed to determine the ground fault direction in case of a short circuit. Depending on the selected ground direction option, different MTA values are used: IGcalc 3V0, IGmeas 3V0 : Ground MTA; IGcalc Neg, IGmeas Neg : $90^\circ + \text{Phase MTA}$; IGcalc IPol : 0° ; IGcalc Dual : 0° (if I2 and V2 available) or Ground MTA; IGmeas Dual : $90^\circ + \text{Phase MTA}$ (if I2 and V2 available) or Ground MTA. | 0 - 360° | 110° | [Field Para /Direction] |
| ECT Angle Cor  | Fine adjustment of the measuring angle of the earth current transformers. By means of the Angle Correction, faults of the earth voltage transformers can be taken into account. | $-45 - 45^\circ$ | 0° | [Field Para /Direction] |
| V Cutoff Level  | The Phase Voltage shown in the Display or within the PC Software will be displayed as zero, if the Phase Voltage falls below this Cutoff Level. This parameter has no impact on recorders. This parameter is related to the voltage that is connected to the device (phase-to-phase or phase-to-earth). | 0.0 - 0.100Vn | 0.005Vn | [Device Para /Measurem Display /Voltage] |
| VG meas Cutoff Level  | The measured Residual Voltage shown in the Display or within the PC Software will be displayed as zero, if the measured Residual Voltage falls below this Cutoff Level. This parameter has no impact on recorders. | 0.0 - 0.100Vn | 0.005Vn | [Device Para /Measurem Display /Voltage] |

Field Parameters

| <i>Parameter</i> | <i>Description</i> | <i>Setting range</i> | <i>Default</i> | <i>Menu path</i> |
|---|--|----------------------|----------------|---|
| VG calc Cutoff Level  | The calculated Residual Voltage shown in the Display or within the PC Software will be displayed as zero, if the calculated Residual Voltage falls below this Cutoff Level. This parameter has no impact on recorders. | 0.0 - 0.100Vn | 0.005Vn | [Device Para /Measurement Display /Voltage] |
| V012 Comp Cutoff Level  | The Symmetrical Component shown in the Display or within the PC Software will be displayed as zero, if the Symmetrical Component falls below this Cutoff Level. This parameter has no impact on recorders. | 0.0 - 0.100Vn | 0.005Vn | [Device Para /Measurement Display /Voltage] |

Blockings

The device provides a function for temporary and permanent blocking of the complete protection functionality or of single protection stages.



WARNING Make absolutely sure that no illogical or even life-threatening blockings are allocated.

Make sure that you do not carelessly deactivate protection functions which have to be available according to the protection concept.

Permanent Blocking

Switching ON or OFF the complete protection functionality

In module »*Protection*« the complete protection of the device can be switched on or off. Set the parameter *Function* to »*active*« or »*inactive*« in module »*Prot*«.



WARNING Only if in module »*Prot*« the parameter »*Function*« is = »*active*«, the protection is activated; i.e. with »*Function*« = »*inactive*«, no protection function is operating. Then the device cannot protect any components.

Switching modules ON or OFF

Each of the modules can be switched on or off (permanently). This is achieved when the parameter »*Function*« is set to »*active*« or »*inactive*« in the respective module.

Activating or deactivating the tripping command of a protection stage permanently

In each of the protection stages the tripping command to the CB can be permanently blocked. For this purpose the parameter »*TripCmd Blo*« has to be set to »*active*«.

Temporary Blocking

To block the complete protection of the device temporarily by a signal

In module »*Prot*« the complete protection of the device can be blocked temporarily by a signal. On condition that a module-external blocking is permitted »*ExBlo Fc=active*«. In addition to this, a related blocking signal from the »assignment list« must have been assigned. For the time the allocated blocking signal is active, the module is blocked.



WARNING If the module »*Prot*« is blocked, the complete protection function does not work. As long as the blocking signal is active, the device cannot protect any components.

To block a complete protection module temporarily by an active assignment

- In order to establish a temporary blockage of a protection module, the parameter »*ExBlo Fc*« of the module has to be set to »*active*«. This gives the permission: »This module can be blocked«.
- Within the general protection parameters a signal has to be additionally chosen from the »ASSIGNMENT LIST«. The blocking only becomes active when the assigned signal is active.

To block the tripping command of a protection stage temporarily by an active assignment.

The tripping command of any of the protection modules can be blocked from external. In this case, external does not only mean from outside the device, but also from outside the module. Not only real external signals are permitted to be used as blocking signals, as for example, the state of a digital input, but you can also choose any other signal from the »assignment list«.

- In order to establish a temporary blockage of a protection stage, the parameter »*ExBlo TripCmd Fc*« of the module has to be set to »*active*«. This gives the permission: »The tripping command of this stage can be blocked«.
- Within the general protection parameters, a signal has to be chosen additionally and assigned to the parameter »*ExBlo*« from the »assignment list«. If the selected signal is activated, the temporary blockage becomes effective.

To Activate or Deactivate the Tripping Command of a Protection Module

Trip blockings

name = all modules that are blockable

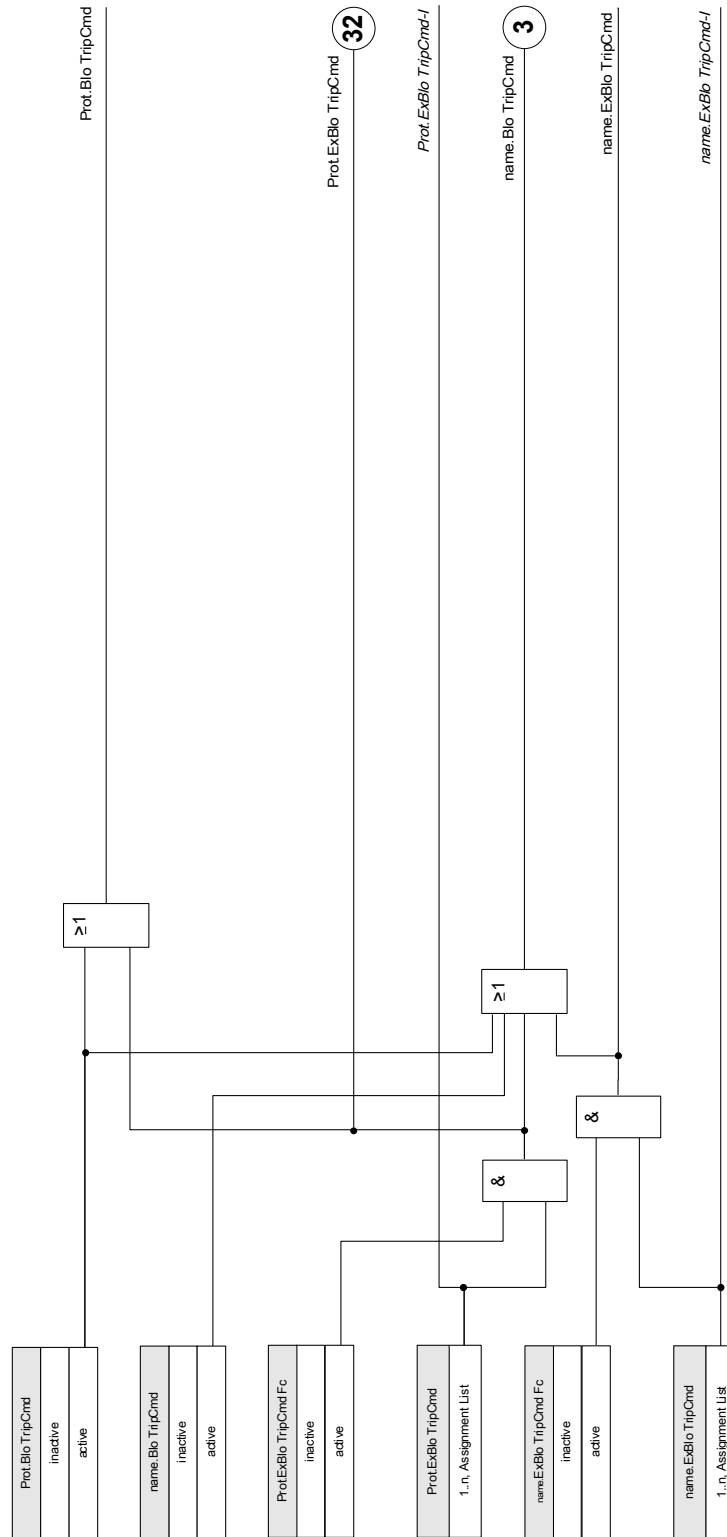

Activate, Deactivate Respectively Block Temporarily Protection Functions

The following diagram applies to all protective elements except: Phase current, Earth current and Q->&V< protection elements.

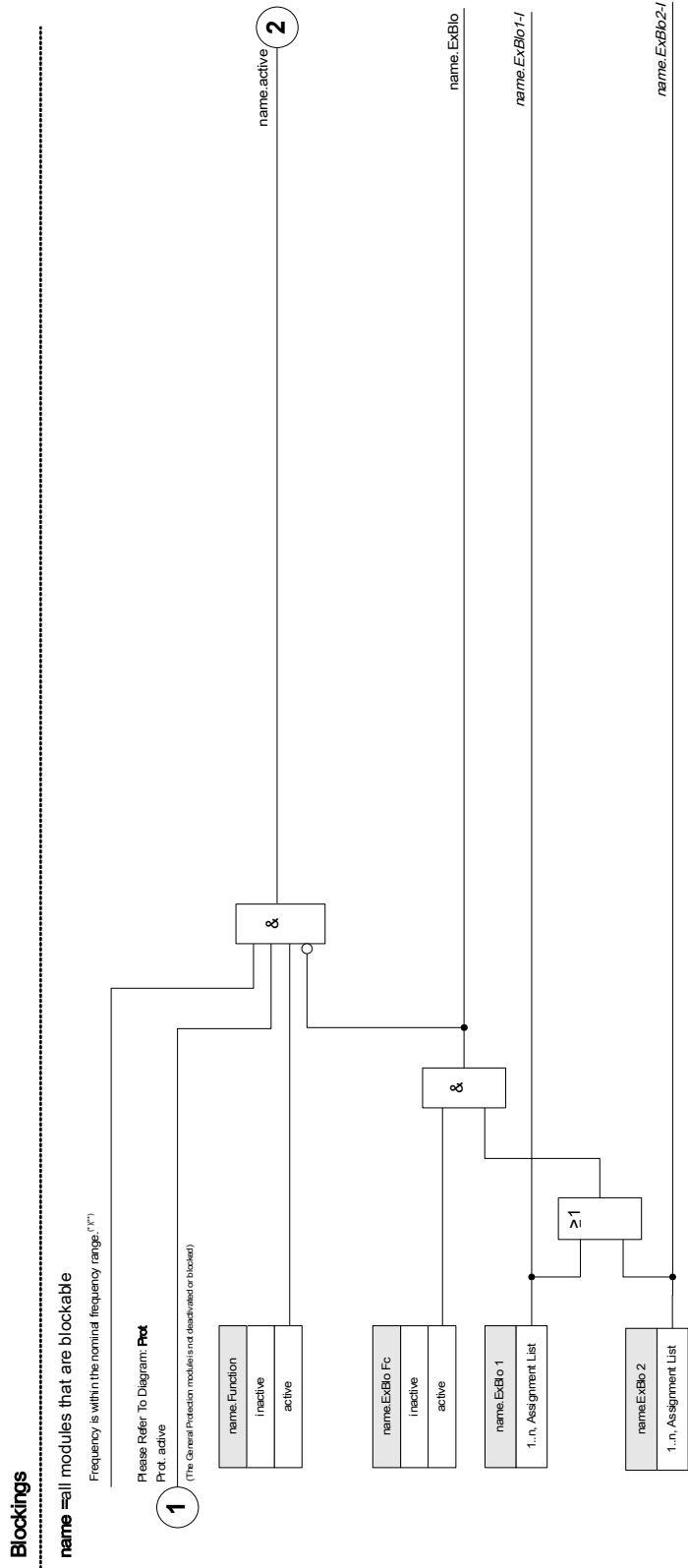

*All protective elements will be blocked that are using fundamental or harmonics measured values; if the frequency leaves the nominal frequency range. Protective elements that are using RMS values will remain active. See chapter "Wide frequency range".

**This applies to devices that offer wide frequency range measurement only.

The following diagram is applies to the Q->&V< Protection:

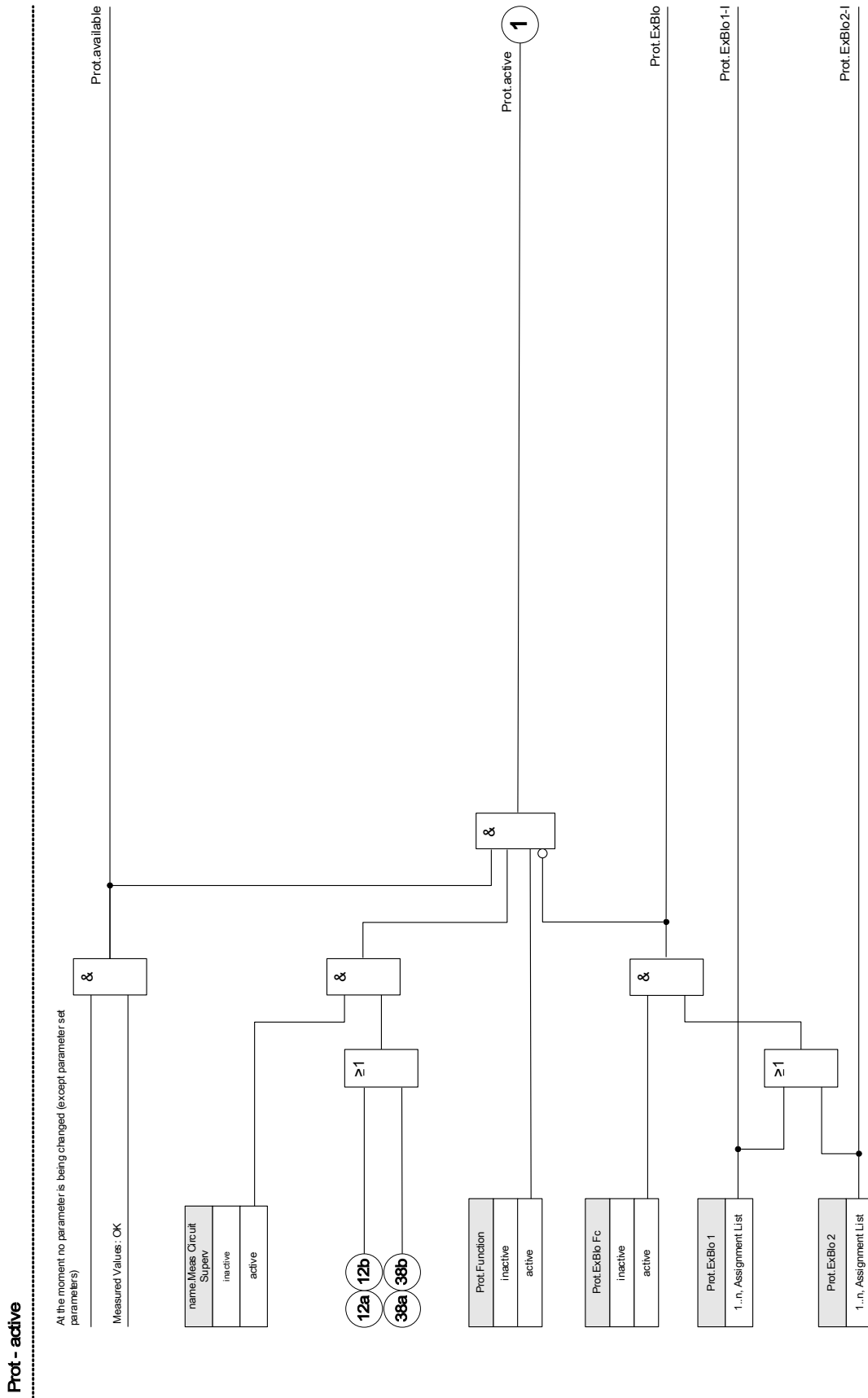

Current protective functions cannot only be blocked permanently («function = inactive») or temporarily by any blocking signal from the »assignment list«, but also by »reverse Interlocking«.

The following diagram applies phase current elements:

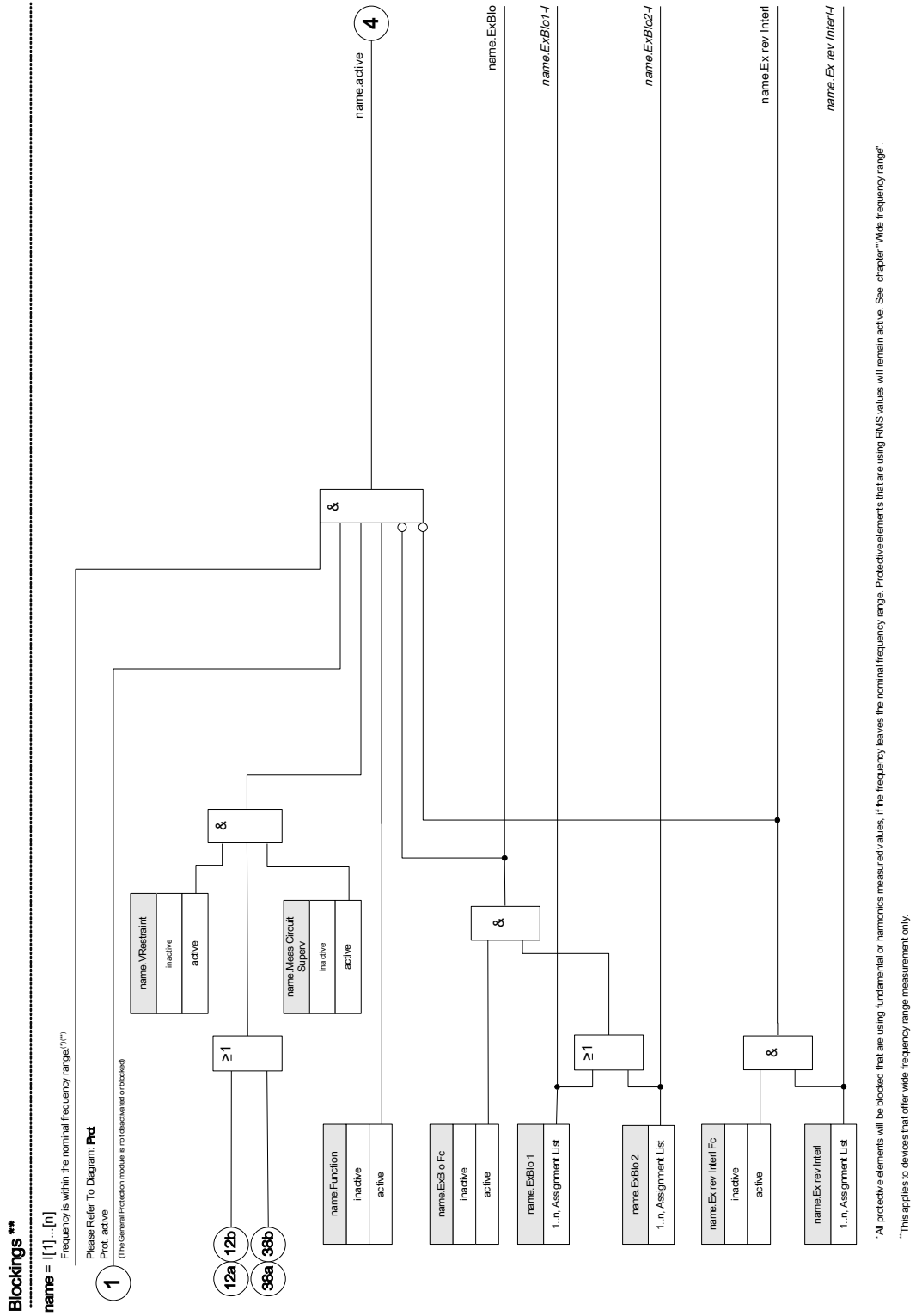

Earth current protective functions cannot only be blocked permanently (»function = inactive«) or temporarily by any blocking signal from the »assignment list«, but also by »reverse Interlocking«.

The following diagram applies to earth current elements:

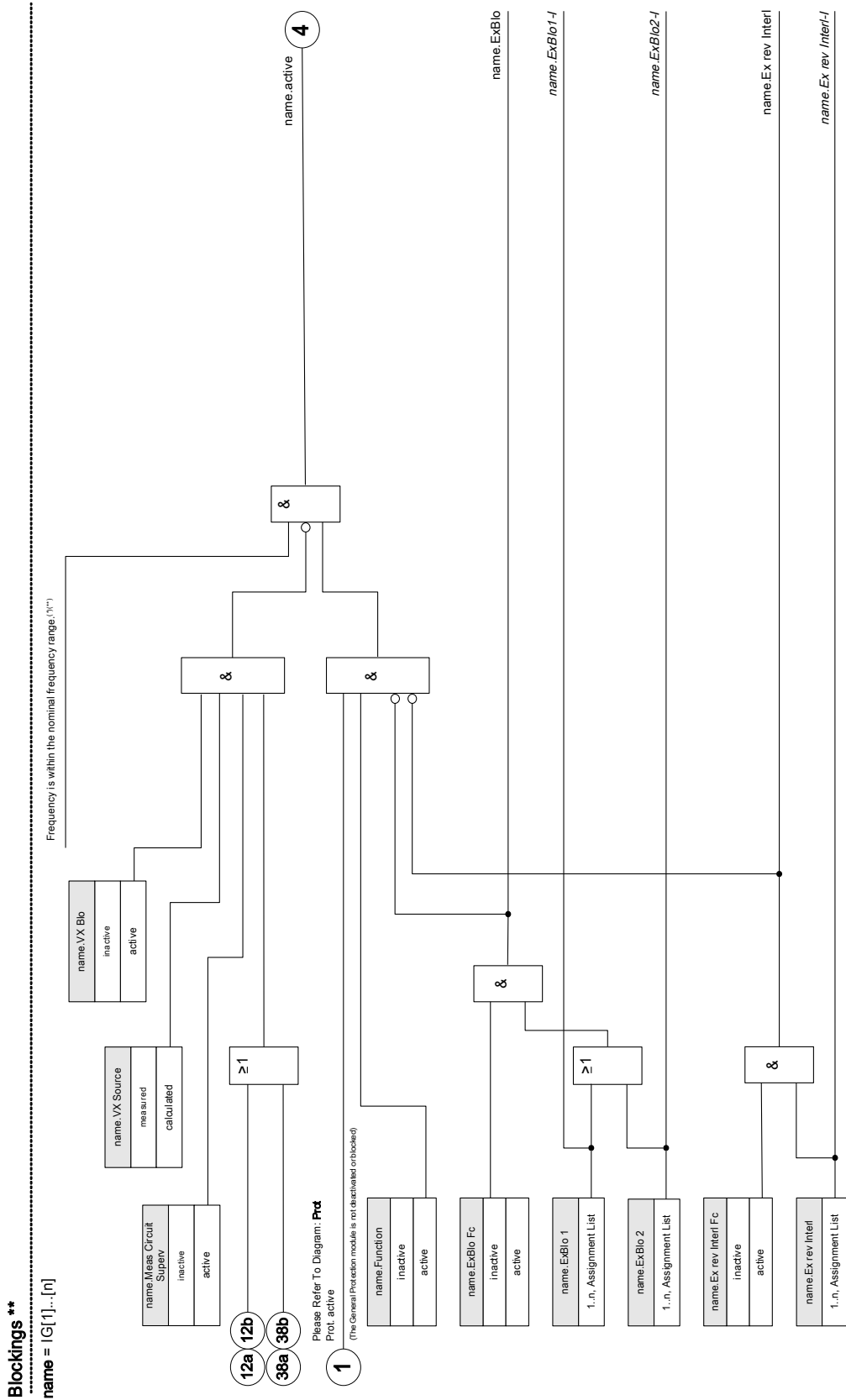

*All protective elements will be blocked that are using fundamental or harmonics measured values. If the frequency leaves the nominal frequency range. Protective elements that are using RMS values will remain active. See chapter "Wide frequency range".

**This applies to devices that offer wide frequency range measurement only.

Module: Protection (Prot)

Prot

The module *»Protection«* serves as outer frame for all other protection modules, i.e. they are all enclosed by the module *»Protection«*.



WARNING

If in module *»Protection«* the parameter *»Function«* is set on *»inactive«* or in case the module is blocked, then the complete protective function of the device does not work anymore.

Protection inactive

If the master module *»Protection«* was permanently deactivated or if a temporary blockage of this module has occurred and the allocated blocking signal is still active, then the complete functionality (protection) of the device is zero. In such a case the protective function is *»inactive«*.

Protection active

If the master module *»Protection«* was activated and a blockade for this module was not activated respectively the assigned blocking signal is inactive at that moment, then the *»Protection«* is *»active«*.

Blocking all Protective Elements enduringly

In order to allow (the principle use) of blocking the entire protection call up the menu [Protection/Para/Global Prot Para/Prot]:

- Set the parameter *»Function = inactive«*.

Blocking all Protective Elements temporarily

In order to allow (the principle use) of blocking the entire protection call up the menu [Protection/Para/Global Prot Para/Prot]:

- Set the parameter *»ExBlo Fc = active«*;
- Choose an assignment for *»ExBlo1«*; and
- Optionally choose an assignment for *»ExBlo2«*.

If one of the signals becomes true, then the entire protection will be blocked as long as one of these signals are true.

Blocking all Trip Commands enduringly

In order to allow (the principle use) of blocking the entire protection call up the menu [Protection/Para/Global Prot Para/Prot]:

- Set the parameter »*Blo TripCmd = inactive*«.

Blocking all Trip Commands temporarily

In order to allow (the principle use) of blocking the entire protection, call up the menu [Protection/Para/Global Prot Para/Prot]:

- Set the parameter »*ExBlo TripCmd Fc= active*«.
- Choose an assignment for »*ExBlo TripCmd*«. All Trip commands will be blocked temporarily if this assignment becomes true.

Prot - active

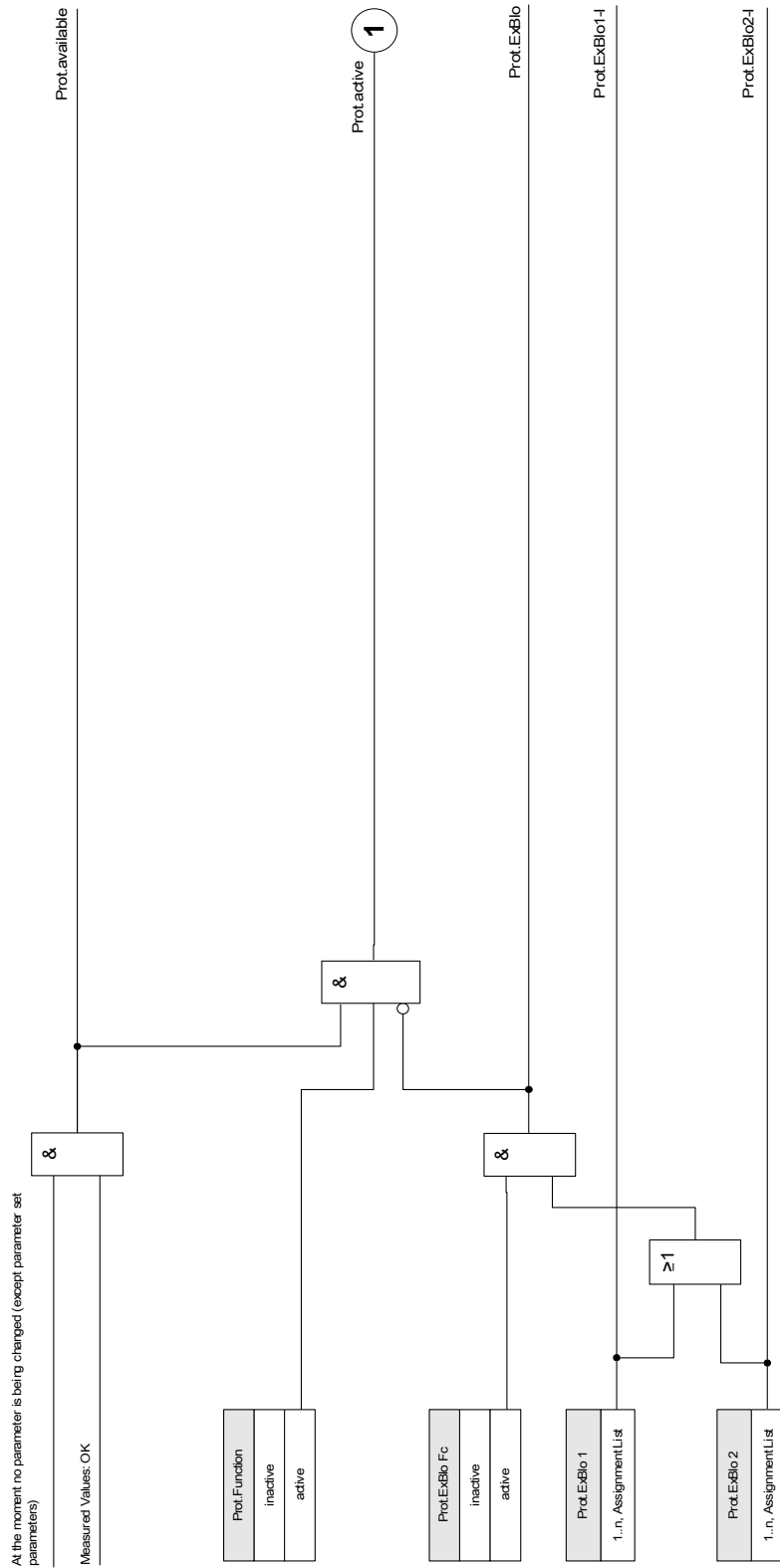

General Alarms and General Trips

Each protective element generates it's own alarm and trip signals. All alarms and trip decision are passed on to the master module *»Prot«*.

If a protective element picks up, respectively has decided about a trip, two signals will be issued:

1. The module or the protection stage issues an alarm e.g. *»I[1].ALARM«* or *»I[1].TRIP«*.
2. The master module *»Prot«* collects/summarizes the signals and issues an alarm or a trip signal *»PROT.ALARM«* *»PROT.TRIP«*.

Further examples: *»PROT.ALARM L1«* is a collective signal (OR-connected) for all alarms issued by any of the protective elements concerning Phase L1.

»PROT.TRIP L1« is a collective signal (OR-connected) for all trips issued by any of the protective elements concerning Phase L1.

»PROT.ALARM« is the collective alarm signal OR-ed from all protection elements. *»PROT.TRIP«* is the collective alarm signal OR-ed from all protection elements.

The trip commands of a the protective elements have to be assigned within the Circuit Breaker Manager *CB Manager*. Only those trip decisions that are assigned within the *CB Manager* are issued to the Circuit Breaker.



Caution: Trip commands that are not assigned within the Circuit Breaker Manager (CB Manager) are not issued to a circuit breaker.

The CB Manager issues the trip commands to a circuit breaker.

Assign within the Circuit Breaker Manager all trip commands that have to switch a circuit breaker.

Prot.Trip

name = Each trip of an active, trip, authorized protection module will lead to a general trip.

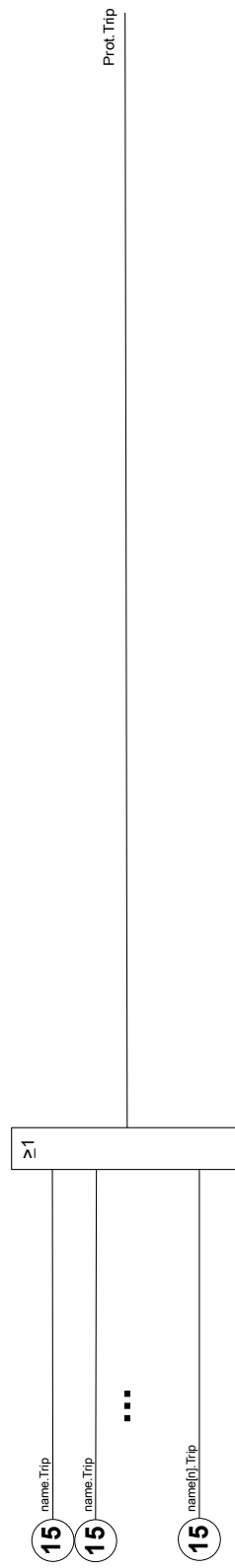

Prot.Alarm

name = Each alarm of a module (except from supervision modules but including CBF) will lead to a general alarm (collective alarm).

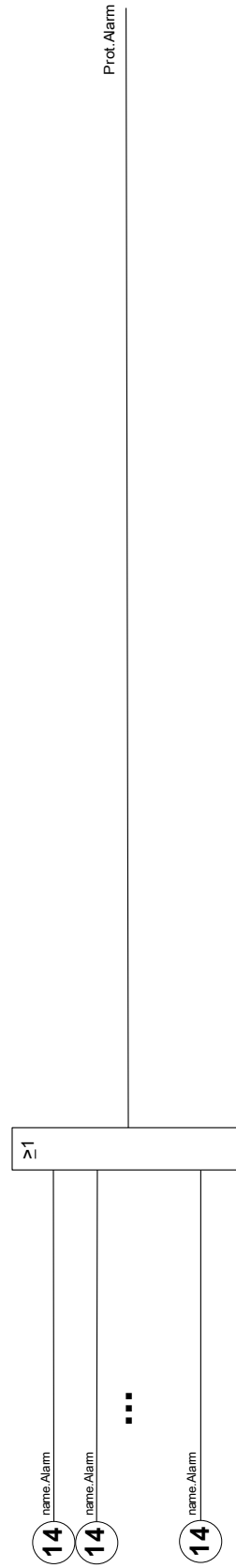

Prot. Trip

Each phase selective trip of a trip authorized module (I, IG, V, VX depending on the device type) will lead to a phase selective general trip.

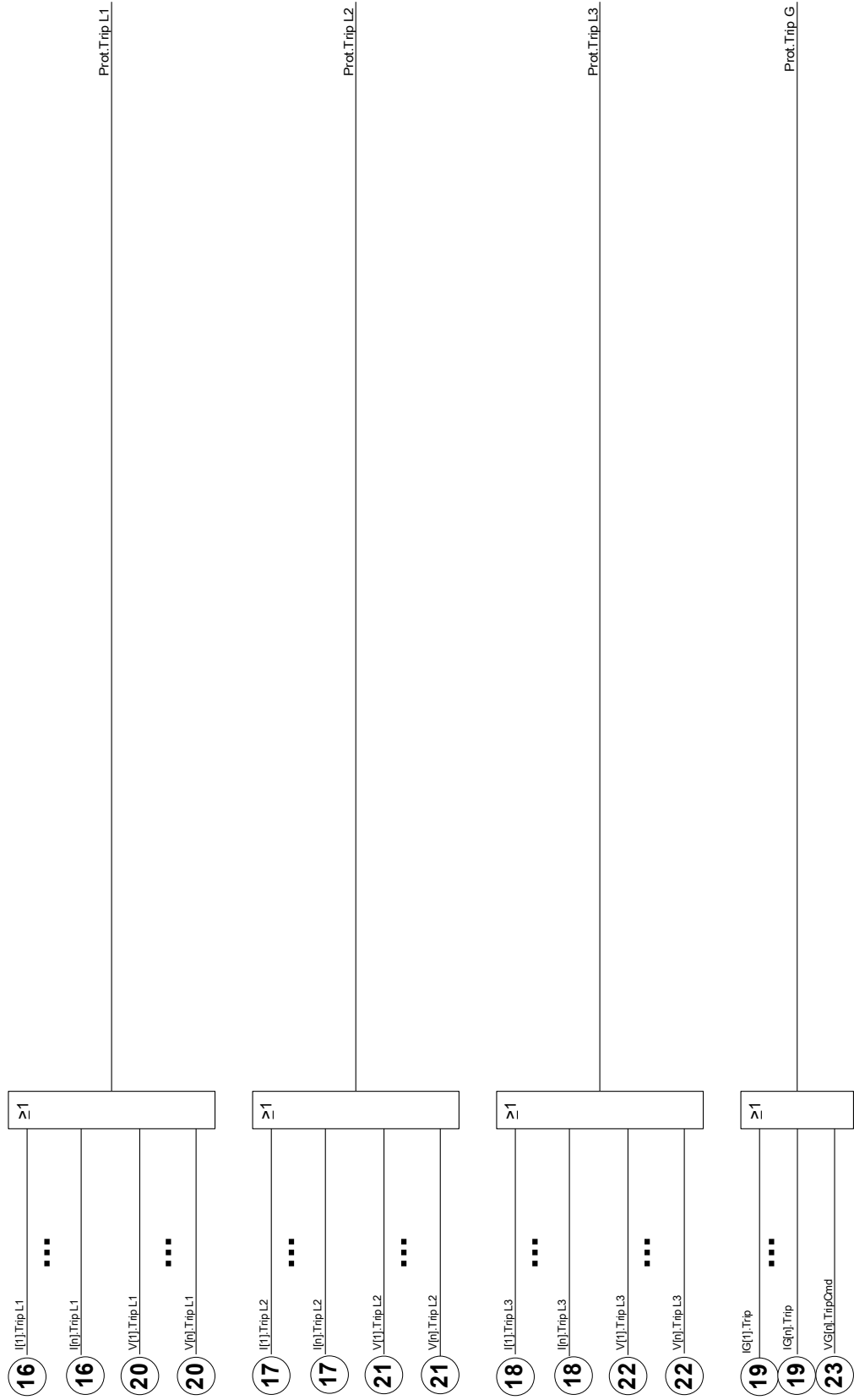

Prot.Alarm



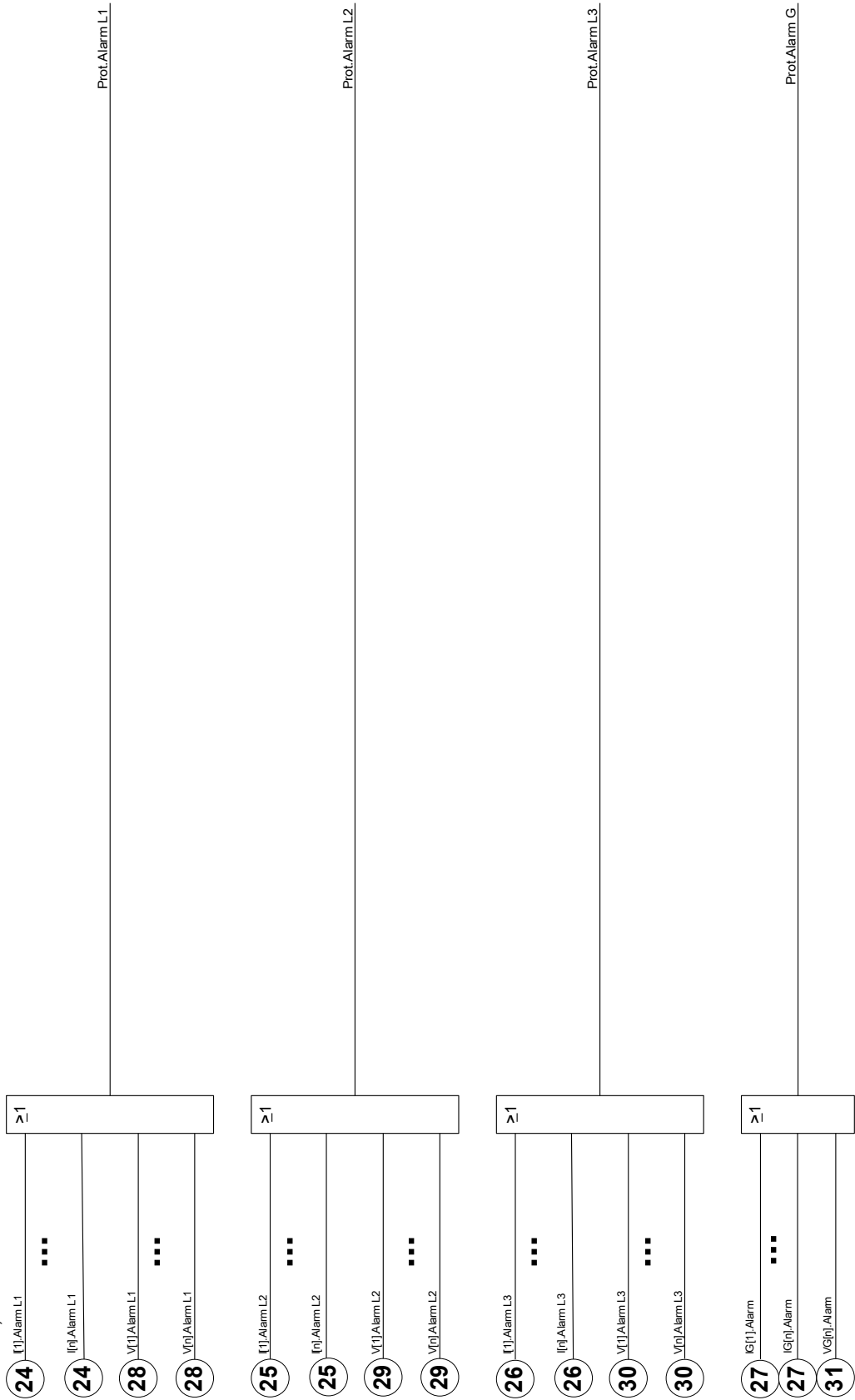



Each phase selective alarm of a module (I, IG, V, VX depending on the device type) will lead to a phase selective general alarm (collective alarm).



Direct Commands of the Protection Module

| Parameter | Description | Setting range | Default | Menu path |
|---|--|---------------------|----------|-----------------------|
| Res Fault a Mains No  | Resetting of fault number and number of grid faults. | inactive, active | inactive | [Operation /Reset] |

Global Protection Parameters of the Protection Module

| Parameter | Description | Setting range | Default | Menu path |
|---|--|-----------------------|----------|---|
| Function  | Permanent activation or deactivation of module/stage. | inactive, active | active | [Protection Para /Global Prot Para /Prot] |
| ExBlo Fc  | Activate (allow) the external blocking of the global protection functionality of the device. | inactive, active | inactive | [Protection Para /Global Prot Para /Prot] |
| ExBlo1  | If external blocking of this module is activated (allowed), the global protection functionality of the device will be blocked if the state of the assigned signal becomes true. | 1..n, Assignment List | -- | [Protection Para /Global Prot Para /Prot] |
| ExBlo2  | If external blocking of this module is activated (allowed), the global protection functionality of the device will be blocked if the state of the assigned signal becomes true. | 1..n, Assignment List | -- | [Protection Para /Global Prot Para /Prot] |
| Blo TripCmd  | Permanent blocking of the Trip Command of the entire Protection. | inactive, active | inactive | [Protection Para /Global Prot Para /Prot] |
| ExBlo TripCmd Fc  | Activate (allow) the external blocking of the trip command of the entire device. | inactive, active | inactive | [Protection Para /Global Prot Para /Prot] |
| ExBlo TripCmd  | If external blocking of the tripping command is activated (allowed), the tripping command of the entire device will be blocked if the state of the assigned signal becomes true. | 1..n, Assignment List | -- | [Protection Para /Global Prot Para /Prot] |

Protection Module Input States

| <i>Name</i> | <i>Description</i> | <i>Assignment via</i> |
|-----------------|---|---|
| ExBlo1-I | Module input state: External blocking1 | [Protection Para /Global Prot Para /Prot] |
| ExBlo2-I | Module input state: External blocking2 | [Protection Para /Global Prot Para /Prot] |
| ExBlo TripCmd-I | Module input state: External Blocking of the Trip Command | [Protection Para /Global Prot Para /Prot] |

Protection Module Signals (Output States)

| <i>Signal</i> | <i>Description</i> |
|----------------------|--|
| available | Signal: Protection is available |
| active | Signal: active |
| ExBlo | Signal: External Blocking |
| Blo TripCmd | Signal: Trip Command blocked |
| ExBlo TripCmd | Signal: External Blocking of the Trip Command |
| Alarm L1 | Signal: General-Alarm L1 |
| Alarm L2 | Signal: General-Alarm L2 |
| Alarm L3 | Signal: General-Alarm L3 |
| Alarm G | Signal: General-Alarm - Earth fault |
| Alarm | Signal: General Alarm |
| Trip L1 | Signal: General Trip L1 |
| Trip L2 | Signal: General Trip L2 |
| Trip L3 | Signal: General Trip L3 |
| Trip G | Signal: General Trip Ground fault |
| Trip | Signal: General Trip |
| Res Fault a Mains No | Signal: Resetting of fault number and number of grid faults. |
| I dir fwd | Signal: Phase current failure forward direction |
| I dir rev | Signal: Phase current failure reverse direction |
| I dir n poss | Signal: Phase fault - missing reference voltage |
| IG calc dir fwd | Signal: Ground fault (calculated) forward |
| IG calc rev dir | Signal: Ground fault (calculated) reverse direction |
| IG calc dir n poss | Signal: Ground fault (calculated) direction detection not possible |
| IG meas dir fwd | Signal: Ground fault (measured) forward |
| IG meas rev dir | Signal: Ground fault (measured) reverse direction |

| <i>Signal</i> | <i>Description</i> |
|--------------------|---|
| IG meas dir n poss | Signal: Ground fault (measured) direction detection not possible |
| f(VL123)<10Hz | Frequency of the measuring channels 1-3 (VL1,VL2,VL3) is lower than 10Hz. |
| f(VL123)>10Hz | Frequency of the measuring channels 1-3 (VL1,VL2,VL3) is greater than 10Hz. |
| f(VL123)<70Hz | Frequency of the measuring channels 1-3 (VL1,VL2,VL3) is lower than 70Hz. |
| f(VL123)>70Hz | Frequency of the measuring channels 1-3 (VL1,VL2,VL3) is greater than 70Hz. |
| DFT Invalid | DFT values of fundamental and harmonics (except VX) are not valid. They depend on period time of frequency and measured channels 1-3 (VL1,VL2,VL3). |
| DFT Valid | DFT values of fundamental and harmonics (except VX) are valid. They depend on period time of frequency and measured channels 1-3 (VL1,VL2,VL3). |
| f(VX)<10Hz | Frequency of the measuring channel 4 (VX) is lower than 10Hz. |
| f(VX)>10Hz | Frequency of the measuring channel 4 (VX) is greater than 10Hz. |
| f(VX)<70Hz | Frequency of the measuring channel 4 (VX) is lower than 70Hz. |
| f(VX)>70Hz | Frequency of the measuring channel 4 (VX) is greater than 70Hz. |
| DFT Invalid (VX) | DFT values of fundamental and harmonics of VX (only) are not valid. |
| DFT Valid (VX) | DFT values of fundamental and harmonics of VX (only) are valid. |

Protection Module Values

| <i>Parameter</i> | <i>Description</i> |
|-------------------|--|
| FaultNo | Disturbance No |
| No of grid faults | Number of grid faults: A grid fault, e.g. a short circuit, might cause several faults with trip and autoreclosing, each fault being identified by an increased fault number. In this case, the grid fault number remains the same. |
| Trip | First trip cause which is the same as listed in fault record: See SCADA doc for code (section Cause of Trip). See manual (section Fault Recorder) for more information. |

Switchgear/Breaker – Manager



WARNING Misconfiguration of switchgear could result in death or serious injury. This e. g. is the case when opening a disconnecter under load or when switching a ground connector to live parts of a system.

Beside protection functions, protective relays more and more will take care about controlling switchgear, like circuit breakers, load break switches, disconnectors and ground connectors.

A correct configuration of all switchgear is an indispensable precondition for the proper functioning of the protective device. This also is the case, when the switchgear are not controlled, but supervised only.

Single Line Diagram

The User can create and modify Single Lines (pages) by means of the Page Editor.

The Single Lines (Control Pages) have to be loaded into the protective device by means of *Smart view*.

For details on the creation, modification and upload of Single Lines (Control Pages) please refer to manual "Page_Editor_uk.pdf" or contact the technical support.

The single line diagram includes the graphically description of the switchgear and its designation (name) as well as its features (short circuit proof or not ...). For displaying in the devices software, the switchgear' designations (e. g. QA1, QA2, instead of SG[x]) will be taken from the single line diagram (configuration file).

The configuration file includes the single line diagram and the switchgear properties. Switchgear properties and single line diagram are coupled via the configuration file.

NOTICE

The default settings of the switchgears depend on the used Single Line. The shown default values correspond to a Single Line with two circuit breakers and to isolating switches.

After the single line diagram has been loaded, each individual switchgear has to be configured. The following table shows the required configurations dependent on the type of switchgear.

| To be configured at: | Type of switchgear | | | | | | | |
|---|------------------------------|------------------------------|----------------------------------|----------------------------------|-------------------------------|-------------------------------|---------------------------|---------------------------|
| | Circuit Breaker (controlled) | Circuit Breaker (supervised) | Switch Disconnector (controlled) | Switch Disconnector (supervised) | Ground Connector (controlled) | Ground Connector (supervised) | Disconnector (controlled) | Disconnector (supervised) |
| Assignment of position indications (Digital inputs) | X | X | X | X | X | X | X | X |
| Assignment of commands (Output relays) | X | - | X | - | X | - | X | - |
| Setting of supervision timers | X | X | X | X | X | X | X | X |
| Interlockings | X | - | X | - | X | - | X | - |
| Trip Manager (Assignment of trip commands) | X | X | - | - | - | - | - | - |
| Optional: Synchronous switching | X | - | - | - | - | - | - | - |
| Optional: Ex ON/OFF Cmd | X | - | X | - | X | - | X | - |
| Optional: SGW | X | X | X | X | X | X | X | X |

Notes on Special Switchgears

Combination of a Disconnecter and an Earthing Switch

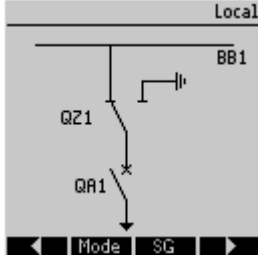

This switchgear is a combination of a disconnecter and an earthing switch. This Switch switches between the »ON-Position« (e.g. Busbar) and the »Earthing-Position«.

NOTICE

The Earthing position of a „Diconnector and Earthing“-Switchgear combination is shown as „CB POS OFF“ within the SCADA documentation (register maps).

Three Position Disconnecter

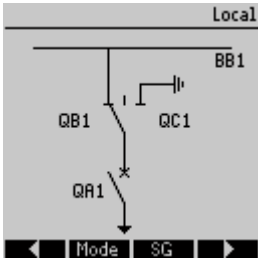

The “Three Position Disconnecter” covers functional two switchgears. One switchgear corresponds to the disconnecter of the “Three Positon Disconnecter”, and the second switchgear corresponds to the earthing switch. The Single Line shows the current position of the “Three Position Disconnecter”. The separation into two switchgears prevent unintentional direct switching from the »ON«-position via the »OFF«-position into the »EARTH«-position. From security aspects there are two clear switch positions »Isolating« and »EARTH«. Thanks to this separation, individual supervision and switching timers for the earthing and isolating part can be set. In addition to that individual interlockings and device names (designations) can be set for the earthing and the isolating part.

NOTICE

The Command Execution Supervision will issue the following message in case of a switching attempt from the earthing position (directly) into the isolator position and vice versa:
 „CES SwitchDir“

NOTICE

The “Earth” position of a „Diconnector and Earthing“-switchgear combination is shown as „CB POS OFF“ within the SCADA documentation (register maps).

Withdrawable Circuit Breaker (Draw Out Circuit Breaker)

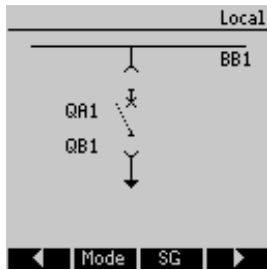

The truck of a withdrawable circuit breaker has to be managed as an individual switchgear. There is no fixed connection between the circuit breaker and the truck. An interlocking has to be set by the User because it is not allowed to withdraw the breaker as long as it is in the closed position. The circuit breaker can be switched in the withdrawn and in the non-withdrawn position.

The signals of the control circuit (low voltage) plug have to be wired and configured with(-in) the protective device. The control (supervision) will be set to »Removed« when the control circuit plug is removed (pulled). The circuit breaker will be set into the »CB OFF«-position as long as the »Removed«-signal is active.

NOTICE

It's not possible to manipulate the Position Signals of a withdrawn (removed) circuit breaker.

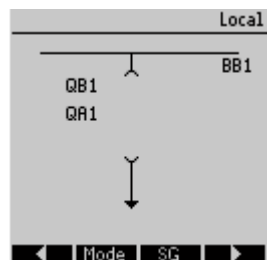

Switchgear Configuration

Wiring

At first the switchgear positioning indicators have to be connected to the digital inputs of the protection device. One of the position indicators (either the »Aux ON« or the »Aux OFF«) contact has to be connected necessarily. It is recommended also to connect the »Aux OFF« contact.

Thereafter the command outputs (relay outputs) have to be connected with the switchgear.

NOTICE

Please observe the following option: In the general settings of a circuit breaker, the ON/OFF commands of a protection element can be issued to the same output relays, where the other control commands are issued. If the commands are issued to different relays output relays the amount of wiring increases.

Assignment of Position Indications

The position indication is needed by the device to get (evaluate) the information about the current status /position of the breaker. The switchgear position indications are shown in the devices display. Each position change of a switchgear results in a change of the corresponding switchgear symbol.

NOTICE

For the detection of a switchgear's position always two separate Aux contacts are recommended! If only one Aux contact is used, no intermediate or disturbed positions can be detected. A (reduced) transition supervision (time between issue of the command and position feedback indication of the switchgear) is also possible by one Aux contact.

In the menu [Control/SG/SG [x]] the assignments for the position indications have to be set.

Detection of switchgear position with two Aux contacts – Aux ON and Aux OFF (recommended!)

For detection of their positions switchgear are provided with Aux contacts (Aux ON and Aux OFF). It is recommended to use both contacts to detect intermediate and disturbed positions too.

The protection device continuously supervises the status of the inputs »Aux ON-I« and »Aux OFF-I«. These signals are validated based on the supervision timers »t-Move ON« and »t-Move OFF« validation functions. As a result, the switchgear position will be detected by the following signals (examples):

- Pos ON
- Pos OFF
- Pos Indeterm
- Pos Disturb.
- Pos (State=0,1,..2 or 3)

Supervision of the ON command

When an ON command is initiated, the »*t-Move ON*« timer will be started. While the timer is running, the »POS INDETERM« State will become true. If the command is executed and properly fed back from the switchgear before the timer has run down, »POS ON« will become true. Otherwise, if the timer has expired »POS DISTURB« will become true.

Supervision of the OFF command

When an OFF command is initiated, the »*t-Move OFF*« timer will be started. While the timer is running, the »POS INDETERM« State will become true. If the command is executed and properly fed back before the timer has run down, »POS OFF« will become true. Otherwise, if the timer has expired »POS DISTURB« will become true.

The following table shows how switchgear positions are validated:

| <i>States of the Digital Inputs</i> | | <i>Validated Breaker Positions</i> | | | | |
|-------------------------------------|------------------|------------------------------------|----------------|--|--|-------------------|
| <i>Aux ON-I</i> | <i>Aux OFF-I</i> | <i>POS ON</i> | <i>POS OFF</i> | <i>POS Indeterm</i> | <i>POS Disturb</i> | <i>POS State</i> |
| 0 | 0 | 0 | 0 | 1 (while a Moving timer is running) | 0 (while a Moving timer is running) | 0 Intermediate |
| 1 | 1 | 0 | 0 | 1 (while a Moving timer is running) | 0 (while a Moving timer is running) | 0 Intermediate |
| 0 | 1 | 0 | 1 | 0 | 0 | 1 OFF |
| 1 | 0 | 1 | 0 | 0 | 0 | 2 ON |
| 0 | 0 | 0 | 0 | 0 (Moving timer elapsed) | 1 (Moving timer elapsed) | 3 Disturbed |
| 1 | 1 | 0 | 0 | 0 (Moving timer elapsed) | 1 (Moving timer elapsed) | 3 Disturbed |

Single Position Indication Aux ON or Aux OFF

If the single pole indication is used, the »SI SINGLECONTACTIND« will become true.

The moving time supervision works only in one direction. If the Aux OFF signal is connected to the device, only the “OFF command” can be supervised and if the Aux ON signal is connected to the device, only the “ON command” can be supervised.

Single Position Indication – Aux ON

If only the Aux ON signal is used for the Status Indication of an “ON command”, the switch command will also start the moving time, the position indication indicates an INTERMEDIATE position during this time interval. When the switchgear reaches the end position indicated by the signals Pos ON and CES succesf before the moving time has elapsed the signal Pos Indeterm disappears.

If the moving time elapsed before the switchgear has reached the end position, the switching operation was not successful and the Position Indication will change to POS Disturb and the signal Pos Indeterm disappears. After the moving time has elapsed, the Dwell time will be started (if set). During this time interval the Position Indication will also indicate an INTERMEDIATE state. When the Dwell time elapses the Position Indication will change to Pos ON.

The following table shows how breaker positions are validated based on Aux ON:

| <i>States of the Digital Input</i> | | <i>Validated Breaker Positions</i> | | | | |
|------------------------------------|------------------|------------------------------------|----------------|-----------------------------------|-----------------------------------|-------------------|
| <i>Aux ON-I</i> | <i>Aux OFF-I</i> | <i>POS ON</i> | <i>POS OFF</i> | <i>POS Indeterm</i> | <i>POS Disturb</i> | <i>POS State</i> |
| 0 | Not wired | 0 | 0 | 1 (while t-Move ON is running) | 0 (while t-Move ON is running) | 0 Intermediate |
| 0 | Not wired | 0 | 1 | 0 | 0 | 1 OFF |
| 1 | Not wired | 1 | 0 | 0 | 0 | 2 ON |

If there is no digital input assigned to the »Aux On« contact, the position indication will have the value 3 (disturbed).

Single Position Indication – Aux OFF

If only the Aux OFF signal is used for the monitoring of the “OFF command”, the switch command will start the moving timer. The Position Indication will indicate an INTERMEDIATE position. When the switchgear reaches its end position before the moving timer elapses, »CES succesf« will be indicated. At the same time the signal »Pos Indeterm« disappears.

If the moving time elapsed before the switchgear has reached the OFF position, the switching operation was not successful and the Position Indication will change to »Pos Disturb« and the signal »Pos Indeterm« disappears. When the moving timer has elapsed, the dwell timer will be started (if configured). During this timer elapses »Pos Disturb« will be indicated. When the dwell time has elapsed, the OFF position of the switchgear will be indicated by the »Pos OFF« signal.

The following table shows how breaker positions are validated based on **Aux OFF**:

| States of the Digital Input | | Validated Breaker Positions | | | | |
|-----------------------------|-----------|-----------------------------|---------|------------------------------------|------------------------------------|-------------------|
| Aux ON-I | Aux OFF-I | POS ON | POS OFF | POS Indeterm | POS Disturb | POS State |
| Not wired | 0 | 0 | 0 | 1 (while t-Move OFF is running) | 0 (while t-Move OFF is running) | 0 Intermediate |
| Not wired | 1 | 0 | 1 | 0 | 0 | 1 OFF |
| Not wired | 0 | 1 | 0 | 0 | 0 | 2 ON |

If there is no digital input assigned to the »Aux OFF« contact, the position indication will have the value 3 (disturbed).

Setting of Supervision Times

In the menu [Control/SG/SG[x]/General Settings] the supervision times of the individual switchgear have to be set. Dependent on the type of switchgear it can be necessary to set further parameters, like dwell time.

Interlockings

To avoid faulty operations, interlockings have to be provided. This can be realised mechanically or electrically.

For a controllable switchgear up to three interlockings can be assigned in both switching directions (ON/OFF). These interlockings prevent switching in the corresponding direction.

The protection OFF command and the reclosing command of the AR module are always executed without interlockings. For the case, that a protection OFF command must not be issued, this must be blocked separately.

Further interlockings can be realised by means of the Logic module.

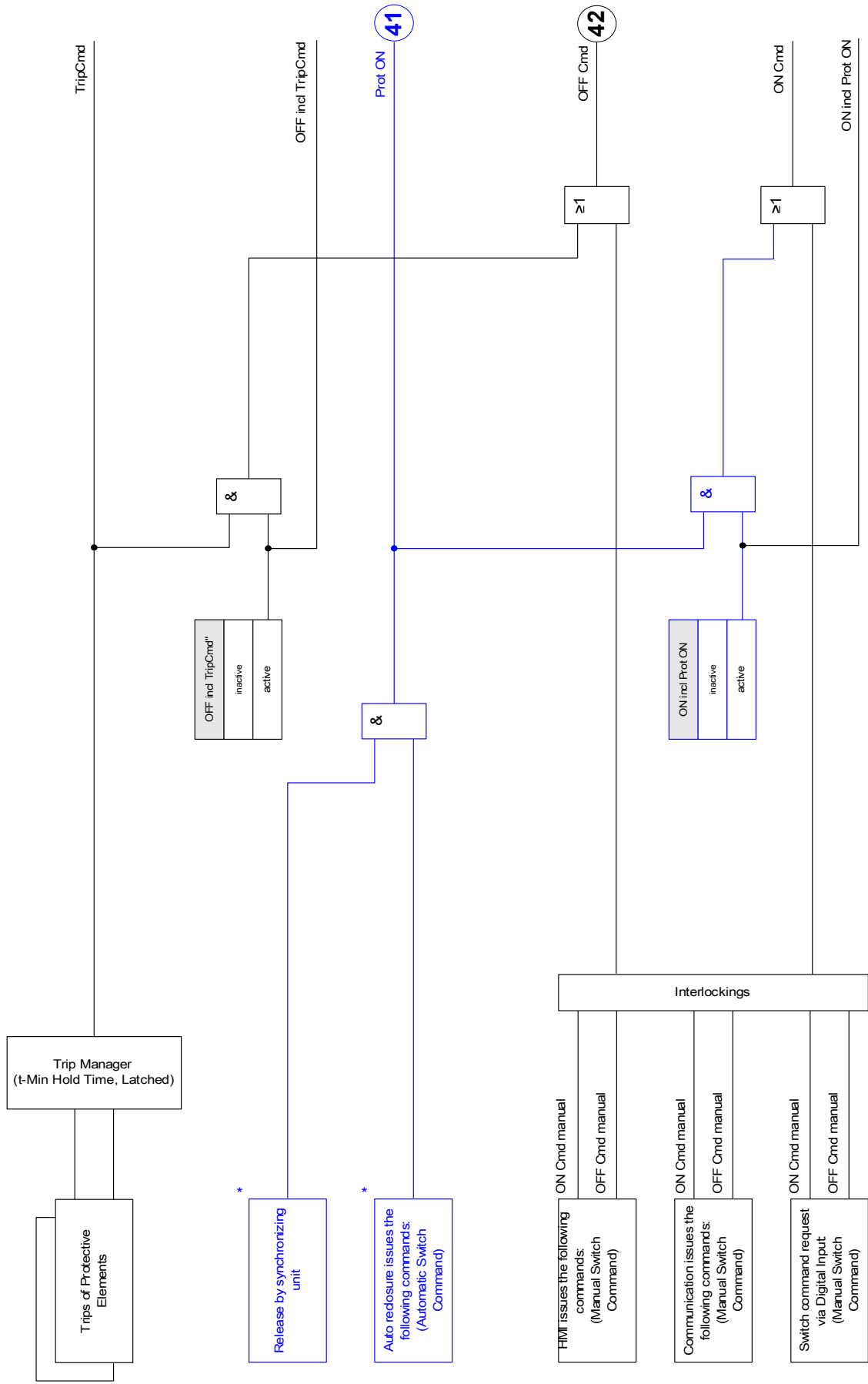

* Availability dependent on device type

Trip Manager – Assignment of commands

The trip commands of the protection elements have to be assigned to those switchgear, that are make/break capable (Circuit Breaker). For every make/break capable switchgear a Trip Manager is provided. In the Trip Manger all tripping commands are combined by an “OR” logic. The actual tripping command to the switchgear is exclusively given by the Trip Manager. This means, that only tripping commands which are assigned in the Trip Manager lead to an operation of the switchgear. In addition to that, the User can set the minimum hold time of the tripping command within this module and define whether the tripping command is latched or not.

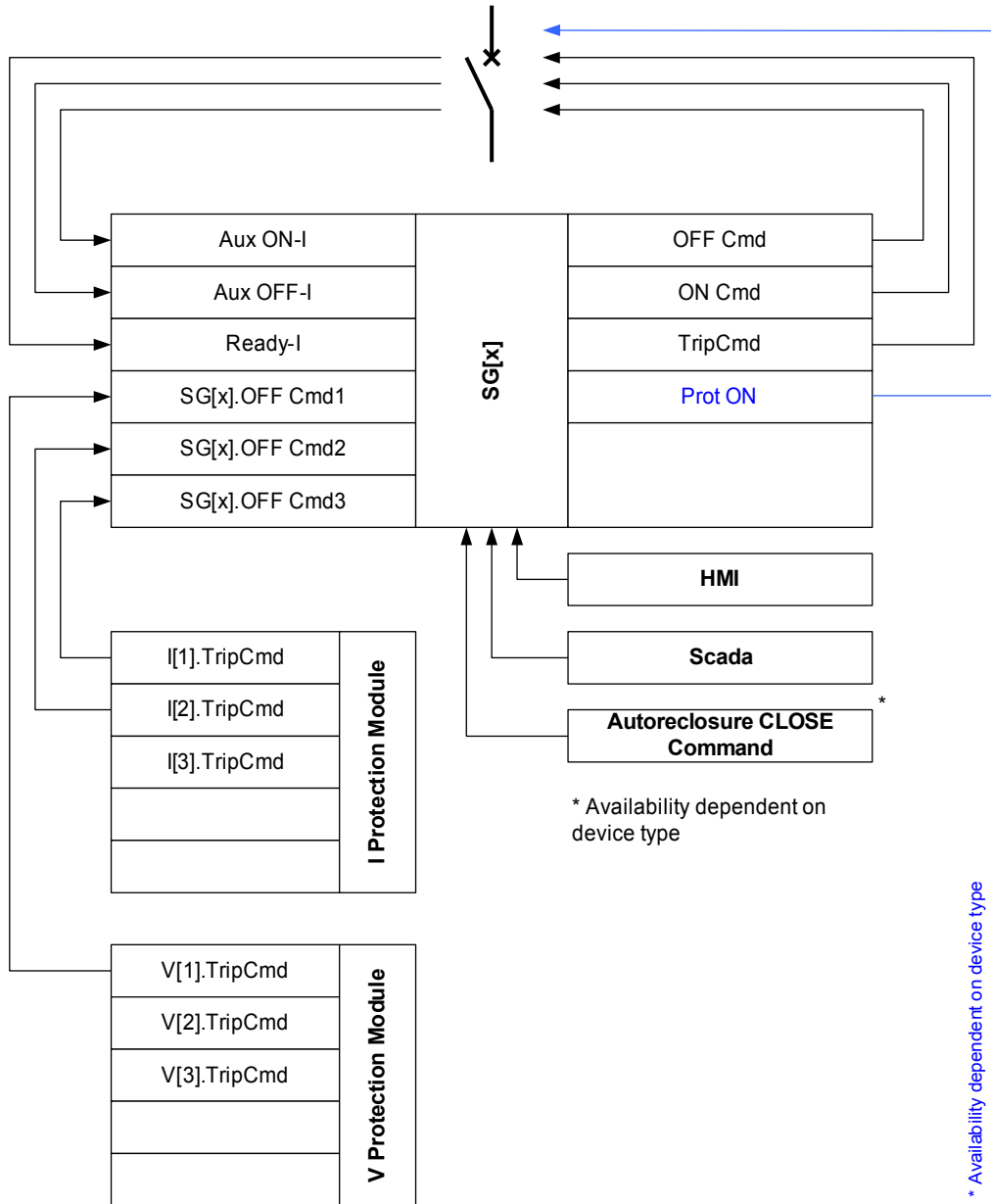

The exact name of the Switchgear is defined in the Single Line file.

SGxj.Trip.CB

name =Module name of the assigned trip command

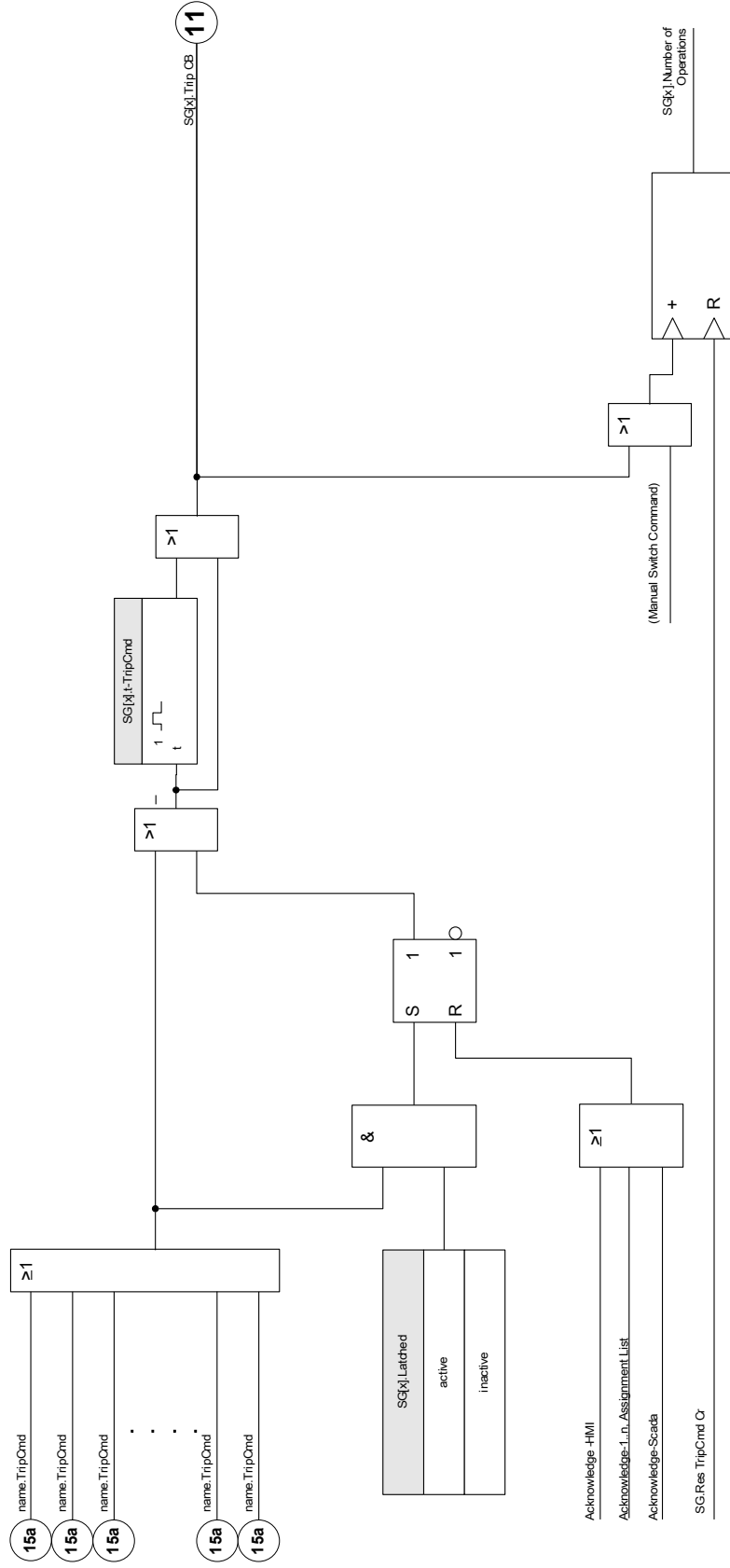

Ex ON/OFF

If the switchgear should be opened or closed by an external signal, the User can assign one signal that will trigger the ON and one signal that will trigger the OFF command (e.g. digital inputs or output signals of the Logics). An OFF command has priority. ON commands are slope oriented, OFF commands are level oriented.

Synchronised Switching*

*=availability depends on ordered device type

Before a switchgear may connect two mains sections, synchronism of these sections must be assured. In the menu [Synchronous Switching] the parameter »Synchronism« defines which signal indicates synchronism.

If the synchronism condition shall be evaluated by the internal Synch-Check module the signal »*Sync. Ready to Close*« (release by synch-check module) has to be assigned. Alternatively a digital input or a logic output can be assigned.

In the synchronisation mode “Generator-to-System” additionally the synchronism request has to be assigned in the menu [Protection Para\Global Prot Para\Sync].

If a synchronism signal is assigned, the switching command will only be executed, when the synchronism signal will become true within the maximum supervision time »*t-MaxSyncSuperv*«. This supervision time will be started with the issued ON command. If no synchronism signal has been assigned, the synchronism release is permanently.

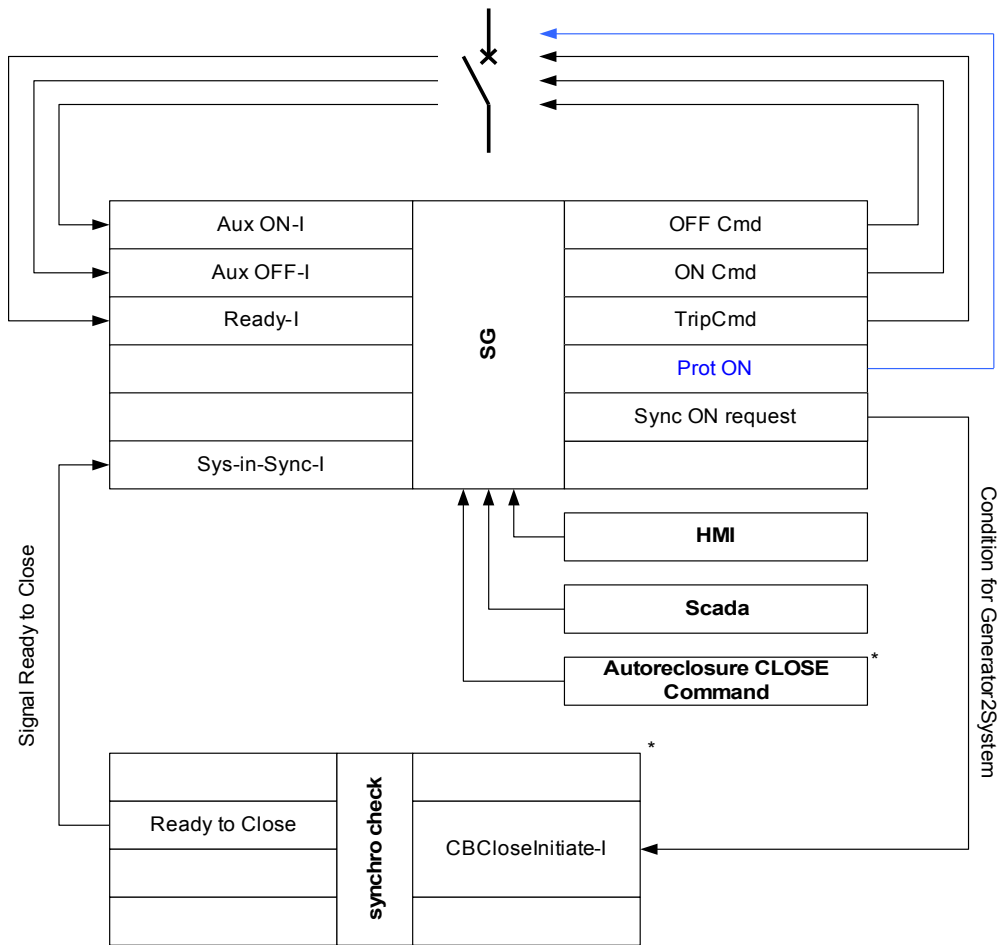

* = * Availability dependent on device type

** = * Availability dependent on device type

Switching Authority

For the Switching Authority [Control\General Settings], the following general settings are possible:

- NONE: No control function;
- LOCAL: Control only via push buttons at the panel;
- REMOTE: Control only via SCADA, digital inputs, or internal signals; and
- LOCAL&REMOTE: Control via push buttons, SCADA, digital inputs, or internal signals.

Non interlocked Switching

For test purposes, during commissioning and temporarily operations, interlockings can be disabled.



WARNING: Non interlocked Switching can lead to serious injuries or death!

For non interlocked switching the menü [Control\General Settings] provides the following options:

- Non interlocked switching for one single command
- Permanent
- Non interlocked switching for a certain time
- Non interlocked switching, activated by an assigned signal

The set time for non interlocked switching applies also for the „single Operation“ mode.

Manual Manipulation of the Switchgear Position

In case of faulty position indication contacts (Aux contacts) or broken wires, the position indication resulted from the assigned signals can be manipulated (overwritten) manually, to keep the ability to switch the affected switchgear. A manipulated switchgear position will be indicated on the display by an exclamation mark “!” beside the switchgear symbol.



WARNING: Manipulation of the Switchgear Position can lead to serious injuries or death!

Double Operation Locking

All control commands to any switchgear in a bay have to be processed sequentially. During a running control command no other command will be handled.

Switch Direction Control



Switching commands are validated before execution. When the switchgear is already in the desired position, the switch command will not be issued again. An opened circuit breaker cannot be opened again. This also applies for switching command at the HMI or via SCADA.

Anti Pumping

By pressing the ON command softkey only a single switching ON impulse will be issued independent, how long the softkey is actuated. The switchgear will close only once per close command.

Ctrl

Direct commands of the Switching Authority

| <i>Parameter</i> | <i>Description</i> | <i>Setting range</i> | <i>Default</i> | <i>Menu path</i> |
|--|-------------------------|--|----------------|--------------------------------|
| Switching Authority  | Switching Authority | None, Local, Remote, Local and Remote | Local | [Control /General settings] |
| NonInterl  | DC for Non-Interlocking | inactive, active | inactive | [Control /General settings] |

Signals of the Switching Authority

| <i>Signal</i> | <i>Description</i> |
|---------------|---|
| Local | Switching Authority: Local |
| Remote | Switching Authority: Remote |
| NonInterl | Non-Interlocking is active |
| SG Indeterm | Minimum one Switchgear is moving (Position cannot be determined). |
| SG Disturb | Minimum one Switchgear is disturbed. |

Counters of the Command Execution Supervision

| <i>Parameter</i> | <i>Description</i> |
|---------------------|---|
| CES SAAuthority | Command Execution Supervision: Number of rejected Commands because of missing switching authority. |
| CES DoubleOperating | Command Execution Supervision: Number of rejected Commands because a second switch command is in conflict with a pending one. |
| CES No. of rej. Com | Command Execution Supervision: Number of rejected Commands because Locked by ParaSystem |

Switchgear Wear

Switchgear Wear Features

The sum of the accumulated interrupted currents.

A »SGwear Slow Switchgear« might indicate malfunction at an early stage.

The protective relay will calculate the »SG OPEN Capacity« continuously. 100% means, that switchgear maintenance is mandatory now.

The protective relay will make a alarm decision based on the curve that the user provides.

The relay will monitor the frequency of ON/OFF cycles. The User can set thresholds for the maximum allowed sum of interrupt currents and the maximum allowed sum of interrupt currents per hour. By means of this alarm, excessive switchgear operations can be detected at an early stage.

Slow Switchgear Alarm

An increase of the close or opening time of the switchgear is an indication for the maintenance need. If the measured time exceeds the time »*t-Move OFF*« or »*t-Move ON*«, the signal »SGwear Slow Switchgear« will be activated.

Switchgear Wear Curve

In order to keep the switchgear in good working condition, the switchgear needs to be monitored. The switchgear health (operation life) depends above all on:







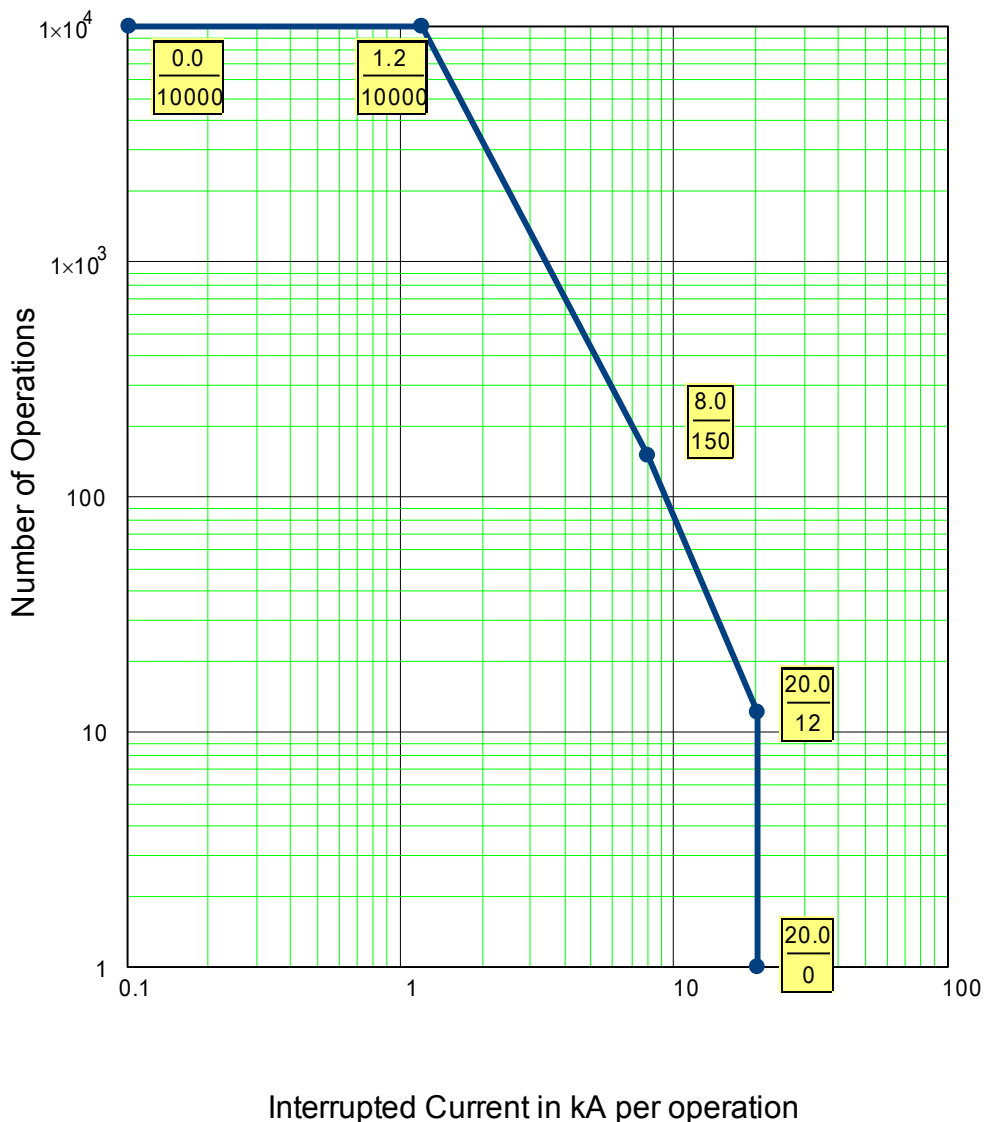

- The number of CLOSE/OPEN cycles.
- The amplitudes of the interrupting currents.
- The frequency that the switchgear operates (Operations per hour).

The User has to maintain the switchgear accordingly to the maintenance schedule that is to be provided by the manufacturer (switchgear operation statistics). By means of up to ten points that the user can replicate the switchgear wear curve within menu [Control/SG/SG[x]/SGW] . Each point has two settings: the interrupt current in kilo amperes and the allowed operation counts. No matter how many points are used, the operation counts the last point as zero. The protective relay will interpolate the allowed operations based on the switchgear wear curve. When the interrupted current is greater than the interrupt current at the last point, the protective relay will assume zero operation counts.

Breaker Maintenance Curve for a typical 25kV Circuit Breaker



Global Protection Parameters of the Breaker Wear Module

| Parameter | Description | Setting range | Default | Menu path |
|--|---|---------------------|----------|--|
|  Operations Alarm | Service Alarm, too many Operations | 1 - 100000 | 9999 | [Control /SG /SG[1] /SG Wear] |
|  Isum Intr Alarm | Alarm, the Sum (Limit) of interrupting currents has been exceeded. | 0.00 - 2000.00kA | 100.00kA | [Control /SG /SG[1] /SG Wear] |
|  Isum Intr ph Alm | Alarm, the per hour Sum (Limit) of interrupting currents has been exceeded. | 0.00 - 2000.00kA | 100.00kA | [Control /SG /SG[1] /SG Wear] |
|  SGwear Curve Fc | The Circuit Breaker (load-break switch) Wear Curve defines the maximum allowed CLOSE/OPEN cycles depending on the brake currents. If the circuit breaker maintenance curve is exceeded, an alarm will be issued. The breaker maintenance curve is to be taken from the technical data sheet of the breaker manufacturer. By means of the available points this curve is to be replicated. | inactive, active | inactive | [Control /SG /SG[1] /SG Wear] |
|  WearLevel Alarm | Threshold for the Alarm Only available if:SGwear Curve Fc = active | 0.00 - 100.00% | 80.00% | [Control /SG /SG[1] /SG Wear] |
|  WearLevel Lockout | Threshold for the Lockout Level Only available if:SGwear Curve Fc = active | 0.00 - 100.00% | 95.00% | [Control /SG /SG[1] /SG Wear] |
|  Current1 | Interrupted Current Level #1 Only available if:SGwear Curve Fc = active | 0.00 - 2000.00kA | 0.00kA | [Control /SG /SG[1] /SG Wear] |
|  Count1 | Open Counts Allowed #1 Only available if:SGwear Curve Fc = active | 1 - 32000 | 10000 | [Control /SG /SG[1] /SG Wear] |

| Parameter | Description | Setting range | Default | Menu path |
|--|------------------|---------------|--|-----------|
|  Current2 Interrupted Current Level #2 Only available if:SGwear Curve Fc = active | 0.00 - 2000.00kA | 1.20kA | [Control /SG /SG[1] /SG Wear] | |
|  Count2 Open Counts Allowed #2 Only available if:SGwear Curve Fc = active | 1 - 32000 | 10000 | [Control /SG /SG[1] /SG Wear] | |
|  Current3 Interrupted Current Level #3 Only available if:SGwear Curve Fc = active | 0.00 - 2000.00kA | 8.00kA | [Control /SG /SG[1] /SG Wear] | |
|  Count3 Open Counts Allowed #3 Only available if:SGwear Curve Fc = active | 1 - 32000 | 150 | [Control /SG /SG[1] /SG Wear] | |
|  Current4 Interrupted Current Level #4 Only available if:SGwear Curve Fc = active | 0.00 - 2000.00kA | 20.00kA | [Control /SG /SG[1] /SG Wear] | |
|  Count4 Open Counts Allowed #4 Only available if:SGwear Curve Fc = active | 1 - 32000 | 12 | [Control /SG /SG[1] /SG Wear] | |
|  Current5 Interrupted Current Level #5 Only available if:SGwear Curve Fc = active | 0.00 - 2000.00kA | 20.00kA | [Control /SG /SG[1] /SG Wear] | |
|  Count5 Open Counts Allowed #5 Only available if:SGwear Curve Fc = active | 1 - 32000 | 1 | [Control /SG /SG[1] /SG Wear] | |
|  Current6 Interrupted Current Level #6 Only available if:SGwear Curve Fc = active | 0.00 - 2000.00kA | 20.00kA | [Control /SG /SG[1] /SG Wear] | |

| Parameter | Description | Setting range | Default | Menu path |
|--|---|------------------|---------|--|
| Count6  | Open Counts Allowed #6 Only available if:SGwear Curve Fc = active | 1 - 32000 | 1 | [Control /SG /SG[1] /SG Wear] |
| Current7  | Interrupted Current Level #7 Only available if:SGwear Curve Fc = active | 0.00 - 2000.00kA | 20.00kA | [Control /SG /SG[1] /SG Wear] |
| Count7  | Open Counts Allowed #7 Only available if:SGwear Curve Fc = active | 1 - 32000 | 1 | [Control /SG /SG[1] /SG Wear] |
| Current8  | Interrupted Current Level #8 Only available if:SGwear Curve Fc = active | 0.00 - 2000.00kA | 20.00kA | [Control /SG /SG[1] /SG Wear] |
| Count8  | Open Counts Allowed #8 Only available if:SGwear Curve Fc = active | 1 - 32000 | 1 | [Control /SG /SG[1] /SG Wear] |
| Current9  | Interrupted Current Level #9 Only available if:SGwear Curve Fc = active | 0.00 - 2000.00kA | 20.00kA | [Control /SG /SG[1] /SG Wear] |
| Count9  | Open Counts Allowed #9 Only available if:SGwear Curve Fc = active | 1 - 32000 | 1 | [Control /SG /SG[1] /SG Wear] |
| Current10  | Interrupted Current Level #10 Only available if:SGwear Curve Fc = active | 0.00 - 2000.00kA | 20.00kA | [Control /SG /SG[1] /SG Wear] |
| Count10  | Open Counts Allowed #10 Only available if:SGwear Curve Fc = active | 1 - 32000 | 1 | [Control /SG /SG[1] /SG Wear] |

Breaker Wear Signals (Output States)

| <i>Signal</i> | <i>Description</i> |
|----------------------|---|
| Operations Alarm | Signal: Service Alarm, too many Operations |
| Isum Intr trip: IL1 | Signal: Maximum permissible Summation of the interrupting (tripping) currents exceeded: IL1 |
| Isum Intr trip: IL2 | Signal: Maximum permissible Summation of the interrupting (tripping) currents exceeded: IL2 |
| Isum Intr trip: IL3 | Signal: Maximum permissible Summation of the interrupting (tripping) currents exceeded: IL3 |
| Isum Intr trip | Signal: Maximum permissible Summation of the interrupting (tripping) currents exceeded in at least one phase. |
| Res TripCmd Cr | Signal: Resetting of the Counter: total number of trip commands |
| Res Sum trip | Signal: Reset summation of the tripping currents |
| WearLevel Alarm | Signal: Threshold for the Alarm |
| WearLevel Lockout | Signal: Threshold for the Lockout Level |
| Res SGwear Curve | Signal: Reset of the Circuit Breaker (load-break switch) Wear maintenance curve. |
| Isum Intr ph Alm | Signal: Alarm, the per hour Sum (Limit) of interrupting currents has been exceeded. |
| Res Isum Intr ph Alm | Signal: Reset of the Alarm, "the per hour Sum (Limit) of interrupting currents has been exceeded". |





Breaker Wear Counter Values

| <i>Value</i> | <i>Description</i> | <i>Default</i> | <i>Size</i> | <i>Menu path</i> |
|--------------|---|----------------|-------------|---|
| TripCmd Cr | Counter: Total number of trips of the switchgear (circuit breaker, load break switch...). Resettable with Total or All. | 0 | 0 - 200000 | [Operation /Count and RevData /Control /SG[1]] |

| <i>Value</i> | <i>Description</i> | <i>Default</i> | <i>Size</i> | <i>Menu path</i> |
|--------------|--|----------------|-----------------|---|
| Sum trip IL1 | Summation of the tripping currents phase | 0.00A | 0.00 - 1000.00A | [Operation /Count and RevData /Control /SG[1]] |
| Sum trip IL2 | Summation of the tripping currents phase | 0.00A | 0.00 - 1000.00A | [Operation /Count and RevData /Control /SG[1]] |





| Value | Description | Default | Size | Menu path |
|--------------------|---|---------|------------------|---|
| Sum trip IL3 | Summation of the tripping currents phase | 0.00A | 0.00 - 1000.00A | [Operation /Count and RevData /Control /SG[1]] |
| Isum Intr per hour | Sum per hour of interrupting currents. | 0.00kA | 0.00 - 1000.00kA | [Operation /Count and RevData /Control /SG[1]] |
| SG OPEN capacity | Used capacity. 100% means, that the switchgear is to be maintained. | 0.0% | 0.0 - 100.0% | [Operation /Count and RevData /Control /SG[1]] |

Direct Commands of the Breaker Wear Module

| Parameter | Description | Setting range | Default | Menu path |
|---|--|---------------------|----------|-----------------------|
| Res TripCmd Cr  | Resetting of the Counter: total number of trip commands | inactive, active | inactive | [Operation /Reset] |
| Res Sum trip  | Reset summation of the tripping currents | inactive, active | inactive | [Operation /Reset] |
| Res Isum Intr per hour  | Reset of the Sum per hour of interrupting currents. | inactive, active | inactive | [Operation /Reset] |
| Res CB OPEN capacity  | Resetting of the CB OPEN capacity. 100% means, that the circuit breaker is to be maintained. | inactive, active | inactive | [Operation /Reset] |

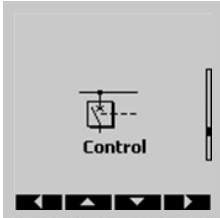
Control - Example: Switching of a Circuit Breaker

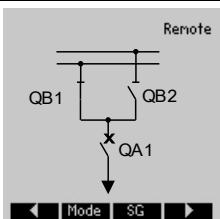
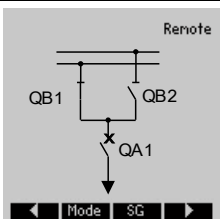
The following example shows how to switch a circuit breaker via the HMI at the device.

| | |
|---|---|
|  | <p>Change into the menu »Control« or alternatively push the »CTRL« button at the device front.</p> |
|  | <p>Change to the control page by pushing the »right arrow« softkey.</p> |
|  | <p>Information only: On the control page a single line diagram with the current switchgear positions is displayed. By means of the softkey »Mode« it can be switched to the menu »General Settings«. In this menu switching authority and interlockings can be set.</p> <p>By means of the softkey »SG« it can be switched to the menu »SG«. In this menu specific settings for the switch gear can be done.</p> |
|  | <p>To execute a switching operation, change into the switching menu by pushing the right arrow softkey button.</p> |
|  | <p>Executing a switching command via the devices HMI is only possible when the switching authority is set to »Local«. If no switching authority is given, this has to be set first to »Local« or »Local and Remote«.</p> <p>With the softkey »OK« it can be switched back to the single line diagram page.</p> |

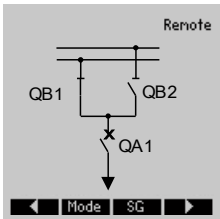
| | |
|---|---|
|  <p>The diagram shows a switching station with two breakers, QB1 and QB2, connected to a busbar. A circuit breaker QA1 is shown below them. The word 'Remote' is in the top right corner. At the bottom, there is a control bar with a left arrow, the text 'Mode', 'SG', and a right arrow.</p> | <p>Pushing the softkey »Mode« leads to the menu »General Settings«.</p> |
|---|---|

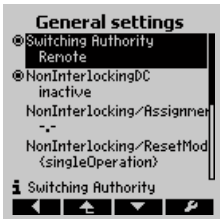
| | |
|---|---|
|  <p>The 'General settings' menu is displayed. It includes options: 'Switching Authority' (selected with a radio button), 'Remote', 'NonInterlockingDC' (selected with a radio button), 'inactive', 'NonInterlocking/Assignment', '---', 'NonInterlocking/ResetMod (singleOperation)', and 'Switching Authority' (with an information icon). Navigation arrows are at the bottom.</p> | <p>In this menu the switching authority can be changed.</p> |
|---|---|

| | |
|---|--|
|  <p>The 'Switching Authority' selection menu is shown. It lists four options: 'None', 'Local' (highlighted), 'Remote', and 'Local and Remote'. Navigation arrows are at the bottom.</p> | <p>Select between »Local« or »Local and Remote«.</p> |
|---|--|

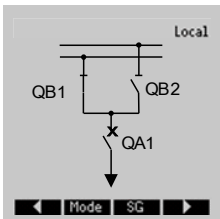
| | |
|---|---|
|  <p>The diagram is identical to the first one but with the word 'Local' in the top right corner. The control bar at the bottom remains the same.</p> | <p>Now it is possible to execute switching commands at the HMI.</p> |
|---|---|

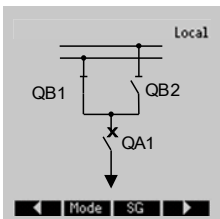
| | |
|--|---|
|  <p>The diagram is identical to the previous one, but the right arrow in the control bar is highlighted, indicating it is the active softkey.</p> | <p>Push the »right arrow« softkey to get to the control page.</p> |
|--|---|

| | |
|--|--|
| | <p>To select a switchgear press the softkey »Select« as long as the desired switchgear is selected. The current selection is displayed by the edges of a rectangle. In this example the circuit breaker is selected. Switchgears that are supervised only, cannot be selected.</p> |
|--|--|

| | |
|--|--|
| | <p>The circuit breaker is opened, therefore it can be closed only. After pushing the softkey »ON« a confirmation window appears.</p> |
|--|--|

| | |
|--|--|
| | <p>When you are sure to proceed with the switching operation, press the softkey »YES«.</p> |
|--|--|

| | |
|--|---|
| | <p>The switching command will be given to the circuit breaker. The display shows the intermediate position of the switchgear.</p> |
|--|---|



| | |
|--|--|
| | <p>It will be shown on the display when the switchgear reaches the new end position. Further possible switching operations (OPEN) will be displayed by softkeys.</p> |
|--|--|



Notice: For the case, the switchgear does not reach the new end position within the set supervision time the following Warning appears on the display.

Control Parameters

Global Protection Parameters of the Control Module

| Parameter | Description | Setting range | Default | Menu path |
|--|---|--|------------------|--------------------------------|
| Res NonIL  | Resetmode Non-Interlocking | single Operation, timeout, permanent | single Operation | [Control /General settings] |
| Timeout NonIL  | Timeout Non-Interlocking Only available if: Res NonIL<>permanent | 2 - 3600s | 60s | [Control /General settings] |
| NonIL Assign  | Assignment Non-Interlocking | 1..n, Assignment List | -.- | [Control /General settings] |

Control Moduel Input States

| Name | Description | Assignment via |
|------------|------------------|--------------------------------|
| NonInter-l | Non-Interlocking | [Control /General settings] |

Synchronization inputs

| Name | Description |
|---------------------|------------------------|
| -.- | No assignment |
| Sync.Ready to Close | Signal: Ready to Close |
| DI Slot X1.DI 1 | Signal: Digital Input |
| DI Slot X1.DI 2 | Signal: Digital Input |
| DI Slot X1.DI 3 | Signal: Digital Input |
| DI Slot X1.DI 4 | Signal: Digital Input |
| DI Slot X1.DI 5 | Signal: Digital Input |
| DI Slot X1.DI 6 | Signal: Digital Input |
| DI Slot X1.DI 7 | Signal: Digital Input |
| DI Slot X1.DI 8 | Signal: Digital Input |
| DI Slot X6.DI 1 | Signal: Digital Input |
| DI Slot X6.DI 2 | Signal: Digital Input |
| DI Slot X6.DI 3 | Signal: Digital Input |
| DI Slot X6.DI 4 | Signal: Digital Input |
| DI Slot X6.DI 5 | Signal: Digital Input |

| <i>Name</i> | <i>Description</i> |
|-------------------------|--|
| DI Slot X6.DI 6 | Signal: Digital Input |
| DI Slot X6.DI 7 | Signal: Digital Input |
| DI Slot X6.DI 8 | Signal: Digital Input |
| Logics.LE1.Gate Out | Signal: Output of the logic gate |
| Logics.LE1.Timer Out | Signal: Timer Output |
| Logics.LE1.Out | Signal: Latched Output (Q) |
| Logics.LE1.Out inverted | Signal: Negated Latched Output (Q NOT) |
| Logics.LE2.Gate Out | Signal: Output of the logic gate |
| Logics.LE2.Timer Out | Signal: Timer Output |
| Logics.LE2.Out | Signal: Latched Output (Q) |
| Logics.LE2.Out inverted | Signal: Negated Latched Output (Q NOT) |
| Logics.LE3.Gate Out | Signal: Output of the logic gate |
| Logics.LE3.Timer Out | Signal: Timer Output |
| Logics.LE3.Out | Signal: Latched Output (Q) |
| Logics.LE3.Out inverted | Signal: Negated Latched Output (Q NOT) |
| Logics.LE4.Gate Out | Signal: Output of the logic gate |
| Logics.LE4.Timer Out | Signal: Timer Output |
| Logics.LE4.Out | Signal: Latched Output (Q) |
| Logics.LE4.Out inverted | Signal: Negated Latched Output (Q NOT) |
| Logics.LE5.Gate Out | Signal: Output of the logic gate |
| Logics.LE5.Timer Out | Signal: Timer Output |
| Logics.LE5.Out | Signal: Latched Output (Q) |
| Logics.LE5.Out inverted | Signal: Negated Latched Output (Q NOT) |
| Logics.LE6.Gate Out | Signal: Output of the logic gate |
| Logics.LE6.Timer Out | Signal: Timer Output |
| Logics.LE6.Out | Signal: Latched Output (Q) |
| Logics.LE6.Out inverted | Signal: Negated Latched Output (Q NOT) |
| Logics.LE7.Gate Out | Signal: Output of the logic gate |
| Logics.LE7.Timer Out | Signal: Timer Output |
| Logics.LE7.Out | Signal: Latched Output (Q) |
| Logics.LE7.Out inverted | Signal: Negated Latched Output (Q NOT) |
| Logics.LE8.Gate Out | Signal: Output of the logic gate |
| Logics.LE8.Timer Out | Signal: Timer Output |
| Logics.LE8.Out | Signal: Latched Output (Q) |
| Logics.LE8.Out inverted | Signal: Negated Latched Output (Q NOT) |
| Logics.LE9.Gate Out | Signal: Output of the logic gate |
| Logics.LE9.Timer Out | Signal: Timer Output |
| Logics.LE9.Out | Signal: Latched Output (Q) |
| Logics.LE9.Out inverted | Signal: Negated Latched Output (Q NOT) |
| Logics.LE10.Gate Out | Signal: Output of the logic gate |

| <i>Name</i> | <i>Description</i> |
|--------------------------|--|
| Logics.LE10.Timer Out | Signal: Timer Output |
| Logics.LE10.Out | Signal: Latched Output (Q) |
| Logics.LE10.Out inverted | Signal: Negated Latched Output (Q NOT) |
| Logics.LE11.Gate Out | Signal: Output of the logic gate |
| Logics.LE11.Timer Out | Signal: Timer Output |
| Logics.LE11.Out | Signal: Latched Output (Q) |
| Logics.LE11.Out inverted | Signal: Negated Latched Output (Q NOT) |
| Logics.LE12.Gate Out | Signal: Output of the logic gate |
| Logics.LE12.Timer Out | Signal: Timer Output |
| Logics.LE12.Out | Signal: Latched Output (Q) |
| Logics.LE12.Out inverted | Signal: Negated Latched Output (Q NOT) |
| Logics.LE13.Gate Out | Signal: Output of the logic gate |
| Logics.LE13.Timer Out | Signal: Timer Output |
| Logics.LE13.Out | Signal: Latched Output (Q) |
| Logics.LE13.Out inverted | Signal: Negated Latched Output (Q NOT) |
| Logics.LE14.Gate Out | Signal: Output of the logic gate |
| Logics.LE14.Timer Out | Signal: Timer Output |
| Logics.LE14.Out | Signal: Latched Output (Q) |
| Logics.LE14.Out inverted | Signal: Negated Latched Output (Q NOT) |
| Logics.LE15.Gate Out | Signal: Output of the logic gate |
| Logics.LE15.Timer Out | Signal: Timer Output |
| Logics.LE15.Out | Signal: Latched Output (Q) |
| Logics.LE15.Out inverted | Signal: Negated Latched Output (Q NOT) |
| Logics.LE16.Gate Out | Signal: Output of the logic gate |
| Logics.LE16.Timer Out | Signal: Timer Output |
| Logics.LE16.Out | Signal: Latched Output (Q) |
| Logics.LE16.Out inverted | Signal: Negated Latched Output (Q NOT) |
| Logics.LE17.Gate Out | Signal: Output of the logic gate |
| Logics.LE17.Timer Out | Signal: Timer Output |
| Logics.LE17.Out | Signal: Latched Output (Q) |
| Logics.LE17.Out inverted | Signal: Negated Latched Output (Q NOT) |
| Logics.LE18.Gate Out | Signal: Output of the logic gate |
| Logics.LE18.Timer Out | Signal: Timer Output |
| Logics.LE18.Out | Signal: Latched Output (Q) |
| Logics.LE18.Out inverted | Signal: Negated Latched Output (Q NOT) |
| Logics.LE19.Gate Out | Signal: Output of the logic gate |
| Logics.LE19.Timer Out | Signal: Timer Output |
| Logics.LE19.Out | Signal: Latched Output (Q) |
| Logics.LE19.Out inverted | Signal: Negated Latched Output (Q NOT) |
| Logics.LE20.Gate Out | Signal: Output of the logic gate |

| <i>Name</i> | <i>Description</i> |
|--------------------------|--|
| Logics.LE20.Timer Out | Signal: Timer Output |
| Logics.LE20.Out | Signal: Latched Output (Q) |
| Logics.LE20.Out inverted | Signal: Negated Latched Output (Q NOT) |
| Logics.LE21.Gate Out | Signal: Output of the logic gate |
| Logics.LE21.Timer Out | Signal: Timer Output |
| Logics.LE21.Out | Signal: Latched Output (Q) |
| Logics.LE21.Out inverted | Signal: Negated Latched Output (Q NOT) |
| Logics.LE22.Gate Out | Signal: Output of the logic gate |
| Logics.LE22.Timer Out | Signal: Timer Output |
| Logics.LE22.Out | Signal: Latched Output (Q) |
| Logics.LE22.Out inverted | Signal: Negated Latched Output (Q NOT) |
| Logics.LE23.Gate Out | Signal: Output of the logic gate |
| Logics.LE23.Timer Out | Signal: Timer Output |
| Logics.LE23.Out | Signal: Latched Output (Q) |
| Logics.LE23.Out inverted | Signal: Negated Latched Output (Q NOT) |
| Logics.LE24.Gate Out | Signal: Output of the logic gate |
| Logics.LE24.Timer Out | Signal: Timer Output |
| Logics.LE24.Out | Signal: Latched Output (Q) |
| Logics.LE24.Out inverted | Signal: Negated Latched Output (Q NOT) |
| Logics.LE25.Gate Out | Signal: Output of the logic gate |
| Logics.LE25.Timer Out | Signal: Timer Output |
| Logics.LE25.Out | Signal: Latched Output (Q) |
| Logics.LE25.Out inverted | Signal: Negated Latched Output (Q NOT) |
| Logics.LE26.Gate Out | Signal: Output of the logic gate |
| Logics.LE26.Timer Out | Signal: Timer Output |
| Logics.LE26.Out | Signal: Latched Output (Q) |
| Logics.LE26.Out inverted | Signal: Negated Latched Output (Q NOT) |
| Logics.LE27.Gate Out | Signal: Output of the logic gate |
| Logics.LE27.Timer Out | Signal: Timer Output |
| Logics.LE27.Out | Signal: Latched Output (Q) |
| Logics.LE27.Out inverted | Signal: Negated Latched Output (Q NOT) |
| Logics.LE28.Gate Out | Signal: Output of the logic gate |
| Logics.LE28.Timer Out | Signal: Timer Output |
| Logics.LE28.Out | Signal: Latched Output (Q) |
| Logics.LE28.Out inverted | Signal: Negated Latched Output (Q NOT) |
| Logics.LE29.Gate Out | Signal: Output of the logic gate |
| Logics.LE29.Timer Out | Signal: Timer Output |
| Logics.LE29.Out | Signal: Latched Output (Q) |
| Logics.LE29.Out inverted | Signal: Negated Latched Output (Q NOT) |
| Logics.LE30.Gate Out | Signal: Output of the logic gate |

| <i>Name</i> | <i>Description</i> |
|--------------------------|--|
| Logics.LE30.Timer Out | Signal: Timer Output |
| Logics.LE30.Out | Signal: Latched Output (Q) |
| Logics.LE30.Out inverted | Signal: Negated Latched Output (Q NOT) |
| Logics.LE31.Gate Out | Signal: Output of the logic gate |
| Logics.LE31.Timer Out | Signal: Timer Output |
| Logics.LE31.Out | Signal: Latched Output (Q) |
| Logics.LE31.Out inverted | Signal: Negated Latched Output (Q NOT) |
| Logics.LE32.Gate Out | Signal: Output of the logic gate |
| Logics.LE32.Timer Out | Signal: Timer Output |
| Logics.LE32.Out | Signal: Latched Output (Q) |
| Logics.LE32.Out inverted | Signal: Negated Latched Output (Q NOT) |
| Logics.LE33.Gate Out | Signal: Output of the logic gate |
| Logics.LE33.Timer Out | Signal: Timer Output |
| Logics.LE33.Out | Signal: Latched Output (Q) |
| Logics.LE33.Out inverted | Signal: Negated Latched Output (Q NOT) |
| Logics.LE34.Gate Out | Signal: Output of the logic gate |
| Logics.LE34.Timer Out | Signal: Timer Output |
| Logics.LE34.Out | Signal: Latched Output (Q) |
| Logics.LE34.Out inverted | Signal: Negated Latched Output (Q NOT) |
| Logics.LE35.Gate Out | Signal: Output of the logic gate |
| Logics.LE35.Timer Out | Signal: Timer Output |
| Logics.LE35.Out | Signal: Latched Output (Q) |
| Logics.LE35.Out inverted | Signal: Negated Latched Output (Q NOT) |
| Logics.LE36.Gate Out | Signal: Output of the logic gate |
| Logics.LE36.Timer Out | Signal: Timer Output |
| Logics.LE36.Out | Signal: Latched Output (Q) |
| Logics.LE36.Out inverted | Signal: Negated Latched Output (Q NOT) |
| Logics.LE37.Gate Out | Signal: Output of the logic gate |
| Logics.LE37.Timer Out | Signal: Timer Output |
| Logics.LE37.Out | Signal: Latched Output (Q) |
| Logics.LE37.Out inverted | Signal: Negated Latched Output (Q NOT) |
| Logics.LE38.Gate Out | Signal: Output of the logic gate |
| Logics.LE38.Timer Out | Signal: Timer Output |
| Logics.LE38.Out | Signal: Latched Output (Q) |
| Logics.LE38.Out inverted | Signal: Negated Latched Output (Q NOT) |
| Logics.LE39.Gate Out | Signal: Output of the logic gate |
| Logics.LE39.Timer Out | Signal: Timer Output |
| Logics.LE39.Out | Signal: Latched Output (Q) |
| Logics.LE39.Out inverted | Signal: Negated Latched Output (Q NOT) |
| Logics.LE40.Gate Out | Signal: Output of the logic gate |

| <i>Name</i> | <i>Description</i> |
|--------------------------|--|
| Logics.LE40.Timer Out | Signal: Timer Output |
| Logics.LE40.Out | Signal: Latched Output (Q) |
| Logics.LE40.Out inverted | Signal: Negated Latched Output (Q NOT) |
| Logics.LE41.Gate Out | Signal: Output of the logic gate |
| Logics.LE41.Timer Out | Signal: Timer Output |
| Logics.LE41.Out | Signal: Latched Output (Q) |
| Logics.LE41.Out inverted | Signal: Negated Latched Output (Q NOT) |
| Logics.LE42.Gate Out | Signal: Output of the logic gate |
| Logics.LE42.Timer Out | Signal: Timer Output |
| Logics.LE42.Out | Signal: Latched Output (Q) |
| Logics.LE42.Out inverted | Signal: Negated Latched Output (Q NOT) |
| Logics.LE43.Gate Out | Signal: Output of the logic gate |
| Logics.LE43.Timer Out | Signal: Timer Output |
| Logics.LE43.Out | Signal: Latched Output (Q) |
| Logics.LE43.Out inverted | Signal: Negated Latched Output (Q NOT) |
| Logics.LE44.Gate Out | Signal: Output of the logic gate |
| Logics.LE44.Timer Out | Signal: Timer Output |
| Logics.LE44.Out | Signal: Latched Output (Q) |
| Logics.LE44.Out inverted | Signal: Negated Latched Output (Q NOT) |
| Logics.LE45.Gate Out | Signal: Output of the logic gate |
| Logics.LE45.Timer Out | Signal: Timer Output |
| Logics.LE45.Out | Signal: Latched Output (Q) |
| Logics.LE45.Out inverted | Signal: Negated Latched Output (Q NOT) |
| Logics.LE46.Gate Out | Signal: Output of the logic gate |
| Logics.LE46.Timer Out | Signal: Timer Output |
| Logics.LE46.Out | Signal: Latched Output (Q) |
| Logics.LE46.Out inverted | Signal: Negated Latched Output (Q NOT) |
| Logics.LE47.Gate Out | Signal: Output of the logic gate |
| Logics.LE47.Timer Out | Signal: Timer Output |
| Logics.LE47.Out | Signal: Latched Output (Q) |
| Logics.LE47.Out inverted | Signal: Negated Latched Output (Q NOT) |
| Logics.LE48.Gate Out | Signal: Output of the logic gate |
| Logics.LE48.Timer Out | Signal: Timer Output |
| Logics.LE48.Out | Signal: Latched Output (Q) |
| Logics.LE48.Out inverted | Signal: Negated Latched Output (Q NOT) |
| Logics.LE49.Gate Out | Signal: Output of the logic gate |
| Logics.LE49.Timer Out | Signal: Timer Output |
| Logics.LE49.Out | Signal: Latched Output (Q) |
| Logics.LE49.Out inverted | Signal: Negated Latched Output (Q NOT) |
| Logics.LE50.Gate Out | Signal: Output of the logic gate |

| <i>Name</i> | <i>Description</i> |
|--------------------------|--|
| Logics.LE50.Timer Out | Signal: Timer Output |
| Logics.LE50.Out | Signal: Latched Output (Q) |
| Logics.LE50.Out inverted | Signal: Negated Latched Output (Q NOT) |
| Logics.LE51.Gate Out | Signal: Output of the logic gate |
| Logics.LE51.Timer Out | Signal: Timer Output |
| Logics.LE51.Out | Signal: Latched Output (Q) |
| Logics.LE51.Out inverted | Signal: Negated Latched Output (Q NOT) |
| Logics.LE52.Gate Out | Signal: Output of the logic gate |
| Logics.LE52.Timer Out | Signal: Timer Output |
| Logics.LE52.Out | Signal: Latched Output (Q) |
| Logics.LE52.Out inverted | Signal: Negated Latched Output (Q NOT) |
| Logics.LE53.Gate Out | Signal: Output of the logic gate |
| Logics.LE53.Timer Out | Signal: Timer Output |
| Logics.LE53.Out | Signal: Latched Output (Q) |
| Logics.LE53.Out inverted | Signal: Negated Latched Output (Q NOT) |
| Logics.LE54.Gate Out | Signal: Output of the logic gate |
| Logics.LE54.Timer Out | Signal: Timer Output |
| Logics.LE54.Out | Signal: Latched Output (Q) |
| Logics.LE54.Out inverted | Signal: Negated Latched Output (Q NOT) |
| Logics.LE55.Gate Out | Signal: Output of the logic gate |
| Logics.LE55.Timer Out | Signal: Timer Output |
| Logics.LE55.Out | Signal: Latched Output (Q) |
| Logics.LE55.Out inverted | Signal: Negated Latched Output (Q NOT) |
| Logics.LE56.Gate Out | Signal: Output of the logic gate |
| Logics.LE56.Timer Out | Signal: Timer Output |
| Logics.LE56.Out | Signal: Latched Output (Q) |
| Logics.LE56.Out inverted | Signal: Negated Latched Output (Q NOT) |
| Logics.LE57.Gate Out | Signal: Output of the logic gate |
| Logics.LE57.Timer Out | Signal: Timer Output |
| Logics.LE57.Out | Signal: Latched Output (Q) |
| Logics.LE57.Out inverted | Signal: Negated Latched Output (Q NOT) |
| Logics.LE58.Gate Out | Signal: Output of the logic gate |
| Logics.LE58.Timer Out | Signal: Timer Output |
| Logics.LE58.Out | Signal: Latched Output (Q) |
| Logics.LE58.Out inverted | Signal: Negated Latched Output (Q NOT) |
| Logics.LE59.Gate Out | Signal: Output of the logic gate |
| Logics.LE59.Timer Out | Signal: Timer Output |
| Logics.LE59.Out | Signal: Latched Output (Q) |
| Logics.LE59.Out inverted | Signal: Negated Latched Output (Q NOT) |
| Logics.LE60.Gate Out | Signal: Output of the logic gate |

| <i>Name</i> | <i>Description</i> |
|--------------------------|--|
| Logics.LE60.Timer Out | Signal: Timer Output |
| Logics.LE60.Out | Signal: Latched Output (Q) |
| Logics.LE60.Out inverted | Signal: Negated Latched Output (Q NOT) |
| Logics.LE61.Gate Out | Signal: Output of the logic gate |
| Logics.LE61.Timer Out | Signal: Timer Output |
| Logics.LE61.Out | Signal: Latched Output (Q) |
| Logics.LE61.Out inverted | Signal: Negated Latched Output (Q NOT) |
| Logics.LE62.Gate Out | Signal: Output of the logic gate |
| Logics.LE62.Timer Out | Signal: Timer Output |
| Logics.LE62.Out | Signal: Latched Output (Q) |
| Logics.LE62.Out inverted | Signal: Negated Latched Output (Q NOT) |
| Logics.LE63.Gate Out | Signal: Output of the logic gate |
| Logics.LE63.Timer Out | Signal: Timer Output |
| Logics.LE63.Out | Signal: Latched Output (Q) |
| Logics.LE63.Out inverted | Signal: Negated Latched Output (Q NOT) |
| Logics.LE64.Gate Out | Signal: Output of the logic gate |
| Logics.LE64.Timer Out | Signal: Timer Output |
| Logics.LE64.Out | Signal: Latched Output (Q) |
| Logics.LE64.Out inverted | Signal: Negated Latched Output (Q NOT) |
| Logics.LE65.Gate Out | Signal: Output of the logic gate |
| Logics.LE65.Timer Out | Signal: Timer Output |
| Logics.LE65.Out | Signal: Latched Output (Q) |
| Logics.LE65.Out inverted | Signal: Negated Latched Output (Q NOT) |
| Logics.LE66.Gate Out | Signal: Output of the logic gate |
| Logics.LE66.Timer Out | Signal: Timer Output |
| Logics.LE66.Out | Signal: Latched Output (Q) |
| Logics.LE66.Out inverted | Signal: Negated Latched Output (Q NOT) |
| Logics.LE67.Gate Out | Signal: Output of the logic gate |
| Logics.LE67.Timer Out | Signal: Timer Output |
| Logics.LE67.Out | Signal: Latched Output (Q) |
| Logics.LE67.Out inverted | Signal: Negated Latched Output (Q NOT) |
| Logics.LE68.Gate Out | Signal: Output of the logic gate |
| Logics.LE68.Timer Out | Signal: Timer Output |
| Logics.LE68.Out | Signal: Latched Output (Q) |
| Logics.LE68.Out inverted | Signal: Negated Latched Output (Q NOT) |
| Logics.LE69.Gate Out | Signal: Output of the logic gate |
| Logics.LE69.Timer Out | Signal: Timer Output |
| Logics.LE69.Out | Signal: Latched Output (Q) |
| Logics.LE69.Out inverted | Signal: Negated Latched Output (Q NOT) |
| Logics.LE70.Gate Out | Signal: Output of the logic gate |

| <i>Name</i> | <i>Description</i> |
|--------------------------|--|
| Logics.LE70.Timer Out | Signal: Timer Output |
| Logics.LE70.Out | Signal: Latched Output (Q) |
| Logics.LE70.Out inverted | Signal: Negated Latched Output (Q NOT) |
| Logics.LE71.Gate Out | Signal: Output of the logic gate |
| Logics.LE71.Timer Out | Signal: Timer Output |
| Logics.LE71.Out | Signal: Latched Output (Q) |
| Logics.LE71.Out inverted | Signal: Negated Latched Output (Q NOT) |
| Logics.LE72.Gate Out | Signal: Output of the logic gate |
| Logics.LE72.Timer Out | Signal: Timer Output |
| Logics.LE72.Out | Signal: Latched Output (Q) |
| Logics.LE72.Out inverted | Signal: Negated Latched Output (Q NOT) |
| Logics.LE73.Gate Out | Signal: Output of the logic gate |
| Logics.LE73.Timer Out | Signal: Timer Output |
| Logics.LE73.Out | Signal: Latched Output (Q) |
| Logics.LE73.Out inverted | Signal: Negated Latched Output (Q NOT) |
| Logics.LE74.Gate Out | Signal: Output of the logic gate |
| Logics.LE74.Timer Out | Signal: Timer Output |
| Logics.LE74.Out | Signal: Latched Output (Q) |
| Logics.LE74.Out inverted | Signal: Negated Latched Output (Q NOT) |
| Logics.LE75.Gate Out | Signal: Output of the logic gate |
| Logics.LE75.Timer Out | Signal: Timer Output |
| Logics.LE75.Out | Signal: Latched Output (Q) |
| Logics.LE75.Out inverted | Signal: Negated Latched Output (Q NOT) |
| Logics.LE76.Gate Out | Signal: Output of the logic gate |
| Logics.LE76.Timer Out | Signal: Timer Output |
| Logics.LE76.Out | Signal: Latched Output (Q) |
| Logics.LE76.Out inverted | Signal: Negated Latched Output (Q NOT) |
| Logics.LE77.Gate Out | Signal: Output of the logic gate |
| Logics.LE77.Timer Out | Signal: Timer Output |
| Logics.LE77.Out | Signal: Latched Output (Q) |
| Logics.LE77.Out inverted | Signal: Negated Latched Output (Q NOT) |
| Logics.LE78.Gate Out | Signal: Output of the logic gate |
| Logics.LE78.Timer Out | Signal: Timer Output |
| Logics.LE78.Out | Signal: Latched Output (Q) |
| Logics.LE78.Out inverted | Signal: Negated Latched Output (Q NOT) |
| Logics.LE79.Gate Out | Signal: Output of the logic gate |
| Logics.LE79.Timer Out | Signal: Timer Output |
| Logics.LE79.Out | Signal: Latched Output (Q) |
| Logics.LE79.Out inverted | Signal: Negated Latched Output (Q NOT) |
| Logics.LE80.Gate Out | Signal: Output of the logic gate |

| <i>Name</i> | <i>Description</i> |
|--------------------------|--|
| Logics.LE80.Timer Out | Signal: Timer Output |
| Logics.LE80.Out | Signal: Latched Output (Q) |
| Logics.LE80.Out inverted | Signal: Negated Latched Output (Q NOT) |

Assignable Trip Commands (Trip Manager)



| <i>Name</i> | <i>Description</i> |
|-----------------------|----------------------|
| .- | No assignment |
| I[1].TripCmd | Signal: Trip Command |
| I[2].TripCmd | Signal: Trip Command |
| I[3].TripCmd | Signal: Trip Command |
| I[4].TripCmd | Signal: Trip Command |
| I[5].TripCmd | Signal: Trip Command |
| I[6].TripCmd | Signal: Trip Command |
| IG[1].TripCmd | Signal: Trip Command |
| IG[2].TripCmd | Signal: Trip Command |
| IG[3].TripCmd | Signal: Trip Command |
| IG[4].TripCmd | Signal: Trip Command |
| ThR.TripCmd | Signal: Trip Command |
| I2>[1].TripCmd | Signal: Trip Command |
| I2>[2].TripCmd | Signal: Trip Command |
| V[1].TripCmd | Signal: Trip Command |
| V[2].TripCmd | Signal: Trip Command |
| V[3].TripCmd | Signal: Trip Command |
| V[4].TripCmd | Signal: Trip Command |
| V[5].TripCmd | Signal: Trip Command |
| V[6].TripCmd | Signal: Trip Command |
| df/dt.TripCmd | Signal: Trip Command |
| delta phi.TripCmd | Signal: Trip Command |
| Intertripping.TripCmd | Signal: Trip Command |
| P.TripCmd | Signal: Trip Command |
| Q.TripCmd | Signal: Trip Command |
| LVRT[1].TripCmd | Signal: Trip Command |
| LVRT[2].TripCmd | Signal: Trip Command |
| VG[1].TripCmd | Signal: Trip Command |
| VG[2].TripCmd | Signal: Trip Command |
| V012[1].TripCmd | Signal: Trip Command |
| V012[2].TripCmd | Signal: Trip Command |
| V012[3].TripCmd | Signal: Trip Command |
| V012[4].TripCmd | Signal: Trip Command |

| <i>Name</i> | <i>Description</i> |
|-----------------|----------------------|
| V012[5].TripCmd | Signal: Trip Command |
| V012[6].TripCmd | Signal: Trip Command |
| f[1].TripCmd | Signal: Trip Command |
| f[2].TripCmd | Signal: Trip Command |
| f[3].TripCmd | Signal: Trip Command |
| f[4].TripCmd | Signal: Trip Command |
| f[5].TripCmd | Signal: Trip Command |
| f[6].TripCmd | Signal: Trip Command |
| PQS[1].TripCmd | Signal: Trip Command |
| PQS[2].TripCmd | Signal: Trip Command |
| PQS[3].TripCmd | Signal: Trip Command |
| PQS[4].TripCmd | Signal: Trip Command |
| PQS[5].TripCmd | Signal: Trip Command |
| PQS[6].TripCmd | Signal: Trip Command |
| PF[1].TripCmd | Signal: Trip Command |
| PF[2].TripCmd | Signal: Trip Command |
| ExP[1].TripCmd | Signal: Trip Command |
| ExP[2].TripCmd | Signal: Trip Command |
| ExP[3].TripCmd | Signal: Trip Command |
| ExP[4].TripCmd | Signal: Trip Command |





Controlled Circuit Breaker

SG[1]

Direct Commands of a Controlled Circuit Breaker

| Parameter | Description | Setting range | Default | Menu path |
|---|---|---------------------------------|----------|---|
|  Manipulate Position | WARNING! Fake Position - Manual Position Manipulation | inactive, Pos OFF, Pos ON | inactive | [Control /SG /SG[1] /General settings] |
|  Res SGwear SI SG | Resetting the slow Switchgear Alarm | inactive, active | inactive | [Operation /Reset] |
|  Ack TripCmd | Acknowledge Trip Command | inactive, active | inactive | [Operation /Acknowledge] |

Global Protection Parameters of a Controlled Circuit Breaker

| Parameter | Description | Setting range | Default | Menu path |
|---|--|--------------------|-----------------|--|
|  Aux ON | The CB is in ON-position if the state of the assigned signal is true (52a). | 1..n, DI-LogicList | DI Slot X1.DI 1 | [Control /SG /SG[1] /Pos Indicatr Wirng] |
|  Aux OFF | The CB is in OFF-position if the state of the assigned signal is true (52b). | 1..n, DI-LogicList | DI Slot X1.DI 2 | [Control /SG /SG[1] /Pos Indicatr Wirng] |
|  Ready | Circuit breaker is ready for operation if the state of the assigned signal is true. This digital input can be used by some protective elements (if they are available within the device) like Auto Reclosure (AR), e.g. as a trigger signal. | 1..n, DI-LogicList | -- | [Control /SG /SG[1] /Pos Indicatr Wirng] |
|  Removed | The withdrawable circuit breaker is Removed Dependency | 1..n, DI-LogicList | -- | [Control /SG /SG[1] /Pos Indicatr Wirng] |

| Parameter | Description | Setting range | Default | Menu path |
|--|---|-----------------------|---------|--|
| Interl ON1  | Interlocking of the ON command | 1..n, Assignment List | -- | [Control /SG /SG[1] /Interlockings] |
| Interl ON2  | Interlocking of the ON command | 1..n, Assignment List | -- | [Control /SG /SG[1] /Interlockings] |
| Interl ON3  | Interlocking of the ON command | 1..n, Assignment List | -- | [Control /SG /SG[1] /Interlockings] |
| Interl OFF1  | Interlocking of the OFF command | 1..n, Assignment List | -- | [Control /SG /SG[1] /Interlockings] |
| Interl OFF2  | Interlocking of the OFF command | 1..n, Assignment List | -- | [Control /SG /SG[1] /Interlockings] |
| Interl OFF3  | Interlocking of the OFF command | 1..n, Assignment List | -- | [Control /SG /SG[1] /Interlockings] |
| SCmd ON  | Switching ON Command, e.g. the state of the Logics or the state of the digital input | 1..n, DI-LogicList | -- | [Control /SG /SG[1] /Ex ON/OFF Cmd] |
| SCmd OFF  | Switching OFF Command, e.g. the state of the Logics or the state of the digital input | 1..n, DI-LogicList | -- | [Control /SG /SG[1] /Ex ON/OFF Cmd] |
| t-TripCmd  | Minimum hold time of the OFF-command (circuit breaker, load break switch) | 0 - 300.00s | 0.2s | [Control /SG /SG[1] /Trip Manager] |

| Parameter | Description | Setting range | Default | Menu path |
|--|--|-----------------------|----------------|---|
| Latched  | Defines whether the Binary Output Relay will be Latched when it picks up. | inactive, active | inactive | [Control /SG /SG[1] /Trip Manager] |
| Ack TripCmd  | Ack TripCmd | 1..n, Assignment List | -- | [Control /SG /SG[1] /Trip Manager] |
| Off Cmd1  | Off Command to the Circuit Breaker if the state of the assigned signal becomes true. | 1..n, Trip Cmds | l[1].TripCmd | [Control /SG /SG[1] /Trip Manager] |
| Off Cmd2  | Off Command to the Circuit Breaker if the state of the assigned signal becomes true. | 1..n, Trip Cmds | V[1].TripCmd | [Control /SG /SG[1] /Trip Manager] |
| Off Cmd3  | Off Command to the Circuit Breaker if the state of the assigned signal becomes true. | 1..n, Trip Cmds | V[2].TripCmd | [Control /SG /SG[1] /Trip Manager] |
| Off Cmd4  | Off Command to the Circuit Breaker if the state of the assigned signal becomes true. | 1..n, Trip Cmds | f[1].TripCmd | [Control /SG /SG[1] /Trip Manager] |
| Off Cmd5  | Off Command to the Circuit Breaker if the state of the assigned signal becomes true. | 1..n, Trip Cmds | f[2].TripCmd | [Control /SG /SG[1] /Trip Manager] |
| Off Cmd6  | Off Command to the Circuit Breaker if the state of the assigned signal becomes true. | 1..n, Trip Cmds | PQS[1].TripCmd | [Control /SG /SG[1] /Trip Manager] |
| Off Cmd7  | Off Command to the Circuit Breaker if the state of the assigned signal becomes true. | 1..n, Trip Cmds | -- | [Control /SG /SG[1] /Trip Manager] |

| Parameter | Description | Setting range | Default | Menu path |
|--|--|-----------------|---------|---|
| Off Cmd8  | Off Command to the Circuit Breaker if the state of the assigned signal becomes true. | 1..n, Trip Cmds | -- | [Control /SG /SG[1] /Trip Manager] |
| Off Cmd9  | Off Command to the Circuit Breaker if the state of the assigned signal becomes true. | 1..n, Trip Cmds | -- | [Control /SG /SG[1] /Trip Manager] |
| Off Cmd10  | Off Command to the Circuit Breaker if the state of the assigned signal becomes true. | 1..n, Trip Cmds | -- | [Control /SG /SG[1] /Trip Manager] |
| Off Cmd11  | Off Command to the Circuit Breaker if the state of the assigned signal becomes true. | 1..n, Trip Cmds | -- | [Control /SG /SG[1] /Trip Manager] |
| Off Cmd12  | Off Command to the Circuit Breaker if the state of the assigned signal becomes true. | 1..n, Trip Cmds | -- | [Control /SG /SG[1] /Trip Manager] |
| Off Cmd13  | Off Command to the Circuit Breaker if the state of the assigned signal becomes true. | 1..n, Trip Cmds | -- | [Control /SG /SG[1] /Trip Manager] |
| Off Cmd14  | Off Command to the Circuit Breaker if the state of the assigned signal becomes true. | 1..n, Trip Cmds | -- | [Control /SG /SG[1] /Trip Manager] |
| Off Cmd15  | Off Command to the Circuit Breaker if the state of the assigned signal becomes true. | 1..n, Trip Cmds | -- | [Control /SG /SG[1] /Trip Manager] |
| Off Cmd16  | Off Command to the Circuit Breaker if the state of the assigned signal becomes true. | 1..n, Trip Cmds | -- | [Control /SG /SG[1] /Trip Manager] |

| Parameter | Description | Setting range | Default | Menu path |
|--|--|-----------------|---------|---|
| Off Cmd17  | Off Command to the Circuit Breaker if the state of the assigned signal becomes true. | 1..n, Trip Cmds | -- | [Control /SG /SG[1] /Trip Manager] |
| Off Cmd18  | Off Command to the Circuit Breaker if the state of the assigned signal becomes true. | 1..n, Trip Cmds | -- | [Control /SG /SG[1] /Trip Manager] |
| Off Cmd19  | Off Command to the Circuit Breaker if the state of the assigned signal becomes true. | 1..n, Trip Cmds | -- | [Control /SG /SG[1] /Trip Manager] |
| Off Cmd20  | Off Command to the Circuit Breaker if the state of the assigned signal becomes true. | 1..n, Trip Cmds | -- | [Control /SG /SG[1] /Trip Manager] |
| Off Cmd21  | Off Command to the Circuit Breaker if the state of the assigned signal becomes true. | 1..n, Trip Cmds | -- | [Control /SG /SG[1] /Trip Manager] |
| Off Cmd22  | Off Command to the Circuit Breaker if the state of the assigned signal becomes true. | 1..n, Trip Cmds | -- | [Control /SG /SG[1] /Trip Manager] |
| Off Cmd23  | Off Command to the Circuit Breaker if the state of the assigned signal becomes true. | 1..n, Trip Cmds | -- | [Control /SG /SG[1] /Trip Manager] |
| Off Cmd24  | Off Command to the Circuit Breaker if the state of the assigned signal becomes true. | 1..n, Trip Cmds | -- | [Control /SG /SG[1] /Trip Manager] |
| Off Cmd25  | Off Command to the Circuit Breaker if the state of the assigned signal becomes true. | 1..n, Trip Cmds | -- | [Control /SG /SG[1] /Trip Manager] |

| Parameter | Description | Setting range | Default | Menu path |
|--|--|-----------------|---------|---|
| Off Cmd26  | Off Command to the Circuit Breaker if the state of the assigned signal becomes true. | 1..n, Trip Cmds | -- | [Control /SG /SG[1] /Trip Manager] |
| Off Cmd27  | Off Command to the Circuit Breaker if the state of the assigned signal becomes true. | 1..n, Trip Cmds | -- | [Control /SG /SG[1] /Trip Manager] |
| Off Cmd28  | Off Command to the Circuit Breaker if the state of the assigned signal becomes true. | 1..n, Trip Cmds | -- | [Control /SG /SG[1] /Trip Manager] |
| Off Cmd29  | Off Command to the Circuit Breaker if the state of the assigned signal becomes true. | 1..n, Trip Cmds | -- | [Control /SG /SG[1] /Trip Manager] |
| Off Cmd30  | Off Command to the Circuit Breaker if the state of the assigned signal becomes true. | 1..n, Trip Cmds | -- | [Control /SG /SG[1] /Trip Manager] |
| Off Cmd31  | Off Command to the Circuit Breaker if the state of the assigned signal becomes true. | 1..n, Trip Cmds | -- | [Control /SG /SG[1] /Trip Manager] |
| Off Cmd32  | Off Command to the Circuit Breaker if the state of the assigned signal becomes true. | 1..n, Trip Cmds | -- | [Control /SG /SG[1] /Trip Manager] |
| Off Cmd33  | Off Command to the Circuit Breaker if the state of the assigned signal becomes true. | 1..n, Trip Cmds | -- | [Control /SG /SG[1] /Trip Manager] |
| Off Cmd34  | Off Command to the Circuit Breaker if the state of the assigned signal becomes true. | 1..n, Trip Cmds | -- | [Control /SG /SG[1] /Trip Manager] |

| Parameter | Description | Setting range | Default | Menu path |
|--|--|-----------------|---------|---|
| Off Cmd35  | Off Command to the Circuit Breaker if the state of the assigned signal becomes true. | 1..n, Trip Cmds | -- | [Control /SG /SG[1] /Trip Manager] |
| Off Cmd36  | Off Command to the Circuit Breaker if the state of the assigned signal becomes true. | 1..n, Trip Cmds | -- | [Control /SG /SG[1] /Trip Manager] |
| Off Cmd37  | Off Command to the Circuit Breaker if the state of the assigned signal becomes true. | 1..n, Trip Cmds | -- | [Control /SG /SG[1] /Trip Manager] |
| Off Cmd38  | Off Command to the Circuit Breaker if the state of the assigned signal becomes true. | 1..n, Trip Cmds | -- | [Control /SG /SG[1] /Trip Manager] |
| Off Cmd39  | Off Command to the Circuit Breaker if the state of the assigned signal becomes true. | 1..n, Trip Cmds | -- | [Control /SG /SG[1] /Trip Manager] |
| Off Cmd40  | Off Command to the Circuit Breaker if the state of the assigned signal becomes true. | 1..n, Trip Cmds | -- | [Control /SG /SG[1] /Trip Manager] |
| Off Cmd41  | Off Command to the Circuit Breaker if the state of the assigned signal becomes true. | 1..n, Trip Cmds | -- | [Control /SG /SG[1] /Trip Manager] |
| Off Cmd42  | Off Command to the Circuit Breaker if the state of the assigned signal becomes true. | 1..n, Trip Cmds | -- | [Control /SG /SG[1] /Trip Manager] |
| Off Cmd43  | Off Command to the Circuit Breaker if the state of the assigned signal becomes true. | 1..n, Trip Cmds | -- | [Control /SG /SG[1] /Trip Manager] |

| Parameter | Description | Setting range | Default | Menu path |
|--|--|-----------------|---------|---|
| Off Cmd44  | Off Command to the Circuit Breaker if the state of the assigned signal becomes true. | 1..n, Trip Cmds | -- | [Control /SG /SG[1] /Trip Manager] |
| Off Cmd45  | Off Command to the Circuit Breaker if the state of the assigned signal becomes true. | 1..n, Trip Cmds | -- | [Control /SG /SG[1] /Trip Manager] |
| Off Cmd46  | Off Command to the Circuit Breaker if the state of the assigned signal becomes true. | 1..n, Trip Cmds | -- | [Control /SG /SG[1] /Trip Manager] |
| Off Cmd47  | Off Command to the Circuit Breaker if the state of the assigned signal becomes true. | 1..n, Trip Cmds | -- | [Control /SG /SG[1] /Trip Manager] |
| Off Cmd48  | Off Command to the Circuit Breaker if the state of the assigned signal becomes true. | 1..n, Trip Cmds | -- | [Control /SG /SG[1] /Trip Manager] |
| Off Cmd49  | Off Command to the Circuit Breaker if the state of the assigned signal becomes true. | 1..n, Trip Cmds | -- | [Control /SG /SG[1] /Trip Manager] |
| Off Cmd50  | Off Command to the Circuit Breaker if the state of the assigned signal becomes true. | 1..n, Trip Cmds | -- | [Control /SG /SG[1] /Trip Manager] |
| Off Cmd51  | Off Command to the Circuit Breaker if the state of the assigned signal becomes true. | 1..n, Trip Cmds | -- | [Control /SG /SG[1] /Trip Manager] |
| Off Cmd52  | Off Command to the Circuit Breaker if the state of the assigned signal becomes true. | 1..n, Trip Cmds | -- | [Control /SG /SG[1] /Trip Manager] |

| Parameter | Description | Setting range | Default | Menu path |
|---|--|---------------------|---------|---|
| Off Cmd53  | Off Command to the Circuit Breaker if the state of the assigned signal becomes true. | 1..n, Trip Cmds | -- | [Control /SG /SG[1] /Trip Manager] |
| Off Cmd54  | Off Command to the Circuit Breaker if the state of the assigned signal becomes true. | 1..n, Trip Cmds | -- | [Control /SG /SG[1] /Trip Manager] |
| Off Cmd55  | Off Command to the Circuit Breaker if the state of the assigned signal becomes true. | 1..n, Trip Cmds | -- | [Control /SG /SG[1] /Trip Manager] |
| Synchronism  | Synchronism | 1..n, In-SyncList | -- | [Control /SG /SG[1] /Synchron Switchg] |
| t-MaxSyncSuperv  | Synchron-Run timer: Max. time allowed for synchronizing process after a close initiate. Only used for GENERATOR2SYSTEM working mode. | 0 - 3000.00s | 0.2s | [Control /SG /SG[1] /Synchron Switchg] |
| ON incl Prot ON  | The ON Command includes the ON Command issued by the Protection module. | inactive, active | active | [Control /SG /SG[1] /General settings] |
| OFF incl TripCmd  | The OFF Command includes the OFF Command issued by the Protection module. | inactive, active | active | [Control /SG /SG[1] /General settings] |
| t-Move ON  | Time to move to the ON Position | 0.01 - 100.00s | 0.1s | [Control /SG /SG[1] /General settings] |
| t-Move OFF  | Time to move to the OFF Position | 0.01 - 100.00s | 0.1s | [Control /SG /SG[1] /General settings] |

| Parameter | Description | Setting range | Default | Menu path |
|--|-------------|---------------|---------|---|
| t-Dwell  | Dwell time | 0 - 100.00s | 0s | [Control /SG /SG[1] /General settings] |

Controlled Circuit Breaker Input States

| Name | Description | Assignment via |
|---------------|--|--|
| Aux ON-I | Module Input State: Position indicator/check-back signal of the CB (52a) | [Control /SG /SG[1] /Pos Indicatrs Wirng] |
| Aux OFF-I | Module input state: Position indicator/check-back signal of the CB (52b) | [Control /SG /SG[1] /Pos Indicatrs Wirng] |
| Ready-I | Module input state: CB ready | [Control /SG /SG[1] /Pos Indicatrs Wirng] |
| Sys-in-Sync-I | State of the module input: This signals has to become true within the synchronization time. If not, switching is unsuccessful. | [Control /SG /SG[1] /Synchron Switchg] |
| Removed-I | State of the module input: The withdrawable circuit breaker is Removed | [Control /SG /SG[1] /Pos Indicatrs Wirng] |
| Ack TripCmd-I | State of the module input: Acknowledgement Signal (only for automatic acknowledgement) Module input signal | [Control /SG /SG[1] /Trip Manager] |
| Interl ON1-I | State of the module input: Interlocking of the ON command | [Control /SG /SG[1] /Interlockings] |

| <i>Name</i> | <i>Description</i> | <i>Assignment via</i> |
|---------------|--|--|
| Interl ON2-I | State of the module input: Interlocking of the ON command | [Control /SG /SG[1] /Interlockings] |
| Interl ON3-I | State of the module input: Interlocking of the ON command | [Control /SG /SG[1] /Interlockings] |
| Interl OFF1-I | State of the module input: Interlocking of the OFF command | [Control /SG /SG[1] /Interlockings] |
| Interl OFF2-I | State of the module input: Interlocking of the OFF command | [Control /SG /SG[1] /Interlockings] |
| Interl OFF3-I | State of the module input: Interlocking of the OFF command | [Control /SG /SG[1] /Interlockings] |
| SCmd ON-I | State of the module input: Switching ON Command, e.g. the state of the Logics or the state of the digital input | [Control /SG /SG[1] /Ex ON/OFF Cmd] |
| SCmd OFF-I | State of the module input: Switching OFF Command, e.g. the state of the Logics or the state of the digital input | [Control /SG /SG[1] /Ex ON/OFF Cmd] |

Signals of a Controlled Circuit Breaker



| <i>Signal</i> | <i>Description</i> |
|----------------------|---|
| SI SingleContactInd | Signal: The Position of the Switchgear is detected by one auxiliary contact (pole) only. Thus indeterminate and disturbed Positions cannot be detected. |
| Pos not ON | Signal: Pos not ON |
| Pos ON | Signal: Circuit Breaker is in ON-Position |
| Pos OFF | Signal: Circuit Breaker is in OFF-Position |
| Pos Indeterm | Signal: Circuit Breaker is in Indeterminate Position |
| Pos Disturb | Signal: Circuit Breaker Disturbed - Undefined Breaker Position. The Position Indicators contradict themselves. After expiring of a supervision timer this signal becomes true. |
| Pos | Signal: Circuit Breaker Position (0 = Indeterminate, 1 = OFF, 2 = ON, 3 = Disturbed) |
| Ready | Signal: Circuit breaker is ready for operation. |
| t-Dwell | Signal: Dwell time |
| Removed | Signal: The withdrawable circuit breaker is Removed |
| Interl ON | Signal: One or more IL_On inputs are active. |
| Interl OFF | Signal: One or more IL_Off inputs are active. |
| CES succesf | Signal: Command Execution Supervision: Switching command executed successfully. |
| CES Disturbed | Signal: Command Execution Supervision: Switching Command unsuccessful. Switchgear in disturbed position. |
| CES Fail TripCmd | Signal: Command Execution Supervision: Command execution failed because trip command is pending. |
| CES SwitchDir | Signal: Command Execution Supervision respectively Switching Direction Control: This signal becomes true, if a switch command is issued even though the switchgear is already in the requested position. Example: A switchgear that is already OFF should be switched OFF again (doubly). The same applies to CLOSE commands. |
| CES ON d OFF | Signal: Command Execution Supervision: On Command during a pending OFF Command. |
| CES SG not ready | Signal: Command Execution Supervision: Switchgear not ready |
| CES Fiel Interl | Signal: Command Execution Supervision: Switching Command not executed because of field interlocking. |
| CES SyncTimeout | Signal: Command Execution Supervision: Switching Command not executed. No Synchronization signal while t-sync was running. |
| CES SG removed | Signal: Command Execution Supervision: Switching Command unsuccessful, Switchgear removed. |
| Prot ON | Signal: ON Command issued by the Prot module |
| TripCmd | Signal: Trip Command |
| Ack TripCmd | Signal: Acknowledge Trip Command |
| ON incl Prot ON | Signal: The ON Command includes the ON Command issued by the Protection module. |
| OFF incl TripCmd | Signal: The OFF Command includes the OFF Command issued by the Protection module. |
| Position Ind manipul | Signal: Position Indicators faked |
| SGwear Slow SG | Signal: Alarm, the circuit breaker (load-break switch) becomes slower |
| Res SGwear SI SG | Signal: Resetting the slow Switchgear Alarm |
| ON Cmd | Signal: ON Command issued to the switchgear. Depending on the setting the signal may include the ON command of the Prot module. |

| <i>Signal</i> | <i>Description</i> |
|-----------------|---|
| OFF Cmd | Signal: OFF Command issued to the switchgear. Depending on the setting the signal may include the OFF command of the Prot module. |
| ON Cmd manual | Signal: ON Cmd manual |
| OFF Cmd manual | Signal: OFF Cmd manual |
| Sync ON request | Signal: Synchronous ON request |



Monitored Circuit Breaker









SG[3]

Direct Commands of a Monitored Circuit Breaker

| <i>Parameter</i> | <i>Description</i> | <i>Setting range</i> | <i>Default</i> | <i>Menu path</i> |
|---|---|---------------------------------|----------------|---|
|  Manipulate Position | WARNING! Fake Position - Manual Position Manipulation | inactive, Pos OFF, Pos ON | inactive | [Control /SG /SG[3] /General settings] |
|  Res SGwear SI SG | Resetting the slow Switchgear Alarm | inactive, active | inactive | [Operation /Reset] |
|  Ack TripCmd | Acknowledge Trip Command | inactive, active | inactive | [Operation /Acknowledge] |

Global Protection Parameters of a Monitored Circuit Breaker

| <i>Parameter</i> | <i>Description</i> | <i>Setting range</i> | <i>Default</i> | <i>Menu path</i> |
|---|--|----------------------|-----------------|---|
|  Aux ON | The CB is in ON-position if the state of the assigned signal is true (52a). | 1..n, DI-LogicList | DI Slot X1.DI 3 | [Control /SG /SG[3] /Pos Indicatrs Wirng] |
|  Aux OFF | The CB is in OFF-position if the state of the assigned signal is true (52b). | 1..n, DI-LogicList | DI Slot X1.DI 4 | [Control /SG /SG[3] /Pos Indicatrs Wirng] |
|  Ready | Circuit breaker is ready for operation if the state of the assigned signal is true. This digital input can be used by some protective elements (if they are available within the device) like Auto Reclosure (AR), e.g. as a trigger signal. | 1..n, DI-LogicList | -- | [Control /SG /SG[3] /Pos Indicatrs Wirng] |

| Parameter | Description | Setting range | Default | Menu path |
|--|---|-----------------------|---------|---|
| Removed  | The withdrawable circuit breaker is Removed Dependency | 1..n, DI-LogicList | -- | [Control /SG /SG[3] /Pos Indicatr Wiring] |
| Interl ON1  | Interlocking of the ON command | 1..n, Assignment List | -- | [Control /SG /SG[3] /Interlockings] |
| Interl ON2  | Interlocking of the ON command | 1..n, Assignment List | -- | [Control /SG /SG[3] /Interlockings] |
| Interl ON3  | Interlocking of the ON command | 1..n, Assignment List | -- | [Control /SG /SG[3] /Interlockings] |
| Interl OFF1  | Interlocking of the OFF command | 1..n, Assignment List | -- | [Control /SG /SG[3] /Interlockings] |
| Interl OFF2  | Interlocking of the OFF command | 1..n, Assignment List | -- | [Control /SG /SG[3] /Interlockings] |
| Interl OFF3  | Interlocking of the OFF command | 1..n, Assignment List | -- | [Control /SG /SG[3] /Interlockings] |
| SCmd ON  | Switching ON Command, e.g. the state of the Logics or the state of the digital input | 1..n, DI-LogicList | -- | [Control /SG /SG[3] /Ex ON/OFF Cmd] |
| SCmd OFF  | Switching OFF Command, e.g. the state of the Logics or the state of the digital input | 1..n, DI-LogicList | -- | [Control /SG /SG[3] /Ex ON/OFF Cmd] |

| Parameter | Description | Setting range | Default | Menu path |
|--|--|-----------------------|----------|---|
| t-TripCmd  | Minimum hold time of the OFF-command (circuit breaker, load break switch) | 0 - 300.00s | 0.2s | [Control /SG /SG[3] /Trip Manager] |
| Latched  | Defines whether the Binary Output Relay will be Latched when it picks up. | inactive, active | inactive | [Control /SG /SG[3] /Trip Manager] |
| Ack TripCmd  | Ack TripCmd | 1..n, Assignment List | -- | [Control /SG /SG[3] /Trip Manager] |
| Off Cmd1  | Off Command to the Circuit Breaker if the state of the assigned signal becomes true. | 1..n, Trip Cmds | -- | [Control /SG /SG[3] /Trip Manager] |
| Off Cmd2  | Off Command to the Circuit Breaker if the state of the assigned signal becomes true. | 1..n, Trip Cmds | -- | [Control /SG /SG[3] /Trip Manager] |
| Off Cmd3  | Off Command to the Circuit Breaker if the state of the assigned signal becomes true. | 1..n, Trip Cmds | -- | [Control /SG /SG[3] /Trip Manager] |
| Off Cmd4  | Off Command to the Circuit Breaker if the state of the assigned signal becomes true. | 1..n, Trip Cmds | -- | [Control /SG /SG[3] /Trip Manager] |
| Off Cmd5  | Off Command to the Circuit Breaker if the state of the assigned signal becomes true. | 1..n, Trip Cmds | -- | [Control /SG /SG[3] /Trip Manager] |
| Off Cmd6  | Off Command to the Circuit Breaker if the state of the assigned signal becomes true. | 1..n, Trip Cmds | -- | [Control /SG /SG[3] /Trip Manager] |

| Parameter | Description | Setting range | Default | Menu path |
|--|--|-----------------|---------|---|
| Off Cmd7  | Off Command to the Circuit Breaker if the state of the assigned signal becomes true. | 1..n, Trip Cmds | -- | [Control /SG /SG[3] /Trip Manager] |
| Off Cmd8  | Off Command to the Circuit Breaker if the state of the assigned signal becomes true. | 1..n, Trip Cmds | -- | [Control /SG /SG[3] /Trip Manager] |
| Off Cmd9  | Off Command to the Circuit Breaker if the state of the assigned signal becomes true. | 1..n, Trip Cmds | -- | [Control /SG /SG[3] /Trip Manager] |
| Off Cmd10  | Off Command to the Circuit Breaker if the state of the assigned signal becomes true. | 1..n, Trip Cmds | -- | [Control /SG /SG[3] /Trip Manager] |
| Off Cmd11  | Off Command to the Circuit Breaker if the state of the assigned signal becomes true. | 1..n, Trip Cmds | -- | [Control /SG /SG[3] /Trip Manager] |
| Off Cmd12  | Off Command to the Circuit Breaker if the state of the assigned signal becomes true. | 1..n, Trip Cmds | -- | [Control /SG /SG[3] /Trip Manager] |
| Off Cmd13  | Off Command to the Circuit Breaker if the state of the assigned signal becomes true. | 1..n, Trip Cmds | -- | [Control /SG /SG[3] /Trip Manager] |
| Off Cmd14  | Off Command to the Circuit Breaker if the state of the assigned signal becomes true. | 1..n, Trip Cmds | -- | [Control /SG /SG[3] /Trip Manager] |
| Off Cmd15  | Off Command to the Circuit Breaker if the state of the assigned signal becomes true. | 1..n, Trip Cmds | -- | [Control /SG /SG[3] /Trip Manager] |



| <i>Parameter</i> | <i>Description</i> | <i>Setting range</i> | <i>Default</i> | <i>Menu path</i> |
|--|--|----------------------|----------------|---|
| Off Cmd16  | Off Command to the Circuit Breaker if the state of the assigned signal becomes true. | 1..n, Trip Cmds | -- | [Control /SG /SG[3] /Trip Manager] |
| Off Cmd17  | Off Command to the Circuit Breaker if the state of the assigned signal becomes true. | 1..n, Trip Cmds | -- | [Control /SG /SG[3] /Trip Manager] |
| Off Cmd18  | Off Command to the Circuit Breaker if the state of the assigned signal becomes true. | 1..n, Trip Cmds | -- | [Control /SG /SG[3] /Trip Manager] |
| Off Cmd19  | Off Command to the Circuit Breaker if the state of the assigned signal becomes true. | 1..n, Trip Cmds | -- | [Control /SG /SG[3] /Trip Manager] |
| Off Cmd20  | Off Command to the Circuit Breaker if the state of the assigned signal becomes true. | 1..n, Trip Cmds | -- | [Control /SG /SG[3] /Trip Manager] |
| Off Cmd21  | Off Command to the Circuit Breaker if the state of the assigned signal becomes true. | 1..n, Trip Cmds | -- | [Control /SG /SG[3] /Trip Manager] |
| Off Cmd22  | Off Command to the Circuit Breaker if the state of the assigned signal becomes true. | 1..n, Trip Cmds | -- | [Control /SG /SG[3] /Trip Manager] |
| Off Cmd23  | Off Command to the Circuit Breaker if the state of the assigned signal becomes true. | 1..n, Trip Cmds | -- | [Control /SG /SG[3] /Trip Manager] |
| Off Cmd24  | Off Command to the Circuit Breaker if the state of the assigned signal becomes true. | 1..n, Trip Cmds | -- | [Control /SG /SG[3] /Trip Manager] |

| Parameter | Description | Setting range | Default | Menu path |
|--|--|-----------------|---------|---|
| Off Cmd25  | Off Command to the Circuit Breaker if the state of the assigned signal becomes true. | 1..n, Trip Cmds | -- | [Control /SG /SG[3] /Trip Manager] |
| Off Cmd26  | Off Command to the Circuit Breaker if the state of the assigned signal becomes true. | 1..n, Trip Cmds | -- | [Control /SG /SG[3] /Trip Manager] |
| Off Cmd27  | Off Command to the Circuit Breaker if the state of the assigned signal becomes true. | 1..n, Trip Cmds | -- | [Control /SG /SG[3] /Trip Manager] |
| Off Cmd28  | Off Command to the Circuit Breaker if the state of the assigned signal becomes true. | 1..n, Trip Cmds | -- | [Control /SG /SG[3] /Trip Manager] |
| Off Cmd29  | Off Command to the Circuit Breaker if the state of the assigned signal becomes true. | 1..n, Trip Cmds | -- | [Control /SG /SG[3] /Trip Manager] |
| Off Cmd30  | Off Command to the Circuit Breaker if the state of the assigned signal becomes true. | 1..n, Trip Cmds | -- | [Control /SG /SG[3] /Trip Manager] |
| Off Cmd31  | Off Command to the Circuit Breaker if the state of the assigned signal becomes true. | 1..n, Trip Cmds | -- | [Control /SG /SG[3] /Trip Manager] |
| Off Cmd32  | Off Command to the Circuit Breaker if the state of the assigned signal becomes true. | 1..n, Trip Cmds | -- | [Control /SG /SG[3] /Trip Manager] |
| Off Cmd33  | Off Command to the Circuit Breaker if the state of the assigned signal becomes true. | 1..n, Trip Cmds | -- | [Control /SG /SG[3] /Trip Manager] |

| Parameter | Description | Setting range | Default | Menu path |
|--|--|-----------------|---------|---|
| Off Cmd34  | Off Command to the Circuit Breaker if the state of the assigned signal becomes true. | 1..n, Trip Cmds | -- | [Control /SG /SG[3] /Trip Manager] |
| Off Cmd35  | Off Command to the Circuit Breaker if the state of the assigned signal becomes true. | 1..n, Trip Cmds | -- | [Control /SG /SG[3] /Trip Manager] |
| Off Cmd36  | Off Command to the Circuit Breaker if the state of the assigned signal becomes true. | 1..n, Trip Cmds | -- | [Control /SG /SG[3] /Trip Manager] |
| Off Cmd37  | Off Command to the Circuit Breaker if the state of the assigned signal becomes true. | 1..n, Trip Cmds | -- | [Control /SG /SG[3] /Trip Manager] |
| Off Cmd38  | Off Command to the Circuit Breaker if the state of the assigned signal becomes true. | 1..n, Trip Cmds | -- | [Control /SG /SG[3] /Trip Manager] |
| Off Cmd39  | Off Command to the Circuit Breaker if the state of the assigned signal becomes true. | 1..n, Trip Cmds | -- | [Control /SG /SG[3] /Trip Manager] |
| Off Cmd40  | Off Command to the Circuit Breaker if the state of the assigned signal becomes true. | 1..n, Trip Cmds | -- | [Control /SG /SG[3] /Trip Manager] |
| Off Cmd41  | Off Command to the Circuit Breaker if the state of the assigned signal becomes true. | 1..n, Trip Cmds | -- | [Control /SG /SG[3] /Trip Manager] |
| Off Cmd42  | Off Command to the Circuit Breaker if the state of the assigned signal becomes true. | 1..n, Trip Cmds | -- | [Control /SG /SG[3] /Trip Manager] |

| Parameter | Description | Setting range | Default | Menu path |
|--|--|-----------------|---------|---|
| Off Cmd43  | Off Command to the Circuit Breaker if the state of the assigned signal becomes true. | 1..n, Trip Cmds | -- | [Control /SG /SG[3] /Trip Manager] |
| Off Cmd44  | Off Command to the Circuit Breaker if the state of the assigned signal becomes true. | 1..n, Trip Cmds | -- | [Control /SG /SG[3] /Trip Manager] |
| Off Cmd45  | Off Command to the Circuit Breaker if the state of the assigned signal becomes true. | 1..n, Trip Cmds | -- | [Control /SG /SG[3] /Trip Manager] |
| Off Cmd46  | Off Command to the Circuit Breaker if the state of the assigned signal becomes true. | 1..n, Trip Cmds | -- | [Control /SG /SG[3] /Trip Manager] |
| Off Cmd47  | Off Command to the Circuit Breaker if the state of the assigned signal becomes true. | 1..n, Trip Cmds | -- | [Control /SG /SG[3] /Trip Manager] |
| Off Cmd48  | Off Command to the Circuit Breaker if the state of the assigned signal becomes true. | 1..n, Trip Cmds | -- | [Control /SG /SG[3] /Trip Manager] |
| Off Cmd49  | Off Command to the Circuit Breaker if the state of the assigned signal becomes true. | 1..n, Trip Cmds | -- | [Control /SG /SG[3] /Trip Manager] |
| Off Cmd50  | Off Command to the Circuit Breaker if the state of the assigned signal becomes true. | 1..n, Trip Cmds | -- | [Control /SG /SG[3] /Trip Manager] |
| Off Cmd51  | Off Command to the Circuit Breaker if the state of the assigned signal becomes true. | 1..n, Trip Cmds | -- | [Control /SG /SG[3] /Trip Manager] |

| Parameter | Description | Setting range | Default | Menu path |
|---|--|---------------------|---------|---|
| Off Cmd52  | Off Command to the Circuit Breaker if the state of the assigned signal becomes true. | 1..n, Trip Cmds | -- | [Control /SG /SG[3] /Trip Manager] |
| Off Cmd53  | Off Command to the Circuit Breaker if the state of the assigned signal becomes true. | 1..n, Trip Cmds | -- | [Control /SG /SG[3] /Trip Manager] |
| Off Cmd54  | Off Command to the Circuit Breaker if the state of the assigned signal becomes true. | 1..n, Trip Cmds | -- | [Control /SG /SG[3] /Trip Manager] |
| Off Cmd55  | Off Command to the Circuit Breaker if the state of the assigned signal becomes true. | 1..n, Trip Cmds | -- | [Control /SG /SG[3] /Trip Manager] |
| Synchronism  | Synchronism | 1..n, In-SyncList | -- | [Control /SG /SG[3] /Synchron Switchg] |
| t-MaxSyncSuperv  | Synchron-Run timer: Max. time allowed for synchronizing process after a close initiate. Only used for GENERATOR2SYSTEM working mode. | 0 - 3000.00s | 0.2s | [Control /SG /SG[3] /Synchron Switchg] |
| ON incl Prot ON  | The ON Command includes the ON Command issued by the Protection module. | inactive, active | active | [Control /SG /SG[3] /General settings] |
| OFF incl TripCmd  | The OFF Command includes the OFF Command issued by the Protection module. | inactive, active | active | [Control /SG /SG[3] /General settings] |
| t-Move ON  | Time to move to the ON Position | 0.01 - 100.00s | 0.1s | [Control /SG /SG[3] /General settings] |

| <i>Parameter</i> | <i>Description</i> | <i>Setting range</i> | <i>Default</i> | <i>Menu path</i> |
|---|----------------------------------|----------------------|----------------|---|
| t-Move OFF  | Time to move to the OFF Position | 0.01 - 100.00s | 0.1s | [Control /SG /SG[3] /General settings] |
| t-Dwell  | Dwell time | 0 - 100.00s | 0s | [Control /SG /SG[3] /General settings] |

Monitored Circuit Breaker Input States

| <i>Name</i> | <i>Description</i> | <i>Assignment via</i> |
|---------------|--|--|
| Aux ON-I | Module Input State: Position indicator/check-back signal of the CB (52a) | [Control /SG /SG[3] /Pos Indicatrs Wirng] |
| Aux OFF-I | Module input state: Position indicator/check-back signal of the CB (52b) | [Control /SG /SG[3] /Pos Indicatrs Wirng] |
| Ready-I | Module input state: CB ready | [Control /SG /SG[3] /Pos Indicatrs Wirng] |
| Sys-in-Sync-I | State of the module input: This signals has to become true within the synchronization time. If not, switching is unsuccessful. | [Control /SG /SG[3] /Synchron Switchg] |
| Removed-I | State of the module input: The withdrawable circuit breaker is Removed | [Control /SG /SG[3] /Pos Indicatrs Wirng] |
| Ack TripCmd-I | State of the module input: Acknowledgement Signal (only for automatic acknowledgement) Module input signal | [Control /SG /SG[3] /Trip Manager] |

| <i>Name</i> | <i>Description</i> | <i>Assignment via</i> |
|---------------|--|--|
| Interl ON1-I | State of the module input: Interlocking of the ON command | [Control /SG /SG[3] /Interlockings] |
| Interl ON2-I | State of the module input: Interlocking of the ON command | [Control /SG /SG[3] /Interlockings] |
| Interl ON3-I | State of the module input: Interlocking of the ON command | [Control /SG /SG[3] /Interlockings] |
| Interl OFF1-I | State of the module input: Interlocking of the OFF command | [Control /SG /SG[3] /Interlockings] |
| Interl OFF2-I | State of the module input: Interlocking of the OFF command | [Control /SG /SG[3] /Interlockings] |
| Interl OFF3-I | State of the module input: Interlocking of the OFF command | [Control /SG /SG[3] /Interlockings] |
| SCmd ON-I | State of the module input: Switching ON Command, e.g. the state of the Logics or the state of the digital input | [Control /SG /SG[3] /Ex ON/OFF Cmd] |
| SCmd OFF-I | State of the module input: Switching OFF Command, e.g. the state of the Logics or the state of the digital input | [Control /SG /SG[3] /Ex ON/OFF Cmd] |

Signals of a Monitored Circuit Breaker



| <i>Signal</i> | <i>Description</i> |
|----------------------|---|
| SI SingleContactInd | Signal: The Position of the Switchgear is detected by one auxiliary contact (pole) only. Thus indeterminate and disturbed Positions cannot be detected. |
| Pos not ON | Signal: Pos not ON |
| Pos ON | Signal: Circuit Breaker is in ON-Position |
| Pos OFF | Signal: Circuit Breaker is in OFF-Position |
| Pos Indeterm | Signal: Circuit Breaker is in Indeterminate Position |
| Pos Disturb | Signal: Circuit Breaker Disturbed - Undefined Breaker Position. The Position Indicators contradict themselves. After expiring of a supervision timer this signal becomes true. |
| Pos | Signal: Circuit Breaker Position (0 = Indeterminate, 1 = OFF, 2 = ON, 3 = Disturbed) |
| Ready | Signal: Circuit breaker is ready for operation. |
| t-Dwell | Signal: Dwell time |
| Removed | Signal: The withdrawable circuit breaker is Removed |
| Interl ON | Signal: One or more IL_On inputs are active. |
| Interl OFF | Signal: One or more IL_Off inputs are active. |
| CES succesf | Signal: Command Execution Supervision: Switching command executed successfully. |
| CES Disturbed | Signal: Command Execution Supervision: Switching Command unsuccessful. Switchgear in disturbed position. |
| CES Fail TripCmd | Signal: Command Execution Supervision: Command execution failed because trip command is pending. |
| CES SwitchDir | Signal: Command Execution Supervision respectively Switching Direction Control: This signal becomes true, if a switch command is issued even though the switchgear is already in the requested position. Example: A switchgear that is already OFF should be switched OFF again (doubly). The same applies to CLOSE commands. |
| CES ON d OFF | Signal: Command Execution Supervision: On Command during a pending OFF Command. |
| CES SG not ready | Signal: Command Execution Supervision: Switchgear not ready |
| CES Fiel Interl | Signal: Command Execution Supervision: Switching Command not executed because of field interlocking. |
| CES SyncTimeout | Signal: Command Execution Supervision: Switching Command not executed. No Synchronization signal while t-sync was running. |
| CES SG removed | Signal: Command Execution Supervision: Switching Command unsuccessful, Switchgear removed. |
| Prot ON | Signal: ON Command issued by the Prot module |
| TripCmd | Signal: Trip Command |
| Ack TripCmd | Signal: Acknowledge Trip Command |
| ON incl Prot ON | Signal: The ON Command includes the ON Command issued by the Protection module. |
| OFF incl TripCmd | Signal: The OFF Command includes the OFF Command issued by the Protection module. |
| Position Ind manipul | Signal: Position Indicators faked |
| SGwear Slow SG | Signal: Alarm, the circuit breaker (load-break switch) becomes slower |
| Res SGwear SI SG | Signal: Resetting the slow Switchgear Alarm |
| ON Cmd | Signal: ON Command issued to the switchgear. Depending on the setting the signal may include the ON command of the Prot module. |

| <i>Signal</i> | <i>Description</i> |
|-----------------|---|
| OFF Cmd | Signal: OFF Command issued to the switchgear. Depending on the setting the signal may include the OFF command of the Prot module. |
| ON Cmd manual | Signal: ON Cmd manual |
| OFF Cmd manual | Signal: OFF Cmd manual |
| Sync ON request | Signal: Synchronous ON request |





Controlled Disconnecter

SG[4]

Direct Commands of a Controlled Disconnecter

| Parameter | Description | Setting range | Default | Menu path |
|---|---|---------------------------------|----------|---|
|  Manipulate Position | WARNING! Fake Position - Manual Position Manipulation | inactive, Pos OFF, Pos ON | inactive | [Control /SG /SG[4] /General settings] |
|  Res SGwear SI SG | Resetting the slow Switchgear Alarm | inactive, active | inactive | [Operation /Reset] |
|  Ack TripCmd | Acknowledge Trip Command | inactive, active | inactive | [Operation /Acknowledge] |

Global Protection Parameters of a Controlled Disconnecter

| Parameter | Description | Setting range | Default | Menu path |
|---|--|--------------------|-----------------|--|
|  Aux ON | The CB is in ON-position if the state of the assigned signal is true (52a). | 1..n, DI-LogicList | DI Slot X1.DI 5 | [Control /SG /SG[4] /Pos Indicatr Wirng] |
|  Aux OFF | The CB is in OFF-position if the state of the assigned signal is true (52b). | 1..n, DI-LogicList | DI Slot X1.DI 6 | [Control /SG /SG[4] /Pos Indicatr Wirng] |
|  Ready | Circuit breaker is ready for operation if the state of the assigned signal is true. This digital input can be used by some protective elements (if they are available within the device) like Auto Reclosure (AR), e.g. as a trigger signal. | 1..n, DI-LogicList | .- | [Control /SG /SG[4] /Pos Indicatr Wirng] |
|  Removed | The withdrawable circuit breaker is Removed Dependency | 1..n, DI-LogicList | .- | [Control /SG /SG[4] /Pos Indicatr Wirng] |

| Parameter | Description | Setting range | Default | Menu path |
|--|---|-----------------------|--------------|--|
| Interl ON1  | Interlocking of the ON command | 1..n, Assignment List | SG[1].Pos ON | [Control /SG /SG[4] /Interlockings] |
| Interl ON2  | Interlocking of the ON command | 1..n, Assignment List | SG[6].Pos ON | [Control /SG /SG[4] /Interlockings] |
| Interl ON3  | Interlocking of the ON command | 1..n, Assignment List | -- | [Control /SG /SG[4] /Interlockings] |
| Interl OFF1  | Interlocking of the OFF command | 1..n, Assignment List | SG[1].Pos ON | [Control /SG /SG[4] /Interlockings] |
| Interl OFF2  | Interlocking of the OFF command | 1..n, Assignment List | -- | [Control /SG /SG[4] /Interlockings] |
| Interl OFF3  | Interlocking of the OFF command | 1..n, Assignment List | -- | [Control /SG /SG[4] /Interlockings] |
| SCmd ON  | Switching ON Command, e.g. the state of the Logics or the state of the digital input | 1..n, DI-LogicList | -- | [Control /SG /SG[4] /Ex ON/OFF Cmd] |
| SCmd OFF  | Switching OFF Command, e.g. the state of the Logics or the state of the digital input | 1..n, DI-LogicList | -- | [Control /SG /SG[4] /Ex ON/OFF Cmd] |
| t-TripCmd  | Minimum hold time of the OFF-command (circuit breaker, load break switch) | 0 - 300.00s | 0.2s | [Control /SG /SG[4] /Trip Manager] |

| Parameter | Description | Setting range | Default | Menu path |
|--|--|--------------------------|----------|---|
| Latched  | Defines whether the Binary Output Relay will be Latched when it picks up. | inactive, active | inactive | [Control /SG /SG[4] /Trip Manager] |
| Ack TripCmd  | Ack TripCmd | 1..n, Assignment List | -- | [Control /SG /SG[4] /Trip Manager] |
| Off Cmd1  | Off Command to the Circuit Breaker if the state of the assigned signal becomes true. | 1..n, Trip Cmds | -- | [Control /SG /SG[4] /Trip Manager] |
| Off Cmd2  | Off Command to the Circuit Breaker if the state of the assigned signal becomes true. | 1..n, Trip Cmds | -- | [Control /SG /SG[4] /Trip Manager] |
| Off Cmd3  | Off Command to the Circuit Breaker if the state of the assigned signal becomes true. | 1..n, Trip Cmds | -- | [Control /SG /SG[4] /Trip Manager] |
| Off Cmd4  | Off Command to the Circuit Breaker if the state of the assigned signal becomes true. | 1..n, Trip Cmds | -- | [Control /SG /SG[4] /Trip Manager] |
| Off Cmd5  | Off Command to the Circuit Breaker if the state of the assigned signal becomes true. | 1..n, Trip Cmds | -- | [Control /SG /SG[4] /Trip Manager] |
| Off Cmd6  | Off Command to the Circuit Breaker if the state of the assigned signal becomes true. | 1..n, Trip Cmds | -- | [Control /SG /SG[4] /Trip Manager] |
| Off Cmd7  | Off Command to the Circuit Breaker if the state of the assigned signal becomes true. | 1..n, Trip Cmds | -- | [Control /SG /SG[4] /Trip Manager] |

| Parameter | Description | Setting range | Default | Menu path |
|--|--|-----------------|---------|---|
| Off Cmd8  | Off Command to the Circuit Breaker if the state of the assigned signal becomes true. | 1..n, Trip Cmds | -- | [Control /SG /SG[4] /Trip Manager] |
| Off Cmd9  | Off Command to the Circuit Breaker if the state of the assigned signal becomes true. | 1..n, Trip Cmds | -- | [Control /SG /SG[4] /Trip Manager] |
| Off Cmd10  | Off Command to the Circuit Breaker if the state of the assigned signal becomes true. | 1..n, Trip Cmds | -- | [Control /SG /SG[4] /Trip Manager] |
| Off Cmd11  | Off Command to the Circuit Breaker if the state of the assigned signal becomes true. | 1..n, Trip Cmds | -- | [Control /SG /SG[4] /Trip Manager] |
| Off Cmd12  | Off Command to the Circuit Breaker if the state of the assigned signal becomes true. | 1..n, Trip Cmds | -- | [Control /SG /SG[4] /Trip Manager] |
| Off Cmd13  | Off Command to the Circuit Breaker if the state of the assigned signal becomes true. | 1..n, Trip Cmds | -- | [Control /SG /SG[4] /Trip Manager] |
| Off Cmd14  | Off Command to the Circuit Breaker if the state of the assigned signal becomes true. | 1..n, Trip Cmds | -- | [Control /SG /SG[4] /Trip Manager] |
| Off Cmd15  | Off Command to the Circuit Breaker if the state of the assigned signal becomes true. | 1..n, Trip Cmds | -- | [Control /SG /SG[4] /Trip Manager] |
| Off Cmd16  | Off Command to the Circuit Breaker if the state of the assigned signal becomes true. | 1..n, Trip Cmds | -- | [Control /SG /SG[4] /Trip Manager] |

| Parameter | Description | Setting range | Default | Menu path |
|--|--|-----------------|---------|---|
| Off Cmd17  | Off Command to the Circuit Breaker if the state of the assigned signal becomes true. | 1..n, Trip Cmds | -- | [Control /SG /SG[4] /Trip Manager] |
| Off Cmd18  | Off Command to the Circuit Breaker if the state of the assigned signal becomes true. | 1..n, Trip Cmds | -- | [Control /SG /SG[4] /Trip Manager] |
| Off Cmd19  | Off Command to the Circuit Breaker if the state of the assigned signal becomes true. | 1..n, Trip Cmds | -- | [Control /SG /SG[4] /Trip Manager] |
| Off Cmd20  | Off Command to the Circuit Breaker if the state of the assigned signal becomes true. | 1..n, Trip Cmds | -- | [Control /SG /SG[4] /Trip Manager] |
| Off Cmd21  | Off Command to the Circuit Breaker if the state of the assigned signal becomes true. | 1..n, Trip Cmds | -- | [Control /SG /SG[4] /Trip Manager] |
| Off Cmd22  | Off Command to the Circuit Breaker if the state of the assigned signal becomes true. | 1..n, Trip Cmds | -- | [Control /SG /SG[4] /Trip Manager] |
| Off Cmd23  | Off Command to the Circuit Breaker if the state of the assigned signal becomes true. | 1..n, Trip Cmds | -- | [Control /SG /SG[4] /Trip Manager] |
| Off Cmd24  | Off Command to the Circuit Breaker if the state of the assigned signal becomes true. | 1..n, Trip Cmds | -- | [Control /SG /SG[4] /Trip Manager] |
| Off Cmd25  | Off Command to the Circuit Breaker if the state of the assigned signal becomes true. | 1..n, Trip Cmds | -- | [Control /SG /SG[4] /Trip Manager] |

| Parameter | Description | Setting range | Default | Menu path |
|--|--|-----------------|---------|---|
| Off Cmd26  | Off Command to the Circuit Breaker if the state of the assigned signal becomes true. | 1..n, Trip Cmds | -- | [Control /SG /SG[4] /Trip Manager] |
| Off Cmd27  | Off Command to the Circuit Breaker if the state of the assigned signal becomes true. | 1..n, Trip Cmds | -- | [Control /SG /SG[4] /Trip Manager] |
| Off Cmd28  | Off Command to the Circuit Breaker if the state of the assigned signal becomes true. | 1..n, Trip Cmds | -- | [Control /SG /SG[4] /Trip Manager] |
| Off Cmd29  | Off Command to the Circuit Breaker if the state of the assigned signal becomes true. | 1..n, Trip Cmds | -- | [Control /SG /SG[4] /Trip Manager] |
| Off Cmd30  | Off Command to the Circuit Breaker if the state of the assigned signal becomes true. | 1..n, Trip Cmds | -- | [Control /SG /SG[4] /Trip Manager] |
| Off Cmd31  | Off Command to the Circuit Breaker if the state of the assigned signal becomes true. | 1..n, Trip Cmds | -- | [Control /SG /SG[4] /Trip Manager] |
| Off Cmd32  | Off Command to the Circuit Breaker if the state of the assigned signal becomes true. | 1..n, Trip Cmds | -- | [Control /SG /SG[4] /Trip Manager] |
| Off Cmd33  | Off Command to the Circuit Breaker if the state of the assigned signal becomes true. | 1..n, Trip Cmds | -- | [Control /SG /SG[4] /Trip Manager] |
| Off Cmd34  | Off Command to the Circuit Breaker if the state of the assigned signal becomes true. | 1..n, Trip Cmds | -- | [Control /SG /SG[4] /Trip Manager] |

| Parameter | Description | Setting range | Default | Menu path |
|--|--|-----------------|---------|---|
| Off Cmd35  | Off Command to the Circuit Breaker if the state of the assigned signal becomes true. | 1..n, Trip Cmds | -- | [Control /SG /SG[4] /Trip Manager] |
| Off Cmd36  | Off Command to the Circuit Breaker if the state of the assigned signal becomes true. | 1..n, Trip Cmds | -- | [Control /SG /SG[4] /Trip Manager] |
| Off Cmd37  | Off Command to the Circuit Breaker if the state of the assigned signal becomes true. | 1..n, Trip Cmds | -- | [Control /SG /SG[4] /Trip Manager] |
| Off Cmd38  | Off Command to the Circuit Breaker if the state of the assigned signal becomes true. | 1..n, Trip Cmds | -- | [Control /SG /SG[4] /Trip Manager] |
| Off Cmd39  | Off Command to the Circuit Breaker if the state of the assigned signal becomes true. | 1..n, Trip Cmds | -- | [Control /SG /SG[4] /Trip Manager] |
| Off Cmd40  | Off Command to the Circuit Breaker if the state of the assigned signal becomes true. | 1..n, Trip Cmds | -- | [Control /SG /SG[4] /Trip Manager] |
| Off Cmd41  | Off Command to the Circuit Breaker if the state of the assigned signal becomes true. | 1..n, Trip Cmds | -- | [Control /SG /SG[4] /Trip Manager] |
| Off Cmd42  | Off Command to the Circuit Breaker if the state of the assigned signal becomes true. | 1..n, Trip Cmds | -- | [Control /SG /SG[4] /Trip Manager] |
| Off Cmd43  | Off Command to the Circuit Breaker if the state of the assigned signal becomes true. | 1..n, Trip Cmds | -- | [Control /SG /SG[4] /Trip Manager] |

| Parameter | Description | Setting range | Default | Menu path |
|--|--|-----------------|---------|---|
| Off Cmd44  | Off Command to the Circuit Breaker if the state of the assigned signal becomes true. | 1..n, Trip Cmds | -- | [Control /SG /SG[4] /Trip Manager] |
| Off Cmd45  | Off Command to the Circuit Breaker if the state of the assigned signal becomes true. | 1..n, Trip Cmds | -- | [Control /SG /SG[4] /Trip Manager] |
| Off Cmd46  | Off Command to the Circuit Breaker if the state of the assigned signal becomes true. | 1..n, Trip Cmds | -- | [Control /SG /SG[4] /Trip Manager] |
| Off Cmd47  | Off Command to the Circuit Breaker if the state of the assigned signal becomes true. | 1..n, Trip Cmds | -- | [Control /SG /SG[4] /Trip Manager] |
| Off Cmd48  | Off Command to the Circuit Breaker if the state of the assigned signal becomes true. | 1..n, Trip Cmds | -- | [Control /SG /SG[4] /Trip Manager] |
| Off Cmd49  | Off Command to the Circuit Breaker if the state of the assigned signal becomes true. | 1..n, Trip Cmds | -- | [Control /SG /SG[4] /Trip Manager] |
| Off Cmd50  | Off Command to the Circuit Breaker if the state of the assigned signal becomes true. | 1..n, Trip Cmds | -- | [Control /SG /SG[4] /Trip Manager] |
| Off Cmd51  | Off Command to the Circuit Breaker if the state of the assigned signal becomes true. | 1..n, Trip Cmds | -- | [Control /SG /SG[4] /Trip Manager] |
| Off Cmd52  | Off Command to the Circuit Breaker if the state of the assigned signal becomes true. | 1..n, Trip Cmds | -- | [Control /SG /SG[4] /Trip Manager] |

| Parameter | Description | Setting range | Default | Menu path |
|---|--|---------------------|---------|---|
| Off Cmd53  | Off Command to the Circuit Breaker if the state of the assigned signal becomes true. | 1..n, Trip Cmds | -- | [Control /SG /SG[4] /Trip Manager] |
| Off Cmd54  | Off Command to the Circuit Breaker if the state of the assigned signal becomes true. | 1..n, Trip Cmds | -- | [Control /SG /SG[4] /Trip Manager] |
| Off Cmd55  | Off Command to the Circuit Breaker if the state of the assigned signal becomes true. | 1..n, Trip Cmds | -- | [Control /SG /SG[4] /Trip Manager] |
| Synchronism  | Synchronism | 1..n, In-SyncList | -- | [Control /SG /SG[4] /Synchron Switchg] |
| t-MaxSyncSuperv  | Synchron-Run timer: Max. time allowed for synchronizing process after a close initiate. Only used for GENERATOR2SYSTEM working mode. | 0 - 3000.00s | 0.2s | [Control /SG /SG[4] /Synchron Switchg] |
| ON incl Prot ON  | The ON Command includes the ON Command issued by the Protection module. | inactive, active | active | [Control /SG /SG[4] /General settings] |
| OFF incl TripCmd  | The OFF Command includes the OFF Command issued by the Protection module. | inactive, active | active | [Control /SG /SG[4] /General settings] |
| t-Move ON  | Time to move to the ON Position | 0.01 - 100.00s | 0.1s | [Control /SG /SG[4] /General settings] |
| t-Move OFF  | Time to move to the OFF Position | 0.01 - 100.00s | 0.1s | [Control /SG /SG[4] /General settings] |

| Parameter | Description | Setting range | Default | Menu path |
|--|-------------|---------------|---------|---|
| t-Dwell  | Dwell time | 0 - 100.00s | 0s | [Control /SG /SG[4] /General settings] |

Controlled Disconnecter Input States

| Name | Description | Assignment via |
|---------------|--|---|
| Aux ON-I | Module Input State: Position indicator/check-back signal of the CB (52a) | [Control /SG /SG[4] /Pos Indicatr Wirng] |
| Aux OFF-I | Module input state: Position indicator/check-back signal of the CB (52b) | [Control /SG /SG[4] /Pos Indicatr Wirng] |
| Ready-I | Module input state: CB ready | [Control /SG /SG[4] /Pos Indicatr Wirng] |
| Sys-in-Sync-I | State of the module input: This signals has to become true within the synchronization time. If not, switching is unsuccessful. | [Control /SG /SG[4] /Synchron Switchg] |
| Removed-I | State of the module input: The withdrawable circuit breaker is Removed | [Control /SG /SG[4] /Pos Indicatr Wirng] |
| Ack TripCmd-I | State of the module input: Acknowledgement Signal (only for automatic acknowledgement) Module input signal | [Control /SG /SG[4] /Trip Manager] |
| Interl ON1-I | State of the module input: Interlocking of the ON command | [Control /SG /SG[4] /Interlockings] |

| <i>Name</i> | <i>Description</i> | <i>Assignment via</i> |
|---------------|--|--|
| Interl ON2-I | State of the module input: Interlocking of the ON command | [Control /SG /SG[4] /Interlockings] |
| Interl ON3-I | State of the module input: Interlocking of the ON command | [Control /SG /SG[4] /Interlockings] |
| Interl OFF1-I | State of the module input: Interlocking of the OFF command | [Control /SG /SG[4] /Interlockings] |
| Interl OFF2-I | State of the module input: Interlocking of the OFF command | [Control /SG /SG[4] /Interlockings] |
| Interl OFF3-I | State of the module input: Interlocking of the OFF command | [Control /SG /SG[4] /Interlockings] |
| SCmd ON-I | State of the module input: Switching ON Command, e.g. the state of the Logics or the state of the digital input | [Control /SG /SG[4] /Ex ON/OFF Cmd] |
| SCmd OFF-I | State of the module input: Switching OFF Command, e.g. the state of the Logics or the state of the digital input | [Control /SG /SG[4] /Ex ON/OFF Cmd] |

Signals of a Controlled Disconnecter



| <i>Signal</i> | <i>Description</i> |
|----------------------|---|
| SI SingleContactInd | Signal: The Position of the Switchgear is detected by one auxiliary contact (pole) only. Thus indeterminate and disturbed Positions cannot be detected. |
| Pos not ON | Signal: Pos not ON |
| Pos ON | Signal: Circuit Breaker is in ON-Position |
| Pos OFF | Signal: Circuit Breaker is in OFF-Position |
| Pos Indeterm | Signal: Circuit Breaker is in Indeterminate Position |
| Pos Disturb | Signal: Circuit Breaker Disturbed - Undefined Breaker Position. The Position Indicators contradict themselves. After expiring of a supervision timer this signal becomes true. |
| Pos | Signal: Circuit Breaker Position (0 = Indeterminate, 1 = OFF, 2 = ON, 3 = Disturbed) |
| Ready | Signal: Circuit breaker is ready for operation. |
| t-Dwell | Signal: Dwell time |
| Removed | Signal: The withdrawable circuit breaker is Removed |
| Interl ON | Signal: One or more IL_On inputs are active. |
| Interl OFF | Signal: One or more IL_Off inputs are active. |
| CES succesf | Signal: Command Execution Supervision: Switching command executed successfully. |
| CES Disturbed | Signal: Command Execution Supervision: Switching Command unsuccessful. Switchgear in disturbed position. |
| CES Fail TripCmd | Signal: Command Execution Supervision: Command execution failed because trip command is pending. |
| CES SwitchDir | Signal: Command Execution Supervision respectively Switching Direction Control: This signal becomes true, if a switch command is issued even though the switchgear is already in the requested position. Example: A switchgear that is already OFF should be switched OFF again (doubly). The same applies to CLOSE commands. |
| CES ON d OFF | Signal: Command Execution Supervision: On Command during a pending OFF Command. |
| CES SG not ready | Signal: Command Execution Supervision: Switchgear not ready |
| CES Fiel Interl | Signal: Command Execution Supervision: Switching Command not executed because of field interlocking. |
| CES SyncTimeout | Signal: Command Execution Supervision: Switching Command not executed. No Synchronization signal while t-sync was running. |
| CES SG removed | Signal: Command Execution Supervision: Switching Command unsuccessful, Switchgear removed. |
| Prot ON | Signal: ON Command issued by the Prot module |
| TripCmd | Signal: Trip Command |
| Ack TripCmd | Signal: Acknowledge Trip Command |
| ON incl Prot ON | Signal: The ON Command includes the ON Command issued by the Protection module. |
| OFF incl TripCmd | Signal: The OFF Command includes the OFF Command issued by the Protection module. |
| Position Ind manipul | Signal: Position Indicators faked |
| SGwear Slow SG | Signal: Alarm, the circuit breaker (load-break switch) becomes slower |
| Res SGwear SI SG | Signal: Resetting the slow Switchgear Alarm |
| ON Cmd | Signal: ON Command issued to the switchgear. Depending on the setting the signal may include the ON command of the Prot module. |

| <i>Signal</i> | <i>Description</i> |
|-----------------|---|
| OFF Cmd | Signal: OFF Command issued to the switchgear. Depending on the setting the signal may include the OFF command of the Prot module. |
| ON Cmd manual | Signal: ON Cmd manual |
| OFF Cmd manual | Signal: OFF Cmd manual |
| Sync ON request | Signal: Synchronous ON request |





Monitored Disconnecter

SG[2] .SG[5] .SG[6]

Direct Commands of a Monitored Disconnecter

| Parameter | Description | Setting range | Default | Menu path |
|--|---|---------------------------------|----------|---|
|  Manipulate Position WARNING! Fake Position - Manual Position Manipulation | WARNING! Fake Position - Manual Position Manipulation | inactive, Pos OFF, Pos ON | inactive | [Control /SG /SG[2] /General settings] |
|  Res SGwear SI SG | Resetting the slow Switchgear Alarm | inactive, active | inactive | [Operation /Reset] |
|  Ack TripCmd | Acknowledge Trip Command | inactive, active | inactive | [Operation /Acknowledge] |

Global Protection Parameters of a Monitored Disconnecter

| Parameter | Description | Setting range | Default | Menu path |
|---|--|--------------------|--|--|
|  Aux ON The CB is in ON-position if the state of the assigned signal is true (52a). | The CB is in ON-position if the state of the assigned signal is true (52a). | 1..n, DI-LogicList | SG[2]: -.- SG[5]: -.- SG[6]: DI Slot X1.DI 7 | [Control /SG /SG[2] /Pos Indicatrs Wirng] |
|  Aux OFF The CB is in OFF-position if the state of the assigned signal is true (52b). | The CB is in OFF-position if the state of the assigned signal is true (52b). | 1..n, DI-LogicList | SG[2]: -.- SG[5]: -.- SG[6]: DI Slot X1.DI 8 | [Control /SG /SG[2] /Pos Indicatrs Wirng] |
|  Ready Circuit breaker is ready for operation if the state of the assigned signal is true. This digital input can be used by some protective elements (if they are available within the device) like Auto Reclosure (AR), e.g. as a trigger signal. | Circuit breaker is ready for operation if the state of the assigned signal is true. This digital input can be used by some protective elements (if they are available within the device) like Auto Reclosure (AR), e.g. as a trigger signal. | 1..n, DI-LogicList | -.- | [Control /SG /SG[2] /Pos Indicatrs Wirng] |
|  Removed The withdrawable circuit breaker is Removed Dependency | The withdrawable circuit breaker is Removed Dependency | 1..n, DI-LogicList | -.- | [Control /SG /SG[2] /Pos Indicatrs Wirng] |

| <i>Parameter</i> | <i>Description</i> | <i>Setting range</i> | <i>Default</i> | <i>Menu path</i> |
|--|---|-----------------------|----------------|--|
| Interl ON1  | Interlocking of the ON command | 1..n, Assignment List | -- | [Control /SG /SG[2] /Interlockings] |
| Interl ON2  | Interlocking of the ON command | 1..n, Assignment List | -- | [Control /SG /SG[2] /Interlockings] |
| Interl ON3  | Interlocking of the ON command | 1..n, Assignment List | -- | [Control /SG /SG[2] /Interlockings] |
| Interl OFF1  | Interlocking of the OFF command | 1..n, Assignment List | -- | [Control /SG /SG[2] /Interlockings] |
| Interl OFF2  | Interlocking of the OFF command | 1..n, Assignment List | -- | [Control /SG /SG[2] /Interlockings] |
| Interl OFF3  | Interlocking of the OFF command | 1..n, Assignment List | -- | [Control /SG /SG[2] /Interlockings] |
| SCmd ON  | Switching ON Command, e.g. the state of the Logics or the state of the digital input | 1..n, DI-LogicList | -- | [Control /SG /SG[2] /Ex ON/OFF Cmd] |
| SCmd OFF  | Switching OFF Command, e.g. the state of the Logics or the state of the digital input | 1..n, DI-LogicList | -- | [Control /SG /SG[2] /Ex ON/OFF Cmd] |
| t-TripCmd  | Minimum hold time of the OFF-command (circuit breaker, load break switch) | 0 - 300.00s | 0.2s | [Control /SG /SG[2] /Trip Manager] |

| Parameter | Description | Setting range | Default | Menu path |
|--|--|--------------------------|----------|---|
| Latched  | Defines whether the Binary Output Relay will be Latched when it picks up. | inactive, active | inactive | [Control /SG /SG[2] /Trip Manager] |
| Ack TripCmd  | Ack TripCmd | 1..n, Assignment List | -- | [Control /SG /SG[2] /Trip Manager] |
| Off Cmd1  | Off Command to the Circuit Breaker if the state of the assigned signal becomes true. | 1..n, Trip Cmds | -- | [Control /SG /SG[2] /Trip Manager] |
| Off Cmd2  | Off Command to the Circuit Breaker if the state of the assigned signal becomes true. | 1..n, Trip Cmds | -- | [Control /SG /SG[2] /Trip Manager] |
| Off Cmd3  | Off Command to the Circuit Breaker if the state of the assigned signal becomes true. | 1..n, Trip Cmds | -- | [Control /SG /SG[2] /Trip Manager] |
| Off Cmd4  | Off Command to the Circuit Breaker if the state of the assigned signal becomes true. | 1..n, Trip Cmds | -- | [Control /SG /SG[2] /Trip Manager] |
| Off Cmd5  | Off Command to the Circuit Breaker if the state of the assigned signal becomes true. | 1..n, Trip Cmds | -- | [Control /SG /SG[2] /Trip Manager] |
| Off Cmd6  | Off Command to the Circuit Breaker if the state of the assigned signal becomes true. | 1..n, Trip Cmds | -- | [Control /SG /SG[2] /Trip Manager] |
| Off Cmd7  | Off Command to the Circuit Breaker if the state of the assigned signal becomes true. | 1..n, Trip Cmds | -- | [Control /SG /SG[2] /Trip Manager] |

| Parameter | Description | Setting range | Default | Menu path |
|--|--|-----------------|---------|---|
| Off Cmd8  | Off Command to the Circuit Breaker if the state of the assigned signal becomes true. | 1..n, Trip Cmds | -- | [Control /SG /SG[2] /Trip Manager] |
| Off Cmd9  | Off Command to the Circuit Breaker if the state of the assigned signal becomes true. | 1..n, Trip Cmds | -- | [Control /SG /SG[2] /Trip Manager] |
| Off Cmd10  | Off Command to the Circuit Breaker if the state of the assigned signal becomes true. | 1..n, Trip Cmds | -- | [Control /SG /SG[2] /Trip Manager] |
| Off Cmd11  | Off Command to the Circuit Breaker if the state of the assigned signal becomes true. | 1..n, Trip Cmds | -- | [Control /SG /SG[2] /Trip Manager] |
| Off Cmd12  | Off Command to the Circuit Breaker if the state of the assigned signal becomes true. | 1..n, Trip Cmds | -- | [Control /SG /SG[2] /Trip Manager] |
| Off Cmd13  | Off Command to the Circuit Breaker if the state of the assigned signal becomes true. | 1..n, Trip Cmds | -- | [Control /SG /SG[2] /Trip Manager] |
| Off Cmd14  | Off Command to the Circuit Breaker if the state of the assigned signal becomes true. | 1..n, Trip Cmds | -- | [Control /SG /SG[2] /Trip Manager] |
| Off Cmd15  | Off Command to the Circuit Breaker if the state of the assigned signal becomes true. | 1..n, Trip Cmds | -- | [Control /SG /SG[2] /Trip Manager] |
| Off Cmd16  | Off Command to the Circuit Breaker if the state of the assigned signal becomes true. | 1..n, Trip Cmds | -- | [Control /SG /SG[2] /Trip Manager] |

| Parameter | Description | Setting range | Default | Menu path |
|--|--|-----------------|---------|---|
| Off Cmd17  | Off Command to the Circuit Breaker if the state of the assigned signal becomes true. | 1..n, Trip Cmds | -- | [Control /SG /SG[2] /Trip Manager] |
| Off Cmd18  | Off Command to the Circuit Breaker if the state of the assigned signal becomes true. | 1..n, Trip Cmds | -- | [Control /SG /SG[2] /Trip Manager] |
| Off Cmd19  | Off Command to the Circuit Breaker if the state of the assigned signal becomes true. | 1..n, Trip Cmds | -- | [Control /SG /SG[2] /Trip Manager] |
| Off Cmd20  | Off Command to the Circuit Breaker if the state of the assigned signal becomes true. | 1..n, Trip Cmds | -- | [Control /SG /SG[2] /Trip Manager] |
| Off Cmd21  | Off Command to the Circuit Breaker if the state of the assigned signal becomes true. | 1..n, Trip Cmds | -- | [Control /SG /SG[2] /Trip Manager] |
| Off Cmd22  | Off Command to the Circuit Breaker if the state of the assigned signal becomes true. | 1..n, Trip Cmds | -- | [Control /SG /SG[2] /Trip Manager] |
| Off Cmd23  | Off Command to the Circuit Breaker if the state of the assigned signal becomes true. | 1..n, Trip Cmds | -- | [Control /SG /SG[2] /Trip Manager] |
| Off Cmd24  | Off Command to the Circuit Breaker if the state of the assigned signal becomes true. | 1..n, Trip Cmds | -- | [Control /SG /SG[2] /Trip Manager] |
| Off Cmd25  | Off Command to the Circuit Breaker if the state of the assigned signal becomes true. | 1..n, Trip Cmds | -- | [Control /SG /SG[2] /Trip Manager] |

| Parameter | Description | Setting range | Default | Menu path |
|--|--|-----------------|---------|---|
| Off Cmd26  | Off Command to the Circuit Breaker if the state of the assigned signal becomes true. | 1..n, Trip Cmds | -- | [Control /SG /SG[2] /Trip Manager] |
| Off Cmd27  | Off Command to the Circuit Breaker if the state of the assigned signal becomes true. | 1..n, Trip Cmds | -- | [Control /SG /SG[2] /Trip Manager] |
| Off Cmd28  | Off Command to the Circuit Breaker if the state of the assigned signal becomes true. | 1..n, Trip Cmds | -- | [Control /SG /SG[2] /Trip Manager] |
| Off Cmd29  | Off Command to the Circuit Breaker if the state of the assigned signal becomes true. | 1..n, Trip Cmds | -- | [Control /SG /SG[2] /Trip Manager] |
| Off Cmd30  | Off Command to the Circuit Breaker if the state of the assigned signal becomes true. | 1..n, Trip Cmds | -- | [Control /SG /SG[2] /Trip Manager] |
| Off Cmd31  | Off Command to the Circuit Breaker if the state of the assigned signal becomes true. | 1..n, Trip Cmds | -- | [Control /SG /SG[2] /Trip Manager] |
| Off Cmd32  | Off Command to the Circuit Breaker if the state of the assigned signal becomes true. | 1..n, Trip Cmds | -- | [Control /SG /SG[2] /Trip Manager] |
| Off Cmd33  | Off Command to the Circuit Breaker if the state of the assigned signal becomes true. | 1..n, Trip Cmds | -- | [Control /SG /SG[2] /Trip Manager] |
| Off Cmd34  | Off Command to the Circuit Breaker if the state of the assigned signal becomes true. | 1..n, Trip Cmds | -- | [Control /SG /SG[2] /Trip Manager] |

| Parameter | Description | Setting range | Default | Menu path |
|--|--|-----------------|---------|---|
| Off Cmd35  | Off Command to the Circuit Breaker if the state of the assigned signal becomes true. | 1..n, Trip Cmds | -- | [Control /SG /SG[2] /Trip Manager] |
| Off Cmd36  | Off Command to the Circuit Breaker if the state of the assigned signal becomes true. | 1..n, Trip Cmds | -- | [Control /SG /SG[2] /Trip Manager] |
| Off Cmd37  | Off Command to the Circuit Breaker if the state of the assigned signal becomes true. | 1..n, Trip Cmds | -- | [Control /SG /SG[2] /Trip Manager] |
| Off Cmd38  | Off Command to the Circuit Breaker if the state of the assigned signal becomes true. | 1..n, Trip Cmds | -- | [Control /SG /SG[2] /Trip Manager] |
| Off Cmd39  | Off Command to the Circuit Breaker if the state of the assigned signal becomes true. | 1..n, Trip Cmds | -- | [Control /SG /SG[2] /Trip Manager] |
| Off Cmd40  | Off Command to the Circuit Breaker if the state of the assigned signal becomes true. | 1..n, Trip Cmds | -- | [Control /SG /SG[2] /Trip Manager] |
| Off Cmd41  | Off Command to the Circuit Breaker if the state of the assigned signal becomes true. | 1..n, Trip Cmds | -- | [Control /SG /SG[2] /Trip Manager] |
| Off Cmd42  | Off Command to the Circuit Breaker if the state of the assigned signal becomes true. | 1..n, Trip Cmds | -- | [Control /SG /SG[2] /Trip Manager] |
| Off Cmd43  | Off Command to the Circuit Breaker if the state of the assigned signal becomes true. | 1..n, Trip Cmds | -- | [Control /SG /SG[2] /Trip Manager] |

| Parameter | Description | Setting range | Default | Menu path |
|--|--|-----------------|---------|---|
| Off Cmd44  | Off Command to the Circuit Breaker if the state of the assigned signal becomes true. | 1..n, Trip Cmds | -- | [Control /SG /SG[2] /Trip Manager] |
| Off Cmd45  | Off Command to the Circuit Breaker if the state of the assigned signal becomes true. | 1..n, Trip Cmds | -- | [Control /SG /SG[2] /Trip Manager] |
| Off Cmd46  | Off Command to the Circuit Breaker if the state of the assigned signal becomes true. | 1..n, Trip Cmds | -- | [Control /SG /SG[2] /Trip Manager] |
| Off Cmd47  | Off Command to the Circuit Breaker if the state of the assigned signal becomes true. | 1..n, Trip Cmds | -- | [Control /SG /SG[2] /Trip Manager] |
| Off Cmd48  | Off Command to the Circuit Breaker if the state of the assigned signal becomes true. | 1..n, Trip Cmds | -- | [Control /SG /SG[2] /Trip Manager] |
| Off Cmd49  | Off Command to the Circuit Breaker if the state of the assigned signal becomes true. | 1..n, Trip Cmds | -- | [Control /SG /SG[2] /Trip Manager] |
| Off Cmd50  | Off Command to the Circuit Breaker if the state of the assigned signal becomes true. | 1..n, Trip Cmds | -- | [Control /SG /SG[2] /Trip Manager] |
| Off Cmd51  | Off Command to the Circuit Breaker if the state of the assigned signal becomes true. | 1..n, Trip Cmds | -- | [Control /SG /SG[2] /Trip Manager] |
| Off Cmd52  | Off Command to the Circuit Breaker if the state of the assigned signal becomes true. | 1..n, Trip Cmds | -- | [Control /SG /SG[2] /Trip Manager] |

| Parameter | Description | Setting range | Default | Menu path |
|---|--|---------------------|---------|---|
| Off Cmd53  | Off Command to the Circuit Breaker if the state of the assigned signal becomes true. | 1..n, Trip Cmds | -- | [Control /SG /SG[2] /Trip Manager] |
| Off Cmd54  | Off Command to the Circuit Breaker if the state of the assigned signal becomes true. | 1..n, Trip Cmds | -- | [Control /SG /SG[2] /Trip Manager] |
| Off Cmd55  | Off Command to the Circuit Breaker if the state of the assigned signal becomes true. | 1..n, Trip Cmds | -- | [Control /SG /SG[2] /Trip Manager] |
| Synchronism  | Synchronism | 1..n, In-SyncList | -- | [Control /SG /SG[2] /Synchron Switchg] |
| t-MaxSyncSuperv  | Synchron-Run timer: Max. time allowed for synchronizing process after a close initiate. Only used for GENERATOR2SYSTEM working mode. | 0 - 3000.00s | 0.2s | [Control /SG /SG[2] /Synchron Switchg] |
| ON incl Prot ON  | The ON Command includes the ON Command issued by the Protection module. | inactive, active | active | [Control /SG /SG[2] /General settings] |
| OFF incl TripCmd  | The OFF Command includes the OFF Command issued by the Protection module. | inactive, active | active | [Control /SG /SG[2] /General settings] |
| t-Move ON  | Time to move to the ON Position | 0.01 - 100.00s | 0.1s | [Control /SG /SG[2] /General settings] |
| t-Move OFF  | Time to move to the OFF Position | 0.01 - 100.00s | 0.1s | [Control /SG /SG[2] /General settings] |

| Parameter | Description | Setting range | Default | Menu path |
|--|-------------|---------------|---------|---|
| t-Dwell  | Dwell time | 0 - 100.00s | 0s | [Control /SG /SG[2] /General settings] |

Monitored Disconnecter Input States

| Name | Description | Assignment via |
|---------------|--|--|
| Aux ON-I | Module Input State: Position indicator/check-back signal of the CB (52a) | [Control /SG /SG[2] /Pos Indicatrs Wirng] |
| Aux OFF-I | Module input state: Position indicator/check-back signal of the CB (52b) | [Control /SG /SG[2] /Pos Indicatrs Wirng] |
| Ready-I | Module input state: CB ready | [Control /SG /SG[2] /Pos Indicatrs Wirng] |
| Sys-in-Sync-I | State of the module input: This signals has to become true within the synchronization time. If not, switching is unsuccessful. | [Control /SG /SG[2] /Synchron Switchg] |
| Removed-I | State of the module input: The withdrawable circuit breaker is Removed | [Control /SG /SG[2] /Pos Indicatrs Wirng] |
| Ack TripCmd-I | State of the module input: Acknowledgement Signal (only for automatic acknowledgement) Module input signal | [Control /SG /SG[2] /Trip Manager] |
| Interl ON1-I | State of the module input: Interlocking of the ON command | [Control /SG /SG[2] /Interlockings] |

| <i>Name</i> | <i>Description</i> | <i>Assignment via</i> |
|---------------|--|--|
| Interl ON2-I | State of the module input: Interlocking of the ON command | [Control /SG /SG[2] /Interlockings] |
| Interl ON3-I | State of the module input: Interlocking of the ON command | [Control /SG /SG[2] /Interlockings] |
| Interl OFF1-I | State of the module input: Interlocking of the OFF command | [Control /SG /SG[2] /Interlockings] |
| Interl OFF2-I | State of the module input: Interlocking of the OFF command | [Control /SG /SG[2] /Interlockings] |
| Interl OFF3-I | State of the module input: Interlocking of the OFF command | [Control /SG /SG[2] /Interlockings] |
| SCmd ON-I | State of the module input: Switching ON Command, e.g. the state of the Logics or the state of the digital input | [Control /SG /SG[2] /Ex ON/OFF Cmd] |
| SCmd OFF-I | State of the module input: Switching OFF Command, e.g. the state of the Logics or the state of the digital input | [Control /SG /SG[2] /Ex ON/OFF Cmd] |

Signals of a Monitored Disconnecter

| <i>Signal</i> | <i>Description</i> |
|---------------------|--|
| SI SingleContactInd | Signal: The Position of the Switchgear is detected by one auxiliary contact (pole) only. Thus indeterminate and disturbed Positions cannot be detected. |
| Pos not ON | Signal: Pos not ON |
| Pos ON | Signal: Circuit Breaker is in ON-Position |
| Pos OFF | Signal: Circuit Breaker is in OFF-Position |
| Pos Indeterm | Signal: Circuit Breaker is in Indeterminate Position |
| Pos Disturb | Signal: Circuit Breaker Disturbed - Undefined Breaker Position. The Position Indicators contradict themselves. After expiring of a supervision timer this signal becomes true. |

| <i>Signal</i> | <i>Description</i> |
|----------------------|---|
| Pos | Signal: Circuit Breaker Position (0 = Indeterminate, 1 = OFF, 2 = ON, 3 = Disturbed) |
| Ready | Signal: Circuit breaker is ready for operation. |
| t-Dwell | Signal: Dwell time |
| Removed | Signal: The withdrawable circuit breaker is Removed |
| Interl ON | Signal: One or more IL_On inputs are active. |
| Interl OFF | Signal: One or more IL_Off inputs are active. |
| CES succesf | Signal: Command Execution Supervision: Switching command executed successfully. |
| CES Disturbed | Signal: Command Execution Supervision: Switching Command unsuccessful. Switchgear in disturbed position. |
| CES Fail TripCmd | Signal: Command Execution Supervision: Command execution failed because trip command is pending. |
| CES SwitchDir | Signal: Command Execution Supervision respectively Switching Direction Control: This signal becomes true, if a switch command is issued even though the switchgear is already in the requested position. Example: A switchgear that is already OFF should be switched OFF again (doubly). The same applies to CLOSE commands. |
| CES ON d OFF | Signal: Command Execution Supervision: On Command during a pending OFF Command. |
| CES SG not ready | Signal: Command Execution Supervision: Switchgear not ready |
| CES Fiel Interl | Signal: Command Execution Supervision: Switching Command not executed because of field interlocking. |
| CES SyncTimeout | Signal: Command Execution Supervision: Switching Command not executed. No Synchronization signal while t-sync was running. |
| CES SG removed | Signal: Command Execution Supervision: Switching Command unsuccessful, Switchgear removed. |
| Prot ON | Signal: ON Command issued by the Prot module |
| TripCmd | Signal: Trip Command |
| Ack TripCmd | Signal: Acknowledge Trip Command |
| ON incl Prot ON | Signal: The ON Command includes the ON Command issued by the Protection module. |
| OFF incl TripCmd | Signal: The OFF Command includes the OFF Command issued by the Protection module. |
| Position Ind manipul | Signal: Position Indicators faked |
| SGwear Slow SG | Signal: Alarm, the circuit breaker (load-break switch) becomes slower |
| Res SGwear SI SG | Signal: Resetting the slow Switchgear Alarm |
| ON Cmd | Signal: ON Command issued to the switchgear. Depending on the setting the signal may include the ON command of the Prot module. |
| OFF Cmd | Signal: OFF Command issued to the switchgear. Depending on the setting the signal may include the OFF command of the Prot module. |
| ON Cmd manual | Signal: ON Cmd manual |
| OFF Cmd manual | Signal: OFF Cmd manual |
| Sync ON request | Signal: Synchronous ON request |

Protective Elements

Interconnection

Various state-of-the-art protective elements have been developed for the *HighPROTEC*. Due to the increasing role of distributed energy resources interconnection protection becomes more and more important. A new, sophisticated protection function package covers all protective elements for interconnection applications. This package can be found within menu [Interconnection].

These protective elements can be used flexible. They can be adapted easily by parameter settings to various international and local grid codes.

In the following an overview is given on this menu. Please refer for details on these protective elements to the corresponding chapters.

The Interconnection menu comprises:

A submenu with mains-decoupling elements. Depending on the grid codes that are to be taken into account various mains decoupling elements are mandatory (or forbidden). Within this menu, you have access to the following mains decoupling elements:

- ROCOF (df/dt) (please refer to chapter frequency protection). This element is consistent with a Frequency Protection element, that is set to „df/dt“ within the Device Planning.
- Vector shift (delta phi) (please refer to chapter frequency protection). This element is consistent with a Frequency Protection element, that is set to „delta phi“ within the Device Planning.
- Pr (please refer to chapter power protection). This element is consistent with a Power Protection element, that is set to „Pr>“ within the Device Planning.
- Qr (please refer to chapter power protection). This element is consistent with a Power Protection element, that is set to „Qr>“ within the Device Planning.
- Intertripping (please refer to chapter intertripping).

A submenu for Low Voltage Ride Through (please refer to the LVRT chapter).

A submenu for Q->&V<-Protection (please refer to the Q->&V< chapter).

A submenu for synchronization (please refer to the synchronization chapter).

NOTICE

The device offers also among other things for low voltage systems a voltage quality supervision based on the ten minutes sliding mean square measurement. (please refer to chapter Voltage Protection).

I - Overcurrent Protection [50, 51,51Q, 51V, 67]

Available stages:
 I[1] .I[2] .I[3] .I[4] .I[5] .I[6]



WARNING

If you are using inrush blockings the tripping delay of the current protection functions must be at least 30ms or more in order to prevent faulty trippings.



CAUTION

In order to ensure correct functioning of the directional detection after single-phase short-circuits, the following reference voltage is used: For phase current *I1* it is the line-to-line voltage *U23*, for phase current *I2* the line-to-line voltage *U31* and for phase current *I3* the line-to-line voltage *U12*.

In case the fault happens to be near the measuring location and there is no reference voltage for directional recognition available any more (neither measured or from history (voltage memory)), then the module will - depending on the parameter setting - either trip non-directional or it will be blocked.



NOTICE

All overcurrent protective elements are identically structured.



NOTICE

This module offers Adaptive Parameter Sets. Parameters can be modified within parameter sets dynamically by means of Adaptive Parameter Sets. Please refer to chapter Parameter / Adaptive Parameter Sets.

The following table shows the application options of the Overcurrent Protection element

| Applications of the I-Protection Module | Setting in | Option |
|--|--|--|
| ANSI 50 – Overcurrent protection, non-directional | Device Planning menu | Measuring Mode: Fundamental/TrueRMS/negative phase sequence current (I2) |
| ANSI 51 – Short circuit protection, non-directional | Device Planning menu | Measuring Mode: Fundamental/TrueRMS/negative phase sequence current (I2) |
| ANSI 67 – Overcurrent/ Short circuit protection, directional | Device Planning menu | Measuring Mode: Fundamental/TrueRMS/negative phase sequence current (I2) |
| ANSI 51V – Voltage restraint overcurrent protection | Parameter Set: VRestraint = active | Measuring Mode: Fundamental/TrueRMS/negative phase sequence current (I2) Measuring Channel: Phase to Phase/Phase to Neutral |
| ANSI 51Q Negative Phase Sequence Overcurrent Protection | Parameter Set: Measuring Method =I2 (Negative Sequence Current) | |

| | | |
|---|----------------------------|--|
| <p>51C Voltage controlled overcurrent protection</p> <p>(Please refer to the chapter Parameter/Adaptive Parameter)</p> | <p>Adaptive Parameters</p> | <p>Measuring Mode: Fundamental/TrueRMS/negative phase sequence current (I2)</p> <p>Measuring Channel: (in voltage protection module) Phase to Phase/Phase to Neutral</p> |
|---|----------------------------|--|

Measuring Mode

For all protection elements it can be determined, whether the measurement is done on basis of the »*Fundamental*« or if »*TrueRMS*« measurement is used.

Alternatively the »*Measuring Mode*« can be set to »*I2*«. In this case the negative phase sequence current will be measured. This is to detect unbalanced faults.

Voltage restraint overcurrent protection 51V

When the Parameter »*VRestraint*« is set to active the overcurrent protection element works voltage restraint. That means, the overcurrent pickup threshold will be lowered during voltage drops. This results in a more sensitive overcurrent protection. For the voltage threshold »*VRestraint max*« additionally the »*Measuring Channel*« can be determined.

Measuring Channel

With the parameter »*Measuring Channel*« it can be determined, whether the »*Phase to Phase*« voltage or the »*Phase to Neutral*« voltage is measured.

All overcurrent protective elements can be planned as non-directional or optionally as directional elements. This means, all 6 elements can be planned user defined in forward/reverse or non directional.

For each element the following characteristics are available:

- DEFT (UMZ)
- NINV (IEC/AMZ)
- VINV (IEC/AMZ)
- LINV (IEC/AMZ)
- EINV (IEC/AMZ)
- MINV (ANSI/AMZ)
- VINV (ANSI/AMZ)
- EINV (ANSI/AMZ)
- Thermal Flat
- IT
- I2T
- I4T

Explanation:

t = Tripping delay

t-char = Time multiplier/tripping characteristic factor . The setting range depends on the selected tripping curve .

I = Fault current

I> = If the pickup value is exceeded , the module/element starts to time out to trip .

By using the projecting parameters each of the overcurrent protective elements can be defined as »*forward*«, »*reverse*« or »*non-directional*«. The forward or reverse direction is based on the characteristic angle for the phase direction specified by the field parameter »*I MTA*«. No directional information will be taken into account if the current protective element is planned as »*non-directional*«

DEFT

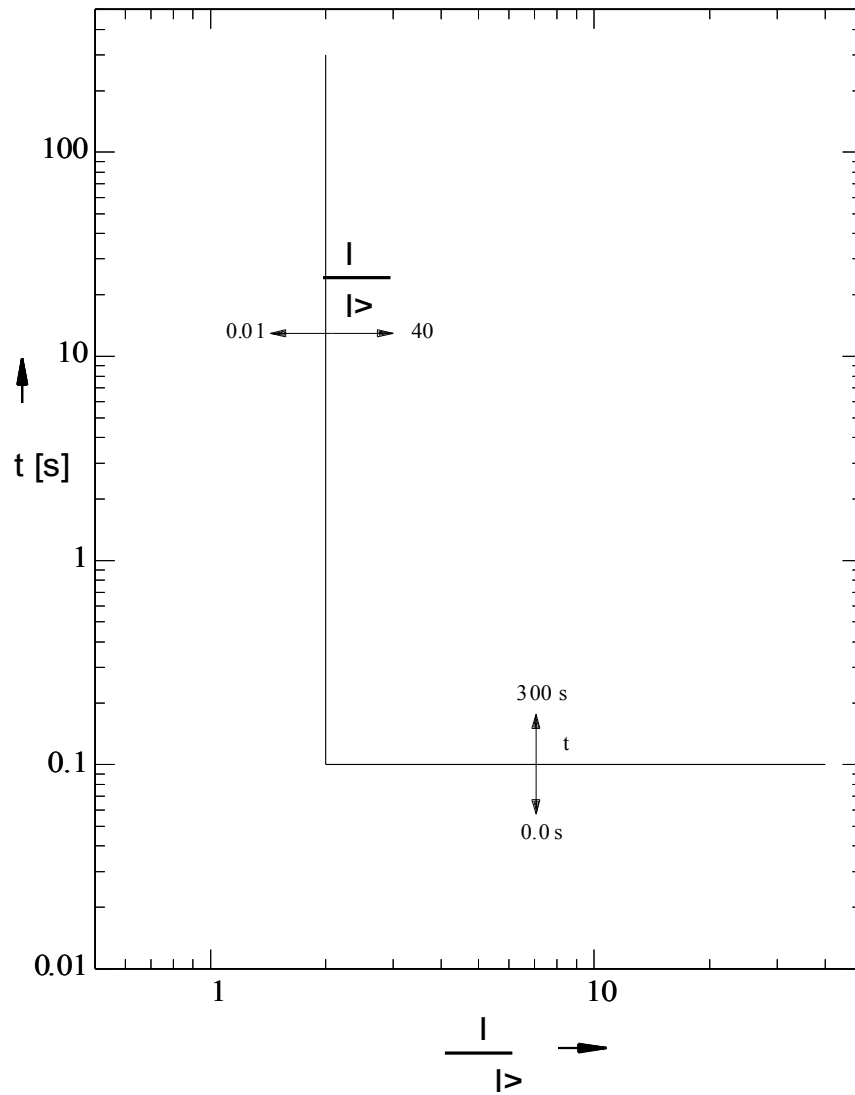

IEC NINV



Notice!

Various reset modes are available . Resetting via characteristic, delayed and instantaneous .

Reset

$$t = \left| \frac{0.14}{\left(\frac{1}{I>} \right)^2 - 1} \right| * t\text{-char [s]}$$

Trip

$$t = \frac{0.14}{\left(\frac{1}{I>} \right)^{0.02} - 1} * t\text{-char [s]}$$

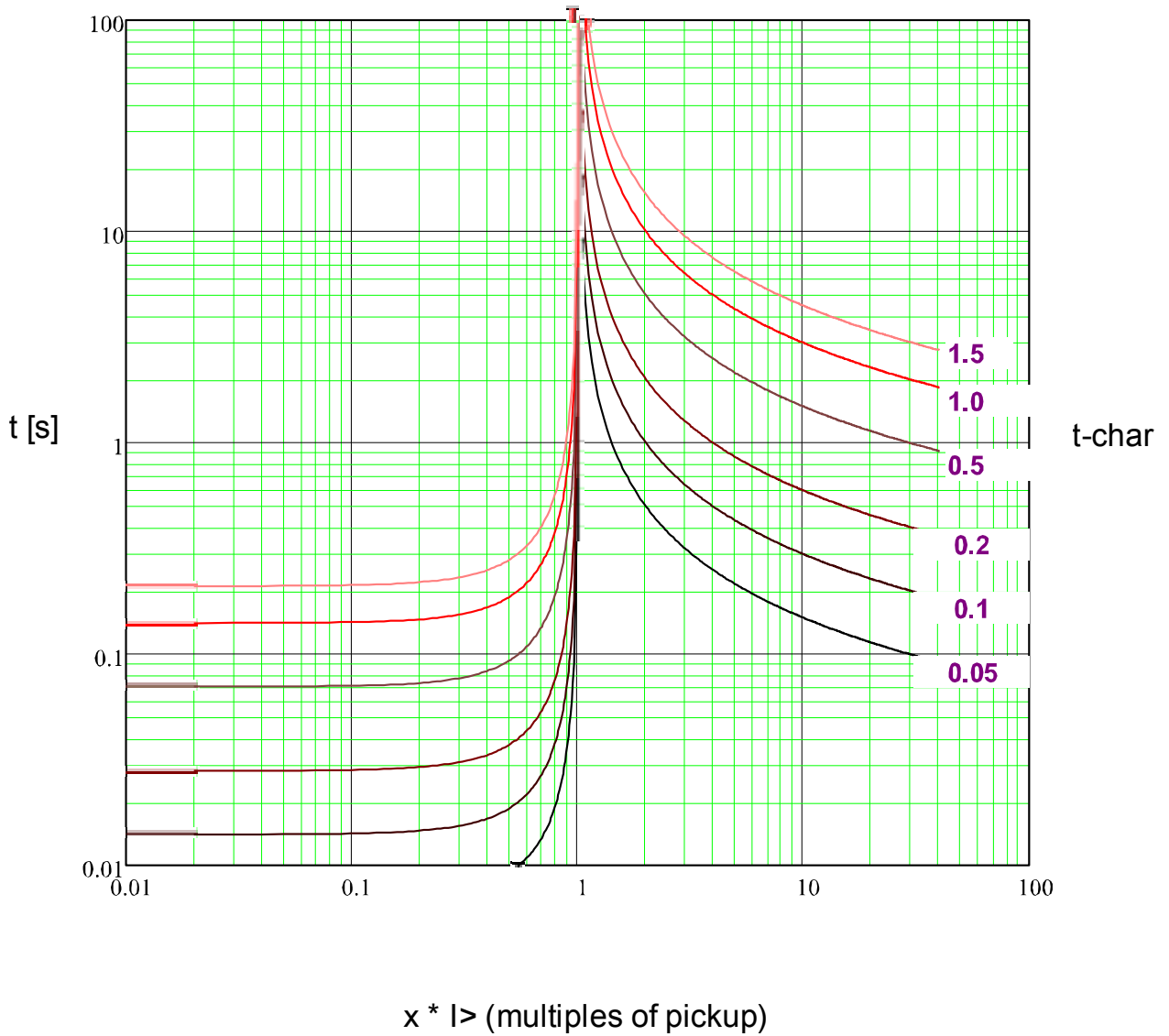

IEC VINV



Notice!

Various reset modes are available . Resetting via characteristic, delayed and instantaneous .

Reset

Trip

$$t = \left| \frac{13.5}{\left(\frac{1}{I>} \right)^2 - 1} \right| * t\text{-char [s]}$$

$$t = \frac{13.5}{\left(\frac{1}{I>} \right) - 1} * t\text{-char [s]}$$

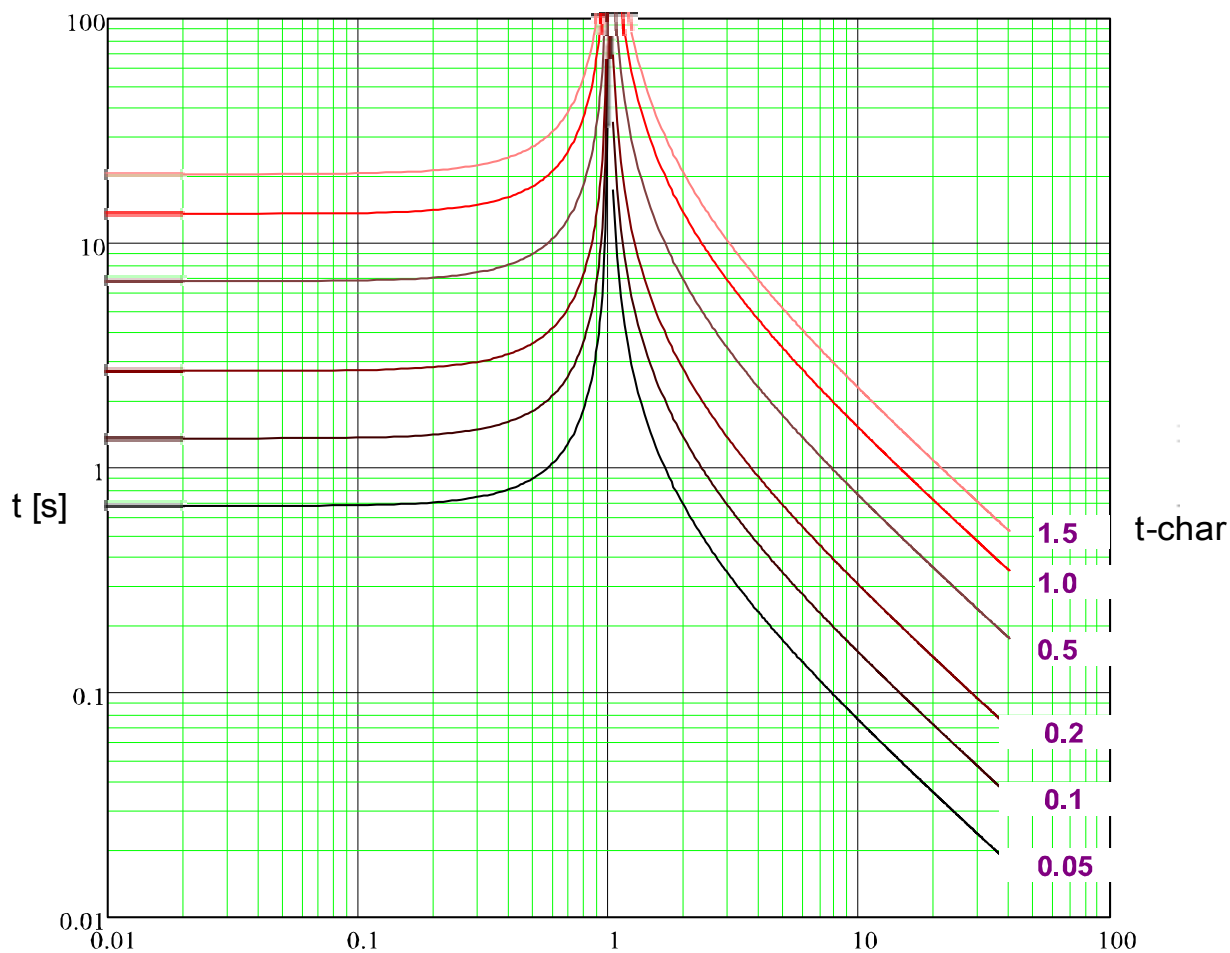

x * I> (multiples of pickup)

IEC LINV



Notice!

Various reset modes are available . Resetting via characteristic, delayed and instantaneous .

Reset

Trip

$$t = \left| \frac{120}{\left(\frac{I}{I_p}\right)^2 - 1} \right| * t\text{-char [s]}$$

$$t = \frac{120}{\left(\frac{I}{I_p}\right) - 1} * t\text{-char [s]}$$

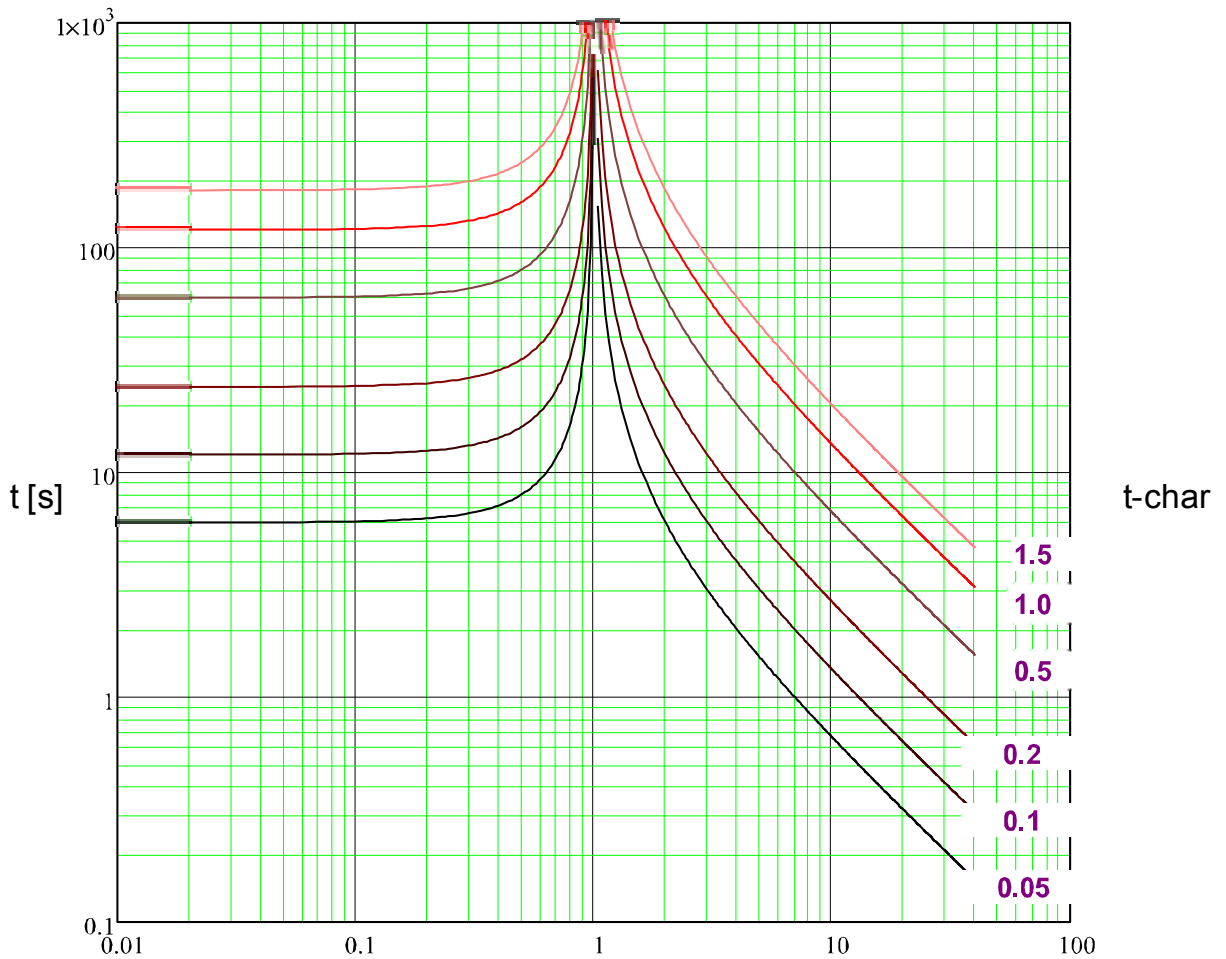

x * I_p (multiples of pickup)

IEC EINV



Notice!

Various reset modes are available . Resetting via characteristic, delayed and instantaneous .

Reset

Trip

$$t = \left| \frac{80}{\left(\frac{1}{I>} \right)^2 - 1} \right| * t\text{-char [s]}$$

$$t = \frac{80}{\left(\frac{1}{I>} \right)^2 - 1} * t\text{-char [s]}$$

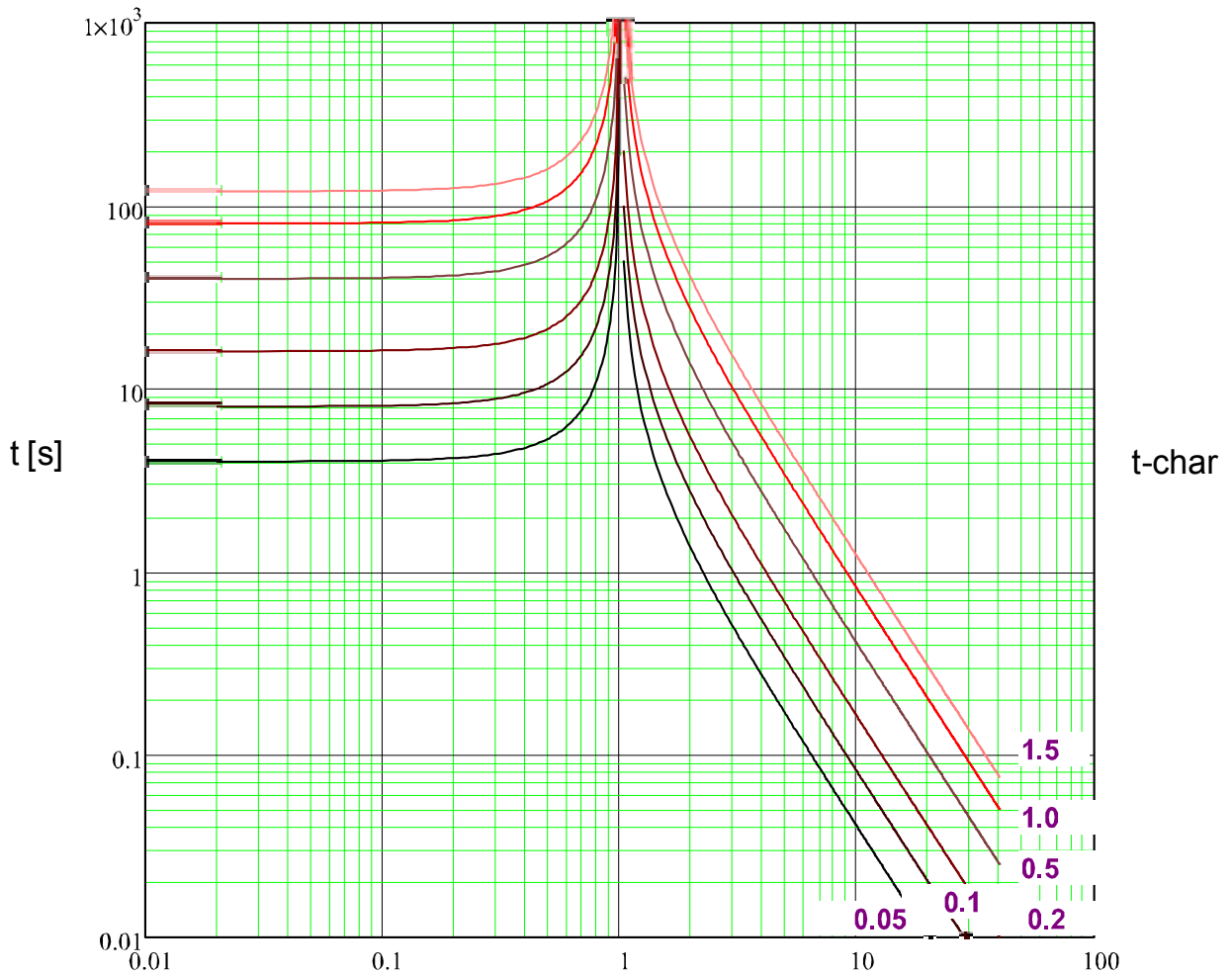

$x * I>$ (multiples of pickup)

ANSI MINV



Notice!

Various reset modes are available . Resetting via characteristic, delayed and instantaneous .

Reset

$$t = \left| \frac{4.85}{\left(\frac{1}{I>} \right)^2 - 1} \right| * t\text{-char [s]}$$

Trip

$$t = \left(\frac{0.0515}{\left(\frac{1}{I>} \right)^{0.02} + 0.1140} \right) * t\text{-char [s]}$$

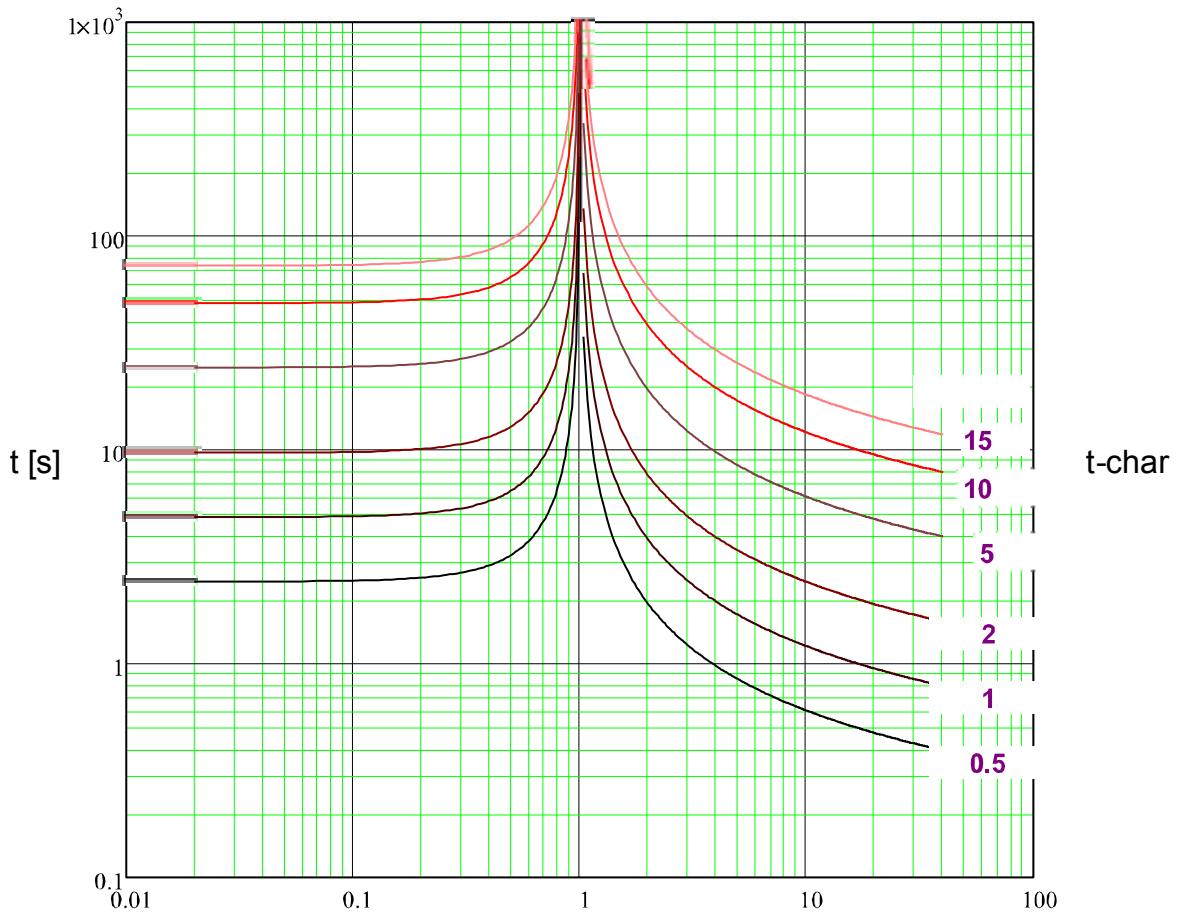

$x * I>$ (multiples of pickup)

ANSI VINV



Notice!

Various reset modes are available . Resetting via characteristic, delayed and instantaneous .

Reset

$$t = \left| \frac{21.6}{\left(\frac{1}{I>} \right)^2 - 1} \right| * t\text{-char [s]}$$

Trip

$$t = \left(\frac{19.61}{\left(\frac{1}{I>} \right)^2} + 0.491 \right) * t\text{-char [s]}$$

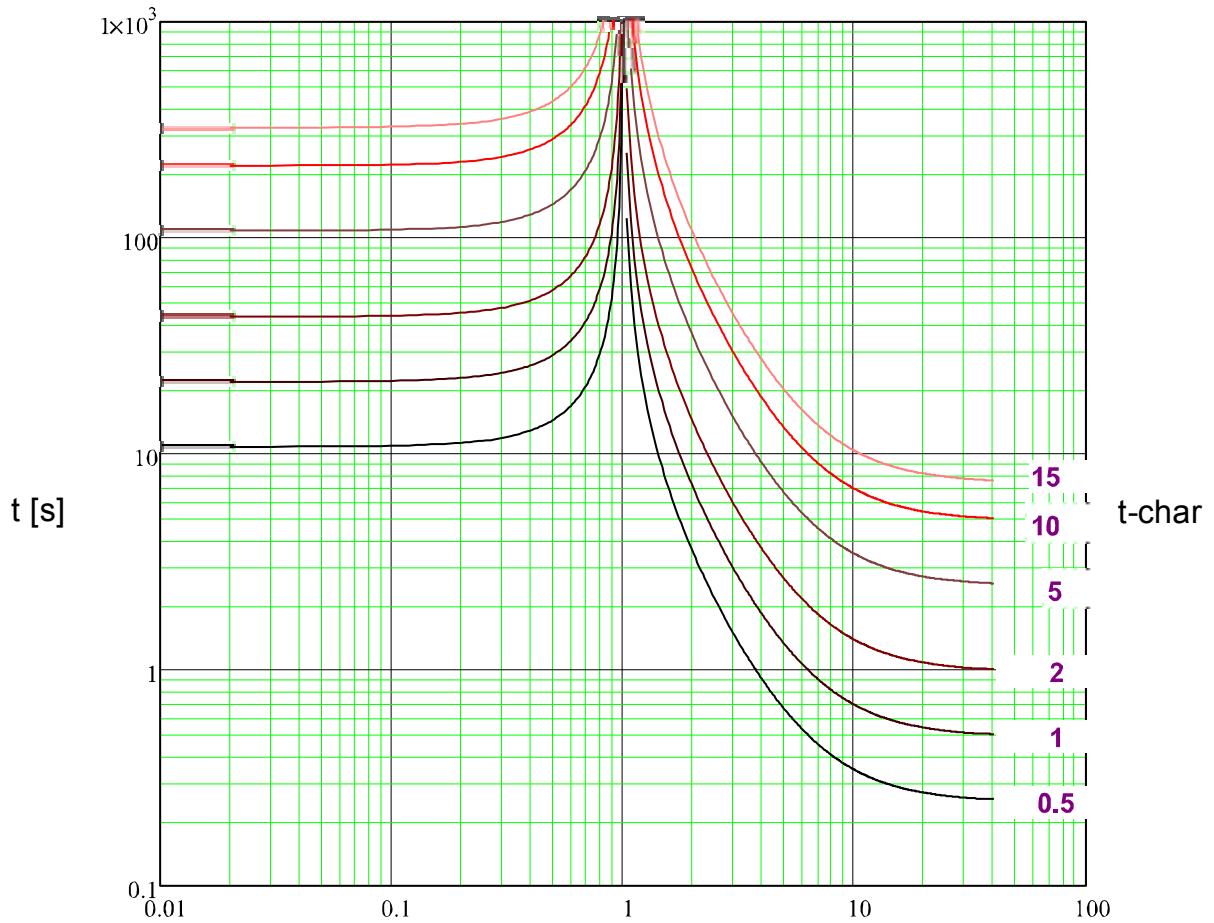

$x * I>$ (multiples of pickup)

ANSI EINV



Notice!

Various reset modes are available . Resetting via characteristic, delayed and instantaneous .

Reset

Trip

$$t = \left| \frac{29.1}{\left(\frac{1}{I>} \right)^2 - 1} \right| * t\text{-char [s]}$$

$$t = \left(\frac{28.2}{\left(\frac{1}{I>} \right)^2 - 1} + 0.1217 \right) * t\text{-char [s]}$$

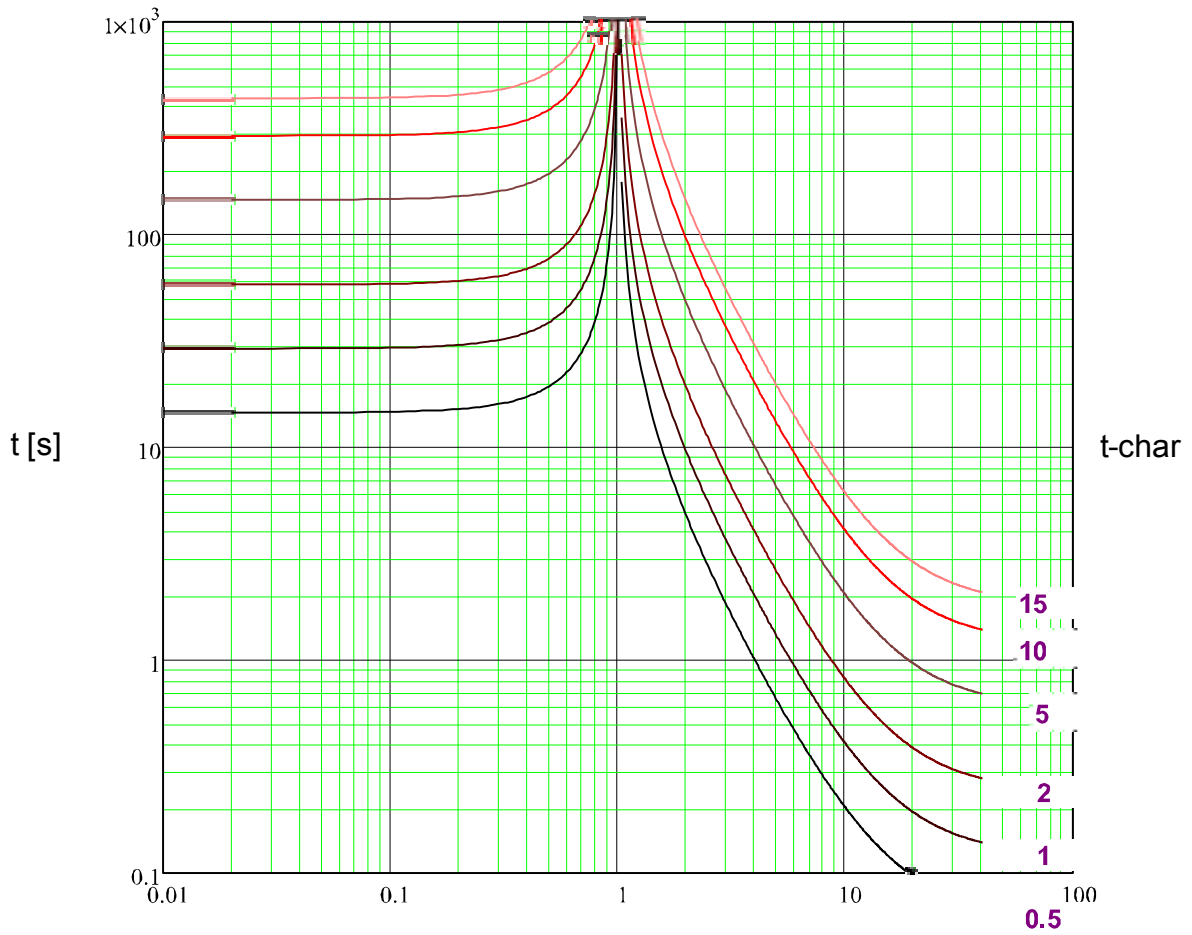

$x * I>$ (multiples of pickup)

Therm Flat



Notice!

Various reset modes are available . Resetting via characteristic , delayed and instantaneous .

Reset

$$t = \left| \frac{5 \cdot 3^2}{\left(\frac{I}{I_n}\right)^0} \right| \cdot t_{\text{-char}} \text{ [s]}$$

Trip

$$t = \frac{5 \cdot 1^2}{\left(\frac{I}{I_n}\right)^0} \cdot t_{\text{-char}} \text{ [s]}$$

$$t = 45 \cdot t_{\text{-char}} \text{ [s]}$$

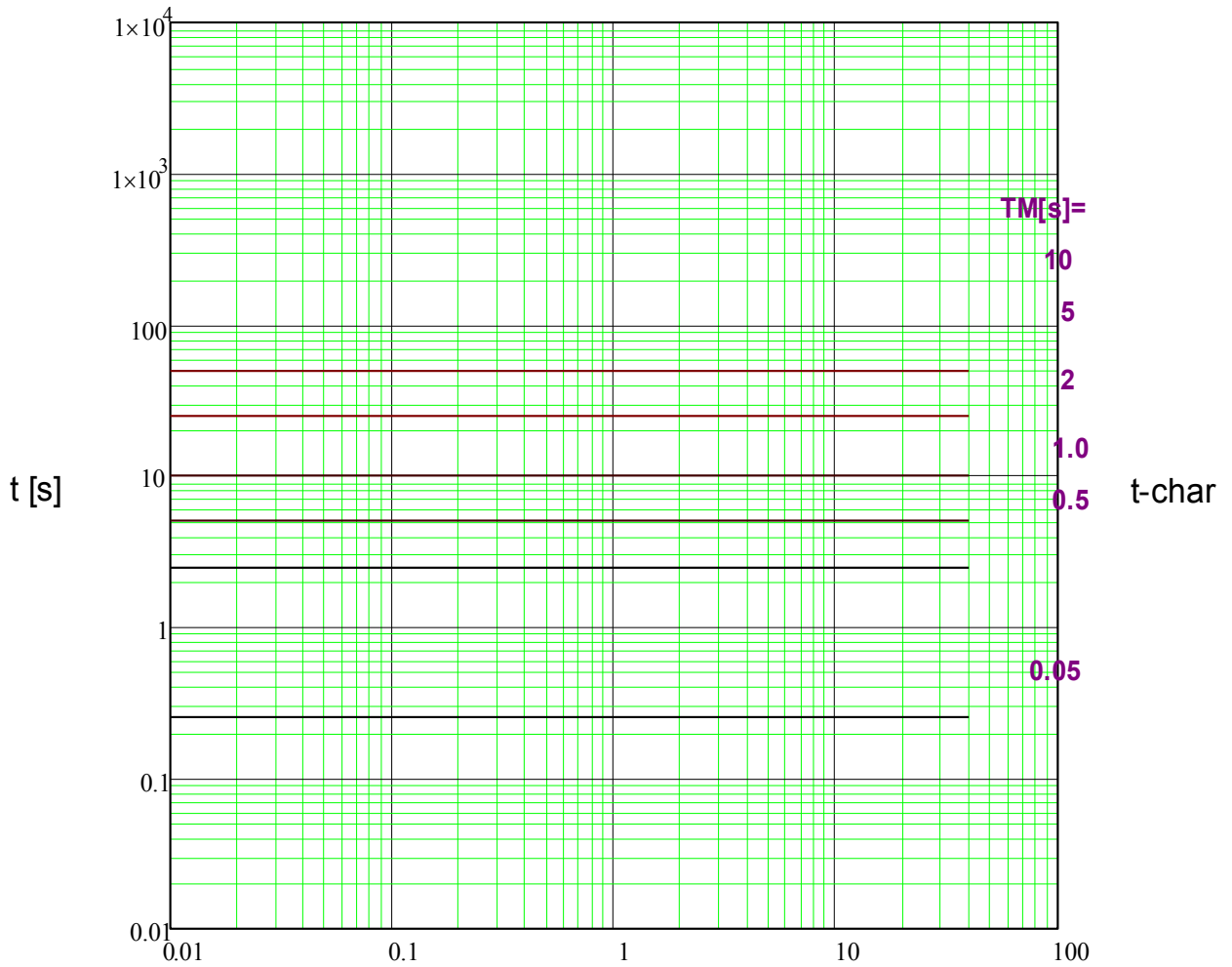

$x \cdot I_n$ (multiples of the nominal current)

IT



Notice!

Various reset modes are available . Resetting via characteristic, delayed and instantaneous .

Reset

Trip

$$t = \left| \frac{5 \cdot 3^2}{\left(\frac{I}{I_n}\right)^0} \right| \cdot t_{\text{-char}} \text{ [s]}$$

$$t = \frac{5 \cdot 3^1}{\left(\frac{I}{I_n}\right)^1} \cdot t_{\text{-char}} \text{ [s]}$$

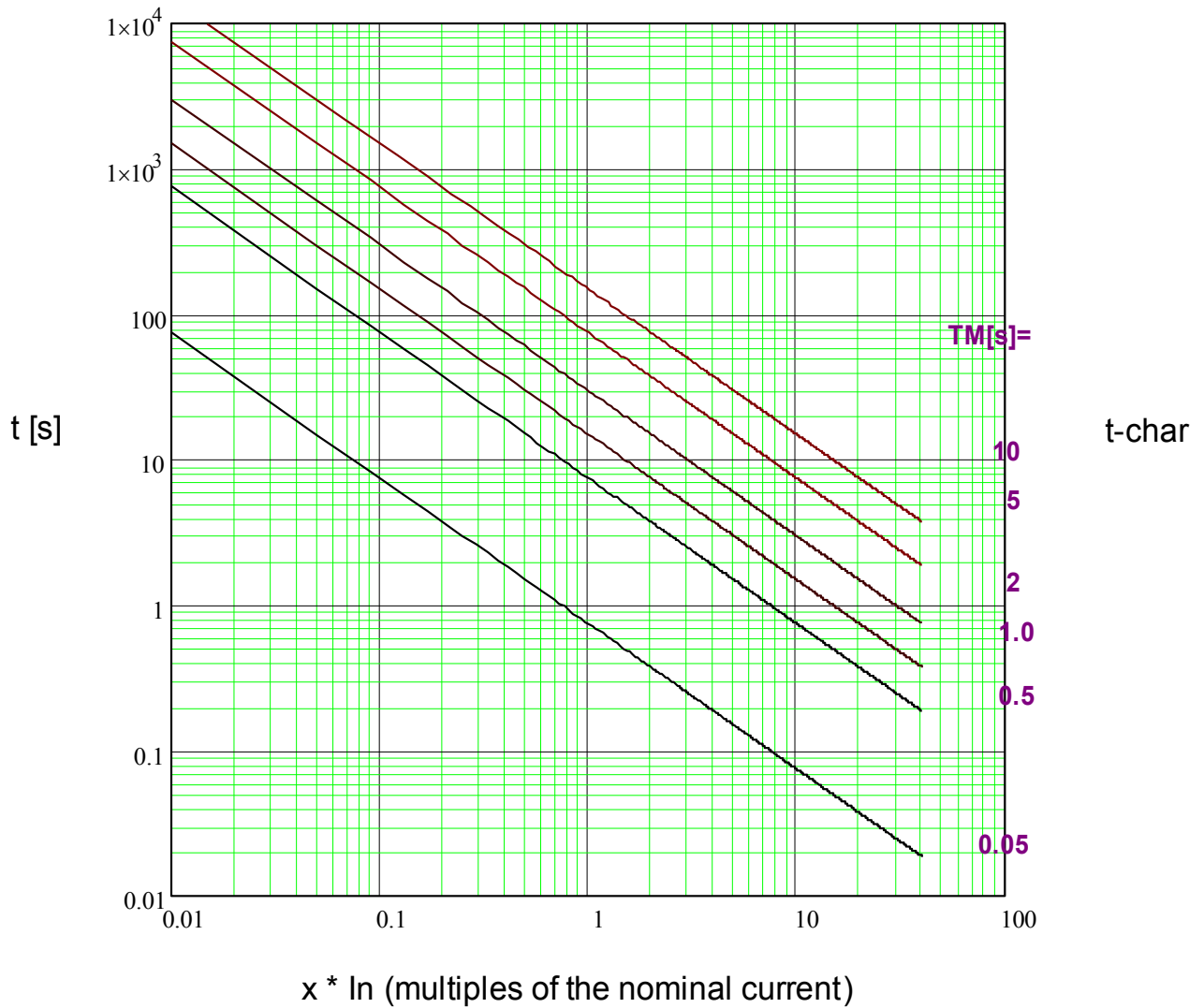

I²T



Notice!

Various reset modes are available . Resetting via characteristic, delayed and instantaneous .

Reset

Trip

$$t = \left| \frac{5 \cdot 3^2}{\left(\frac{I}{I_n}\right)^0} \right| \cdot t_{\text{-char}} \text{ [s]}$$

$$t = \frac{5 \cdot 3^2}{\left(\frac{I}{I_n}\right)^2} \cdot t_{\text{-char}} \text{ [s]}$$

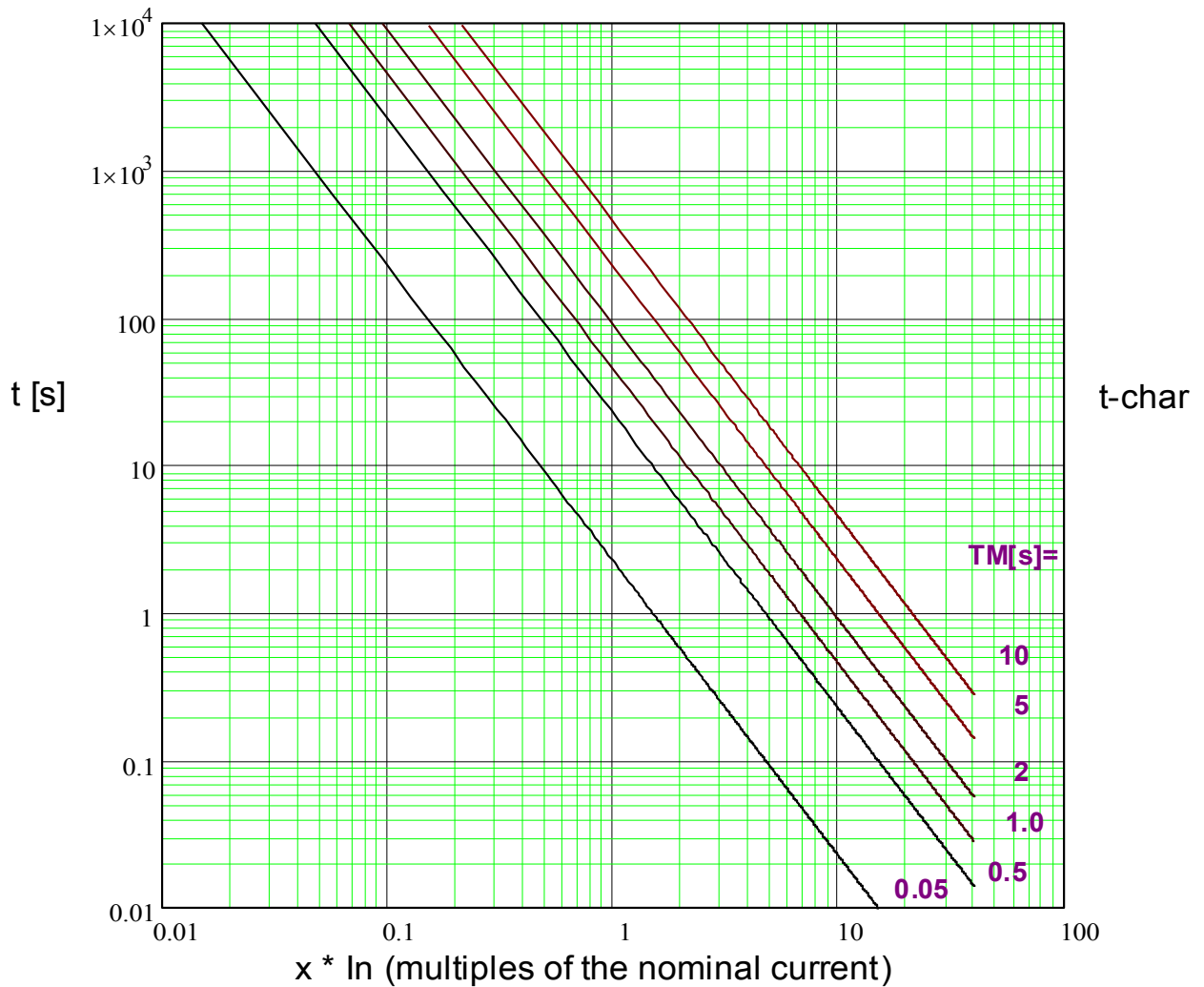

I4T



Notice!

Various reset modes are available . Resetting via characteristic, delayed and instantaneous .

Reset

Trip

$$t = \left| \frac{5 \cdot 3^2}{\left(\frac{I}{I_n}\right)^0} \right| \cdot t_{\text{-char}} \text{ [s]}$$

$$t = \frac{5 \cdot 3^4}{\left(\frac{I}{I_n}\right)^4} \cdot t_{\text{-char}} \text{ [s]}$$

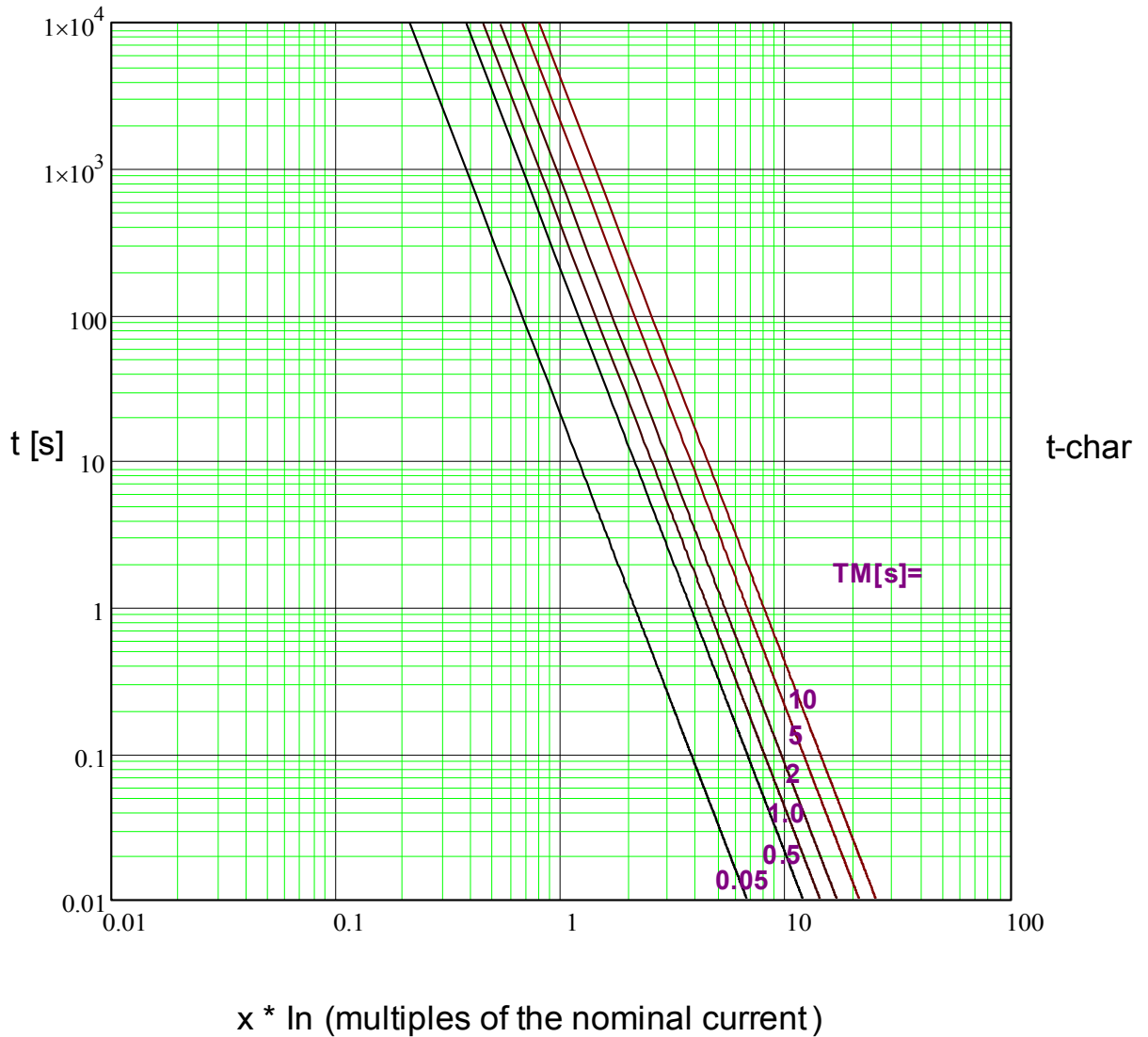

Prot - phase failure direction detection

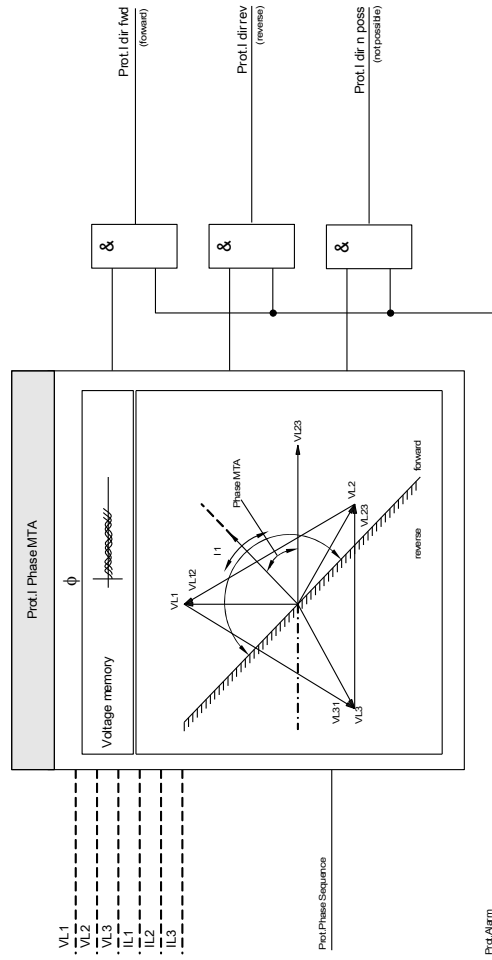

direction decision phase overcurrent

name = [1]...[n]

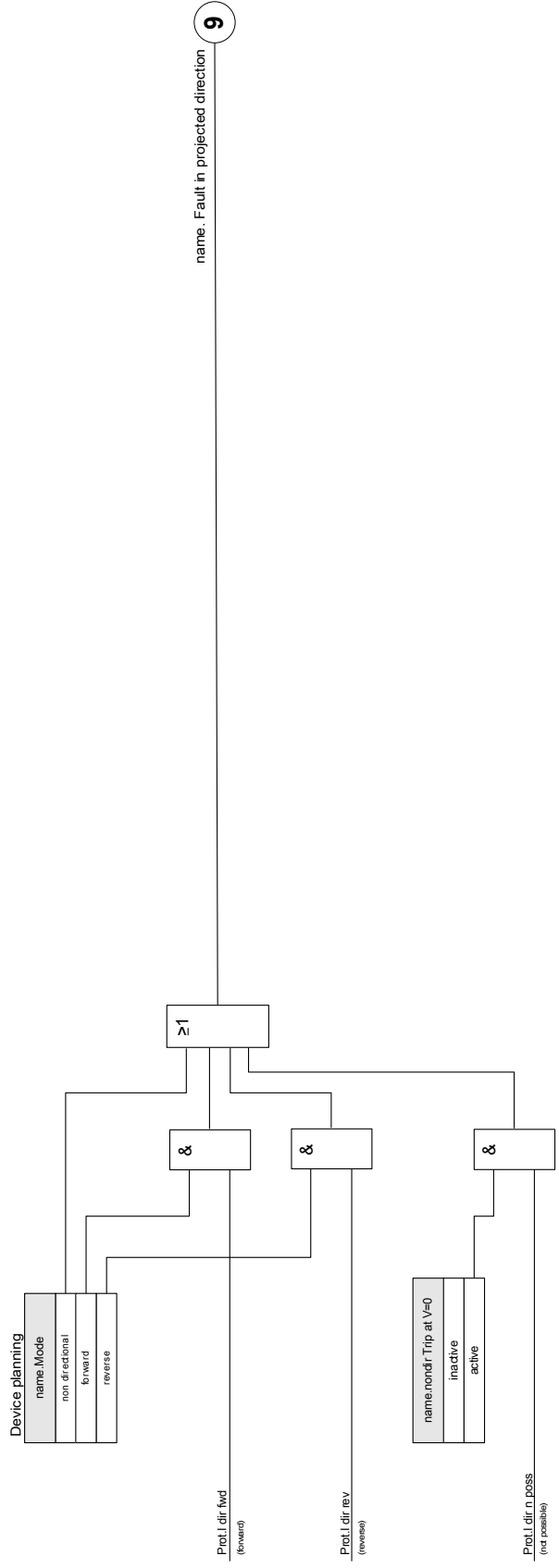

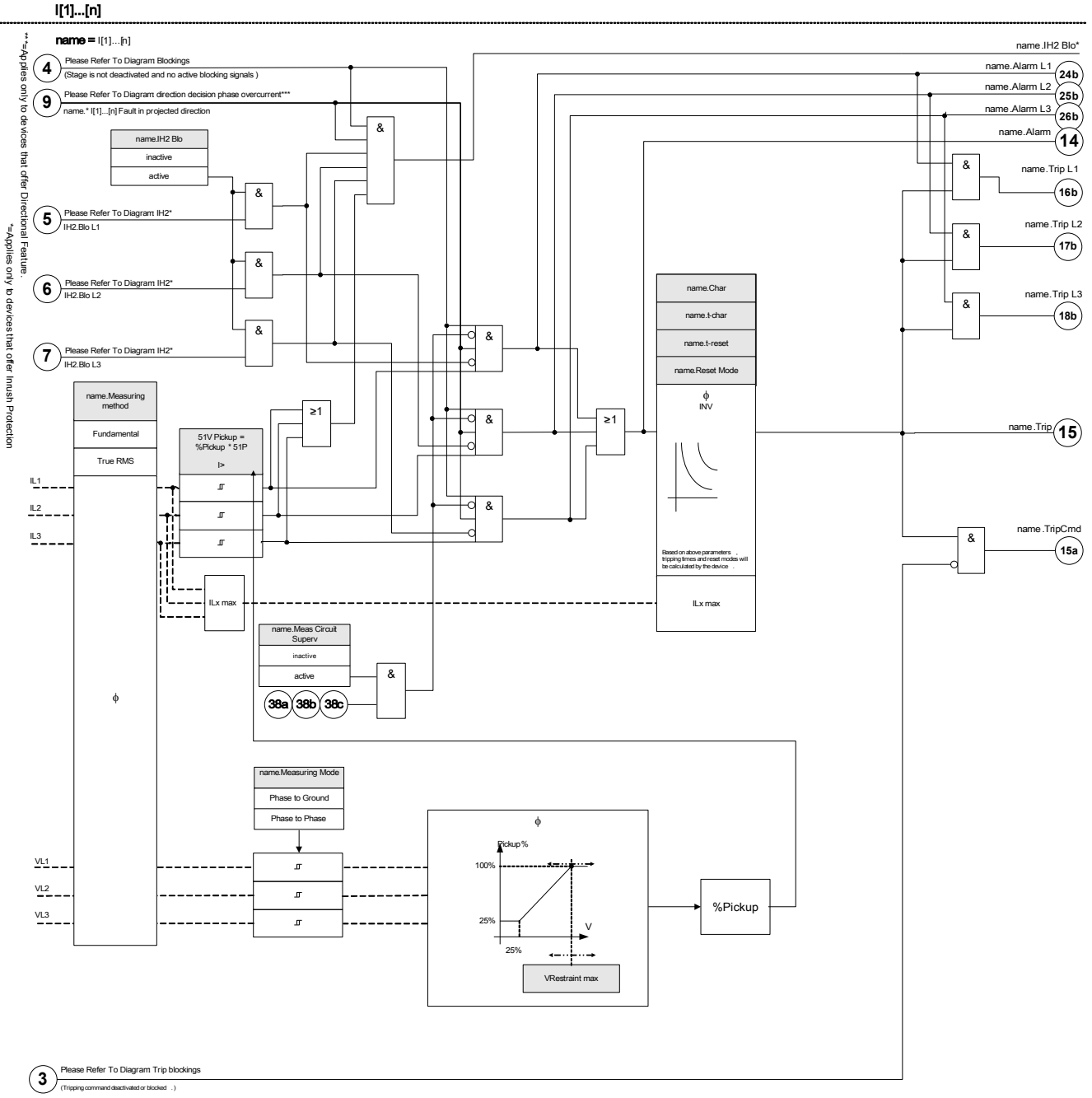









Device Planning Parameters of the I Module

| Parameter | Description | Options | Default | Menu path |
|---|-------------|--|---|-------------------|
| Mode  | Mode | do not use, non directional, forward, reverse | I[1]: non directional I[2]: do not use I[3]: do not use I[4]: do not use I[5]: do not use I[6]: do not use | [Device planning] |







Global Protection Parameters of the I Module

| Parameter | Description | Setting range | Default | Menu path |
|--|--|-----------------------|---------|---|
| ExBlo1  | External blocking of the module, if blocking is activated (allowed) within a parameter set and if the state of the assigned signal is true. | 1..n, Assignment List | -- | [Protection Para /Global Prot Para /I-Prot /[1]] |
| ExBlo2  | External blocking of the module, if blocking is activated (allowed) within a parameter set and if the state of the assigned signal is true. | 1..n, Assignment List | -- | [Protection Para /Global Prot Para /I-Prot /[1]] |
| ExBlo TripCmd  | External blocking of the Trip Command of the module/the stage, if blocking is activated (allowed) within a parameter set and if the state of the assigned signal is true. | 1..n, Assignment List | -- | [Protection Para /Global Prot Para /I-Prot /[1]] |
| Ex rev Interl  | External blocking of the module by external reverse interlocking, if blocking is activated (allowed) within a parameter set and if the state of the assigned signal is true. | 1..n, Assignment List | -- | [Protection Para /Global Prot Para /I-Prot /[1]] |
| AdaptSet 1  | Assignment Adaptive Parameter 1 | AdaptSet | -- | [Protection Para /Global Prot Para /I-Prot /[1]] |
| AdaptSet 2  | Assignment Adaptive Parameter 2 | AdaptSet | -- | [Protection Para /Global Prot Para /I-Prot /[1]] |

Protective Elements

| <i>Parameter</i> | <i>Description</i> | <i>Setting range</i> | <i>Default</i> | <i>Menu path</i> |
|---|---------------------------------|----------------------|----------------|---|
| AdaptSet 3  | Assignment Adaptive Parameter 3 | AdaptSet | -.- | [Protection Para /Global Prot Para /I-Prot /[1]] |
| AdaptSet 4  | Assignment Adaptive Parameter 4 | AdaptSet | -.- | [Protection Para /Global Prot Para /I-Prot /[1]] |

Setting Group Parameters of the I Module

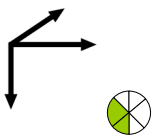
| Parameter | Description | Setting range | Default | Menu path |
|---|---|---------------------------------|--|--|
|  Function | Permanent activation or deactivation of module/stage. | inactive, active | I[1]: active I[2]: inactive I[3]: inactive I[4]: inactive I[5]: inactive I[6]: inactive | [Protection Para /<1..4> /I-Prot /I[1]] |
|  ExBlo Fc | Activate (allow) or inactivate (disallow) blocking of the module/stage. This parameter is only effective if a signal is assigned to the corresponding global protection parameter. If the signal becomes true, those modules/stages are blocked that are parameterized "ExBlo Fc=active". | inactive, active | inactive | [Protection Para /<1..4> /I-Prot /I[1]] |
|  Ex rev Interl Fc | Activate (allow) or inactivate (disallow) blocking of the module/stage. This parameter is only effective if a signal is assigned to the corresponding global protection parameter. If the signal becomes true, those modules/stages are blocked that are parameterized "Ex rev Interl Fc = active". | inactive, active | inactive | [Protection Para /<1..4> /I-Prot /I[1]] |
|  Blo TripCmd | Permanent blocking of the Trip Command of the module/stage. | inactive, active | inactive | [Protection Para /<1..4> /I-Prot /I[1]] |
|  ExBlo TripCmd Fc | Activate (allow) or inactivate (disallow) blocking of the module/stage. This parameter is only effective if a signal is assigned to the corresponding global protection parameter. If the signal becomes true, those modules/stages are blocked that are parameterized "ExBlo TripCmd Fc=active". | inactive, active | inactive | [Protection Para /<1..4> /I-Prot /I[1]] |
|  Measuring method | Measuring method: fundamental or rms or 3rd harmonic (only generator protection relays) | Fundamental, True RMS, I2 | Fundamental | [Protection Para /<1..4> /I-Prot /I[1]] |
|  I> | If the pickup value is exceeded, the module/element starts to time out to trip. Only available if: Characteristic = DEFT Or Characteristic = INV Minimum of the setting range If: VRestrained = active Minimum of the setting range If: VRestrained = inactive | 0.02 - 40.00In | 1.00In | [Protection Para /<1..4> /I-Prot /I[1]] |

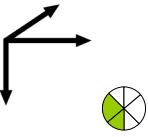
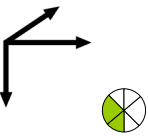
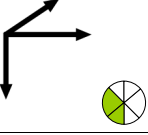
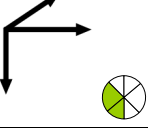
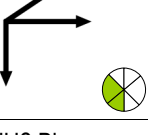
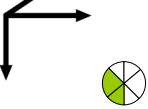
| Parameter | Description | Setting range | Default | Menu path |
|---|--|--|---------------|---|
| Char  | Characteristic | DEFT, IEC NINV, IEC VINV, IEC EINV, IEC LINV, ANSI MINV, ANSI VINV, ANSI EINV, Therm Flat, IT, I2T, I4T | DEFT | [Protection Para /<1..4> /I-Prot /[1]] |
| t  | Tripping delay Only available if: Characteristic = DEFT | 0.00 - 300.00s | 1.00s | [Protection Para /<1..4> /I-Prot /[1]] |
| t-char  | Time multiplier/tripping characteristic factor. The setting range depends on the selected tripping curve. Only available if: Characteristic = INV Or Characteristic = Therm Flat Or Characteristic = IT Or Characteristic = I2T Or Characteristic = I4T | 0.02 - 20.00 | 1 | [Protection Para /<1..4> /I-Prot /[1]] |
| Reset Mode  | Reset Mode Only available if: Characteristic = INV Or Characteristic = Therm Flat Or Characteristic = IT Or Characteristic = I2T Or Characteristic = I4T | instantaneous, t-delay, calculated | instantaneous | [Protection Para /<1..4> /I-Prot /[1]] |
| t-reset  | Reset time for intermittent phase failures (INV characteristics only) Available if: Reset Mode = t-delay | 0.00 - 60.00s | 0s | [Protection Para /<1..4> /I-Prot /[1]] |
| IH2 Blo  | Blocking the trip command, if an inrush is detected. | inactive, active | inactive | [Protection Para /<1..4> /I-Prot /[1]] |

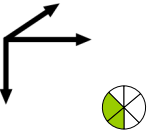
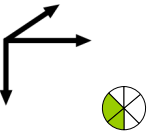
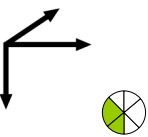
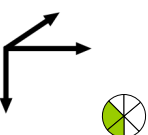
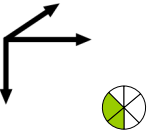
| Parameter | Description | Setting range | Default | Menu path |
|--|---|-------------------------------------|------------------|---|
| nondir Trip at V=0  | Only relevant for current protection modules/stages with directional feature! The device will trip non directional if this parameter is set to active and no direction could be determined because no reference voltage (V=0) could be measured any more (e.g. if there is a three-phase short circuit close to the device). If this parameter is set to inactive, the protection stage will be blocked in case of V=0. Only available if: Device planning: I.Mode = directional | inactive, active | inactive | [Protection Para /<1..4> /I-Prot /[1]] |
| VRestraint  | Voltage Restraint Protection | inactive, active | inactive | [Protection Para /<1..4> /I-Prot /[1]] |
| Measuring Mode  | Measuring Mode Only available if: VRestraint = active | Phase to Neutral, Phase to Phase | Phase to Neutral | [Protection Para /<1..4> /I-Prot /[1]] |
| VRestraint max  | Maximum voltage restraint level. Definition of Vn: Vn is dependent on the System Parameter setting of "VT con". When the System Parameters "VT con" is set to "phase-to-phase", "Vn = VT sec ". When the System Parameters "VT con" is set to "phase-to-ground", "Vn = VT sec/SQRT(3)". Only available if: VRestraint = active | 0.04 - 1.50Vn | 1.00Vn | [Protection Para /<1..4> /I-Prot /[1]] |
| Meas Circuit Superv  | Activates the use of the measuring circuit supervision. In this case the module will be blocked if a measuring circuit supervision module (e.g. LOP, VTS) signals a disturbed measuring circuit (e.g. caused by a fuse failure). Only available if: VRestraint = active | inactive, active | inactive | [Protection Para /<1..4> /I-Prot /[1]] |

I Module Input States

| <i>Name</i> | <i>Description</i> | <i>Assignment via</i> |
|-----------------|---|---|
| ExBlo1-I | Module input state: External blocking1 | [Protection Para /Global Prot Para /I-Prot /[1]] |
| ExBlo2-I | Module input state: External blocking2 | [Protection Para /Global Prot Para /I-Prot /[1]] |
| ExBlo TripCmd-I | Module input state: External Blocking of the Trip Command | [Protection Para /Global Prot Para /I-Prot /[1]] |
| Ex rev Inter-I | Module input state: External reverse interlocking | [Protection Para /Global Prot Para /I-Prot /[1]] |
| AdaptSet1-I | Module input state: Adaptive Parameter1 | [Protection Para /Global Prot Para /I-Prot /[1]] |
| AdaptSet2-I | Module input state: Adaptive Parameter2 | [Protection Para /Global Prot Para /I-Prot /[1]] |
| AdaptSet3-I | Module input state: Adaptive Parameter3 | [Protection Para /Global Prot Para /I-Prot /[1]] |
| AdaptSet4-I | Module input state: Adaptive Parameter4 | [Protection Para /Global Prot Para /I-Prot /[1]] |

I Module Signals (Output States)

| <i>Signal</i> | <i>Description</i> |
|-----------------|--|
| active | Signal: active |
| ExBlo | Signal: External Blocking |
| Ex rev Interl | Signal: External reverse Interlocking |
| Blo TripCmd | Signal: Trip Command blocked |
| ExBlo TripCmd | Signal: External Blocking of the Trip Command |
| IH2 Blo | Signal: Blocking the trip command by an inrush |
| Alarm L1 | Signal: Alarm L1 |
| Alarm L2 | Signal: Alarm L2 |
| Alarm L3 | Signal: Alarm L3 |
| Alarm | Signal: Alarm |
| Trip L1 | Signal: General Trip Phase L1 |
| Trip L2 | Signal: General Trip Phase L2 |
| Trip L3 | Signal: General Trip Phase L3 |
| Trip | Signal: Trip |
| TripCmd | Signal: Trip Command |
| Active AdaptSet | Active Adaptive Parameter |
| DefaultSet | Signal: Default Parameter Set |
| AdaptSet 1 | Signal: Adaptive Parameter 1 |
| AdaptSet 2 | Signal: Adaptive Parameter 2 |
| AdaptSet 3 | Signal: Adaptive Parameter 3 |
| AdaptSet 4 | Signal: Adaptive Parameter 4 |

Commissioning: Overcurrent Protection, non-directional [50, 51]

Object to be tested

- Signals to be measured for each current protection element, the threshold values, total tripping time (recommended), or alternatively tripping delays and the fallback ratios; each time 3 x single-phase and 1 x three-phase.

NOTICE

Especially in Holmgreen connections, wiring errors can easily happen, and these are then detected safely. Measuring the total tripping time can ensure that the secondary wiring is o.k. (from the terminal on, up to the trip coil of the CB).

NOTICE

It is recommended to measure the total tripping time instead of the tripping delay. The tripping delay should be specified by the customer. The total tripping time is measured at the position signalling contact of the CB (not at the relay output!).

Total tripping time = tripping delay (please refer to the tolerances of the protection stages) + CB operating time (about 50 ms)

Please take the CB operating times from the technical data specified in the relevant documentation provided by the CB manufacturer.

Necessary means

- Current source
- May be: ampere meters
- Timer

Procedure

Testing the threshold values (3 x single-phase and 1 x three-phase)

Each time feed a current which is about 3-5% above the threshold value for activation/tripping. Then check the threshold values.

Testing the total tripping delay (recommendation)

Measure the total tripping times at the auxiliary contacts of the CB (CB tripping).

Testing the tripping delay (measuring at the relay output)

Measure the tripping times at the relay output.

Testing the fallback ratio

Reduce the current to 97% below the trip value and check the fallback ratio.

Successful test result

The measured total tripping delays or individual tripping delays, threshold values and fallback ratios correspond with those values, specified in the adjustment list. Permissible deviations/tolerances can be found under Technical Data.

Commissioning: Overcurrent Protection, directional [67]

Object to be tested

For each directional overcurrent element is to be measured: the total tripping time (recommendation) or alternatively tripping delays and the fallback ratios; each time 3 x single-phase and 1 x three-phase.

NOTICE

Especially in Holmgreen connections, wiring errors can happen easily and these are then detected safely. By measuring the total tripping time, it can be ensured that the secondary wiring is o.k. (from the terminal on, up to the trip coil of the CB).

NOTICE

It is recommended to measure the total tripping time instead of the tripping time. The tripping delay should be specified by the customer. The total tripping time is measured at the position signaling contacts of the CBs (not at the relay output!).

Total tripping time: = tripping delay (please refer to the tolerances of the protection stages) + CB operating time (about 50 ms)

Please take the CB switching times from the technical data, specified in the relevant documentation, provided by the CB manufacturer.

Necessary means

- Synchronizable current and voltage sources
- May be: ampere meters
- Timer

Procedure

Synchronize the 3-phase current and voltage sources with each other. Then simulate the tripping directions to be tested by the angle between current and voltage.

Testing the threshold values (3 x single-phase and 1 x three-phase)

Each time feed a current which is about 3-5% above the threshold value for activation/tripping. Check then the threshold values.

Testing the total tripping delay (recommendation)

Measure the total tripping times at the auxiliary contacts of the CB (CB tripping).

Testing the trip delay (measured at the relay output)

Measure the tripping times at the relay output.

Testing the fallback ratio

Reduce the current to 97% below the trip value and check the fallback ratio.

Successful test result

The measured total tripping delays or individual tripping delays, threshold values and fallback ratios correspond with those values, specified in the adjustment list. Permissible deviations/tolerances can be found under Technical Data.

51V - Voltage Restraint Overcurrent

For activating this function, the parameter »*VRestraint*« has to be set to *active* in the parameter set of the corresponding overcurrent element I[x].

The *51V* protection function restrains operation which reduces pickup levels. This allows the User to lower the pickup value of the *51V* protection function with the corresponding phase input voltage (phase-to-phase or phase-to-ground, depending on the setting of »*Measuring Channel*« within the current protection module). When the minimum fault phase current is close to the load current, it may make the phase time overcurrent protection coordination difficult. In this case, an undervoltage function may be used to alleviate this situation. When the voltage is low, the phase time overcurrent pickup threshold may be set low accordingly, so that the phase time overcurrent protection may achieve adequate sensitivity and better coordination. The device uses a simple linear model to determine the effective pickup by characterizing the relationship between the voltage and the phase time overcurrent pickup threshold.

Once the voltage restraint protection function is activated, the effective phase time overcurrent pickup threshold will be the calculated Pickup% times the phase time overcurrent pickup setting. The effective pickup threshold must be within the setting range allowed and, if it is less, the minimum pickup value will be used.

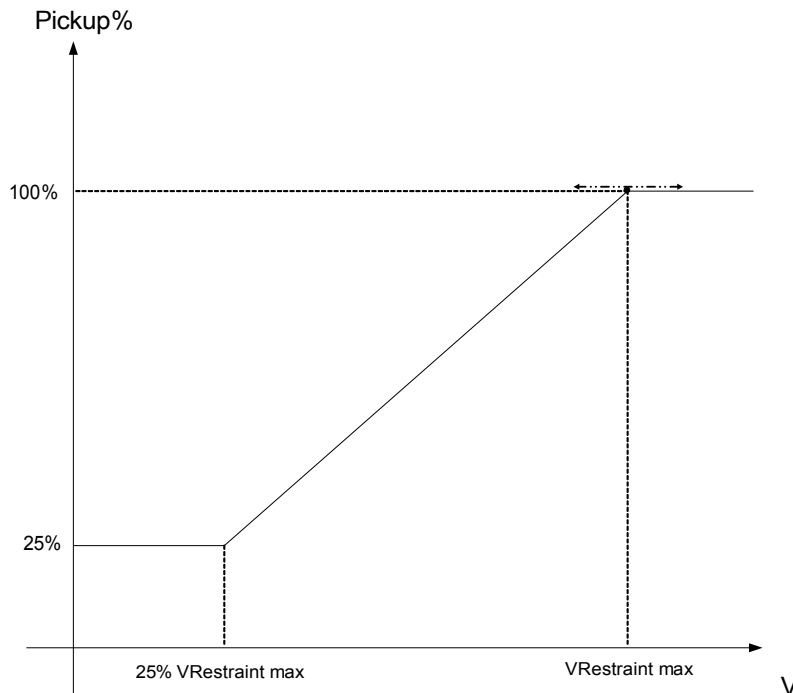

That means:

$$V_{min} = 0.25 \cdot V_{max};$$

- Pickup%_{min} = 25%;

- Pickup% = 25%, if $V \leq V_{min}$;

- Pickup% = $1/V_{max} \cdot (V - V_{min}) + 25\%$, if $V_{min} < V < V_{max}$;

- Pickup% = 100%, if $V \geq V_{max}$;

The tripping curves (characteristic) will not be influenced by the voltage restraint function.

If the voltage transformer supervision is activated, the voltage restraint overcurrent protection element is blocked in case of m.c.b. trip to avoid false trippings.

NOTICE

Definition of V_n :

V_n is dependent on the »*Measuring Channel*« setting in the current protection modules.

In case that this parameter is set to "Phase to Phase":

$$V_n = \text{Main } VT \text{ sec}$$

In case that this parameter is set to "Phase to Neutral":

$$V_n = \frac{\text{Main } VT \text{ sec}}{\sqrt{3}}$$

If the parameter »*VT con*« within the field parameters is set to »*Phase to Phase*« the setting »*Phase to Neutral*« in the current modules is effectless.

Commissioning: Overcurrent Protection, Non-directional [ANSI 51V]

Object to be tested:

Signals to be measured for Voltage Restraint protection function: the threshold values, total tripping time (recommended), or alternatively tripping delays and the dropout ratios; each time 3 x single-phase and 1 x three-phase.

NOTICE

It is recommended to measure the total tripping time instead of the tripping time. The tripping delay should be specified by the customer. The total tripping time is measured at the position signaling contacts of the CBs (not at the relay output!).

Total tripping time: = tripping delay (please refer to the tolerances of the protection stages) + CB operating time (about 50 ms)

Please take the CB switching times from the technical data, specified in the relevant documentation, provided by the CB manufacturer.

Necessary means:

- Current source;
- Voltage Source;
- Current and Voltage meters; and
- Timer.

Procedure:

Testing the threshold values (3 x single-phase and 1 x three-phase)

Feed %Pickup voltage. For each test performed, feed a current that is about 3-5% above the threshold value for activation/tripping. Then check if the pickup values are %Pickup of the value according to the standard overcurrent protection.

Testing the total tripping delay (recommendation)

Measure the total tripping times at the auxiliary contacts of the breakers (breaker tripping).

Testing the tripping delay (measuring at the relay output contact)

Measure the tripping times at the relay output contact.

Testing the dropout ratio

Reduce the current to 97% below the trip value and check the dropout ratio.

Successful test result

The measured total tripping delays or individual tripping delays, threshold values, and dropout ratios correspond with those values specified in the adjustment list. Permissible deviations/tolerances can be found under Technical Data.

I2> - Negative-Sequence Overcurrent [51Q]

For activating this function, the parameter »Measuring Mode« has to be set to »I2« in the parameter set of the corresponding overcurrent element I[x].

The negative-sequence overcurrent protection function (I2>) is to be seen as an equivalent to the phase overcurrent protection with the exception that it uses negative-sequence current (I2>) as measured quantities instead of the three phase currents used by phase overcurrent protection function. The negative-sequence current used by I2> is derived from the following well-known symmetrical component transformation:

$$I_2 = \frac{1}{3}(I_{L1} + a^2 I_{L2} + a I_{L3})$$

The pickup set value of a I2> protection function should be set in accordance of the negative-sequence current occurrence in the protected object.

Besides that, the negative-sequence overcurrent protection function (I2>) uses the same setting parameters as the phase overcurrent protection function, like trip and reset characteristics from both IEC/ANSI standards, time multiplier, etc.

The negative-sequence overcurrent protection function (I2>) can be used for line, generator, transformer and motor protection to protect the system from unbalanced faults. Because the I2> protection function operates on the negative-sequence current component which is normally absent during load conditions, the I2> can, therefore, be set more sensitive than the phase overcurrent protection functions. On the other hand, coordination of negative-sequence overcurrent protection function in a radial system does not mean automatically very long fault clearing time for the furthest upstream protection devices, because the tripping time of concerned negative-sequence overcurrent protection function needs only be coordinate with the next downstream device with the negative-sequence overcurrent protection function. This makes the I2> in many cases as an advantageous protection concept in addition to the phase overcurrent protection function.

**WARNING**

If you are using inrush blockings, the tripping delay of the current protection functions must be at least 30 ms or more in order to prevent faulty trippings.

NOTICE

At the moment of breaker closure, negative-sequence current might be the result of transients.

I[1]...[n]: Measuring method = (I2>

name = [1]...[n]

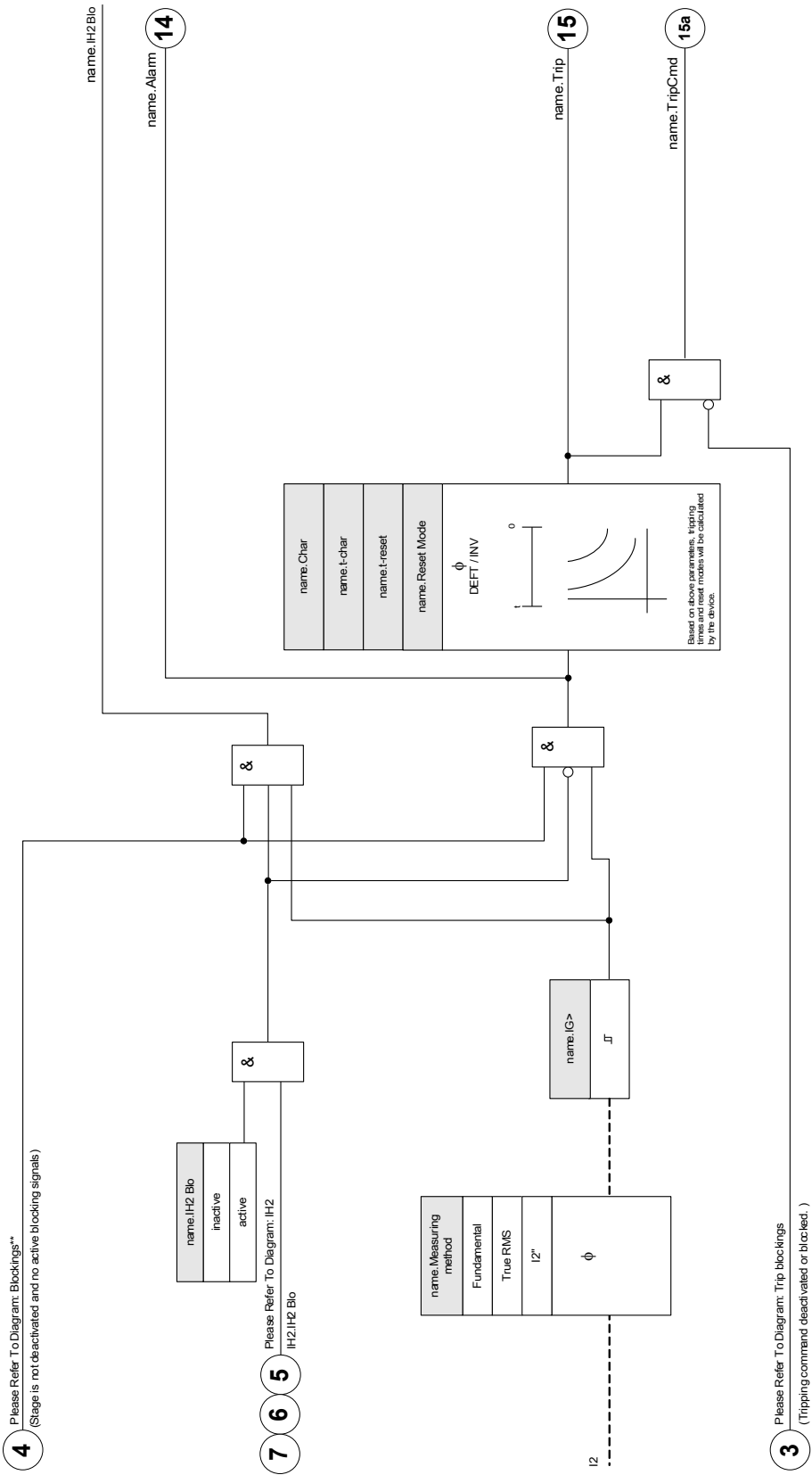

Commissioning: Negative Sequence Overcurrent

Object to be tested

Signals to be measured for each current protection function: the threshold values, total tripping time (recommended), or alternatively tripping delays and the dropout ratios.

NOTICE

It is recommended to measure the total tripping time instead of the tripping time. The tripping delay should be specified by the customer. The total tripping time is measured at the position signalling contacts of the CBs (not at the relay output!).

Total tripping time: = tripping delay (please refer to the tolerances of the protection stages) + CB operating time (about 50 ms)

Please take the CB switching times from the technical data, specified in the relevant documentation, provided by the CB manufacturer.

Necessary means:

- Current source
- Current meters
- Timer

Procedure:

Testing the threshold values

In order to get a negative-sequence current, please change the phase sequence at the terminals of the current source (in case of ABC sequence to ACB – in case of a ACB sequence to ABC).

For each test performed, feed a current that is about 3-5% above the threshold value for activation/tripping. Then check the threshold values.

Testing the total tripping delay (recommendation)

Measure the total tripping times at the auxiliary contacts of the breakers (breaker tripping).

Testing the tripping delay (measuring at the relay output contact)

Measure the tripping times at the relay output contact.

Testing the dropout ratio

Reduce the current to 97% below the trip value and check the dropout ratio.

Successful test result

The measured total tripping delays or individual tripping delays, threshold values, and dropout ratios correspond with those values specified in the adjustment list. Permissible deviations/tolerances can be found under Technical Data.

Voltage Controlled Overcurrent Protection [51C]

When a short circuit is near the generator, the voltage might drop down. By means of **Adaptive Parameters** (Please refer to chapter Parameter) the tripping times or tripping characteristics can be modified by the output signal of a voltage element (depending on a threshold). The device might change a load curve to a fault curve (taking influence on tripping time, trip curves and reset modes).

Please proceed as follows:

- Read and understand the section „Adaptive Parameters“ within the chapter Parameter.
- Do the device planning and set all required parameters for the Undervoltage element.
- Do the device planning and set all required parameters for the Overcurrent element.
- Set the **Adaptive Parameters** within the Overcurrent element in the relevant parameter sets (e.g. Curve multiplier, curve type...).
- Assign the Undervoltage alarm (pickup) within the **Global Parameters** as an activation signal for the corresponding **Adaptive Parameter set** of the overcurrent element that should be modified.
- Check the functionality by a commissioning test.

IH2 - Inrush

Available elements:

IH2

The inrush module can prevent false trips caused by switching actions of saturated inductive loads. The ratio of the 2nd harmonic to the 1st harmonic is taken into account.

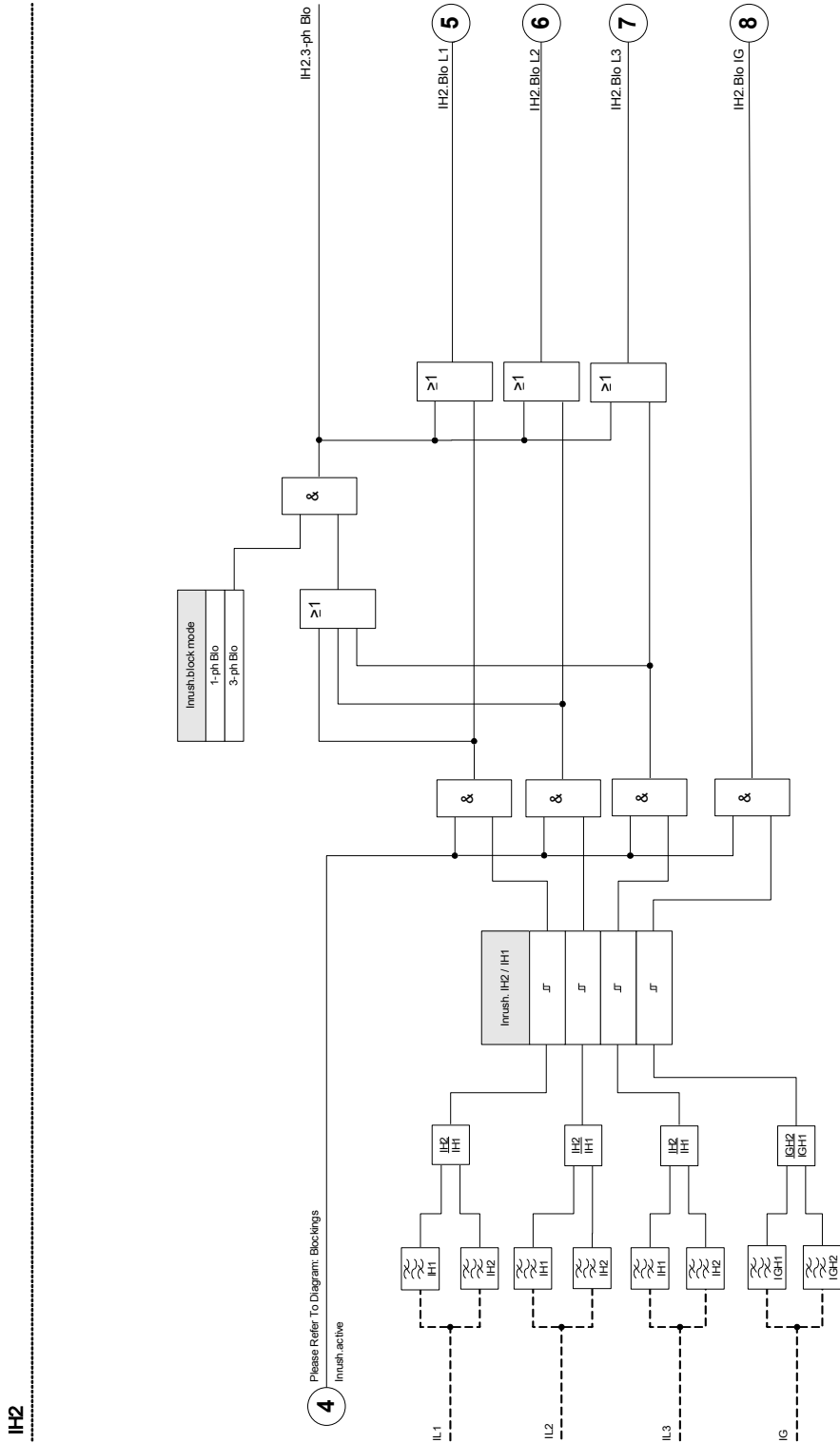



NOTICE

Do not use the Inrush element in combination with undelayed/instantaneous overcurrent protection (in order to prevent faulty tripping).





Device Planning Parameters of the Inrush Module

| Parameter | Description | Options | Default | Menu path |
|---|-------------|--------------------|------------|-------------------|
| Mode  | Mode | do not use, use | do not use | [Device planning] |

Global Protection Parameters of the Inrush module

| Parameter | Description | Setting range | Default | Menu path |
|---|---|-----------------------|---------|---|
| ExBlo1  | External blocking of the module, if blocking is activated (allowed) within a parameter set and if the state of the assigned signal is true. | 1..n, Assignment List | -.- | [Protection Para /Global Prot Para /I-Prot /IH2] |
| ExBlo2  | External blocking of the module, if blocking is activated (allowed) within a parameter set and if the state of the assigned signal is true. | 1..n, Assignment List | -.- | [Protection Para /Global Prot Para /I-Prot /IH2] |

Setting Group Parameters of the Inrush Module

| Parameter | Description | Setting range | Default | Menu path |
|---|---|-----------------------|----------|---|
|  Function | Permanent activation or deactivation of module/stage. | inactive, active | inactive | [Protection Para /<1..4> /I-Prot /IH2] |
|  ExBlo Fc | Activate (allow) or inactivate (disallow) blocking of the module/stage. This parameter is only effective if a signal is assigned to the corresponding global protection parameter. If the signal becomes true, those modules/stages are blocked that are parameterized "ExBlo Fc=active". | inactive, active | inactive | [Protection Para /<1..4> /I-Prot /IH2] |
|  IH2 / IH1 | Maximum permissible percentage of the 2nd harmonic of the 1st harmonic. | 10 - 40% | 15% | [Protection Para /<1..4> /I-Prot /IH2] |
|  block mode | 1-ph Blo: If an inrush is detected in one phase, the corresponding phase of those modules will be blocked, where inrush blocking is set to active./3-ph Blo: If an inrush is detected in at least one phase, all three phases of those modules where inrush blocking is set to active will be blocked (cross blocking). | 1-ph Blo, 3-ph Blo | 1-ph Blo | [Protection Para /<1..4> /I-Prot /IH2] |

Inrush Module Input States

| Name | Description | Assignment via |
|----------|--|---|
| ExBlo1-I | Module input state: External blocking1 | [Protection Para /Global Prot Para /I-Prot /IH2] |
| ExBlo2-I | Module input state: External blocking2 | [Protection Para /Global Prot Para /I-Prot /IH2] |

Inrush Module Signals (Output States)

| Signal | Description |
|--------|---------------------------|
| active | Signal: active |
| ExBlo | Signal: External Blocking |

Protective Elements

| <i>Signal</i> | <i>Description</i> |
|---------------|--|
| Blo L1 | Signal: Blocked L1 |
| Blo L2 | Signal: Blocked L2 |
| Blo L3 | Signal: Blocked L3 |
| Blo IG meas | Signal: Blocking of the ground (earth) protection module (measured ground current) |
| Blo IG calc | Signal: Blocking of the ground (earth) protection module (calculated ground current) |
| 3-ph Blo | Signal: Inrush was detected in at least one phase - trip command blocked. |

Commissioning: Inrush

NOTICE

Dependent on the parameterized inrush-blocking-mode («*1-ph Blo* or *3-ph Blo*»), the test procedure is different.

For mode «*1-ph-Blo*» the test has to be carried out first for each individual phase and then for all three phases together.

For mode «*3-ph-Blo*» the test is a three-phase one.

Object to be tested

Test of inrush blocking.

Necessary means

- three-phase current source with adjustable frequency
- three-phase current source (for the first harmonic)

Procedure (dependent on the parameterized blocking mode)

- Feed the current to the secondary side with nominal frequency.
- Feed abruptly current to the secondary side with double nominal frequency. The amplitude must exceed the preset ratio/threshold «*I_{H2}/I_N*».
- Ascertain that the signal «*INRUSH ALARM*» is generated now.

Successful test results

The signal «*INRUSH ALARM*» is generated and the event recorder indicates the blocking of the current protection stage.

Directional Features for Measured Ground Fault Elements 50N/51N

All ground fault elements can be selected as »non-directional/forward/reverse« operated. This has to be done in the »Device Planning« menu.

Important Definitions

Polarizing Quantity: This is the quantity that is used as a reference value. The *polarizing quantity* can be selected by the parameter »IG meas dir ctrl« in the [Field Para/Direction] menu as follows:

- »IG meas 3V0«: The neutral voltage selected by the parameter »3V0 Source« will be used as the polarizing quantity. The traditional way to polarize a ground fault element is to use neutral voltage (3V0). The neutral voltage can, however, be either »measured« or »calculated«. This can be selected by the parameter »3V0 Source« in the [Field Para/Direction] menu.
- »I2, V2«: With this selection, the negative phase sequence voltage and current (Polarizing: V2/Operating: I2) will be used to detect direction. The monitored current is still the measured residual current IG meas.
- »Dual«: For this method, the negative phase sequence voltage »V2« will be used as polarizing quantity if »V2« and »I2« are available, otherwise 3V0 will be used. The operating quantity is either I2 if »V2« and »I2« are available, else IG meas.

The following table gives the User a quick overview of all possible directional settings.

| 50N/51N Direction Decision by Angle Between: | [Field Para/Direction] The Following Angle Has to Be Set: | [Field Para/Direction]: IG meas dir ctrl = | [Field Para/Direction]: 3V0 Source = |
|---|--|---|---|
| Measured ground current and neutral voltage: IG meas, 3V0 (measured) | Ground MTA | IG meas 3V0 | measured |
| Measured ground current and neutral voltage: IG meas, 3V0 (calculated) | Ground MTA | IG meas 3V0 | calculated |
| Negative sequence voltage and current I2, V2 | 90° + Phase MTA | I2,V2 | not used |
| Negative phase sequence current and voltage (preferred), measured ground current and neutral voltage (alternatively): I2, V2 (if available) or else: IG meas, 3V0 (measured) | If V2 and I2 are available: 90° + Phase MTA else: Ground MTA | Dual | measured |
| Negative phase sequence current and voltage (preferred), measured ground current and neutral voltage (alternatively): I2, V2 (if available) or else: IG meas, 3V0 (calculated) | If V2 and I2 are available: 90° + Phase MTA else: Ground MTA | Dual | calculated |

Prot - 50G/51G - direction detection

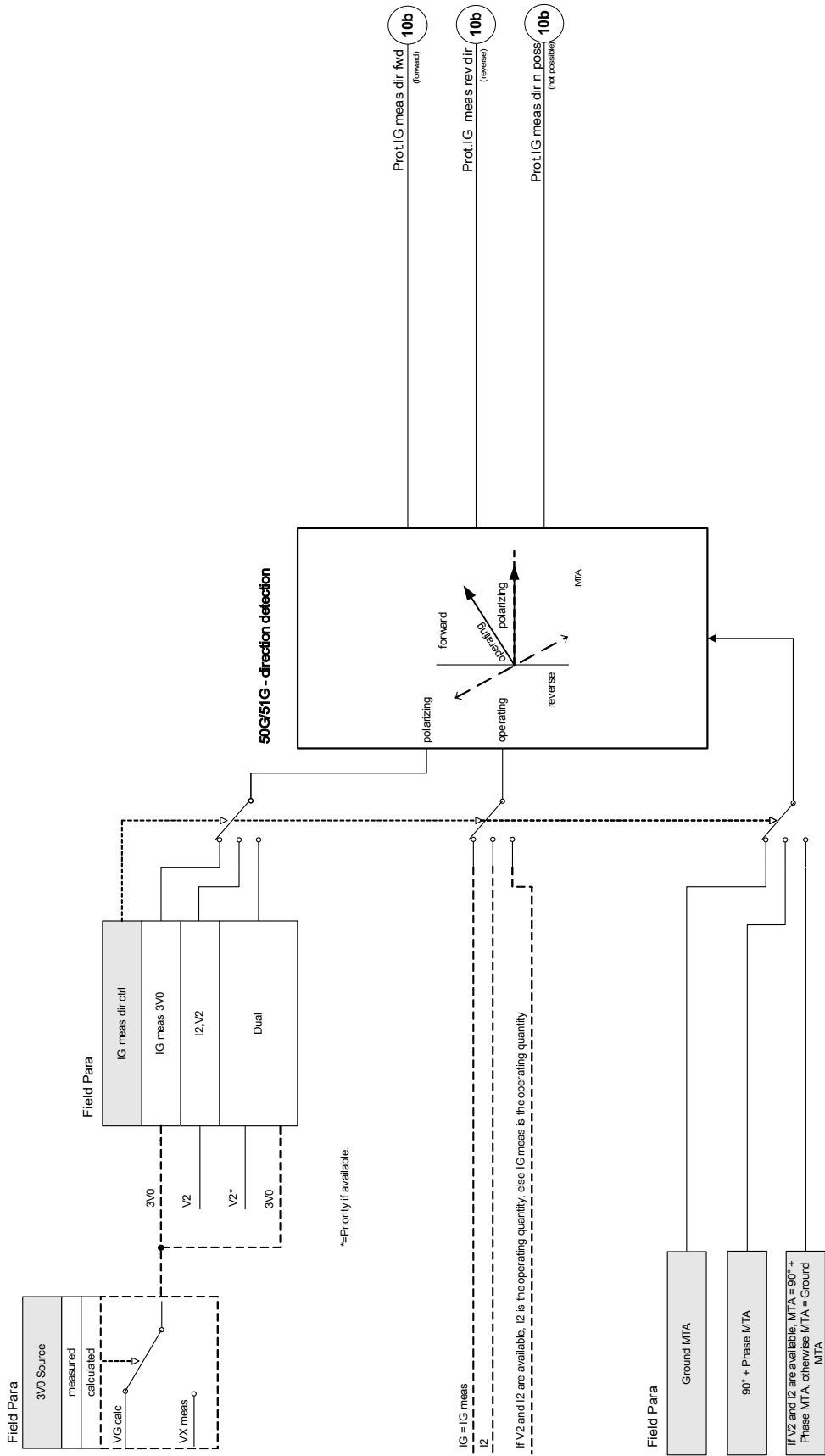

Directional Features for Calculated (IG calc) Ground Fault 50N/51N

All ground fault elements can be selected as »*non-directional/forward/reverse*« operated. This has to be done in the »*Device Planning*« menu.

Important Definitions

Polarizing Quantity: This is the quantity that is used as a reference value. The *polarizing quantity* can be selected by the parameter »*IG calc dir ctrl*« in the [Field Para/Direction] menu as follows:

- »*IG calc 3V0*«: The neutral voltage selected by the parameter »*3V0 Source*« will be used as the polarizing quantity. The traditional way to polarize a ground fault element is to use neutral voltage (3V0). The neutral voltage can, however, be either »*measured*« or »*calculated*«. This can be selected by the parameter »*3V0 Source*« in the [Field Para/Direction] menu.
- »*IG calc Ipol (IG meas)*«: The measured neutral current (usually = IG meas) will be used as polarizing quantity.
- »*Dual*«: For this method, the measured neutral current $I_{pol}=IG\ meas$ will be used as polarizing quantity, if available, otherwise 3V0 will be used.
- »*I2, V2*«: With this selection, the negative phase sequence voltage and current will be used to detect the direction. The monitored current is still the calculated residual current IG calc.

Operating Quantity: For the directional IG calc elements, the *operating quantity* is in general the *calculated neutral current IG calc* (except from »*I2, V2*« mode, where »*I2*« is the operating quantity).

The ground maximum torque angles (MTA) can be adjusted from 0° to 360°, except, if »*IG calc Ipol (IG meas)*« is selected. In this case it is set to 0° (fixed).

The MTA will also be set internally to 0° in case that $I_{pol}=IG\ meas$ is available within the Dual-Mode

The following table gives the User a quick overview of all possible directional settings.

| 50N/51N Direction Decision by Angle Between: | [Field Para/ Direction] The Following Angle Has to Be Set: | [Field Para/Direction]: IG calc dir ctrl = | [Field Para/Direction]: 3V0 Source = |
|--|---|---|---|
| Residual current and neutral voltage: IG calc, 3V0 (measured) | Ground MTA | <i>IG calc 3V0</i> | measured |
| Residual current and neutral voltage: IG calc, 3V0 (calculated) | Ground MTA | <i>IG calc 3V0</i> | calculated |
| Residual current and neutral/ground current IG calc, IG meas | 0° (fixed) | IG calc Ipol (IG meas) | not used |
| Residual current and neutral/ground current (preferred), residual current and neutral voltage (alternatively): IG calc, IG meas (if available) or else: IG calc, 3V0 (measured) | If Ipol (=IG meas) is available, MTA = 0° (fixed); else MTA=Ground MTA | Dual | measured |
| Residual current and neutral/ground current (preferred), residual current and neutral voltage (alternatively): IG calc, IG meas (if available) or else: IG calc, 3V0 (calculated) | If Ipol (=IG meas) is available, MTA = 0° (fixed); else MTA=Ground MTA | Dual | calculated |
| Negative sequence voltage and current I2, V2 | 90° + Phase MTA | <i>I2, V2</i> | not used |

Prot. - 50N51N - direction detection

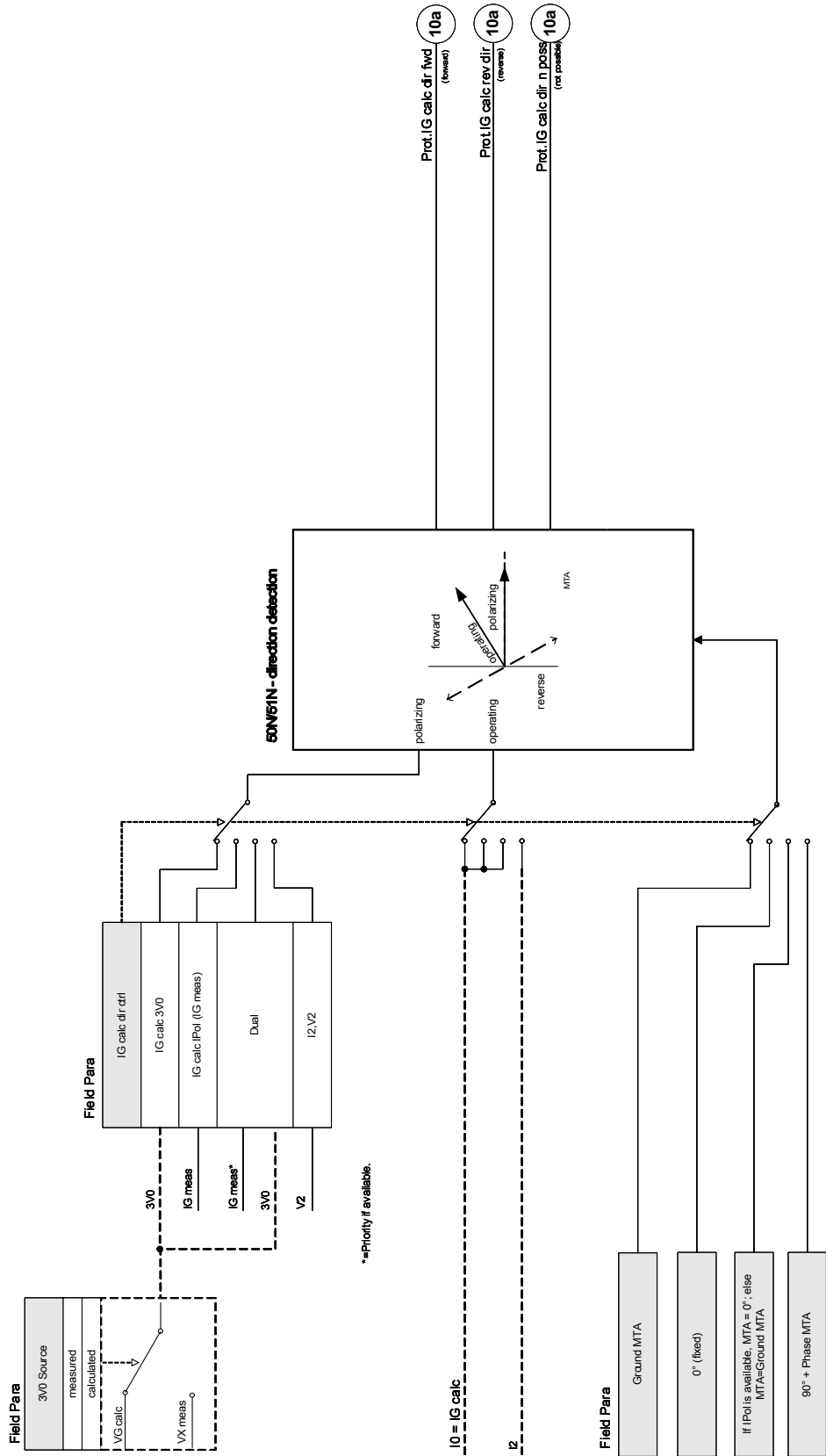

IG - Ground Fault [50N/G, 51N/G, 67N/G]

Available elements:
IG[1] .IG[2] .IG[3] .IG[4]

⚠ WARNING If you are using inrush blockings the tripping delay of the earth current protection functions must be at least 30ms or more in order to prevent faulty trippings.

NOTICE All earth current elements are identically structured.

NOTICE This module offers Adaptive Parameter Sets. Parameters can be modified within parameter sets dynamically by means of Adaptive Parameter Sets. Please refer to chapter Parameter / Adaptive Parameter Sets.

The following table shows the application options of the earth overcurrent protection element

| Applications of the IE-Protection Module | Setting in | Option |
|--|--|--|
| ANSI 50N/G – Earth overcurrent protection, non directional | Device Planning menu Setting: non directional | Measuring Mode: Fundamental/TrueRMS |
| ANSI 51N/G – Earth short circuit protection, non directional | Device Planning menu Setting: non directional | Measuring Mode: Fundamental/TrueRMS |
| ANSI 67N/G – Earth overcurrent/Earth short circuit protection, directional | Device Planning menu Setting: directional Field parameter menu 3V0 Source: measured/calculated 3I0 Source: measured/calculated | Measuring Mode: Fundamental/TrueRMS IG Source: measured/calculated VG Source: measured/calculated |

Measuring Mode

For all protection elements it can be determined, whether the measurement is done on basis of the »*Fundamental*« or if »*TrueRMS*« measurement is used.

IG Source/VG Source

Within the parameter menu, this parameter determines, whether the earth current and the residual voltage is »*measured*« or »*calculated*«.

Direction detection (3V0 Source und 3I0 Source)

In the field parameter menu it can be determined, if the earth current directional detection should be based on measured or calculated values of currents and voltages. This setting takes effect on all earth current elements.



- Calculation of the residual voltage is only possible, when phase to neutral voltage is applied to the voltage inputs.

At setting »measured« the quantities to be measured, i. e. Residual voltage and the measured earth current have to be applied to the corresponding 4th measuring input.

All earth current protective elements can be planned user defined as non-directional or as directional stages. This means, for instance, all 4 elements can be projected in forward/reverse direction. For each element the following characteristics are available:

- DEFT
- NINV (IEC)
- VINV (IEC)
- LINV (IEC)
- EINV (IEC)
- MINV (ANSI)
- VINV (ANSI)
- EINV (ANSI)
- RXIDG
- Thermal Flat
- IT
- I2T
- I4T

Explanation:

t = Tripping delay

t-char = Time multiplier/tripping characteristic factor. The setting range depends on the selected tripping curve.
IG = Fault current

IG> = If the pickup value is exceeded, the module/element starts to time out to trip .

The earth current can be measured either directly via a cable-type transformer or detected by a Holmgreen connection. The earth current can alternatively be calculated from the phase currents; but this is only possible if the phase currents are not ascertained by a V-connection.

The device can optionally be procured with a sensitive earth current measuring input.

DEFT

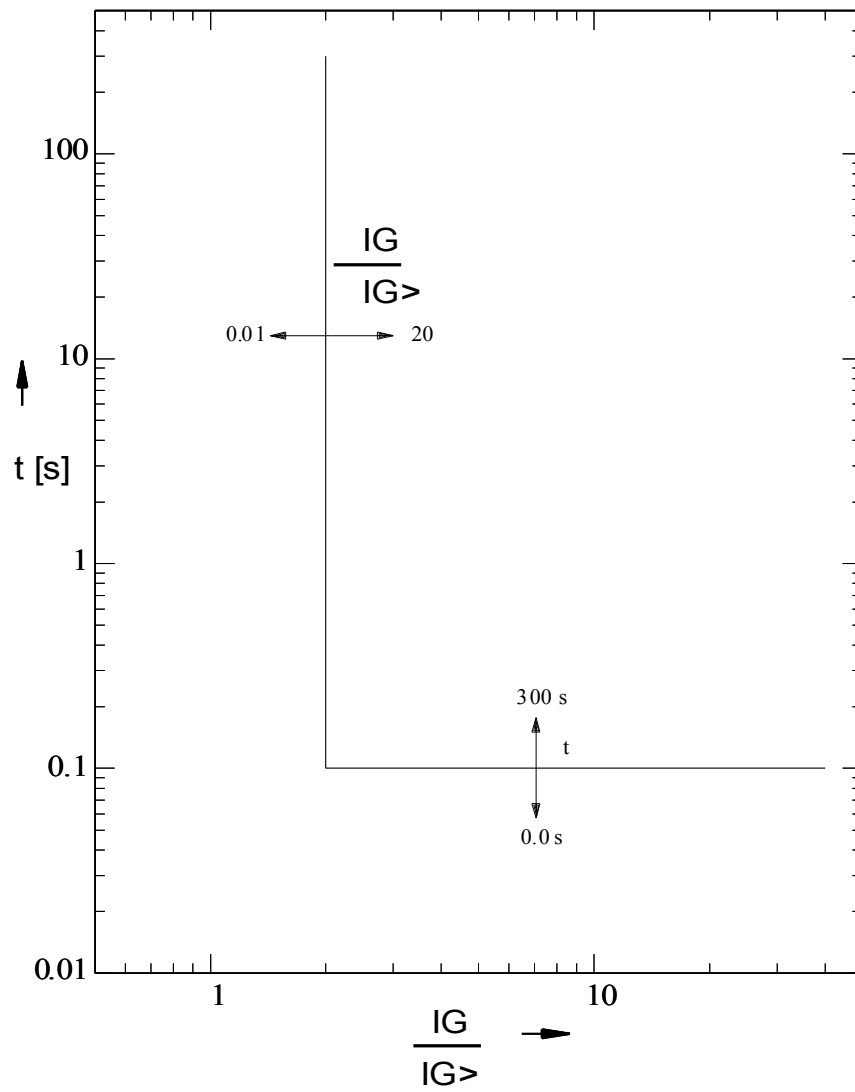

IEC NINV



Notice!

Various reset modes are available . Resetting via characteristic, delayed and instantaneous .

Reset

Trip

$$t = \left| \frac{0.14}{\left(\frac{IG}{IG>} \right)^2 - 1} \right| * t\text{-char [s]}$$

$$t = \frac{0.14}{\left(\frac{IG}{IG>} \right)^{0.02} - 1} * t\text{-char [s]}$$

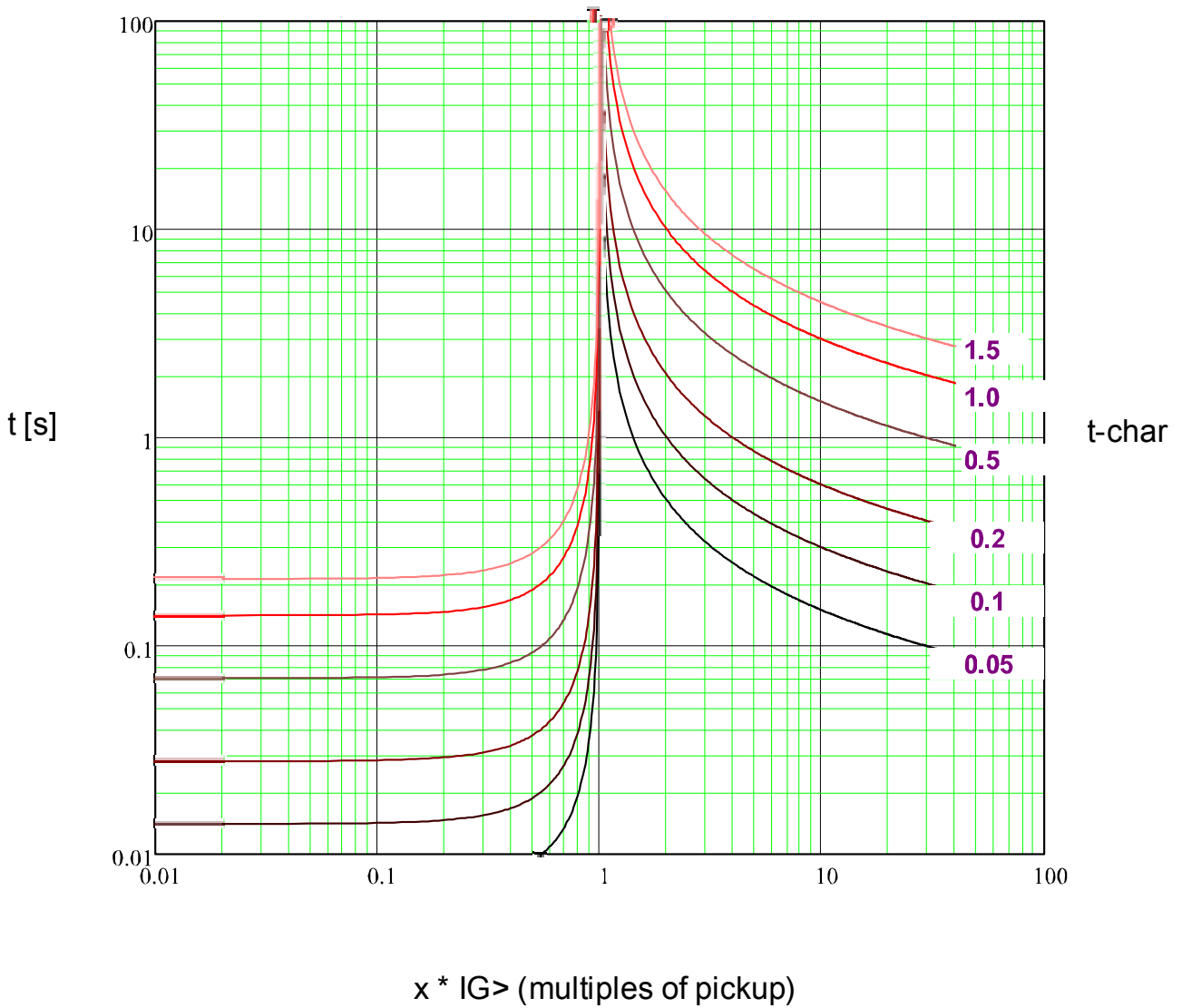

IEC VINV



Notice!

Various reset modes are available . Resetting via characteristic, delayed and instantaneous .

Reset

Trip

$$t = \left| \frac{13.5}{\left(\frac{IG}{IG>}\right)^2 - 1} \right| * t\text{-char [s]}$$

$$t = \frac{13.5}{\left(\frac{IG}{IG>}\right) - 1} * t\text{-char [s]}$$

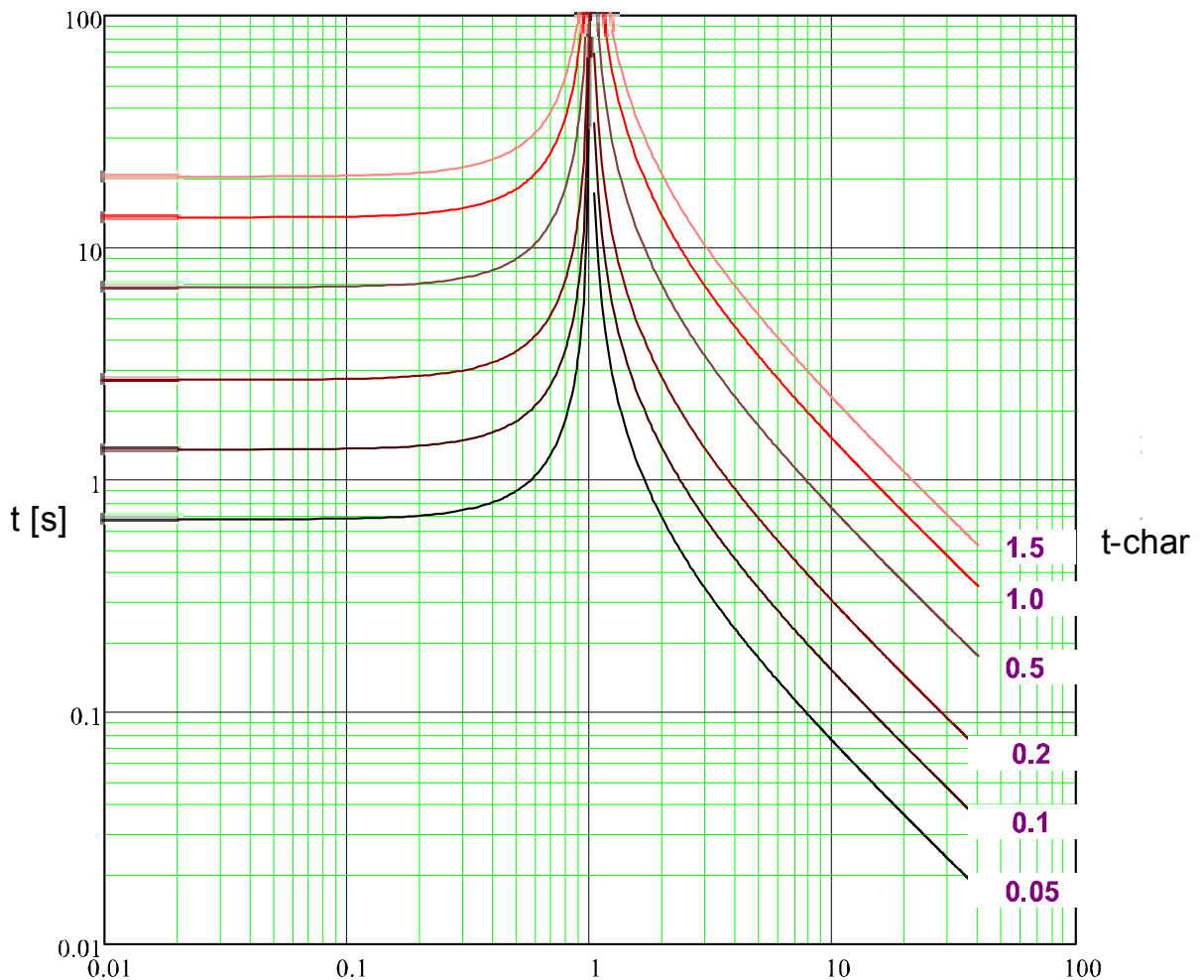

$x * IG>$ (multiples of pickup)

IEC LINV



Notice!

Various reset modes are available . Resetting via characteristic, delayed and instantaneous .

Reset

$$t = \left| \frac{120}{\left(\frac{IG}{IG>} \right)^2 - 1} \right| * t\text{-char [s]}$$

Trip

$$t = \frac{120}{\left(\frac{IG}{IG>} \right)^2 - 1} * t\text{-char [s]}$$

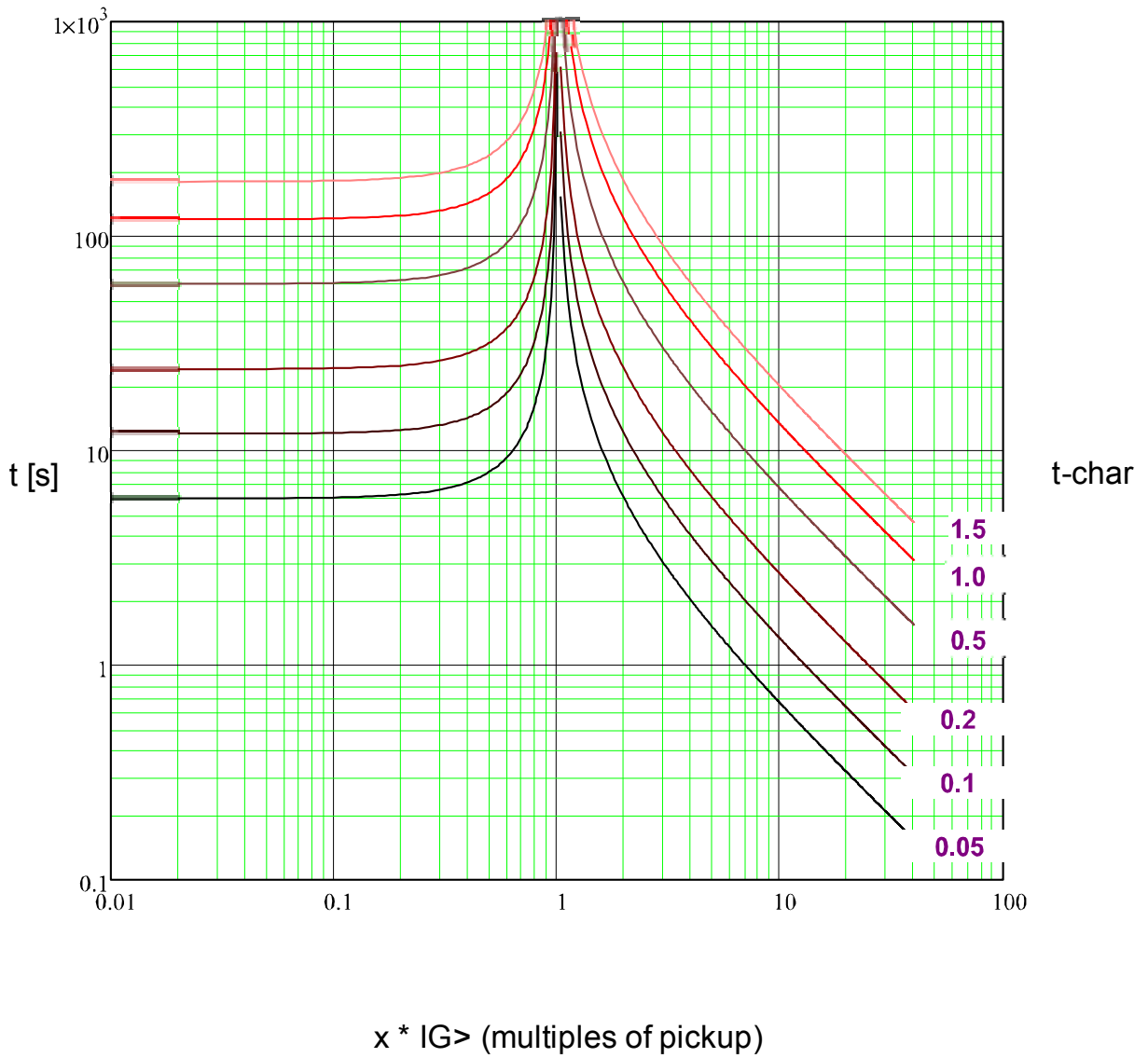

IEC EINV



Notice!

Various reset modes are available . Resetting via characteristic, delayed and instantaneous .

Reset

Trip

$$t = \left| \frac{80}{\left(\frac{IG}{IG>}\right)^2 - 1} \right| * t\text{-char [s]}$$

$$t = \frac{80}{\left(\frac{IG}{IG>}\right)^2 - 1} * t\text{-char [s]}$$

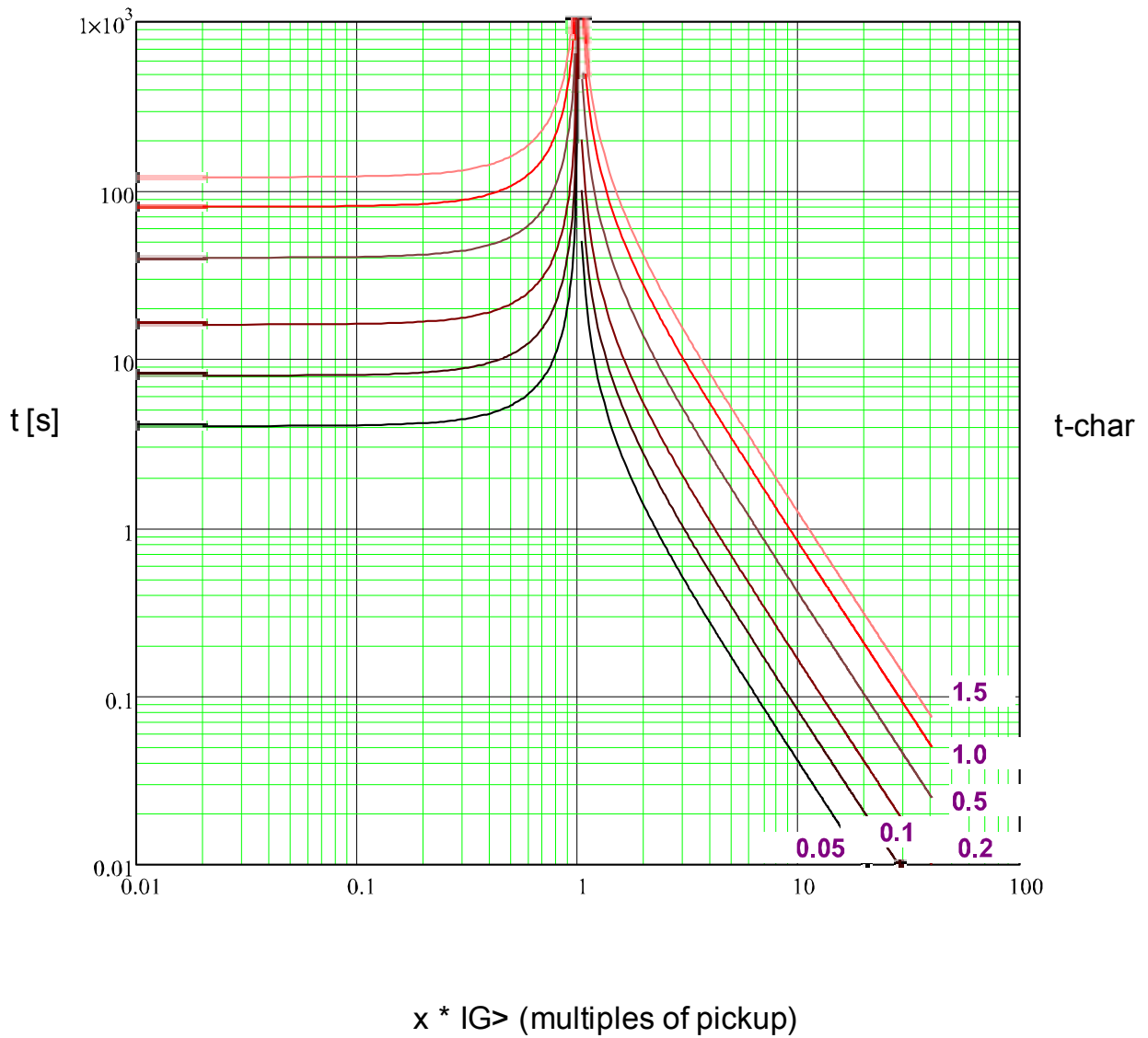

ANSI MINV



Notice!

Various reset modes are available . Resetting via characteristic, delayed and instantaneous .

Reset

Trip

$$t = \left| \frac{4.85}{\left(\frac{IG}{I>} \right)^2 - 1} \right| * t\text{-char [s]}$$

$$t = \left(\frac{0.0515}{\left(\frac{IG}{IG>} \right)^{0.02} + 0.1140} \right) * t\text{-char [s]}$$

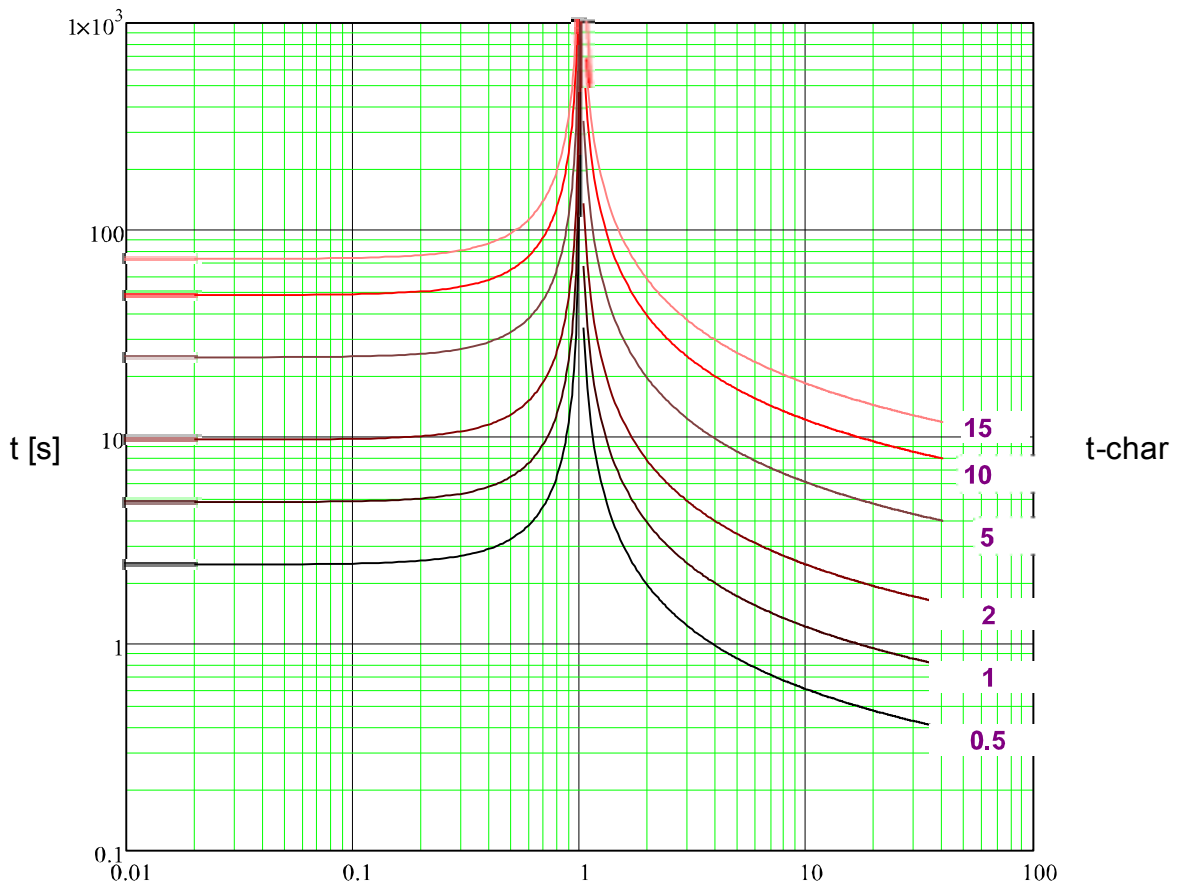

x * IG> (multiples of pickup)

ANSI VINV



Notice!

Various reset modes are available . Resetting via characteristic, delayed and instantaneous .

Reset

$$t = \left| \frac{21.6}{\left(\frac{IG}{IG>} \right)^2 - 1} \right| * t-char [s]$$

Trip

$$t = \left(\frac{19.61}{\left(\frac{IG}{IG>} \right)^2 - 1} + 0.491 \right) * t-char [s]$$

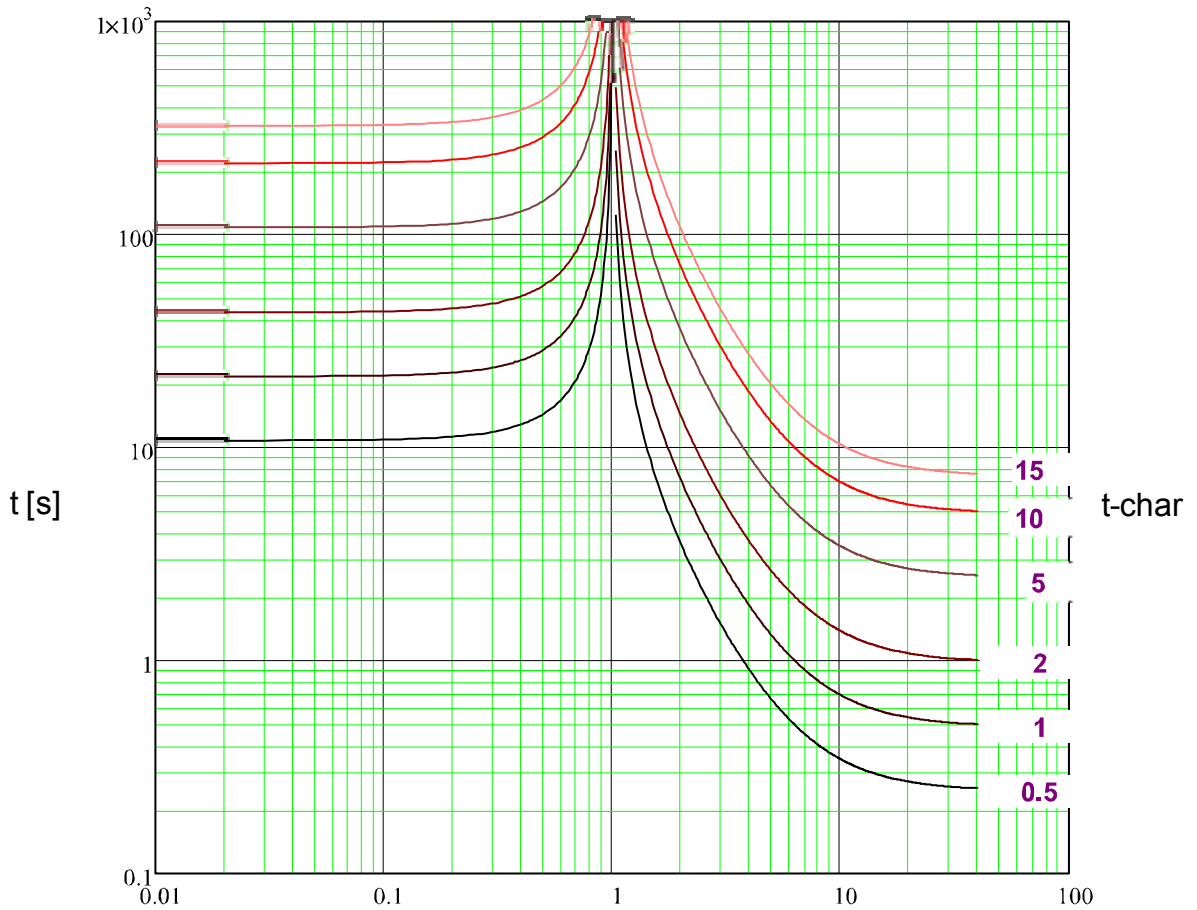

x * IG> (multiples of pickup)

ANSI EINV



Notice!

Various reset modes are available . Resetting via characteristic, delayed and instantaneous .

Reset

$$t = \left| \frac{29.1}{\left(\frac{IG}{IG>}\right)^2 - 1} \right| * t\text{-char [s]}$$

Trip

$$t = \left(\frac{28.2}{\left(\frac{IG}{IG>}\right)^2 - 1} + 0.1217 \right) * t\text{-char [s]}$$

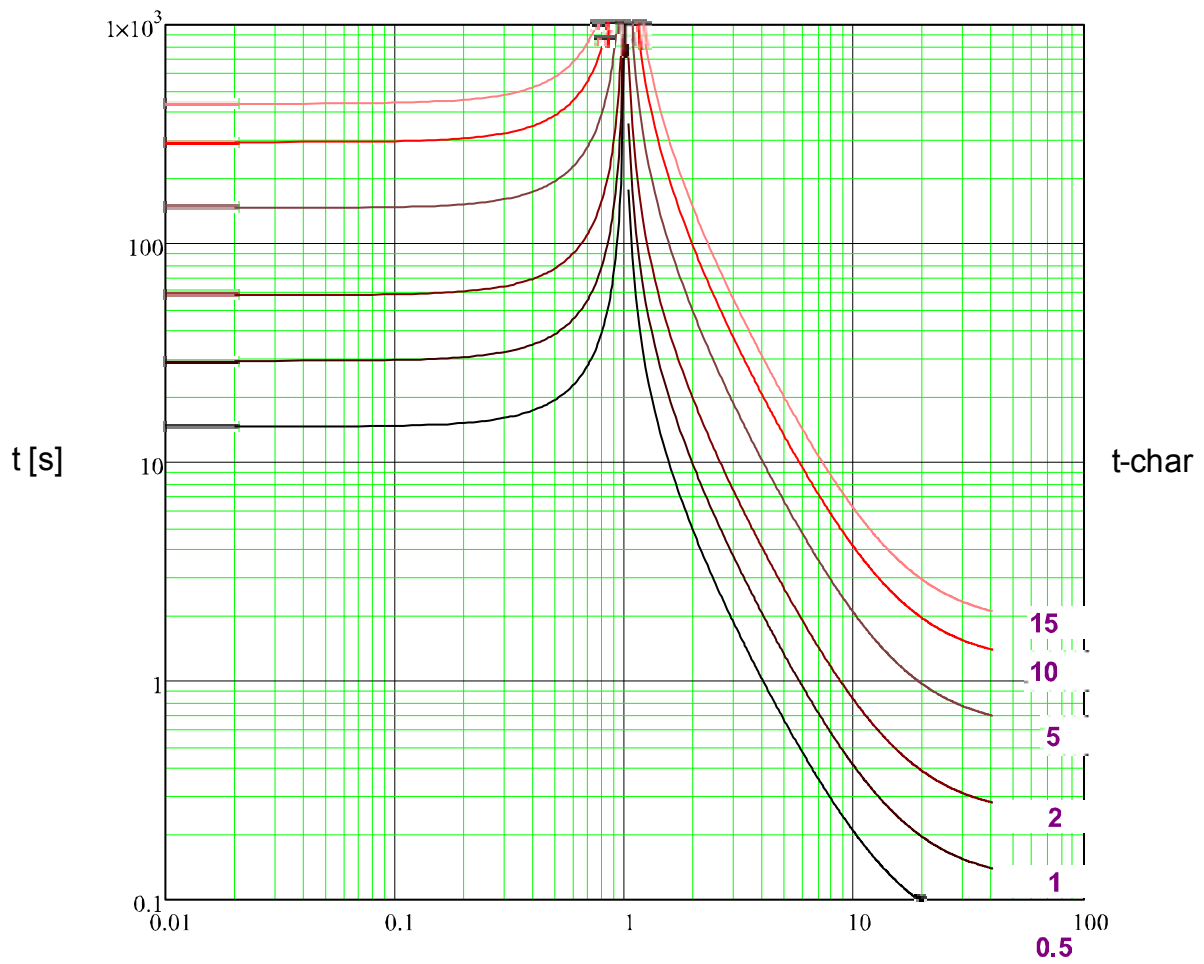

x * IG> (multiples of pickup)

RXIDG

Trip

$$t = 5.8 - 1.35 * \ln \left(\frac{IG}{t\text{-char} * IG>} \right) \text{ [s]}$$

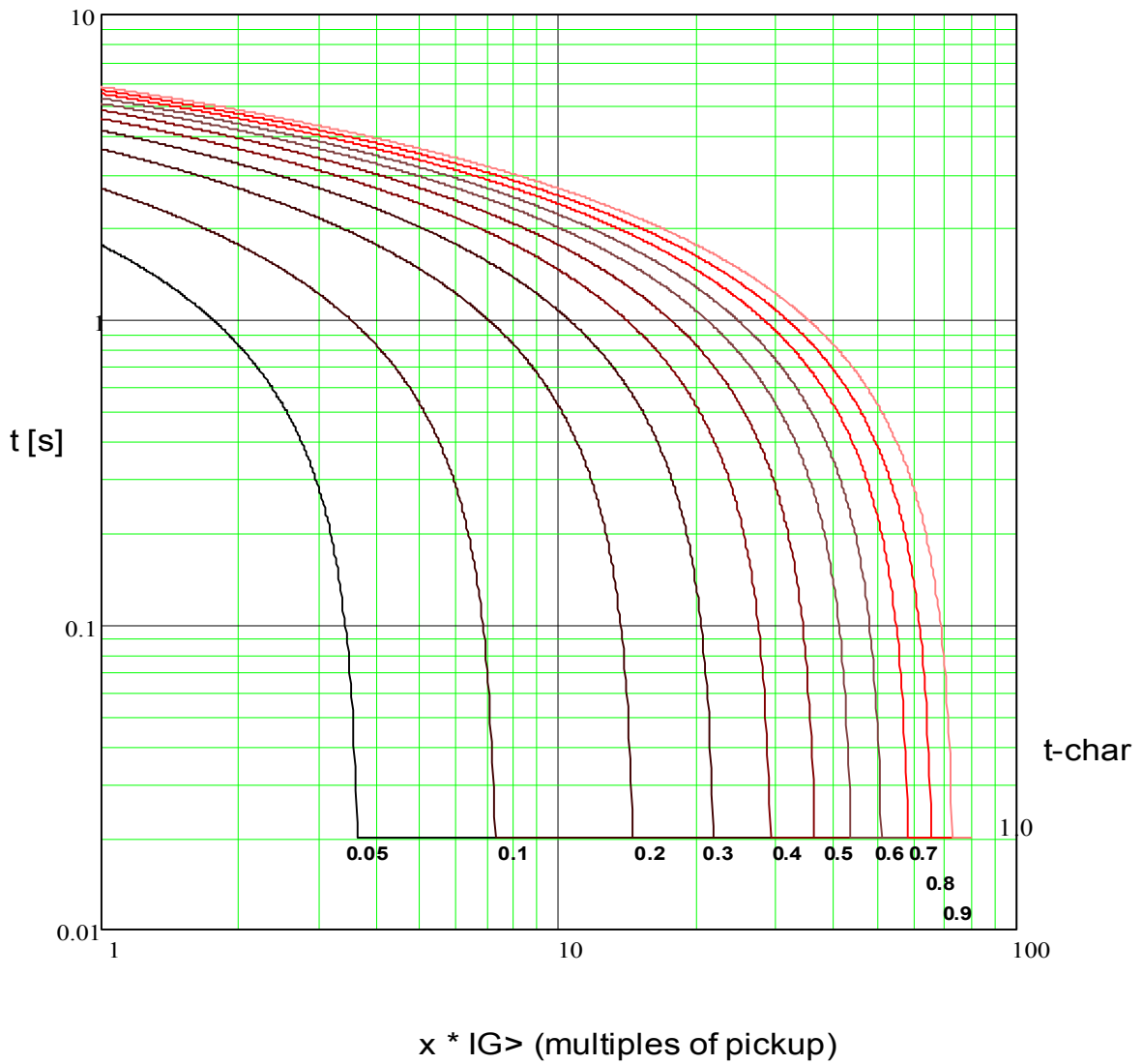

Therm Flat



Notice!

Various reset modes are available . Resetting via characteristic, delayed and instantaneous .

Reset

$$t = \left| \frac{5 \cdot 1^2}{\left(\frac{IG}{IGnom}\right)^0} \right| \cdot t-char [s]$$

Trip

$$t = \frac{5}{\left(\frac{IG}{IGnom}\right)^0} \cdot t-char [s]$$

$$t = 5 \cdot t-char [s]$$

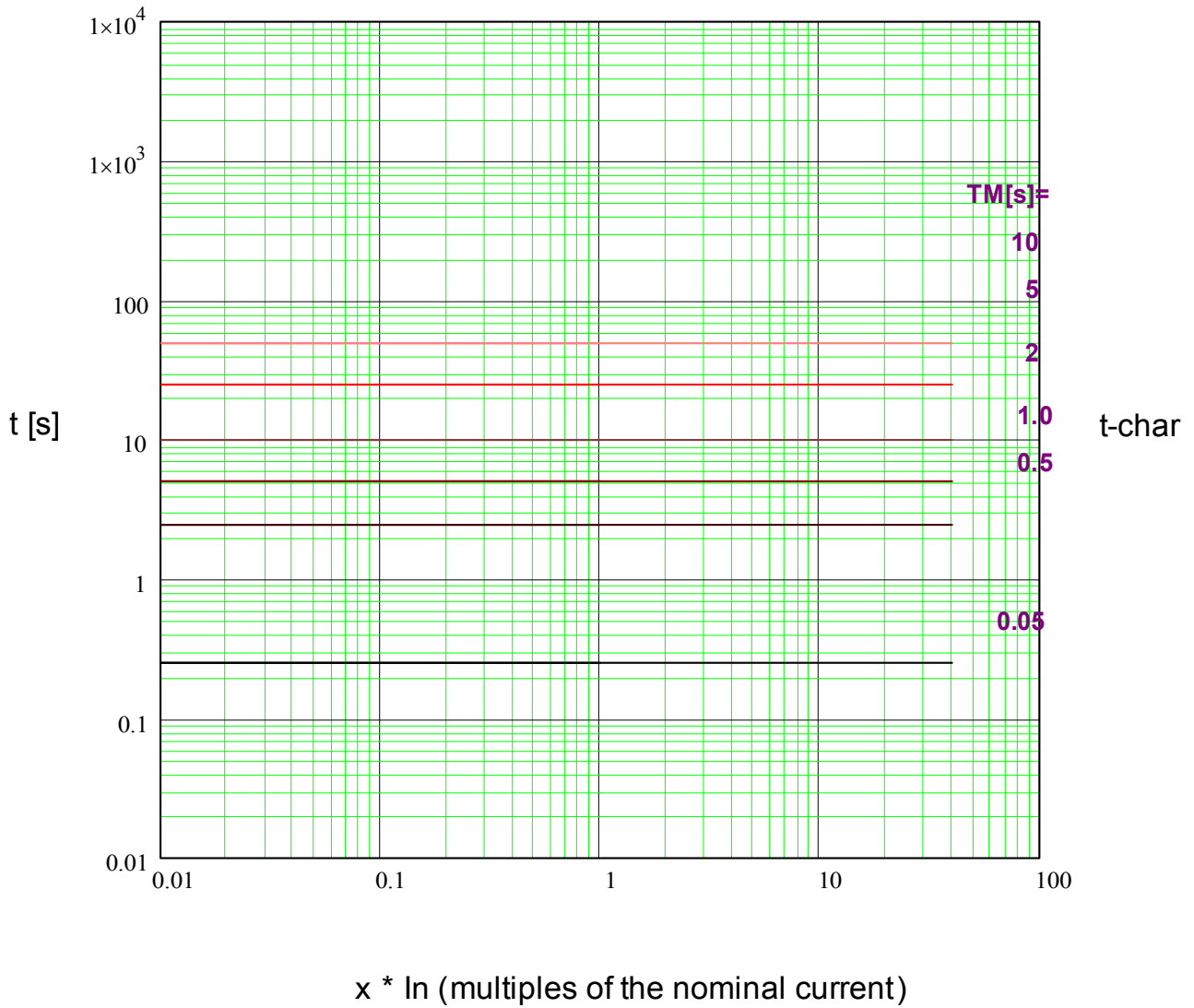

IT



Notice!

Various reset modes are available . Resetting via characteristic, delayed and instantaneous .

Reset

Trip

$$t = \left| \frac{5 \cdot 1^2}{\left(\frac{IG}{IGnom}\right)^0} \right| * t-char [s]$$

$$t = \frac{5 \cdot 1^1}{\left(\frac{IG}{IGnom}\right)^1} * t-char [s]$$

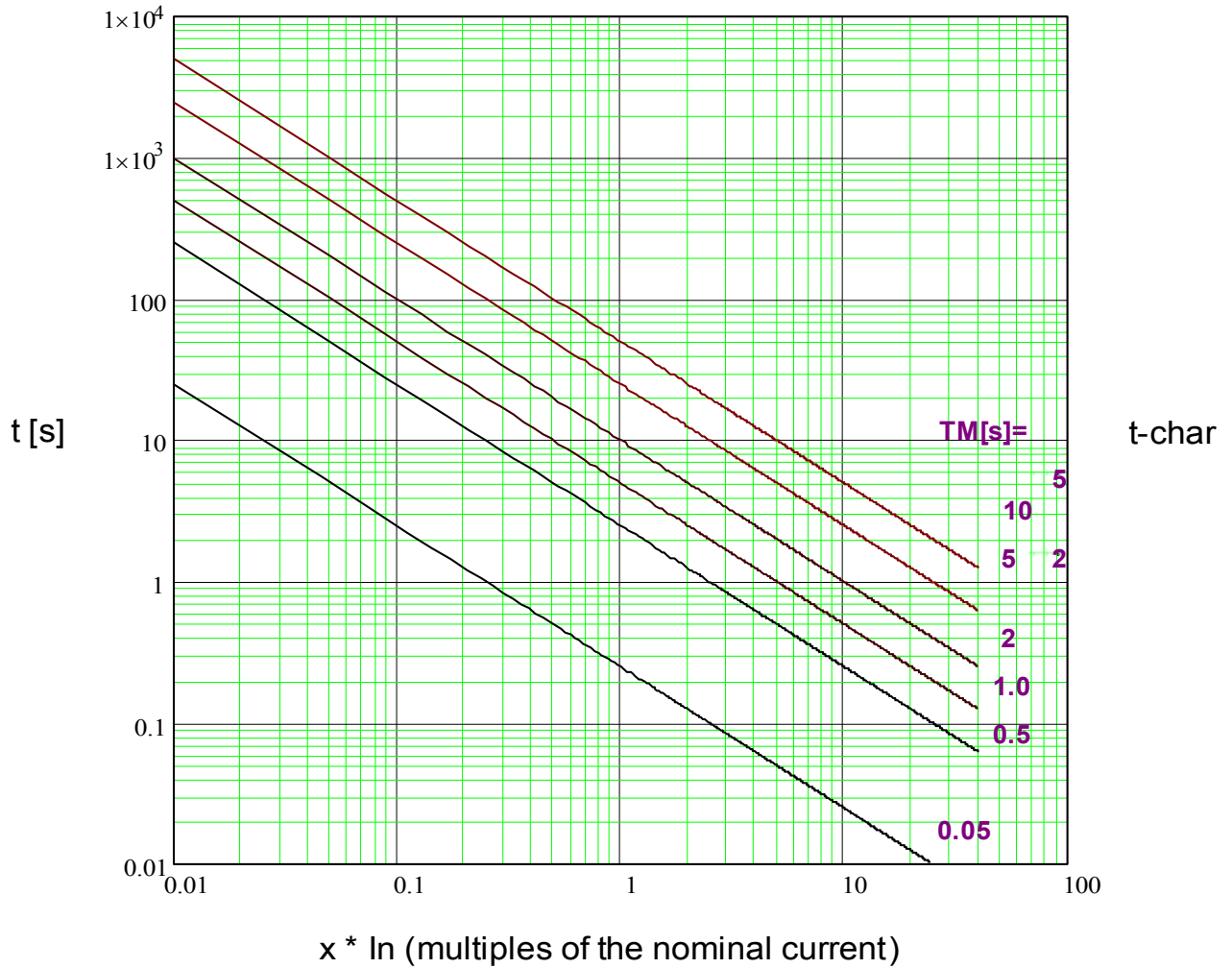

I²T



Notice!

Various reset modes are available . Resetting via characteristic, delayed and instantaneous .

Reset

$$t = \left| \frac{5 \cdot 1^2}{\left(\frac{IG}{IG_{nom}}\right)^0} \right| \cdot t_{char} [s]$$

Trip

$$t = \frac{5 \cdot 1^2}{\left(\frac{IG}{IG_{nom}}\right)^2} \cdot t_{char} [s]$$

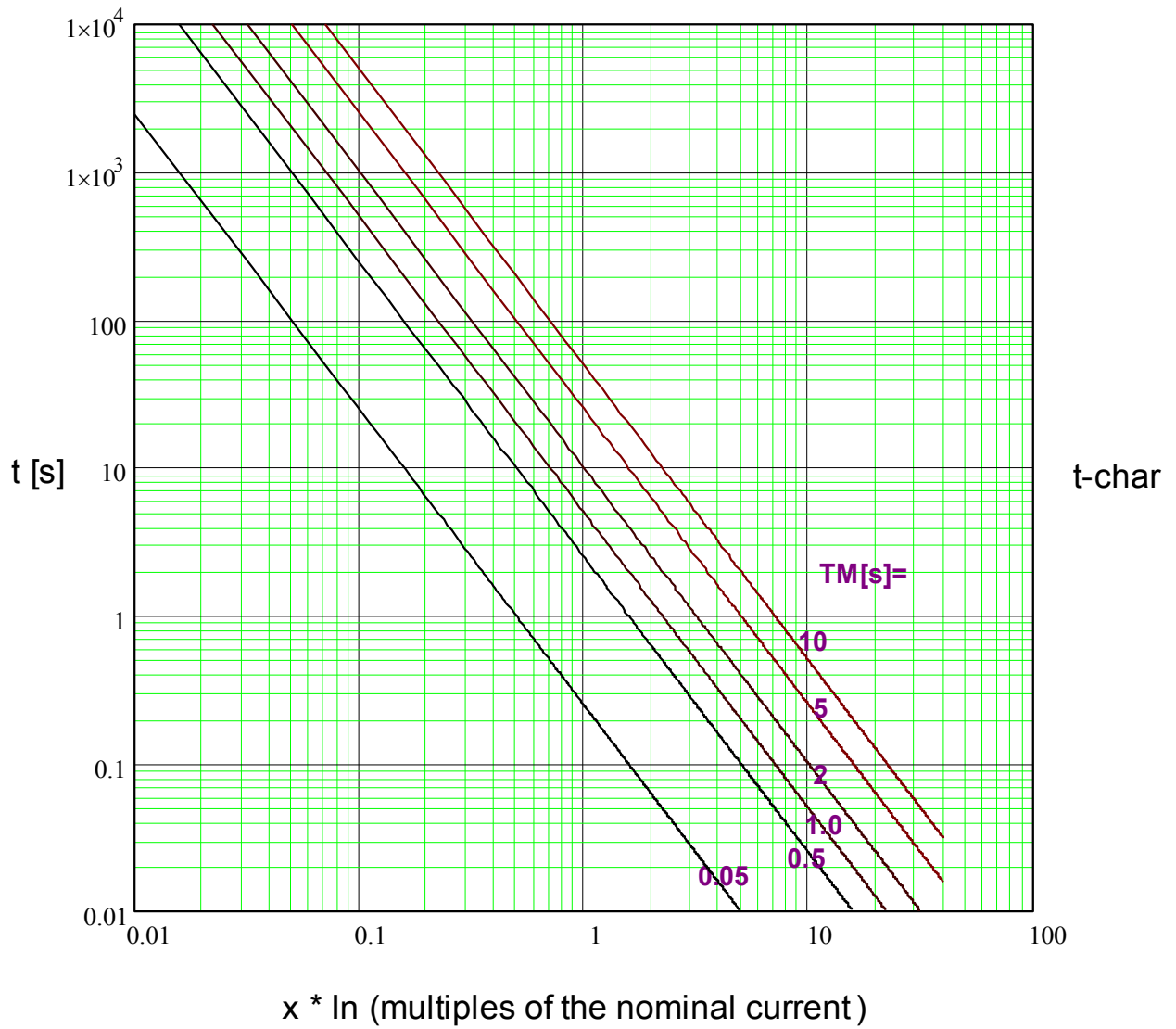

I4T



Notice!

Various reset modes are available . Resetting via characteristic, delayed and instantaneous .

Reset

$$t = \left| \frac{5 \cdot 1^2}{\left(\frac{IG}{IGnom}\right)^0} \right| \cdot t\text{-char [s]}$$

Trip

$$t = \frac{5 \cdot 1^4}{\left(\frac{IG}{IGnom}\right)^4} \cdot t\text{-char [s]}$$

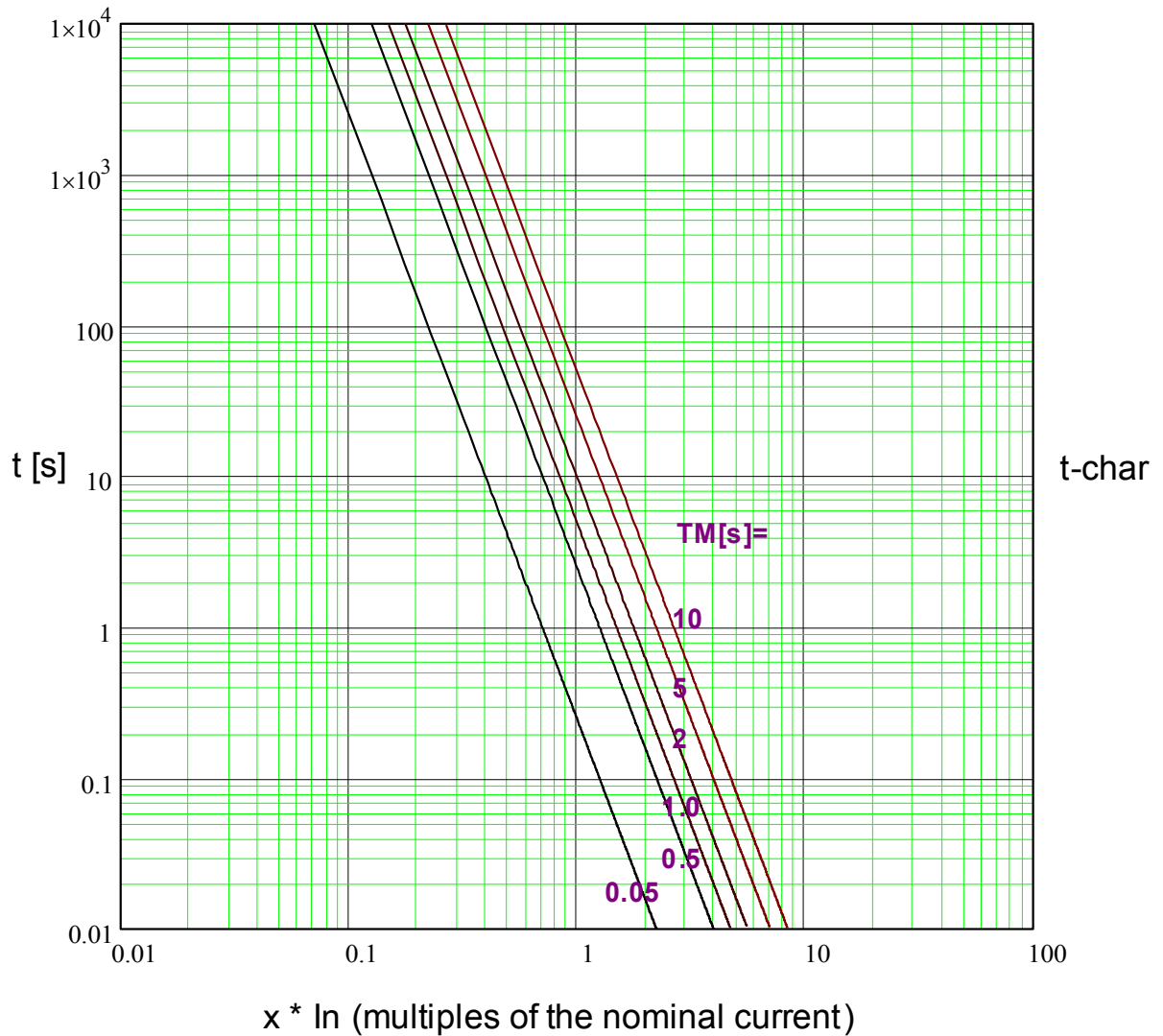

Prot - Earth fault - direction detection

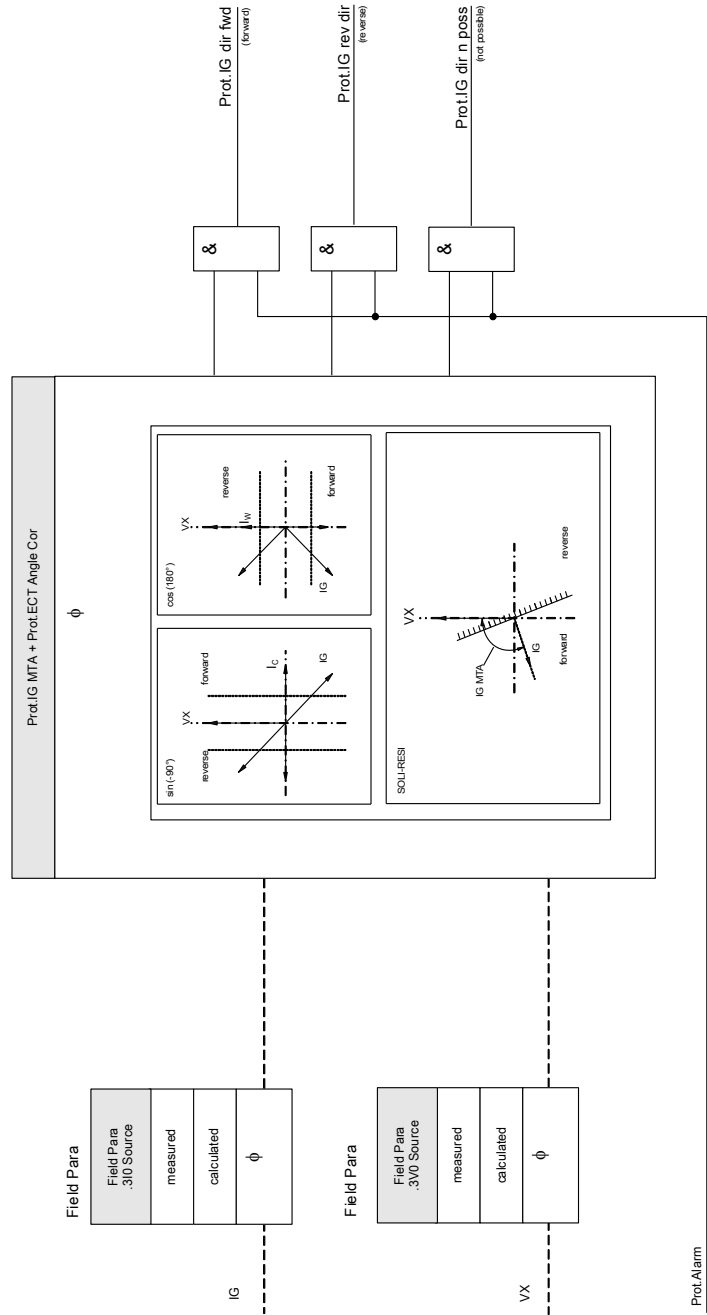

direction decision Earth fault

name = IG[1]...[n]

| | |
|-----------------|--|
| Device planning | |
| name.Mode | |
| non directional | |
| forward | |
| reverse | |

| | |
|------------------------|--|
| Field Para | |
| Field Para .3V0 Source | |
| measured | |
| calculated | |
| ϕ | |

IG
VX

≥ 1

&

&

name. Fault in projected direction

10

| | |
|------------------------------|--|
| name.Dir n.poss->NonDir Trip | |
| inactive | |
| active | |

&

Prot.IG dir n.poss
(not possible)

IG[1]...[n]

name = IG[1]...[n]

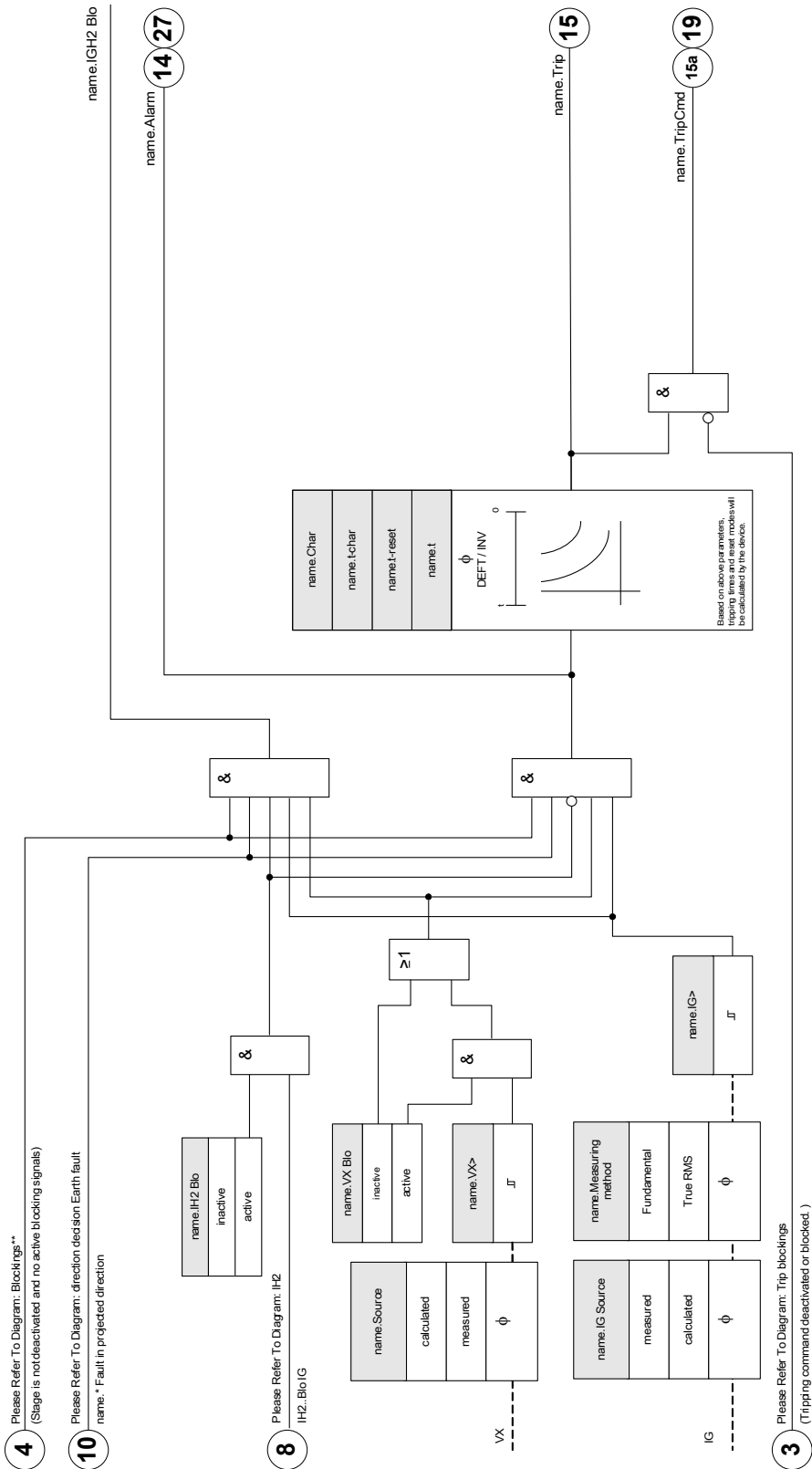

Device Planning Parameters of the Ground Fault Protection

| Parameter | Description | Options | Default | Menu path |
|---|-------------|--|------------|-------------------|
| Mode  | Mode | do not use, non directional, forward, reverse | do not use | [Device planning] |





Global Protection Parameters of the Ground Fault Protection

| Parameter | Description | Setting range | Default | Menu path |
|--|--|-----------------------|---------|---|
| ExBlo1  | External blocking of the module, if blocking is activated (allowed) within a parameter set and if the state of the assigned signal is true. | 1..n, Assignment List | -- | [Protection Para /Global Prot Para /I-Prot /IG[1]] |
| ExBlo2  | External blocking of the module, if blocking is activated (allowed) within a parameter set and if the state of the assigned signal is true. | 1..n, Assignment List | -- | [Protection Para /Global Prot Para /I-Prot /IG[1]] |
| ExBlo TripCmd  | External blocking of the Trip Command of the module/the stage, if blocking is activated (allowed) within a parameter set and if the state of the assigned signal is true. | 1..n, Assignment List | -- | [Protection Para /Global Prot Para /I-Prot /IG[1]] |
| Ex rev Interl  | External blocking of the module by external reverse interlocking, if blocking is activated (allowed) within a parameter set and if the state of the assigned signal is true. | 1..n, Assignment List | -- | [Protection Para /Global Prot Para /I-Prot /IG[1]] |
| AdaptSet 1  | Assignment Adaptive Parameter 1 | AdaptSet | -- | [Protection Para /Global Prot Para /I-Prot /IG[1]] |
| AdaptSet 2  | Assignment Adaptive Parameter 2 | AdaptSet | -- | [Protection Para /Global Prot Para /I-Prot /IG[1]] |
| AdaptSet 3  | Assignment Adaptive Parameter 3 | AdaptSet | -- | [Protection Para /Global Prot Para /I-Prot /IG[1]] |

Protective Elements

| <i>Parameter</i> | <i>Description</i> | <i>Setting range</i> | <i>Default</i> | <i>Menu path</i> |
|---|---------------------------------|----------------------|----------------|---|
| AdaptSet 4  | Assignment Adaptive Parameter 4 | AdaptSet | -.- | [Protection Para /Global Prot Para /I-Prot /IG[1]] |

Setting Group Parameters of the Ground Fault Protection

| Parameter | Description | Setting range | Default | Menu path |
|---|---|--|-------------|---|
|  Function | Permanent activation or deactivation of module/stage. | inactive, active | inactive | [Protection Para /<1..4> /I-Prot /IG[1]] |
|  ExBlo Fc | Activate (allow) or inactivate (disallow) blocking of the module/stage. This parameter is only effective if a signal is assigned to the corresponding global protection parameter. If the signal becomes true, those modules/stages are blocked that are parameterized "ExBlo Fc=active". | inactive, active | inactive | [Protection Para /<1..4> /I-Prot /IG[1]] |
|  Ex rev Interl Fc | Activate (allow) or inactivate (disallow) blocking of the module/stage. This parameter is only effective if a signal is assigned to the corresponding global protection parameter. If the signal becomes true, those modules/stages are blocked that are parameterized "Ex rev Interl Fc = active". | inactive, active | inactive | [Protection Para /<1..4> /I-Prot /IG[1]] |
|  Blo TripCmd | Permanent blocking of the Trip Command of the module/stage. | inactive, active | inactive | [Protection Para /<1..4> /I-Prot /IG[1]] |
|  ExBlo TripCmd Fc | Activate (allow) or inactivate (disallow) blocking of the module/stage. This parameter is only effective if a signal is assigned to the corresponding global protection parameter. If the signal becomes true, those modules/stages are blocked that are parameterized "ExBlo TripCmd Fc=active". | inactive, active | inactive | [Protection Para /<1..4> /I-Prot /IG[1]] |
|  IG Source | Selection if measured or calculated ground current should be used. | sensitive measurement, measured, calculated | calculated | [Protection Para /<1..4> /I-Prot /IG[1]] |
|  Measuring method | Measuring method: fundamental or rms or 3rd harmonic (only generator protection relays) | Fundamental, True RMS | Fundamental | [Protection Para /<1..4> /I-Prot /IG[1]] |
|  VX Source | Selection if VG is measured or calculated (neutral voltage or residual voltage) | measured, calculated | measured | [Protection Para /<1..4> /I-Prot /IG[1]] |

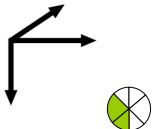
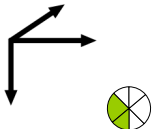
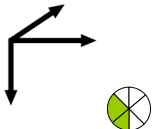
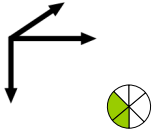
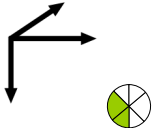
| Parameter | Description | Setting range | Default | Menu path |
|--|--|--|----------|---|
| Meas Circuit Superv  | Activates the use of the measuring circuit supervision. In this case the module will be blocked if a measuring circuit supervision module (e.g. LOP, VTS) signals a disturbed measuring circuit (e.g. caused by a fuse failure). Only available if "VX Source" ist set to "calculated". | inactive, active | inactive | [Protection Para /<1..4> /I-Prot /IG[1]] |
| IG>  | If the pickup value is exceeded, the module/stage will be started. | 0.02 - 20.00In | 0.02In | [Protection Para /<1..4> /I-Prot /IG[1]] |
| IGs>  | If the pickup value is exceeded, the module/stage will be started. | 0.002 - 2.000In | 0.02In | [Protection Para /<1..4> /I-Prot /IG[1]] |
| Char  | Characteristic | DEFT, IEC NINV, IEC VINV, IEC EINV, IEC LINV, ANSI MINV, ANSI VINV, ANSI EINV, Therm Flat, IT, I2T, I4T, RXIDG | DEFT | [Protection Para /<1..4> /I-Prot /IG[1]] |
| t  | Tripping delay Only available if: Characteristic = DEFT | 0.00 - 300.00s | 0.00s | [Protection Para /<1..4> /I-Prot /IG[1]] |
| t-char  | Time multiplier/tripping characteristic factor. The setting range depends on the selected tripping curve. Only available if: Characteristic = INV Or Characteristic = Therm Flat Or Characteristic = IT Or Characteristic = I2T Or Characteristic = I4T Or Characteristic = RXIDG | 0.02 - 20.00 | 1 | [Protection Para /<1..4> /I-Prot /IG[1]] |

Protective Elements

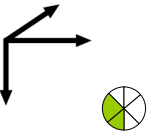
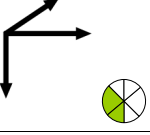
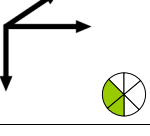
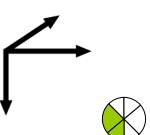
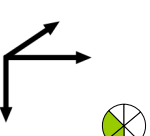
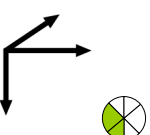
| Parameter | Description | Setting range | Default | Menu path |
|--|---|--|---------------|--|
|  Reset Mode | Reset Mode Only available if: Characteristic = INV Or Characteristic = Therm Flat Or Characteristic = IT Or Characteristic = I2T Or Characteristic = I4T Or Characteristic = RXIDG | instantaneous, t-delay, calculated | instantaneous | [Protection Para <1..4> /I-Prot /IG[1]] |
|  t-reset | Reset time for intermittent phase failures (INV characteristics only) Only available if: Characteristic = INV Or Characteristic = Therm Flat Or Characteristic = IT Or Characteristic = I2T Or Characteristic = I4T Or Characteristic = RXIDG Only available if: Reset Mode = t-delay | 0.00 - 60.00s | 0.00s | [Protection Para <1..4> /I-Prot /IG[1]] |
|  IH2 Blo | Blocking the trip command, if an inrush is detected. | inactive, active | inactive | [Protection Para <1..4> /I-Prot /IG[1]] |
|  Dir n poss->Nondir Trip | Only relevant for current protection elements with directional feature! The device will trip non directional if this parameter is set to active and no direction could be determined. Direction detection is impossible e.g. if the required quantities for the direction detection cannot be measured or validated. Direction detection is also impossible if the frequency deviates significantly from the nominal frequency. Caution: If this parameter is set to inactive, the protective element will trip only if the direction can be detected. Only available if: Device planning: Earth current protection - Stage.Mode = directional | inactive, active | inactive | [Protection Para <1..4> /I-Prot /IG[1]] |
|  VX Blo | VX Blo = active means that the IG-stage will only excite if a residual voltage higher than the pickup value is measured at the same time. VX Blo = inactive means that the excitation of the IG stage does not depend on any residual voltage stage. | inactive, active | inactive | [Protection Para <1..4> /I-Prot /IG[1]] |
|  VX> | If the pickup value is exceeded, the module/stage will be started. Only available if: VX Blo = active | 0.01 - 1.50Vn | 1.00Vn | [Protection Para <1..4> /I-Prot /IG[1]] |

Ground Fault Protection Input States

| <i>Name</i> | <i>Description</i> | <i>Assignment via</i> |
|-----------------|---|---|
| ExBlo1-I | Module input state: External blocking1 | [Protection Para /Global Prot Para /I-Prot /IG[1]] |
| ExBlo2-I | Module input state: External blocking2 | [Protection Para /Global Prot Para /I-Prot /IG[1]] |
| ExBlo TripCmd-I | Module input state: External Blocking of the Trip Command | [Protection Para /Global Prot Para /I-Prot /IG[1]] |
| Ex rev Inter-I | Module input state: External reverse interlocking | [Protection Para /Global Prot Para /I-Prot /IG[1]] |
| AdaptSet1-I | Module input state: Adaptive Parameter1 | [Protection Para /Global Prot Para /I-Prot /IG[1]] |
| AdaptSet2-I | Module input state: Adaptive Parameter2 | [Protection Para /Global Prot Para /I-Prot /IG[1]] |
| AdaptSet3-I | Module input state: Adaptive Parameter3 | [Protection Para /Global Prot Para /I-Prot /IG[1]] |
| AdaptSet4-I | Module input state: Adaptive Parameter4 | [Protection Para /Global Prot Para /I-Prot /IG[1]] |

Ground Fault Protection Signals (Output States)

| <i>Signal</i> | <i>Description</i> |
|-----------------|---|
| active | Signal: active |
| ExBlo | Signal: External Blocking |
| Ex rev Interl | Signal: External reverse Interlocking |
| Blo TripCmd | Signal: Trip Command blocked |
| ExBlo TripCmd | Signal: External Blocking of the Trip Command |
| Alarm | Signal: Alarm IG |
| Trip | Signal: Trip |
| TripCmd | Signal: Trip Command |
| IGH2 Blo | Signal: blocked by an inrush |
| Active AdaptSet | Active Adaptive Parameter |
| DefaultSet | Signal: Default Parameter Set |
| AdaptSet 1 | Signal: Adaptive Parameter 1 |
| AdaptSet 2 | Signal: Adaptive Parameter 2 |
| AdaptSet 3 | Signal: Adaptive Parameter 3 |
| AdaptSet 4 | Signal: Adaptive Parameter 4 |

Commissioning: Ground Fault Protection – non-directional [50N/G, 51N/G]

Please test the non-directional earth overcurrent analog to the non-directional phase overcurrent protection.

Commissioning: Ground Fault Protection – directional [50N/G, 51N/G, 67N/G]

Please test the directional earth overcurrent analog to the directional phase overcurrent protection.

I2> and %I2/I1> - Unbalanced Load [46]

Elements:

I2>[1], I2>[2]

The I2> Current Unbalance element works similar to the V012 Voltage Unbalance element. The positive and negative sequence currents are calculated from the 3-phase currents. The Threshold setting defines a minimum operating current magnitude of I2 for the 46 function to operate, which insures that the relay has a solid basis for initiating a current unbalance trip. The »%(I2/I1)« (option) setting is the unbalance trip pickup setting. It is defined by the ratio of negative sequence current to positive sequence current »%(I2/I1)«.

This function requires negative sequence current magnitude above the threshold setting and the percentage current unbalance above the »%(I2/I1)« setting before allowing a current unbalance trip. Therefore, both the threshold and percent settings must be met for the specified Delay time setting before the relay initiates a trip for current unbalance.

NOTICE All elements are identically structured.

Rating value I2> is the permitted continuous unbalanced load current. For both steps trip characteristics are provided, namely a definite time characteristic (DEFT) and an inverse characteristic (INV).

The characteristic of the inverse curve is as follows:

$$t [s] \leq \frac{K * I_n^2}{I_2^2 - I_2>^2}$$

Legend:

I_n [A] = Nominal current

t [s] = Tripping delay

K [s] = Indicates the thermal load capability of the engine while running with 100% unbalanced load current.

I2> [A] = The Threshold setting defines a minimum operating current magnitude of I2 for the 46 function to operate, which ensures that the relay has a solid basis for initiating a current unbalance trip. This is a supervisory function and not a trip level.

I2 [A] = Measured value (calculated): Unbalanced load current

In the equation shown above the heating-up process is assumed by integration of the counter system current I2. When I2> is undershoot, the built-up heat amount will be reduced in line with the adjusted cooling-down constant "tau-cool".

$$\Theta(t) = \Theta_0 * e^{-\frac{t}{\tau_{cool}}}$$

Legend:

t = Tripping delay

τ -cool = Cooling time constant

$\Theta(t)$ = Momentary heat (thermal) energy

Θ_0 = Heat (thermal) energy before the cooling down has started

If the heat amount is not reduced when the permitted unbalanced load current is overshoot again, the remaining heat amount will cause an earlier tripping.

46[1]...[n]

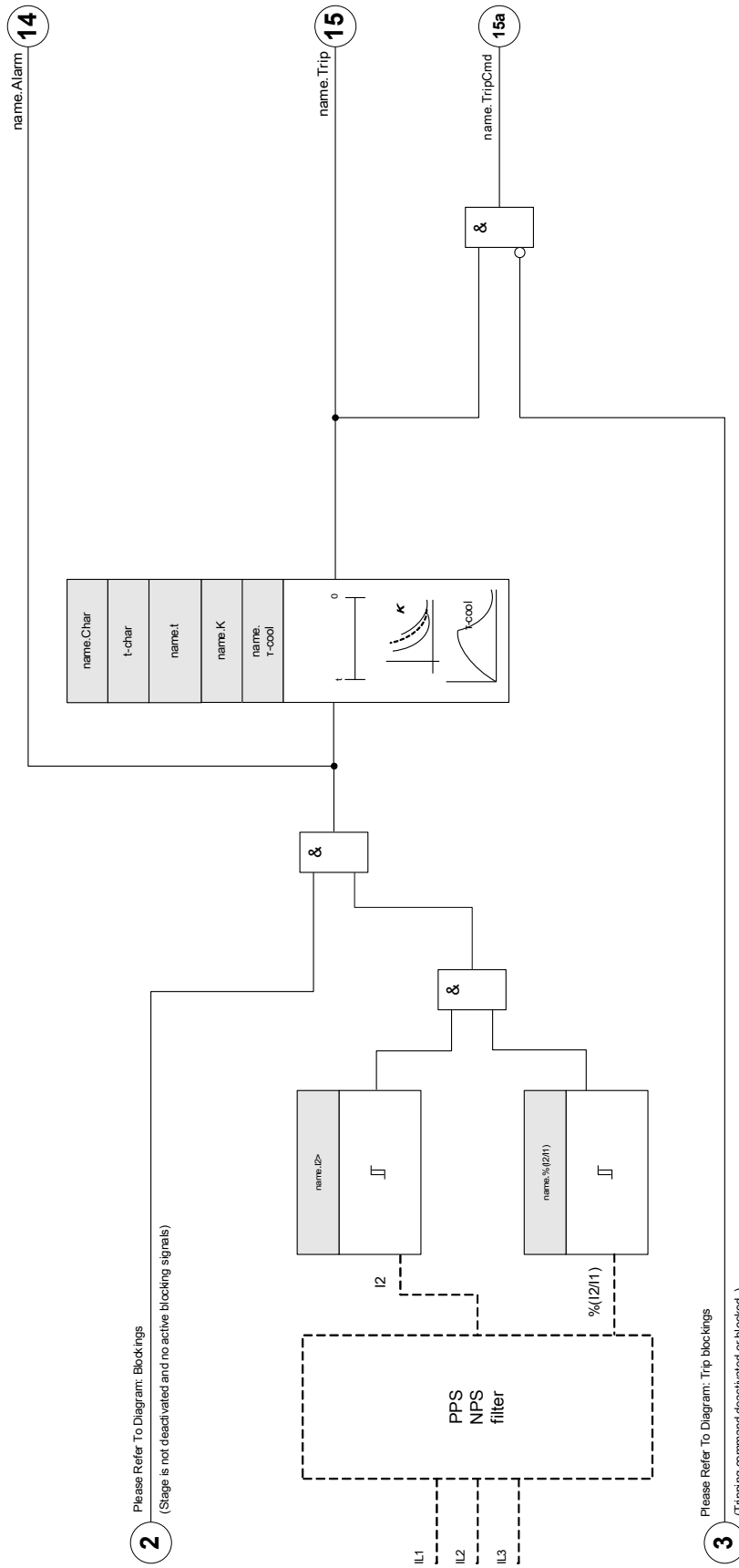

name = 46[1]...[n]











Device Planning Parameters of the Current Unbalance Module

| <i>Parameter</i> | <i>Description</i> | <i>Options</i> | <i>Default</i> | <i>Menu path</i> |
|---|--------------------|--------------------|----------------|-------------------|
| Mode  | Mode | do not use, use | do not use | [Device planning] |



Global Protection Parameters of the Current Unbalance Module

| <i>Parameter</i> | <i>Description</i> | <i>Setting range</i> | <i>Default</i> | <i>Menu path</i> |
|--|---|-----------------------|----------------|--|
| ExBlo1  | External blocking of the module, if blocking is activated (allowed) within a parameter set and if the state of the assigned signal is true. | 1..n, Assignment List | -.- | [Protection Para /Global Prot Para /I-Prot /I2>[1]] |
| ExBlo2  | External blocking of the module, if blocking is activated (allowed) within a parameter set and if the state of the assigned signal is true. | 1..n, Assignment List | -.- | [Protection Para /Global Prot Para /I-Prot /I2>[1]] |
| ExBlo TripCmd  | External blocking of the Trip Command of the module/the stage, if blocking is activated (allowed) within a parameter set and if the state of the assigned signal is true. | 1..n, Assignment List | -.- | [Protection Para /Global Prot Para /I-Prot /I2>[1]] |

Setting Group Parameters of the Current Unbalance Module

| Parameter | Description | Setting range | Default | Menu path |
|---|---|---------------------|----------|--|
| Function  | Permanent activation or deactivation of module/stage. | inactive, active | inactive | [Protection Para /<1..4> /I-Prot /I2>[1]] |
| ExBlo Fc  | Activate (allow) or inactivate (disallow) blocking of the module/stage. This parameter is only effective if a signal is assigned to the corresponding global protection parameter. If the signal becomes true, those modules/stages are blocked that are parameterized "ExBlo Fc=active". | inactive, active | inactive | [Protection Para /<1..4> /I-Prot /I2>[1]] |
| Blo TripCmd  | Permanent blocking of the Trip Command of the module/stage. | inactive, active | inactive | [Protection Para /<1..4> /I-Prot /I2>[1]] |
| ExBlo TripCmd Fc  | Activate (allow) or inactivate (disallow) blocking of the module/stage. This parameter is only effective if a signal is assigned to the corresponding global protection parameter. If the signal becomes true, those modules/stages are blocked that are parameterized "ExBlo TripCmd Fc=active". | inactive, active | inactive | [Protection Para /<1..4> /I-Prot /I2>[1]] |
| I2>  | The Threshold setting defines a minimum operating current magnitude of I2 for the 46 function to operate, which ensures that the relay has a solid basis for initiating a current unbalance trip. This is a supervisory function and not a trip level. Only available if: Device planning: I2>.Mode = 46 | 0.01 - 4.00In | 0.01In | [Protection Para /<1..4> /I-Prot /I2>[1]] |
| %(I2/I1)  | The %(I2/I1) setting is the unbalance trip pickup setting. It is defined by the ratio of negative sequence current to positive sequence current (% Unbalance=I2/I1). Phase sequence will be taken into account automatically. | inactive, active | inactive | [Protection Para /<1..4> /I-Prot /I2>[1]] |
| %(I2/I1)  | The %(I2/I1) setting is the unbalance trip pickup setting. It is defined by the ratio of negative sequence current to positive sequence current (% Unbalance=I2/I1). Phase sequence will be taken into account automatically. Only available if: %(I2/I1) = use | 2 - 40% | 20% | [Protection Para /<1..4> /I-Prot /I2>[1]] |
| Char  | Characteristic | DEFT, INV | DEFT | [Protection Para /<1..4> /I-Prot /I2>[1]] |

Protective Elements

| Parameter | Description | Setting range | Default | Menu path |
|---|---|----------------|---------|--|
| t  | <p>Tripping delay</p> <p>Only available if: Characteristic = DEFT</p> | 0.00 - 300.00s | 0.00s | [Protection Para /<1..4> /I-Prot /I2>[1]] |
| K  | <p>This setting is the negative sequence capability constant. This value is normally provided by the generator manufacturer.</p> <p>Only available if: Characteristic = INV</p> | 1.00 - 200.00s | 10.0s | [Protection Para /<1..4> /I-Prot /I2>[1]] |
| T-cool  | <p>If the unbalanced load current falls below the pickup value, the cooling-off time is taken into account. If the unbalanced load exceeds the pickup value again, than the saved heat within the electrical equipment will lead to an accelerated trip.</p> <p>Only available if: Characteristic = INV</p> | 0.0 - 60000.0s | 0.0s | [Protection Para /<1..4> /I-Prot /I2>[1]] |

Current Unbalance Module Input States

| <i>Name</i> | <i>Description</i> | <i>Assignment via</i> |
|-----------------|---|--|
| ExBlo1-I | Module input state: External blocking1 | [Protection Para /Global Prot Para /I-Prot /I2>[1]] |
| ExBlo2-I | Module input state: External blocking2 | [Protection Para /Global Prot Para /I-Prot /I2>[1]] |
| ExBlo TripCmd-I | Module input state: External Blocking of the Trip Command | [Protection Para /Global Prot Para /I-Prot /I2>[1]] |

Current Unbalance Module Signals (Output States)

| <i>Signal</i> | <i>Description</i> |
|---------------|---|
| active | Signal: active |
| ExBlo | Signal: External Blocking |
| Blo TripCmd | Signal: Trip Command blocked |
| ExBlo TripCmd | Signal: External Blocking of the Trip Command |
| Alarm | Signal: Alarm Negative Sequence |
| Trip | Signal: Trip |
| TripCmd | Signal: Trip Command |

Commissioning: Current Unbalance Module

Object to be tested:

Test of the unbalanced load protection function.

Necessary means:

- Three-phase current source with adjustable current unbalance; and
- Timer.

Procedure:

Check the phase sequence:

- Ensure that the phase sequence is the same as that set in the field parameters.
- Feed-in a three-phase nominal current.
- Change to the »Measuring Values« menu.
- Check the measuring value for the unbalanced current »I2«. The measuring value displayed for »I2« should be zero (within the physical measuring accuracy).

NOTICE

If the displayed magnitude for I2 is the same as that for the symmetrical nominal currents fed to the relay, it implies that the phase sequence of the currents seen by the relay is reversed.

- Now turn-off phase L1.
- Again check the measuring value of the unbalanced current »I2« in the »Measuring Values« menu. The measuring value of the asymmetrical current »I2« should now be 33%.
- Turn-on phase L1, but turn-off phase L2.
- Once again check the measuring value of the asymmetrical current I2 in the »Measuring Values« menu. The measuring value of the asymmetrical current »I2« should be again 33%.
- Turn-on phase L2, but turn-off phase L3.
- Again check the measuring value of asymmetrical current »I2« in the »Measuring Values« menu. The measuring value of the asymmetrical current »I2« should still be 33%.

Testing the trip delay:

- Apply a symmetrical three-phase current system (nominal currents).
- Switch off IL1 (the threshold value »Threshold« for »I2« must be below 33%).
- Measure the tripping time.

The present current unbalance »I2« corresponds with 1/3 of the existing phase current displayed.

Testing the threshold values

- Configure minimum » $I_{2/1}$ « setting (2%) and an arbitrary threshold value » *Threshold* « (I2).
- For testing the threshold value, a current has to be fed to phase A which is lower than three times the adjusted threshold value » *Threshold* « (I2).
- Feeding only phase A results in » $I_{2/1} = 100\%$ «, so the first condition » $I_{2/1} \geq 2\%$ « is always fulfilled.
- Now increase the phase L1 current until the relay is activated.

Testing the dropout ratio of the threshold values

Having tripped the relay in the previous test, now decrease the phase A current. The dropout ratio must not be higher than 0.97 times the threshold value.

Testing $I_{2/1}$

- Configure minimum threshold value » *Threshold* « (I2) ($0.01 \times I_n$) and set » $I_{2/1}$ « greater or equal to 10%.
- Apply a symmetrical three-phase current system (nominal currents). The measuring value of » $I_{2/1}$ « should be 0%.
- Now increase the phase L1 current. With this configuration, the threshold value » *Threshold* « (I2) should be reached before the value » $I_{2/1}$ « reaches the set » $I_{2/1}$ « ratio threshold.
- Continue increasing the phase 1 current until the relay is activated.

Testing the dropout ratio of $I_{2/1}$

Having tripped the relay in the previous test, now decrease the phase L1 current. The dropout of » $I_{2/1}$ « has to be 1% below the » $I_{2/1}$ « setting.

Successful test result:

The measured trip delays, threshold values, and dropout ratios are within the permitted deviations/tolerances, specified under Technical Data.

ThR-Protection Module: Thermal Replica [49]

ThR

The maximal permissible thermal loading capacity, and consequently the tripping delay of a component, depends on the amount of the flowing current at a specific time, the »previously existing load (current)« as well as on a constant specified by the component.

The thermal overload protection is in compliance with IEC255-8 (VDE 435 T301). A complete thermal replica function is implemented in the device as Homogeneous-Body Replica of the equipment to be protected and by taking the previously existing load into account. The protection function is of one step design, provided with a warning limit.

For this the device calculates the thermal load of the equipment by using the existing measured values and the parameter settings. When knowing the thermal constants, the temperature of the equipment can be established (simulated).

The general tripping times of the overload protection can be gathered from the following equation according to IEC 255-8:

$$t = \tau\text{-warm} \ln\left(\frac{I^2 - I_p^2}{I^2 - (K \cdot I_b)^2}\right)$$

Legend:

t = Tripping delay

$\tau\text{-warm}$ = Warming-up time constant

$\tau\text{-cool}$ = Cooling time constant

I_b = Base current: Maximum permissible thermal continuous current.

K = Overload Factor: The maximum thermal limit is defined as $k \cdot I_b$, the product of the overload factor and the base current .

I = measured current (x ln)

I_p = Preload Current

Thr

name = Thr

2

Please Refer To Diagram: Blockings
(Stage is not deactivated and no active blocking signals)

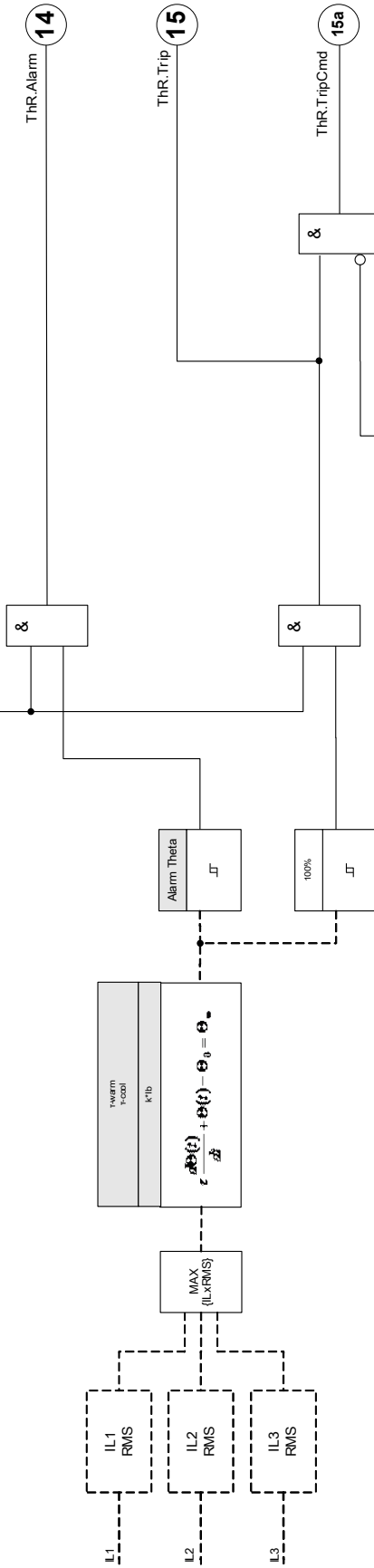

3

Please Refer To Diagram: Trip blockings
(Tripping command deactivated or blocked.)



Direct Commands of the Thermal Overload Module

| <i>Parameter</i> | <i>Description</i> | <i>Setting range</i> | <i>Default</i> | <i>Menu path</i> |
|--|---------------------------|----------------------|----------------|-----------------------|
| Reset  | Reset the Thermal Replica | inactive, active | inactive | [Operation /Reset] |









Device Planning Parameters of the Thermal Overload Module

| <i>Parameter</i> | <i>Description</i> | <i>Options</i> | <i>Default</i> | <i>Menu path</i> |
|---|--------------------|--------------------|----------------|-------------------|
| Mode  | Mode | do not use, use | do not use | [Device planning] |

Global Protection Parameters of the Thermal Overload Module

| <i>Parameter</i> | <i>Description</i> | <i>Setting range</i> | <i>Default</i> | <i>Menu path</i> |
|--|---|-----------------------|----------------|---|
| ExBlo1  | External blocking of the module, if blocking is activated (allowed) within a parameter set and if the state of the assigned signal is true. | 1..n, Assignment List | .- | [Protection Para /Global Prot Para /I-Prot /ThR] |
| ExBlo2  | External blocking of the module, if blocking is activated (allowed) within a parameter set and if the state of the assigned signal is true. | 1..n, Assignment List | .- | [Protection Para /Global Prot Para /I-Prot /ThR] |
| ExBlo TripCmd  | External blocking of the Trip Command of the module/the stage, if blocking is activated (allowed) within a parameter set and if the state of the assigned signal is true. | 1..n, Assignment List | .- | [Protection Para /Global Prot Para /I-Prot /ThR] |

Setting Group Parameters of the Thermal Overload Module

| Parameter | Description | Setting range | Default | Menu path |
|---|---|---------------------|----------|---|
| Function  | Permanent activation or deactivation of module/stage. | inactive, active | inactive | [Protection Para /<1..4> /I-Prot /ThR] |
| ExBlo Fc  | Activate (allow) or inactivate (disallow) blocking of the module/stage. This parameter is only effective if a signal is assigned to the corresponding global protection parameter. If the signal becomes true, those modules/stages are blocked that are parameterized "ExBlo Fc=active". | inactive, active | inactive | [Protection Para /<1..4> /I-Prot /ThR] |
| Blo TripCmd  | Permanent blocking of the Trip Command of the module/stage. | inactive, active | inactive | [Protection Para /<1..4> /I-Prot /ThR] |
| ExBlo TripCmd Fc  | Activate (allow) or inactivate (disallow) blocking of the module/stage. This parameter is only effective if a signal is assigned to the corresponding global protection parameter. If the signal becomes true, those modules/stages are blocked that are parameterized "ExBlo TripCmd Fc=active". | inactive, active | inactive | [Protection Para /<1..4> /I-Prot /ThR] |
| Ib  | Base current: Maximum permissible thermal continuous current. | 0.01 - 4.00In | 1.00In | [Protection Para /<1..4> /I-Prot /ThR] |
| K  | Overload Factor: The maximum thermal limit is defined as $k \cdot I_B$, the product of the overload factor and the base current. | 0.80 - 1.20 | 1.00 | [Protection Para /<1..4> /I-Prot /ThR] |
| Alarm Theta  | Pickup value | 50 - 100% | 80% | [Protection Para /<1..4> /I-Prot /ThR] |
| τ -warm  | Warming-up time constant | 1 - 60000s | 10s | [Protection Para /<1..4> /I-Prot /ThR] |

Protective Elements

| <i>Parameter</i> | <i>Description</i> | <i>Setting range</i> | <i>Default</i> | <i>Menu path</i> |
|---|-----------------------|----------------------|----------------|---|
| τ -cool  | Cooling time constant | 1 - 60000s | 10s | [Protection Para /<1..4> /I-Prot /ThR] |

Thermal Overload Module Input States

| <i>Name</i> | <i>Description</i> | <i>Assignment via</i> |
|-----------------|---|---|
| ExBlo1-I | Module input state: External blocking1 | [Protection Para /Global Prot Para /I-Prot /ThR] |
| ExBlo2-I | Module input state: External blocking2 | [Protection Para /Global Prot Para /I-Prot /ThR] |
| ExBlo TripCmd-I | Module input state: External Blocking of the Trip Command | [Protection Para /Global Prot Para /I-Prot /ThR] |

Signals of the Thermal Overload Signals (Output States)

| <i>Signal</i> | <i>Description</i> |
|-----------------|---|
| active | Signal: active |
| ExBlo | Signal: External Blocking |
| Blo TripCmd | Signal: Trip Command blocked |
| ExBlo TripCmd | Signal: External Blocking of the Trip Command |
| Alarm | Signal: Alarm Thermal Overload |
| Trip | Signal: Trip |
| TripCmd | Signal: Trip Command |
| Res Thermal Cap | Signal: Resetting Thermal Replica |

Thermal Overload Module Values

| <i>Value</i> | <i>Description</i> | <i>Menu path</i> |
|------------------|--|---|
| Thermal Cap Used | Measured value: Thermal Capacity Used | [Operation /Measured Values /ThR] |
| Time To Trip | Measured value (calculated/measured): Remaining time until the thermal overload module will trip | [Operation /Measured Values /ThR] |

Thermal Overload Module Statistics

| <i>Value</i> | <i>Description</i> | <i>Menu path</i> |
|-----------------|--------------------------------|--|
| Thermal Cap max | Thermal Capacity maximum value | [Operation /Statistics /Max /ThR] |

Commissioning: Thermal Replica

Object to be tested

Protective function *ThR*

Necessary means

- Three-phase current source
- Timer

Procedure

Calculate the tripping time for the current to be constantly impressed by using the formula for the thermal image.

NOTICE The parameter of the temperature rise of the component » τ_w « has to be known to guarantee an optimal protection.

$$t = \tau_{\text{warm}} \ln\left(\frac{I^2 - I_p^2}{I^2 - (K \cdot I_b)^2}\right)$$

Legend:

t = Tripping delay

τ_{warm} = Warming-up time constant

τ_{cool} = Cooling time constant

I_b = Base current: Maximum permissible thermal continuous current.

K = Overload Factor: The maximum thermal limit is defined as $k \cdot I_b$, the product of the overload factor and the base current .

I = measured current (x ln)

I_p = Preload Current

Testing the threshold values

Apply the current you have based your mathematical calculation on.

Testing the trip delay

NOTICE The thermal capacity should be zero before the test is started. See »Measuring Values«.

For testing the trip delay, a timer is to be connected to the contact of the associated trip relay.

Apply the current you have based your mathematical calculation on. The timer is started as soon as the current is applied and it is stopped when the relay trips.

Successful test result

The calculated tripping time and the fallback ratio comply with the measured values. For permissible deviations/tolerances, please see Technical Data.

SOTF - Switch Onto Fault

SOTF

In case a faulty line is energized (e.g.: when an earthing switch is in the ON-Position), an instantaneous trip is required. The SOTF module is provided to generate a permissive signal for other protection functions such as overcurrents to accelerate their trips (via adaptive parameters). The SOTF condition is recognized according to the User's operation mode that can be based on:

- The breaker state (CB Pos);
- No current flowing ($I <$);
- Breaker state and no current flowing (CB Pos and $I <$);
- Breaker switched on manually (CB manually On); and/or
- An external trigger (Ex SOTF).

This protection module can initiate a high speed trip of the overcurrent protection modules.



This module issues a signal only (the module is not armed and does not issue a trip command).

In order to influence the trip settings of the overcurrent protection in case of switching onto a fault, the User has to assign the signal "SOTF.ENABLED" onto an Adaptive Parameter Set. Please refer to Parameter / Adaptive Parameter Sets sections. Within the Adaptive Parameter Set, the User has to modify the trip characteristic of the overcurrent protection according to the User's needs.

NOTICE

This Notice applies to protective devices that offer control functionality only! This protective element requires, that a switchgear (circuit breaker) is assigned to it. It is allowed only to assign switchgears (circuit breaker) to this protective element, whose measuring transformers provide measuring data to the protective device.

SOTF

name = SOTF

2 Please Refer To Diagram: Blockings
(Stages is not de-activated and no active blocking signals)

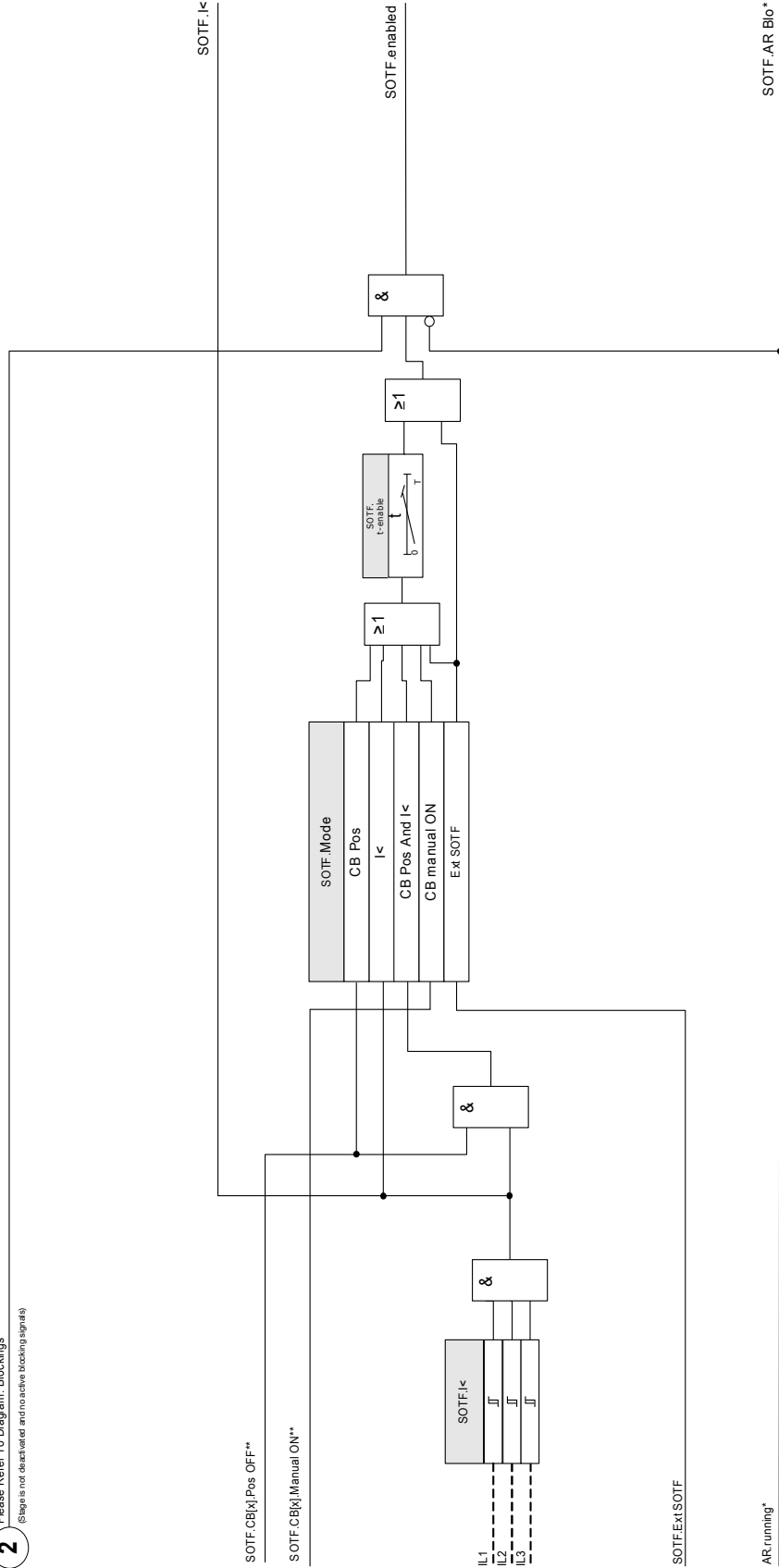

*Applies only for devices with Auto Reclosure

**This signal is the output of the switchgear that is assigned to this protective element. This applies to protective devices that offer control functionality.





Device Planning Parameters of the Switch Onto Fault Module

| <i>Parameter</i> | <i>Description</i> | <i>Options</i> | <i>Default</i> | <i>Menu path</i> |
|---|--------------------|--------------------|----------------|-------------------|
| Mode  | Mode | do not use, use | do not use | [Device planning] |

Global Protection Parameters of the Switch Onto Fault Module

| Parameter | Description | Setting range | Default | Menu path |
|---|--|---|---------|---|
| Mode  | Mode | CB Pos, I<, CB Pos And I<, CB manual ON, Ext SOTF | CB Pos | [Protection Para /Global Prot Para /SOTF] |
| ExBlo1  | External blocking of the module, if blocking is activated (allowed) within a parameter set and if the state of the assigned signal is true. | 1..n, Assignment List | -- | [Protection Para /Global Prot Para /SOTF] |
| ExBlo2  | External blocking of the module, if blocking is activated (allowed) within a parameter set and if the state of the assigned signal is true. | 1..n, Assignment List | -- | [Protection Para /Global Prot Para /SOTF] |
| Ex rev Interl  | External blocking of the module by external reverse interlocking, if blocking is activated (allowed) within a parameter set and if the state of the assigned signal is true. | 1..n, Assignment List | -- | [Protection Para /Global Prot Para /SOTF] |
| Assigned SG  | Assigned Switchgear Only available if: Mode = CB Pos Or CB Pos And I< | -, SG[1], SG[2], SG[3], SG[4], SG[5], SG[6] | SG[1] | [Protection Para /Global Prot Para /SOTF] |
| Ext SOTF  | External Switch Onto Fault Only available if: Mode = Ext SOTF | 1..n, DI-LogicList | -- | [Protection Para /Global Prot Para /SOTF] |

Setting Group Parameters of the Switch Onto Fault Module

| Parameter | Description | Setting range | Default | Menu path |
|---|---|---------------------|----------|---------------------------------------|
| Function  | Permanent activation or deactivation of module/stage. | inactive, active | inactive | [Protection Para /<1..4> /SOTF] |
| ExBlo Fc  | Activate (allow) or inactivate (disallow) blocking of the module/stage. This parameter is only effective if a signal is assigned to the corresponding global protection parameter. If the signal becomes true, those modules/stages are blocked that are parameterized "ExBlo Fc=active". | inactive, active | inactive | [Protection Para /<1..4> /SOTF] |
| Ex rev Interl Fc  | Activate (allow) or inactivate (disallow) blocking of the module/stage. This parameter is only effective if a signal is assigned to the corresponding global protection parameter. If the signal becomes true, those modules/stages are blocked that are parameterized "Ex rev Interl Fc = active". | inactive, active | inactive | [Protection Para /<1..4> /SOTF] |
| I<  | The CB is in the OFF Position, if the measured current is less than this parameter. | 0.01 - 1.00In | 0.01In | [Protection Para /<1..4> /SOTF] |
| t-enable  | While this timer is running, and while the module is not blocked, the Switch Onto Fault Module is effective (SOTF is armed). | 0.10 - 10.00s | 2s | [Protection Para /<1..4> /SOTF] |

Switch Onto Fault Module Input States

| <i>Name</i> | <i>Description</i> | <i>Assignment via</i> |
|-----------------|--|---|
| ExBlo1-I | Module input state: External blocking | [Protection Para /Global Prot Para /SOTF] |
| ExBlo2-I | Module input state: External blocking | [Protection Para /Global Prot Para /SOTF] |
| Ex rev Interl-I | Module input state: External reverse interlocking | [Protection Para /Global Prot Para /SOTF] |
| Ext SOTF-I | Module input state: External Switch Onto Fault Alarm | [Protection Para /Global Prot Para /SOTF] |

Signals of the Switch Onto Fault Module (Output States)

| <i>Signal</i> | <i>Description</i> |
|---------------|---|
| active | Signal: active |
| ExBlo | Signal: External Blocking |
| Ex rev Interl | Signal: External reverse Interlocking |
| enabled | Signal: Switch Onto Fault enabled. This Signal can be used to modify Overcurrent Protection Settings. |
| AR Blo | Signal: Blocked by AR |
| I< | Signal: No Load Current. |

Commissioning: Switch Onto Fault

Object to be tested

Testing the module *Switch Onto Fault* according to the parameterized operating mode:

- The breaker state (CB Pos);
- No current flowing ($I <$);
- Breaker state and no current flowing (CB Pos and $I <$);
- Breaker switched on manually (CB manually On); and/or
- An external trigger (Ex SOTF).

Necessary means:

- Three-phase current source (If the Enable-Mode depends on current);
- Ampere meters (May be needed if the Enable-Mode depends on current); and
- Timer.

Test Example for Mode CB manual ON

NOTICE

Mode $I <$: In order to test the effectiveness: Initially do not feed any current. Start the timer and feed with an abrupt change current that is distinctly greater than the $I <$ -threshold to the measuring inputs of the relay.

Mode $I <$ and Bkr state: Simultaneous switch on the breaker manually and feed with an abrupt change current that is distinctly greater than the $I <$ -threshold.

Mode Bkr state: The breaker has to be in the OFF Position. The signal „SOTF.ENABLED“=0 is untrue. If the breaker is switched on, the signal „SOTF.ENABLED“=1 becomes true as long as the timer t-enabled is running.

- The Circuit Breaker has to be in the OFF Position. There must be no load current.
- The Status Display of the device shows the signal „SOTF.ENABLED“=1.

Testing

- Switch the Circuit Breaker manually ON and start the timer at the same time.
- After the hold time t-enable is expired the state of the signal has to change to „SOTF.ENABLED“=0.
- Write down the measured time.

Successful test result

The measured total tripping delays or individual tripping delays, threshold values and fallback ratios correspond with those values, specified in the adjustment list. Permissible deviations/tolerances can be found under Technical Data.

CLPU - Cold Load Pickup

Available Elements:

CLPU

When the electric load is freshly started or restarted after a prolonged outage, the load current tends to have a temporary surge that could be several times the normal load current in magnitude due to motor starting. This phenomena is called cold load inrush. If the overcurrent pickup threshold is set according to the maximum possible load inrush, the overcurrent protection may be insensitive to some faults, thus making whole protection systems coordination difficult or even impossible. On the other hand, the overcurrent protection could trip on load inrush if it is set based on the fault current studies. The CLPU module is provided to generate a temporary blocking/desensitizing signal to prevent overcurrent protections from unwanted tripping. The cold load pickup function detects a warm-to-cold load transition according to the four selectable cold load detection modes:

- CB POS (Breaker state);
- I< (Undercurrent);
- CB POS AND I< (Breaker state and undercurrent); and
- CB POS OR I< (Breaker state OR undercurrent).

After a warm-to-cold load transition has been detected, a specified load-off timer will be started. This User-settable load-off timer is used in some cases to make sure that the load is really “cold” enough. After the load-off timer times out, the CLPU function issues an “enable” signal »CLPU.ENABLED« that can be used to block some sensitive protection elements like instantaneous overcurrent elements, current unbalance, or power protection elements at User’s choice. Using this enable signal, some time inverse overcurrent elements may also be desensitized at the User’s choice by means of activating adaptive settings of the corresponding overcurrent elements.

When a cold load condition is finished (a cold-to-warm load condition is detected) due to, for example, breaker closing or load current injection, a load inrush detector will be initiated that supervises the coming and going of the load inrush current process. A load inrush is detected if the coming load current exceeds a User-specified inrush current threshold. This load inrush is considered as finished if the load current is decreased to 90% of the inrush current threshold. After the inrush current is diminished, a settle timer starts. The cold load pickup enable signal can only be reset after the settle timer times out. Another max-Block timer, which is started parallel with the load inrush detector after a cold load condition is finished, may also terminate the CLPU enable signal if a load inrush condition is prolonged abnormally.

The cold load pickup function can be blocked manually by external or internal signal at the User’s choice. For the devices with Auto-Reclosing function, the CLPU function will be blocked automatically if auto-reclosure is initiated (AR is running).



This module issues a signal only (it is not armed).

In order to influence the tripping settings of the overcurrent protection, the User has to assign the signal “CLPU.ENABLED“ to an adaptive parameter set. Please refer to the Parameter / Adaptive Parameter Sets section. Within the adaptive parameter set, the User has to modify the tripping characteristic of the overcurrent protection according to the needs.

NOTICE

Please be aware of the meaning of the two delay timers.

t load Off (Pickup Delay): After this time expires, the load is no longer diversified.

t Max Block (Release Delay): After the starting condition is fulfilled (e.g.: breaker switched on manually), the "CLPU.enabled" signal will be issued for this time. That means for the duration of this time, the tripping thresholds of the overcurrent protection can be desensitized by means of adaptive parameters (please refer to the Parameters section). This timer will be stopped if the current falls below 0.9 times of the threshold of the load inrush detector and remains below 0.9 times of the threshold for the duration of the settle time.

NOTICE

This Notice applies to protective devices that offer control functionality only! This protective element requires, that a switchgear (circuit breaker) is assigned to it. It is allowed only to assign switchgears (circuit breaker) to this protective element, whose measuring transformers provide measuring data to the protective device.

CLPU
name = CLPU

2 Please Refer To Diagram: Blockings
(Stage is not deactived and no active blocking signals)

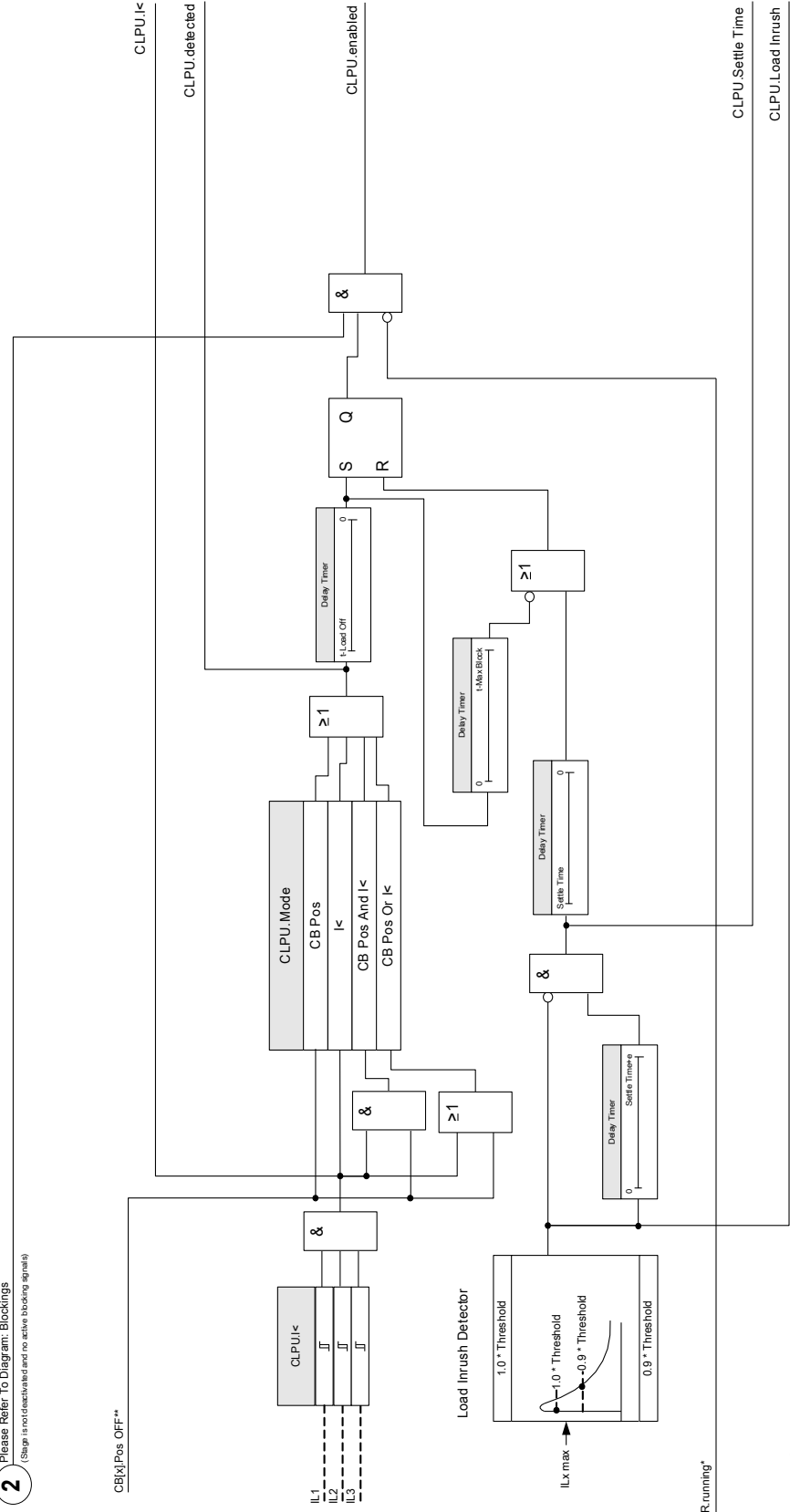

*Applies only for devices with Auto Reclosure

**This signal is the output of the switchgear that is assigned to this protective element. This applies to protective devices that offer control functionality.



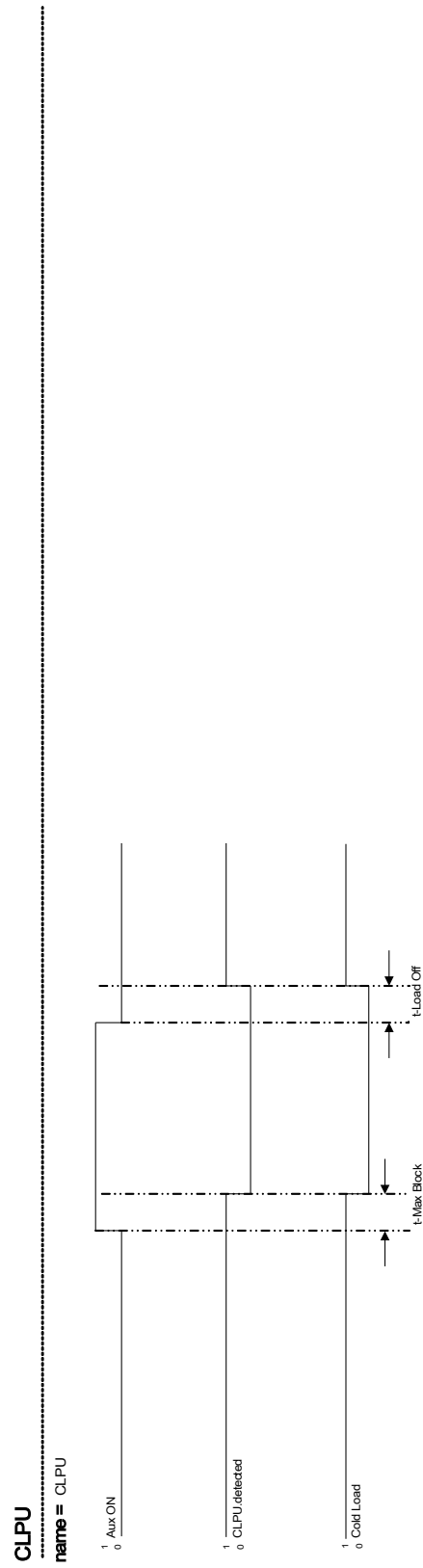

Example Mode: Breaker Position











Device Planning Parameters of the Cold Load Pickup Module

| Parameter | Description | Options | Default | Menu path |
|---|-------------|--------------------|------------|-------------------|
| Mode  | Mode | do not use, use | do not use | [Device planning] |

Global Protection Parameter of the Cold Load Pickup Module

| Parameter | Description | Setting range | Default | Menu path |
|--|--|--|-----------|---|
| Mode  | Mode | CB Pos, I<, CB Pos Or I<, CB Pos And I< | CB Pos | [Protection Para /Global Prot Para /CLPU] |
| ExBlo1  | External blocking of the module, if blocking is activated (allowed) within a parameter set and if the state of the assigned signal is true. | 1..n, Assignment List | -- | [Protection Para /Global Prot Para /CLPU] |
| ExBlo2  | External blocking of the module, if blocking is activated (allowed) within a parameter set and if the state of the assigned signal is true. | 1..n, Assignment List | -- | [Protection Para /Global Prot Para /CLPU] |
| Ex rev Interl  | External blocking of the module by external reverse interlocking, if blocking is activated (allowed) within a parameter set and if the state of the assigned signal is true. | 1..n, Assignment List | -- | [Protection Para /Global Prot Para /CLPU] |
| CB Pos Detect  | Criterion by which the Circuit Breaker Switch Position is to be detected. Only available if: CLPU.Mode = I< | --, SG[1].Pos, SG[2].Pos, SG[3].Pos, SG[4].Pos, SG[5].Pos, SG[6].Pos | SG[1].Pos | [Protection Para /Global Prot Para /CLPU] |

Set Parameters of the Cold Load Pickup Module

| Parameter | Description | Setting range | Default | Menu path |
|---|---|---------------------|----------|---------------------------------------|
| Function  | Permanent activation or deactivation of module/stage. | inactive, active | inactive | [Protection Para /<1..4> /CLPU] |
| ExBlo Fc  | Activate (allow) or inactivate (disallow) blocking of the module/stage. This parameter is only effective if a signal is assigned to the corresponding global protection parameter. If the signal becomes true, those modules/stages are blocked that are parameterized "ExBlo Fc=active". | inactive, active | inactive | [Protection Para /<1..4> /CLPU] |
| Ex rev Interl Fc  | Activate (allow) or inactivate (disallow) blocking of the module/stage. This parameter is only effective if a signal is assigned to the corresponding global protection parameter. If the signal becomes true, those modules/stages are blocked that are parameterized "Ex rev Interl Fc = active". | inactive, active | inactive | [Protection Para /<1..4> /CLPU] |
| t-Load Off  | Select the outage time required for a load to be considered cold. If the Pickup Timer (Delay) has run out, a Cold Load Signal will be issued. | 0.00 - 7200.00s | 1.00s | [Protection Para /<1..4> /CLPU] |
| t-Max Block  | Select the amount of time for the cold load inrush. If the Release Time (Delay) has run out, a Warm Load Signal will be issued. | 0.00 - 300.00s | 1.00s | [Protection Para /<1..4> /CLPU] |
| I<  | The CB is in the OFF Position, if the measured current is less than this parameter. | 0.01 - 1.00In | 0.01In | [Protection Para /<1..4> /CLPU] |
| Threshold  | Set the load current inrush threshold. | 0.10 - 4.00In | 1.2In | [Protection Para /<1..4> /CLPU] |
| Settle Time  | Select the time for the cold load inrush | 0.00 - 300.00s | 1.00s | [Protection Para /<1..4> /CLPU] |

States of the Inputs of the Cold Load Pickup Module

| <i>Name</i> | <i>Description</i> | <i>Assignment via</i> |
|----------------|---|---|
| ExBlo1-I | Module input state: External blocking | [Protection Para /Global Prot Para /CLPU] |
| ExBlo2-I | Module input state: External blocking | [Protection Para /Global Prot Para /CLPU] |
| Ex rev Inter-I | Module input state: External reverse interlocking | [Protection Para /Global Prot Para /CLPU] |

Signals of the Cold Load Pickup Module (States of the Outputs)

| <i>Signal</i> | <i>Description</i> |
|---------------|---------------------------------------|
| active | Signal: active |
| ExBlo | Signal: External Blocking |
| Ex rev Interl | Signal: External reverse Interlocking |
| enabled | Signal: Cold Load enabled |
| detected | Signal: Cold Load detected |
| AR Blo | Signal: Blocked by AR |
| I< | Signal: No Load Current. |
| Load Inrush | Signal: Load Inrush |
| Settle Time | Signal: Settle Time |

Commissioning of the Cold Load Pickup Module

Object to be tested:

Testing the *Cold Load Pickup* module according to the configured operating mode:

- I< (No current);
- Bkr state (Breaker position);
- I< (No Current) and Bkr state (Breaker position); and
- I< (No Current) or Bkr state (Breaker position).

Necessary means:

- Three-phase current source (if the Enable Mode depends on current);
- Ampere meters (may be needed if the Enable Mode depends on current); and
- Timer.

Test Example for Mode Bkr State (Breaker Position)

NOTICE

Mode I<: In order to test the tripping delay, start the timer and feed with an abrupt change current that is distinctly less than the I<-threshold. Measure the tripping delay. In order to measure the drop-out ratio, feed a current with an abrupt change that is distinctly above the I<-threshold.

Mode I< and Bkr state: Combine the abrupt change (switching the current ON and OFF) with the manual switching ON and OFF of the breaker.

Mode I< or Bkr state: Initially carry out the test with an abrupt changing current that is switched ON and OFF (above and below the I<-threshold). Measure the tripping times. Finally, carry out the test by manually switching the breaker ON and OFF.

- The breaker has to be in the OFF position. There must not be any load current.
- The Status Display of the device shows the signal "CLPU.ENABLED"=1.
- The Status Display of the device shows the signal "CLPU.I<"=1.
- Testing the tripping delay and the resetting ratio:*
- Switch the breaker manually ON and simultaneously start the timer.
- After the the »t Max Block (Release Delay)« timer has expired, the signal "CPLU.Enabled"=0 has to become untrue.
- Write down the measured time.
- Manually switch the breaker OFF and simultaneously start the timer.
- After the »t load Off« timer has expired, the signal "CPLU.ENABLED"=1 has to become true.
- Write down the measured time.

Successful test result:

The measured total tripping delays or individual tripping delays, threshold values, and drop-out ratios correspond with those values specified in the adjustment list. Permissible deviations/tolerances can be found in the Technical Data section.

AR - Automatic Reclosure [79]

AR

The autoreclosure is used to minimize outages on overhead lines. The majority¹ (>60% in medium voltage and >85% in high voltage) of faults (arc flash over) on overhead lines are temporary and can be cleared by means of the autoreclosure element.

NOTICE

Deproject the autoreclosure element within the device planning if the protective device is used in order to protect cables, generators or transformers.

Features

The autoreclose function is designed with diverse very comprehensive yet flexible features which meet all requirements of different utility concepts and technical applications.

The available features of the autoreclose function can be summarized as follows:

- Flexible assignment of initiate functions for individual shots.
- Maximum six autoreclose shots.
- Dynamic adjustment of protection setting values (e.g. pickup, time delay tripping curve etc.) during autoreclose process via adaptive set concept.
- Reclose shots per hour limit.
- Autorecloser wear monitor with maintenance alarm.
- Programmable reclosing blocking feature.
- Auto zone coordination with downstream reclosers.
- Automatic manual-breaker-close blocking feature.
- Manual/Auto reset lockout (panel, contact input, communications, etc)
- Autoreclose with Synchron-Check (only in conjunction with internal Sync-Check and Control modules).
- External AR shot counter increment is possible.
- Automatic autoreclose result evaluation (successful/unsuccessful).
- Separate counters to register total, successful/unsuccessful reclosing numbers.

1: VDE-Verlag: Schutztechnik in elektrischen Netzen 1, Page179, ISBN 3-8007-1753-0

The following table gives a folder (structure) overview:

| AR Menu Folder | Purpose |
|--|---|
| <p>AR</p> <p>Path: [Protection Para\Global Prot Para\AR]</p> | <p>Within this menu, external blockings, external lockings, external shot increments and external resets can be assigned. Those external events can only become effective, if they have been activated (allowed) within the General Settings. Please see table row below.</p> |
| <p>General Settings</p> <p>Path: [Protection Para\Set[x]\AR\General Settings]</p> | <p>Within this menu several general settings can be activated: The function itself, external blocking, zone coordination, external locking and external shot increment can be set to active. The corresponding trigger events (e.g. digital inputs) have to be assigned within the corresponding global protection parameters. Please see table row above.</p> <p>Furthermore, this menu contains some timers, the number of permitted reclosure attempts, the alarm mode (trip/alarm) and the reset mode can be set</p> |
| <p>Shot Manager</p> <p>Path: [Protection Para\Set[x]\AR\Shot Manager]</p> | <p>In Shot-manager setting menu the control logics between individual shots and protective functions will be specified. For each shot (inclusive the pre shot) the trigger (start) events can be assigned.</p> <p>For each shot, maximum 4 initiate functions (protective functions which are dedicated to start this shot) can be selected from an available protective function list.</p> <p>When the autoreclosure process is running in the shot X stage, the corresponding protection and control settings will be used to control the operation during this stage.</p> <p>In addition to that the dead times have to be set. For each shot, its dead time will be set individually, except for the shot 0, for which no dead timer setting is necessary. The shot 0 is just a virtual state to define the time before the first shot is to issue. Each dead timer specifies the time duration which has to be expired before the reclosure command for this shot can be issued.</p> |
| <p>Wear Monitor</p> <p>Path: [Protection Para\Set[x]\AR\Wear Monitor]</p> | <p>This setting group contains all parameters which monitor the wear and maintenance conditions related to the autoreclosure operations. The corresponding information and control can be useful for an optimal autoreclosure application.</p> |
| <p>Blo Fc</p> <p>Path: [Protection Para\Global Prot Para\AR\Blo Fc]</p> | <p>This group of settings specifies the protection functions by which the autoreclosure function must be blocked even if the autoreclosure function is already initiated.</p> <p>Note the difference between the protection function which can be blocked by auto-recloser and the function(s) here to block the auto-recloser.</p> |

AR States

The following diagram shows the state transitions between the various states of the autoreclosure function. This diagram visualizes the run time logic and timing sequence according to the state transition direction and the events which trigger the transitions.

State transition diagram

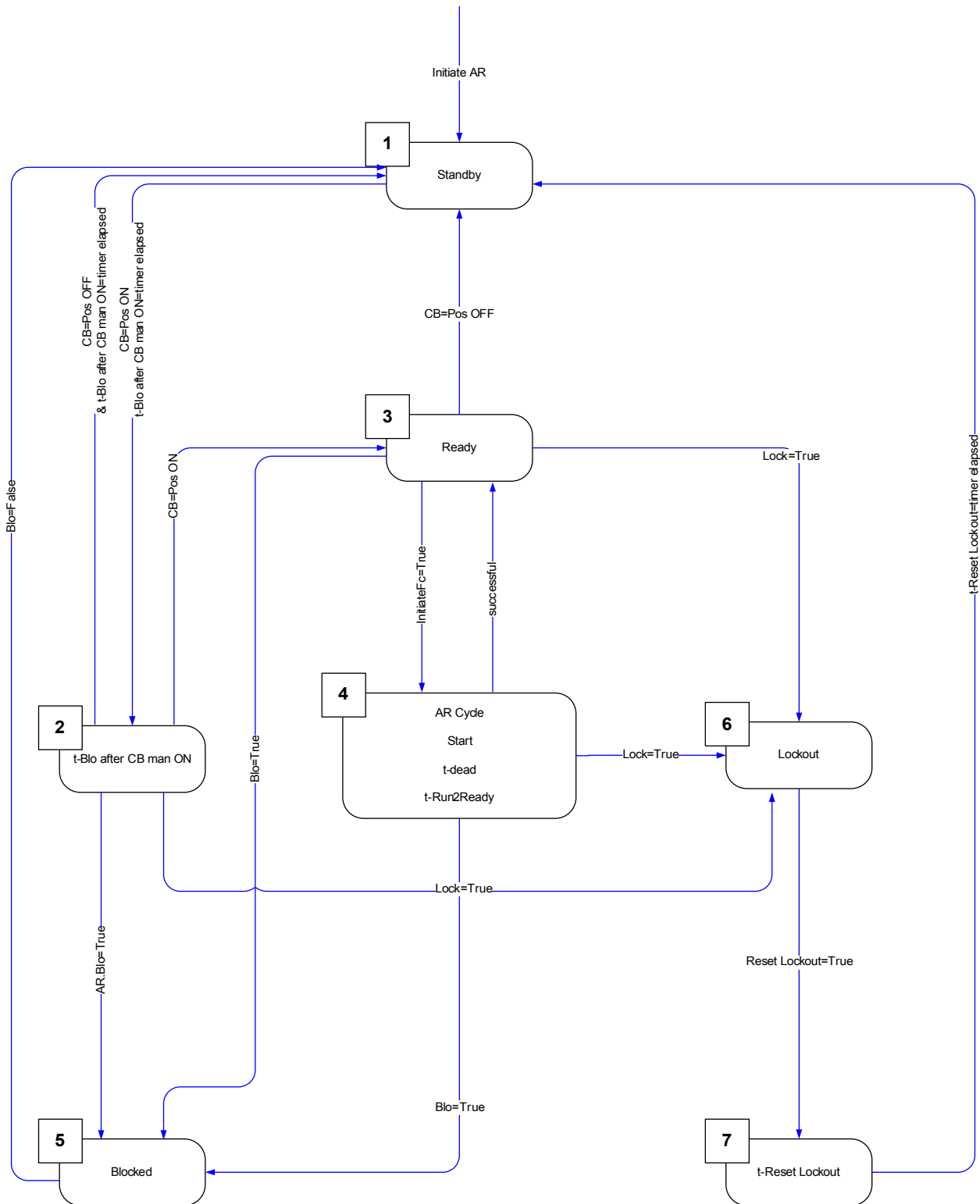

In general, the autoreclosure function is only active (will be initiated) when all of the following conditions are met:

- Autoreclosure function is enabled (In AR General Setting: Function =active)
 - The breaker (CB) is configured within the “AR/General Settings”.
 - Autoreclosure is not blocked by the blocking inputs (ExBlo1/2).
-

1 *Standby*

The autoreclosure is in this state when the following conditions are met:

- The breaker is in the open position.
- The autoreclose function is not initiated from any initiate (start) functions.
- No external or internal AR blocking signals are present.

NOTICE

No autoreclose shot operation is possible if the autoreclose function is within Standby state.

2 *t-manual close block*

Suppose that the breaker is open and the AR state is in Standby state. Then the breaker is closed manually. The event “CB Pos On” starts a Manual-Close-Blocking timer and results in a state transition from »STANDBY« to a transit state - »T-BLO AFTER CB MAN ON«. The autoreclosure function changes into the »READY« state only as the Manual-Close-Blocking timer elapses and the breaker is closed. By means of the manual close blocking timer a faulty starting of the autoreclose function in case of a Switch-OnTo-Fault condition is prevented.

3 *Ready*

An activated autoreclose function is considered to be in »READY« state when all of the following conditions are true:

- The breaker is in closed position.
- The Manual-Close-Block-timer elapses after a breaker manual/remote close operation.

- The autoreclose function is not initiated from any initiate (start) functions.
- No external or internal AR blocking signals are present.

NOTICE

An autoreclose start is only possible if the autoreclose function is in Ready state.

4 *Run (Cycle)*

The »RUN« state can only be reached if the following conditions are fulfilled:

- The autoreclose was in »READY« state before.
- The breaker was in closed position before.
- No external or internal AR Blocking signals exist.
- At least one of the assigned initiate functions is true (triggers the Autoreclosure).

NOTICE

A complete autoreclose process with multi-shot reclosing will be accomplished inside the Run state.

If the autoreclose gets into the »RUN« state, the autoreclose function transfers its control to a »RUN« state control automat with several subordinate states which will be described in detail in the next chapter (AR Cycle).

5 *Blocked*

An activated autoreclose function goes into the »BLOCKED« state when one of the assigned blocking function is true.

The autoreclose function exits the »BLOCKED« state if the assigned blocking signal is no longer present.

6 *Lockout*

An activated autoreclose function goes into the »LOCKOUT« state when one of the following conditions is true:

- An unsuccessful autoreclose is detected after all programmed autoreclose shots. The fault is of permanent nature.
- Reclose failure (incomplete sequence)
- Autoreclose rate per hour exceeds the limit
- Fault timer elapses (tripping time too long)
- Breaker failure during AR starting
- Manual breaker close operation during autoreclose process
- At least one protective function is still tripping before reclose command is issued

The autoreclose function exits the »LOCKOUT« state if the programmed lockout reset signal asserts and programmed Lockout Reset timer elapses.

NOTICE

A Service Alarm (Service Alarm 1 or Service Alarm 2) will not lead to a lockout of the AR function.

AR Cycle (Shot)

4 Run (Cycle)

The following drawing shows in detail an AR run cycle.

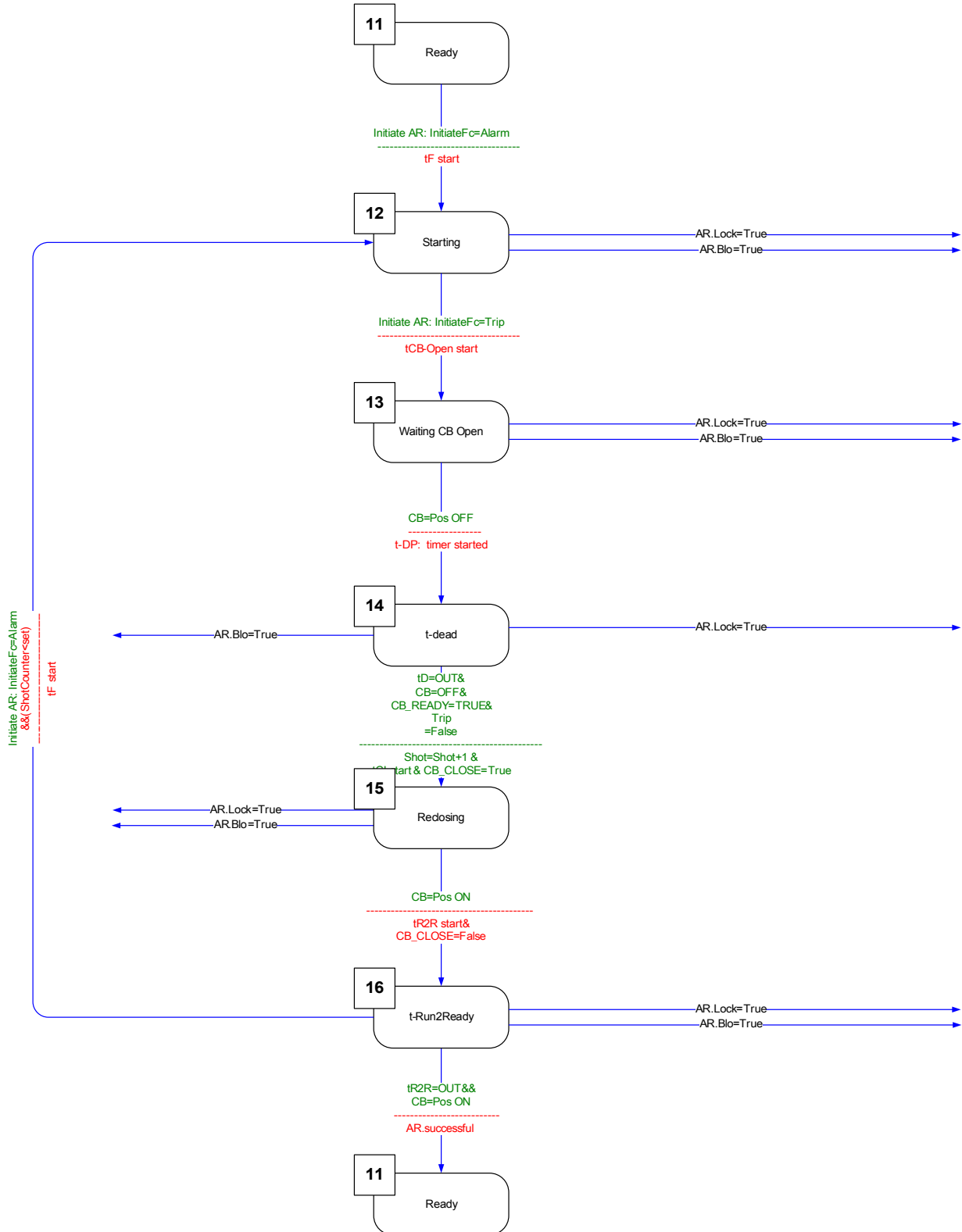

11 *Ready*

An activated autoreclose function is considered to be in »READY« state when all of the following conditions are true:

- The breaker is in closed position.
 - The Manual-Close-Block-timer elapses after a breaker manual/remote close operation.
 - The autoreclose function is not initiated from any initiate (start) functions.
 - No external or internal AR blocking signals are present.
-

12 *Run*

This is the first subordinate state after the autoreclosure process goes from »READY« into »RUN« state triggered from the first AR initiate event. During the »RUNNING« state, the autoreclosure element supervises the trip signal of the initiate function while a preset fault timer is timing. The autoreclosure element transfers to the »WAITING BKR OPEN« state by receiving the trip signal if the fault timer does NOT time out and there are no other blocking and lockout conditions.

13 *Waiting Bkr Open*

While in the »WAITING BKR OPEN« state, the autoreclosure supervises if the breaker is really tripped (open) after receiving the trip flag of the initiate protection function within a preset breaker supervision time (200ms). If this is the case, the autoreclosure starts the programmed dead timer and goes to the dead timing state »*t-dead*«.

14 *t-dead*

While in the dead timing state »*t-dead*«, the preset dead timer for current AR shot is timing and cannot be interrupted unless there are any blocking or lockout conditions coming.

After dead timer elapses, the autoreclosure issues the breaker reclosing command and goes into the next state: »RECLOSING«, only if the following conditions are met:

- The breaker is in open position,
 - The breaker is ready for next reclosing operation (if the CB Ready logic input is used)
 - No pickup from current (assigned) AR initiate function(s)
-

- No trip from current (assigned) AR initiate function(s)
- No general tripping command

Before issuing the breaker reclosing command, the current shot counter will be incremented. This is very important for the shot-controlled initiate and blocking functions.

Before entering into the »RECLOSING« state, the preset breaker reclosing supervision timer (»*t-Brk-ON-cmd*«) will be started, too.

15 *Reclosing*

If there is no other blocking or lockout conditions and the breaker is closed while the breaker reclosing supervision timer is timing, the autoreclosure starts the »*t-Run2Ready*« timer and goes into the state:

»T-RUN2READY«.

16 *t-Run2Ready*

Successful Autoreclosure:

While in »T-RUN2READY« state, if there is no other blocking or lockout conditions and no more faults detected within the »*t-Run2Ready*« timer, the autoreclosure logic will leave the »RUN« state and goes back to the »READY« state. The flag "successful" is set.

Unsuccessful Autoreclose:

If a fault is detected again (the shot-controlled initiate function is triggering) while »*t-Run2Ready*« timer is still timing, the autoreclosure control transfers to the »RUNNING« state again. For a permanent fault, the process described before will be repeated until all programmed shots were operated and the autoreclose process changes into the »LOCKOUT« state. The flag "failed" is set.

Timing Diagrams

Auto Reclosing timing diagram for *unsuccessful* 2-shot auto reclosing scheme with acceleration at pre-shot

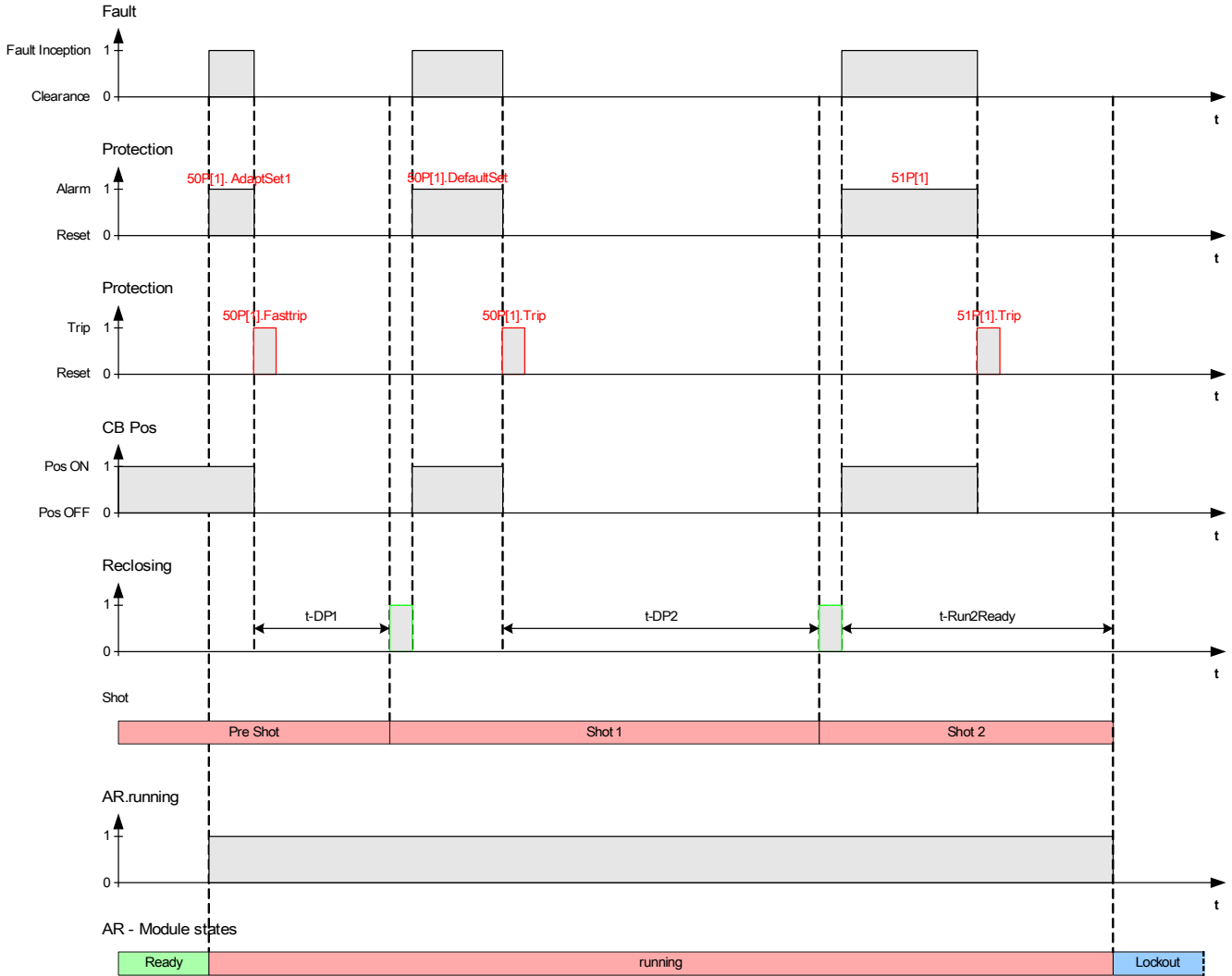

Auto Reclosing timing diagram for **successful** 2-shot auto reclosing scheme with acceleration at pre-shot

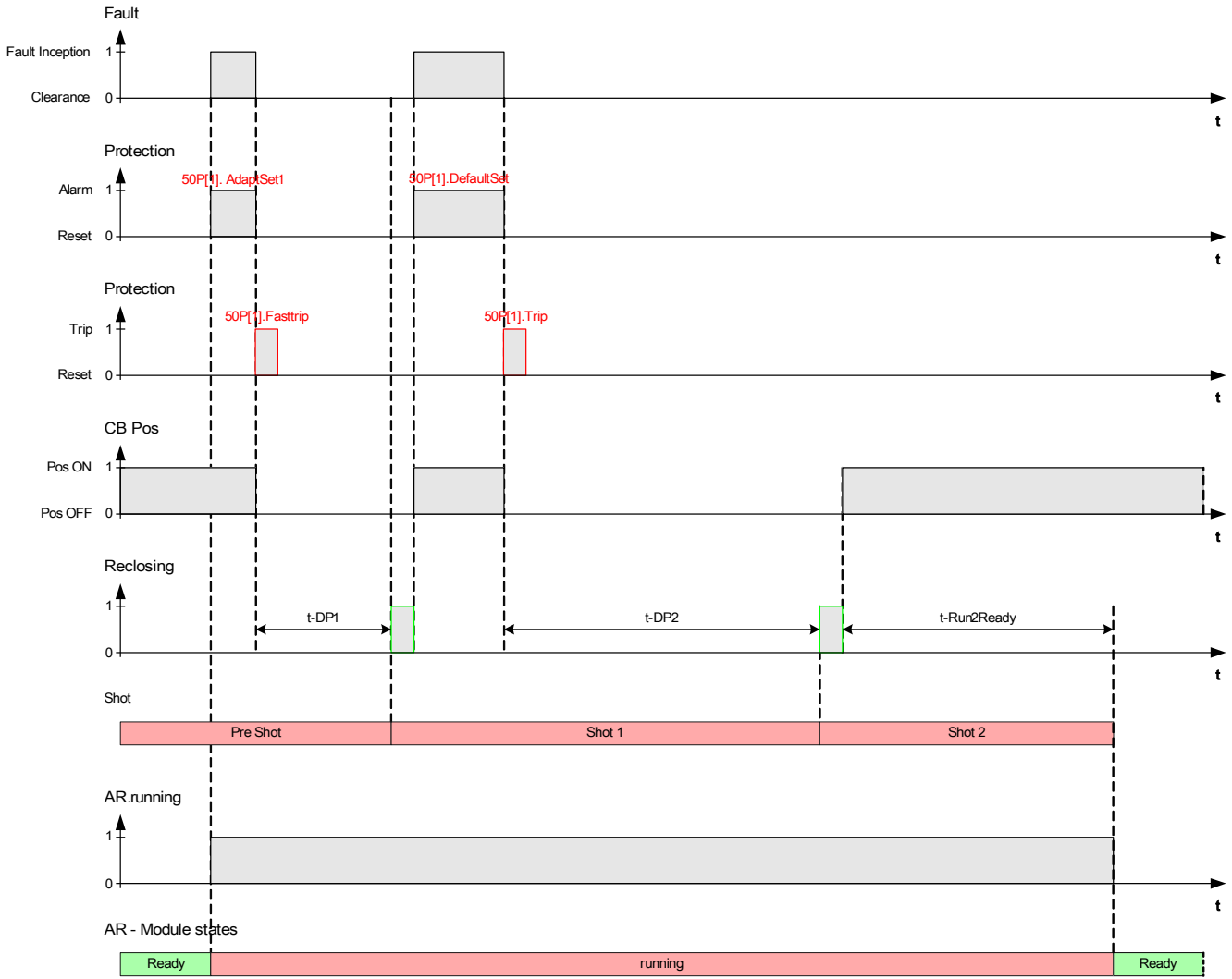

Auto Reclosing States during manual breaker closing

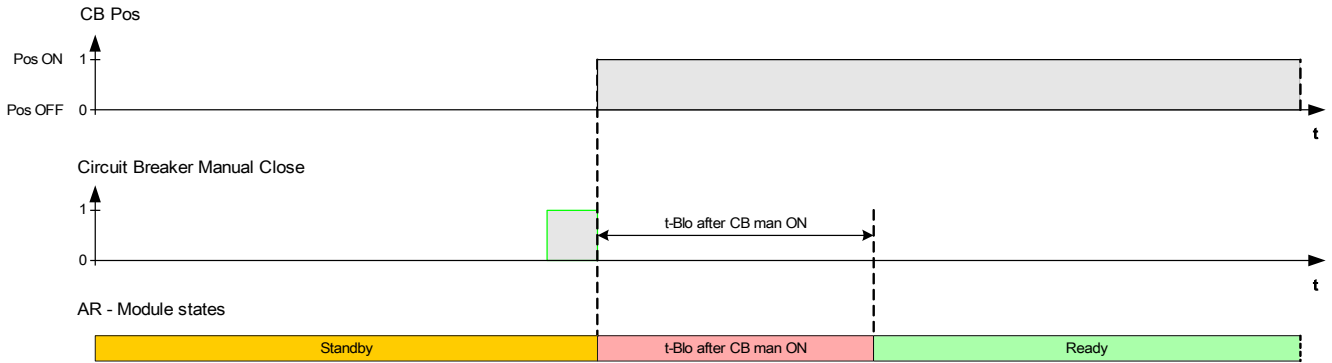

Protection Trip while Manual Close Blocking time is Timing

What happens if while the timer manual close block time is timing down the protective device gets a trip signal?

While the timer manual close block time is timing, any trip during this time period trips the breaker. The manual close block timer doesn't care about that and timing further until it times out.

After it times out, the AR-module looks at the breaker status again, and sees that the breaker is open. The AR goes to the »STANDBY« state, no autoreclose is possible (Note: The AR doesn't go to »LOCKOUT« state!)

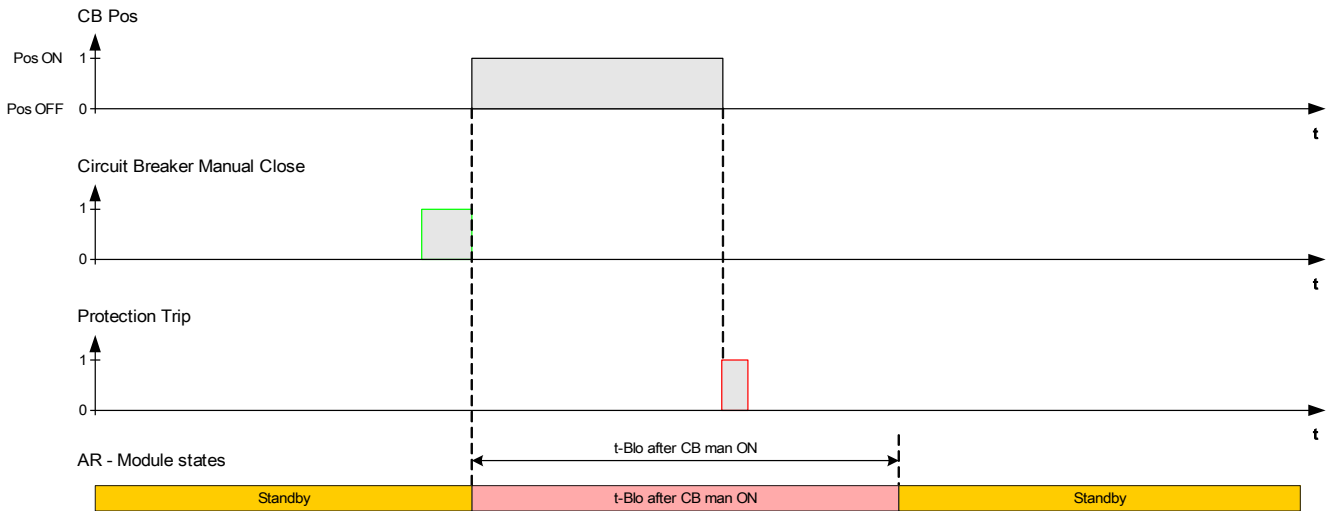

AR Lockout Reset Logic in case lockout Reset coming before manual breaker closed

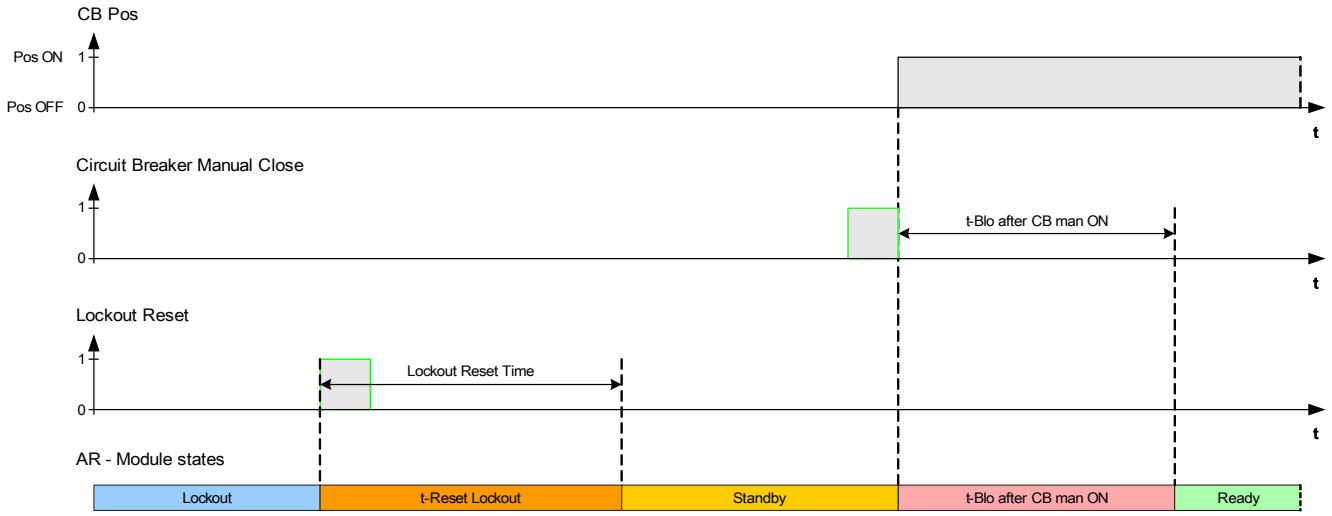

AR Lockout Reset Logic in case lockout Reset coming after manual breaker closed

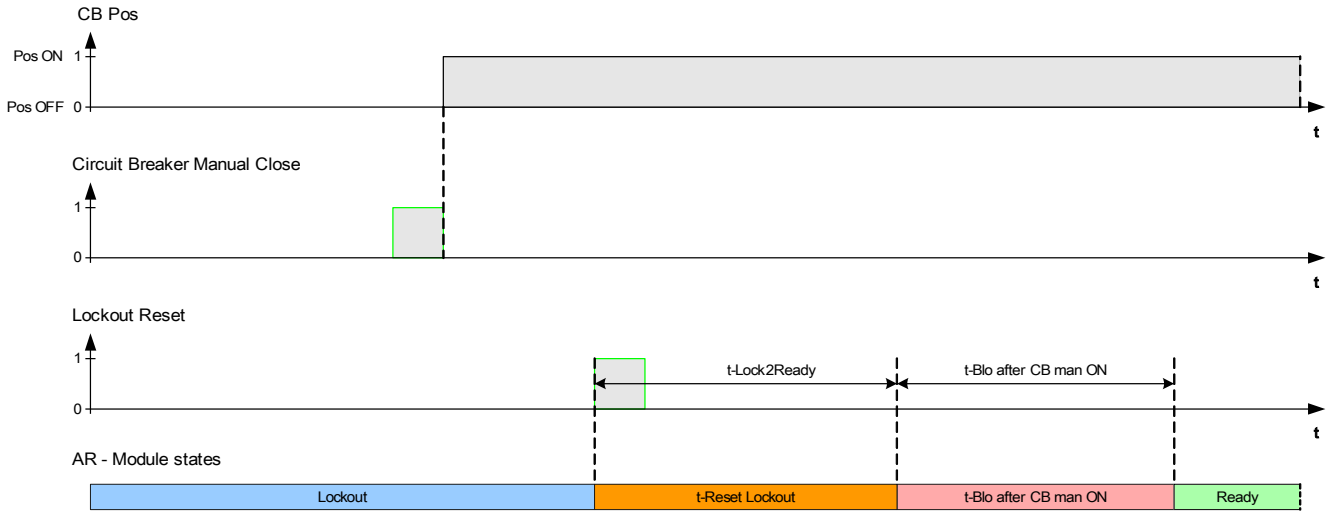

Zone Coordination

General Description

What does Zone Coordination mean?

Zone Coordination means, that the upstream protection device is doing a virtual autoreclosure while the downstream protective device is doing a “real” autoreclosure. By means of the zone coordination selectivity can be kept, even if a downstream protective device changes its tripping characteristic after a reclosure cycle. The virtual autoreclosure of the upstream device follows the downstream autoreclosure.

What application can be realized by means of Zone Coordination?

A radial distribution system is protected by an upstream protective device (with a circuit breaker) and a downstream protective device with a reclosure and fuse. By means of the zone coordination a “fuse saving scheme” might be realised. In order to “save fuses” the downstream protective device might trip for the first reclosure attempt at low tripping values (undergrade the fuse, trying to avoid a damaging of the fuse). If the reclosure attempt fails the tripping values might be risen (overgrade the fuse) for the second reclosure attempt (using higher tripping values/characteristics).

What is essential?

The triggering thresholds of the upstream and the downstream devices have to be the same but the tripping times have to be selectively.

How is Zone Coordination activated?

The zone coordination function is part of the autoreclosure element and it can be enabled by setting the parameter »Zone coordination« as »active« within the menu [Protection Para/AR/General Settings] for an upstream feeder protection device.

How does the Zone Coordination work (within the upstream protection device)?



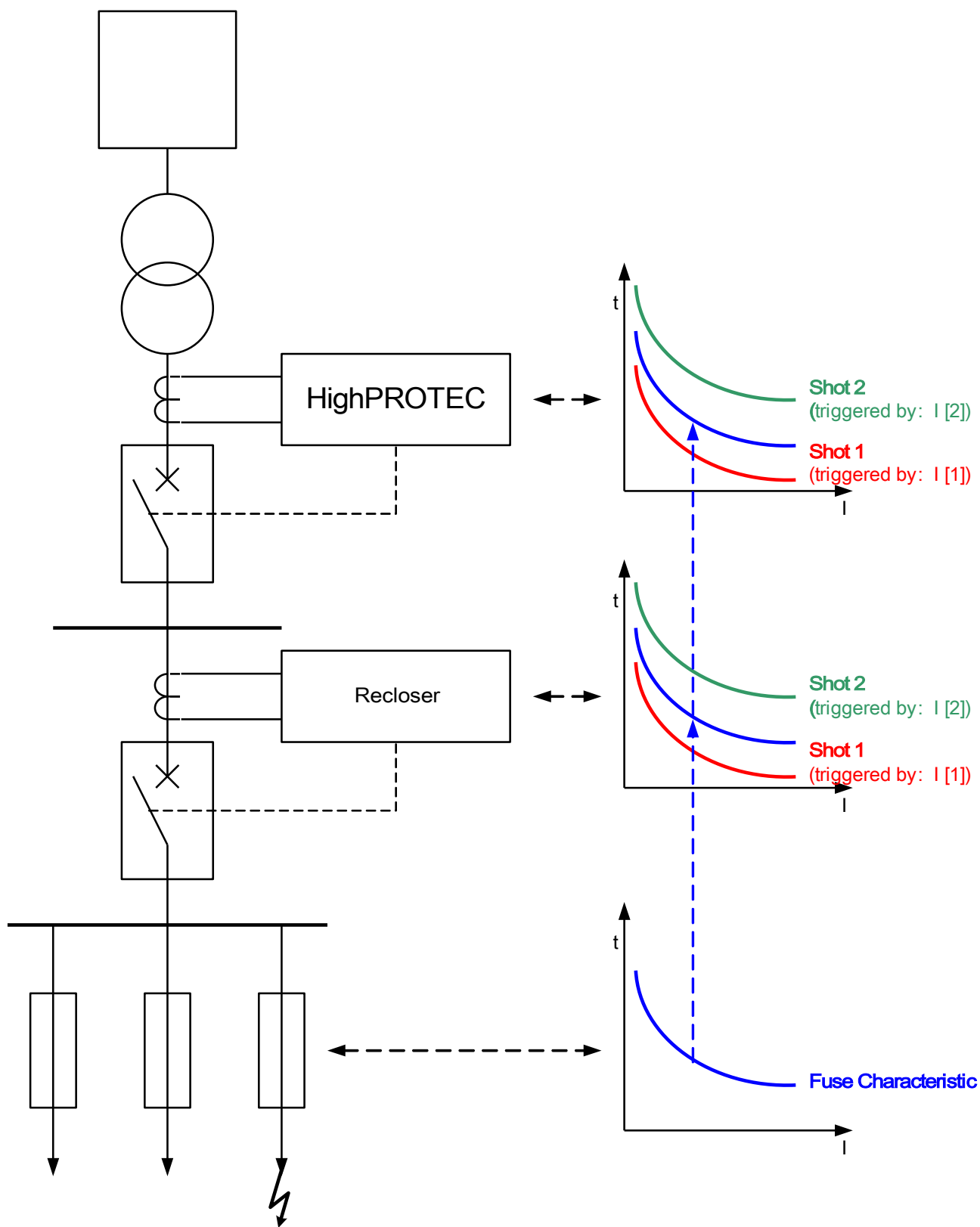

When the zone coordination function is enabled, it works similar to a normal autoreclose function with the same setting parameters: maximum reclosure attempts, dead timer for each shot, initiate functions for each shot and other timers for autoreclose process, but with the following zone coordination features to coordinate with the downstream reclosers:

- The corresponding dead timer for each shot will be started even the breaker of the upstream feeder relay is NOT tripped from the assigned initiate protective functions.
- The dead timer begins timing once the autoreclose senses a drawback of the assigned overcurrent protection pickup signal. This exhibits that the fault current was tripped by the downstream recloser opening.
- The shot counter of an enabled zone coordination will be incremented after the dead timer elapses, even there is no breaker reclosing command issued and meanwhile the »T-RUN2READY« timer is started.
- If a permanent fault exists after the downstream recloser is reclosed, the fault current makes the upstream overcurrent protection picks up again, but with the pickup thresholds or operating curves controlled by the incremented shot number. In this way, the upstream feeder will “follow” the protective settings of downstream recloser shot by shot.

- For a transient fault the autoreclose with zone coordination will not be initiated again because of absence of the fault current and will be reset normally after the expiration of the reset timer » *t-Run2Ready*«.









Direct Commands of the Automatic Reclosure Module

| <i>Parameter</i> | <i>Description</i> | <i>Setting range</i> | <i>Default</i> | <i>Menu path</i> |
|---|--|----------------------|----------------|-----------------------|
| Res TotNo suc unsuc  | Reset all statistic AR counters: Total number of AR, successful and unsuccessful no of AR. | inactive, active | inactive | [Operation /Reset] |
| Res Service Cr  | Reset the Service Counters | inactive, active | inactive | [Operation /Reset] |
| Reset Lock via HMI  | Reset the AR Lockout via the panel. | inactive, active | inactive | [Operation /Reset] |
| Res Max Shots / h Cr  | Resetting the Counter for the maximum allowed shots per hour. | inactive, active | inactive | [Operation /Reset] |







Device Planning Parameters of the Module Automatic Reclosure

| <i>Parameter</i> | <i>Description</i> | <i>Options</i> | <i>Default</i> | <i>Menu path</i> |
|---|--------------------|--------------------|----------------|-------------------|
| Mode  | Mode | do not use, use | do not use | [Device planning] |







Global Protection Parameters of the Module Automatic Reclosure

| Parameter | Description | Setting range | Default | Menu path |
|--|---|---|---------|--|
|  CB | Circuit Breaker Module | -.-, SG[1]., SG[2]., SG[3]., SG[4]., SG[5]., SG[6]. | SG[1]. | [Protection Para /Global Prot Para /AR /General settings] |
|  ExBlo1 | External blocking of the module, if blocking is activated (allowed) within a parameter set and if the state of the assigned signal is true. | 1..n, Assignment List | -.- | [Protection Para /Global Prot Para /AR /General settings] |
|  ExBlo2 | External blocking of the module, if blocking is activated (allowed) within a parameter set and if the state of the assigned signal is true. | 1..n, Assignment List | -.- | [Protection Para /Global Prot Para /AR /General settings] |
|  Ex Shot Inc | The AR Shot counter will be incremented by this external Signal. This can be used for Zone Coordination (of upstream Auto Reclosure devices). | 1..n, DI-LogicList | -.- | [Protection Para /Global Prot Para /AR /General settings] |
|  Ex Lock | The auto reclosure will be locked out by this external Signal (set into the lockout state). | 1..n, DI-LogicList | -.- | [Protection Para /Global Prot Para /AR /General settings] |
|  DI Reset Ex Lock | The Lockout State of the AR can be reset by a digital input. | 1..n, DI-LogicList | -.- | [Protection Para /Global Prot Para /AR /General settings] |
|  Scada Reset Ex Lock | The Lockout State of the AR can be reset by Scada. | Communication Commands | -.- | [Protection Para /Global Prot Para /AR /General settings] |

Setting Group Parameters of the Module Automatic Reclosure

| Parameter | Description | Setting range | Default | Menu path |
|--|---|--|----------|--|
|  Function | Permanent activation or deactivation of module/stage. | inactive, active | inactive | [Protection Para /<1..4> /AR /General settings] |
|  ExBlo Fc | Activate (allow) or inactivate (disallow) blocking of the module/stage. This parameter is only effective if a signal is assigned to the corresponding global protection parameter. If the signal becomes true, those modules/stages are blocked that are parameterized "ExBlo Fc=active". | inactive, active | inactive | [Protection Para /<1..4> /AR /General settings] |
|  Zone coordination | Zone coordination: Sequence coordination is to keep upstream reclosers in step with the downstream ones for fast and delay curve operation, thus avoiding overtripping. | inactive, active | inactive | [Protection Para /<1..4> /AR /General settings] |
|  Ex Shot Inc Fc | The AR Shot counter will be incremented by this external Signal. This can be used for Zone Coordination (of upstream Auto Reclosure devices). Note: This parameter enables the functionality only. The assignment has to be set within the global parameters. | inactive, active | inactive | [Protection Para /<1..4> /AR /General settings] |
|  Ex Lock Fc | The auto reclosure will be locked out by this external Signal. Note: This parameter enables the functionality only. The assignment has to be set within the global parameters. | inactive, active | inactive | [Protection Para /<1..4> /AR /General settings] |
|  Reset Mode | Reset Mode | auto, HMI, DI, Scada, HMI And Scada, HMI And DI, Scada And DI, HMI And DI | auto | [Protection Para /<1..4> /AR /General settings] |
|  Shots | Maximum number of permitted reclosure attempts. | 1 - 6 | 1 | [Protection Para /<1..4> /AR /General settings] |







Protective Elements

| Parameter | Description | Setting range | Default | Menu path |
|--|---|-------------------|---------|---|
|  Initiate Mode | Initiate Mode | Alarm, TripCmd | Alarm | [Protection Para /<1..4> /AR /General settings] |
|  t-start | <p>Start timer - While the start timer runs down, an AR attempt can be started. Only if the trip command is given within the start time/duration an AR attempt could be started. The location and the resistance of the fault have a big influence on the tripping time. The start time has an impact on whether an AR attempt should be started when the fault is far away or high resistance.</p> <p>Only available if: Initiate Mode = TripCmd</p> | 0.01 - 9999.00s | 1s | [Protection Para /<1..4> /AR /General settings] |
|  t-DP1 | <p>Dead time between trip and reclosure attempt for phase faults.</p> <p>Only available if: Shots = 1-6</p> | 0.01 - 9999.00s | 1s | [Protection Para /<1..4> /AR /Shot Manager /Shot Ctrl1] |
|  t-DP2 | <p>Dead time between trip and reclosure attempt for phase faults.</p> <p>Only available if: Shots = 2-6</p> | 0.01 - 9999.00s | 1s | [Protection Para /<1..4> /AR /Shot Manager /Shot Ctrl2] |
|  t-DP3 | <p>Dead time between trip and reclosure attempt for phase faults.</p> <p>Only available if: Shots = 3-6</p> | 0.01 - 9999.00s | 1s | [Protection Para /<1..4> /AR /Shot Manager /Shot Ctrl3] |
|  t-DP4 | <p>Dead time between trip and reclosure attempt for phase faults.</p> <p>Only available if: Shots = 4-6</p> | 0.1 - 9999.00s | 1s | [Protection Para /<1..4> /AR /Shot Manager /Shot Ctrl4] |
|  t-DP5 | <p>Dead time between trip and reclosure attempt for phase faults.</p> <p>Only available if: Shots = 5-6</p> | 0.01 - 9999.00s | 1s | [Protection Para /<1..4> /AR /Shot Manager /Shot Ctrl5] |

Protective Elements

| Parameter | Description | Setting range | Default | Menu path |
|--|--|-----------------|---------|---|
| t-DP6  | Dead time between trip and reclosure attempt for phase faults. Only available if: Shots = 6 | 0.01 - 9999.00s | 1s | [Protection Para /<1..4> /AR /Shot Manager /Shot Ctrl6] |
| t-DE1  | Dead time between trip and reclosure attempt for earth faults Only available if: Shots = 1-6 | 0.01 - 9999.00s | 1s | [Protection Para /<1..4> /AR /Shot Manager /Shot Ctrl1] |
| t-DE2  | Dead time between trip and reclosure attempt for earth faults Only available if: Shots = 2-6 | 0.01 - 9999.00s | 1s | [Protection Para /<1..4> /AR /Shot Manager /Shot Ctrl2] |
| t-DE3  | Dead time between trip and reclosure attempt for earth faults Only available if: Shots = 3-6 | 0.01 - 9999.00s | 1s | [Protection Para /<1..4> /AR /Shot Manager /Shot Ctrl3] |
| t-DE4  | Dead time between trip and reclosure attempt for earth faults Only available if: Shots = 4-6 | 0.01 - 9999.00s | 1s | [Protection Para /<1..4> /AR /Shot Manager /Shot Ctrl4] |
| t-DE5  | Dead time between trip and reclosure attempt for earth faults Only available if: Shots = 5-6 | 0.01 - 9999.00s | 1s | [Protection Para /<1..4> /AR /Shot Manager /Shot Ctrl5] |
| t-DE6  | Dead time between trip and reclosure attempt for earth faults Only available if: Shots = 6 | 0.01 - 9999.00s | 1s | [Protection Para /<1..4> /AR /Shot Manager /Shot Ctrl6] |
| t-Blo after CB man ON  | This timer will be started if the circuit breaker was switched on manually. While this timer is running, AR cannot be started. | 0.01 - 9999.00s | 10.0s | [Protection Para /<1..4> /AR /General settings] |

Protective Elements

| Parameter | Description | Setting range | Default | Menu path |
|--|---|-----------------|---------|---|
| t-Lock2Ready  | This timer is started by the lockout reset signal, and before the timer expire the AR cannot go to any other state. | 0.01 - 9999.00s | 10.0s | [Protection Para <1..4> /AR /General settings] |
| t-Run2Ready  | Examination Time: If the Circuit Breaker remains after an reclosure attempt for the duration of this timer in the Closed position, the AR has been successful and the AR module returns into the ready state. | 0.01 - 9999.00s | 10.0s | [Protection Para <1..4> /AR /General settings] |
| t-Blk2Ready  | The release (de-blocking) of the AR will be delayed for this time, if there is no blocking signal anymore. | 0.01 - 9999.00s | 10.0s | [Protection Para <1..4> /AR /General settings] |
| t-AR Supervision  | AR Overall supervision time (> sum of all the timers used by AR) | 1.00 - 9999.00s | 100.0s | [Protection Para <1..4> /AR /General settings] |
| Service Alarm 1  | As soon as the AR-Counter exceeds this number of reclosure attempts an alarm will be given out (overhauling of the CB) | 1 - 65535 | 1000 | [Protection Para <1..4> /AR /Wear Monitor] |
| Service Alarm 2  | Too many auto reclosure attempts. If the parameterized number of AR cycles is reached, an alarm will be given out. | 1 - 65535 | 65535 | [Protection Para <1..4> /AR /Wear Monitor] |
| Max AR/h  | Maximum Number of permitted Auto Reclosure Cycles per hour. | 1 - 20 | 10 | [Protection Para <1..4> /AR /Wear Monitor] |
| Initiate AR: InitiateFc1  | Initiate Auto Reclosure : Initiate Function | Start fct | - | [Protection Para <1..4> /AR /Shot Manager /Pre Shot Ctrl] |
| Initiate AR: InitiateFc2  | Initiate Auto Reclosure : Initiate Function | Start fct | - | [Protection Para <1..4> /AR /Shot Manager /Pre Shot Ctrl] |

Protective Elements

| Parameter | Description | Setting range | Default | Menu path |
|---|---|---------------|---------|--|
| Initiate AR: InitiateFc3  | Initiate Auto Reclosure : Initiate Function | Start fct | - | [Protection Para /<1..4> /AR /Shot Manager /Pre Shot Ctrl] |
| Initiate AR: InitiateFc4  | Initiate Auto Reclosure : Initiate Function | Start fct | - | [Protection Para /<1..4> /AR /Shot Manager /Pre Shot Ctrl] |
| Shot 1: InitiateFc1  | Automatic Reclosure Attempt : Initiate Function Only available if: Shots = 1-6 | Start fct | - | [Protection Para /<1..4> /AR /Shot Manager /Shot Ctrl1] |
| Shot 1: InitiateFc2  | Automatic Reclosure Attempt : Initiate Function Only available if: Shots = 1-6 | Start fct | - | [Protection Para /<1..4> /AR /Shot Manager /Shot Ctrl1] |
| Shot 1: InitiateFc3  | Automatic Reclosure Attempt : Initiate Function Only available if: Shots = 1-6 | Start fct | - | [Protection Para /<1..4> /AR /Shot Manager /Shot Ctrl1] |
| Shot 1: InitiateFc4  | Automatic Reclosure Attempt : Initiate Function Only available if: Shots = 1-6 | Start fct | - | [Protection Para /<1..4> /AR /Shot Manager /Shot Ctrl1] |
| Shot 2: InitiateFc1  | Automatic Reclosure Attempt : Initiate Function Only available if: Shots = 2-6 | Start fct | - | [Protection Para /<1..4> /AR /Shot Manager /Shot Ctrl2] |





Protective Elements

| Parameter | Description | Setting range | Default | Menu path |
|--|---|---------------|---------|---|
| Shot 2: InitiateFc2  | Automatic Reclosure Attempt : Initiate Function Only available if: Shots = 2-6 | Start fct | - | [Protection Para /<1..4> /AR /Shot Manager /Shot Ctrl2] |
| Shot 2: InitiateFc3  | Automatic Reclosure Attempt : Initiate Function Only available if: Shots = 2-6 | Start fct | - | [Protection Para /<1..4> /AR /Shot Manager /Shot Ctrl2] |
| Shot 2: InitiateFc4  | Automatic Reclosure Attempt : Initiate Function Only available if: Shots = 2-6 | Start fct | - | [Protection Para /<1..4> /AR /Shot Manager /Shot Ctrl2] |
| Shot 3: InitiateFc1  | Automatic Reclosure Attempt : Initiate Function Only available if: Shots = 3-6 | Start fct | - | [Protection Para /<1..4> /AR /Shot Manager /Shot Ctrl3] |
| Shot 3: InitiateFc2  | Automatic Reclosure Attempt : Initiate Function Only available if: Shots = 3-6 | Start fct | - | [Protection Para /<1..4> /AR /Shot Manager /Shot Ctrl3] |
| Shot 3: InitiateFc3  | Automatic Reclosure Attempt : Initiate Function Only available if: Shots = 3-6 | Start fct | - | [Protection Para /<1..4> /AR /Shot Manager /Shot Ctrl3] |
| Shot 3: InitiateFc4  | Automatic Reclosure Attempt : Initiate Function Only available if: Shots = 3-6 | Start fct | - | [Protection Para /<1..4> /AR /Shot Manager /Shot Ctrl3] |

Protective Elements

| Parameter | Description | Setting range | Default | Menu path |
|--|---|---------------|---------|---|
| Shot 4: InitiateFc1  | Automatic Reclosure Attempt : Initiate Function Only available if: Shots = 4-6 | Start fct | - | [Protection Para /<1..4> /AR /Shot Manager /Shot Ctrl4] |
| Shot 4: InitiateFc2  | Automatic Reclosure Attempt : Initiate Function Only available if: Shots = 4-6 | Start fct | - | [Protection Para /<1..4> /AR /Shot Manager /Shot Ctrl4] |
| Shot 4: InitiateFc3  | Automatic Reclosure Attempt : Initiate Function Only available if: Shots = 4-6 | Start fct | - | [Protection Para /<1..4> /AR /Shot Manager /Shot Ctrl4] |
| Shot 4: InitiateFc4  | Automatic Reclosure Attempt : Initiate Function Only available if: Shots = 4-6 | Start fct | - | [Protection Para /<1..4> /AR /Shot Manager /Shot Ctrl4] |
| Shot 5: InitiateFc1  | Automatic Reclosure Attempt : Initiate Function Only available if: Shots = 5-6 | Start fct | - | [Protection Para /<1..4> /AR /Shot Manager /Shot Ctrl5] |
| Shot 5: InitiateFc2  | Automatic Reclosure Attempt : Initiate Function Only available if: Shots = 5-6 | Start fct | - | [Protection Para /<1..4> /AR /Shot Manager /Shot Ctrl5] |
| Shot 5: InitiateFc3  | Automatic Reclosure Attempt : Initiate Function Only available if: Shots = 5-6 | Start fct | - | [Protection Para /<1..4> /AR /Shot Manager /Shot Ctrl5] |

Protective Elements

| <i>Parameter</i> | <i>Description</i> | <i>Setting range</i> | <i>Default</i> | <i>Menu path</i> |
|--|---|----------------------|----------------|---|
| Shot 5: InitiateFc4  | Automatic Reclosure Attempt : Initiate Function Only available if: Shots = 5-6 | Start fct | - | [Protection Para /<1..4> /AR /Shot Manager /Shot Ctrl5] |
| Shot 6: InitiateFc1  | Automatic Reclosure Attempt : Initiate Function Only available if: Shots = 6 | Start fct | - | [Protection Para /<1..4> /AR /Shot Manager /Shot Ctrl6] |
| Shot 6: InitiateFc2  | Automatic Reclosure Attempt : Initiate Function Only available if: Shots = 6 | Start fct | - | [Protection Para /<1..4> /AR /Shot Manager /Shot Ctrl6] |
| Shot 6: InitiateFc3  | Automatic Reclosure Attempt : Initiate Function Only available if: Shots = 6 | Start fct | - | [Protection Para /<1..4> /AR /Shot Manager /Shot Ctrl6] |
| Shot 6: InitiateFc4  | Automatic Reclosure Attempt : Initiate Function Only available if: Shots = 6 | Start fct | - | [Protection Para /<1..4> /AR /Shot Manager /Shot Ctrl6] |

Module Automatic Reclosure Input States

| <i>Name</i> | <i>Description</i> | <i>Assignment via</i> |
|-----------------------|---|--|
| ExBlo1-I | Module input state: External blocking1 | [Protection Para /Global Prot Para /AR /General settings] |
| ExBlo2-I | Module input state: External blocking2 | [Protection Para /Global Prot Para /AR /General settings] |
| Ex Shot Inc-I | Module input state: The AR Shot counter will be incremented by this external Signal. This can be used for Zone Coordination (of upstream Auto Reclosure devices). Note: This parameter enables the functionality only. The assignment has to be set within the global parameters. | [Protection Para /Global Prot Para /AR /General settings] |
| Ex Lock-I | Module input state: External AR lockout. | [Protection Para /Global Prot Para /AR /General settings] |
| DI Reset Ex Lock-I | Module input state: Resetting the lockout state of the AR (if the resetting via digital inputs has been selected). | [Protection Para /Global Prot Para /AR /General settings] |
| Scada Reset Ex Lock-I | Module input state: Resetting the Lockout State of the AR by Communication. | [Protection Para /Global Prot Para /AR /General settings] |





Module Automatic Reclosure Signals (Output States)

| <i>Signal</i> | <i>Description</i> |
|------------------------|--|
| active | Signal: active |
| ExBlo | Signal: External Blocking |
| Standby | Signal: Standby |
| t-Blo after CB man ON | Signal: AR blocked after circuit breaker was switched on manually. This timer will be started if the circuit breaker was switched on manually. While this timer is running, AR cannot be started. |
| Ready | Signal: Ready to shoot |
| running | Signal: Auto Reclosing running |
| t-dead | Signal: Dead time between trip and reclosure attempt |
| CB ON Cmd | Signal: CB switch ON Command |
| t-Run2Ready | Signal: Examination Time: If the Circuit Breaker remains after a reclosure attempt for the duration of this timer in the Closed position, the AR has been successful and the AR module returns into the ready state. |
| Lock | Signal: Auto Reclosure is locked out |
| t-Reset Lockout | Signal: Delay Timer for resetting the AR lockout. The reset of the AR lockout state will be delayed for this time, after the reset signal (e.g digital input or Scada) has been detected . |
| Blo | Signal: Auto Reclosure is blocked |
| t-Blo Reset | Signal: Delay Timer for resetting the AR blocking. The release (de-blocking) of the AR will be delayed for this time, if there is no blocking signal anymore. |
| successful | Signal: Auto Reclosing successful |
| failed | Signal: Auto Reclosing failure |
| t-AR Supervision | Signal: AR Supervision |
| Pre Shot | Pre Shot Control |
| Shot 1 | Shot Control |
| Shot 2 | Shot Control |
| Shot 3 | Shot Control |
| Shot 4 | Shot Control |
| Shot 5 | Shot Control |
| Shot 6 | Shot Control |
| Service Alarm 1 | Signal: AR - Service Alarm 1, too many switching operations |
| Service Alarm 2 | Signal: AR - Service Alarm 2 - too many switching operations |
| Max Shots / h exceeded | Signal: The maximum allowed number of shots per hour has been exceeded. |
| Res Statistics Cr | Signal: Reset all statistic AR counters: Total number of AR, successful and unsuccessful no of AR. |
| Res Service Cr | Signal: Reset the Service Counters for Alarm and Blocking |
| Reset Lockout | Signal: The AR Lockout has been reset via the panel. |
| Res Max Shots / h | Signal: The Counter for the maximum allowed shots per hour has been reset. |
| ARRecCState | Signal: AutoReclosing states defined by IEC61850:1=Ready/2=In Progress/3=Successful |

Automatic Reclosure Module Values

| <i>Value</i> | <i>Description</i> | <i>Default</i> | <i>Size</i> | <i>Menu path</i> |
|-------------------|--|----------------|-------------|--|
| AR Shot No. | Counter - Auto Reclosure Attempts | 0 | 0 - 6 | [Operation /Count and RevData /AR] |
| Total number Cr | Total number of all executed Automatic Reclosures Attempts | 0 | 0 - 65536 | [Operation /Count and RevData /AR] |
| Cr successfl | Total number of successfully executed Automatic Reclosures | 0 | 0 - 65536 | [Operation /Count and RevData /AR] |
| Cr failed | Total number of unsuccessfully executed automatic reclosure attempts | 0 | 0 - 65536 | [Operation /Count and RevData /AR] |
| Cr Service Alarm1 | Remaining numbers of ARs until Service Alarm 1 | 1000 | 0 - 1000 | [Operation /Count and RevData /AR] |
| Cr Service Alarm2 | Remaining numbers of ARs until Service Alarm 2 | 65536 | 0 - 65536 | [Operation /Count and RevData /AR] |
| Max Shots / h Cr | Counter for the maximum allowed shots per hour. | 0 | 0 - 65536 | [Operation /Count and RevData /AR] |

Global Protection Parameters of the of the AR Abort Functions

| <i>Parameter</i> | <i>Description</i> | <i>Setting range</i> | <i>Default</i> | <i>Menu path</i> |
|---|--|-----------------------|----------------|--|
| abort: 1  | Abort the AR-cycle, if the state of the assigned signal is true. If the state of this function is true the AR will be aborted. | 1..n, Assignment List | -.- | [Protection Para /Global Prot Para /AR /Block Fc] |
| abort: 2  | Abort the AR-cycle, if the state of the assigned signal is true. If the state of this function is true the AR will be aborted. | 1..n, Assignment List | -.- | [Protection Para /Global Prot Para /AR /Block Fc] |
| abort: 3  | Abort the AR-cycle, if the state of the assigned signal is true. If the state of this function is true the AR will be aborted. | 1..n, Assignment List | -.- | [Protection Para /Global Prot Para /AR /Block Fc] |
| abort: 4  | Abort the AR-cycle, if the state of the assigned signal is true. If the state of this function is true the AR will be aborted. | 1..n, Assignment List | -.- | [Protection Para /Global Prot Para /AR /Block Fc] |
| abort: 5  | Abort the AR-cycle, if the state of the assigned signal is true. If the state of this function is true the AR will be aborted. | 1..n, Assignment List | -.- | [Protection Para /Global Prot Para /AR /Block Fc] |
| abort: 6  | Abort the AR-cycle, if the state of the assigned signal is true. If the state of this function is true the AR will be aborted. | 1..n, Assignment List | -.- | [Protection Para /Global Prot Para /AR /Block Fc] |

Input States of the AR Abort Functions

| Name | Description | Assignment via |
|----------|--|--|
| abort: 1 | Abort the AR-cycle, if the state of the assigned signal is true. If the state of this function is true the AR will be aborted. | [Protection Para /Global Prot Para /AR /Block Fc] |
| abort: 2 | Abort the AR-cycle, if the state of the assigned signal is true. If the state of this function is true the AR will be aborted. | [Protection Para /Global Prot Para /AR /Block Fc] |
| abort: 3 | Abort the AR-cycle, if the state of the assigned signal is true. If the state of this function is true the AR will be aborted. | [Protection Para /Global Prot Para /AR /Block Fc] |
| abort: 4 | Abort the AR-cycle, if the state of the assigned signal is true. If the state of this function is true the AR will be aborted. | [Protection Para /Global Prot Para /AR /Block Fc] |
| abort: 5 | Abort the AR-cycle, if the state of the assigned signal is true. If the state of this function is true the AR will be aborted. | [Protection Para /Global Prot Para /AR /Block Fc] |
| abort: 6 | Abort the AR-cycle, if the state of the assigned signal is true. If the state of this function is true the AR will be aborted. | [Protection Para /Global Prot Para /AR /Block Fc] |

AR Start Functions

| <i>Name</i> | <i>Description</i> |
|-------------|----------------------------------|
| - | No assignment |
| I[1] | Phase Overcurrent Stage |
| I[2] | Phase Overcurrent Stage |
| I[3] | Phase Overcurrent Stage |
| I[4] | Phase Overcurrent Stage |
| I[5] | Phase Overcurrent Stage |
| I[6] | Phase Overcurrent Stage |
| IG[1] | Earth current protection - Stage |
| IG[2] | Earth current protection - Stage |
| IG[3] | Earth current protection - Stage |
| IG[4] | Earth current protection - Stage |
| I2>[1] | Unbalanced Load-Stage |
| I2>[2] | Unbalanced Load-Stage |
| ExP[1] | External Protection - Module |
| ExP[2] | External Protection - Module |
| ExP[3] | External Protection - Module |
| ExP[4] | External Protection - Module |

Scada Commands of the Auto Reclosure

| <i>Name</i> | <i>Description</i> |
|---------------------|--|
| -- | No assignment |
| DNP3.BinaryOutput0 | Virtual Digital Output (DNP). This corresponds to a virtual binary input of the protective device. |
| DNP3.BinaryOutput1 | Virtual Digital Output (DNP). This corresponds to a virtual binary input of the protective device. |
| DNP3.BinaryOutput2 | Virtual Digital Output (DNP). This corresponds to a virtual binary input of the protective device. |
| DNP3.BinaryOutput3 | Virtual Digital Output (DNP). This corresponds to a virtual binary input of the protective device. |
| DNP3.BinaryOutput4 | Virtual Digital Output (DNP). This corresponds to a virtual binary input of the protective device. |
| DNP3.BinaryOutput5 | Virtual Digital Output (DNP). This corresponds to a virtual binary input of the protective device. |
| DNP3.BinaryOutput6 | Virtual Digital Output (DNP). This corresponds to a virtual binary input of the protective device. |
| DNP3.BinaryOutput7 | Virtual Digital Output (DNP). This corresponds to a virtual binary input of the protective device. |
| DNP3.BinaryOutput8 | Virtual Digital Output (DNP). This corresponds to a virtual binary input of the protective device. |
| DNP3.BinaryOutput9 | Virtual Digital Output (DNP). This corresponds to a virtual binary input of the protective device. |
| DNP3.BinaryOutput10 | Virtual Digital Output (DNP). This corresponds to a virtual binary input of the protective device. |
| DNP3.BinaryOutput11 | Virtual Digital Output (DNP). This corresponds to a virtual binary input of the protective device. |
| DNP3.BinaryOutput12 | Virtual Digital Output (DNP). This corresponds to a virtual binary input of the protective device. |
| DNP3.BinaryOutput13 | Virtual Digital Output (DNP). This corresponds to a virtual binary input of the protective device. |
| DNP3.BinaryOutput14 | Virtual Digital Output (DNP). This corresponds to a virtual binary input of the protective device. |
| DNP3.BinaryOutput15 | Virtual Digital Output (DNP). This corresponds to a virtual binary input of the protective device. |

Protective Elements

| <i>Name</i> | <i>Description</i> |
|---------------------|--|
| DNP3.BinaryOutput16 | Virtual Digital Output (DNP). This corresponds to a virtual binary input of the protective device. |
| DNP3.BinaryOutput17 | Virtual Digital Output (DNP). This corresponds to a virtual binary input of the protective device. |
| DNP3.BinaryOutput18 | Virtual Digital Output (DNP). This corresponds to a virtual binary input of the protective device. |
| DNP3.BinaryOutput19 | Virtual Digital Output (DNP). This corresponds to a virtual binary input of the protective device. |
| DNP3.BinaryOutput20 | Virtual Digital Output (DNP). This corresponds to a virtual binary input of the protective device. |
| DNP3.BinaryOutput21 | Virtual Digital Output (DNP). This corresponds to a virtual binary input of the protective device. |
| DNP3.BinaryOutput22 | Virtual Digital Output (DNP). This corresponds to a virtual binary input of the protective device. |
| DNP3.BinaryOutput23 | Virtual Digital Output (DNP). This corresponds to a virtual binary input of the protective device. |
| DNP3.BinaryOutput24 | Virtual Digital Output (DNP). This corresponds to a virtual binary input of the protective device. |
| DNP3.BinaryOutput25 | Virtual Digital Output (DNP). This corresponds to a virtual binary input of the protective device. |
| DNP3.BinaryOutput26 | Virtual Digital Output (DNP). This corresponds to a virtual binary input of the protective device. |
| DNP3.BinaryOutput27 | Virtual Digital Output (DNP). This corresponds to a virtual binary input of the protective device. |
| DNP3.BinaryOutput28 | Virtual Digital Output (DNP). This corresponds to a virtual binary input of the protective device. |
| DNP3.BinaryOutput29 | Virtual Digital Output (DNP). This corresponds to a virtual binary input of the protective device. |
| DNP3.BinaryOutput30 | Virtual Digital Output (DNP). This corresponds to a virtual binary input of the protective device. |
| DNP3.BinaryOutput31 | Virtual Digital Output (DNP). This corresponds to a virtual binary input of the protective device. |
| Modbus.Scada Cmd 1 | Scada Command |
| Modbus.Scada Cmd 2 | Scada Command |
| Modbus.Scada Cmd 3 | Scada Command |
| Modbus.Scada Cmd 4 | Scada Command |
| Modbus.Scada Cmd 5 | Scada Command |
| Modbus.Scada Cmd 6 | Scada Command |
| Modbus.Scada Cmd 7 | Scada Command |
| Modbus.Scada Cmd 8 | Scada Command |
| Modbus.Scada Cmd 9 | Scada Command |
| Modbus.Scada Cmd 10 | Scada Command |
| Modbus.Scada Cmd 11 | Scada Command |
| Modbus.Scada Cmd 12 | Scada Command |
| Modbus.Scada Cmd 13 | Scada Command |
| Modbus.Scada Cmd 14 | Scada Command |
| Modbus.Scada Cmd 15 | Scada Command |
| Modbus.Scada Cmd 16 | Scada Command |
| IEC61850.VirtInp1 | Signal: Virtual Input (IEC61850 GGIO Ind) |
| IEC61850.VirtInp2 | Signal: Virtual Input (IEC61850 GGIO Ind) |
| IEC61850.VirtInp3 | Signal: Virtual Input (IEC61850 GGIO Ind) |
| IEC61850.VirtInp4 | Signal: Virtual Input (IEC61850 GGIO Ind) |
| IEC61850.VirtInp5 | Signal: Virtual Input (IEC61850 GGIO Ind) |
| IEC61850.VirtInp6 | Signal: Virtual Input (IEC61850 GGIO Ind) |
| IEC61850.VirtInp7 | Signal: Virtual Input (IEC61850 GGIO Ind) |
| IEC61850.VirtInp8 | Signal: Virtual Input (IEC61850 GGIO Ind) |

Protective Elements

| <i>Name</i> | <i>Description</i> |
|--------------------|--|
| IEC61850.VirtInp9 | Signal: Virtual Input (IEC61850 GGIO Ind) |
| IEC61850.VirtInp10 | Signal: Virtual Input (IEC61850 GGIO Ind) |
| IEC61850.VirtInp11 | Signal: Virtual Input (IEC61850 GGIO Ind) |
| IEC61850.VirtInp12 | Signal: Virtual Input (IEC61850 GGIO Ind) |
| IEC61850.VirtInp13 | Signal: Virtual Input (IEC61850 GGIO Ind) |
| IEC61850.VirtInp14 | Signal: Virtual Input (IEC61850 GGIO Ind) |
| IEC61850.VirtInp15 | Signal: Virtual Input (IEC61850 GGIO Ind) |
| IEC61850.VirtInp16 | Signal: Virtual Input (IEC61850 GGIO Ind) |
| IEC61850.VirtInp17 | Signal: Virtual Input (IEC61850 GGIO Ind) |
| IEC61850.VirtInp18 | Signal: Virtual Input (IEC61850 GGIO Ind) |
| IEC61850.VirtInp19 | Signal: Virtual Input (IEC61850 GGIO Ind) |
| IEC61850.VirtInp20 | Signal: Virtual Input (IEC61850 GGIO Ind) |
| IEC61850.VirtInp21 | Signal: Virtual Input (IEC61850 GGIO Ind) |
| IEC61850.VirtInp22 | Signal: Virtual Input (IEC61850 GGIO Ind) |
| IEC61850.VirtInp23 | Signal: Virtual Input (IEC61850 GGIO Ind) |
| IEC61850.VirtInp24 | Signal: Virtual Input (IEC61850 GGIO Ind) |
| IEC61850.VirtInp25 | Signal: Virtual Input (IEC61850 GGIO Ind) |
| IEC61850.VirtInp26 | Signal: Virtual Input (IEC61850 GGIO Ind) |
| IEC61850.VirtInp27 | Signal: Virtual Input (IEC61850 GGIO Ind) |
| IEC61850.VirtInp28 | Signal: Virtual Input (IEC61850 GGIO Ind) |
| IEC61850.VirtInp29 | Signal: Virtual Input (IEC61850 GGIO Ind) |
| IEC61850.VirtInp30 | Signal: Virtual Input (IEC61850 GGIO Ind) |
| IEC61850.VirtInp31 | Signal: Virtual Input (IEC61850 GGIO Ind) |
| IEC61850.VirtInp32 | Signal: Virtual Input (IEC61850 GGIO Ind) |
| IEC61850.SPCSO1 | Status bit that can be set by clients like e.g. SCADA (Single Point Controllable Status Output). |
| IEC61850.SPCSO2 | Status bit that can be set by clients like e.g. SCADA (Single Point Controllable Status Output). |
| IEC61850.SPCSO3 | Status bit that can be set by clients like e.g. SCADA (Single Point Controllable Status Output). |
| IEC61850.SPCSO4 | Status bit that can be set by clients like e.g. SCADA (Single Point Controllable Status Output). |
| IEC61850.SPCSO5 | Status bit that can be set by clients like e.g. SCADA (Single Point Controllable Status Output). |
| IEC61850.SPCSO6 | Status bit that can be set by clients like e.g. SCADA (Single Point Controllable Status Output). |
| IEC61850.SPCSO7 | Status bit that can be set by clients like e.g. SCADA (Single Point Controllable Status Output). |
| IEC61850.SPCSO8 | Status bit that can be set by clients like e.g. SCADA (Single Point Controllable Status Output). |
| IEC61850.SPCSO9 | Status bit that can be set by clients like e.g. SCADA (Single Point Controllable Status Output). |
| IEC61850.SPCSO10 | Status bit that can be set by clients like e.g. SCADA (Single Point Controllable Status Output). |
| IEC61850.SPCSO11 | Status bit that can be set by clients like e.g. SCADA (Single Point Controllable Status Output). |
| IEC61850.SPCSO12 | Status bit that can be set by clients like e.g. SCADA (Single Point Controllable Status Output). |
| IEC61850.SPCSO13 | Status bit that can be set by clients like e.g. SCADA (Single Point Controllable Status Output). |
| IEC61850.SPCSO14 | Status bit that can be set by clients like e.g. SCADA (Single Point Controllable Status Output). |
| IEC61850.SPCSO15 | Status bit that can be set by clients like e.g. SCADA (Single Point Controllable Status Output). |
| IEC61850.SPCSO16 | Status bit that can be set by clients like e.g. SCADA (Single Point Controllable Status Output). |

Protective Elements

| <i>Name</i> | <i>Description</i> |
|-----------------------|--------------------|
| IEC 103.Scada Cmd 1 | Scada Command |
| IEC 103.Scada Cmd 2 | Scada Command |
| IEC 103.Scada Cmd 3 | Scada Command |
| IEC 103.Scada Cmd 4 | Scada Command |
| IEC 103.Scada Cmd 5 | Scada Command |
| IEC 103.Scada Cmd 6 | Scada Command |
| IEC 103.Scada Cmd 7 | Scada Command |
| IEC 103.Scada Cmd 8 | Scada Command |
| IEC 103.Scada Cmd 9 | Scada Command |
| IEC 103.Scada Cmd 10 | Scada Command |
| Profibus.Scada Cmd 1 | Scada Command |
| Profibus.Scada Cmd 2 | Scada Command |
| Profibus.Scada Cmd 3 | Scada Command |
| Profibus.Scada Cmd 4 | Scada Command |
| Profibus.Scada Cmd 5 | Scada Command |
| Profibus.Scada Cmd 6 | Scada Command |
| Profibus.Scada Cmd 7 | Scada Command |
| Profibus.Scada Cmd 8 | Scada Command |
| Profibus.Scada Cmd 9 | Scada Command |
| Profibus.Scada Cmd 10 | Scada Command |
| Profibus.Scada Cmd 11 | Scada Command |
| Profibus.Scada Cmd 12 | Scada Command |
| Profibus.Scada Cmd 13 | Scada Command |
| Profibus.Scada Cmd 14 | Scada Command |
| Profibus.Scada Cmd 15 | Scada Command |
| Profibus.Scada Cmd 16 | Scada Command |

V - Voltage Protection [27,59]

Available stages:
V[1] .V[2] .V[3] .V[4] .V[5] .V[6]

CAUTION

If the VT measurement location is not at the bus bar side but at the output side, the following has to be taken into account:

When disconnecting the line it has to be ensured that by an »*External Blocking*« undervoltage tripping of the U<-elements cannot happen. This is realized through detecting of the CB position (via digital inputs).

When the aux. voltage is switched on and the measuring voltage has not yet been applied, undervoltage tripping has to be prevented by an »*External Blocking*«

CAUTION

In case of an fuse failure, it is important to block the »*U<-stages*« so that an undesired operation can be prevented.

NOTICE

All voltage elements are identically structured and can optionally be projected as over- or undervoltage element.

NOTICE

If phase voltages are applied to the measuring inputs of the device and field parameter »VT con« is set to »Phase-to-neutral«, the messages issued by the voltage protection module in case of actuation or trip should be interpreted as follows:

»V[1].ALARM L1« or »V[1].TRIP L1« => alarm or trip caused by phase voltage »VL1«.

»V[1].ALARM L2« or »V[1].TRIP L2« => alarm or trip caused by phase voltage »VL2«.

»V[1].ALARM L3« or »V[1].TRIP L3« => alarm or trip caused by phase voltage »VL3«.

If, however, line-to-line voltages are applied to the measuring inputs and field parameter »VT con« is set to »Phase to Phase«, then the messages should be interpreted as follows:

»V[1].ALARM L1« or »V[1].TRIP L1« => alarm or trip caused by line-to-line voltage »V12«.

»V[1].ALARM L2« or »V[1].TRIP L2« => alarm or trip caused by line-to-line voltage »V23«.

»V[1].ALARM L3« or »V[1].TRIP L3« => alarm or trip caused by line-to-line voltage »V31«.

The following table shows the application options of the voltage protection element

| Applications of the V-Protection Module | Setting in | Option |
|---|-------------------------------------|--|
| ANSI 27 Undervoltage protection | Device Planning menu Setting: V< | <i>Measuring Method:</i> Fundamental/TrueRMS <i>Measuring Mode:</i> Phase to ground, Phase-to-Phase |
| 10 minutes sliding average supervision V< | Device Planning menu Setting: V< | <i>Measuring Method:</i> Umit <i>Measuring Mode:</i> Phase to ground, Phase-to-Phase |
| ANSI 59 Overvoltage protection | Device Planning menu Setting: V> | <i>Measuring Method:</i> Fundamental/TrueRMS <i>Measuring Mode:</i> Phase to ground, Phase-to-Phase |
| Sliding average supervision V> | Device Planning menu Setting: V> | <i>Measuring Method:</i> Vavg <i>Measuring Mode:</i> Phase to ground, Phase-to-Phase |

Measuring Method

For all protection elements it can be determined, whether the measurement is done on basis of the »Fundamental« or if »TrueRMS« measurement is used. In addition to that a sliding average supervision »Vavg« can be parametrized.

NOTICE The required settings for the calculation of the “average value” of the “sliding average value supervision” have to be taken within menu [Device Para\Statistics\Vavg].

Measuring Method

If the measuring inputs of the voltage measuring card is fed with "Phase-to-Ground" voltages, the Field Parameter »VT con« has to be set to »Phase-to-Ground«. In this case, the user has the option, to set the »Measuring Mode« of each phase voltage protection element to »Phase-to-Ground« or »Phase-to-Phase«. That means, he can determine for each phase voltage protection element if » $V_n = VT_{sec} / \sqrt{3}$ « by setting »Measuring-Mode = phase-to-ground« or if » $V_n = VT_{sec}$ « by setting »Measuring-Mode = Phase-to-Phase«. CAUTION! If the measuring inputs of the voltage measuring card is fed with »Phase-to-Phase« voltages, the Field Parameter »VT con« has to be set to »Phase-to-Phase«. In this case the parameter »Measuring Mode« has to be set to »Phase-to-Ground«. In this case the device works always based on »Phase-to-Phase« voltages. In this case the parameter »Measuring mode« is internally set to »Phase-to-Phase«.

For each of the voltage protection elements it can be defined if it picks up when over- or undervoltage is detected in one of three, two of three or in all three phases. The dropout ratio is settable.

V[1]...[n]

name = V[1]...[n]

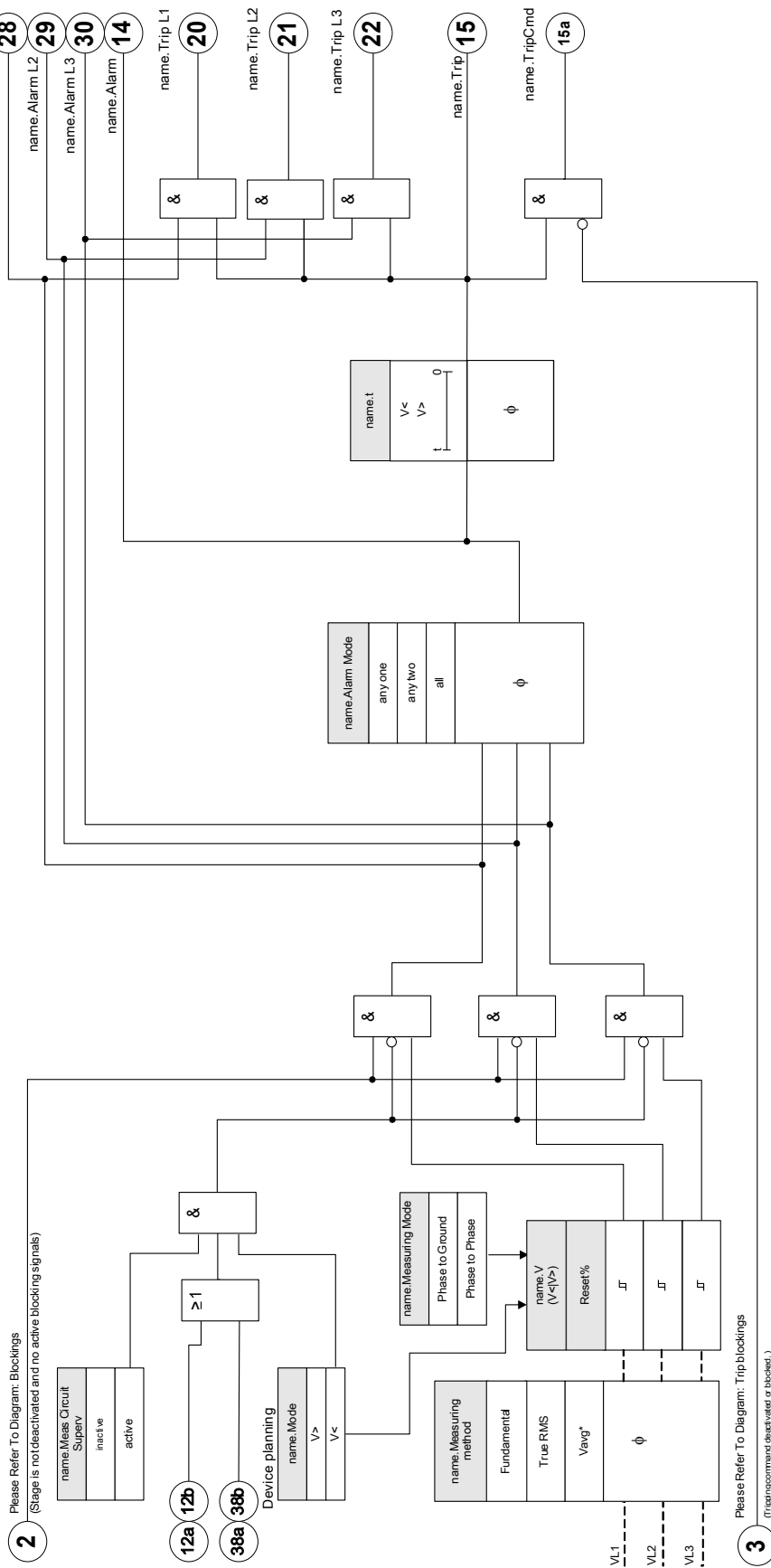

2 Please Refer To Diagram: Blockings
(Stage is not deactivated and no active blocking signals)

12a 12b
38a 38b



3 Please Refer To Diagram: Trip blockings
(Trippingcommand deactivated or blocked.)

*Do not use this setting (Vavg) with V(t)-elements.







Device Planning Parameters of the Voltage Protection Module





| Parameter | Description | Options | Default | Menu path |
|---|-------------|--------------------------|--|-------------------|
| Mode  | Mode | do not use, V>, V< | V[1]: V> V[2]: V< V[3]: do not use V[4]: do not use V[5]: do not use V[6]: do not use | [Device planning] |

Global Protection Parameters of the Voltage Protection Module



| Parameter | Description | Setting range | Default | Menu path |
|--|---|-----------------------|---------|---|
| ExBlo1  | External blocking of the module, if blocking is activated (allowed) within a parameter set and if the state of the assigned signal is true. | 1..n, Assignment List | -.- | [Protection Para /Global Prot Para /V-Prot /N[1]] |
| ExBlo2  | External blocking of the module, if blocking is activated (allowed) within a parameter set and if the state of the assigned signal is true. | 1..n, Assignment List | -.- | [Protection Para /Global Prot Para /V-Prot /N[1]] |
| ExBlo TripCmd  | External blocking of the Trip Command of the module/the stage, if blocking is activated (allowed) within a parameter set and if the state of the assigned signal is true. | 1..n, Assignment List | -.- | [Protection Para /Global Prot Para /V-Prot /N[1]] |

Setting Group Parameters of the Voltage Protection Module

| Parameter | Description | Setting range | Default | Menu path |
|---|---|------------------------------------|--|--|
|  Function | Permanent activation or deactivation of module/stage. | inactive, active | V[1]: active V[2]: inactive V[3]: inactive V[4]: inactive V[5]: inactive V[6]: inactive | [Protection Para /<1..4> /V-Prot /N[1]] |
|  ExBlo Fc | Activate (allow) or inactivate (disallow) blocking of the module/stage. This parameter is only effective if a signal is assigned to the corresponding global protection parameter. If the signal becomes true, those modules/stages are blocked that are parameterized "ExBlo Fc=active". | inactive, active | inactive | [Protection Para /<1..4> /V-Prot /N[1]] |
|  Blo TripCmd | Permanent blocking of the Trip Command of the module/stage. | inactive, active | inactive | [Protection Para /<1..4> /V-Prot /N[1]] |
|  ExBlo TripCmd Fc | Activate (allow) or inactivate (disallow) blocking of the module/stage. This parameter is only effective if a signal is assigned to the corresponding global protection parameter. If the signal becomes true, those modules/stages are blocked that are parameterized "ExBlo TripCmd Fc=active". | inactive, active | inactive | [Protection Para /<1..4> /V-Prot /N[1]] |
|  Measuring Mode | Measuring/Supervision Mode: Determines if the phase-to-phase or phase-to-earth voltages are to be supervised | Phase to Ground, Phase to Phase | Phase to Ground | [Protection Para /<1..4> /V-Prot /N[1]] |
|  Measuring method | Measuring method: fundamental or rms or "sliding average supervision" | Fundamental, True RMS, Vavg | Fundamental | [Protection Para /<1..4> /V-Prot /N[1]] |
|  Alarm Mode | Alarm criterion for the voltage protection stage. | any one, any two, all | any one | [Protection Para /<1..4> /V-Prot /N[1]] |

| Parameter | Description | Setting range | Default | Menu path |
|--|---|----------------|---|--|
| V>  | If the pickup value is exceeded, the module/element will be started. Definition of Vn: If the measuring inputs of the voltage measuring card is fed with "Phase-to-Ground" voltages, the Field Parameter "VT con" has to be set to "Phase-to-Ground". In this case, the user has the option, to set the "Measuring Mode" of each phase voltage protection element to "Phase-to-Ground" or "Phase-to-Phase". That means, he can determine for each phase voltage protection element if "Vn=VTsec/SQRT(3)" by setting "Measuring-Mode = phase-to-ground" or if "Vn=VTsec" by setting "Measuring-Mode = Phase-to-Phase". CAUTION! If the measuring inputs of the voltage measuring card is fed with "Phase-to-Phase" voltages, the Field Parameter "VT con" has to be set to "Phase-to-Phase". In this case the parameter "Measuring Mode" has to be set to "Phase-to-Ground". In this case the device works always based on "Phase-to-Phase" Voltages. In this case the parameter "Measuring mode" is internally set to "Phase-to-Phase". | 0.01 - 1.500Vn | V[1]: 1.1Vn V[2]: 1.20Vn V[3]: 1.20Vn V[4]: 1.20Vn V[5]: 1.20Vn V[6]: 1.20Vn | [Protection Para <1..4> /V-Prot /[1]] |
| V> Reset%  | Drop Out (is in percent of setting) | 80 - 99% | 97% | [Protection Para <1..4> /V-Prot /[1]] |
| V<  | If the pickup value is exceeded, the module/element will be started. Definition of Vn: If the measuring inputs of the voltage measuring card is fed with "Phase-to-Ground" voltages, the Field Parameter "VT con" has to be set to "Phase-to-Ground". In this case, the user has the option, to set the "Measuring Mode" of each phase voltage protection element to "Phase-to-Ground" or "Phase-to-Phase". That means, he can determine for each phase voltage protection element if "Vn=VTsec/SQRT(3)" by setting "Measuring-Mode = phase-to-ground" or if "Vn=VTsec" by setting "Measuring-Mode = Phase-to-Phase". CAUTION! If the measuring inputs of the voltage measuring card is fed with "Phase-to-Phase" voltages, the Field Parameter "VT con" has to be set to "Phase-to-Phase". In this case the parameter "Measuring Mode" has to be set to "Phase-to-Ground". In this case the device works always based on "Phase-to-Phase" Voltages. In this case the parameter "Measuring mode" is internally set to "Phase-to-Phase". | 0.01 - 1.500Vn | V[1]: 0.80Vn V[2]: 0.9Vn V[3]: 0.80Vn V[4]: 0.80Vn V[5]: 0.80Vn V[6]: 0.80Vn | [Protection Para <1..4> /V-Prot /[1]] |
| V< Reset%  | Drop Out (is in percent of setting) | 101 - 110% | 103% | [Protection Para <1..4> /V-Prot /[1]] |

Protective Elements

| Parameter | Description | Setting range | Default | Menu path |
|---|--|---------------------|--|--|
| t  | Tripping delay | 0.00 - 3000.00s | V[1]: 1s V[2]: 1s V[3]: 0.00s V[4]: 0.00s V[5]: 0.00s V[6]: 0.00s | [Protection Para /<1..4> /V-Prot /V[1]] |
| Meas Circuit Superv  | Activates the use of the measuring circuit supervision. In this case the module will be blocked if a measuring circuit supervision module (e.g. LOP, VTS) signals a disturbed measuring circuit (e.g. caused by a fuse failure). | inactive, active | inactive | [Protection Para /<1..4> /V-Prot /V[1]] |

Voltage Protection Module Input States

| <i>Name</i> | <i>Description</i> | <i>Assignment via</i> |
|-----------------|---|--|
| ExBlo1-I | Module input state: External blocking1 | [Protection Para /Global Prot Para /V-Prot /V[1]] |
| ExBlo2-I | Module input state: External blocking2 | [Protection Para /Global Prot Para /V-Prot /V[1]] |
| ExBlo TripCmd-I | Module input state: External Blocking of the Trip Command | [Protection Para /Global Prot Para /V-Prot /V[1]] |

Voltage Protection Module Signals (Output States)

| <i>Signal</i> | <i>Description</i> |
|---------------|---|
| active | Signal: active |
| ExBlo | Signal: External Blocking |
| Blo TripCmd | Signal: Trip Command blocked |
| ExBlo TripCmd | Signal: External Blocking of the Trip Command |
| Alarm L1 | Signal: Alarm L1 |
| Alarm L2 | Signal: Alarm L2 |
| Alarm L3 | Signal: Alarm L3 |
| Alarm | Signal: Alarm voltage stage |
| Trip L1 | Signal: General Trip Phase L1 |
| Trip L2 | Signal: General Trip Phase L2 |
| Trip L3 | Signal: General Trip Phase L3 |
| Trip | Signal: Trip |
| TripCmd | Signal: Trip Command |

Commissioning: Overvoltage Protection [59]

Object to be tested

Test of the overvoltage protection elements, 3 x single-phase and 1 x three-phase (for each element)

CAUTION

Through testing the overvoltage protection stages, it can also be ensured that the wiring from the switchboard input terminals is correct. Wiring errors at the voltage measuring inputs might result in:

- False tripping of the directional current protection
Example: Device suddenly trips in reverse direction but it does not trip in forward direction.
- Wrong or no power factor indication
- Errors with regard to power directions etc.

Necessary means

- 3-phase AC voltage source
- Timer for measuring of the tripping time
- Voltmeter

Procedure (3 x single-phase, 1 x three-phase, for each element)

Testing the threshold values

For testing the threshold values and fallback values, the test voltage has to be increased until the relay is activated. When comparing the displayed values with those of the voltmeter, the deviation must be within the permissible tolerances.

Testing the trip delay

For testing the trip delay, a timer is to be connected to the contact of the associated trip relay.

The timer is started when the limiting value of the tripping voltage is exceeded and it is stopped when the relay trips.

Testing the fallback ratio

Reduce the measuring quantity to less than (e.g.) 97% of the trip value. The relay must only fall back at 97% of the trip value at the earliest.

Successful test result

The measured threshold values, trip delays and fallback ratios comply with those specified in the adjustment list. Permissible deviations/tolerances can be taken from the Technical Data.

Commissioning: Undervoltage Protection [27]

This test can be carried out similar to the test for overvoltage protection (by using the related undervoltage values).

Please consider the following deviations:

- For testing the threshold values the test voltage has to be decreased until the relay is activated.
- For detection of the fallback value, the measuring quantity has to be increased so to achieve more than (e.g.) 103% of the trip value. At 103% of the trip value the relay is to fall back at the earliest.

VG, VX - Voltage Supervision [27A, 27TN/59N, 59A]

Available elements:
 VG[1] ,VG[2]

NOTICE All elements of the voltage supervision of the fourth measuring input are identically structured.

This protective element can be used to (depending on device planning and setting)

- Supervision of the calculated or measured residual voltage. The residual voltage can be calculated only if the phase voltages (star connection) are connected to the measuring inputs of the device.
- Supervision of another (auxiliary) voltage against overvoltage or undervoltage.

The following table shows the application options of the voltage protection element

| Applications of the VG/VX-Protection Module | Setting in | Option |
|---|--|--|
| ANSI 59N/G Residual voltage protection (measured or calculated) | Device Planning menu Setting: V> | Criterion: Fundamental/TrueRMS VG Source: measured/calculated |
| ANSI 59A Supervision of an Auxiliary (additional) Voltage in relation to Overvoltage. | Device Planning menu Setting: V> Within the corresponding Parameter-Set: VG Source:measured | Criterion: Fundamental/TrueRMS |
| ANSI 27A Supervision of an Auxiliary (additional) Voltage in relation to Undervoltage. | Device Planning menu Setting: V< Within the corresponding Parameter-Set: VG Source:measured | Criterion: Fundamental/TrueRMS |
| ANSI 27TN/59N "Vx meas H3" Stator Ground Fault Protection Note: This option is available in some Generator Protection Relays only. In order to detect 100% Stator Ground faults, a 27TN element has to be or-connected with a 59N element within the programmable logic. | Device Planning menu Setting: V< Within the corresponding Parameter-Set: VX Source:measured | Criterion: VX meas H3 VX Source: measured |

Measuring Mode

For all protection elements it can be determined, whether the measurement is done on basis of the »Fundamental« or if »TrueRMS« measurement is used.

27TN/59N - 100% Stator Ground Fault Protection »*VX meas H3*«*

*=only available in Generator Protection Relays

With this setting the relay can detect stator ground faults at high impedance grounded generators near the machines stator neutral.

In order to detect 100% Stator Ground faults, a 27TN element has to be or-connected with a 59N element within the programmable logic.

With the 27TN element the 3rd harmonic of the connected voltage is monitored at the generator neutral side. It is able to detect ground faults, which occur between the stator neutral and up to approx. 20% of the winding towards the stator terminals. In combination with the 59N element, that detects ground faults from the stator terminals down to approximately 10% of the stator winding towards the neutral, a 100% stator ground fault protection can be realized.

The following figure shows the combination of a 27TN with measuring criterion »*VX meas H3*« (third harmonic) and a 59N element.

Both elements have to be or connected via Programmable logic.

In addition to that it is recommended to provide the 27TN element with a voltage release via a AND-Logic with an 59 element in order to prevent faulty tripping e.g. during generator standstill (see logic diagram next page).

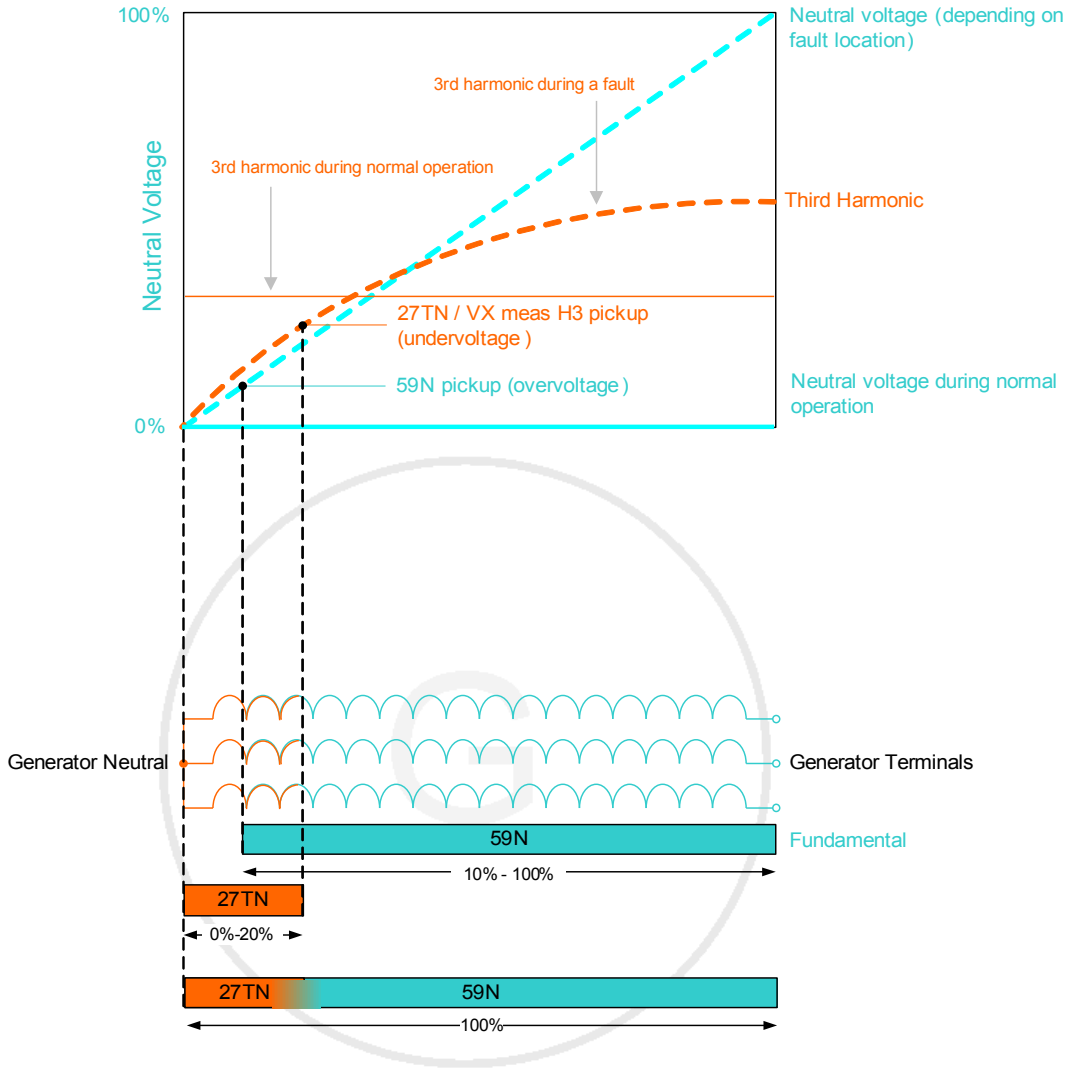

prevents faulty tripping during dead system / generator standstill

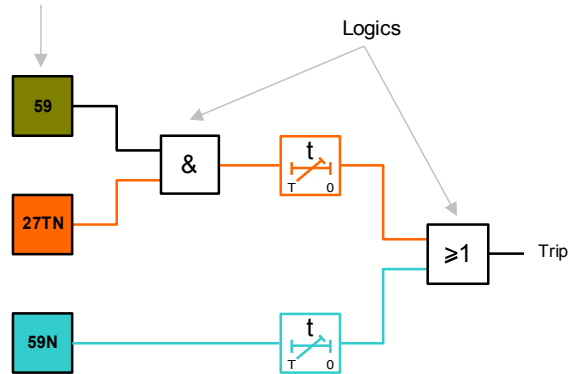

VGf1]..[n]

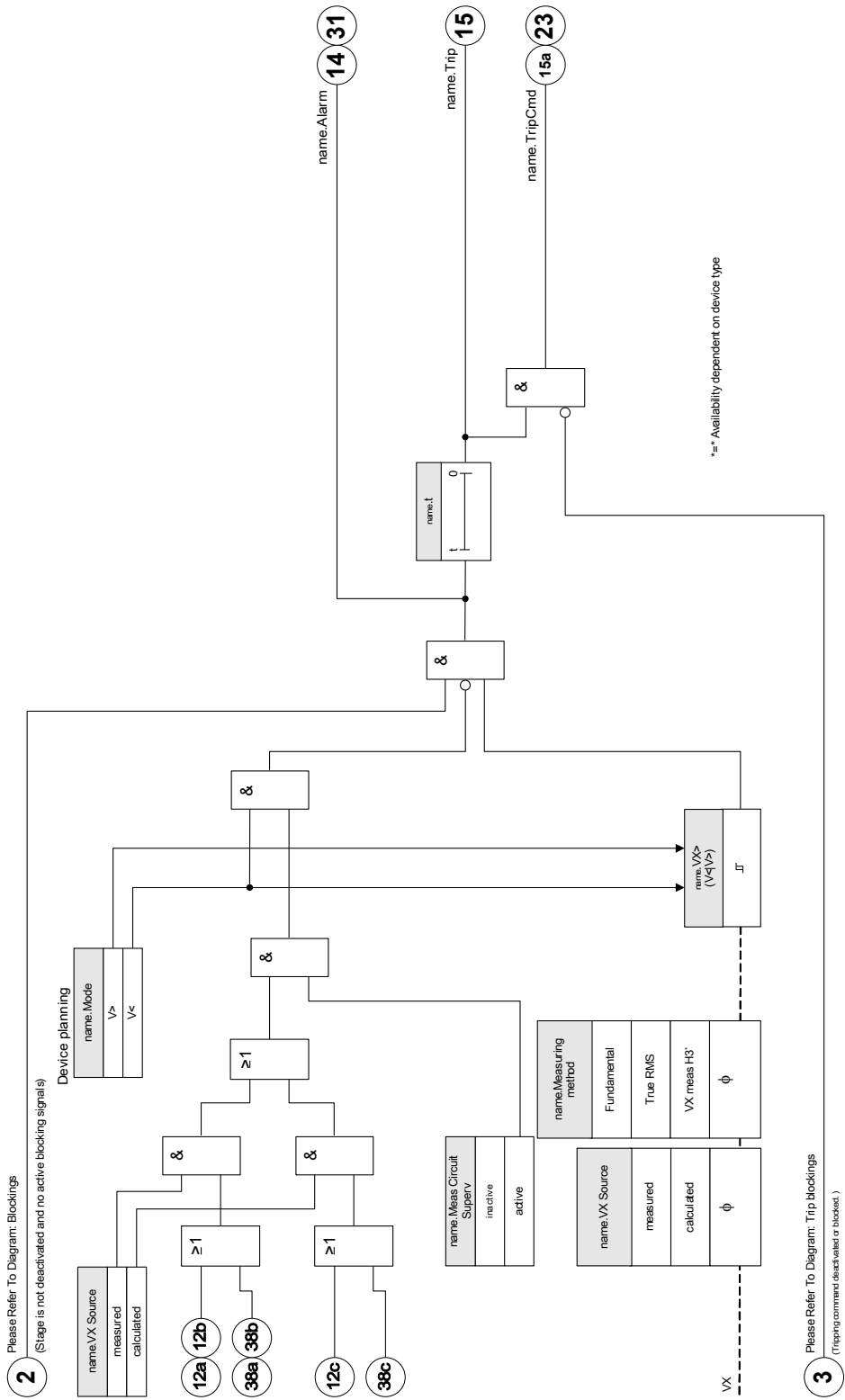

name = VGf1]..[n]











Device Planning Parameters of the Residual Voltage Supervision Module

| Parameter | Description | Options | Default | Menu path |
|---|-------------|--------------------------|------------|-------------------|
| Mode  | Mode | do not use, V>, V< | do not use | [Device planning] |



Global Protection Parameters of the Residual Voltage Supervision Module

| Parameter | Description | Setting range | Default | Menu path |
|--|---|-----------------------|---------|---|
| ExBlo1  | External blocking of the module, if blocking is activated (allowed) within a parameter set and if the state of the assigned signal is true. | 1..n, Assignment List | -- | [Protection Para /Global Prot Para /V-Prot /VG[1]] |
| ExBlo2  | External blocking of the module, if blocking is activated (allowed) within a parameter set and if the state of the assigned signal is true. | 1..n, Assignment List | -- | [Protection Para /Global Prot Para /V-Prot /VG[1]] |
| ExBlo TripCmd  | External blocking of the Trip Command of the module/the stage, if blocking is activated (allowed) within a parameter set and if the state of the assigned signal is true. | 1..n, Assignment List | -- | [Protection Para /Global Prot Para /V-Prot /VG[1]] |

Setting Group Parameters of the Residual Voltage Supervision Module.

| Parameter | Description | Setting range | Default | Menu path |
|---|---|--------------------------|-------------|--|
| Function  | Permanent activation or deactivation of module/stage. | inactive, active | inactive | [Protection Para <1..4> N-Prot VG[1]] |
| ExBlo Fc  | Activate (allow) or inactivate (disallow) blocking of the module/stage. This parameter is only effective if a signal is assigned to the corresponding global protection parameter. If the signal becomes true, those modules/stages are blocked that are parameterized "ExBlo Fc=active". | inactive, active | inactive | [Protection Para <1..4> N-Prot VG[1]] |
| Blo TripCmd  | Permanent blocking of the Trip Command of the module/stage. | inactive, active | inactive | [Protection Para <1..4> N-Prot VG[1]] |
| ExBlo TripCmd Fc  | Activate (allow) or inactivate (disallow) blocking of the module/stage. This parameter is only effective if a signal is assigned to the corresponding global protection parameter. If the signal becomes true, those modules/stages are blocked that are parameterized "ExBlo TripCmd Fc=active". | inactive, active | inactive | [Protection Para <1..4> N-Prot VG[1]] |
| VX Source  | Selection if VG is measured or calculated (neutral voltage or residual voltage) | measured, calculated | measured | [Protection Para <1..4> N-Prot VG[1]] |
| Measuring method  | Measuring method: fundamental or rms or 3rd harmonic (only generator protection relays) | Fundamental, True RMS | Fundamental | [Protection Para <1..4> N-Prot VG[1]] |
| VX>  | If the pickup value is exceeded, the module/stage will be started. Only available if: Device planning: VG.Mode = V> | 0.01 - 1.50Vn | 1Vn | [Protection Para <1..4> N-Prot VG[1]] |
| VG<  | Undervoltage Threshold Only available if: Device planning: VG.Mode = V< | 0.01 - 1.50Vn | 0.8Vn | [Protection Para <1..4> N-Prot VG[1]] |

Protective Elements

| <i>Parameter</i> | <i>Description</i> | <i>Setting range</i> | <i>Default</i> | <i>Menu path</i> |
|---|--|----------------------|----------------|---|
| t  | Tripping delay | 0.00 - 300.00s | 0.00s | [Protection Para /<1..4> /N-Prot /VG[1]] |
| Meas Circuit Superv  | Activates the use of the measuring circuit supervision. In this case the module will be blocked if a measuring circuit supervision module (e.g. LOP, VTS) signals a disturbed measuring circuit (e.g. caused by a fuse failure). | inactive, active | inactive | [Protection Para /<1..4> /N-Prot /VG[1]] |

Residual Voltage Supervision Module Input States

| <i>Name</i> | <i>Description</i> | <i>Assignment via</i> |
|-----------------|---|---|
| ExBlo1-I | Module input state: External blocking1 | [Protection Para /Global Prot Para /V-Prot /VG[1]] |
| ExBlo2-I | Module input state: External blocking2 | [Protection Para /Global Prot Para /V-Prot /VG[1]] |
| ExBlo TripCmd-I | Module input state: External Blocking of the Trip Command | [Protection Para /Global Prot Para /V-Prot /VG[1]] |

Residual Voltage Supervision Module Signals (Output States)

| <i>Signal</i> | <i>Description</i> |
|---------------|--|
| active | Signal: active |
| ExBlo | Signal: External Blocking |
| Blo TripCmd | Signal: Trip Command blocked |
| ExBlo TripCmd | Signal: External Blocking of the Trip Command |
| Alarm | Signal: Alarm Residual Voltage Supervision-stage |
| Trip | Signal: Trip |
| TripCmd | Signal: Trip Command |

Commissioning: Residual Voltage Protection - Measured [59N]

Object to be tested

Residual voltage protection stages.

Necessary components

- 1-phase AC voltage source
- Timer for measuring of the tripping time
- Voltmeter

Procedure (for each element)

Testing the threshold values

For testing the threshold and fallback values, the test voltage at the measuring input for the residual voltage has to be increased until the relay is activated. When comparing the displayed values with those of the voltmeter, the deviation must be within the permissible tolerances.

Testing the trip delay

For testing the trip delay a timer is to be connected to the contact of the associated trip relay.

The timer is started when the limiting value of the tripping voltage is exceeded and it is stopped when the relay trips.

Testing the fallback ratio

Reduce the measuring quantity to less than 97% of the trip value. The relay must only fall back at 97% of the trip value at the latest.

Successful test result

The measured threshold values, trip delays and fallback ratios comply with those specified in the adjustment list. Permissible deviations/tolerances can be taken from the Technical Data.

Commissioning: Residual Voltage Protection - Calculated [59N]

Object to be tested

Test of the residual voltage protection elements

Necessary means

- 3-phase voltage source

NOTICE

Calculation of the residual voltage is only possible if phase voltages (star) were applied to the voltage measuring inputs and if »VX Source=calculated« is set within the corresponding parameter set.

Procedure

- Feed a three-phase, symmetrical voltage system (V_n) into the voltage measuring inputs of the relay.
- Set the limiting value of VX[x] to 90% V_n .
- Disconnect the phase voltage at two measuring inputs (symmetrical feeding at the secondary side has to be maintained).
- Now the »VX calc« measuring value has to be about 100% of the value V_n .
- Ascertain that the signal »VX.ALARM« or »VX.TRIP« is generated now.

Successful test result

The signal »VX.ALARM« or »VX.TRIP« is generated.

f - Frequency [81O/U, 78, 81R]

Available elements:

f[1] .f[2] .f[3] .f[4] .f[5] .f[6]

NOTICE

All frequency protective elements are identically structured.

Frequency - Measuring Principle

NOTICE

The frequency is calculated as the average of the measured values of the three phase frequencies. Only valid measured frequency values are taken into account. If a phase voltage is no longer measurable, this phase will be excluded from the calculation of the average value.

The measuring principle of the frequency supervision is based in general on the time measurement of complete cycles, whereby a new measurement is started at each zero passage. The influence of harmonics on the measuring result is thus minimized.

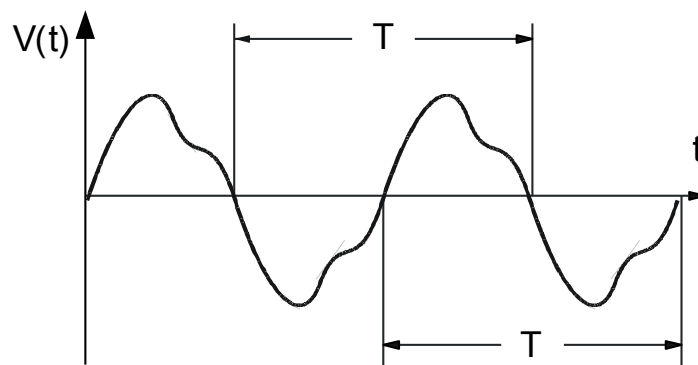

Frequency tripping is sometimes not desired by low measured voltages which for instance occur during alternator acceleration. All frequency supervision functions are blocked if the voltage is lower 0.15 times V_n .

Frequency Functions

Due to its various frequency functions, the device is very flexible. That makes it suitable for a wide range of applications, where frequency supervision is an important criterion.

In the *Device Planning* menu, the User can decide how to use each of the six frequency elements.

f[1] to f[6] can be assigned as:

- f< – Underfrequency;
- f> – Overfrequency;
- df/dt - Rate of Change of Frequency;
- f< + df/dt – Underfrequency and Rate of Change of Frequency;
- f> + df/dt - Overfrequency and Rate of Change of Frequency;

Protective Elements

- $f < + DF/DT$ – Underfrequency and absolute frequency change per definite time interval;
- $f > + DF/DT$ - Overfrequency and absolute frequency change per definite time interval and
- $\Delta\phi$ - Vector Surge

f< – Underfrequency

This protection element provides a pickup threshold and a tripping delay. If the frequency falls below the set pickup threshold, an alarm will be issued instantaneously. If the frequency remains under the set pickup threshold until the tripping delay has elapsed, a tripping command will be issued.

With this setting, the frequency element protects electrical generators, consumers, or electrical operating equipment in general against underfrequency.

f> – Overfrequency

This protection element provides a pickup threshold and a tripping delay. If the frequency exceeds the set pickup threshold, an alarm will be issued instantaneously. If the frequency remains above the set tripping pickup until the tripping delay has elapsed, a tripping command will be issued.

With this setting the frequency element protects electrical generators, consumers, or electrical operating equipment in general against overfrequency.

Working Principle $f<$ and $f>$

(Please refer to the block diagram on next page.)

The frequency element supervises the three voltages (depending on if the voltage transformers are wired in Star or Delta connection » $VL12$ «, » $VL23$ « und » $VL31$ « oder » $VL1$ «, » $VL2$ « und » $VL3$ «). If all of the three phase voltages are e.g. below 15% V_n , the frequency calculation is blocked (settable via parameter » $V\ Block\ f$ «). According to the frequency supervision mode set in the Device Planning ($f<$ or $f>$), the evaluated phase voltages are compared to the set pickup threshold for over- or under-frequency. If in any of the phases, the frequency exceeds or falls below the set pickup threshold and if there are no blocking commands for the frequency element, an alarm is issued instantaneously and the tripping delay timer is started. When the frequency still exceeds or is below the set pickup threshold after the tripping delay timer has elapsed, a tripping command will be issued.

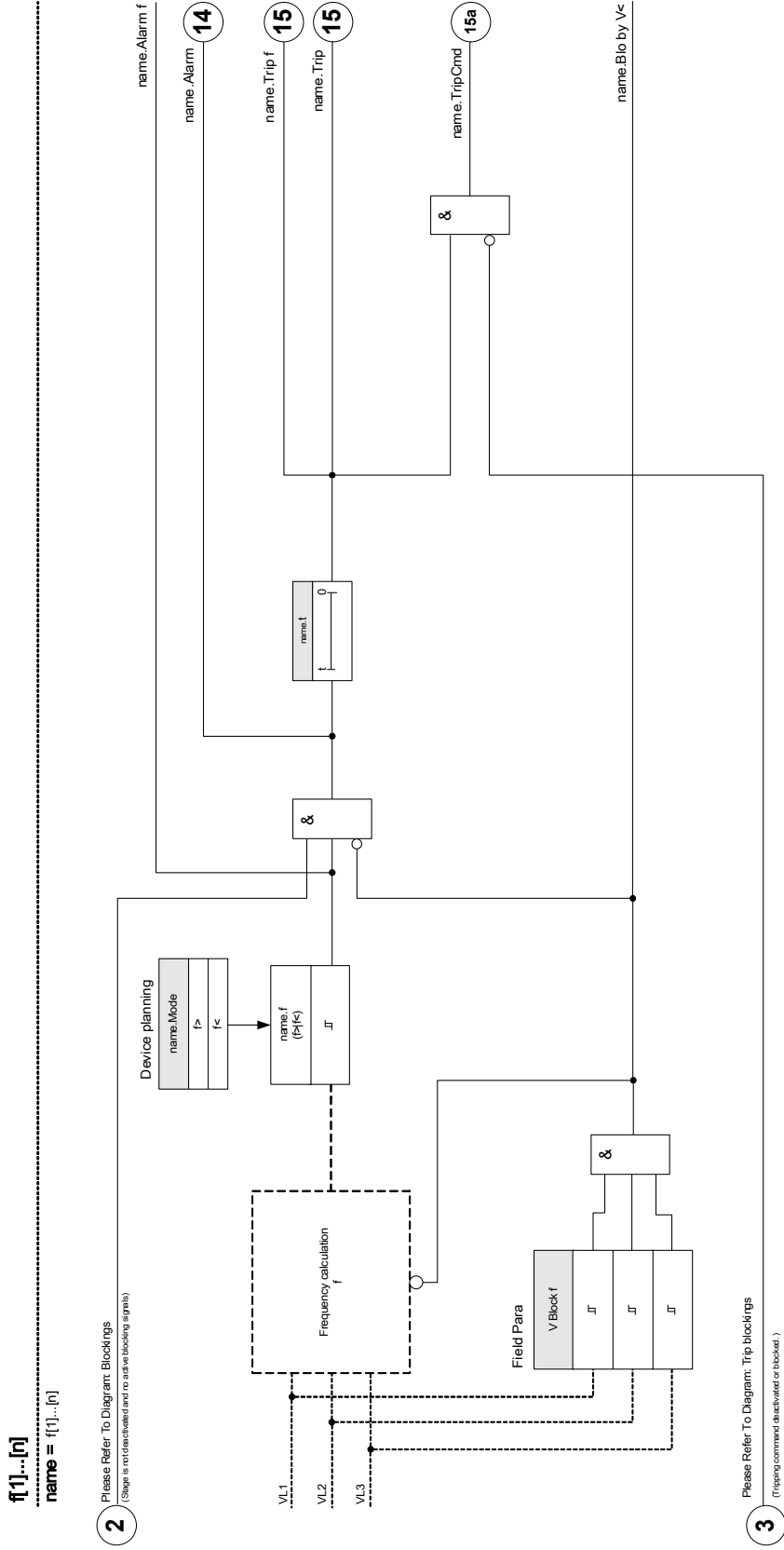

df/dt - Rate of Change of Frequency

Electrical generators running in parallel with the mains, (e. g. industrial internal power supply plants), should be separated from the mains when failure in the intra-system occurs for the following reasons:

- Damage to electrical generators must be prevented when mains voltage is recovering asynchronously, (e. g. after a short interruption).
- The industrial internal power supply must be maintained.

A reliable criterion of detecting mains failure is the measurement of the rate of change of frequency (df/dt). The precondition for this is a load flow via the mains coupling point. At mains failure the load flow change spontaneously leads to an increasing or decreasing frequency. At active power deficit of the internal power station, a linear drop of the frequency occurs and a linear increase occurs at power excess. Typical frequency gradients during application of "mains decoupling" are in the range of 0.5 Hz/s up to over 2 Hz/s.

The protective device detects the instantaneous frequency gradient (df/dt) of each mains voltage period. Through multiple evaluations of the frequency gradient in sequence the continuity of the directional change (sign of the frequency gradient) is determined. Because of this special measuring procedure a high safety in tripping and thus a high stability against transient processes, (e. g. switching procedure) are achieved.

The frequency gradient (rate of change of frequency [df/dt]) may have a negative or positive sign, depending on frequency increase (positive sign) or decrease (negative sign).

In the frequency parameter sets, the User can define the kind of df/dt mode:

- Positive df/dt = the frequency element detects an increase in frequency
- Negative df/dt = the frequency element detects a decrease in frequency and
- Absolute df/dt (positive and negative) = the frequency element detects both, increase and decrease in frequency

This protection element provides a tripping threshold and a tripping delay. If the frequency gradient df/dt exceeds or falls below the set tripping threshold, an alarm will be issued instantaneously. If the frequency gradient remains still above/below the set tripping threshold until the tripping delay has elapsed, a tripping command will be issued.

Working Principle df/dt

(Please refer to the block diagram on next page)

The frequency element supervises the three voltages (depending on if the voltage transformers are wired in Star or Delta connection » *VL12*«, » *VL23*« und » *VL31*« oder » *VL1*«, » *VL2*« und » *VL3*«). If any of the three phase voltages is e.g. below 15% V_n , the frequency calculation is blocked (settable via parameter » *V Block f*«). According to the frequency supervision mode set in the Device Planning (df/dt), the evaluated phase voltages are compared to the set frequency gradient (df/dt) threshold. If in any of the phases, the frequency gradient exceeds or falls below the set pickup threshold (acc. to the set df/dt mode) and if there are no blocking commands for the frequency element, an alarm is issued instantaneously and the tripping delay timer is started. When the frequency gradient still exceeds or is below the set pickup threshold after the tripping delay timer has elapsed, a tripping command will be issued.

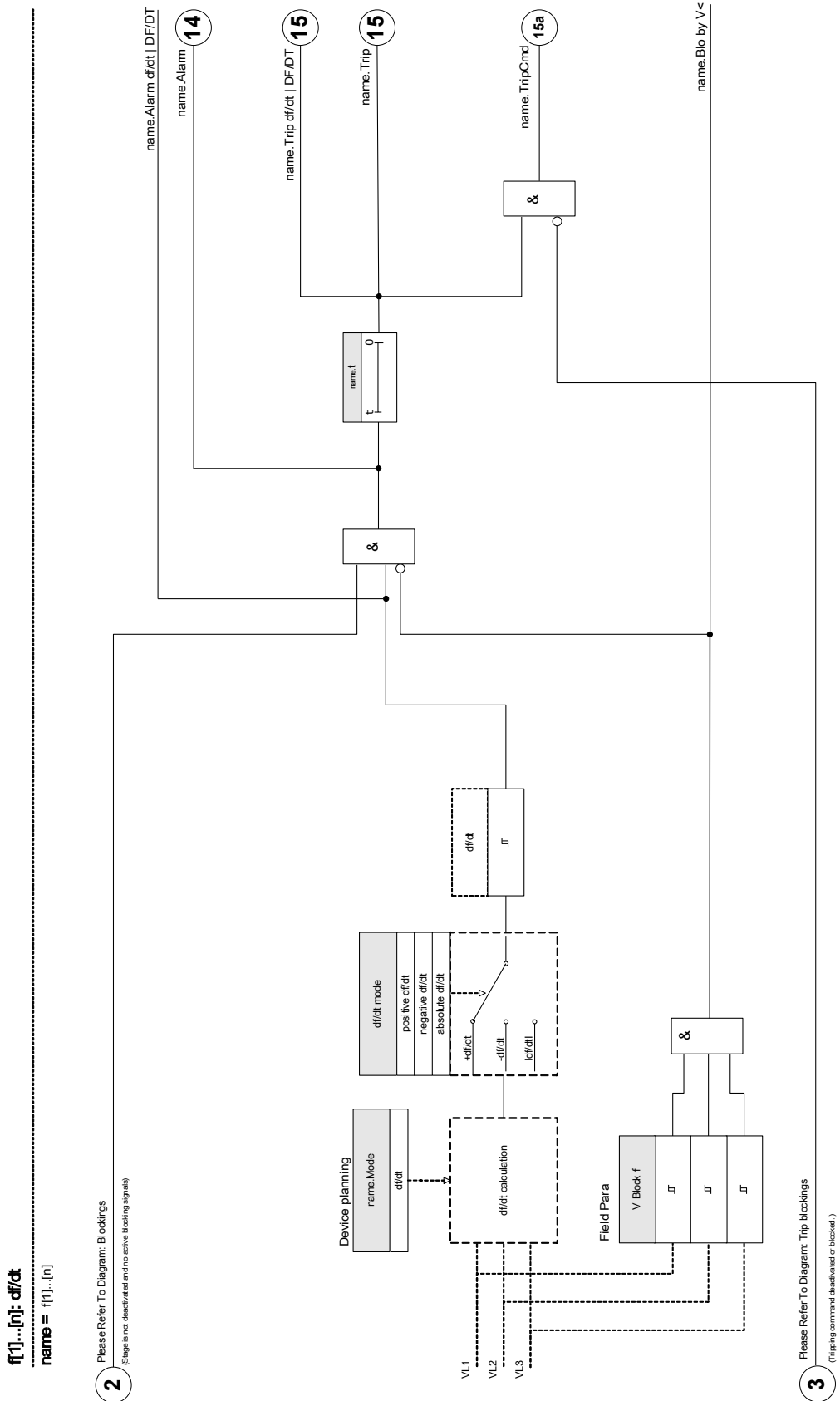

f< and df/dt – Underfrequency and Rate of Change of Frequency

With this setting the frequency element supervises if the frequency falls below a set pickup threshold and if the frequency gradient exceeds a set threshold at the same time.

In the selected frequency parameter set f[X], an underfrequency pickup threshold f<, a frequency gradient df/dt and a tripping delay can be set.

Whereby:

- Positive df/dt = the frequency element detects an increase in frequency
- Negative df/dt = the frequency element detects a decrease in frequency and
- Absolute df/dt (positive and negative) = the frequency element detects both, increase and decrease in frequency

f> and df/dt – Overfrequency and Rate of Change of Frequency

With this setting the frequency element supervises if the frequency exceeds a set pickup threshold and if the frequency gradient exceeds a set threshold at the same time.

In the selected frequency parameter set f[X], an overfrequency pickup threshold f>, a frequency gradient df/dt and a tripping delay can be set.

Whereby:

- Positive df/dt = the frequency element detects an increase in frequency
- Negative df/dt = the frequency element detects a decrease in frequency and
- Absolute df/dt (positive and negative) = the frequency element detects both, increase and decrease in frequency

Working Principle f< and df/dt | f> and df/dt

(Please refer to the block diagram on next page)

The frequency element supervises the three voltages (depending on if the voltage transformers are wired in Star or Delta connection » VL12«, » VL23« und » VL31« oder » VL1«, » VL2« und » VL3«).

If any of the three phase voltages is e.g. below 15% Vn, the frequency calculation is blocked (settable via parameter » V Block f«). According to the frequency supervision mode set in the Device Planning (f< and df/dt or f> and dt/dt), the evaluated phase voltages are compared to the set frequency pickup threshold and the set frequency gradient (df/dt) threshold. If in any of the phases, both - the frequency and the frequency gradient exceed or fall below the set thresholds and if there are no blocking commands for the frequency element, an alarm is issued instantaneously and the tripping delay timer is started. When the frequency and the frequency gradient still exceed or are below the set threshold after the tripping delay timer has elapsed, a tripping command will be issued.

2 If [1]...[n]: f< and df/dt Or f> and df/dt
 name = f[1]...[n]

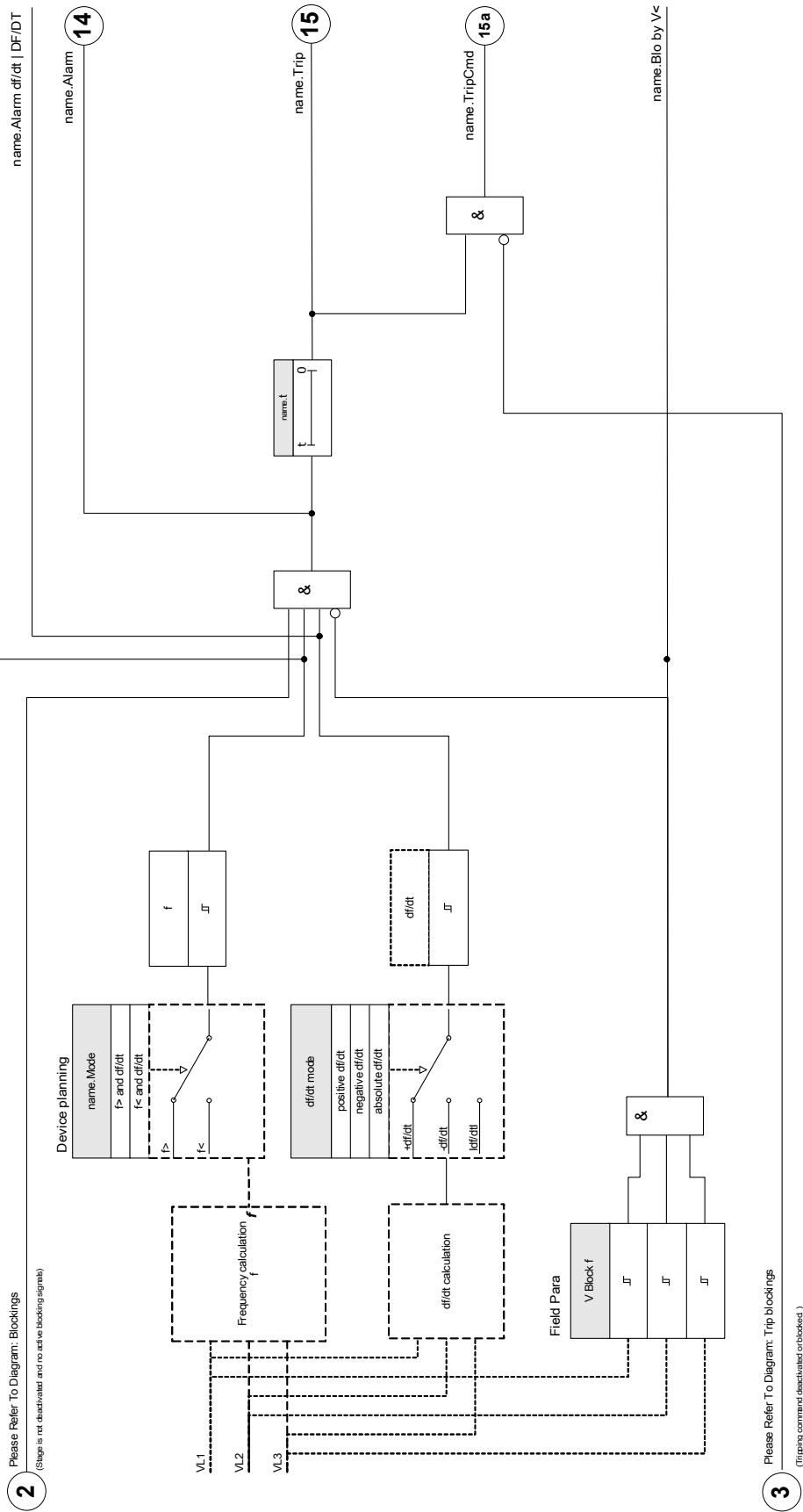

2 Please Refer To Diagram: Blockings
 (Step is not deactivated and no active blockings present)

3 Please Refer To Diagram: Trip blockings
 (Tripping command deactivated or blocked)

f< and DF/DT – Underfrequency and DF/DT

With this setting the frequency element supervises the frequency and the absolute frequency difference during a definite time interval.

In the selected frequency parameter set f[X], an underfrequency pickup threshold f<, a threshold for the absolute frequency difference (frequency decrease) DF and supervision interval DT can be set.

f> and DF/DT – Overfrequency and DF/DT

With this setting the frequency element supervises the frequency and the absolute frequency difference during a definite time interval.

In the selected frequency parameter set f[X], an overfrequency pickup threshold f>, a threshold for the absolute frequency difference (frequency increase) DF and supervision interval DT can be set.

Working principle f< and DF/DT | f> and DF/DT

(please refer to block diagram on next page)

The frequency element supervises the three voltages (depending on if the voltage transformers are wired in Star or Delta connection »VL12«, »VL23« und »VL31« oder »VL1«, »VL2« und »VL3«).

If any of the three phase voltages is e.g. below 15% Vn, the frequency calculation is blocked (settable via parameter »V Block f«). According to the frequency supervision mode set in the Device Planning (f< and DF/DT or f> and DF/DT), the evaluated phase voltages are compared to the set frequency pickup threshold and the set frequency decrease or increase threshold DF.

If in any of the phases, the frequency exceeds or falls below the set pickup threshold and if there are no blocking commands for the frequency element, an alarm is issued instantaneously. At the same time the timer for the supervision interval DT is started. When, during the supervision interval DT, the frequency still exceeds or is below the set pickup threshold and the frequency decrease/increase reaches the set threshold DF, a tripping command will be issued.

Working Principle of DF/DT Function

(Please refer to f(t) diagram after the block diagram)

Case 1:

When the frequency falls below a set f< threshold at t1, the DF/DT element energizes. If the frequency difference (decrease) does not reach the set value DF before the time interval DT has expired, no trip will occur. The frequency element remains blocked until the frequency falls below the underfrequency threshold f< again.

Case 2:

When the frequency falls below a set f< threshold at t4, the DF/DT element energizes. If the frequency difference (decrease) reaches the set value DF before the time interval DT has expired (t5), a trip command is issued.

f(1)...[n]: f< and DF/DT Or f> and DF/DT
name = f(1)...[n]

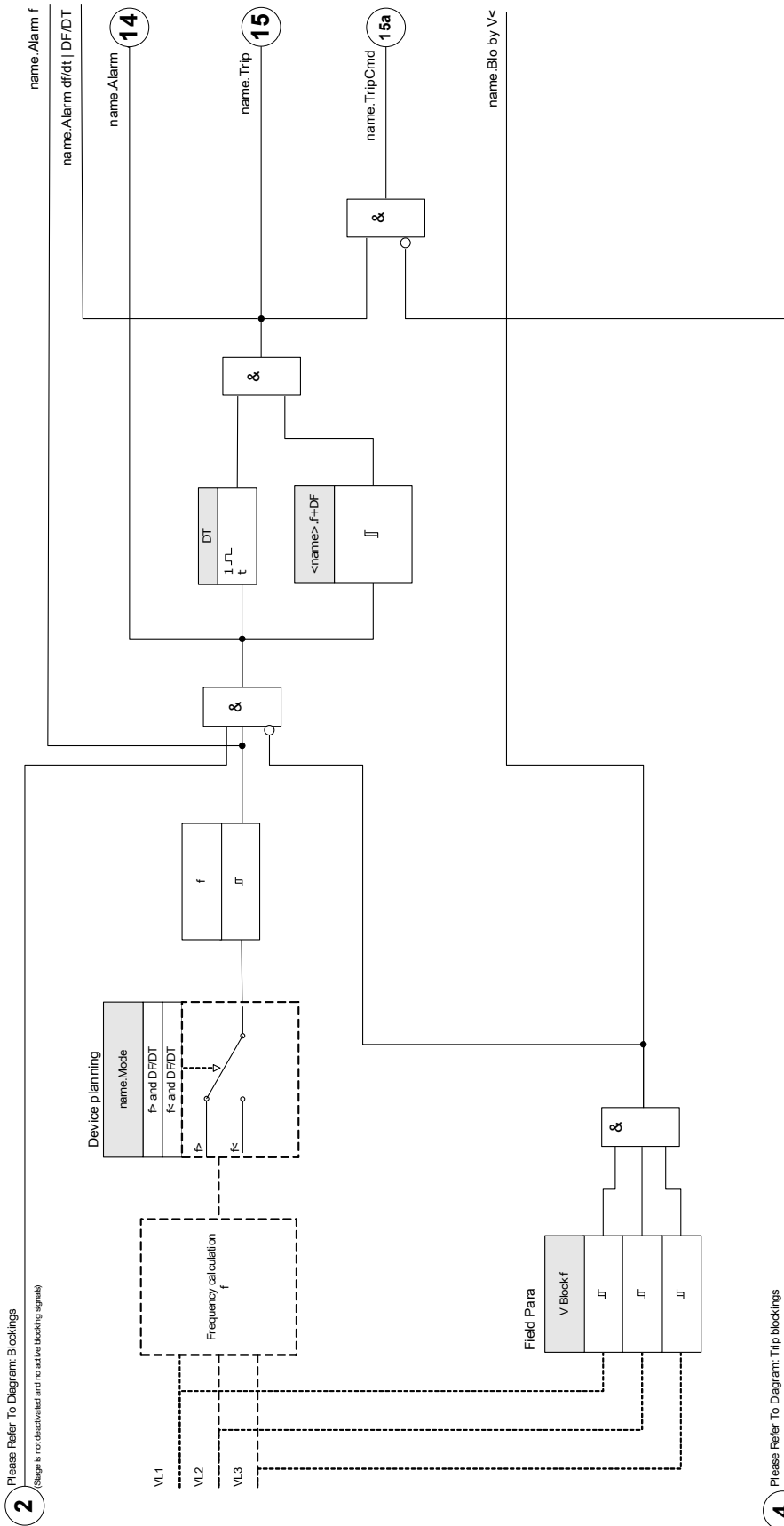

f(1)..
name = f(1)..
k and DF/DT

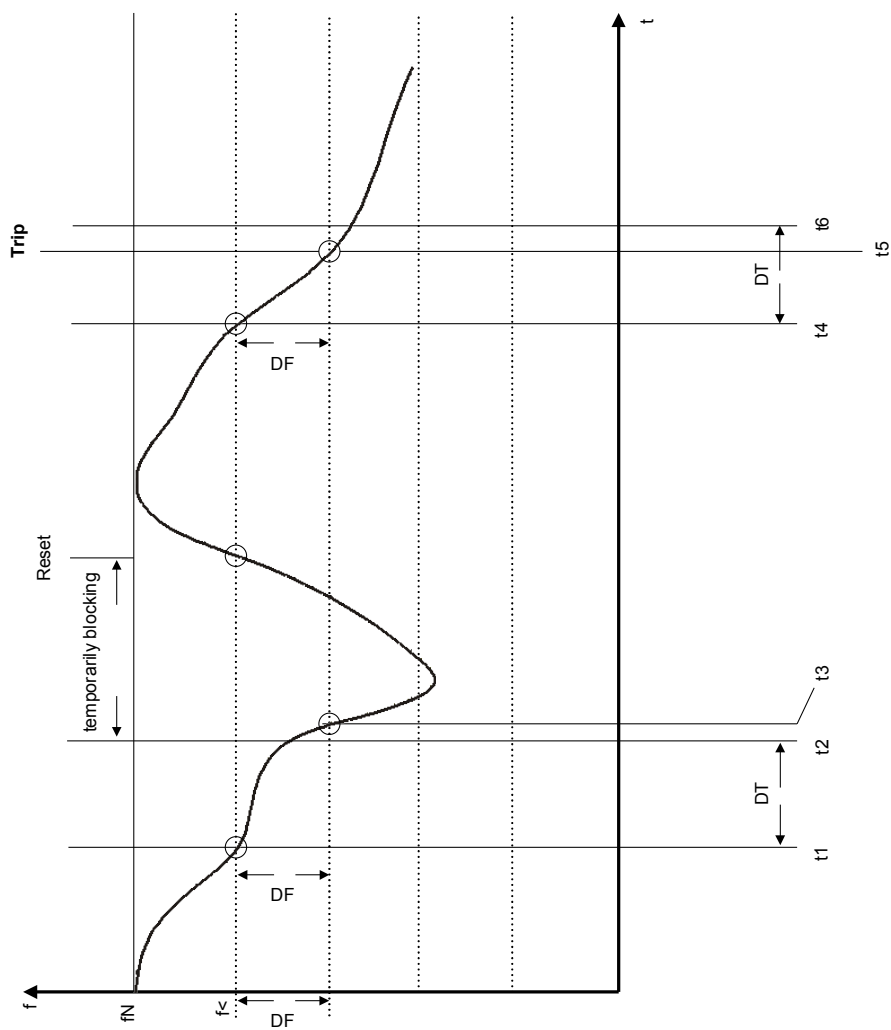

Delta phi - Vector Surge

The vector surge supervision protects synchronous generators in mains parallel operation due to very fast decoupling in case of mains failure. Very dangerous are mains auto reclosings for synchronous generators. The mains voltage returning typically after 300 ms can hit the generator in asynchronous position. A very fast decoupling is also necessary in case of long time mains failures.

Generally there are two different applications:

Only mains parallel operation - no single operation:

In this application the vector surge supervision protects the generator by tripping the generator circuit breaker in case of mains failure.

Mains parallel operation and single operation:

For this application the vector surge supervision trips the mains circuit breaker. Here it is insured that the gen.-set is not blocked when it is required as an emergency set.

A very fast decoupling in case of mains failures for synchronous generators is very difficult. Voltage supervision units cannot be used because the synchronous alternator as well as the consumer impedance support the decreasing voltage.

In this situation the mains voltage drops only after some 100 ms below the pickup threshold of the voltage supervision and therefore a safe detection of mains auto reclosings is not possible with voltage supervision only.

Frequency supervision is partially unsuitable because only a highly loaded generator decreases its speed within 100 ms. Current relays detect a fault only when short-circuit type currents exist, but cannot avoid their development. Power relays are able to pickup within 200 ms, but they also cannot prevent the power rising to short-circuit values. Since power changes are also caused by sudden loaded alternators, the use of power relays can be problematic.

Whereas the vector surge supervision of the device detects mains failures within 60 ms without the restrictions described above because it is specially designed for applications where very fast decoupling from the mains is required. Adding the typical operating time of a circuit breaker or contactor, the total disconnection time remains below 150 ms.

Basic requirement for tripping of the generator/mains monitor is a change in load of more than 15 - 20% of the rated load. Slow changes of the system frequency, for instance at regulating processes (adjustment of speed regulator) do not cause the relay to trip.

Trippings can also be caused by short-circuits within the grid, because a voltage vector surge higher than the preset value can occur. The magnitude of the voltage vector surge depends on the distance between the short-circuit and the generator. This function is also of advantage to the Power Utility Company because the mains short-circuit capacity and, consequently, the energy feeding the short-circuit is limited.

To prevent a possible false tripping, the vector surge measuring is blocked at a low input voltage e.g. <15% V_n (settable via parameter »V Block f«). The undervoltage lockout acts faster than the vector surge measurement.

Vector surge tripping is blocked by a phase loss so that a VT fault (e. g.: faulty VTs fuse) does not cause false tripping.

Measuring Principle of Vector Surge Supervision

Equivalent circuit at synchronous generator in parallel with the mains.

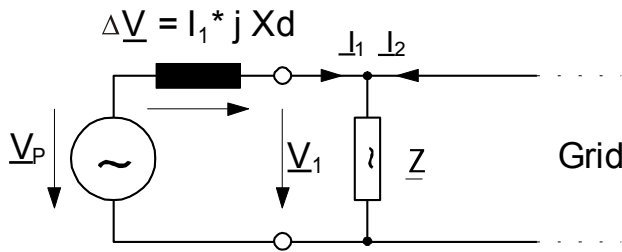

Voltage vectors at mains parallel operation.

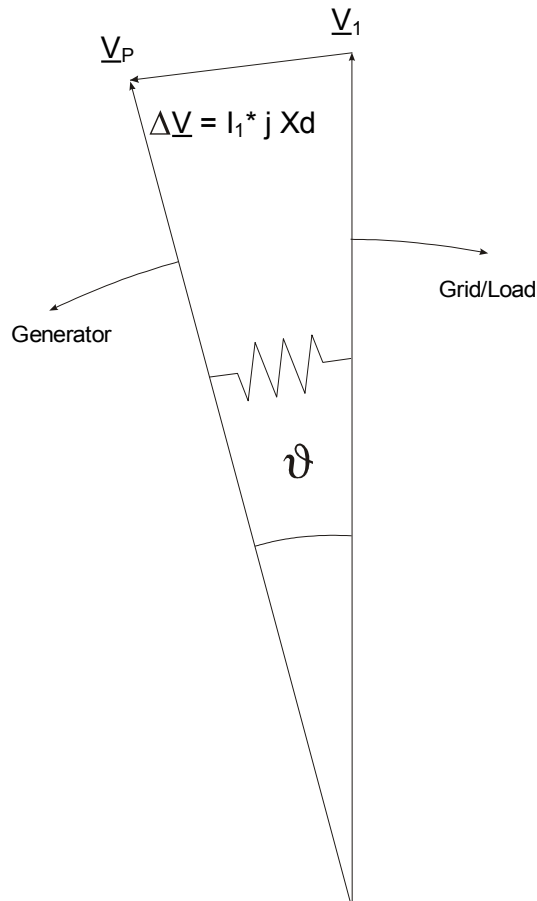

The rotor displacement angle between stator and rotor is dependent on the mechanical moving torque of the generator. The mechanical shaft power is balanced with the electrical fed mains power and, therefore the synchronous speed keeps constant.

Equivalent circuit at mains failure.

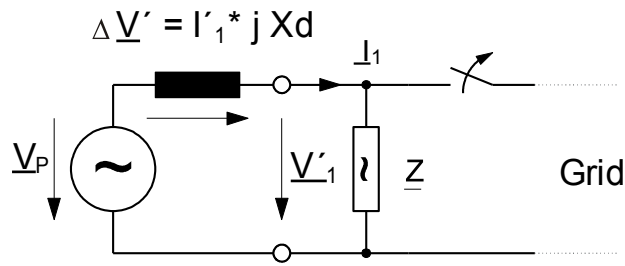

In case of mains failure or auto reclosing the generator suddenly feeds a very high consumer load. The rotor displacement angle is decreased repeatedly and the voltage vector V_1 changes its direction (V'_1).

Voltage vectors at mains failure.

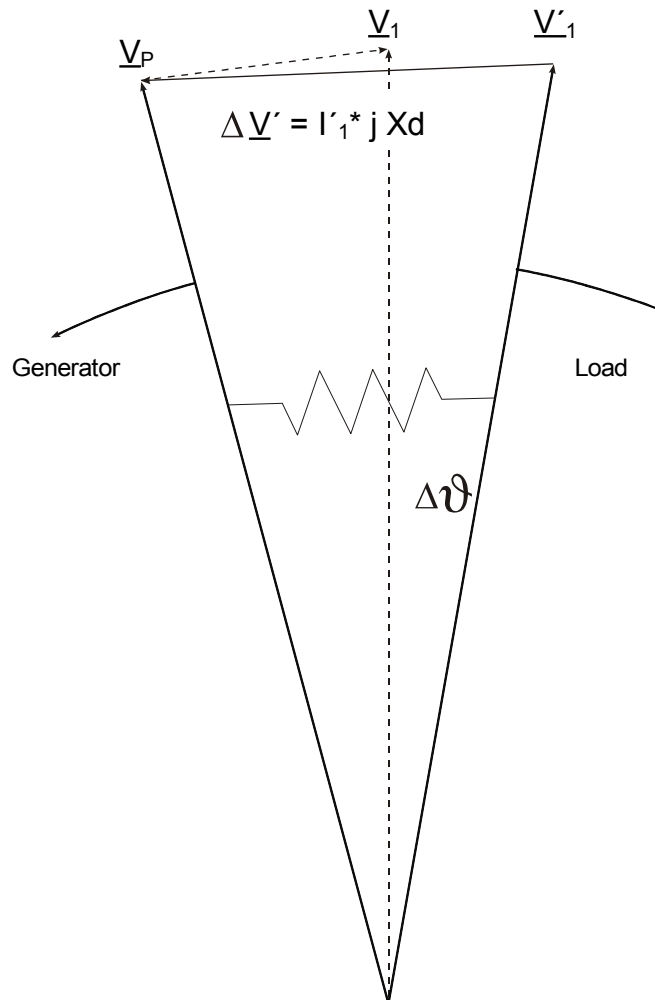

Voltage vector surge.

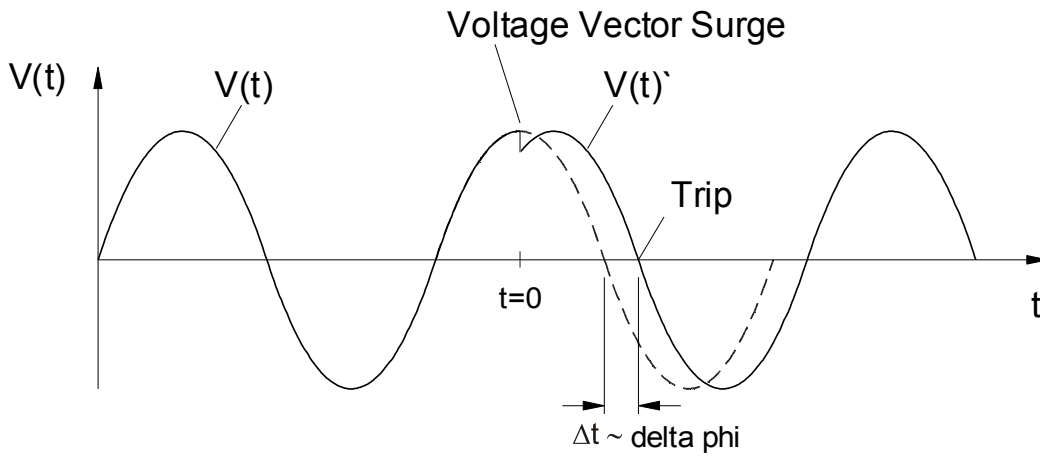

As shown in the voltage/time diagram the instantaneous value of the voltage jumps to another value and the phase position changes. This is called phase or vector surge.

The relay measures the cycle duration. A new measuring is started at each zero passage. The measured cycle duration is internally compared with a reference time and from this the deviation of the cycle duration of the voltage signal is ascertained. In case of a vector surge as shown in the above graphic, the zero passage occurs either earlier or later. The established deviation of the cycle duration is in compliance with the vector surge angle. If the vector surge angle exceeds the set value, the relay trips immediately.

Tripping of the vector surge is blocked in case of loss of one or more phases of the measuring voltage.

Working Principle delta phi

(Please refer to the block diagram on next page)

The frequency element supervises the three voltages (depending on if the voltage transformers are wired in Star or Delta connection »VL12«, »VL23« und »VL31« oder »VL1«, »VL2« und »VL3«).

If any of the three phase voltages is e.g. below 15% V_n , the vector surge calculation is blocked (settable via parameter »V Block f«). According to the frequency supervision mode set in the Device Planning (delta phi), the phase voltages are compared to the set vector surge threshold. If, depending on the parameter setting, in all three, in two or in one of the phases, the vector surge exceeds the set threshold and if there are no blocking commands for the frequency element, an alarm and a trip command is issued instantaneously.

f[1]...[n]: delta phi
name = f[1]...[n]

2

Please Refer To Diagram: Blockings

(Range is not discarded and nonactive blocking signals)

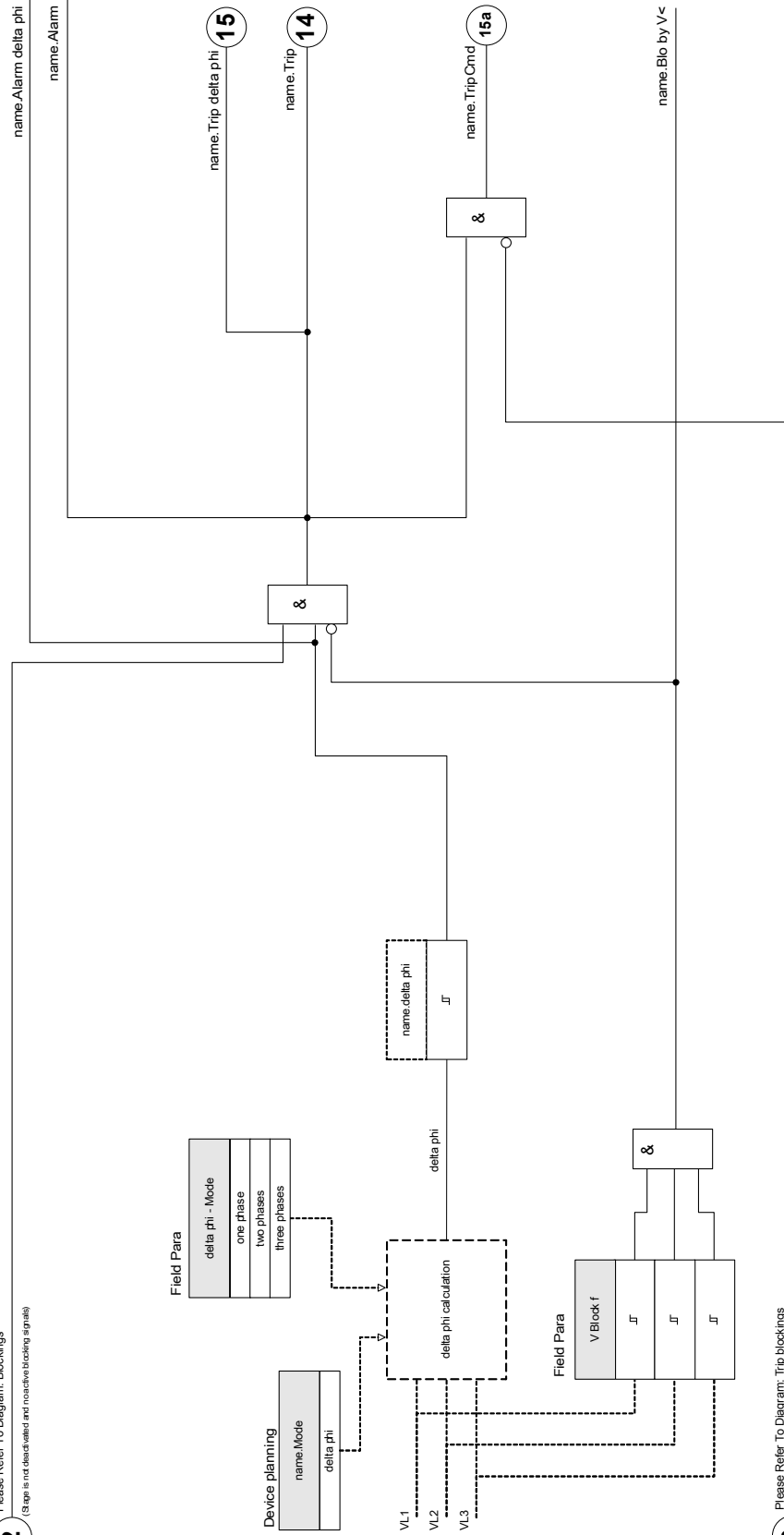

3



Please Refer To Diagram: Trip blockings

(Trip command disabled or locked.)









Device Planning Parameters of the Frequency Protection Module

| Parameter | Description | Options | Default | Menu path |
|---|-------------|--|--|-------------------|
| Mode  | Mode | do not use, f<, f>, f< and df/dt, f> and df/dt, f< and DF/DT, f> and DF/DT, df/dt, delta phi | f[1]: f< f[2]: f> f[3]: do not use f[4]: do not use f[5]: do not use f[6]: do not use | [Device planning] |





Global Protection Parameters of the Frequency Protection Module

| Parameter | Description | Setting range | Default | Menu path |
|--|---|-----------------------|---------|---|
| ExBlo1  | External blocking of the module, if blocking is activated (allowed) within a parameter set and if the state of the assigned signal is true. | 1..n, Assignment List | -- | [Protection Para /Global Prot Para /f-Prot /f[1]] |
| ExBlo2  | External blocking of the module, if blocking is activated (allowed) within a parameter set and if the state of the assigned signal is true. | 1..n, Assignment List | -- | [Protection Para /Global Prot Para /f-Prot /f[1]] |
| ExBlo TripCmd  | External blocking of the Trip Command of the module/the stage, if blocking is activated (allowed) within a parameter set and if the state of the assigned signal is true. | 1..n, Assignment List | -- | [Protection Para /Global Prot Para /f-Prot /f[1]] |

Setting Group Parameters of the Frequency Protection Module

| Parameter | Description | Setting range | Default | Menu path |
|---|---|---------------------|--|--|
|  Function | Permanent activation or deactivation of module/stage. | inactive, active | f[1]: active f[2]: active f[3]: inactive f[4]: inactive f[5]: inactive f[6]: inactive | [Protection Para /<1..4> /f-Prot /f[1]] |
|  ExBlo Fc | Activate (allow) or inactivate (disallow) blocking of the module/stage. This parameter is only effective if a signal is assigned to the corresponding global protection parameter. If the signal becomes true, those modules/stages are blocked that are parameterized "ExBlo Fc=active". | inactive, active | inactive | [Protection Para /<1..4> /f-Prot /f[1]] |
|  Blo TripCmd | Permanent blocking of the Trip Command of the module/stage. | inactive, active | inactive | [Protection Para /<1..4> /f-Prot /f[1]] |
|  ExBlo TripCmd Fc | Activate (allow) or inactivate (disallow) blocking of the module/stage. This parameter is only effective if a signal is assigned to the corresponding global protection parameter. If the signal becomes true, those modules/stages are blocked that are parameterized "ExBlo TripCmd Fc=active". | inactive, active | inactive | [Protection Para /<1..4> /f-Prot /f[1]] |
|  f> | Pickup value for overfrequency. Only available if: Device planning: f.Mode = f> Or f> and df/dt Or f> and DF/DT | 40.00 - 69.95Hz | 51.00Hz | [Protection Para /<1..4> /f-Prot /f[1]] |
|  f< | Pickup value for underfrequency. Only available if: Device planning: f.Mode = f< Or f< and df/dt Or f< and DF/DT | 40.00 - 69.95Hz | 49.00Hz | [Protection Para /<1..4> /f-Prot /f[1]] |
|  t | Tripping delay Only available if: Device planning: f.Mode = f< Or f>Or f> and df/dt Or f< and df/dt | 0.00 - 3600.00s | 1.00s | [Protection Para /<1..4> /f-Prot /f[1]] |
|  df/dt | Measured value (calculated): Rate-of-frequency-change. Only available if: Device planning: f.Mode = df/dt Or f< and df/dt Or f> and df/dt | 0.100 - 10.000Hz/s | 1.000Hz/s | [Protection Para /<1..4> /f-Prot /f[1]] |

Protective Elements

| Parameter | Description | Setting range | Default | Menu path |
|--|--|--|----------------|--|
| t-df/dt  | Trip delay df/dt | 0.00 - 300.00s | 1.00s | [Protection Para /<1..4> /f-Prot /f[1]] |
| DF  | Frequency difference for the maximum admissible variation of the mean of the rate of frequency-change. This function is inactive if DF=0. Only available if: Device planning: f.Mode = f< and DF/DT Or f> and DF/DT | 0.0 - 10.0Hz | 1.00Hz | [Protection Para /<1..4> /f-Prot /f[1]] |
| DT  | Time interval of the maximum admissible rate-of-frequency-change. Only available if: Device planning: f.Mode = f< and DF/DT Or f> and DF/DT | 0.1 - 10.0s | 1.00s | [Protection Para /<1..4> /f-Prot /f[1]] |
| df/dt mode  | df/dt mode Only available if: Device planning: f.Mode = df/dt Or f< and df/dt Or f> and df/dt Only available if: Device planning: f.Mode = df/dt Or f< and df/dt Or f> and df/dt Only available if: Device planning: f.Mode = df/dt | absolute df/dt, positive df/dt, negative df/dt | absolute df/dt | [Protection Para /<1..4> /f-Prot /f[1]] |
| delta phi  | Measured value (calculated): Vector surge Only available if: Device planning: f.Mode = delta phi | 1 - 30° | 10° | [Protection Para /<1..4> /f-Prot /f[1]] |

Frequency Protection Module Input States

| <i>Name</i> | <i>Description</i> | <i>Assignment via</i> |
|-----------------|---|--|
| ExBlo1-I | Module input state: External blocking1 | [Protection Para /Global Prot Para /f-Prot /f[1]] |
| ExBlo2-I | Module input state: External blocking2 | [Protection Para /Global Prot Para /f-Prot /f[1]] |
| ExBlo TripCmd-I | Module input state: External Blocking of the Trip Command | [Protection Para /Global Prot Para /f-Prot /f[1]] |

Frequency Protection Module Signals (Output States)

| <i>Signal</i> | <i>Description</i> |
|---------------------|--|
| active | Signal: active |
| ExBlo | Signal: External Blocking |
| Blo by V< | Signal: Module is blocked by undervoltage. |
| Blo TripCmd | Signal: Trip Command blocked |
| ExBlo TripCmd | Signal: External Blocking of the Trip Command |
| Alarm f | Signal: Alarm Frequency Protection |
| Alarm df/dt DF/DT | Alarm instantaneous or average value of the rate-of-frequency-change |
| Alarm delta phi | Signal: Alarm Vector Surge |
| Alarm | Signal: Alarm Frequency Protection (collective signal) |
| Trip f | Signal: Frequency has exceeded the limit. |
| Trip df/dt DF/DT | Signal: Trip df/dt or DF/DT |
| Trip delta phi | Signal: Trip Vector Surge |
| Trip | Signal: Trip Frequency Protection (collective signal) |
| TripCmd | Signal: Trip Command |

Commissioning: Overfrequency [f>]

Object to be tested

All configured overfrequency protection stages.

Necessary means

- Three-phase voltage source with variable frequency and
- Timer

Procedure

Testing the threshold values

- Keep on increasing the frequency until the respective frequency element is activated;
- Note the frequency value and
- Disconnect the test voltage.

Testing the trip delay

- Set the test voltage to nominal frequency and
- Now connect a frequency jump (activation value) and then start a timer. Measure the tripping time at the relay output.

Testing the fallback ratio

Reduce the measuring quantity to less than 99.95% of the trip value (or 0.05% fn). The relay must only fall back at 99.95% of the trip value at the earliest (or 0.05% fn).

Successful test result

Permissible deviations/tolerances can be taken from the Technical Data.

Commissioning: Underfrequency [f<]

For all configured underfrequency elements, this test can be carried out similar to the test for overfrequency protection (by using the related underfrequency values).

Please consider the following deviations:

- For testing the threshold values, the frequency has to be decreased until the protection element is activated.
- For detection of the fallback ratio, the measuring quantity has to be increased to more than 100.05% of the trip value (or 0.05% fn). At 100.05% of the trip value the relay is to fall back at the earliest (or 0.05% fn).

Commissioning: df/dt - ROCOF

Object to be tested

All frequency protection stages that are projected as df/dt .

Necessary means

- Three-phase voltage source and
- Frequency generator that can generate and measure a linear, defined rate of change of frequency.

Procedure

Testing the threshold values

- Keep on increasing the rate of change of frequency until the respective element is activated.
- Note the value.

Testing the trip delay

- Set the test voltage to nominal frequency.
- Now apply a step change (sudden change) that is 1.5 times the setting value (example: apply 3 Hz per second if the setting value is 2 Hz per second) and
- Measure the tripping time at the relay output. Compare the measured tripping time to the configured tripping time.

Successful test result:

Permissible deviations/tolerances and dropout ratios can be taken from the Technical Data.

Commissioning: $f <$ and $-df/dt$ – Underfrequency and ROCOF

Object to be tested:

All frequency protection stages that are projected as $f <$ and $-df/dt$.

Necessary means:

- Three-phase voltage source and
- Frequency generator that can generate and measure a linear, defined rate of change of frequency.

Procedure:

Testing the threshold values

- Feed nominal voltage and nominal frequency to the device
- Decrease the frequency below the $f <$ threshold and
- Apply a rate of change of frequency (step change) that is below the setting value (example apply -1 Hz per second if the setting value is -0.8 Hz per second). After the tripping delay is expired the relay has to trip.

Successful test result

Permissible deviations/tolerances and dropout ratios can be taken from the Technical Data.

Commissioning: $f >$ and df/dt – Overfrequency and ROCOF

Object to be tested

All frequency protection stages that are projected as $f >$ and df/dt .

Necessary means

- Three-phase voltage source and.
- Frequency generator that can generate and measure a linear, defined rate of change of frequency.

Procedure

Testing the threshold values

- Feed nominal voltage and nominal frequency to the device.
- Increase the frequency above the $f >$ threshold and.
- Apply a rate of change of frequency (step change) that is above the setting value (example apply 1 Hz per second if the setting value is 0.8 Hz per second). After the tripping delay is expired the relay has to trip.

Successful test result:

Permissible deviations/tolerances and dropout ratios can be taken from the Technical Data.

Commissioning: $f <$ and DF/DT – Underfrequency and DF/DT

Object to be tested:

All frequency protection stages that are projected as $f <$ and Df/Dt.

Necessary means:

- Three-phase voltage source and
- Frequency generator that can generate and measure a defined frequency change.

Procedure:

Testing the threshold values

- Feed nominal voltage and nominal frequency to the device:
- Decrease the frequency below the $f <$ threshold and
- Apply a defined frequency change (step change) that is above the setting value (example: apply a frequency change of 1 Hz during the set time interval DT if the setting value DF is 0.8 Hz). The relay has to trip immediately.

Successful test result

Permissible deviations/tolerances and dropout ratios can be taken from the Technical Data.

Commissioning: $f >$ and DF/DT – Overfrequency and DF/DT

Object to be tested:

All frequency protection stages that are projected as $f >$ and Df/Dt.

Necessary means:

- Three-phase voltage source and
- Frequency generator that can generate and measure a defined frequency change.

Procedure:

Testing the threshold values

- Feed nominal voltage and nominal frequency to the device:
- Increase the frequency above the $f >$ threshold and
- Apply a defined frequency change (step change) that is above the setting value (example: apply a frequency change of 1 Hz during the set time interval DT if the setting value DF is 0.8 Hz). The relay has to trip immediately.

Successful test result:

Permissible deviations/tolerances and dropout ratios can be taken from the Technical Data.

Commissioning: delta phi - Vector Surge

Object to be tested:

All frequency protection stages that are projected as delta phi (vector surge).

Necessary means:

- Three-phase voltage source that can generate a definite step (sudden change) of the voltage pointers (phase shift).

Procedure:

Testing the threshold values

- Apply a vector surge (sudden change) that is 1.5 times the setting value (example: if the setting value is 10° apply 15°).

Successful test result:

Permissible deviations/tolerances and dropout ratio can be taken from the Technical Data.

V 012 – Voltage Asymmetry [47]

Available elements:

V012[1] .V012[2] .V012[3] .V012[4] .V012[5] .V012[6]

Within the Device planning menu this module can be projected in order to supervise the positive phase sequence voltage for over- or undervoltage or the negative phase sequence system for overvoltage. This module is based on the 3-phase voltages.

The module is alarmed, if the threshold is exceeded. The module will trip, if the measured values remain for the duration of the delay timer above the threshold continuously.

In case that the negative phase sequence voltage is monitored, the threshold » $V2>$ « can be combined with an additional percentage criterion » $\%V2/V1$ « (AND-connected) in order to prevent faulty tripping in case of a lack of voltage within the positive phase sequence system.

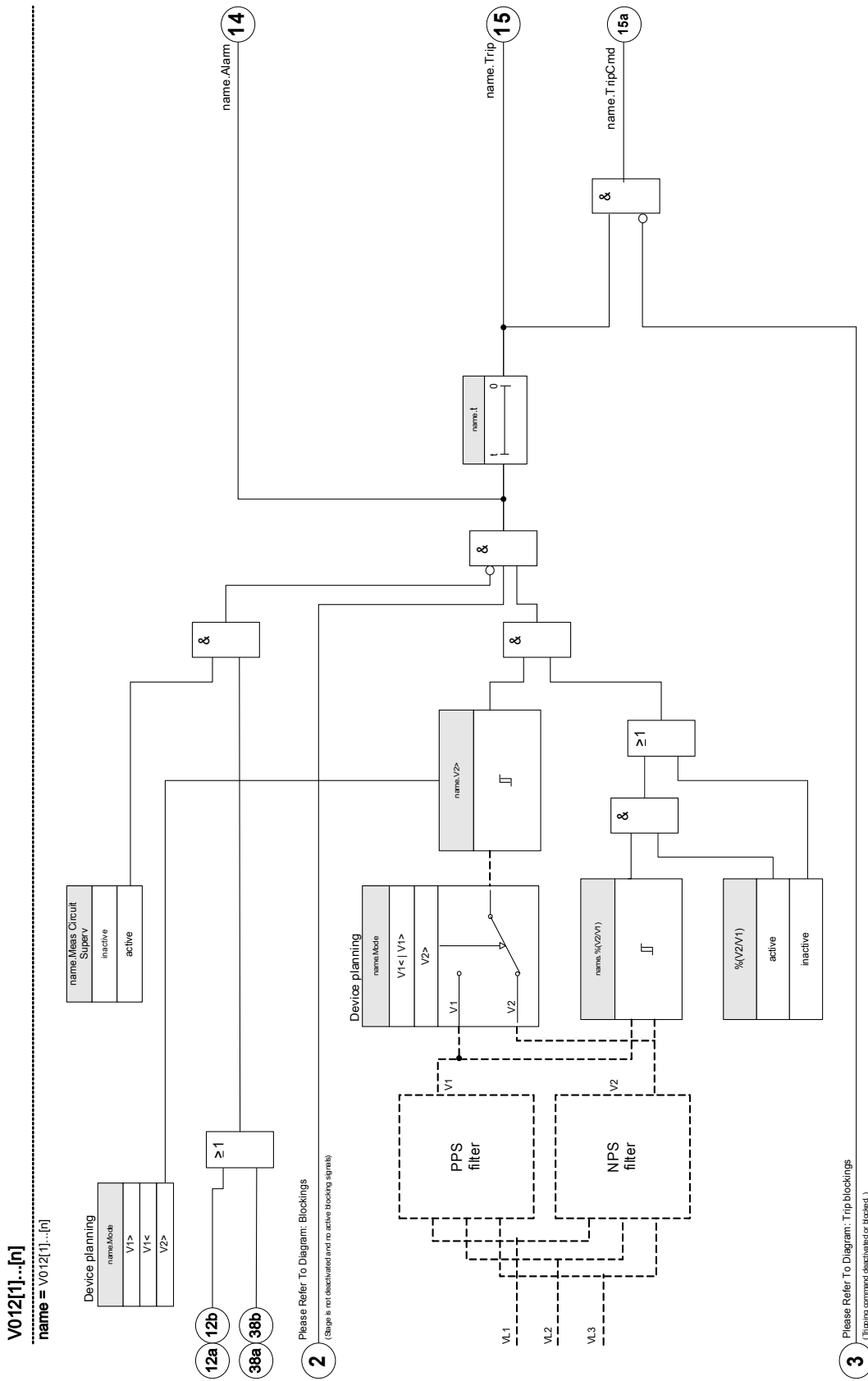

| Application Options of the V 012 Module | Setting in | Option |
|--|----------------------|--|
| ANSI 47 – Negative Sequence Overvoltage (Supervision of the Negative Phase Sequence System) Setting within the Device Planning ($V2>$) | Device Planning Menu | $\%V2/V1$: The Module trips, if the threshold $U2>$ and the ratio of negative to positive phase sequence voltage is exceeded (after the delay timer has expired). This criterion is to be activated and parametrized within the parameter set. |
| ANSI 59U1 Overvoltage within the Positive Phase Sequence System Setting within the Device Planning ($V1>$) | Device Planning Menu | - |
| ANSI 27U1 Undervoltage within the Positive Phase Sequence System Setting within the Device Planning ($V1<$) | Device Planning Menu | - |



Device planning parameters of the asymmetry module



| Parameter | Description | Options | Default | Menu path |
|---|---|------------------------------------|------------|-------------------|
| Mode  | Unbalance Protection: Supervision of the Voltage System | do not use, V1>, V1<, V2> | do not use | [Device planning] |

Global protection parameter of the asymmetry-module

| Parameter | Description | Setting range | Default | Menu path |
|--|---|-----------------------|---------|---|
| ExBlo1  | External blocking of the module, if blocking is activated (allowed) within a parameter set and if the state of the assigned signal is true.1 | 1..n, Assignment List | -- | [Protection Para /Global Prot Para /V-Prot /V012[1]] |
| ExBlo2  | External blocking of the module, if blocking is activated (allowed) within a parameter set and if the state of the assigned signal is true.2 | 1..n, Assignment List | -- | [Protection Para /Global Prot Para /V-Prot /V012[1]] |
| ExBlo TripCmd  | External blocking of the Trip Command of the module/the stage, if blocking is activated (allowed) within a parameter set and if the state of the assigned signal is true. | 1..n, Assignment List | -- | [Protection Para /Global Prot Para /V-Prot /V012[1]] |

Parameter set parameters of the asymmetry module

| Parameter | Description | Setting range | Default | Menu path |
|---|---|---------------------|----------|---|
| Function  | Permanent activation or deactivation of module/stage. | inactive, active | inactive | [Protection Para /<1..4> /V-Prot /V012[1]] |
| ExBlo Fc  | Activate (allow) or inactivate (disallow) blocking of the module/stage. This parameter is only effective if a signal is assigned to the corresponding global protection parameter. If the signal becomes true, those modules/stages are blocked that are parameterized "ExBlo Fc=active". | inactive, active | inactive | [Protection Para /<1..4> /V-Prot /V012[1]] |
| Blo TripCmd  | Permanent blocking of the Trip Command of the module/stage. | inactive, active | inactive | [Protection Para /<1..4> /V-Prot /V012[1]] |
| ExBlo TripCmd Fc  | Activate (allow) or inactivate (disallow) blocking of the module/stage. This parameter is only effective if a signal is assigned to the corresponding global protection parameter. If the signal becomes true, those modules/stages are blocked that are parameterized "ExBlo TripCmd Fc=active". | inactive, active | inactive | [Protection Para /<1..4> /V-Prot /V012[1]] |
| V1>  | Positive Phase Sequence Overvoltage Only available if: Device planning: V012.Mode = V1> | 0.01 - 1.50Vn | 1.00Vn | [Protection Para /<1..4> /V-Prot /V012[1]] |
| V1<  | Positive Phase Sequence Undervoltage Only available if: Device planning: V012.Mode = V1< | 0.01 - 1.50Vn | 1.00Vn | [Protection Para /<1..4> /V-Prot /V012[1]] |
| V2>  | Negative Phase Sequence Overvoltage Only available if: Device planning: V012.Mode = V2> | 0.01 - 1.50Vn | 1.00Vn | [Protection Para /<1..4> /V-Prot /V012[1]] |
| %(V2/V1)  | The %(V2/V1) setting is the unbalance trip pickup setting. It is defined by the ratio of negative sequence voltage to positive sequence voltage (% Unbalance=V2/V1). Phase sequence will be taken into account automatically. | inactive, active | inactive | [Protection Para /<1..4> /V-Prot /V012[1]] |

| Parameter | Description | Setting range | Default | Menu path |
|--|--|---------------------|----------|---|
|  %(V2/V1) | The %(V2/V1) setting is the unbalance trip pickup setting. It is defined by the ratio of negative sequence voltage to positive sequence voltage (% Unbalance=V2/V1). Phase sequence will be taken into account automatically. Only available if: %(V2/V1) = use | 2 - 40% | 20% | [Protection Para /<1..4> /V-Prot /V012[1]] |
|  t | Tripping delay | 0.00 - 300.00s | 0.00s | [Protection Para /<1..4> /V-Prot /V012[1]] |
|  Meas Circuit Superv | Activates the use of the measuring circuit supervision. In this case the module will be blocked if a measuring circuit supervision module (e.g. LOP, VTS) signals a disturbed measuring circuit (e.g. caused by a fuse failure). | inactive, active | inactive | [Protection Para /<1..4> /V-Prot /V012[1]] |

States of the inputs of the asymmetry module

| Name | Description | Assignment via |
|-----------------|---|---|
| ExBlo1-I | Module input state: External blocking1 | [Protection Para /Global Prot Para /V-Prot /V012[1]] |
| ExBlo2-I | Module input state: External blocking2 | [Protection Para /Global Prot Para /V-Prot /V012[1]] |
| ExBlo TripCmd-I | Module input state: External Blocking of the Trip Command | [Protection Para /Global Prot Para /V-Prot /V012[1]] |

Signals of the asymmetry module (states of the outputs)

| Signal | Description |
|---------------|---|
| active | Signal: active |
| ExBlo | Signal: External Blocking |
| Blo TripCmd | Signal: Trip Command blocked |
| ExBlo TripCmd | Signal: External Blocking of the Trip Command |
| Alarm | Signal: Alarm voltage asymmetry |

Protective Elements

| <i>Signal</i> | <i>Description</i> |
|---------------|----------------------|
| Trip | Signal: Trip |
| TripCmd | Signal: Trip Command |

Commissioning: Asymmetry Protection

Object to be tested

Test of the asymmetry protection elements.

Necessary means

- 3-phase AC voltage source
- Timer for measuring of the tripping time
- Voltmeter

Testing the tripping values (Example)

Set the pickup value for the voltage in the negative phase sequence to $0.5 V_n$. Set the tripping delay to 1 s.

In order to generate a negative phase sequence voltage interchange the wiring of two phases (VL2 and VL3).

Testing the trip delay

Start the timer and abrupt change (switch) to 1.5 times of the set tripping value. Measure the trip delay.

Successful test result

The measured threshold values and trip delays comply with those specified in the adjustment list. Permissible deviations/tolerances can be taken from the Technical Data.

Sync - Synchrocheck [25]

Available Elements:
Sync



WARNING

The synchrocheck function can be bypassed by external sources. In this case, synchronization has to be secured by other synchronizing systems before breaker closing!

NOTICE

The first three measuring inputs of the voltage measuring card (VL1/VL1-L2, VL2/VL2-L3, VL3/VL3-L1) are named /labeld as bus voltages within the synchrocheck element (this applies also to generator protection devices). The fourth measuring input of the voltage measuring card (VX) is named /labeld as line-voltage (this applies also to generator protection devices). In the menu [Field Para/Voltage transf/V Sync] the User has to define to which phase the fourth measuring input is compared.

Synchrocheck

The synchrocheck function is provided for the applications where a line has two-ended power sources. The synchrocheck function has the abilities to check voltage magnitude, angle differences, and frequency difference (slip frequency) between the bus and the line. If enabled, the synchrocheck may supervise the closing operation manually, automatically, or both. This function can be overridden by certain bus-line operation conditions and can be bypassed with an external source.

Voltage Difference ΔV

The first condition for paralleling two electrical systems is that their voltage phasors have the same magnitude. This can be controlled by the generator's AVR.

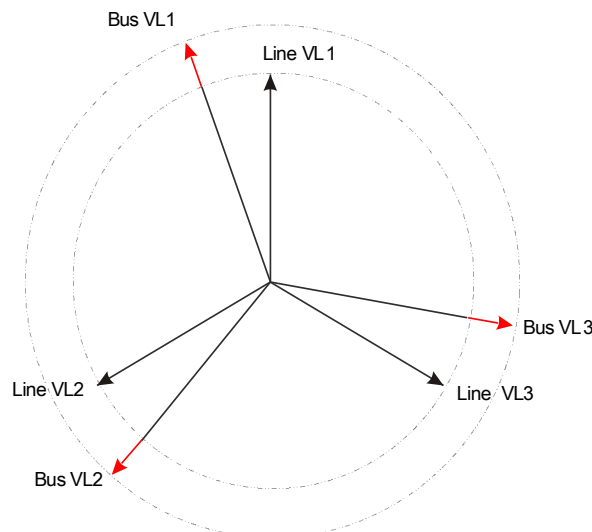

Frequency Difference (Slip Frequency) ΔF

The second condition for paralleling two electrical systems is that their frequencies are nearly equal. This can be controlled by the generator's speed governor.

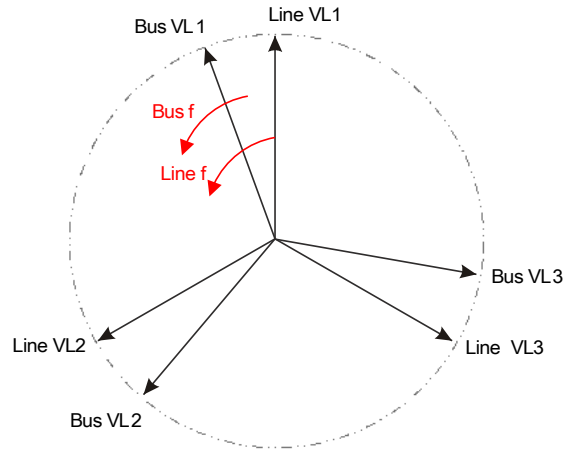

If the generator frequency f_{Bus} is not equal to the mains frequency f_{Line} , it results in a slip frequency $\Delta F = |f_{\text{Bus}} - f_{\text{Line}}|$ between the two system frequencies.

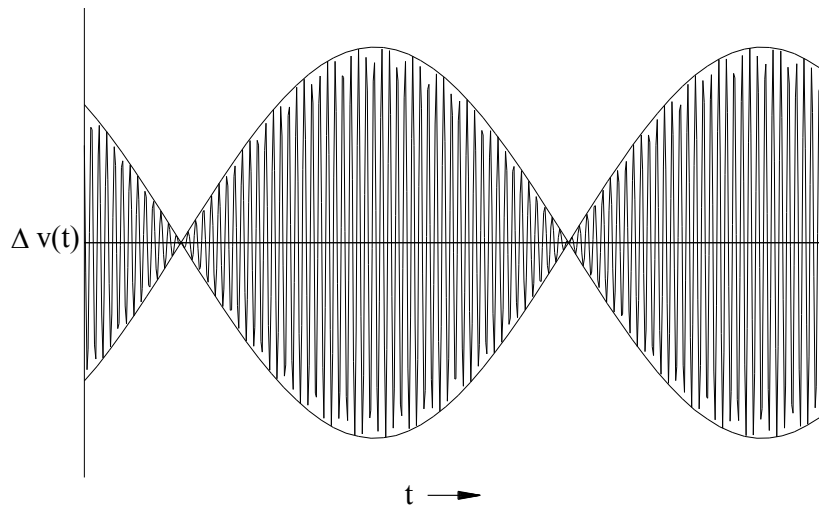

Voltage Curve with Enlarged Resolution.

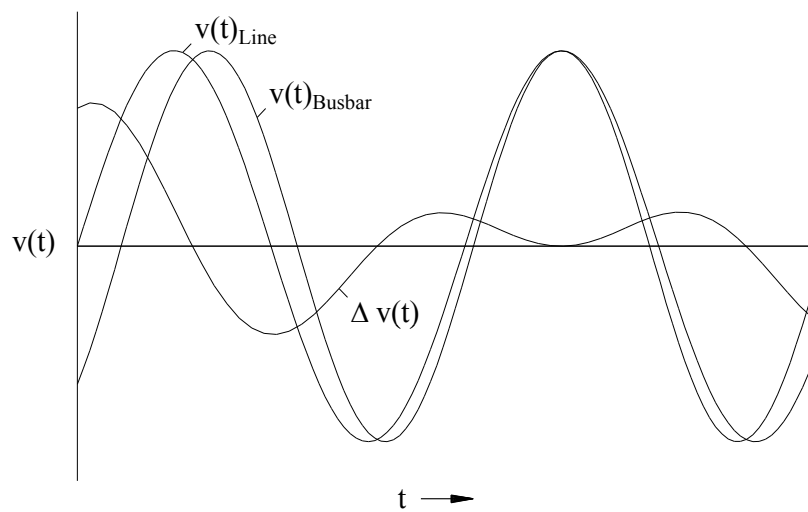

Angular or Phase Difference.

Even if the frequency of both systems is exactly identical, usually an angular difference of the voltage phasors is the case.

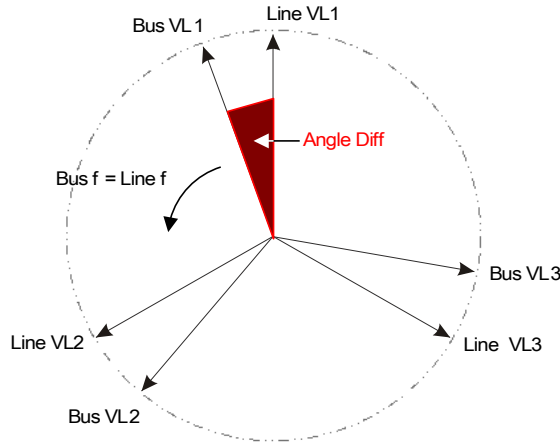

At the instant of synchronization, the angular difference of the two systems should be nearly zero because, otherwise, unwanted load inrushes occur. Theoretically, the angular difference can be regulated to zero by giving short pulses to the speed governors. When paralleling generators with the grid, in practice, synchronization is requested as quick as possible and so usually a slight frequency difference is accepted. In such cases, the angular difference is not constant but changes with the slip frequency ΔF .

By taking the breaker closing time into consideration, a lead of the closing release impulse can be calculated in a way that breaker closing takes place at exactly the time when both systems are in angular conformity.

Basically the following applies:

Where large rotating masses are concerned, the frequency difference (slip frequency) of the two systems should possibly be nearly zero, because of the very high load inrushes at the instant of breaker closing. For smaller rotating masses, the frequency difference of the systems can be higher.

NOTICE This sync-check cannot be used for two voltages that are shifted by a fixed angle (e.g because they are measured on the two sides of a block transformer of a generator).

Synchronization Modes

The synchrocheck module is able to check the synchronization of two electrical systems (system-to-system) or between a generator and an electrical system (generator-to-system). For paralleling two electrical systems, the station frequency, voltage and phase angle should be exactly the same as the utility grid. Whereas the synchronization of a generator to a system can be done with a certain slip-frequency, depending on the size of the generator used. Therefore the maximum breaker closing time has to be taken into consideration. With the set breaker closing time, the synchrocheck module is able to calculate the moment of synchronization and gives the paralleling release.



When paralleling two systems, it has to be verified that the system-to-system mode is selected. Paralleling two systems in generator-to-system mode can cause severe damage!

Working Principle Synchrocheck (Generator-to-System)

(Please refer to the block diagram on next page.)

The synchrocheck element measures the three phase-to-neutral voltages »VL1«, »VL2«, and »VL3« or the three phase-to-phase voltages »VL1-L2«, »VL2-L3«, and »VL3-L1« of the generator busbar. The line voltage V_x is measured by the fourth voltage input. If all synchronous conditions are fulfilled (i. e.: ΔV [VoltageDiff], ΔF [SlipFrequency], and $\Delta\phi$ [AngleDiff]) are within the limits, a signal will be issued that both systems are synchronous. An advanced Close Angle Evaluator function takes the breaker closing time into consideration.

Sync=; SyncMode= Generator2System

2 Please Refer To Diagram: Blockings
 (Stage is not deactivated and no active blocking signals)

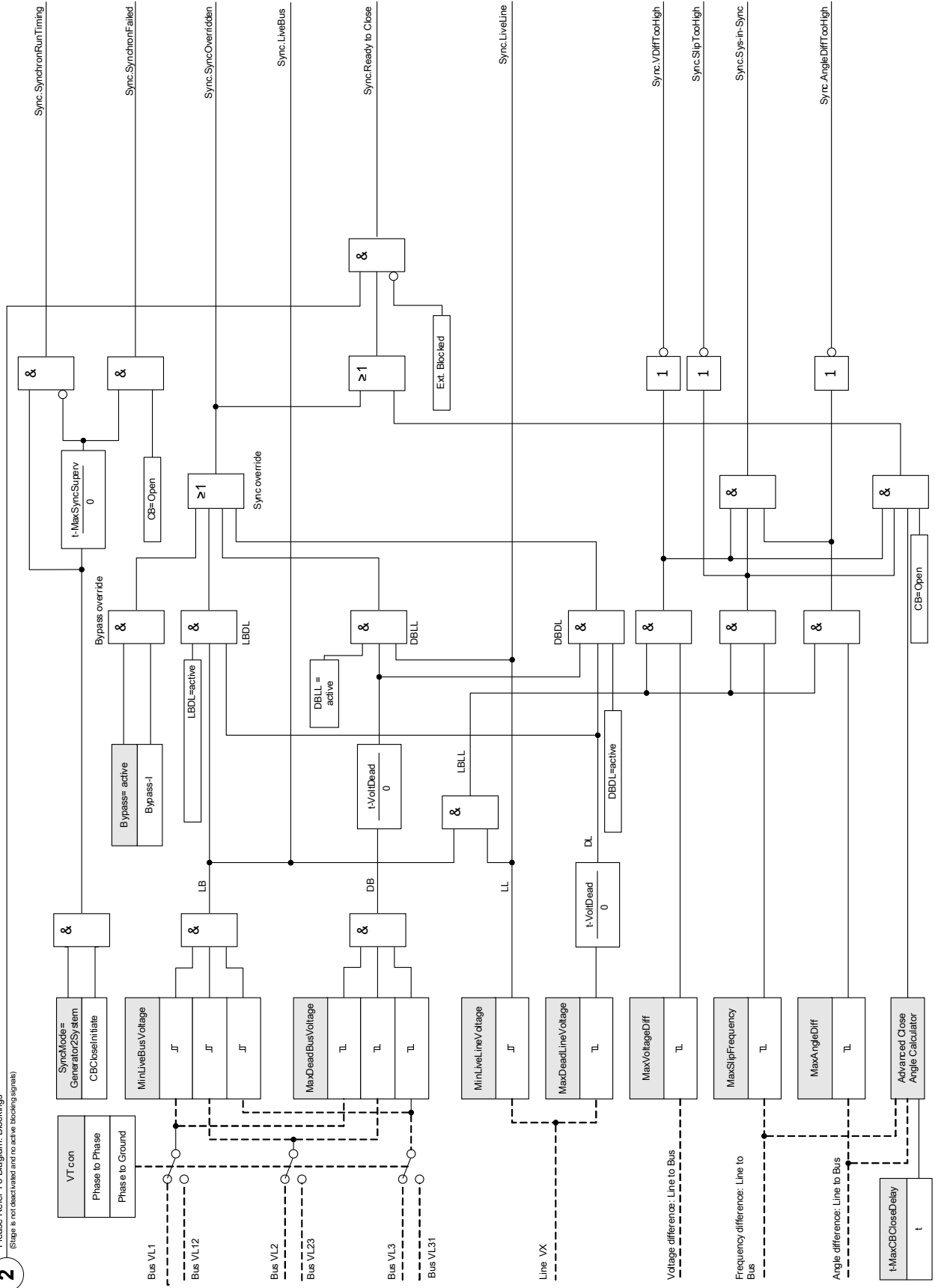

Working Principle Synchrocheck (System-to-System)

(Please refer to the block diagram on next page.)

The synchrocheck function for two systems is very similar to the synchrocheck function for generator-to-system except there is no need to take the breaker closing time into account. The synchrocheck element measures the three phase-to-neutral voltages »VL1«, »VL2«, and »VL3« or the three phase-to-phase voltages »VL1-L2«, »VL2-L3«, and »VL3-L1« of the station voltage bus bar. The line voltage V_x is measured by the fourth voltage input. If all synchronous conditions are fulfilled (i. e.: ΔV [VoltageDiff], ΔF [SlipFrequency], and $\Delta\phi$ [AngleDiff]) are within the limits, a signal will be issued that both systems are synchronous.

Sync: SyncMode= System2System

2

Please Refer To Diagram: Blockings
(Shape is not described and no active blocking signals)

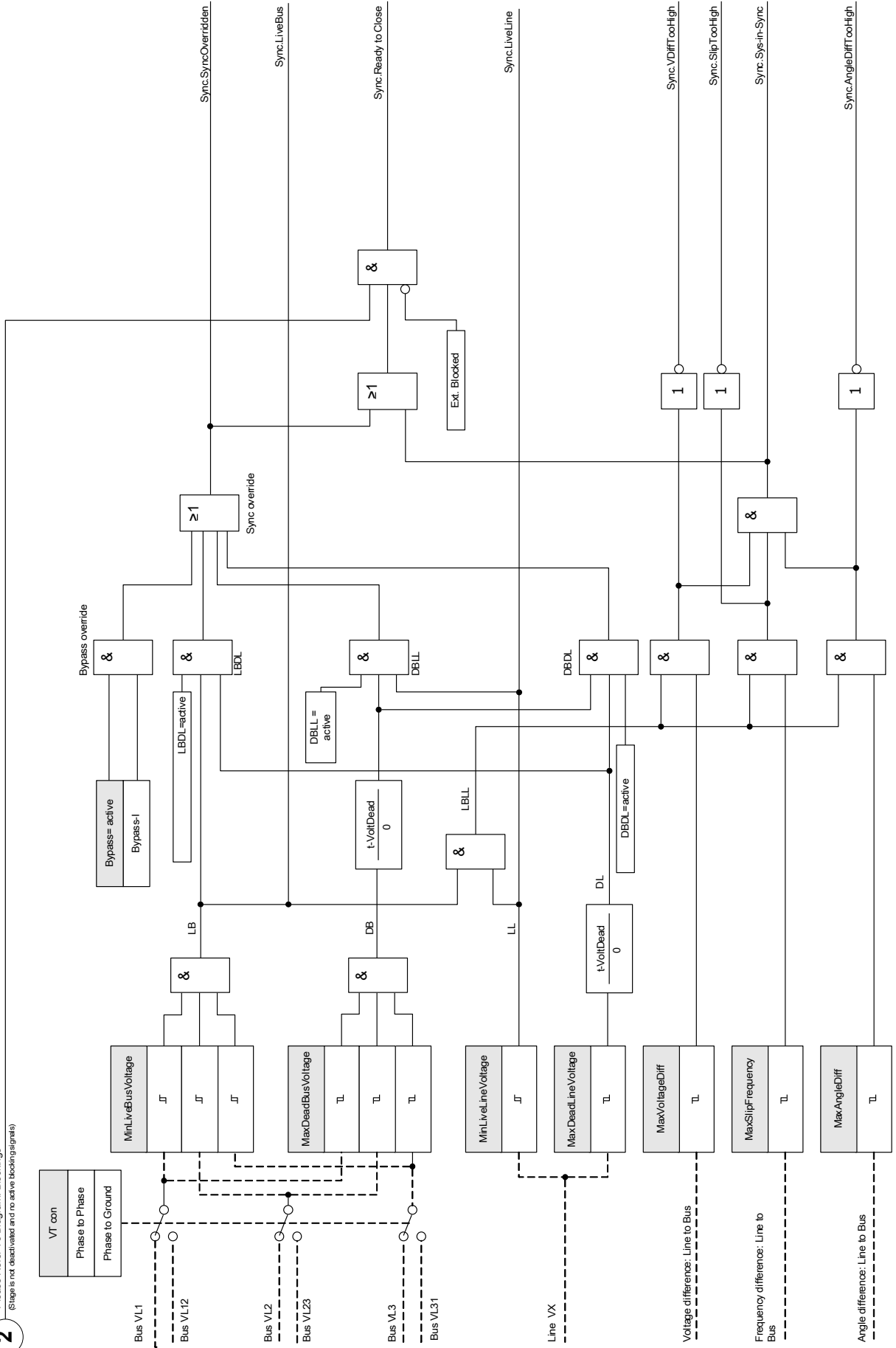

Synchrocheck Override Conditions

If enabled the following conditions can override the synchrocheck function:

- LBDL = Live Bus – Dead Line
- DBLL = Dead Bus – Live Line
- DBDL = Dead Bus – Dead Line

Also the synchrocheck function can be bypassed by an external source.







When the synchrocheck function is overridden or bypassed, synchronization has to be secured by other synchronizing systems before breaker closing!

Device Planning Parameters of the Synchrocheck Module

| <i>Parameter</i> | <i>Description</i> | <i>Options</i> | <i>Default</i> | <i>Menu path</i> |
|---|--------------------|--------------------|----------------|-------------------|
| Mode  | Mode | do not use, use | do not use | [Device planning] |

Global Protection Parameters of the Synchrocheck Module

| Parameter | Description | Setting range | Default | Menu path |
|--|--|--|-----------|---|
| ExBlo1  | External blocking of the module, if blocking is activated (allowed) within a parameter set and if the state of the assigned signal is true. | 1..n, Assignment List | -- | [Protection Para /Global Prot Para /Intercon-Prot /Sync] |
| ExBlo2  | External blocking of the module, if blocking is activated (allowed) within a parameter set and if the state of the assigned signal is true. | 1..n, Assignment List | -- | [Protection Para /Global Prot Para /Intercon-Prot /Sync] |
| Bypass  | The Synchrocheck will be bypassed if the state of the assigned signal (logic input) becomes true. | 1..n, DI-LogicList | -- | [Protection Para /Global Prot Para /Intercon-Prot /Sync] |
| CB Pos Detect  | Criterion by which the Circuit Breaker Switch Position is to be detected. | --, SG[1].Pos, SG[2].Pos, SG[3].Pos, SG[4].Pos, SG[5].Pos, SG[6].Pos | SG[1].Pos | [Protection Para /Global Prot Para /Intercon-Prot /Sync] |
| CBCloseInitiate  | Breaker Close Initiate with synchronism check from any control sources (e.g. HMI / SCADA). If the state of the assigned signal becomes true, a Breaker Close will be initiated (Trigger Source). | 1..n, SyncRequestList | -- | [Protection Para /Global Prot Para /Intercon-Prot /Sync] |



Setting Group Parameters of the Synchrocheck Fault Module

| Parameter | Description | Setting range | Default | Menu path |
|---|---|------------------------------------|---------------|--|
|  Function | Permanent activation or deactivation of module/stage. | inactive, active | inactive | [Protection Para /<1..4> /Intercon-Prot /Sync /General settings] |
|  ExBlo Fc | Activate (allow) or inactivate (disallow) blocking of the module/stage. This parameter is only effective if a signal is assigned to the corresponding global protection parameter. If the signal becomes true, those modules/stages are blocked that are parameterized "ExBlo Fc=active". | inactive, active | inactive | [Protection Para /<1..4> /Intercon-Prot /Sync /General settings] |
|  Bypass Fc | Allowing to bypass the Synchrocheck, if the state signal that is assigned to the parameter with the same name within the Global Parameters (logic input) becomes true. | inactive, active | inactive | [Protection Para /<1..4> /Intercon-Prot /Sync /General settings] |
|  SyncMode | Synchrocheck mode: GENERATOR2SYSTEM = Synchronizing generator to system (breaker close initiate needed). SYSTEM2SYSTEM = SynchronCheck between two systems (Stand-Alone, no breaker info needed) | System2System, Generator2System | System2System | [Protection Para /<1..4> /Intercon-Prot /Sync /Mode / Times] |
|  t- MaxCBCCloseDelay | Maximum circuit breaker close time delay (Only used for GENERATOR-SYSTEM working mode and is critical for a correct synchronized switching) Only available if: SyncMode = System2System | 0.00 - 300.00s | 0.05s | [Protection Para /<1..4> /Intercon-Prot /Sync /Mode / Times] |
|  t-MaxSyncSuperv | Synchron-Run timer: Max. time allowed for synchronizing process after a close initiate. Only used for GENERATOR2SYSTEM working mode. Only available if: SyncMode = System2System | 0.00 - 3000.00s | 30.00s | [Protection Para /<1..4> /Intercon-Prot /Sync /Mode / Times] |
|  MinLiveBusVoltage | Minimum Live Bus voltage (Live bus detected, when all three phase bus voltages are above this limit). | 0.10 - 1.50Vn | 0.65Vn | [Protection Para /<1..4> /Intercon-Prot /Sync /DeadLiveVLevels] |

Protective Elements

| Parameter | Description | Setting range | Default | Menu path |
|--|---|------------------|---------|---|
|  MaxDeadBusVoltage | Maximum Dead Bus voltage (Dead bus detected, when all three phase bus voltages are below this limit). | 0.01 - 1.00Vn | 0.03Vn | [Protection Para /<1..4> /Intercon-Prot /Sync /DeadLiveVLevels] |
|  MinLiveLineVoltage | Minimum Live Line voltage (Live line detected, when line voltage above this limit). | 0.10 - 1.50Vn | 0.65Vn | [Protection Para /<1..4> /Intercon-Prot /Sync /DeadLiveVLevels] |
|  MaxDeadLineVoltage | Maximum Dead Line voltage (Dead Line detected, when line voltage below this limit). | 0.01 - 1.00Vn | 0.03Vn | [Protection Para /<1..4> /Intercon-Prot /Sync /DeadLiveVLevels] |
|  t-VoltDead | Voltage dead time (A Dead Bus/Line condition will be accepted only if the voltage falls below the set dead voltage levels longer than this time setting). | 0.000 - 300.000s | 0.167s | [Protection Para /<1..4> /Intercon-Prot /Sync /DeadLiveVLevels] |
|  MaxVoltageDiff | Maximum voltage difference between bus and line voltage phasors (Delta V)for synchronism (Related to bus voltage secondary rating) | 0.01 - 1.00Vn | 0.24Vn | [Protection Para /<1..4> /Intercon-Prot /Sync /Conditions] |
|  MaxSlipFrequency | Maximum frequency difference (Slip: Delta f) between bus and line voltage allowed for synchronism | 0.01 - 2.00Hz | 0.20Hz | [Protection Para /<1..4> /Intercon-Prot /Sync /Conditions] |
|  MaxAngleDiff | Maximum phase angle difference (Delta-Phi in degree) between bus and line voltages allowed for synchronism | 1 - 60° | 20° | [Protection Para /<1..4> /Intercon-Prot /Sync /Conditions] |

Protective Elements

| <i>Parameter</i> | <i>Description</i> | <i>Setting range</i> | <i>Default</i> | <i>Menu path</i> |
|---|--|----------------------|----------------|--|
| DBDL  | Enable/disable Dead-Bus AND Dead-Line synchronism overriding | inactive, active | inactive | [Protection Para /<1..4> /Intercon-Prot /Sync /Override] |
| DBLL  | Enable/disable Dead-Bus AND Live-Line synchronism overriding | inactive, active | inactive | [Protection Para /<1..4> /Intercon-Prot /Sync /Override] |
| LBDL  | Enable/disable Live-Bus AND Dead-Line synchronism overriding | inactive, active | inactive | [Protection Para /<1..4> /Intercon-Prot /Sync /Override] |

Synchrocheck Module Input States

| <i>Name</i> | <i>Description</i> | <i>Assignment via</i> |
|-------------------|---|---|
| ExBlo1-I | Module input state: External blocking1 | [Protection Para /Global Prot Para /Intercon-Prot /Sync] |
| ExBlo2-I | Module input state: External blocking2 | [Protection Para /Global Prot Para /Intercon-Prot /Sync] |
| Bypass-I | State of the module input: Bypass | [Protection Para /Global Prot Para /Intercon-Prot /Sync] |
| CBCloseInitiate-I | State of the module input: Breaker Close Initiate with synchronism check from any control sources (e.g. HMI / SCADA). If the state of the assigned signal becomes true, a Breaker Close will be initiated (Trigger Source). | [Protection Para /Global Prot Para /Intercon-Prot /Sync] |

Signals of the Synchrocheck Module (Output States)

| <i>Signal</i> | <i>Description</i> |
|-------------------|---|
| active | Signal: active |
| ExBlo | Signal: External Blocking |
| LiveBus | Signal: Live-Bus flag: 1=Live-Bus, 0=Voltage is below the LiveBus threshold |
| LiveLine | Signal: Live Line flag: 1=Live-Line, 0=Voltage is below the LiveLine threshold |
| SynchronRunTiming | Signal: SynchronRunTiming |
| SynchronFailed | Signal: This signal indicates a failed synchronization. It is set for 5s when the circuit breaker is still open after the Synchron-Run-timer has timed out. |
| SyncOverridden | Signal: Synchronism Check is overridden because one of the Synchronism overriding conditions (DB/DL or ExtBypass) is met. |
| VDiffTooHigh | Signal: Voltage difference between bus and line too high. |
| SlipTooHigh | Signal: Frequency difference (slip frequency) between bus and line voltages too high. |
| AngleDiffTooHigh | Signal: Phase Angle difference between bus and line voltages too high. |
| Sys-in-Sync | Signal: Bus and line voltages are in synchronism according to the system synchronism criteria. |
| Ready to Close | Signal: Ready to Close |

Values of the Synchrocheck

| <i>Value</i> | <i>Description</i> | <i>Default</i> | <i>Size</i> | <i>Menu path</i> |
|--------------|---|----------------|-----------------|---|
| Slip Freq | Slip frequency | 0Hz | 0 - 70.000Hz | [Operation /Measured Values /Synchronism] |
| Volt Diff | Voltage difference between bus and line. | 0V | 0 - 500000.0V | [Operation /Measured Values /Synchronism] |
| Angle Diff | Angle difference between bus and line voltages. | 0° | -360.0 - 360.0° | [Operation /Measured Values /Synchronism] |
| f Bus | Bus frequency | 0Hz | 0 - 70.000Hz | [Operation /Measured Values /Synchronism] |
| f Line | Line frequency | 0Hz | 0 - 70.000Hz | [Operation /Measured Values /Synchronism] |
| V Bus | Bus Voltage | 0V | 0 - 500000.0V | [Operation /Measured Values /Synchronism] |
| V Line | Line Voltage | 0V | 0 - 500000.0V | [Operation /Measured Values /Synchronism] |
| Angle Bus | Bus Angle (Reference) | 0° | 0 - 360° | [Operation /Measured Values /Synchronism] |
| Angle Line | Line Angle | 0° | 0 - 360° | [Operation /Measured Values /Synchronism] |

Signals that Trigger a Synchrocheck

| <i>Name</i> | <i>Description</i> |
|-----------------------|--------------------------------|
| -- | No assignment |
| SG[1].Sync ON request | Signal: Synchronous ON request |
| SG[2].Sync ON request | Signal: Synchronous ON request |
| SG[3].Sync ON request | Signal: Synchronous ON request |
| SG[4].Sync ON request | Signal: Synchronous ON request |
| SG[5].Sync ON request | Signal: Synchronous ON request |
| SG[6].Sync ON request | Signal: Synchronous ON request |
| DI Slot X1.DI 1 | Signal: Digital Input |

Protective Elements

| <i>Name</i> | <i>Description</i> |
|-------------------------|--|
| DI Slot X1.DI 2 | Signal: Digital Input |
| DI Slot X1.DI 3 | Signal: Digital Input |
| DI Slot X1.DI 4 | Signal: Digital Input |
| DI Slot X1.DI 5 | Signal: Digital Input |
| DI Slot X1.DI 6 | Signal: Digital Input |
| DI Slot X1.DI 7 | Signal: Digital Input |
| DI Slot X1.DI 8 | Signal: Digital Input |
| DI Slot X6.DI 1 | Signal: Digital Input |
| DI Slot X6.DI 2 | Signal: Digital Input |
| DI Slot X6.DI 3 | Signal: Digital Input |
| DI Slot X6.DI 4 | Signal: Digital Input |
| DI Slot X6.DI 5 | Signal: Digital Input |
| DI Slot X6.DI 6 | Signal: Digital Input |
| DI Slot X6.DI 7 | Signal: Digital Input |
| DI Slot X6.DI 8 | Signal: Digital Input |
| Logics.LE1.Gate Out | Signal: Output of the logic gate |
| Logics.LE1.Timer Out | Signal: Timer Output |
| Logics.LE1.Out | Signal: Latched Output (Q) |
| Logics.LE1.Out inverted | Signal: Negated Latched Output (Q NOT) |
| Logics.LE2.Gate Out | Signal: Output of the logic gate |
| Logics.LE2.Timer Out | Signal: Timer Output |
| Logics.LE2.Out | Signal: Latched Output (Q) |
| Logics.LE2.Out inverted | Signal: Negated Latched Output (Q NOT) |
| Logics.LE3.Gate Out | Signal: Output of the logic gate |
| Logics.LE3.Timer Out | Signal: Timer Output |
| Logics.LE3.Out | Signal: Latched Output (Q) |
| Logics.LE3.Out inverted | Signal: Negated Latched Output (Q NOT) |
| Logics.LE4.Gate Out | Signal: Output of the logic gate |
| Logics.LE4.Timer Out | Signal: Timer Output |
| Logics.LE4.Out | Signal: Latched Output (Q) |
| Logics.LE4.Out inverted | Signal: Negated Latched Output (Q NOT) |
| Logics.LE5.Gate Out | Signal: Output of the logic gate |
| Logics.LE5.Timer Out | Signal: Timer Output |
| Logics.LE5.Out | Signal: Latched Output (Q) |
| Logics.LE5.Out inverted | Signal: Negated Latched Output (Q NOT) |
| Logics.LE6.Gate Out | Signal: Output of the logic gate |
| Logics.LE6.Timer Out | Signal: Timer Output |
| Logics.LE6.Out | Signal: Latched Output (Q) |
| Logics.LE6.Out inverted | Signal: Negated Latched Output (Q NOT) |
| Logics.LE7.Gate Out | Signal: Output of the logic gate |

Protective Elements

| <i>Name</i> | <i>Description</i> |
|--------------------------|--|
| Logics.LE7.Timer Out | Signal: Timer Output |
| Logics.LE7.Out | Signal: Latched Output (Q) |
| Logics.LE7.Out inverted | Signal: Negated Latched Output (Q NOT) |
| Logics.LE8.Gate Out | Signal: Output of the logic gate |
| Logics.LE8.Timer Out | Signal: Timer Output |
| Logics.LE8.Out | Signal: Latched Output (Q) |
| Logics.LE8.Out inverted | Signal: Negated Latched Output (Q NOT) |
| Logics.LE9.Gate Out | Signal: Output of the logic gate |
| Logics.LE9.Timer Out | Signal: Timer Output |
| Logics.LE9.Out | Signal: Latched Output (Q) |
| Logics.LE9.Out inverted | Signal: Negated Latched Output (Q NOT) |
| Logics.LE10.Gate Out | Signal: Output of the logic gate |
| Logics.LE10.Timer Out | Signal: Timer Output |
| Logics.LE10.Out | Signal: Latched Output (Q) |
| Logics.LE10.Out inverted | Signal: Negated Latched Output (Q NOT) |
| Logics.LE11.Gate Out | Signal: Output of the logic gate |
| Logics.LE11.Timer Out | Signal: Timer Output |
| Logics.LE11.Out | Signal: Latched Output (Q) |
| Logics.LE11.Out inverted | Signal: Negated Latched Output (Q NOT) |
| Logics.LE12.Gate Out | Signal: Output of the logic gate |
| Logics.LE12.Timer Out | Signal: Timer Output |
| Logics.LE12.Out | Signal: Latched Output (Q) |
| Logics.LE12.Out inverted | Signal: Negated Latched Output (Q NOT) |
| Logics.LE13.Gate Out | Signal: Output of the logic gate |
| Logics.LE13.Timer Out | Signal: Timer Output |
| Logics.LE13.Out | Signal: Latched Output (Q) |
| Logics.LE13.Out inverted | Signal: Negated Latched Output (Q NOT) |
| Logics.LE14.Gate Out | Signal: Output of the logic gate |
| Logics.LE14.Timer Out | Signal: Timer Output |
| Logics.LE14.Out | Signal: Latched Output (Q) |
| Logics.LE14.Out inverted | Signal: Negated Latched Output (Q NOT) |
| Logics.LE15.Gate Out | Signal: Output of the logic gate |
| Logics.LE15.Timer Out | Signal: Timer Output |
| Logics.LE15.Out | Signal: Latched Output (Q) |
| Logics.LE15.Out inverted | Signal: Negated Latched Output (Q NOT) |
| Logics.LE16.Gate Out | Signal: Output of the logic gate |
| Logics.LE16.Timer Out | Signal: Timer Output |
| Logics.LE16.Out | Signal: Latched Output (Q) |
| Logics.LE16.Out inverted | Signal: Negated Latched Output (Q NOT) |
| Logics.LE17.Gate Out | Signal: Output of the logic gate |

Protective Elements

| <i>Name</i> | <i>Description</i> |
|--------------------------|--|
| Logics.LE17.Timer Out | Signal: Timer Output |
| Logics.LE17.Out | Signal: Latched Output (Q) |
| Logics.LE17.Out inverted | Signal: Negated Latched Output (Q NOT) |
| Logics.LE18.Gate Out | Signal: Output of the logic gate |
| Logics.LE18.Timer Out | Signal: Timer Output |
| Logics.LE18.Out | Signal: Latched Output (Q) |
| Logics.LE18.Out inverted | Signal: Negated Latched Output (Q NOT) |
| Logics.LE19.Gate Out | Signal: Output of the logic gate |
| Logics.LE19.Timer Out | Signal: Timer Output |
| Logics.LE19.Out | Signal: Latched Output (Q) |
| Logics.LE19.Out inverted | Signal: Negated Latched Output (Q NOT) |
| Logics.LE20.Gate Out | Signal: Output of the logic gate |
| Logics.LE20.Timer Out | Signal: Timer Output |
| Logics.LE20.Out | Signal: Latched Output (Q) |
| Logics.LE20.Out inverted | Signal: Negated Latched Output (Q NOT) |
| Logics.LE21.Gate Out | Signal: Output of the logic gate |
| Logics.LE21.Timer Out | Signal: Timer Output |
| Logics.LE21.Out | Signal: Latched Output (Q) |
| Logics.LE21.Out inverted | Signal: Negated Latched Output (Q NOT) |
| Logics.LE22.Gate Out | Signal: Output of the logic gate |
| Logics.LE22.Timer Out | Signal: Timer Output |
| Logics.LE22.Out | Signal: Latched Output (Q) |
| Logics.LE22.Out inverted | Signal: Negated Latched Output (Q NOT) |
| Logics.LE23.Gate Out | Signal: Output of the logic gate |
| Logics.LE23.Timer Out | Signal: Timer Output |
| Logics.LE23.Out | Signal: Latched Output (Q) |
| Logics.LE23.Out inverted | Signal: Negated Latched Output (Q NOT) |
| Logics.LE24.Gate Out | Signal: Output of the logic gate |
| Logics.LE24.Timer Out | Signal: Timer Output |
| Logics.LE24.Out | Signal: Latched Output (Q) |
| Logics.LE24.Out inverted | Signal: Negated Latched Output (Q NOT) |
| Logics.LE25.Gate Out | Signal: Output of the logic gate |
| Logics.LE25.Timer Out | Signal: Timer Output |
| Logics.LE25.Out | Signal: Latched Output (Q) |
| Logics.LE25.Out inverted | Signal: Negated Latched Output (Q NOT) |
| Logics.LE26.Gate Out | Signal: Output of the logic gate |
| Logics.LE26.Timer Out | Signal: Timer Output |
| Logics.LE26.Out | Signal: Latched Output (Q) |
| Logics.LE26.Out inverted | Signal: Negated Latched Output (Q NOT) |
| Logics.LE27.Gate Out | Signal: Output of the logic gate |

Protective Elements

| <i>Name</i> | <i>Description</i> |
|--------------------------|--|
| Logics.LE27.Timer Out | Signal: Timer Output |
| Logics.LE27.Out | Signal: Latched Output (Q) |
| Logics.LE27.Out inverted | Signal: Negated Latched Output (Q NOT) |
| Logics.LE28.Gate Out | Signal: Output of the logic gate |
| Logics.LE28.Timer Out | Signal: Timer Output |
| Logics.LE28.Out | Signal: Latched Output (Q) |
| Logics.LE28.Out inverted | Signal: Negated Latched Output (Q NOT) |
| Logics.LE29.Gate Out | Signal: Output of the logic gate |
| Logics.LE29.Timer Out | Signal: Timer Output |
| Logics.LE29.Out | Signal: Latched Output (Q) |
| Logics.LE29.Out inverted | Signal: Negated Latched Output (Q NOT) |
| Logics.LE30.Gate Out | Signal: Output of the logic gate |
| Logics.LE30.Timer Out | Signal: Timer Output |
| Logics.LE30.Out | Signal: Latched Output (Q) |
| Logics.LE30.Out inverted | Signal: Negated Latched Output (Q NOT) |
| Logics.LE31.Gate Out | Signal: Output of the logic gate |
| Logics.LE31.Timer Out | Signal: Timer Output |
| Logics.LE31.Out | Signal: Latched Output (Q) |
| Logics.LE31.Out inverted | Signal: Negated Latched Output (Q NOT) |
| Logics.LE32.Gate Out | Signal: Output of the logic gate |
| Logics.LE32.Timer Out | Signal: Timer Output |
| Logics.LE32.Out | Signal: Latched Output (Q) |
| Logics.LE32.Out inverted | Signal: Negated Latched Output (Q NOT) |
| Logics.LE33.Gate Out | Signal: Output of the logic gate |
| Logics.LE33.Timer Out | Signal: Timer Output |
| Logics.LE33.Out | Signal: Latched Output (Q) |
| Logics.LE33.Out inverted | Signal: Negated Latched Output (Q NOT) |
| Logics.LE34.Gate Out | Signal: Output of the logic gate |
| Logics.LE34.Timer Out | Signal: Timer Output |
| Logics.LE34.Out | Signal: Latched Output (Q) |
| Logics.LE34.Out inverted | Signal: Negated Latched Output (Q NOT) |
| Logics.LE35.Gate Out | Signal: Output of the logic gate |
| Logics.LE35.Timer Out | Signal: Timer Output |
| Logics.LE35.Out | Signal: Latched Output (Q) |
| Logics.LE35.Out inverted | Signal: Negated Latched Output (Q NOT) |
| Logics.LE36.Gate Out | Signal: Output of the logic gate |
| Logics.LE36.Timer Out | Signal: Timer Output |
| Logics.LE36.Out | Signal: Latched Output (Q) |
| Logics.LE36.Out inverted | Signal: Negated Latched Output (Q NOT) |
| Logics.LE37.Gate Out | Signal: Output of the logic gate |

Protective Elements

| <i>Name</i> | <i>Description</i> |
|--------------------------|--|
| Logics.LE37.Timer Out | Signal: Timer Output |
| Logics.LE37.Out | Signal: Latched Output (Q) |
| Logics.LE37.Out inverted | Signal: Negated Latched Output (Q NOT) |
| Logics.LE38.Gate Out | Signal: Output of the logic gate |
| Logics.LE38.Timer Out | Signal: Timer Output |
| Logics.LE38.Out | Signal: Latched Output (Q) |
| Logics.LE38.Out inverted | Signal: Negated Latched Output (Q NOT) |
| Logics.LE39.Gate Out | Signal: Output of the logic gate |
| Logics.LE39.Timer Out | Signal: Timer Output |
| Logics.LE39.Out | Signal: Latched Output (Q) |
| Logics.LE39.Out inverted | Signal: Negated Latched Output (Q NOT) |
| Logics.LE40.Gate Out | Signal: Output of the logic gate |
| Logics.LE40.Timer Out | Signal: Timer Output |
| Logics.LE40.Out | Signal: Latched Output (Q) |
| Logics.LE40.Out inverted | Signal: Negated Latched Output (Q NOT) |
| Logics.LE41.Gate Out | Signal: Output of the logic gate |
| Logics.LE41.Timer Out | Signal: Timer Output |
| Logics.LE41.Out | Signal: Latched Output (Q) |
| Logics.LE41.Out inverted | Signal: Negated Latched Output (Q NOT) |
| Logics.LE42.Gate Out | Signal: Output of the logic gate |
| Logics.LE42.Timer Out | Signal: Timer Output |
| Logics.LE42.Out | Signal: Latched Output (Q) |
| Logics.LE42.Out inverted | Signal: Negated Latched Output (Q NOT) |
| Logics.LE43.Gate Out | Signal: Output of the logic gate |
| Logics.LE43.Timer Out | Signal: Timer Output |
| Logics.LE43.Out | Signal: Latched Output (Q) |
| Logics.LE43.Out inverted | Signal: Negated Latched Output (Q NOT) |
| Logics.LE44.Gate Out | Signal: Output of the logic gate |
| Logics.LE44.Timer Out | Signal: Timer Output |
| Logics.LE44.Out | Signal: Latched Output (Q) |
| Logics.LE44.Out inverted | Signal: Negated Latched Output (Q NOT) |
| Logics.LE45.Gate Out | Signal: Output of the logic gate |
| Logics.LE45.Timer Out | Signal: Timer Output |
| Logics.LE45.Out | Signal: Latched Output (Q) |
| Logics.LE45.Out inverted | Signal: Negated Latched Output (Q NOT) |
| Logics.LE46.Gate Out | Signal: Output of the logic gate |
| Logics.LE46.Timer Out | Signal: Timer Output |
| Logics.LE46.Out | Signal: Latched Output (Q) |
| Logics.LE46.Out inverted | Signal: Negated Latched Output (Q NOT) |
| Logics.LE47.Gate Out | Signal: Output of the logic gate |

Protective Elements

| <i>Name</i> | <i>Description</i> |
|--------------------------|--|
| Logics.LE47.Timer Out | Signal: Timer Output |
| Logics.LE47.Out | Signal: Latched Output (Q) |
| Logics.LE47.Out inverted | Signal: Negated Latched Output (Q NOT) |
| Logics.LE48.Gate Out | Signal: Output of the logic gate |
| Logics.LE48.Timer Out | Signal: Timer Output |
| Logics.LE48.Out | Signal: Latched Output (Q) |
| Logics.LE48.Out inverted | Signal: Negated Latched Output (Q NOT) |
| Logics.LE49.Gate Out | Signal: Output of the logic gate |
| Logics.LE49.Timer Out | Signal: Timer Output |
| Logics.LE49.Out | Signal: Latched Output (Q) |
| Logics.LE49.Out inverted | Signal: Negated Latched Output (Q NOT) |
| Logics.LE50.Gate Out | Signal: Output of the logic gate |
| Logics.LE50.Timer Out | Signal: Timer Output |
| Logics.LE50.Out | Signal: Latched Output (Q) |
| Logics.LE50.Out inverted | Signal: Negated Latched Output (Q NOT) |
| Logics.LE51.Gate Out | Signal: Output of the logic gate |
| Logics.LE51.Timer Out | Signal: Timer Output |
| Logics.LE51.Out | Signal: Latched Output (Q) |
| Logics.LE51.Out inverted | Signal: Negated Latched Output (Q NOT) |
| Logics.LE52.Gate Out | Signal: Output of the logic gate |
| Logics.LE52.Timer Out | Signal: Timer Output |
| Logics.LE52.Out | Signal: Latched Output (Q) |
| Logics.LE52.Out inverted | Signal: Negated Latched Output (Q NOT) |
| Logics.LE53.Gate Out | Signal: Output of the logic gate |
| Logics.LE53.Timer Out | Signal: Timer Output |
| Logics.LE53.Out | Signal: Latched Output (Q) |
| Logics.LE53.Out inverted | Signal: Negated Latched Output (Q NOT) |
| Logics.LE54.Gate Out | Signal: Output of the logic gate |
| Logics.LE54.Timer Out | Signal: Timer Output |
| Logics.LE54.Out | Signal: Latched Output (Q) |
| Logics.LE54.Out inverted | Signal: Negated Latched Output (Q NOT) |
| Logics.LE55.Gate Out | Signal: Output of the logic gate |
| Logics.LE55.Timer Out | Signal: Timer Output |
| Logics.LE55.Out | Signal: Latched Output (Q) |
| Logics.LE55.Out inverted | Signal: Negated Latched Output (Q NOT) |
| Logics.LE56.Gate Out | Signal: Output of the logic gate |
| Logics.LE56.Timer Out | Signal: Timer Output |
| Logics.LE56.Out | Signal: Latched Output (Q) |
| Logics.LE56.Out inverted | Signal: Negated Latched Output (Q NOT) |
| Logics.LE57.Gate Out | Signal: Output of the logic gate |

Protective Elements

| <i>Name</i> | <i>Description</i> |
|--------------------------|--|
| Logics.LE57.Timer Out | Signal: Timer Output |
| Logics.LE57.Out | Signal: Latched Output (Q) |
| Logics.LE57.Out inverted | Signal: Negated Latched Output (Q NOT) |
| Logics.LE58.Gate Out | Signal: Output of the logic gate |
| Logics.LE58.Timer Out | Signal: Timer Output |
| Logics.LE58.Out | Signal: Latched Output (Q) |
| Logics.LE58.Out inverted | Signal: Negated Latched Output (Q NOT) |
| Logics.LE59.Gate Out | Signal: Output of the logic gate |
| Logics.LE59.Timer Out | Signal: Timer Output |
| Logics.LE59.Out | Signal: Latched Output (Q) |
| Logics.LE59.Out inverted | Signal: Negated Latched Output (Q NOT) |
| Logics.LE60.Gate Out | Signal: Output of the logic gate |
| Logics.LE60.Timer Out | Signal: Timer Output |
| Logics.LE60.Out | Signal: Latched Output (Q) |
| Logics.LE60.Out inverted | Signal: Negated Latched Output (Q NOT) |
| Logics.LE61.Gate Out | Signal: Output of the logic gate |
| Logics.LE61.Timer Out | Signal: Timer Output |
| Logics.LE61.Out | Signal: Latched Output (Q) |
| Logics.LE61.Out inverted | Signal: Negated Latched Output (Q NOT) |
| Logics.LE62.Gate Out | Signal: Output of the logic gate |
| Logics.LE62.Timer Out | Signal: Timer Output |
| Logics.LE62.Out | Signal: Latched Output (Q) |
| Logics.LE62.Out inverted | Signal: Negated Latched Output (Q NOT) |
| Logics.LE63.Gate Out | Signal: Output of the logic gate |
| Logics.LE63.Timer Out | Signal: Timer Output |
| Logics.LE63.Out | Signal: Latched Output (Q) |
| Logics.LE63.Out inverted | Signal: Negated Latched Output (Q NOT) |
| Logics.LE64.Gate Out | Signal: Output of the logic gate |
| Logics.LE64.Timer Out | Signal: Timer Output |
| Logics.LE64.Out | Signal: Latched Output (Q) |
| Logics.LE64.Out inverted | Signal: Negated Latched Output (Q NOT) |
| Logics.LE65.Gate Out | Signal: Output of the logic gate |
| Logics.LE65.Timer Out | Signal: Timer Output |
| Logics.LE65.Out | Signal: Latched Output (Q) |
| Logics.LE65.Out inverted | Signal: Negated Latched Output (Q NOT) |
| Logics.LE66.Gate Out | Signal: Output of the logic gate |
| Logics.LE66.Timer Out | Signal: Timer Output |
| Logics.LE66.Out | Signal: Latched Output (Q) |
| Logics.LE66.Out inverted | Signal: Negated Latched Output (Q NOT) |
| Logics.LE67.Gate Out | Signal: Output of the logic gate |

Protective Elements

| <i>Name</i> | <i>Description</i> |
|--------------------------|--|
| Logics.LE67.Timer Out | Signal: Timer Output |
| Logics.LE67.Out | Signal: Latched Output (Q) |
| Logics.LE67.Out inverted | Signal: Negated Latched Output (Q NOT) |
| Logics.LE68.Gate Out | Signal: Output of the logic gate |
| Logics.LE68.Timer Out | Signal: Timer Output |
| Logics.LE68.Out | Signal: Latched Output (Q) |
| Logics.LE68.Out inverted | Signal: Negated Latched Output (Q NOT) |
| Logics.LE69.Gate Out | Signal: Output of the logic gate |
| Logics.LE69.Timer Out | Signal: Timer Output |
| Logics.LE69.Out | Signal: Latched Output (Q) |
| Logics.LE69.Out inverted | Signal: Negated Latched Output (Q NOT) |
| Logics.LE70.Gate Out | Signal: Output of the logic gate |
| Logics.LE70.Timer Out | Signal: Timer Output |
| Logics.LE70.Out | Signal: Latched Output (Q) |
| Logics.LE70.Out inverted | Signal: Negated Latched Output (Q NOT) |
| Logics.LE71.Gate Out | Signal: Output of the logic gate |
| Logics.LE71.Timer Out | Signal: Timer Output |
| Logics.LE71.Out | Signal: Latched Output (Q) |
| Logics.LE71.Out inverted | Signal: Negated Latched Output (Q NOT) |
| Logics.LE72.Gate Out | Signal: Output of the logic gate |
| Logics.LE72.Timer Out | Signal: Timer Output |
| Logics.LE72.Out | Signal: Latched Output (Q) |
| Logics.LE72.Out inverted | Signal: Negated Latched Output (Q NOT) |
| Logics.LE73.Gate Out | Signal: Output of the logic gate |
| Logics.LE73.Timer Out | Signal: Timer Output |
| Logics.LE73.Out | Signal: Latched Output (Q) |
| Logics.LE73.Out inverted | Signal: Negated Latched Output (Q NOT) |
| Logics.LE74.Gate Out | Signal: Output of the logic gate |
| Logics.LE74.Timer Out | Signal: Timer Output |
| Logics.LE74.Out | Signal: Latched Output (Q) |
| Logics.LE74.Out inverted | Signal: Negated Latched Output (Q NOT) |
| Logics.LE75.Gate Out | Signal: Output of the logic gate |
| Logics.LE75.Timer Out | Signal: Timer Output |
| Logics.LE75.Out | Signal: Latched Output (Q) |
| Logics.LE75.Out inverted | Signal: Negated Latched Output (Q NOT) |
| Logics.LE76.Gate Out | Signal: Output of the logic gate |
| Logics.LE76.Timer Out | Signal: Timer Output |
| Logics.LE76.Out | Signal: Latched Output (Q) |
| Logics.LE76.Out inverted | Signal: Negated Latched Output (Q NOT) |
| Logics.LE77.Gate Out | Signal: Output of the logic gate |

Protective Elements

| <i>Name</i> | <i>Description</i> |
|--------------------------|--|
| Logics.LE77.Timer Out | Signal: Timer Output |
| Logics.LE77.Out | Signal: Latched Output (Q) |
| Logics.LE77.Out inverted | Signal: Negated Latched Output (Q NOT) |
| Logics.LE78.Gate Out | Signal: Output of the logic gate |
| Logics.LE78.Timer Out | Signal: Timer Output |
| Logics.LE78.Out | Signal: Latched Output (Q) |
| Logics.LE78.Out inverted | Signal: Negated Latched Output (Q NOT) |
| Logics.LE79.Gate Out | Signal: Output of the logic gate |
| Logics.LE79.Timer Out | Signal: Timer Output |
| Logics.LE79.Out | Signal: Latched Output (Q) |
| Logics.LE79.Out inverted | Signal: Negated Latched Output (Q NOT) |
| Logics.LE80.Gate Out | Signal: Output of the logic gate |
| Logics.LE80.Timer Out | Signal: Timer Output |
| Logics.LE80.Out | Signal: Latched Output (Q) |
| Logics.LE80.Out inverted | Signal: Negated Latched Output (Q NOT) |

Q->&V< Reactive-Power/Undervoltage Protection

Available Elements:

Q->&V<

The number of distributed energy resources (DER) raises continuously. At the same time the controllable power reserve through large-scale power plants decreases.

Therefore various grid codes requirements and regulations stipulate that mains parallel distributed power plants, consisting of one or more power generation units feeding power into the MV grid, have to support the mains voltage in case of failures.

In case of failure the voltage close to the short circuit location drops nearly to zero. Around the fault location a potential gradient area is built whose expansion can be restricted by feeding reactive-power into the grid. At mains failures (voltage drop) the Q->V< protection prevents the expansion of the potential gradient area for the case that any further reactive-power is taken from the mains.

The function of this protection module is not the protection of the power generation system itself, but more the decoupling of the power generation system when it takes reactive current from the mains in case the voltage drops below a certain value. This protection is an upstream system protection.

The Q->V< protection module is implemented as an autonomous protection element according to the German regulations ¹ and ² mentioned below (for reconnection see separate element).

The comprehensive setting and configuration possibilities of this protection element allow the adaptation of connected energy resources to various grid conditions.

For the correct function of this protection module you have to

- Configure the »General Settings«,
- Select and set the decoupling method.
- Configure the reconnection of the power generation units (see chapter Reconnection).

General Settings

For each parameter set [Protection Para\Set [x]\Q->&U<] the general settings »General Settings« can be configured.

Here the entire function of this protection element can be activated or deactivated.

By activating the voltage transformer supervision a malfunction of this protection module can be prevented.

¹ Technische Anschlussregeln für die Hochspannung (VDE-AR-N 4120)

² Technische Richtlinie „Erzeugungsanlagen am Mittelspannungsnetz“, Richtlinie für Anschluss und Parallelbetrieb von Erzeugungsanlagen am Mittelspannungsnetz, Ausgabe Juni 2008, BDEW Bundesverband der Energie- und Wasserwirtschaft e.V., siehe Kap. 3.2.3.2 – Blindleistungs-Unterspannungsschutz Q->&U<

QV Protection Trip Direction

Definitons

- Load Flow Arrow System = Consumed active and reactive are counted positive (greater than zero)
- Generator Flow Arrow System = produced power is to be counted positive (greater than zero)

By means of the parameter power trip dir positive/negative a sign reversal can be applied to the reactive power within the QV-Protection module. Protective devices that use the load flow arrow (like the MCA4 or the MRA4) are to be set to »*Power Trip dir= positive*«. Protective devices that are working on the base of the generator flow arrow system (like the MCDGV4) are to be set to »*Power Trip dir= negative*«. By means of that generator protection relays like the MCDGV4 can be set to the load flow arrow system internal within the QV-Protection (only). That means that outside of the QV-Protection no other power measurement or power protection is effected.

Trip Direction of the QV-Protection

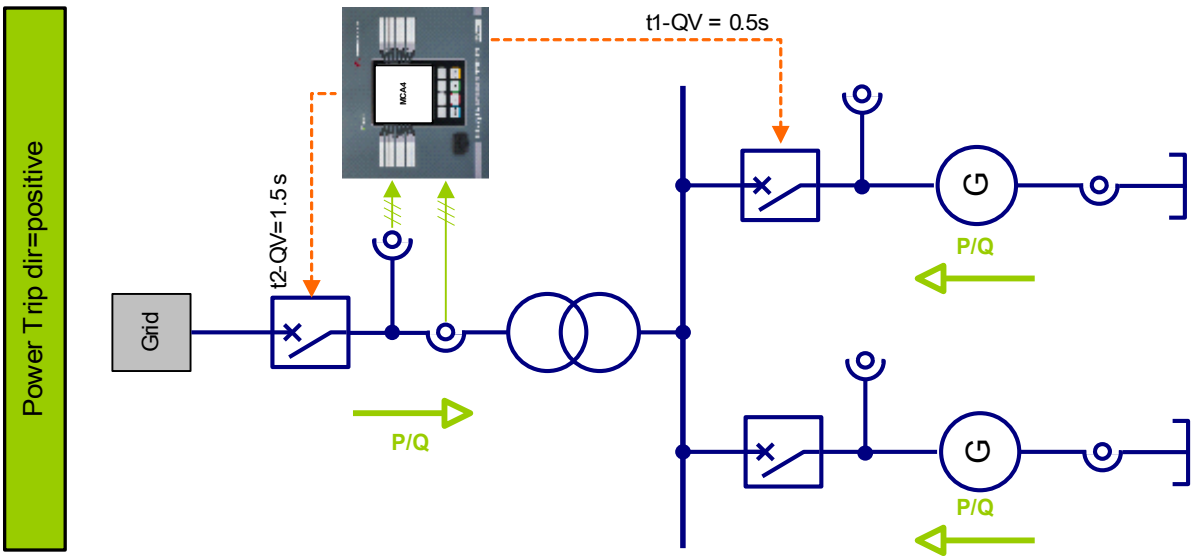
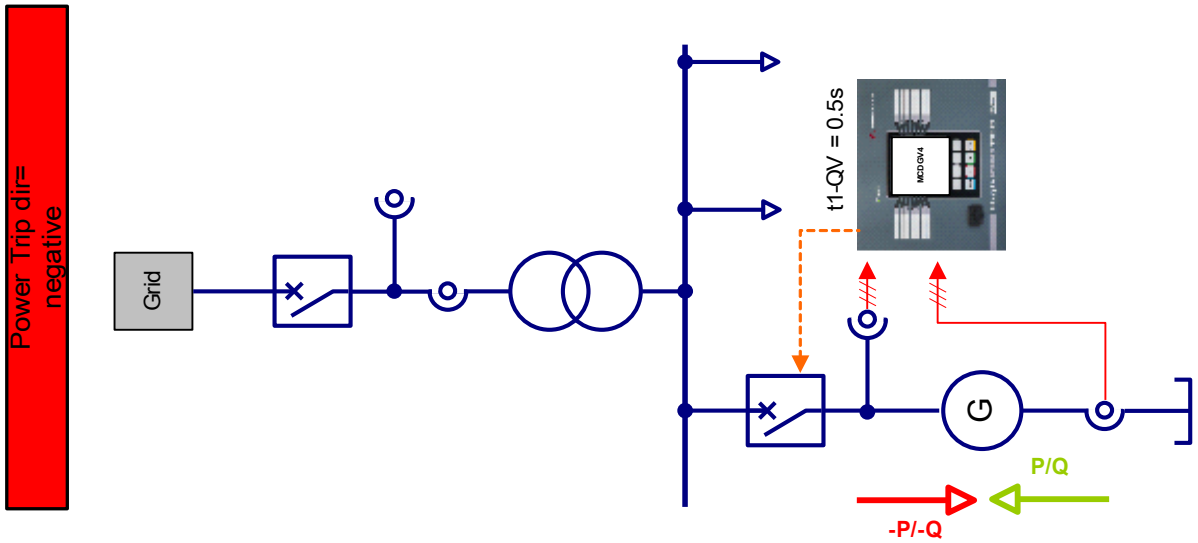

Parameter Setting of Decoupling

To support dynamical the decreasing voltage (voltage drop) during faults the grid codes of the transmission system owners (e.g. VDE AR 4120 page 57) require the following behavior during grid problems (voltage sags) by the connected energy resources:

The QV-Protection supervises the grid compliant behavior after a grid fault. Energy sources that have a negative impact on the restoration by consuming inductive reactive power have to be disconnected from the grid before timers of grid protection devices expire.

Therefore the energy source will be disconnected from the grid after 0.5 seconds by the QV-protection if all three line-to-line voltages at the point of common coupling are less than 0.85 times V_n (logical AND connected) and if the energy resource consumes at the same time inductive reactive power from the grid (VDE AR 4120 page 57).

NOTICE

The reactive-power of the positive phase sequence system (Q1) is evaluated.

The voltage supervision only monitors the phase to phase voltages.
This prevents any influence on the measurement through neutral point displacement in resonant earthed systems.

In the menu [Protection Para\Set[x]\Q->&U<] the »Decoupling« parameters can be set.

The reactive-power demand from the grid can be detected by two different methods. Therefor the decoupling method »*QV-Method*« has to be selected first.

- Power Angle Supervision (method 1)
- Pure Reactive Power Supervision (method 2)

Method 1: Power Angle Supervision

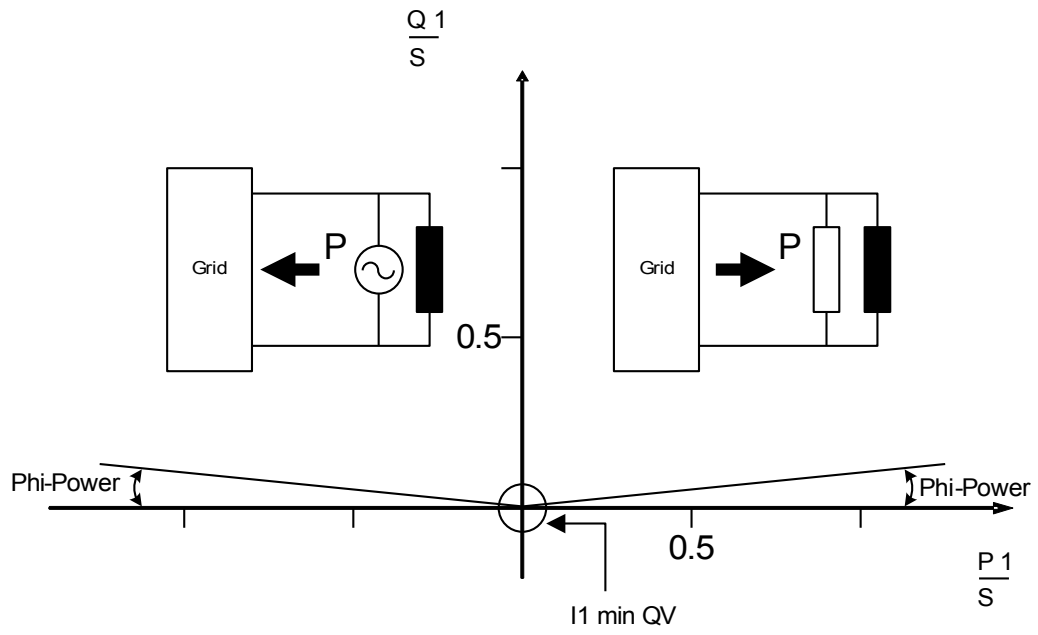

Method 2: Pure Reactive Power Supervision

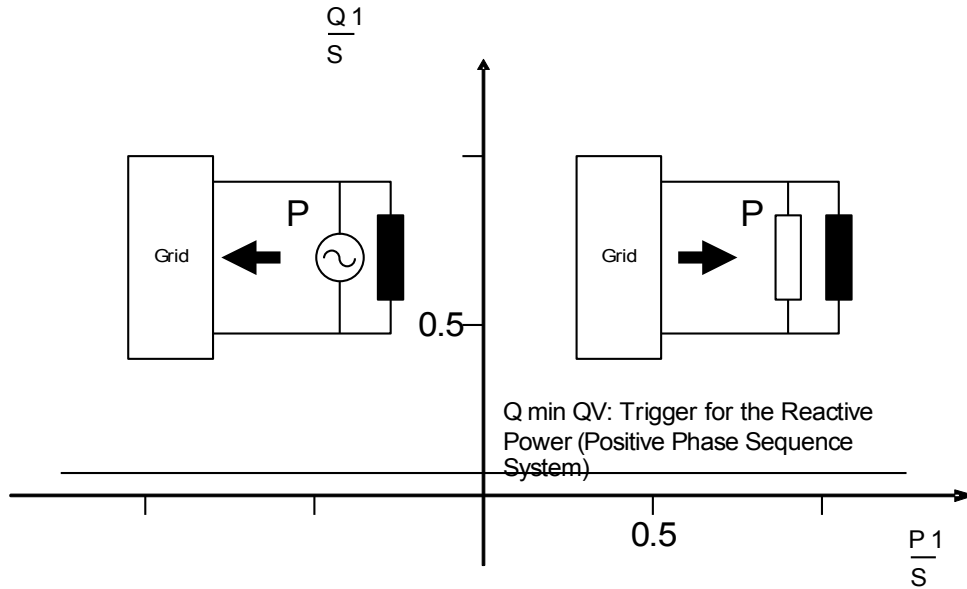

A minimum current supervision (I_1) in the positive phase sequence system prevents a hyperfunction of the reactive-power supervision at lower power levels.

For the power angle supervision, the minimum current supervision is always active. For the pure reactive-power supervision the minimum current supervision is optional.

When using the power angle supervision (method 1):

- Set the power angle »Phi-Power« (Default setting 3°).
- Select a suitable minimum current »I min QV« (Default setting 0.1 In) which prevents false tripping.

When using the pure reactive power supervision (method 2):

- Set the reactive-power threshold »Q min QV«(Default setting 0.05 Sn).
- Optionally select a suitable minimum current »I min QV« (Default setting 0.1 In) to prevent false tripping.

Two timer elements are available »t1-QV« and »t2-QV«. Both timer elements will be started at pick-up of the Q->U< module.

First timer element (Decoupling of the power generation unit)

When several mains parallel power generation units feed one PCC, the first timer element can give a trip command to the generator circuit breaker of the power generation unit (Default setting 0.5 s)

Second timer element (Decoupling at the PCC)

For the case, that tripping of the first timer element (decoupling of a certain power generation unit) does not have the expected effect the second timer element can give a trip command to the circuit breaker at the PCC (Default setting 1.5 s). This decouples the entire DER from the grid.

Q->&V<

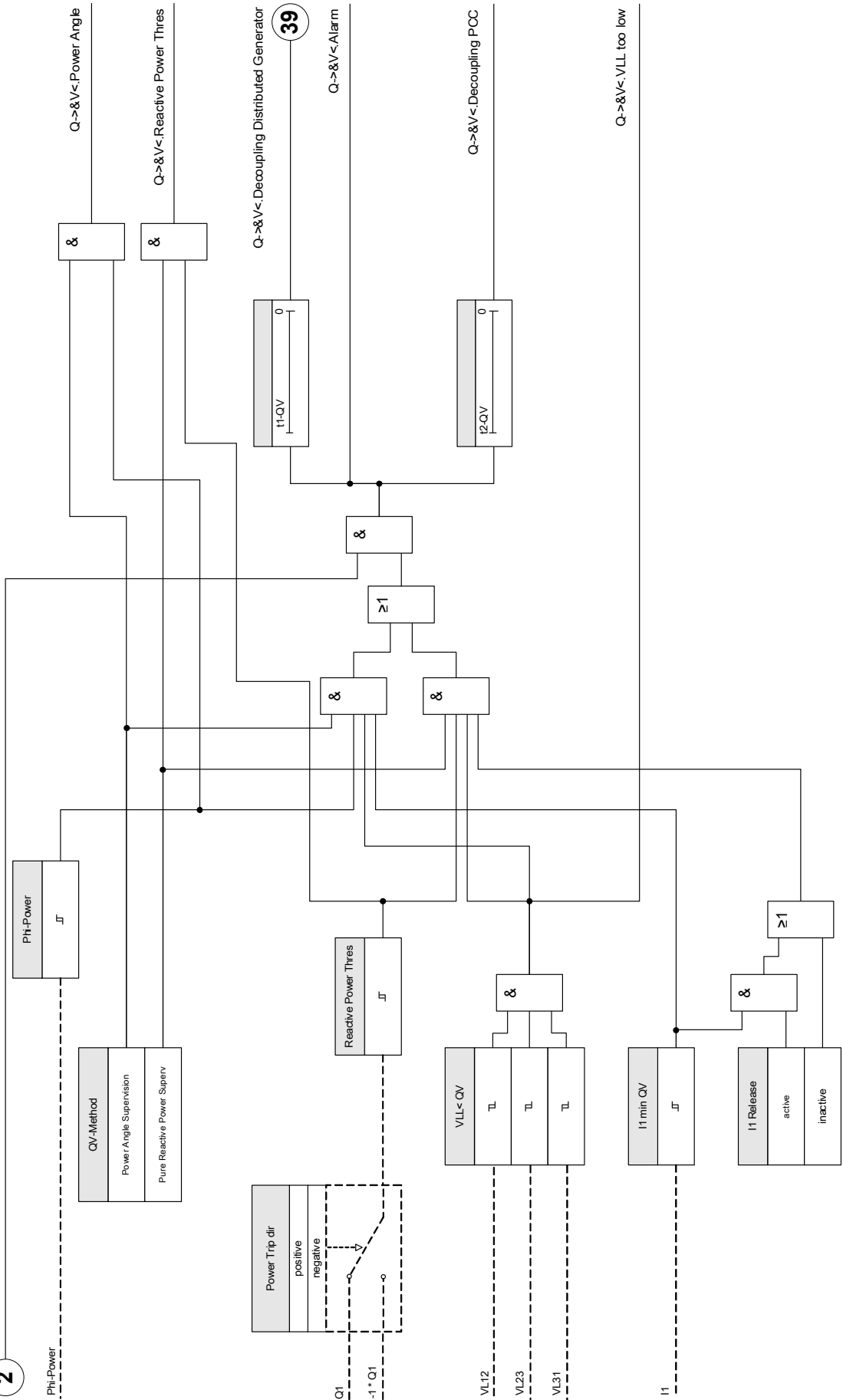

2









Device Planning Parameters of the Q->&V< Module

| Parameter | Description | Options | Default | Menu path |
|---|-------------|--------------------|------------|-------------------|
| Mode  | Mode | do not use, use | do not use | [Device planning] |





Global Protection Parameters of the Q->&V< Module

| Parameter | Description | Setting range | Default | Menu path |
|---|---|-----------------------|----------|---|
| ExBlo1  | External blocking of the module, if blocking is activated (allowed) within a parameter set and if the state of the assigned signal is true. | 1..n, Assignment List | -- | [Protection Para /Global Prot Para /Intercon-Prot /Q->&V<] |
| ExBlo2  | External blocking of the module, if blocking is activated (allowed) within a parameter set and if the state of the assigned signal is true. | 1..n, Assignment List | -- | [Protection Para /Global Prot Para /Intercon-Prot /Q->&V<] |
| Power Trip dir  | By means of this parameter the trip direction of active and reactive power can be inverted within the QV-Module (sign reversal). | positive, negative | positive | [Protection Para /Global Prot Para /Intercon-Prot /Q->&V<] |

Setting Group Parameters of the Q->&V< Module

| Parameter | Description | Setting range | Default | Menu path |
|---|---|--|-------------------------|--|
|  Function | Permanent activation or deactivation of module/stage. | inactive, active | inactive | [Protection Para /<1..4> /Intercon-Prot /Q->&V< /General settings] |
|  ExBlo Fc | Activate (allow) or inactivate (disallow) blocking of the module/stage. This parameter is only effective if a signal is assigned to the corresponding global protection parameter. If the signal becomes true, those modules/stages are blocked that are parameterized "ExBlo Fc=active". | inactive, active | inactive | [Protection Para /<1..4> /Intercon-Prot /Q->&V< /General settings] |
|  Meas Circuit Superv | Activates the use of the measuring circuit supervision. In this case the module will be blocked if a measuring circuit supervision module (e.g. LOP, VTS) signals a disturbed measuring circuit (e.g. caused by a fuse failure). | inactive, active | inactive | [Protection Para /<1..4> /Intercon-Prot /Q->&V< /General settings] |
|  QV-Method | Selection of the Q(V)-Method: Power Angle or Reactive Power Threshold | Power Angle Supervision, Pure Reactive Power Superv | Power Angle Supervision | [Protection Para /<1..4> /Intercon-Prot /Q->&V< /Decoupling] |
|  I1 Release | Activation of the "I1 Minimum Current"-Criterion. Only available if: QV-Method = Power Angle Supervision | inactive, active | active | [Protection Para /<1..4> /Intercon-Prot /Q->&V< /Decoupling] |
|  I1 min QV | Activation of an "I1 Minimum Current" of the rated current of the (distributed) energy resource can prevent faulty tripping. Only available if: Activation of the "I1 Minimum Current"-Criterion. = active | 0.01 - 0.20In | 0.10In | [Protection Para /<1..4> /Intercon-Prot /Q->&V< /Decoupling] |
|  VLL< QV | Undervoltage threshold (line-to-line voltage!) | 0.70 - 1.00Vn | 0.85Vn | [Protection Para /<1..4> /Intercon-Prot /Q->&V< /Decoupling] |

Protective Elements

| Parameter | Description | Setting range | Default | Menu path |
|---|--|---------------|---------|--|
|  Phi-Power | Trigger Phi-Power (Positive Phase Sequence System) Only available if: QV-Method = Power Angle Supervision | 0 - 10° | 3° | [Protection Para /<1..4> /Intercon-Prot /Q->&V< /Decoupling] |
|  Q min QV | Trigger for the Reactive Power (Positive Phase Sequence System) Only available if: QV-Method = Pure Reactive Power Superv | 0.01 - 0.20Sn | 0.05Sn | [Protection Para /<1..4> /Intercon-Prot /Q->&V< /Decoupling] |
|  t1-QV | First timer. If this timer has elapsed, a trip signal will be issued to the (local) energy resource. | 0.00 - 2.00s | 0.5s | [Protection Para /<1..4> /Intercon-Prot /Q->&V< /Decoupling] |
|  t2-QV | Second timer. If this timer is elapsed, the an trip signal will be issued to the PCC (Point of Common Coupling) | 0.00 - 4.00s | 1.5s | [Protection Para /<1..4> /Intercon-Prot /Q->&V< /Decoupling] |

Input States of the Q->&V< Module

| <i>Name</i> | <i>Description</i> | <i>Assignment via</i> |
|-------------|--|---|
| ExBlo1-l | Module input state: External blocking1 | [Protection Para /Global Prot Para /Intercon-Prot /Q->&V<] |
| ExBlo2-l | Module input state: External blocking2 | [Protection Para /Global Prot Para /Intercon-Prot /Q->&V<] |

Q->&V< Module Signals (Output States)

| <i>Signal</i> | <i>Description</i> |
|----------------------------------|---|
| active | Signal: active |
| ExBlo | Signal: External Blocking |
| Fuse Fail VT Blo | Signal: Blocked by Fuse Failure (VT) |
| Alarm | Signal: Alarm Reactive Power Undervoltage Protection |
| Decoupling Distributed Generator | Signal: Decoupling of the (local) Energy Generator/Resource |
| Decoupling PCC | Signal: Decoupling at the Point of Common Coupling |
| Power Angle | Signal: Admissible power angle exceeded |
| Reactive Power Thres | Signal: Admissible Reactive Power Threshold exceeded |
| VLL too low | Signal: Line-to-Line voltage too low |

Reconnection Module

Available Elements:
[ReCon\[1\]](#), [ReCon\[2\]](#)

The reconnection function after a mains decoupling is based on the requirements of the VDE AR-N 4120¹ and the German directive „Erzeugungsanlagen am MS-Netz“².

To monitor the reconnection conditions after a mains decoupling, a reconnection function has been implemented in parallel to the decoupling functions.

Mains voltage (phase to phase) and frequency are the main criteria for reconnection. Always the mains side voltage (line to line) at the generator circuit breaker (mains side) has to be evaluated.

The reconnection function is only one of the system functions for mains decoupling and return synchronizing. The reconnection element is tied to decoupling functions like the $Q \rightarrow V$ element and other integrated decoupling functions like under-/overvoltage, under-/overfrequency. The reconnection can be triggered by up to 6 decoupling elements or via digital input signals, logic functions or via SCADA (communication system).

After a trip of the circuit breaker at the PCC by the decoupling function, reconnection has to be done manually.

⚠ WARNING **Danger of an asynchronous reconnection:**
The reconnection function does not substitute a synchronizing device.
Before connecting different electrical networks, synchronism has to be secured.

After decoupling by the $Q \rightarrow V$ module or other decoupling functions, like $V \rightarrow V$, $V \rightarrow f$, the reconnection release signal for reconnection the circuit breaker of the power generating unit will be blocked for a preset time interval (default setting 10 minutes). This is to wait until all switching operations are completed. The automatic reconnection must not be executed before mains voltage and frequency are inside the acceptable bands (quasi permanent) that means within the admissible limit values for a preset, settable time.

The purpose of the reconnection function is to reconnect a decoupled energy resource safe to the mains/grid.

Release logic for the Generator Circuit Breaker

If the PCC circuit breaker has tripped the reconnection has to be done manually. A special blocking logic is not necessary.

NOTICE **If a power generating unit should be reconnected by the generator circuit breaker the voltage transformers have to be installed at the mains side of the circuit breaker.**

¹ „Technische Anschlussregeln für die Hochspannung“ (VDE-AR-N 4120)

² Technische Richtlinie „Erzeugungsanlagen am Mittelspannungsnetz“, Richtlinie für Anschluss und Parallelbetrieb von Erzeugungsanlagen am Mittelspannungsnetz, Ausgabe Juni 2008, BDEW Bundesverband der Energie- und Wasserwirtschaft e.V., → see „3.2.3.2 – Blindleistungs-Unterspannungsschutz $Q \rightarrow U$ “ therein.

After the decoupling functions have tripped so that the generator circuit breaker has been opened, some conditions must be fulfilled by the network operator before the reconnection of the power generating unit may be performed. These release conditions involve making sure that the mains voltages are within their valid value and frequency ranges. Such a test can (or must) be performed via direct measurement of the mains side voltages or/and an remote control release signal "External Release from PCC".

Since the various network operators may require their individual release conditions for a (re-)connection to their medium or high voltage networks there is a choice between three different release conditions:

1. » *V Internal Release* (Release after a test based on direct measurement of the mains voltages)
2. » *V Ext Release PCC*« (Release based on an external release signal from the PCC)
3. » *Both*« (Release if 1. and 2. are both fulfilled)

Voltage release by (self-) measured voltage values

NOTICE

This method can be used if the PCC is on the MV side.

If the PCC is on the MV side, the device can measure the phase to phase voltages on the mains side and decide if the mains voltage has stabilized sufficiently for reconnection.

For this method the parameter » *V Ext Release PCC Fk*« in the menu [Protection Para\Set[x]\Intercon-Prot\ReCon\General settings] has to be set to » *inactive*«.

Additionally the parameter » *Reclosure. Release Cond*« in the menu [Protection Para\Set[x]\Intercon-Prot\ReCon\Reclosure Release] has to be set to » *V internal release* «

Voltage release via remote control connection from the PCC

NOTICE

The voltage has to be recovered at the PCC before the reconnection is done.

If the PCC is located in the HV level the distance to the PCC is in general large. The information that the voltage is restored is to be transmitted via a remote control signal to the distributed energy resource.

This method has to be used if the PCC is on the HV side.

This method can be used if the PCC is on the MV side.

If reconnection release based on the remote control signal from the PCC is required:

In the menu [Protection Para\Set[x]\Intercon-Prot\ReCon\General settings] the parameter » *V Ext Release PCC Fc*« has to be set to » *active*«. With this setting the voltage release signal from the PCC is used (e. g. signal via digital input).

Additionally the parameter » *Reclosure Release Cond*« in the menu [Protection Para\Set[x]\Intercon-Prot\ReCon\Release Para\Reconnect. Release Cond] has to be set to » *V Ext Release PCC*«.

Moreover, the remote control release signal has to be assigned to the parameter » *V Ext Release PCC*« in the menu [Protection Para\Global Prot Para\Intercon-Prot\ReCon\General settings].

Voltage release by (self-) measured voltage values AND via remote control connection from the PCC

NOTICE

This method can be used if the PCC is on the HV side.

If the PCC is on the HV side the VDE AR-N 4120 (01/2015) permits connecting the power generation unit only if **both** the remote control release signal is present **and** the mains voltage connected to the generation unit is healthy. Therefore the logical AND operation of the internal and external signals has been made available and can be selected in case of HV network applications.

In the menu [Protection Para\Set[x]\Intercon-Prot\ReCon\General settings] the parameter »*V Ext Release PCC Fc*« has to be set to »*active*«. With this setting the voltage release signal from the PCC is used (e. g. signal via digital input).

Additionally the parameter »*Reclosure Release Cond*« in the menu [Protection Para\Set[x]\Intercon-Prot\ReCon\Release Para\Reconnect. Release Cond] has to be set to »*Both*«.

Moreover the remote control release signal has to be assigned to the parameter »*V Ext Release PCC*« in the menu [Protection Para\Global Prot Para\Intercon-Prot\ReCon\General settings].

PCC in HV systems

According to VDE-AR-N 4120 a reconnection of a Distributed Energy Resource to the grid is not allowed before the following conditions are fulfilled: The frequency of the mains/grid has to be between 47.5 and 51.5 Hz and the voltage between 93.5 and 127 kV (100 kV level). Voltage and frequency have to be within their limits for minimum 5 minutes.

Reconnection Conditions:

Before reconnecting a power generation unit it has to be secured that mains voltage has been stabilized sufficiently. According to VDE AR-N 4120 a corresponding remote signal has to be available and also the voltage at the Distributed Energy Resource too.

Set the parameter *»Reclosure Release Cond«* in the menu [Protection Para\Set[x]\Intercon-Prot\ReCon\Release Para] to *»Both«*. The required parameter settings are described in the chapter *»General Settings«*.

Set the blocking signals in the menu [Protection Para\Set[x]\Intercon-Prot\ReCon] the trigger (decoupling) signals which start the mains recovery time (OR logic).

Select a sufficiently long recovery time *»t-Release Blo«* in the menu [Protection Para\Set[x]\Intercon-Prot\Reconnection\Release Para]. Reconnection is only possible after this timer has been elapsed. This timer will be started by the triggers that have to be set in: [Global Para\Intercon-Prot\Reconnection\Decoupling]. (If it happens that the voltage or frequency values are outside the permissible ranges before the timer elapses then the timer is automatically restarted.)

In the menu [Protection Para\Set[x]\Intercon-Prot\Reconnection\Release Para] the frequency and voltage range to be met for reconnection can be set.

Set the parameters for the release of the voltage for the reconnection as described in section "Voltage release by (self-) measured voltage values AND via remote control connection from the PCC".

If one-minute average voltages are required for release condition, the (self-) measured voltage can use the average voltages from the Statistics module:

Set the parameter *»Measuring method«* in the menu [Protection Para\Set[x]\Intercon-Prot\ReCon\Release Para] to *»Vavg«*. Set the parameters for the release of the voltage for the reconnection as described in section "Configuration of the Voltage Based Average Value Calculation".

PCC in MV systems

The German regulation „Erzeugungsanlagen am MS-Netz“ (BDEW, Issue June 2008 ^[2]) recommends to have a time delay (some minutes) between mains voltage recovery and reclosure after a trip of a decoupling system as a result of a mains failure. This is to wait until all switching operations are completed. Usually this is the case after 10 minutes. A reconnection of the DER is only permitted, when the mains voltage is >95% of V_n and the frequency is in the range of 47.5 Hz to 50.05 Hz.

Set the trigger (decoupling) signals in the menu
[Global Prot Para\Intercon-Prot\ReCon\Decoupling] which start the mains recovery time
(OR logic).

Select a sufficiently long recovery time »t1-Release Blo« in the menu
[Protection Para\Set[x]\Intercon-Prot\ReCon\Release Para]. Reconnection is only possible after this timer has elapsed. (This timer stage will be triggered by the signals that are assigned in menu [Global Para\Intercon-Prot\Reconnection\Decoupling]).

In the menu [Protection Para\Set[x]\Intercon-Prot\ReCon\Release Para] the frequency and voltage range to be met for reconnection can be set.

Set the parameters for the release of the voltage as described in the corresponding sections for the voltage release.

Release logic for the Generator Circuit Breaker

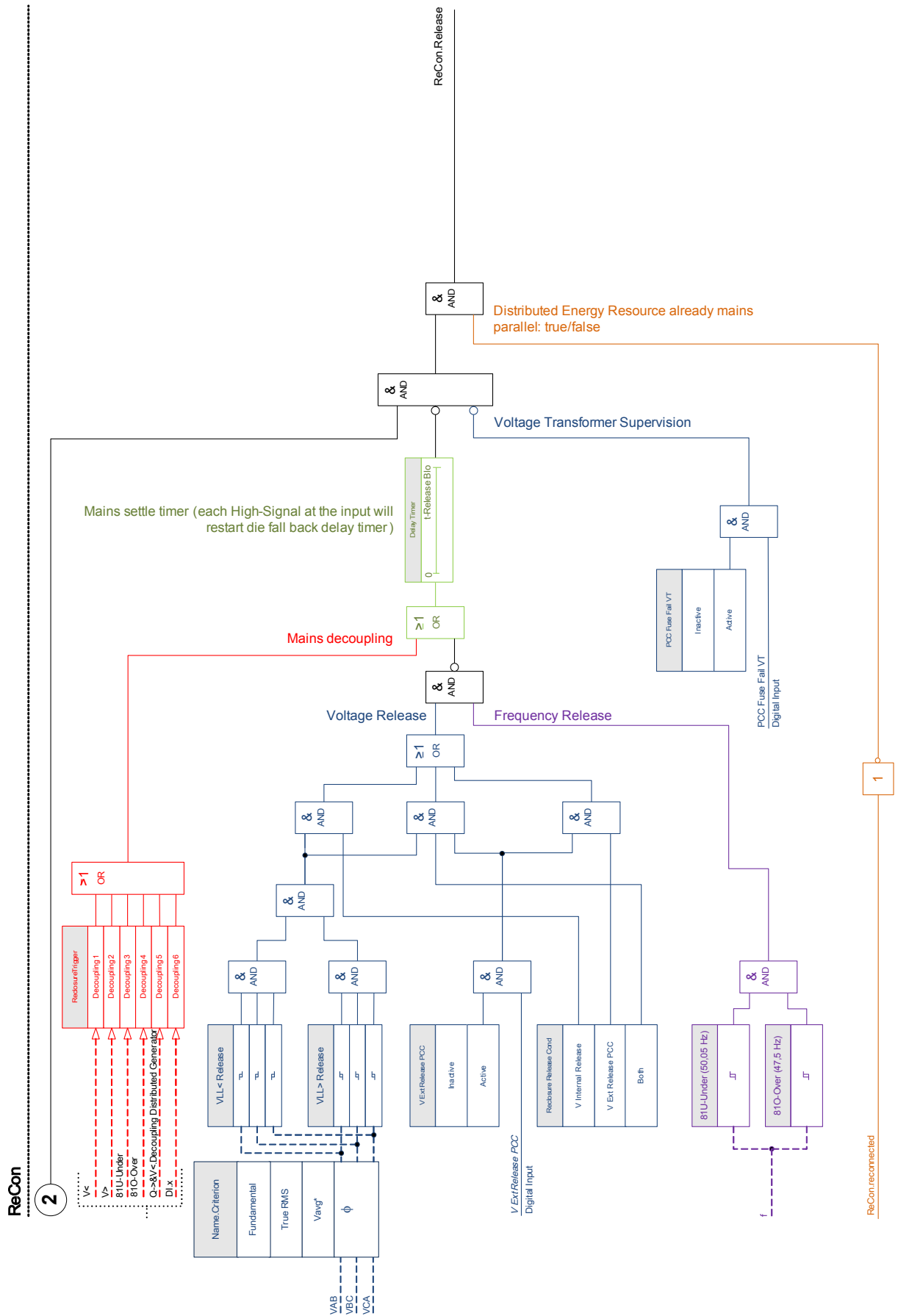





Device Planning Parameters of the Reconnection Module

| Parameter | Description | Options | Default | Menu path |
|---|-------------|--------------------|------------|-------------------|
| Mode  | Mode | do not use, use | do not use | [Device planning] |

Global Protection Parameters of the Reconnection Module

| Parameter | Description | Setting range | Default | Menu path |
|--|---|-----------------------|---------|--|
| ExBlo1  | External blocking of the module, if blocking is activated (allowed) within a parameter set and if the state of the assigned signal is true. | 1..n, Assignment List | -- | [Protection Para /Global Prot Para /Intercon-Prot /ReCon[1] /General settings] |
| ExBlo2  | External blocking of the module, if blocking is activated (allowed) within a parameter set and if the state of the assigned signal is true. | 1..n, Assignment List | -- | [Protection Para /Global Prot Para /Intercon-Prot /ReCon[1] /General settings] |
| V Ext Release PCC  | Release Signal by the Point of Common Coupling. The line-to-line voltage is greater than 95% of VN. | 1..n, Assignment List | -- | [Protection Para /Global Prot Para /Intercon-Prot /ReCon[1] /General settings] |
| PCC Fuse Fail VT  | Blocking if the fuse of a voltage transformer has tripped at the PCC. | 1..n, Dig Inputs | -- | [Protection Para /Global Prot Para /Intercon-Prot /ReCon[1] /General settings] |
| reconnected  | This signal indicates the state "reconnected" (mains parallel). | 1..n, Assignment List | -- | [Protection Para /Global Prot Para /Intercon-Prot /ReCon[1] /General settings] |
| Decoupling1  | Decoupling function, that blocks the reconnection. | Decoupling Functions | -- | [Protection Para /Global Prot Para /Intercon-Prot /ReCon[1] /Decoupling] |

| Parameter | Description | Setting range | Default | Menu path |
|--|--|----------------------|---------|--|
| Decoupling2  | Decoupling function, that blocks the reconnection. | Decoupling Functions | -- | [Protection Para /Global Prot Para /Intercon-Prot /ReCon[1] /Decoupling] |
| Decoupling3  | Decoupling function, that blocks the reconnection. | Decoupling Functions | -- | [Protection Para /Global Prot Para /Intercon-Prot /ReCon[1] /Decoupling] |
| Decoupling4  | Decoupling function, that blocks the reconnection. | Decoupling Functions | -- | [Protection Para /Global Prot Para /Intercon-Prot /ReCon[1] /Decoupling] |
| Decoupling5  | Decoupling function, that blocks the reconnection. | Decoupling Functions | -- | [Protection Para /Global Prot Para /Intercon-Prot /ReCon[1] /Decoupling] |
| Decoupling6  | Decoupling function, that blocks the reconnection. | Decoupling Functions | -- | [Protection Para /Global Prot Para /Intercon-Prot /ReCon[1] /Decoupling] |

Decoupling Functions of the Reconnection Module

| Name | Description |
|---------------|----------------------|
| -- | No assignment |
| I[1].TripCmd | Signal: Trip Command |
| I[2].TripCmd | Signal: Trip Command |
| I[3].TripCmd | Signal: Trip Command |
| I[4].TripCmd | Signal: Trip Command |
| I[5].TripCmd | Signal: Trip Command |
| I[6].TripCmd | Signal: Trip Command |
| IG[1].TripCmd | Signal: Trip Command |
| IG[2].TripCmd | Signal: Trip Command |
| IG[3].TripCmd | Signal: Trip Command |

Protective Elements

| <i>Name</i> | <i>Description</i> |
|-----------------------|----------------------|
| IG[4].TripCmd | Signal: Trip Command |
| ThR.TripCmd | Signal: Trip Command |
| I2>[1].TripCmd | Signal: Trip Command |
| I2>[2].TripCmd | Signal: Trip Command |
| V[1].TripCmd | Signal: Trip Command |
| V[2].TripCmd | Signal: Trip Command |
| V[3].TripCmd | Signal: Trip Command |
| V[4].TripCmd | Signal: Trip Command |
| V[5].TripCmd | Signal: Trip Command |
| V[6].TripCmd | Signal: Trip Command |
| df/dt.TripCmd | Signal: Trip Command |
| delta phi.TripCmd | Signal: Trip Command |
| Intertripping.TripCmd | Signal: Trip Command |
| P.TripCmd | Signal: Trip Command |
| Q.TripCmd | Signal: Trip Command |
| LVRT[1].TripCmd | Signal: Trip Command |
| LVRT[2].TripCmd | Signal: Trip Command |
| VG[1].TripCmd | Signal: Trip Command |
| VG[2].TripCmd | Signal: Trip Command |
| V012[1].TripCmd | Signal: Trip Command |
| V012[2].TripCmd | Signal: Trip Command |
| V012[3].TripCmd | Signal: Trip Command |
| V012[4].TripCmd | Signal: Trip Command |
| V012[5].TripCmd | Signal: Trip Command |
| V012[6].TripCmd | Signal: Trip Command |
| f[1].TripCmd | Signal: Trip Command |
| f[2].TripCmd | Signal: Trip Command |
| f[3].TripCmd | Signal: Trip Command |
| f[4].TripCmd | Signal: Trip Command |
| f[5].TripCmd | Signal: Trip Command |
| f[6].TripCmd | Signal: Trip Command |
| PQS[1].TripCmd | Signal: Trip Command |
| PQS[2].TripCmd | Signal: Trip Command |
| PQS[3].TripCmd | Signal: Trip Command |
| PQS[4].TripCmd | Signal: Trip Command |
| PQS[5].TripCmd | Signal: Trip Command |
| PQS[6].TripCmd | Signal: Trip Command |
| PF[1].TripCmd | Signal: Trip Command |
| PF[2].TripCmd | Signal: Trip Command |

Protective Elements

| <i>Name</i> | <i>Description</i> |
|---|--|
| Q->&V<.Decoupling Distributed Generator | Signal: Decoupling of the (local) Energy Generator/Resource |
| Q->&V<.Decoupling PCC | Signal: Decoupling at the Point of Common Coupling |
| UFLS.Trip | Signal: Signal: Trip |
| Exp[1].TripCmd | Signal: Trip Command |
| Exp[2].TripCmd | Signal: Trip Command |
| Exp[3].TripCmd | Signal: Trip Command |
| Exp[4].TripCmd | Signal: Trip Command |
| DI Slot X1.DI 1 | Signal: Digital Input |
| DI Slot X1.DI 2 | Signal: Digital Input |
| DI Slot X1.DI 3 | Signal: Digital Input |
| DI Slot X1.DI 4 | Signal: Digital Input |
| DI Slot X1.DI 5 | Signal: Digital Input |
| DI Slot X1.DI 6 | Signal: Digital Input |
| DI Slot X1.DI 7 | Signal: Digital Input |
| DI Slot X1.DI 8 | Signal: Digital Input |
| DI Slot X6.DI 1 | Signal: Digital Input |
| DI Slot X6.DI 2 | Signal: Digital Input |
| DI Slot X6.DI 3 | Signal: Digital Input |
| DI Slot X6.DI 4 | Signal: Digital Input |
| DI Slot X6.DI 5 | Signal: Digital Input |
| DI Slot X6.DI 6 | Signal: Digital Input |
| DI Slot X6.DI 7 | Signal: Digital Input |
| DI Slot X6.DI 8 | Signal: Digital Input |
| DNP3.BinaryOutput0 | Virtual Digital Output (DNP). This corresponds to a virtual binary input of the protective device. |
| DNP3.BinaryOutput1 | Virtual Digital Output (DNP). This corresponds to a virtual binary input of the protective device. |
| DNP3.BinaryOutput2 | Virtual Digital Output (DNP). This corresponds to a virtual binary input of the protective device. |
| DNP3.BinaryOutput3 | Virtual Digital Output (DNP). This corresponds to a virtual binary input of the protective device. |
| DNP3.BinaryOutput4 | Virtual Digital Output (DNP). This corresponds to a virtual binary input of the protective device. |
| DNP3.BinaryOutput5 | Virtual Digital Output (DNP). This corresponds to a virtual binary input of the protective device. |
| DNP3.BinaryOutput6 | Virtual Digital Output (DNP). This corresponds to a virtual binary input of the protective device. |
| DNP3.BinaryOutput7 | Virtual Digital Output (DNP). This corresponds to a virtual binary input of the protective device. |
| DNP3.BinaryOutput8 | Virtual Digital Output (DNP). This corresponds to a virtual binary input of the protective device. |
| DNP3.BinaryOutput9 | Virtual Digital Output (DNP). This corresponds to a virtual binary input of the protective device. |
| DNP3.BinaryOutput10 | Virtual Digital Output (DNP). This corresponds to a virtual binary input of the protective device. |
| DNP3.BinaryOutput11 | Virtual Digital Output (DNP). This corresponds to a virtual binary input of the protective device. |
| DNP3.BinaryOutput12 | Virtual Digital Output (DNP). This corresponds to a virtual binary input of the protective device. |
| DNP3.BinaryOutput13 | Virtual Digital Output (DNP). This corresponds to a virtual binary input of the protective device. |
| DNP3.BinaryOutput14 | Virtual Digital Output (DNP). This corresponds to a virtual binary input of the protective device. |
| DNP3.BinaryOutput15 | Virtual Digital Output (DNP). This corresponds to a virtual binary input of the protective device. |

Protective Elements

| <i>Name</i> | <i>Description</i> |
|---------------------|--|
| DNP3.BinaryOutput16 | Virtual Digital Output (DNP). This corresponds to a virtual binary input of the protective device. |
| DNP3.BinaryOutput17 | Virtual Digital Output (DNP). This corresponds to a virtual binary input of the protective device. |
| DNP3.BinaryOutput18 | Virtual Digital Output (DNP). This corresponds to a virtual binary input of the protective device. |
| DNP3.BinaryOutput19 | Virtual Digital Output (DNP). This corresponds to a virtual binary input of the protective device. |
| DNP3.BinaryOutput20 | Virtual Digital Output (DNP). This corresponds to a virtual binary input of the protective device. |
| DNP3.BinaryOutput21 | Virtual Digital Output (DNP). This corresponds to a virtual binary input of the protective device. |
| DNP3.BinaryOutput22 | Virtual Digital Output (DNP). This corresponds to a virtual binary input of the protective device. |
| DNP3.BinaryOutput23 | Virtual Digital Output (DNP). This corresponds to a virtual binary input of the protective device. |
| DNP3.BinaryOutput24 | Virtual Digital Output (DNP). This corresponds to a virtual binary input of the protective device. |
| DNP3.BinaryOutput25 | Virtual Digital Output (DNP). This corresponds to a virtual binary input of the protective device. |
| DNP3.BinaryOutput26 | Virtual Digital Output (DNP). This corresponds to a virtual binary input of the protective device. |
| DNP3.BinaryOutput27 | Virtual Digital Output (DNP). This corresponds to a virtual binary input of the protective device. |
| DNP3.BinaryOutput28 | Virtual Digital Output (DNP). This corresponds to a virtual binary input of the protective device. |
| DNP3.BinaryOutput29 | Virtual Digital Output (DNP). This corresponds to a virtual binary input of the protective device. |
| DNP3.BinaryOutput30 | Virtual Digital Output (DNP). This corresponds to a virtual binary input of the protective device. |
| DNP3.BinaryOutput31 | Virtual Digital Output (DNP). This corresponds to a virtual binary input of the protective device. |
| Modbus.Scada Cmd 1 | Scada Command |
| Modbus.Scada Cmd 2 | Scada Command |
| Modbus.Scada Cmd 3 | Scada Command |
| Modbus.Scada Cmd 4 | Scada Command |
| Modbus.Scada Cmd 5 | Scada Command |
| Modbus.Scada Cmd 6 | Scada Command |
| Modbus.Scada Cmd 7 | Scada Command |
| Modbus.Scada Cmd 8 | Scada Command |
| Modbus.Scada Cmd 9 | Scada Command |
| Modbus.Scada Cmd 10 | Scada Command |
| Modbus.Scada Cmd 11 | Scada Command |
| Modbus.Scada Cmd 12 | Scada Command |
| Modbus.Scada Cmd 13 | Scada Command |
| Modbus.Scada Cmd 14 | Scada Command |
| Modbus.Scada Cmd 15 | Scada Command |
| Modbus.Scada Cmd 16 | Scada Command |
| IEC61850.VirtInp1 | Signal: Virtual Input (IEC61850 GGIO Ind) |
| IEC61850.VirtInp2 | Signal: Virtual Input (IEC61850 GGIO Ind) |
| IEC61850.VirtInp3 | Signal: Virtual Input (IEC61850 GGIO Ind) |
| IEC61850.VirtInp4 | Signal: Virtual Input (IEC61850 GGIO Ind) |
| IEC61850.VirtInp5 | Signal: Virtual Input (IEC61850 GGIO Ind) |
| IEC61850.VirtInp6 | Signal: Virtual Input (IEC61850 GGIO Ind) |
| IEC61850.VirtInp7 | Signal: Virtual Input (IEC61850 GGIO Ind) |
| IEC61850.VirtInp8 | Signal: Virtual Input (IEC61850 GGIO Ind) |

Protective Elements

| <i>Name</i> | <i>Description</i> |
|--------------------|--|
| IEC61850.VirtInp9 | Signal: Virtual Input (IEC61850 GGIO Ind) |
| IEC61850.VirtInp10 | Signal: Virtual Input (IEC61850 GGIO Ind) |
| IEC61850.VirtInp11 | Signal: Virtual Input (IEC61850 GGIO Ind) |
| IEC61850.VirtInp12 | Signal: Virtual Input (IEC61850 GGIO Ind) |
| IEC61850.VirtInp13 | Signal: Virtual Input (IEC61850 GGIO Ind) |
| IEC61850.VirtInp14 | Signal: Virtual Input (IEC61850 GGIO Ind) |
| IEC61850.VirtInp15 | Signal: Virtual Input (IEC61850 GGIO Ind) |
| IEC61850.VirtInp16 | Signal: Virtual Input (IEC61850 GGIO Ind) |
| IEC61850.VirtInp17 | Signal: Virtual Input (IEC61850 GGIO Ind) |
| IEC61850.VirtInp18 | Signal: Virtual Input (IEC61850 GGIO Ind) |
| IEC61850.VirtInp19 | Signal: Virtual Input (IEC61850 GGIO Ind) |
| IEC61850.VirtInp20 | Signal: Virtual Input (IEC61850 GGIO Ind) |
| IEC61850.VirtInp21 | Signal: Virtual Input (IEC61850 GGIO Ind) |
| IEC61850.VirtInp22 | Signal: Virtual Input (IEC61850 GGIO Ind) |
| IEC61850.VirtInp23 | Signal: Virtual Input (IEC61850 GGIO Ind) |
| IEC61850.VirtInp24 | Signal: Virtual Input (IEC61850 GGIO Ind) |
| IEC61850.VirtInp25 | Signal: Virtual Input (IEC61850 GGIO Ind) |
| IEC61850.VirtInp26 | Signal: Virtual Input (IEC61850 GGIO Ind) |
| IEC61850.VirtInp27 | Signal: Virtual Input (IEC61850 GGIO Ind) |
| IEC61850.VirtInp28 | Signal: Virtual Input (IEC61850 GGIO Ind) |
| IEC61850.VirtInp29 | Signal: Virtual Input (IEC61850 GGIO Ind) |
| IEC61850.VirtInp30 | Signal: Virtual Input (IEC61850 GGIO Ind) |
| IEC61850.VirtInp31 | Signal: Virtual Input (IEC61850 GGIO Ind) |
| IEC61850.VirtInp32 | Signal: Virtual Input (IEC61850 GGIO Ind) |
| IEC61850.SPSCO1 | Status bit that can be set by clients like e.g. SCADA (Single Point Controllable Status Output). |
| IEC61850.SPSCO2 | Status bit that can be set by clients like e.g. SCADA (Single Point Controllable Status Output). |
| IEC61850.SPSCO3 | Status bit that can be set by clients like e.g. SCADA (Single Point Controllable Status Output). |
| IEC61850.SPSCO4 | Status bit that can be set by clients like e.g. SCADA (Single Point Controllable Status Output). |
| IEC61850.SPSCO5 | Status bit that can be set by clients like e.g. SCADA (Single Point Controllable Status Output). |
| IEC61850.SPSCO6 | Status bit that can be set by clients like e.g. SCADA (Single Point Controllable Status Output). |
| IEC61850.SPSCO7 | Status bit that can be set by clients like e.g. SCADA (Single Point Controllable Status Output). |
| IEC61850.SPSCO8 | Status bit that can be set by clients like e.g. SCADA (Single Point Controllable Status Output). |
| IEC61850.SPSCO9 | Status bit that can be set by clients like e.g. SCADA (Single Point Controllable Status Output). |
| IEC61850.SPSCO10 | Status bit that can be set by clients like e.g. SCADA (Single Point Controllable Status Output). |
| IEC61850.SPSCO11 | Status bit that can be set by clients like e.g. SCADA (Single Point Controllable Status Output). |
| IEC61850.SPSCO12 | Status bit that can be set by clients like e.g. SCADA (Single Point Controllable Status Output). |
| IEC61850.SPSCO13 | Status bit that can be set by clients like e.g. SCADA (Single Point Controllable Status Output). |
| IEC61850.SPSCO14 | Status bit that can be set by clients like e.g. SCADA (Single Point Controllable Status Output). |
| IEC61850.SPSCO15 | Status bit that can be set by clients like e.g. SCADA (Single Point Controllable Status Output). |
| IEC61850.SPSCO16 | Status bit that can be set by clients like e.g. SCADA (Single Point Controllable Status Output). |

Protective Elements

| <i>Name</i> | <i>Description</i> |
|-------------------------|--|
| IEC 103.Scada Cmd 1 | Scada Command |
| IEC 103.Scada Cmd 2 | Scada Command |
| IEC 103.Scada Cmd 3 | Scada Command |
| IEC 103.Scada Cmd 4 | Scada Command |
| IEC 103.Scada Cmd 5 | Scada Command |
| IEC 103.Scada Cmd 6 | Scada Command |
| IEC 103.Scada Cmd 7 | Scada Command |
| IEC 103.Scada Cmd 8 | Scada Command |
| IEC 103.Scada Cmd 9 | Scada Command |
| IEC 103.Scada Cmd 10 | Scada Command |
| Profibus.Scada Cmd 1 | Scada Command |
| Profibus.Scada Cmd 2 | Scada Command |
| Profibus.Scada Cmd 3 | Scada Command |
| Profibus.Scada Cmd 4 | Scada Command |
| Profibus.Scada Cmd 5 | Scada Command |
| Profibus.Scada Cmd 6 | Scada Command |
| Profibus.Scada Cmd 7 | Scada Command |
| Profibus.Scada Cmd 8 | Scada Command |
| Profibus.Scada Cmd 9 | Scada Command |
| Profibus.Scada Cmd 10 | Scada Command |
| Profibus.Scada Cmd 11 | Scada Command |
| Profibus.Scada Cmd 12 | Scada Command |
| Profibus.Scada Cmd 13 | Scada Command |
| Profibus.Scada Cmd 14 | Scada Command |
| Profibus.Scada Cmd 15 | Scada Command |
| Profibus.Scada Cmd 16 | Scada Command |
| Logics.LE1.Gate Out | Signal: Output of the logic gate |
| Logics.LE1.Timer Out | Signal: Timer Output |
| Logics.LE1.Out | Signal: Latched Output (Q) |
| Logics.LE1.Out inverted | Signal: Negated Latched Output (Q NOT) |
| Logics.LE2.Gate Out | Signal: Output of the logic gate |
| Logics.LE2.Timer Out | Signal: Timer Output |
| Logics.LE2.Out | Signal: Latched Output (Q) |
| Logics.LE2.Out inverted | Signal: Negated Latched Output (Q NOT) |
| Logics.LE3.Gate Out | Signal: Output of the logic gate |
| Logics.LE3.Timer Out | Signal: Timer Output |
| Logics.LE3.Out | Signal: Latched Output (Q) |
| Logics.LE3.Out inverted | Signal: Negated Latched Output (Q NOT) |
| Logics.LE4.Gate Out | Signal: Output of the logic gate |
| Logics.LE4.Timer Out | Signal: Timer Output |

Protective Elements

| <i>Name</i> | <i>Description</i> |
|--------------------------|--|
| Logics.LE4.Out | Signal: Latched Output (Q) |
| Logics.LE4.Out inverted | Signal: Negated Latched Output (Q NOT) |
| Logics.LE5.Gate Out | Signal: Output of the logic gate |
| Logics.LE5.Timer Out | Signal: Timer Output |
| Logics.LE5.Out | Signal: Latched Output (Q) |
| Logics.LE5.Out inverted | Signal: Negated Latched Output (Q NOT) |
| Logics.LE6.Gate Out | Signal: Output of the logic gate |
| Logics.LE6.Timer Out | Signal: Timer Output |
| Logics.LE6.Out | Signal: Latched Output (Q) |
| Logics.LE6.Out inverted | Signal: Negated Latched Output (Q NOT) |
| Logics.LE7.Gate Out | Signal: Output of the logic gate |
| Logics.LE7.Timer Out | Signal: Timer Output |
| Logics.LE7.Out | Signal: Latched Output (Q) |
| Logics.LE7.Out inverted | Signal: Negated Latched Output (Q NOT) |
| Logics.LE8.Gate Out | Signal: Output of the logic gate |
| Logics.LE8.Timer Out | Signal: Timer Output |
| Logics.LE8.Out | Signal: Latched Output (Q) |
| Logics.LE8.Out inverted | Signal: Negated Latched Output (Q NOT) |
| Logics.LE9.Gate Out | Signal: Output of the logic gate |
| Logics.LE9.Timer Out | Signal: Timer Output |
| Logics.LE9.Out | Signal: Latched Output (Q) |
| Logics.LE9.Out inverted | Signal: Negated Latched Output (Q NOT) |
| Logics.LE10.Gate Out | Signal: Output of the logic gate |
| Logics.LE10.Timer Out | Signal: Timer Output |
| Logics.LE10.Out | Signal: Latched Output (Q) |
| Logics.LE10.Out inverted | Signal: Negated Latched Output (Q NOT) |
| Logics.LE11.Gate Out | Signal: Output of the logic gate |
| Logics.LE11.Timer Out | Signal: Timer Output |
| Logics.LE11.Out | Signal: Latched Output (Q) |
| Logics.LE11.Out inverted | Signal: Negated Latched Output (Q NOT) |
| Logics.LE12.Gate Out | Signal: Output of the logic gate |
| Logics.LE12.Timer Out | Signal: Timer Output |
| Logics.LE12.Out | Signal: Latched Output (Q) |
| Logics.LE12.Out inverted | Signal: Negated Latched Output (Q NOT) |
| Logics.LE13.Gate Out | Signal: Output of the logic gate |
| Logics.LE13.Timer Out | Signal: Timer Output |
| Logics.LE13.Out | Signal: Latched Output (Q) |
| Logics.LE13.Out inverted | Signal: Negated Latched Output (Q NOT) |
| Logics.LE14.Gate Out | Signal: Output of the logic gate |
| Logics.LE14.Timer Out | Signal: Timer Output |

Protective Elements

| <i>Name</i> | <i>Description</i> |
|--------------------------|--|
| Logics.LE14.Out | Signal: Latched Output (Q) |
| Logics.LE14.Out inverted | Signal: Negated Latched Output (Q NOT) |
| Logics.LE15.Gate Out | Signal: Output of the logic gate |
| Logics.LE15.Timer Out | Signal: Timer Output |
| Logics.LE15.Out | Signal: Latched Output (Q) |
| Logics.LE15.Out inverted | Signal: Negated Latched Output (Q NOT) |
| Logics.LE16.Gate Out | Signal: Output of the logic gate |
| Logics.LE16.Timer Out | Signal: Timer Output |
| Logics.LE16.Out | Signal: Latched Output (Q) |
| Logics.LE16.Out inverted | Signal: Negated Latched Output (Q NOT) |
| Logics.LE17.Gate Out | Signal: Output of the logic gate |
| Logics.LE17.Timer Out | Signal: Timer Output |
| Logics.LE17.Out | Signal: Latched Output (Q) |
| Logics.LE17.Out inverted | Signal: Negated Latched Output (Q NOT) |
| Logics.LE18.Gate Out | Signal: Output of the logic gate |
| Logics.LE18.Timer Out | Signal: Timer Output |
| Logics.LE18.Out | Signal: Latched Output (Q) |
| Logics.LE18.Out inverted | Signal: Negated Latched Output (Q NOT) |
| Logics.LE19.Gate Out | Signal: Output of the logic gate |
| Logics.LE19.Timer Out | Signal: Timer Output |
| Logics.LE19.Out | Signal: Latched Output (Q) |
| Logics.LE19.Out inverted | Signal: Negated Latched Output (Q NOT) |
| Logics.LE20.Gate Out | Signal: Output of the logic gate |
| Logics.LE20.Timer Out | Signal: Timer Output |
| Logics.LE20.Out | Signal: Latched Output (Q) |
| Logics.LE20.Out inverted | Signal: Negated Latched Output (Q NOT) |
| Logics.LE21.Gate Out | Signal: Output of the logic gate |
| Logics.LE21.Timer Out | Signal: Timer Output |
| Logics.LE21.Out | Signal: Latched Output (Q) |
| Logics.LE21.Out inverted | Signal: Negated Latched Output (Q NOT) |
| Logics.LE22.Gate Out | Signal: Output of the logic gate |
| Logics.LE22.Timer Out | Signal: Timer Output |
| Logics.LE22.Out | Signal: Latched Output (Q) |
| Logics.LE22.Out inverted | Signal: Negated Latched Output (Q NOT) |
| Logics.LE23.Gate Out | Signal: Output of the logic gate |
| Logics.LE23.Timer Out | Signal: Timer Output |
| Logics.LE23.Out | Signal: Latched Output (Q) |
| Logics.LE23.Out inverted | Signal: Negated Latched Output (Q NOT) |
| Logics.LE24.Gate Out | Signal: Output of the logic gate |
| Logics.LE24.Timer Out | Signal: Timer Output |

Protective Elements

| <i>Name</i> | <i>Description</i> |
|--------------------------|--|
| Logics.LE24.Out | Signal: Latched Output (Q) |
| Logics.LE24.Out inverted | Signal: Negated Latched Output (Q NOT) |
| Logics.LE25.Gate Out | Signal: Output of the logic gate |
| Logics.LE25.Timer Out | Signal: Timer Output |
| Logics.LE25.Out | Signal: Latched Output (Q) |
| Logics.LE25.Out inverted | Signal: Negated Latched Output (Q NOT) |
| Logics.LE26.Gate Out | Signal: Output of the logic gate |
| Logics.LE26.Timer Out | Signal: Timer Output |
| Logics.LE26.Out | Signal: Latched Output (Q) |
| Logics.LE26.Out inverted | Signal: Negated Latched Output (Q NOT) |
| Logics.LE27.Gate Out | Signal: Output of the logic gate |
| Logics.LE27.Timer Out | Signal: Timer Output |
| Logics.LE27.Out | Signal: Latched Output (Q) |
| Logics.LE27.Out inverted | Signal: Negated Latched Output (Q NOT) |
| Logics.LE28.Gate Out | Signal: Output of the logic gate |
| Logics.LE28.Timer Out | Signal: Timer Output |
| Logics.LE28.Out | Signal: Latched Output (Q) |
| Logics.LE28.Out inverted | Signal: Negated Latched Output (Q NOT) |
| Logics.LE29.Gate Out | Signal: Output of the logic gate |
| Logics.LE29.Timer Out | Signal: Timer Output |
| Logics.LE29.Out | Signal: Latched Output (Q) |
| Logics.LE29.Out inverted | Signal: Negated Latched Output (Q NOT) |
| Logics.LE30.Gate Out | Signal: Output of the logic gate |
| Logics.LE30.Timer Out | Signal: Timer Output |
| Logics.LE30.Out | Signal: Latched Output (Q) |
| Logics.LE30.Out inverted | Signal: Negated Latched Output (Q NOT) |
| Logics.LE31.Gate Out | Signal: Output of the logic gate |
| Logics.LE31.Timer Out | Signal: Timer Output |
| Logics.LE31.Out | Signal: Latched Output (Q) |
| Logics.LE31.Out inverted | Signal: Negated Latched Output (Q NOT) |
| Logics.LE32.Gate Out | Signal: Output of the logic gate |
| Logics.LE32.Timer Out | Signal: Timer Output |
| Logics.LE32.Out | Signal: Latched Output (Q) |
| Logics.LE32.Out inverted | Signal: Negated Latched Output (Q NOT) |
| Logics.LE33.Gate Out | Signal: Output of the logic gate |
| Logics.LE33.Timer Out | Signal: Timer Output |
| Logics.LE33.Out | Signal: Latched Output (Q) |
| Logics.LE33.Out inverted | Signal: Negated Latched Output (Q NOT) |
| Logics.LE34.Gate Out | Signal: Output of the logic gate |
| Logics.LE34.Timer Out | Signal: Timer Output |

Protective Elements

| <i>Name</i> | <i>Description</i> |
|--------------------------|--|
| Logics.LE34.Out | Signal: Latched Output (Q) |
| Logics.LE34.Out inverted | Signal: Negated Latched Output (Q NOT) |
| Logics.LE35.Gate Out | Signal: Output of the logic gate |
| Logics.LE35.Timer Out | Signal: Timer Output |
| Logics.LE35.Out | Signal: Latched Output (Q) |
| Logics.LE35.Out inverted | Signal: Negated Latched Output (Q NOT) |
| Logics.LE36.Gate Out | Signal: Output of the logic gate |
| Logics.LE36.Timer Out | Signal: Timer Output |
| Logics.LE36.Out | Signal: Latched Output (Q) |
| Logics.LE36.Out inverted | Signal: Negated Latched Output (Q NOT) |
| Logics.LE37.Gate Out | Signal: Output of the logic gate |
| Logics.LE37.Timer Out | Signal: Timer Output |
| Logics.LE37.Out | Signal: Latched Output (Q) |
| Logics.LE37.Out inverted | Signal: Negated Latched Output (Q NOT) |
| Logics.LE38.Gate Out | Signal: Output of the logic gate |
| Logics.LE38.Timer Out | Signal: Timer Output |
| Logics.LE38.Out | Signal: Latched Output (Q) |
| Logics.LE38.Out inverted | Signal: Negated Latched Output (Q NOT) |
| Logics.LE39.Gate Out | Signal: Output of the logic gate |
| Logics.LE39.Timer Out | Signal: Timer Output |
| Logics.LE39.Out | Signal: Latched Output (Q) |
| Logics.LE39.Out inverted | Signal: Negated Latched Output (Q NOT) |
| Logics.LE40.Gate Out | Signal: Output of the logic gate |
| Logics.LE40.Timer Out | Signal: Timer Output |
| Logics.LE40.Out | Signal: Latched Output (Q) |
| Logics.LE40.Out inverted | Signal: Negated Latched Output (Q NOT) |
| Logics.LE41.Gate Out | Signal: Output of the logic gate |
| Logics.LE41.Timer Out | Signal: Timer Output |
| Logics.LE41.Out | Signal: Latched Output (Q) |
| Logics.LE41.Out inverted | Signal: Negated Latched Output (Q NOT) |
| Logics.LE42.Gate Out | Signal: Output of the logic gate |
| Logics.LE42.Timer Out | Signal: Timer Output |
| Logics.LE42.Out | Signal: Latched Output (Q) |
| Logics.LE42.Out inverted | Signal: Negated Latched Output (Q NOT) |
| Logics.LE43.Gate Out | Signal: Output of the logic gate |
| Logics.LE43.Timer Out | Signal: Timer Output |
| Logics.LE43.Out | Signal: Latched Output (Q) |
| Logics.LE43.Out inverted | Signal: Negated Latched Output (Q NOT) |
| Logics.LE44.Gate Out | Signal: Output of the logic gate |
| Logics.LE44.Timer Out | Signal: Timer Output |

Protective Elements

| <i>Name</i> | <i>Description</i> |
|--------------------------|--|
| Logics.LE44.Out | Signal: Latched Output (Q) |
| Logics.LE44.Out inverted | Signal: Negated Latched Output (Q NOT) |
| Logics.LE45.Gate Out | Signal: Output of the logic gate |
| Logics.LE45.Timer Out | Signal: Timer Output |
| Logics.LE45.Out | Signal: Latched Output (Q) |
| Logics.LE45.Out inverted | Signal: Negated Latched Output (Q NOT) |
| Logics.LE46.Gate Out | Signal: Output of the logic gate |
| Logics.LE46.Timer Out | Signal: Timer Output |
| Logics.LE46.Out | Signal: Latched Output (Q) |
| Logics.LE46.Out inverted | Signal: Negated Latched Output (Q NOT) |
| Logics.LE47.Gate Out | Signal: Output of the logic gate |
| Logics.LE47.Timer Out | Signal: Timer Output |
| Logics.LE47.Out | Signal: Latched Output (Q) |
| Logics.LE47.Out inverted | Signal: Negated Latched Output (Q NOT) |
| Logics.LE48.Gate Out | Signal: Output of the logic gate |
| Logics.LE48.Timer Out | Signal: Timer Output |
| Logics.LE48.Out | Signal: Latched Output (Q) |
| Logics.LE48.Out inverted | Signal: Negated Latched Output (Q NOT) |
| Logics.LE49.Gate Out | Signal: Output of the logic gate |
| Logics.LE49.Timer Out | Signal: Timer Output |
| Logics.LE49.Out | Signal: Latched Output (Q) |
| Logics.LE49.Out inverted | Signal: Negated Latched Output (Q NOT) |
| Logics.LE50.Gate Out | Signal: Output of the logic gate |
| Logics.LE50.Timer Out | Signal: Timer Output |
| Logics.LE50.Out | Signal: Latched Output (Q) |
| Logics.LE50.Out inverted | Signal: Negated Latched Output (Q NOT) |
| Logics.LE51.Gate Out | Signal: Output of the logic gate |
| Logics.LE51.Timer Out | Signal: Timer Output |
| Logics.LE51.Out | Signal: Latched Output (Q) |
| Logics.LE51.Out inverted | Signal: Negated Latched Output (Q NOT) |
| Logics.LE52.Gate Out | Signal: Output of the logic gate |
| Logics.LE52.Timer Out | Signal: Timer Output |
| Logics.LE52.Out | Signal: Latched Output (Q) |
| Logics.LE52.Out inverted | Signal: Negated Latched Output (Q NOT) |
| Logics.LE53.Gate Out | Signal: Output of the logic gate |
| Logics.LE53.Timer Out | Signal: Timer Output |
| Logics.LE53.Out | Signal: Latched Output (Q) |
| Logics.LE53.Out inverted | Signal: Negated Latched Output (Q NOT) |
| Logics.LE54.Gate Out | Signal: Output of the logic gate |
| Logics.LE54.Timer Out | Signal: Timer Output |

Protective Elements

| <i>Name</i> | <i>Description</i> |
|--------------------------|--|
| Logics.LE54.Out | Signal: Latched Output (Q) |
| Logics.LE54.Out inverted | Signal: Negated Latched Output (Q NOT) |
| Logics.LE55.Gate Out | Signal: Output of the logic gate |
| Logics.LE55.Timer Out | Signal: Timer Output |
| Logics.LE55.Out | Signal: Latched Output (Q) |
| Logics.LE55.Out inverted | Signal: Negated Latched Output (Q NOT) |
| Logics.LE56.Gate Out | Signal: Output of the logic gate |
| Logics.LE56.Timer Out | Signal: Timer Output |
| Logics.LE56.Out | Signal: Latched Output (Q) |
| Logics.LE56.Out inverted | Signal: Negated Latched Output (Q NOT) |
| Logics.LE57.Gate Out | Signal: Output of the logic gate |
| Logics.LE57.Timer Out | Signal: Timer Output |
| Logics.LE57.Out | Signal: Latched Output (Q) |
| Logics.LE57.Out inverted | Signal: Negated Latched Output (Q NOT) |
| Logics.LE58.Gate Out | Signal: Output of the logic gate |
| Logics.LE58.Timer Out | Signal: Timer Output |
| Logics.LE58.Out | Signal: Latched Output (Q) |
| Logics.LE58.Out inverted | Signal: Negated Latched Output (Q NOT) |
| Logics.LE59.Gate Out | Signal: Output of the logic gate |
| Logics.LE59.Timer Out | Signal: Timer Output |
| Logics.LE59.Out | Signal: Latched Output (Q) |
| Logics.LE59.Out inverted | Signal: Negated Latched Output (Q NOT) |
| Logics.LE60.Gate Out | Signal: Output of the logic gate |
| Logics.LE60.Timer Out | Signal: Timer Output |
| Logics.LE60.Out | Signal: Latched Output (Q) |
| Logics.LE60.Out inverted | Signal: Negated Latched Output (Q NOT) |
| Logics.LE61.Gate Out | Signal: Output of the logic gate |
| Logics.LE61.Timer Out | Signal: Timer Output |
| Logics.LE61.Out | Signal: Latched Output (Q) |
| Logics.LE61.Out inverted | Signal: Negated Latched Output (Q NOT) |
| Logics.LE62.Gate Out | Signal: Output of the logic gate |
| Logics.LE62.Timer Out | Signal: Timer Output |
| Logics.LE62.Out | Signal: Latched Output (Q) |
| Logics.LE62.Out inverted | Signal: Negated Latched Output (Q NOT) |
| Logics.LE63.Gate Out | Signal: Output of the logic gate |
| Logics.LE63.Timer Out | Signal: Timer Output |
| Logics.LE63.Out | Signal: Latched Output (Q) |
| Logics.LE63.Out inverted | Signal: Negated Latched Output (Q NOT) |
| Logics.LE64.Gate Out | Signal: Output of the logic gate |
| Logics.LE64.Timer Out | Signal: Timer Output |

Protective Elements

| <i>Name</i> | <i>Description</i> |
|--------------------------|--|
| Logics.LE64.Out | Signal: Latched Output (Q) |
| Logics.LE64.Out inverted | Signal: Negated Latched Output (Q NOT) |
| Logics.LE65.Gate Out | Signal: Output of the logic gate |
| Logics.LE65.Timer Out | Signal: Timer Output |
| Logics.LE65.Out | Signal: Latched Output (Q) |
| Logics.LE65.Out inverted | Signal: Negated Latched Output (Q NOT) |
| Logics.LE66.Gate Out | Signal: Output of the logic gate |
| Logics.LE66.Timer Out | Signal: Timer Output |
| Logics.LE66.Out | Signal: Latched Output (Q) |
| Logics.LE66.Out inverted | Signal: Negated Latched Output (Q NOT) |
| Logics.LE67.Gate Out | Signal: Output of the logic gate |
| Logics.LE67.Timer Out | Signal: Timer Output |
| Logics.LE67.Out | Signal: Latched Output (Q) |
| Logics.LE67.Out inverted | Signal: Negated Latched Output (Q NOT) |
| Logics.LE68.Gate Out | Signal: Output of the logic gate |
| Logics.LE68.Timer Out | Signal: Timer Output |
| Logics.LE68.Out | Signal: Latched Output (Q) |
| Logics.LE68.Out inverted | Signal: Negated Latched Output (Q NOT) |
| Logics.LE69.Gate Out | Signal: Output of the logic gate |
| Logics.LE69.Timer Out | Signal: Timer Output |
| Logics.LE69.Out | Signal: Latched Output (Q) |
| Logics.LE69.Out inverted | Signal: Negated Latched Output (Q NOT) |
| Logics.LE70.Gate Out | Signal: Output of the logic gate |
| Logics.LE70.Timer Out | Signal: Timer Output |
| Logics.LE70.Out | Signal: Latched Output (Q) |
| Logics.LE70.Out inverted | Signal: Negated Latched Output (Q NOT) |
| Logics.LE71.Gate Out | Signal: Output of the logic gate |
| Logics.LE71.Timer Out | Signal: Timer Output |
| Logics.LE71.Out | Signal: Latched Output (Q) |
| Logics.LE71.Out inverted | Signal: Negated Latched Output (Q NOT) |
| Logics.LE72.Gate Out | Signal: Output of the logic gate |
| Logics.LE72.Timer Out | Signal: Timer Output |
| Logics.LE72.Out | Signal: Latched Output (Q) |
| Logics.LE72.Out inverted | Signal: Negated Latched Output (Q NOT) |
| Logics.LE73.Gate Out | Signal: Output of the logic gate |
| Logics.LE73.Timer Out | Signal: Timer Output |
| Logics.LE73.Out | Signal: Latched Output (Q) |
| Logics.LE73.Out inverted | Signal: Negated Latched Output (Q NOT) |
| Logics.LE74.Gate Out | Signal: Output of the logic gate |
| Logics.LE74.Timer Out | Signal: Timer Output |





Protective Elements

| <i>Name</i> | <i>Description</i> |
|--------------------------|--|
| Logics.LE74.Out | Signal: Latched Output (Q) |
| Logics.LE74.Out inverted | Signal: Negated Latched Output (Q NOT) |
| Logics.LE75.Gate Out | Signal: Output of the logic gate |
| Logics.LE75.Timer Out | Signal: Timer Output |
| Logics.LE75.Out | Signal: Latched Output (Q) |
| Logics.LE75.Out inverted | Signal: Negated Latched Output (Q NOT) |
| Logics.LE76.Gate Out | Signal: Output of the logic gate |
| Logics.LE76.Timer Out | Signal: Timer Output |
| Logics.LE76.Out | Signal: Latched Output (Q) |
| Logics.LE76.Out inverted | Signal: Negated Latched Output (Q NOT) |
| Logics.LE77.Gate Out | Signal: Output of the logic gate |
| Logics.LE77.Timer Out | Signal: Timer Output |
| Logics.LE77.Out | Signal: Latched Output (Q) |
| Logics.LE77.Out inverted | Signal: Negated Latched Output (Q NOT) |
| Logics.LE78.Gate Out | Signal: Output of the logic gate |
| Logics.LE78.Timer Out | Signal: Timer Output |
| Logics.LE78.Out | Signal: Latched Output (Q) |
| Logics.LE78.Out inverted | Signal: Negated Latched Output (Q NOT) |
| Logics.LE79.Gate Out | Signal: Output of the logic gate |
| Logics.LE79.Timer Out | Signal: Timer Output |
| Logics.LE79.Out | Signal: Latched Output (Q) |
| Logics.LE79.Out inverted | Signal: Negated Latched Output (Q NOT) |
| Logics.LE80.Gate Out | Signal: Output of the logic gate |
| Logics.LE80.Timer Out | Signal: Timer Output |
| Logics.LE80.Out | Signal: Latched Output (Q) |
| Logics.LE80.Out inverted | Signal: Negated Latched Output (Q NOT) |

Setting Group Parameters of the Reconnection Module

| Parameter | Description | Setting range | Default | Menu path |
|--|---|---|-------------|--|
|  Function | Permanent activation or deactivation of module/stage. | inactive, active | inactive | [Protection Para /<1..4> /Intercon-Prot /ReCon[1] /General settings] |
|  ExBlo Fc | Activate (allow) or inactivate (disallow) blocking of the module/stage. This parameter is only effective if a signal is assigned to the corresponding global protection parameter. If the signal becomes true, those modules/stages are blocked that are parameterized "ExBlo Fc=active". | inactive, active | inactive | [Protection Para /<1..4> /Intercon-Prot /ReCon[1] /General settings] |
|  Meas Circuit Superv | Activates the use of the measuring circuit supervision. In this case the module will be blocked if a measuring circuit supervision module (e.g. LOP, VTS) signals a disturbed measuring circuit (e.g. caused by a fuse failure). | inactive, active | inactive | [Protection Para /<1..4> /Intercon-Prot /ReCon[1] /General settings] |
|  V Ext Release PCC Fc | Activate the release signal of the Point of Common Coupling. The line-to-line voltage is greater than 95% of VN. | inactive, active | inactive | [Protection Para /<1..4> /Intercon-Prot /ReCon[1] /General settings] |
|  Reconnect. Release Cond | This parameter ensures that the mains voltage is recovered. | V Internal Release, V Ext Release PCC, Both | Both | [Protection Para /<1..4> /Intercon-Prot /ReCon[1] /Release Para] |
|  PCC Fuse Fail VT Fk | Blocking if the fuse of a voltage transformer has tripped at the PCC. Only available if: Reconnect. Release Cond = V Ext Release PCC Only available if: Reconnect. Release Cond = V Ext Release PCC or Both | inactive, active | inactive | [Protection Para /<1..4> /Intercon-Prot /ReCon[1] /Release Para] |
|  Measuring method | Measuring method: fundamental or rms or "sliding average supervision" | Fundamental, True RMS, Vavg | Fundamental | [Protection Para /<1..4> /Intercon-Prot /ReCon[1] /Release Para] |

Protective Elements

| Parameter | Description | Setting range | Default | Menu path |
|--|--|-----------------|---------|--|
| VLL> Release  | Minimum voltage (line-to-line) for reclosure (Restoration Voltage) Only available if: Reconnect. Release Cond = V Internal Release Only available if: Reconnect. Release Cond = V Internal Release or Both | 0.70 - 1.00Vn | 0.95Vn | [Protection Para /<1..4> /Intercon-Prot /ReCon[1] /Release Para] |
| VLL< Release  | Maximum voltage (line-to-line) for reclosure (Restoration Voltage) Only available if: Reconnect. Release Cond = V Internal Release Only available if: Reconnect. Release Cond = V Internal Release or Both | 1.00 - 1.50Vn | 1.10Vn | [Protection Para /<1..4> /Intercon-Prot /ReCon[1] /Release Para] |
| f<  | Lower frequency limit for the reclosure (Restoration Voltage) | 40.00 - 69.90Hz | 47.5Hz | [Protection Para /<1..4> /Intercon-Prot /ReCon[1] /Release Para] |
| f>  | Upper frequency limit for the reclosure | 40.00 - 69.90Hz | 50.05Hz | [Protection Para /<1..4> /Intercon-Prot /ReCon[1] /Release Para] |
| t-Release Blo  | Time stage (delay) for the reclosure of the energy resources. The Mains saddle time takes based on exirience approx. 10 - 15 minutes. | 0.00 - 3600.00s | 600s | [Protection Para /<1..4> /Intercon-Prot /ReCon[1] /Release Para] |

Input States of the Reconnection Module

| <i>Name</i> | <i>Description</i> | <i>Assignment via</i> |
|---------------------|--|--|
| ExBlo1-I | Module input state: External blocking1 | [Protection Para /Global Prot Para /Intercon-Prot /ReCon[1] /General settings] |
| ExBlo2-I | Module input state: External blocking2 | [Protection Para /Global Prot Para /Intercon-Prot /ReCon[1] /General settings] |
| V Ext Release PCC-I | Module input state: Release signal is being generated by the PCC (External Release) | [Protection Para /Global Prot Para /Intercon-Prot /ReCon[1] /General settings] |
| PCC Fuse Fail VT-I | State of the module input: Blocking if the fuse of a voltage transformer has tripped at the PCC. | [Protection Para /Global Prot Para /Intercon-Prot /ReCon[1] /General settings] |
| reconnected-I | This signal indicates the state "reconnected" (mains parallel). | [Protection Para /Global Prot Para /Intercon-Prot /ReCon[1] /General settings] |
| Decoupling1-I | Decoupling function, that blocks the reconnection. | [Protection Para /Global Prot Para /Intercon-Prot /ReCon[1] /Decoupling] |
| Decoupling2-I | Decoupling function, that blocks the reconnection. | [Protection Para /Global Prot Para /Intercon-Prot /ReCon[1] /Decoupling] |

Protective Elements

| <i>Name</i> | <i>Description</i> | <i>Assignment via</i> |
|---------------|--|--|
| Decoupling3-l | Decoupling function, that blocks the reconnection. | [Protection Para /Global Prot Para /Intercon-Prot /ReCon[1] /Decoupling] |
| Decoupling4-l | Decoupling function, that blocks the reconnection. | [Protection Para /Global Prot Para /Intercon-Prot /ReCon[1] /Decoupling] |
| Decoupling5-l | Decoupling function, that blocks the reconnection. | [Protection Para /Global Prot Para /Intercon-Prot /ReCon[1] /Decoupling] |
| Decoupling6-l | Decoupling function, that blocks the reconnection. | [Protection Para /Global Prot Para /Intercon-Prot /ReCon[1] /Decoupling] |

Reconnection Module Signals (Output States)

| <i>Signal</i> | <i>Description</i> |
|----------------------------|---|
| active | Signal: active |
| ExBlo | Signal: External Blocking |
| Blo by Meas Circuit Superv | Signal: Module blocked by measuring circuit supervision |
| Release Energy Resource | Signal: Release Energy Resource. |

UFLS Under Frequency Load Shedding

Available Elements:

UFLS

The number of distributed energy resources (DER) raises continuously. At the same time the controllable power reserve through large-scale power plants decreases.

Therefore various grid codes (see also [1], [2],[3],[4],[5]) requirements and regulations stipulate that mains parallel distributed power plants, consisting of one or more power generation units feeding power into the MV grid, have to support the grid in case of failures.

The frequency will decrease if more active power is taken out of the grid than fed into the grid.

The main task of the *Under Frequency Load Shedding* is to stabilize the grid frequency by intelligent load shedding in order to balance produced and consumed active power.

In contrast to classical load shedding the *Under Frequency Load Shedding* will shed only those sub-grids that decrease the frequency (because they consume active power). A shedding of sub-grids that have a positive influence on the frequency (because they feed active power) will be blocked.

By means of adaptive parameters a non-discriminating load shedding can be established.

1 Technische Anschlussregeln für die Hochspannung (VDE-AR-N 4120)

2 Technische Richtlinie „Erzeugungsanlagen am Mittelspannungsnetz“, Richtlinie für Anschluss und Parallelbetrieb von Erzeugungsanlagen am Mittelspannungsnetz, Ausgabe Juni 2008, BDEW Bundesverband der Energie- und Wasserwirtschaft e.V., siehe Kap. 3.2.3.2 – Blindleistungs-Unterspannungsschutz Q->&U<

3 Entso-E Operation Handbook, Policy 5, Emergency Operations, V1, August 2010

4 Distribution Code 2007. VDN, Version 1.1, August 2007

5 FNN: Technische Anforderungen an die Frequenzentlastung, Juni 2012

Application Examples

Classical centralized load shedding

Classical load shedding of a sub-grid from a central connection point. The load shedding will be initiated by under frequency.

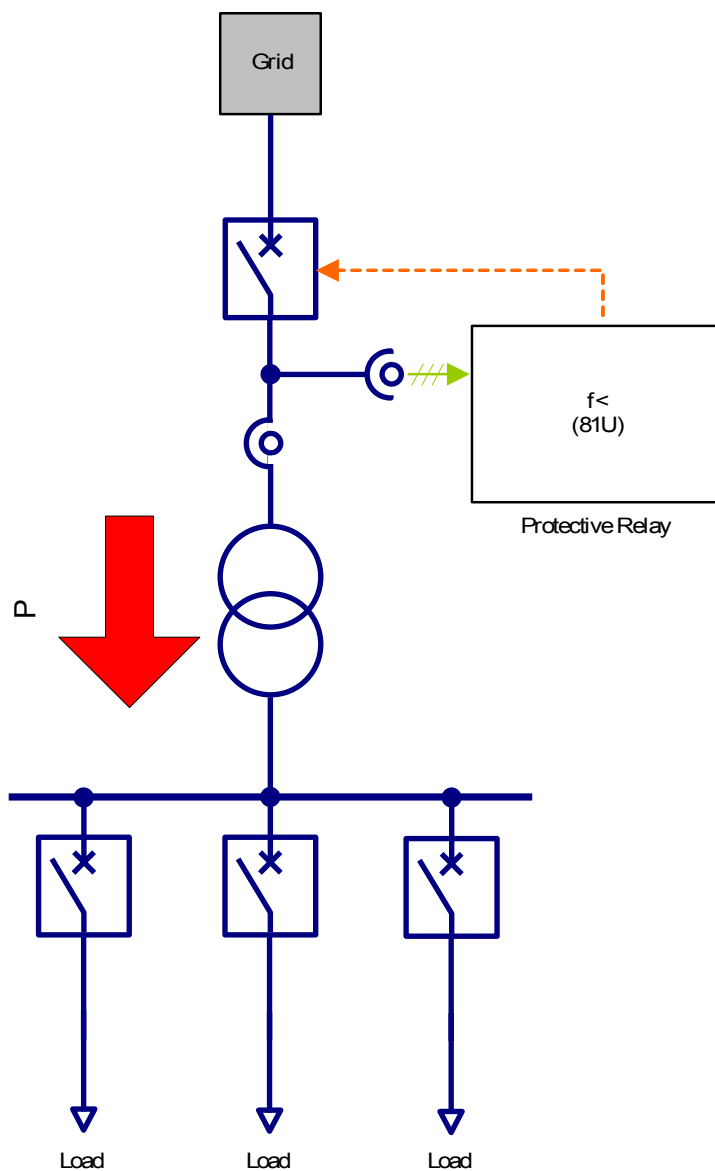

Classical staged decentral load shedding

A classical decentralized load shedding can be done by deactivating the power flow direction detection. By means of alternating (rotation) the the sub-grids to be shed a non-discriminating load shedding (of consumers) can be established.

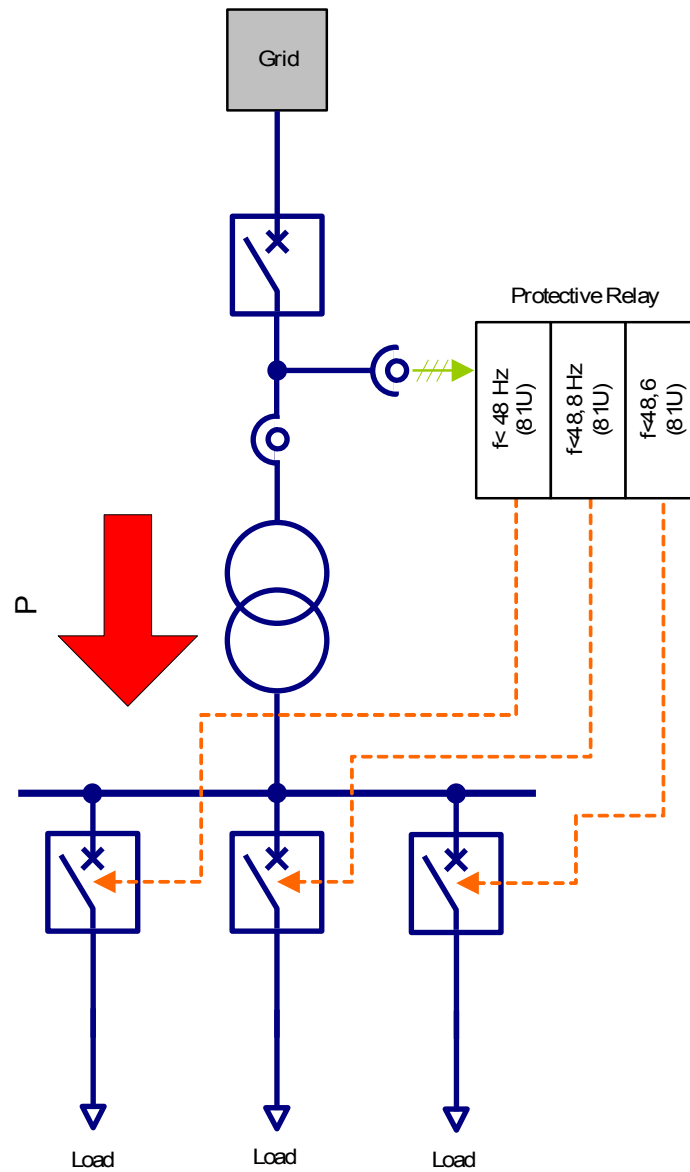

Centralized Under Frequency Load Shedding within grids with temporary power supply.

The power flow direction detection (if activated) will block the shedding of sub-grids in case of an under frequency situation of those sub-grids that stabilize the frequency. The sub-grid will be shed only if it decreases the frequency (by consuming active power).

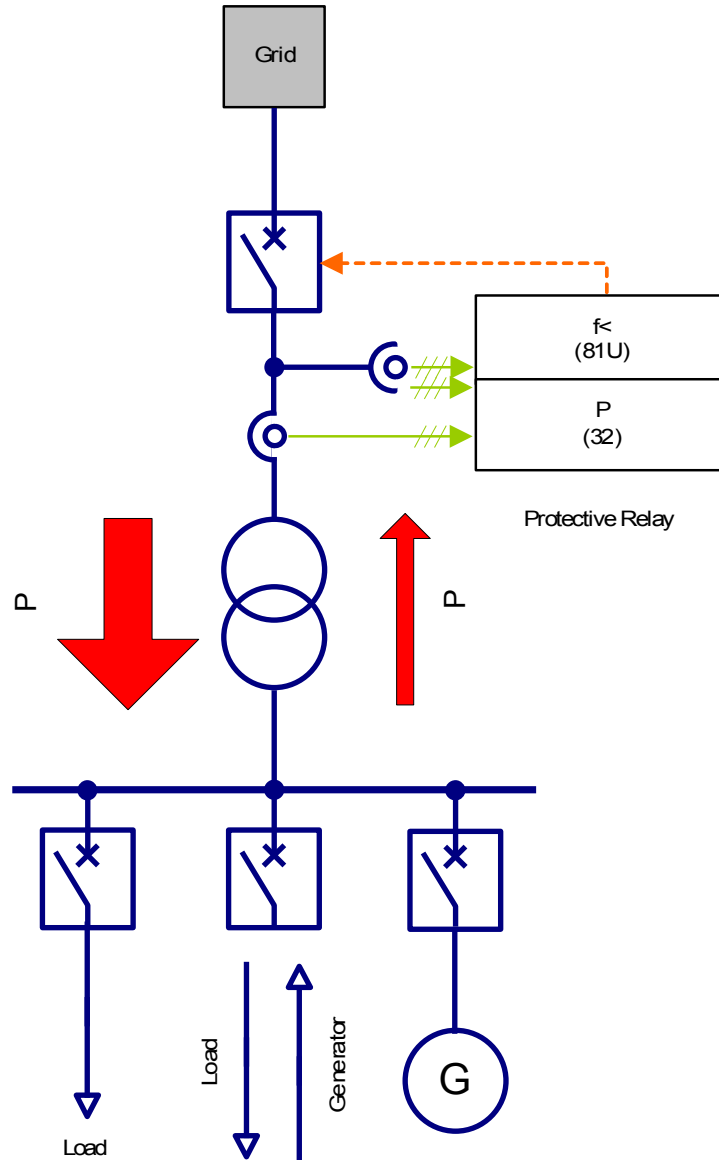

Decentralized Under Frequency Load Shedding within grids with temporary power supply

The power flow direction detection (if activated) will block the shedding of sub-grids in case of an under frequency situation of those sub-grids that stabilize the frequency.

Individual consumers, that destabilize the frequency by consuming active power can be shed non-discriminating.

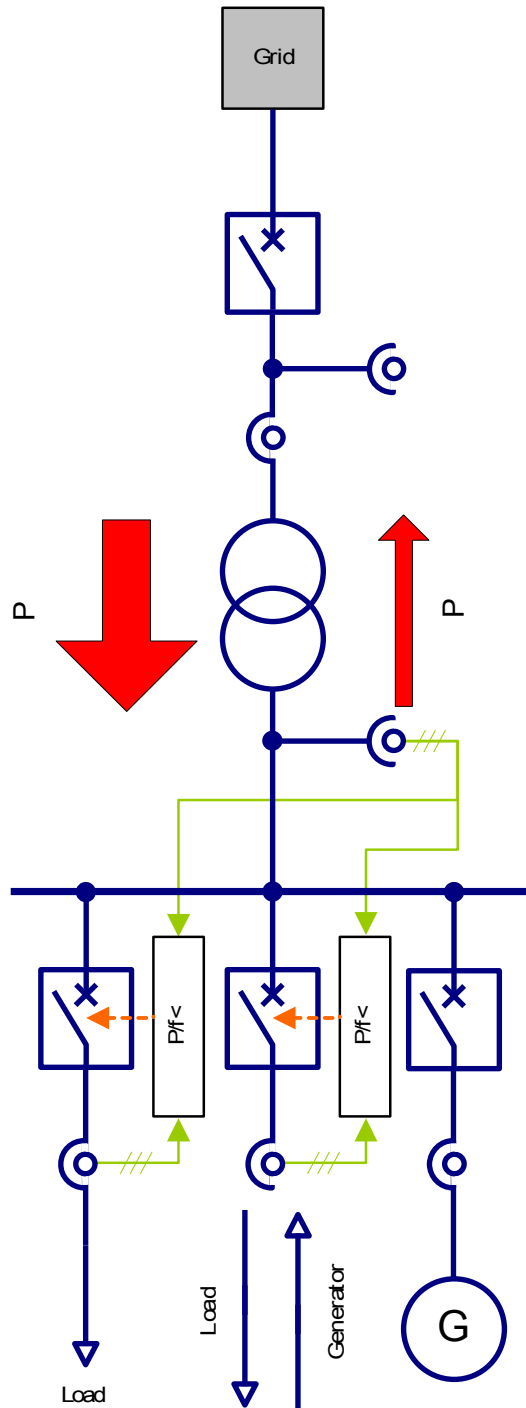

Centralized use within grids with predominant power supply

There is no need to use the Under Frequency Load Shedding because on average the sub-grid feeds (produces) more active power than it consumes. The sub-grid has over all a positive impact on the grid frequency.

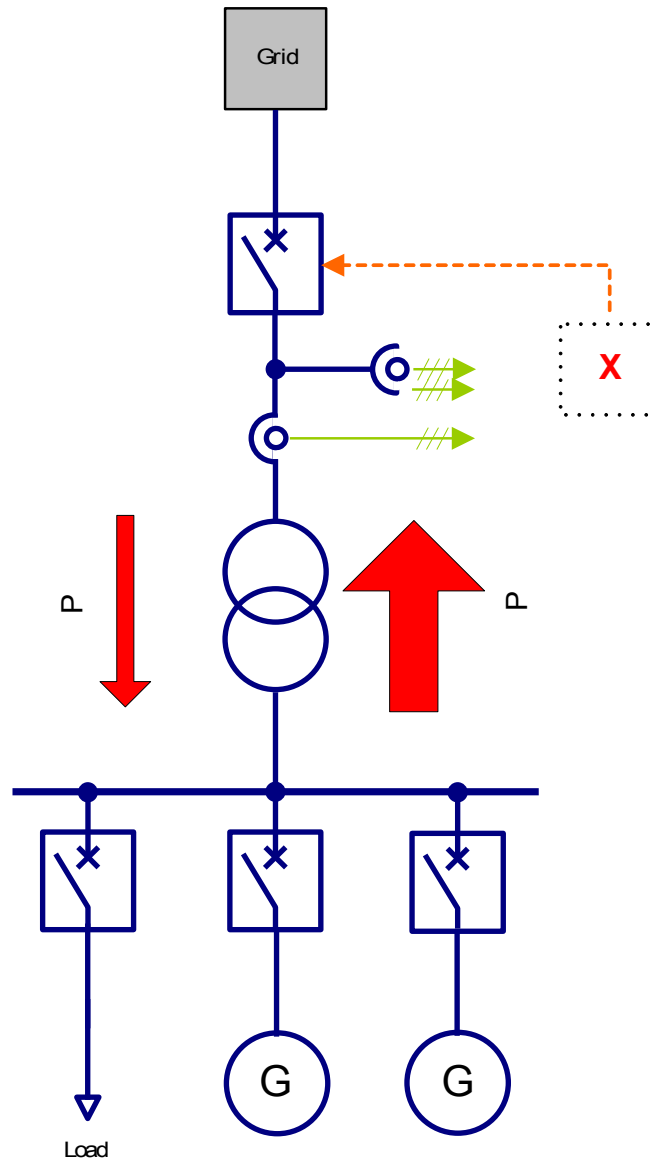

Decentralized use within grids with predominant power supply

There is no need to use the Under Frequency Load Shedding because on average the sub-grid feeds (produces) more active power than it consumes. The sub-grid has over all a positive impact on the grid frequency.

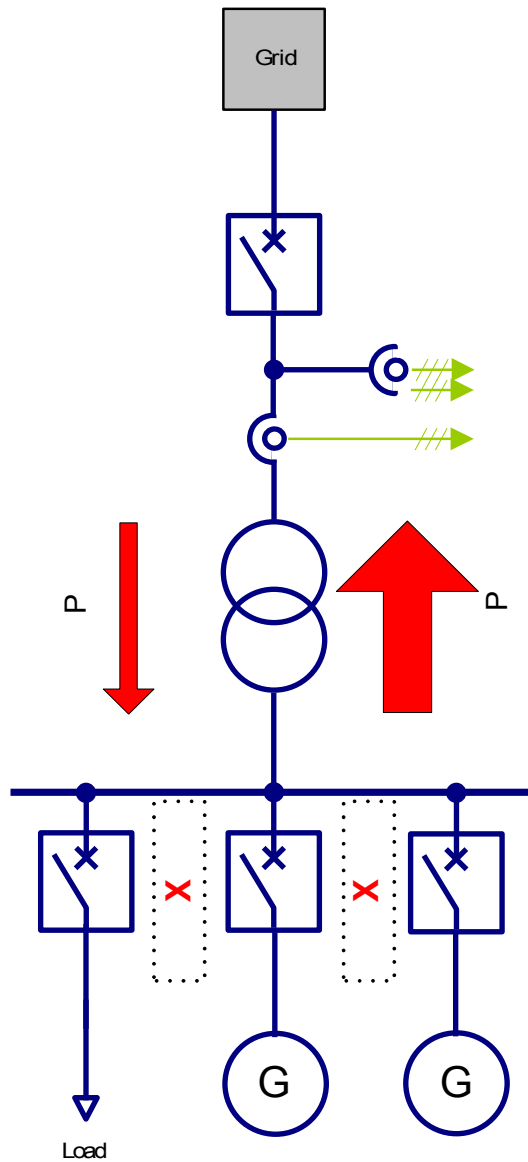

Trip Direction of the Under Frequency Load Shedding

Definitions

- Load Flow Arrow System = Consumed active and reactive are counted positive (greater than zero)
- Generator Flow Arrow System = produced power is to be counted positive (greater than zero)

By means of the parameter »*P Block dir*« a sign reversal can be applied to the active power within the *UFLS* module. Protective devices that use the load flow arrow (like the MCA4 or the MRA4) are to be set to »*Power Trip dir= negative*«. Protective devices that are working on the base of the generator flow arrow system to be set to »*Power Trip dir= positive*«.

Parameter Setting of the Under Frequency Load Shedding

NOTICE

The active-power of the positive phase sequence system (P1) is evaluated.

General Settings

Call up menu [Protection Para\Global Prot Para\Intercon-Prot\UFLS]

Within this menu you can:

- Assign signals, that activate adaptive parameters.

- Assign a signal that blocks the evaluation of the active power flow direction.

- Do a sign reversal on the active power. Please refer to chapter "Trip direction of the under frequency load shedding".

Configuration of the Load Shedding

Call up menu [Protection Para\Set[x]\Intercon-Prot\UFLS]

Within menu [Protection Para\Set[x]\Intercon-Prot\UFLS] you can define variant respectively the active power area that will not lead to a load shedding (load shedding blocked) in case of under frequency.

The active power flow direction can be determined by two different methods. Please select the UFLS method:

- Power Angle Supervision (Method 1)
- Pure Active Power Supervision (Method 2)
- External (Method 4)

Method 1: Power Angle Supervision

A load shedding during under frequency will be blocked, if the active power is within the area limited by the power angle.

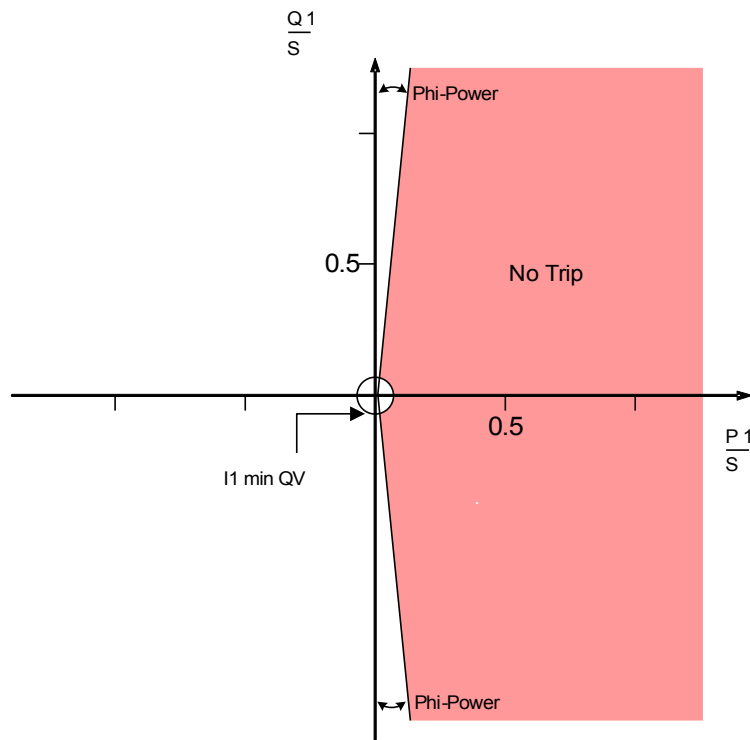

UFLS-Method = Power Angle Supervision

NOTICE The diagram above is in compliance with FNN ⁵. This diagram shows the blocking area within the generator arrow flow system.

Method 2: Pure Active Power Supervision

A trip during under frequency will be blocked if the active power is above the set threshold.

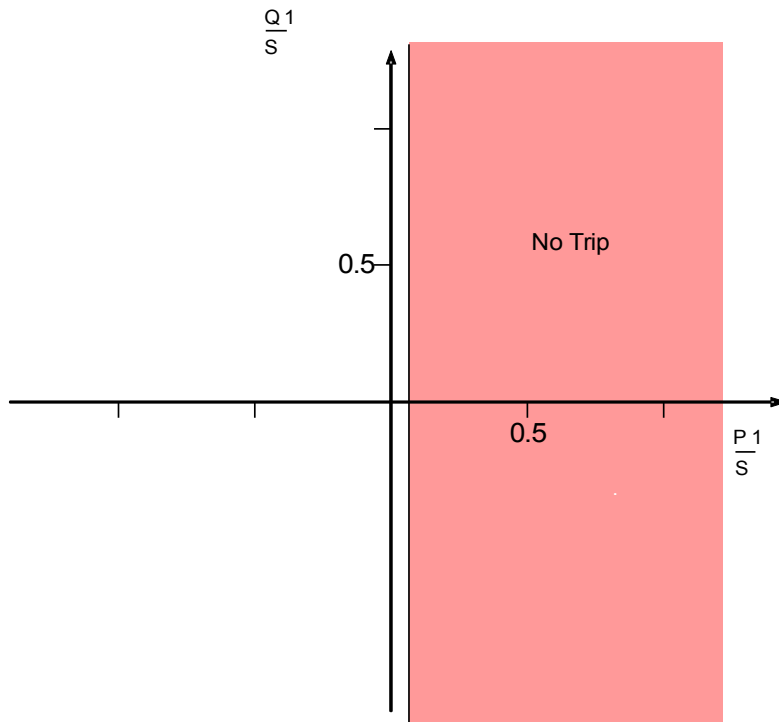

UFLS-Method = Pure Active Power Superv

NOTICE

The diagram above is in compliance with FNN⁵. This diagram shows the blocking area within the generator arrow flow system.

Method 3 – classical load shedding without taking into account the active power flow direction

The load shedding will be initiated by under frequency only. The active power flow direction wont be taken into account.

A minimum current supervision (I1 min) in the positive phase sequence system prevents unwanted operation of the active-power supervision at lower power levels.

The release voltages determine from which voltage (line-to-line) on the UFLS will be released.

When using the power angle supervision (method 1):

- Select »UFLS method = Power Angle Supervision.«
- Set the angle »Power Angle« .
- Select a suitable minimum current »I1 min« which prevents false tripping.

When using the pure active power supervision (method 2):

- Select »UFLS method= Pure Active Power Superv.«
- Set the active power threshold »P min«.
- Select a suitable minimum current »I min« to prevent false tripping.

When the active power flow direction should not be taken into account (Method 3 – classical load shedding)

- Set the parameter »UFLS method = No Pdir / Ex Pdir«.

When the active power flow direction should not be taken into account (Method 4)

- Set the parameter »UFLS method = No Pdir / Ex Pdir«.
- Assign within menu [Protection Para/Global Prot Para/Intercon-Prot/UFLS] onto parameter »Ex Pdir« a signal that indicates the active power flow direction.

Under frequency threshold and tripping delay

The following parameters can be used as adaptive parameters in order to establish a non-discriminating load shedding (please refer to section non-discriminating load shedding by means of adaptive parameters)

- Set the under frequency threshold $f <$
- Set the tripping delay »t-UFLS« . This timer will be started if the UFLS module is alarmed.

Non-discriminating load shedding by means of adaptive parameters

By means of adaptive parameters a non-discriminating load shedding can be established. By means of this commissioning and setting parameters newly is not required. Adaptive parameters/settings offer the possibility to switch the setting of a single function by an activation signal without switching over to another parameter set.

- Assign the signals that should activate the corresponding adaptive parameters within the Global Parameters [Protection Para\Global Prot Para\Intercon-Prot\UFLS] (please refer to chapter Adaptive Parameters).
- Within the Protection Parameters [Protection Para\Set[x]\Intercon-Prot\UFLS\Load shedding] the adaptive parameters itself can be set.



Device Planning Parameters of the UFLS Module

| Parameter | Description | Options | Default | Menu path |
|---|-------------|--------------------|------------|-------------------|
| Mode  | Mode | do not use, use | do not use | [Device planning] |







Global Protection Parameters of the UFLS Module

| Parameter | Description | Setting range | Default | Menu path |
|--|---|-----------------------|----------|--|
| ExBlo1  | External blocking of the module, if blocking is activated (allowed) within a parameter set and if the state of the assigned signal is true. | 1..n, Assignment List | -- | [Protection Para /Global Prot Para /Intercon-Prot /UFLS] |
| ExBlo2  | External blocking of the module, if blocking is activated (allowed) within a parameter set and if the state of the assigned signal is true. | 1..n, Assignment List | -- | [Protection Para /Global Prot Para /Intercon-Prot /UFLS] |
| Ex Pdir  | Ignore (block) the evaluation of the power flow direction. This results in classical frequency based load shedding functionality. When this feature is set and active, the functionality of the module turns into conventional, only frequency based load shedding. | 1..n, Assignment List | -- | [Protection Para /Global Prot Para /Intercon-Prot /UFLS] |
| P Block dir  | By means of this parameter the block direction of active power can be inverted within this (sign reversal). | positive, negative | negative | [Protection Para /Global Prot Para /Intercon-Prot /UFLS] |
| AdaptSet 1  | Assignment Adaptive Parameter 1 | AdaptSet | -- | [Protection Para /Global Prot Para /Intercon-Prot /UFLS] |
| AdaptSet 2  | Assignment Adaptive Parameter 2 | AdaptSet | -- | [Protection Para /Global Prot Para /Intercon-Prot /UFLS] |
| AdaptSet 3  | Assignment Adaptive Parameter 3 | AdaptSet | -- | [Protection Para /Global Prot Para /Intercon-Prot /UFLS] |

Protective Elements

| <i>Parameter</i> | <i>Description</i> | <i>Setting range</i> | <i>Default</i> | <i>Menu path</i> |
|---|---------------------------------|----------------------|----------------|---|
| AdaptSet 4  | Assignment Adaptive Parameter 4 | AdaptSet | -.- | [Protection Para /Global Prot Para /Intercon-Prot /UFLS] |
| AdaptSet 5  | Assignment Adaptive Parameter 5 | AdaptSet | -.- | [Protection Para /Global Prot Para /Intercon-Prot /UFLS] |

Setting Group Parameters of the UFLS Module

| Parameter | Description | Setting range | Default | Menu path |
|---|---|--|-------------------|---|
| Function  | Permanent activation or deactivation of module/stage. | inactive, active | inactive | [Protection Para <1..4> /Intercon-Prot /UFLS /General settings] |
| ExBlo Fc  | Activate (allow) or inactivate (disallow) blocking of the module/stage. This parameter is only effective if a signal is assigned to the corresponding global protection parameter. If the signal becomes true, those modules/stages are blocked that are parameterized "ExBlo Fc=active". | inactive, active | inactive | [Protection Para <1..4> /Intercon-Prot /UFLS /General settings] |
| Meas Circuit Superv  | Activates the use of the measuring circuit supervision. In this case the module will be blocked if a measuring circuit supervision module (e.g. LOP, VTS) signals a disturbed measuring circuit (e.g. caused by a fuse failure). | inactive, active | inactive | [Protection Para <1..4> /Intercon-Prot /UFLS /General settings] |
| UFLS-Method  | How should the active power be taken into account. | No Pdir / Ex Pdir, Power Angle Supervision, Pure Active Power Superv | No Pdir / Ex Pdir | [Protection Para <1..4> /Intercon-Prot /UFLS /LoadShedding] |
| I1 Release  | "I Minimum Current" in order to prevent faulty tripping. Module will be released if the current exceeds this value. Only available if: UFLS-Method = Power Angle Supervision | inactive, active | inactive | [Protection Para <1..4> /Intercon-Prot /UFLS /LoadShedding] |
| I1 min  | Minimum current Only available if: I1 Release = active | 0.02 - 0.20In | 0.05In | [Protection Para <1..4> /Intercon-Prot /UFLS /LoadShedding] |
| VLL min  | Minimum Voltage | 0.50 - 1.00Vn | 0.70Vn | [Protection Para <1..4> /Intercon-Prot /UFLS /LoadShedding] |

Protective Elements

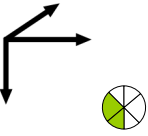
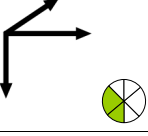
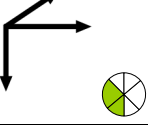
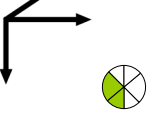
| Parameter | Description | Setting range | Default | Menu path |
|--|--|-----------------|---------|--|
| Power Angle  | Trigger Phi-Power (Positive Phase Sequence System) Only available if: UFLS-Method = Power Angle Supervision | 0 - 10° | 5° | [Protection Para /<1..4> /Intercon-Prot /UFLS /LoadShedding] |
| P min  | Minimum Value (threshold) for the Active Power Only available if: UFLS-Method = Pure Active Power Superv | 0.01 - 0.10Sn | 0.05Sn | [Protection Para /<1..4> /Intercon-Prot /UFLS /LoadShedding] |
| f<  | Underfrequency threshold | 45.00 - 65.00Hz | 49.00Hz | [Protection Para /<1..4> /Intercon-Prot /UFLS /LoadShedding] |
| t-UFLS  | Tripping delay time | 0.00 - 300.00s | 0.1s | [Protection Para /<1..4> /Intercon-Prot /UFLS /LoadShedding] |

Input States of the UFLS Module

| <i>Name</i> | <i>Description</i> | <i>Assignment via</i> |
|-------------|---|---|
| ExBlo1-I | Module input state: External blocking1 | [Protection Para /Global Prot Para /Intercon-Prot /UFLS] |
| ExBlo2-I | Module input state: External blocking2 | [Protection Para /Global Prot Para /Intercon-Prot /UFLS] |
| Ex Pdir-I | Ignore (block) the evaluation of the power flow direction. This results in classical frequency based load shedding functionality. When this feature is set and active, the functionality of the module turns into conventional, only frequency based load shedding. | [Protection Para /Global Prot Para /Intercon-Prot /UFLS] |
| AdaptSet1-I | Module input state: Adaptive Parameter1 | [Protection Para /Global Prot Para /Intercon-Prot /UFLS] |
| AdaptSet2-I | Module input state: Adaptive Parameter2 | [Protection Para /Global Prot Para /Intercon-Prot /UFLS] |
| AdaptSet3-I | Module input state: Adaptive Parameter3 | [Protection Para /Global Prot Para /Intercon-Prot /UFLS] |
| AdaptSet4-I | Module input state: Adaptive Parameter4 | [Protection Para /Global Prot Para /Intercon-Prot /UFLS] |
| AdaptSet5-I | Module input state: Adaptive Parameter5 | [Protection Para /Global Prot Para /Intercon-Prot /UFLS] |

UFLS Module Signals (Output States)

| <i>Signal</i> | <i>Description</i> |
|--------------------|---|
| active | Signal: active |
| ExBlo | Signal: External Blocking |
| Fuse Fail VT Blo | Signal: Blocked by Fuse Failure (VT) |
| I1 Release | Signal: "I Minimum Current" in order to prevent faulty tripping. Module will be released if the current exceeds this value. |
| VLL min | Signal: Minimum Voltage |
| Power Angle | Signal: Trigger Phi-Power (Positive Phase Sequence System) |
| P min | Signal: Minimum Value (threshold) for the Active Power |
| P Blo Loadshedding | Signal: Load shedding blocked based on evaluation of active power |
| f< | Signal: Underfrequency threshold |
| Alarm | Signal: Alarm P->&f< |
| Trip | Signal: Signal: Trip |
| Active AdaptSet | Active Adaptive Parameter |
| DefaultSet | Signal: Default Parameter Set |
| AdaptSet 1 | Signal: Adaptive Parameter 1 |
| AdaptSet 2 | Signal: Adaptive Parameter 2 |
| AdaptSet 3 | Signal: Adaptive Parameter 3 |
| AdaptSet 4 | Signal: Adaptive Parameter 4 |
| AdaptSet 5 | Signal: Adaptive Parameter 5 |

LVRT – Low Voltage Ride Through [27(t)]

Available Elements:

LVRT[1], LVRT[2]

Why LVRT? - Motivation for LVRT

The rapid development of distributed resources (DR) based on the renewable energy such as wind, solar and others has been changing the electric power system and concepts for its control, protection, metering and communication rapidly, too.

One of the important challenges for the interconnection between the DR and local electric power system (EPS) is the behaviour of the DR during disturbances within the electrical power system. Most of the disturbances within the EPS are characterized mainly by non-permanent system voltage collapses (voltage dip/sag) with different time durations.

According to traditional protection concepts a distributed energy resource should be tripped as fast as possible from the grid in case of a significant low voltage condition. This is no longer acceptable because of the continuous rising share of distributed energy resources within the energy market. Uncontrolled disconnecting significant parts of the power generation during disturbances within the grid endangers the system stability of the electrical power system.

It was reported³ that during system fault with low voltage drops, a complete 5000 MW wind park (without LVRT capability) was decoupled from the electrical power system. The consequence was a dangerous system voltage and frequency instability.

Based on experiences like that, lots of electric utilities and state public utilities have issued interconnection standards which require Low-Voltage-Ride-Through (LVRT) capability during EPS disturbances.

What does LVRT mean in detail?

It is no longer allowed to decouple/disconnect a DR from the grid just because of a non-permanent voltage dip. Protective relays and control units have to take this into account.

Instead of that, the distributed resource has to be able to ride through such disturbances according to a LVRT profile. The shape of this LVRT profile is very similar according to the different guidelines within different countries or local utilities. But they could differ in details.

By means of LVRT the system stability is improved in situations, when the contribution of DRs is needed mostly. The importance of LVRT will rise with the growing share of DRs within the electrical power system.

Based on the technical requirements mentioned above, a LVRT protection function was developed for the *HighPROTEC* product line which covers the LVRT profiles (capabilities) defined by all relevant national and local grid interconnection standards.

The following drawing shows details on the different LVRT standards in different countries. Please note, that the standards and hence the grid codes are in some countries still under development.

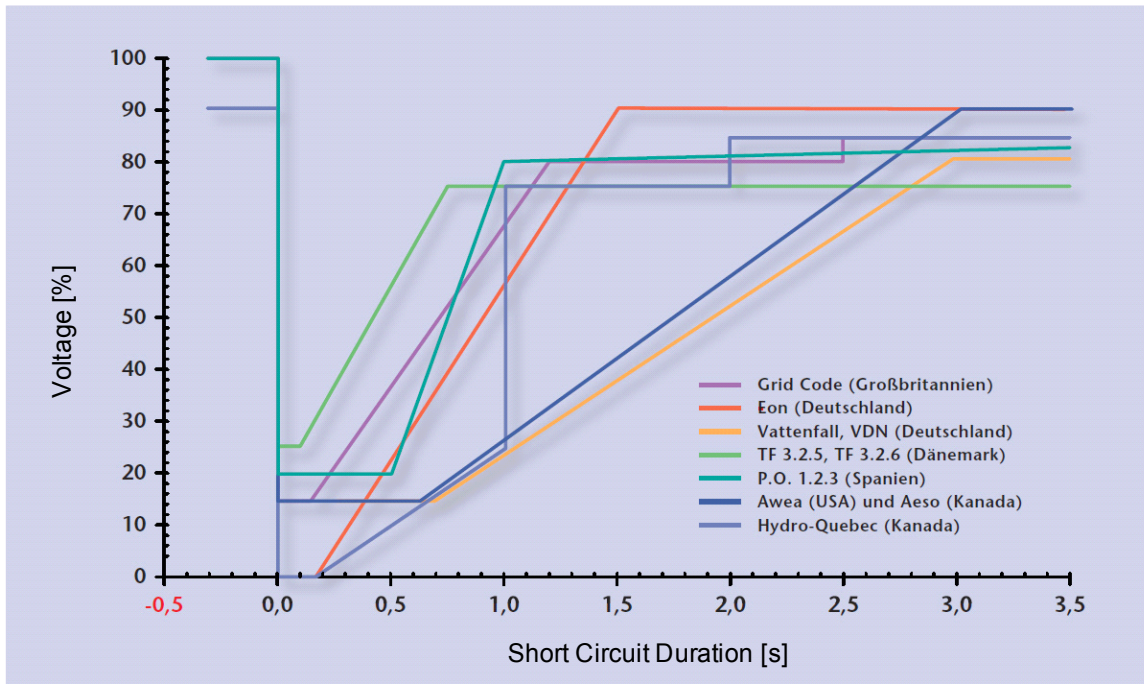

Source: eBWK Bd. 60 (2008) Nr. 4

Authors: Dipl.-Ing. Thomas Smolka, Dr.-Ing. Karl-Heinz Weck, Zertifizierungstelle der FGH e.V., Mannheim, sowie Dipl.-Ing. (FH) Matthias Bartsch, Enercon GmbH, Aurich.

Functional Principle of the LVRT

From the grid operators point of view, a LVRT profile defines a voltage profile which a distributed energy resource, that is connected to the grid, should be able to ride through in case of a low voltage event (voltage dip). The distributed energy resource is only allowed to disconnect from the grid if the voltage at the point of common coupling drops below the LVRT borderline. In other words, a LVRT protection function is a time-dependent voltage supervision according to a predefined voltage profile. The time-dependent voltage supervision will be started, as soon as the voltage at the point of common coupling falls below the start voltage level. The LVRT will be stopped, as soon as the voltage rises above the recover voltage level.

Auto Reclosure controlled LVRT

As already mentioned, the purpose of LVRT is to keep the DR connected to the grid in case of a non-permanent voltage dip/sag. For faults within the electrical power system by which auto-reclosing function is used to coordinate with the short circuit protections like overcurrent or distance protections, it is to expect that more than one voltage dips are coming one after another in a time period which is determined by the preset auto-reclosing dead times and protection relay operating times. Voltage dips/sags caused by the dead times of auto reclosings are non-permanent. Hence the protective device has to be able to detect voltage sags/dips in accordance with an auto reclosure and issues a trip command in that case that the voltage drops below the profile or that all parameterized auto reclosure shots were unsuccessful.

The following figure¹ depicts the voltage excursion by an unsuccessful two-shot Auto-Reclosing. According to some grid codes¹ it is obligated for a distributed generation to ride through a series of temporary voltage dips, but can be disconnected from the electrical power system immediately for a permanent fault. This kind of applications can be realized easily using the feature of »AR-controlled LVRT« in LVRT protection function.

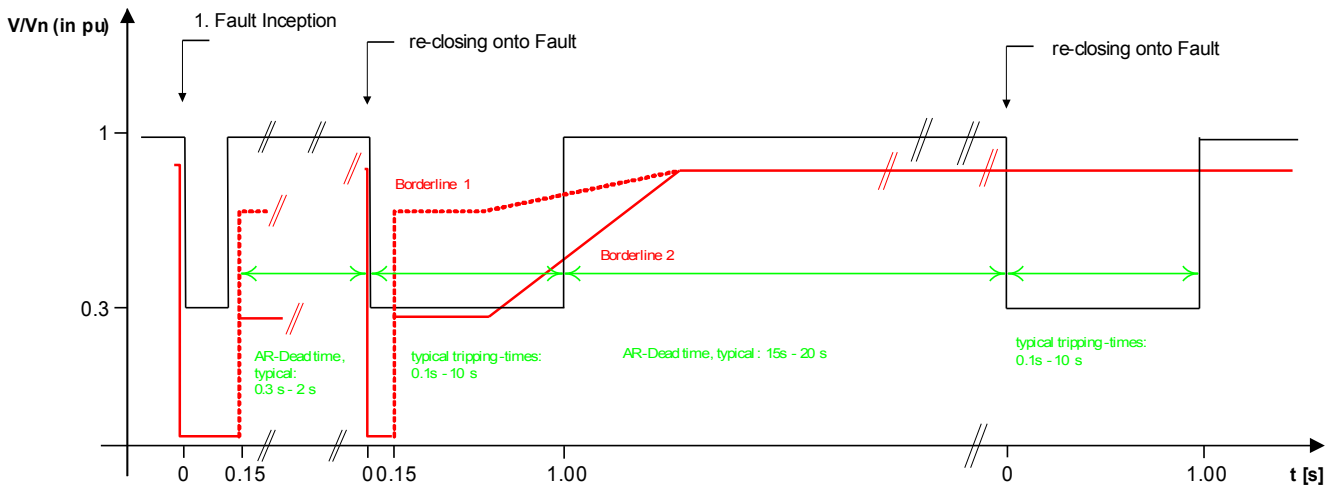

Source: Technische Richtlinie, Erzeugungsanlagen am Mittelspannungsnetz, Ausgabe Juni 2008, BDEW Bundesverband der Energie- und Wasserwirtschaft e.V. (Page 89).

Figure: Run of voltage curve during an unsuccessful two-shot auto reclosure

Functional Description of the LVRT

The LVRT element is designed for distributed generation resources that operate in parallel with the grid. It supervises system voltage disturbances by comparing them with a configurable voltage profile that is triggered once the system voltage falls below a configurable start value »Vstart«.

Once triggered, the LVRT element supervises the system voltage consecutively and determines if the voltage excursion is above or below of the preset voltage profile. A trip signal is only issued if the voltage excursion exits the "Ride-Through" region and goes into the "Tripping" region.

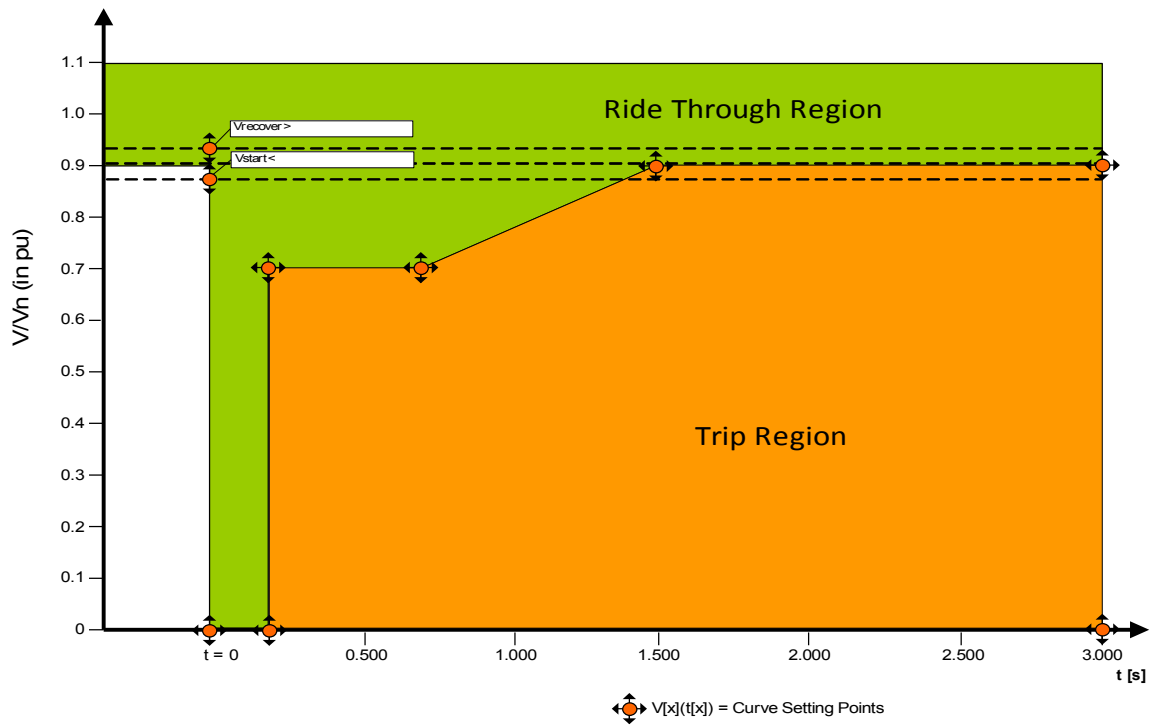

The VRT element will change into standby again as soon as the system voltage recovers: That means, the voltage has risen above the preset recover voltage » *Vrecover*«.

Auto Reclosure controlled LVRT

In case that the LVRT should be able to ride through auto reclosures, the parameter »*ARControlledLVRT*« has to be set to »*active*«.

In order to supervise the Low Voltage Ride Through events during reclosure, the user has to set the supervision timer »*tLVRT*« *at least equal or greater than* the complete Multi-Shot AR-runtime. In addition to that the number of permitted LVRTs has to be set which is usually the number of auto reclosure attempts. The actual LVRT supervision will be controlled to ride through the preset LVRT voltage pattern. By reaching the preset number of LVRT events »*NumberOfLVRT*«, the actual LVRT supervision assumes that the detected system fault is permanent, ignores the voltage profile and issues a tripping command instantaneously in order to disconnect the distributed resource from the electrical power system.

LVRT

name = LVRT[1]...[n]

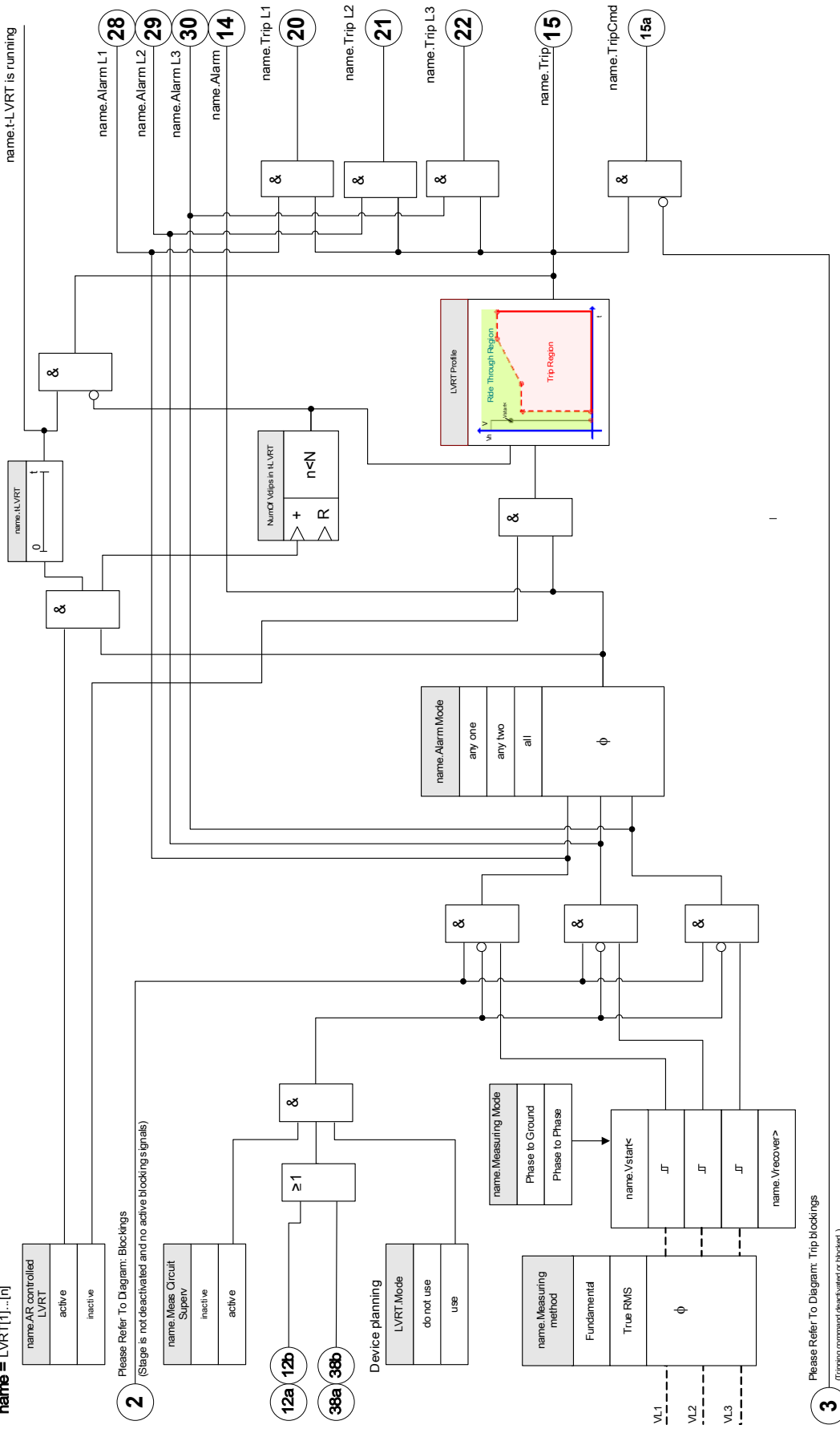

2 Please Refer To Diagram: Blockings (Stage is not deactivated and no active blocking signals)



12a 12b ≥ 1
38a 38b

3 Please Refer To Diagram: Trip blockings (Tripping command deactivated or blocked.)







Device Planning Parameters of the Low-Voltage-Ride-Through

| Parameter | Description | Options | Default | Menu path |
|---|-------------|--------------------|------------|-------------------|
| Mode  | Mode | do not use, use | do not use | [Device planning] |





Setting Group Parameters of the Low-Voltage-Ride-Through

| Parameter | Description | Setting range | Default | Menu path |
|---|---|------------------------------------|-----------------|---|
| Function  | Permanent activation or deactivation of module/stage. | inactive, active | inactive | [Protection Para /<1..4> /Intercon-Prot /LVRT[1] /General settings] |
| ExBlo Fc  | Activate (allow) or inactivate (disallow) blocking of the module/stage. This parameter is only effective if a signal is assigned to the corresponding global protection parameter. If the signal becomes true, those modules/stages are blocked that are parameterized "ExBlo Fc=active". | inactive, active | inactive | [Protection Para /<1..4> /Intercon-Prot /LVRT[1] /General settings] |
| Blo TripCmd  | Permanent blocking of the Trip Command of the module/stage. | inactive, active | inactive | [Protection Para /<1..4> /Intercon-Prot /LVRT[1] /General settings] |
| ExBlo TripCmd Fc  | Activate (allow) or inactivate (disallow) blocking of the module/stage. This parameter is only effective if a signal is assigned to the corresponding global protection parameter. If the signal becomes true, those modules/stages are blocked that are parameterized "ExBlo TripCmd Fc=active". | inactive, active | inactive | [Protection Para /<1..4> /Intercon-Prot /LVRT[1] /General settings] |
| Measuring Mode  | Measuring/Supervision Mode: Determines if the phase-to-phase or phase-to-earth voltages are to be supervised | Phase to Ground, Phase to Phase | Phase to Ground | [Protection Para /<1..4> /Intercon-Prot /LVRT[1] /General settings] |





Protective Elements

| Parameter | Description | Setting range | Default | Menu path |
|---|---|-----------------------------|-------------|--|
|  Measuring method | Measuring method: fundamental or rms or 3rd harmonic (only generator protection relays) | Fundamental, True RMS | Fundamental | [Protection Para <1..4> /Intercon-Prot /LVRT[1] /General settings] |
|  Alarm Mode | Alarm criterion for the voltage protection stage. | any one, any two, all | any one | [Protection Para <1..4> /Intercon-Prot /LVRT[1] /General settings] |
|  Meas Circuit Superv | Activates the use of the measuring circuit supervision. In this case the module will be blocked if a measuring circuit supervision module (e.g. LOP, VTS) signals a disturbed measuring circuit (e.g. caused by a fuse failure). | inactive, active | inactive | [Protection Para <1..4> /Intercon-Prot /LVRT[1] /General settings] |
|  AR controlled LVRT | Activates the supervision of the number of voltage dips during a defined time (t-LVRT). | inactive, active | inactive | [Protection Para <1..4> /Intercon-Prot /LVRT[1] /General settings] |
|  Number of V dips to trip | Number of voltage dips until the disconnection signal (trip) will be issued. Only available if:AR controlled LVRT = active | 1 - 6 | 1 | [Protection Para <1..4> /Intercon-Prot /LVRT[1] /General settings] |
|  t-LVRT | This timer defines the supervision interval (window/period) for counting the number of voltage dips to trip ("No of V dips to trip"). The first voltage dip will start the timer. The counted number of voltage dips will be reset if the timer is expired. The timer will also be reset if the maximum "No of V dips to trip" is reached. Only available if:AR controlled LVRT = active | 0.00 - 3000.00s | 30.00s | [Protection Para <1..4> /Intercon-Prot /LVRT[1] /General settings] |
|  Vstart< | A voltage dip is detected if the measured voltage falls below this threshold. | 0.00 - 1.50Vn | 0.90Vn | [Protection Para <1..4> /Intercon-Prot /LVRT[1] /LVRT Profile] |







Protective Elements

| Parameter | Description | Setting range | Default | Menu path |
|--|--|---------------|---------|---|
| Vrecover>  | The voltage is recovered if the measured voltage raises above this threshold. | 0.10 - 1.50Vn | 0.93Vn | [Protection Para /<1..4> /Intercon-Prot /LVRT[1] /LVRT Profile] |
| V(t1)  | Voltage value of a point V(t(n)). These points define the LVRT profile. | 0.00 - 1.50Vn | 0.00Vn | [Protection Para /<1..4> /Intercon-Prot /LVRT[1] /LVRT Profile] |
| t1  | Point in time for the corresponding voltage value V(t(n)). These points define the LVRT profile. | 0.00 - 20.00s | 0.00s | [Protection Para /<1..4> /Intercon-Prot /LVRT[1] /LVRT Profile] |
| V(t2)  | Voltage value of a point V(t(n)). These points define the LVRT profile. | 0.00 - 1.50Vn | 0.00Vn | [Protection Para /<1..4> /Intercon-Prot /LVRT[1] /LVRT Profile] |
| t2  | Point in time for the corresponding voltage value V(t(n)). These points define the LVRT profile. | 0.00 - 20.00s | 0.15s | [Protection Para /<1..4> /Intercon-Prot /LVRT[1] /LVRT Profile] |
| V(t3)  | Voltage value of a point V(t(n)). These points define the LVRT profile. | 0.00 - 1.50Vn | 0.70Vn | [Protection Para /<1..4> /Intercon-Prot /LVRT[1] /LVRT Profile] |
| t3  | Point in time for the corresponding voltage value V(t(n)). These points define the LVRT profile. | 0.00 - 20.00s | 0.15s | [Protection Para /<1..4> /Intercon-Prot /LVRT[1] /LVRT Profile] |

Protective Elements

| Parameter | Description | Setting range | Default | Menu path |
|--|--|---------------|---------|---|
| V(t4)  | Voltage value of a point V(t(n)). These points define the LVRT profile. | 0.00 - 1.50Vn | 0.70Vn | [Protection Para /<1..4> /Intercon-Prot /LVRT[1] /LVRT Profile] |
| t4  | Point in time for the corresponding voltage value V(t(n)). These points define the LVRT profile. | 0.00 - 20.00s | 0.70s | [Protection Para /<1..4> /Intercon-Prot /LVRT[1] /LVRT Profile] |
| V(t5)  | Voltage value of a point V(t(n)). These points define the LVRT profile. | 0.00 - 1.50Vn | 0.90Vn | [Protection Para /<1..4> /Intercon-Prot /LVRT[1] /LVRT Profile] |
| t5  | Point in time for the corresponding voltage value V(t(n)). These points define the LVRT profile. | 0.00 - 20.00s | 1.50s | [Protection Para /<1..4> /Intercon-Prot /LVRT[1] /LVRT Profile] |
| V(t6)  | Voltage value of a point V(t(n)). These points define the LVRT profile. | 0.00 - 1.50Vn | 0.90Vn | [Protection Para /<1..4> /Intercon-Prot /LVRT[1] /LVRT Profile] |
| t6  | Point in time for the corresponding voltage value V(t(n)). These points define the LVRT profile. | 0.00 - 20.00s | 3.00s | [Protection Para /<1..4> /Intercon-Prot /LVRT[1] /LVRT Profile] |
| V(t7)  | Voltage value of a point V(t(n)). These points define the LVRT profile. | 0.00 - 1.50Vn | 0.90Vn | [Protection Para /<1..4> /Intercon-Prot /LVRT[1] /LVRT Profile] |

Protective Elements

| Parameter | Description | Setting range | Default | Menu path |
|---|---|---------------|---------|---|
| t7  | Point in time for the corresponding voltage value $V(t(n))$. These points define the LVRT profile. | 0.00 - 20.00s | 3.00s | [Protection Para /<1..4> /Intercon-Prot /LVRT[1] /LVRT Profile] |
| V(t8)  | Voltage value of a point $V(t(n))$. These points define the LVRT profile. | 0.00 - 1.50Vn | 0.90Vn | [Protection Para /<1..4> /Intercon-Prot /LVRT[1] /LVRT Profile] |
| t8  | Point in time for the corresponding voltage value $V(t(n))$. These points define the LVRT profile. | 0.00 - 20.00s | 3.00s | [Protection Para /<1..4> /Intercon-Prot /LVRT[1] /LVRT Profile] |
| V(t9)  | Voltage value of a point $V(t(n))$. These points define the LVRT profile. | 0.00 - 1.50Vn | 0.90Vn | [Protection Para /<1..4> /Intercon-Prot /LVRT[1] /LVRT Profile] |
| t9  | Point in time for the corresponding voltage value $V(t(n))$. These points define the LVRT profile. | 0.00 - 20.00s | 3.00s | [Protection Para /<1..4> /Intercon-Prot /LVRT[1] /LVRT Profile] |
| V(t10)  | Voltage value of a point $V(t(n))$. These points define the LVRT profile. | 0.00 - 1.50Vn | 0.90Vn | [Protection Para /<1..4> /Intercon-Prot /LVRT[1] /LVRT Profile] |
| t10  | Point in time for the corresponding voltage value $V(t(n))$. These points define the LVRT profile. | 0.00 - 20.00s | 3.00s | [Protection Para /<1..4> /Intercon-Prot /LVRT[1] /LVRT Profile] |

General application notes on setting the LVRT

The LVRT menu comprises among other things the following parameters:

- By means of »Vstart«, the LVRT will be started (triggered).
- By means of »Vrecover« the LVRT will detect the end of the disturbance.
- Please note, that the »Vrecover« should be greater than »Vstart«. If this is not the case, the internal plausibility supervision will set »Vrecover« to 103% of »Vstart«.
- »Vk«, »tk« are the set points for setting the LVRT-profile.

Special application notes on setting the LVRT-profile

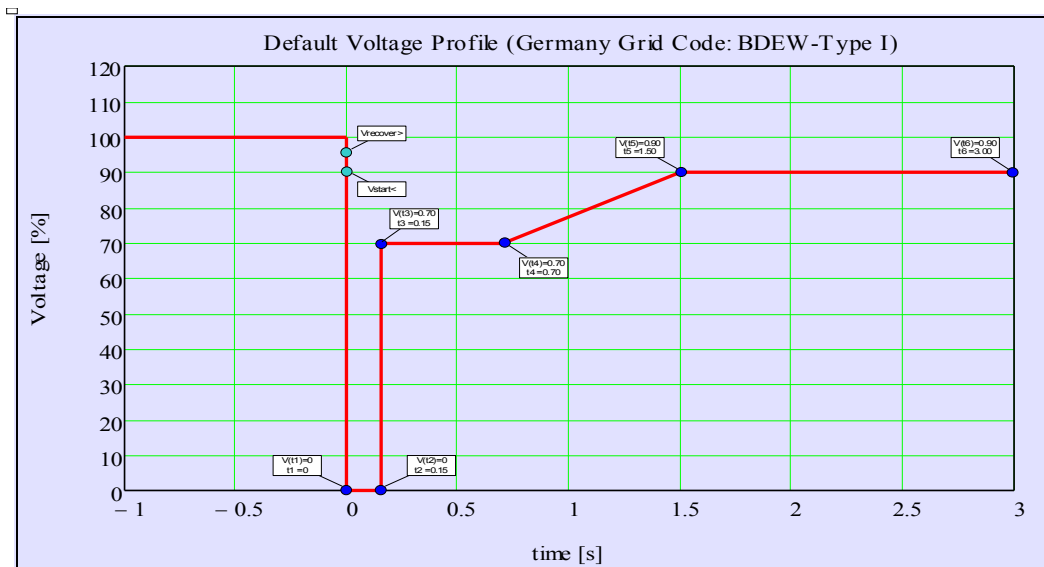

- In many cases not all available setpoints are needed in order to build up the LVRT-profile.
- In case that not all available setpoints are used, the unused setpoints can be set to the same values as the last set point.
- Set points should be selected in a manner of left-to-right with time begin at t=0 (tk+1>tk).
- The voltage setpoints must be selected in a ascending manner (Vk+1>Vk).
- The voltage value for last used set point should be set greater than the starting voltage. If this is not the case, the starting voltage will be modified internally to the value of maximum voltage set value.

In general the factory default LVRT-profile is preset based on the Type-I curve from Germany Grid Code¹⁾ (BDEW 2008) as shown in the following drawing:



LVRT-Default Profile (BDEW-TypI)

Global Protection Parameters of the Low-Voltage-Ride-Through

| Parameter | Description | Setting range | Default | Menu path |
|--|---|-----------------------|---------|--|
| ExBlo1  | External blocking of the module, if blocking is activated (allowed) within a parameter set and if the state of the assigned signal is true. | 1..n, Assignment List | .- | [Protection Para /Global Prot Para /Intercon-Prot /LVRT[1]] |
| ExBlo2  | External blocking of the module, if blocking is activated (allowed) within a parameter set and if the state of the assigned signal is true. | 1..n, Assignment List | .- | [Protection Para /Global Prot Para /Intercon-Prot /LVRT[1]] |
| ExBlo TripCmd  | External blocking of the Trip Command of the module/the stage, if blocking is activated (allowed) within a parameter set and if the state of the assigned signal is true. | 1..n, Assignment List | .- | [Protection Para /Global Prot Para /Intercon-Prot /LVRT[1]] |

Inputs of the Low-Voltage-Ride-Through

| Name | Description | Assignment via |
|-----------------|---|--|
| ExBlo1-I | Module input state: External blocking1 | [Protection Para /Global Prot Para /Intercon-Prot /LVRT[1]] |
| ExBlo2-I | Module input state: External blocking2 | [Protection Para /Global Prot Para /Intercon-Prot /LVRT[1]] |
| ExBlo TripCmd-I | Module input state: External Blocking of the Trip Command | [Protection Para /Global Prot Para /Intercon-Prot /LVRT[1]] |

Signals (Output States) of the Low-Voltage-Ride-Through

| Signal | Description |
|---------------|---|
| active | Signal: active |
| ExBlo | Signal: External Blocking |
| Blo TripCmd | Signal: Trip Command blocked |
| ExBlo TripCmd | Signal: External Blocking of the Trip Command |

| <i>Signal</i> | <i>Description</i> |
|-------------------|-------------------------------|
| Alarm L1 | Signal: Alarm L1 |
| Alarm L2 | Signal: Alarm L2 |
| Alarm L3 | Signal: Alarm L3 |
| Alarm | Signal: Alarm voltage stage |
| Trip L1 | Signal: General Trip Phase L1 |
| Trip L2 | Signal: General Trip Phase L2 |
| Trip L3 | Signal: General Trip Phase L3 |
| Trip | Signal: Trip |
| TripCmd | Signal: Trip Command |
| t-LVRT is running | Signal: t-LVRT is running |

Counter Values of the Low-Voltage-Ride-Through

| <i>Value</i> | <i>Description</i> | <i>Menu path</i> |
|------------------------------|--|---|
| NumOf Vdips in t-LVRT | Number of Voltage dips during t-LVRT | [Operation /Count and RevData /LVRT[1]] |
| Cr Tot Numb of Vdips | Counter Total number of voltage dips. | [Operation /Count and RevData /LVRT[1]] |
| Cr Tot Numb of Vdips to Trip | Counter Total number of voltage dips that caused a Trip. | [Operation /Count and RevData /LVRT[1]] |

Direct Commands of the Low-Voltage-Ride-Through

| <i>Parameter</i> | <i>Description</i> | <i>Setting range</i> | <i>Default</i> | <i>Menu path</i> |
|--|--|----------------------|----------------|-----------------------|
| Res LVRT Cr  | Reset of the counter for the total number of voltage dips and reset of the counter of the total number of voltage dips that caused a trip. | inactive, active | inactive | [Operation /Reset] |

References:

¹ Technische Richtlinie „Erzeugungsanlagen am Mittelspannungsnetz – Richtlinie für Anschluss und Parallelbetrieb von Erzeugungsanlagen am Mittelspannungsnetz“, Juni 2008, BDEW, Berlin

² IEEE Std 1547™-2003, IEEE Standard for Interconnecting Distributed Resources with Electric Power Systems.

³ Title: Can China Wind Power meet the challenge of “Low-Voltage-Ride-Through” Date: 18.05.2011 Author: Shi Feng-Lei.
<http://energy.people.com.cn/GB/14667118.html>.

Intertripping (Remote)

Elements:

Intertripping

This module enables intertripping (executing external trip commands)

Application Example

Several Distributed Energy Resources are feeding mains parallel into the grid via one point of common coupling (PCC).

A mains protection relay is mounted at the point of common coupling. This might be a distance protection relay that protects the outgoing transmission line.

Let us assume that the outgoing transmission line becomes faulty ❶.

The feeding Distributed Energy Resources will be disconnected from the outgoing transmission line.

Now the produced electrical energy cannot be fed into the grid.

The element „Intertripping“ provides the option to pass the trip command from the mains protection device to the feeding distributed energy resource.

The trip decision of the mains protection relay (at the point of common coupling) will be transmitted via Digital Inputs to the „Intertripping“ elements of the protective devices of the distributed energy resources within the downstream ❷.

The feeding distributed energy resources will overtake the trip command and the corresponding infeeds will be disconnected from the mains ❸. The trip decision of the mains protection device within the upstream will be overtaken.

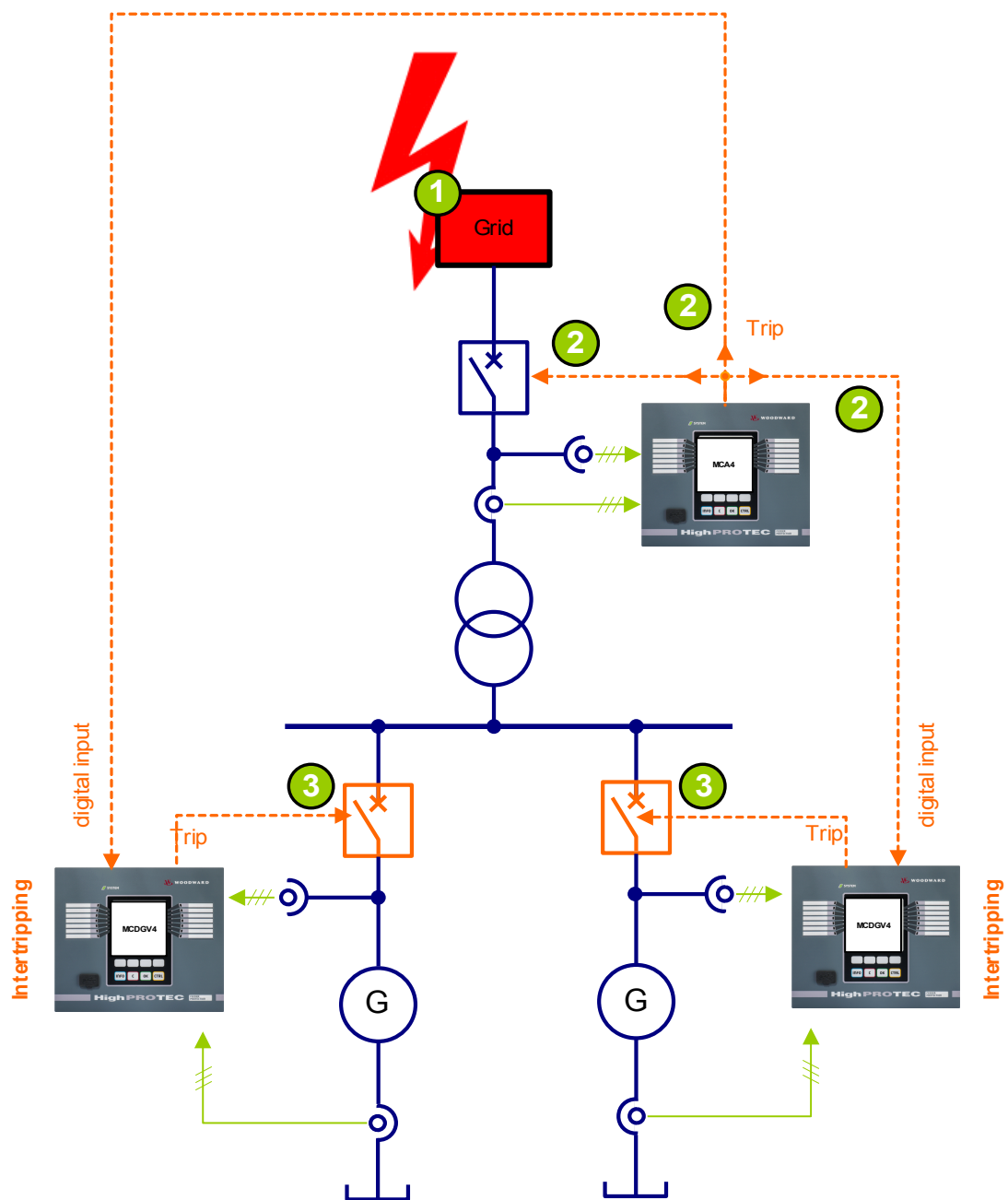

name = Remote Trip

Remote Trip



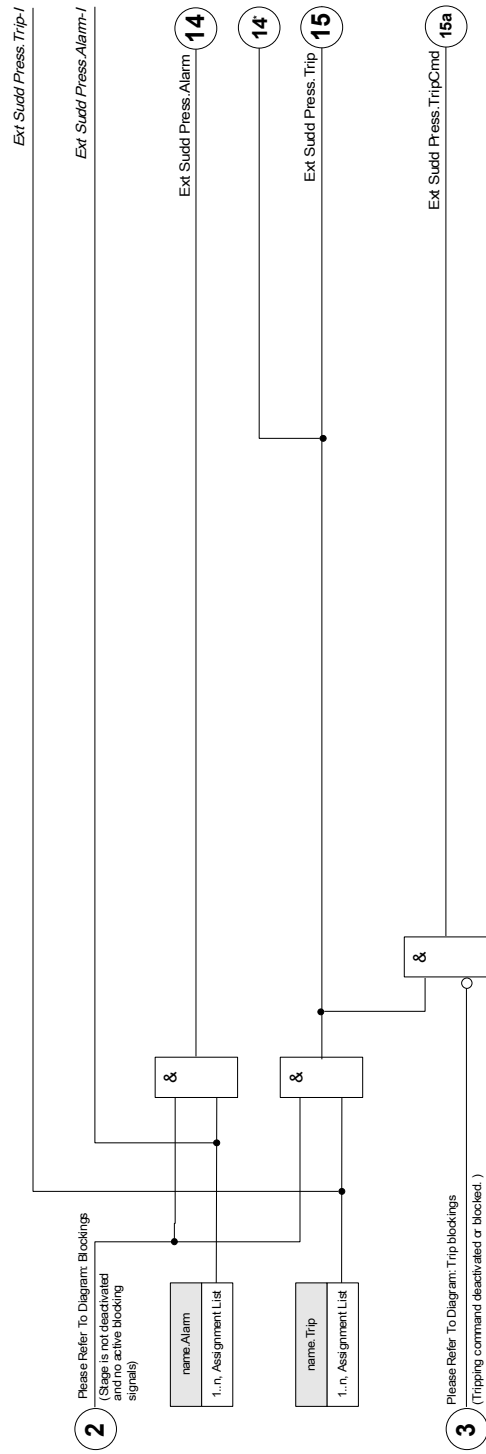

*=If no signal is assigned to the alarm input







Device Planning Parameters of the Intertripping Module

| Parameter | Description | Options | Default | Menu path |
|---|-------------|--------------------|------------|-------------------|
| Mode  | Mode | do not use, use | do not use | [Device planning] |

Global Protection Parameters of the Intertripping Module

| Parameter | Description | Setting range | Default | Menu path |
|--|---|-----------------------|---------|---|
| ExBlo1  | External blocking of the module, if blocking is activated (allowed) within a parameter set and if the state of the assigned signal is true. | 1..n, Assignment List | -- | [Protection Para /Global Prot Para /Intercon-Prot /Mains Decouplg /Intertripping] |
| ExBlo2  | External blocking of the module, if blocking is activated (allowed) within a parameter set and if the state of the assigned signal is true. | 1..n, Assignment List | -- | [Protection Para /Global Prot Para /Intercon-Prot /Mains Decouplg /Intertripping] |
| ExBlo TripCmd  | External blocking of the Trip Command of the module/the stage, if blocking is activated (allowed) within a parameter set and if the state of the assigned signal is true. | 1..n, Assignment List | -- | [Protection Para /Global Prot Para /Intercon-Prot /Mains Decouplg /Intertripping] |
| Alarm  | Assignment for External Alarm | 1..n, Assignment List | -- | [Protection Para /Global Prot Para /Intercon-Prot /Mains Decouplg /Intertripping] |
| Trip  | External trip of the CB if the state of the assigned signal is true. | 1..n, Assignment List | -- | [Protection Para /Global Prot Para /Intercon-Prot /Mains Decouplg /Intertripping] |

Setting Group Parameters of the Intertripping Module

| Parameter | Description | Setting range | Default | Menu path |
|---|---|---------------------|----------|---|
|  Function | Permanent activation or deactivation of module/stage. | inactive, active | inactive | [Protection Para /<1..4> /Intercon-Prot /Mains Decouplg /Intertripping] |
|  ExBlo Fc | Activate (allow) or inactivate (disallow) blocking of the module/stage. This parameter is only effective if a signal is assigned to the corresponding global protection parameter. If the signal becomes true, those modules/stages are blocked that are parameterized "ExBlo Fc=active". | inactive, active | inactive | [Protection Para /<1..4> /Intercon-Prot /Mains Decouplg /Intertripping] |
|  Blo TripCmd | Permanent blocking of the Trip Command of the module/stage. | inactive, active | inactive | [Protection Para /<1..4> /Intercon-Prot /Mains Decouplg /Intertripping] |
|  ExBlo TripCmd Fc | Activate (allow) or inactivate (disallow) blocking of the module/stage. This parameter is only effective if a signal is assigned to the corresponding global protection parameter. If the signal becomes true, those modules/stages are blocked that are parameterized "ExBlo TripCmd Fc=active". | inactive, active | inactive | [Protection Para /<1..4> /Intercon-Prot /Mains Decouplg /Intertripping] |

Intertripping Module Input States

| <i>Name</i> | <i>Description</i> | <i>Assignment via</i> |
|-----------------|---|---|
| ExBlo1-I | Module input state: External blocking1 | [Protection Para /Global Prot Para /Intercon-Prot /Mains Decouplg /Intertripping] |
| ExBlo2-I | Module input state: External blocking2 | [Protection Para /Global Prot Para /Intercon-Prot /Mains Decouplg /Intertripping] |
| ExBlo TripCmd-I | Module input state: External Blocking of the Trip Command | [Protection Para /Global Prot Para /Intercon-Prot /Mains Decouplg /Intertripping] |
| Alarm-I | Module input state: Alarm | [Protection Para /Global Prot Para /Intercon-Prot /Mains Decouplg /Intertripping] |
| Trip-I | Module input state: Trip | [Protection Para /Global Prot Para /Intercon-Prot /Mains Decouplg /Intertripping] |

Intertripping Module Signals (Output States)

| <i>Signal</i> | <i>Description</i> |
|---------------|---|
| active | Signal: active |
| ExBlo | Signal: External Blocking |
| Blo TripCmd | Signal: Trip Command blocked |
| ExBlo TripCmd | Signal: External Blocking of the Trip Command |
| Alarm | Signal: Alarm |
| Trip | Signal: Trip |
| TripCmd | Signal: Trip Command |

Commissioning: Intertripping

Object to be tested:

Test of the Intertripping (Remote) module.

Necessary means:

Dependent on the application.

Procedure:

Simulate the functionality of the Intertripping Trip (pickup, trip, blockings) by (de-)energizing of the digital inputs.

Successful test result:

All external pickups, external trips, and external blockings are correctly recognized and processed by the device.

PQS - Power [32, 37]

Available stages:

PQS[1] .PQS[2] .PQS[3] .PQS[4] .PQS[5] .PQS[6]

Each of the elements can be used as P<, P>, Pr>, Q<, Q>, Qr>, S< or S> within the device planning.

P< and P> are settable and effective in positive active power range, Q< and Q> in positive reactive power range. These modes are used for protecting against underload or overload in positive power direction.

The apparent power makes S< or S> effective like a circle in all power quadrants. Protection is against underload and overload.

In reverse mode, Pr> is effective in negative active power range and Qr> in negative reactive power range. Both modes protect against power direction reversing from positive into negative direction.

The following graphics show the areas that are protected by the corresponding modes.

Setting the Thresholds

All settings/thresholds within the power module are to be set as per unit thresholds. Per definition S_n is to be used as scale basis.

$$S_n = \sqrt{3} * \text{VoltageTransformer}_{\text{Line-to-Line_Rated_Voltage}} * \text{CurrentTransformer}_{\text{Rated_Current}}$$

If thresholds should base on primary side values:

$$S_n = \sqrt{3} * \text{VoltageTransformer}_{\text{Pri_Line-to-Line_Rated_Voltage}} * \text{CurrentTransformer}_{\text{Pri_Rated_Current}}$$

If thresholds should base on secondary side values

$$S_n = \sqrt{3} * \text{VoltageTransformer}_{\text{Sec_Line-to-Line_Rated_Voltage}} * \text{CurrentTransformer}_{\text{Sec_Rated_Current}}$$

Example – Field Data

- CurrentTransformer CT pri =200 A; CT sec = 5 A
- VoltageTransformer VT pri = 10 kV; VT sec =100 V
- Generator rated power 2 MVA
- Reverse power should trip at 3%.

Setting Example 1 for Pr> based on primary side values

Reverse power should trip at 3%. That means 60 kW (on primary side).

First S_n is to be calculated:

$$S_n = \sqrt{3} * \text{VoltageTransformer}_{\text{Pri_Line-to-Line_Rated_Voltage}} * \text{CurrentTransformer}_{\text{Pri_Rated_Current}}$$

$$S_n = 1.73 * 10000 \text{ V} * 200 \text{ A} = 3.464 \text{ MVA}$$

The following threshold is to be set for Pr> within the device = 60 kW / S_n

$$\text{Pr>} = 60 \text{ kW} / 3464 \text{ kVA} = \underline{0,0173} \cdot S_n$$

Setting Example 1 for Pr> based on secondary side values

Reverse power should trip at 3%. That means 60 kW (on primary side).

First S_n is to be calculated:

$$S_n = \sqrt{3} * \text{VoltageTransformer}_{\text{Sec_Line-to-Line_Rated_Voltage}} * \text{CurrentTransformer}_{\text{Sec_Rated_Current}}$$

$$S_n = 1,73 * 100 \text{ V} * 5 \text{ A} = 866,05 \text{ VA}$$

Convert the reverse power onto the secondary side:

$$Pr_{\text{sec}>} = Pr_{\text{Pri}>} / (VT_{\text{Pri_VLL Rated}} / VT_{\text{Sec_VLL Rated}} * CT_{\text{Pri Rated Current}} / CT_{\text{Sec Rated Current}}) = 60 \text{ kW} / 4000 = 15 \text{ W}$$

The following threshold is to be set for Pr> within the device = 15W /Sn

$$Pr> = 15 \text{ W} / 866 \text{ VA} = \underline{0,0173 S_n}$$

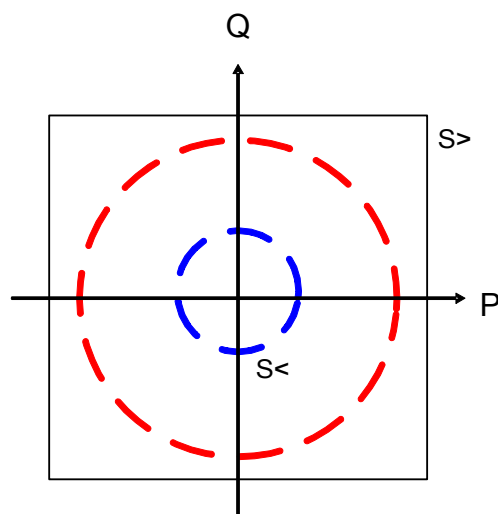
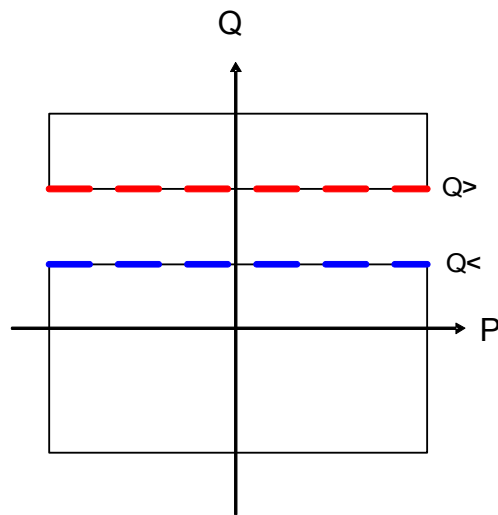
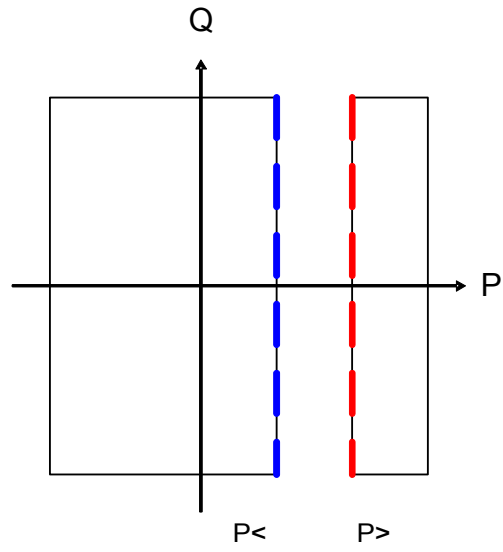

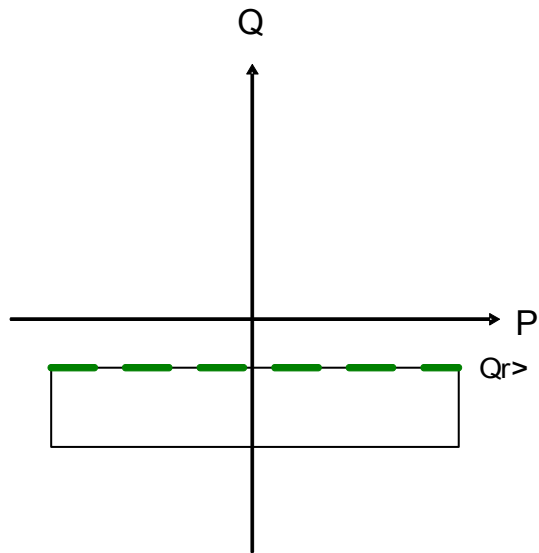
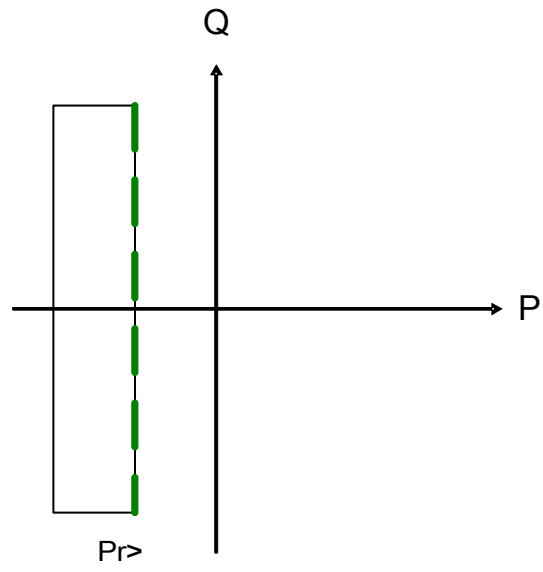

PQS[1]..[n]

name = PQS[1]..[n]

2 Please Refer To Diagram: Blockings
(Stage is not deactivatd and no active blockings)

38a 38b

name.Alarm 14

40

name.Trip 15

Device planning

| |
|----------|
| PCS.Mode |
| P> |
| P< |
| Pr> |
| Q> |
| Q< |
| Qr> |
| S> |
| S< |

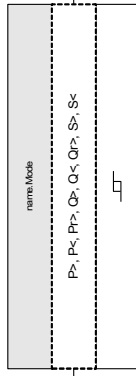
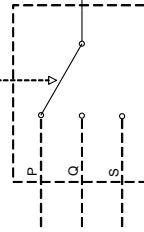

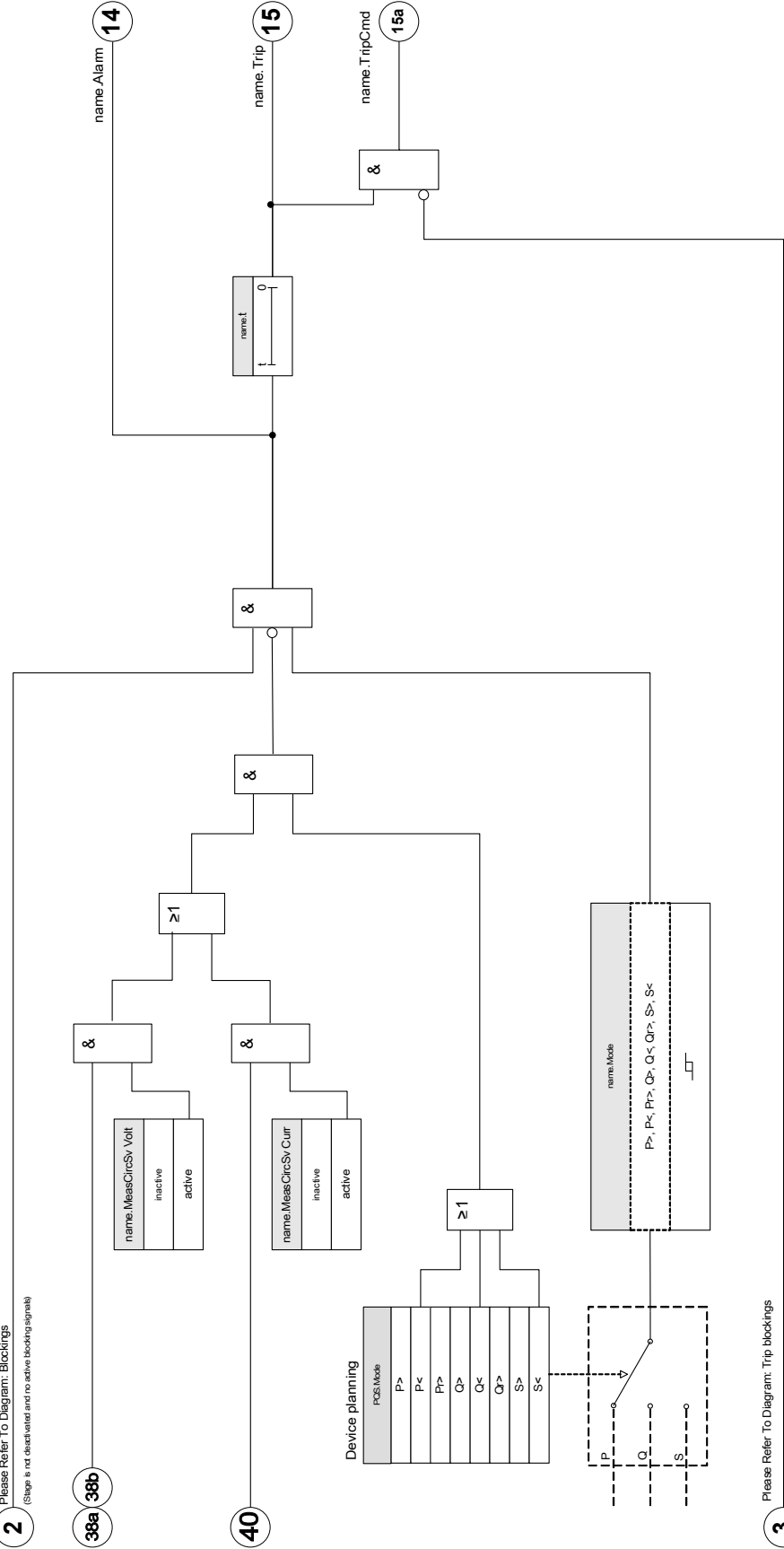

3 Please Refer To Diagram: Trip blockings
(Tripping command deactivatd or blocked)









Device planning parameters of the Power Protection module









| Parameter | Description | Options | Default | Menu path |
|---|-------------|--|--|-------------------|
| Mode  | Mode | do not use, P>, P<, Pr<, Pr>, Q>, Q<, Qr<, Qr>, S>, S< | PQS[1]: P> PQS[2]: do not use PQS[3]: do not use PQS[4]: do not use PQS[5]: do not use PQS[6]: do not use | [Device planning] |



Global protection parameter of the Power Protection-module

| Parameter | Description | Setting range | Default | Menu path |
|--|---|-----------------------|---------|---|
| ExBlo1  | External blocking of the module, if blocking is activated (allowed) within a parameter set and if the state of the assigned signal is true. | 1..n, Assignment List | -.- | [Protection Para /Global Prot Para /P-Prot /PQS[1]] |
| ExBlo2  | External blocking of the module, if blocking is activated (allowed) within a parameter set and if the state of the assigned signal is true. | 1..n, Assignment List | -.- | [Protection Para /Global Prot Para /P-Prot /PQS[1]] |
| ExBlo TripCmd  | External blocking of the Trip Command of the module/the stage, if blocking is activated (allowed) within a parameter set and if the state of the assigned signal is true. | 1..n, Assignment List | -.- | [Protection Para /Global Prot Para /P-Prot /PQS[1]] |

Parameter set parameters of the Power Protection module

| Parameter | Description | Setting range | Default | Menu path |
|---|---|---------------------|--|---|
|  Function | Permanent activation or deactivation of module/stage. | inactive, active | PQS[1]: active PQS[2]: inactive PQS[3]: inactive PQS[4]: inactive PQS[5]: inactive PQS[6]: inactive | [Protection Para <1..4> /P-Prot /PQS[1]] |
|  ExBlo Fc | Activate (allow) or inactivate (disallow) blocking of the module/stage. This parameter is only effective if a signal is assigned to the corresponding global protection parameter. If the signal becomes true, those modules/stages are blocked that are parameterized "ExBlo Fc=active". | inactive, active | inactive | [Protection Para <1..4> /P-Prot /PQS[1]] |
|  Blo TripCmd | Permanent blocking of the Trip Command of the module/stage. | inactive, active | inactive | [Protection Para <1..4> /P-Prot /PQS[1]] |
|  ExBlo TripCmd Fc | Activate (allow) or inactivate (disallow) blocking of the module/stage. This parameter is only effective if a signal is assigned to the corresponding global protection parameter. If the signal becomes true, those modules/stages are blocked that are parameterized "ExBlo TripCmd Fc=active". | inactive, active | inactive | [Protection Para <1..4> /P-Prot /PQS[1]] |
|  MeasCircSv Volt | Measuring Circuit Supervision Voltage Only available if: Device planning: PQS.Mode = P< Only available if: Device planning: PQS.Mode = Q< Only available if: Device planning: PQS.Mode = S< | inactive, active | inactive | [Protection Para <1..4> /P-Prot /PQS[1]] |
|  MeasCircSv Curr | Measuring Circuit Supervision Curent Only available if: Device planning: PQS.Mode = P< Only available if: Device planning: PQS.Mode = Q< Only available if: Device planning: PQS.Mode = S< | inactive, active | inactive | [Protection Para <1..4> /P-Prot /PQS[1]] |
|  P> | Over(load) Active Power Pickup Value. Can be used for monitoring the maximum allowed forward power limits of transformers or overhead lines. Definition for Sn is as follows: $Sn = 1.7321 * VT \text{ rating} * CT \text{ rating}$. The voltage is the line-to-line voltage. Only available if: Device planning: PQS.Mode = P> | 0.003 - 10.000Sn | PQS[1]: 1.0Sn PQS[2]: 1.20Sn PQS[3]: 1.20Sn PQS[4]: 1.20Sn PQS[5]: 1.20Sn PQS[6]: 1.20Sn | [Protection Para <1..4> /P-Prot /PQS[1]] |

| Parameter | Description | Setting range | Default | Menu path |
|--|--|------------------|---------|---|
| P<  | Under(load) Active Power Pickup Value (e.g. caused by idling motors). Definition for Sn is as follows: $S_n = 1.7321 * VT \text{ rating} * CT \text{ rating}$. The voltage is the line-to-line voltage. Only available if: Device planning: PQS.Mode = P< | 0.003 - 10.000Sn | 0.80Sn | [Protection Para <1..4> /P-Prot /PQS[1]] |
| Pr>  | Overload Reverse Active Power Pickup Value. Protection against reverse feeding into the power supply network. Definition for Sn is as follows: $S_n = 1.7321 * VT \text{ rating} * CT \text{ rating}$. The voltage is the line-to-line voltage. Only available if: Device planning: PQS.Mode = Pr> | 0.003 - 10.000Sn | 0.020Sn | [Protection Para <1..4> /P-Prot /PQS[1]] |
| Pr<  | Under Reverse Definition for Sn is as follows: $S_n = 1.7321 * VT \text{ rating} * CT \text{ rating}$. The voltage is the line-to-line voltage. Only available if: Device planning: PQS.Mode = P | 0.003 - 10.000Sn | 0.80Sn | [Protection Para <1..4> /P-Prot /PQS[1]] |
| Q>  | Over(load) Reactive Power Pickup Value. Monitoring the maximum allowed reactive power of the electrical equipment like transformers or overhead lines). If the maximum value is exceeded a condensator bank could be switched off. Definition for Sn is as follows: $S_n = 1.7321 * VT \text{ rating} * CT \text{ rating}$. The voltage is the line-to-line voltage. Only available if: Device planning: PQS.Mode = Q> | 0.003 - 10.000Sn | 1.20Sn | [Protection Para <1..4> /P-Prot /PQS[1]] |
| Q<  | Under(load) Reactive Power Pickup Value. Monitoring the minimum value of the reactive power. If it falls below the set value a condensator bank could be switched on. Definition for Sn is as follows: $S_n = 1.7321 * VT \text{ rating} * CT \text{ rating}$. The voltage is the line-to-line voltage. Only available if: Device planning: PQS.Mode = Q< | 0.003 - 10.000Sn | 0.80Sn | [Protection Para <1..4> /P-Prot /PQS[1]] |
| Qr>  | Overload Reverse Reactive Power Pickup Value Definition for Sn is as follows: $S_n = 1.7321 * VT \text{ rating} * CT \text{ rating}$. The voltage is the line-to-line voltage. Only available if: Device planning: PQS.Mode = Qr> | 0.003 - 10.000Sn | 0.020Sn | [Protection Para <1..4> /P-Prot /PQS[1]] |
| Qr<  | Under Reverse Definition for Sn is as follows: $S_n = 1.7321 * VT \text{ rating} * CT \text{ rating}$. The voltage is the line-to-line voltage. Only available if: Device planning: PQS.Mode = Q | 0.003 - 10.000Sn | 0.80Sn | [Protection Para <1..4> /P-Prot /PQS[1]] |
| S>  | Over(load) Apparent Power Pickup Value Definition for Sn is as follows: $S_n = 1.7321 * VT \text{ rating} * CT \text{ rating}$. The voltage is the line-to-line voltage. Only available if: Device planning: PQS.Mode = S> | 0.02 - 10.00Sn | 1.20Sn | [Protection Para <1..4> /P-Prot /PQS[1]] |

| Parameter | Description | Setting range | Default | Menu path |
|--|--|--------------------------|--|--|
| S<  | Under(load) Apparent Power Pickup Value Definition for Sn is as follows: $S_n = 1.7321 \cdot VT \text{ rating} \cdot CT \text{ rating}$. The voltage is the line-to-line voltage. Only available if: Device planning: PQS.Mode = S< | 0.02 - 10.00Sn | 0.80Sn | [Protection Para /<1..4> /P-Prot /PQS[1]] |
| t  | Tripping delay | 0.00 - 1100.00s | PQS[1]: 1.00s PQS[2]: 0.01s PQS[3]: 0.01s PQS[4]: 0.01s PQS[5]: 0.01s PQS[6]: 0.01s | [Protection Para /<1..4> /P-Prot /PQS[1]] |
| PowMeasMethod  | Determines if the active power, reactive power and apparent power are calculated on the basis of RMS or DFT. | Fundamental, True RMS | Fundamental | [Protection Para /<1..4> /P-Prot /PQS[1]] |

States of the inputs of the Power Protection module

| Name | Description | Assignment via |
|-----------------|---|--|
| ExBlo1-I | Module input state: External blocking | [Protection Para /Global Prot Para /P-Prot /PQS[1]] |
| ExBlo2-I | Module input state: External blocking | [Protection Para /Global Prot Para /P-Prot /PQS[1]] |
| ExBlo TripCmd-I | Module input state: External Blocking of the Trip Command | [Protection Para /Global Prot Para /P-Prot /PQS[1]] |

Signals of the Power Protection module (states of the outputs)

| Signal | Description |
|---------------|---|
| active | Signal: active |
| ExBlo | Signal: External Blocking |
| Blo TripCmd | Signal: Trip Command blocked |
| ExBlo TripCmd | Signal: External Blocking of the Trip Command |
| Alarm | Signal: Alarm Power Protection |

Protective Elements

| <i>Signal</i> | <i>Description</i> |
|---------------|-------------------------------|
| Trip | Signal: Trip Power Protection |
| TripCmd | Signal: Trip Command |

Commissioning Examples for the Power Protection Module

Object to be tested

- Testing the projected Power Protection Modules.
- P>
- P<
- Pr
- Q>
- Q<
- Qr
- S>
- S<

Necessary means

- 3-phase AC voltage source
- 3-phase AC current source
- Timer

Procedure – Testing the wiring

- Feed rated voltage and rated current to the measuring inputs of the relay.
- Adjust the current pointers 30° lagging to the voltage pointers.
- The following measuring values have to be shown:
P=0.86 P_n
Q=0.5 Q_n
S=1 S_n

NOTICE

If the measured values are shown with a negative (algebraic) sign check the wiring.

NOTICE

The examples shown within this chapter have to be carried out with the tripping values and tripping delays that apply to your switchboard.

If you are testing „greater than thresholds“ (e.g. P>) start by 80% of the tripping value and increase the object to be tested until the relay picks up.

In case that you are testing „less than thresholds“ (e.g. P<) start by 120% of the tripping value and reduce the object to be tested until the relay picks up.

If you are testing tripping delays of „greater than“ modules (e.g. P>) start a timer simultaneously with an abrupt change of the object to be tested from 80% of the tripping value to 120% of the tripping value.

If you are testing tripping delays of „less than“ modules (e.g. P<) start a timer simultaneously with an abrupt change of the object to be tested from 120% of the tripping value to 80% of the tripping value.

NOTICE

P>

Testing the threshold values (Example, Threshold 1.1 Pn)

- Feed rated voltage and 0.9 times rated current in phase to the measuring inputs of the relay (PF=1).
- The measured values for the active power „P“ must show a positive algebraic sign.
- Set the tripping threshold (e.g. 1.1 Pn).
- In order to test the tripping thresholds feed 0.9 times rated current to the measuring inputs of the relay. Increase the current slowly until the relay picks up. Ensure that the angle between current and voltage remains constant. Compare the tripping value to the parameterized.

Testing the tripping delay (Example, Threshold 1.1 Pn)

- Feed rated voltage and rated current in phase to the measuring inputs of the relay (PF=1).
- The measured values for the active power „P“ must show a positive algebraic sign.
- Set the tripping threshold (e.g. 1.1 Pn).
- In order to test the tripping delay feed 0.9 times rated current to the measuring inputs of the relay. Increase the current with an abrupt change to 1.2 In. Ensure that the angle between current and voltage remains constant. Measure the tripping delay at the output of the relay.

Successful test result

The measured total tripping delays or individual tripping delays, threshold values and fallback ratios correspond with those values, specified in the adjustment list. Permissible deviations/tolerances can be found under Technical Data.

NOTICE

Q>

Testing the threshold values (Example, Threshold 1,1 Qn)

- Feed rated voltage and 0.9 times rated current (90° phase shift) to the measuring inputs of the relay (PF=0).
- The measured values for the active power „Q“ must show a positive algebraic sign.
- Set the tripping threshold (e.g. 1.1 Qn).
- In order to test the tripping thresholds feed 0.9 times rated current to the measuring inputs of the relay. Increase the current slowly until the relay picks up. Ensure that the angle between current and voltage remains constant. Compare the tripping value to the parameterized.

Testing the tripping delay (Example, Threshold 1.1 Qn)

- Feed rated voltage and rated current (90° phase shift) to the measuring inputs of the relay (PF=0).
- The measured values for the active power „Q“ must show a positive algebraic sign.
- Set the tripping threshold (e.g. 1.1 Qn).
- In order to test the tripping delay feed 0.9 times rated current to the measuring inputs of the relay. Increase the current with an abrupt change to 1.2 In. Ensure that the angle between current and voltage remains constant. Measure the tripping delay at the output of the relay.

Successful test result

The measured total tripping delays or individual tripping delays, threshold values and fallback ratios correspond with those values, specified in the adjustment list. Permissible deviations/tolerances can be found under Technical Data.

NOTICE

P<

Testing the threshold values (Example, Threshold 0.3 P_n)

- Feed rated voltage and rated current in phase to the measuring inputs of the relay (PF=1).
- The measured values for the active power „P“ must show a positive algebraic sign.
- Set the tripping threshold (e.g. 0.3 P_n).
- In order to test the tripping thresholds feed 0.5 times rated current to the measuring inputs of the relay. Reduce the current slowly until the relay picks up. Ensure that the angle between current and voltage remains constant. Compare the tripping value to the parameterized.

Testing the tripping delay (Example, Threshold 0.3 P_n)

- Feed rated voltage and rated current in phase to the measuring inputs of the relay (PF=1).
- The measured values for the active power „P“ must show a positive algebraic sign.
- Set the tripping threshold (e.g. 0.3 P_n).
- In order to test the tripping delay feed 0.5 times rated current to the measuring inputs of the relay. Increase the current with an abrupt change to 0.2 I_n. Ensure that the angle between current and voltage remains constant. Measure the tripping delay at the output of the relay.

Successful test result

The measured total tripping delays or individual tripping delays, threshold values and fallback ratios correspond with those values, specified in the adjustment list. Permissible deviations/tolerances can be found under Technical Data.

NOTICE

Q<

Testing the threshold values (Example, Threshold 0.3 Qn)

- Feed rated voltage and 0.9 times rated current (90° phase shift) to the measuring inputs of the relay (PF=0).
- The measured values for the active power „Q“ must show a positive algebraic sign.
- Set the tripping threshold (e.g. 0.3 Qn).
- In order to test the tripping thresholds feed 0.5 times rated current to the measuring inputs of the relay. Reduce the current slowly until the relay picks up. Ensure that the angle between current and voltage remains constant. Compare the tripping value to the parameterized.

Testing the tripping delay (Example, Threshold 0.3 Qn)

- Feed rated voltage and 0.9 times rated current (90° phase shift) to the measuring inputs of the relay (PF=0).
- The measured values for the active power „Q“ must show a positive algebraic sign.
- Set the tripping threshold (e.g. 0.3 Qn).
- In order to test the tripping delay feed 0.5 times rated current to the measuring inputs of the relay. Increase the current with an abrupt change to 0.2 In. Ensure that the angle between current and voltage remains constant. Measure the tripping delay at the output of the relay.

Successful test result

The measured total tripping delays or individual tripping delays, threshold values and fallback ratios correspond with those values, specified in the adjustment list. Permissible deviations/tolerances can be found under Technical Data.

NOTICE

Pr

Testing the threshold values (Example, Threshold 0.2 Pn)

- Feed rated voltage and rated current with 180 degree phase shift between voltage and current pointers to the measuring inputs of the relay.
- The measured values for the active power „P“ must show a negative algebraic sign.
- Set the tripping threshold (e. g. 0.2 Pn).
- In order to test the tripping thresholds feed 0.1 times rated current to the measuring inputs of the relay. Increase the current slowly until the relay picks up. Ensure that the angle between current and voltage remains constant. Compare the tripping value to the parameterized.

Testing the tripping delay (Example, Threshold 0.2 Pn)

- Feed rated voltage and rated current with 180 degree phase shift between voltage and current pointers to the measuring inputs of the relay.
- The measured values for the active power „P“ must show a negative algebraic sign.
- Set the tripping threshold (e.g. 0.2 Pn).
- In order to test the tripping delay feed 0.1 times rated current to the measuring inputs of the relay. Increase the current with an abrupt change to 0.3 In. Ensure that the angle between current and voltage remains constant. Measure the tripping delay at the output of the relay.

Successful test result

The measured total tripping delays or individual tripping delays, threshold values and fallback ratios correspond with those values, specified in the adjustment list. Permissible deviations/tolerances can be found under Technical Data.

NOTICE

Qr

Testing the threshold values (Example, Threshold 0.2 Qn)

- Feed rated voltage and rated current with -90 degree phase shift between voltage and current pointers to the measuring inputs of the relay.
- The measured values for the active power „Q“ must show a negative algebraic sign.
- Set the tripping threshold (e. g. 0.2 Qn).
- In order to test the tripping delay feed 0.1 times rated current to the measuring inputs of the relay. Increase the current slowly until the relay picks up. Ensure that the angle between current and voltage remains constant. Measure the tripping delay at the output of the relay.

Testing the tripping delay (Example, Threshold 0.2 Qn)

- Feed rated voltage and rated current with -90 degree phase shift between voltage and current pointers to the measuring inputs of the relay.
- The measured values for the active power „Q“ must show a negative algebraic sign.
- Set the tripping threshold (e. g. 0.2 Qn).
- In order to test the tripping thresholds feed 0.1 times rated current to the measuring inputs of the relay. Increase the current with an abrupt change to 0.3 In. Ensure that the angle between current and voltage remains constant. Compare the tripping value to the parameterized.

Successful test result

The measured total tripping delays or individual tripping delays, threshold values and fallback ratios correspond with those values, specified in the adjustment list. Permissible deviations/tolerances can be found under Technical Data.

NOTICE

S>

Testing the threshold values

- Feed 80% of the S> threshold to the measuring inputs of the relay.
- Increase the fed power slowly until the relay picks up. Compare the measured value at the time of tripping to the parameterized setting.

Testing the tripping delay

- Feed 80% of the S> threshold to the measuring inputs of the relay.
- Increase the fed power with an abrupt change to 120% of the S> threshold. Measure the tripping delay at the output of the relay.

Successful test result

The measured total tripping delays or individual tripping delays, threshold values and fallback ratios correspond with those values, specified in the adjustment list. Permissible deviations/tolerances can be found under Technical Data.

NOTICE

S<

Testing the threshold values

- Feed 120% of the S< threshold to the measuring inputs of the relay.
- Reduce the fed power slowly until the relay picks up. Compare the measured value at the time of tripping to the parameterized setting.

Testing the tripping delay

- Feed 120% of the S< threshold to the measuring inputs of the relay.
- Reduce the fed power with an abrupt change to 80% of the S< threshold. Measure the tripping delay at the output of the relay.

Successful test result

The measured total tripping delays or individual tripping delays, threshold values and fallback ratios correspond with those values, specified in the adjustment list. Permissible deviations/tolerances can be found under Technical Data.

PF - Power Factor [55]

Available stages:

PF[1].PF[2]

These Element supervises the Power Factor within a defined area (limits).

The area is defined by four parameters.

- The Trigger quadrant (lead or lag).
- The Threshold (Power Factor value)
- The Reset quadrant (lead or lag).
- The Reset Value (Power Factor value)

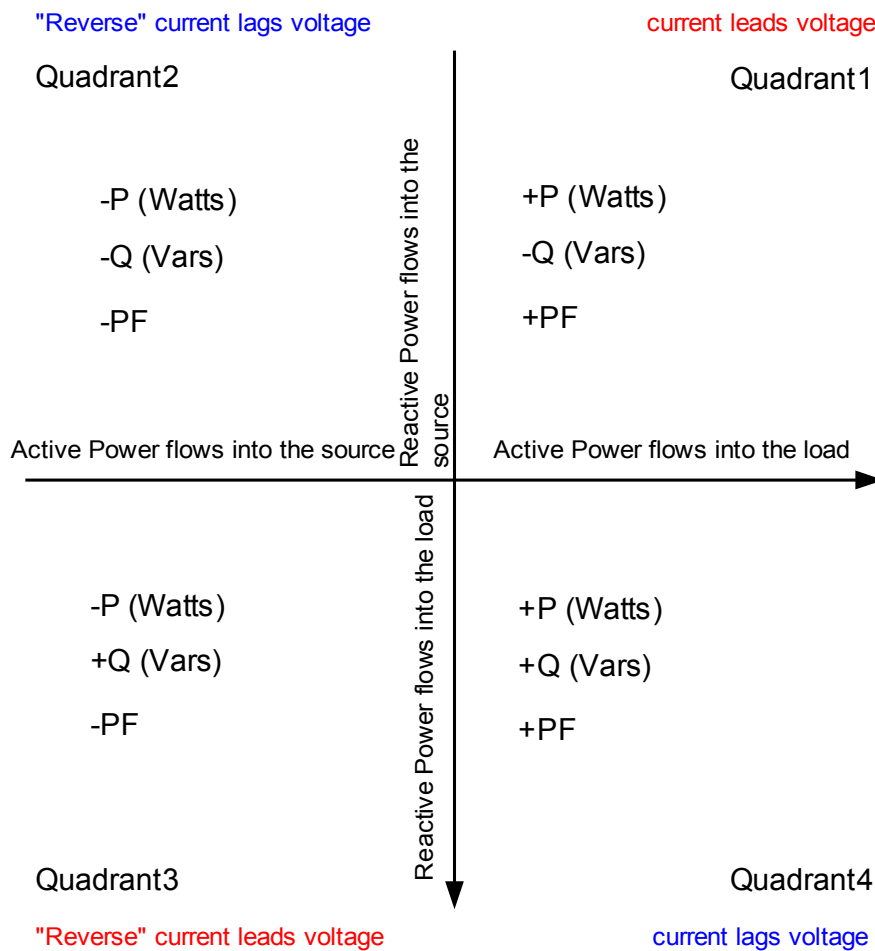

PF1]...[n]

name = PF1]...[n]

2

Please Refer To Diagram: Blockings
(Stage is not deactivated and no active blocking signals)

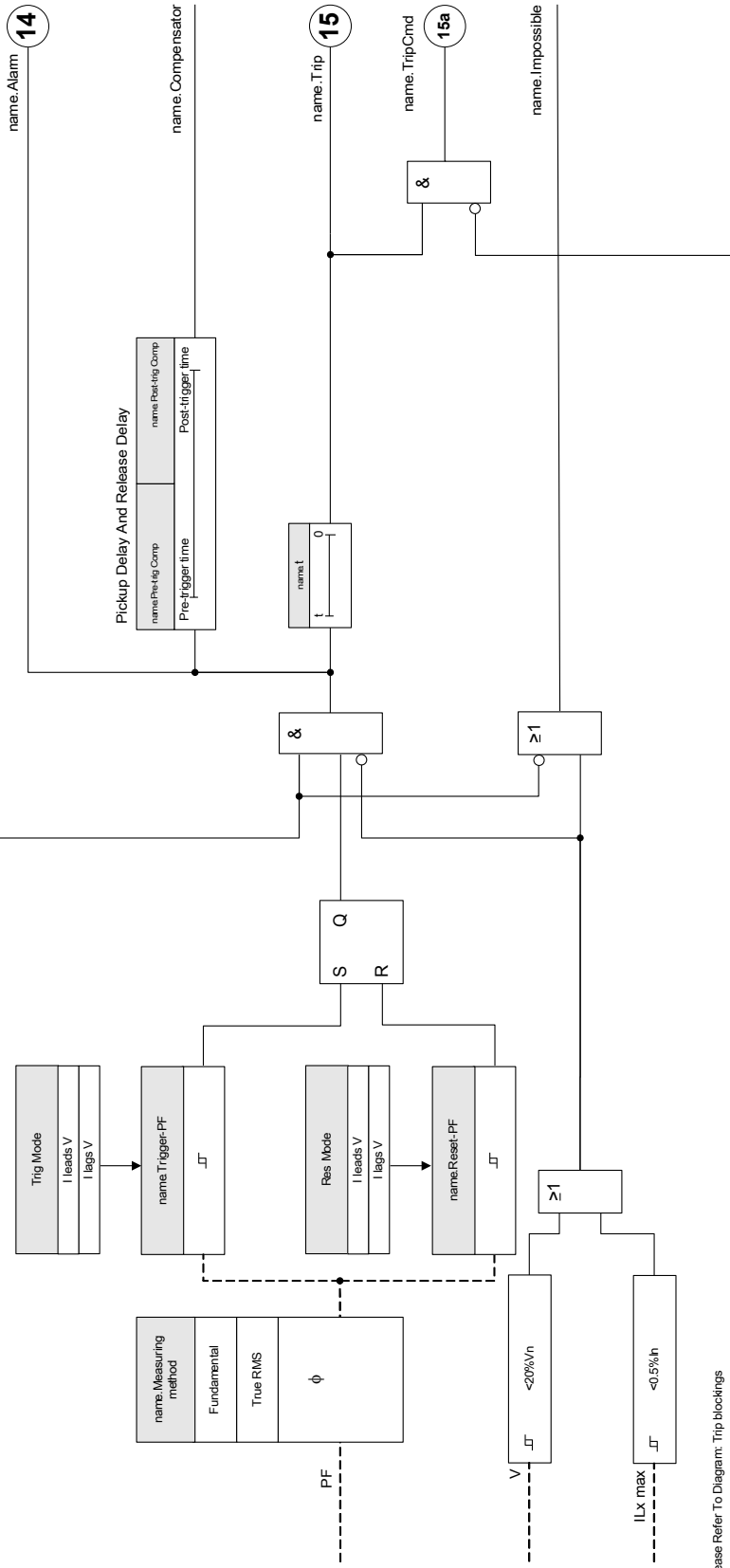



3

Please Refer To Diagram: Trip blockings
(Tripping command deactivated or blocked)

Device planning parameters of the Power Factor module

| Parameter | Description | Options | Default | Menu path |
|---|-------------|--------------------|------------|-------------------|
| Mode  | Mode | do not use, use | do not use | [Device planning] |





Global protection parameter of the Power Factor-module

| Parameter | Description | Setting range | Default | Menu path |
|--|---|-----------------------|---------|--|
| ExBlo1  | External blocking of the module, if blocking is activated (allowed) within a parameter set and if the state of the assigned signal is true. | 1..n, Assignment List | -- | [Protection Para /Global Prot Para /PF-Prot /PF[1]] |
| ExBlo2  | External blocking of the module, if blocking is activated (allowed) within a parameter set and if the state of the assigned signal is true. | 1..n, Assignment List | -- | [Protection Para /Global Prot Para /PF-Prot /PF[1]] |
| ExBlo TripCmd  | External blocking of the Trip Command of the module/the stage, if blocking is activated (allowed) within a parameter set and if the state of the assigned signal is true. | 1..n, Assignment List | -- | [Protection Para /Global Prot Para /PF-Prot /PF[1]] |

Parameter set parameters of the Power Factor module

| Parameter | Description | Setting range | Default | Menu path |
|---|---|--------------------------|-------------|--|
|  Function | Permanent activation or deactivation of module/stage. | inactive, active | inactive | [Protection Para /<1..4> /PF-Prot /PF[1]] |
|  ExBlo Fc | Activate (allow) or inactivate (disallow) blocking of the module/stage. This parameter is only effective if a signal is assigned to the corresponding global protection parameter. If the signal becomes true, those modules/stages are blocked that are parameterized "ExBlo Fc=active". | inactive, active | inactive | [Protection Para /<1..4> /PF-Prot /PF[1]] |
|  Blo TripCmd | Permanent blocking of the Trip Command of the module/stage. | inactive, active | inactive | [Protection Para /<1..4> /PF-Prot /PF[1]] |
|  ExBlo TripCmd Fc | Activate (allow) or inactivate (disallow) blocking of the module/stage. This parameter is only effective if a signal is assigned to the corresponding global protection parameter. If the signal becomes true, those modules/stages are blocked that are parameterized "ExBlo TripCmd Fc=active". | inactive, active | inactive | [Protection Para /<1..4> /PF-Prot /PF[1]] |
|  Measuring method | Measuring method: fundamental or rms or 3rd harmonic (only generator protection relays) | Fundamental, True RMS | Fundamental | [Protection Para /<1..4> /PF-Prot /PF[1]] |
|  Trig Mode | Trigger Mode. Should the Module be triggered if the Current Phasor is leading to the Voltage Phasor = Lead? Or should the Module be triggered if the Current Phasor is lagging to the Voltage Phasor = Lag? | I leads V, I lags V | I lags V | [Protection Para /<1..4> /PF-Prot /PF[1]] |
|  Triggr-PF | This is the power factor where the relay will pick-up. | 0.5 - 0.99 | 0.8 | [Protection Para /<1..4> /PF-Prot /PF[1]] |
|  Res Mode | Trigger Mode. Should the Module be triggered if the Current Phasor is leading to the Voltage Phasor = Lead? Or should the Module be triggered if the Current Phasor is lagging to the Voltage Phasor = Lag? | I leads V, I lags V | I leads V | [Protection Para /<1..4> /PF-Prot /PF[1]] |

Protective Elements

| Parameter | Description | Setting range | Default | Menu path |
|---|---|----------------|---------|---|
| Reset-PF  | This setting is the power factor, at which the relay will reset the power factor trip. It is like setting a hysteresis for the Trigger setting. | 0.5 - 0.99 | 0.99 | [Protection Para <1..4> /PF-Prot /PF[1]] |
| t  | Tripping delay | 0.00 - 300.00s | 0.00s | [Protection Para <1..4> /PF-Prot /PF[1]] |
| Pre-trig Comp  | Pickup (Pre-trigger) time for the Compensation Signal. When this timer is elapsed the compensation signal will be activated. | 0.00 - 300.00s | 5.00s | [Protection Para <1..4> /PF-Prot /PF[1]] |
| Post-trig Comp  | Post-trigger time of the Compensation Signal. When this timer is elapsed the compensation signal will be deactivated. | 0.00 - 300.00s | 5.00s | [Protection Para <1..4> /PF-Prot /PF[1]] |

States of the inputs of the Power Factor module

| Name | Description | Assignment via |
|-----------------|---|--|
| ExBlo1-I | Module input state: External blocking | [Protection Para /Global Prot Para /PF-Prot /PF[1]] |
| ExBlo2-I | Module input state: External blocking | [Protection Para /Global Prot Para /PF-Prot /PF[1]] |
| ExBlo TripCmd-I | Module input state: External Blocking of the Trip Command | [Protection Para /Global Prot Para /PF-Prot /PF[1]] |

Signals of the Power Factor module (states of the outputs)

| <i>Signal</i> | <i>Description</i> |
|---------------|---|
| active | Signal: active |
| ExBlo | Signal: External Blocking |
| Blo TripCmd | Signal: Trip Command blocked |
| ExBlo TripCmd | Signal: External Blocking of the Trip Command |
| Alarm | Signal: Alarm Power Factor |
| Trip | Signal: Trip Power Factor |
| TripCmd | Signal: Trip Command |
| Compensator | Signal: Compensation Signal |
| Impossible | Signal: Alarm Power Factor Impossible |

Commissioning: Power Factor [55]

Object to be tested

- Testing the projected Power Factor Modules

Necessary means

- 3-phase AC voltage source
- 3-phase AC current source
- Timer

Procedure – Testing the wiring

- Feed rated voltage and rated current to the measuring inputs of the relay.
- Adjust the current pointers 30° lagging to the voltage pointers.
- The following measuring values have to be shown:
P=0.86 P_n
Q=0.5 Q_n
S=1 S_n

NOTICE

If the measured values are shown with a negative (algebraic) sign check the wiring.

NOTICE

In this example PF-Trigger is set to $0.86 = 30^\circ$ (lagging) and PF-Reset is set to $0.86 = 30^\circ$ leading.

Carry out the test with the settings (trigger and reset) that fit to your switchboard.

Testing the threshold values (Trigger) (PF Trigger: Example = 0.86 lagging)

- Feed rated voltage and rated current in phase to the measuring inputs of the relay (PF=1).
- Adjust the angle between voltage and current (current pointer lagging) until the relay picks up.
- Write down the pickup value.

Testing the Reset (PF Reset: Example = 0.86 leading)

- Reduce the angle between voltage and current beyond PF = 1 (current pointer leading) until the alarm drops off.
- Write down the reset value.

Testing the trip delay (PF Trigger: Example = 0.86 lagging)

- Feed rated voltage and rated current in phase to the measuring inputs of the relay (PF=1).
- Adjust the angle between voltage and current (current pointer lagging) with an abrupt change to PF = 0.707 (45°) lagging.
- Measure the tripping delay at the output of the relay. Compare the measured tripping time to the parameterized.

Successful test result

The measured total tripping delays, threshold and reset values correspond with those values, specified in the adjustment list. Permissible deviations/tolerances can be found under Technical Data.

ExP - External Protection

Available stages:

ExP[1] , ExP[2] , ExP[3] , ExP[4]

NOTICE

All 4 stages of the external protection ExP[1]...[4] are identically structured.

By using the module External Protection the following can be incorporated into the device function: trip commands, alarms and blockades of external protection facilities. Devices which are not provided with a communication interface can be connected to the control system as well.

Exp[1]...[n]

name = Exp[1]...[n]



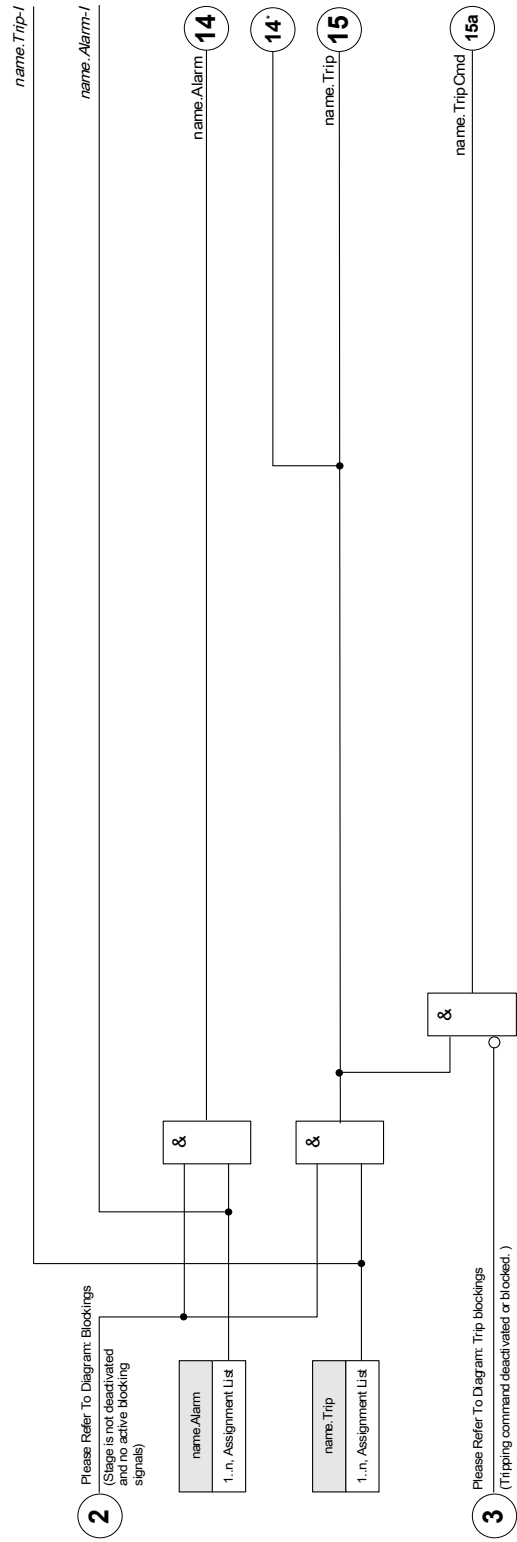

*=if no signal is assigned to the alarm input







Device Planning Parameters of the Module External Protection

| Parameter | Description | Options | Default | Menu path |
|---|-------------|--------------------|------------|-------------------|
| Mode  | Mode | do not use, use | do not use | [Device planning] |

Global Protection Parameters of the Module External Protection

| Parameter | Description | Setting range | Default | Menu path |
|--|---|-----------------------|---------|---|
| ExBlo1  | External blocking of the module, if blocking is activated (allowed) within a parameter set and if the state of the assigned signal is true. | 1..n, Assignment List | -- | [Protection Para /Global Prot Para /ExP /ExP[1]] |
| ExBlo2  | External blocking of the module, if blocking is activated (allowed) within a parameter set and if the state of the assigned signal is true. | 1..n, Assignment List | -- | [Protection Para /Global Prot Para /ExP /ExP[1]] |
| ExBlo TripCmd  | External blocking of the Trip Command of the module/the stage, if blocking is activated (allowed) within a parameter set and if the state of the assigned signal is true. | 1..n, Assignment List | -- | [Protection Para /Global Prot Para /ExP /ExP[1]] |
| Alarm  | Assignment for External Alarm | 1..n, Assignment List | -- | [Protection Para /Global Prot Para /ExP /ExP[1]] |
| Trip  | External trip of the CB if the state of the assigned signal is true. | 1..n, Assignment List | -- | [Protection Para /Global Prot Para /ExP /ExP[1]] |

Setting Group Parameters of the Module External Protection

| <i>Parameter</i> | <i>Description</i> | <i>Setting range</i> | <i>Default</i> | <i>Menu path</i> |
|---|---|----------------------|----------------|---|
| Function  | Permanent activation or deactivation of module/stage. | inactive, active | inactive | [Protection Para /<1..4> /ExP /ExP[1]] |
| ExBlo Fc  | Activate (allow) or inactivate (disallow) blocking of the module/stage. This parameter is only effective if a signal is assigned to the corresponding global protection parameter. If the signal becomes true, those modules/stages are blocked that are parameterized "ExBlo Fc=active". | inactive, active | inactive | [Protection Para /<1..4> /ExP /ExP[1]] |
| Blo TripCmd  | Permanent blocking of the Trip Command of the module/stage. | inactive, active | inactive | [Protection Para /<1..4> /ExP /ExP[1]] |
| ExBlo TripCmd Fc  | Activate (allow) or inactivate (disallow) blocking of the module/stage. This parameter is only effective if a signal is assigned to the corresponding global protection parameter. If the signal becomes true, those modules/stages are blocked that are parameterized "ExBlo TripCmd Fc=active". | inactive, active | inactive | [Protection Para /<1..4> /ExP /ExP[1]] |

Module External Protection Input States

| <i>Name</i> | <i>Description</i> | <i>Assignment via</i> |
|-----------------|---|---|
| ExBlo1-I | Module input state: External blocking1 | [Protection Para /Global Prot Para /ExP /ExP[1]] |
| ExBlo2-I | Module input state: External blocking2 | [Protection Para /Global Prot Para /ExP /ExP[1]] |
| ExBlo TripCmd-I | Module input state: External Blocking of the Trip Command | [Protection Para /Global Prot Para /ExP /ExP[1]] |
| Alarm-I | Module input state: Alarm | [Protection Para /Global Prot Para /ExP /ExP[1]] |
| Trip-I | Module input state: Trip | [Protection Para /Global Prot Para /ExP /ExP[1]] |

Module External Protection Signals (Output States)

| <i>Signal</i> | <i>Description</i> |
|---------------|---|
| active | Signal: active |
| ExBlo | Signal: External Blocking |
| Blo TripCmd | Signal: Trip Command blocked |
| ExBlo TripCmd | Signal: External Blocking of the Trip Command |
| Alarm | Signal: Alarm |
| Trip | Signal: Trip |
| TripCmd | Signal: Trip Command |

Commissioning: External Protection

Object to be tested

Test of the module External Protection

Necessary means

- Depending on the application

Procedure

Simulate the functionality of the External Protection (Alarm, Trip, Blockings...) by (de-)energizing of the digital inputs.

Successful test result

All external alarms, external trips and external blockings are correctly recognized and processed by the device.

Supervision

CBF- Circuit Breaker Failure [50BF*/62BF]

*=only available in protective relays that offer current measurement.

Available elements:

CBF

Principle – General Use

The breaker failure (BF) protection is used to provide backup protection in the event that a breaker fails to operate properly during fault clearing. This signal is to be used to trip the upstream breaker (e.g. infeed of a busbar) either via an output relay or via Communication (SCADA). Depending on the ordered device and type there are different/multiple schemes available to detect a breaker failure.

Start/Trigger of the CBF Timer

A supervision timer »*t-CBF*« will be started, once the CBF module is triggered. Even if the Trigger signal drops again, this timer will continue to run. If the timer runs down/elapses (is not stopped), the module will issue a trip afterwards. This trip signal is to be used to trip the upstream breaker (backup).

Stopping the CBF

The timer will be stopped if the opening of the breaker is detected. Depending on the supervision scheme the timer will be stopped if the current falls below the current threshold or if the position signals indicate the open position of the breaker or a combination of both. The CBF module will remain within the state rejected until the trigger signal drops (falls back).

Detecting a Breaker Failure

Depending on the supervision scheme, the Circuit Breaker Failure signal (Trip) will be set if either:

- the current doesn't fall below the threshold or
- the position signals indicate that the breaker is in the closed position or
- both.

Reject state of the CBF module

The CBF module will switch into the rejected state if the circuit breaker failure triggers are still active while the open position of the breaker has been detected successfully.

Readiness for Operation

The CBF module will switch back into the Stand-by if the trigger signals drop (fall back).

Locking

A locking signal will be issued simultaneously with the CBF-Signal (Trip). The locking signal is permanent. This signal has to be acknowledged at the HMI.

NOTICE

Note on devices that offer Wide Frequency Range measurement:

The supervision scheme 50BF will be blocked as soon as the frequency differs more than 5% from the nominal frequency. As long as the frequency differs more than 5% from the nominal frequency the supervision scheme “50BF and CB Pos” will work according to the “CB Pos” scheme.

Supervision Schemes

Up to three supervision schemes are available depending on the ordered device type and variant in order to detect a circuit breaker failure.

*50BF**

A supervision timer will be started as soon as the CBF module is triggered by a trip signal. A breaker failure will be detected and a signal will be issued if the measured current does not fall below a set threshold while this timer runs down.

This supervision scheme is available within protective relays that offer current measurement.

CB Pos

A supervision timer will be started as soon as the CBF module is triggered by a trip signal. A breaker failure will be detected and a signal will be issued if the evaluation of the position indicators of the circuit breaker does not indicate that the breaker has been switched off successfully while this timer runs down.

This supervision scheme is available within all protective relays. This scheme is recommended if breaker failures have to be detected while there is no or not much load flow (small currents). This might e.g. be the case if overvoltage or overfrequency is supervised for a Gen-Set that is running in Stand-by.

*50 BF and CB Pos**

A supervision timer will be started as soon as the CBF module is triggered by a trip signal. A breaker failure will be detected and a signal will be issued if the measured current does not fall below a set threshold and if simultaneously the evaluation of the position indicators of the circuit breaker does not indicate that the breaker has been switched off successfully while this timer runs down.

This scheme is recommended if breaker failures have to be double checked. This scheme will issue a trip command to the upstream breaker even if position indicators indicate misleadingly (faulty) that the breaker has been opened or if the current measurement indicates misleadingly (faulty) that the breaker is now in the open position.

*=only available in protective relays that offer current measurement.

Trigger Modes

There are three trigger modes for the CBF module available. In addition to that, there are three assignable trigger inputs available that might trigger the CBF module even if they are not assigned within the breaker manager onto the breaker that is to be monitored.

- *All Trips*: All trip signals that are assigned to this breaker (within the trip manager) will start the CBF module (please refer also to section „Trigger signals of the Circuit Breaker Failure“).
- *Current Trips*: All current trips that are assigned to this breaker (within the trip manager) will start the CBF module (please refer also to section „Trigger signals of the Circuit Breaker Failure“).
- *External Trips*: All external trips that are assigned to this breaker (within the trip manager) will start the CBF module (please refer also to section „Trigger signals of the Circuit Breaker Failure“).

•In addition, the User can also select *none* (e.g.: if the User intends to use one of the three additional assignable trigger inputs).

NOTICE

Those trips can exclusively start the breaker failures that are assigned within the trip manager to the breaker that is to be supervised. In contrast to that the additional three triggers 1-3 will trigger the CBFmodule even if they are not assigned onto the breaker within the corresponding breaker manager.

NOTICE

Select the winding side (Breaker, Winding) from which the measured currents should be taken in case this protective device provides more than one current measurement card.

NOTICE

This Notice applies to protective devices that offer control functionality only! This protective element requires, that a switchgear (circuit breaker) is assigned to it. It is allowed only to assign switchgears (circuit breaker) to this protective element, whose measuring transformers provide measuring data to the protective device.

Breaker Failure Lockout

The signal of the Circuit Breaker Failure is latched. This signal can be used to block the breaker against a switching on attempt.

Tabular Summary

| | <i>Supervision Schemes</i> | | |
|---|---|---|---|
| | Where? Within [Protection Para\Global Prot Para\Supervision\CBF] | | |
| | CB Pos ²⁾ | 50BF ³⁾ | CBPos und 50BF ⁴⁾ |
| <p><i>Which breaker is to be monitored?</i></p> <p>Where to select? Within [Protection Para\Global Prot Para\Supervision\CBF]</p> | <p>Selection of the breaker that is to be monitored.</p> <p>(In case that more than one breaker is available)</p> | <p>Selection of the breaker that is to be monitored.</p> <p>(In case that more than one breaker is available)</p> | <p>Selection of the breaker that is to be monitored.</p> <p>(In case that more than one breaker is available)</p> |
| <p><i>Trigger Modi</i></p> <p>(Who starts the CBF-timer ?)</p> <p>Where to set? Within [Protection Para\Global Prot Para\Supervision\CBF]</p> | <p>All Trips⁵⁾</p> <p>or</p> <p>All Current Trips⁵⁾</p> <p>or</p> <p>External Trips⁵⁾</p> <p>...and the breaker is in the closed position and the CBF module is within the stand-by state.</p> | <p>All Trips⁵⁾</p> <p>or</p> <p>All Current Trips⁵⁾</p> <p>or</p> <p>External Trips⁵⁾</p> <p>...and the CBF module is within the stand-by state.</p> | <p>All Trips⁵⁾</p> <p>or</p> <p>All Current Trips⁵⁾</p> <p>or</p> <p>External Trips⁵⁾</p> <p>...and the breaker is in the closed position and the CBF module is within the stand-by state.</p> |
| <p><i>Who stops the CBF-Timer?</i></p> <p>Once the timer has been stopped the CBF module will switch into the state „Rejected“. The module will switch back into the state „Stand-by“ if the trigger signals are dropped.</p> | <p>Position indicators indicate that the switchgear (breaker) is in the open position.</p> | <p>Current is fallen below the I<-threshold¹⁾.</p> | <p>Position indicators indicate that the switchgear (breaker) is in the open position and current is fallen below the I<-threshold¹⁾.</p> |
| <p><i>A Breaker Failure will be detected</i></p> <p>...and a trip signal to the upstream breaker will be issued?</p> | <p>When the CBF-Timer has run down (elapsed).</p> | <p>When the CBF-Timer has run down (elapsed).</p> | <p>When the CBF-Timer has run down (elapsed).</p> |
| <p><i>When does the trip signal to the upstream breaker drops (falls back)?</i></p> | <p>If the position indicators indicate that the switchgear (breaker) is in the open position and if the trigger signals are dropped (fallen back)</p> | <p>If the current is fallen below the I< and if the trigger signals are dropped (fallen back)</p> | <p>If the position indicators indicate that the switchgear (breaker) is in the open position and if the current is fallen below the I< and if the trigger signals are dropped (fallen back)</p> |

¹⁾ It is recommended to set the I< threshold to a value that is slightly below the fault current that is expectable. By means of that it is possible to shorten the CBF supervision timer and hence reduce thermal and mechanical damage of the electrical equipment in case of a breaker failure. The lower the threshold, the longer the time that is needed to detect, that the breaker is in the open position, especially if there are transients/harmonics.

Note: Tripping delay of the CBF module = Minimum delay time (tripping time) of the backup protection!

Supervision

2), 3), 4)

Available in all devices with the corresponding software

Available in all devices that offer current measurement

Available in all devices that offer current measurement

5)

Only if the signals are assigned onto the breaker within the breaker manager.

Circuit Breaker Failure Protection for devices that offer current measurement

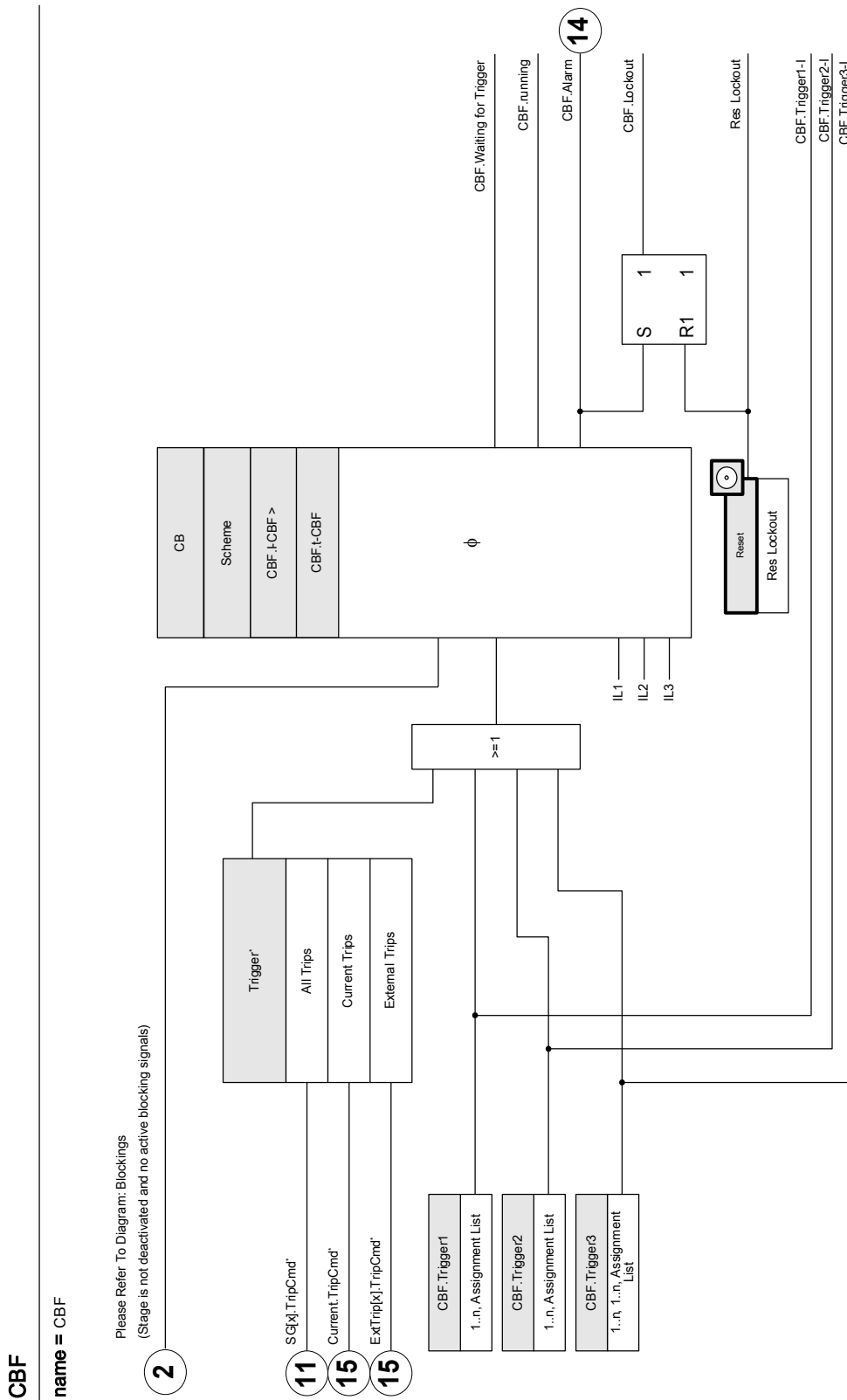

*The Breaker Failure will be triggered only by those trip signals that are assigned onto the breaker within the Trip Manager.

Circuit Breaker Failure Protection for devices that offer voltage measurement only

CBF

name = CBF

Please Refer To Diagram: Blockings
(Stage is not deactivated and no active blocking signals)

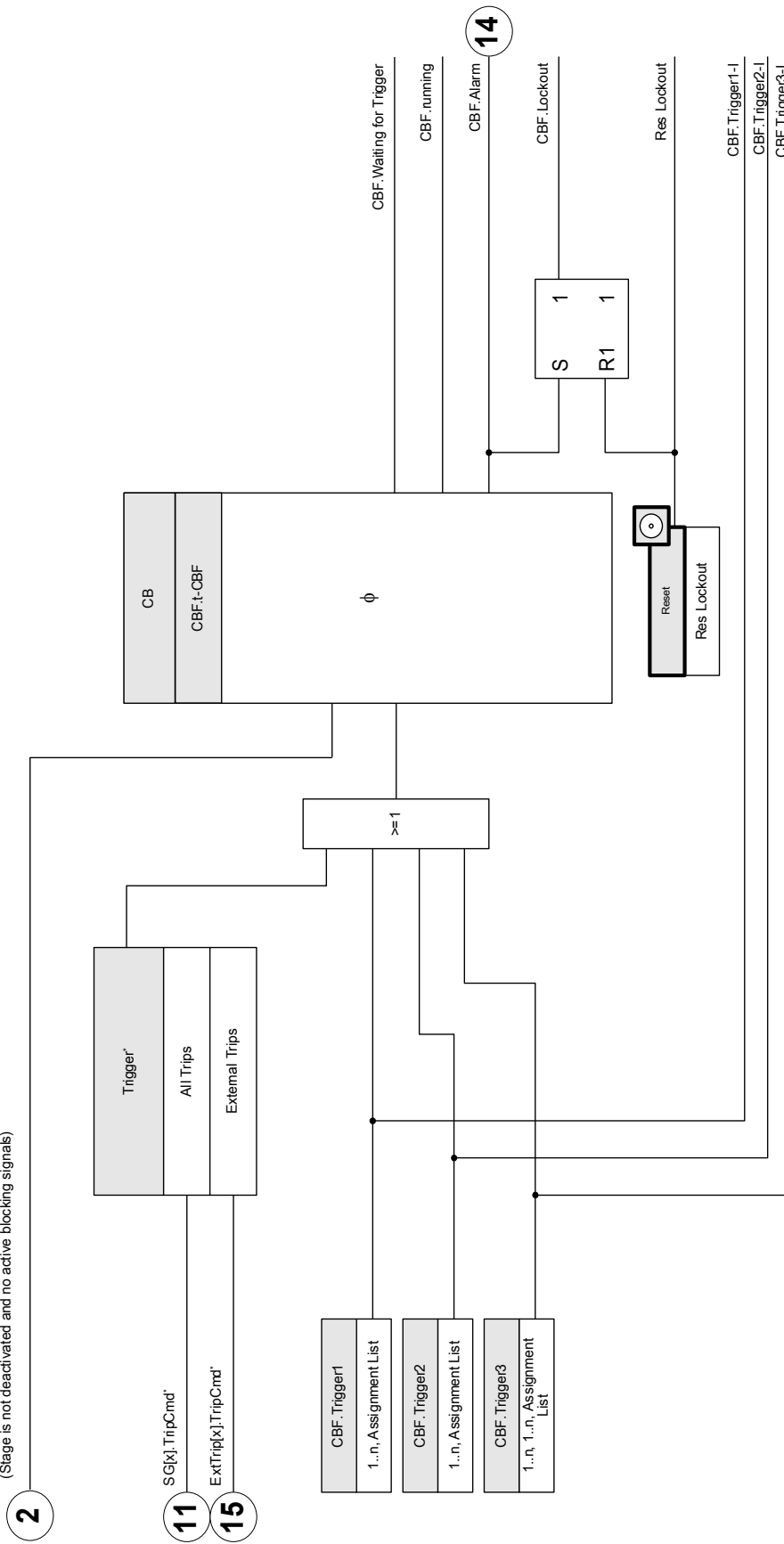

*The Breaker Failure will be triggered only by those trip signals that are assigned onto the breaker within the Trip Manager.



Device Planning Parameters of the CBF

| Parameter | Description | Options | Default | Menu path |
|---|-------------|--------------------|------------|-------------------|
| Mode  | Mode | do not use, use | do not use | [Device planning] |

Global Protection Parameters of the CBF

| Parameter | Description | Setting range | Default | Menu path |
|---|---|---|-----------|--|
| Scheme  | Scheme | 50BF, CB Pos, 50BF and CB Pos | 50BF | [Protection Para /Global Prot Para /Supervision /CBF] |
| CB  | Selection of the Circuit Breaker to be monitored. | -. , SG[1]., SG[2]., SG[3]., SG[4]., SG[5]., SG[6]. | SG[1]. | [Protection Para /Global Prot Para /Supervision /CBF] |
| ExBlo1  | External blocking of the module, if blocking is activated (allowed) within a parameter set and if the state of the assigned signal is true. | 1..n, Assignment List | -. - | [Protection Para /Global Prot Para /Supervision /CBF] |
| ExBlo2  | External blocking of the module, if blocking is activated (allowed) within a parameter set and if the state of the assigned signal is true. | 1..n, Assignment List | -. - | [Protection Para /Global Prot Para /Supervision /CBF] |
| Trigger  | Determining the trigger mode for the Breaker Failure. | - . - , All Trips, External Trips, Current Trips | All Trips | [Protection Para /Global Prot Para /Supervision /CBF] |
| Trigger1  | Trigger that will start the CBF | Trigger | -. - | [Protection Para /Global Prot Para /Supervision /CBF] |

Supervision

| <i>Parameter</i> | <i>Description</i> | <i>Setting range</i> | <i>Default</i> | <i>Menu path</i> |
|---|---------------------------------|----------------------|----------------|--|
| Trigger2  | Trigger that will start the CBF | Trigger | -.- | [Protection Para /Global Prot Para /Supervision /CBF] |
| Trigger3  | Trigger that will start the CBF | Trigger | -.- | [Protection Para /Global Prot Para /Supervision /CBF] |

Direct Commands of the CBF





| <i>Parameter</i> | <i>Description</i> | <i>Setting range</i> | <i>Default</i> | <i>Menu path</i> |
|--|--------------------|----------------------|----------------|-----------------------|
| Res Lockout  | Reset Lockout | inactive, active | inactive | [Operation /Reset] |

Setting Group Parameters of the CBF

NOTICE

In order to prevent a faulty activation of the BF Module, the pickup (alarm) time must be greater than the sum of:

- Operating time of the protective relay
- +The close-open time of the breaker (please refer to the technical data of the manufacturer of the breaker);
- +Drop off time (current- or position indicators)
- +Security margin.

| Parameter | Description | Setting range | Default | Menu path |
|---|---|---------------------|----------|--|
| Function  | Permanent activation or deactivation of module/stage. | inactive, active | inactive | [Protection Para /<1..4> /Supervision /CBF] |
| ExBlo Fc  | Activate (allow) or inactivate (disallow) blocking of the module/stage. This parameter is only effective if a signal is assigned to the corresponding global protection parameter. If the signal becomes true, those modules/stages are blocked that are parameterized "ExBlo Fc=active". | inactive, active | inactive | [Protection Para /<1..4> /Supervision /CBF] |
| I-CBF >  | Breaker Failure Alarm will be initiated if this threshold is still exceeded after the timer has expired (50 BF). Only available if: Scheme50BF = Or Scheme = 50BF and CB Pos | 0.02 - 4.00In | 0.02In | [Protection Para /<1..4> /Supervision /CBF] |
| t-CBF  | If the delay time is expired, an CBF alarm is given out. | 0.00 - 10.00s | 0.20s | [Protection Para /<1..4> /Supervision /CBF] |

CBF Input States

| <i>Name</i> | <i>Description</i> | <i>Assignment via</i> |
|-------------|---|--|
| ExBlo1-I | Module input state: External blocking1 | [Protection Para /Global Prot Para /Supervision /CBF] |
| ExBlo2-I | Module input state: External blocking2 | [Protection Para /Global Prot Para /Supervision /CBF] |
| Trigger1-I | Module Input: Trigger that will start the CBF | [Protection Para /Global Prot Para /Supervision /CBF] |
| Trigger2-I | Module Input: Trigger that will start the CBF | [Protection Para /Global Prot Para /Supervision /CBF] |
| Trigger3-I | Module Input: Trigger that will start the CBF | [Protection Para /Global Prot Para /Supervision /CBF] |

CBF Signals (Output States)

| <i>Signal</i> | <i>Description</i> |
|---------------------|---------------------------------|
| active | Signal: active |
| ExBlo | Signal: External Blocking |
| Waiting for Trigger | Waiting for Trigger |
| running | Signal: CBF-Module started |
| Alarm | Signal: Circuit Breaker Failure |
| Lockout | Signal: Lockout |
| Res Lockout | Signal: Reset Lockout |

Trigger signals of the Circuit Breaker Failure

These trips will start the CBF module if »All trips« have been selected as the trigger event.

| Name | Description |
|-----------------------|----------------------|
| -- | No assignment |
| I[1].TripCmd | Signal: Trip Command |
| I[2].TripCmd | Signal: Trip Command |
| I[3].TripCmd | Signal: Trip Command |
| I[4].TripCmd | Signal: Trip Command |
| I[5].TripCmd | Signal: Trip Command |
| I[6].TripCmd | Signal: Trip Command |
| IG[1].TripCmd | Signal: Trip Command |
| IG[2].TripCmd | Signal: Trip Command |
| IG[3].TripCmd | Signal: Trip Command |
| IG[4].TripCmd | Signal: Trip Command |
| ThR.TripCmd | Signal: Trip Command |
| I2>[1].TripCmd | Signal: Trip Command |
| I2>[2].TripCmd | Signal: Trip Command |
| V[1].TripCmd | Signal: Trip Command |
| V[2].TripCmd | Signal: Trip Command |
| V[3].TripCmd | Signal: Trip Command |
| V[4].TripCmd | Signal: Trip Command |
| V[5].TripCmd | Signal: Trip Command |
| V[6].TripCmd | Signal: Trip Command |
| df/dt.TripCmd | Signal: Trip Command |
| delta phi.TripCmd | Signal: Trip Command |
| Intertripping.TripCmd | Signal: Trip Command |
| P.TripCmd | Signal: Trip Command |
| Q.TripCmd | Signal: Trip Command |
| LVRT[1].TripCmd | Signal: Trip Command |
| LVRT[2].TripCmd | Signal: Trip Command |
| VG[1].TripCmd | Signal: Trip Command |
| VG[2].TripCmd | Signal: Trip Command |
| V012[1].TripCmd | Signal: Trip Command |
| V012[2].TripCmd | Signal: Trip Command |
| V012[3].TripCmd | Signal: Trip Command |
| V012[4].TripCmd | Signal: Trip Command |
| V012[5].TripCmd | Signal: Trip Command |
| V012[6].TripCmd | Signal: Trip Command |
| f[1].TripCmd | Signal: Trip Command |

| <i>Name</i> | <i>Description</i> |
|---|---|
| f[2].TripCmd | Signal: Trip Command |
| f[3].TripCmd | Signal: Trip Command |
| f[4].TripCmd | Signal: Trip Command |
| f[5].TripCmd | Signal: Trip Command |
| f[6].TripCmd | Signal: Trip Command |
| PQS[1].TripCmd | Signal: Trip Command |
| PQS[2].TripCmd | Signal: Trip Command |
| PQS[3].TripCmd | Signal: Trip Command |
| PQS[4].TripCmd | Signal: Trip Command |
| PQS[5].TripCmd | Signal: Trip Command |
| PQS[6].TripCmd | Signal: Trip Command |
| PF[1].TripCmd | Signal: Trip Command |
| PF[2].TripCmd | Signal: Trip Command |
| Q->&V<.Decoupling PCC | Signal: Decoupling at the Point of Common Coupling |
| Q->&V<.Decoupling Distributed Generator | Signal: Decoupling of the (local) Energy Generator/Resource |
| UFLS.Trip | Signal: Signal: Trip |
| ExP[1].TripCmd | Signal: Trip Command |
| ExP[2].TripCmd | Signal: Trip Command |
| ExP[3].TripCmd | Signal: Trip Command |
| ExP[4].TripCmd | Signal: Trip Command |
| DI Slot X1.DI 1 | Signal: Digital Input |
| DI Slot X1.DI 2 | Signal: Digital Input |
| DI Slot X1.DI 3 | Signal: Digital Input |
| DI Slot X1.DI 4 | Signal: Digital Input |
| DI Slot X1.DI 5 | Signal: Digital Input |
| DI Slot X1.DI 6 | Signal: Digital Input |
| DI Slot X1.DI 7 | Signal: Digital Input |
| DI Slot X1.DI 8 | Signal: Digital Input |
| DI Slot X6.DI 1 | Signal: Digital Input |
| DI Slot X6.DI 2 | Signal: Digital Input |
| DI Slot X6.DI 3 | Signal: Digital Input |
| DI Slot X6.DI 4 | Signal: Digital Input |
| DI Slot X6.DI 5 | Signal: Digital Input |
| DI Slot X6.DI 6 | Signal: Digital Input |
| DI Slot X6.DI 7 | Signal: Digital Input |
| DI Slot X6.DI 8 | Signal: Digital Input |
| Logics.LE1.Gate Out | Signal: Output of the logic gate |
| Logics.LE1.Timer Out | Signal: Timer Output |
| Logics.LE1.Out | Signal: Latched Output (Q) |

| <i>Name</i> | <i>Description</i> |
|--------------------------|--|
| Logics.LE1.Out inverted | Signal: Negated Latched Output (Q NOT) |
| Logics.LE2.Gate Out | Signal: Output of the logic gate |
| Logics.LE2.Timer Out | Signal: Timer Output |
| Logics.LE2.Out | Signal: Latched Output (Q) |
| Logics.LE2.Out inverted | Signal: Negated Latched Output (Q NOT) |
| Logics.LE3.Gate Out | Signal: Output of the logic gate |
| Logics.LE3.Timer Out | Signal: Timer Output |
| Logics.LE3.Out | Signal: Latched Output (Q) |
| Logics.LE3.Out inverted | Signal: Negated Latched Output (Q NOT) |
| Logics.LE4.Gate Out | Signal: Output of the logic gate |
| Logics.LE4.Timer Out | Signal: Timer Output |
| Logics.LE4.Out | Signal: Latched Output (Q) |
| Logics.LE4.Out inverted | Signal: Negated Latched Output (Q NOT) |
| Logics.LE5.Gate Out | Signal: Output of the logic gate |
| Logics.LE5.Timer Out | Signal: Timer Output |
| Logics.LE5.Out | Signal: Latched Output (Q) |
| Logics.LE5.Out inverted | Signal: Negated Latched Output (Q NOT) |
| Logics.LE6.Gate Out | Signal: Output of the logic gate |
| Logics.LE6.Timer Out | Signal: Timer Output |
| Logics.LE6.Out | Signal: Latched Output (Q) |
| Logics.LE6.Out inverted | Signal: Negated Latched Output (Q NOT) |
| Logics.LE7.Gate Out | Signal: Output of the logic gate |
| Logics.LE7.Timer Out | Signal: Timer Output |
| Logics.LE7.Out | Signal: Latched Output (Q) |
| Logics.LE7.Out inverted | Signal: Negated Latched Output (Q NOT) |
| Logics.LE8.Gate Out | Signal: Output of the logic gate |
| Logics.LE8.Timer Out | Signal: Timer Output |
| Logics.LE8.Out | Signal: Latched Output (Q) |
| Logics.LE8.Out inverted | Signal: Negated Latched Output (Q NOT) |
| Logics.LE9.Gate Out | Signal: Output of the logic gate |
| Logics.LE9.Timer Out | Signal: Timer Output |
| Logics.LE9.Out | Signal: Latched Output (Q) |
| Logics.LE9.Out inverted | Signal: Negated Latched Output (Q NOT) |
| Logics.LE10.Gate Out | Signal: Output of the logic gate |
| Logics.LE10.Timer Out | Signal: Timer Output |
| Logics.LE10.Out | Signal: Latched Output (Q) |
| Logics.LE10.Out inverted | Signal: Negated Latched Output (Q NOT) |
| Logics.LE11.Gate Out | Signal: Output of the logic gate |
| Logics.LE11.Timer Out | Signal: Timer Output |
| Logics.LE11.Out | Signal: Latched Output (Q) |

| <i>Name</i> | <i>Description</i> |
|--------------------------|--|
| Logics.LE11.Out inverted | Signal: Negated Latched Output (Q NOT) |
| Logics.LE12.Gate Out | Signal: Output of the logic gate |
| Logics.LE12.Timer Out | Signal: Timer Output |
| Logics.LE12.Out | Signal: Latched Output (Q) |
| Logics.LE12.Out inverted | Signal: Negated Latched Output (Q NOT) |
| Logics.LE13.Gate Out | Signal: Output of the logic gate |
| Logics.LE13.Timer Out | Signal: Timer Output |
| Logics.LE13.Out | Signal: Latched Output (Q) |
| Logics.LE13.Out inverted | Signal: Negated Latched Output (Q NOT) |
| Logics.LE14.Gate Out | Signal: Output of the logic gate |
| Logics.LE14.Timer Out | Signal: Timer Output |
| Logics.LE14.Out | Signal: Latched Output (Q) |
| Logics.LE14.Out inverted | Signal: Negated Latched Output (Q NOT) |
| Logics.LE15.Gate Out | Signal: Output of the logic gate |
| Logics.LE15.Timer Out | Signal: Timer Output |
| Logics.LE15.Out | Signal: Latched Output (Q) |
| Logics.LE15.Out inverted | Signal: Negated Latched Output (Q NOT) |
| Logics.LE16.Gate Out | Signal: Output of the logic gate |
| Logics.LE16.Timer Out | Signal: Timer Output |
| Logics.LE16.Out | Signal: Latched Output (Q) |
| Logics.LE16.Out inverted | Signal: Negated Latched Output (Q NOT) |
| Logics.LE17.Gate Out | Signal: Output of the logic gate |
| Logics.LE17.Timer Out | Signal: Timer Output |
| Logics.LE17.Out | Signal: Latched Output (Q) |
| Logics.LE17.Out inverted | Signal: Negated Latched Output (Q NOT) |
| Logics.LE18.Gate Out | Signal: Output of the logic gate |
| Logics.LE18.Timer Out | Signal: Timer Output |
| Logics.LE18.Out | Signal: Latched Output (Q) |
| Logics.LE18.Out inverted | Signal: Negated Latched Output (Q NOT) |
| Logics.LE19.Gate Out | Signal: Output of the logic gate |
| Logics.LE19.Timer Out | Signal: Timer Output |
| Logics.LE19.Out | Signal: Latched Output (Q) |
| Logics.LE19.Out inverted | Signal: Negated Latched Output (Q NOT) |
| Logics.LE20.Gate Out | Signal: Output of the logic gate |
| Logics.LE20.Timer Out | Signal: Timer Output |
| Logics.LE20.Out | Signal: Latched Output (Q) |
| Logics.LE20.Out inverted | Signal: Negated Latched Output (Q NOT) |
| Logics.LE21.Gate Out | Signal: Output of the logic gate |
| Logics.LE21.Timer Out | Signal: Timer Output |
| Logics.LE21.Out | Signal: Latched Output (Q) |

| <i>Name</i> | <i>Description</i> |
|--------------------------|--|
| Logics.LE21.Out inverted | Signal: Negated Latched Output (Q NOT) |
| Logics.LE22.Gate Out | Signal: Output of the logic gate |
| Logics.LE22.Timer Out | Signal: Timer Output |
| Logics.LE22.Out | Signal: Latched Output (Q) |
| Logics.LE22.Out inverted | Signal: Negated Latched Output (Q NOT) |
| Logics.LE23.Gate Out | Signal: Output of the logic gate |
| Logics.LE23.Timer Out | Signal: Timer Output |
| Logics.LE23.Out | Signal: Latched Output (Q) |
| Logics.LE23.Out inverted | Signal: Negated Latched Output (Q NOT) |
| Logics.LE24.Gate Out | Signal: Output of the logic gate |
| Logics.LE24.Timer Out | Signal: Timer Output |
| Logics.LE24.Out | Signal: Latched Output (Q) |
| Logics.LE24.Out inverted | Signal: Negated Latched Output (Q NOT) |
| Logics.LE25.Gate Out | Signal: Output of the logic gate |
| Logics.LE25.Timer Out | Signal: Timer Output |
| Logics.LE25.Out | Signal: Latched Output (Q) |
| Logics.LE25.Out inverted | Signal: Negated Latched Output (Q NOT) |
| Logics.LE26.Gate Out | Signal: Output of the logic gate |
| Logics.LE26.Timer Out | Signal: Timer Output |
| Logics.LE26.Out | Signal: Latched Output (Q) |
| Logics.LE26.Out inverted | Signal: Negated Latched Output (Q NOT) |
| Logics.LE27.Gate Out | Signal: Output of the logic gate |
| Logics.LE27.Timer Out | Signal: Timer Output |
| Logics.LE27.Out | Signal: Latched Output (Q) |
| Logics.LE27.Out inverted | Signal: Negated Latched Output (Q NOT) |
| Logics.LE28.Gate Out | Signal: Output of the logic gate |
| Logics.LE28.Timer Out | Signal: Timer Output |
| Logics.LE28.Out | Signal: Latched Output (Q) |
| Logics.LE28.Out inverted | Signal: Negated Latched Output (Q NOT) |
| Logics.LE29.Gate Out | Signal: Output of the logic gate |
| Logics.LE29.Timer Out | Signal: Timer Output |
| Logics.LE29.Out | Signal: Latched Output (Q) |
| Logics.LE29.Out inverted | Signal: Negated Latched Output (Q NOT) |
| Logics.LE30.Gate Out | Signal: Output of the logic gate |
| Logics.LE30.Timer Out | Signal: Timer Output |
| Logics.LE30.Out | Signal: Latched Output (Q) |
| Logics.LE30.Out inverted | Signal: Negated Latched Output (Q NOT) |
| Logics.LE31.Gate Out | Signal: Output of the logic gate |
| Logics.LE31.Timer Out | Signal: Timer Output |
| Logics.LE31.Out | Signal: Latched Output (Q) |

| <i>Name</i> | <i>Description</i> |
|--------------------------|--|
| Logics.LE31.Out inverted | Signal: Negated Latched Output (Q NOT) |
| Logics.LE32.Gate Out | Signal: Output of the logic gate |
| Logics.LE32.Timer Out | Signal: Timer Output |
| Logics.LE32.Out | Signal: Latched Output (Q) |
| Logics.LE32.Out inverted | Signal: Negated Latched Output (Q NOT) |
| Logics.LE33.Gate Out | Signal: Output of the logic gate |
| Logics.LE33.Timer Out | Signal: Timer Output |
| Logics.LE33.Out | Signal: Latched Output (Q) |
| Logics.LE33.Out inverted | Signal: Negated Latched Output (Q NOT) |
| Logics.LE34.Gate Out | Signal: Output of the logic gate |
| Logics.LE34.Timer Out | Signal: Timer Output |
| Logics.LE34.Out | Signal: Latched Output (Q) |
| Logics.LE34.Out inverted | Signal: Negated Latched Output (Q NOT) |
| Logics.LE35.Gate Out | Signal: Output of the logic gate |
| Logics.LE35.Timer Out | Signal: Timer Output |
| Logics.LE35.Out | Signal: Latched Output (Q) |
| Logics.LE35.Out inverted | Signal: Negated Latched Output (Q NOT) |
| Logics.LE36.Gate Out | Signal: Output of the logic gate |
| Logics.LE36.Timer Out | Signal: Timer Output |
| Logics.LE36.Out | Signal: Latched Output (Q) |
| Logics.LE36.Out inverted | Signal: Negated Latched Output (Q NOT) |
| Logics.LE37.Gate Out | Signal: Output of the logic gate |
| Logics.LE37.Timer Out | Signal: Timer Output |
| Logics.LE37.Out | Signal: Latched Output (Q) |
| Logics.LE37.Out inverted | Signal: Negated Latched Output (Q NOT) |
| Logics.LE38.Gate Out | Signal: Output of the logic gate |
| Logics.LE38.Timer Out | Signal: Timer Output |
| Logics.LE38.Out | Signal: Latched Output (Q) |
| Logics.LE38.Out inverted | Signal: Negated Latched Output (Q NOT) |
| Logics.LE39.Gate Out | Signal: Output of the logic gate |
| Logics.LE39.Timer Out | Signal: Timer Output |
| Logics.LE39.Out | Signal: Latched Output (Q) |
| Logics.LE39.Out inverted | Signal: Negated Latched Output (Q NOT) |
| Logics.LE40.Gate Out | Signal: Output of the logic gate |
| Logics.LE40.Timer Out | Signal: Timer Output |
| Logics.LE40.Out | Signal: Latched Output (Q) |
| Logics.LE40.Out inverted | Signal: Negated Latched Output (Q NOT) |
| Logics.LE41.Gate Out | Signal: Output of the logic gate |
| Logics.LE41.Timer Out | Signal: Timer Output |
| Logics.LE41.Out | Signal: Latched Output (Q) |

| <i>Name</i> | <i>Description</i> |
|--------------------------|--|
| Logics.LE41.Out inverted | Signal: Negated Latched Output (Q NOT) |
| Logics.LE42.Gate Out | Signal: Output of the logic gate |
| Logics.LE42.Timer Out | Signal: Timer Output |
| Logics.LE42.Out | Signal: Latched Output (Q) |
| Logics.LE42.Out inverted | Signal: Negated Latched Output (Q NOT) |
| Logics.LE43.Gate Out | Signal: Output of the logic gate |
| Logics.LE43.Timer Out | Signal: Timer Output |
| Logics.LE43.Out | Signal: Latched Output (Q) |
| Logics.LE43.Out inverted | Signal: Negated Latched Output (Q NOT) |
| Logics.LE44.Gate Out | Signal: Output of the logic gate |
| Logics.LE44.Timer Out | Signal: Timer Output |
| Logics.LE44.Out | Signal: Latched Output (Q) |
| Logics.LE44.Out inverted | Signal: Negated Latched Output (Q NOT) |
| Logics.LE45.Gate Out | Signal: Output of the logic gate |
| Logics.LE45.Timer Out | Signal: Timer Output |
| Logics.LE45.Out | Signal: Latched Output (Q) |
| Logics.LE45.Out inverted | Signal: Negated Latched Output (Q NOT) |
| Logics.LE46.Gate Out | Signal: Output of the logic gate |
| Logics.LE46.Timer Out | Signal: Timer Output |
| Logics.LE46.Out | Signal: Latched Output (Q) |
| Logics.LE46.Out inverted | Signal: Negated Latched Output (Q NOT) |
| Logics.LE47.Gate Out | Signal: Output of the logic gate |
| Logics.LE47.Timer Out | Signal: Timer Output |
| Logics.LE47.Out | Signal: Latched Output (Q) |
| Logics.LE47.Out inverted | Signal: Negated Latched Output (Q NOT) |
| Logics.LE48.Gate Out | Signal: Output of the logic gate |
| Logics.LE48.Timer Out | Signal: Timer Output |
| Logics.LE48.Out | Signal: Latched Output (Q) |
| Logics.LE48.Out inverted | Signal: Negated Latched Output (Q NOT) |
| Logics.LE49.Gate Out | Signal: Output of the logic gate |
| Logics.LE49.Timer Out | Signal: Timer Output |
| Logics.LE49.Out | Signal: Latched Output (Q) |
| Logics.LE49.Out inverted | Signal: Negated Latched Output (Q NOT) |
| Logics.LE50.Gate Out | Signal: Output of the logic gate |
| Logics.LE50.Timer Out | Signal: Timer Output |
| Logics.LE50.Out | Signal: Latched Output (Q) |
| Logics.LE50.Out inverted | Signal: Negated Latched Output (Q NOT) |
| Logics.LE51.Gate Out | Signal: Output of the logic gate |
| Logics.LE51.Timer Out | Signal: Timer Output |
| Logics.LE51.Out | Signal: Latched Output (Q) |

| <i>Name</i> | <i>Description</i> |
|--------------------------|--|
| Logics.LE51.Out inverted | Signal: Negated Latched Output (Q NOT) |
| Logics.LE52.Gate Out | Signal: Output of the logic gate |
| Logics.LE52.Timer Out | Signal: Timer Output |
| Logics.LE52.Out | Signal: Latched Output (Q) |
| Logics.LE52.Out inverted | Signal: Negated Latched Output (Q NOT) |
| Logics.LE53.Gate Out | Signal: Output of the logic gate |
| Logics.LE53.Timer Out | Signal: Timer Output |
| Logics.LE53.Out | Signal: Latched Output (Q) |
| Logics.LE53.Out inverted | Signal: Negated Latched Output (Q NOT) |
| Logics.LE54.Gate Out | Signal: Output of the logic gate |
| Logics.LE54.Timer Out | Signal: Timer Output |
| Logics.LE54.Out | Signal: Latched Output (Q) |
| Logics.LE54.Out inverted | Signal: Negated Latched Output (Q NOT) |
| Logics.LE55.Gate Out | Signal: Output of the logic gate |
| Logics.LE55.Timer Out | Signal: Timer Output |
| Logics.LE55.Out | Signal: Latched Output (Q) |
| Logics.LE55.Out inverted | Signal: Negated Latched Output (Q NOT) |
| Logics.LE56.Gate Out | Signal: Output of the logic gate |
| Logics.LE56.Timer Out | Signal: Timer Output |
| Logics.LE56.Out | Signal: Latched Output (Q) |
| Logics.LE56.Out inverted | Signal: Negated Latched Output (Q NOT) |
| Logics.LE57.Gate Out | Signal: Output of the logic gate |
| Logics.LE57.Timer Out | Signal: Timer Output |
| Logics.LE57.Out | Signal: Latched Output (Q) |
| Logics.LE57.Out inverted | Signal: Negated Latched Output (Q NOT) |
| Logics.LE58.Gate Out | Signal: Output of the logic gate |
| Logics.LE58.Timer Out | Signal: Timer Output |
| Logics.LE58.Out | Signal: Latched Output (Q) |
| Logics.LE58.Out inverted | Signal: Negated Latched Output (Q NOT) |
| Logics.LE59.Gate Out | Signal: Output of the logic gate |
| Logics.LE59.Timer Out | Signal: Timer Output |
| Logics.LE59.Out | Signal: Latched Output (Q) |
| Logics.LE59.Out inverted | Signal: Negated Latched Output (Q NOT) |
| Logics.LE60.Gate Out | Signal: Output of the logic gate |
| Logics.LE60.Timer Out | Signal: Timer Output |
| Logics.LE60.Out | Signal: Latched Output (Q) |
| Logics.LE60.Out inverted | Signal: Negated Latched Output (Q NOT) |
| Logics.LE61.Gate Out | Signal: Output of the logic gate |
| Logics.LE61.Timer Out | Signal: Timer Output |
| Logics.LE61.Out | Signal: Latched Output (Q) |

| <i>Name</i> | <i>Description</i> |
|--------------------------|--|
| Logics.LE61.Out inverted | Signal: Negated Latched Output (Q NOT) |
| Logics.LE62.Gate Out | Signal: Output of the logic gate |
| Logics.LE62.Timer Out | Signal: Timer Output |
| Logics.LE62.Out | Signal: Latched Output (Q) |
| Logics.LE62.Out inverted | Signal: Negated Latched Output (Q NOT) |
| Logics.LE63.Gate Out | Signal: Output of the logic gate |
| Logics.LE63.Timer Out | Signal: Timer Output |
| Logics.LE63.Out | Signal: Latched Output (Q) |
| Logics.LE63.Out inverted | Signal: Negated Latched Output (Q NOT) |
| Logics.LE64.Gate Out | Signal: Output of the logic gate |
| Logics.LE64.Timer Out | Signal: Timer Output |
| Logics.LE64.Out | Signal: Latched Output (Q) |
| Logics.LE64.Out inverted | Signal: Negated Latched Output (Q NOT) |
| Logics.LE65.Gate Out | Signal: Output of the logic gate |
| Logics.LE65.Timer Out | Signal: Timer Output |
| Logics.LE65.Out | Signal: Latched Output (Q) |
| Logics.LE65.Out inverted | Signal: Negated Latched Output (Q NOT) |
| Logics.LE66.Gate Out | Signal: Output of the logic gate |
| Logics.LE66.Timer Out | Signal: Timer Output |
| Logics.LE66.Out | Signal: Latched Output (Q) |
| Logics.LE66.Out inverted | Signal: Negated Latched Output (Q NOT) |
| Logics.LE67.Gate Out | Signal: Output of the logic gate |
| Logics.LE67.Timer Out | Signal: Timer Output |
| Logics.LE67.Out | Signal: Latched Output (Q) |
| Logics.LE67.Out inverted | Signal: Negated Latched Output (Q NOT) |
| Logics.LE68.Gate Out | Signal: Output of the logic gate |
| Logics.LE68.Timer Out | Signal: Timer Output |
| Logics.LE68.Out | Signal: Latched Output (Q) |
| Logics.LE68.Out inverted | Signal: Negated Latched Output (Q NOT) |
| Logics.LE69.Gate Out | Signal: Output of the logic gate |
| Logics.LE69.Timer Out | Signal: Timer Output |
| Logics.LE69.Out | Signal: Latched Output (Q) |
| Logics.LE69.Out inverted | Signal: Negated Latched Output (Q NOT) |
| Logics.LE70.Gate Out | Signal: Output of the logic gate |
| Logics.LE70.Timer Out | Signal: Timer Output |
| Logics.LE70.Out | Signal: Latched Output (Q) |
| Logics.LE70.Out inverted | Signal: Negated Latched Output (Q NOT) |
| Logics.LE71.Gate Out | Signal: Output of the logic gate |
| Logics.LE71.Timer Out | Signal: Timer Output |
| Logics.LE71.Out | Signal: Latched Output (Q) |

| <i>Name</i> | <i>Description</i> |
|--------------------------|--|
| Logics.LE71.Out inverted | Signal: Negated Latched Output (Q NOT) |
| Logics.LE72.Gate Out | Signal: Output of the logic gate |
| Logics.LE72.Timer Out | Signal: Timer Output |
| Logics.LE72.Out | Signal: Latched Output (Q) |
| Logics.LE72.Out inverted | Signal: Negated Latched Output (Q NOT) |
| Logics.LE73.Gate Out | Signal: Output of the logic gate |
| Logics.LE73.Timer Out | Signal: Timer Output |
| Logics.LE73.Out | Signal: Latched Output (Q) |
| Logics.LE73.Out inverted | Signal: Negated Latched Output (Q NOT) |
| Logics.LE74.Gate Out | Signal: Output of the logic gate |
| Logics.LE74.Timer Out | Signal: Timer Output |
| Logics.LE74.Out | Signal: Latched Output (Q) |
| Logics.LE74.Out inverted | Signal: Negated Latched Output (Q NOT) |
| Logics.LE75.Gate Out | Signal: Output of the logic gate |
| Logics.LE75.Timer Out | Signal: Timer Output |
| Logics.LE75.Out | Signal: Latched Output (Q) |
| Logics.LE75.Out inverted | Signal: Negated Latched Output (Q NOT) |
| Logics.LE76.Gate Out | Signal: Output of the logic gate |
| Logics.LE76.Timer Out | Signal: Timer Output |
| Logics.LE76.Out | Signal: Latched Output (Q) |
| Logics.LE76.Out inverted | Signal: Negated Latched Output (Q NOT) |
| Logics.LE77.Gate Out | Signal: Output of the logic gate |
| Logics.LE77.Timer Out | Signal: Timer Output |
| Logics.LE77.Out | Signal: Latched Output (Q) |
| Logics.LE77.Out inverted | Signal: Negated Latched Output (Q NOT) |
| Logics.LE78.Gate Out | Signal: Output of the logic gate |
| Logics.LE78.Timer Out | Signal: Timer Output |
| Logics.LE78.Out | Signal: Latched Output (Q) |
| Logics.LE78.Out inverted | Signal: Negated Latched Output (Q NOT) |
| Logics.LE79.Gate Out | Signal: Output of the logic gate |
| Logics.LE79.Timer Out | Signal: Timer Output |
| Logics.LE79.Out | Signal: Latched Output (Q) |
| Logics.LE79.Out inverted | Signal: Negated Latched Output (Q NOT) |
| Logics.LE80.Gate Out | Signal: Output of the logic gate |
| Logics.LE80.Timer Out | Signal: Timer Output |
| Logics.LE80.Out | Signal: Latched Output (Q) |
| Logics.LE80.Out inverted | Signal: Negated Latched Output (Q NOT) |

These trips will start the BF module if »All current« functions have been selected as the trigger event.

| Name | Description |
|----------------|----------------------|
| -.- | No assignment |
| I[1].TripCmd | Signal: Trip Command |
| I[2].TripCmd | Signal: Trip Command |
| I[3].TripCmd | Signal: Trip Command |
| I[4].TripCmd | Signal: Trip Command |
| I[5].TripCmd | Signal: Trip Command |
| I[6].TripCmd | Signal: Trip Command |
| IG[1].TripCmd | Signal: Trip Command |
| IG[2].TripCmd | Signal: Trip Command |
| IG[3].TripCmd | Signal: Trip Command |
| IG[4].TripCmd | Signal: Trip Command |
| ThR.TripCmd | Signal: Trip Command |
| I2>[1].TripCmd | Signal: Trip Command |
| I2>[2].TripCmd | Signal: Trip Command |

These trips will start the BF module if »External trips« have been selected as the trigger event.

| Name | Description |
|-----------------------|----------------------|
| -.- | No assignment |
| Intertripping.TripCmd | Signal: Trip Command |
| Exp[1].TripCmd | Signal: Trip Command |
| Exp[2].TripCmd | Signal: Trip Command |
| Exp[3].TripCmd | Signal: Trip Command |
| Exp[4].TripCmd | Signal: Trip Command |

Commissioning Example: Supervision Scheme 50BF

Object to Be Tested:

Test of the breaker failure protection (Supervision Scheme 50BF).

Necessary Means:

- Current source;
- Ammeter; and
- Timer.

NOTICE

When testing, the applied test current must always be higher than the tripping threshold »I-CBF«. If the test current falls below the threshold while the breaker is in the "Off" position, no pickup will be generated.

Procedure (Single-Phase):

For testing the tripping time of the CBF protection, a test current has to be higher than the threshold value of one of the current protection modules that are assigned to trigger the CBF protection. The CBF trip delay can be measured from the time when one of the triggering inputs becomes active to the time when the CBF protection trip is asserted.

To avoid wiring errors, checked to make sure the breaker in the upstream system switches off.

The time, measured by the timer, should be in line with the specified tolerances.

Successful Test Result:

The actual times measured comply with the setpoint times. The breaker in the higher-level section switches off.

⚠ WARNING

Re-connect the control cable to the breaker!

TCS - Trip Circuit Supervision [74TC]

Available elements:

TCS

The trip circuit monitoring is used for monitoring if the trip circuit is ready for operations. The monitoring can be fulfilled in two ways. The first assumes only »Aux On (52a)« is used in the trip circuit. The second assumes that, in addition to »Aux On (52a)«, »Aux Off(52b)« is also used for the circuit monitoring.

With »Aux On (52a)«, only in the trip circuit, the monitoring is only effective when the breaker is closed while if both »Aux On (52a)«, and »Aux Off(52b)« are used, the trip circuit will be monitored all time as long as the control power is on.

Note that the digital inputs used for this purpose must be configured properly based on the trip circuit control voltage. If the trip circuit is detected broken, an alarm will be issued with a specified delay, which must be longer than the time when a trip contact is closed to the time when the breaker status is clearly recognized by the relay.

NOTICE

In Slot 1 has 2 digital inputs, each of which has a separate root (contact separation) for the trip circuit supervision.

NOTICE

This Notice applies to protective devices that offer control functionality only!
This protective element requires, that a switchgear (circuit breaker) is assigned to it.

In this case, the trip circuit supply voltage serves also as supply voltage for the digital inputs and so the supply voltage failure of a trip circuit can be detected directly.

In order to identify a conductor failure in the trip circuit on the supply line or in the trip coil, the off-coil has to be looped-in to the supervision circuit.

The time delay is to be set in a way that switching actions cannot cause false trips in this module.

Connection example: Trip circuit supervision with two CB auxiliary contacts.

TCS

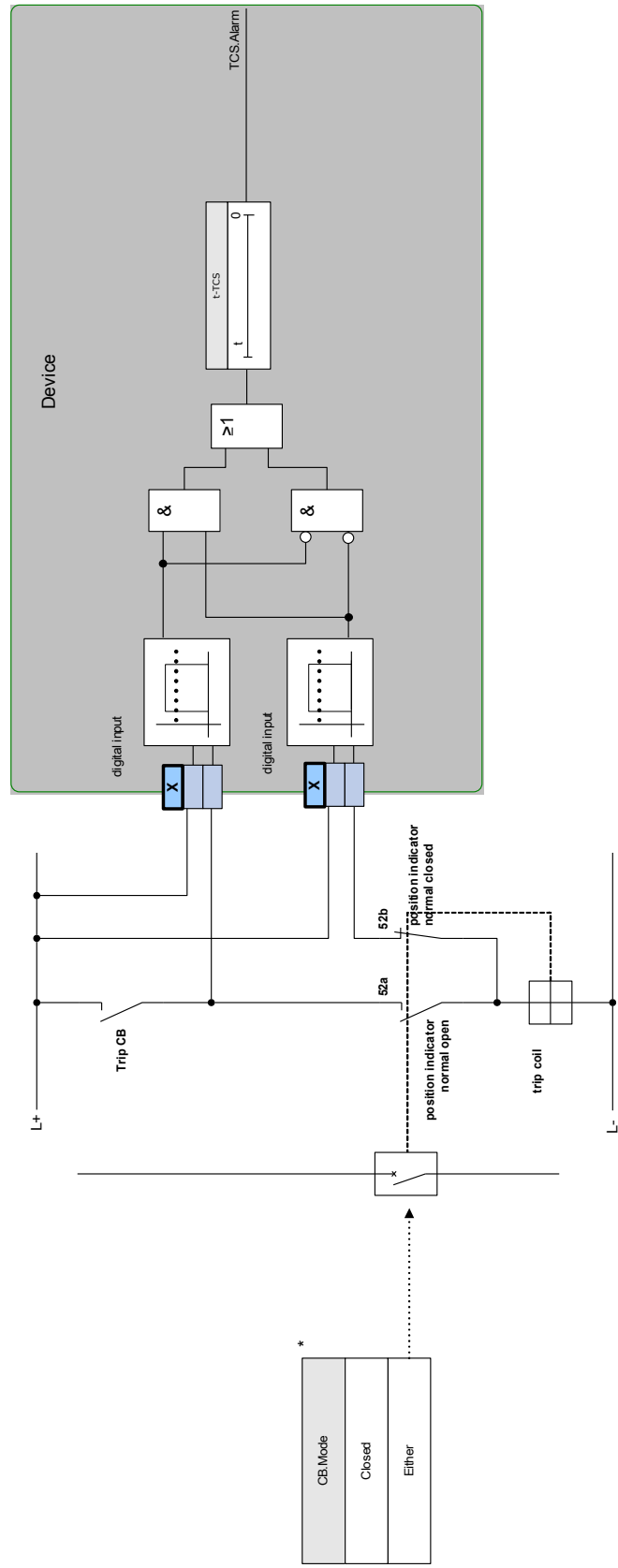

| * | |
|---------|--|
| CB.Mode | |
| Closed | |
| Either | |

*This signal is the output of the switchgear that is assigned to this protective element. This applies to protective devices that offer control functionality.

Connection example: Trip circuit supervision with one CB auxiliary contact (Aux On (52a)) only.

TCS

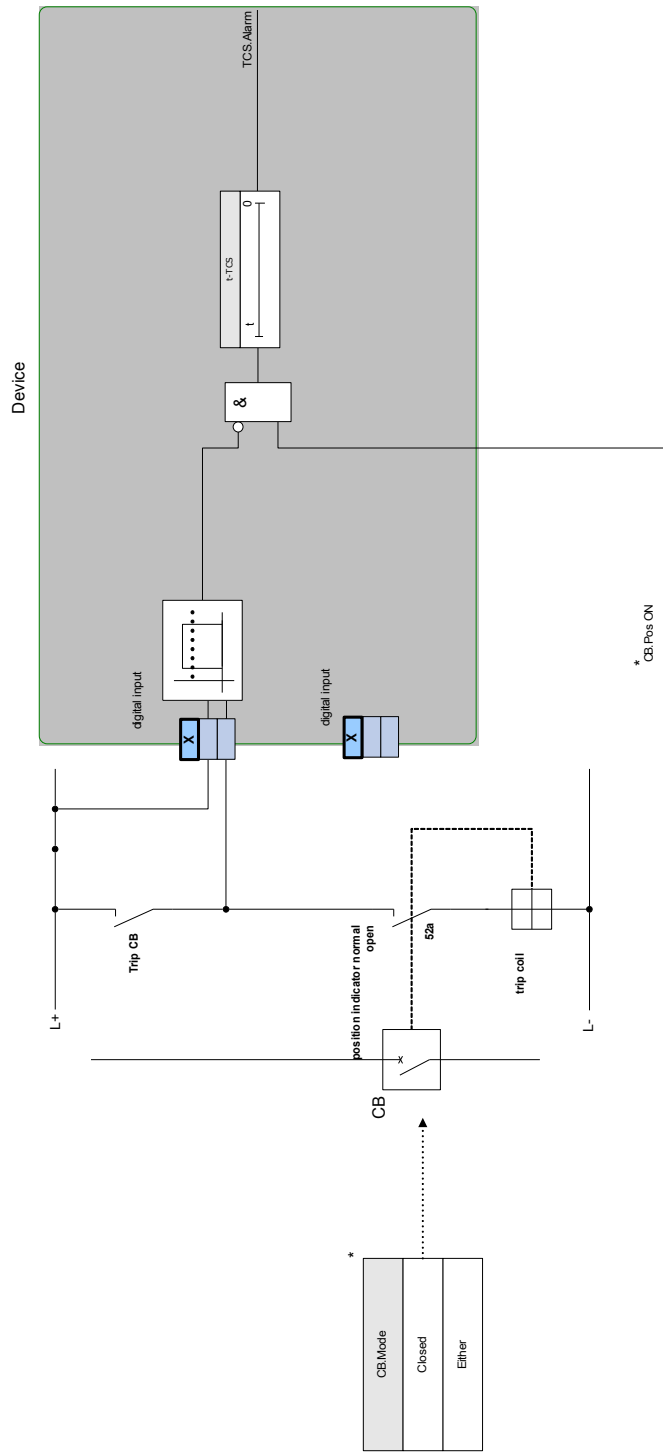



Device Planning Parameters of the Trip Circuit Supervision

| <i>Parameter</i> | <i>Description</i> | <i>Options</i> | <i>Default</i> | <i>Menu path</i> |
|---|--------------------|--------------------|----------------|-------------------|
| Mode  | Mode | do not use, use | do not use | [Device planning] |

Global Protection Parameters of the Trip Circuit Supervision

| Parameter | Description | Setting range | Default | Menu path |
|---|--|---|-----------|---|
|  CB Pos Detect | Criterion by which the Circuit Breaker Switch Position is to be detected. | -.-, SG[1].Pos, SG[2].Pos, SG[3].Pos, SG[4].Pos, SG[5].Pos, SG[6].Pos | SG[1].Pos | [Protection Para /Global Prot Para /Supervision /TCS] |
|  Mode | Select if trip circuit is going to be monitored when the breaker is closed or when the breaker is either open or close. | Closed, Either | Closed | [Protection Para /Global Prot Para /Supervision /TCS] |
|  Input 1 | Select the input configured to monitor the trip coil when the breaker is closed. | 1..n, Dig Inputs | -.- | [Protection Para /Global Prot Para /Supervision /TCS] |
|  Input 2 | Select the input configured to monitor the trip coil when the breaker is open. Only available if Mode set to "Either". Only available if: Mode = Either | 1..n, Dig Inputs | -.- | [Protection Para /Global Prot Para /Supervision /TCS] |
|  ExBlo1 | External blocking of the module, if blocking is activated (allowed) within a parameter set and if the state of the assigned signal is true. | 1..n, Assignment List | -.- | [Protection Para /Global Prot Para /Supervision /TCS] |
|  ExBlo2 | External blocking of the module, if blocking is activated (allowed) within a parameter set and if the state of the assigned signal is true. | 1..n, Assignment List | -.- | [Protection Para /Global Prot Para /Supervision /TCS] |

Setting Group Parameters of the Trip Circuit Supervision

| <i>Parameter</i> | <i>Description</i> | <i>Setting range</i> | <i>Default</i> | <i>Menu path</i> |
|---|---|----------------------|----------------|--|
| Function  | Permanent activation or deactivation of module/stage. | inactive, active | inactive | [Protection Para /<1..4> /Supervision /TCS] |
| ExBlo Fc  | Activate (allow) or inactivate (disallow) blocking of the module/stage. This parameter is only effective if a signal is assigned to the corresponding global protection parameter. If the signal becomes true, those modules/stages are blocked that are parameterized "ExBlo Fc=active". | inactive, active | inactive | [Protection Para /<1..4> /Supervision /TCS] |
| t-TCS  | Tripping delay time of the Trip Circuit Supervision | 0.10 - 10.00s | 0.2s | [Protection Para /<1..4> /Supervision /TCS] |

Trip Circuit Supervision Input States

| <i>Name</i> | <i>Description</i> | <i>Assignment via</i> |
|-------------|--|--|
| Aux ON-I | Module Input State: Position indicator/check-back signal of the CB (52a) | [Protection Para /Global Prot Para /Supervision /TCS] |
| Aux OFF-I | Module input state: Position indicator/check-back signal of the CB (52b) | [Protection Para /Global Prot Para /Supervision /TCS] |
| ExBlo1-I | Module input state: External blocking1 | [Protection Para /Global Prot Para /Supervision /TCS] |
| ExBlo2-I | Module input state: External blocking2 | [Protection Para /Global Prot Para /Supervision /TCS] |

Trip Circuit Supervision Signals (Output States)

| <i>Signal</i> | <i>Description</i> |
|---------------|--|
| active | Signal: active |
| ExBlo | Signal: External Blocking |
| Alarm | Signal: Alarm Trip Circuit Supervision |
| Not Possible | Not possible because no state indicator assigned to the breaker. |

Commissioning: Trip Circuit Supervision [74TC]

NOTICE

For CBs that trip by means of little energy (e.g. via an optocoupler), it has to be ensured that the current applied by the digital inputs will not cause false tripping of the CB.

Object to be tested

Test of the trip circuit supervision.

Procedure, part 1

Simulate failure of the control voltage in the power circuits.

Successful test result, part 1

After expiry of »*t-TCS*« the trip circuit supervision TCS of the device should signal an alarm.

Procedure, part 2

Simulate a broken cable in the CB control circuit.

Successful test result, part 2

After expiry of »*t-TCS*« the trip circuit supervision TCS of the device should signal an alarm.

CTS - Current Transformer Supervision [60L]

Available elements:

CTS

Wire breaks and failures within measuring circuits cause current transformer failures.

The module »CTS« can detect a failure of the CT if the calculated earth current does not match the measured one. If an adjustable threshold value (Difference of measured and calculated earth current) is exceeded, a CT failure can be assumed. This is signaled through a message/alarm.

The precondition is that the conductor currents are measured by the device and the earth current, for instance, by a ring core type current transformer.

The measuring principles of the circuit supervision are based on comparing the measured and the calculated residual currents:

In an ideal case these are:

$$(\vec{I}L1 + \vec{I}L2 + \vec{I}L3) + KI * \vec{I}G = 3 * I_0 + KI * \vec{I}G = 0$$

KI represents a correction factor which takes the different transformation ratio of the phase- and earth current transformers into account. The device automatically calculates this factor from the rated field parameters, i.e. the relation between the rated primary and secondary current values of the phase- and earth current transformers.

For compensating the current proportional ratio error of the measuring circuits, the dynamic correction factor Kd can be used. As a function of the measured max. current this factor is considering the linear rising measuring error.

The limiting value of the CT supervision is calculated as follows:

ΔI = deviation I (rated value)

Kd = correction factor

I_{max} = current maximum

Limiting value = $\Delta I + Kd \times I_{max}$

Precondition for identifying an error

$$3 * \vec{I}_0 + KI * \vec{I}G \geq \Delta I + Kd * I_{max}$$

The evaluation method of the circuit supervision by using factor Kd can be graphically represented as follows:

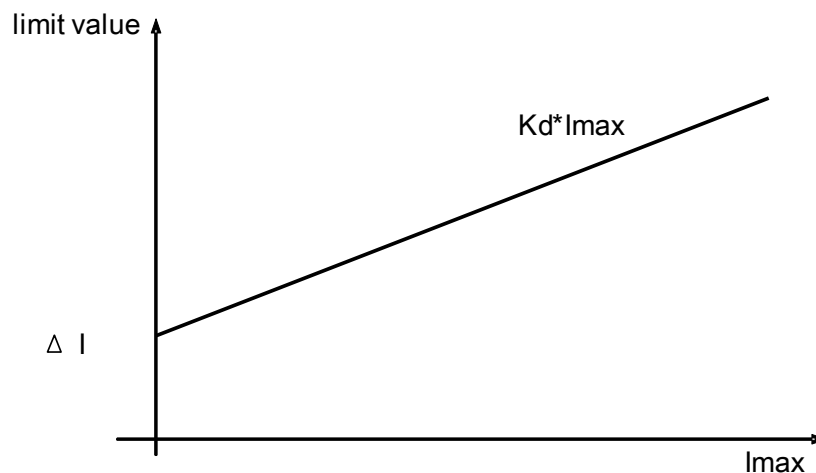

CAUTION

If the current is measured in two phases only (for instant only IL1/IL3) or if there is no separate earth current measuring (e.g. normally via a cable-type CT), the supervision function should be deactivated.

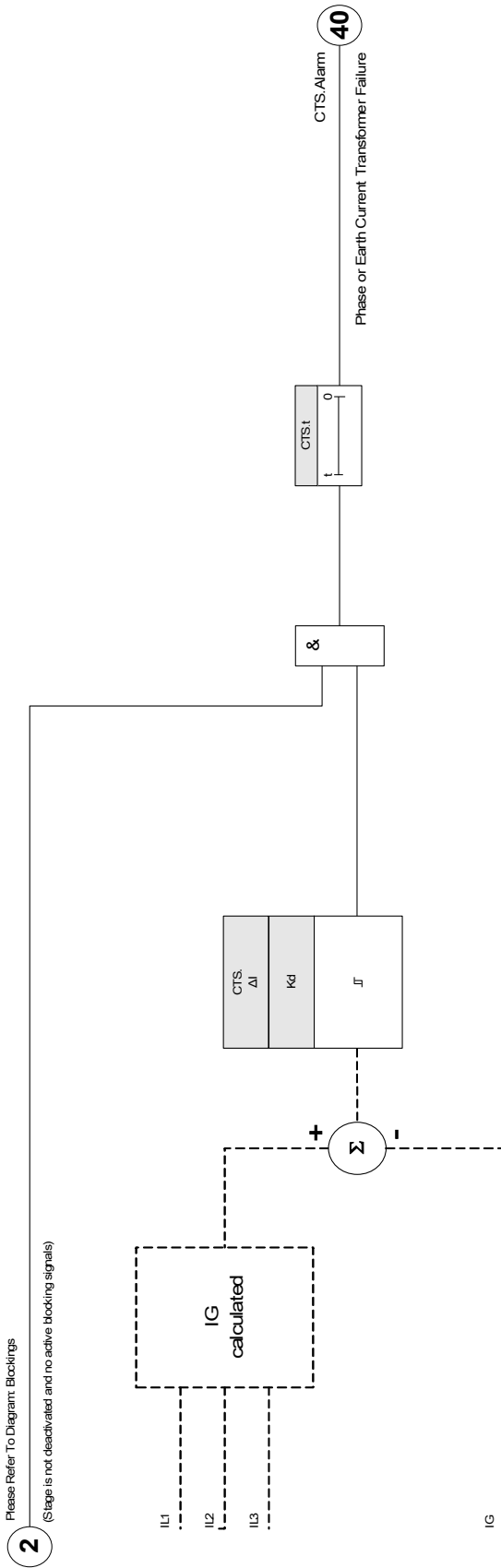

CTS







Device Planning Parameters of the Current Transformer Supervision

| <i>Parameter</i> | <i>Description</i> | <i>Options</i> | <i>Default</i> | <i>Menu path</i> |
|---|--------------------|--------------------|----------------|-------------------|
| Mode  | Mode | do not use, use | do not use | [Device planning] |

Global Protection Parameter of the Current Transformer Supervision

| <i>Parameter</i> | <i>Description</i> | <i>Setting range</i> | <i>Default</i> | <i>Menu path</i> |
|--|---|-----------------------|----------------|--|
| ExBlo1  | External blocking of the module, if blocking is activated (allowed) within a parameter set and if the state of the assigned signal is true. | 1..n, Assignment List | -- | [Protection Para /Global Prot Para /Supervision /CTS] |
| ExBlo2  | External blocking of the module, if blocking is activated (allowed) within a parameter set and if the state of the assigned signal is true. | 1..n, Assignment List | -- | [Protection Para /Global Prot Para /Supervision /CTS] |

Setting Group Parameters of the Current Transformer Supervision

| Parameter | Description | Setting range | Default | Menu path |
|--|---|---------------------|----------|--|
|  Function | Permanent activation or deactivation of module/stage. | inactive, active | inactive | [Protection Para /<1..4> /Supervision /CTS] |
|  ExBlo Fc | Activate (allow) or inactivate (disallow) blocking of the module/stage. This parameter is only effective if a signal is assigned to the corresponding global protection parameter. If the signal becomes true, those modules/stages are blocked that are parameterized "ExBlo Fc=active". | inactive, active | inactive | [Protection Para /<1..4> /Supervision /CTS] |
|  ΔI | In order to prevent faulty tripping of phase selective protection functions that use the current as tripping criterion. If the difference of the measured earth current and the calculated value I_0 is higher than the pick up value ΔI , an alarm event is generated after expiring of the excitation time. In such a case, a fuse failure, a broken wire or a faulty measuring circuit can be assumed. | 0.10 - 1.00In | 0.50In | [Protection Para /<1..4> /Supervision /CTS] |
|  Alarm delay | Alarm delay | 0.1 - 9999.0s | 1.0s | [Protection Para /<1..4> /Supervision /CTS] |
|  Kd | Dynamic correction factor for the evaluation of the difference between calculated and measured earth current. This correction factor allows transformer faults, caused by higher currents, to be compensated. | 0.00 - 0.99 | 0.00 | [Protection Para /<1..4> /Supervision /CTS] |

Current Transformer Supervision Input States

| <i>Name</i> | <i>Description</i> | <i>Assignment via</i> |
|-------------|--|--|
| ExBlo1-I | Module input state: External blocking1 | [Protection Para /Global Prot Para /Supervision /CTS] |
| ExBlo2-I | Module input state: External blocking2 | [Protection Para /Global Prot Para /Supervision /CTS] |

Current Transformer Supervision Signals (Outputs States)

| <i>Signal</i> | <i>Description</i> |
|---------------|---|
| active | Signal: active |
| ExBlo | Signal: External Blocking |
| Alarm | Signal: Alarm Current Transformer Measuring Circuit Supervision |

Commissioning: Current Transformer Failure Supervision

NOTICE

Precondition:

1. Measurement of all three phase currents (are applied to the measuring inputs of the device).
2. The earth current is detected via a cable-type transformer (not in Holmgreen connection).

Object to be tested

Check of the CT supervision (by comparing the calculated with the measured earth current).

Necessary means

- Three-phase current source

Procedure, part 1

- Set the limiting value of the CTS to » $\Delta I = 0.1 \cdot I_n$ «.
- Feed a three-phase, symmetrical current system (approx. nominal current) to the secondary side.
- Disconnect the current of one phase from one of the measuring inputs (the symmetrical feeding at secondary side has to be maintained).
- Make sure that the signal »CTS.ALARM« is generated now.

Successful test result, part 1

- The signal »CTS.ALARM« is generated.

Procedure, part 2

- Feed a three-phase, symmetrical current system (approx. nominal current) to the secondary side.
- Feed a current that is higher than the threshold value for the measuring circuit supervision to the earth current measuring input.
- Ascertain that the signal »CTS.ALARM« is generated now.

Successful test result, part 2

The signal »CTS.ALARM« is generated.

LOP - Loss of Potential

Available elements:

LOP

Loss of Potential - Evaluating Measured Quantities

NOTICE

Ensure that the LOP has enough time to block faulty tripping of modules that use LOP. That means, the delay time of the LOP should to be shorter than the tripping delay of modules that use LOP.

NOTICE

In case of transformer protection relays the LOP element uses current and voltage measured at the winding side determined by paramter: [Field Para / VT / VT Winding Side].

The LOP function detects the loss of voltage in any of the voltage input measuring circuits. Faulty tripping of protective elements that take voltage into account can be prevented by means of this supervision element. The following measured values and information to detect an Phase VT Failure condition:

- Three-phase voltages;
- Ratio of negative-to-positive sequence voltages;
- Zero sequence voltage;
- Three-phase currents;
- Residual current (I0);
- Pickup flags from all overcurrent elements; and
- Breaker status (option)

After a set time delay time an Alarm »LOP.LOP BLo« will be issued.

How to set up the Loss of Potential (Evaluating Measured Quantities)

- Set the Alarm Time Delay »t-Alarm«.
- To prevent a malfunction of the VT supervision for a system fault assign Alarms of overcurrent elements that should block the Loss of Potential element.
- It is necessary to set the parameter »*LOP.LOP Blo Enable*« to »*active*«. Otherwise the Measuring circuit supervision cannot block elements in case of a loss of potential.

How to make the Loss of Potential (Evaluating Measured Quantities) effective

The Loss of Potential respectively measuring circuit supervision can be used to block protective elements like undervoltage protection in order to prevent faulty tripping.

- Set the parameter »*Measuring Circuit Supervision=active*« within those protective elements that should be blocked by the Loss of Potential supervision.

Loss of Potential - Fuse Failure

VT Supervision via digital inputs (Fuse Failure)

The module »LOP« is capable of detecting a fuse failure at the secondary side of the VTs as long as the automatic circuit breakers of the VTs are connected with the device via a digital input and if this input is assigned to the module »LOP«.

Setting the Parameters for detecting a fuse failure (FF) of a phase voltage transformer

In order to detect a fuse failure of a phase voltage transformer via digital input, please proceed as follows:

- Assign a digital input onto the parameter »*LOP.Ex FF VT*« that represents the state of the automatic circuit breaker of the phase voltage transformer.
- Set the parameter »*Measuring Crcuit Supervison=active*« within all those protective elements, that should be blocked by a fuse failure.

Setting the Parameters for detecting a fuse failure (FF) of a earth phase voltage transformer

In order to detect a fuse failure of a phase voltage transformer via digital input, please proceed as follows:

- Assign a digital input onto the parameter »*LOP.Ex FF EVT*« that represents the state of the automatic circuit breaker of the phase voltage transformer.
- Set the parameter »*Measuring Crcuit Supervison=active*« within all those protective elements, that should be blocked by a fuse failure.

LOP

name = LOP

2

Please Refer To Diagram: Blockings
(Stage is not deactivated and no active blocking signals)

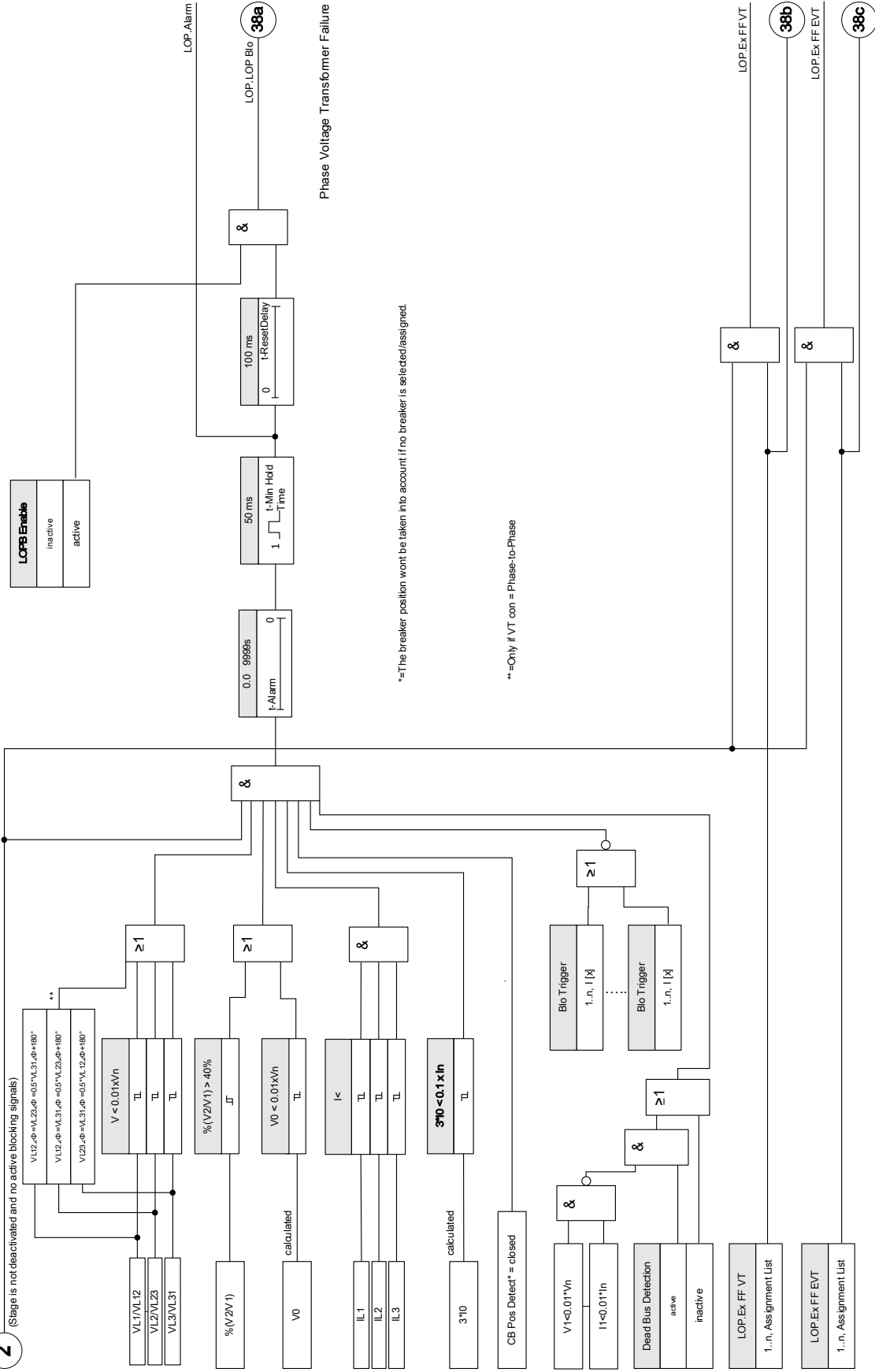





Device Planning Parameters of the LOP Module







| Parameter | Description | Options | Default | Menu path |
|---|-------------|--------------------|------------|-------------------|
| Mode  | Mode | do not use, use | do not use | [Device planning] |

Global Protection Parameters of the LOP Module

| Parameter | Description | Setting range | Default | Menu path |
|---|--|---|---------|--|
| CB Pos Detect  | If there is a circuit breaker assigned, LOP will be inhibited if the circuit breaker is open. The position of the breaker will not be taken into account by LOP if no breaker is assigned. | -. , SG[1].Pos, SG[2].Pos, SG[3].Pos, SG[4].Pos, SG[5].Pos, SG[6].Pos | -.- | [Protection Para /Global Prot Para /Supervision /LOP] |
| ExBlo1  | External blocking of the module, if blocking is activated (allowed) within a parameter set and if the state of the assigned signal is true. | 1..n, Assignment List | -.- | [Protection Para /Global Prot Para /Supervision /LOP] |
| ExBlo2  | External blocking of the module, if blocking is activated (allowed) within a parameter set and if the state of the assigned signal is true. | 1..n, Assignment List | -.- | [Protection Para /Global Prot Para /Supervision /LOP] |
| Blo Trigger1  | An Alarm of this protective element will block the Loss of Potential Detection. | Blo Trigger | -.- | [Protection Para /Global Prot Para /Supervision /LOP] |
| Blo Trigger2  | An Alarm of this protective element will block the Loss of Potential Detection. | Blo Trigger | -.- | [Protection Para /Global Prot Para /Supervision /LOP] |
| Blo Trigger3  | An Alarm of this protective element will block the Loss of Potential Detection. | Blo Trigger | -.- | [Protection Para /Global Prot Para /Supervision /LOP] |

| <i>Parameter</i> | <i>Description</i> | <i>Setting range</i> | <i>Default</i> | <i>Menu path</i> |
|---|---|-----------------------|----------------|--|
| Blo Trigger4  | An Alarm of this protective element will block the Loss of Potential Detection. | Blo Trigger | -.- | [Protection Para /Global Prot Para /Supervision /LOP] |
| Blo Trigger5  | An Alarm of this protective element will block the Loss of Potential Detection. | Blo Trigger | -.- | [Protection Para /Global Prot Para /Supervision /LOP] |
| Ex FF VT  | Alarm Fuse Failure Voltage Transformers | 1..n, Assignment List | -.- | [Protection Para /Global Prot Para /Supervision /LOP] |
| Ex FF EVT  | Alarm Fuse Failure Earth Voltage Transformers | 1..n, Assignment List | -.- | [Protection Para /Global Prot Para /Supervision /LOP] |

Setting Group Parameters of the LOP Module

| Parameter | Description | Setting range | Default | Menu path |
|--|---|---------------------|----------|--|
| Function  | Permanent activation or deactivation of module/stage. | inactive, active | inactive | [Protection Para /<1..4> /Supervision /LOP] |
| ExBlo Fc  | Activate (allow) or inactivate (disallow) blocking of the module/stage. This parameter is only effective if a signal is assigned to the corresponding global protection parameter. If the signal becomes true, those modules/stages are blocked that are parameterized "ExBlo Fc=active". | inactive, active | inactive | [Protection Para /<1..4> /Supervision /LOP] |
| LOPB Enable  | Activate (allow) or inactivate (disallow) blocking by the module LOP. | inactive, active | inactive | [Protection Para /<1..4> /Supervision /LOP] |
| I<  | To prevent unintended operation during faults, this threshold should be used to distinguish between load current and overcurrent. A current above this threshold will be seen as overcurrent and LOP will be inhibited. If the current detector identifies load current as overcurrent (threshold too low), a LOP situation will not be detected and if the threshold is too high, a fault situation will be identified as LOP which results in blocking of protection functions. | 0.5 - 4.0In | 2.0In | [Protection Para /<1..4> /Supervision /LOP] |
| t-Alarm  | Pickup Delay | 0 - 9999.0s | 0.1s | [Protection Para /<1..4> /Supervision /LOP] |
| Dead Bus Detection  | If this detection is active, LOP will be inhibited if there is no current and voltage applied. | inactive, active | inactive | [Protection Para /<1..4> /Supervision /LOP] |

LOP Module Input States

| <i>Name</i> | <i>Description</i> | <i>Assignment via</i> |
|----------------|--|--|
| ExBlo1-I | Module input state: External blocking1 | [Protection Para /Global Prot Para /Supervision /LOP] |
| ExBlo2-I | Module input state: External blocking2 | [Protection Para /Global Prot Para /Supervision /LOP] |
| Ex FF VT-I | State of the module input: Alarm Fuse Failure Voltage Transformers | [Protection Para /Global Prot Para /Supervision /LOP] |
| Ex FF EVT-I | State of the module input: Alarm Fuse Failure Earth Voltage Transformers | [Protection Para /Global Prot Para /Supervision /LOP] |
| Blo Trigger1-I | State of the module input: An Alarm of this protective element will block the Loss of Potential Detection. | [Protection Para /Global Prot Para /Supervision /LOP] |
| Blo Trigger2-I | State of the module input: An Alarm of this protective element will block the Loss of Potential Detection. | [Protection Para /Global Prot Para /Supervision /LOP] |
| Blo Trigger3-I | State of the module input: An Alarm of this protective element will block the Loss of Potential Detection. | [Protection Para /Global Prot Para /Supervision /LOP] |
| Blo Trigger4-I | State of the module input: An Alarm of this protective element will block the Loss of Potential Detection. | [Protection Para /Global Prot Para /Supervision /LOP] |
| Blo Trigger5-I | State of the module input: An Alarm of this protective element will block the Loss of Potential Detection. | [Protection Para /Global Prot Para /Supervision /LOP] |

LOP Module Signals (Output States)

| <i>Signal</i> | <i>Description</i> |
|---------------|---|
| active | Signal: active |
| ExBlo | Signal: External Blocking |
| Alarm | Signal: Alarm Loss of Potential |
| LOP Blo | Signal: Loss of Potential blocks other elements. |
| Ex FF VT | Signal: Ex FF VT |
| Ex FF EVT | Signal: Alarm Fuse Failure Earth Voltage Transformers |

Blocking Trigger

| <i>Name</i> | <i>Description</i> |
|-------------|--------------------|
| -.- | No assignment |
| I[1].Alarm | Signal: Alarm |
| I[2].Alarm | Signal: Alarm |
| I[3].Alarm | Signal: Alarm |
| I[4].Alarm | Signal: Alarm |
| I[5].Alarm | Signal: Alarm |
| I[6].Alarm | Signal: Alarm |
| IG[1].Alarm | Signal: Alarm IG |
| IG[2].Alarm | Signal: Alarm IG |
| IG[3].Alarm | Signal: Alarm IG |
| IG[4].Alarm | Signal: Alarm IG |

Commissioning: Loss of Potential

Object to be tested:

Test of the module LOP.

Necessary means:

- Three-phase current source
- Three-phase voltage source.

Procedure

Test part 1:

Examine if the output signal »LOP BLO « becomes true if:

- Any of the three-phase voltages becomes less $0.01 \cdot V_n$ Volt
- The residual voltage is less than $0.01 \cdot V_n$ Volt or the $\%V2/V1$ ratio is greater 40%
- All three-phase currents are less than the load current / overcurrent detection (I_{\leq}) threshold.
- The residual current is less than $0.1 I_{pu}$ (rated current)
- No pickup of an OC element which should blocks VT Supervision
- The breaker is closed (option, if a breaker is assigned).
- The offline detection has not detected a dead busbar (No current, no voltage measured).

Successful test result part 1:

The output signals only become true if all the above mentioned conditions are fulfilled.

Test part 2:

Set the parameter »*Measuring Circuit Supervision=active*« within those protective elements that should be blocked by the Loss of Potential supervision (like undervoltage protection., voltage controlled overcurrent protection...).

Check those protective elements if they are blocked if the Loss of Potential supervision has generated a block command.

Successful test result part 2:

All protective elements that should be blocked in case of Loss of Potential supervision are blocked if the conditions (Procedure part 1) are fulfilled.

Commissioning: Loss of Potential (FF via DI)

Object to be tested:

Check if the auto fuse failure is correctly identified by the device.

Procedure

- Turn off the automatic circuit breaker of the VTs (all poles to be dead)

Successful test result

- The state of the respective digital input changes.
- All protective elements are blocked which should not have an unwanted operation caused by a fuse failure
»*Measuring Circuit Supervision=active*«.

Self Supervision

SSV

The protection devices are supervised by various check routines during normal operation and during the start-up phase on faulty operation.

The protection devices are carrying out various self supervision tests.

| <i>Self Supervision within the devices</i> | | |
|---|---|---|
| Supervision of... | Supervised by... | Action on detected issue... |
| Start phase | The duration (permitted time) of the boot phase is monitored. | The device will be rebooted. => The device will be taken out of service after three unsuccessful start attempts. |
| Supervision of the duration of a protection cycle (Software cycle) | The maximum permitted time for a protection cycle is monitored by a timing analysis. | The self-supervision contact will be deenergized if the permitted time for a protection cycle is exceeded (first threshold). The protection device will be rebooted, if the protection cycle exceeds the second threshold. |
| Monitoring of the communication between Main and Digital Signal Processor (DSP) | The cyclic measured value processing of the DSP is monitored by the main processor. | The device will be rebooted, if a failure is detected. The self-supervision contact will be deenergized. |
| Analog-Digital-Converter | The DSP does a plausibility check on the digitalized data. | Protection will be blocked, if a failure is detected, in order to prevent faulty tripping. |
| Supervision of data consistency after an outage of the power supply. (e.g. outage of the power supply while changing the parameter settings). | An internal logic detects fragmentary saved data after an outage of the power supply. | If the new data is incomplete or corrupt, it will be deleted during the reboot phase of the device. The device will continue to work with the last valid data set. |
| Data consistency in general | Generation of check-sums. | The device will be taken out of service in case that inconsistent data is detected that is not caused by an outage of the power supply. (fatal internal error). |

| <i>Self Supervision within the devices</i> | | |
|--|---|--|
| Parameter Setting (Device) | Protecting the parameter setting by plausibility checks. | Implausibilities within the parameter configuration can be detected by means of plausibility checks. Detected implausibilities are highlighted by a question mark symbol. Please refer to chapter parameter setting for detailed information. |
| Quality of the power supply | A hardware circuit ensures that the device can only be used, if the power supply is in the range specified by the technical data. | If the supply voltage is too low, the device will not start up or it will be set out of service respectively. |
| Sags of the supply voltage | Short-term sags of the supply voltage are detected and can be bridged in most of the cases by means of the integrated buffer within the power supply hardware. This buffer also allows the termination of ongoing data writing procedures. | The module for the supervision of the system utilization will detect repetitive short-term sags of the supply voltage. |
| Internal data of the device (memory load, internal resources, ...) | An internal module monitors the system utilization. | The module for the supervision of the system utilization initiates in case of a fatal error a reboot of the device. In case of minor faults the system led will flash alternating red and green (please refer to the trouble shooting guide). The issue will be recorded within an integrated fault memory. |
| Status of the device communication (SCADA) | The projected and activated SCADA module supervises its connection to the master communication system. | You can check if there is active communication with the master system within menu <Operation/ Status display/ Communication>. In order to monitor this state you can assign this status onto an LED and/or an output relay. For details on the status of the GOOSE communication please refer to chapter IEC61850. |

Device Start (Reboot)

The device starts up if:

- it is connected to the supply voltage,
- the User initiates (intentionally) a restart of the device,
- the device is set back to factory defaults,
- the internal self-supervision of the device detects a fatal error.

The reason for a device start/reboot is shown numerically within menu <Operation/ Status display/ Sys/ Restart> (please refer to the table below). The reason will also be logged within the event recorder (Event: Sys.Restart).

The table below explains the numbers indicating the reason of the restart.

| <i>Device Start-up Codes</i> | |
|------------------------------|---|
| 1. | Normal Start-up Start-up after clean disconnection of the supply voltage. |
| 2. | Reboot by the Operator Device reboot triggered by the operator via HMI or Smart view. |
| 3. | Reboot by means of Super Reset Automatic reboot when setting the device back to factory defaults. |
| 4. | -- (outdated) |
| 5. | -- (outdated) |
| 6. | Unknown Error Source Reboot due to unknown error source. |
| 7. | Forced Reboot (initiated by the main processor) The main processor identified invalid conditions or data. |
| 8. | Exceeded Time Limit of the Protection Cycle Unexpected interruption of the Protection Cycle. |
| 9. | Forced Reboot (initiated by the digital signal processor) The digital signal processor identified invalid conditions or data. |
| 10. | Exceeded Time Limit of the Measured Value Processing Unexpected interruption of the cyclic measured value processing. |
| 11. | Sags of the Supply Voltage Reboot after short-term sag or outage of the supply voltage. |
| 12. | Illegal Memory Access Reboot after illegal memory access. |

Device taken out of Service „Device Stopped“

The protection device will be taken out of service, if there is an undefined state that cannot be escaped after three reboots.

In this state the system LED will be illuminated red or red flashing. The display will show the message „Device Stopped“ followed by a 6-digit error code, e.g. E01487.

In addition to the recorders, messages and display information that can be accessed by the user, there may exist additional error information accessible by the Service Staff. These offer further failure analysis and diagnosis opportunities to the Service Staff.

NOTICE

In such a case please contact the Woodward Service Staff and provide them the error code.

For further information on trouble shooting please refer to the separately provided „Trouble Shooting Guide“.

Direct Commands of the Self Supervision

| <i>Parameter</i> | <i>Description</i> | <i>Setting range</i> | <i>Default</i> | <i>Menu path</i> |
|---|---|----------------------|----------------|-----------------------------|
| Ack System LED  | Ack System LED (red/green flashing LED) | False, True | False | [Operation /Acknowledge] |

Signals (Output States) of the Self Supervision

| <i>Signal</i> | <i>Description</i> |
|-------------------------|---------------------------------|
| System Error | Signal: Device Failure |
| SelfSuperVision Contact | Signal: SelfSuperVision Contact |

Values of the Self Supervision

| <i>Value</i> | <i>Description</i> | <i>Menu path</i> |
|--------------|--------------------|---|
| Last Failure | Last Failure | [Operation /Self Supervision /System Error] |

Counter Values of the Self Supervision

| <i>Value</i> | <i>Description</i> | <i>Menu path</i> |
|-----------------------|--|---|
| Resets by Device | Resets initiated by the device | [Operation /Self Supervision /System Error] |
| Cr No of free sockets | Counter for network diagnosis. Number of free sockets. | [Operation /Self Supervision /System State] |

Programmable Logic

Available Elements (Equations):
Logics

General Description

The Protective Relay includes programmable Logic Equations for programming output relays, blocking of protective functions and custom logic functions in the relay.

The logic provides control of the output relays based on the state of the inputs that can be chosen from the assignment list (protective function pickups, protective function states, breaker states, system alarms, and module inputs). The user can use the outputs signals of a Logic Equation as inputs in higher equations (e.g. the output signal of Logic Equation 10 might be used as an input of Logic Equation 11).

Principle Overview

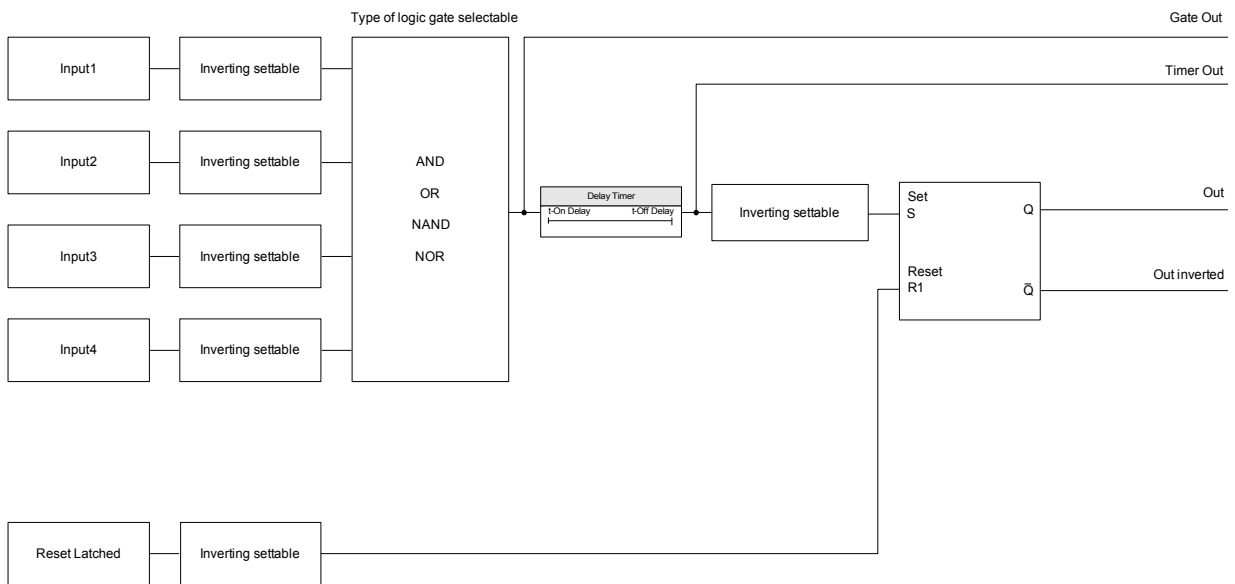

Detailed Overview – Overall Logic diagram

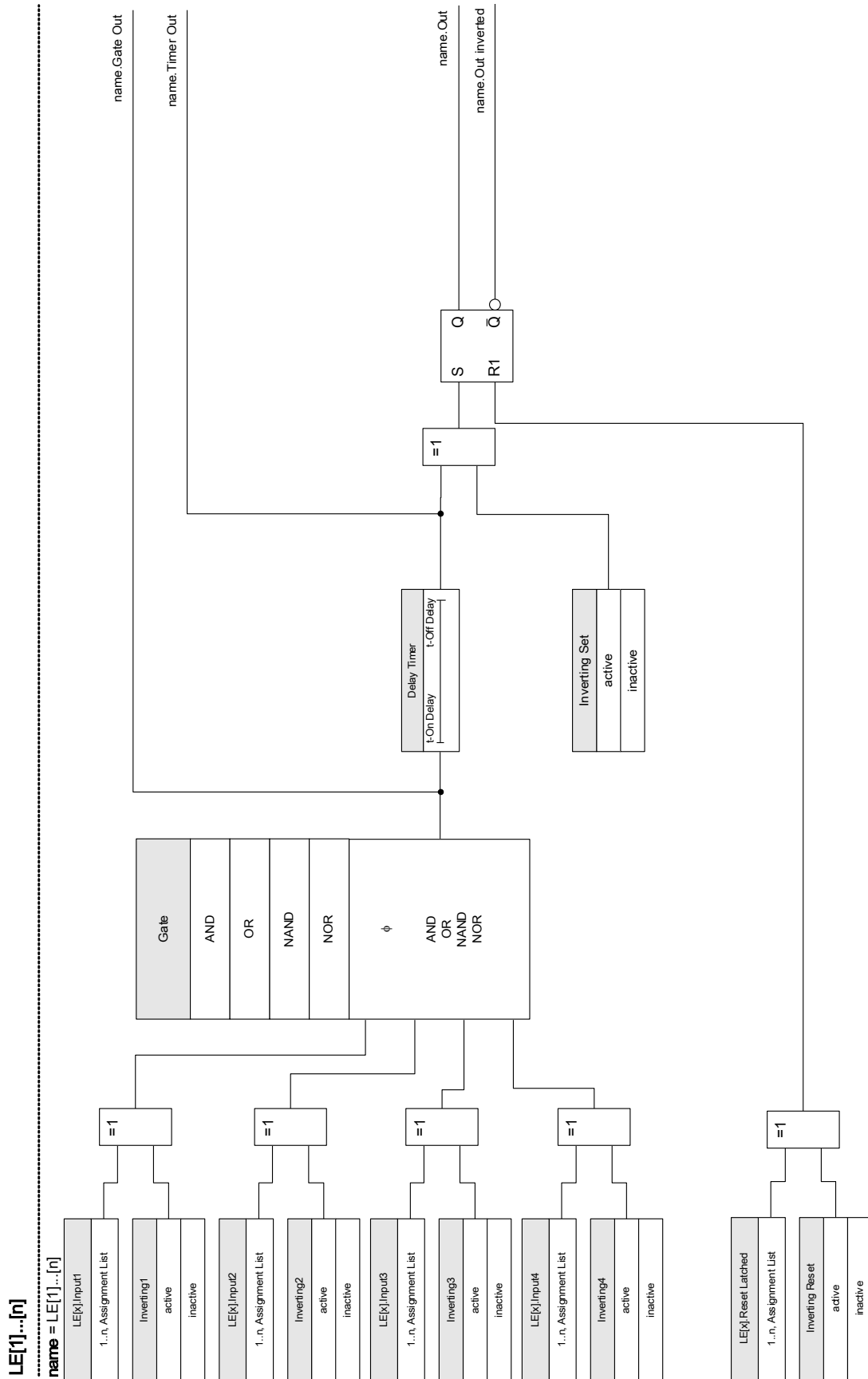

Available Gates (Operators)

Within the Logic Equation, the following Gates can be used:

Gate

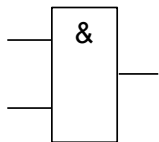

AND

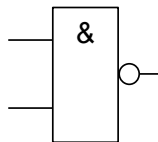

NAND

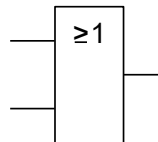

OR

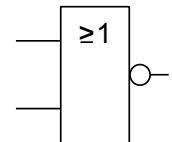

NOR

Input Signals

The user can assign up to 4 Input signals (from the assignment list) to the inputs of the gate.

As an option, each of the 4 input signals can be inverted (negated)

Timer Gate (On Delay and Off Delay)

The output of the gate can be delayed. The user has the option to set an On and an Off delay.

Latching

The logic equations issues two signals. An unlatched and a latched signal. The latched output is also available as an inverted output.

In order to reset the latched signal the user has to assign a reset signal from the assignment list. The reset signal can also optionally be inverted. The latching works based on reset priority. That means, the reset input is dominant.

Cascading Logical Outputs

The device will evaluate output states of the Logic Equations starting from Logic Equation 1 up to the Logic Equation with the highest number. This evaluation (device) cycle will be continuously repeated.

Cascading Logic Equations in an ascending sequence

Cascading in an ascending sequence means that the user uses the output signal of “Logic Equation n ” as input of “Logic Equation $n+1$ ”. If the state of “Logic Equation n ” changes, the state of the output of “Logic Equation $n+1$ ” will be updated within the same cycle.

Cascading Logic Equations in a descending sequence

Cascading in a descending sequence means that the user uses the output signal of “Logic Equation $n+1$ ” as input of “Logic Equation n ”. If the output of “Logic Equation $n+1$ ” changes, this change of the feed back signal at the input of “Logic Equation n ” will be delayed for one cycle.

Cascading in Ascending Order

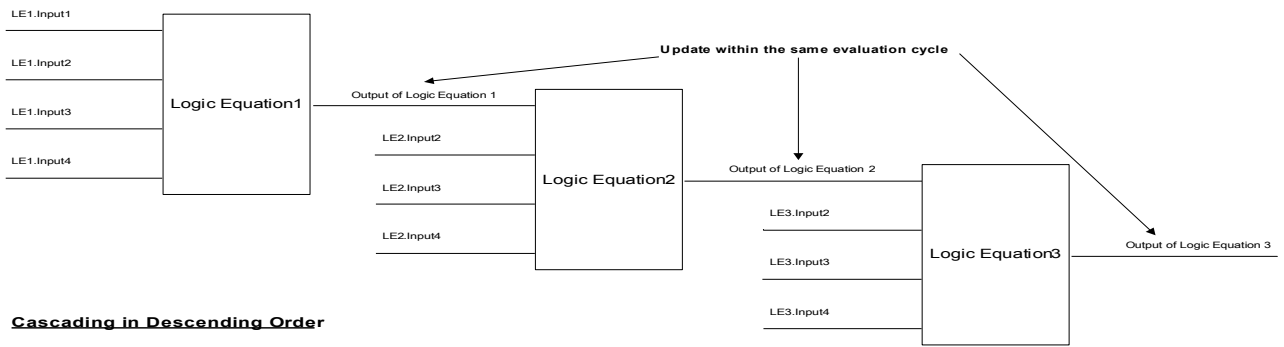
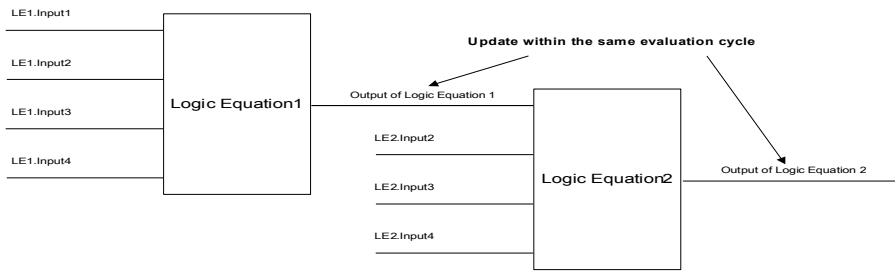

Cascading in Descending Order

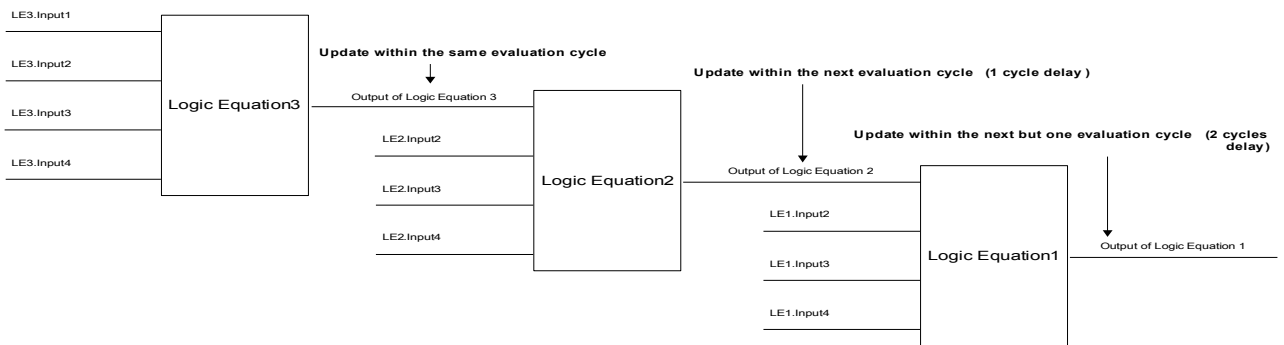
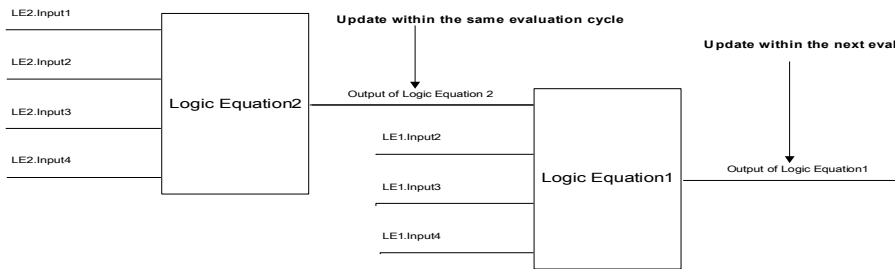

Programmable Logic at the Panel



WARNING improper use of Logic Equations might result in personal injury or damage the electrical equipment.

Don't use Logic Equations unless that you can ensure the safe functionality.

How to configure a Logic Equation?

- Call up menu [Logics/LE [x]]:

- Set the Input Signals (where necessary, invert them).

- If required, configure the timer (» *On delay*« and » *Off delay*«).

- If the latched output signal is used assign a reset signal to the reset input.

- Within the »status display«, the user can check the status of the logical inputs and outputs of the Logic Equation.









In case that Logic Equations should be cascaded the user has to be aware of timing delays (cycles) in case of descending sequences (Please refer to section: Cascading Logical Outputs).





By means the Status Display [Operation/Status Display] the logical states can be verified.]

Device Planning Parameters of the Programmable Logic

| <i>Parameter</i> | <i>Description</i> | <i>Options</i> | <i>Default</i> | <i>Menu path</i> |
|---|-------------------------------------|-------------------------------------|----------------|-------------------|
| No of Equations:  | Number of required Logic Equations: | 0, 5, 10, 20, 40, 80 | 20 | [Device planning] |

Global Protection Parameter of the Programmable Logic

| Parameter | Description | Setting range | Default | Menu path |
|---|--|-----------------------------|----------|-------------------|
| LE1.Gate  | Logic gate | AND, OR, NAND, NOR | AND | [Logics /LE 1] |
| LE1.Input1  | Assignment of the Input Signal | 1..n, Assignment List | -- | [Logics /LE 1] |
| LE1.Inverting1  | Inverting the input signals. Only available if an input signal has been assigned. | inactive, active | inactive | [Logics /LE 1] |
| LE1.Input2  | Assignment of the Input Signal | 1..n, Assignment List | -- | [Logics /LE 1] |
| LE1.Inverting2  | Inverting the input signals. Only available if an input signal has been assigned. | inactive, active | inactive | [Logics /LE 1] |
| LE1.Input3  | Assignment of the Input Signal | 1..n, Assignment List | -- | [Logics /LE 1] |
| LE1.Inverting3  | Inverting the input signals. Only available if an input signal has been assigned. | inactive, active | inactive | [Logics /LE 1] |
| LE1.Input4  | Assignment of the Input Signal | 1..n, Assignment List | -- | [Logics /LE 1] |
| LE1.Inverting4  | Inverting the input signals. Only available if an input signal has been assigned. | inactive, active | inactive | [Logics /LE 1] |
| LE1.t-On Delay  | Switch On Delay | 0.00 - 36000.00s | 0.00s | [Logics /LE 1] |

| <i>Parameter</i> | <i>Description</i> | <i>Setting range</i> | <i>Default</i> | <i>Menu path</i> |
|--|---|-----------------------|----------------|-------------------|
| LE1.t-Off Delay  | Switch Off Delay | 0.00 - 36000.00s | 0.00s | [Logics /LE 1] |
| LE1.Reset Latched  | Reset Signal for the Latching | 1..n, Assignment List | -- | [Logics /LE 1] |
| LE1.Inverting Reset  | Inverting Reset Signal for the Latching | inactive, active | inactive | [Logics /LE 1] |
| LE1.Inverting Set  | Inverting the Setting Signal for the Latching | inactive, active | inactive | [Logics /LE 1] |

Programmable Logic Inputs

| <i>Name</i> | <i>Description</i> | <i>Assignment via</i> |
|-------------------|---|-----------------------|
| LE1.Gate In1-I | State of the module input: Assignment of the Input Signal | [Logics /LE 1] |
| LE1.Gate In2-I | State of the module input: Assignment of the Input Signal | [Logics /LE 1] |
| LE1.Gate In3-I | State of the module input: Assignment of the Input Signal | [Logics /LE 1] |
| LE1.Gate In4-I | State of the module input: Assignment of the Input Signal | [Logics /LE 1] |
| LE1.Reset Latch-I | State of the module input: Reset Signal for the Latching | [Logics /LE 1] |

Programmable Logic Outputs

| <i>Signal</i> | <i>Description</i> |
|------------------|--|
| LE1.Gate Out | Signal: Output of the logic gate |
| LE1.Timer Out | Signal: Timer Output |
| LE1.Out | Signal: Latched Output (Q) |
| LE1.Out inverted | Signal: Negated Latched Output (Q NOT) |

Commissioning

Before starting work on an opened switchboard it is imperative that the complete switchboard is dead and the following 5 safety regulations are always met: ,

DANGER

Safety precautions:

- Disconnect from the power supply
- Secure against reconnection
- Verify if the equipment is dead
- Connect to ground and short-circuit all phases
- Cover or safeguard all live adjacent parts

DANGER

The secondary circuit of a current transformer must never be opened during operation. The prevailing high voltages are dangerous to life.

WARNING

Even when the auxiliary voltage is switched off, it is likely that there are still hazardous voltages at the component connections.

All locally applicable national and international installation and safety regulations for working at electrical power installations must always be followed (e.g. VDE, EN, DIN, IEC).

WARNING

Prior to the initial voltage connection, the following must be guaranteed:

- Correct grounding of the device
- That all signal circuits are tested
- That all control circuits are tested
- Transformer wiring is checked
- Correct rating of the CTs
- Correct burden of the CTs
- That the operational conditions are in line with the Technical Data
- Correct rating of the transformer protection
- Function of the transformer fuses
- Correct wiring of all digital inputs
- Polarity and capacity of the supply voltage
- Correct wiring of the analogue inputs and outputs

NOTICE

The permissible deviations of measuring values and device adjustment are dependent on the technical data/tolerances.

Commissioning/Protection Test

WARNING

Putting into operation/Protection test must be carried out by authorized and qualified personnel. Before the device is put into operation the related documentation has to be read and understood.

WARNING

With any test of the protection functions the following has to be checked:

- Is activation/tripping saved in the event recorder?
- Is tripping saved in the fault recorder?
- Is tripping saved in the disturbance recorder?
- Are all signals/messages correctly generated?
- Do all general parameterized blocking functions work properly?
- Do all temporary parameterized (via DI) blocking functions work properly?
- To enable checks on all LEDs and relay functions, these have to be provided with the relevant alarm and tripping functions of the respective protection functions/elements. This has to be tested in practical operation.

WARNING

Check of all temporary blockings (via digital inputs):

- In order to avoid malfunctions, all blockings related to tripping/non-tripping of protection function have to be tested. The test can be very complex and should therefore be performed by the same people who set up the protection concept.

CAUTION

Check of all general trip blockings:

- All general trip blockings have to be tested.

NOTICE

Prior to the initial operation of the protection device all tripping times and values shown in the adjustment list have to be confirmed by a secondary test

NOTICE

Any description of functions, parameters, inputs or outputs that does not match the device in hand, can be ignored.

Putting out of Operation – Plug out the Relay



Warning! Dismounting the relay will lead to a loss of the protection functionality. Ensure that there is a back-up protection. If you are not aware of the consequences of dismantling the device – stop! Don't start.



Inform SCADA before you start.

Switch-off the power supply.

Ensure, that the cabinet is dead and that there are no voltages that could lead to personal injury.

Plug-out the terminals at the rear-side of the device. Do not pull any cable – pull on the plugs! If it is stuck use for example a screw driver.

Fasten the cables and terminals in the cabinet by means of cable clips to ensure that no accidental electrical connections are caused.

Hold the device at the front-side while opening the mounting nuts.

Remove the device carefully out of the cabinet.

In case no other device is to be mounted or replaced cover/close the cut-out in the front-door.

Close the cabinet.

Service and Commissioning Support

Within the service menu various functions support maintenance and commissioning of the device.

General

Within the menu [Service/General], the user can initiate a reboot of the device.

Forcing the Relay Output Contacts

NOTICE

The parameters, their defaults and setting ranges have to be taken from Relay Output Contacts section.

Principle – General Use

⚠ DANGER

The User **MUST ENSURE** that the relay output contacts operate normally after the maintenance is completed. If the relay output contacts do not operate normally, the protective device **WILL NOT** provide protection.

For commissioning purposes or for maintenance, relay output contacts can be set by force.

Within this mode [Service/Test Mode/Force OR/BO Slot X(2/5)], relay output contacts can be set by force:

- Permanent; or
- Via timeout.

If they are set with a timeout, they will only keep their “Force Position” as long as this timer runs. If the timer expires, the relay will operate normally. If they are set as Permanent, they will keep the “Force Position” continuously.

There are two options available:

- Forcing a single relay »*Force ORx*«; and
- Forcing an entire group of relay output contacts »*Force all Outs*«.

Forcing an entire group takes precedence over forcing a single relay output contact!

NOTICE

A relay output contact will NOT follow a force command as long as it is disarmed at the same time.

NOTICE

A relay output contact will follow a force command:

- If it is not disarmed; and
- If the Direct Command is applied to the relay(s).

Keep in mind, that the forcing of all relay output contacts (of the same assembly group) takes precedence over the force command of a single relay output contact.

Disarming the Relay Output Contacts

NOTICE

The parameters, their defaults, and setting ranges have to be taken from the Relay Output Contacts section.

Principle – General Use

Within this mode [Service/Test Mode/DISARMED], entire groups of relay output contacts can be disabled. By means of this test mode, contact outputs switching actions of the relay output contacts are prevented. If the relay output contacts are disarmed, maintenance actions can be carried out without the risk of taking entire processes off-line.

⚠ DANGER

The User **MUST ENSURE** that the relay output contacts are **ARMED AGAIN** after the maintenance is complete. If they are not armed, the protective device **WILL NOT** provide protection.

NOTICE

Zone Interlocking Output and the Supervision Contact cannot be disarmed.

Within this mode [Service/Test Mode/DISARMED] entire groups of relay output contacts can be disarmed:

- Permanent; or
- Via timeout.

If they are set with a timeout, they will only keep their “Disarm Position” as long as this timer runs. If the timer expires, the relay output contacts will operate normally. If they are set Permanent, they will keep the “Disarm State” continuously.

NOTICE

A relay output contact will NOT be disarmed as long as:

- It's latched (and not yet reset).
- As long as a running t-OFF-delay timer is not yet expired (hold time of a relay output contact).
- The Disarm Control is not set to active.
- The Direct Command is not applied.

NOTICE

A relay output contact will be disarmed if it's not latched and

- There is no running t-OFF-delay timer (hold time of a relay output contact) and

- The DISARM Control is set to active and

- The Direct Command Disarm is applied.

Forcing RTDs*

* = Availability depends on ordered device.

NOTICE

The parameters, their defaults, and setting ranges have to be taken from RTD/UTRD section.

Principle – General Use

⚠ DANGER

The User **MUST ENSURE** that the RTDs operate normally after the maintenance is completed. If the RTDs do not operate normally, the protective device **WILL NOT** provide protection.

For commissioning purposes or for maintenance, RTD temperatures can be set by force.

Within this mode [Service/Test Mode/URTD], RTD temperatures can be set by force:

- Permanent; or
- Via timeout.

If they are set with a timeout, they will keep their “Forced Temperature” only as long as this timer runs. If the timer expires, the RTD will operate normally. If they are set as »*Permanent*«, they will keep the “Forced Temperature” continuously. This menu will show the measured values of the RTDs until the User activates the force mode by calling up the »*Function*«. As soon as the force mode is activated, the shown values will be frozen as long as this mode is active. Now the User can force RTD values. As soon as the force mode is deactivated, measured values will be shown again.

Forcing Analog Outputs*

* = Availability depends on ordered device.

NOTICE

The parameters, their defaults, and setting ranges have to be taken from Analog Output section.

Principle – General Use

⚠ DANGER

The User **MUST ENSURE** that the Analog Outputs operate normally after maintenance is completed. Do not use this mode if forced Analog Outputs cause issues in external processes.

For commissioning purposes or for maintenance, Analog Outputs can be set by force.

Within this mode [Service/Test Mode/Analog Output(x)], Analog Outputs can be set by force:

- Permanent; or
- Via timeout.

If they are set with a timeout, they will only keep their “Forced Value” as long as this timer runs. If the timer expires, the Analog Output will operate normally. If they are set as »*Permanent*«, they will keep the “Forced Value” continuously. This menu will show the current value that is assigned onto the Analog Output until the User activates the force mode by calling up the »*Function*«. As soon as the force mode is activated, the shown values will be frozen as long as this mode is active. Now the User can force Analog Output values. As soon as the force mode is deactivated, measured values will be shown again.

Forcing Analog Inputs*

* = Availability depends on ordered device.

NOTICE

The parameters, their defaults, and setting ranges have to be taken from Analog Inputs section.

Principle – General Use

⚠ DANGER

The User **MUST ENSURE** that the Analog Inputs operate normally after maintenance is completed.

For commissioning purposes or for maintenance, Analog Inputs can be set by force.

Within this mode [Service/Test Mode (Prot inhibit)/WARNING! Cont?/Analog Inputs], Analog Inputs can be set by force:

- Permanent; or
- Via timeout.

If they are set with a timeout, they will only keep their “Forced Value” as long as this timer runs. If the timer expires, the Analog Input will operate normally. If they are set as »*Permanent*«, they will keep the “Forced Value” continuously. This menu will show the current value that is fed to the Analog Input until the User activates the force mode by calling up the »*Function*«. As soon as the force mode is activated, the shown value will be frozen as long as this mode is active. Now the User can force the Analog Input value. As soon as the force mode is deactivated, measured value will be shown again.

Failure Simulator (Sequencer)*

Available Elements:

Sgen

* = Availability depends on ordered device.

For commissioning support and in order to analyze failures, the protective device offers the option to simulate measuring quantities. The simulation menu can be found within the [Service/Test Mode/Sgen] menu.

The simulation cycle consists of three states:

- Pre-failure;
- Failure; and
- Post-failure State (Phase).

Within the [Service/Test Mode/Sgen/Configuration/Times] sub-menu, the duration of each phase can be set. In addition; the measuring quantities to be simulated can be determined (e.g.: voltages, currents, and the corresponding angles) for each phase (and ground). The simulation will be terminated, if a phase current exceeds 0.1 times I_n . A simulation can be restarted, five seconds after the current has fallen below 0.1 times I_n .

⚠ DANGER Setting the device into the simulation mode means taking the protective device out of operation for the duration of the simulation. Do not use this feature during operation of the device if the User cannot guarantee that there is a running and properly working backup protection.

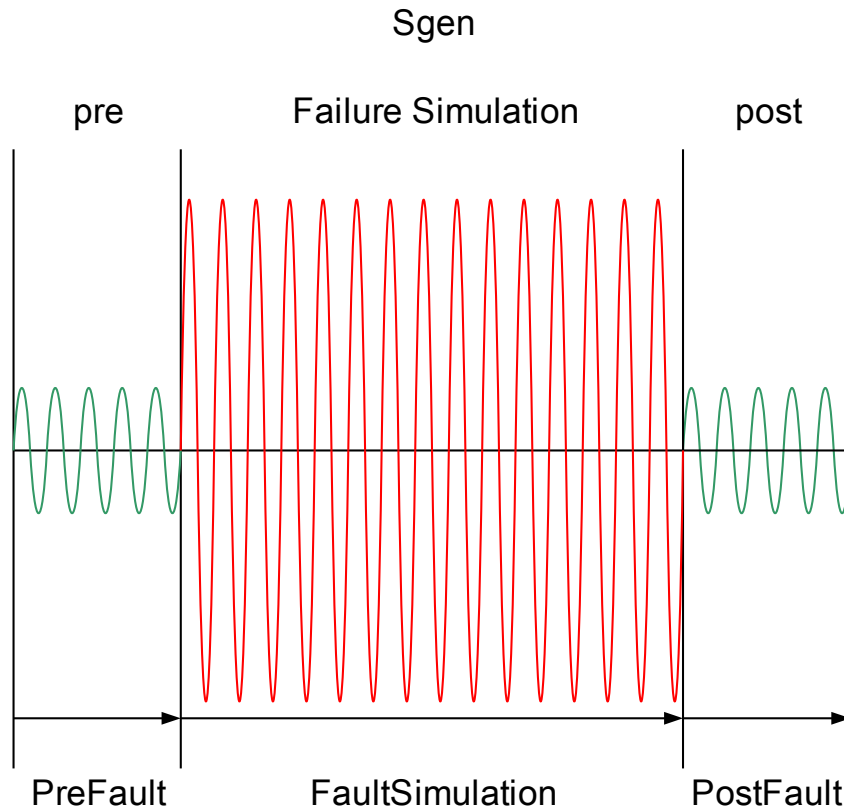

The energy counters will be stopped while the failure simulator is running.

NOTICE

The simulation voltages are always phase to neutral voltages, irrespectively of the mains voltage transformers' connection method (Phase-to-phase / Wey / Open Delta).

Application Options of the Fault Simulator**:

| Stop Options | Cold Simulation (Option 1) | Hot Simulation (Option 2) |
|---|--|--|
| <p>Do not stop</p> <p>Run complete: Pre Failure, Failure, Post Failure.</p> <p>How To?: Call up [Service/Test Mode/Sgen /Process] Ex Force Post = no assignment</p> <p>Press/Call up Start Simulation.</p> | <p>Simulation without tripping the breaker:</p> <p>The TripCmd of all protection functions will be blocked. The protection function will possibly trip but not generate a TripCmd.</p> <p>How To?: Call up [Service/Test Mode/Sgen /Process]</p> <p>TripCmd Mode = No TripCmd</p> | <p>Simulation is authorized to trip the breaker:</p> <p>How To?: Call up [Service/Test Mode/Sgen /Process]</p> <p>TripCmd Mode = With TripCmd</p> |
| <p>Stop by external signal</p> <p>Force Post: As soon as this signal becomes true, the Fault Simulation will be forced to switch into the Post Failure mode.</p> <p>How To?: Call up [Service/Test Mode/Sgen /Process] Ex Force Post = Assigned Signal</p> | | |
| <p>Manual stop</p> <p>As soon as this signal becomes true, the Fault Simulation will be terminated and the device changes back to normal operation.</p> <p>How To?: Call up [Service/Test Mode/Sgen /Process] Press/Call up Stop Simulation.</p> | | |

**Please note: Due to internal dependencies, the frequency of the simulation module is 0.16% greater than the rated one.

Device Planning Parameters of the Failure Simulator

| Parameter | Description | Options | Default | Menu path |
|---|-------------|--------------------|---------|-------------------|
| Mode  | Mode | do not use, use | use | [Device planning] |

Global Protection Parameter of the Failure Simulator

| Parameter | Description | Setting range | Default | Menu path |
|--|---|-----------------------------|--------------|--|
| PreFault  | Pre Fault Duration | 0.00 - 300.00s | 0.0s | [Service /Test (Prot inhibit) /Sgen /Configuration /Times] |
| FaultSimulation  | Duration of Fault Simulation | 0.00 - 10800.00s | 0.0s | [Service /Test (Prot inhibit) /Sgen /Configuration /Times] |
| PostFault  | PostFault | 0.00 - 300.00s | 0.0s | [Service /Test (Prot inhibit) /Sgen /Configuration /Times] |
| TripCmd Mode  | Trip Command Mode | No TripCmd, With TripCmd | No TripCmd | [Service /Test (Prot inhibit) /Sgen /Process] |
| Ex Start Simulation  | External Start of Fault Simulation (Using the test parameters) | 1..n, Assignment List | -- | [Service /Test (Prot inhibit) /Sgen /Process] |
| ExBlo  | External blocking of the module, if blocking is activated (allowed) within a parameter set and if the state of the assigned signal is true. | 1..n, Assignment List | SG[1].Pos ON | [Service /Test (Prot inhibit) /Sgen /Process] |

| Parameter | Description | Setting range | Default | Menu path |
|---|-------------------------------------|-----------------------|---------|--|
| Ex ForcePost  | Force Post state. Abort simulation. | 1..n, Assignment List | .- | [Service /Test (Prot inhibit) /Sgen /Process] |

Voltage Parameter of the Failure Simulator

| Parameter | Description | Setting range | Default | Menu path |
|--|---|---------------|---------|--|
| VL1  | Voltage Fundamental Magnitude in Pre State: phase L1 | 0.00 - 1.50Vn | 0.57Vn | [Service /Test (Prot inhibit) /Sgen /Configuration /PreFault /VT] |
| VL2  | Voltage Fundamental Magnitude in Pre State: phase L2 | 0.00 - 1.50Vn | 0.57Vn | [Service /Test (Prot inhibit) /Sgen /Configuration /PreFault /VT] |
| VL3  | Voltage Fundamental Magnitude in Pre State: phase L3 | 0.00 - 1.50Vn | 0.57Vn | [Service /Test (Prot inhibit) /Sgen /Configuration /PreFault /VT] |
| VX  | Voltage Fundamental Magnitude in Pre State: VX | 0.00 - 1.50Vn | 0.0Vn | [Service /Test (Prot inhibit) /Sgen /Configuration /PreFault /VT] |
| phi VL1  | Start Position respectively Start Angle of the Voltage Phasor during Pre-Phase:phase L1 | -360 - 360° | 0° | [Service /Test (Prot inhibit) /Sgen /Configuration /PreFault /VT] |



| Parameter | Description | Setting range | Default | Menu path |
|--|---|---------------|---------|---|
| phi VL2  | Start Position respectively Start Angle of the Voltage Phasor during Pre-Phase:phase L2 | -360 - 360° | 240° | [Service /Test (Prot inhibit) /Sgen /Configuration /PreFault /VT] |
| phi VL3  | Start Position respectively Start Angle of the Voltage Phasor during Pre-Phase:phase L3 | -360 - 360° | 120° | [Service /Test (Prot inhibit) /Sgen /Configuration /PreFault /VT] |
| phi VX meas  | Start Position respectively Start Angle of the Voltage Phasor during Pre-Phase: VX | -360 - 360° | 0° | [Service /Test (Prot inhibit) /Sgen /Configuration /PreFault /VT] |
| VL1  | Voltage Fundamental Magnitude in Fault State: phase L1 | 0.00 - 1.50Vn | 0.29Vn | [Service /Test (Prot inhibit) /Sgen /Configuration /FaultSimulation /VT] |
| VL2  | Voltage Fundamental Magnitude in Fault State: phase L2 | 0.00 - 1.50Vn | 0.29Vn | [Service /Test (Prot inhibit) /Sgen /Configuration /FaultSimulation /VT] |
| VL3  | Voltage Fundamental Magnitude in Fault State: phase L3 | 0.00 - 1.50Vn | 0.29Vn | [Service /Test (Prot inhibit) /Sgen /Configuration /FaultSimulation /VT] |

| Parameter | Description | Setting range | Default | Menu path |
|--|---|---------------|---------|---|
| VX  | Voltage Fundamental Magnitude in Fault State: phase VX | 0.00 - 1.50Vn | 0.29Vn | [Service /Test (Prot inhibit) /Sgen /Configuration /FaultSimulation /VT] |
| phi VL1  | Start Position respectively Start Angle of the Voltage Phasor during Fault-Phase:phase L1 | -360 - 360° | 0° | [Service /Test (Prot inhibit) /Sgen /Configuration /FaultSimulation /VT] |
| phi VL2  | Start Position respectively Start Angle of the Voltage Phasor during Fault-Phase:phase L2 | -360 - 360° | 240° | [Service /Test (Prot inhibit) /Sgen /Configuration /FaultSimulation /VT] |
| phi VL3  | Start Position respectively Start Angle of the Voltage Phasor during Fault-Phase:phase L3 | -360 - 360° | 120° | [Service /Test (Prot inhibit) /Sgen /Configuration /FaultSimulation /VT] |
| phi VX meas  | Start Position respectively Start Angle of the Voltage Phasor during Fault-Phase: VX | -360 - 360° | 0° | [Service /Test (Prot inhibit) /Sgen /Configuration /FaultSimulation /VT] |
| VL1  | Voltage Fundamental Magnitude during Post phase: phase L1 | 0.00 - 1.50Vn | 0.57Vn | [Service /Test (Prot inhibit) /Sgen /Configuration /PostFault /VT] |

| Parameter | Description | Setting range | Default | Menu path |
|--|---|---------------|---------|---|
| VL2  | Voltage Fundamental Magnitude during Post phase: phase L2 | 0.00 - 1.50Vn | 0.57Vn | [Service /Test (Prot inhibit) /Sgen /Configuration /PostFault /VT] |
| VL3  | Voltage Fundamental Magnitude during Post phase: phase L3 | 0.00 - 1.50Vn | 0.57Vn | [Service /Test (Prot inhibit) /Sgen /Configuration /PostFault /VT] |
| VX  | Voltage Fundamental Magnitude during Post phase: phase VX | 0.00 - 1.50Vn | 0.0Vn | [Service /Test (Prot inhibit) /Sgen /Configuration /PostFault /VT] |
| phi VL1  | Start Position respectively Start Angle of the Voltage Phasor during Post phase: phase L1 | -360 - 360° | 0° | [Service /Test (Prot inhibit) /Sgen /Configuration /PostFault /VT] |
| phi VL2  | Start Position respectively Start Angle of the Voltage Phasor during Post phase: phase L2 | -360 - 360° | 240° | [Service /Test (Prot inhibit) /Sgen /Configuration /PostFault /VT] |
| phi VL3  | Start Position respectively Start Angle of the Voltage Phasor during Post phase: phase L3 | -360 - 360° | 120° | [Service /Test (Prot inhibit) /Sgen /Configuration /PostFault /VT] |

| Parameter | Description | Setting range | Default | Menu path |
|--|---|---------------|---------|---|
| phi VX meas  | Start Position respectively Start Angle of the Voltage Phasor during Post phase: phase VX | -360 - 360° | 0° | [Service /Test (Prot inhibit) /Sgen /Configuration /PostFault /VT] |



Current Parameter of the Failure Simulator

| Parameter | Description | Setting range | Default | Menu path |
|--|--|----------------|---------|--|
| IL1  | Current Fundamental Magnitude in Pre State: phase L1 | 0.00 - 40.00In | 0.0In | [Service /Test (Prot inhibit) /Sgen /Configuration /PreFault /CT] |
| IL2  | Current Fundamental Magnitude in Pre State: phase L2 | 0.00 - 40.00In | 0.0In | [Service /Test (Prot inhibit) /Sgen /Configuration /PreFault /CT] |
| IL3  | Current Fundamental Magnitude in Pre State: phase L3 | 0.00 - 40.00In | 0.0In | [Service /Test (Prot inhibit) /Sgen /Configuration /PreFault /CT] |
| IG meas  | Current Fundamental Magnitude in Pre State: IG | 0.00 - 25.00In | 0.0In | [Service /Test (Prot inhibit) /Sgen /Configuration /PreFault /CT] |

| Parameter | Description | Setting range | Default | Menu path |
|--|---|----------------|---------|---|
| phi IL1  | Start Position respectively Start Angle of the Current Phasor during Pre-Phase:phase L1 | -360 - 360° | 0° | [Service /Test (Prot inhibit) /Sgen /Configuration /PreFault /CT] |
| phi IL2  | Start Position respectively Start Angle of the Current Phasor during Pre-Phase:phase L2 | -360 - 360° | 240° | [Service /Test (Prot inhibit) /Sgen /Configuration /PreFault /CT] |
| phi IL3  | Start Position respectively Start Angle of the Current Phasor during Pre-Phase:phase L3 | -360 - 360° | 120° | [Service /Test (Prot inhibit) /Sgen /Configuration /PreFault /CT] |
| phi IG meas  | Start Position respectively Start Angle of the Current Phasor during Pre-Phase: IG | -360 - 360° | 0° | [Service /Test (Prot inhibit) /Sgen /Configuration /PreFault /CT] |
| IL1  | Current Fundamental Magnitude in Fault State: phase L1 | 0.00 - 40.00In | 0.0In | [Service /Test (Prot inhibit) /Sgen /Configuration /FaultSimulation /CT] |
| IL2  | Current Fundamental Magnitude in Fault State: phase L2 | 0.00 - 40.00In | 0.0In | [Service /Test (Prot inhibit) /Sgen /Configuration /FaultSimulation /CT] |

| Parameter | Description | Setting range | Default | Menu path |
|--|---|----------------|---------|---|
| IL3  | Current Fundamental Magnitude in Fault State: phase L3 | 0.00 - 40.00In | 0.0In | [Service /Test (Prot inhibit) /Sgen /Configuration /FaultSimulation /CT] |
| IG meas  | Current Fundamental Magnitude in Fault State: IG | 0.00 - 25.00In | 0.0In | [Service /Test (Prot inhibit) /Sgen /Configuration /FaultSimulation /CT] |
| phi IL1  | Start Position respectively Start Angle of the Current Phasor during Fault-Phase:phase L1 | -360 - 360° | 0° | [Service /Test (Prot inhibit) /Sgen /Configuration /FaultSimulation /CT] |
| phi IL2  | Start Position respectively Start Angle of the Current Phasor during Fault-Phase:phase L2 | -360 - 360° | 240° | [Service /Test (Prot inhibit) /Sgen /Configuration /FaultSimulation /CT] |
| phi IL3  | Start Position respectively Start Angle of the Current Phasor during Fault-Phase:phase L3 | -360 - 360° | 120° | [Service /Test (Prot inhibit) /Sgen /Configuration /FaultSimulation /CT] |
| phi IG meas  | Start Position respectively Start Angle of the Current Phasor during Fault-Phase: IG | -360 - 360° | 0° | [Service /Test (Prot inhibit) /Sgen /Configuration /FaultSimulation /CT] |

| Parameter | Description | Setting range | Default | Menu path |
|--|---|----------------|---------|---|
| IL1  | Current Fundamental Magnitude during Post phase: phase L1 | 0.00 - 40.00In | 0.0In | [Service /Test (Prot inhibit) /Sgen /Configuration /PostFault /CT] |
| IL2  | Current Fundamental Magnitude during Post phase: phase L2 | 0.00 - 40.00In | 0.0In | [Service /Test (Prot inhibit) /Sgen /Configuration /PostFault /CT] |
| IL3  | Current Fundamental Magnitude during Post phase: phase L3 | 0.00 - 40.00In | 0.0In | [Service /Test (Prot inhibit) /Sgen /Configuration /PostFault /CT] |
| IG meas  | Current Fundamental Magnitude during Post phase: IG | 0.00 - 25.00In | 0.0In | [Service /Test (Prot inhibit) /Sgen /Configuration /PostFault /CT] |
| phi IL1  | Start Position respectively Start Angle of the Current Phasor during Post phase: phase L1 | -360 - 360° | 0° | [Service /Test (Prot inhibit) /Sgen /Configuration /PostFault /CT] |
| phi IL2  | Start Position respectively Start Angle of the Current Phasor during Post phase: phase L2 | -360 - 360° | 240° | [Service /Test (Prot inhibit) /Sgen /Configuration /PostFault /CT] |

| <i>Parameter</i> | <i>Description</i> | <i>Setting range</i> | <i>Default</i> | <i>Menu path</i> |
|--|---|----------------------|----------------|---|
| phi IL3  | Start Position respectively Start Angle of the Current Phasor during Post phase: phase L3 | -360 - 360° | 120° | [Service /Test (Prot inhibit) /Sgen /Configuration /PostFault /CT] |
| phi IG meas  | Start Position respectively Start Angle of the Current Phasor during Post phase: IG | -360 - 360° | 0° | [Service /Test (Prot inhibit) /Sgen /Configuration /PostFault /CT] |



States of the Inputs of the Failure Simulator

| Name | Description | Assignment via |
|-----------------------|--|--|
| Ex Start Simulation-I | State of the module input:External Start of Fault Simulation (Using the test parameters) | [Service /Test (Prot inhibit) /Sgen /Process] |
| ExBlo | Module input state: External blocking | [Service /Test (Prot inhibit) /Sgen /Process] |
| Ex ForcePost-I | State of the module input:Force Post state. Abort simulation. | [Service /Test (Prot inhibit) /Sgen /Process] |

Signals of the Failure Simulator (States of the Outputs)

| Signal | Description |
|---------|--|
| Running | Signal; Measuring value simulation is running |
| State | Signal: Wave generation states: 0=Off, 1=PreFault, 2=Fault, 3=PostFault, 4=InitReset |

Direct Commands of the Failure Simulator

| Parameter | Description | Setting range | Default | Menu path |
|---|--|---------------------|----------|--|
| Start Simulation  | Start Fault Simulation (Using the test parameters) | inactive, active | inactive | [Service /Test (Prot inhibit) /Sgen /Process] |
| Stop Simulation  | Stopp Fault Simulation (Using the test parameters) | inactive, active | inactive | [Service /Test (Prot inhibit) /Sgen /Process] |

Failure Simulator Values

| <i>Value</i> | <i>Description</i> | <i>Default</i> | <i>Size</i> | <i>Menu path</i> |
|--------------|--|----------------|---|--|
| State | Wave generation states: 0=Off, 1=PreFault, 2=Fault, 3=PostFault, 4=InitReset | Off | Off, PreFault, FaultSimulation, PostFault, Init Res | [Service /Test (Prot inhibit) /Sgen /State] |

Technical Data

NOTICE

Use Copper conductors only, 75°C.
Conductor size AWG 14 [2.5 mm²].

Climatic Environmental Conditions

| | |
|------------------------------------|-----------------------------------|
| Storage Temperature: | Operating Temperature: |
| -30°C up to +70°C (-22°F to 158°F) | -20°C up to +60°C (-4°F to 140°F) |

Permissible Humidity at Ann. Average: <75% rel. (on 56d up to 95% rel.)
 Permissible Installation Altitude: <2000 m (6561.67 ft) above sea level
 If 4000 m (13123.35 ft) altitude apply a changed classification of the operating and test voltages may be necessary.

Degree of Protection EN 60529

| | |
|------------------------------|------|
| HMI front panel with seal | IP54 |
| HMI front panel without seal | IP50 |
| Rear side terminals | IP20 |

Routine Test

Insulation test acc. to IEC60255-5: All tests to be carried out against earth and other input- and output circuits
 Aux. voltage supply, digital inputs, 2.5 kV (eff) / 50 Hz
 current measuring inputs, signal relay outputs:
 Voltage measuring inputs: 3.0 kV (eff) / 50 Hz
 All wire-bound communication interfaces: 1.5 kV DC

Housing

| | |
|--|--|
| Housing B2: height/-width (7 Pushbottons/Door Mounting) | 173 mm (6.811")/ 212.7 mm (8.374") |
| Housing B2: height/-width (8 Pushbottons/Door Mounting) | 183 mm (7.205")/ 212.7 mm (8.374") |
| Housing B2: height/-width (7 and 8 Pushbottons/19") | 173 mm (6.811" / 4U)/ 212.7 mm (8.374" / 42 HP) |
| Housing depth (incl. terminals): | 208 mm (8.189") |
| Material, housing: | Aluminum extruded section |
| Material, front panel: | Aluminum/Foil front |
| Mounting position: | Horizontal ($\pm 45^\circ$ around the X-axis are allowed) |
| Weight: | approx. 4.7 kg (10.36 lb) |

Current and Earth Current Measurement

Plug-in Connectors with Integrated Short-Circuiter

(Conventional Current Inputs)

| | | |
|------------------------------|--|---|
| Nominal currents: | 1 A / 5 A | |
| Max. measuring range: | up to 40 x I _n (phase currents) up to 25 x I _n (earth current standard) | up to 2.5 x I _n (earth current sensitive) ¹⁾ |
| Continuous loading capacity: | Phase current/Earth current 4 x I _n /continuously | Earth current sensitive ¹⁾ 2 x I _n /continuously |
| Overcurrent proof: | Phase current/Earth current 30 x I _n /10 s 100 x I _n /1 s 250 x I _n /10 ms (1 half-wave) | Earth current sensitive ¹⁾ 10 x I _n /10 s 25 x I _n /1 s 100 x I _n /10 ms (1 half-wave) |
| Power consumption: | Phase current inputs: at I _n = 1 A S = 25 mVA at I _n = 5 A S = 90 mVA Earth current input: at I _n = 1 A S = 25 mVA at I _n = 5 A S = 90 mVA | Sensitive earth ¹⁾ current input: at 0,1 A (1A) S = 7 mVA (550 mVA) at 0,5 A (5A) S = 10 mVA (870 mVA) |
| Frequency range: | 50 Hz / 60 Hz ±10% | |
| Terminals: | Screw-type terminals with integrated short-circuiters (contacts) | |
| Screws: | M4, captive type acc. to VDEW | |
| Connection Cross Sections: | 1 x or 2 x 2.5 mm ² (2 x AWG 14) with wire end ferrule 1 x or 2 x 4.0 mm ² (2 x AWG 12) with ring cable sleeve or cable sleeve 1 x or 2 x 6 mm ² (2 x AWG 10) with ring cable sleeve or cable sleeve Only The current measuring board's terminal blocks may be used as with 2 (double) conductors AWG 10,12,14 otherwise with single conductors only. | |

¹⁾ only in completion with sensitive earth measuring (see ordering information)

Voltage and Residual Voltage Measurement

The following Technical Data are valid for 8-pole (large) voltage measurement terminals.

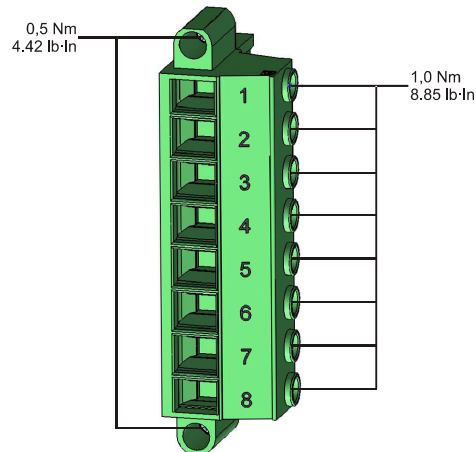

Nominal voltages: 60 - 520 V (can be configured)

Max. measuring range: 800 V AC

Continuous loading capacity: 800 V AC

Power consumption:
at $V_n = 100\text{ V}$ $S = 22\text{ mVA}$
at $V_n = 110\text{ V}$ $S = 25\text{ mVA}$
at $V_n = 230\text{ V}$ $S = 110\text{ mVA}$
at $V_n = 400\text{ V}$ $S = 330\text{ mVA}$

Frequency range: 50 Hz or 60 Hz $\pm 10\%$

Terminals: Screw-type terminals

Frequency Measurement

Nominal frequencies: 50 Hz / 60 Hz

Voltage Supply

Aux. Voltage: 24V - 270 V DC/48 - 230 V AC (-20/+10%) \approx

Buffer time in case of supply failure: \geq 50 ms at minimal aux. voltage. The device will shut down if the buffer time is expired.

Note: communication could be interrupted

Max. permissible making current: 18 A peak value for <0.25 ms
12 A peak value for <1 ms

The voltage supply must be protected by a fuse of:

- 2,5 A time-lag miniature fuse 5x20 mm (approx. 1/5" x 0.8") according to IEC 60127
- 3,5 A time-lag miniature fuse 6,3x32 mm (approx. 1/4" x 1 1/4") according to UL 248-14

Power Consumption

| Power supply range: | Power consumption in idle mode | Max. power consumption |
|---|-----------------------------------|------------------------|
| 24-270 V DC: | 8 W | 13 W |
| 48-230 V AC (for frequencies of 50-60 Hz): | 8W / 16 VA | 13 W / 21 VA |

Display

Display type: LCD with LED background illumination
Resolution graphics display: 128 x 128 pixel

LED-Type: Two colored: red/green
Number of LEDs, Housing B2: 15

Front Interface USB

Type: Mini B

Real Time Clock

Running reserve of the real time clock: 1 year min.

Digital Inputs

Max. input voltage: 300 V DC/259 V AC
 Input current: DC <4 mA
 AC <16 mA

Reaction time: <20 ms

Fallback Time:
 Shorted inputs <30 ms
 Open inputs <90 ms

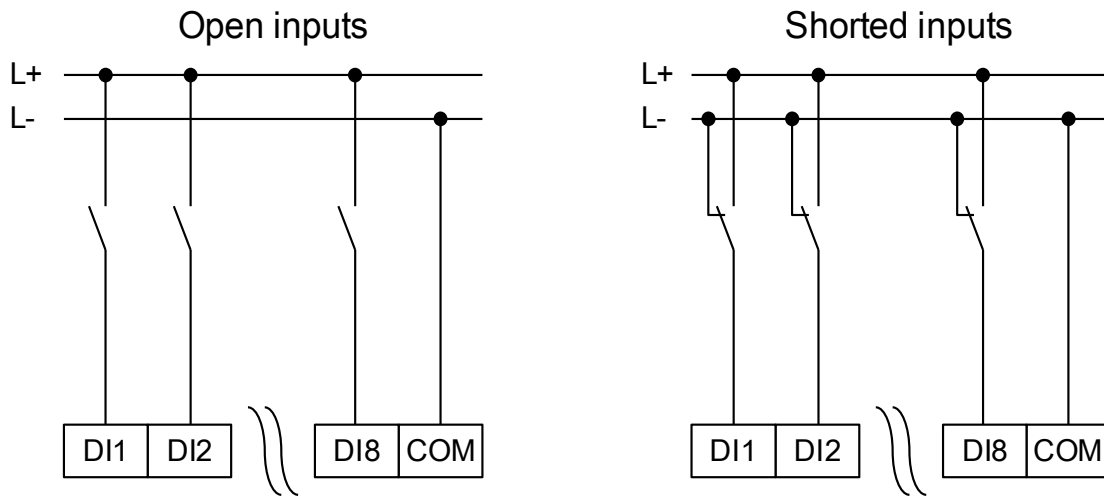

(Safe state of the digital inputs)

4 Switching thresholds: $U_n = 24 \text{ V DC}, 48 \text{ V DC}, 60 \text{ V DC}, 110 \text{ V AC/DC}, 230 \text{ V AC/DC}$

$U_n = 24 \text{ V DC}$:
 Switching threshold 1 ON: min. 19.2 V DC
 Switching threshold 1 OFF: max. 9.6 V DC

$U_n = 48 \text{ V}/60 \text{ V DC}$:
 Switching threshold 2 ON: Min. 42.6 V DC
 Switching threshold 2 OFF: max. 21.3 V DC

$U_n = 110 \text{ V AC/DC}$:
 Switching threshold 3 ON: min. 88.0 V DC/88.0 V AC
 Switching threshold 3 OFF: max. 44.0 V DC/44.0 V AC

$U_n = 230 \text{ V AC/DC}$:
 Switching threshold 4 ON: min. 184 V DC/184 V AC
 Switching threshold 4 OFF: max. 92 V DC/92 V AC

Terminals: Screw-type terminals

Binary Output Relays

| | |
|-------------------------|---|
| Continuous current: | 5 A AC/DC |
| Max. Switch-on current: | 25 A AC/DC for 4 s 48W (VA) at L/R = 40ms 30 A / 230 Vac according to ANSI IEEE Std C37.90-2005 30 A / 250 Vdc according to ANSI IEEE Std C37.90-2005 |
| Max. breaking current: | 5 A AC up to 240 V AC 4 A AC at 230V and $\cos \phi = 0,4$ 5 A DC up to 30 V (resistive) 0.3 A DC at 250 V (resistive) 0,1 A DC at 220 V and L/R = 40ms |
| Max. switching voltage: | 250 V AC/250 V DC |
| Switching capacity: | 3000 VA |
| Contact type: | 1 changeover contact or normally open or normally closed |
| Terminals: | Screw-type terminals |

Supervision Contact (SC)

| | |
|-------------------------|--|
| Continuous current:: | 5 A AC/DC |
| Max. Switch-on current: | 15 A AC/DC for 4 s |
| Max. breaking current: | 5 A AC up to 250 V AC 5 A DC up to 30 V (resistive) 0.25 A DC at 250 V (resistive) |
| Max. switching voltage: | 250 V AC/250 V DC |
| Switching capacity: | 1250 VA |
| Contact type: | 1 changeover contact |
| Terminals: | Screw-type terminals |

Time Synchronization IRIG

Nominal input voltage: 5 V
 Connection: Screw-type terminals (twisted pair)

RS485*

Master/Slave: Slave
 Connection: 9-pole D-Sub socket
 (external terminating resistors/in D-Sub)
 or 6 screw-clamping terminals RM 3.5 mm (138 MIL)
 (terminating resistors internal)

*availability depends on device

CAUTION In case that the RS485 interface is realised via terminals, the communication cable has to be shielded.

Fibre Optic Module with ST connector*

Master/Slave: Slave
 Connector: ST Port
 Compatible Fibre: 50/125 µm, 62,5/125 µm, 100/140 µm and 200 µm HCS
 Wavelength: 820 nm
 Minimum Optical Input Power: -24,0 dBm
 Minimum Optical Output Power: -19,8 dBm with 50/125 µm fibre
 -16,0 dBm with 62,5/125 µm fibre
 -12,5 dBm with 100/145 µm fibre
 -8,5 dBm with 200 µm HCS fibre
 Maximum Link Length: 2.7 km (depending on link attenuation)

*availability depends on device

Please note: The transmission speed of the optical interfaces is limited to 3 MBaud for Profibus.

Fibre Optic Module with LC Connector for Long-distance Protection Communication**

Master/Slave: Master/Slave
 Connector: LC Port
 Compatible Fibre: 9 µm single mode
 Wavelength: 1310 nm
 Minimum Optical Input Power: -31.0 dBm
 Minimum Optical Output Power: -15.0 dBm
 Maximum Link Length: ≥15 km (depending on link attenuation)

** only for Line Differential Protection (MCDLV4)

Optical Ethernet Module with LC connector*

Connector: LC-Port
 Compatible Fiber: 50/125 µm and 62,5/125 µm
 Wavelength: 1300 nm
 Minimum Optical Input Power: -30,0 dBm

Optical Ethernet Module with LC connector*

Connector: LC-Port
Minimum Optical Output Power: -22.5 dBm with 50/125 μ m fibre
-19,0 dBm with 62,5/125 μ m fibre

*availability depends on device

URTD-Interface*

Connector: Versatile Link
Compatible Fiber: 1 mm
Wavelength: 660 nm
Minimum Optical Input Power: -39,0 dBm

*availability depends on device

Boot phase

After switching on the power supply the protection will be available in approximately 9 seconds. After approximately 58 seconds (depending on the configuration) the boot phase is completed (HMI and Communication initialized).

Servicing and Maintenance

Within the scope of servicing and maintenance following checks of the unit hardware have to be conducted:

| <i>Component</i> | <i>Step</i> | <i>Interval/How often?</i> |
|---|---|---|
| Output Relays | Please check the Output Relays via Test menu Force/Disarm (please see chapter Service) | Each 1-4 years, according to ambience conditions. |
| Digital Inputs | Please supply a voltage to the Digital Inputs and control if the appropriate status signal appears. | Each 1-4 years, according to ambience conditions. |
| Current plugs and Current measurements | Please supply testing current to the Current measurement inputs and control the displayed measure values from the unit. | Each 1-4 years, according to ambience conditions. |
| Voltage plugs and Voltage measurements | Please supply testing current to the Voltage measurement inputs and control the displayed measure values from the unit. | Each 1-4 years, according to ambience conditions. |
| Analog Inputs | Please feed analog signals into the measurement inputs and check if the displayed measure values match. | Each 1-4 years, according to ambience conditions. |
| Analog Outputs | Please check the Analog Outputs via Test menu Force/Disarm (please see chapter Service) | Each 1-4 years, according to ambience conditions. |
| Battery | Readout the clock of the unit. Switch of the unit de-energized for a short moment (>20s). Reset the unit. Please check if the clock ran onwards correctly. | Generally after 10 years at the earliest. Exchange by manufacturer. Advice, the battery serves as buffering of the clock (real time clock). There's no impact of the functionality of the unit if the battery breaks down in addition to the buffering of the clock while the unit is in de-energized condition. |
| Self-monitoring contact | Switch of the auxiliary supply of the unit. The Self-monitoring contact has to dropout now. Please switch on the auxiliary supply again. | Each 1-4 years, according to ambience conditions. |
| Mechanical mounting of the unit of the cabinet door | Check the torque related to the specification of the Installation chapter. | With each maintenance or yearly. |
| Torque of all cable connections | Check the torque related to the specification of the Installation chapter which describes the hardware modules. | With each maintenance or yearly. |

We recommend to execute an protection test after each 4 years period. This period can be extended to 6 years if a function test is executed latest each 3 years.

Standards

Approvals

- UL- File No.: E217753
- CSA File No.: 251990**
- CEI 0-16* (Tested by EuroTest Laboratori S.r.l, Italy)*
- BDEW Certified (FGW TR3/ FGW TR8/ Q-U-Schutz)**
- KEMA***
- EAC

* = applies to MRU4

** = applies to MCA4

*** = applies to (MRDT4, MCA4, MRA4, MRI4, MRU4)

Design Standards

Generic standard

EN 61000-6-2 , 2005
EN 61000-6-3 , 2006

Product standard

IEC 60255-1; 2009
IEC 60255-27, 2013
EN 50178, 1998
UL 508 (Industrial Control Equipment), 2005
CSA C22.2 No. 14-95 (Industrial Control Equipment), 1995
ANSI C37.90, 2005

High Voltage Tests

High frequency interference test

| | | |
|----------------|--------------------|--------------|
| IEC 60255-22-1 | Within one circuit | 1 kV , 2 s |
| IEEE C37.90.1 | | |
| IEC 61000-4-18 | Circuit to earth | 2.5 kV , 2 s |
| class 3 | Circuit to circuit | 2.5 kV , 2 s |

Insulation voltage test

| | | |
|-------------------------|---|-----------------------------|
| IEC 60255-27 (10.5.3.2) | All circuits to other circuits and exposed conductive parts | 2.5 kV (eff.)/50Hz , 1 min. |
| IEC 60255-5 | Except interfaces | 1,5 kV DC , 1 min. |
| EN 50178 | and Voltage measuring input | 3 kV (eff.)/50 Hz , 1 min. |

Impulse voltage test

| | | |
|-------------------------|--|---------------------------|
| IEC 60255-27 (10.5.3.1) | | 5 kV/0.5J, 1.2/50 μ s |
| IEC 60255-5 | | |

Insulation resistance test

| | | |
|-------------------------|--------------------|--------------|
| IEC 60255-27 (10.5.3.3) | Within one circuit | 500V DC , 5s |
| EN 50178 | Circuit to circuit | 500V DC , 5s |

EMC Immunity Tests

Fast transient disturbance immunity test (Burst)

| | | |
|--------------------------|----------------------------|----------------|
| IEC 60255-22-4 | Power supply, mains inputs | ±4 kV, 2.5 kHz |
| IEC 61000-4-4 class 4 | Other in- and outputs | ±2 kV, 5 kHz |

Surge immunity test (Surge)

| | | |
|--------------------------|-------------------------------|------|
| IEC 60255-22-5 | Within one circuit | 2 kV |
| IEC 61000-4-5 class 4 | Circuit to earth | 4 kV |
| class 3 | Communication cables to earth | 2 kV |

Electrical discharge immunity test (ESD)

| | | |
|--------------------------|-------------------|------|
| IEC 60255-22-2 | Air discharge | 8 kV |
| IEC 61000-4-2 class 3 | Contact discharge | 6 kV |

Radiated radio-frequency electromagnetic field immunity test

| | | |
|----------------|-----------------|--------|
| IEC 60255-22-3 | 26 MHz – 80 MHz | 10 V/m |
| IEC 61000-4-3 | 80 MHz – 1 GHz | 35 V/m |
| | 1 GHz – 3 GHz | 10 V/m |

Immunity to conducted disturbances induced by radio frequency fields

| | | |
|--------------------------|----------------|------|
| IEC 61000-4-6 class 3 | 150kHz - 80MHz | 10 V |
|--------------------------|----------------|------|

Power frequency magnetic field immunity test

| | | |
|--------------------------|--------------------|-------------------|
| IEC 61000-4-8 class 4 | continues 3 sec | 30 A/m 300 A/m |
|--------------------------|--------------------|-------------------|

EMC Emission Tests

Radio interference suppression test

IEC/CISPR22 150kHz - 30MHz
IEC60255-26
DIN EN 55022

Limit value class B

Radio interference radiation test

IEC/CISPR22 30MHz - 1GHz
IEC60255-25
DIN EN 55022

Limit value class B

Environmental Tests

| | | |
|--|--|---|
| <i>Classification:</i> IEC 60068-1 | Climatic classification | 20/060/56 |
| IEC 60721-3-1 | Classification of ambient conditions (Storage) | 1K5/1B1/1C1L/1S1/1M2 but min. -30°C |
| IEC 60721-3-2 | Classification of ambient conditions (Transportation) | 2K2/2B1/2C1/2S1/2M2 but min. -30°C |
| IEC 60721-3-3 | Classification of ambient conditions (Stationary use at weather protected locations) | 3K6/3B1/3C1/3S1/3M2 but min. -20°C/max +60°C |
| <i>Test Ad: Cold</i> IEC 60068-2-1 | Temperature test duration | -20°C 16 h |
| <i>Test Bd: Dry Heat</i> IEC 60068-2-2 | Temperature Relative humidity test duration | 60°C <50% 72 h |
| <i>Test Db: Damp Heat (cyclic)</i> IEC 60068-2-30 | Temperature Relative humidity Cycles (12 + 12-hour) | 60°C 95% 2 |

Environmental Tests

Test Cab: Damp Heat (permanent)

| | | |
|----------------------|-------------------|---------|
| IEC 60255 (6.12.3.6) | Temperature | 60°C |
| IEC 60068-2-78 | Relative humidity | 95% |
| | test duration | 56 days |

Test Nb: Temperature Change

| | | |
|----------------------|---------------|------------|
| IEC 60255 (6.12.3.5) | Temperature | 60°C/-20°C |
| IEC 60068-2-14 | cycle | 5 |
| | test duration | 1°C/5min |

Test BD: Dry Heat Transport and storage test

| | | |
|----------------------|---------------|------|
| IEC 60255 (6.12.3.3) | Temperature | 70°C |
| IEC 60068-2-2 | test duration | 16 h |

Test AB: Cold Transport and storage test

| | | |
|------------------------|---------------|-------|
| IEC 60255-1 (6.12.3.4) | Temperature | -30°C |
| IEC 60068-2-1 | test duration | 16 h |

Mechanical Tests

Test Fc: Vibration response test

| | | |
|----------------|-------------------------------|----------|
| IEC 60068-2-6 | (10 Hz – 59 Hz) | 0.035 mm |
| IEC 60255-21-1 | Displacement | |
| class 1 | (59Hz – 150Hz) | 0,5 gn |
| | Acceleration | |
| | Number of cycles in each axis | 1 |

Test Fc: Vibration endurance test

| | | |
|----------------|-------------------------------|--------|
| IEC 60068-2-6 | (10 Hz – 150 Hz) | 1.0 gn |
| IEC 60255-21-1 | Acceleration | |
| class 1 | Number of cycles in each axis | 20 |

Test Ea: Shock tests

| | | |
|----------------|-----------------------|--|
| IEC 60068-2-27 | Shock response test | 5 gn, 11 ms, 3 impulses in each direction |
| IEC 60255-21-2 | | |
| class 1 | Shock resistance test | 15 gn, 11 ms, 3 impulses in each direction |

Test Eb: Shockendurance test

| | | |
|----------------|----------------------|---|
| IEC 60068-2-29 | Shock endurance test | 10 gn, 16 ms, 1000 impulses in each direction |
| IEC 60255-21-2 | | |
| class 1 | | |

Test Fe: Earthquake test

| | | |
|----------------|---------------------------------------|------------------------------|
| IEC 60068-3-3 | Single axis earthquake vibration test | 1 – 9 Hz horizontal: 7.5 mm, |
| IEC 60255-21-3 | | 1 – 9 Hz vertical :3.5 mm, |
| | | 1 sweep per axis |
| class 2 | | 9 – 35 Hz horizontal: 2 gn, |
| | | 9 – 35 Hz vertical : 1 gn, |
| | | 1 sweep per axis |

General Lists

Assignment List

The »ASSIGNMENT LIST« [below](#) summarizes all module outputs (signals) and inputs (e.g. states of the assignments).

| <i>Name</i> | <i>Description</i> |
|---------------------------|---|
| -.- | No assignment |
| Prot.available | Signal: Protection is available |
| Prot.active | Signal: active |
| Prot.ExBlo | Signal: External Blocking |
| Prot.Blo TripCmd | Signal: Trip Command blocked |
| Prot.ExBlo TripCmd | Signal: External Blocking of the Trip Command |
| Prot.Alarm L1 | Signal: General-Alarm L1 |
| Prot.Alarm L2 | Signal: General-Alarm L2 |
| Prot.Alarm L3 | Signal: General-Alarm L3 |
| Prot.Alarm G | Signal: General-Alarm - Earth fault |
| Prot.Alarm | Signal: General Alarm |
| Prot.Trip L1 | Signal: General Trip L1 |
| Prot.Trip L2 | Signal: General Trip L2 |
| Prot.Trip L3 | Signal: General Trip L3 |
| Prot.Trip G | Signal: General Trip Ground fault |
| Prot.Trip | Signal: General Trip |
| Prot.Res Fault a Mains No | Signal: Resetting of fault number and number of grid faults. |
| Prot.I dir fwd | Signal: Phase current failure forward direction |
| Prot.I dir rev | Signal: Phase current failure reverse direction |
| Prot.I dir n poss | Signal: Phase fault - missing reference voltage |
| Prot.IG calc dir fwd | Signal: Ground fault (calculated) forward |
| Prot.IG calc rev dir | Signal: Ground fault (calculated) reverse direction |
| Prot.IG calc dir n poss | Signal: Ground fault (calculated) direction detection not possible |
| Prot.IG meas dir fwd | Signal: Ground fault (measured) forward |
| Prot.IG meas rev dir | Signal: Ground fault (measured) reverse direction |
| Prot.IG meas dir n poss | Signal: Ground fault (measured) direction detection not possible |
| Prot.f(VL123)<10Hz | Frequency of the measuring channels 1-3 (VL1,VL2,VL3) is lower than 10Hz. |
| Prot.f(VL123)>10Hz | Frequency of the measuring channels 1-3 (VL1,VL2,VL3) is greater than 10Hz. |
| Prot.f(VL123)<70Hz | Frequency of the measuring channels 1-3 (VL1,VL2,VL3) is lower than 70Hz. |
| Prot.f(VL123)>70Hz | Frequency of the measuring channels 1-3 (VL1,VL2,VL3) is greater than 70Hz. |
| Prot.DFT Invalid | DFT values of fundamental and harmonics (except VX) are not valid. They depend on period time of frequency and measured channels 1-3 (VL1,VL2,VL3). |
| Prot.DFT Valid | DFT values of fundamental and harmonics (except VX) are valid. They depend on period time of frequency and measured channels 1-3 (VL1,VL2,VL3). |
| Prot.f(VX)<10Hz | Frequency of the measuring channel 4 (VX) is lower than 10Hz. |

General Lists

| Name | Description |
|---------------------------|---|
| Prot.f(VX)>10Hz | Frequency of the measuring channel 4 (VX) is greater than 10Hz. |
| Prot.f(VX)<70Hz | Frequency of the measuring channel 4 (VX) is lower than 70Hz. |
| Prot.f(VX)>70Hz | Frequency of the measuring channel 4 (VX) is greater than 70Hz. |
| Prot.DFT Invalid (VX) | DFT values of fundamental and harmonics of VX (only) are not valid. |
| Prot.DFT Valid (VX) | DFT values of fundamental and harmonics of VX (only) are valid. |
| Prot.ExBlo1-I | Module input state: External blocking1 |
| Prot.ExBlo2-I | Module input state: External blocking2 |
| Prot.ExBlo TripCmd-I | Module input state: External Blocking of the Trip Command |
| Ctrl.Local | Switching Authority: Local |
| Ctrl.Remote | Switching Authority: Remote |
| Ctrl.NonInterl | Non-Interlocking is active |
| Ctrl.SG Indeterm | Minimum one Switchgear is moving (Position cannot be determined). |
| Ctrl.SG Disturb | Minimum one Switchgear is disturbed. |
| Ctrl.NonInterl-I | Non-Interlocking |
| SG[1].SI SingleContactInd | Signal: The Position of the Switchgear is detected by one auxiliary contact (pole) only. Thus indeterminate and disturbed Positions cannot be detected. |
| SG[1].Pos not ON | Signal: Pos not ON |
| SG[1].Pos ON | Signal: Circuit Breaker is in ON-Position |
| SG[1].Pos OFF | Signal: Circuit Breaker is in OFF-Position |
| SG[1].Pos Indeterm | Signal: Circuit Breaker is in Indeterminate Position |
| SG[1].Pos Disturb | Signal: Circuit Breaker Disturbed - Undefined Breaker Position. The Position Indicators contradict themselves. After expiring of a supervision timer this signal becomes true. |
| SG[1].Ready | Signal: Circuit breaker is ready for operation. |
| SG[1].t-Dwell | Signal: Dwell time |
| SG[1].Removed | Signal: The withdrawable circuit breaker is Removed |
| SG[1].Interl ON | Signal: One or more IL_On inputs are active. |
| SG[1].Interl OFF | Signal: One or more IL_Off inputs are active. |
| SG[1].CES succesf | Signal: Command Execution Supervision: Switching command executed successfully. |
| SG[1].CES Disturbed | Signal: Command Execution Supervision: Switching Command unsuccessful. Switchgear in disturbed position. |
| SG[1].CES Fail TripCmd | Signal: Command Execution Supervision: Command execution failed because trip command is pending. |
| SG[1].CES SwitchDir | Signal: Command Execution Supervision respectively Switching Direction Control: This signal becomes true, if a switch command is issued even though the switchgear is already in the requested position. Example: A switchgear that is already OFF should be switched OFF again (doubly). The same applies to CLOSE commands. |
| SG[1].CES ON d OFF | Signal: Command Execution Supervision: On Command during a pending OFF Command. |
| SG[1].CES SG not ready | Signal: Command Execution Supervision: Switchgear not ready |
| SG[1].CES Fiel Interl | Signal: Command Execution Supervision: Switching Command not executed because of field interlocking. |
| SG[1].CES SyncTimeout | Signal: Command Execution Supervision: Switching Command not executed. No Synchronization signal while t-sync was running. |
| SG[1].CES SG removed | Signal: Command Execution Supervision: Switching Command unsuccessful, Switchgear removed. |
| SG[1].Prot ON | Signal: ON Command issued by the Prot module |

General Lists

| <i>Name</i> | <i>Description</i> |
|----------------------------|---|
| SG[1].TripCmd | Signal: Trip Command |
| SG[1].Ack TripCmd | Signal: Acknowledge Trip Command |
| SG[1].ON incl Prot ON | Signal: The ON Command includes the ON Command issued by the Protection module. |
| SG[1].OFF incl TripCmd | Signal: The OFF Command includes the OFF Command issued by the Protection module. |
| SG[1].Position Ind manipul | Signal: Position Indicators faked |
| SG[1].SGwear Slow SG | Signal: Alarm, the circuit breaker (load-break switch) becomes slower |
| SG[1].Res SGwear SI SG | Signal: Resetting the slow Switchgear Alarm |
| SG[1].ON Cmd | Signal: ON Command issued to the switchgear. Depending on the setting the signal may include the ON command of the Prot module. |
| SG[1].OFF Cmd | Signal: OFF Command issued to the switchgear. Depending on the setting the signal may include the OFF command of the Prot module. |
| SG[1].ON Cmd manual | Signal: ON Cmd manual |
| SG[1].OFF Cmd manual | Signal: OFF Cmd manual |
| SG[1].Sync ON request | Signal: Synchronous ON request |
| SG[1].Aux ON-I | Module Input State: Position indicator/check-back signal of the CB (52a) |
| SG[1].Aux OFF-I | Module input state: Position indicator/check-back signal of the CB (52b) |
| SG[1].Ready-I | Module input state: CB ready |
| SG[1].Sys-in-Sync-I | State of the module input: This signals has to become true within the synchronization time. If not, switching is unsuccessful. |
| SG[1].Removed-I | State of the module input: The withdrawable circuit breaker is Removed |
| SG[1].Ack TripCmd-I | State of the module input: Acknowledgement Signal (only for automatic acknowledgement) Module input signal |
| SG[1].Interl ON1-I | State of the module input: Interlocking of the ON command |
| SG[1].Interl ON2-I | State of the module input: Interlocking of the ON command |
| SG[1].Interl ON3-I | State of the module input: Interlocking of the ON command |
| SG[1].Interl OFF1-I | State of the module input: Interlocking of the OFF command |
| SG[1].Interl OFF2-I | State of the module input: Interlocking of the OFF command |
| SG[1].Interl OFF3-I | State of the module input: Interlocking of the OFF command |
| SG[1].SCmd ON-I | State of the module input: Switching ON Command, e.g. the state of the Logics or the state of the digital input |
| SG[1].SCmd OFF-I | State of the module input: Switching OFF Command, e.g. the state of the Logics or the state of the digital input |
| SG[1].Operations Alarm | Signal: Service Alarm, too many Operations |
| SG[1].Isum Intr trip: IL1 | Signal: Maximum permissible Summation of the interrupting (tripping) currents exceeded: IL1 |
| SG[1].Isum Intr trip: IL2 | Signal: Maximum permissible Summation of the interrupting (tripping) currents exceeded: IL2 |
| SG[1].Isum Intr trip: IL3 | Signal: Maximum permissible Summation of the interrupting (tripping) currents exceeded: IL3 |
| SG[1].Isum Intr trip | Signal: Maximum permissible Summation of the interrupting (tripping) currents exceeded in at least one phase. |
| SG[1].Res TripCmd Cr | Signal: Resetting of the Counter: total number of trip commands |
| SG[1].Res Sum trip | Signal: Reset summation of the tripping currents |
| SG[1].WearLevel Alarm | Signal: Threshold for the Alarm |
| SG[1].WearLevel Lockout | Signal: Threshold for the Lockout Level |

General Lists

| Name | Description |
|----------------------------|---|
| SG[1].Res SGwear Curve | Signal: Reset of the Circuit Breaker (load-break switch) Wear maintenance curve. |
| SG[1].Isum Intr ph Alm | Signal: Alarm, the per hour Sum (Limit) of interrupting currents has been exceeded. |
| SG[1].Res Isum Intr ph Alm | Signal: Reset of the Alarm, "the per hour Sum (Limit) of interrupting currents has been exceeded". |
| SG[2].SI SingleContactInd | Signal: The Position of the Switchgear is detected by one auxiliary contact (pole) only. Thus indeterminate and disturbed Positions cannot be detected. |
| SG[2].Pos not ON | Signal: Pos not ON |
| SG[2].Pos ON | Signal: Circuit Breaker is in ON-Position |
| SG[2].Pos OFF | Signal: Circuit Breaker is in OFF-Position |
| SG[2].Pos Indeterm | Signal: Circuit Breaker is in Indeterminate Position |
| SG[2].Pos Disturb | Signal: Circuit Breaker Disturbed - Undefined Breaker Position. The Position Indicators contradict themselves. After expiring of a supervision timer this signal becomes true. |
| SG[2].Ready | Signal: Circuit breaker is ready for operation. |
| SG[2].t-Dwell | Signal: Dwell time |
| SG[2].Removed | Signal: The withdrawable circuit breaker is Removed |
| SG[2].Interl ON | Signal: One or more IL_On inputs are active. |
| SG[2].Interl OFF | Signal: One or more IL_Off inputs are active. |
| SG[2].CES succesf | Signal: Command Execution Supervision: Switching command executed successfully. |
| SG[2].CES Disturbed | Signal: Command Execution Supervision: Switching Command unsuccessful. Switchgear in disturbed position. |
| SG[2].CES Fail TripCmd | Signal: Command Execution Supervision: Command execution failed because trip command is pending. |
| SG[2].CES SwitchDir | Signal: Command Execution Supervision respectively Switching Direction Control: This signal becomes true, if a switch command is issued even though the switchgear is already in the requested position. Example: A switchgear that is already OFF should be switched OFF again (doubly). The same applies to CLOSE commands. |
| SG[2].CES ON d OFF | Signal: Command Execution Supervision: On Command during a pending OFF Command. |
| SG[2].CES SG not ready | Signal: Command Execution Supervision: Switchgear not ready |
| SG[2].CES Fiel Interl | Signal: Command Execution Supervision: Switching Command not executed because of field interlocking. |
| SG[2].CES SyncTimeout | Signal: Command Execution Supervision: Switching Command not executed. No Synchronization signal while t-sync was running. |
| SG[2].CES SG removed | Signal: Command Execution Supervision: Switching Command unsuccessful, Switchgear removed. |
| SG[2].Prot ON | Signal: ON Command issued by the Prot module |
| SG[2].TripCmd | Signal: Trip Command |
| SG[2].Ack TripCmd | Signal: Acknowledge Trip Command |
| SG[2].ON incl Prot ON | Signal: The ON Command includes the ON Command issued by the Protection module. |
| SG[2].OFF incl TripCmd | Signal: The OFF Command includes the OFF Command issued by the Protection module. |
| SG[2].Position Ind manipul | Signal: Position Indicators faked |
| SG[2].SGwear Slow SG | Signal: Alarm, the circuit breaker (load-break switch) becomes slower |
| SG[2].Res SGwear SI SG | Signal: Resetting the slow Switchgear Alarm |
| SG[2].ON Cmd | Signal: ON Command issued to the switchgear. Depending on the setting the signal may include the ON command of the Prot module. |
| SG[2].OFF Cmd | Signal: OFF Command issued to the switchgear. Depending on the setting the signal may include the OFF command of the Prot module. |
| SG[2].ON Cmd manual | Signal: ON Cmd manual |

General Lists

| <i>Name</i> | <i>Description</i> |
|----------------------------|--|
| SG[2].OFF Cmd manual | Signal: OFF Cmd manual |
| SG[2].Sync ON request | Signal: Synchronous ON request |
| SG[2].Aux ON-I | Module Input State: Position indicator/check-back signal of the CB (52a) |
| SG[2].Aux OFF-I | Module input state: Position indicator/check-back signal of the CB (52b) |
| SG[2].Ready-I | Module input state: CB ready |
| SG[2].Sys-in-Sync-I | State of the module input: This signals has to become true within the synchronization time. If not, switching is unsuccessful. |
| SG[2].Removed-I | State of the module input: The withdrawable circuit breaker is Removed |
| SG[2].Ack TripCmd-I | State of the module input: Acknowledgement Signal (only for automatic acknowledgement) Module input signal |
| SG[2].Interl ON1-I | State of the module input: Interlocking of the ON command |
| SG[2].Interl ON2-I | State of the module input: Interlocking of the ON command |
| SG[2].Interl ON3-I | State of the module input: Interlocking of the ON command |
| SG[2].Interl OFF1-I | State of the module input: Interlocking of the OFF command |
| SG[2].Interl OFF2-I | State of the module input: Interlocking of the OFF command |
| SG[2].Interl OFF3-I | State of the module input: Interlocking of the OFF command |
| SG[2].SCmd ON-I | State of the module input: Switching ON Command, e.g. the state of the Logics or the state of the digital input |
| SG[2].SCmd OFF-I | State of the module input: Switching OFF Command, e.g. the state of the Logics or the state of the digital input |
| SG[2].Operations Alarm | Signal: Service Alarm, too many Operations |
| SG[2].Isum Intr trip: IL1 | Signal: Maximum permissible Summation of the interrupting (tripping) currents exceeded: IL1 |
| SG[2].Isum Intr trip: IL2 | Signal: Maximum permissible Summation of the interrupting (tripping) currents exceeded: IL2 |
| SG[2].Isum Intr trip: IL3 | Signal: Maximum permissible Summation of the interrupting (tripping) currents exceeded: IL3 |
| SG[2].Isum Intr trip | Signal: Maximum permissible Summation of the interrupting (tripping) currents exceeded in at least one phase. |
| SG[2].Res TripCmd Cr | Signal: Resetting of the Counter: total number of trip commands |
| SG[2].Res Sum trip | Signal: Reset summation of the tripping currents |
| SG[2].WearLevel Alarm | Signal: Threshold for the Alarm |
| SG[2].WearLevel Lockout | Signal: Threshold for the Lockout Level |
| SG[2].Res SGwear Curve | Signal: Reset of the Circuit Breaker (load-break switch) Wear maintenance curve. |
| SG[2].Isum Intr ph Alm | Signal: Alarm, the per hour Sum (Limit) of interrupting currents has been exceeded. |
| SG[2].Res Isum Intr ph Alm | Signal: Reset of the Alarm, "the per hour Sum (Limit) of interrupting currents has been exceeded". |
| SG[3].SI SingleContactInd | Signal: The Position of the Switchgear is detected by one auxiliary contact (pole) only. Thus indeterminate and disturbed Positions cannot be detected. |
| SG[3].Pos not ON | Signal: Pos not ON |
| SG[3].Pos ON | Signal: Circuit Breaker is in ON-Position |
| SG[3].Pos OFF | Signal: Circuit Breaker is in OFF-Position |
| SG[3].Pos Indeterm | Signal: Circuit Breaker is in Indeterminate Position |
| SG[3].Pos Disturb | Signal: Circuit Breaker Disturbed - Undefined Breaker Position. The Position Indicators contradict themselves. After expiring of a supervision timer this signal becomes true. |
| SG[3].Ready | Signal: Circuit breaker is ready for operation. |

General Lists

| <i>Name</i> | <i>Description</i> |
|----------------------------|---|
| SG[3].t-Dwell | Signal: Dwell time |
| SG[3].Removed | Signal: The withdrawable circuit breaker is Removed |
| SG[3].Interl ON | Signal: One or more IL_On inputs are active. |
| SG[3].Interl OFF | Signal: One or more IL_Off inputs are active. |
| SG[3].CES succesf | Signal: Command Execution Supervision: Switching command executed successfully. |
| SG[3].CES Disturbed | Signal: Command Execution Supervision: Switching Command unsuccessful. Switchgear in disturbed position. |
| SG[3].CES Fail TripCmd | Signal: Command Execution Supervision: Command execution failed because trip command is pending. |
| SG[3].CES SwitchDir | Signal: Command Execution Supervision respectively Switching Direction Control: This signal becomes true, if a switch command is issued even though the switchgear is already in the requested position. Example: A switchgear that is already OFF should be switched OFF again (doubly). The same applies to CLOSE commands. |
| SG[3].CES ON d OFF | Signal: Command Execution Supervision: On Command during a pending OFF Command. |
| SG[3].CES SG not ready | Signal: Command Execution Supervision: Switchgear not ready |
| SG[3].CES Fiel Interl | Signal: Command Execution Supervision: Switching Command not executed because of field interlocking. |
| SG[3].CES SyncTimeout | Signal: Command Execution Supervision: Switching Command not executed. No Synchronization signal while t-sync was running. |
| SG[3].CES SG removed | Signal: Command Execution Supervision: Switching Command unsuccessful, Switchgear removed. |
| SG[3].Prot ON | Signal: ON Command issued by the Prot module |
| SG[3].TripCmd | Signal: Trip Command |
| SG[3].Ack TripCmd | Signal: Acknowledge Trip Command |
| SG[3].ON incl Prot ON | Signal: The ON Command includes the ON Command issued by the Protection module. |
| SG[3].OFF incl TripCmd | Signal: The OFF Command includes the OFF Command issued by the Protection module. |
| SG[3].Position Ind manipul | Signal: Position Indicators faked |
| SG[3].SGwear Slow SG | Signal: Alarm, the circuit breaker (load-break switch) becomes slower |
| SG[3].Res SGwear SI SG | Signal: Resetting the slow Switchgear Alarm |
| SG[3].ON Cmd | Signal: ON Command issued to the switchgear. Depending on the setting the signal may include the ON command of the Prot module. |
| SG[3].OFF Cmd | Signal: OFF Command issued to the switchgear. Depending on the setting the signal may include the OFF command of the Prot module. |
| SG[3].ON Cmd manual | Signal: ON Cmd manual |
| SG[3].OFF Cmd manual | Signal: OFF Cmd manual |
| SG[3].Sync ON request | Signal: Synchronous ON request |
| SG[3].Aux ON-I | Module Input State: Position indicator/check-back signal of the CB (52a) |
| SG[3].Aux OFF-I | Module input state: Position indicator/check-back signal of the CB (52b) |
| SG[3].Ready-I | Module input state: CB ready |
| SG[3].Sys-in-Sync-I | State of the module input: This signals has to become true within the synchronization time. If not, switching is unsuccessful. |
| SG[3].Removed-I | State of the module input: The withdrawable circuit breaker is Removed |
| SG[3].Ack TripCmd-I | State of the module input: Acknowledgement Signal (only for automatic acknowledgement) Module input signal |
| SG[3].Interl ON1-I | State of the module input: Interlocking of the ON command |
| SG[3].Interl ON2-I | State of the module input: Interlocking of the ON command |

General Lists

| <i>Name</i> | <i>Description</i> |
|----------------------------|---|
| SG[3].Interl ON3-I | State of the module input: Interlocking of the ON command |
| SG[3].Interl OFF1-I | State of the module input: Interlocking of the OFF command |
| SG[3].Interl OFF2-I | State of the module input: Interlocking of the OFF command |
| SG[3].Interl OFF3-I | State of the module input: Interlocking of the OFF command |
| SG[3].SCmd ON-I | State of the module input: Switching ON Command, e.g. the state of the Logics or the state of the digital input |
| SG[3].SCmd OFF-I | State of the module input: Switching OFF Command, e.g. the state of the Logics or the state of the digital input |
| SG[3].Operations Alarm | Signal: Service Alarm, too many Operations |
| SG[3].Isum Intr trip: IL1 | Signal: Maximum permissible Summation of the interrupting (tripping) currents exceeded: IL1 |
| SG[3].Isum Intr trip: IL2 | Signal: Maximum permissible Summation of the interrupting (tripping) currents exceeded: IL2 |
| SG[3].Isum Intr trip: IL3 | Signal: Maximum permissible Summation of the interrupting (tripping) currents exceeded: IL3 |
| SG[3].Isum Intr trip | Signal: Maximum permissible Summation of the interrupting (tripping) currents exceeded in at least one phase. |
| SG[3].Res TripCmd Cr | Signal: Resetting of the Counter: total number of trip commands |
| SG[3].Res Sum trip | Signal: Reset summation of the tripping currents |
| SG[3].WearLevel Alarm | Signal: Threshold for the Alarm |
| SG[3].WearLevel Lockout | Signal: Threshold for the Lockout Level |
| SG[3].Res SGwear Curve | Signal: Reset of the Circuit Breaker (load-break switch) Wear maintenance curve. |
| SG[3].Isum Intr ph Alm | Signal: Alarm, the per hour Sum (Limit) of interrupting currents has been exceeded. |
| SG[3].Res Isum Intr ph Alm | Signal: Reset of the Alarm, "the per hour Sum (Limit) of interrupting currents has been exceeded". |
| SG[4].SI SingleContactInd | Signal: The Position of the Switchgear is detected by one auxiliary contact (pole) only. Thus indeterminate and disturbed Positions cannot be detected. |
| SG[4].Pos not ON | Signal: Pos not ON |
| SG[4].Pos ON | Signal: Circuit Breaker is in ON-Position |
| SG[4].Pos OFF | Signal: Circuit Breaker is in OFF-Position |
| SG[4].Pos Indeterm | Signal: Circuit Breaker is in Indeterminate Position |
| SG[4].Pos Disturb | Signal: Circuit Breaker Disturbed - Undefined Breaker Position. The Position Indicators contradict themselves. After expiring of a supervision timer this signal becomes true. |
| SG[4].Ready | Signal: Circuit breaker is ready for operation. |
| SG[4].t-Dwell | Signal: Dwell time |
| SG[4].Removed | Signal: The withdrawable circuit breaker is Removed |
| SG[4].Interl ON | Signal: One or more IL_On inputs are active. |
| SG[4].Interl OFF | Signal: One or more IL_Off inputs are active. |
| SG[4].CES succesf | Signal: Command Execution Supervision: Switching command executed successfully. |
| SG[4].CES Disturbed | Signal: Command Execution Supervision: Switching Command unsuccessful. Switchgear in disturbed position. |
| SG[4].CES Fail TripCmd | Signal: Command Execution Supervision: Command execution failed because trip command is pending. |
| SG[4].CES SwitchDir | Signal: Command Execution Supervision respectively Switching Direction Control: This signal becomes true, if a switch command is issued even though the switchgear is already in the requested position. Example: A switchgear that is already OFF should be switched OFF again (doubly). The same applies to CLOSE commands. |
| SG[4].CES ON d OFF | Signal: Command Execution Supervision: On Command during a pending OFF Command. |

General Lists

| <i>Name</i> | <i>Description</i> |
|----------------------------|---|
| SG[4].CES SG not ready | Signal: Command Execution Supervision: Switchgear not ready |
| SG[4].CES Fiel Interl | Signal: Command Execution Supervision: Switching Command not executed because of field interlocking. |
| SG[4].CES SyncTimeout | Signal: Command Execution Supervision: Switching Command not executed. No Synchronization signal while t-sync was running. |
| SG[4].CES SG removed | Signal: Command Execution Supervision: Switching Command unsuccessful, Switchgear removed. |
| SG[4].Prot ON | Signal: ON Command issued by the Prot module |
| SG[4].TripCmd | Signal: Trip Command |
| SG[4].Ack TripCmd | Signal: Acknowledge Trip Command |
| SG[4].ON incl Prot ON | Signal: The ON Command includes the ON Command issued by the Protection module. |
| SG[4].OFF incl TripCmd | Signal: The OFF Command includes the OFF Command issued by the Protection module. |
| SG[4].Position Ind manipul | Signal: Position Indicators faked |
| SG[4].SGwear Slow SG | Signal: Alarm, the circuit breaker (load-break switch) becomes slower |
| SG[4].Res SGwear SI SG | Signal: Resetting the slow Switchgear Alarm |
| SG[4].ON Cmd | Signal: ON Command issued to the switchgear. Depending on the setting the signal may include the ON command of the Prot module. |
| SG[4].OFF Cmd | Signal: OFF Command issued to the switchgear. Depending on the setting the signal may include the OFF command of the Prot module. |
| SG[4].ON Cmd manual | Signal: ON Cmd manual |
| SG[4].OFF Cmd manual | Signal: OFF Cmd manual |
| SG[4].Sync ON request | Signal: Synchronous ON request |
| SG[4].Aux ON-I | Module Input State: Position indicator/check-back signal of the CB (52a) |
| SG[4].Aux OFF-I | Module input state: Position indicator/check-back signal of the CB (52b) |
| SG[4].Ready-I | Module input state: CB ready |
| SG[4].Sys-in-Sync-I | State of the module input: This signals has to become true within the synchronization time. If not, switching is unsuccessful. |
| SG[4].Removed-I | State of the module input: The withdrawable circuit breaker is Removed |
| SG[4].Ack TripCmd-I | State of the module input: Acknowledgement Signal (only for automatic acknowledgement) Module input signal |
| SG[4].Interl ON1-I | State of the module input: Interlocking of the ON command |
| SG[4].Interl ON2-I | State of the module input: Interlocking of the ON command |
| SG[4].Interl ON3-I | State of the module input: Interlocking of the ON command |
| SG[4].Interl OFF1-I | State of the module input: Interlocking of the OFF command |
| SG[4].Interl OFF2-I | State of the module input: Interlocking of the OFF command |
| SG[4].Interl OFF3-I | State of the module input: Interlocking of the OFF command |
| SG[4].SCmd ON-I | State of the module input: Switching ON Command, e.g. the state of the Logics or the state of the digital input |
| SG[4].SCmd OFF-I | State of the module input: Switching OFF Command, e.g. the state of the Logics or the state of the digital input |
| SG[4].Operations Alarm | Signal: Service Alarm, too many Operations |
| SG[4].Isum Intr trip: IL1 | Signal: Maximum permissible Summation of the interrupting (tripping) currents exceeded: IL1 |
| SG[4].Isum Intr trip: IL2 | Signal: Maximum permissible Summation of the interrupting (tripping) currents exceeded: IL2 |
| SG[4].Isum Intr trip: IL3 | Signal: Maximum permissible Summation of the interrupting (tripping) currents exceeded: IL3 |

General Lists

| Name | Description |
|----------------------------|---|
| SG[4].Isum Intr trip | Signal: Maximum permissible Summation of the interrupting (tripping) currents exceeded in at least one phase. |
| SG[4].Res TripCmd Cr | Signal: Resetting of the Counter: total number of trip commands |
| SG[4].Res Sum trip | Signal: Reset summation of the tripping currents |
| SG[4].WearLevel Alarm | Signal: Threshold for the Alarm |
| SG[4].WearLevel Lockout | Signal: Threshold for the Lockout Level |
| SG[4].Res SGwear Curve | Signal: Reset of the Circuit Breaker (load-break switch) Wear maintenance curve. |
| SG[4].Isum Intr ph Alm | Signal: Alarm, the per hour Sum (Limit) of interrupting currents has been exceeded. |
| SG[4].Res Isum Intr ph Alm | Signal: Reset of the Alarm, "the per hour Sum (Limit) of interrupting currents has been exceeded". |
| SG[5].SI SingleContactInd | Signal: The Position of the Switchgear is detected by one auxiliary contact (pole) only. Thus indeterminate and disturbed Positions cannot be detected. |
| SG[5].Pos not ON | Signal: Pos not ON |
| SG[5].Pos ON | Signal: Circuit Breaker is in ON-Position |
| SG[5].Pos OFF | Signal: Circuit Breaker is in OFF-Position |
| SG[5].Pos Inderm | Signal: Circuit Breaker is in Indeterminate Position |
| SG[5].Pos Disturb | Signal: Circuit Breaker Disturbed - Undefined Breaker Position. The Position Indicators contradict themselves. After expiring of a supervision timer this signal becomes true. |
| SG[5].Ready | Signal: Circuit breaker is ready for operation. |
| SG[5].t-Dwell | Signal: Dwell time |
| SG[5].Removed | Signal: The withdrawable circuit breaker is Removed |
| SG[5].Interl ON | Signal: One or more IL_On inputs are active. |
| SG[5].Interl OFF | Signal: One or more IL_Off inputs are active. |
| SG[5].CES succesf | Signal: Command Execution Supervision: Switching command executed successfully. |
| SG[5].CES Disturbed | Signal: Command Execution Supervision: Switching Command unsuccessful. Switchgear in disturbed position. |
| SG[5].CES Fail TripCmd | Signal: Command Execution Supervision: Command execution failed because trip command is pending. |
| SG[5].CES SwitchDir | Signal: Command Execution Supervision respectively Switching Direction Control: This signal becomes true, if a switch command is issued even though the switchgear is already in the requested position. Example: A switchgear that is already OFF should be switched OFF again (doubly). The same applies to CLOSE commands. |
| SG[5].CES ON d OFF | Signal: Command Execution Supervision: On Command during a pending OFF Command. |
| SG[5].CES SG not ready | Signal: Command Execution Supervision: Switchgear not ready |
| SG[5].CES Fiel Interl | Signal: Command Execution Supervision: Switching Command not executed because of field interlocking. |
| SG[5].CES SyncTimeout | Signal: Command Execution Supervision: Switching Command not executed. No Synchronization signal while t-sync was running. |
| SG[5].CES SG removed | Signal: Command Execution Supervision: Switching Command unsuccessful, Switchgear removed. |
| SG[5].Prot ON | Signal: ON Command issued by the Prot module |
| SG[5].TripCmd | Signal: Trip Command |
| SG[5].Ack TripCmd | Signal: Acknowledge Trip Command |
| SG[5].ON incl Prot ON | Signal: The ON Command includes the ON Command issued by the Protection module. |
| SG[5].OFF incl TripCmd | Signal: The OFF Command includes the OFF Command issued by the Protection module. |
| SG[5].Position Ind manipul | Signal: Position Indicators faked |

General Lists

| <i>Name</i> | <i>Description</i> |
|----------------------------|---|
| SG[5].SGwear Slow SG | Signal: Alarm, the circuit breaker (load-break switch) becomes slower |
| SG[5].Res SGwear SI SG | Signal: Resetting the slow Switchgear Alarm |
| SG[5].ON Cmd | Signal: ON Command issued to the switchgear. Depending on the setting the signal may include the ON command of the Prot module. |
| SG[5].OFF Cmd | Signal: OFF Command issued to the switchgear. Depending on the setting the signal may include the OFF command of the Prot module. |
| SG[5].ON Cmd manual | Signal: ON Cmd manual |
| SG[5].OFF Cmd manual | Signal: OFF Cmd manual |
| SG[5].Sync ON request | Signal: Synchronous ON request |
| SG[5].Aux ON-I | Module Input State: Position indicator/check-back signal of the CB (52a) |
| SG[5].Aux OFF-I | Module input state: Position indicator/check-back signal of the CB (52b) |
| SG[5].Ready-I | Module input state: CB ready |
| SG[5].Sys-in-Sync-I | State of the module input: This signals has to become true within the synchronization time. If not, switching is unsuccessful. |
| SG[5].Removed-I | State of the module input: The withdrawable circuit breaker is Removed |
| SG[5].Ack TripCmd-I | State of the module input: Acknowledgement Signal (only for automatic acknowledgement) Module input signal |
| SG[5].Interl ON1-I | State of the module input: Interlocking of the ON command |
| SG[5].Interl ON2-I | State of the module input: Interlocking of the ON command |
| SG[5].Interl ON3-I | State of the module input: Interlocking of the ON command |
| SG[5].Interl OFF1-I | State of the module input: Interlocking of the OFF command |
| SG[5].Interl OFF2-I | State of the module input: Interlocking of the OFF command |
| SG[5].Interl OFF3-I | State of the module input: Interlocking of the OFF command |
| SG[5].SCmd ON-I | State of the module input: Switching ON Command, e.g. the state of the Logics or the state of the digital input |
| SG[5].SCmd OFF-I | State of the module input: Switching OFF Command, e.g. the state of the Logics or the state of the digital input |
| SG[5].Operations Alarm | Signal: Service Alarm, too many Operations |
| SG[5].Isum Intr trip: IL1 | Signal: Maximum permissible Summation of the interrupting (tripping) currents exceeded: IL1 |
| SG[5].Isum Intr trip: IL2 | Signal: Maximum permissible Summation of the interrupting (tripping) currents exceeded: IL2 |
| SG[5].Isum Intr trip: IL3 | Signal: Maximum permissible Summation of the interrupting (tripping) currents exceeded: IL3 |
| SG[5].Isum Intr trip | Signal: Maximum permissible Summation of the interrupting (tripping) currents exceeded in at least one phase. |
| SG[5].Res TripCmd Cr | Signal: Resetting of the Counter: total number of trip commands |
| SG[5].Res Sum trip | Signal: Reset summation of the tripping currents |
| SG[5].WearLevel Alarm | Signal: Threshold for the Alarm |
| SG[5].WearLevel Lockout | Signal: Threshold for the Lockout Level |
| SG[5].Res SGwear Curve | Signal: Reset of the Circuit Breaker (load-break switch) Wear maintenance curve. |
| SG[5].Isum Intr ph Alm | Signal: Alarm, the per hour Sum (Limit) of interrupting currents has been exceeded. |
| SG[5].Res Isum Intr ph Alm | Signal: Reset of the Alarm, "the per hour Sum (Limit) of interrupting currents has been exceeded". |
| SG[6].SI SingleContactInd | Signal: The Position of the Switchgear is detected by one auxiliary contact (pole) only. Thus indeterminate and disturbed Positions cannot be detected. |

General Lists

| Name | Description |
|----------------------------|---|
| SG[6].Pos not ON | Signal: Pos not ON |
| SG[6].Pos ON | Signal: Circuit Breaker is in ON-Position |
| SG[6].Pos OFF | Signal: Circuit Breaker is in OFF-Position |
| SG[6].Pos Indeterm | Signal: Circuit Breaker is in Indeterminate Position |
| SG[6].Pos Disturb | Signal: Circuit Breaker Disturbed - Undefined Breaker Position. The Position Indicators contradict themselves. After expiring of a supervision timer this signal becomes true. |
| SG[6].Ready | Signal: Circuit breaker is ready for operation. |
| SG[6].t-Dwell | Signal: Dwell time |
| SG[6].Removed | Signal: The withdrawable circuit breaker is Removed |
| SG[6].Interl ON | Signal: One or more IL_On inputs are active. |
| SG[6].Interl OFF | Signal: One or more IL_Off inputs are active. |
| SG[6].CES succesf | Signal: Command Execution Supervision: Switching command executed successfully. |
| SG[6].CES Disturbed | Signal: Command Execution Supervision: Switching Command unsuccessful. Switchgear in disturbed position. |
| SG[6].CES Fail TripCmd | Signal: Command Execution Supervision: Command execution failed because trip command is pending. |
| SG[6].CES SwitchDir | Signal: Command Execution Supervision respectively Switching Direction Control: This signal becomes true, if a switch command is issued even though the switchgear is already in the requested position. Example: A switchgear that is already OFF should be switched OFF again (doubly). The same applies to CLOSE commands. |
| SG[6].CES ON d OFF | Signal: Command Execution Supervision: On Command during a pending OFF Command. |
| SG[6].CES SG not ready | Signal: Command Execution Supervision: Switchgear not ready |
| SG[6].CES Fiel Interl | Signal: Command Execution Supervision: Switching Command not executed because of field interlocking. |
| SG[6].CES SyncTimeout | Signal: Command Execution Supervision: Switching Command not executed. No Synchronization signal while t-sync was running. |
| SG[6].CES SG removed | Signal: Command Execution Supervision: Switching Command unsuccessful, Switchgear removed. |
| SG[6].Prot ON | Signal: ON Command issued by the Prot module |
| SG[6].TripCmd | Signal: Trip Command |
| SG[6].Ack TripCmd | Signal: Acknowledge Trip Command |
| SG[6].ON incl Prot ON | Signal: The ON Command includes the ON Command issued by the Protection module. |
| SG[6].OFF incl TripCmd | Signal: The OFF Command includes the OFF Command issued by the Protection module. |
| SG[6].Position Ind manipul | Signal: Position Indicators faked |
| SG[6].SGwear Slow SG | Signal: Alarm, the circuit breaker (load-break switch) becomes slower |
| SG[6].Res SGwear SI SG | Signal: Resetting the slow Switchgear Alarm |
| SG[6].ON Cmd | Signal: ON Command issued to the switchgear. Depending on the setting the signal may include the ON command of the Prot module. |
| SG[6].OFF Cmd | Signal: OFF Command issued to the switchgear. Depending on the setting the signal may include the OFF command of the Prot module. |
| SG[6].ON Cmd manual | Signal: ON Cmd manual |
| SG[6].OFF Cmd manual | Signal: OFF Cmd manual |
| SG[6].Sync ON request | Signal: Synchronous ON request |
| SG[6].Aux ON-I | Module Input State: Position indicator/check-back signal of the CB (52a) |
| SG[6].Aux OFF-I | Module input state: Position indicator/check-back signal of the CB (52b) |

General Lists

| <i>Name</i> | <i>Description</i> |
|----------------------------|--|
| SG[6].Ready-I | Module input state: CB ready |
| SG[6].Sys-in-Sync-I | State of the module input: This signals has to become true within the synchronization time. If not, switching is unsuccessful. |
| SG[6].Removed-I | State of the module input: The withdrawable circuit breaker is Removed |
| SG[6].Ack TripCmd-I | State of the module input: Acknowledgement Signal (only for automatic acknowledgement) Module input signal |
| SG[6].Interl ON1-I | State of the module input: Interlocking of the ON command |
| SG[6].Interl ON2-I | State of the module input: Interlocking of the ON command |
| SG[6].Interl ON3-I | State of the module input: Interlocking of the ON command |
| SG[6].Interl OFF1-I | State of the module input: Interlocking of the OFF command |
| SG[6].Interl OFF2-I | State of the module input: Interlocking of the OFF command |
| SG[6].Interl OFF3-I | State of the module input: Interlocking of the OFF command |
| SG[6].SCmd ON-I | State of the module input: Switching ON Command, e.g. the state of the Logics or the state of the digital input |
| SG[6].SCmd OFF-I | State of the module input: Switching OFF Command, e.g. the state of the Logics or the state of the digital input |
| SG[6].Operations Alarm | Signal: Service Alarm, too many Operations |
| SG[6].Isum Intr trip: IL1 | Signal: Maximum permissible Summation of the interrupting (tripping) currents exceeded: IL1 |
| SG[6].Isum Intr trip: IL2 | Signal: Maximum permissible Summation of the interrupting (tripping) currents exceeded: IL2 |
| SG[6].Isum Intr trip: IL3 | Signal: Maximum permissible Summation of the interrupting (tripping) currents exceeded: IL3 |
| SG[6].Isum Intr trip | Signal: Maximum permissible Summation of the interrupting (tripping) currents exceeded in at least one phase. |
| SG[6].Res TripCmd Cr | Signal: Resetting of the Counter: total number of trip commands |
| SG[6].Res Sum trip | Signal: Reset summation of the tripping currents |
| SG[6].WearLevel Alarm | Signal: Threshold for the Alarm |
| SG[6].WearLevel Lockout | Signal: Threshold for the Lockout Level |
| SG[6].Res SGwear Curve | Signal: Reset of the Circuit Breaker (load-break switch) Wear maintenance curve. |
| SG[6].Isum Intr ph Alm | Signal: Alarm, the per hour Sum (Limit) of interrupting currents has been exceeded. |
| SG[6].Res Isum Intr ph Alm | Signal: Reset of the Alarm, "the per hour Sum (Limit) of interrupting currents has been exceeded". |
| I[1].active | Signal: active |
| I[1].ExBlo | Signal: External Blocking |
| I[1].Ex rev Interl | Signal: External reverse Interlocking |
| I[1].Blo TripCmd | Signal: Trip Command blocked |
| I[1].ExBlo TripCmd | Signal: External Blocking of the Trip Command |
| I[1].IH2 Blo | Signal: Blocking the trip command by an inrush |
| I[1].Alarm L1 | Signal: Alarm L1 |
| I[1].Alarm L2 | Signal: Alarm L2 |
| I[1].Alarm L3 | Signal: Alarm L3 |
| I[1].Alarm | Signal: Alarm |
| I[1].Trip L1 | Signal: General Trip Phase L1 |
| I[1].Trip L2 | Signal: General Trip Phase L2 |

General Lists

| <i>Name</i> | <i>Description</i> |
|----------------------|---|
| I[1].Trip L3 | Signal: General Trip Phase L3 |
| I[1].Trip | Signal: Trip |
| I[1].TripCmd | Signal: Trip Command |
| I[1].DefaultSet | Signal: Default Parameter Set |
| I[1].AdaptSet 1 | Signal: Adaptive Parameter 1 |
| I[1].AdaptSet 2 | Signal: Adaptive Parameter 2 |
| I[1].AdaptSet 3 | Signal: Adaptive Parameter 3 |
| I[1].AdaptSet 4 | Signal: Adaptive Parameter 4 |
| I[1].ExBlo1-I | Module input state: External blocking1 |
| I[1].ExBlo2-I | Module input state: External blocking2 |
| I[1].ExBlo TripCmd-I | Module input state: External Blocking of the Trip Command |
| I[1].Ex rev Inter-I | Module input state: External reverse interlocking |
| I[1].AdaptSet1-I | Module input state: Adaptive Parameter1 |
| I[1].AdaptSet2-I | Module input state: Adaptive Parameter2 |
| I[1].AdaptSet3-I | Module input state: Adaptive Parameter3 |
| I[1].AdaptSet4-I | Module input state: Adaptive Parameter4 |
| I[2].active | Signal: active |
| I[2].ExBlo | Signal: External Blocking |
| I[2].Ex rev Interl | Signal: External reverse Interlocking |
| I[2].Blo TripCmd | Signal: Trip Command blocked |
| I[2].ExBlo TripCmd | Signal: External Blocking of the Trip Command |
| I[2].IH2 Blo | Signal: Blocking the trip command by an inrush |
| I[2].Alarm L1 | Signal: Alarm L1 |
| I[2].Alarm L2 | Signal: Alarm L2 |
| I[2].Alarm L3 | Signal: Alarm L3 |
| I[2].Alarm | Signal: Alarm |
| I[2].Trip L1 | Signal: General Trip Phase L1 |
| I[2].Trip L2 | Signal: General Trip Phase L2 |
| I[2].Trip L3 | Signal: General Trip Phase L3 |
| I[2].Trip | Signal: Trip |
| I[2].TripCmd | Signal: Trip Command |
| I[2].DefaultSet | Signal: Default Parameter Set |
| I[2].AdaptSet 1 | Signal: Adaptive Parameter 1 |
| I[2].AdaptSet 2 | Signal: Adaptive Parameter 2 |
| I[2].AdaptSet 3 | Signal: Adaptive Parameter 3 |
| I[2].AdaptSet 4 | Signal: Adaptive Parameter 4 |
| I[2].ExBlo1-I | Module input state: External blocking1 |
| I[2].ExBlo2-I | Module input state: External blocking2 |
| I[2].ExBlo TripCmd-I | Module input state: External Blocking of the Trip Command |
| I[2].Ex rev Interl-I | Module input state: External reverse interlocking |

General Lists

| <i>Name</i> | <i>Description</i> |
|----------------------|---|
| I[2].AdaptSet1-I | Module input state: Adaptive Parameter1 |
| I[2].AdaptSet2-I | Module input state: Adaptive Parameter2 |
| I[2].AdaptSet3-I | Module input state: Adaptive Parameter3 |
| I[2].AdaptSet4-I | Module input state: Adaptive Parameter4 |
| I[3].active | Signal: active |
| I[3].ExBlo | Signal: External Blocking |
| I[3].Ex rev Interl | Signal: External reverse Interlocking |
| I[3].Blo TripCmd | Signal: Trip Command blocked |
| I[3].ExBlo TripCmd | Signal: External Blocking of the Trip Command |
| I[3].IH2 Blo | Signal: Blocking the trip command by an inrush |
| I[3].Alarm L1 | Signal: Alarm L1 |
| I[3].Alarm L2 | Signal: Alarm L2 |
| I[3].Alarm L3 | Signal: Alarm L3 |
| I[3].Alarm | Signal: Alarm |
| I[3].Trip L1 | Signal: General Trip Phase L1 |
| I[3].Trip L2 | Signal: General Trip Phase L2 |
| I[3].Trip L3 | Signal: General Trip Phase L3 |
| I[3].Trip | Signal: Trip |
| I[3].TripCmd | Signal: Trip Command |
| I[3].DefaultSet | Signal: Default Parameter Set |
| I[3].AdaptSet 1 | Signal: Adaptive Parameter 1 |
| I[3].AdaptSet 2 | Signal: Adaptive Parameter 2 |
| I[3].AdaptSet 3 | Signal: Adaptive Parameter 3 |
| I[3].AdaptSet 4 | Signal: Adaptive Parameter 4 |
| I[3].ExBlo1-I | Module input state: External blocking1 |
| I[3].ExBlo2-I | Module input state: External blocking2 |
| I[3].ExBlo TripCmd-I | Module input state: External Blocking of the Trip Command |
| I[3].Ex rev Interl-I | Module input state: External reverse interlocking |
| I[3].AdaptSet1-I | Module input state: Adaptive Parameter1 |
| I[3].AdaptSet2-I | Module input state: Adaptive Parameter2 |
| I[3].AdaptSet3-I | Module input state: Adaptive Parameter3 |
| I[3].AdaptSet4-I | Module input state: Adaptive Parameter4 |
| I[4].active | Signal: active |
| I[4].ExBlo | Signal: External Blocking |
| I[4].Ex rev Interl | Signal: External reverse Interlocking |
| I[4].Blo TripCmd | Signal: Trip Command blocked |
| I[4].ExBlo TripCmd | Signal: External Blocking of the Trip Command |
| I[4].IH2 Blo | Signal: Blocking the trip command by an inrush |
| I[4].Alarm L1 | Signal: Alarm L1 |
| I[4].Alarm L2 | Signal: Alarm L2 |

General Lists

| <i>Name</i> | <i>Description</i> |
|----------------------|---|
| I[4].Alarm L3 | Signal: Alarm L3 |
| I[4].Alarm | Signal: Alarm |
| I[4].Trip L1 | Signal: General Trip Phase L1 |
| I[4].Trip L2 | Signal: General Trip Phase L2 |
| I[4].Trip L3 | Signal: General Trip Phase L3 |
| I[4].Trip | Signal: Trip |
| I[4].TripCmd | Signal: Trip Command |
| I[4].DefaultSet | Signal: Default Parameter Set |
| I[4].AdaptSet 1 | Signal: Adaptive Parameter 1 |
| I[4].AdaptSet 2 | Signal: Adaptive Parameter 2 |
| I[4].AdaptSet 3 | Signal: Adaptive Parameter 3 |
| I[4].AdaptSet 4 | Signal: Adaptive Parameter 4 |
| I[4].ExBlo1-I | Module input state: External blocking1 |
| I[4].ExBlo2-I | Module input state: External blocking2 |
| I[4].ExBlo TripCmd-I | Module input state: External Blocking of the Trip Command |
| I[4].Ex rev Interl-I | Module input state: External reverse interlocking |
| I[4].AdaptSet1-I | Module input state: Adaptive Parameter1 |
| I[4].AdaptSet2-I | Module input state: Adaptive Parameter2 |
| I[4].AdaptSet3-I | Module input state: Adaptive Parameter3 |
| I[4].AdaptSet4-I | Module input state: Adaptive Parameter4 |
| I[5].active | Signal: active |
| I[5].ExBlo | Signal: External Blocking |
| I[5].Ex rev Interl | Signal: External reverse Interlocking |
| I[5].Blo TripCmd | Signal: Trip Command blocked |
| I[5].ExBlo TripCmd | Signal: External Blocking of the Trip Command |
| I[5].IH2 Blo | Signal: Blocking the trip command by an inrush |
| I[5].Alarm L1 | Signal: Alarm L1 |
| I[5].Alarm L2 | Signal: Alarm L2 |
| I[5].Alarm L3 | Signal: Alarm L3 |
| I[5].Alarm | Signal: Alarm |
| I[5].Trip L1 | Signal: General Trip Phase L1 |
| I[5].Trip L2 | Signal: General Trip Phase L2 |
| I[5].Trip L3 | Signal: General Trip Phase L3 |
| I[5].Trip | Signal: Trip |
| I[5].TripCmd | Signal: Trip Command |
| I[5].DefaultSet | Signal: Default Parameter Set |
| I[5].AdaptSet 1 | Signal: Adaptive Parameter 1 |
| I[5].AdaptSet 2 | Signal: Adaptive Parameter 2 |
| I[5].AdaptSet 3 | Signal: Adaptive Parameter 3 |
| I[5].AdaptSet 4 | Signal: Adaptive Parameter 4 |

General Lists

| <i>Name</i> | <i>Description</i> |
|----------------------|---|
| I[5].ExBlo1-I | Module input state: External blocking1 |
| I[5].ExBlo2-I | Module input state: External blocking2 |
| I[5].ExBlo TripCmd-I | Module input state: External Blocking of the Trip Command |
| I[5].Ex rev Interl-I | Module input state: External reverse interlocking |
| I[5].AdaptSet1-I | Module input state: Adaptive Parameter1 |
| I[5].AdaptSet2-I | Module input state: Adaptive Parameter2 |
| I[5].AdaptSet3-I | Module input state: Adaptive Parameter3 |
| I[5].AdaptSet4-I | Module input state: Adaptive Parameter4 |
| I[6].active | Signal: active |
| I[6].ExBlo | Signal: External Blocking |
| I[6].Ex rev Interl | Signal: External reverse Interlocking |
| I[6].Blo TripCmd | Signal: Trip Command blocked |
| I[6].ExBlo TripCmd | Signal: External Blocking of the Trip Command |
| I[6].IH2 Blo | Signal: Blocking the trip command by an inrush |
| I[6].Alarm L1 | Signal: Alarm L1 |
| I[6].Alarm L2 | Signal: Alarm L2 |
| I[6].Alarm L3 | Signal: Alarm L3 |
| I[6].Alarm | Signal: Alarm |
| I[6].Trip L1 | Signal: General Trip Phase L1 |
| I[6].Trip L2 | Signal: General Trip Phase L2 |
| I[6].Trip L3 | Signal: General Trip Phase L3 |
| I[6].Trip | Signal: Trip |
| I[6].TripCmd | Signal: Trip Command |
| I[6].DefaultSet | Signal: Default Parameter Set |
| I[6].AdaptSet 1 | Signal: Adaptive Parameter 1 |
| I[6].AdaptSet 2 | Signal: Adaptive Parameter 2 |
| I[6].AdaptSet 3 | Signal: Adaptive Parameter 3 |
| I[6].AdaptSet 4 | Signal: Adaptive Parameter 4 |
| I[6].ExBlo1-I | Module input state: External blocking1 |
| I[6].ExBlo2-I | Module input state: External blocking2 |
| I[6].ExBlo TripCmd-I | Module input state: External Blocking of the Trip Command |
| I[6].Ex rev Interl-I | Module input state: External reverse interlocking |
| I[6].AdaptSet1-I | Module input state: Adaptive Parameter1 |
| I[6].AdaptSet2-I | Module input state: Adaptive Parameter2 |
| I[6].AdaptSet3-I | Module input state: Adaptive Parameter3 |
| I[6].AdaptSet4-I | Module input state: Adaptive Parameter4 |
| IG[1].active | Signal: active |
| IG[1].ExBlo | Signal: External Blocking |
| IG[1].Ex rev Interl | Signal: External reverse Interlocking |
| IG[1].Blo TripCmd | Signal: Trip Command blocked |

General Lists

| <i>Name</i> | <i>Description</i> |
|-----------------------|---|
| IG[1].ExBlo TripCmd | Signal: External Blocking of the Trip Command |
| IG[1].Alarm | Signal: Alarm IG |
| IG[1].Trip | Signal: Trip |
| IG[1].TripCmd | Signal: Trip Command |
| IG[1].IGH2 Blo | Signal: blocked by an inrush |
| IG[1].DefaultSet | Signal: Default Parameter Set |
| IG[1].AdaptSet 1 | Signal: Adaptive Parameter 1 |
| IG[1].AdaptSet 2 | Signal: Adaptive Parameter 2 |
| IG[1].AdaptSet 3 | Signal: Adaptive Parameter 3 |
| IG[1].AdaptSet 4 | Signal: Adaptive Parameter 4 |
| IG[1].ExBlo1-I | Module input state: External blocking1 |
| IG[1].ExBlo2-I | Module input state: External blocking2 |
| IG[1].ExBlo TripCmd-I | Module input state: External Blocking of the Trip Command |
| IG[1].Ex rev Interl-I | Module input state: External reverse interlocking |
| IG[1].AdaptSet1-I | Module input state: Adaptive Parameter1 |
| IG[1].AdaptSet2-I | Module input state: Adaptive Parameter2 |
| IG[1].AdaptSet3-I | Module input state: Adaptive Parameter3 |
| IG[1].AdaptSet4-I | Module input state: Adaptive Parameter4 |
| IG[2].active | Signal: active |
| IG[2].ExBlo | Signal: External Blocking |
| IG[2].Ex rev Interl | Signal: External reverse Interlocking |
| IG[2].Blo TripCmd | Signal: Trip Command blocked |
| IG[2].ExBlo TripCmd | Signal: External Blocking of the Trip Command |
| IG[2].Alarm | Signal: Alarm IG |
| IG[2].Trip | Signal: Trip |
| IG[2].TripCmd | Signal: Trip Command |
| IG[2].IGH2 Blo | Signal: blocked by an inrush |
| IG[2].DefaultSet | Signal: Default Parameter Set |
| IG[2].AdaptSet 1 | Signal: Adaptive Parameter 1 |
| IG[2].AdaptSet 2 | Signal: Adaptive Parameter 2 |
| IG[2].AdaptSet 3 | Signal: Adaptive Parameter 3 |
| IG[2].AdaptSet 4 | Signal: Adaptive Parameter 4 |
| IG[2].ExBlo1-I | Module input state: External blocking1 |
| IG[2].ExBlo2-I | Module input state: External blocking2 |
| IG[2].ExBlo TripCmd-I | Module input state: External Blocking of the Trip Command |
| IG[2].Ex rev Interl-I | Module input state: External reverse interlocking |
| IG[2].AdaptSet1-I | Module input state: Adaptive Parameter1 |
| IG[2].AdaptSet2-I | Module input state: Adaptive Parameter2 |
| IG[2].AdaptSet3-I | Module input state: Adaptive Parameter3 |
| IG[2].AdaptSet4-I | Module input state: Adaptive Parameter4 |

General Lists

| <i>Name</i> | <i>Description</i> |
|-----------------------|---|
| IG[3].active | Signal: active |
| IG[3].ExBlo | Signal: External Blocking |
| IG[3].Ex rev Interl | Signal: External reverse Interlocking |
| IG[3].Blo TripCmd | Signal: Trip Command blocked |
| IG[3].ExBlo TripCmd | Signal: External Blocking of the Trip Command |
| IG[3].Alarm | Signal: Alarm IG |
| IG[3].Trip | Signal: Trip |
| IG[3].TripCmd | Signal: Trip Command |
| IG[3].IGH2 Blo | Signal: blocked by an inrush |
| IG[3].DefaultSet | Signal: Default Parameter Set |
| IG[3].AdaptSet 1 | Signal: Adaptive Parameter 1 |
| IG[3].AdaptSet 2 | Signal: Adaptive Parameter 2 |
| IG[3].AdaptSet 3 | Signal: Adaptive Parameter 3 |
| IG[3].AdaptSet 4 | Signal: Adaptive Parameter 4 |
| IG[3].ExBlo1-I | Module input state: External blocking1 |
| IG[3].ExBlo2-I | Module input state: External blocking2 |
| IG[3].ExBlo TripCmd-I | Module input state: External Blocking of the Trip Command |
| IG[3].Ex rev Interl-I | Module input state: External reverse interlocking |
| IG[3].AdaptSet1-I | Module input state: Adaptive Parameter1 |
| IG[3].AdaptSet2-I | Module input state: Adaptive Parameter2 |
| IG[3].AdaptSet3-I | Module input state: Adaptive Parameter3 |
| IG[3].AdaptSet4-I | Module input state: Adaptive Parameter4 |
| IG[4].active | Signal: active |
| IG[4].ExBlo | Signal: External Blocking |
| IG[4].Ex rev Interl | Signal: External reverse Interlocking |
| IG[4].Blo TripCmd | Signal: Trip Command blocked |
| IG[4].ExBlo TripCmd | Signal: External Blocking of the Trip Command |
| IG[4].Alarm | Signal: Alarm IG |
| IG[4].Trip | Signal: Trip |
| IG[4].TripCmd | Signal: Trip Command |
| IG[4].IGH2 Blo | Signal: blocked by an inrush |
| IG[4].DefaultSet | Signal: Default Parameter Set |
| IG[4].AdaptSet 1 | Signal: Adaptive Parameter 1 |
| IG[4].AdaptSet 2 | Signal: Adaptive Parameter 2 |
| IG[4].AdaptSet 3 | Signal: Adaptive Parameter 3 |
| IG[4].AdaptSet 4 | Signal: Adaptive Parameter 4 |
| IG[4].ExBlo1-I | Module input state: External blocking1 |
| IG[4].ExBlo2-I | Module input state: External blocking2 |
| IG[4].ExBlo TripCmd-I | Module input state: External Blocking of the Trip Command |
| IG[4].Ex rev Interl-I | Module input state: External reverse interlocking |

General Lists

| <i>Name</i> | <i>Description</i> |
|------------------------|---|
| IG[4].AdaptSet1-I | Module input state: Adaptive Parameter1 |
| IG[4].AdaptSet2-I | Module input state: Adaptive Parameter2 |
| IG[4].AdaptSet3-I | Module input state: Adaptive Parameter3 |
| IG[4].AdaptSet4-I | Module input state: Adaptive Parameter4 |
| ThR.active | Signal: active |
| ThR.ExBlo | Signal: External Blocking |
| ThR.Blo TripCmd | Signal: Trip Command blocked |
| ThR.ExBlo TripCmd | Signal: External Blocking of the Trip Command |
| ThR.Alarm | Signal: Alarm Thermal Overload |
| ThR.Trip | Signal: Trip |
| ThR.TripCmd | Signal: Trip Command |
| ThR.Res Thermal Cap | Signal: Resetting Thermal Replica |
| ThR.ExBlo1-I | Module input state: External blocking1 |
| ThR.ExBlo2-I | Module input state: External blocking2 |
| ThR.ExBlo TripCmd-I | Module input state: External Blocking of the Trip Command |
| I2>[1].active | Signal: active |
| I2>[1].ExBlo | Signal: External Blocking |
| I2>[1].Blo TripCmd | Signal: Trip Command blocked |
| I2>[1].ExBlo TripCmd | Signal: External Blocking of the Trip Command |
| I2>[1].Alarm | Signal: Alarm Negative Sequence |
| I2>[1].Trip | Signal: Trip |
| I2>[1].TripCmd | Signal: Trip Command |
| I2>[1].ExBlo1-I | Module input state: External blocking1 |
| I2>[1].ExBlo2-I | Module input state: External blocking2 |
| I2>[1].ExBlo TripCmd-I | Module input state: External Blocking of the Trip Command |
| I2>[2].active | Signal: active |
| I2>[2].ExBlo | Signal: External Blocking |
| I2>[2].Blo TripCmd | Signal: Trip Command blocked |
| I2>[2].ExBlo TripCmd | Signal: External Blocking of the Trip Command |
| I2>[2].Alarm | Signal: Alarm Negative Sequence |
| I2>[2].Trip | Signal: Trip |
| I2>[2].TripCmd | Signal: Trip Command |
| I2>[2].ExBlo1-I | Module input state: External blocking1 |
| I2>[2].ExBlo2-I | Module input state: External blocking2 |
| I2>[2].ExBlo TripCmd-I | Module input state: External Blocking of the Trip Command |
| IH2.active | Signal: active |
| IH2.ExBlo | Signal: External Blocking |
| IH2.Blo L1 | Signal: Blocked L1 |
| IH2.Blo L2 | Signal: Blocked L2 |
| IH2.Blo L3 | Signal: Blocked L3 |

General Lists

| <i>Name</i> | <i>Description</i> |
|----------------------|--|
| IH2.Blo IG meas | Signal: Blocking of the ground (earth) protection module (measured ground current) |
| IH2.Blo IG calc | Signal: Blocking of the ground (earth) protection module (calculated ground current) |
| IH2.3-ph Blo | Signal: Inrush was detected in at least one phase - trip command blocked. |
| IH2.ExBlo1-I | Module input state: External blocking1 |
| IH2.ExBlo2-I | Module input state: External blocking2 |
| V[1].active | Signal: active |
| V[1].ExBlo | Signal: External Blocking |
| V[1].Blo TripCmd | Signal: Trip Command blocked |
| V[1].ExBlo TripCmd | Signal: External Blocking of the Trip Command |
| V[1].Alarm L1 | Signal: Alarm L1 |
| V[1].Alarm L2 | Signal: Alarm L2 |
| V[1].Alarm L3 | Signal: Alarm L3 |
| V[1].Alarm | Signal: Alarm voltage stage |
| V[1].Trip L1 | Signal: General Trip Phase L1 |
| V[1].Trip L2 | Signal: General Trip Phase L2 |
| V[1].Trip L3 | Signal: General Trip Phase L3 |
| V[1].Trip | Signal: Trip |
| V[1].TripCmd | Signal: Trip Command |
| V[1].ExBlo1-I | Module input state: External blocking1 |
| V[1].ExBlo2-I | Module input state: External blocking2 |
| V[1].ExBlo TripCmd-I | Module input state: External Blocking of the Trip Command |
| V[2].active | Signal: active |
| V[2].ExBlo | Signal: External Blocking |
| V[2].Blo TripCmd | Signal: Trip Command blocked |
| V[2].ExBlo TripCmd | Signal: External Blocking of the Trip Command |
| V[2].Alarm L1 | Signal: Alarm L1 |
| V[2].Alarm L2 | Signal: Alarm L2 |
| V[2].Alarm L3 | Signal: Alarm L3 |
| V[2].Alarm | Signal: Alarm voltage stage |
| V[2].Trip L1 | Signal: General Trip Phase L1 |
| V[2].Trip L2 | Signal: General Trip Phase L2 |
| V[2].Trip L3 | Signal: General Trip Phase L3 |
| V[2].Trip | Signal: Trip |
| V[2].TripCmd | Signal: Trip Command |
| V[2].ExBlo1-I | Module input state: External blocking1 |
| V[2].ExBlo2-I | Module input state: External blocking2 |
| V[2].ExBlo TripCmd-I | Module input state: External Blocking of the Trip Command |
| V[3].active | Signal: active |
| V[3].ExBlo | Signal: External Blocking |
| V[3].Blo TripCmd | Signal: Trip Command blocked |

General Lists

| <i>Name</i> | <i>Description</i> |
|----------------------|---|
| V[3].ExBlo TripCmd | Signal: External Blocking of the Trip Command |
| V[3].Alarm L1 | Signal: Alarm L1 |
| V[3].Alarm L2 | Signal: Alarm L2 |
| V[3].Alarm L3 | Signal: Alarm L3 |
| V[3].Alarm | Signal: Alarm voltage stage |
| V[3].Trip L1 | Signal: General Trip Phase L1 |
| V[3].Trip L2 | Signal: General Trip Phase L2 |
| V[3].Trip L3 | Signal: General Trip Phase L3 |
| V[3].Trip | Signal: Trip |
| V[3].TripCmd | Signal: Trip Command |
| V[3].ExBlo1-I | Module input state: External blocking1 |
| V[3].ExBlo2-I | Module input state: External blocking2 |
| V[3].ExBlo TripCmd-I | Module input state: External Blocking of the Trip Command |
| V[4].active | Signal: active |
| V[4].ExBlo | Signal: External Blocking |
| V[4].Blo TripCmd | Signal: Trip Command blocked |
| V[4].ExBlo TripCmd | Signal: External Blocking of the Trip Command |
| V[4].Alarm L1 | Signal: Alarm L1 |
| V[4].Alarm L2 | Signal: Alarm L2 |
| V[4].Alarm L3 | Signal: Alarm L3 |
| V[4].Alarm | Signal: Alarm voltage stage |
| V[4].Trip L1 | Signal: General Trip Phase L1 |
| V[4].Trip L2 | Signal: General Trip Phase L2 |
| V[4].Trip L3 | Signal: General Trip Phase L3 |
| V[4].Trip | Signal: Trip |
| V[4].TripCmd | Signal: Trip Command |
| V[4].ExBlo1-I | Module input state: External blocking1 |
| V[4].ExBlo2-I | Module input state: External blocking2 |
| V[4].ExBlo TripCmd-I | Module input state: External Blocking of the Trip Command |
| V[5].active | Signal: active |
| V[5].ExBlo | Signal: External Blocking |
| V[5].Blo TripCmd | Signal: Trip Command blocked |
| V[5].ExBlo TripCmd | Signal: External Blocking of the Trip Command |
| V[5].Alarm L1 | Signal: Alarm L1 |
| V[5].Alarm L2 | Signal: Alarm L2 |
| V[5].Alarm L3 | Signal: Alarm L3 |
| V[5].Alarm | Signal: Alarm voltage stage |
| V[5].Trip L1 | Signal: General Trip Phase L1 |
| V[5].Trip L2 | Signal: General Trip Phase L2 |
| V[5].Trip L3 | Signal: General Trip Phase L3 |

General Lists

| <i>Name</i> | <i>Description</i> |
|-------------------------|---|
| V[5].Trip | Signal: Trip |
| V[5].TripCmd | Signal: Trip Command |
| V[5].ExBlo1-I | Module input state: External blocking1 |
| V[5].ExBlo2-I | Module input state: External blocking2 |
| V[5].ExBlo TripCmd-I | Module input state: External Blocking of the Trip Command |
| V[6].active | Signal: active |
| V[6].ExBlo | Signal: External Blocking |
| V[6].Blo TripCmd | Signal: Trip Command blocked |
| V[6].ExBlo TripCmd | Signal: External Blocking of the Trip Command |
| V[6].Alarm L1 | Signal: Alarm L1 |
| V[6].Alarm L2 | Signal: Alarm L2 |
| V[6].Alarm L3 | Signal: Alarm L3 |
| V[6].Alarm | Signal: Alarm voltage stage |
| V[6].Trip L1 | Signal: General Trip Phase L1 |
| V[6].Trip L2 | Signal: General Trip Phase L2 |
| V[6].Trip L3 | Signal: General Trip Phase L3 |
| V[6].Trip | Signal: Trip |
| V[6].TripCmd | Signal: Trip Command |
| V[6].ExBlo1-I | Module input state: External blocking1 |
| V[6].ExBlo2-I | Module input state: External blocking2 |
| V[6].ExBlo TripCmd-I | Module input state: External Blocking of the Trip Command |
| df/dt.active | Signal: active |
| df/dt.ExBlo | Signal: External Blocking |
| df/dt.Blo by V< | Signal: Module is blocked by undervoltage. |
| df/dt.Blo TripCmd | Signal: Trip Command blocked |
| df/dt.ExBlo TripCmd | Signal: External Blocking of the Trip Command |
| df/dt.Alarm | Signal: Alarm Frequency Protection (collective signal) |
| df/dt.Trip | Signal: Trip Frequency Protection (collective signal) |
| df/dt.TripCmd | Signal: Trip Command |
| df/dt.ExBlo1-I | Module input state: External blocking1 |
| df/dt.ExBlo2-I | Module input state: External blocking2 |
| df/dt.ExBlo TripCmd-I | Module input state: External Blocking of the Trip Command |
| delta phi.active | Signal: active |
| delta phi.ExBlo | Signal: External Blocking |
| delta phi.Blo by V< | Signal: Module is blocked by undervoltage. |
| delta phi.Blo TripCmd | Signal: Trip Command blocked |
| delta phi.ExBlo TripCmd | Signal: External Blocking of the Trip Command |
| delta phi.Alarm | Signal: Alarm Frequency Protection (collective signal) |
| delta phi.Trip | Signal: Trip Frequency Protection (collective signal) |
| delta phi.TripCmd | Signal: Trip Command |

General Lists

| <i>Name</i> | <i>Description</i> |
|-------------------------------|---|
| delta phi.ExBlo1-I | Module input state: External blocking1 |
| delta phi.ExBlo2-I | Module input state: External blocking2 |
| delta phi.ExBlo TripCmd-I | Module input state: External Blocking of the Trip Command |
| Intertripping.active | Signal: active |
| Intertripping.ExBlo | Signal: External Blocking |
| Intertripping.Blo TripCmd | Signal: Trip Command blocked |
| Intertripping.ExBlo TripCmd | Signal: External Blocking of the Trip Command |
| Intertripping.Alarm | Signal: Alarm |
| Intertripping.Trip | Signal: Trip |
| Intertripping.TripCmd | Signal: Trip Command |
| Intertripping.ExBlo1-I | Module input state: External blocking1 |
| Intertripping.ExBlo2-I | Module input state: External blocking2 |
| Intertripping.ExBlo TripCmd-I | Module input state: External Blocking of the Trip Command |
| Intertripping.Alarm-I | Module input state: Alarm |
| Intertripping.Trip-I | Module input state: Trip |
| P.active | Signal: active |
| P.ExBlo | Signal: External Blocking |
| P.Blo TripCmd | Signal: Trip Command blocked |
| P.ExBlo TripCmd | Signal: External Blocking of the Trip Command |
| P.Alarm | Signal: Alarm Power Protection |
| P.Trip | Signal: Trip Power Protection |
| P.TripCmd | Signal: Trip Command |
| P.ExBlo1-I | Module input state: External blocking |
| P.ExBlo2-I | Module input state: External blocking |
| P.ExBlo TripCmd-I | Module input state: External Blocking of the Trip Command |
| Q.active | Signal: active |
| Q.ExBlo | Signal: External Blocking |
| Q.Blo TripCmd | Signal: Trip Command blocked |
| Q.ExBlo TripCmd | Signal: External Blocking of the Trip Command |
| Q.Alarm | Signal: Alarm Power Protection |
| Q.Trip | Signal: Trip Power Protection |
| Q.TripCmd | Signal: Trip Command |
| Q.ExBlo1-I | Module input state: External blocking |
| Q.ExBlo2-I | Module input state: External blocking |
| Q.ExBlo TripCmd-I | Module input state: External Blocking of the Trip Command |
| LVRT[1].active | Signal: active |
| LVRT[1].ExBlo | Signal: External Blocking |
| LVRT[1].Blo TripCmd | Signal: Trip Command blocked |
| LVRT[1].ExBlo TripCmd | Signal: External Blocking of the Trip Command |
| LVRT[1].Alarm L1 | Signal: Alarm L1 |

General Lists

| <i>Name</i> | <i>Description</i> |
|---------------------------|---|
| LVRT[1].Alarm L2 | Signal: Alarm L2 |
| LVRT[1].Alarm L3 | Signal: Alarm L3 |
| LVRT[1].Alarm | Signal: Alarm voltage stage |
| LVRT[1].Trip L1 | Signal: General Trip Phase L1 |
| LVRT[1].Trip L2 | Signal: General Trip Phase L2 |
| LVRT[1].Trip L3 | Signal: General Trip Phase L3 |
| LVRT[1].Trip | Signal: Trip |
| LVRT[1].TripCmd | Signal: Trip Command |
| LVRT[1].t-LVRT is running | Signal: t-LVRT is running |
| LVRT[1].ExBlo1-I | Module input state: External blocking1 |
| LVRT[1].ExBlo2-I | Module input state: External blocking2 |
| LVRT[1].ExBlo TripCmd-I | Module input state: External Blocking of the Trip Command |
| LVRT[2].active | Signal: active |
| LVRT[2].ExBlo | Signal: External Blocking |
| LVRT[2].Blo TripCmd | Signal: Trip Command blocked |
| LVRT[2].ExBlo TripCmd | Signal: External Blocking of the Trip Command |
| LVRT[2].Alarm L1 | Signal: Alarm L1 |
| LVRT[2].Alarm L2 | Signal: Alarm L2 |
| LVRT[2].Alarm L3 | Signal: Alarm L3 |
| LVRT[2].Alarm | Signal: Alarm voltage stage |
| LVRT[2].Trip L1 | Signal: General Trip Phase L1 |
| LVRT[2].Trip L2 | Signal: General Trip Phase L2 |
| LVRT[2].Trip L3 | Signal: General Trip Phase L3 |
| LVRT[2].Trip | Signal: Trip |
| LVRT[2].TripCmd | Signal: Trip Command |
| LVRT[2].t-LVRT is running | Signal: t-LVRT is running |
| LVRT[2].ExBlo1-I | Module input state: External blocking1 |
| LVRT[2].ExBlo2-I | Module input state: External blocking2 |
| LVRT[2].ExBlo TripCmd-I | Module input state: External Blocking of the Trip Command |
| VG[1].active | Signal: active |
| VG[1].ExBlo | Signal: External Blocking |
| VG[1].Blo TripCmd | Signal: Trip Command blocked |
| VG[1].ExBlo TripCmd | Signal: External Blocking of the Trip Command |
| VG[1].Alarm | Signal: Alarm Residual Voltage Supervision-stage |
| VG[1].Trip | Signal: Trip |
| VG[1].TripCmd | Signal: Trip Command |
| VG[1].ExBlo1-I | Module input state: External blocking1 |
| VG[1].ExBlo2-I | Module input state: External blocking2 |
| VG[1].ExBlo TripCmd-I | Module input state: External Blocking of the Trip Command |
| VG[2].active | Signal: active |

General Lists

| <i>Name</i> | <i>Description</i> |
|-------------------------|---|
| VG[2].ExBlo | Signal: External Blocking |
| VG[2].Blo TripCmd | Signal: Trip Command blocked |
| VG[2].ExBlo TripCmd | Signal: External Blocking of the Trip Command |
| VG[2].Alarm | Signal: Alarm Residual Voltage Supervision-stage |
| VG[2].Trip | Signal: Trip |
| VG[2].TripCmd | Signal: Trip Command |
| VG[2].ExBlo1-I | Module input state: External blocking1 |
| VG[2].ExBlo2-I | Module input state: External blocking2 |
| VG[2].ExBlo TripCmd-I | Module input state: External Blocking of the Trip Command |
| V012[1].active | Signal: active |
| V012[1].ExBlo | Signal: External Blocking |
| V012[1].Blo TripCmd | Signal: Trip Command blocked |
| V012[1].ExBlo TripCmd | Signal: External Blocking of the Trip Command |
| V012[1].Alarm | Signal: Alarm voltage asymmetry |
| V012[1].Trip | Signal: Trip |
| V012[1].TripCmd | Signal: Trip Command |
| V012[1].ExBlo1-I | Module input state: External blocking1 |
| V012[1].ExBlo2-I | Module input state: External blocking2 |
| V012[1].ExBlo TripCmd-I | Module input state: External Blocking of the Trip Command |
| V012[2].active | Signal: active |
| V012[2].ExBlo | Signal: External Blocking |
| V012[2].Blo TripCmd | Signal: Trip Command blocked |
| V012[2].ExBlo TripCmd | Signal: External Blocking of the Trip Command |
| V012[2].Alarm | Signal: Alarm voltage asymmetry |
| V012[2].Trip | Signal: Trip |
| V012[2].TripCmd | Signal: Trip Command |
| V012[2].ExBlo1-I | Module input state: External blocking1 |
| V012[2].ExBlo2-I | Module input state: External blocking2 |
| V012[2].ExBlo TripCmd-I | Module input state: External Blocking of the Trip Command |
| V012[3].active | Signal: active |
| V012[3].ExBlo | Signal: External Blocking |
| V012[3].Blo TripCmd | Signal: Trip Command blocked |
| V012[3].ExBlo TripCmd | Signal: External Blocking of the Trip Command |
| V012[3].Alarm | Signal: Alarm voltage asymmetry |
| V012[3].Trip | Signal: Trip |
| V012[3].TripCmd | Signal: Trip Command |
| V012[3].ExBlo1-I | Module input state: External blocking1 |
| V012[3].ExBlo2-I | Module input state: External blocking2 |
| V012[3].ExBlo TripCmd-I | Module input state: External Blocking of the Trip Command |
| V012[4].active | Signal: active |

General Lists

| Name | Description |
|--------------------------|--|
| V012[4].ExBlo | Signal: External Blocking |
| V012[4].Blo TripCmd | Signal: Trip Command blocked |
| V012[4].ExBlo TripCmd | Signal: External Blocking of the Trip Command |
| V012[4].Alarm | Signal: Alarm voltage asymmetry |
| V012[4].Trip | Signal: Trip |
| V012[4].TripCmd | Signal: Trip Command |
| V012[4].ExBlo1-I | Module input state: External blocking1 |
| V012[4].ExBlo2-I | Module input state: External blocking2 |
| V012[4].ExBlo TripCmd-I | Module input state: External Blocking of the Trip Command |
| V012[5].active | Signal: active |
| V012[5].ExBlo | Signal: External Blocking |
| V012[5].Blo TripCmd | Signal: Trip Command blocked |
| V012[5].ExBlo TripCmd | Signal: External Blocking of the Trip Command |
| V012[5].Alarm | Signal: Alarm voltage asymmetry |
| V012[5].Trip | Signal: Trip |
| V012[5].TripCmd | Signal: Trip Command |
| V012[5].ExBlo1-I | Module input state: External blocking1 |
| V012[5].ExBlo2-I | Module input state: External blocking2 |
| V012[5].ExBlo TripCmd-I | Module input state: External Blocking of the Trip Command |
| V012[6].active | Signal: active |
| V012[6].ExBlo | Signal: External Blocking |
| V012[6].Blo TripCmd | Signal: Trip Command blocked |
| V012[6].ExBlo TripCmd | Signal: External Blocking of the Trip Command |
| V012[6].Alarm | Signal: Alarm voltage asymmetry |
| V012[6].Trip | Signal: Trip |
| V012[6].TripCmd | Signal: Trip Command |
| V012[6].ExBlo1-I | Module input state: External blocking1 |
| V012[6].ExBlo2-I | Module input state: External blocking2 |
| V012[6].ExBlo TripCmd-I | Module input state: External Blocking of the Trip Command |
| f[1].active | Signal: active |
| f[1].ExBlo | Signal: External Blocking |
| f[1].Blo by V< | Signal: Module is blocked by undervoltage. |
| f[1].Blo TripCmd | Signal: Trip Command blocked |
| f[1].ExBlo TripCmd | Signal: External Blocking of the Trip Command |
| f[1].Alarm f | Signal: Alarm Frequency Protection |
| f[1].Alarm df/dt DF/DT | Alarm instantaneous or average value of the rate-of-frequency-change |
| f[1].Alarm delta phi | Signal: Alarm Vector Surge |
| f[1].Alarm | Signal: Alarm Frequency Protection (collective signal) |
| f[1].Trip f | Signal: Frequency has exceeded the limit. |
| f[1].Trip df/dt DF/DT | Signal: Trip df/dt or DF/DT |

General Lists

| <i>Name</i> | <i>Description</i> |
|--------------------------|--|
| f[1].Trip delta phi | Signal: Trip Vector Surge |
| f[1].Trip | Signal: Trip Frequency Protection (collective signal) |
| f[1].TripCmd | Signal: Trip Command |
| f[1].ExBlo1-l | Module input state: External blocking1 |
| f[1].ExBlo2-l | Module input state: External blocking2 |
| f[1].ExBlo TripCmd-l | Module input state: External Blocking of the Trip Command |
| f[2].active | Signal: active |
| f[2].ExBlo | Signal: External Blocking |
| f[2].Blo by V< | Signal: Module is blocked by undervoltage. |
| f[2].Blo TripCmd | Signal: Trip Command blocked |
| f[2].ExBlo TripCmd | Signal: External Blocking of the Trip Command |
| f[2].Alarm f | Signal: Alarm Frequency Protection |
| f[2].Alarm df/dt DF/DT | Alarm instantaneous or average value of the rate-of-frequency-change |
| f[2].Alarm delta phi | Signal: Alarm Vector Surge |
| f[2].Alarm | Signal: Alarm Frequency Protection (collective signal) |
| f[2].Trip f | Signal: Frequency has exceeded the limit. |
| f[2].Trip df/dt DF/DT | Signal: Trip df/dt or DF/DT |
| f[2].Trip delta phi | Signal: Trip Vector Surge |
| f[2].Trip | Signal: Trip Frequency Protection (collective signal) |
| f[2].TripCmd | Signal: Trip Command |
| f[2].ExBlo1-l | Module input state: External blocking1 |
| f[2].ExBlo2-l | Module input state: External blocking2 |
| f[2].ExBlo TripCmd-l | Module input state: External Blocking of the Trip Command |
| f[3].active | Signal: active |
| f[3].ExBlo | Signal: External Blocking |
| f[3].Blo by V< | Signal: Module is blocked by undervoltage. |
| f[3].Blo TripCmd | Signal: Trip Command blocked |
| f[3].ExBlo TripCmd | Signal: External Blocking of the Trip Command |
| f[3].Alarm f | Signal: Alarm Frequency Protection |
| f[3].Alarm df/dt DF/DT | Alarm instantaneous or average value of the rate-of-frequency-change |
| f[3].Alarm delta phi | Signal: Alarm Vector Surge |
| f[3].Alarm | Signal: Alarm Frequency Protection (collective signal) |
| f[3].Trip f | Signal: Frequency has exceeded the limit. |
| f[3].Trip df/dt DF/DT | Signal: Trip df/dt or DF/DT |
| f[3].Trip delta phi | Signal: Trip Vector Surge |
| f[3].Trip | Signal: Trip Frequency Protection (collective signal) |
| f[3].TripCmd | Signal: Trip Command |
| f[3].ExBlo1-l | Module input state: External blocking1 |
| f[3].ExBlo2-l | Module input state: External blocking2 |
| f[3].ExBlo TripCmd-l | Module input state: External Blocking of the Trip Command |

General Lists

| <i>Name</i> | <i>Description</i> |
|--------------------------|--|
| f[4].active | Signal: active |
| f[4].ExBlo | Signal: External Blocking |
| f[4].Blo by V< | Signal: Module is blocked by undervoltage. |
| f[4].Blo TripCmd | Signal: Trip Command blocked |
| f[4].ExBlo TripCmd | Signal: External Blocking of the Trip Command |
| f[4].Alarm f | Signal: Alarm Frequency Protection |
| f[4].Alarm df/dt DF/DT | Alarm instantaneous or average value of the rate-of-frequency-change |
| f[4].Alarm delta phi | Signal: Alarm Vector Surge |
| f[4].Alarm | Signal: Alarm Frequency Protection (collective signal) |
| f[4].Trip f | Signal: Frequency has exceeded the limit. |
| f[4].Trip df/dt DF/DT | Signal: Trip df/dt or DF/DT |
| f[4].Trip delta phi | Signal: Trip Vector Surge |
| f[4].Trip | Signal: Trip Frequency Protection (collective signal) |
| f[4].TripCmd | Signal: Trip Command |
| f[4].ExBlo1-l | Module input state: External blocking1 |
| f[4].ExBlo2-l | Module input state: External blocking2 |
| f[4].ExBlo TripCmd-l | Module input state: External Blocking of the Trip Command |
| f[5].active | Signal: active |
| f[5].ExBlo | Signal: External Blocking |
| f[5].Blo by V< | Signal: Module is blocked by undervoltage. |
| f[5].Blo TripCmd | Signal: Trip Command blocked |
| f[5].ExBlo TripCmd | Signal: External Blocking of the Trip Command |
| f[5].Alarm f | Signal: Alarm Frequency Protection |
| f[5].Alarm df/dt DF/DT | Alarm instantaneous or average value of the rate-of-frequency-change |
| f[5].Alarm delta phi | Signal: Alarm Vector Surge |
| f[5].Alarm | Signal: Alarm Frequency Protection (collective signal) |
| f[5].Trip f | Signal: Frequency has exceeded the limit. |
| f[5].Trip df/dt DF/DT | Signal: Trip df/dt or DF/DT |
| f[5].Trip delta phi | Signal: Trip Vector Surge |
| f[5].Trip | Signal: Trip Frequency Protection (collective signal) |
| f[5].TripCmd | Signal: Trip Command |
| f[5].ExBlo1-l | Module input state: External blocking1 |
| f[5].ExBlo2-l | Module input state: External blocking2 |
| f[5].ExBlo TripCmd-l | Module input state: External Blocking of the Trip Command |
| f[6].active | Signal: active |
| f[6].ExBlo | Signal: External Blocking |
| f[6].Blo by V< | Signal: Module is blocked by undervoltage. |
| f[6].Blo TripCmd | Signal: Trip Command blocked |
| f[6].ExBlo TripCmd | Signal: External Blocking of the Trip Command |
| f[6].Alarm f | Signal: Alarm Frequency Protection |

General Lists

| <i>Name</i> | <i>Description</i> |
|--------------------------|--|
| f[6].Alarm df/dt DF/DT | Alarm instantaneous or average value of the rate-of-frequency-change |
| f[6].Alarm delta phi | Signal: Alarm Vector Surge |
| f[6].Alarm | Signal: Alarm Frequency Protection (collective signal) |
| f[6].Trip f | Signal: Frequency has exceeded the limit. |
| f[6].Trip df/dt DF/DT | Signal: Trip df/dt or DF/DT |
| f[6].Trip delta phi | Signal: Trip Vector Surge |
| f[6].Trip | Signal: Trip Frequency Protection (collective signal) |
| f[6].TripCmd | Signal: Trip Command |
| f[6].ExBlo1-I | Module input state: External blocking1 |
| f[6].ExBlo2-I | Module input state: External blocking2 |
| f[6].ExBlo TripCmd-I | Module input state: External Blocking of the Trip Command |
| PQS[1].active | Signal: active |
| PQS[1].ExBlo | Signal: External Blocking |
| PQS[1].Blo TripCmd | Signal: Trip Command blocked |
| PQS[1].ExBlo TripCmd | Signal: External Blocking of the Trip Command |
| PQS[1].Alarm | Signal: Alarm Power Protection |
| PQS[1].Trip | Signal: Trip Power Protection |
| PQS[1].TripCmd | Signal: Trip Command |
| PQS[1].ExBlo1-I | Module input state: External blocking |
| PQS[1].ExBlo2-I | Module input state: External blocking |
| PQS[1].ExBlo TripCmd-I | Module input state: External Blocking of the Trip Command |
| PQS[2].active | Signal: active |
| PQS[2].ExBlo | Signal: External Blocking |
| PQS[2].Blo TripCmd | Signal: Trip Command blocked |
| PQS[2].ExBlo TripCmd | Signal: External Blocking of the Trip Command |
| PQS[2].Alarm | Signal: Alarm Power Protection |
| PQS[2].Trip | Signal: Trip Power Protection |
| PQS[2].TripCmd | Signal: Trip Command |
| PQS[2].ExBlo1-I | Module input state: External blocking |
| PQS[2].ExBlo2-I | Module input state: External blocking |
| PQS[2].ExBlo TripCmd-I | Module input state: External Blocking of the Trip Command |
| PQS[3].active | Signal: active |
| PQS[3].ExBlo | Signal: External Blocking |
| PQS[3].Blo TripCmd | Signal: Trip Command blocked |
| PQS[3].ExBlo TripCmd | Signal: External Blocking of the Trip Command |
| PQS[3].Alarm | Signal: Alarm Power Protection |
| PQS[3].Trip | Signal: Trip Power Protection |
| PQS[3].TripCmd | Signal: Trip Command |
| PQS[3].ExBlo1-I | Module input state: External blocking |
| PQS[3].ExBlo2-I | Module input state: External blocking |

General Lists

| <i>Name</i> | <i>Description</i> |
|------------------------|---|
| PQS[3].ExBlo TripCmd-I | Module input state: External Blocking of the Trip Command |
| PQS[4].active | Signal: active |
| PQS[4].ExBlo | Signal: External Blocking |
| PQS[4].Blo TripCmd | Signal: Trip Command blocked |
| PQS[4].ExBlo TripCmd | Signal: External Blocking of the Trip Command |
| PQS[4].Alarm | Signal: Alarm Power Protection |
| PQS[4].Trip | Signal: Trip Power Protection |
| PQS[4].TripCmd | Signal: Trip Command |
| PQS[4].ExBlo1-I | Module input state: External blocking |
| PQS[4].ExBlo2-I | Module input state: External blocking |
| PQS[4].ExBlo TripCmd-I | Module input state: External Blocking of the Trip Command |
| PQS[5].active | Signal: active |
| PQS[5].ExBlo | Signal: External Blocking |
| PQS[5].Blo TripCmd | Signal: Trip Command blocked |
| PQS[5].ExBlo TripCmd | Signal: External Blocking of the Trip Command |
| PQS[5].Alarm | Signal: Alarm Power Protection |
| PQS[5].Trip | Signal: Trip Power Protection |
| PQS[5].TripCmd | Signal: Trip Command |
| PQS[5].ExBlo1-I | Module input state: External blocking |
| PQS[5].ExBlo2-I | Module input state: External blocking |
| PQS[5].ExBlo TripCmd-I | Module input state: External Blocking of the Trip Command |
| PQS[6].active | Signal: active |
| PQS[6].ExBlo | Signal: External Blocking |
| PQS[6].Blo TripCmd | Signal: Trip Command blocked |
| PQS[6].ExBlo TripCmd | Signal: External Blocking of the Trip Command |
| PQS[6].Alarm | Signal: Alarm Power Protection |
| PQS[6].Trip | Signal: Trip Power Protection |
| PQS[6].TripCmd | Signal: Trip Command |
| PQS[6].ExBlo1-I | Module input state: External blocking |
| PQS[6].ExBlo2-I | Module input state: External blocking |
| PQS[6].ExBlo TripCmd-I | Module input state: External Blocking of the Trip Command |
| PF[1].active | Signal: active |
| PF[1].ExBlo | Signal: External Blocking |
| PF[1].Blo TripCmd | Signal: Trip Command blocked |
| PF[1].ExBlo TripCmd | Signal: External Blocking of the Trip Command |
| PF[1].Alarm | Signal: Alarm Power Factor |
| PF[1].Trip | Signal: Trip Power Factor |
| PF[1].TripCmd | Signal: Trip Command |
| PF[1].Compensator | Signal: Compensation Signal |
| PF[1].Impossible | Signal: Alarm Power Factor Impossible |

General Lists

| <i>Name</i> | <i>Description</i> |
|---|--|
| PF[1].ExBlo1-I | Module input state: External blocking |
| PF[1].ExBlo2-I | Module input state: External blocking |
| PF[1].ExBlo TripCmd-I | Module input state: External Blocking of the Trip Command |
| PF[2].active | Signal: active |
| PF[2].ExBlo | Signal: External Blocking |
| PF[2].Blo TripCmd | Signal: Trip Command blocked |
| PF[2].ExBlo TripCmd | Signal: External Blocking of the Trip Command |
| PF[2].Alarm | Signal: Alarm Power Factor |
| PF[2].Trip | Signal: Trip Power Factor |
| PF[2].TripCmd | Signal: Trip Command |
| PF[2].Compensator | Signal: Compensation Signal |
| PF[2].Impossible | Signal: Alarm Power Factor Impossible |
| PF[2].ExBlo1-I | Module input state: External blocking |
| PF[2].ExBlo2-I | Module input state: External blocking |
| PF[2].ExBlo TripCmd-I | Module input state: External Blocking of the Trip Command |
| Q->&V<.active | Signal: active |
| Q->&V<.ExBlo | Signal: External Blocking |
| Q->&V<.Fuse Fail VT Blo | Signal: Blocked by Fuse Failure (VT) |
| Q->&V<.Alarm | Signal: Alarm Reactive Power Undervoltage Protection |
| Q->&V<.Decoupling Distributed Generator | Signal: Decoupling of the (local) Energy Generator/Resource |
| Q->&V<.Decoupling PCC | Signal: Decoupling at the Point of Common Coupling |
| Q->&V<.Power Angle | Signal: Admissible power angle exceeded |
| Q->&V<.Reactive Power Thres | Signal: Admissible Reactive Power Threshold exceeded |
| Q->&V<.VLL too low | Signal: Line-to-Line voltage too low |
| Q->&V<.ExBlo1-I | Module input state: External blocking1 |
| Q->&V<.ExBlo2-I | Module input state: External blocking2 |
| ReCon[1].active | Signal: active |
| ReCon[1].ExBlo | Signal: External Blocking |
| ReCon[1].Blo by Meas Circuit Superv | Signal: Module blocked by measuring circuit supervision |
| ReCon[1].Release Energy Resource | Signal: Release Energy Resource. |
| ReCon[1].ExBlo1-I | Module input state: External blocking1 |
| ReCon[1].ExBlo2-I | Module input state: External blocking2 |
| ReCon[1].V Ext Release PCC-I | Module input state: Release signal is being generated by the PCC (External Release) |
| ReCon[1].PCC Fuse Fail VT-I | State of the module input: Blocking if the fuse of a voltage transformer has tripped at the PCC. |
| ReCon[1].reconnected-I | This signal indicates the state "reconnected" (mains parallel). |
| ReCon[1].Decoupling1-I | Decoupling function, that blocks the reconnection. |
| ReCon[1].Decoupling2-I | Decoupling function, that blocks the reconnection. |

General Lists

| <i>Name</i> | <i>Description</i> |
|-------------------------------------|---|
| ReCon[1].Decoupling3-I | Decoupling function, that blocks the reconnection. |
| ReCon[1].Decoupling4-I | Decoupling function, that blocks the reconnection. |
| ReCon[1].Decoupling5-I | Decoupling function, that blocks the reconnection. |
| ReCon[1].Decoupling6-I | Decoupling function, that blocks the reconnection. |
| ReCon[2].active | Signal: active |
| ReCon[2].ExBlo | Signal: External Blocking |
| ReCon[2].Blo by Meas Circuit Superv | Signal: Module blocked by measuring circuit supervision |
| ReCon[2].Release Energy Resource | Signal: Release Energy Resource. |
| ReCon[2].ExBlo1-I | Module input state: External blocking1 |
| ReCon[2].ExBlo2-I | Module input state: External blocking2 |
| ReCon[2].V Ext Release PCC-I | Module input state: Release signal is being generated by the PCC (External Release) |
| ReCon[2].PCC Fuse Fail VT-I | State of the module input: Blocking if the fuse of a voltage transformer has tripped at the PCC. |
| ReCon[2].reconnected-I | This signal indicates the state "reconnected" (mains parallel). |
| ReCon[2].Decoupling1-I | Decoupling function, that blocks the reconnection. |
| ReCon[2].Decoupling2-I | Decoupling function, that blocks the reconnection. |
| ReCon[2].Decoupling3-I | Decoupling function, that blocks the reconnection. |
| ReCon[2].Decoupling4-I | Decoupling function, that blocks the reconnection. |
| ReCon[2].Decoupling5-I | Decoupling function, that blocks the reconnection. |
| ReCon[2].Decoupling6-I | Decoupling function, that blocks the reconnection. |
| UFLS.active | Signal: active |
| UFLS.ExBlo | Signal: External Blocking |
| UFLS.Fuse Fail VT Blo | Signal: Blocked by Fuse Failure (VT) |
| UFLS.I1 Release | Signal: "I Minimum Current" in order to prevent faulty tripping. Module will be released if the current exceeds this value. |
| UFLS.VLL min | Signal: Minimum Voltage |
| UFLS.Power Angle | Signal: Trigger Phi-Power (Positive Phase Sequence System) |
| UFLS.P min | Signal: Minimum Value (threshold) for the Active Power |
| UFLS.P Blo Loadshedding | Signal: Load shedding blocked based on evaluation of active power |
| UFLS.f< | Signal: Underfrequency threshold |
| UFLS.Alarm | Signal: Alarm P->&f< |
| UFLS.Trip | Signal: Signal: Trip |
| UFLS.DefaultSet | Signal: Default Parameter Set |
| UFLS.AdaptSet 1 | Signal: Adaptive Parameter 1 |
| UFLS.AdaptSet 2 | Signal: Adaptive Parameter 2 |
| UFLS.AdaptSet 3 | Signal: Adaptive Parameter 3 |
| UFLS.AdaptSet 4 | Signal: Adaptive Parameter 4 |
| UFLS.AdaptSet 5 | Signal: Adaptive Parameter 5 |
| UFLS.ExBlo1-I | Module input state: External blocking1 |

General Lists

| <i>Name</i> | <i>Description</i> |
|---------------------------|---|
| UFLS.ExBlo2-I | Module input state: External blocking2 |
| UFLS.Ex Pdir-I | Ignore (block) the evaluation of the power flow direction. This results in classical frequency based load shedding functionality. When this feature is set and active, the functionality of the module turns into conventional, only frequency based load shedding. |
| UFLS.AdaptSet1-I | Module input state: Adaptive Parameter1 |
| UFLS.AdaptSet2-I | Module input state: Adaptive Parameter2 |
| UFLS.AdaptSet3-I | Module input state: Adaptive Parameter3 |
| UFLS.AdaptSet4-I | Module input state: Adaptive Parameter4 |
| UFLS.AdaptSet5-I | Module input state: Adaptive Parameter5 |
| AR.active | Signal: active |
| AR.ExBlo | Signal: External Blocking |
| AR.Standby | Signal: Standby |
| AR.t-Blo after CB man ON | Signal: AR blocked after circuit breaker was switched on manually. This timer will be started if the circuit breaker was switched on manually. While this timer is running, AR cannot be started. |
| AR.Ready | Signal: Ready to shoot |
| AR.running | Signal: Auto Reclosing running |
| AR.t-dead | Signal: Dead time between trip and reclosure attempt |
| AR.CB ON Cmd | Signal: CB switch ON Command |
| AR.t-Run2Ready | Signal: Examination Time: If the Circuit Breaker remains after a reclosure attempt for the duration of this timer in the Closed position, the AR has been successful and the AR module returns into the ready state. |
| AR.Lock | Signal: Auto Reclosure is locked out |
| AR.t-Reset Lockout | Signal: Delay Timer for resetting the AR lockout. The reset of the AR lockout state will be delayed for this time, after the reset signal (e.g digital input or Scada) has been detected . |
| AR.Blo | Signal: Auto Reclosure is blocked |
| AR.t-Blo Reset | Signal: Delay Timer for resetting the AR blocking. The release (de-blocking) of the AR will be delayed for this time, if there is no blocking signal anymore. |
| AR.successful | Signal: Auto Reclosing successful |
| AR.failed | Signal: Auto Reclosing failure |
| AR.t-AR Supervision | Signal: AR Supervision |
| AR.Pre Shot | Pre Shot Control |
| AR.Shot 1 | Shot Control |
| AR.Shot 2 | Shot Control |
| AR.Shot 3 | Shot Control |
| AR.Shot 4 | Shot Control |
| AR.Shot 5 | Shot Control |
| AR.Shot 6 | Shot Control |
| AR.Service Alarm 1 | Signal: AR - Service Alarm 1, too many switching operations |
| AR.Service Alarm 2 | Signal: AR - Service Alarm 2 - too many switching operations |
| AR.Max Shots / h exceeded | Signal: The maximum allowed number of shots per hour has been exceeded. |
| AR.Res Statistics Cr | Signal: Reset all statistic AR counters: Total number of AR, successful and unsuccessful no of AR. |
| AR.Res Service Cr | Signal: Reset the Service Counters for Alarm and Blocking |
| AR.Reset Lockout | Signal: The AR Lockout has been reset via the panel. |

General Lists

| <i>Name</i> | <i>Description</i> |
|--------------------------|---|
| AR.Res Max Shots / h | Signal: The Counter for the maximum allowed shots per hour has been reset. |
| AR.ExBlo1-I | Module input state: External blocking1 |
| AR.ExBlo2-I | Module input state: External blocking2 |
| AR.Ex Shot Inc-I | Module input state: The AR Shot counter will be incremented by this external Signal. This can be used for Zone Coordination (of upstream Auto Reclosure devices). Note: This parameter enables the functionality only. The assignment has to be set within the global parameters. |
| AR.Ex Lock-I | Module input state: External AR lockout. |
| AR.DI Reset Ex Lock-I | Module input state: Resetting the lockout state of the AR (if the resetting via digital inputs has been selected). |
| AR.Scada Reset Ex Lock-I | Module input state: Resetting the Lockout State of the AR by Communication. |
| AR.abort: 1 | Abort the AR-cycle, if the state of the assigned signal is true. If the state of this function is true the AR will be aborted. |
| AR.abort: 2 | Abort the AR-cycle, if the state of the assigned signal is true. If the state of this function is true the AR will be aborted. |
| AR.abort: 3 | Abort the AR-cycle, if the state of the assigned signal is true. If the state of this function is true the AR will be aborted. |
| AR.abort: 4 | Abort the AR-cycle, if the state of the assigned signal is true. If the state of this function is true the AR will be aborted. |
| AR.abort: 5 | Abort the AR-cycle, if the state of the assigned signal is true. If the state of this function is true the AR will be aborted. |
| AR.abort: 6 | Abort the AR-cycle, if the state of the assigned signal is true. If the state of this function is true the AR will be aborted. |
| Sync.active | Signal: active |
| Sync.ExBlo | Signal: External Blocking |
| Sync.LiveBus | Signal: Live-Bus flag: 1=Live-Bus, 0=Voltage is below the LiveBus threshold |
| Sync.LiveLine | Signal: Live Line flag: 1=Live-Line, 0=Voltage is below the LiveLine threshold |
| Sync.SynchronRunTiming | Signal: SynchronRunTiming |
| Sync.SynchronFailed | Signal: This signal indicates a failed synchronization. It is set for 5s when the circuit breaker is still open after the Synchron-Run-timer has timed out. |
| Sync.SyncOverridden | Signal:Synchronism Check is overridden because one of the Synchronism overriding conditions (DB/DL or ExtBypass) is met. |
| Sync.VDiffTooHigh | Signal: Voltage difference between bus and line too high. |
| Sync.SlipTooHigh | Signal: Frequency difference (slip frequency) between bus and line voltages too high. |
| Sync.AngleDiffTooHigh | Signal: Phase Angle difference between bus and line voltages too high. |
| Sync.Sys-in-Sync | Signal: Bus and line voltages are in synchronism according to the system synchronism criteria. |
| Sync.Ready to Close | Signal: Ready to Close |
| Sync.ExBlo1-I | Module input state: External blocking1 |
| Sync.ExBlo2-I | Module input state: External blocking2 |
| Sync.Bypass-I | State of the module input: Bypass |
| Sync.CBCloseInitiate-I | State of the module input: Breaker Close Initiate with synchronism check from any control sources (e.g. HMI / SCADA). If the state of the assigned signal becomes true, a Breaker Close will be initiated (Trigger Source). |
| SOTF.active | Signal: active |
| SOTF.ExBlo | Signal: External Blocking |

General Lists

| <i>Name</i> | <i>Description</i> |
|------------------------|---|
| SOTF.Ex rev Interl | Signal: External reverse Interlocking |
| SOTF.enabled | Signal: Switch Onto Fault enabled. This Signal can be used to modify Overcurrent Protection Settings. |
| SOTF.AR Blo | Signal: Blocked by AR |
| SOTF.I< | Signal: No Load Current. |
| SOTF.ExBlo1-I | Module input state: External blocking |
| SOTF.ExBlo2-I | Module input state: External blocking |
| SOTF.Ex rev Inter-I | Module input state: External reverse interlocking |
| SOTF.Ext SOTF-I | Module input state: External Switch Onto Fault Alarm |
| CLPU.active | Signal: active |
| CLPU.ExBlo | Signal: External Blocking |
| CLPU.Ex rev Interl | Signal: External reverse Interlocking |
| CLPU.enabled | Signal: Cold Load enabled |
| CLPU.detected | Signal: Cold Load detected |
| CLPU.AR Blo | Signal: Blocked by AR |
| CLPU.I< | Signal: No Load Current. |
| CLPU.Load Inrush | Signal: Load Inrush |
| CLPU.Settle Time | Signal: Settle Time |
| CLPU.ExBlo1-I | Module input state: External blocking |
| CLPU.ExBlo2-I | Module input state: External blocking |
| CLPU.Ex rev Inter-I | Module input state: External reverse interlocking |
| ExP[1].active | Signal: active |
| ExP[1].ExBlo | Signal: External Blocking |
| ExP[1].Blo TripCmd | Signal: Trip Command blocked |
| ExP[1].ExBlo TripCmd | Signal: External Blocking of the Trip Command |
| ExP[1].Alarm | Signal: Alarm |
| ExP[1].Trip | Signal: Trip |
| ExP[1].TripCmd | Signal: Trip Command |
| ExP[1].ExBlo1-I | Module input state: External blocking1 |
| ExP[1].ExBlo2-I | Module input state: External blocking2 |
| ExP[1].ExBlo TripCmd-I | Module input state: External Blocking of the Trip Command |
| ExP[1].Alarm-I | Module input state: Alarm |
| ExP[1].Trip-I | Module input state: Trip |
| ExP[2].active | Signal: active |
| ExP[2].ExBlo | Signal: External Blocking |
| ExP[2].Blo TripCmd | Signal: Trip Command blocked |
| ExP[2].ExBlo TripCmd | Signal: External Blocking of the Trip Command |
| ExP[2].Alarm | Signal: Alarm |
| ExP[2].Trip | Signal: Trip |
| ExP[2].TripCmd | Signal: Trip Command |
| ExP[2].ExBlo1-I | Module input state: External blocking1 |

General Lists

| <i>Name</i> | <i>Description</i> |
|-------------------------|---|
| Exp[2].ExBlo2-I | Module input state: External blocking2 |
| Exp[2].ExBlo TripCmd-I | Module input state: External Blocking of the Trip Command |
| Exp[2].Alarm-I | Module input state: Alarm |
| Exp[2].Trip-I | Module input state: Trip |
| Exp[3].active | Signal: active |
| Exp[3].ExBlo | Signal: External Blocking |
| Exp[3].Blo TripCmd | Signal: Trip Command blocked |
| Exp[3].ExBlo TripCmd | Signal: External Blocking of the Trip Command |
| Exp[3].Alarm | Signal: Alarm |
| Exp[3].Trip | Signal: Trip |
| Exp[3].TripCmd | Signal: Trip Command |
| Exp[3].ExBlo1-I | Module input state: External blocking1 |
| Exp[3].ExBlo2-I | Module input state: External blocking2 |
| Exp[3].ExBlo TripCmd-I | Module input state: External Blocking of the Trip Command |
| Exp[3].Alarm-I | Module input state: Alarm |
| Exp[3].Trip-I | Module input state: Trip |
| Exp[4].active | Signal: active |
| Exp[4].ExBlo | Signal: External Blocking |
| Exp[4].Blo TripCmd | Signal: Trip Command blocked |
| Exp[4].ExBlo TripCmd | Signal: External Blocking of the Trip Command |
| Exp[4].Alarm | Signal: Alarm |
| Exp[4].Trip | Signal: Trip |
| Exp[4].TripCmd | Signal: Trip Command |
| Exp[4].ExBlo1-I | Module input state: External blocking1 |
| Exp[4].ExBlo2-I | Module input state: External blocking2 |
| Exp[4].ExBlo TripCmd-I | Module input state: External Blocking of the Trip Command |
| Exp[4].Alarm-I | Module input state: Alarm |
| Exp[4].Trip-I | Module input state: Trip |
| CBF.active | Signal: active |
| CBF.ExBlo | Signal: External Blocking |
| CBF.Waiting for Trigger | Waiting for Trigger |
| CBF.running | Signal: CBF-Module started |
| CBF.Alarm | Signal: Circuit Breaker Failure |
| CBF.Lockout | Signal: Lockout |
| CBF.Res Lockout | Signal: Reset Lockout |
| CBF.ExBlo1-I | Module input state: External blocking1 |
| CBF.ExBlo2-I | Module input state: External blocking2 |
| CBF.Trigger1-I | Module Input: Trigger that will start the CBF |
| CBF.Trigger2-I | Module Input: Trigger that will start the CBF |
| CBF.Trigger3-I | Module Input: Trigger that will start the CBF |

General Lists

| <i>Name</i> | <i>Description</i> |
|---------------------|--|
| TCS.active | Signal: active |
| TCS.ExBlo | Signal: External Blocking |
| TCS.Alarm | Signal: Alarm Trip Circuit Supervision |
| TCS.Not Possible | Not possible because no state indicator assigned to the breaker. |
| TCS.Aux ON-I | Module Input State: Position indicator/check-back signal of the CB (52a) |
| TCS.Aux OFF-I | Module input state: Position indicator/check-back signal of the CB (52b) |
| TCS.ExBlo1-I | Module input state: External blocking1 |
| TCS.ExBlo2-I | Module input state: External blocking2 |
| CTS.active | Signal: active |
| CTS.ExBlo | Signal: External Blocking |
| CTS.Alarm | Signal: Alarm Current Transformer Measuring Circuit Supervision |
| CTS.ExBlo1-I | Module input state: External blocking1 |
| CTS.ExBlo2-I | Module input state: External blocking2 |
| LOP.active | Signal: active |
| LOP.ExBlo | Signal: External Blocking |
| LOP.Alarm | Signal: Alarm Loss of Potential |
| LOP.LOP Blo | Signal: Loss of Potential blocks other elements. |
| LOP.Ex FF VT | Signal: Ex FF VT |
| LOP.Ex FF EVT | Signal: Alarm Fuse Failure Earth Voltage Transformers |
| LOP.ExBlo1-I | Module input state: External blocking1 |
| LOP.ExBlo2-I | Module input state: External blocking2 |
| LOP.Ex FF VT-I | State of the module input: Alarm Fuse Failure Voltage Transformers |
| LOP.Ex FF EVT-I | State of the module input: Alarm Fuse Failure Earth Voltage Transformers |
| LOP.Blo Trigger1-I | State of the module input: An Alarm of this protective element will block the Loss of Potential Detection. |
| LOP.Blo Trigger2-I | State of the module input: An Alarm of this protective element will block the Loss of Potential Detection. |
| LOP.Blo Trigger3-I | State of the module input: An Alarm of this protective element will block the Loss of Potential Detection. |
| LOP.Blo Trigger4-I | State of the module input: An Alarm of this protective element will block the Loss of Potential Detection. |
| LOP.Blo Trigger5-I | State of the module input: An Alarm of this protective element will block the Loss of Potential Detection. |
| PQSCr.Cr Ofw Ws Net | Signal: Counter Overflow Ws Net |
| PQSCr.Cr Ofw Wp Net | Signal: Counter Overflow Wp Net |
| PQSCr.Cr Ofw Wp+ | Signal: Counter Overflow Wp+ |
| PQSCr.Cr Ofw Wp- | Signal: Counter Overflow Wp- |
| PQSCr.Cr Ofw Wq Net | Signal: Counter Overflow Wq Net |
| PQSCr.Cr Ofw Wq+ | Signal: Counter Overflow Wq+ |
| PQSCr.Cr Ofw Wq- | Signal: Counter Overflow Wq- |
| PQSCr.Ws Net Res Cr | Signal: Ws Net Reset Counter |
| PQSCr.Wp Net Res Cr | Signal: Wp Net Reset Counter |
| PQSCr.Wp+ Res Cr | Signal: Wp+ Reset Counter |
| PQSCr.Wp- Res Cr | Signal: Wp- Reset Counter |
| PQSCr.Wq Net Res Cr | Signal: Wq Net Reset Counter |

General Lists

| <i>Name</i> | <i>Description</i> |
|--------------------------|---|
| PQSCr.Wq+ Res Cr | Signal: Wq+ Reset Counter |
| PQSCr.Wq- Res Cr | Signal: Wq- Reset Counter |
| PQSCr.Res all Energy Cr | Signal: Reset of all Energy Counters |
| PQSCr.Cr OflwW Ws Net | Signal: Counter Ws Net will overflow soon |
| PQSCr.Cr OflwW Wp Net | Signal: Counter Wp Net will overflow soon |
| PQSCr.Cr OflwW Wp+ | Signal: Counter Wp+ will overflow soon |
| PQSCr.Cr OflwW Wp- | Signal: Counter Wp- will overflow soon |
| PQSCr.Cr OflwW Wq Net | Signal: Counter Wq Net will overflow soon |
| PQSCr.Cr OflwW Wq+ | Signal: Counter Wq+ will overflow soon |
| PQSCr.Cr OflwW Wq- | Signal: Counter Wq- will overflow soon |
| SysA.active | Signal: active |
| SysA.ExBlo | Signal: External Blocking |
| SysA.Alarm Watt Power | Signal: Alarm permitted Active Power exceeded |
| SysA.Alarm VAr Power | Signal: Alarm permitted Reactive Power exceeded |
| SysA.Alarm VA Power | Signal: Alarm permitted Apparent Power exceeded |
| SysA.Alarm Watt Demand | Signal: Alarm averaged Active Power exceeded |
| SysA.Alarm VAr Demand | Signal: Alarm averaged Reactive Power exceeded |
| SysA.Alarm VA Demand | Signal: Alarm averaged Apparent Power exceeded |
| SysA.Alm Current Demd | Signal: Alarm averaged demand current |
| SysA.Alarm I THD | Signal: Alarm Total Harmonic Distortion Current |
| SysA.Alarm V THD | Signal: Alarm Total Harmonic Distortion Voltage |
| SysA.Trip Watt Power | Signal: Trip permitted Active Power exceeded |
| SysA.Trip VAr Power | Signal: Trip permitted Reactive Power exceeded |
| SysA.Trip VA Power | Signal: Trip permitted Apparent Power exceeded |
| SysA.Trip Watt Demand | Signal: Trip averaged Active Power exceeded |
| SysA.Trip VAr Demand | Signal: Trip averaged Reactive Power exceeded |
| SysA.Trip VA Demand | Signal: Trip averaged Apparent Power exceeded |
| SysA.Trip Current Demand | Signal: Trip averaged demand current |
| SysA.Trip I THD | Signal: Trip Total Harmonic Distortion Current |
| SysA.Trip V THD | Signal: Trip Total Harmonic Distortion Voltage |
| SysA.ExBlo-I | Module input state: External blocking |
| DI Slot X1.DI 1 | Signal: Digital Input |
| DI Slot X1.DI 2 | Signal: Digital Input |
| DI Slot X1.DI 3 | Signal: Digital Input |
| DI Slot X1.DI 4 | Signal: Digital Input |
| DI Slot X1.DI 5 | Signal: Digital Input |
| DI Slot X1.DI 6 | Signal: Digital Input |
| DI Slot X1.DI 7 | Signal: Digital Input |
| DI Slot X1.DI 8 | Signal: Digital Input |
| DI Slot X6.DI 1 | Signal: Digital Input |

General Lists

| <i>Name</i> | <i>Description</i> |
|-----------------------------|---|
| DI Slot X6.DI 2 | Signal: Digital Input |
| DI Slot X6.DI 3 | Signal: Digital Input |
| DI Slot X6.DI 4 | Signal: Digital Input |
| DI Slot X6.DI 5 | Signal: Digital Input |
| DI Slot X6.DI 6 | Signal: Digital Input |
| DI Slot X6.DI 7 | Signal: Digital Input |
| DI Slot X6.DI 8 | Signal: Digital Input |
| BO Slot X2.BO 1 | Signal: Binary Output Relay |
| BO Slot X2.BO 2 | Signal: Binary Output Relay |
| BO Slot X2.BO 3 | Signal: Binary Output Relay |
| BO Slot X2.BO 4 | Signal: Binary Output Relay |
| BO Slot X2.BO 5 | Signal: Binary Output Relay |
| BO Slot X2.BO 6 | Signal: Binary Output Relay |
| BO Slot X2.DISARMED! | Signal: CAUTION! RELAYS DISARMED in order to safely perform maintenance while eliminating the risk of taking an entire process off-line. (Note: The Self Supervision Contact cannot be disarmed). YOU MUST ENSURE that the relays are ARMED AGAIN after maintenance |
| BO Slot X2.Outs forced | Signal: The State of at least one Relay Output has been set by force. That means that the state of at least one Relay is forced and hence does not show the state of the assigned signals. |
| BO Slot X5.BO 1 | Signal: Binary Output Relay |
| BO Slot X5.BO 2 | Signal: Binary Output Relay |
| BO Slot X5.BO 3 | Signal: Binary Output Relay |
| BO Slot X5.BO 4 | Signal: Binary Output Relay |
| BO Slot X5.BO 5 | Signal: Binary Output Relay |
| BO Slot X5.BO 6 | Signal: Binary Output Relay |
| BO Slot X5.DISARMED! | Signal: CAUTION! RELAYS DISARMED in order to safely perform maintenance while eliminating the risk of taking an entire process off-line. (Note: The Self Supervision Contact cannot be disarmed). YOU MUST ENSURE that the relays are ARMED AGAIN after maintenance |
| BO Slot X5.Outs forced | Signal: The State of at least one Relay Output has been set by force. That means that the state of at least one Relay is forced and hence does not show the state of the assigned signals. |
| Event rec.Res all records | Signal: All records deleted |
| Disturb rec.recording | Signal: Recording |
| Disturb rec.memory full | Signal: Memory full |
| Disturb rec.Clear fail | Signal: Clear failure in memory |
| Disturb rec.Res all records | Signal: All records deleted |
| Disturb rec.Res rec | Signal: Delete record |
| Disturb rec.Man Trigger | Signal: Manual Trigger |
| Disturb rec.Start1-l | State of the module input:: Trigger event / start recording if: |
| Disturb rec.Start2-l | State of the module input:: Trigger event / start recording if: |
| Disturb rec.Start3-l | State of the module input:: Trigger event / start recording if: |
| Disturb rec.Start4-l | State of the module input:: Trigger event / start recording if: |
| Disturb rec.Start5-l | State of the module input:: Trigger event / start recording if: |
| Disturb rec.Start6-l | State of the module input:: Trigger event / start recording if: |

General Lists

| <i>Name</i> | <i>Description</i> |
|-----------------------------|--|
| Disturb rec.Start7-l | State of the module input:: Trigger event / start recording if: |
| Disturb rec.Start8-l | State of the module input:: Trigger event / start recording if: |
| Fault rec.Res rec | Signal: Delete record |
| Trend rec.Hand Reset | Hand Reset |
| SSV.System Error | Signal: Device Failure |
| SSV.SelfSuperVision Contact | Signal: SelfSuperVision Contact |
| Scada.SCADA connected | At least one SCADA System is connected to the device. |
| Scada.SCADA not connected | No SCADA System is connected to the device |
| DNP3.busy | This message is set if the protocol is started. It will be reset if the protocol is shut down. |
| DNP3.ready | The message will be set if the protocol is successfully started and ready for data exchange. |
| DNP3.active | The communication with the Master (Scada) is active. |
| DNP3.BinaryOutput0 | Virtual Digital Output (DNP). This corresponds to a virtual binary input of the protective device. |
| DNP3.BinaryOutput1 | Virtual Digital Output (DNP). This corresponds to a virtual binary input of the protective device. |
| DNP3.BinaryOutput2 | Virtual Digital Output (DNP). This corresponds to a virtual binary input of the protective device. |
| DNP3.BinaryOutput3 | Virtual Digital Output (DNP). This corresponds to a virtual binary input of the protective device. |
| DNP3.BinaryOutput4 | Virtual Digital Output (DNP). This corresponds to a virtual binary input of the protective device. |
| DNP3.BinaryOutput5 | Virtual Digital Output (DNP). This corresponds to a virtual binary input of the protective device. |
| DNP3.BinaryOutput6 | Virtual Digital Output (DNP). This corresponds to a virtual binary input of the protective device. |
| DNP3.BinaryOutput7 | Virtual Digital Output (DNP). This corresponds to a virtual binary input of the protective device. |
| DNP3.BinaryOutput8 | Virtual Digital Output (DNP). This corresponds to a virtual binary input of the protective device. |
| DNP3.BinaryOutput9 | Virtual Digital Output (DNP). This corresponds to a virtual binary input of the protective device. |
| DNP3.BinaryOutput10 | Virtual Digital Output (DNP). This corresponds to a virtual binary input of the protective device. |
| DNP3.BinaryOutput11 | Virtual Digital Output (DNP). This corresponds to a virtual binary input of the protective device. |
| DNP3.BinaryOutput12 | Virtual Digital Output (DNP). This corresponds to a virtual binary input of the protective device. |
| DNP3.BinaryOutput13 | Virtual Digital Output (DNP). This corresponds to a virtual binary input of the protective device. |
| DNP3.BinaryOutput14 | Virtual Digital Output (DNP). This corresponds to a virtual binary input of the protective device. |
| DNP3.BinaryOutput15 | Virtual Digital Output (DNP). This corresponds to a virtual binary input of the protective device. |
| DNP3.BinaryOutput16 | Virtual Digital Output (DNP). This corresponds to a virtual binary input of the protective device. |
| DNP3.BinaryOutput17 | Virtual Digital Output (DNP). This corresponds to a virtual binary input of the protective device. |
| DNP3.BinaryOutput18 | Virtual Digital Output (DNP). This corresponds to a virtual binary input of the protective device. |
| DNP3.BinaryOutput19 | Virtual Digital Output (DNP). This corresponds to a virtual binary input of the protective device. |
| DNP3.BinaryOutput20 | Virtual Digital Output (DNP). This corresponds to a virtual binary input of the protective device. |
| DNP3.BinaryOutput21 | Virtual Digital Output (DNP). This corresponds to a virtual binary input of the protective device. |
| DNP3.BinaryOutput22 | Virtual Digital Output (DNP). This corresponds to a virtual binary input of the protective device. |
| DNP3.BinaryOutput23 | Virtual Digital Output (DNP). This corresponds to a virtual binary input of the protective device. |
| DNP3.BinaryOutput24 | Virtual Digital Output (DNP). This corresponds to a virtual binary input of the protective device. |
| DNP3.BinaryOutput25 | Virtual Digital Output (DNP). This corresponds to a virtual binary input of the protective device. |
| DNP3.BinaryOutput26 | Virtual Digital Output (DNP). This corresponds to a virtual binary input of the protective device. |
| DNP3.BinaryOutput27 | Virtual Digital Output (DNP). This corresponds to a virtual binary input of the protective device. |
| DNP3.BinaryOutput28 | Virtual Digital Output (DNP). This corresponds to a virtual binary input of the protective device. |

General Lists

| <i>Name</i> | <i>Description</i> |
|--------------------------------------|--|
| Modbus.Scada Cmd 13 | Scada Command |
| Modbus.Scada Cmd 14 | Scada Command |
| Modbus.Scada Cmd 15 | Scada Command |
| Modbus.Scada Cmd 16 | Scada Command |
| Modbus.Config Bin Inp1-I | State of the module input: Config Bin Inp |
| Modbus.Config Bin Inp2-I | State of the module input: Config Bin Inp |
| Modbus.Config Bin Inp3-I | State of the module input: Config Bin Inp |
| Modbus.Config Bin Inp4-I | State of the module input: Config Bin Inp |
| Modbus.Config Bin Inp5-I | State of the module input: Config Bin Inp |
| Modbus.Config Bin Inp6-I | State of the module input: Config Bin Inp |
| Modbus.Config Bin Inp7-I | State of the module input: Config Bin Inp |
| Modbus.Config Bin Inp8-I | State of the module input: Config Bin Inp |
| Modbus.Config Bin Inp9-I | State of the module input: Config Bin Inp |
| Modbus.Config Bin Inp10-I | State of the module input: Config Bin Inp |
| Modbus.Config Bin Inp11-I | State of the module input: Config Bin Inp |
| Modbus.Config Bin Inp12-I | State of the module input: Config Bin Inp |
| Modbus.Config Bin Inp13-I | State of the module input: Config Bin Inp |
| Modbus.Config Bin Inp14-I | State of the module input: Config Bin Inp |
| Modbus.Config Bin Inp15-I | State of the module input: Config Bin Inp |
| Modbus.Config Bin Inp16-I | State of the module input: Config Bin Inp |
| Modbus.Config Bin Inp17-I | State of the module input: Config Bin Inp |
| Modbus.Config Bin Inp18-I | State of the module input: Config Bin Inp |
| Modbus.Config Bin Inp19-I | State of the module input: Config Bin Inp |
| Modbus.Config Bin Inp20-I | State of the module input: Config Bin Inp |
| Modbus.Config Bin Inp21-I | State of the module input: Config Bin Inp |
| Modbus.Config Bin Inp22-I | State of the module input: Config Bin Inp |
| Modbus.Config Bin Inp23-I | State of the module input: Config Bin Inp |
| Modbus.Config Bin Inp24-I | State of the module input: Config Bin Inp |
| Modbus.Config Bin Inp25-I | State of the module input: Config Bin Inp |
| Modbus.Config Bin Inp26-I | State of the module input: Config Bin Inp |
| Modbus.Config Bin Inp27-I | State of the module input: Config Bin Inp |
| Modbus.Config Bin Inp28-I | State of the module input: Config Bin Inp |
| Modbus.Config Bin Inp29-I | State of the module input: Config Bin Inp |
| Modbus.Config Bin Inp30-I | State of the module input: Config Bin Inp |
| Modbus.Config Bin Inp31-I | State of the module input: Config Bin Inp |
| Modbus.Config Bin Inp32-I | State of the module input: Config Bin Inp |
| IEC61850.MMS Client connected | At least one MMS client is connected to the device |
| IEC61850.All Goose Subscriber active | All Goose subscriber in the device are working |

General Lists

| <i>Name</i> | <i>Description</i> |
|------------------------------|---|
| IEC61850.VirtInp1 | Signal: Virtual Input (IEC61850 GGIO Ind) |
| IEC61850.VirtInp2 | Signal: Virtual Input (IEC61850 GGIO Ind) |
| IEC61850.VirtInp3 | Signal: Virtual Input (IEC61850 GGIO Ind) |
| IEC61850.VirtInp4 | Signal: Virtual Input (IEC61850 GGIO Ind) |
| IEC61850.VirtInp5 | Signal: Virtual Input (IEC61850 GGIO Ind) |
| IEC61850.VirtInp6 | Signal: Virtual Input (IEC61850 GGIO Ind) |
| IEC61850.VirtInp7 | Signal: Virtual Input (IEC61850 GGIO Ind) |
| IEC61850.VirtInp8 | Signal: Virtual Input (IEC61850 GGIO Ind) |
| IEC61850.VirtInp9 | Signal: Virtual Input (IEC61850 GGIO Ind) |
| IEC61850.VirtInp10 | Signal: Virtual Input (IEC61850 GGIO Ind) |
| IEC61850.VirtInp11 | Signal: Virtual Input (IEC61850 GGIO Ind) |
| IEC61850.VirtInp12 | Signal: Virtual Input (IEC61850 GGIO Ind) |
| IEC61850.VirtInp13 | Signal: Virtual Input (IEC61850 GGIO Ind) |
| IEC61850.VirtInp14 | Signal: Virtual Input (IEC61850 GGIO Ind) |
| IEC61850.VirtInp15 | Signal: Virtual Input (IEC61850 GGIO Ind) |
| IEC61850.VirtInp16 | Signal: Virtual Input (IEC61850 GGIO Ind) |
| IEC61850.VirtInp17 | Signal: Virtual Input (IEC61850 GGIO Ind) |
| IEC61850.VirtInp18 | Signal: Virtual Input (IEC61850 GGIO Ind) |
| IEC61850.VirtInp19 | Signal: Virtual Input (IEC61850 GGIO Ind) |
| IEC61850.VirtInp20 | Signal: Virtual Input (IEC61850 GGIO Ind) |
| IEC61850.VirtInp21 | Signal: Virtual Input (IEC61850 GGIO Ind) |
| IEC61850.VirtInp22 | Signal: Virtual Input (IEC61850 GGIO Ind) |
| IEC61850.VirtInp23 | Signal: Virtual Input (IEC61850 GGIO Ind) |
| IEC61850.VirtInp24 | Signal: Virtual Input (IEC61850 GGIO Ind) |
| IEC61850.VirtInp25 | Signal: Virtual Input (IEC61850 GGIO Ind) |
| IEC61850.VirtInp26 | Signal: Virtual Input (IEC61850 GGIO Ind) |
| IEC61850.VirtInp27 | Signal: Virtual Input (IEC61850 GGIO Ind) |
| IEC61850.VirtInp28 | Signal: Virtual Input (IEC61850 GGIO Ind) |
| IEC61850.VirtInp29 | Signal: Virtual Input (IEC61850 GGIO Ind) |
| IEC61850.VirtInp30 | Signal: Virtual Input (IEC61850 GGIO Ind) |
| IEC61850.VirtInp31 | Signal: Virtual Input (IEC61850 GGIO Ind) |
| IEC61850.VirtInp32 | Signal: Virtual Input (IEC61850 GGIO Ind) |
| IEC61850.Quality of GGIO In1 | Self-Supervision of the GGIO Input |
| IEC61850.Quality of GGIO In2 | Self-Supervision of the GGIO Input |
| IEC61850.Quality of GGIO In3 | Self-Supervision of the GGIO Input |
| IEC61850.Quality of GGIO In4 | Self-Supervision of the GGIO Input |
| IEC61850.Quality of GGIO In5 | Self-Supervision of the GGIO Input |
| IEC61850.Quality of GGIO In6 | Self-Supervision of the GGIO Input |
| IEC61850.Quality of GGIO In7 | Self-Supervision of the GGIO Input |
| IEC61850.Quality of GGIO In8 | Self-Supervision of the GGIO Input |

General Lists

| Name | Description |
|-------------------------------|------------------------------------|
| IEC61850.Quality of GGIO In9 | Self-Supervision of the GGIO Input |
| IEC61850.Quality of GGIO In10 | Self-Supervision of the GGIO Input |
| IEC61850.Quality of GGIO In11 | Self-Supervision of the GGIO Input |
| IEC61850.Quality of GGIO In12 | Self-Supervision of the GGIO Input |
| IEC61850.Quality of GGIO In13 | Self-Supervision of the GGIO Input |
| IEC61850.Quality of GGIO In14 | Self-Supervision of the GGIO Input |
| IEC61850.Quality of GGIO In15 | Self-Supervision of the GGIO Input |
| IEC61850.Quality of GGIO In16 | Self-Supervision of the GGIO Input |
| IEC61850.Quality of GGIO In17 | Self-Supervision of the GGIO Input |
| IEC61850.Quality of GGIO In18 | Self-Supervision of the GGIO Input |
| IEC61850.Quality of GGIO In19 | Self-Supervision of the GGIO Input |
| IEC61850.Quality of GGIO In20 | Self-Supervision of the GGIO Input |
| IEC61850.Quality of GGIO In21 | Self-Supervision of the GGIO Input |
| IEC61850.Quality of GGIO In22 | Self-Supervision of the GGIO Input |
| IEC61850.Quality of GGIO In23 | Self-Supervision of the GGIO Input |
| IEC61850.Quality of GGIO In24 | Self-Supervision of the GGIO Input |
| IEC61850.Quality of GGIO In25 | Self-Supervision of the GGIO Input |
| IEC61850.Quality of GGIO In26 | Self-Supervision of the GGIO Input |
| IEC61850.Quality of GGIO In27 | Self-Supervision of the GGIO Input |
| IEC61850.Quality of GGIO In28 | Self-Supervision of the GGIO Input |
| IEC61850.Quality of GGIO In29 | Self-Supervision of the GGIO Input |
| IEC61850.Quality of GGIO In30 | Self-Supervision of the GGIO Input |
| IEC61850.Quality of GGIO In31 | Self-Supervision of the GGIO Input |
| IEC61850.Quality of GGIO In32 | Self-Supervision of the GGIO Input |

General Lists

| <i>Name</i> | <i>Description</i> |
|----------------------------|--|
| IEC61850.VirtOut9-I | Module input state: Binary state of the Virtual Output (GGIO) |
| IEC61850.VirtOut10-I | Module input state: Binary state of the Virtual Output (GGIO) |
| IEC61850.VirtOut11-I | Module input state: Binary state of the Virtual Output (GGIO) |
| IEC61850.VirtOut12-I | Module input state: Binary state of the Virtual Output (GGIO) |
| IEC61850.VirtOut13-I | Module input state: Binary state of the Virtual Output (GGIO) |
| IEC61850.VirtOut14-I | Module input state: Binary state of the Virtual Output (GGIO) |
| IEC61850.VirtOut15-I | Module input state: Binary state of the Virtual Output (GGIO) |
| IEC61850.VirtOut16-I | Module input state: Binary state of the Virtual Output (GGIO) |
| IEC61850.VirtOut17-I | Module input state: Binary state of the Virtual Output (GGIO) |
| IEC61850.VirtOut18-I | Module input state: Binary state of the Virtual Output (GGIO) |
| IEC61850.VirtOut19-I | Module input state: Binary state of the Virtual Output (GGIO) |
| IEC61850.VirtOut20-I | Module input state: Binary state of the Virtual Output (GGIO) |
| IEC61850.VirtOut21-I | Module input state: Binary state of the Virtual Output (GGIO) |
| IEC61850.VirtOut22-I | Module input state: Binary state of the Virtual Output (GGIO) |
| IEC61850.VirtOut23-I | Module input state: Binary state of the Virtual Output (GGIO) |
| IEC61850.VirtOut24-I | Module input state: Binary state of the Virtual Output (GGIO) |
| IEC61850.VirtOut25-I | Module input state: Binary state of the Virtual Output (GGIO) |
| IEC61850.VirtOut26-I | Module input state: Binary state of the Virtual Output (GGIO) |
| IEC61850.VirtOut27-I | Module input state: Binary state of the Virtual Output (GGIO) |
| IEC61850.VirtOut28-I | Module input state: Binary state of the Virtual Output (GGIO) |
| IEC61850.VirtOut29-I | Module input state: Binary state of the Virtual Output (GGIO) |
| IEC61850.VirtOut30-I | Module input state: Binary state of the Virtual Output (GGIO) |
| IEC61850.VirtOut31-I | Module input state: Binary state of the Virtual Output (GGIO) |
| IEC61850.VirtOut32-I | Module input state: Binary state of the Virtual Output (GGIO) |
| IEC 103.Scada Cmd 1 | Scada Command |
| IEC 103.Scada Cmd 2 | Scada Command |
| IEC 103.Scada Cmd 3 | Scada Command |
| IEC 103.Scada Cmd 4 | Scada Command |
| IEC 103.Scada Cmd 5 | Scada Command |
| IEC 103.Scada Cmd 6 | Scada Command |
| IEC 103.Scada Cmd 7 | Scada Command |
| IEC 103.Scada Cmd 8 | Scada Command |
| IEC 103.Scada Cmd 9 | Scada Command |
| IEC 103.Scada Cmd 10 | Scada Command |
| IEC 103.Transmission | Signal: SCADA active |
| IEC 103.Failure Event lost | Failure event lost |
| Profibus.Data OK | Data within the Input field are OK (Yes=1) |
| Profibus.SubModul Err | Assignable Signal, Failure in Sub-Module, Communication Failure. |
| Profibus.Connection active | Connection active |
| Profibus.Scada Cmd 1 | Scada Command |

General Lists

| <i>Name</i> | <i>Description</i> |
|-------------------------|--|
| Profibus.Scada Cmd 2 | Scada Command |
| Profibus.Scada Cmd 3 | Scada Command |
| Profibus.Scada Cmd 4 | Scada Command |
| Profibus.Scada Cmd 5 | Scada Command |
| Profibus.Scada Cmd 6 | Scada Command |
| Profibus.Scada Cmd 7 | Scada Command |
| Profibus.Scada Cmd 8 | Scada Command |
| Profibus.Scada Cmd 9 | Scada Command |
| Profibus.Scada Cmd 10 | Scada Command |
| Profibus.Scada Cmd 11 | Scada Command |
| Profibus.Scada Cmd 12 | Scada Command |
| Profibus.Scada Cmd 13 | Scada Command |
| Profibus.Scada Cmd 14 | Scada Command |
| Profibus.Scada Cmd 15 | Scada Command |
| Profibus.Scada Cmd 16 | Scada Command |
| IRIG-B.IRIG-B active | Signal: If there is no valid IRIG-B signal for 60 sec, IRIG-B is regarded as inactive. |
| IRIG-B.High-Low Invert | Signal: The High and Low signals of the IRIG-B are inverted. This does NOT mean that the wiring is faulty. If the wiring is faulty no IRIG-B signal will be detected. |
| IRIG-B.Control Signal1 | Signal: IRIG-B Control Signal. The external IRIG-B generator can set these signals. They can be used for further control procedures inside the device (e.g. logic funtions). |
| IRIG-B.Control Signal2 | Signal: IRIG-B Control Signal. The external IRIG-B generator can set these signals. They can be used for further control procedures inside the device (e.g. logic funtions). |
| IRIG-B.Control Signal3 | Signal: IRIG-B Control Signal. The external IRIG-B generator can set these signals. They can be used for further control procedures inside the device (e.g. logic funtions). |
| IRIG-B.Control Signal4 | Signal: IRIG-B Control Signal. The external IRIG-B generator can set these signals. They can be used for further control procedures inside the device (e.g. logic funtions). |
| IRIG-B.Control Signal5 | Signal: IRIG-B Control Signal. The external IRIG-B generator can set these signals. They can be used for further control procedures inside the device (e.g. logic funtions). |
| IRIG-B.Control Signal6 | Signal: IRIG-B Control Signal. The external IRIG-B generator can set these signals. They can be used for further control procedures inside the device (e.g. logic funtions). |
| IRIG-B.Control Signal7 | Signal: IRIG-B Control Signal. The external IRIG-B generator can set these signals. They can be used for further control procedures inside the device (e.g. logic funtions). |
| IRIG-B.Control Signal8 | Signal: IRIG-B Control Signal. The external IRIG-B generator can set these signals. They can be used for further control procedures inside the device (e.g. logic funtions). |
| IRIG-B.Control Signal9 | Signal: IRIG-B Control Signal. The external IRIG-B generator can set these signals. They can be used for further control procedures inside the device (e.g. logic funtions). |
| IRIG-B.Control Signal10 | Signal: IRIG-B Control Signal. The external IRIG-B generator can set these signals. They can be used for further control procedures inside the device (e.g. logic funtions). |
| IRIG-B.Control Signal11 | Signal: IRIG-B Control Signal. The external IRIG-B generator can set these signals. They can be used for further control procedures inside the device (e.g. logic funtions). |
| IRIG-B.Control Signal12 | Signal: IRIG-B Control Signal. The external IRIG-B generator can set these signals. They can be used for further control procedures inside the device (e.g. logic funtions). |
| IRIG-B.Control Signal13 | Signal: IRIG-B Control Signal. The external IRIG-B generator can set these signals. They can be used for further control procedures inside the device (e.g. logic funtions). |

General Lists

| Name | Description |
|-------------------------------|--|
| IRIG-B.Control Signal14 | Signal: IRIG-B Control Signal. The external IRIG-B generator can set these signals. They can be used for further control procedures inside the device (e.g. logic funtions). |
| IRIG-B.Control Signal15 | Signal: IRIG-B Control Signal. The external IRIG-B generator can set these signals. They can be used for further control procedures inside the device (e.g. logic funtions). |
| IRIG-B.Control Signal16 | Signal: IRIG-B Control Signal. The external IRIG-B generator can set these signals. They can be used for further control procedures inside the device (e.g. logic funtions). |
| IRIG-B.Control Signal17 | Signal: IRIG-B Control Signal. The external IRIG-B generator can set these signals. They can be used for further control procedures inside the device (e.g. logic funtions). |
| IRIG-B.Control Signal18 | Signal: IRIG-B Control Signal. The external IRIG-B generator can set these signals. They can be used for further control procedures inside the device (e.g. logic funtions). |
| SNTP.SNTP active | Signal: If there is no valid SNTP signal for 120 sec, SNTP is regarded as inactive. |
| Statistics.ResFc all | Signal: Resetting of all Statistic values (Current Demand, Power Demand, Min, Max) |
| Statistics.ResFc Vavg | Signal: Resetting of the sliding average calculation. |
| Statistics.ResFc I Demand | Signal: Resetting of Statistics - Current Demand (avg, peak avg) |
| Statistics.ResFc P Demand | Signal: Resetting of Statistics - Power Demand (avg, peak avg) |
| Statistics.ResFc Max | Signal: Resetting of all Maximum values |
| Statistics.ResFc Min | Signal: Resetting of all Minimum values |
| Statistics.StartFc Vavg-I | State of the module input: (StartFunc3_h) |
| Statistics.StartFc I Demand-I | State of the module input: Start of the Statistics of the Current Demand |
| Statistics.StartFc P Demand-I | State of the module input: Start of the Statistics of the Active Power Demand |
| Logics.LE1.Gate Out | Signal: Output of the logic gate |
| Logics.LE1.Timer Out | Signal: Timer Output |
| Logics.LE1.Out | Signal: Latched Output (Q) |
| Logics.LE1.Out inverted | Signal: Negated Latched Output (Q NOT) |
| Logics.LE1.Gate In1-I | State of the module input: Assignment of the Input Signal |
| Logics.LE1.Gate In2-I | State of the module input: Assignment of the Input Signal |
| Logics.LE1.Gate In3-I | State of the module input: Assignment of the Input Signal |
| Logics.LE1.Gate In4-I | State of the module input: Assignment of the Input Signal |
| Logics.LE1.Reset Latch-I | State of the module input: Reset Signal for the Latching |
| Logics.LE2.Gate Out | Signal: Output of the logic gate |
| Logics.LE2.Timer Out | Signal: Timer Output |
| Logics.LE2.Out | Signal: Latched Output (Q) |
| Logics.LE2.Out inverted | Signal: Negated Latched Output (Q NOT) |
| Logics.LE2.Gate In1-I | State of the module input: Assignment of the Input Signal |
| Logics.LE2.Gate In2-I | State of the module input: Assignment of the Input Signal |
| Logics.LE2.Gate In3-I | State of the module input: Assignment of the Input Signal |
| Logics.LE2.Gate In4-I | State of the module input: Assignment of the Input Signal |
| Logics.LE2.Reset Latch-I | State of the module input: Reset Signal for the Latching |
| Logics.LE3.Gate Out | Signal: Output of the logic gate |
| Logics.LE3.Timer Out | Signal: Timer Output |
| Logics.LE3.Out | Signal: Latched Output (Q) |

General Lists

| <i>Name</i> | <i>Description</i> |
|--------------------------|---|
| Logics.LE3.Out inverted | Signal: Negated Latched Output (Q NOT) |
| Logics.LE3.Gate In1-I | State of the module input: Assignment of the Input Signal |
| Logics.LE3.Gate In2-I | State of the module input: Assignment of the Input Signal |
| Logics.LE3.Gate In3-I | State of the module input: Assignment of the Input Signal |
| Logics.LE3.Gate In4-I | State of the module input: Assignment of the Input Signal |
| Logics.LE3.Reset Latch-I | State of the module input: Reset Signal for the Latching |
| Logics.LE4.Gate Out | Signal: Output of the logic gate |
| Logics.LE4.Timer Out | Signal: Timer Output |
| Logics.LE4.Out | Signal: Latched Output (Q) |
| Logics.LE4.Out inverted | Signal: Negated Latched Output (Q NOT) |
| Logics.LE4.Gate In1-I | State of the module input: Assignment of the Input Signal |
| Logics.LE4.Gate In2-I | State of the module input: Assignment of the Input Signal |
| Logics.LE4.Gate In3-I | State of the module input: Assignment of the Input Signal |
| Logics.LE4.Gate In4-I | State of the module input: Assignment of the Input Signal |
| Logics.LE4.Reset Latch-I | State of the module input: Reset Signal for the Latching |
| Logics.LE5.Gate Out | Signal: Output of the logic gate |
| Logics.LE5.Timer Out | Signal: Timer Output |
| Logics.LE5.Out | Signal: Latched Output (Q) |
| Logics.LE5.Out inverted | Signal: Negated Latched Output (Q NOT) |
| Logics.LE5.Gate In1-I | State of the module input: Assignment of the Input Signal |
| Logics.LE5.Gate In2-I | State of the module input: Assignment of the Input Signal |
| Logics.LE5.Gate In3-I | State of the module input: Assignment of the Input Signal |
| Logics.LE5.Gate In4-I | State of the module input: Assignment of the Input Signal |
| Logics.LE5.Reset Latch-I | State of the module input: Reset Signal for the Latching |
| Logics.LE6.Gate Out | Signal: Output of the logic gate |
| Logics.LE6.Timer Out | Signal: Timer Output |
| Logics.LE6.Out | Signal: Latched Output (Q) |
| Logics.LE6.Out inverted | Signal: Negated Latched Output (Q NOT) |
| Logics.LE6.Gate In1-I | State of the module input: Assignment of the Input Signal |
| Logics.LE6.Gate In2-I | State of the module input: Assignment of the Input Signal |
| Logics.LE6.Gate In3-I | State of the module input: Assignment of the Input Signal |
| Logics.LE6.Gate In4-I | State of the module input: Assignment of the Input Signal |
| Logics.LE6.Reset Latch-I | State of the module input: Reset Signal for the Latching |
| Logics.LE7.Gate Out | Signal: Output of the logic gate |
| Logics.LE7.Timer Out | Signal: Timer Output |
| Logics.LE7.Out | Signal: Latched Output (Q) |
| Logics.LE7.Out inverted | Signal: Negated Latched Output (Q NOT) |
| Logics.LE7.Gate In1-I | State of the module input: Assignment of the Input Signal |
| Logics.LE7.Gate In2-I | State of the module input: Assignment of the Input Signal |
| Logics.LE7.Gate In3-I | State of the module input: Assignment of the Input Signal |

General Lists

| <i>Name</i> | <i>Description</i> |
|---------------------------|---|
| Logics.LE7.Gate In4-I | State of the module input: Assignment of the Input Signal |
| Logics.LE7.Reset Latch-I | State of the module input: Reset Signal for the Latching |
| Logics.LE8.Gate Out | Signal: Output of the logic gate |
| Logics.LE8.Timer Out | Signal: Timer Output |
| Logics.LE8.Out | Signal: Latched Output (Q) |
| Logics.LE8.Out inverted | Signal: Negated Latched Output (Q NOT) |
| Logics.LE8.Gate In1-I | State of the module input: Assignment of the Input Signal |
| Logics.LE8.Gate In2-I | State of the module input: Assignment of the Input Signal |
| Logics.LE8.Gate In3-I | State of the module input: Assignment of the Input Signal |
| Logics.LE8.Gate In4-I | State of the module input: Assignment of the Input Signal |
| Logics.LE8.Reset Latch-I | State of the module input: Reset Signal for the Latching |
| Logics.LE9.Gate Out | Signal: Output of the logic gate |
| Logics.LE9.Timer Out | Signal: Timer Output |
| Logics.LE9.Out | Signal: Latched Output (Q) |
| Logics.LE9.Out inverted | Signal: Negated Latched Output (Q NOT) |
| Logics.LE9.Gate In1-I | State of the module input: Assignment of the Input Signal |
| Logics.LE9.Gate In2-I | State of the module input: Assignment of the Input Signal |
| Logics.LE9.Gate In3-I | State of the module input: Assignment of the Input Signal |
| Logics.LE9.Gate In4-I | State of the module input: Assignment of the Input Signal |
| Logics.LE9.Reset Latch-I | State of the module input: Reset Signal for the Latching |
| Logics.LE10.Gate Out | Signal: Output of the logic gate |
| Logics.LE10.Timer Out | Signal: Timer Output |
| Logics.LE10.Out | Signal: Latched Output (Q) |
| Logics.LE10.Out inverted | Signal: Negated Latched Output (Q NOT) |
| Logics.LE10.Gate In1-I | State of the module input: Assignment of the Input Signal |
| Logics.LE10.Gate In2-I | State of the module input: Assignment of the Input Signal |
| Logics.LE10.Gate In3-I | State of the module input: Assignment of the Input Signal |
| Logics.LE10.Gate In4-I | State of the module input: Assignment of the Input Signal |
| Logics.LE10.Reset Latch-I | State of the module input: Reset Signal for the Latching |
| Logics.LE11.Gate Out | Signal: Output of the logic gate |
| Logics.LE11.Timer Out | Signal: Timer Output |
| Logics.LE11.Out | Signal: Latched Output (Q) |
| Logics.LE11.Out inverted | Signal: Negated Latched Output (Q NOT) |
| Logics.LE11.Gate In1-I | State of the module input: Assignment of the Input Signal |
| Logics.LE11.Gate In2-I | State of the module input: Assignment of the Input Signal |
| Logics.LE11.Gate In3-I | State of the module input: Assignment of the Input Signal |
| Logics.LE11.Gate In4-I | State of the module input: Assignment of the Input Signal |
| Logics.LE11.Reset Latch-I | State of the module input: Reset Signal for the Latching |
| Logics.LE12.Gate Out | Signal: Output of the logic gate |
| Logics.LE12.Timer Out | Signal: Timer Output |

General Lists

| <i>Name</i> | <i>Description</i> |
|---------------------------|---|
| Logics.LE12.Out | Signal: Latched Output (Q) |
| Logics.LE12.Out inverted | Signal: Negated Latched Output (Q NOT) |
| Logics.LE12.Gate In1-I | State of the module input: Assignment of the Input Signal |
| Logics.LE12.Gate In2-I | State of the module input: Assignment of the Input Signal |
| Logics.LE12.Gate In3-I | State of the module input: Assignment of the Input Signal |
| Logics.LE12.Gate In4-I | State of the module input: Assignment of the Input Signal |
| Logics.LE12.Reset Latch-I | State of the module input: Reset Signal for the Latching |
| Logics.LE13.Gate Out | Signal: Output of the logic gate |
| Logics.LE13.Timer Out | Signal: Timer Output |
| Logics.LE13.Out | Signal: Latched Output (Q) |
| Logics.LE13.Out inverted | Signal: Negated Latched Output (Q NOT) |
| Logics.LE13.Gate In1-I | State of the module input: Assignment of the Input Signal |
| Logics.LE13.Gate In2-I | State of the module input: Assignment of the Input Signal |
| Logics.LE13.Gate In3-I | State of the module input: Assignment of the Input Signal |
| Logics.LE13.Gate In4-I | State of the module input: Assignment of the Input Signal |
| Logics.LE13.Reset Latch-I | State of the module input: Reset Signal for the Latching |
| Logics.LE14.Gate Out | Signal: Output of the logic gate |
| Logics.LE14.Timer Out | Signal: Timer Output |
| Logics.LE14.Out | Signal: Latched Output (Q) |
| Logics.LE14.Out inverted | Signal: Negated Latched Output (Q NOT) |
| Logics.LE14.Gate In1-I | State of the module input: Assignment of the Input Signal |
| Logics.LE14.Gate In2-I | State of the module input: Assignment of the Input Signal |
| Logics.LE14.Gate In3-I | State of the module input: Assignment of the Input Signal |
| Logics.LE14.Gate In4-I | State of the module input: Assignment of the Input Signal |
| Logics.LE14.Reset Latch-I | State of the module input: Reset Signal for the Latching |
| Logics.LE15.Gate Out | Signal: Output of the logic gate |
| Logics.LE15.Timer Out | Signal: Timer Output |
| Logics.LE15.Out | Signal: Latched Output (Q) |
| Logics.LE15.Out inverted | Signal: Negated Latched Output (Q NOT) |
| Logics.LE15.Gate In1-I | State of the module input: Assignment of the Input Signal |
| Logics.LE15.Gate In2-I | State of the module input: Assignment of the Input Signal |
| Logics.LE15.Gate In3-I | State of the module input: Assignment of the Input Signal |
| Logics.LE15.Gate In4-I | State of the module input: Assignment of the Input Signal |
| Logics.LE15.Reset Latch-I | State of the module input: Reset Signal for the Latching |
| Logics.LE16.Gate Out | Signal: Output of the logic gate |
| Logics.LE16.Timer Out | Signal: Timer Output |
| Logics.LE16.Out | Signal: Latched Output (Q) |
| Logics.LE16.Out inverted | Signal: Negated Latched Output (Q NOT) |
| Logics.LE16.Gate In1-I | State of the module input: Assignment of the Input Signal |
| Logics.LE16.Gate In2-I | State of the module input: Assignment of the Input Signal |

General Lists

| <i>Name</i> | <i>Description</i> |
|---------------------------|---|
| Logics.LE16.Gate In3-I | State of the module input: Assignment of the Input Signal |
| Logics.LE16.Gate In4-I | State of the module input: Assignment of the Input Signal |
| Logics.LE16.Reset Latch-I | State of the module input: Reset Signal for the Latching |
| Logics.LE17.Gate Out | Signal: Output of the logic gate |
| Logics.LE17.Timer Out | Signal: Timer Output |
| Logics.LE17.Out | Signal: Latched Output (Q) |
| Logics.LE17.Out inverted | Signal: Negated Latched Output (Q NOT) |
| Logics.LE17.Gate In1-I | State of the module input: Assignment of the Input Signal |
| Logics.LE17.Gate In2-I | State of the module input: Assignment of the Input Signal |
| Logics.LE17.Gate In3-I | State of the module input: Assignment of the Input Signal |
| Logics.LE17.Gate In4-I | State of the module input: Assignment of the Input Signal |
| Logics.LE17.Reset Latch-I | State of the module input: Reset Signal for the Latching |
| Logics.LE18.Gate Out | Signal: Output of the logic gate |
| Logics.LE18.Timer Out | Signal: Timer Output |
| Logics.LE18.Out | Signal: Latched Output (Q) |
| Logics.LE18.Out inverted | Signal: Negated Latched Output (Q NOT) |
| Logics.LE18.Gate In1-I | State of the module input: Assignment of the Input Signal |
| Logics.LE18.Gate In2-I | State of the module input: Assignment of the Input Signal |
| Logics.LE18.Gate In3-I | State of the module input: Assignment of the Input Signal |
| Logics.LE18.Gate In4-I | State of the module input: Assignment of the Input Signal |
| Logics.LE18.Reset Latch-I | State of the module input: Reset Signal for the Latching |
| Logics.LE19.Gate Out | Signal: Output of the logic gate |
| Logics.LE19.Timer Out | Signal: Timer Output |
| Logics.LE19.Out | Signal: Latched Output (Q) |
| Logics.LE19.Out inverted | Signal: Negated Latched Output (Q NOT) |
| Logics.LE19.Gate In1-I | State of the module input: Assignment of the Input Signal |
| Logics.LE19.Gate In2-I | State of the module input: Assignment of the Input Signal |
| Logics.LE19.Gate In3-I | State of the module input: Assignment of the Input Signal |
| Logics.LE19.Gate In4-I | State of the module input: Assignment of the Input Signal |
| Logics.LE19.Reset Latch-I | State of the module input: Reset Signal for the Latching |
| Logics.LE20.Gate Out | Signal: Output of the logic gate |
| Logics.LE20.Timer Out | Signal: Timer Output |
| Logics.LE20.Out | Signal: Latched Output (Q) |
| Logics.LE20.Out inverted | Signal: Negated Latched Output (Q NOT) |
| Logics.LE20.Gate In1-I | State of the module input: Assignment of the Input Signal |
| Logics.LE20.Gate In2-I | State of the module input: Assignment of the Input Signal |
| Logics.LE20.Gate In3-I | State of the module input: Assignment of the Input Signal |
| Logics.LE20.Gate In4-I | State of the module input: Assignment of the Input Signal |
| Logics.LE20.Reset Latch-I | State of the module input: Reset Signal for the Latching |
| Logics.LE21.Gate Out | Signal: Output of the logic gate |

General Lists

| <i>Name</i> | <i>Description</i> |
|---------------------------|---|
| Logics.LE21.Timer Out | Signal: Timer Output |
| Logics.LE21.Out | Signal: Latched Output (Q) |
| Logics.LE21.Out inverted | Signal: Negated Latched Output (Q NOT) |
| Logics.LE21.Gate In1-I | State of the module input: Assignment of the Input Signal |
| Logics.LE21.Gate In2-I | State of the module input: Assignment of the Input Signal |
| Logics.LE21.Gate In3-I | State of the module input: Assignment of the Input Signal |
| Logics.LE21.Gate In4-I | State of the module input: Assignment of the Input Signal |
| Logics.LE21.Reset Latch-I | State of the module input: Reset Signal for the Latching |
| Logics.LE22.Gate Out | Signal: Output of the logic gate |
| Logics.LE22.Timer Out | Signal: Timer Output |
| Logics.LE22.Out | Signal: Latched Output (Q) |
| Logics.LE22.Out inverted | Signal: Negated Latched Output (Q NOT) |
| Logics.LE22.Gate In1-I | State of the module input: Assignment of the Input Signal |
| Logics.LE22.Gate In2-I | State of the module input: Assignment of the Input Signal |
| Logics.LE22.Gate In3-I | State of the module input: Assignment of the Input Signal |
| Logics.LE22.Gate In4-I | State of the module input: Assignment of the Input Signal |
| Logics.LE22.Reset Latch-I | State of the module input: Reset Signal for the Latching |
| Logics.LE23.Gate Out | Signal: Output of the logic gate |
| Logics.LE23.Timer Out | Signal: Timer Output |
| Logics.LE23.Out | Signal: Latched Output (Q) |
| Logics.LE23.Out inverted | Signal: Negated Latched Output (Q NOT) |
| Logics.LE23.Gate In1-I | State of the module input: Assignment of the Input Signal |
| Logics.LE23.Gate In2-I | State of the module input: Assignment of the Input Signal |
| Logics.LE23.Gate In3-I | State of the module input: Assignment of the Input Signal |
| Logics.LE23.Gate In4-I | State of the module input: Assignment of the Input Signal |
| Logics.LE23.Reset Latch-I | State of the module input: Reset Signal for the Latching |
| Logics.LE24.Gate Out | Signal: Output of the logic gate |
| Logics.LE24.Timer Out | Signal: Timer Output |
| Logics.LE24.Out | Signal: Latched Output (Q) |
| Logics.LE24.Out inverted | Signal: Negated Latched Output (Q NOT) |
| Logics.LE24.Gate In1-I | State of the module input: Assignment of the Input Signal |
| Logics.LE24.Gate In2-I | State of the module input: Assignment of the Input Signal |
| Logics.LE24.Gate In3-I | State of the module input: Assignment of the Input Signal |
| Logics.LE24.Gate In4-I | State of the module input: Assignment of the Input Signal |
| Logics.LE24.Reset Latch-I | State of the module input: Reset Signal for the Latching |
| Logics.LE25.Gate Out | Signal: Output of the logic gate |
| Logics.LE25.Timer Out | Signal: Timer Output |
| Logics.LE25.Out | Signal: Latched Output (Q) |
| Logics.LE25.Out inverted | Signal: Negated Latched Output (Q NOT) |
| Logics.LE25.Gate In1-I | State of the module input: Assignment of the Input Signal |

General Lists

| <i>Name</i> | <i>Description</i> |
|---------------------------|---|
| Logics.LE25.Gate In2-I | State of the module input: Assignment of the Input Signal |
| Logics.LE25.Gate In3-I | State of the module input: Assignment of the Input Signal |
| Logics.LE25.Gate In4-I | State of the module input: Assignment of the Input Signal |
| Logics.LE25.Reset Latch-I | State of the module input: Reset Signal for the Latching |
| Logics.LE26.Gate Out | Signal: Output of the logic gate |
| Logics.LE26.Timer Out | Signal: Timer Output |
| Logics.LE26.Out | Signal: Latched Output (Q) |
| Logics.LE26.Out inverted | Signal: Negated Latched Output (Q NOT) |
| Logics.LE26.Gate In1-I | State of the module input: Assignment of the Input Signal |
| Logics.LE26.Gate In2-I | State of the module input: Assignment of the Input Signal |
| Logics.LE26.Gate In3-I | State of the module input: Assignment of the Input Signal |
| Logics.LE26.Gate In4-I | State of the module input: Assignment of the Input Signal |
| Logics.LE26.Reset Latch-I | State of the module input: Reset Signal for the Latching |
| Logics.LE27.Gate Out | Signal: Output of the logic gate |
| Logics.LE27.Timer Out | Signal: Timer Output |
| Logics.LE27.Out | Signal: Latched Output (Q) |
| Logics.LE27.Out inverted | Signal: Negated Latched Output (Q NOT) |
| Logics.LE27.Gate In1-I | State of the module input: Assignment of the Input Signal |
| Logics.LE27.Gate In2-I | State of the module input: Assignment of the Input Signal |
| Logics.LE27.Gate In3-I | State of the module input: Assignment of the Input Signal |
| Logics.LE27.Gate In4-I | State of the module input: Assignment of the Input Signal |
| Logics.LE27.Reset Latch-I | State of the module input: Reset Signal for the Latching |
| Logics.LE28.Gate Out | Signal: Output of the logic gate |
| Logics.LE28.Timer Out | Signal: Timer Output |
| Logics.LE28.Out | Signal: Latched Output (Q) |
| Logics.LE28.Out inverted | Signal: Negated Latched Output (Q NOT) |
| Logics.LE28.Gate In1-I | State of the module input: Assignment of the Input Signal |
| Logics.LE28.Gate In2-I | State of the module input: Assignment of the Input Signal |
| Logics.LE28.Gate In3-I | State of the module input: Assignment of the Input Signal |
| Logics.LE28.Gate In4-I | State of the module input: Assignment of the Input Signal |
| Logics.LE28.Reset Latch-I | State of the module input: Reset Signal for the Latching |
| Logics.LE29.Gate Out | Signal: Output of the logic gate |
| Logics.LE29.Timer Out | Signal: Timer Output |
| Logics.LE29.Out | Signal: Latched Output (Q) |
| Logics.LE29.Out inverted | Signal: Negated Latched Output (Q NOT) |
| Logics.LE29.Gate In1-I | State of the module input: Assignment of the Input Signal |
| Logics.LE29.Gate In2-I | State of the module input: Assignment of the Input Signal |
| Logics.LE29.Gate In3-I | State of the module input: Assignment of the Input Signal |
| Logics.LE29.Gate In4-I | State of the module input: Assignment of the Input Signal |
| Logics.LE29.Reset Latch-I | State of the module input: Reset Signal for the Latching |

General Lists

| <i>Name</i> | <i>Description</i> |
|---------------------------|---|
| Logics.LE30.Gate Out | Signal: Output of the logic gate |
| Logics.LE30.Timer Out | Signal: Timer Output |
| Logics.LE30.Out | Signal: Latched Output (Q) |
| Logics.LE30.Out inverted | Signal: Negated Latched Output (Q NOT) |
| Logics.LE30.Gate In1-I | State of the module input: Assignment of the Input Signal |
| Logics.LE30.Gate In2-I | State of the module input: Assignment of the Input Signal |
| Logics.LE30.Gate In3-I | State of the module input: Assignment of the Input Signal |
| Logics.LE30.Gate In4-I | State of the module input: Assignment of the Input Signal |
| Logics.LE30.Reset Latch-I | State of the module input: Reset Signal for the Latching |
| Logics.LE31.Gate Out | Signal: Output of the logic gate |
| Logics.LE31.Timer Out | Signal: Timer Output |
| Logics.LE31.Out | Signal: Latched Output (Q) |
| Logics.LE31.Out inverted | Signal: Negated Latched Output (Q NOT) |
| Logics.LE31.Gate In1-I | State of the module input: Assignment of the Input Signal |
| Logics.LE31.Gate In2-I | State of the module input: Assignment of the Input Signal |
| Logics.LE31.Gate In3-I | State of the module input: Assignment of the Input Signal |
| Logics.LE31.Gate In4-I | State of the module input: Assignment of the Input Signal |
| Logics.LE31.Reset Latch-I | State of the module input: Reset Signal for the Latching |
| Logics.LE32.Gate Out | Signal: Output of the logic gate |
| Logics.LE32.Timer Out | Signal: Timer Output |
| Logics.LE32.Out | Signal: Latched Output (Q) |
| Logics.LE32.Out inverted | Signal: Negated Latched Output (Q NOT) |
| Logics.LE32.Gate In1-I | State of the module input: Assignment of the Input Signal |
| Logics.LE32.Gate In2-I | State of the module input: Assignment of the Input Signal |
| Logics.LE32.Gate In3-I | State of the module input: Assignment of the Input Signal |
| Logics.LE32.Gate In4-I | State of the module input: Assignment of the Input Signal |
| Logics.LE32.Reset Latch-I | State of the module input: Reset Signal for the Latching |
| Logics.LE33.Gate Out | Signal: Output of the logic gate |
| Logics.LE33.Timer Out | Signal: Timer Output |
| Logics.LE33.Out | Signal: Latched Output (Q) |
| Logics.LE33.Out inverted | Signal: Negated Latched Output (Q NOT) |
| Logics.LE33.Gate In1-I | State of the module input: Assignment of the Input Signal |
| Logics.LE33.Gate In2-I | State of the module input: Assignment of the Input Signal |
| Logics.LE33.Gate In3-I | State of the module input: Assignment of the Input Signal |
| Logics.LE33.Gate In4-I | State of the module input: Assignment of the Input Signal |
| Logics.LE33.Reset Latch-I | State of the module input: Reset Signal for the Latching |
| Logics.LE34.Gate Out | Signal: Output of the logic gate |
| Logics.LE34.Timer Out | Signal: Timer Output |
| Logics.LE34.Out | Signal: Latched Output (Q) |
| Logics.LE34.Out inverted | Signal: Negated Latched Output (Q NOT) |

General Lists

| <i>Name</i> | <i>Description</i> |
|---------------------------|---|
| Logics.LE34.Gate In1-I | State of the module input: Assignment of the Input Signal |
| Logics.LE34.Gate In2-I | State of the module input: Assignment of the Input Signal |
| Logics.LE34.Gate In3-I | State of the module input: Assignment of the Input Signal |
| Logics.LE34.Gate In4-I | State of the module input: Assignment of the Input Signal |
| Logics.LE34.Reset Latch-I | State of the module input: Reset Signal for the Latching |
| Logics.LE35.Gate Out | Signal: Output of the logic gate |
| Logics.LE35.Timer Out | Signal: Timer Output |
| Logics.LE35.Out | Signal: Latched Output (Q) |
| Logics.LE35.Out inverted | Signal: Negated Latched Output (Q NOT) |
| Logics.LE35.Gate In1-I | State of the module input: Assignment of the Input Signal |
| Logics.LE35.Gate In2-I | State of the module input: Assignment of the Input Signal |
| Logics.LE35.Gate In3-I | State of the module input: Assignment of the Input Signal |
| Logics.LE35.Gate In4-I | State of the module input: Assignment of the Input Signal |
| Logics.LE35.Reset Latch-I | State of the module input: Reset Signal for the Latching |
| Logics.LE36.Gate Out | Signal: Output of the logic gate |
| Logics.LE36.Timer Out | Signal: Timer Output |
| Logics.LE36.Out | Signal: Latched Output (Q) |
| Logics.LE36.Out inverted | Signal: Negated Latched Output (Q NOT) |
| Logics.LE36.Gate In1-I | State of the module input: Assignment of the Input Signal |
| Logics.LE36.Gate In2-I | State of the module input: Assignment of the Input Signal |
| Logics.LE36.Gate In3-I | State of the module input: Assignment of the Input Signal |
| Logics.LE36.Gate In4-I | State of the module input: Assignment of the Input Signal |
| Logics.LE36.Reset Latch-I | State of the module input: Reset Signal for the Latching |
| Logics.LE37.Gate Out | Signal: Output of the logic gate |
| Logics.LE37.Timer Out | Signal: Timer Output |
| Logics.LE37.Out | Signal: Latched Output (Q) |
| Logics.LE37.Out inverted | Signal: Negated Latched Output (Q NOT) |
| Logics.LE37.Gate In1-I | State of the module input: Assignment of the Input Signal |
| Logics.LE37.Gate In2-I | State of the module input: Assignment of the Input Signal |
| Logics.LE37.Gate In3-I | State of the module input: Assignment of the Input Signal |
| Logics.LE37.Gate In4-I | State of the module input: Assignment of the Input Signal |
| Logics.LE37.Reset Latch-I | State of the module input: Reset Signal for the Latching |
| Logics.LE38.Gate Out | Signal: Output of the logic gate |
| Logics.LE38.Timer Out | Signal: Timer Output |
| Logics.LE38.Out | Signal: Latched Output (Q) |
| Logics.LE38.Out inverted | Signal: Negated Latched Output (Q NOT) |
| Logics.LE38.Gate In1-I | State of the module input: Assignment of the Input Signal |
| Logics.LE38.Gate In2-I | State of the module input: Assignment of the Input Signal |
| Logics.LE38.Gate In3-I | State of the module input: Assignment of the Input Signal |
| Logics.LE38.Gate In4-I | State of the module input: Assignment of the Input Signal |

General Lists

| <i>Name</i> | <i>Description</i> |
|---------------------------|---|
| Logics.LE38.Reset Latch-I | State of the module input: Reset Signal for the Latching |
| Logics.LE39.Gate Out | Signal: Output of the logic gate |
| Logics.LE39.Timer Out | Signal: Timer Output |
| Logics.LE39.Out | Signal: Latched Output (Q) |
| Logics.LE39.Out inverted | Signal: Negated Latched Output (Q NOT) |
| Logics.LE39.Gate In1-I | State of the module input: Assignment of the Input Signal |
| Logics.LE39.Gate In2-I | State of the module input: Assignment of the Input Signal |
| Logics.LE39.Gate In3-I | State of the module input: Assignment of the Input Signal |
| Logics.LE39.Gate In4-I | State of the module input: Assignment of the Input Signal |
| Logics.LE39.Reset Latch-I | State of the module input: Reset Signal for the Latching |
| Logics.LE40.Gate Out | Signal: Output of the logic gate |
| Logics.LE40.Timer Out | Signal: Timer Output |
| Logics.LE40.Out | Signal: Latched Output (Q) |
| Logics.LE40.Out inverted | Signal: Negated Latched Output (Q NOT) |
| Logics.LE40.Gate In1-I | State of the module input: Assignment of the Input Signal |
| Logics.LE40.Gate In2-I | State of the module input: Assignment of the Input Signal |
| Logics.LE40.Gate In3-I | State of the module input: Assignment of the Input Signal |
| Logics.LE40.Gate In4-I | State of the module input: Assignment of the Input Signal |
| Logics.LE40.Reset Latch-I | State of the module input: Reset Signal for the Latching |
| Logics.LE41.Gate Out | Signal: Output of the logic gate |
| Logics.LE41.Timer Out | Signal: Timer Output |
| Logics.LE41.Out | Signal: Latched Output (Q) |
| Logics.LE41.Out inverted | Signal: Negated Latched Output (Q NOT) |
| Logics.LE41.Gate In1-I | State of the module input: Assignment of the Input Signal |
| Logics.LE41.Gate In2-I | State of the module input: Assignment of the Input Signal |
| Logics.LE41.Gate In3-I | State of the module input: Assignment of the Input Signal |
| Logics.LE41.Gate In4-I | State of the module input: Assignment of the Input Signal |
| Logics.LE41.Reset Latch-I | State of the module input: Reset Signal for the Latching |
| Logics.LE42.Gate Out | Signal: Output of the logic gate |
| Logics.LE42.Timer Out | Signal: Timer Output |
| Logics.LE42.Out | Signal: Latched Output (Q) |
| Logics.LE42.Out inverted | Signal: Negated Latched Output (Q NOT) |
| Logics.LE42.Gate In1-I | State of the module input: Assignment of the Input Signal |
| Logics.LE42.Gate In2-I | State of the module input: Assignment of the Input Signal |
| Logics.LE42.Gate In3-I | State of the module input: Assignment of the Input Signal |
| Logics.LE42.Gate In4-I | State of the module input: Assignment of the Input Signal |
| Logics.LE42.Reset Latch-I | State of the module input: Reset Signal for the Latching |
| Logics.LE43.Gate Out | Signal: Output of the logic gate |
| Logics.LE43.Timer Out | Signal: Timer Output |
| Logics.LE43.Out | Signal: Latched Output (Q) |

General Lists

| <i>Name</i> | <i>Description</i> |
|---------------------------|---|
| Logics.LE43.Out inverted | Signal: Negated Latched Output (Q NOT) |
| Logics.LE43.Gate In1-I | State of the module input: Assignment of the Input Signal |
| Logics.LE43.Gate In2-I | State of the module input: Assignment of the Input Signal |
| Logics.LE43.Gate In3-I | State of the module input: Assignment of the Input Signal |
| Logics.LE43.Gate In4-I | State of the module input: Assignment of the Input Signal |
| Logics.LE43.Reset Latch-I | State of the module input: Reset Signal for the Latching |
| Logics.LE44.Gate Out | Signal: Output of the logic gate |
| Logics.LE44.Timer Out | Signal: Timer Output |
| Logics.LE44.Out | Signal: Latched Output (Q) |
| Logics.LE44.Out inverted | Signal: Negated Latched Output (Q NOT) |
| Logics.LE44.Gate In1-I | State of the module input: Assignment of the Input Signal |
| Logics.LE44.Gate In2-I | State of the module input: Assignment of the Input Signal |
| Logics.LE44.Gate In3-I | State of the module input: Assignment of the Input Signal |
| Logics.LE44.Gate In4-I | State of the module input: Assignment of the Input Signal |
| Logics.LE44.Reset Latch-I | State of the module input: Reset Signal for the Latching |
| Logics.LE45.Gate Out | Signal: Output of the logic gate |
| Logics.LE45.Timer Out | Signal: Timer Output |
| Logics.LE45.Out | Signal: Latched Output (Q) |
| Logics.LE45.Out inverted | Signal: Negated Latched Output (Q NOT) |
| Logics.LE45.Gate In1-I | State of the module input: Assignment of the Input Signal |
| Logics.LE45.Gate In2-I | State of the module input: Assignment of the Input Signal |
| Logics.LE45.Gate In3-I | State of the module input: Assignment of the Input Signal |
| Logics.LE45.Gate In4-I | State of the module input: Assignment of the Input Signal |
| Logics.LE45.Reset Latch-I | State of the module input: Reset Signal for the Latching |
| Logics.LE46.Gate Out | Signal: Output of the logic gate |
| Logics.LE46.Timer Out | Signal: Timer Output |
| Logics.LE46.Out | Signal: Latched Output (Q) |
| Logics.LE46.Out inverted | Signal: Negated Latched Output (Q NOT) |
| Logics.LE46.Gate In1-I | State of the module input: Assignment of the Input Signal |
| Logics.LE46.Gate In2-I | State of the module input: Assignment of the Input Signal |
| Logics.LE46.Gate In3-I | State of the module input: Assignment of the Input Signal |
| Logics.LE46.Gate In4-I | State of the module input: Assignment of the Input Signal |
| Logics.LE46.Reset Latch-I | State of the module input: Reset Signal for the Latching |
| Logics.LE47.Gate Out | Signal: Output of the logic gate |
| Logics.LE47.Timer Out | Signal: Timer Output |
| Logics.LE47.Out | Signal: Latched Output (Q) |
| Logics.LE47.Out inverted | Signal: Negated Latched Output (Q NOT) |
| Logics.LE47.Gate In1-I | State of the module input: Assignment of the Input Signal |
| Logics.LE47.Gate In2-I | State of the module input: Assignment of the Input Signal |
| Logics.LE47.Gate In3-I | State of the module input: Assignment of the Input Signal |

General Lists

| <i>Name</i> | <i>Description</i> |
|---------------------------|---|
| Logics.LE47.Gate In4-I | State of the module input: Assignment of the Input Signal |
| Logics.LE47.Reset Latch-I | State of the module input: Reset Signal for the Latching |
| Logics.LE48.Gate Out | Signal: Output of the logic gate |
| Logics.LE48.Timer Out | Signal: Timer Output |
| Logics.LE48.Out | Signal: Latched Output (Q) |
| Logics.LE48.Out inverted | Signal: Negated Latched Output (Q NOT) |
| Logics.LE48.Gate In1-I | State of the module input: Assignment of the Input Signal |
| Logics.LE48.Gate In2-I | State of the module input: Assignment of the Input Signal |
| Logics.LE48.Gate In3-I | State of the module input: Assignment of the Input Signal |
| Logics.LE48.Gate In4-I | State of the module input: Assignment of the Input Signal |
| Logics.LE48.Reset Latch-I | State of the module input: Reset Signal for the Latching |
| Logics.LE49.Gate Out | Signal: Output of the logic gate |
| Logics.LE49.Timer Out | Signal: Timer Output |
| Logics.LE49.Out | Signal: Latched Output (Q) |
| Logics.LE49.Out inverted | Signal: Negated Latched Output (Q NOT) |
| Logics.LE49.Gate In1-I | State of the module input: Assignment of the Input Signal |
| Logics.LE49.Gate In2-I | State of the module input: Assignment of the Input Signal |
| Logics.LE49.Gate In3-I | State of the module input: Assignment of the Input Signal |
| Logics.LE49.Gate In4-I | State of the module input: Assignment of the Input Signal |
| Logics.LE49.Reset Latch-I | State of the module input: Reset Signal for the Latching |
| Logics.LE50.Gate Out | Signal: Output of the logic gate |
| Logics.LE50.Timer Out | Signal: Timer Output |
| Logics.LE50.Out | Signal: Latched Output (Q) |
| Logics.LE50.Out inverted | Signal: Negated Latched Output (Q NOT) |
| Logics.LE50.Gate In1-I | State of the module input: Assignment of the Input Signal |
| Logics.LE50.Gate In2-I | State of the module input: Assignment of the Input Signal |
| Logics.LE50.Gate In3-I | State of the module input: Assignment of the Input Signal |
| Logics.LE50.Gate In4-I | State of the module input: Assignment of the Input Signal |
| Logics.LE50.Reset Latch-I | State of the module input: Reset Signal for the Latching |
| Logics.LE51.Gate Out | Signal: Output of the logic gate |
| Logics.LE51.Timer Out | Signal: Timer Output |
| Logics.LE51.Out | Signal: Latched Output (Q) |
| Logics.LE51.Out inverted | Signal: Negated Latched Output (Q NOT) |
| Logics.LE51.Gate In1-I | State of the module input: Assignment of the Input Signal |
| Logics.LE51.Gate In2-I | State of the module input: Assignment of the Input Signal |
| Logics.LE51.Gate In3-I | State of the module input: Assignment of the Input Signal |
| Logics.LE51.Gate In4-I | State of the module input: Assignment of the Input Signal |
| Logics.LE51.Reset Latch-I | State of the module input: Reset Signal for the Latching |
| Logics.LE52.Gate Out | Signal: Output of the logic gate |
| Logics.LE52.Timer Out | Signal: Timer Output |

General Lists

| <i>Name</i> | <i>Description</i> |
|---------------------------|---|
| Logics.LE52.Out | Signal: Latched Output (Q) |
| Logics.LE52.Out inverted | Signal: Negated Latched Output (Q NOT) |
| Logics.LE52.Gate In1-I | State of the module input: Assignment of the Input Signal |
| Logics.LE52.Gate In2-I | State of the module input: Assignment of the Input Signal |
| Logics.LE52.Gate In3-I | State of the module input: Assignment of the Input Signal |
| Logics.LE52.Gate In4-I | State of the module input: Assignment of the Input Signal |
| Logics.LE52.Reset Latch-I | State of the module input: Reset Signal for the Latching |
| Logics.LE53.Gate Out | Signal: Output of the logic gate |
| Logics.LE53.Timer Out | Signal: Timer Output |
| Logics.LE53.Out | Signal: Latched Output (Q) |
| Logics.LE53.Out inverted | Signal: Negated Latched Output (Q NOT) |
| Logics.LE53.Gate In1-I | State of the module input: Assignment of the Input Signal |
| Logics.LE53.Gate In2-I | State of the module input: Assignment of the Input Signal |
| Logics.LE53.Gate In3-I | State of the module input: Assignment of the Input Signal |
| Logics.LE53.Gate In4-I | State of the module input: Assignment of the Input Signal |
| Logics.LE53.Reset Latch-I | State of the module input: Reset Signal for the Latching |
| Logics.LE54.Gate Out | Signal: Output of the logic gate |
| Logics.LE54.Timer Out | Signal: Timer Output |
| Logics.LE54.Out | Signal: Latched Output (Q) |
| Logics.LE54.Out inverted | Signal: Negated Latched Output (Q NOT) |
| Logics.LE54.Gate In1-I | State of the module input: Assignment of the Input Signal |
| Logics.LE54.Gate In2-I | State of the module input: Assignment of the Input Signal |
| Logics.LE54.Gate In3-I | State of the module input: Assignment of the Input Signal |
| Logics.LE54.Gate In4-I | State of the module input: Assignment of the Input Signal |
| Logics.LE54.Reset Latch-I | State of the module input: Reset Signal for the Latching |
| Logics.LE55.Gate Out | Signal: Output of the logic gate |
| Logics.LE55.Timer Out | Signal: Timer Output |
| Logics.LE55.Out | Signal: Latched Output (Q) |
| Logics.LE55.Out inverted | Signal: Negated Latched Output (Q NOT) |
| Logics.LE55.Gate In1-I | State of the module input: Assignment of the Input Signal |
| Logics.LE55.Gate In2-I | State of the module input: Assignment of the Input Signal |
| Logics.LE55.Gate In3-I | State of the module input: Assignment of the Input Signal |
| Logics.LE55.Gate In4-I | State of the module input: Assignment of the Input Signal |
| Logics.LE55.Reset Latch-I | State of the module input: Reset Signal for the Latching |
| Logics.LE56.Gate Out | Signal: Output of the logic gate |
| Logics.LE56.Timer Out | Signal: Timer Output |
| Logics.LE56.Out | Signal: Latched Output (Q) |
| Logics.LE56.Out inverted | Signal: Negated Latched Output (Q NOT) |
| Logics.LE56.Gate In1-I | State of the module input: Assignment of the Input Signal |
| Logics.LE56.Gate In2-I | State of the module input: Assignment of the Input Signal |

General Lists

| <i>Name</i> | <i>Description</i> |
|---------------------------|---|
| Logics.LE56.Gate In3-I | State of the module input: Assignment of the Input Signal |
| Logics.LE56.Gate In4-I | State of the module input: Assignment of the Input Signal |
| Logics.LE56.Reset Latch-I | State of the module input: Reset Signal for the Latching |
| Logics.LE57.Gate Out | Signal: Output of the logic gate |
| Logics.LE57.Timer Out | Signal: Timer Output |
| Logics.LE57.Out | Signal: Latched Output (Q) |
| Logics.LE57.Out inverted | Signal: Negated Latched Output (Q NOT) |
| Logics.LE57.Gate In1-I | State of the module input: Assignment of the Input Signal |
| Logics.LE57.Gate In2-I | State of the module input: Assignment of the Input Signal |
| Logics.LE57.Gate In3-I | State of the module input: Assignment of the Input Signal |
| Logics.LE57.Gate In4-I | State of the module input: Assignment of the Input Signal |
| Logics.LE57.Reset Latch-I | State of the module input: Reset Signal for the Latching |
| Logics.LE58.Gate Out | Signal: Output of the logic gate |
| Logics.LE58.Timer Out | Signal: Timer Output |
| Logics.LE58.Out | Signal: Latched Output (Q) |
| Logics.LE58.Out inverted | Signal: Negated Latched Output (Q NOT) |
| Logics.LE58.Gate In1-I | State of the module input: Assignment of the Input Signal |
| Logics.LE58.Gate In2-I | State of the module input: Assignment of the Input Signal |
| Logics.LE58.Gate In3-I | State of the module input: Assignment of the Input Signal |
| Logics.LE58.Gate In4-I | State of the module input: Assignment of the Input Signal |
| Logics.LE58.Reset Latch-I | State of the module input: Reset Signal for the Latching |
| Logics.LE59.Gate Out | Signal: Output of the logic gate |
| Logics.LE59.Timer Out | Signal: Timer Output |
| Logics.LE59.Out | Signal: Latched Output (Q) |
| Logics.LE59.Out inverted | Signal: Negated Latched Output (Q NOT) |
| Logics.LE59.Gate In1-I | State of the module input: Assignment of the Input Signal |
| Logics.LE59.Gate In2-I | State of the module input: Assignment of the Input Signal |
| Logics.LE59.Gate In3-I | State of the module input: Assignment of the Input Signal |
| Logics.LE59.Gate In4-I | State of the module input: Assignment of the Input Signal |
| Logics.LE59.Reset Latch-I | State of the module input: Reset Signal for the Latching |
| Logics.LE60.Gate Out | Signal: Output of the logic gate |
| Logics.LE60.Timer Out | Signal: Timer Output |
| Logics.LE60.Out | Signal: Latched Output (Q) |
| Logics.LE60.Out inverted | Signal: Negated Latched Output (Q NOT) |
| Logics.LE60.Gate In1-I | State of the module input: Assignment of the Input Signal |
| Logics.LE60.Gate In2-I | State of the module input: Assignment of the Input Signal |
| Logics.LE60.Gate In3-I | State of the module input: Assignment of the Input Signal |
| Logics.LE60.Gate In4-I | State of the module input: Assignment of the Input Signal |
| Logics.LE60.Reset Latch-I | State of the module input: Reset Signal for the Latching |
| Logics.LE61.Gate Out | Signal: Output of the logic gate |

General Lists

| <i>Name</i> | <i>Description</i> |
|---------------------------|---|
| Logics.LE61.Timer Out | Signal: Timer Output |
| Logics.LE61.Out | Signal: Latched Output (Q) |
| Logics.LE61.Out inverted | Signal: Negated Latched Output (Q NOT) |
| Logics.LE61.Gate In1-I | State of the module input: Assignment of the Input Signal |
| Logics.LE61.Gate In2-I | State of the module input: Assignment of the Input Signal |
| Logics.LE61.Gate In3-I | State of the module input: Assignment of the Input Signal |
| Logics.LE61.Gate In4-I | State of the module input: Assignment of the Input Signal |
| Logics.LE61.Reset Latch-I | State of the module input: Reset Signal for the Latching |
| Logics.LE62.Gate Out | Signal: Output of the logic gate |
| Logics.LE62.Timer Out | Signal: Timer Output |
| Logics.LE62.Out | Signal: Latched Output (Q) |
| Logics.LE62.Out inverted | Signal: Negated Latched Output (Q NOT) |
| Logics.LE62.Gate In1-I | State of the module input: Assignment of the Input Signal |
| Logics.LE62.Gate In2-I | State of the module input: Assignment of the Input Signal |
| Logics.LE62.Gate In3-I | State of the module input: Assignment of the Input Signal |
| Logics.LE62.Gate In4-I | State of the module input: Assignment of the Input Signal |
| Logics.LE62.Reset Latch-I | State of the module input: Reset Signal for the Latching |
| Logics.LE63.Gate Out | Signal: Output of the logic gate |
| Logics.LE63.Timer Out | Signal: Timer Output |
| Logics.LE63.Out | Signal: Latched Output (Q) |
| Logics.LE63.Out inverted | Signal: Negated Latched Output (Q NOT) |
| Logics.LE63.Gate In1-I | State of the module input: Assignment of the Input Signal |
| Logics.LE63.Gate In2-I | State of the module input: Assignment of the Input Signal |
| Logics.LE63.Gate In3-I | State of the module input: Assignment of the Input Signal |
| Logics.LE63.Gate In4-I | State of the module input: Assignment of the Input Signal |
| Logics.LE63.Reset Latch-I | State of the module input: Reset Signal for the Latching |
| Logics.LE64.Gate Out | Signal: Output of the logic gate |
| Logics.LE64.Timer Out | Signal: Timer Output |
| Logics.LE64.Out | Signal: Latched Output (Q) |
| Logics.LE64.Out inverted | Signal: Negated Latched Output (Q NOT) |
| Logics.LE64.Gate In1-I | State of the module input: Assignment of the Input Signal |
| Logics.LE64.Gate In2-I | State of the module input: Assignment of the Input Signal |
| Logics.LE64.Gate In3-I | State of the module input: Assignment of the Input Signal |
| Logics.LE64.Gate In4-I | State of the module input: Assignment of the Input Signal |
| Logics.LE64.Reset Latch-I | State of the module input: Reset Signal for the Latching |
| Logics.LE65.Gate Out | Signal: Output of the logic gate |
| Logics.LE65.Timer Out | Signal: Timer Output |
| Logics.LE65.Out | Signal: Latched Output (Q) |
| Logics.LE65.Out inverted | Signal: Negated Latched Output (Q NOT) |
| Logics.LE65.Gate In1-I | State of the module input: Assignment of the Input Signal |

General Lists

| <i>Name</i> | <i>Description</i> |
|---------------------------|---|
| Logics.LE65.Gate In2-I | State of the module input: Assignment of the Input Signal |
| Logics.LE65.Gate In3-I | State of the module input: Assignment of the Input Signal |
| Logics.LE65.Gate In4-I | State of the module input: Assignment of the Input Signal |
| Logics.LE65.Reset Latch-I | State of the module input: Reset Signal for the Latching |
| Logics.LE66.Gate Out | Signal: Output of the logic gate |
| Logics.LE66.Timer Out | Signal: Timer Output |
| Logics.LE66.Out | Signal: Latched Output (Q) |
| Logics.LE66.Out inverted | Signal: Negated Latched Output (Q NOT) |
| Logics.LE66.Gate In1-I | State of the module input: Assignment of the Input Signal |
| Logics.LE66.Gate In2-I | State of the module input: Assignment of the Input Signal |
| Logics.LE66.Gate In3-I | State of the module input: Assignment of the Input Signal |
| Logics.LE66.Gate In4-I | State of the module input: Assignment of the Input Signal |
| Logics.LE66.Reset Latch-I | State of the module input: Reset Signal for the Latching |
| Logics.LE67.Gate Out | Signal: Output of the logic gate |
| Logics.LE67.Timer Out | Signal: Timer Output |
| Logics.LE67.Out | Signal: Latched Output (Q) |
| Logics.LE67.Out inverted | Signal: Negated Latched Output (Q NOT) |
| Logics.LE67.Gate In1-I | State of the module input: Assignment of the Input Signal |
| Logics.LE67.Gate In2-I | State of the module input: Assignment of the Input Signal |
| Logics.LE67.Gate In3-I | State of the module input: Assignment of the Input Signal |
| Logics.LE67.Gate In4-I | State of the module input: Assignment of the Input Signal |
| Logics.LE67.Reset Latch-I | State of the module input: Reset Signal for the Latching |
| Logics.LE68.Gate Out | Signal: Output of the logic gate |
| Logics.LE68.Timer Out | Signal: Timer Output |
| Logics.LE68.Out | Signal: Latched Output (Q) |
| Logics.LE68.Out inverted | Signal: Negated Latched Output (Q NOT) |
| Logics.LE68.Gate In1-I | State of the module input: Assignment of the Input Signal |
| Logics.LE68.Gate In2-I | State of the module input: Assignment of the Input Signal |
| Logics.LE68.Gate In3-I | State of the module input: Assignment of the Input Signal |
| Logics.LE68.Gate In4-I | State of the module input: Assignment of the Input Signal |
| Logics.LE68.Reset Latch-I | State of the module input: Reset Signal for the Latching |
| Logics.LE69.Gate Out | Signal: Output of the logic gate |
| Logics.LE69.Timer Out | Signal: Timer Output |
| Logics.LE69.Out | Signal: Latched Output (Q) |
| Logics.LE69.Out inverted | Signal: Negated Latched Output (Q NOT) |
| Logics.LE69.Gate In1-I | State of the module input: Assignment of the Input Signal |
| Logics.LE69.Gate In2-I | State of the module input: Assignment of the Input Signal |
| Logics.LE69.Gate In3-I | State of the module input: Assignment of the Input Signal |
| Logics.LE69.Gate In4-I | State of the module input: Assignment of the Input Signal |
| Logics.LE69.Reset Latch-I | State of the module input: Reset Signal for the Latching |

General Lists

| <i>Name</i> | <i>Description</i> |
|---------------------------|---|
| Logics.LE70.Gate Out | Signal: Output of the logic gate |
| Logics.LE70.Timer Out | Signal: Timer Output |
| Logics.LE70.Out | Signal: Latched Output (Q) |
| Logics.LE70.Out inverted | Signal: Negated Latched Output (Q NOT) |
| Logics.LE70.Gate In1-I | State of the module input: Assignment of the Input Signal |
| Logics.LE70.Gate In2-I | State of the module input: Assignment of the Input Signal |
| Logics.LE70.Gate In3-I | State of the module input: Assignment of the Input Signal |
| Logics.LE70.Gate In4-I | State of the module input: Assignment of the Input Signal |
| Logics.LE70.Reset Latch-I | State of the module input: Reset Signal for the Latching |
| Logics.LE71.Gate Out | Signal: Output of the logic gate |
| Logics.LE71.Timer Out | Signal: Timer Output |
| Logics.LE71.Out | Signal: Latched Output (Q) |
| Logics.LE71.Out inverted | Signal: Negated Latched Output (Q NOT) |
| Logics.LE71.Gate In1-I | State of the module input: Assignment of the Input Signal |
| Logics.LE71.Gate In2-I | State of the module input: Assignment of the Input Signal |
| Logics.LE71.Gate In3-I | State of the module input: Assignment of the Input Signal |
| Logics.LE71.Gate In4-I | State of the module input: Assignment of the Input Signal |
| Logics.LE71.Reset Latch-I | State of the module input: Reset Signal for the Latching |
| Logics.LE72.Gate Out | Signal: Output of the logic gate |
| Logics.LE72.Timer Out | Signal: Timer Output |
| Logics.LE72.Out | Signal: Latched Output (Q) |
| Logics.LE72.Out inverted | Signal: Negated Latched Output (Q NOT) |
| Logics.LE72.Gate In1-I | State of the module input: Assignment of the Input Signal |
| Logics.LE72.Gate In2-I | State of the module input: Assignment of the Input Signal |
| Logics.LE72.Gate In3-I | State of the module input: Assignment of the Input Signal |
| Logics.LE72.Gate In4-I | State of the module input: Assignment of the Input Signal |
| Logics.LE72.Reset Latch-I | State of the module input: Reset Signal for the Latching |
| Logics.LE73.Gate Out | Signal: Output of the logic gate |
| Logics.LE73.Timer Out | Signal: Timer Output |
| Logics.LE73.Out | Signal: Latched Output (Q) |
| Logics.LE73.Out inverted | Signal: Negated Latched Output (Q NOT) |
| Logics.LE73.Gate In1-I | State of the module input: Assignment of the Input Signal |
| Logics.LE73.Gate In2-I | State of the module input: Assignment of the Input Signal |
| Logics.LE73.Gate In3-I | State of the module input: Assignment of the Input Signal |
| Logics.LE73.Gate In4-I | State of the module input: Assignment of the Input Signal |
| Logics.LE73.Reset Latch-I | State of the module input: Reset Signal for the Latching |
| Logics.LE74.Gate Out | Signal: Output of the logic gate |
| Logics.LE74.Timer Out | Signal: Timer Output |
| Logics.LE74.Out | Signal: Latched Output (Q) |
| Logics.LE74.Out inverted | Signal: Negated Latched Output (Q NOT) |

General Lists

| <i>Name</i> | <i>Description</i> |
|---------------------------|---|
| Logics.LE74.Gate In1-I | State of the module input: Assignment of the Input Signal |
| Logics.LE74.Gate In2-I | State of the module input: Assignment of the Input Signal |
| Logics.LE74.Gate In3-I | State of the module input: Assignment of the Input Signal |
| Logics.LE74.Gate In4-I | State of the module input: Assignment of the Input Signal |
| Logics.LE74.Reset Latch-I | State of the module input: Reset Signal for the Latching |
| Logics.LE75.Gate Out | Signal: Output of the logic gate |
| Logics.LE75.Timer Out | Signal: Timer Output |
| Logics.LE75.Out | Signal: Latched Output (Q) |
| Logics.LE75.Out inverted | Signal: Negated Latched Output (Q NOT) |
| Logics.LE75.Gate In1-I | State of the module input: Assignment of the Input Signal |
| Logics.LE75.Gate In2-I | State of the module input: Assignment of the Input Signal |
| Logics.LE75.Gate In3-I | State of the module input: Assignment of the Input Signal |
| Logics.LE75.Gate In4-I | State of the module input: Assignment of the Input Signal |
| Logics.LE75.Reset Latch-I | State of the module input: Reset Signal for the Latching |
| Logics.LE76.Gate Out | Signal: Output of the logic gate |
| Logics.LE76.Timer Out | Signal: Timer Output |
| Logics.LE76.Out | Signal: Latched Output (Q) |
| Logics.LE76.Out inverted | Signal: Negated Latched Output (Q NOT) |
| Logics.LE76.Gate In1-I | State of the module input: Assignment of the Input Signal |
| Logics.LE76.Gate In2-I | State of the module input: Assignment of the Input Signal |
| Logics.LE76.Gate In3-I | State of the module input: Assignment of the Input Signal |
| Logics.LE76.Gate In4-I | State of the module input: Assignment of the Input Signal |
| Logics.LE76.Reset Latch-I | State of the module input: Reset Signal for the Latching |
| Logics.LE77.Gate Out | Signal: Output of the logic gate |
| Logics.LE77.Timer Out | Signal: Timer Output |
| Logics.LE77.Out | Signal: Latched Output (Q) |
| Logics.LE77.Out inverted | Signal: Negated Latched Output (Q NOT) |
| Logics.LE77.Gate In1-I | State of the module input: Assignment of the Input Signal |
| Logics.LE77.Gate In2-I | State of the module input: Assignment of the Input Signal |
| Logics.LE77.Gate In3-I | State of the module input: Assignment of the Input Signal |
| Logics.LE77.Gate In4-I | State of the module input: Assignment of the Input Signal |
| Logics.LE77.Reset Latch-I | State of the module input: Reset Signal for the Latching |
| Logics.LE78.Gate Out | Signal: Output of the logic gate |
| Logics.LE78.Timer Out | Signal: Timer Output |
| Logics.LE78.Out | Signal: Latched Output (Q) |
| Logics.LE78.Out inverted | Signal: Negated Latched Output (Q NOT) |
| Logics.LE78.Gate In1-I | State of the module input: Assignment of the Input Signal |
| Logics.LE78.Gate In2-I | State of the module input: Assignment of the Input Signal |
| Logics.LE78.Gate In3-I | State of the module input: Assignment of the Input Signal |
| Logics.LE78.Gate In4-I | State of the module input: Assignment of the Input Signal |

General Lists

| <i>Name</i> | <i>Description</i> |
|----------------------------|---|
| Logics.LE78.Reset Latch-I | State of the module input: Reset Signal for the Latching |
| Logics.LE79.Gate Out | Signal: Output of the logic gate |
| Logics.LE79.Timer Out | Signal: Timer Output |
| Logics.LE79.Out | Signal: Latched Output (Q) |
| Logics.LE79.Out inverted | Signal: Negated Latched Output (Q NOT) |
| Logics.LE79.Gate In1-I | State of the module input: Assignment of the Input Signal |
| Logics.LE79.Gate In2-I | State of the module input: Assignment of the Input Signal |
| Logics.LE79.Gate In3-I | State of the module input: Assignment of the Input Signal |
| Logics.LE79.Gate In4-I | State of the module input: Assignment of the Input Signal |
| Logics.LE79.Reset Latch-I | State of the module input: Reset Signal for the Latching |
| Logics.LE80.Gate Out | Signal: Output of the logic gate |
| Logics.LE80.Timer Out | Signal: Timer Output |
| Logics.LE80.Out | Signal: Latched Output (Q) |
| Logics.LE80.Out inverted | Signal: Negated Latched Output (Q NOT) |
| Logics.LE80.Gate In1-I | State of the module input: Assignment of the Input Signal |
| Logics.LE80.Gate In2-I | State of the module input: Assignment of the Input Signal |
| Logics.LE80.Gate In3-I | State of the module input: Assignment of the Input Signal |
| Logics.LE80.Gate In4-I | State of the module input: Assignment of the Input Signal |
| Logics.LE80.Reset Latch-I | State of the module input: Reset Signal for the Latching |
| Sgen.Running | Signal; Measuring value simulation is running |
| Sgen.Ex Start Simulation-I | State of the module input:External Start of Fault Simulation (Using the test parameters) |
| Sgen.ExBlo | Module input state: External blocking |
| Sgen.Ex ForcePost-I | State of the module input:Force Post state. Abort simulation. |
| Sys.PS 1 | Signal: Parameter Set 1 |
| Sys.PS 2 | Signal: Parameter Set 2 |
| Sys.PS 3 | Signal: Parameter Set 3 |
| Sys.PS 4 | Signal: Parameter Set 4 |
| Sys.PSS manual | Signal: Manual Switch over of a Parameter Set |
| Sys.PSS via Scada | Signal: Parameter Set Switch via Scada. Write into this output byte the integer of the parameter set that should become active (e.g. 4 => Switch onto parameter set 4). |
| Sys.PSS via Inp fct | Signal: Parameter Set Switch via input function |
| Sys.min 1 param changed | Signal: At least one parameter has been changed |
| Sys.Setting Lock Bypass | Signal: Short-period unlock of the Setting Lock |
| Sys.Ack LED | Signal: LEDs acknowledgement |
| Sys.Ack BO | Signal: Acknowledgement of the Binary Outputs |
| Sys.Ack Scada | Signal: Acknowledge Scada |
| Sys.Ack TripCmd | Signal: Reset Trip Command |
| Sys.Ack LED-HMI | Signal: LEDs acknowledgement :HMI |
| Sys.Ack BO-HMI | Signal: Acknowledgement of the Binary Outputs :HMI |
| Sys.Ack Scada-HMI | Signal: Acknowledge Scada :HMI |

General Lists

| <i>Name</i> | <i>Description</i> |
|----------------------|---|
| Sys.Ack TripCmd-HMI | Signal: Reset Trip Command :HMI |
| Sys.Ack LED-Sca | Signal: LEDs acknowledgement :SCADA |
| Sys.Ack BO-Sca | Signal: Acknowledgement of the Binary Outputs :SCADA |
| Sys.Ack Counter-Sca | Signal: Reset of all Counters :SCADA |
| Sys.Ack Scada-Sca | Signal: Acknowledge Scada :SCADA |
| Sys.Ack TripCmd-Sca | Signal: Reset Trip Command :SCADA |
| Sys.Res OperationsCr | Signal:: Res OperationsCr |
| Sys.Res AlarmCr | Signal:: Res AlarmCr |
| Sys.Res TripCmdCr | Signal:: Res TripCmdCr |
| Sys.Res TotalCr | Signal:: Res TotalCr |
| Sys.Ack LED-I | Module input state: LEDs acknowledgement by digital input |
| Sys.Ack BO-I | Module input state: Acknowledgement of the binary Output Relays |
| Sys.Ack Scada-I | Module input state: Acknowledge Scada via digital input. The replica that SCADA has got from the device is to be reset. |
| Sys.PS1-I | State of the module input respectively of the signal, that should activate this Parameter Setting Group. |
| Sys.PS2-I | State of the module input respectively of the signal, that should activate this Parameter Setting Group. |
| Sys.PS3-I | State of the module input respectively of the signal, that should activate this Parameter Setting Group. |
| Sys.PS4-I | State of the module input respectively of the signal, that should activate this Parameter Setting Group. |
| Sys.Lock Settings-I | State of the module input: No parameters can be changed as long as this input is true. The parameter settings are locked. |

List of the Digital Inputs

The following list comprises all Digital Inputs. This list is used in various Protective Elements (e.g. TCS, Q->&V<...). The availability and the number of entries depends on the type of device.

| <i>Name</i> | <i>Description</i> |
|-----------------|-----------------------|
| -- | No assignment |
| DI Slot X1.DI 1 | Signal: Digital Input |
| DI Slot X1.DI 2 | Signal: Digital Input |
| DI Slot X1.DI 3 | Signal: Digital Input |
| DI Slot X1.DI 4 | Signal: Digital Input |
| DI Slot X1.DI 5 | Signal: Digital Input |
| DI Slot X1.DI 6 | Signal: Digital Input |
| DI Slot X1.DI 7 | Signal: Digital Input |
| DI Slot X1.DI 8 | Signal: Digital Input |
| DI Slot X6.DI 1 | Signal: Digital Input |
| DI Slot X6.DI 2 | Signal: Digital Input |
| DI Slot X6.DI 3 | Signal: Digital Input |
| DI Slot X6.DI 4 | Signal: Digital Input |
| DI Slot X6.DI 5 | Signal: Digital Input |
| DI Slot X6.DI 6 | Signal: Digital Input |
| DI Slot X6.DI 7 | Signal: Digital Input |
| DI Slot X6.DI 8 | Signal: Digital Input |

Signals of the Digital Inputs and Logic

The following list comprises the signals of the Digital Inputs and the Logic. This list is used in various protective elements.

| <i>Name</i> | <i>Description</i> |
|---------------------|--|
| -- | No assignment |
| DI Slot X1.DI 1 | Signal: Digital Input |
| DI Slot X1.DI 2 | Signal: Digital Input |
| DI Slot X1.DI 3 | Signal: Digital Input |
| DI Slot X1.DI 4 | Signal: Digital Input |
| DI Slot X1.DI 5 | Signal: Digital Input |
| DI Slot X1.DI 6 | Signal: Digital Input |
| DI Slot X1.DI 7 | Signal: Digital Input |
| DI Slot X1.DI 8 | Signal: Digital Input |
| DI Slot X6.DI 1 | Signal: Digital Input |
| DI Slot X6.DI 2 | Signal: Digital Input |
| DI Slot X6.DI 3 | Signal: Digital Input |
| DI Slot X6.DI 4 | Signal: Digital Input |
| DI Slot X6.DI 5 | Signal: Digital Input |
| DI Slot X6.DI 6 | Signal: Digital Input |
| DI Slot X6.DI 7 | Signal: Digital Input |
| DI Slot X6.DI 8 | Signal: Digital Input |
| DNP3.BinaryOutput0 | Virtual Digital Output (DNP). This corresponds to a virtual binary input of the protective device. |
| DNP3.BinaryOutput1 | Virtual Digital Output (DNP). This corresponds to a virtual binary input of the protective device. |
| DNP3.BinaryOutput2 | Virtual Digital Output (DNP). This corresponds to a virtual binary input of the protective device. |
| DNP3.BinaryOutput3 | Virtual Digital Output (DNP). This corresponds to a virtual binary input of the protective device. |
| DNP3.BinaryOutput4 | Virtual Digital Output (DNP). This corresponds to a virtual binary input of the protective device. |
| DNP3.BinaryOutput5 | Virtual Digital Output (DNP). This corresponds to a virtual binary input of the protective device. |
| DNP3.BinaryOutput6 | Virtual Digital Output (DNP). This corresponds to a virtual binary input of the protective device. |
| DNP3.BinaryOutput7 | Virtual Digital Output (DNP). This corresponds to a virtual binary input of the protective device. |
| DNP3.BinaryOutput8 | Virtual Digital Output (DNP). This corresponds to a virtual binary input of the protective device. |
| DNP3.BinaryOutput9 | Virtual Digital Output (DNP). This corresponds to a virtual binary input of the protective device. |
| DNP3.BinaryOutput10 | Virtual Digital Output (DNP). This corresponds to a virtual binary input of the protective device. |
| DNP3.BinaryOutput11 | Virtual Digital Output (DNP). This corresponds to a virtual binary input of the protective device. |
| DNP3.BinaryOutput12 | Virtual Digital Output (DNP). This corresponds to a virtual binary input of the protective device. |
| DNP3.BinaryOutput13 | Virtual Digital Output (DNP). This corresponds to a virtual binary input of the protective device. |
| DNP3.BinaryOutput14 | Virtual Digital Output (DNP). This corresponds to a virtual binary input of the protective device. |
| DNP3.BinaryOutput15 | Virtual Digital Output (DNP). This corresponds to a virtual binary input of the protective device. |
| DNP3.BinaryOutput16 | Virtual Digital Output (DNP). This corresponds to a virtual binary input of the protective device. |
| DNP3.BinaryOutput17 | Virtual Digital Output (DNP). This corresponds to a virtual binary input of the protective device. |
| DNP3.BinaryOutput18 | Virtual Digital Output (DNP). This corresponds to a virtual binary input of the protective device. |

General Lists

| <i>Name</i> | <i>Description</i> |
|-------------------------|--|
| DNP3.BinaryOutput19 | Virtual Digital Output (DNP). This corresponds to a virtual binary input of the protective device. |
| DNP3.BinaryOutput20 | Virtual Digital Output (DNP). This corresponds to a virtual binary input of the protective device. |
| DNP3.BinaryOutput21 | Virtual Digital Output (DNP). This corresponds to a virtual binary input of the protective device. |
| DNP3.BinaryOutput22 | Virtual Digital Output (DNP). This corresponds to a virtual binary input of the protective device. |
| DNP3.BinaryOutput23 | Virtual Digital Output (DNP). This corresponds to a virtual binary input of the protective device. |
| DNP3.BinaryOutput24 | Virtual Digital Output (DNP). This corresponds to a virtual binary input of the protective device. |
| DNP3.BinaryOutput25 | Virtual Digital Output (DNP). This corresponds to a virtual binary input of the protective device. |
| DNP3.BinaryOutput26 | Virtual Digital Output (DNP). This corresponds to a virtual binary input of the protective device. |
| DNP3.BinaryOutput27 | Virtual Digital Output (DNP). This corresponds to a virtual binary input of the protective device. |
| DNP3.BinaryOutput28 | Virtual Digital Output (DNP). This corresponds to a virtual binary input of the protective device. |
| DNP3.BinaryOutput29 | Virtual Digital Output (DNP). This corresponds to a virtual binary input of the protective device. |
| DNP3.BinaryOutput30 | Virtual Digital Output (DNP). This corresponds to a virtual binary input of the protective device. |
| DNP3.BinaryOutput31 | Virtual Digital Output (DNP). This corresponds to a virtual binary input of the protective device. |
| Logics.LE1.Gate Out | Signal: Output of the logic gate |
| Logics.LE1.Timer Out | Signal: Timer Output |
| Logics.LE1.Out | Signal: Latched Output (Q) |
| Logics.LE1.Out inverted | Signal: Negated Latched Output (Q NOT) |
| Logics.LE2.Gate Out | Signal: Output of the logic gate |
| Logics.LE2.Timer Out | Signal: Timer Output |
| Logics.LE2.Out | Signal: Latched Output (Q) |
| Logics.LE2.Out inverted | Signal: Negated Latched Output (Q NOT) |
| Logics.LE3.Gate Out | Signal: Output of the logic gate |
| Logics.LE3.Timer Out | Signal: Timer Output |
| Logics.LE3.Out | Signal: Latched Output (Q) |
| Logics.LE3.Out inverted | Signal: Negated Latched Output (Q NOT) |
| Logics.LE4.Gate Out | Signal: Output of the logic gate |
| Logics.LE4.Timer Out | Signal: Timer Output |
| Logics.LE4.Out | Signal: Latched Output (Q) |
| Logics.LE4.Out inverted | Signal: Negated Latched Output (Q NOT) |
| Logics.LE5.Gate Out | Signal: Output of the logic gate |
| Logics.LE5.Timer Out | Signal: Timer Output |
| Logics.LE5.Out | Signal: Latched Output (Q) |
| Logics.LE5.Out inverted | Signal: Negated Latched Output (Q NOT) |
| Logics.LE6.Gate Out | Signal: Output of the logic gate |
| Logics.LE6.Timer Out | Signal: Timer Output |
| Logics.LE6.Out | Signal: Latched Output (Q) |
| Logics.LE6.Out inverted | Signal: Negated Latched Output (Q NOT) |
| Logics.LE7.Gate Out | Signal: Output of the logic gate |
| Logics.LE7.Timer Out | Signal: Timer Output |
| Logics.LE7.Out | Signal: Latched Output (Q) |

General Lists

| <i>Name</i> | <i>Description</i> |
|--------------------------|--|
| Logics.LE7.Out inverted | Signal: Negated Latched Output (Q NOT) |
| Logics.LE8.Gate Out | Signal: Output of the logic gate |
| Logics.LE8.Timer Out | Signal: Timer Output |
| Logics.LE8.Out | Signal: Latched Output (Q) |
| Logics.LE8.Out inverted | Signal: Negated Latched Output (Q NOT) |
| Logics.LE9.Gate Out | Signal: Output of the logic gate |
| Logics.LE9.Timer Out | Signal: Timer Output |
| Logics.LE9.Out | Signal: Latched Output (Q) |
| Logics.LE9.Out inverted | Signal: Negated Latched Output (Q NOT) |
| Logics.LE10.Gate Out | Signal: Output of the logic gate |
| Logics.LE10.Timer Out | Signal: Timer Output |
| Logics.LE10.Out | Signal: Latched Output (Q) |
| Logics.LE10.Out inverted | Signal: Negated Latched Output (Q NOT) |
| Logics.LE11.Gate Out | Signal: Output of the logic gate |
| Logics.LE11.Timer Out | Signal: Timer Output |
| Logics.LE11.Out | Signal: Latched Output (Q) |
| Logics.LE11.Out inverted | Signal: Negated Latched Output (Q NOT) |
| Logics.LE12.Gate Out | Signal: Output of the logic gate |
| Logics.LE12.Timer Out | Signal: Timer Output |
| Logics.LE12.Out | Signal: Latched Output (Q) |
| Logics.LE12.Out inverted | Signal: Negated Latched Output (Q NOT) |
| Logics.LE13.Gate Out | Signal: Output of the logic gate |
| Logics.LE13.Timer Out | Signal: Timer Output |
| Logics.LE13.Out | Signal: Latched Output (Q) |
| Logics.LE13.Out inverted | Signal: Negated Latched Output (Q NOT) |
| Logics.LE14.Gate Out | Signal: Output of the logic gate |
| Logics.LE14.Timer Out | Signal: Timer Output |
| Logics.LE14.Out | Signal: Latched Output (Q) |
| Logics.LE14.Out inverted | Signal: Negated Latched Output (Q NOT) |
| Logics.LE15.Gate Out | Signal: Output of the logic gate |
| Logics.LE15.Timer Out | Signal: Timer Output |
| Logics.LE15.Out | Signal: Latched Output (Q) |
| Logics.LE15.Out inverted | Signal: Negated Latched Output (Q NOT) |
| Logics.LE16.Gate Out | Signal: Output of the logic gate |
| Logics.LE16.Timer Out | Signal: Timer Output |
| Logics.LE16.Out | Signal: Latched Output (Q) |
| Logics.LE16.Out inverted | Signal: Negated Latched Output (Q NOT) |
| Logics.LE17.Gate Out | Signal: Output of the logic gate |
| Logics.LE17.Timer Out | Signal: Timer Output |
| Logics.LE17.Out | Signal: Latched Output (Q) |

General Lists

| <i>Name</i> | <i>Description</i> |
|--------------------------|--|
| Logics.LE17.Out inverted | Signal: Negated Latched Output (Q NOT) |
| Logics.LE18.Gate Out | Signal: Output of the logic gate |
| Logics.LE18.Timer Out | Signal: Timer Output |
| Logics.LE18.Out | Signal: Latched Output (Q) |
| Logics.LE18.Out inverted | Signal: Negated Latched Output (Q NOT) |
| Logics.LE19.Gate Out | Signal: Output of the logic gate |
| Logics.LE19.Timer Out | Signal: Timer Output |
| Logics.LE19.Out | Signal: Latched Output (Q) |
| Logics.LE19.Out inverted | Signal: Negated Latched Output (Q NOT) |
| Logics.LE20.Gate Out | Signal: Output of the logic gate |
| Logics.LE20.Timer Out | Signal: Timer Output |
| Logics.LE20.Out | Signal: Latched Output (Q) |
| Logics.LE20.Out inverted | Signal: Negated Latched Output (Q NOT) |
| Logics.LE21.Gate Out | Signal: Output of the logic gate |
| Logics.LE21.Timer Out | Signal: Timer Output |
| Logics.LE21.Out | Signal: Latched Output (Q) |
| Logics.LE21.Out inverted | Signal: Negated Latched Output (Q NOT) |
| Logics.LE22.Gate Out | Signal: Output of the logic gate |
| Logics.LE22.Timer Out | Signal: Timer Output |
| Logics.LE22.Out | Signal: Latched Output (Q) |
| Logics.LE22.Out inverted | Signal: Negated Latched Output (Q NOT) |
| Logics.LE23.Gate Out | Signal: Output of the logic gate |
| Logics.LE23.Timer Out | Signal: Timer Output |
| Logics.LE23.Out | Signal: Latched Output (Q) |
| Logics.LE23.Out inverted | Signal: Negated Latched Output (Q NOT) |
| Logics.LE24.Gate Out | Signal: Output of the logic gate |
| Logics.LE24.Timer Out | Signal: Timer Output |
| Logics.LE24.Out | Signal: Latched Output (Q) |
| Logics.LE24.Out inverted | Signal: Negated Latched Output (Q NOT) |
| Logics.LE25.Gate Out | Signal: Output of the logic gate |
| Logics.LE25.Timer Out | Signal: Timer Output |
| Logics.LE25.Out | Signal: Latched Output (Q) |
| Logics.LE25.Out inverted | Signal: Negated Latched Output (Q NOT) |
| Logics.LE26.Gate Out | Signal: Output of the logic gate |
| Logics.LE26.Timer Out | Signal: Timer Output |
| Logics.LE26.Out | Signal: Latched Output (Q) |
| Logics.LE26.Out inverted | Signal: Negated Latched Output (Q NOT) |
| Logics.LE27.Gate Out | Signal: Output of the logic gate |
| Logics.LE27.Timer Out | Signal: Timer Output |
| Logics.LE27.Out | Signal: Latched Output (Q) |

General Lists

| <i>Name</i> | <i>Description</i> |
|--------------------------|--|
| Logics.LE27.Out inverted | Signal: Negated Latched Output (Q NOT) |
| Logics.LE28.Gate Out | Signal: Output of the logic gate |
| Logics.LE28.Timer Out | Signal: Timer Output |
| Logics.LE28.Out | Signal: Latched Output (Q) |
| Logics.LE28.Out inverted | Signal: Negated Latched Output (Q NOT) |
| Logics.LE29.Gate Out | Signal: Output of the logic gate |
| Logics.LE29.Timer Out | Signal: Timer Output |
| Logics.LE29.Out | Signal: Latched Output (Q) |
| Logics.LE29.Out inverted | Signal: Negated Latched Output (Q NOT) |
| Logics.LE30.Gate Out | Signal: Output of the logic gate |
| Logics.LE30.Timer Out | Signal: Timer Output |
| Logics.LE30.Out | Signal: Latched Output (Q) |
| Logics.LE30.Out inverted | Signal: Negated Latched Output (Q NOT) |
| Logics.LE31.Gate Out | Signal: Output of the logic gate |
| Logics.LE31.Timer Out | Signal: Timer Output |
| Logics.LE31.Out | Signal: Latched Output (Q) |
| Logics.LE31.Out inverted | Signal: Negated Latched Output (Q NOT) |
| Logics.LE32.Gate Out | Signal: Output of the logic gate |
| Logics.LE32.Timer Out | Signal: Timer Output |
| Logics.LE32.Out | Signal: Latched Output (Q) |
| Logics.LE32.Out inverted | Signal: Negated Latched Output (Q NOT) |
| Logics.LE33.Gate Out | Signal: Output of the logic gate |
| Logics.LE33.Timer Out | Signal: Timer Output |
| Logics.LE33.Out | Signal: Latched Output (Q) |
| Logics.LE33.Out inverted | Signal: Negated Latched Output (Q NOT) |
| Logics.LE34.Gate Out | Signal: Output of the logic gate |
| Logics.LE34.Timer Out | Signal: Timer Output |
| Logics.LE34.Out | Signal: Latched Output (Q) |
| Logics.LE34.Out inverted | Signal: Negated Latched Output (Q NOT) |
| Logics.LE35.Gate Out | Signal: Output of the logic gate |
| Logics.LE35.Timer Out | Signal: Timer Output |
| Logics.LE35.Out | Signal: Latched Output (Q) |
| Logics.LE35.Out inverted | Signal: Negated Latched Output (Q NOT) |
| Logics.LE36.Gate Out | Signal: Output of the logic gate |
| Logics.LE36.Timer Out | Signal: Timer Output |
| Logics.LE36.Out | Signal: Latched Output (Q) |
| Logics.LE36.Out inverted | Signal: Negated Latched Output (Q NOT) |
| Logics.LE37.Gate Out | Signal: Output of the logic gate |
| Logics.LE37.Timer Out | Signal: Timer Output |
| Logics.LE37.Out | Signal: Latched Output (Q) |

General Lists

| <i>Name</i> | <i>Description</i> |
|--------------------------|--|
| Logics.LE37.Out inverted | Signal: Negated Latched Output (Q NOT) |
| Logics.LE38.Gate Out | Signal: Output of the logic gate |
| Logics.LE38.Timer Out | Signal: Timer Output |
| Logics.LE38.Out | Signal: Latched Output (Q) |
| Logics.LE38.Out inverted | Signal: Negated Latched Output (Q NOT) |
| Logics.LE39.Gate Out | Signal: Output of the logic gate |
| Logics.LE39.Timer Out | Signal: Timer Output |
| Logics.LE39.Out | Signal: Latched Output (Q) |
| Logics.LE39.Out inverted | Signal: Negated Latched Output (Q NOT) |
| Logics.LE40.Gate Out | Signal: Output of the logic gate |
| Logics.LE40.Timer Out | Signal: Timer Output |
| Logics.LE40.Out | Signal: Latched Output (Q) |
| Logics.LE40.Out inverted | Signal: Negated Latched Output (Q NOT) |
| Logics.LE41.Gate Out | Signal: Output of the logic gate |
| Logics.LE41.Timer Out | Signal: Timer Output |
| Logics.LE41.Out | Signal: Latched Output (Q) |
| Logics.LE41.Out inverted | Signal: Negated Latched Output (Q NOT) |
| Logics.LE42.Gate Out | Signal: Output of the logic gate |
| Logics.LE42.Timer Out | Signal: Timer Output |
| Logics.LE42.Out | Signal: Latched Output (Q) |
| Logics.LE42.Out inverted | Signal: Negated Latched Output (Q NOT) |
| Logics.LE43.Gate Out | Signal: Output of the logic gate |
| Logics.LE43.Timer Out | Signal: Timer Output |
| Logics.LE43.Out | Signal: Latched Output (Q) |
| Logics.LE43.Out inverted | Signal: Negated Latched Output (Q NOT) |
| Logics.LE44.Gate Out | Signal: Output of the logic gate |
| Logics.LE44.Timer Out | Signal: Timer Output |
| Logics.LE44.Out | Signal: Latched Output (Q) |
| Logics.LE44.Out inverted | Signal: Negated Latched Output (Q NOT) |
| Logics.LE45.Gate Out | Signal: Output of the logic gate |
| Logics.LE45.Timer Out | Signal: Timer Output |
| Logics.LE45.Out | Signal: Latched Output (Q) |
| Logics.LE45.Out inverted | Signal: Negated Latched Output (Q NOT) |
| Logics.LE46.Gate Out | Signal: Output of the logic gate |
| Logics.LE46.Timer Out | Signal: Timer Output |
| Logics.LE46.Out | Signal: Latched Output (Q) |
| Logics.LE46.Out inverted | Signal: Negated Latched Output (Q NOT) |
| Logics.LE47.Gate Out | Signal: Output of the logic gate |
| Logics.LE47.Timer Out | Signal: Timer Output |
| Logics.LE47.Out | Signal: Latched Output (Q) |

General Lists

| <i>Name</i> | <i>Description</i> |
|--------------------------|--|
| Logics.LE47.Out inverted | Signal: Negated Latched Output (Q NOT) |
| Logics.LE48.Gate Out | Signal: Output of the logic gate |
| Logics.LE48.Timer Out | Signal: Timer Output |
| Logics.LE48.Out | Signal: Latched Output (Q) |
| Logics.LE48.Out inverted | Signal: Negated Latched Output (Q NOT) |
| Logics.LE49.Gate Out | Signal: Output of the logic gate |
| Logics.LE49.Timer Out | Signal: Timer Output |
| Logics.LE49.Out | Signal: Latched Output (Q) |
| Logics.LE49.Out inverted | Signal: Negated Latched Output (Q NOT) |
| Logics.LE50.Gate Out | Signal: Output of the logic gate |
| Logics.LE50.Timer Out | Signal: Timer Output |
| Logics.LE50.Out | Signal: Latched Output (Q) |
| Logics.LE50.Out inverted | Signal: Negated Latched Output (Q NOT) |
| Logics.LE51.Gate Out | Signal: Output of the logic gate |
| Logics.LE51.Timer Out | Signal: Timer Output |
| Logics.LE51.Out | Signal: Latched Output (Q) |
| Logics.LE51.Out inverted | Signal: Negated Latched Output (Q NOT) |
| Logics.LE52.Gate Out | Signal: Output of the logic gate |
| Logics.LE52.Timer Out | Signal: Timer Output |
| Logics.LE52.Out | Signal: Latched Output (Q) |
| Logics.LE52.Out inverted | Signal: Negated Latched Output (Q NOT) |
| Logics.LE53.Gate Out | Signal: Output of the logic gate |
| Logics.LE53.Timer Out | Signal: Timer Output |
| Logics.LE53.Out | Signal: Latched Output (Q) |
| Logics.LE53.Out inverted | Signal: Negated Latched Output (Q NOT) |
| Logics.LE54.Gate Out | Signal: Output of the logic gate |
| Logics.LE54.Timer Out | Signal: Timer Output |
| Logics.LE54.Out | Signal: Latched Output (Q) |
| Logics.LE54.Out inverted | Signal: Negated Latched Output (Q NOT) |
| Logics.LE55.Gate Out | Signal: Output of the logic gate |
| Logics.LE55.Timer Out | Signal: Timer Output |
| Logics.LE55.Out | Signal: Latched Output (Q) |
| Logics.LE55.Out inverted | Signal: Negated Latched Output (Q NOT) |
| Logics.LE56.Gate Out | Signal: Output of the logic gate |
| Logics.LE56.Timer Out | Signal: Timer Output |
| Logics.LE56.Out | Signal: Latched Output (Q) |
| Logics.LE56.Out inverted | Signal: Negated Latched Output (Q NOT) |
| Logics.LE57.Gate Out | Signal: Output of the logic gate |
| Logics.LE57.Timer Out | Signal: Timer Output |
| Logics.LE57.Out | Signal: Latched Output (Q) |

General Lists

| <i>Name</i> | <i>Description</i> |
|--------------------------|--|
| Logics.LE57.Out inverted | Signal: Negated Latched Output (Q NOT) |
| Logics.LE58.Gate Out | Signal: Output of the logic gate |
| Logics.LE58.Timer Out | Signal: Timer Output |
| Logics.LE58.Out | Signal: Latched Output (Q) |
| Logics.LE58.Out inverted | Signal: Negated Latched Output (Q NOT) |
| Logics.LE59.Gate Out | Signal: Output of the logic gate |
| Logics.LE59.Timer Out | Signal: Timer Output |
| Logics.LE59.Out | Signal: Latched Output (Q) |
| Logics.LE59.Out inverted | Signal: Negated Latched Output (Q NOT) |
| Logics.LE60.Gate Out | Signal: Output of the logic gate |
| Logics.LE60.Timer Out | Signal: Timer Output |
| Logics.LE60.Out | Signal: Latched Output (Q) |
| Logics.LE60.Out inverted | Signal: Negated Latched Output (Q NOT) |
| Logics.LE61.Gate Out | Signal: Output of the logic gate |
| Logics.LE61.Timer Out | Signal: Timer Output |
| Logics.LE61.Out | Signal: Latched Output (Q) |
| Logics.LE61.Out inverted | Signal: Negated Latched Output (Q NOT) |
| Logics.LE62.Gate Out | Signal: Output of the logic gate |
| Logics.LE62.Timer Out | Signal: Timer Output |
| Logics.LE62.Out | Signal: Latched Output (Q) |
| Logics.LE62.Out inverted | Signal: Negated Latched Output (Q NOT) |
| Logics.LE63.Gate Out | Signal: Output of the logic gate |
| Logics.LE63.Timer Out | Signal: Timer Output |
| Logics.LE63.Out | Signal: Latched Output (Q) |
| Logics.LE63.Out inverted | Signal: Negated Latched Output (Q NOT) |
| Logics.LE64.Gate Out | Signal: Output of the logic gate |
| Logics.LE64.Timer Out | Signal: Timer Output |
| Logics.LE64.Out | Signal: Latched Output (Q) |
| Logics.LE64.Out inverted | Signal: Negated Latched Output (Q NOT) |
| Logics.LE65.Gate Out | Signal: Output of the logic gate |
| Logics.LE65.Timer Out | Signal: Timer Output |
| Logics.LE65.Out | Signal: Latched Output (Q) |
| Logics.LE65.Out inverted | Signal: Negated Latched Output (Q NOT) |
| Logics.LE66.Gate Out | Signal: Output of the logic gate |
| Logics.LE66.Timer Out | Signal: Timer Output |
| Logics.LE66.Out | Signal: Latched Output (Q) |
| Logics.LE66.Out inverted | Signal: Negated Latched Output (Q NOT) |
| Logics.LE67.Gate Out | Signal: Output of the logic gate |
| Logics.LE67.Timer Out | Signal: Timer Output |
| Logics.LE67.Out | Signal: Latched Output (Q) |

General Lists

| <i>Name</i> | <i>Description</i> |
|--------------------------|--|
| Logics.LE67.Out inverted | Signal: Negated Latched Output (Q NOT) |
| Logics.LE68.Gate Out | Signal: Output of the logic gate |
| Logics.LE68.Timer Out | Signal: Timer Output |
| Logics.LE68.Out | Signal: Latched Output (Q) |
| Logics.LE68.Out inverted | Signal: Negated Latched Output (Q NOT) |
| Logics.LE69.Gate Out | Signal: Output of the logic gate |
| Logics.LE69.Timer Out | Signal: Timer Output |
| Logics.LE69.Out | Signal: Latched Output (Q) |
| Logics.LE69.Out inverted | Signal: Negated Latched Output (Q NOT) |
| Logics.LE70.Gate Out | Signal: Output of the logic gate |
| Logics.LE70.Timer Out | Signal: Timer Output |
| Logics.LE70.Out | Signal: Latched Output (Q) |
| Logics.LE70.Out inverted | Signal: Negated Latched Output (Q NOT) |
| Logics.LE71.Gate Out | Signal: Output of the logic gate |
| Logics.LE71.Timer Out | Signal: Timer Output |
| Logics.LE71.Out | Signal: Latched Output (Q) |
| Logics.LE71.Out inverted | Signal: Negated Latched Output (Q NOT) |
| Logics.LE72.Gate Out | Signal: Output of the logic gate |
| Logics.LE72.Timer Out | Signal: Timer Output |
| Logics.LE72.Out | Signal: Latched Output (Q) |
| Logics.LE72.Out inverted | Signal: Negated Latched Output (Q NOT) |
| Logics.LE73.Gate Out | Signal: Output of the logic gate |
| Logics.LE73.Timer Out | Signal: Timer Output |
| Logics.LE73.Out | Signal: Latched Output (Q) |
| Logics.LE73.Out inverted | Signal: Negated Latched Output (Q NOT) |
| Logics.LE74.Gate Out | Signal: Output of the logic gate |
| Logics.LE74.Timer Out | Signal: Timer Output |
| Logics.LE74.Out | Signal: Latched Output (Q) |
| Logics.LE74.Out inverted | Signal: Negated Latched Output (Q NOT) |
| Logics.LE75.Gate Out | Signal: Output of the logic gate |
| Logics.LE75.Timer Out | Signal: Timer Output |
| Logics.LE75.Out | Signal: Latched Output (Q) |
| Logics.LE75.Out inverted | Signal: Negated Latched Output (Q NOT) |
| Logics.LE76.Gate Out | Signal: Output of the logic gate |
| Logics.LE76.Timer Out | Signal: Timer Output |
| Logics.LE76.Out | Signal: Latched Output (Q) |
| Logics.LE76.Out inverted | Signal: Negated Latched Output (Q NOT) |
| Logics.LE77.Gate Out | Signal: Output of the logic gate |
| Logics.LE77.Timer Out | Signal: Timer Output |
| Logics.LE77.Out | Signal: Latched Output (Q) |

General Lists

| <i>Name</i> | <i>Description</i> |
|--------------------------|--|
| Logics.LE77.Out inverted | Signal: Negated Latched Output (Q NOT) |
| Logics.LE78.Gate Out | Signal: Output of the logic gate |
| Logics.LE78.Timer Out | Signal: Timer Output |
| Logics.LE78.Out | Signal: Latched Output (Q) |
| Logics.LE78.Out inverted | Signal: Negated Latched Output (Q NOT) |
| Logics.LE79.Gate Out | Signal: Output of the logic gate |
| Logics.LE79.Timer Out | Signal: Timer Output |
| Logics.LE79.Out | Signal: Latched Output (Q) |
| Logics.LE79.Out inverted | Signal: Negated Latched Output (Q NOT) |
| Logics.LE80.Gate Out | Signal: Output of the logic gate |
| Logics.LE80.Timer Out | Signal: Timer Output |
| Logics.LE80.Out | Signal: Latched Output (Q) |
| Logics.LE80.Out inverted | Signal: Negated Latched Output (Q NOT) |

Specifications

Specifications of the Real Time Clock

| | |
|-------------|--|
| Resolution: | 1 ms |
| Tolerance: | <1 minute / month (+20°C [68°F]) <±1ms if synchronized via IRIG-B |

Time Synchronisation Tolerances

The different protocols for time synchronisation vary in their accuracy:

| <i>Used Protocol</i> | <i>Time drift over one month</i> | <i>Deviation to time generator</i> |
|------------------------------|---|---|
| Without time synchronization | <1 min (+20°C) | Time drifts |
| IRIG-B | Dependent on the time drift of the time generator | <±1 ms |
| SNTP | Dependent on the time drift of the time generator | <±1 ms |
| IEC60870-5-103 | Dependent on the time drift of the time generator | <±1 ms |
| Modbus TCP | Dependent on the time drift of the time generator | Dependent on the network load |
| Modbus RTU | Dependent on the time drift of the time generator | <±1 ms |
| DNP3 | Dependent on the time drift of the time generator | <±1 ms |

Specifications of the Measured Value Acquisition Phase and Ground Current Measuring

| | |
|----------------------------------|---|
| Frequency Range: | 50 Hz / 60 Hz \pm 10% ^{*1)} |
| Accuracy: | Class 0.5 |
| Amplitude Error if $I < I_n$: | \pm 0.5% of the rated current ^{*2) *3)} |
| Amplitude Error if $I > I_n$: | \pm 0.5% of the measured current ^{*2) *3)} |
| Amplitude Error if $I > 2 I_n$: | \pm 1.0% of the measured current ^{*2) *3)} |
| Harmonics: | Up to 20% 3rd harmonic \pm 2% Up to 20% 5th harmonic \pm 2% |
| Frequency Influence: | $<\pm$ 2% / Hz in the range of \pm 5 Hz of the configured nominal frequency |
| Temperature Influence: | $<\pm$ 1% within the range of 0°C to +60°C (+32°F to +140°F) |

*1) Wide frequency range (10..70Hz) is active outside 50Hz/60Hz \pm 5Hz. DFT values get more inaccurate, protective elements which have DFT values as input may be blocked automatically.

*2) Accuracy for True RMS values in wide frequency range: 30...70Hz same accuracy like specified above. $<$ 30Hz accuracy is $<$ 3%. True RMS values are updated only every full cycle (period time).

*3) For earth current sensitive the precision does not depend on the nominal value but is referenced to 100 mA (with $I_n = 1$ A) respectively. 500 mA (with $I_n = 5$ A)

Phase-to-ground and Residual Voltage Measurement

| | |
|--|---|
| Frequency Range: | 50 Hz / 60 Hz \pm 10% ^{*1)} |
| Accuracy for <u>measured</u> values: | Class 0.5 |
| Amplitude error for $V < V_n$: | \pm 0.5% of rated voltage or \pm 0.5 V ^{*2)} |
| Amplitude error for $V > V_n$: | \pm 0.5% of measured voltage or \pm 0.5 V ^{*2)} |
| Accuracy for <u>calculated</u> values: | Class 1.0 |
| Amplitude error for $V < V_n$: | \pm 1.0% of rated voltage or \pm 1.0 V ^{*2)} |
| Amplitude error for $V > V_n$: | \pm 1.0% of calculated voltage or \pm 1.0 V ^{*2)} |
| Harmonics: | Up to 20% 3rd harmonic \pm 1% Up to 20% 5th harmonic \pm 1% |
| Frequency influence: | $<\pm$ 2% / Hz in the range of \pm 5 Hz of the configured nominal frequency |
| Temperature influence: | $<\pm$ 1% within the range of 0°C up to +60°C |

*1) Wide frequency range (10..70Hz) is active outside 50Hz/60Hz \pm 5Hz. DFT values get more inaccurate, protective elements which have DFT values as input may be blocked automatically.

*2) Accuracy for True RMS values in wide frequency range: 30...70Hz same accuracy like specified above. $<$ 30Hz accuracy is $<$ 3%. True RMS values are updated only every full cycle (period time).

Frequency measurement

| | |
|---------------------|--|
| Nominal frequency: | 50 Hz / 60 Hz |
| Precision: | $\pm 0.05\%$ of f_n within the range of 40-70 Hz at voltages >50 V |
| Voltage dependency: | frequency acquisition of 5 V – 800 V |

Energy measurement*

| | |
|----------------------|--|
| Energy counter error | 1.5% of measured energy or 1.5% $S_n \cdot 1h$ |
|----------------------|--|

Power Measurement*

| | |
|----------|--|
| S, P, Q: | $<\pm 1\%$ of the measured value or 0.1% S_n (for fundamental) $<\pm 2\%$ of the measured value or 0.1% S_n (for RMS) |
|----------|--|

Power Factor Measurement*

| | |
|-----|--|
| PF: | ± 0.01 of measured power factor or 1° $I > 30\% I_n$ and $S > 2\% S_n$ |
|-----|--|

*)Tolerance at $0.8 \dots 1.2 \times V_n$ (with $V_n=100V$), $|PF|>0.5$, at f_n , symmetrically fed
 $S_n=1.73 \cdot V_T \text{ rating} \cdot CT \text{ rating}$

Protection Elements Accuracy

NOTICE

The tripping delay relates to the time between alarm and trip.
 The accuracy of the operating time relates to the time between fault entry and the time when the protection element is picked-up.

Reference conditions for all Protection Elements: sine wave, at rated frequency, THD < 1%
 Measuring method: Fundamental

| Overcurrent Protection Elements: I[x] | Accuracy ^{*1) *2)} |
|---|--|
| I> | ±1.5% of the setting value or ±1% I _n |
| Dropout Ratio | 97% or 0.5% I _n |
| t | DEFT ±1% or ±10 ms |
| Operating Time At testing current ≥ 2 times pickup value | <36ms (directional elements: <40ms) |
| Disengaging Time | <55ms |
| t-char | ±5% (according to selected curve) |
| t-reset (Reset Mode = t-delay) | ±1% or ±10 ms |

| Overcurrent Protection Elements: I[x] with selected Measuring method = I2 (Negative phase sequence current) | Accuracy ^{*3)} |
|--|--|
| I> | ±2% of the setting value or ±1% I _n |
| Dropout Ratio | 97% or 0.5% I _n |
| t | DEFT ±1% or ±10 ms |
| Operating Time At testing current ≥ 2 times pickup value | <60ms |
| Disengaging Time | <45ms |

- *1) When RMS is selected and |f - fn| > 5Hz: operating and disengaging time < 4 cycles.
 If f < 30Hz, pickup accuracy ±6% of the setting value or 5% I_n.
- *2) For directional elements, accuracy of MTA: ±3° at I > 20% I_n.
- *3) works only in frequency range |f - fn| < 5Hz.

| Ground Current Elements: IG[x] | Accuracy ^{*1) *2) *3)} |
|--|--|
| IG> | ±1.5% of the setting value or ±1% I _n |
| Dropout Ratio | 97% or 0.5% x I _n |
| t | DEFT ±1% or ±10 ms |
| Operating time Starting from IG higher than 1.2 x IG> | <45ms |
| Disengaging Time | <55ms |
| t-char | ±5% (according to selected curve) |
| t-reset (Reset Mode = t-delay) | ±1% or ±10 ms |
| VE> | ±1.5% of the setting value or ±1% V _n |
| Dropout Ratio | 97% or 0.5% V _n |

- *1) When RMS is selected and |f - fn| > 5Hz: operating and disengaging time < 4 cycles.
 If f < 30Hz, pickup accuracy < ±6% of the setting value or 5% I_n.
- *2) For directional elements, accuracy of MTA: ±3° at IG > 20% I_n.
- *3) For earth current sensitive the precision does not depend on the nominal value but is referenced to 100 mA (with I_n = 1 A) respectively 500 mA (with I_n = 5 A)

NOTICE

Because detection of direction is based on DFT values, direction elements works only in nominal range ($f_N \pm 5\text{Hz}$).

| Phase Directional Sensitivity: I[x] | Value | Release Level | Blocking Level |
|--|--------------|----------------------|-----------------------|
| I - V (3-phases) | I V | 10 mA 0.35 V | 5 mA 0.25 V |

| Ground Directional Sensitivity: IG[x] | Value | Release Level | Blocking Level |
|--|--------------------------------------|-------------------------|--------------------------|
| IG meas - 3V0 | IG meas IG (sensitive) 3V0 | 10 mA 1 mA 0.35 V | 5 mA 0.5 mA 0.25 V |
| IG calc - 3V0 | IG calc 3V0 | 18 mA 1 V | 11 mA 0.8 V |
| IG calc - Ipol (IG meas) | IG calc IG meas IG (sensitive) | 18 mA 10 mA 1 mA | 11 mA 5 mA 0.5 mA |
| IG meas - Neg, IG calc - Neg | I2 V2 | 10 mA 0.35 V | 5 mA 0.25 V |

| Thermal Replica: ThR | Accuracy |
|---------------------------------|---|
| Ib | $\pm 2\%$ of the setting value or 1% In |
| Alarm ThR | $\pm 1.5\%$ of the setting value |

| Inrush Supervision: IH2 | Accuracy |
|------------------------------------|-----------------------|
| IH2/IH1 | $\pm 1\%$ In |
| Dropout Ratio | 5% IH2 or 1% In |
| Operating Time | <30 ms ^{*1)} |

*1) Inrush supervision is possible, if the fundamental Harmonic (IH1) > 0.1 In and 2nd Harmonic (IH2) > 0.01 In.

| Current unbalance: I2>[x] | Accuracy ^{*1)} |
|---|---|
| I2> | $\pm 2\%$ of the setting value or 1% In |
| Dropout Ratio | 97% or 0.5% x In |
| %(I2/I1) | $\pm 1\%$ |
| t | DEFT $\pm 1\%$ or ± 10 ms |
| Operating Time | <70 ms |
| Disengaging Time | <50 ms |
| K | $\pm 5\%$ INV |
| T-cool | $\pm 5\%$ INV |

*1) Negative-sequence current I2 must be $\geq 0.01 \times I_n$, I1 must be $\geq 0.1 \times I_n$.

| Voltage Protection: V[x] | Accuracy ^{*1)} |
|---|---|
| Pickup | ±1.5% of the setting value or 1% Vn |
| Dropout Ratio | 97% or 0.5% Vn for V> 103% or 0.5% Vn for V< |
| t | DEFT ±1% or ±10 ms |
| Operating Time Starting from V higher than 1.2 x pickup value for V> or V lower than 0.8 x pickup value for V< | <40 ms 35 ms typically |
| Disengaging Time | <45 ms |

| Residual Voltage Protection: VG[x] | Accuracy ^{*1)} |
|---|---|
| Pickup | ±1.5% of the setting value or 1% Vn |
| Dropout Ratio | 97% or 0.5% Vn for VG> 103% or 0.5% Vn for VG< |
| t | DEFT ±1% or ±10 ms |
| Operating Time Starting from V higher than 1.2 x pickup value for VG> or V lower than 0.8 x pickup value for VG< | <40 ms 35 ms typically |
| Disengaging Time | <45 ms |

*1) When RMS is selected and $|f - fn| > 5\text{Hz}$: operating and disengaging time < 4 cycles or ±1%.
If $f < 30\text{Hz}$, pickup accuracy < ±6% of the setting value or 5% Vn.

| Low Voltage Ride Through Protection: LVRT | Accuracy ^{*1)} |
|--|-------------------------------------|
| Voltage Pickup (Start) | ±1.5% of the setting value or 1% Vn |
| Voltage Dropout Ratio (Recover) | Adjustable, at least 0.5% Vn |
| Tripping time delay | ±1% from settings or ±10 ms |
| Operating Time Starting from V lower than 0.9 x pickup value | <35 ms |
| Disengaging Time | <45 ms |

*1) When RMS is selected and $|f - fn| > 5\text{Hz}$: operating and disengaging time < 4 cycles or ±1%.
If $f < 30\text{Hz}$, pickup accuracy < ±6% of the setting value or 5% Vn.

| Voltage unbalance: V012[x] | Accuracy ^{*1)} |
|---------------------------------------|--|
| Threshold | ±2% of the setting value or 1% Vn |
| Dropout Ratio | 97% or 0.5% x Vn for V1> or V2> 103% or 0.5% x Vn for V1< |
| %(V2/V1) | ±1% |
| t | DEFT ±1% or ±10 ms |
| Operating Time | <60 ms |
| Disengaging Time | <45 ms |

*1) Negative-sequence voltage V2 must be $\geq 0.01 \times Vn$, V1 must be $\geq 0.1 \times Vn$.

| Over Frequency Protection: f>[x] | Accuracy ^{*1)} |
|--|---|
| f> | ±10 mHz at fn |
| Dropout | < 0.05% fn |
| t | ±1% or ±10 ms |
| Operating time Starting from f higher than f> + 0.02 Hz + 0.1 Hz + 2.0 Hz | <100 ms typically 70 ms typically 50 ms |
| Disengaging time | <120 ms |

| Under Frequency Protection: f<[x] | Accuracy ^{*1)} |
|---|---|
| f< | ±10 mHz at fn |
| Dropout | < 0.05% fn |
| t | ±1% or ±10 ms |
| Operating time Starting from f lower than f< - 0.02 Hz - 0.1 Hz - 2.0 Hz | <100 ms typically 70 ms typically 50 ms |
| Disengaging time | <120 ms |
| V Block f | ±1.5% of the setting value or 1% Vn |
| Dropout ratio | 103% or 0.5% Vn |

*1) Accuracy is given for rated frequency fn±10%.

| Rate of Change of Frequency: df/dt | Accuracy ^{*1)} |
|--|---|
| df/dt | ±0.1 Hz/s ²⁾ |
| t | ±1% or ±10 ms |
| Operating time Starting from fn and df/dt > pickup + 0.1 Hz/s At df/dt > 2 times pickup At df/dt > 5 times pickup | <200 ms typically <100 ms typically < 70 ms |
| Disengaging time | <120 ms |

*1) Accuracy is given for rated frequency fn±10%.

*2) 10% additional tolerance per Hz deviation from nominal frequency fn (e.g. at 45Hz, tolerance is 0.15Hz/s).

| Rate of Change of Frequency: DF/DT | Accuracy |
|---|-----------------|
| DF | ±20 mHz at fn |
| DT | ±1% or ±10 ms |

| Vector surge: delta phi | Accuracy |
|--|----------------------------|
| delta phi | ±0.5° [1-30°] at Vn and fn |
| Operating time | <40 ms |

| Power Factor: PF[x] | Accuracy |
|--------------------------------------|--------------------------|
| Trigger-PF | ± 0.01 (absolute) or ±1° |
| Reset-PF | ± 0.01 (absolute) or ±1° |
| t-trip | ±1% or ±10 ms |
| Operating time | ^{*1)} |
| Measuring Method = Fundamental | <130 ms |
| Measuring Method = True RMS | <200 ms |

*1) The calculation of the Power Factor will be available 300 ms after the required measuring values (I > 2.5% In and V > 20% Vn) have

Specifications

energized the measuring inputs.

| Directional Power Protection: PQS[x] with Mode = S> or S< | Accuracy ^{*1)} ^{*2)} |
|--|---|
| Threshold | ±3% or ±0.1% Sn |
| Dropout Ratio | 97% or 1 VA for S> 103% or 1 VA for S< |
| t | ±1% or ±10 ms |
| Operating time | 75 ms |
| Disengaging time | 100 ms |

| Directional Power Protection: PQS[x] with Mode = P> P< or Pr>/Pr< | Accuracy ^{*1)} ^{*2)} |
|--|---|
| Threshold | ±3% or ±0.1% Sn |
| Dropout Ratio | 97% or 1 VA for P> and Pr> 103% or 1 VA for P< and Pr< for setting values ≤ 0.1 Sn: 58% or 0.5 VA for P> and Pr> 142% or 0.5 VA for P< and Pr< for setting values ≤ 0.01 Sn 58% or 0.2 VA for P> and Pr> 142% or 0.2 VA for P< and Pr< |
| t | ±1% or ±10 ms |
| Operating time | 75 ms |
| Disengaging time | 100 ms |

| Directional Power Protection: PQS[x] with Mode = Q>/Q< or Qr>/Qr< | Accuracy ^{*1)} ^{*2)} |
|--|---|
| Threshold | ±3% or ±0.1% Sn |
| Dropout Ratio | 97% or 1 VA for Q> and Qr> 103% or 1 VA for Q< and Qr< for setting values ≤ 0.1 Sn: 58% or 0.5 VA for Q> and Qr> 142% or 0.5 VA for Q< and Qr< for setting values ≤ 0.01 Sn 58% or 0.2 VA for Q> and Qr> 142% or 0.2 VA for Q< and Qr< |
| t | ±1% or ±10 ms |
| Operating time | 75 ms |
| Disengaging time | 100 ms |

*1) Common reference conditions: at |PF|>0.5, symmetrically fed, at fn and 0.8 - 1.3 x Vn (Vn=100V)

*2) If RMS is selected and |f - fn| > 5Hz: operating and disengaging time < 6 cycles or ±1%.

If f < 30Hz, pickup accuracy < ±6% of the setting value or 5% Sn. Q[x] protection elements may be blocked if |f - fn| > 5Hz.

If DFT is selected protection elements are blocked if |f - fn| > 5Hz

| Auto Reclosing: AR | Accuracy |
|-------------------------------|-----------------|
| t (all timers) | ±1% or ±20 ms |

| Sync-Check: Sync | Accuracy |
|--------------------------------|-------------------------------------|
| Voltage measurement | ±1.5% of the setting value or 1% Vn |
| Slip Frequency measurement | ±20 mHz at fn |
| Angle measurement | ±2° |
| Angle Compensation measurement | ±4° |
| t (all timers) | ±1% or ±10 ms |

| Q->&V< / Decoupling | Tolerance |
|--------------------------------------|--------------------------------------|
| I min QV | ±1.5% of the setting value or ±1% In |
| Dropout Ratio | 95% or 0.5% In |
| VLL< QV | ±1,5% of the setting value or ±1% Vn |
| Dropout Ratio | 102% or 0.5% Vn |
| Phi-Power | ±1° |
| Q min QV | ±3% of the setting value or ±0.1% Sn |
| Dropout Ratio | 95% |
| t1-QV | ±1% or ±10 ms |
| t2-QV | ±1% or ±10 ms |
| Operating Time | <40 ms |
| Disengaging Time | <40 ms |

| ReCon / Reconnection | Tolerance |
|-----------------------------|---|
| VLL-Release | ±1.5% of the setting value or ±1% Vn |
| Dropout Ratio | 98% or 0.5% Vn for VLL> 102% or 0.5% Vn for VLL< |
| f | ±20 mHz at fn |
| Dropout | < 0.05% fn |
| t-Release | ±1% or ±10 ms |
| Operating Time | <100 ms |

| UFLS | Tolerance |
|------------------|---|
| I min | ±1.5% of the setting value or ±1% In |
| Dropout Ratio | 95% or 0.5% In |
| V min | ±1.5% of the setting value or ±1% Vn |
| Dropout Ratio | 98% or 0.5% Vn |
| Phi-Power | ±2° |
| P min | ±5% of the setting value or ±0.1% Sn |
| Dropout Ratio | 95% or 0.5 W |
| f< | ±10 mHz at fn |
| Dropout | < 0.05% fn |
| t-UFLS | ±1% or ±10 ms |
| Operating time | Starting from f lower than f< - 0.02 Hz <100 ms - 0.1 Hz typically 70 ms - 2.0 Hz typically 50 ms |
| Disengaging time | <120 ms |

| Switch onto Fault: SOTF | Accuracy |
|------------------------------------|-------------------------------------|
| Operating time | <35 ms |
| I< | ±1.5% of the setting value or 1% In |
| t-enable | ±1% or ±10 ms |

| Cold Load Pickup: CLPU | Accuracy |
|-----------------------------------|-------------------------------------|
| Threshold | ±1.5% of the setting value or 1% In |
| Operating time | <35 ms |
| I< | ±1.5% of the setting value or 1% In |
| t-Load OFF | ±1% or ±15 ms |
| t-Max Block | ±1% or ±15 ms |
| Settle Time | ±1% or ±15 ms |

| Circuit Breaker Failure Protection: CBF | Accuracy |
|--|-------------------------------------|
| I-CBF> | ±1.5% of the setting value or 1% In |
| t-CBF | ±1% or ±10 ms |
| Operating Time Starting from I Higher than 1.3 x I-CBF> | <40 ms |
| Disengaging Time | <40 ms |

| Trip Circuit Supervision: TCS | Accuracy |
|--|-----------------|
| t-TCS | ±1% or ±10 ms |

| Current Transformer Supervision: CTS | Accuracy |
|---|-------------------------------------|
| ΔI | ±2% of the setting value or 1.5% In |
| Dropout Ratio | 94% |
| Alarm delay | ±1% or ± 10 ms |

| Loss of Potential: LOP | Accuracy |
|-----------------------------------|-----------------|
| t-Pickup | ±1% or ±10 ms |

Abbreviations, and Acronyms

The following abbreviations and acronyms are used in this manual.

| | |
|------------|--|
| °C | Degrees Celsius |
| °F | Degrees Fahrenheit |
| A | Ampere(s), Amp(s) |
| AC | Alternating current |
| Ack. | Acknowledge |
| AND | Logical gate (The output becomes true if all Input signals are true.) |
| ANSI | American National Standards Institute |
| avg. | Average |
| AWG | American wire gauge |
| BF | Circuit breaker failure |
| Bkr | Breaker |
| Blo | Blocking(s) |
| BO | Binary output relay |
| BO1 | 1st binary output relay |
| BO2 | 2nd binary output relay |
| BO3 | 3rd binary output relay |
| calc | Calculated |
| CB | Circuit breaker |
| CBF | Module Circuit Breaker Failure protection |
| CD | Compact disk |
| Char | Curve shape |
| CLPU | Cold Load Pickup Module |
| Cmd. | Command |
| CMN | Common input |
| COM | Common input |
| Comm | Communication |
| Cr. | Counter(s) |
| CSA | Canadian Standards Association |
| CT | Control transformer |
| Ctrl. | Control |
| CTS | Current Transformer Supervision |
| CTS | Current transformer supervision |
| d | Day |
| D-Sub-Plug | Communication interface |
| DC | Direct current |
| DEFT | Definite time characteristic (Tripping time does not depend on the height of the current.) |
| delta phi | Vector surge |
| df/dt | Rate-of-frequency-change |
| DI | Digital Input |
| Diagn Cr | Diagnosis counter(s) |
| Diagn. | Diagnosis |

Abbreviations, and Acronyms

| | |
|-----------------|--|
| DIN | Deutsche Industrie Norm |
| dir | Directional |
| EINV | Extremely inverse tripping characteristic |
| EMC | Electromagnetic compatibility |
| EN | Europäische Norm |
| err. / Err. | Error |
| EVTcon | Parameter determines if the residual voltage is measured or calculated. |
| Ex | External |
| Ex Oil Temp | External Oil Temperature |
| ExBlo | External blocking(s) |
| ExP | External Protection - Module |
| ExP | External protection |
| Ext Sudd Press | Sudden Pressure |
| Ext Temp Superv | External Temperature Supervision |
| f | Frequency Protection Module |
| Fc | Function (Enable or disable functionality = allow or disallow.) |
| FIFO | First in first out |
| FIFO Principal | First in first out |
| fund | Fundamental (ground wave) |
| gn | Acceleration of the earth in vertical direction (9.81 m/s ²) |
| GND | Ground |
| h | Hour |
| HMI | Human machine interface (Front of the protective relay) |
| HTL | Manufacturer internal product designation |
| Hz | Hertz |
| I | Phase Overcurrent Stage |
| I | Fault current |
| I | Current |
| I-BF | Tripping threshold |
| I0 | Zero current (symmetrical components) |
| I1 | Positive sequence current (symmetrical components) |
| I2 | Negative sequence current (symmetrical components) |
| I2> | Unbalanced Load-Stage |
| I2T | Thermal Characteristic |
| I4T | Thermal Characteristic |
| IA | Phase A current |
| IB | Phase B current |
| IC | Phase C current |
| IC's | Manufacturer internal product designation |
| Id | Differential Protection Module |
| IdG | Restricted Ground Fault Differential Protection Module |
| IdGH | Restricted Ground Fault Highset Protection Module |
| IdH | High-Set Differential Protection Module |
| IEC | International Electrotechnical Commission |
| IEC61850 | IEC61850 |

Abbreviations, and Acronyms

| | |
|---------------|--|
| IEEE | Institute of Electrical and Electronics Engineers |
| IG | Earth current protection - Stage |
| IG | Ground current |
| IG | Fault current |
| IGNom | Nominal ground current |
| IH1 | 1st harmonic |
| IH2 | Module Inrush |
| IH2 | 2nd harmonic |
| in. | Inch |
| incl. | Include, including |
| InEn | Inadvertent Energization |
| Info. | Information |
| Interl. | Interlocking |
| Intertripping | Intertripping |
| INV | Inverse characteristic (The tripping time will be calculated depending on the height of the current) |
| IR | Calculated ground current |
| IRIG | Input for time synchronization (Clock) |
| IRIG-B | IRIG-B-Module |
| IT | Thermal Characteristic |
| IX | 4th measuring input of the current measuring assembly group (either ground or neutral current) |
| J | Joule |
| kg | Kilogram |
| kHz | Kilohertz |
| kV | Kilovolt(s) |
| kVdc or kVDC | Kilovolt(s) direct current |
| I/In | Ratio of current to nominal current. |
| L1 | Phase A |
| L2 | Phase B |
| L3 | Phase C |
| lb-in | Pound-inch |
| LED | Light emitting diode |
| LINV | Long time inverse tripping characteristic |
| LoE-Z1 | Loss of Excitation |
| LoE-Z2 | Loss of Excitation |
| Logics | Logic |
| LOP | Loss of Potential |
| LV | Low voltage |
| LVRT | Low Voltage Ride Through |
| m | Meter |
| mA | Milliampere(s), Milliamp(s) |
| man. | Manual |
| max. | Maximum |
| meas | Measured |
| min. | Minimum |

Abbreviations, and Acronyms

| | |
|--------------|---|
| min. | Minute |
| MINV | Moderately Inverse Tripping Characteristic |
| MK | Manufacturer Internal Product Designation Code |
| mm | Millimeter |
| MMU | Memory mapping unit |
| ms | Milli-second(s) |
| MV | Medium voltage |
| mVA | Milli volt amperes (Power) |
| N.C. | Not connected |
| N.O. | Normal open (Contact) |
| NINV | Normal inverse tripping characteristic |
| Nm | Newton-meter |
| No | Number |
| Nom. | Nominal |
| NT | Manufacturer internal product designation code |
| P | Reverse Active Power |
| Para. | Parameter |
| PC | Personal computer |
| PCB | Printed circuit board |
| PE | Protected Earth |
| p.u. | per unit |
| PF | Power Factor - Module |
| Ph | Phase |
| PQS | Power Protection - Module |
| pri | Primary |
| PROT or Prot | Protection Module (Master Module) |
| PS1 | Parameter set 1 |
| PS2 | Parameter set 2 |
| PS3 | Parameter set 3 |
| PS4 | Parameter set 4 |
| PSet | Parameter set |
| PSS | Parameter set switch (Switching from one parameter set to another) |
| Q | Reverse Reactive Power |
| Q->&V< | Undervoltage and Reactive Power Direction Protection |
| R | Reset |
| rec. | Record |
| rel | Relative |
| res | Reset |
| ResetFct | Reset function |
| RevData | Review data |
| RMS | Root mean square |
| Rst | Reset |
| RTD | Temperature Protection Module |
| s | Second |
| SC | Supervision Contact (Synonyms: Life-Contact, Watchdog, State of Health Contact) |

| | |
|------------|---|
| Sca | SCADA |
| SCADA | Communication module |
| sec | Second(s) |
| sec | Secondary |
| Sgen | Sine wave generator |
| Sig. | Signal |
| SNTP | SNTP-Module |
| SOTF | Switch Onto Fault - Module |
| StartFct | Start function |
| Sum | Summation |
| SW | Software |
| Sync | Synchrocheck |
| Sys. | System |
| t | Tripping delay |
| t or t. | Time |
| Tcmd | Trip command |
| TCP/IP | Communication protocol |
| TCS | Trip circuit supervision |
| ThR | Thermal replica module |
| TI | Manufacturer internal product designation code |
| TripCmd | Trip command |
| txt | Text |
| UL | Underwriters Laboratories |
| UMZ | DEFT (definite time tripping characteristic) |
| USB | Universal serial bus |
| V | Voltage-stage |
| V | Volts |
| V/f> | Overexcitation |
| V012 | Symmetrical Components: Supervision of the Positive Phase Sequence or Negative Phase Sequence |
| Vac / V ac | Volts alternating current |
| Vdc / V dc | Volts direct current |
| VDE | Verband Deutscher Elektrotechnik |
| VDEW | Verband der Elektrizitätswirtschaft |
| VE | Residual voltage |
| VG | Residual voltage-Stage |
| VINV | Very inverse tripping characteristic |
| VTS | Voltage transformer supervision |
| W | Watt(s) |
| WDC | Watch dog contact (supervision contact) |
| www | World wide web |
| XCT | 4th current measuring input (ground or neutral current) |
| XInv | Inverse characteristic |

List of ANSI Codes

| ANSI | Functions |
|-------|---|
| 14 | Underspeed |
| 24 | Overexcitation Protection (Volts per Hertz) |
| 25 | Synchronizing or Synchronism-check via 4 th measuring channel of voltage measurement card |
| 26 | Temperature Protection |
| 27 | Undervoltage Protection |
| 27(t) | Undervoltage (time dependent) Protection |
| 27A | Undervoltage Protection (Auxiliar) via 4 th measuring channel of voltage measurement card |
| 27N | Neutral Undervoltage via 4 th measuring channel of voltage measurement card |
| 27TN | Third Harmonic Neutral Undervoltage via 4 th measuring channel of voltage measurement card |
| 32 | Directional Power Protection |
| 32F | Forward Power Protection |
| 32R | Reverse Power Protection |
| 37 | Undercurrent / Under Power |
| 38 | Temperature Protection (optional via Interface/external Box) |
| 40 | Loss of Excitation / Loss of Field |
| 46 | Unbalanced Current Protection |
| 46G | Unbalanced Generator Current Protection |
| 47 | Unbalanced Voltage Protection |
| 48 | Incomplete Sequence (Start-up time Supervision) |
| 49 | Thermal Protection |
| 49M | Thermal Motor Protection |
| 49R | Thermal Rotor Protection |
| 49S | Thermal Stator Protection |
| 50BF | Breaker Failure |
| 50 | Overcurrent (instantaneous) |
| 50P | Phase Overcurrent (instantaneous) |
| 50N | Neutral Overcurrent (instantaneous) |
| 50Ns | Sensitive Neutral Overcurrent (instantaneous) |
| 51 | Overcurrent |
| 51P | Phase Overcurrent |
| 51N | Neutral Overcurrent |
| 51Ns | Sensitive Neutral Overcurrent |
| 51LR | Locked Rotor |
| 51LRS | Locked Rotor Start (during start sequence) |
| 51C | Voltage Controlled Overcurrent (via adaptive Parameters) |
| 51Q | Negative Phase Sequence Overcurrent (multiple trip characteristics) |
| 51V | Voltage Restrained Overcurrent |
| 55 | Power Factor Protection |
| 56 | Field Application Relay |
| 59 | Overvoltage Protection |
| 59TN | Third Harmonic Neutral Overvoltage via 4 th measuring channel of voltage measurement card |
| 59A | Overvoltage Protection via 4 th (Auxiliar) measuring channel of voltage measurement card |
| 59N | Neutral Overvoltage Protection |
| 60FL | Voltage Transformer Supervision |
| 60L | Current Transformer Supervision |
| 64R | Rotor Earth Fault Protection |
| 64REF | Restricted Ground Fault Protection |
| 66 | Starts per h (Start Inhibit) |
| 67 | Directional Overcurrent |

| ANSI | Functions |
|-------------|--|
| 67N | Directional Neutral Overcurrent |
| 67Ns | Sensitive Directional Neutral Overcurrent |
| 74TC | Trip Circuit Supervision |
| 78V | Vector Surge Protection |
| 79 | Auto Reclosure |
| 81 | Frequency Protection |
| 81U | Underfrequency Protection |
| 81O | Overfrequency Protection |
| 81R | ROCOF (df/dt) |
| 86 | Lock Out |
| 87B | Busbar Differential Protection |
| 87G | Generator Differential Protection |
| 87GP | Generator Phase Differential Protection |
| 87GN | Generator Ground Differential Protection |
| 87M | Motor Differential Protection |
| 87T | Transformer Differential Protection |
| 87TP | Transformer Phase Differential Protection |
| 87TN | Transformer Ground Differential Protection |
| 87U | Unit Differential Protection (protected zone includes generator and step-up transformer) |
| 87UP | Unit Phase Differential Protection (protected zone includes generator and step-up transformer) |

We appreciate your comments about the content of our publications.

Please send comments to: kemp.doc@woodward.com

Please include the manual number from the front cover of this publication.

Woodward Kempen GmbH reserves the right to update any portion of this publication at any time. Information provided by Woodward Kempen GmbH is believed to be correct and reliable. However, Woodward Kempen GmbH assumes no responsibility unless otherwise expressly undertaken.

This is the original manual (source).

© Woodward Kempen GmbH , all rights reserved



Woodward Kempen GmbH

Krefelder Weg 47 · D – 47906 Kempen (Germany)
Postfach 10 07 55 (P.O.Box) · D – 47884 Kempen (Germany)
Phone: +49 (0) 21 52 145 1

Internet

www.woodward.com

Sales

Phone: +49 (0) 21 52 145 331 or +49 (0) 711 789 54 510
Fax: +49 (0) 21 52 145 354 or +49 (0) 711 789 54 101
e-mail: SalesPGD_EUROPE@woodward.com

Service

Phone: +49 (0) 21 52 145 600 · Telefax: +49 (0) 21 52 145 455
e-mail: SupportPGD_Europe@woodward.com