

ASSEMBLY INSTRUCTIONS AND INSTALLATION GUIDE

System Line
→ HighPROTEC

PROTECTION TECHNOLOGY
MADE SIMPLE

CSP2-F → MCA4

RETROFIT KIT FOR THE REPLACEMENT OF SYSTEM LINE DEVICES
BY HIGHPROTEC DEVICES

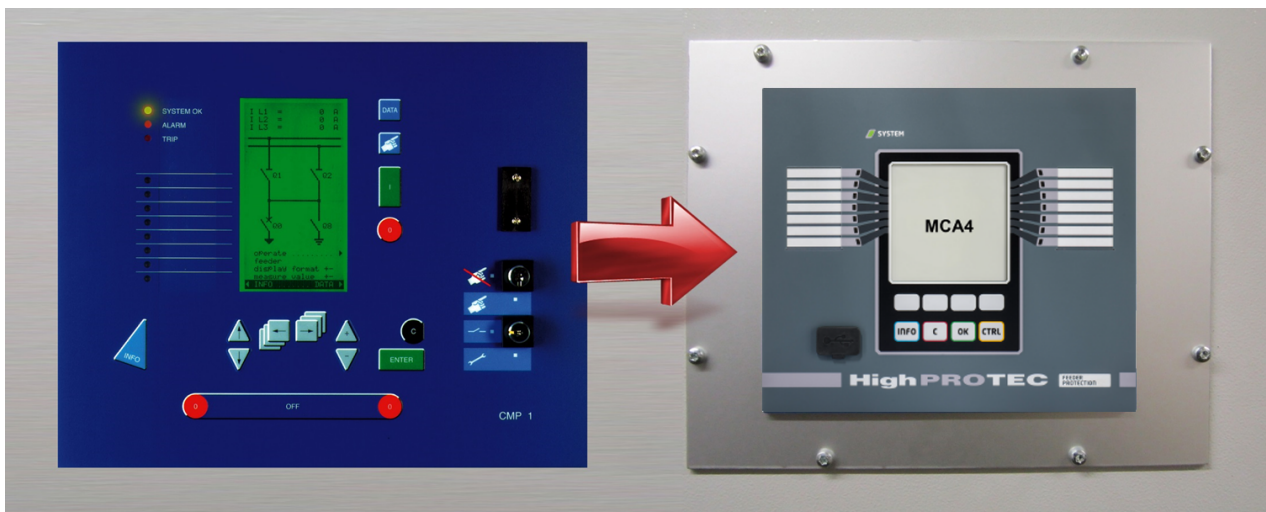

RETROFIT KIT FOR THE REPLACEMENT OF SYSTEM LINE DEVICES BY HIGHPROTEC DEVICES

Original document
English

Revision: A

General

The following notes/warnings can be used in this document:

DANGER



"DANGER" indicates a dangerous situation which, if not avoided, will result in death or serious injury.

WARNING



"WARNING" indicates a dangerous situation which, if not avoided, could result in death or serious injury.

CAUTION



"CAUTION" with a warning symbol indicates a dangerous situation which, if not avoided, may result in moderate or minor injury.

NOTE



"NOTE" is used to highlight information that is not related to injury.

WARNUNGRNING



Only to be carried out by qualified personnel!

If the devices are operated by inadequately qualified personnel, there is a justified risk that health and/or devices will be dramatically damaged!

All activities marked in this way must be carried out by appropriately qualified personnel.

Requirements

This product manual assumes that System Line devices be replaced by HighPROTEC devices.

WARNING



Please read the present application description and all other publications that need to be consulted for working with this product (especially for installation, operation or maintenance). Observe all applicable safety regulations and warnings.

Failure to follow the instructions may result in personal injury and/or damage to the product.

Any unauthorized modification or use of this device beyond the specified mechanical, electrical or other operating limits may result in personal injury and/or damage to the product.

Any such unauthorized modification constitutes "misuse" and/or "negligence" in the sense of the warranty for the product; this excludes the warranty for the coverage of possible damages resulting therefrom, and cancels product certifications and/or listings.

CAUTION



This document may have been revised or updated since this copy was made. To ensure that you have the latest revision, please refer to the download area of SEG Electronics GmbH:

<https://docs.SEGelectronics.de/csp>

General Information

Retrofit-kit for the replacement of a System Line device by a HighPROTEC device.

- As the CSP System Line series of protection and control devices has been phased out, it is now necessary to replace them with new protection and control devices if necessary.
- SEG Electronics GmbH provides a retrofit-kit with which the devices of the System-Line can be exchanged for devices of the HighPROTEC with minimum effort. The existing control cabinet door can still be used. No need to saw a new door cutout. There is no need to drill a hole for fixing.
- Where it is not possible to take over certain functions by simply setting the parameters, appropriate logic blocks can be used and parameterised in the HighPROTEC series.
- The HighPROTEC devices offer more communication options, protection and monitoring functions at a significantly lower price.
- In addition, these devices offer more possibilities for error analysis (disturbance recorders).

NOTICE



The CSP2 has several control outputs with separate power circuit for direct control of switching devices. These are no longer available with HighPROTEC devices. Therefore, check whether the output relays of the HighPROTEC are designed for this current load (see "DOK-HB-MCA4-2E" manual >> Technical Data) or whether additional coupling relays may have to be used.

Procedure Before Starting the Remodeling on Site:

- The mechanical possibilities (space; sufficient installation depth) must also be checked before remodeling!
- Define communication protocol.
- Determine the distance of the entire cable section.
- Wiring diagrams must be adapted.
- The parameterization must be created for the new protective device.
- The secondary inspection must be planned after the remodeling has been completed.

Hardware – Structure of Terminal Strips CSP2-F

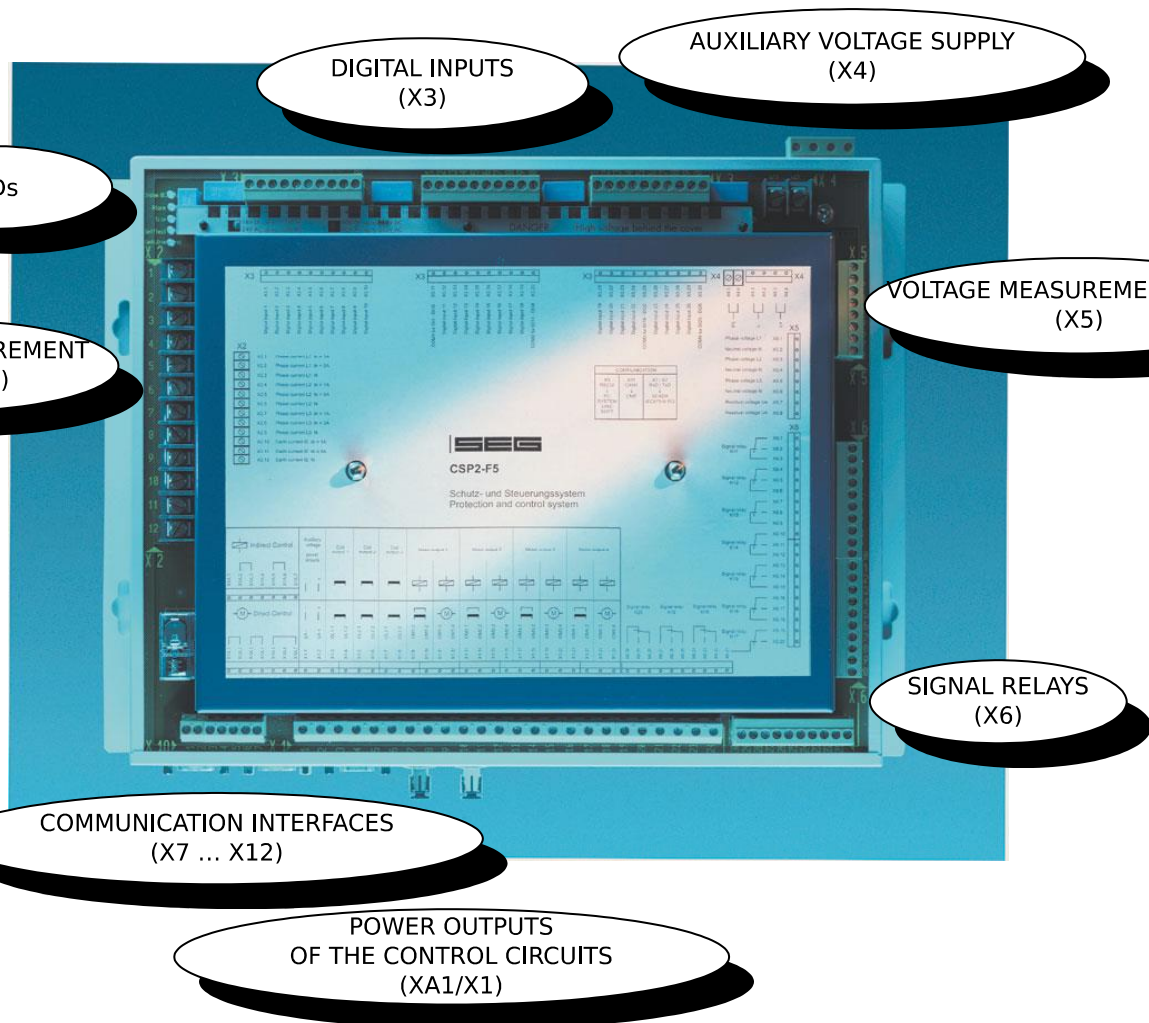

Hardware – Structure of Terminal Strips MCA4

The figure shows a possible example variant, the available variants are shown in the order code ("Typecode MCA4", see page 15).

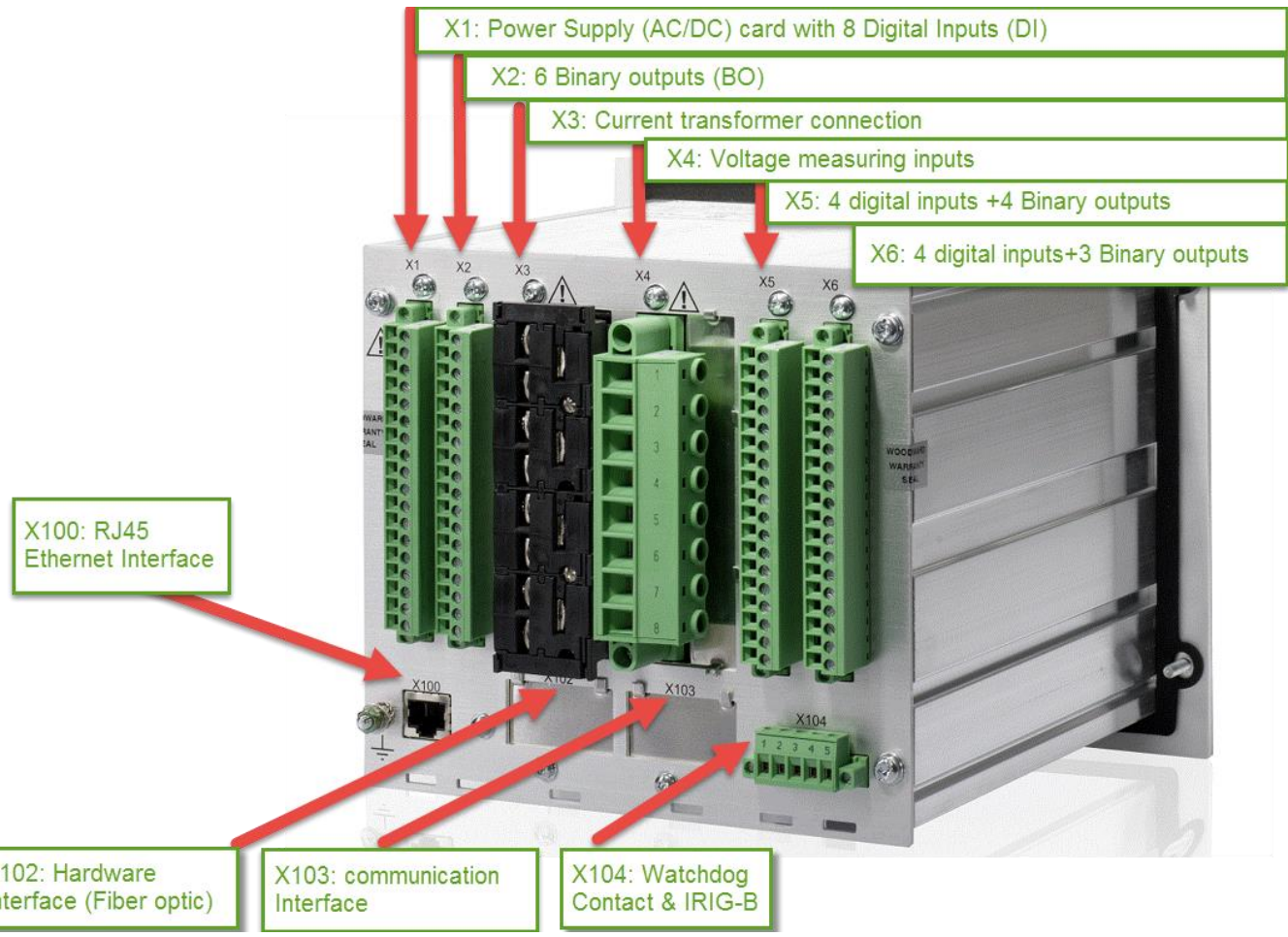

Overview of the Terminal Strip Assignment for the CSP2-F >>> MCA4

CSP2-F >>> MCA4	terminal strip CSP2-F	terminal strip MCA4
Power supply	X4	X1
Digital Inputs (DI)	X3	X1 / X5 / X6
Signalling relay (BO)	X6	X2 / X5 / X6
Phase current measurement	X2	X3
Phase voltage measurement	X5	X4
Self-monitoring	X6 / Relais K11	X104
IRIG-B	X15	X104
Control interface	X9 / X10 / X11	X103
Optical fiber interface	X7	X102
Ethernet-(RJ45-)interface	N/A	X100
Grounding / PE	X4	X1
Power outputs (control circuits)	XA1 / X1	N/A (see the note in section "General Information", page 4)

Overview Device Software CSP2-F >>> MCA4

- The CSP2-F works with the System Line software, the MCA4 works with the *Smart view* software. Although these are two different user programs, care has been taken to ensure that the structure tree is basically structured in the same way.
- Simple parameterization of the new MCA4 protective devices.

The image displays two software windows side-by-side, illustrating the parameterization of MCA4 protective devices.

System Line - Field settings (Left Window):

- Tree view: CSP2 -F3 V03.00.00/0000 > System parameter > Field settings (selected).
- Table: System parameter set

Parameter	Value
fn	50 Hz
CT prim	350 A
CT sec	1 A
CT dir	0°
ECT prim	350 A
ECT sec	1 A
ECT dir	0°
VT prim	10000 V
VT sec	100 V
VT con	Y
VT loc	Busbar
EVT con	broken DELTA
EVT prim	10000 V
EVT sec	100 V

Smart view (Right Window):

- Tree view: MCA4 > Field Para (selected).
- Field Para/CT Table:

Name	Value	Unit
CT pri	350	A
CT sec	1	A
CT dir	0	°
ECT pri	350	A
ECT sec	1	A
ECT dir	0	°

- Field Para/VT Table:

Name	Value	Unit
VT pri	10000	V
VT sec	100	V
VT con	Phase to Ground	
EVT pri	10000	V
EVT sec	100	V
V Sync	L12	
delta phi - Mode	two phases	

What Has to be Taken into Account During the Remodeling on Site:

1. Disassembly of the CSP2-F

- Label the plugs of the CSP2-F and the plugs (base unit >mounting plate). This helps to assign the connectors later.
- Only remove the individual cables from the plug/terminal strip after checking with a continuity tester that you have removed the correct cable.
- Remove the CSP2-F from the mounting plate.



2. Disassembly of the Control Unit CMP1

- Remove the CAN bus cable from the control unit.
- Remove the power supply/grounding cable.
- Remove the control unit from the control cabinet door.



3. Fasten the Adapter Plate

- Fasten the adapter plate in the control cabinet door using the washers and screws supplied.
No drilling or sawing required!
(See the dimension drawing on the next page.)

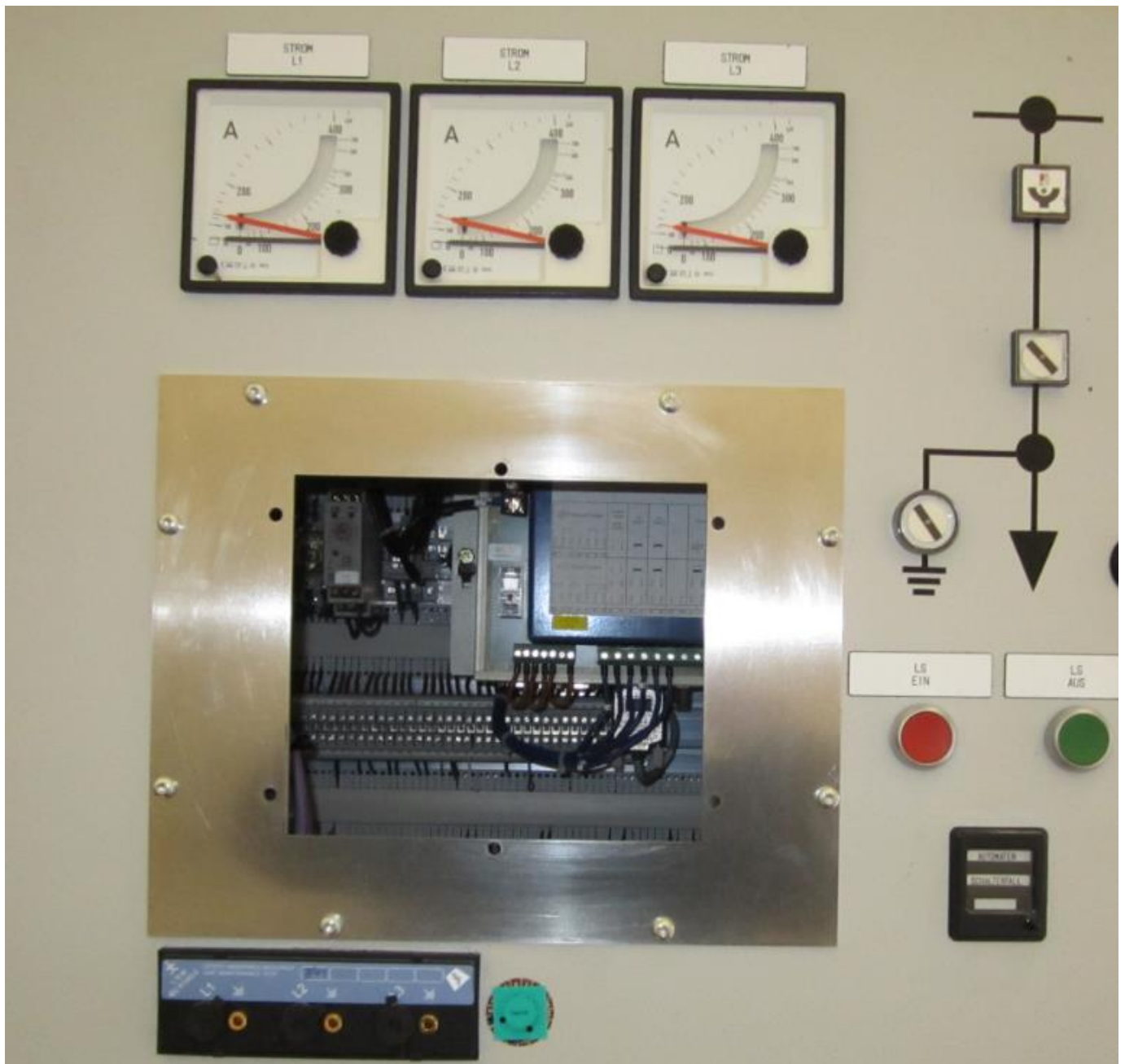

Adapter Plate HPT

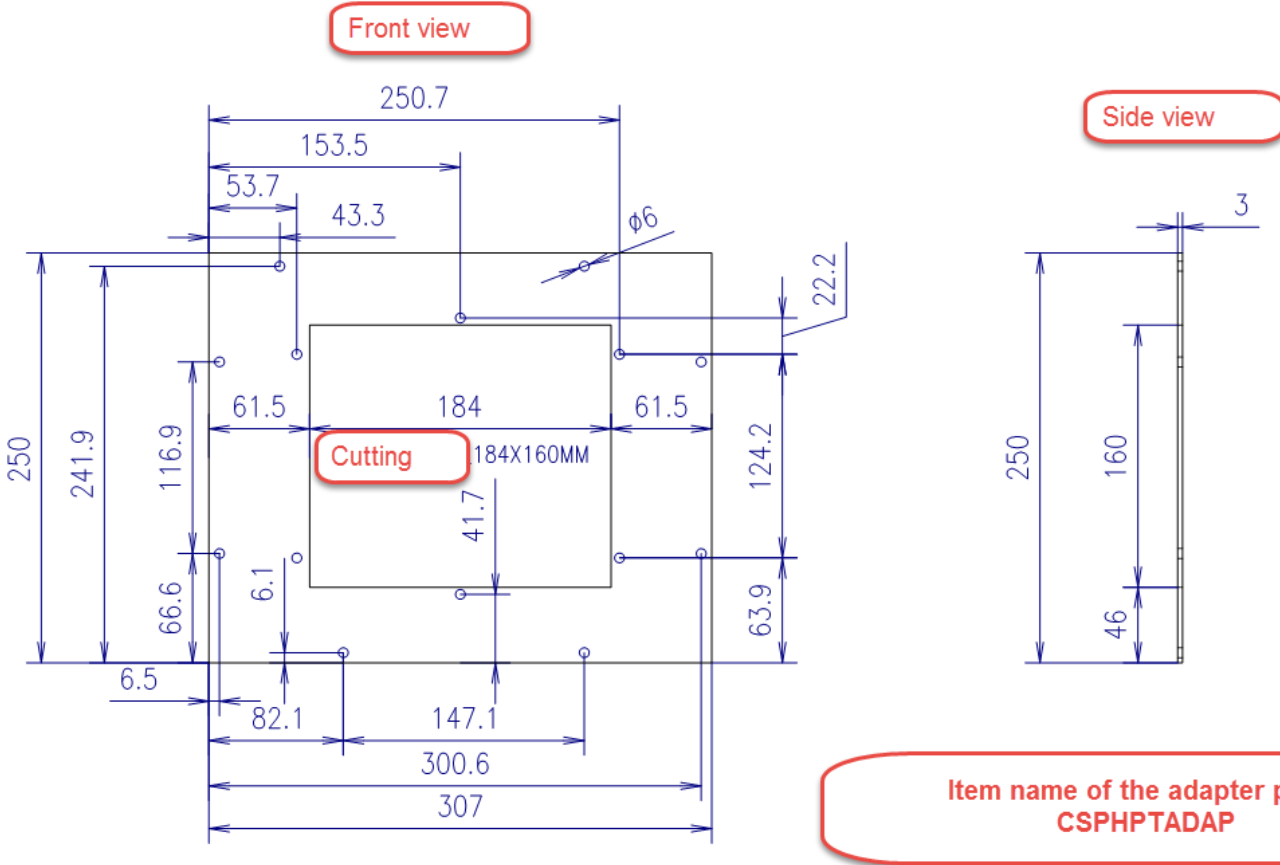

Item name of the adapter plate:
CSPHPTADAP

**Catalog- / article identifier of the adapter plate:
CSPHPTADAP**

4. Assembly of the HighPROTEC Device

- Push the HighPROTEC device into the cover frame.
- Then screw the device to the control cabinet door using the supplied screw-nuts.



Wiring of the HighPROTEC device (1)

- Check whether the cross-section of the cable duct is sufficient. As a rule, a larger cable duct is recommended.
- Start the rewiring on the door side (device side). The cables of each module should be connected to a string by cable ties. The strings must be clearly marked.
- Install an additional empty conduit so that the complete wire harness can be safely routed into the medium voltage cell.
- Feed the cable harnesses through the empty conduits into the MS cell.

Wiring of the HighPROTEC device (2)

- Connect the wires to the corresponding terminal strips (according to the circuit diagram).
- To avoid possible wiring errors, check the correct cable occupation with a continuity tester.

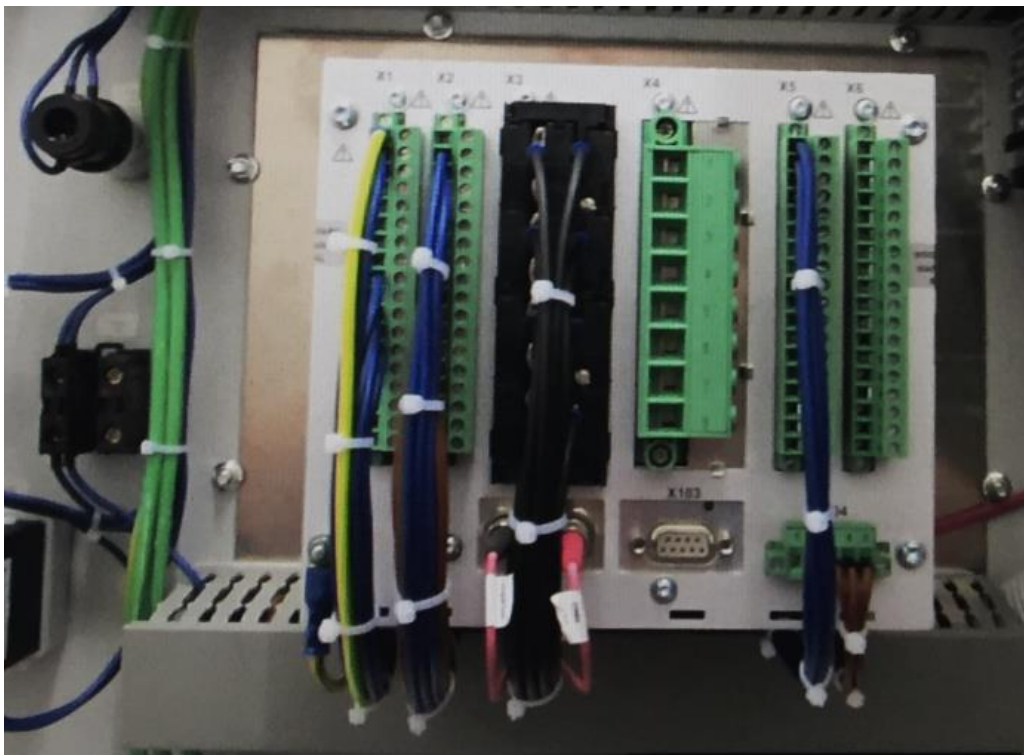

5. Commissioning and Protection Test of the System Must be Carried out by a Commissioning Engineer

NOTICEHINWEIS



SEG Electronics GmbH can take over the commissioning and protection testing for your system.

Please contact the SEG Electronics GmbH service team if required.

All functions of the CSP2-F can be easily covered by the HighPROTEC MCA4.

- Where it is not possible to take over certain functions by simply setting the parameters, corresponding logic modules can be used and parameterised in the HighPROTEC series.
- Otherwise it is important to adjust the number of inputs and outputs of the old wiring with the new devices. For example, the complete System Line devices had a very large number of digital inputs.
- These can be covered by selecting the appropriate hardware variant of the MCA4. Note that some information is no longer exchanged via digital inputs, but via communication protocols (e.g. IEC 61850).

DANGER



Dangerous voltages!

Observe the usual protective measures, legal regulations and local guidelines.

Especially before any work:

- Unlock
- Secure against being switched on again
- Check that there is no voltage
- Grounding and short-circuiting
- Cover or isolate adjacent live parts.

NOTICE



When selecting the appropriate device type for the MCA4, ensure a sufficient number of digital inputs/outputs.

Typecode MCA4 (for Release 3.7)

Directional Feeder Protection

MCA4	#	#	#	#	#	#
Hardware version						
Hardware version 2, USB Mini B connector at the front plate	-2					
Optional Hardware Extension 1						
8 digital inputs 7 binary output relays voltage transformer inputs (0 ... 800 VAC)						A
16 digital inputs 13 binary output relays voltage transformer inputs (0 ... 800 VAC)						D
24 digital inputs 20 binary output relays voltage transformer inputs (0 ... 300 VAC)						E
16 digital inputs 14 binary output relays 2 Analog Inputs 2 Analog Outputs voltage transformer inputs (0 ... 800 VAC)						F
Optional Hardware Extension 2						
Phase Current 5A/1A, Ground Current 5A/1A						0
Phase Current 5A/1A, Sensitive Ground Current 5A/1A						1
Mounting form						
Housing suitable for door mounting						A
Housing suitable for 19" rack mounting						B
Communication						
Without communication protocol						A
RS 485: Modbus RTU IEC 60870-5-103 DNP3 RTU						B
Ethernet: Modbus TCP DNP3 UDP/TCP IEC 60870-5-104						C
Fiber Optics: Profibus-DP						D
D-SUB: Profibus-DP						E
Fiber Optics: Modbus RTU IEC 60870-5-103 DNP3 RTU						F
RS 485/D-SUB: Modbus RTU IEC 60870-5-103 DNP3 RTU						G
Ethernet: IEC 61850 Modbus TCP DNP3 UDP/TCP IEC 60870-5-104						H
RS 485, Ethernet: Modbus TCP/RTU IEC 60870-5-103 IEC 60870-5-104 DNP3 UDP/TCP/RTU						I
Ethernet/Fiber Optics: IEC 61850 Modbus TCP DNP3 UDP/TCP IEC 60870-5-104						K
Ethernet/Fiber Optics: Modbus TCP DNP3 UDP/TCP IEC 60870-5-104						L
RS 485, Ethernet: IEC 61850 Modbus TCP/RTU IEC 60870-5-103 IEC 60870-5-104 DNP3 UDP/TCP/RTU						T
Printed Circuit Board						
Standard						A
Printed circuit boards are conformal coated						B

Back View MCA4 (for an example typecode)

MCA4-2D0ACA

(example device variant)

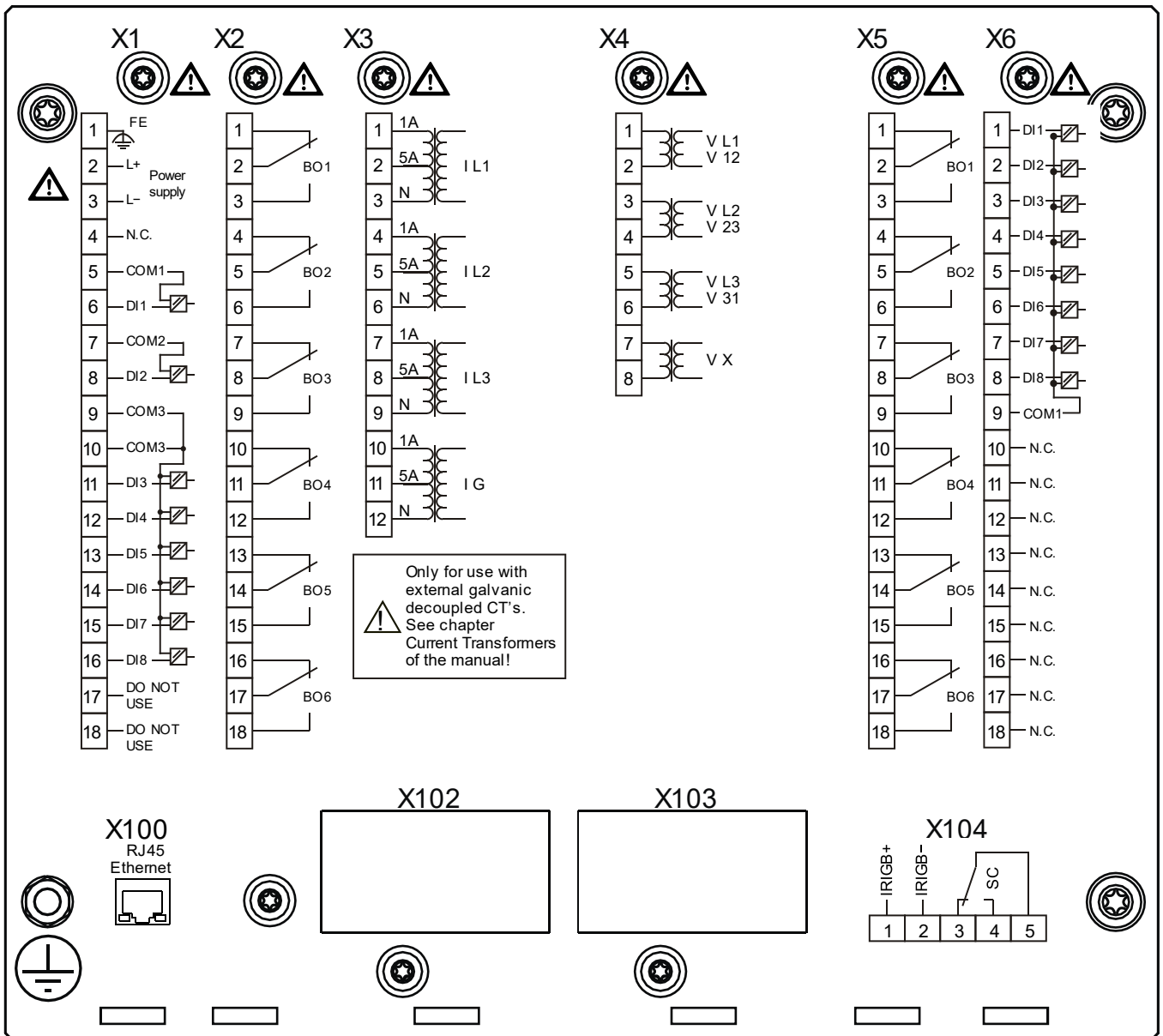

Back View CSP2-F

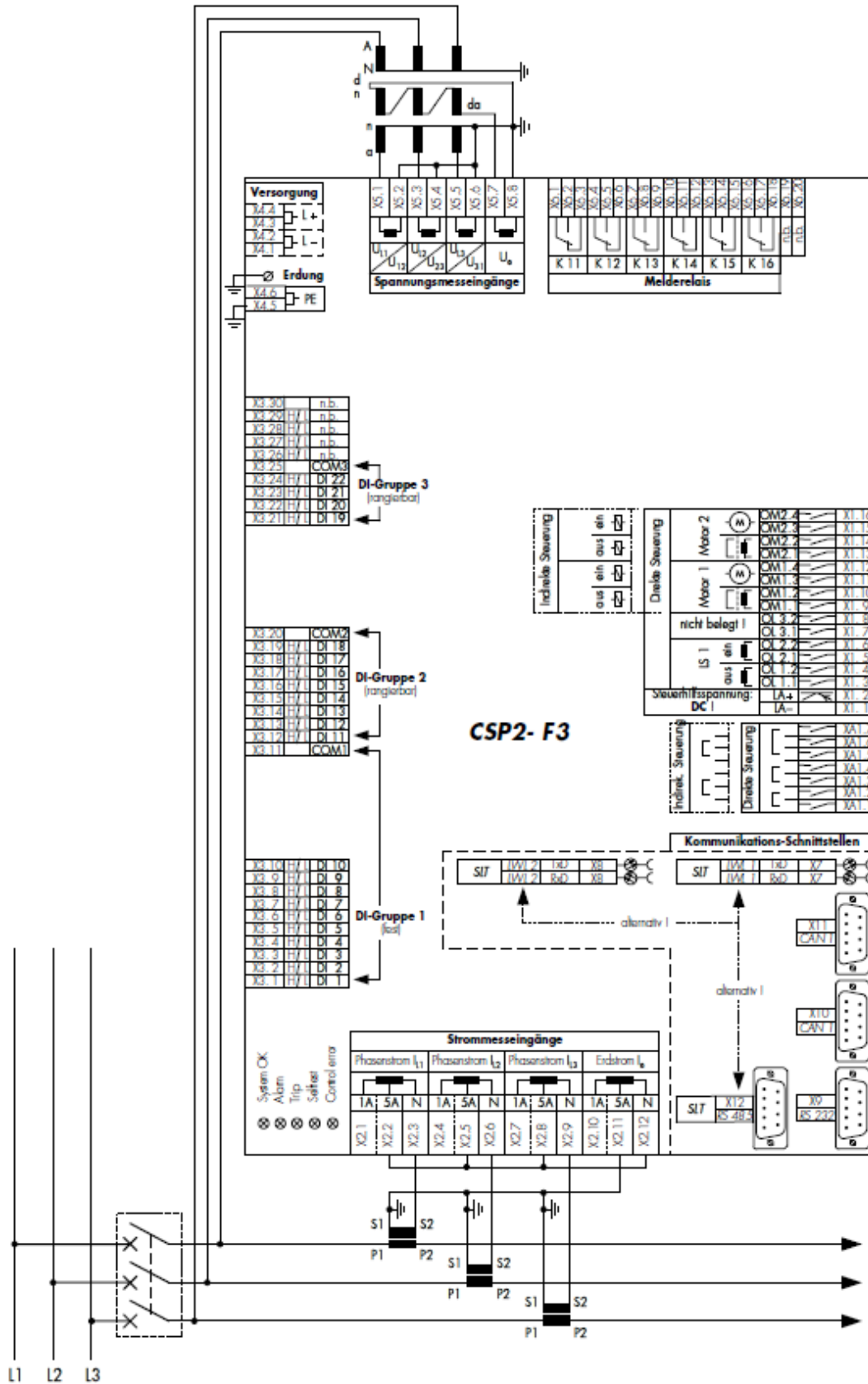

Photos from Practice

System in original condition - exterior view



View of the cable bushing (before)



System Line CMP1 operating unit dismantled

Main unit CSP2-F System Line dismantled



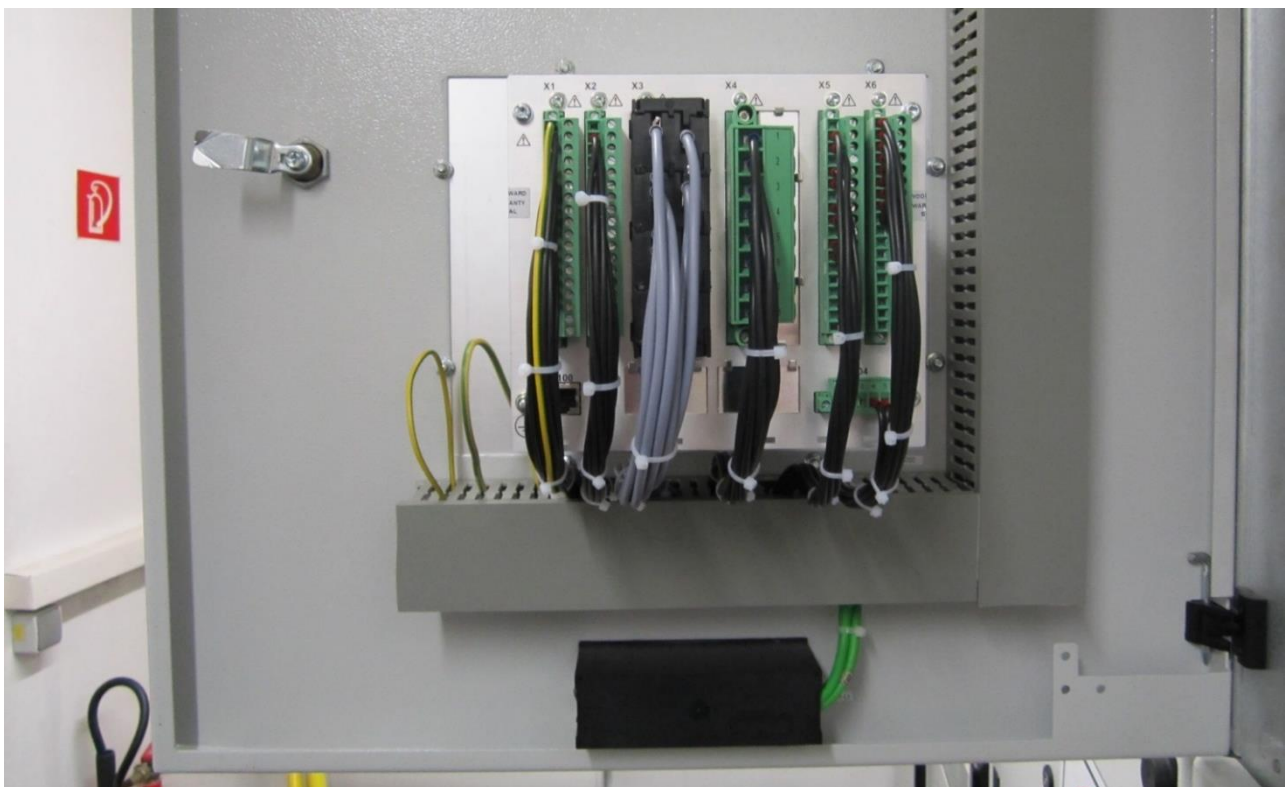

System Line → HighPROTEC

<https://docs.SEGelectronics.de/csp>



SEG Electronics GmbH reserves the right to update any portion of this publication at any time. Information provided by SEG Electronics GmbH is believed to be correct and reliable. However, SEG Electronics GmbH assumes no responsibility unless otherwise expressly undertaken.



SEG Electronics GmbH
Krefelder Weg 47 • D-47906 Kempen (Germany)
Postfach 10 07 55 (P.O.Box) • D-47884 Kempen (Germany)
Telephone: +49 (0) 21 52 145 1

Internet: www.SEGelectronics.de

Sales
Telephone: +49 (0) 21 52 145 331
Fax: +49 (0) 21 52 145 354
E-mail: info@SEGelectronics.de

Service
Telephone: +49 (0) 21 52 145 614
Fax: +49 (0) 21 52 145 354
E-mail: info@SEGelectronics.de

Complete address / phone / fax / email information for all locations is available on our website.