

MANUAL

Professional Line | PROTECTION TECHNOLOGY
MADE SIMPLE

XI11 | TIME OVERCURRENT RELAY



TIME OVERCURRENT RELAY

Original document

English

Revision: C

**SEG Electronics GmbH reserves the right to update any portion of this publication at any time.
Information provided by SEG Electronics GmbH is believed to be correct and reliable.
However, no responsibility is assumed by SEG Electronics GmbH unless otherwise expressly undertaken.**

© SEG Electronics GmbH 2022

Contents

1. Applications and features	4
2. Design	5
3. Function.....	6
3.1 Requirements for the main current transformers	6
4. Operation and settings	7
4.1 Setting of DIP-switches	8
4.2 Communication via serial interface adapter XRS1	10
5. Relay case and technical data	11
5.1 Relay case.....	11
5.2 Technical data	12
5.3 Definite time overcurrent protection	14
5.4 Inverse time overcurrent protection	14
5.5 Tripping characteristics	15
6. Order form	17

1. Applications and features

As an universal time overcurrent protection, the XI1-I relay of the PROFESSIONAL LINE is generally used in radial and meshed systems. Among other, it is applied as:

- selective overload and short-circuit protection relay for electr. machines, lines and networks or for
- load dependent connection and disconnection of consumers and electric power generators.

It is possible to select from the following tripping characteristics:

- Definite time overcurrent protection (DMT)
- Inverse time overcurrent protection (IDMT) with selectable tripping characteristics
 - Normal Inverse
 - Very Inverse
 - Extremely Inverse

Furthermore, the XI1-I can be employed as a back-up protection for differential and distance protection relays.

When compared to the conventional protection equipment all relays of the PROFESSIONAL LINE reflect the superiority of digital protection techniques with the following features:

- High measuring accuracy by digital data processing
- Fault indication via LEDs
- Extremely wide operating ranges of the supply voltage by universal wide-range power supply
- Very fine graded wide setting ranges
- Data exchange with process management system by serial interface adapter XRS1 which can be retrofitted
- RMS measurement
- Extremely short response time
- Compact design by SMD-technology

2. Design

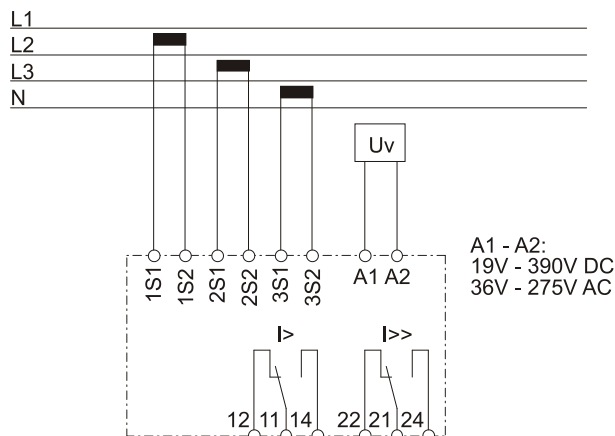

Figure 2.1: Connections

Analog inputs

The analog input signals are connected to the protection device via terminals 1S1 - 1S2, 2S1 - 2S2 and 3S1 - 3S2.

Auxiliary voltage supply

Unit XI1 needs a separate auxiliary voltage supply. Therefore a DC or AC voltage must be used. Unit XI1 has an integrated wide range power supply. Voltages in the range from 19 - 390 V DC or 36 - 275 V AC can be applied at connection terminals A1 and A2.

Contact positions

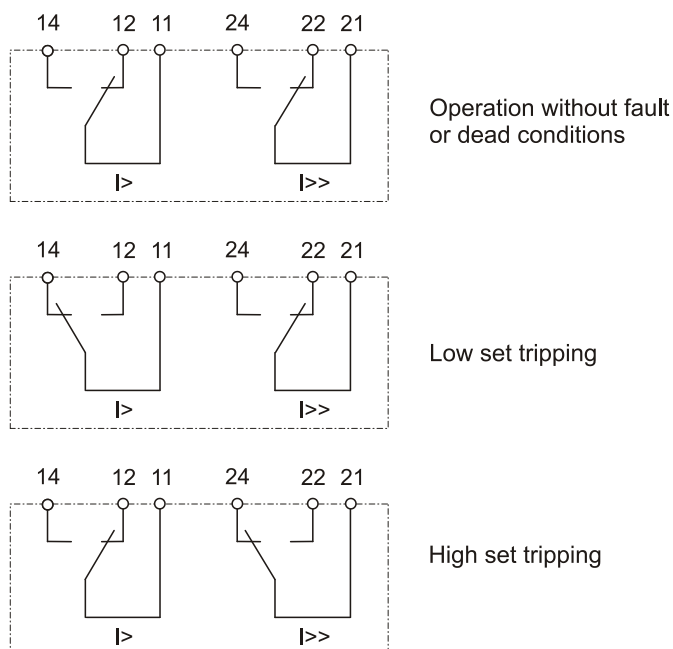

Figure 2.2: Contact positions of the output relays

Note:

In case of both the tripping contacts of I> and I>> should cause the tripping coil of the C.B. to trip, they have to be interconnected.

3. Function

The incoming currents from the main current transformers of the protected objects are converted to voltage signals in proportion to the currents via the input transformers and burden. The noise signals caused by inductive and capacitive coupling are suppressed by an analog R-C filter circuit. The analog voltage signals are fed to the A/D-converter of the microprocessor and transformed to digital signals through Sample and Hold circuits. All the processing is carried out on these digitized values. The measuring values are detected with a sampling frequency of 800 Hz (960 Hz), and a sampling rate of 1.25 ms (1.11 ms) for each measurement (at 50 Hz (60 Hz)). A pickup of a supervision circuit is indicated by flashing of the corresponding LED. At tripping the flashing light changes to steady light.

3.1 Requirements for the main current transformers

The current transformers have to be rated in such a way, that a saturation should not occur within the following operating current ranges:

Independent time overcurrent function $K1 = 2$

Inverse time overcurrent function $K1 = 20$

High-set function $K1 = 20$

$K1$ = Current factor related to set value with the current transformer not yet operating in the saturation range.

Moreover, the current transformers have to be rated according to the maximum expected short-circuit currents of the network or the object to be protected.

The low consumption of the XI1, i.e. < 0.1 VA has a positive effect on the rating of the current transformers. It implies that, if an electromechanical relay is replaced by XI1, a high accuracy limit factor is automatically obtained by using the same current transformer.

4. Operation and settings

All operating elements needed for setting parameters are located on the front plate of the XI1 as well as all display elements.

Because of this all adjustments of the unit can be made or changed without disconnecting the unit off the DIN-rail.

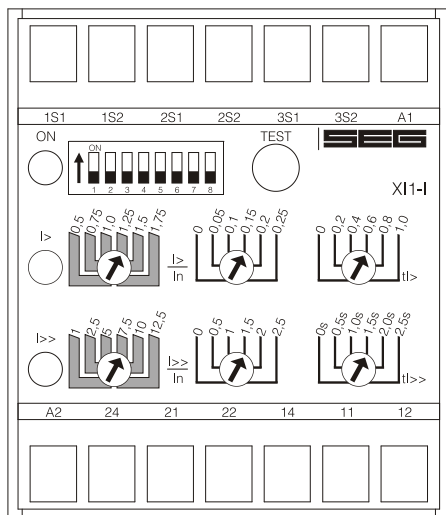

Figure 4.1: Front plate

For adjustment of the unit the transparent cover has to be opened as illustrated. Do not use force! The transparent cover has two inserts for labels.

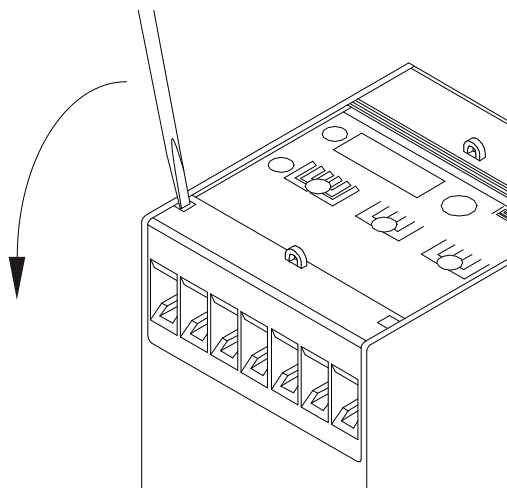

Figure 4.2: How to open the transparent cover

LEDs

LED „ON“ is used for display of the readiness for service (at applied auxiliary voltage U_v). LED I> and I>> signal pickup (flashing) or tripping (steady light) of the corresponding function.

Test push button

This push button is used for test tripping of the unit and when pressed for 5 s a check-up of the hardware takes place. Both output relays are tripped and all tripping LEDs light up.

4.1 Setting of DIP-switches

The DIP-switch block on the front plate of the XI1 is used for adjustment of the nominal values and setting of function parameters:

DIP-switch	OFF	ON	Function
1*	DEFT	NINV	Adjustment of the tripping characteristic
2*	DEFT	VINV	
3*	DEFT	EINV	
4	not blocked	blocked	Blocking of the I> element
5	not blocked	blocked	Blocking of the I>> element
6	50 Hz	60 Hz	Adjustment of the rated frequency
7*	x1 s (x1)	x10 s (x2)	Time multiplier DEFT for tI> (the multipliers for inverse time characteristic are indicated in brackets)
8*	x1 s	x100 s	Time multiplier DEFT for tI>

Table 4.1: Functions of DIP-switches

*Only one of the DIP-switches 1 - 3 or 7 - 8 shall be in „ON“-position at the same time.

Blocking of the low set element (I>)

The low set element can be blocked with the aid of DIP-switch 4 (position „ON“).

Tripping characteristic

The required tripping characteristic for the time over-current protection can be adjusted with the aid of DIP--switches 1 - 3. It must be ensured that only one of the three DIP-switches is switched on. Wrong adjustment (e.g. 2 DIP-switches „ON“) leads to instant tripping.

For the adjustment of the tripping characteristics, the following DIP-switch configurations are allowed:

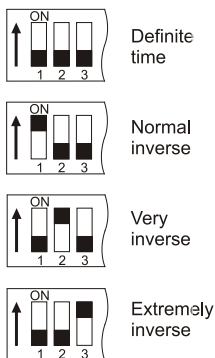

Figure 4.3: Setting the tripping characteristics

Blocking of the high set element (I>>)

When the DIP-switch 5 is in position „ON“, the high set element of the relay is blocked.

Rated frequency

With the aid of DIP-switch 6 the rated frequency can be set to 50 or 60 Hz, depending upon the given mains characteristics.

4.2 Setting of the tripping values

The PROFESSIONAL LINE units have the unique possibility of high accuracy fine adjustments. For this, two potentiometers are used. The course setting potentiometer can be set in discrete steps of 0.25 or 2.5 x I_n . A second fine adjustment potentiometer is then used for continuously variable setting of the final. Adding of the two values results in the precise tripping value.

Low set element

The tripping value can be set in the range from 0.5 - 2 x I_n with the aid of the potentiometer illustrated on the following diagram.

Example:

A tripping value of 1.4 x I_n is to be set. The set value of the right potentiometer is just added to the value of the coarse setting potentiometer. (The arrow of the coarse setting potentiometer must be inside of the marked bar, otherwise no defined setting value).

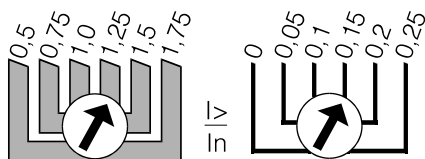

Figure 4.4: Adjustment example

Trip delay for the low set element

The time delay for the low set element (DEFT) can be adjusted in the range from 0 - 100 s. For inverse time characteristics (NINV, VINV or EINV) the time multiplier is adjustable in the range from 0 - 2.

High set element

The high set element can be adjusted in the range from 1 - 15 x I_n . This adjustment is done similar to the low set element adjustment.

Trip delay for high set element

The time delay for the high set element is adjustable in the range from 0 - 2.5 s.

4.2 Communication via serial interface adapter XRS1

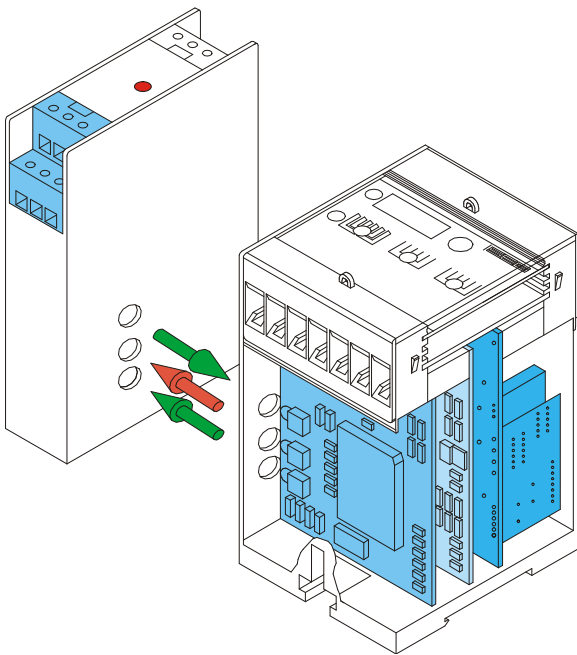

Figure 4.5: Communication principle

For communication of the units among each other and with a superior management system, the interface adapter XRS1 is available for data transmission, including operating software for our relays. This adapter can easily be retrofitted at the side of relay. Screw terminals simplify its installation. Optical transmission of this adapter makes galvanic isolation of the relay possible. Aided by the software, actual measured values can be processed, relay parameters set and protection functions programmed at the output relays. Information about unit XRS1 in de-tail can be taken from the description of this unit.

5. Relay case and technical data

5.1 Relay case

Relay XI1 is designed to be fastened onto a DIN-rail acc. to DIN EN 50022, the same as all units of the PROFESSIONAL LINE.

The front plate of the relay is protected with a sealable transparent cover (IP40).

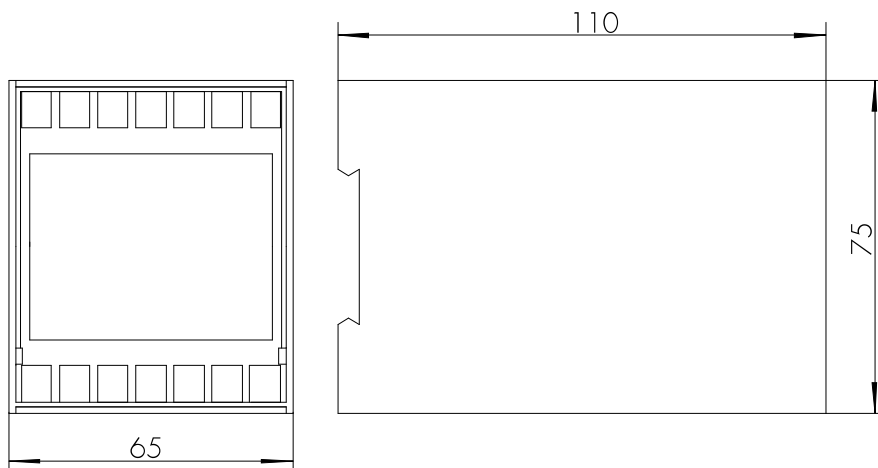

Figure 5.1: Dimensional drawing

Connection terminals

The connection of up to a maximum $2 \times 2.5 \text{ mm}^2$ cross-section conductors is possible. For this the transparent cover of the unit has to be removed (see para. 4).

5.2 Technical data

Measuring input circuits

Rated frequency fn:	50/60 Hz
Thermal withstand capability in current circuits:	dynamic current withstand (half wave) 250 x In for 1 s 100 x In for 10 s 30 x In continuously 4 x In
Power consumption in current circuit	at In = 1 A 0.1 VA at In = 5 A 0.1 VA
Max. 300 V AC against ground (earth)	

Auxiliary voltage

Auxiliary voltage range / Power consumption:	19 - 390 V DC or 36 - 275 V AC (f = 40 - 70 Hz) / 4 W (terminals A1 and A2)
--	--

Common data

Dropout to pickup ratio:	> 97 %
Resetting time from pickup:	<50 ms
Returning time from trip:	200 ms
Minimum initialization time after supply voltage has applied:	100 ms
Minimum response time when supply voltage is available:	50 ms

Output relay

Number of relays:	2
Contacts:	1 changeover contact for each trip relay
Maximum breaking capacity:	ohmic 1250 VA / AC resp. 120 W / DC inductive 500VA / AC resp. 75 W / DC
Max. rated voltage:	250 V AC 220 V DC ohmic load I _{max.} = 0,2 A inductive load I _{max.} = 0,1 A at L/R ≤ 50 ms
Minimum load:	24 V DC inductive load I _{max.} = 5 A 1 W / 1 VA at U _{min} ≥ 10 V
Maximum rated current:	5 A
Making current (16ms):	20 A
Contact life span:	10 ⁵ operations at max. breaking capacity
Contact material:	AgCdO

System data

Design standard:	VDE 0435, VDE 0843 Part 1-4, VDE 0871, EN 50178:1998
Temperature range at storage and operation:	- 25°C to + 70°C
Constant climate class F acc. DIN 40040 and DIN IEC 68, part 2-3:	more than 56 days at 40°C and 95 % relative humidity

High voltage test acc. to VDE 0435, part 303

Voltage test:	2.5 kV (eff.)/50 Hz; 1 min
Surge voltage test:	5 kV; 1.2/50 μs, 0.5 J
High frequency test:	2.5 kV/1 MHz

Electrostatic discharge (ESD)
acc. to IEC 0801, part 2:

8 kV

Radiated electromagnetic field test acc. to IEC 0801, part 3:	10 V/m
Electrical fast transient (burst) acc. to IEC 0801, part 4:	4 kV/2.5kHz, 15 ms
Radio interference suppression test as per DIN 57871 and VDE 0871:	limit value class A
Repeat accuracy:	1 %
Basic time delay accuracy:	0.5 % or ± 25 ms
Basic accuracy of current:	± 3 % of the setting value
Accuracy of time delay in the range of 2 - 20 x I _s :	2 % DEFT/5 % NINV and VINV/7,5 % EINV/or 25 ms
Transient overreach at instantaneous operation:	≤ 5 % Temperature effect: 0.02 % per K
Frequency effect:	0.5 % per K deviation from rated value
Mechanical test:	
Shock:	class 1 acc. to DIN IEC 255-21-2
Vibration:	class 1 acc. to DIN IEC 255-21-1
Degree of protection	
Front plate:	IP40 at closed front cover
Weight:	approx. 0.7 kg
Mounting position:	any
Relay case material:	self-extinguishing

5.3 Definite time overcurrent protection

Parameter	Setting range	Graduation
I>	0.5 - 2 x I _n	Continuously variable
I>>	1 - 15 x I _n	Continuously variable
tI>	0 - 1s/0 - 10s/0 - 100s	Continuously variable
tI>>	0 - 2.5 s	Continuously variable

Table 5.11: Setting ranges and graduation

5.4 Inverse time overcurrent protection

Tripping characteristics according to IEC 255-4 or BS 142

Normal Inverse

$$t = \frac{0.14}{\left(\frac{I}{I_{>}}\right)^{0.02} - 1} \cdot t_I > [s]$$

Very Inverse

$$t = \frac{13.5}{\left(\frac{I}{I_{>}}\right) - 1} \cdot t_I > [s]$$

Extremely Inverse

$$t = \frac{80}{\left(\frac{I}{I_{>}}\right)^2 - 1} \cdot t_I > [s]$$

Where:

t	=	tripping time
tI>	=	time multiplier
I	=	fault current
I>	=	setting value of the current

Parameter	Setting range	Graduation
I>	0.5 - 2 x I _N	Continuously variable
I>>	1 - 15 x I _N	Continuously variable
tI>	0.1 - 2	Continuously variable
tI>>	0 - 2.5 s	Continuously variable

Table 5.2: Setting ranges and graduation

5.5 Tripping characteristics

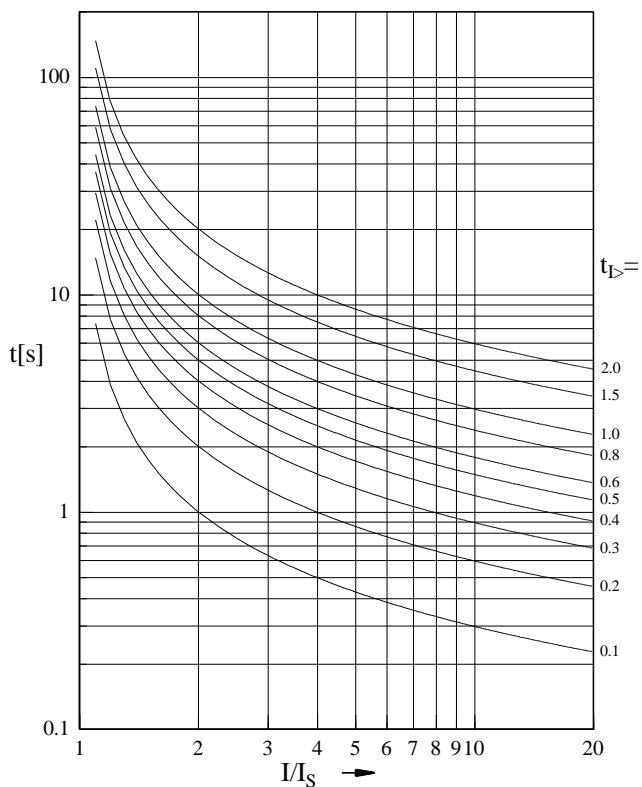

Figure 5.2: Normal inverse

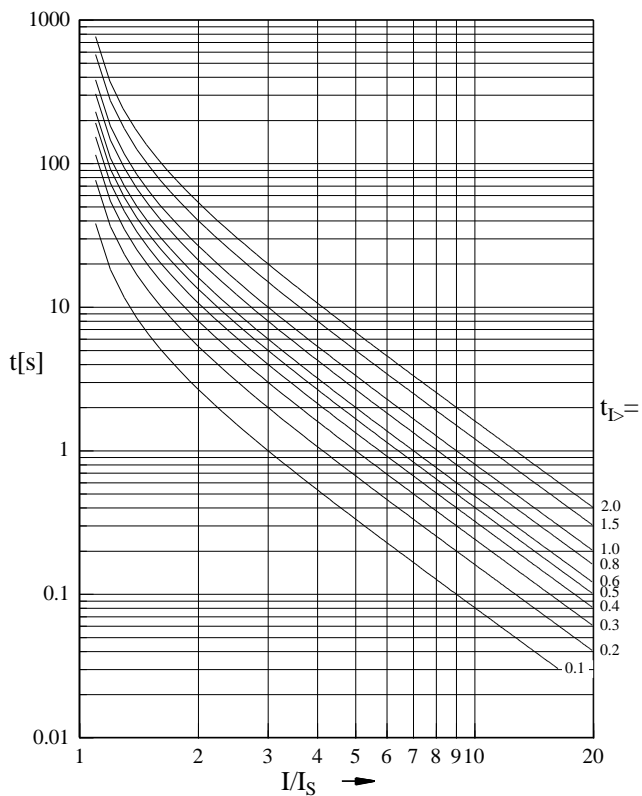

Figure 5.3: Extremely inverse

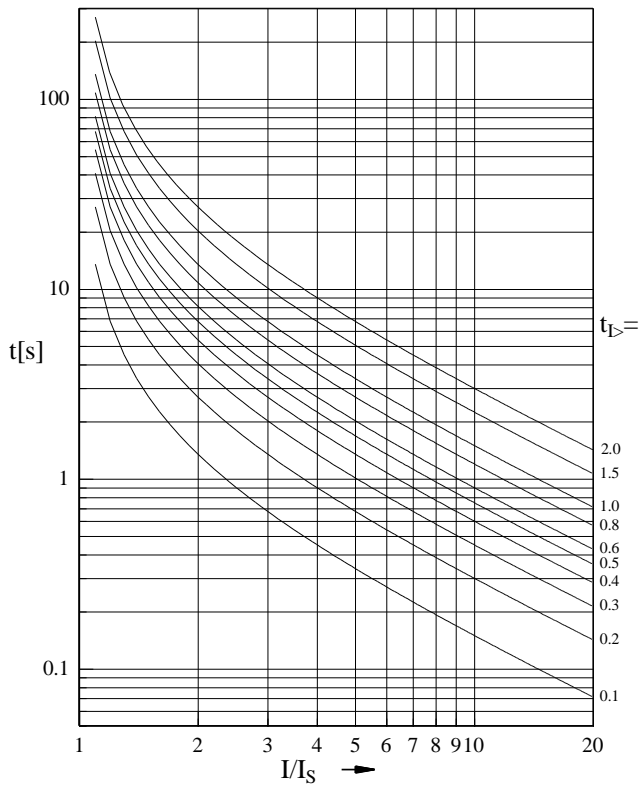

Figure 5.4: Very inverse

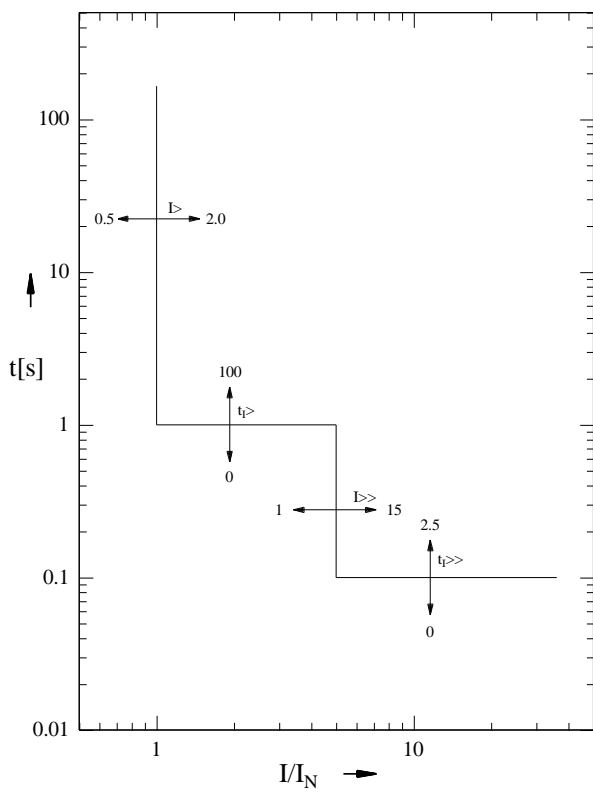

Figure 5.5: Definite time

6. Order form

Time overcurrent relay	<i>XI1-I-</i>	<input type="text"/>
Rated current:	1 A	1
	5 A	5

Technical data subject to change without notice!

Setting-list XI1-I

Project: _____ SEG Electronics GmbH job.-no.: _____

Function group: = _____ Location: + _____ Relay code: - _____

Relay functions: _____ Date: _____

Setting of parameters

Function		Unit	Default settings	Actual settings
I>	Overcurrent low set element	x In	0.5	
I>>	Overcurrent high set element	x In	1	
tI>	Trip delay for overcurrent low set element (DEFT)	s	0	
tI>	Time multiplier for inverse time tripping characteristic			
tI>>	Trip delay for overcurrent set element	s	0	

DIP-switch	Function	Default settings	Actual settings
1*		DEFT	
2*	Adjustment of the tripping characteristic	DEFT	
3*		DEFT	
4	Blocking of the I> element	not blocked	
5	Blocking of the I>> element	not blocked	
6	Adjustment of the rated frequency	50 Hz	
7*	Time multiplier DEFT for tI> (the multipliers for inverse time characteristic are indicated in brackets)	x 1s (x 1)	
8*	Time multiplier DEFT for tI>	x 1s	

*Only one of the DIP-switches 1 - 3 or 7 - 8 shall be in „ON“-position at the same time.

Professional Line

www.SEGelectronics.de

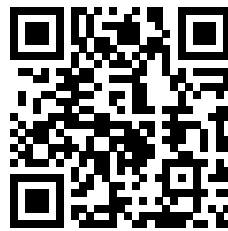

SEG Electronics GmbH reserves the right to update any portion of this publication at any time. Information provided by SEG Electronics GmbH is believed to be correct and reliable. However, SEG Electronics GmbH assumes no responsibility unless otherwise expressly undertaken.



SEG Electronics GmbH
Krefelder Weg 47 • D-47906 Kempen (Germany)
Postfach 10 07 55 (P.O.Box) • D-47884 Kempen (Germany)
Telephone: +49 (0) 21 52 145 1

Internet: www.SEGelectronics.de

Sales
Telephone: +49 (0) 21 52 145 331
Fax: +49 (0) 21 52 145 354
E-mail: info@SEGelectronics.de

Service
Telephone: +49 (0) 21 52 145 600
Fax: +49 (0) 21 52 145 354
E-mail: info@SEGelectronics.de

SEG Electronics has company-owned plants, subsidiaries, and branches, as well as authorized distributors and other authorized service and sales facilities throughout the world.

Complete address / phone / fax / email information for all locations is available on our website.